

TEST REPORTS ON STEREO CARTRIDGES

HiFi/Stereo Review

JULY 1967 • 75 CENTS

Arturo Toscanini: A New Look at the Recorded Legacy
The Basic Repertoire: Forty-seven Best Performances

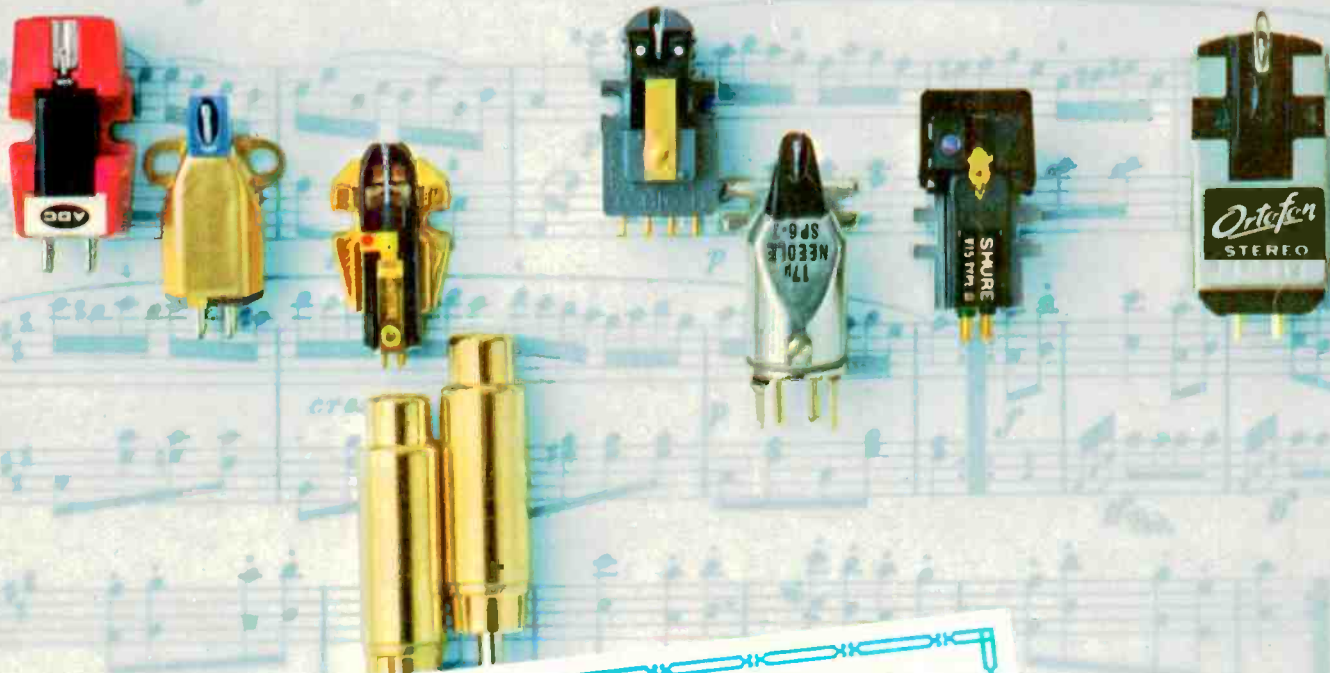

The ninth installment in the series
THE GREAT AMERICAN COMPOSERS

JOHN PHILIP SOUSA

Are you loving your records to death?

Every time you play your favorite record, it dies a little.

The first time you play any record it comes off sounding crisp and clear and beautiful.

The 20th time you play it, it sounds just a wee bit tinny. By the 30th time, you get the vague feeling that the performance was recorded—underwater.

Your record is dead. It's a crime. And Panasonic has solved it.

You'll never again hurt the ones you love. Now with a little bit of effort your records can live forever. They can always sound as clear as the first time you played them. This is because all you'll ever hear is the crisp, clear sound of the first time you played them.

You'll hear them on tape. And all it takes is a Panasonic Tape Deck. The Panasonic RS-766 is a Solid State, 4-track, stereo tape deck that enables you to take full advantage of the sound equipment you presently own.

The RS-766 has a lot of the features that you should look for in a fine quality tape deck. It has three speeds. Record and playback pre-amplifier. Separate record volume controls. Operates vertically or horizontally. It has two VU Meters. A four place reset digital counter. There's also a safety lock which makes it impossible to erase

a tape accidentally. So no matter how clumsy you may be, you won't erase that once-in-a-lifetime collector's record that you loaned to a friend who left the country with it.

What does a Panasonic Tape Deck cost? \$149.95 (suggested list price)... including a solid walnut base. And when you figure out that most fine quality tape decks start at \$200.00, we have a feeling you'll take one look at your fast-aging record collection, and go out and buy yourself a Panasonic Tape Deck, and never again hurt the ones you love.

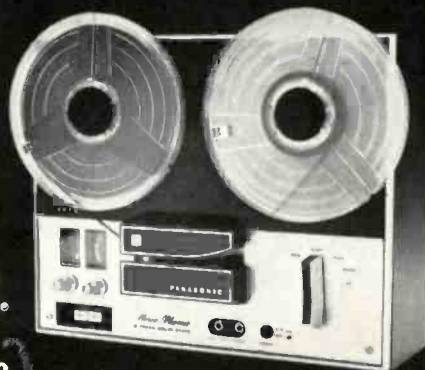

PANASONIC.

200 PARK AVENUE NEW YORK 10017

CIRCLE NO. 36 ON READER SERVICE CARD

GREAT SCOTT...

the stereo compact with component features!

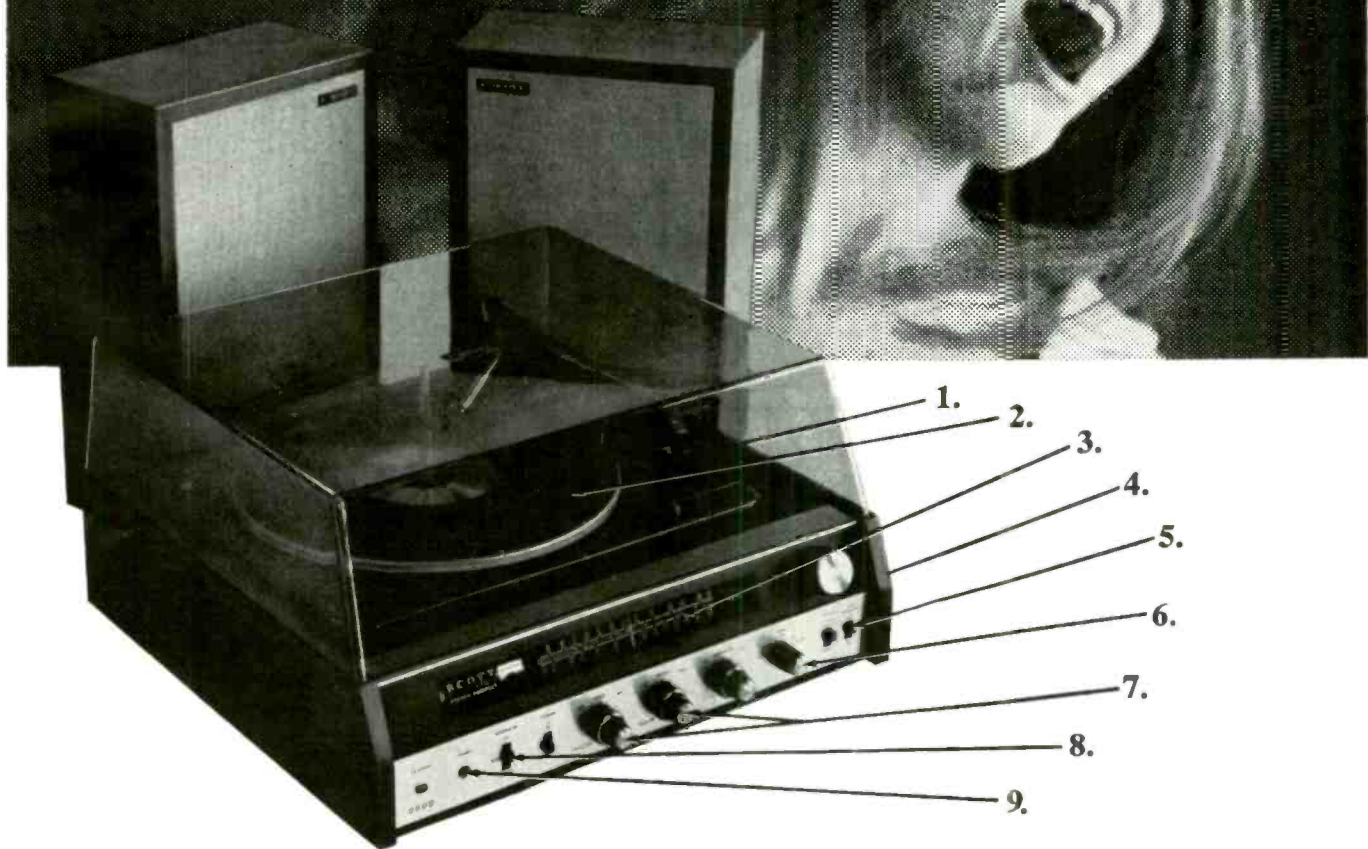

Here's what's happening . . . the only stereo compacts with component circuitry, component features and component sound!

1. Radically new Field Effect Transistors let you hear more stations more clearly.
2. Professional automatic turntable with magnetic cartridge just as used in expensive component systems.
3. Exclusive automatic variable bandwidth gives amazing clarity to AM broadcasts.
4. All silicon circuitry for rugged trouble-free performance.
5. Tape recorder and tape cartridge player connections

expand your range of musical enjoyment.

6. Electric guitar and microphone inputs and mixer provide you with a stereo showcase for your own talents.
7. Complete component controls, including dual Bass and Treble, let you tune the music to your taste and room requirements.
8. Provision for extra speakers lets you bring great Scott sound to other rooms.
9. Stereo headphone output enables you to listen in privacy, without disturbing others.

\$339.95 (Model 2502, illustrated. Other models start at \$249.95) Optional transparent dustcover, \$22.95

Scott . . . where innovation is a tradition



For complete information, write: H.M. Scott, Inc., Dept. 245-07, 111 Powdermill Road, Maynard, Mass., 01754 Export: Scott International, Maynard, Mass.
Another innovation from Scott, manufacturers of superb components, compacts, kits, speakers, and consoles. © copyright 1967, H.M. Scott, Inc.

CIRCLE NO. 100 ON READER SERVICE CARD

Mark of the leader...

GARRARD'S LAB 80 MK II

The ultimate expression of over 50 years of Garrard leadership, this much-imitated but unequaled automatic transcription turntable contains many developments invented, perfected and brilliantly refined by the Garrard Laboratories, and now considered essential for the finest record reproduction.



Heavy, cast 12" anti-magnetic turntable is dynamically balanced with copper weights on underside.



Anti-static, dust-repellent turntable mat has safety rings at 12", 10" and 7" positions to protect stylus should automatic switch be activated without record on turntable.

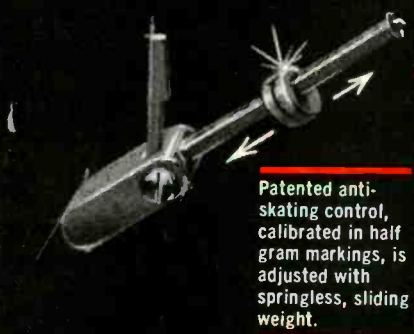

Patented anti-skating control, calibrated in half gram markings, is adjusted with springless, sliding weight.



Two interchangeable spindles: short spindle facilitates manual play; long, center-drop spindle handles eight records fully automatically.

Hydraulic cueing and pause control eliminates damage to records or stylus through manual handling.

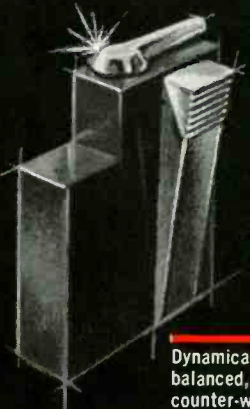

Dynamically balanced, counter-weight-adjusted tone arm of Afrormosia wood and aluminum for light weight, low resonance.

Low mass cutaway shell compatible with the most advanced, lightest tracking cartridges.

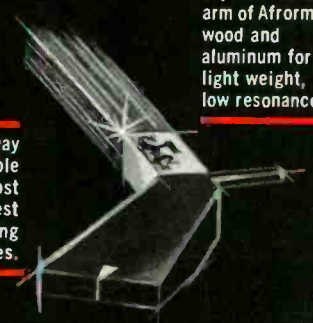

Built-in stylus pressure gauge, calibrated in quarter gram intervals, has click-stops for precise, audible/visible settings.

Just two years ago, the stereo high fidelity world was introduced to the Lab 80, the first Automatic Transcription Turntable. It was instantly acclaimed because of the significant developments it contained. These imparted professional performance capabilities never before anticipated in automatic record playing units. Now, the Garrard Laboratories have refined and surpassed the original model with the Lab 80 Mark II, still priced at only \$99.50, less base and cartridge. It is one of five new Garrard Automatic Turntables each of them the leader in its class. For complimentary Comparator Guide, write Garrard, Dept. AG-5, Westbury, N.Y. 11590.

HiFi/Stereo Review

JULY 1967 • VOLUME 19 • NUMBER 1

THE MUSIC

- THE FEAR OF GOD—AND TOSCANINI**
A critic re-examines a conductorial legend..... ERIC SALZMAN..... **31**
- JOHN PHILIP SOUSA**
The March King was "an original [and] important composer"...
..... RICHARD FRANKO GOLDMAN..... **35**
- THE BASIC REPERTOIRE**
Updatings and Second Thoughts, Part Two..... MARTIN BOOKSPAN..... **48**
- BEST OF THE MONTH**
Reviews of outstanding new record releases **61**
- EVEREST/CETRA: A HARVEST OF REISSUES FOR OPERA LOVERS**
The fabled Cetra-Sovia opera recordings are again available..... GEORGE JELLINEK..... **80**

THE EQUIPMENT

- NEW PRODUCTS**
A roundup of the latest high-fidelity equipment..... **16**
- HI-FI Q & A**
Answers to your technical questions..... LARRY KLEIN..... **24**
- AUDIO BASICS**
Audio Specifications XI: Amplifier Power..... HANS H. FANTEL..... **28**
- LABORATORY TESTS OF ELEVEN STEREO CARTRIDGES**
Full reports on a number of top-rated models... JULIAN D. HIRSCH AND GLADEN B. HOUCK..... **52**
- "THE DOLBY" AUDIO NOISE REDUCTION SYSTEM**
Two new discs introduce a breakthrough in recording technique..... JOHN MILDER..... **76**
- TAPE HORIZONS**
Tapes for Troops..... DRUMMOND MCINNIS..... **103**

THE REVIEWS

- CLASSICAL**..... **67**
- ENTERTAINMENT**..... **87**
- TAPE**..... **99**

THE REGULARS

- EDITORIALLY SPEAKING**..... **4**
- LETTERS TO THE EDITOR**..... **6**
- ADVERTISERS' INDEX; PRODUCT INDEX**..... **106**

COVER: DESIGN BY BORYS PATCHOWSKY; PHOTO BY BRUCE FENDELTON

Copyright © 1967 by Ziff-Davis Publishing Company. All rights reserved. HiFi/Stereo Review, July 1967, Volume 19, Number 1. Published monthly at 307 North Michigan Avenue, Chicago, Illinois 60601, by Ziff-Davis Publishing Company—also the publishers of Airline Management and Marketing, Boating, Business & Commercial Aviation, Car and Driver, Cycle, Electronics World, Flying, Modern Bride, Popular Aviation, Popular Electronics, Popular Photography, Skiing, Skiing Area News, and Skiing Trade News. (Travel Weekly is published by Robinson Publications, Inc., a subsidiary of Ziff-Davis Publishing Company.) One year subscription rate for U.S., U.S. Possessions, and Canada, \$6.00; all other countries, \$7.00. Second Class postage paid at Chicago, Illinois and at additional mailing offices. Authorized as second-class mail by the Post Office Department, Ottawa, Canada and for payment of postage in cash. SUBSCRIPTION SERVICE: All subscription correspondence should be addressed to HiFi/Stereo Review, Circulation Department, Portland Place, Boulder, Colorado 80302. Please allow at least six weeks for change of address. Include your old address, as well as new—enclosing if possible an address label from a recent issue.

HiFi/Stereo Review

PUBLISHER
PHILLIP T. HEFFERNAN

EDITOR
WILLIAM ANDERSON

MANAGING EDITOR
WILLIAM LIVINGSTONE

MUSIC EDITOR
JAMES GOODFRIEND

TECHNICAL EDITOR
LARRY KLEIN

ASSOCIATE EDITOR
ROBERT S. CLARK

ART DIRECTOR
BORYS PATCHOWSKY

CONTRIBUTING EDITORS

MARTIN BOOKSPAN
HANS H. FANTEL
WILLIAM FLANAGAN
DAVID HALL
NAT HENTOFF
JULIAN D. HIRSCH
GEORGE JELLINEK
IGOR KIPNIS
PAUL KRESH
DRUMMOND McINNIS
REX REED
PETER REILLY
ERIC SALZMAN

EUROPEAN EDITOR
FREDERIC GRUNFELD

LONDON EDITOR
HENRY PLEASANTS

ADVERTISING SALES MANAGER
LAWRENCE SPORN

ADVERTISING
SERVICE MANAGER
ARDYS C. MORAN

Editorial and Executive Offices
Ziff-Davis Publishing Company
One Park Avenue, New York, New York 10016
212 679-7200
Eastern Advertising Manager: Jerry Sweeney
Robert Ur

Midwestern Office
9025 Wisconsin Avenue, Chicago, Illinois 60601
312 726-0892
Advertising Manager: Jerry Sweeney

Western Office
9025 Wilshire Boulevard
Beverly Hills, California 90211
213 Crestview 4-0265; BRadshaw 2-1161
Western Advertising Manager: Bud Dean

Japan: James Yagi
Ishikawa Mansion
4, Sakuragaoka, Shibuya-ku
Tokyo, Japan
Telephone: 462-2911-3

Circulation Office
Portland Place, Boulder, Colorado 80302

EDITORIAL CONTRIBUTIONS must be accompanied by return postage and will be handled with reasonable care; however, publisher assumes no responsibility for return or safety of art work, photographs, or manuscripts.

Member Audit Bureau of Circulations



ZIFF-DAVIS PUBLISHING COMPANY
William E. Ziff, Chairman of the Board (1948-1953)
William Ziff, President
W. Bradford Briggs, Executive Vice President
Hershel B. Sarbin, Senior Vice President
Philip Sine, Financial Vice President
Walter S. Mills, Jr., Vice President, Circulation
Stanley R. Greenfield, Vice President, Marketing
Phillip T. Heffernan, Vice President,
Electronics Division
Frank Pomerantz, Vice President, Creative Services
Arthur W. Butzow, Vice President, Production
Edward D. Muhlfield, Vice President, Aviation Division
Irwin Robinson, Vice President, Travel Division



EDITORIALLY SPEAKING

By William Anderson

ALTHOUGH Mother Nature somewhere along the line saw fit to make man the most adaptable of her creatures, it begins to appear that she also set some limits to that adaptability. The press, the public, and even our legislatures are starting to pay belated attention to what might be rather generally referred to as eye, ear, nose, and throat disturbances—visual outrages, unbearable noise, and polluted air—that are direct results of our indefatigable and ingenious exploitation of the world around us. As a resident of a city mightily afflicted with air and noise problems, I must admit that I am fast reaching the limits of *my* adaptability, and therefore side with the militant angels.

On the visual front, however, I still have one resource—I can selectively ignore what I don't wish to see. Although it gives me great pleasure to know that there is one county in upstate New York which, by local option, forbids billboard advertising, the tireless onslaught of the pitchman—whether he writes large in the sky or small on the inside of matchbook covers—leaves me largely unaffected. In this, I suspect, I am like most Americans: we have been the target, for most of our lives, of the mightiest propaganda barrage ever mounted anywhere; we have been shouted at and whispered to, cajoled, amused, kidded, and pampered—and we have somehow learned to ignore it all. Advertising is, of course, one of the larger gears in our economic machine, and we would have to sacrifice many other delightful things (this magazine included) if we proposed to do without it. But we have, in fact, developed a large measure of immunity, and it is therefore not surprising that important advertising messages sometimes fail to get through, that someone actually *has* made that better mousetrap you have been waiting for—and you missed the news.

I must confess, adaptable and selective observer that I am, that I had missed a bit of news until recently, and it took the first draft of Julian Hirsch's reports on the new phono cartridges in this issue to bring me up to date. Mine, in all candor and humble honesty, is probably one of the busiest turntables in this country, and it has been running without complaint for the past year and a half with a cartridge—a *very* good cartridge—with which I could find no fault. A well-founded confidence in Julian Hirsch's judgment sent me scurrying home nonetheless to try a trio of the new cartridges myself. I don't know whether the advertising fashion right now is to shout or whisper, but the message is clear, and I hope you're reading: there *is* a new generation of phono cartridges, and they are a definite, distinct, and immediately audible improvement over those of only two years ago.

Small as it is, it is difficult to overestimate the importance of the phono cartridge in the total audio system. It is the *first* transducer (changing mechanical to electrical energy) your music encounters on its journey from the disc to your ear, and no amplifier or speaker, however expensive, can do any more than amplify and reproduce whatever comes to it. For this reason, the cartridge is the least expensive (prices these days range from \$10 to \$80) means of significantly upgrading the quality of your recording system. If you are presently using a cartridge more than two or three years old, you owe it to yourself and your record collection to make the switch: cartridges *are* better than ever.

NOW—HAVE A DISCOUNT RECORD STORE IN YOUR OWN HOME

Save up to 55% on every record you ever want to buy! No obligation to buy any records

The Longines Symphonette's new service, THE CITADEL RECORD CLUB gives you any record, any artist, any label at savings up to 55% off manufacturer's suggested price. No obligation to buy any records • Free Record Bonus Certificates • Jet Speed Service • Special Money-Back Membership—Just Like a Free Trial • See details below!

You've seen the ads in this and other publications: Get 10 records FREE, they say. Then in smaller print, if you agree to buy 10 or 11 more in just one year, they give you your choice of from 30 to 90 records... and that is not free choice, for the Schwann Catalog lists more than 30,000 long-play records now available to you. The extra records you have to buy (no matter what choice is given you) are part of the offer. More records you really don't want. And did you ever try to turn down a record club selection of the month? You have to move fast. This kind of club requires you to buy records you don't really want.

THERE IS A BETTER WAY: The Longines Symphonette's New Citadel Club gives you a huge "Discount Record Store" in your own home... acts like a "record buyers cooperative".

The sincere CITADEL CLUB way is quite simple. There are no hidden contracts, no obligation to buy any records at all, and you have your FREE choice of any record available today at discounts of up to 55%, with a minimum of 35% guaranteed. Here's how easy it is to start saving on the records you buy:

1 ANY RECORD, ANY ARTIST, ANY LABEL, ANY KIND OF MUSIC! What do you prefer? Popular? Classical? Broadway Show? Rock and roll? Movie or TV themes? Order Herb Alpert, Barbra Streisand, Robert Goulet, Dean Martin, Frank Sinatra, Herman's Hermits, any original Broadway Cast... you name it. Citadel has it.

2 YOU ARE NOT REQUIRED TO BUY ANY RECORDS AT ALL! Buy as many or as few records as you need—records of your choice!

3 IRON CLAD GUARANTEE: FACTORY-FRESH RECORDS, MOST SEALED IN PLASTIC. Any record that passes our inspection team and is imperfect, is replaced without additional cost to you.

4 24 HOUR SERVICE IN MOST CASES! Your orders filled promptly... The fastest service in the industry.

5 FREE MEMBERSHIP KIT INCLUDES 300-PAGE SCHWANN CATALOG PLUS TWO OTHER BIG BOOKS! As a member you get the famous SCHWANN catalog which lists more than 30,000 long-play records now available. Same book used by the biggest stores... tells you the manufacturers' suggested price and other information. And you get two BONUS BIG BOOK CATALOGS listing special bargains and current top sellers. All FREE with your membership.

6 "MONEY-BACK" MEMBERSHIP—JUST LIKE A FREE TRIAL! We invite you to accept a three-month trial for just \$1. And—we will even give you a Record Bonus Certificate worth \$1 toward your first purchase... just like a FREE trial. AND—we'll even bill you later for the small \$1 fee. Remember—every Citadel Club membership is for the entire family. Your children can order and save. Any member of your family can order records... and save. Three-month "Money-Back" trial for only \$1.

TYPICAL CITADEL SUPER BARGAINS!

Performer	Normal List Price	Your Citadel Price	Performer	Normal List Price	Your Citadel Price
Herb Alpert and The Tijuana Brass	3.79	1.99	Frank Sinatra	3.79	1.99
Barbra Streisand	3.79	1.99	Eric Leinsdorf	4.79	2.49
The Monkees	3.79	1.99	Mantovani	3.79	1.99
Harry Belafonte	3.79	1.99	Leonard Bernstein	4.79	2.49

**SEND NO MONEY
MAIL COUPON TODAY!**

CITADEL RECORD CLUB • Symphonette Square, Larchmont, N.Y. 10538

Enroll me in the club for all the privileges described in the advertisement. I get FREE kit including SCHWANN catalog plus two bonus big books. I AM NOT OBLIGATED TO BUY ANY RECORDS... but save up to 55% on those I really want, any artist, any label. Bill me for the \$1 trial membership and send the \$1 Record Bonus Certificate which I can use toward my first purchase.

CHECK HERE FOR STEREO TAPE MEMBERSHIP

STEREO TAPE MEMBERSHIP includes FREE KIT plus famed HARRISON Stereo Tape Catalog (Just 50¢ additional)

NAME Mr. Mrs. Miss _____
ADDRESS _____
CITY _____
STATE _____ ZIP _____

© C. S. Inc.

CIRCLE NO. 11 ON READER SERVICE CARD

With a name like
Pioneer, you'd expect
something different
in a Receiver



Well, here are
a few somethings

- Unique vertical throw lever controls assure positive, finger-tip switching.
- Separate compensation for 3¾ and 7½ ips tape speeds.
- Special DIN socket accommodates connecting plugs to the outputs of European recorders.
- Separate input jacks provide for two magnetic phono and for ceramic/crystal cartridges.
- Matched grain, oiled walnut cabinet included at no extra charge (\$360).
- Plug-in Speaker Connectors instead of conventional terminal strips insure positive contact. Plugs are covered with flexible Neoprene to insure against shorts.
- Operates at 115 volts or 230 volts, A.C. 50-60 cps. The utmost in line voltage flexibility.

The SX-1000TA is the kind of receiver you'd design for yourself. Happily, Pioneer has done it for you. In one handsome unit it incorporates more features, more flexibility plus quality.

You should see and listen to the SX-1000TA. If you desire complete specifications, fill in the publication's reader service card. However, for dealer listings, please write us direct.

PIONEER ELECTRONICS U.S.A. CORP.
140 Smith St., Farmingdale, L. I., N. Y. 11735
(516) 694-7720

PIONEER

Manufacturers of
Quality High Fidelity Receivers • Turntables
Speaker Systems • Loudspeakers • Headsets

CIRCLE NO. 40 ON READER SERVICE CARD



LETTERS TO THE EDITOR

FM—In Decline?

● I agree one hundred per cent with the views of John Milder ("Editorially Speaking," April) concerning the creeping mediocrity in the FM medium as a whole. However, there are exceptions to every rule and Station KMMK-FM here in Little Rock, Arkansas, is one of them, I believe. KMMK-FM was the first FM radio station in central Arkansas, and since the very beginning the Arkansas Power and Light Company has sponsored a two-hour classical program every evening from eight to ten o'clock. I've been doing the announcing for this program for over four years now, and I have an excellent opportunity to provide an interesting and varied program. In the two-hour period there are only six commercials, and these are reserved ones, with no hard sell. A musical piece is played without interruption, even though the composition may last anywhere from thirty minutes to one and a half hours. There are Baroque, Classical, and contemporary compositions. As a further service KMMK-FM has a five-hour classical program that features a complete opera each Saturday from one until six in the afternoon.

WILBURN THOMAS
Little Rock, Ark.

● I have just read John Milder's statement on the deterioration of the quality of FM radio. I fully agree. I personally love Baroque and Classical music, but I feel I have been robbed, for there is hardly a single FM station that broadcasts this type of music. I plan to follow your suggestion and write to several FM stations and also to the FCC to complain.

WERNER K. OSTMANN
Boston, Mass.

● John Milder's point concerning the current state of FM is fairly accurate. Even though the FCC decision about AM/FM programming can be said to contribute to FM's deplorable condition, the search for a larger audience and increased revenue must be considered the principal factor in FM's decline.

But the details about the state of FM in Boston are quite inaccurate, and I would like to defend at least one of those "commercial stations [that] are all playing stereo lullabies." Aside from the principally classical Station WCRB, WHRB-FM is the only commercial FM station that continually broad-

casts good music of uncompromised quality. Operated solely by students at Harvard University, yet independent in all respects of the university, WHRB-FM has for ten years maintained for its Boston and Cambridge listeners a high standard of excellence.

This fact is borne out by our programming alone. WHRB broadcasts about sixty hours of classical music every week, classical music which never includes the semi-classical favorites or numerous warhorses that are featured on other stations. In addition, WHRB is the principal forum for real jazz in Boston, with almost thirty hours of knowledgeable programming ranging from the traditional to the avant-garde and including live jazz performances every week.

BARRY M. SCHNEIDER, *Station Manager*
Station WHRB-FM
Cambridge, Mass.

Saint Cecilia

● H. C. Robbins Landon's article entitled "Music's Saint Cecilia" (April), identifying the saint and some of the more important music inspired by or dedicated to her, is interesting and informative, and it suggests considerable research on a subject that has left only the vaguest trace across the last sixteen centuries. As Mr. Robbins Landon suggests, her influence was particularly strong on early English composers, who through her found inspiration for some of their most profound music.

There is one notable contribution of this small but select group of worshipers at her shrine that Mr. Robbins Landon fails to mention. I refer to Alessandro Scarlatti's *Messa di Santa Cecilia*, which is considered by many to be one of this composer's finest works. I feel that it was deserving of mention in the treatment of this subject.

E. R. BADEAUX
Houston, Tex.

Mr. Landon limited his discussion of St. Cecilia works to those currently blessed by recorded representations. As he noted in his article, his list is "representative, though by no means comprehensive."

G & S

● I would like to thank Paul Kresh for his intriguing article on Gilbert and Sullivan (February). When I read it at first I wasn't

(Continued on page 8)

COLUMBIA STEREO TAPE CLUB
now offers you

ANY 5 STEREO TAPES FREE

if you begin your membership by purchasing just one tape now, and agree to purchase as few as five additional selections in the next 12 months, from the more than 200 to be offered

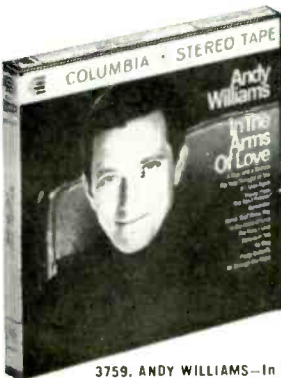

3759. ANDY WILLIAMS—In The Arms Of Love, Remember, Sand And Sea, All Through The Night, 7 more



3728. FRANK SINATRA — That's Life. Plus: Winchester Cathedral, What Now My Love, Somewhere My Love, 10 in all



3684. HERB ALPERT & THE TIJUANA BRASS—S.R.O. Plus: Our Day Will Come, The Work Song, Mame, Flamingo, etc.

THE SUPREMES
sing
HOLLAND - DOZIER - HOLLAND
You Keep Me Hangin' On
Love Is Here and Now You're Gone
[MOTOWN] 10 MORE

3790. Plus: Remove This Doubt, I'll Turn To Stone, 8 more

BARBRA STREISAND
Je m'appelle Barbra
Autumn Leaves
What Now My Love
10 MORE

3443. Also: I Wish You Love, Free Again, Le Mur, Martina, etc.

THE HAPPY WONDERLAND OF BERT KAEMPFERT
Danke Schoen
23 MORE

3202. Twin-Pack Counts As Only One Selection.

NANCY SINATRA
SUGAR
Sugar Town
[REPRISE]

3734. Plus: All By Myself, What'll I Do, Coastin', etc.

HANG ON RAMSEY
RAMSEY LEWIS TRIO
Hang On Sloopy
A Hard Jay's Night
9 MORE

2436. Plus: And I Love Her, Billy Boy, Satin Doll, etc.

Beethoven
Fifth Symphony
BERNSTEIN
N.Y. PHILHARMONIC

1325. "Wonderfully convincing." — High Fidelity

ROGER WILLIAMS
I'll Remember You
PLUS
Lara's Theme
Ebb Tide
9 MORE

2535. Also: A Taste Of Honey, Yesterday, Oulicinea, 12 in all

THE MAMAS & THE PAPAS
Liss - Jane - Michelle - Dianne
[COLUMBIA]

3244. Plus: That Kind Of Girl, Words Of Love, 9 more

SERGIO MENDES & BRASIL '66
EQUINOX
Constant Rain
(Chove Chuva)
9 MORE

3832. Plus: Cinnamon And Clove, Bim-Bom, Night And Day, etc.

ORMANDY: PHILADELPHIA ORCHESTRA'S GREATEST HITS
Clare de Lune
Sabre Dance

3628. Also: Cancan, Greensteens, Blue Danube Waltz, etc.

THE HAPPY WONDERLAND OF BERT KAEMPFERT
Danke Schoen
23 MORE

3202. Twin-Pack Counts As Only One Selection.

NANCY SINATRA
SUGAR
Sugar Town
[REPRISE]

3734. Plus: All By Myself, What'll I Do, Coastin', etc.

HANG ON RAMSEY
RAMSEY LEWIS TRIO
Hang On Sloopy
A Hard Jay's Night
9 MORE

2436. Plus: And I Love Her, Billy Boy, Satin Doll, etc.

Beethoven
Fifth Symphony
BERNSTEIN
N.Y. PHILHARMONIC

1325. "Wonderfully convincing." — High Fidelity

ROGER WILLIAMS
I'll Remember You
PLUS
Lara's Theme
Ebb Tide
9 MORE

2535. Also: A Taste Of Honey, Yesterday, Oulicinea, 12 in all

CABARET
starring
Jill Jack Best
Haworth Gifford Convy
ORIGINAL
BROADWAY CAST

3675. "Stunning musical. Brilliantly conceived." — N.Y. Times

"I started out as a child"
bill cosby
[WARNER BROS.]

1721. A childhood re-captured through a wacky looking glass

HOROWITZ IN CONCERT
Recorded Live at his 1966 Carnegie Hall Concerts

3767-3768. Twin-Pack Counts As Two Selections.

GERSHWIN
Rhapsody In Blue
An American In Paris
Twin pack Tape

2644. Leonard Bernstein conducts three American favorites. This special Twin-Pack counts as only one selection!

GROFÉ
Grand Canyon Suite
LEONARD BERNSTEIN
[COLUMBIA]

2644. Leonard Bernstein conducts three American favorites. This special Twin-Pack counts as only one selection!

JOHNNY MATHIS SINGS
Sunny
Somewhere, My Love
19 MORE

3789. Also: I Wish You Love, Who Can I Turn To, 8 more

Andre Kostelanetz and his Orchestra
THE KOSTELANETZ SOUND OF TODAY
Born Free - Allie
Garnes That Lovers Play
8 MORE

3798. Also: Summer Wind, Guantanamera, Cabaret, etc.

SINATRA AT THE SANDS
with
COUNT BASIE and the Orchestra

3414-3415. Twin-Pack Counts As Two Selections.

WATCH OUT!
BAJA MARIMBA BAND
Cast Your Fate to the Wind
Yours - 9 MORE

3618. Plus: Ghost Riders in the Sky, Gay Ranchero, etc.

THE DEAN MARTIN SHOW
The Shadow of Your Smile
I've Grown Accustomed To Her Face
[REPRISE] 9 MORE

3707. Also: If I Had You, Just Friends, Home, S'posin', etc.

BOOTS RANDOLPH
Boots With Straps
The Shadow of Your Smile
Michelle
10 MORE [MONUMENT]

3747. Plus: Dear Heart, Yesterday, Unchained Melody, etc.

PETULA CLARK
COLOR MY WORLD WHO AM I
Plus
Winchester Cathedral
Cherish
8 MORE [WARNER BROS.]

3735. Also: England Swings, Color My World, 12 in all

MILES DAVIS QUINTET
Miles Smiles
Footprints • Orbits
Freedom Jazz Dance
3 MORE [COLUMBIA]

3719. Also: Circle, Dolores, Ginger Bread Boy, etc.

RAY CONNORF'S WORLD OF HITS
Twin pack Tape
SOMEWHERE MY LOVE
23 Songs [COLUMBIA]

3335. This special Twin-Pack includes two great Ray Conniff albums. Counts as only one selection!

TWIN-PACK Counts As Only One Selection!

SABRE DANCE
EUGENE ORMANDY
Philadelphia Orchestra
[COLUMBIA]

3792. Also: Russian Sailors' Dance, Polonaise, 6 more

THE DAVE BRUBECK QUARTET plays COLE PORTER
ANYTHING GOES!
plus Night and Day
You're the Top - 5 MORE [COLUMBIA]

3769. Also: Love For Sale, I Get A Kick Out Of You, etc.

YES, IT'S TRUE! By joining the Columbia Stereo Tape Club right now, you may have ANY FIVE of the magnificently recorded 4-track stereo tapes described here — sold regularly by the Club for up to \$47.75 — ALL FIVE FREE!

TO RECEIVE YOUR 5 PRE-RECORDED STEREO TAPES FREE — simply write in the numbers of the 5 tapes you wish in the coupon at the right. Then choose another tape as your first selection, for which you will be billed \$7.95, plus postage and handling. At the same time, be sure to indicate the type of music in which you are mainly interested: Classical or Popular.

HOW THE CLUB OPERATES: Each month the Club's staff of music experts chooses a wide variety of outstanding selections. These selections are described in the entertaining and informative Club magazine which you receive free each month.

You may accept the monthly selection for the field of music in which you are primarily interested... or take any of the wide variety of other tapes offered by the Club... or take NO tape in any particular month.

After purchasing your first tape through this advertisement, your only membership obligation is to purchase 5 additional tapes from the more than 200 to be offered in the coming 12 months. Thereafter, you have no further obligation to buy any additional tapes... and you may discontinue your membership at any time.

FREE TAPES GIVEN REGULARLY. If you wish to continue as a member after fulfilling your enrollment agreement, you will receive — FREE — a 4-track stereo tape of your choice for every two additional tapes you buy from the Club.

The tapes you want are mailed and billed to you at the regular Club price of \$7.95 (occasional Original Cast recordings somewhat higher), plus a small mailing and handling charge.

SEND NO MONEY — Just mail the coupon today to receive your six stereo tapes and your FREE take-up reel!

Note: All tapes offered by the Club must be played back on 4-track stereo equipment.

APO, FPO addressees: write for special offer.

SEND NO MONEY — JUST MAIL COUPON!

COLUMBIA STEREO TAPE CLUB
Terre Haute, Indiana 47808

I AM BUYING THIS TAPE NOW (fill in number)

Please enroll me as a member of the Club. I've indicated at the right the five tapes I wish to receive FREE. I've also indicated the tape I am buying now as my first selection, for which I am to be billed \$7.95, plus postage and handling. Include the self-threading take-up reel FREE.

My main musical interest is (check one):

CLASSICAL POPULAR

In addition to the first selection I am buying now, I agree to purchase five additional selections during the next year... and I may cancel membership at any time thereafter. If I continue, I am to receive a stereo tape of my choice FREE for every two additional selections I accept.

ALSO SEND THESE 5 TAPES — FREE!

Name..... (Please Print) First Name Initial Last Name

Address.....

City..... State..... Zip Code.....

415-2/49

© 1967 CBS Direct Marketing Services

T60/F67

COLUMBIA STEREO TAPE CLUB • Terre Haute, Indiana

CIRCLE NO. 13 ON READER SERVICE CARD



**Take
this ad
with you
when you look
for the best Tape
Recorder you can get.**

Then you know what to look for.

**LOOK FOR the exclusive
phosphor sensitive cutoff switch**

This transistor-amplified sensing switch stops the ReVox recorder automatically at pre-selected points on the tape, either between selections or before the end of the reel. The switch also acts as an automatic cutoff in the event of a tape-break or after a reel has been rewound.

LOOK FOR 10 1/2" tape reels

On other tape recorder at this price they take up to 4,800 feet of LP tape. Enough for 4 1/2 hours of straight entertainment or recording. Rewinds at an accelerated speed.

**LOOK FOR three Papst motors for
reels and capstan**

No belts . . . no pulleys . . . no gears . . . no noise or trouble makers. Separate motors.

**LOOK FOR separate VU-Meters
for each channel**

These are precision instruments with dynamic characteristics as required by the A.S.F. They help you maintain accurate control of the recorder level at all times.

**LOOK FOR separate record and play-
back amplifiers for both channels**

The record amplifier has a reserve gain

of 14 db before any distortion. You can monitor continuously by using separate heads for record and play.

LOOK FOR tape tension controls

Whatever your needs are, simple adjustment for playing 10 1/2" or 7" reels.

LOOK FOR built-in mixing facilities

Any two signals may be mixed and recorded in the mono mode. Additionally one channel can be set to playback while the other is recording and all forms of sound-on-sound and sound-with-sound are possible.

**LOOK FOR "Freedom-of-Installation"
choice and Speeds**

Your ReVox Mark III comes in a matched grain hand-polished walnut cabinet, portable case and for rack mounting. Various tape speeds provide individual requirement satisfaction.

LOOK NO FURTHER

With all these features, no wonder the ReVox Mark III tape recorder is the first choice of amateur and professional alike.

The ReVox Mark III G-36 Tape Recorder, from \$535. If you want more details on the ReVox and a free copy of "The Tape Recording Omnibook" look for it at franchised dealers everywhere or write direct to:

REVOX  MARK III

G-36 TAPE RECORDER

E.F.A. MARKETING INDUSTRIES, INC. DEPT. R, NEW HYDE PARK, N. Y. 11040

CIRCLE NO. 21 ON READER SERVICE CARD

sure whether he was just being silly or not, and I'm still not too sure that he didn't exaggerate. But I started listening to Gilbert and Sullivan, and reading the librettos to find out what was so great about them . . . a fatal mistake.

By this time I'm convinced that there was ninety-nine percent absolute truth in his description of the symptoms of the Gilbert and Sullivan malady. I hope he is filled with remorse at the thought of creating another Savoyard. I hope sincerely and earnestly that he is unable to sleep at night after reading this letter and meditating on his sins. There is no one in my freshman class at school who understands my feelings about G & S. I have no one to talk to—and it's all Mr. Kresh's fault!

BARBARA ALICE WEDYCK
Westchester, Ill.

Dear Reviewer: . . .

● See Peter Reilly. He has a hi-fi stereo. He gets a lot of free records each month. He is supposed to tell people if the records are good records or bad records.

Peter tries to be funny. Peter tries to be cute. Peter likes Peter, Paul and Mary. He also likes very pretty girls. He likes Linda Ronstadt of the Stone Poneys (May). Does the very pretty girl have talent? Does the very pretty girl sing well? Peter did not tell people this about the very pretty girl.

I do not know Linda Ronstadt, nor have I ever heard her sing. But I assume Capitol Records must feel the group is talented.

BERT KIENER
Rochester, N. Y.

● Peter Reilly's reviews have become my favorite part of HiFi/STEREO REVIEW. His style of independent sincerity is objective and at the same time quite enjoyable. I am waiting for him to apply his talents to my pet sound: Paul Revere and the Raiders.

J. E. RAUER
Iowa City, Iowa

● I think you have on your staff one of the best music reviewers in the business. His insight and his delightful sense of humor are a rare combination. Even when he pans a record I like, I still get a kick from his description of his personal reaction. I am referring, of course, to Peter Reilly.

DAVID FLETCHER
Mill Valley, Cal.

● I must fling down the gauntlet of protest to Rex Reed for his venomous review of Jane Morgan's latest recording (May). He did not really review the record, but rather lambasted a great performer who has great popularity because she earns it. Teach Miss Morgan to phrase? Well, the teacher will certainly not be Mr. Reed. Mr. Reed must be a longhair like Simon and Garfunkel. I suggest that Mr. Reed review something in his league, like the Beatles or the Monkees.

D. D. SKOW
Charleston, S. C.

● Rex Reed continues to amuse me. In his recent worshipful review of Liza Minnelli's latest offering (March), he waxes eloquent and long on the subject of her patrician musical taste. Miss Minnelli, we are told, has never "succumbed to singing rock-and-roll trash." Later in the review he especially sin-

(Continued on page 10)

Why did $\frac{3}{4}$ million record collectors pay \$5 to join Record Club of America...

when any other record club would have accepted them free?

Compare the "Big 4" Record Clubs and see

	COLUMBIA Record Club (as advertised in TV GUIDE Feb. 25, 1967)	CAPITOL Record Club (as advertised in TV GUIDE Feb. 11, 1967)	RCA VICTOR Record Club (as advertised in PLAYBOY Mar., 1967)	RECORD CLUB OF AMERICA
CAN YOU CHOOSE FROM ALL LABELS?	NO	NO	NO	YES! Choose any LP on any label! No exceptions! Over 300 different manufacturers including CAPITOL, COLUMBIA, RCA VICTOR, ANGEL, LONDON, etc.
MUST YOU BUY A "MINIMUM" NUMBER OF RECORDS? HOW MANY?	12	10	4	NONE! No obligations! No yearly "quotas"! Take as many, as few, or no records at all if you so decide!
HOW MUCH MUST YOU SPEND TO FULFILL YOUR LEGAL OBLIGATION?	\$47.76 TO \$59.72	\$39.80 TO \$49.80	\$15.92 TO \$19.92	ZERO DOLLARS You don't have to spend a penny—because you're not "legally obligated" to buy even a single record!
CAN YOU BUY ANY RECORD YOU WANT AT A DISCOUNT?	NO	NO	NO	ALWAYS! Your discount up to 77% OFF—GUARANTEED never less than a third! No exceptions!
DO YOU EVER RECEIVE UNORDERED RECORDS?	YES	YES	YES	NEVER! There are no cards which you must return. Only the records you want are sent—and only when you ask us to send them.
HOW LONG MUST YOU WAIT FOR SELECTIONS TO ARRIVE?	5 to 6 weeks	5 to 6 weeks	5 to 6 weeks	NO LONG WAITS! Your order processed same day received.

AT LAST A RECORD CLUB WITH NO "OBLIGATIONS"—ONLY BENEFITS!

This is the way YOU want it—a record club with no strings attached! Ordinary record clubs make you choose from just a few labels—usually their own labels! They make you buy up to 10 or more records a year—at full price—to fulfill your "obligation." And if you forget to return their monthly card—they send you a record you don't want and a bill for \$5.00 or \$6.00! In effect, you are charged almost double for your records!

But Record Club of America Ends All That!

Now choose any LP... on any label. Everything from Bernstein and Baez to Sinatra and the Monkees—including new releases. No exceptions! Take as many, or as few, or no records at all if you so decide. Discounts are NEVER LESS THAN ONE THIRD, and GUARANTEED AS HIGH AS 77% OFF! You never pay full price—and never pay \$1 extra for stereo! You get best-sellers for as low as 94¢, plus a small handling and mailing charge.

How Can We Break All The Record Club "Rules"? We are the only major record club NOT OWNED... NOT CONTROLLED... NOT "SUBSIDIZED" by any record manufacturer anywhere. (No other major club can make that claim!) Therefore we are never obliged by "company policy" to push any one label, or honor the list price of any manufacturers. Nor are we prevented by distribution commitments, as are other major record clubs, from offering the very newest records. So we can—and do—offer all records and cut prices to the bone! Only Record Club of America offers records as low as 94¢! (You can't expect "conventional" clubs to be interested in keeping record prices down—when they are manipulated by the very manufacturers who want to keep record prices up!)

To join, mail coupon with check or money order for \$5. This entitles you to LIFETIME MEMBERSHIP—and you never pay another club fee!

Look What You Get

- Lifetime Membership Card guarantees you brand new LPs at dealer cost. Discounts up to 77%!
- Free 300-Page Schwann Catalog lists all LPs available.
- Disc®, the Club's FREE magazine, and special Club Sales Announcements which update "Schwann" and list extra discount specials.

Guaranteed Same-Day Service

The Club's own computer system, located on our premises, processes your order same day received! Every record brand new, factory fresh (never "club pressings" or "seconds")! You must be completely satisfied or every record fully returnable!

Money Back Guarantee

If you aren't absolutely delighted with our discounts (up to 77%), or our selection (largest in the world!)—or even if you've simply changed your mind—return items within 10 days and membership fee will be refunded AT ONCE!

Over 750,000 music lovers, schools, libraries, and other budget-wise institutions now get brand new LPs for as little as 94¢—through the only major record club not dominated by the record manufacturers! Join now and save. Mail coupon to: Record Club of America, Club Headquarters, York, Pa. 17405.

Your membership entitles you to buy or offer gift memberships to friends, relatives, neighbors for only \$2.50 each with full privileges. You can split the total between you: Your membership and one gift membership divided equally brings cost down to \$3.75 each. The more gift members you get—the more you save! See coupon for your big savings.

12B

© 1967 Record Club of America
CIRCLE NO. 43 ON READER SERVICE CARD

DISCOUNTS TO 77%—PRICES AS LOW AS 94¢ PER RECORD!

TYPICAL ALL LABEL "EXTRA DISCOUNT" SALE

BUDGET SERIES AT 1/2 PRICE... \$.94

Ella Fitzgerald · Frank Sinatra · John Gary · Stan Getz
Nat Cole · Jack Jones · Ferrante & Teicher
and more...

BEST SELLERS AT 1/2 PRICE... \$1.89

Roger Williams · Johnny Rivers · Bill Cosby
Ray Charles · Eddy Arnold · The Monkees
Lawrence Welk and others...

BEST SELLERS AT 1/2 PRICE... \$2.39

Dr. Zhivago · Rubinstein · George Szell
Jimmy Smith · Born Free · Ramsey Lewis
Van Cliburn · Wes Montgomery and others...

plus... from 50% to as high as 77% discount on famous labels: Roulette, Westminster, Vox, Decca, Atlantic, Monument, and others.

★ Choose any LP on any label! Mono and Stereo! No exceptions!

★ No "quotas" to buy. Take 0 records—or 100!

★ SAVE! Discounts up to 77%! Prices as low as 94¢ per LP!

★ No "hold-back" on exciting new records!

★ All orders processed same day received—no long waits!

★ Every record brand new, first quality, factory fresh—and guaranteed fully returnable!



FREE! 300-page Schwann Catalog to pick your records from when you join Record Club of America

GIANT CATALOG lists all records of all manufacturers. Over 300 labels. More than 25,000 albums. Classical — Popular — Jazz — Folk — Broadway & Hollywood soundtracks — Spoken Word — Rock-N-Roll — Comedy — Rhythm & Blues — Country & Western — Dancing — Listening — Mood! Prices as low as 94¢. No exceptions!

RECORD CLUB OF AMERICA X-917F
Club Headquarters • York, Pennsylvania 17405

YES — rush me LIFETIME MEMBERSHIP CARD, FREE 300-page Schwann Catalog, DISC®, and Special Sales Announcements. Enclosed is \$5 membership fee (never another club fee for the rest of my life) which entitles me to buy any LPs at discounts up to 77%, plus a small handling and mailing charge. I am not obligated to buy any records—no yearly "quota." If not completely delighted I may return items above within 10 days for immediate refund of membership fee.

Also send Gift Memberships at \$2.50 each to names on attached sheet. Alone I pay \$5; if I join with one friend and split the total, cost is only \$3.75 each; with two friends, \$3.33 each; with three friends, \$3.13 each; with four friends only \$3 each.

I ENCLOSE TOTAL OF \$_____ covering one \$5 Lifetime Membership plus any Gift Memberships at \$2.50 each.

Print Name _____

Address _____

City _____ State _____ Zip _____



Introducing... 3 ALL SOLID STATE
STEREO TAPE RECORDERS
from **ROBERTS**
at New Low Popular Prices!

ROBERTS 1719
**COMPLETE
STEREO TAPE
RECORDER**

with ...
BUILT-IN SPEAKERS,
SOUND ADDING, and
INCLUDING MIKE.

Less than **\$199.95**

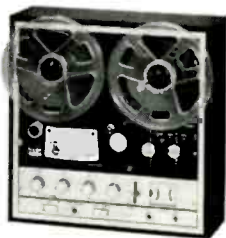

ROBERTS 1721
**STEREO TAPE
DECK**

Ideal Component to Complete
your Stereo System ...
Features Sound Adding

Less than **\$179.95**

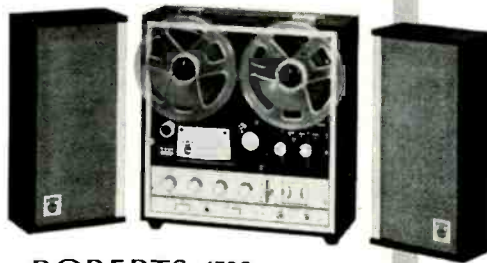

ROBERTS 1720
**STEREO TAPE
RECORDER**

featuring
Detachable Matching Speakers
FOR FULL STEREO SEPARATION
... Sound Adding, and 2 Mikes

Less than **\$219.95**

Above models fully featured even at these economy prices:

15,000 CPS response • 10 Watts stereo output • Twin VU meters •
3 Speed option • Stereo Headphone Jack for private listening •
FM Multiplex Ready • 3 Digit Counter in conjunction with simple
Fast Forward/Fast Rewind for rapid and precise position locating •
Automatic Shutoff • Monitor Pause/Edit Lever Control • Equalized
preamp outputs for connecting to high powered external amplifier



the Pro Line

ROBERTS

Division of Rheem Manufacturing Company
5922 Bowcroft Street, Los Angeles, California 90016
CIRCLE NO. 45 ON READER SERVICE CARD

gles out for praise her performance of a "magnificent" song, *I Who Am Nothing*.

I hate to break the news to Mr. Reed, but that particular song was written for and is identified with a well known rock-and-roll performer, Ben. E. King, and only recently was a hit for a rock group called Terry Knight and the Pack.

ABRAM TURNER
Hackensack, N. J.

● I never cease to marvel at your rock-and-roll reviews. The latest to come to my unbelieving attention was one by Rex Reed on the Beach Boys' "Pet Sounds" (May). For this reviewer, the merit of a group's work is directly related to the degree of resemblance it shows to a musical standard for "popular" music which has become an *idée fixe*—here, we are referred back to Stan Kenton, the Hi-Lo's, and the Four Freshmen of the mid-Fifties. The resemblance to these older musical groups, according to Mr. Reed, is what makes the Beach Boys "... so far ahead of their other scraggly contemporaries..."

In addition to being illogical, this statement shows an utter misunderstanding of rock-and-roll as an "art" form. Rock-and-roll groups do not grow up and become Baja Marimba bands, background musicians, or big bands playing standards. True rock-and-roll neither evolves nor matures into music that "adults" such as Mr. Reed understand, hum, tap their foot to, etc. Perhaps its most general features are involvement with youth and rapid obsolescence of style and personnel, and it must be judged in these terms, or not at all.

When someone musically fixated at the "sha-boom" stage attempts to do a rock-and-roll review, he is saying in effect, "See, I'm not an old fuddy-duddy; I listen to this rock-and-roll stuff, and by golly, I like some of it!" He then assumes he is a competent critic. Well, Mr. Reed, I say sha-boom to you. You don't know what you're talking about.

JILL NASH
Cambridge, Mass.

In the words of the preacher, there is nothing new under the sun, and rock-and-roll does have a musical history pre-dating even the oldest living teen-ager. If we understand where our popular music comes from, then we have some chance of knowing where it is going. Old fuddy-duddy Reed, by the way, is a fast twenty-eight.

● After having read Eric Salzman's description of Toshiro Mayuzumi's score for "The Bible" (February), I can only assume that he must not have examined the contents of the album cover very well. He states that the orchestra and chorus are unidentified. If he looks on the front of the album, he will see, near the bottom, that the work is performed by the Orchestra Cinefonica Italiana and the Chorus Carapellucci conducted by Franco Ferrara.

CHARLES W. GILBERT, JR.
Phoenix, Ariz.

Mr. Salzman replies: "Mr. Gilbert is right—the credits are there on the album cover. But the type is so small and the position so inconspicuous that they fairly beg to be overlooked. And does 'Orchestra Cinefonica Italiana' really make us any wiser?"

(Continued on page 12)

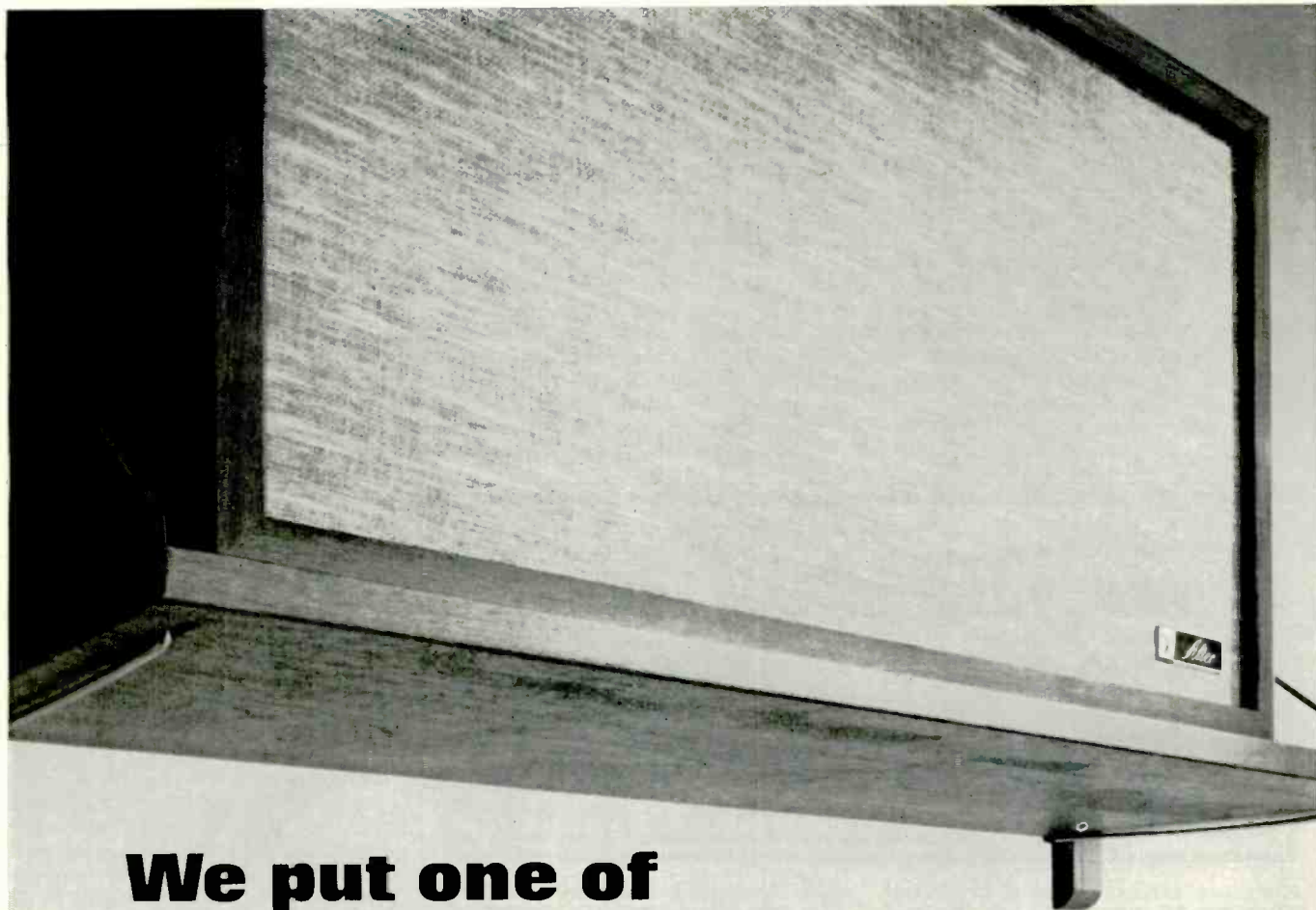

We put one of our best ideas on the shelf.

Over the past 30 years, we've had a lot of good ideas about speaker systems. Some of them ended up in Cinerama, in the Houston Astrodome, in Todd A-O, and places like that.

This one ended up on a shelf. (Or a lot of shelves, matter of fact.)

Which is where you'd expect to find a 2 cubic foot speaker. Only the Bolero isn't just another small-size speaker, with a small-size sound. It's different.

What makes it different is that part of this speaker isn't what it seems to be. There appear to be two woofers, but one of them is actually



a free-suspension phase inverter. So?

So it's tuned to work in precise phase with the woofer. And as a result, you get a bass response that few large systems could match.

The true woofer is a full 10", with a massive 10-lb. magnetic structure that makes the Bolero as efficient as a big speaker. With one watt of input, you get a rousing 92 dB of sound. Clean sound, no matter how loud you play it. Powerful sound, even with a medium-power amplifier.

Then Altec's 3000H multicellular horn and driver handles the highs without shrillness, shriek or quaver. In addition, a built-in 3000 Hz dual element crossover network with variable shelving control gives you

precise frequency separation.

We didn't stint on the styling, either. The cabinet is hand-rubbed walnut, finished on all 4 sides so you can show off the Bolero any way you want to. And, just to please the hard-to-please, we made the grille a snap-on, so you can change the grille cloth to suit your mood or decor. Any time.

The Bolero fits almost anywhere. (14½" x 25¾" x 12".)

It also fits almost any budget at just \$169.50.

Give it a listen at your Altec dealer's. And while you're there, ask for your free 1967 Altec Stereo catalog. Or write us for one. You can keep it on the shelf next to your Bolero speaker.



A Division of *LSV* Ling Altec, Inc., Anaheim, California 92803

● I wish to know exactly what Eric Salzman means when he says, reviewing the fifth album in Columbia's "Music of Arnold Schoenberg" series (March), that "what Schoenberg once called Brahms' Fifth [Schoenberg's orchestration of Brahms' G Minor Quartet] needs exactly what the first four need—big scale and big gesture." Does he mean that the symphonies lack "big scale and big gesture"?

Brahms stands as the greatest composer of Western music. If Mr. Salzman means to deride the work of Brahms, let him point to a later composer of equal developmental logic, intensity, or *rational* emotional expression—not the neurotic, frenzied noise perpetrated as music today.

RICHARD H. MITCHELL, A1C, USAF
APO, San Francisco, Cal.

Mr. Salzman replies: "All I meant to say was that, in performance, the Schoenberg orchestration ought to be treated exactly as if it were an actual Brahms symphony."

American Liszt Society

● At the suggestion of the Honorable Secretary of the Liszt Society, London, the American Liszt Society has been organized. The purpose of the Society is to develop interest in the works of Franz Liszt through performance, recording, and publication, as well as by providing a forum for the presentation of scholarly papers. Plans for a festival, to be held at Radford College, Radford, Virginia, are currently in the making.

Application for basic membership is now being accepted. Membership is not restricted to professional musicians; all interested par-

ties are invited to apply to Mr. David Kushner, Associate Professor of Music, Graduate Division, Radford College, Radford, Virginia 24141.

RICHARD W. MASSA, *Treasurer*
American Liszt Society
Chickasha, Okla.

Piano Rolls

● Frankly, I have been disturbed by the reviews in general, not necessarily just Igor Kipnis' (February), of recent piano-roll recordings. I am thinking particularly of the



Argo records, which everybody praises, and the Everest records, which everyone seems to pan.

I heard Rachmaninoff, Hofmann, and Paderewski many times. I own most of their phonograph records, and I have a fairly vivid recollection of how they played. In light of this, an Argo record I purchased was not as good as I expected, and the Everest records, judging by the three I have now acquired, are infinitely better than the reviews would have led me to expect. Incidentally, I am also fairly familiar with how the Duo-Art, Ampico, and Welte-Mignon rolls sounded when they were new.

Let's not kid ourselves: all these transfers sound a little bit like piano rolls, even the much-praised Argo. And some sound more lifelike than others—wasn't this true of all phonograph records until just lately?

However, the Everest Grainger—and I heard him many times—stands up to the measure of memory, and also when compared to his Columbia records. The Everest Hofmann Beethoven Sonata, Opus 2, No. 3, seems to me a real roll-recording achievement. I've listened to it several times now and am most impressed. And just now, I listened to a third Everest record, the Paderewski Chopin. It's Paderewski, there's just no doubt about it—slightly limited by piano-roll techniques, but still there in essence.

As time goes on, I am more and more impressed by what this purely mechanical recording technique accomplished. I hope both Everest and Argo go on with their good work!

FRANKLIN W. BARTLE
Martinsville, N. J.

Sara Carter's Records

● Regarding the album "Sara and Maybelle Carter: The Original Carters" reviewed by Peter Reilly in the February issue: someone goofed, and it appears that it is not Mr. Reilly. "Uncle" Johnny Cash states, in the liner notes to the album, that this is Sara's first recording in over twenty-six years. He's wrong. In 1952 and 1956, the Carters (minus Maybelle, but with the addition of Sara and A.P.'s children Joe and Janette) recorded some seventy-one tunes for Acme Records. At least half of these were released.

KATHY KAPLAN
Oceanside, N. Y.

uniCLUB Inc.

saves you plenty on

RECORDS TAPES STEREO GEAR BOOKS



Here are 10 facts about uniCLUB. They are 10 reasons to clip the coupon and join now!

1. Any LP or tape on every U.S. or foreign label available. Columbia—Capitol—RCA—London & 350 more. No exceptions.
2. You save a minimum of 35% on LP's; 33% on tapes and 25% on books.

LP's LIST	uniCLUB
\$1.98	\$1.23
2.98	1.85
3.79/98	2.39
4.79/98	2.99
5.79/98	3.69

3. You can save even more by taking advantage of the regular extra discount "Specials." Save up to 80% off list price. Right now, for example, the entire RCA Red-Seal catalog is \$2.75 mono; \$3.25 stereo. The Vox \$4.98 series is \$1.75 mono and stereo.

4. Never a requirement to buy. No monthly "stop-order" forms to return. You receive just what you order.

5. LIFETIME MEMBERSHIP

The club membership fee is \$5. This is for lifetime privileges which are increasing all the time.

6. FREE CLUB MAGAZINE

Members regularly receive "uniGUIDE" advising them of the latest releases, recommended best-buys and extra discount "Specials." When you join you receive a free 300-page Schwann record catalog listing every available record and its price. You receive a free Harrison tape catalog if you specify.

7. FASTEST SERVICE ANYWHERE

Your orders are not only processed but shipped the same day we receive them. This unique service is possible because your orders are picked from an inventory of over 250,000 LP's & tapes. You get factory-new sealed albums and tapes only. Defects are fully returnable at no charge.

8. SAVE UP TO 50% ON STEREO GEAR

Individual components or complete systems—

uniCLUB supplies hi-fidelity equipment of virtually every manufacturer at tremendous savings. This month's "Hi-Fi Special" is a Garrard Lab 80 turntable; List \$100.00, to members only \$59.95.

9. BOOKS OF ALL PUBLISHERS

The Book Division—only uniCLUB has it—offers members at least 25% off on any book in print.* You get only original publishers' editions. uniGUIDE lists best-sellers, just-published works and book "Specials."

*Texts are reduced 10%.

10. FOUR CLUBS IN ONE

uniCLUB is really a time-saver. It makes joining many clubs unnecessary. Now you can buy all your records, tapes, auto-cartridges, books and stereo-gear from one convenient source. We hope you'll join today!

SAVE MONEY EVEN ON YOUR MEMBERSHIP FEE

Give gift memberships with full lifetime privileges for only \$2.50 each. Splitting the cost with one other person lowers cost to \$3.75; enrolling five at a time brings cost down to only \$3 each.

Send my Free Schwann catalog, order blanks & uniGUIDE by return mail.

\$5 enclosed guarantees me:

1. LIFETIME MEMBERSHIP in uniCLUB
2. 35%-80% savings on LP albums, 1/3 off on tapes, 25% on books.
3. No requirements ever to buy anything. Nothing will ever be sent until I order it.

I must be delighted with uniCLUB or within 10 days I will let you know and receive a full refund.

uniCLUB Inc.

255 West 42nd Street DEPT. HS767
New York, N. Y. 10036

NAME _____

ADDRESS _____

CITY _____

STATE _____

ZIP _____

- Send gift memberships at \$2.50 each to names and addresses listed on attached sheet.
- I am also interested in pre-recorded tapes.

CIRCLE NO. 56 ON READER SERVICE CARD

Souped-up stereo

All-silicon transistors. Goes from 20-50,000 cps. +0-1 db.
Moving coil cartridge. 2 dual 5" speakers. Extra inputs and outputs.

The new Sony HP-450A proves once and for all that big sounds can come in small packages. Because in spite of its size, we've managed to give it the guts of a great big stereo system.

Our solid state, for instance, means *all* (not some) silicon transistors. Sure they're more expensive, but they're more reliable than germaniums, so we use them.

We don't try to get off cheap when it comes to cartridges either. We use the moving coil type. Like the kind used in broadcast equipment. (We don't try to

get by with the moving magnet or ceramic type.)

Our power amplifier picks up frequencies you can't hear (20-50,000 cps.) just to give truer sound to the frequencies you can hear (20-22,000 cps.).

It's set into a solid walnut cabinet and topped off with the big name in little distortion, Garrard's newest 60MKII turntable. (The amp, by the way, would run \$150 and up as a separate unit.)

There's even more speaker to our speakers. 2 dual 5" jobs (instead of 4") with a full 30 watts of music power.

Turn the set on full blast and it gives enough power to fill up a 50' x 50' room. Or turn it down low. Get into the headset. And no one will have to put up with your jazz at one o'clock in the morning.

Besides the headset jack there are enough inputs and outputs in the new HP-450A to build a do-it-yourself recording studio (8 in all).

That's our souped-up stereo.

Even with all its extras, it'll fit into the tightest parking spots. And the tightest budgets. **The new Sony HP-450A stereo music system.**



CIRCLE NO. 51 ON READER SERVICE CARD

Want to take full advantage of all that new AM and FM programming?



Fisher has a system.



With all the new stations, and with the system shown here, you can listen to Fisher quality AM, FM and FM-Stereo at the lowest cost-per-station in history.

The 220-T is Fisher's medium priced receiver that makes AM sound hi-fi enough to move in with FM-Stereo. And with 55 watts of music power, it can drive just about any speaker system.

The two XP-55 compact speaker systems shown are a logical complement to the 220-T. They put forth many times their size in clean, undistorted stereo sound.

As is, the 220-T receiver and XP-55 speakers make beautiful stereo music together. And, of course, they'll graciously lend their Fisher quality to a turntable or tape deck — or both — whenever you say the word.

The 220-T AM-FM-Stereo receiver. 55 watts music power. Fully transistorized. Utilizes Field Effect Transistors for extremely selective front-end with high sensitivity. Illuminated tuning meter. Patented Stereo Beacon. Transist-O-Gard^(TM) overload protection circuit. Many other Fisher exclusives. \$329.50 (cabinet \$24.95). ■ The XP-55 compact speaker system. Cleanly reproduces the entire audible spectrum and beyond. Woofer utilizes a totally new suspension system. Special low-mass treble speaker. 10" x 20" x 9" deep. \$59.50.

CIRCLE NO. 26 ON READER SERVICE CARD



Mail this coupon for your free copy of the Fisher Handbook, 1967 Edition. This 80-page reference guide to hi-fi and stereo also includes detailed information on all Fisher components.

Fisher Radio Corporation
11-35 45th Road, Long Island City, N.Y. 11101

Name _____

Address _____

City _____ State _____ Zip _____

The Fisher 02016/7

NEW PRODUCTS

A ROUNDUP OF THE LATEST HIGH-FIDELITY EQUIPMENT



● **Harman-Kardon** is producing the Model SC6, a new AM/stereo FM receiver-turntable combination. The SC6 incorporates a BSR/McDonald four-speed record changer

equipped with an Empire 808 stereo magnetic phono pickup. The receiver has automatic stereo switching on FM, a stereo-indicator light, a front-panel stereo headphone jack, a tuning meter for AM and FM, and a switchable loudness control.

Specifications of the amplifier section include a power bandwidth of 17 to 23,000 Hz and a music-power output of 50 watts (25 watts per channel), both at less than 1 per cent distortion. Specifications of the tuner section include an FM sensitivity (IHF) of 2.9 microvolts and stereo separation of 30 db. AM bandwidth is 10 kHz. Price: \$329.50. A plastic dust cover is \$19.95 additional.

Circle 172 on reader service card



● **Olson** has available an octagonal three-way speaker system, Model S-879. The system employs a 12-inch high-compliance woofer, a cellular-horn mid-range, and a pair of 2½-inch super tweeters operating through an inductance-capacitance crossover network. The mid-range and tweeters are equipped with level controls to permit adjustment of their relative output levels. The cabinet is finished in oiled walnut and is accented with fretwork grilles. Power-handling capacity is 30 watts, frequency response is 40 to 20,000 Hz, and nominal impedance is 8 ohms. The cabinet measures 18½ inches in diameter and stands 25½ inches high. Price: \$200.

Circle 173 on reader service card

● **Furn-a-Kit's** Model S-2700-MC console cabinet kit is 84 inches long and approximately 32 inches high. It comes with panels cut out and fitted to accommodate the builder's choice of components, including a tape recorder. The cabinet also contains room for record and tape storage. Cabinets of other sizes and styles are available plus a variety of



matching hutches. The kits are available in sixteen different wood finishes to match any decor. All clamps, glue, hardware, and finishing materials are supplied; only a screwdriver is needed for assembly. All units have an unconditional money-back guarantee. Price for a kit of the unit shown is \$200.

Circle 174 on reader service card

● **Eico** has announced the publication of a new fully illustrated thirty-six-page catalog that includes their complete

line of two hundred electronic kits and factory-assembled instruments in the fields of high fidelity, amateur radio, and test equipment. Featured in the catalog are the new Cortina series of hi-fi instruments. The catalog is available free of charge.

Circle 175 on reader service card



● **Rectilinear Sound** has designed a three-way speaker system, the Rectilinear III, that employs six separate drivers. The low-frequency reproducer has a 10-pound magnetic structure and a butylized cone surround that permits 1-inch cone excursions. The fundamental resonant frequency of the low-frequency speaker is 20 Hz. At 250 Hz, the woofer crosses over to the mid-range driver which is sealed in a

non-resonant fiber chamber. The mid-range unit has a secondary dispersion cone that provides a wide diffusion pattern without mid-range peaks. Crossover to the four high-frequency drivers (consisting of two tweeters and two super tweeters) takes place at 3,000 and 11,000 Hz. The high-frequency membranes are fabricated for wide dispersion characteristics, and all six speakers are bonded to the front panel with an epoxy resin. System impedance is 8 ohms, and overall frequency response is 22 to 18,500 Hz, ±4 db. The amplifier power required is 20 watts, and the maximum power capacity of the speaker is 100 watts. The oiled walnut enclosure measures 35 x 18 x 12 inches. Price: \$269.

Circle 176 on reader service card



● **Aiwa's** Model 719 is one of the few battery-powered (eight D-type cells), 7-inch-reel tape recorders available. The three-speed machine (7½, 3¾, and 1⅞ ips) will also operate from a car battery, and has a built-in con-

verter for a.c. operation. A separate motor is used in the 719 to achieve fast wind and rewind. Other features include a built-in 5 x 3 inch speaker, a digital tape counter with pushbutton reset, an automatic volume control (AVC) circuit to prevent recording-level overload, a playback tone control, and a microphone with a remote-control switch. Equalization conforms to NAB standards, and wow and flutter are less than 0.25 per cent at 7½ ips. When closed, the 719 has the appearance of a standard 16½ x 13 x 3½ inch attaché case. It weighs 16½ pounds. Price is \$139.95.

Circle 177 on reader service card

● **Audio Magnetics** has published a free six-page illustrated booklet, "Magnetism and the Critical Dimensions," that discusses the manufacturing procedure and technical properties of high-grade magnetic tape. A special prerecorded demonstration tape is offered in the booklet.

Circle 178 on reader service card

● **Channel Master** is producing a semi-automatic antenna rotator in several styles in addition to the standard manual models. The drive units for all new models have been given increased torque to handle heaviest fringe-area antennas and stacked arrays. The semi-automatic Colorotor,

(Continued on page 20)

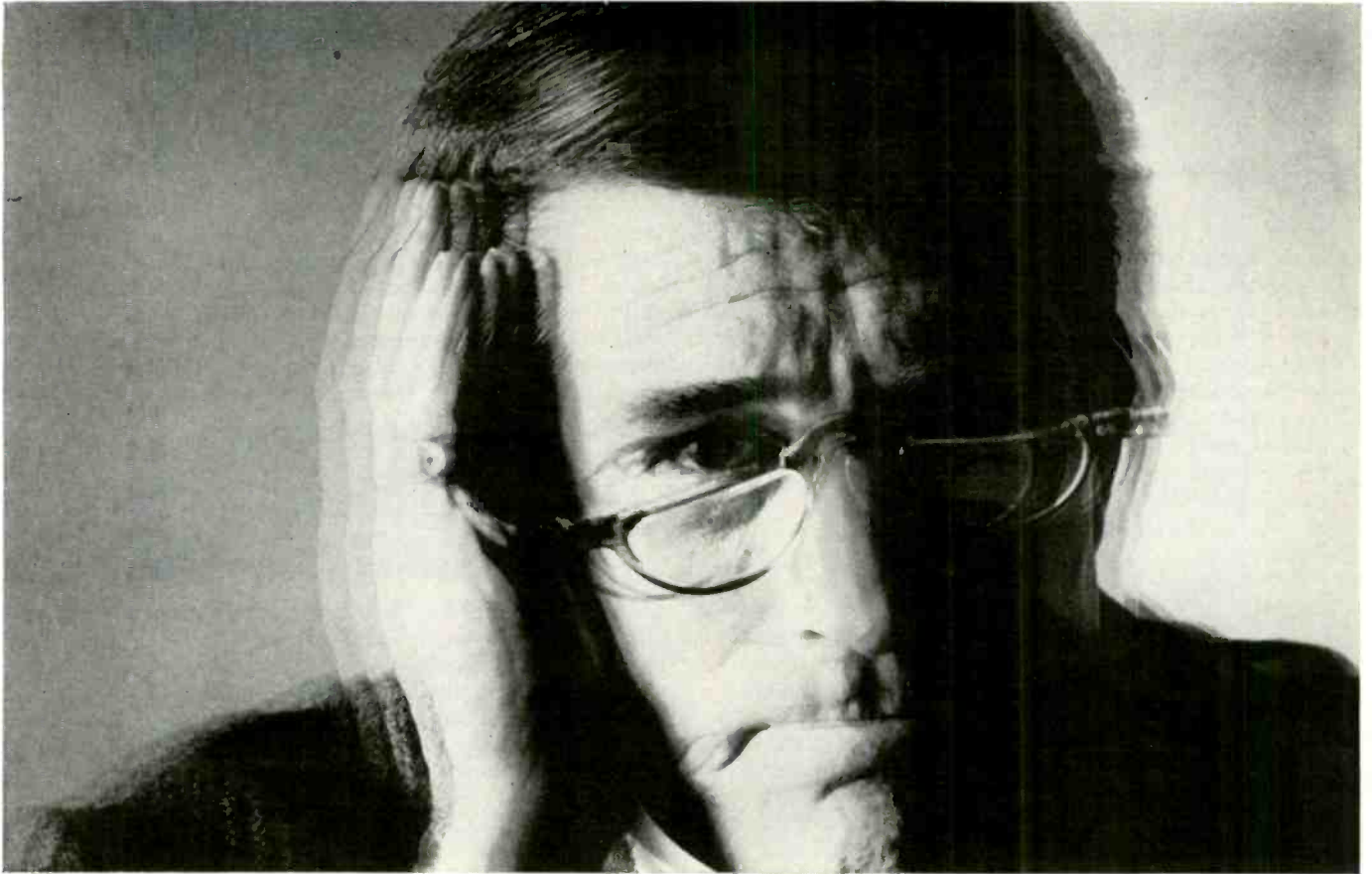

This will bring out the worst in your high fidelity system

Shure development engineers have created a unique recording that authoritative high fidelity critics call the most significant new test record in years. It enables you to identify certain prevalent distortions that you may have blamed on speaker break-up, pressings, or amplifier overloading for what they really are: tracking distortions brought about by the stylus parting company with the record groove. Comprehensive notes and a working "score chart" guide you through the entire recording. Your own ears are the only diagnosis "instrument" necessary. It will conclusively prove to you the importance of the new specification called "Trackability", and demonstrate the clear-cut superiority of the revolutionary Shure V-15 Type II Super-Track™ cartridge in achieving maximum trackability. Recording TTR 101, "An Audio Obstacle Course" is available directly from Shure for only \$3.95. (Residents of Illinois must include Illinois State Sales Tax.) Send your check or money order to Shure Brothers, Inc., Dept. 63, 222 Hartrey Avenue, Evanston, Ill. 60204.



P.S. Incidentally, purchasers of the Shure V-15 Type II cartridge automatically get the record free.

NEW PRODUCTS

A ROUNDUP OF THE LATEST HIGH-FIDELITY EQUIPMENT

Model 9513, incorporates a servomotor instead of a meter in the control box. This motor, driving the position indicator dial, is synchronized with the rotator drive motor to provide more precise aiming and relocation of stations than is possible with the usual meter indicators. Connection of the new semi-automatic model is simplified through the use of three-conductor wire that carries the antenna signal and the rotator-control signal. Suggested list prices are \$39.95 for the manual model, \$44.95 for the semi-automatic, \$49.95 for the automatic, and \$59.95 for the automatic model with wood cabinet control console.

Circle 182 on reader service card



● **Dual's** new Model 1015 automatic turntable has a number of the same features as Dual's more expensive models, including a dynamically balanced tone arm, four speeds, direct-dial skating compensation, and a tone-arm cueing

system that can be used with either manual or automatic start. In addition to raising and lowering the tone arm at any point on the record, Dual's cueing device allows the slow arm descent of the damped cueing to be used during automatic start.

The low-mass, low-friction tone arm of the 1015 can track with a stylus force as low as 0.5 gram. The tone-arm counterbalance is controlled by a geared adjustment knob that can be locked in position when the tone-arm is balanced. Both tracking force and anti-skating are applied at the pivot of the tone arm by direct-reading numerical dials, each calibrated to the other.

The 1015 has adjustable stylus overhang for minimum tracking error, and its motor holds constant speed within 0.1 per cent even when a.c. line voltage varies ± 10 per cent. Two spindles are provided: a short spindle for single-play operation and a long changer spindle that will accommodate up to ten discs. The width and depth of the Model 1015 are $12\frac{1}{2} \times 10\frac{3}{4}$ inches. Price: \$89.50. A variety of bases are available, including some with dust covers, ranging in price from \$6.95 to \$29.50.

Circle 183 on reader service card



● **Lafayette** is introducing a voice-activated six-transistor microphone designed for use with any battery-operated transistor tape recorder that is equipped with a jack for remote microphone control. An electronically controlled relay in the microphone automatically starts the recorder when sound is picked up and stops the recorder when the sound stops. The microphone is equipped with a three-position switch for voice-control/off/-remote-manual functions. There is an additional control for adjusting the sensitivity of the microphone to compensate for background-noise levels. The microphone comes complete with cord, plugs, and instructions. Price: \$14.95.

Circle 184 on reader service card

● **Sherwood's** new Model S-7800-FET all-silicon transistor AM/stereo FM receiver is rated at 140 watts music power (with 4-ohm speaker loads) at 0.6 per cent harmonic dis-

ortion. The 8-ohm load power rating is 100 watts. The S-7800-FET has a field-effect transistor front-end tuning section that achieves a cross modulation (overload) rejection of -95 db. It has an FM sensitivity of 1.8 microvolts (IHF). The S-7800 incorporates automatic noise-gated FM stereo/mono switching; a stereo-indicator light; a zero-center tuning meter; a front-panel stereo-headphone jack;

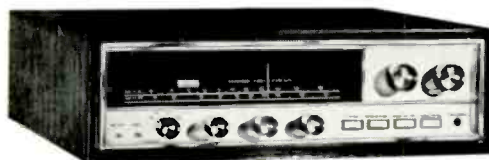

and rocker switches for selection of the tape-monitor, noise-filter, loudness-contour, and speaker-switching functions. Front-panel controls also permit adjustment of interstation muting and phono-preamplifier gain.

Other specifications include an IM distortion of 0.1 per cent or less at normal listening levels and a power bandwidth of 12 to 35,000 Hz. Sensitivity at the auxiliary input is 0.2 volt; at the phono input, 1.8 millivolts. The hum and noise level (below rated output) is -75 db at the high-level inputs and -63 db at the magnetic-phono input. FM signal-to-noise ratio is 70 db, capture ratio is 2.4 db, and FM distortion is 0.3 per cent at 100 per cent modulation. The S-7800-FET carries a three-year parts and labor warranty. Chassis size is $16\frac{1}{2} \times 14 \times 4\frac{1}{2}$ inches. Price: \$409.50 for the custom-mount chassis, \$418.50 in walnut-grained leatherette case.

Circle 185 on reader service card



● **Ampex** has announced a new series of compact professional tape recorders, the AG-500 series, designed for high reliability and intended for radio stations, small recording studios, and other critical users. The AG-500 replaces the previous

model PR-10 and has completely solid-state electronics and a new drive motor designed for long running time between lubrications and other service procedures.

The recorder is available in a one-channel version (shown), a two-channel half-track stereo version, and a two-channel quarter-track stereo version. Four heads can be accommodated. All three configurations have two inputs with built-in mixing facilities for each channel. The one-channel portable model is 20 inches wide, 14 inches high, 9 inches deep, and weighs 42 pounds. The stereo unit (two- or four-track) weighs 10 pounds more. The AG-500 is also available for rack mounting and with remote control.

A choice of two speeds is offered—15 and $7\frac{1}{2}$ ips or $3\frac{3}{4}$ ips. Overall frequency response, at the fastest speed, is 30 to 18,000 Hz ± 2 db. Signal-to-noise ratio ranges from 50 to 60 db, depending on speed and track width. Flutter and wow range from 0.15 per cent to 0.25 per cent (at the slowest speed). Timing accuracy is ± 0.25 per cent at $7\frac{1}{2}$ ips. Cost of the AG-500 ranges from \$1,202 to \$1,524, depending upon head and channel configurations.

Circle 186 on reader service card

What makes a loudspeaker a bargain?

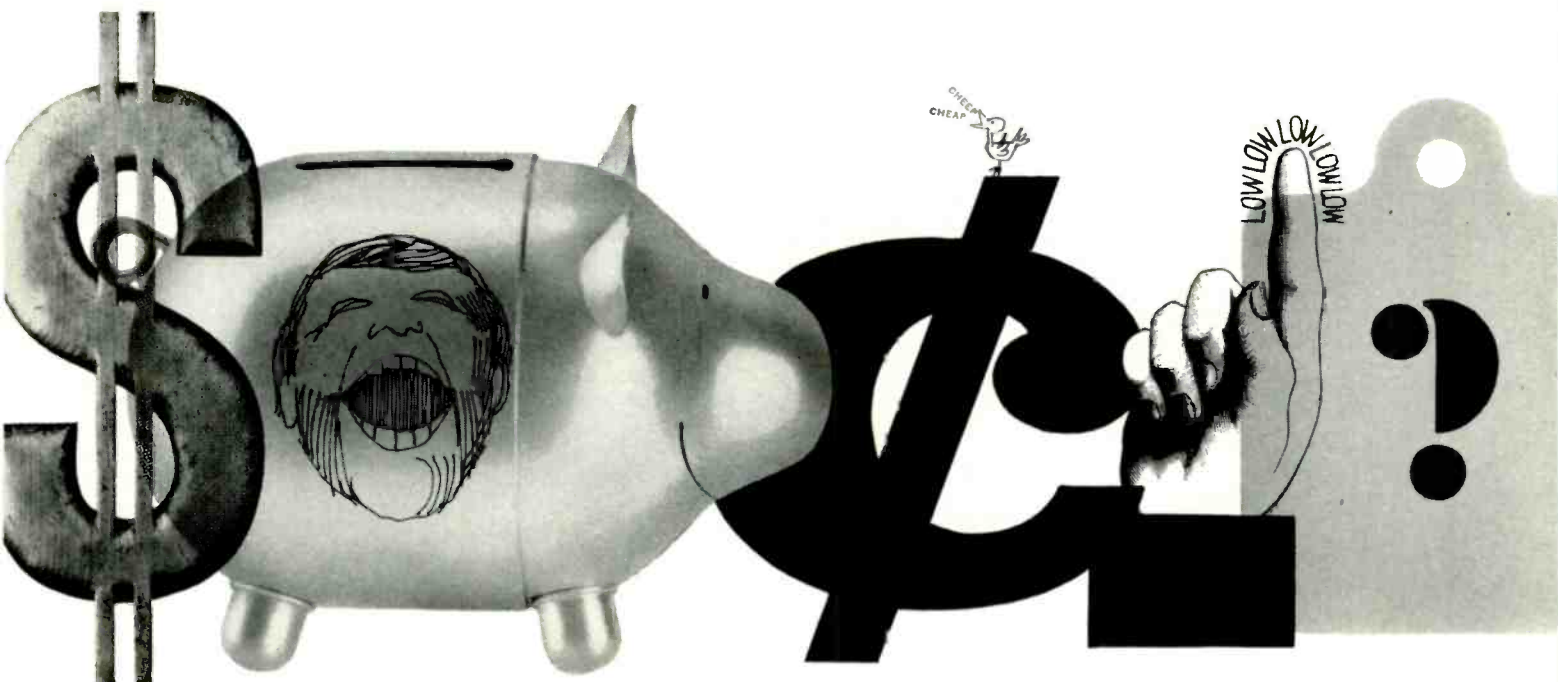

According to quite a few marketing experts, a bargain-priced product ought to have a little something missing. Just enough to leave you vaguely dissatisfied after a while, and get you thinking about trading up to something better.

We don't agree.

We are in business to make products that are at least as much of a bargain as their price says they are—and, hopefully, a lot more.

The new KLH* Model Twenty-Two is a case in point. We used every design technique in our experience to make it sound better than you expect. And since our experience in speaker manufacture is deeper than any other company's (we make every critical part in our speakers ourselves), we were able to design a low-priced system with virtually the same characteristic sound as a \$200 speaker.

We also took pains to make sure that the Model Twenty-Two would sound its best with moderately-priced, moderately-powered equipment. We used heavy

and expensive magnetic assemblies, and the same four-layer voice-coil design for its eight-inch woofer that we have employed in all of our more expensive speakers. And we designed a new two-inch high-frequency speaker that combines high efficiency with the ability to handle power at low mid-range frequencies.

We produced a speaker system that not only sounds expensive, but does so without the help of expensive equipment.

If you buy a Model Twenty-Two, you almost certainly won't be tempted to trade up next year to one of our more expensive systems. That doesn't disturb us at all. We would

much rather have you enjoy the Model Twenty-Two—and tell a friend about it.

Quite a few people already seem to be spreading the word on our new speaker. Before this first public announcement, we have already sold over three thousand Twenty-Two's. We think that says a good deal about it—and about your ability to recognize value when you see and hear it.

For more information on the Model Twenty-Two, please write to KLH, 30 Cross Street, Cambridge, Massachusetts 02139, Dept. H1.

Suggested
Retail Price: \$54.95
Slightly higher
in the West



CIRCLE NO. 32 ON READER SERVICE CARD

Surround Yourself with SONY Sound!



THE SOLID-STATE 530

...with XL-4 Quadradiial Sound

Imagine yourself at the podium, surrounded by a full symphony orchestra. Hearing everything. Missing nothing. Imagine that, and you will have begun to appreciate the exhilarating experience of the totally enveloping presence of the Sony 530's XL-4 Quadradiial Sound System. This four-speaker system, two in the 530's case and two in its detachable split-lid, produces a virtual curtain of stereophonic sound. And only speakers this magnificent could complement a recording and playback instrument as superb as the Sony solid-state 530. Sensitive to virtually the entire audible range, the 530 captures exactly what it hears from 40 to 15,000 cps, and dramatically reproduces it with

20 watts of pure music power. Certainly a performance to please the audiophile. Yet the 530 achieves its remarkable performance with a simplicity that will delight the entire family. From Retractable Pinch Roller for almost automatic threading to Automatic Sentinel shut-off, Sony designed the 530 to make professional-quality tape recording and playback a marvelously uncomplicated pleasure. The 530's features include 4-track stereo or mono modes, three speeds, separate bass and treble controls, pause control and two famous F-96 dynamic mikes. Truly, the 530 is a complete stereo entertainment system for the home, any home. It's yours to enjoy for under \$399.50.

AMERICA'S FIRST CHOICE IN TAPE RECORDERS



SONY'S PROOF OF QUALITY — A FULL ONE YEAR WARRANTY

For descriptive literature on the 530 or the rest of the best from Sony, write Superscope, Inc., Sun Valley, California, Dept. H-18

SONY MAKES THE WORLD'S MOST COMPLETE LINE OF TAPE RECORDERS, INCLUDING THIS SOLID-STATE STEREO TRIO

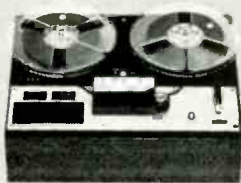

MODEL 250-A PERFECT PLAYMATE STEREO TAPE DECK RECORDER. UNDER \$149.50



MODEL 660 ESP-REVERSE SOLID-STATE STEREO TAPE SYSTEM. UNDER \$575.

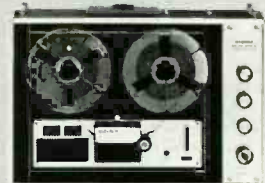

MODEL 260 RADIAL SOUND STEREO TAPE SYSTEM. UNDER \$249.50

CIRCLE NO. 52 ON READER SERVICE CARD

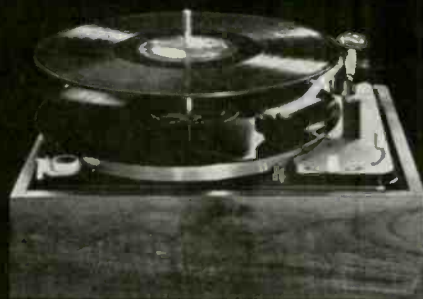

Perfect Playmates

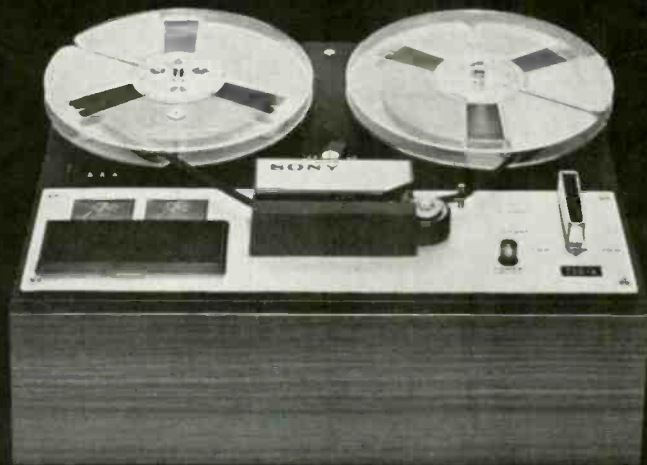

Sony adds an exciting new dimension to home entertainment for less than \$149⁵⁰

Now, from World-famous Sony, the perfect playmate for your record player—the new Sony model 250 solid state stereo tape recorder. With a simple, instant connection to your record player you add the amazing versatility of four track stereo recording and playback to complete your home entertainment center and create your own tapes from records, AM or FM Stereo receivers, or live from microphones—6¼ hours of listening pleasure on *one* tape! This beautiful instrument

is handsomely mounted in a low-profile walnut cabinet, complete with built-in stereo recording amplifiers and playback pre-amps, dual V.U. meters, automatic sentinel switch and all the other superb features you can always expect with a Sony. *All the best from Sony for less than \$149.50.* Send today for our informative booklet on Sony PR-150, a sensational new development in magnetic recording tape. Write: Sony/Superscope, Magnetic Tape, Sun Valley, California.

AMERICA'S FIRST CHOICE IN TAPE RECORDERS

SONY **SUPERSCOPE** *The Tapeway to Stereo*

SONY'S PROOF OF QUALITY — A FULL ONE YEAR WARRANTY
CIRCLE NO. 53 ON READER SERVICE CARD

TOP THIS!

**STEREO
tape decks
by AMPEX!**

\$199.95! Buys you the famous Ampex #850 stereo deck with 3 speeds, die-cast construction, dual capstan drive, deep gap heads, solid state circuits, VU meters and more! Or, for

\$299.95! get our feature-packed #1150 stereo deck with all the above plus automatic threading and automatic reversing!

SPECIAL TAPE OFFER!

Buy either of the above decks, and get \$100 worth of tape for \$39.95: any 10 of more than 75 of our top stereo tapes, plus two reels of blank tape. (Special tape offer and prices good only in the U.S.A.)

**Get true Ampex
quality at rock**

BOTTOM PRICES!

See your dealer today.

ask anyone who knows

AMPEX

AMPEX CORPORATION,
2201 LUNT AVE., ELK GROVE VILLAGE, ILL. 60007

CIRCLE NO. 4 ON READER SERVICE CARD

HiFi Q&A



By
**LARRY
KLEIN**

Video Tape Incompatibility

Q. I have been thinking about buying a video tape recorder, but considering the incompatibilities between the various makes of machines, it would seem to make little sense at the present time when one can not exchange personal tapes among friends and family or purchase prerecorded tapes with any assurance that they will be playable on other machines. Why haven't the manufacturers standardized tape speed, tape width, and so forth, with a view toward assuring compatibility among the various brands such as now exists with audio tape recorders? Are there problems not apparent to the casual observer?

MARK S. ELGIN
New Canaan, Conn.

A. Unfortunately, one cannot draw a parallel between the development of audio tape recorders and their standardization, and the development of video tape recorders. It is quite difficult to make a good, reliable, and inexpensive video tape recorder. When a manufacturer discovers an "easy" way to do it, he patents his technique and wants to be paid by anyone who uses the same approach. A potential competitor may feel that he can develop a video recorder using different techniques that work just as well, and thereby save himself a considerable amount of money by avoiding royalty payments. He therefore develops his own non-compatible technique for video recording, and it is used in machines produced by his company. In the next several years a shake-out should take place, probably when new manufacturers come into the field and choose to pay royalties to use existing systems rather than develop their own. Once this happens—and it has already started—there will be a certain pressure toward inter-brand compatibility. It is not improbable, however, that at least two or three mutually incompatible home video systems will be with us for the next four or five years.

Adding a Headphone Jack

Q. I have a 30-watt stereo amplifier jack, and I would like to install one on its front panel. How do I go about doing this?

ROSS AMATO
Cleveland, Ohio

A. Installing a headphone jack is not as simple a matter as it might appear. You will want some provision for cutting out the speakers when listening to the headphones, and you may need to place some attenuator resistors in series with each earphone in order to reduce the output level of the amplifier sufficiently to avoid hum and noise. Unless you have the electronic know-how to do all of this, your best bet is to purchase a ready-made headphone adapter box, such as is available from a number of manufacturers (wired or in kit form), and use it installed adjacent to your amplifier or in some other convenient place.

DIN Symbols

Q. A number of amplifiers and tape recorders have appeared that use small symbols to represent some control functions or the purpose of an input or output jack. What is the significance of the symbols and where do they come from?

ARTHUR GOLDEN
Oak Ridge, Tenn.

A. The symbols have been more or less standardized internationally by a German group known as the Deutsche Industrie Norm, which corresponds to our own ASA (American Standards Association). The symbols shown below are the most common and are used throughout Europe and the British Isles. They can be used either horizontally or vertically and indicate either an input or output jack or a control for some particular function.

(Continued on page 26)



PHONO



STEREO
MICROPHONE



TAPE RECORDER

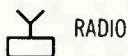

RADIO



HEADPHONE



DETECTOR OUTPUT



MICROPHONE



TEST POINT

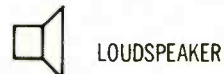

LOUSPEAKER

CIRCLE NO. 57 ON READER SERVICE CARD →

**Several interesting facts about the design of the new Dual 1015:
after you read them, you may wonder why other automatic turntables aren't made this way.**

You've probably noticed that many of the new automatic turntables, in several price ranges, offer features like anti-skating devices, levers for raising and lowering the tonearm (cueing devices), interesting motors of one kind or another, plus some pretty fancy designs for overall appearance.

Well, the new Dual 1015 has these things too. Even the fancy design for overall appearance.

But our features are different. Different because we don't offer them just to offer them. They are there to perform a real function. With precision and accuracy.

Take our anti-skating control.

It's there because, quite simply, our low-mass tonearm skates. No, that isn't something to be ashamed of. In fact, it indicates bearing friction so low (less than 40 milligrams, always) that there's no internal resistance to skating. Even at 1/2-gram. (You'll note that other arms offering anti-skating devices don't mention bearing friction. It's understandable. If bearing friction is high, skating never occurs in the first place.)

And that's not all.

Our anti-skating control is continuously variable and dead-accurate. It doesn't under-compensate or over-compensate. This means the stylus will track with equal force on both walls of the stereo groove. Also, our anti-skating control applies force internally, at the pivot, keeping the force constant throughout the record. You can't do this by applying

a dead weight to the outside of the arm.

Okay, now for our cueing control.

The purpose of cueing is to lower a stylus to a predetermined spot on a record. Accurately and gently. If it does neither, or just one of these things, it's not cueing. It's simply doing what you could do by hand (that includes damaging a high-compliance stylus).

Dual's cue-control is accurate and gentle. Rate of descent is .5cm/second and is controlled by silicon damping and piston action (which also prevent side-thrust from anti-skating). And the cue-control works on automatic as well as manual start.

Here are a few more things that should interest you:

Our hi-torque motor is a constant speed motor. It's quieter and more powerful than a synchronous motor, and turns the record accurately. Not just itself. (It maintains record speed within 0.1% even if voltage varies $\pm 10\%$.) Our counterbalance has practically no overhang (for compactness), and locks in position to prevent accidental shifting.

By the way, about that fancy design for overall appearance:

We know that a lot of you wouldn't even consider a top, precision product if it didn't look good.

With all that precision, and a price of only \$89.50, the Dual 1015 gets better looking all the time.

United Audio Products, Inc., 535 Madison Ave., New York, N.Y. 10022.

Dual 1015



The Perspicacious Germans Rate It

Wunderschön

"That the JansZen Z-600 is in first place is, no doubt, due to its extremely pure reproduction over the whole—and by no means short—frequency range."

*Hifi-Stereophonie—
Competitive tests of 49 speaker systems*



Technical specs alone aren't what led a German Hi-fi journal to rate the Z-600 speaker system tops in its class. **Hifi-Stereophonie** also comparatively tested speakers from around the world on the basis of musical quality. The practiced ears of hi-fi experts, audio engineers, record critics, and musicians judged the Z-600 best in its price-size category (which included some of the best known American and European speakers).

The Z-600 performance that earned their votes starts with the unique twin element JansZen Model 130 Electrostatic radiator. Its clean, transparent mid-high range reproduction is perfectly complemented by the Model 350 dynamic woofer specifically-designed to match the low-distortion characteristics of the Electrostatic. With its low-mass cone and flexible foam-treated suspension, the 350 does just as beautifully at 30 cps as the JansZen Electrostatic does at 22,000.

Just \$208.95 buys the speaker system that the discriminating Germans rated best. And a postcard gets you free literature plus a reprint of the full comparative test. See your dealer, or write:

NESHAMINY ELECTRONIC CORP.
JansZen FURLONG, PENNSYLVANIA
CIRCLE NO. 39 ON READER SERVICE CARD

Hi-Fi Storage

Q. I have recently been ordered to an overseas assignment, and since my hi-fi console system is far from portable, I was considering putting it in storage with the rest of my furniture. I have been told, however, that such "dead storage" can prove harmful to the equipment. Is this true?

1ST LT. ALVIN THOMAS
APO San Francisco, Calif.

A. Assuming that the equipment is being stored in a reasonably dry area, and not in someone's damp basement, no harm should come to the electronic parts, speakers, and wiring; however, the electrolytic capacitors in your set may, after a long period of disuse, undergo an electrochemical change. When this occurs, the capacitors have to be "reformed." That is best done by plugging in the amplifier to a variable source of a.c. power, such as a Variac, and slowly (over a 5-minute period) bringing up the a.c. line voltage from 0 to 120 volts. This will prevent blow-outs when the set is first turned on after a long period of disuse.

Automobile FM Antennas

Q. Since my car did not come equipped with an FM radio, I bought a portable transistor radio to use in it. Is there any particular type of wire antenna I could rig outside or inside the car to improve reception?

CLIFTON L. GANUS III
Denton, Texas

A. Most FM broadcast stations have gone over to, or are contemplating the use of, vertically polarized antennas, or at least antennas with a vertically polarized element. This means that ordinary automobile whip antennas now are quite effective in picking up FM. You need only rig some sort of jack or connection on your FM radio so that it will accept the particular type of plug used on automobile antennas. (A number of FM radios already have such jacks.)

If your car does not have an automobile antenna, simply install one. However, there are two points to watch out for. First, avoid any antenna that has a spring or a coil in its base; although this may enhance or make no difference in AM reception, it could choke off the FM frequencies. Second, unlike the situation with AM, where the longer the antenna the better, an FM antenna will pick up most efficiently when it is adjusted to a specific length. In general this will be about 30 inches (or $\frac{1}{4}$ the wavelength of a mid-band 98-MHz FM signal), but local conditions and the capacity of the antenna lead-in may require a slightly different length. In any case, adjust the antenna to some length around 30 inches that provides the best reception on the stations you wish to receive.

**WE DON'T
GUARANTEE THAT
THE DYNATUNER WILL
OUTPERFORM ALL
OTHERS . . .**



KIT 99.95
ASSEMBLED 154.95

But we can be confident that you can spend far, far more for an FM Stereo tuner and not receive more stations than you can get with a Dynatuner. Its low distortion and superior quieting will give complete listening satisfaction in comparison with the most expensive competitive units.

Perhaps our specifications are somewhat confusing. How can our modest 4 μ V IHF sensitivity compare with advertised claims which superficially appear to offer far greater sensitivity? Well, the answer is rather complex because effective sensitivity is not fully described by one measurement. It is the actual in-the-home performance which counts, though, and Mr. Baker's letter is just one of many examples of the Dynatuner's outstanding capability.

Because specifications measured under laboratory conditions do not relate directly to the reception problems encountered in the home, only an on-the-scene comparison can establish relative performance. Since this is not always possible, follow the lead of tens of thousands of satisfied users, and

TRY A DYNATUNER

More Dynatuners are in happy owners' homes than any other brand. It's just as easy to use as it looks. Tuning indication is precise, it automatically switches to stereo operation when you tune to a stereo broadcast, and drift is a thing of the past. Dynaco concentrates on performance.

... Shouldn't you?

Humboldt, Iowa

Dynaco Inc.
3912 Powelton Avenue
Philadelphia, Pa.

Gentlemen:

In January of 1966 I purchased an FM-3 Dynatuner from Holland Standards, Inc., Cedar Rapids, Iowa, who assembled it from a kit. While I have used it mostly for fine music listening (my principal station is over 60 miles away and broadcasts in multiplex stereo with an ERF of only 16,000 watts), I do some FM DXing for fun. The tuner is fed by a JFD 10 element log periodic FM antenna with a rotor on a tower approximately 40 feet above ground level. I do not live in a good reception area, altitude wise, for there are low hills (about 100 feet) less than a mile away in all four directions.

As of this date I have received 93 FM stations (list attached) plus 3 TV stations on Channel 6 received at about 87.7 Mc dial calibration. My most distant reception was a fully-separated multiplex signal from WFSU-FM in Tallahassee, Florida - a distance of over 1000 miles - in August of 1966. All stations listed have been verified by station ID's.

I believe that this number of stations received is unusual, particularly when you consider that there are only two FM stations within a 50 mile radius of my home.

I am very pleased with the performance of my Dynatuner.

Yours very truly,
Robert H. Baker
Robert H. Baker

A list of the stations Mr. Baker received is obtainable from Dynaco on request, along with two similar tabulations from other users: 125 stations received on a mono Dynatuner in northern New Jersey, and more than 60 stations received in Baltimore, Maryland on a simple indoor folded dipole antenna. All were logged on Dynatuners which were built and aligned from kits. Not all stations were received regularly, of course, nor all at the same time. Antenna position and design as well as atmospheric conditions affect reception, and it is not unlikely that another top-flight tuner might possibly match this performance. If you are spending more than \$300, you might well expect such results, but under \$100 it is unique.

Complete specifications and a comprehensive report on the Dynatuner is available on request, providing detailed test reports on several different samples for objective evaluation.

dynaco inc. 3912 Powelton Avenue
Philadelphia, Pa. 19104
IN EUROPE WRITE: Dynaco A/S Christian X's Vej 42 Aarhus C, Denmark

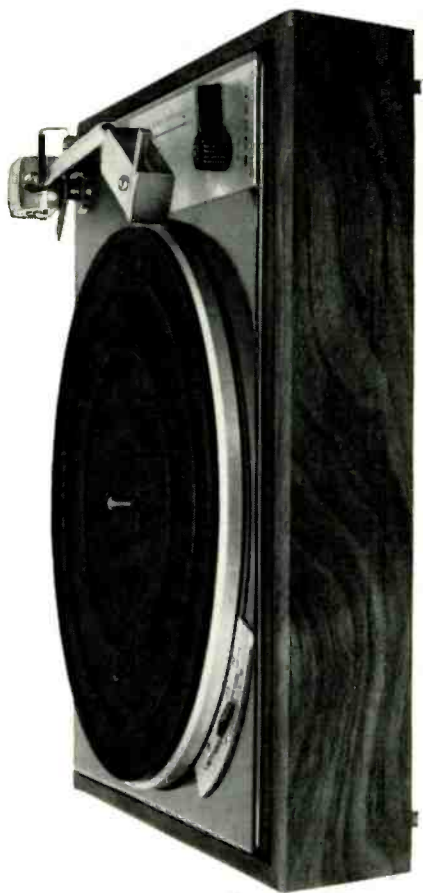

don't
just stand
there.

do something!

such as:

- cue automatically, precisely
- play all 4 speeds (with continuously variable range from 29 to 86 rpm)
- track flawlessly at 1½ grams
- boast a 12", 7¾ lb. platter

Bogen B-62
does it all...and all
for \$67.95

And it does it all on its handsome new oiled walnut tapered base. Says High Fidelity: "A turntable and arm combination of fine design and high quality performance... Well suited for any high fidelity installation". See your dealer or write Bogen for further details.

BOGEN

COMMUNICATIONS DIV.  LEAR SIEGLER, INC.
Paramus, New Jersey

CIRCLE NO. 7 ON READER SERVICE CARD

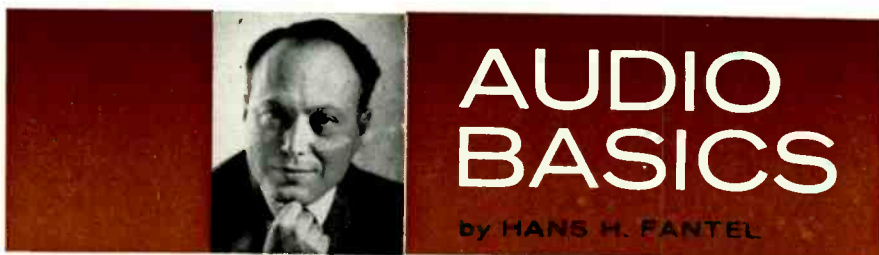

SPECIFICATIONS XI: AMPLIFIER POWER

IN THE whole realm of audio, there is no question more certain to inspire argument, and no argument more likely to generate heat than this one: How much power is enough power? This is understandable, because there is no standard answer. It is all very well to say "the bigger the better," but an amplifier's cost goes up along with its power rating, and for a given purpose in a given situation, an amplifier with an output of 25 watts per channel may fill the bill as well as one with 60. If he is not to be caught up in a numbers game that treats watts as Detroit treats horsepower, what the buyer needs are rational guidelines that will relate amplifier wattage to his specific needs.

Reputable audio manufacturers of course know better, but others spread confusion with grandiloquent claims typified by a recent newspaper ad that came to my attention: an inexpensive console with "300 watts superpower stereo." Even if such a rating were an honest one—and it surely is not—the obvious question is, "Is all that power necessary?" The best way of answering this is to examine the meaning of audio power in *musical* terms.

Contrary to all-too-prevalent notions, a lot of watts doesn't necessarily mean a lot of sound. A 100-watt amplifier at full volume, for example, can not play ten times as loud as a 10-watt amplifier, because the human ear doesn't translate power output into a directly proportional sense of loudness. What, then, is the reason for those extra watts, and why pay for them? The answer is that the difference made by greater amplifier power is *qualitative* rather than *quantitative*, showing up only in certain musical passages—a sharply attacked *forte*, a deeply resonant *sostenuto* in the lower strings, or a hugely swelling orchestral crescendo. Greater power improves reproduction in such passages not by increasing loudness, but by reducing distortion. Sudden strong accents, low bass notes, massed sonorities, and rip-roaring orchestral fireworks demand great surges of acoustical power. The larger amplifier, with its great power potential, has ample reserves that enable it to accommodate itself to the most strenuous demands of program material without strain.

A small amplifier, on the other hand, may sound perfectly fine most of the time, but then falter when the musical demands made on it become excessive. The result is distortion—blurs, crackups, and loss of clarity. This often happens within a fraction of a second—during the instant the piano hammer hits the strings or the stick crashes against the drumhead—so fast that the listener may not be aware that he is hearing distortion. Yet the overall impression of the music becomes clouded, losing its immediacy, and the result over any extended period is listening fatigue.

This does not, of course, answer the "how much power?" question in any but the most general way—in other words, "as much power as is necessary." What is "necessary" will be governed also by such other important factors as room size, the sound level at which you customarily listen to your music, and the music itself—a recording of a string quartet, for example, seldom makes excessive demands on the amplifier.

Having described the meaning of amplifier wattage in terms of subjective listening, I will next month consider some objective criteria for picking the power rating you need for your particular circumstances.



SONY[®]
NEW TA-1080

The new TA-1080 employs 30 Sony silicon transistors, some of them built specially for this new integrated stereo amplifier. The result: clean, natural performance over a wide frequency range.

The TA-1080, modestly-powered heir to the highly-regarded Sony TA-1120, delivers 90 watts IHF power to 8 ohms, both channels operating. Distortion is virtually non-existent at all power levels—less than 0.1% at ½ watt and 0.15 at rated output. Overall frequency response is flat from 30 to 100,000 Hz (+0 db/-2 db). Damping factor and signal-to-noise ratio are excellent.

The control facilities are everything you'd expect from the most deluxe units: quick-action switch for selecting the program sources most often used; a tone-control cancel switch and tape source monitor switch. Separate and independent tone controls for each channel provide better than 10 db bass and treble boost and attenuation.

The TA-1080 at \$299.50 is impressive in every way. You'll be most impressed when you hear it. The more powerful TA-1120, accorded a place in the top rank of stereo amplifiers by leading high fidelity editors, costs \$399.50. Hear them at your Sony high fidelity dealer. Sony Corporation of America, Dept. H, 47-47 Van Dam Street, Long Island City, N.Y. 11101

Prices suggested list

Building our own transistors has its advantages...Listen.



Marantz components are too good for most people.

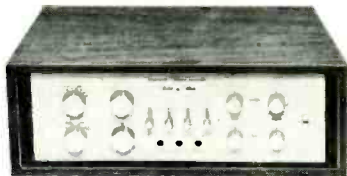

Are you one of the exceptions? For the most astonishing set of specifications you've ever read, write "Exceptions," Marantz, Inc., 37-04 57th St., Woodside, New York 11377, Department A-18.

marantz
A SUBSIDIARY OF SUPERSCOPE, INC.

The Marantz components illustrated, top to bottom: SLT-12 Straight-Line Tracking Playback System • Model 15 solid-state 120-watt Stereo Power Amplifier • Model 7T solid-state Stereo Pre-amplifier Console • Model 10B Stereo FM Tuner

CIRCLE NO. 35 ON READER SERVICE CARD

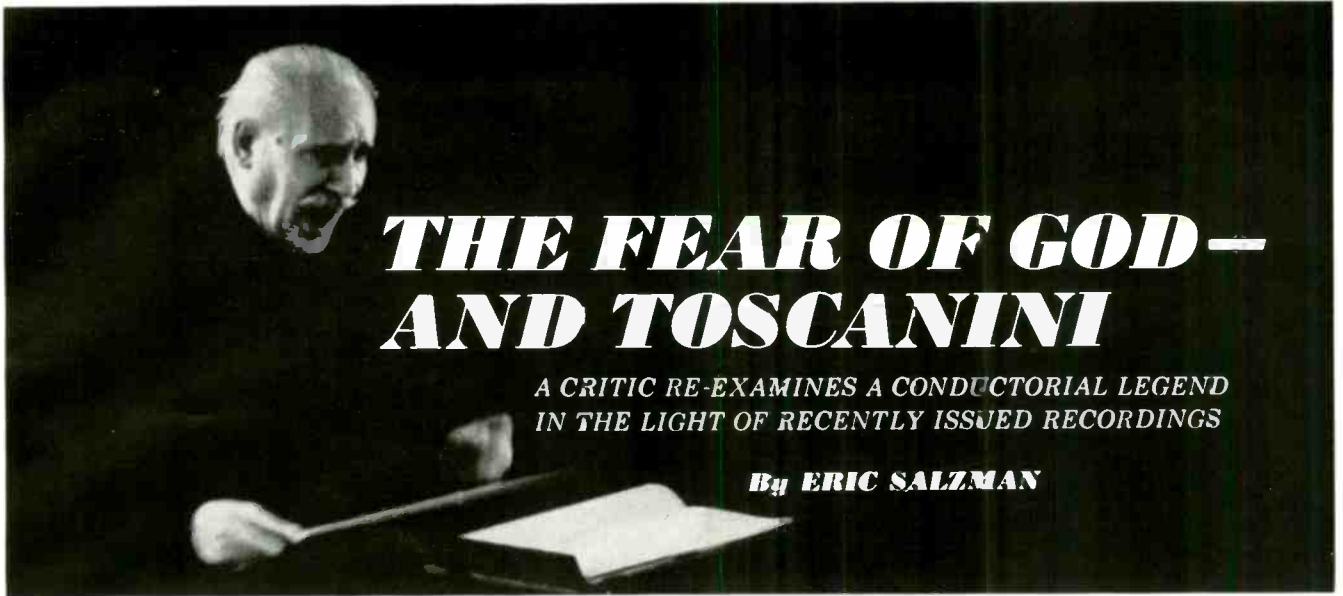

THE FEAR OF GOD— AND TOSCANINI

A CRITIC RE-EXAMINES A CONDUCTORIAL LEGEND
IN THE LIGHT OF RECENTLY ISSUED RECORDINGS

By ERIC SALZMAN

THE Toscanini centenary goes on apace: reissues of recordings, recollections, editorials, Sunday articles, and magazine pieces. No single musical interpreter—in his own lifetime, let alone years after his death—has continued to evoke such consistent admiration not only from the big public (à la Caruso), but from the cognoscenti as well.

At hand at the moment, for the centenary-minded, are (1) a batch of reissues stemming from Toscanini's famous 1937 B.B.C. performances (Seraphim) and (2) a selection of N.B.C. broadcast performances ranging over more than a decade and never before commercially available in recorded form (RCA Victor). All of the many N.B.C. broadcasts have been preserved, so RCA's set of five discs is a mere sampler, although a perfectly welcome one. I think every one of the broadcasts and recordings Toscanini (and, for that matter, anybody else) ever made ought to be available in dubbings from master-tape archives—on payment of a reasonable fee, of course.

Okay. Toscanini was born a hundred years ago, and some sort of commemoration is in order. But so is a reevaluation of the continuing and extraordinary phenomenon of Toscaniniolatry, the renewed admonitions to the faithful to come to the shrine and worship. Should we kneel and adore? Or should we stop and listen first?

Toscanini was a great man, without a doubt. He was a fiery, temperamental Italian, a musical genius, and all the other things the journalistic adjectives said he was. He was already famous by 1900, when he had more than fifty years of life and musical activity before him. And in those fifty years this little man bestrode the narrow world of music like a colossus. He was an autocrat in music and a democratic anti-fascist in life. He demanded and received a higher quality of orchestral playing than anyone had before him. He ended his career with a personal court orchestra put totally at his disposal with a full week-long rehearsal schedule to prepare a mere hour of music, most of it already familiar to his players. (Compare this with Haydn's orchestra at Esterháza or the modern European radio orchestras playing new repertoire every week—or with the hectic schedules of other American orchestras.) Toscanini revolutionized conducting, taking the play away from the old romantic virtuosos

and setting the crisp modern style now almost totally dominant in our orchestras (see, for example, Szell, Karajan, Solti, Leinsdorf—in the younger generation only Bernstein, a Koussevitzky pupil, is a stylistic hold-out). Toscanini and his orchestra set new high levels for orchestral performance; American standards have, in part owing to his influence, become the highest in the world. I am not sure that he was the very first non-Central European to invade the German-speaking countries with German repertoire (he was a great success at Bayreuth and Salzburg), but he was certainly the only one to leave a lasting impression. (Ironically, along with expatriate Bruno Walter, this Italian did more than anyone else for the best ideals of Germanic culture during its darkest days.)

Although Toscanini professed not to be terribly fond of recordings, he became the first major conductor to work for great periods of time within the orbit of mechanical reproduction processes, and this may have influenced his style. At any rate, ear witnesses have suggested that his familiar, clean, fast, high-powered approach was characteristic primarily of his later years. This may have been a response to the pitiless demands of the microphone (and of N.B.C.'s Studio 8-H), or it may have been a consciousness—something new in musical performance—of working for posterity. Toscanini, the perfectionist, unable to bear the (to him) glaring imperfections mercilessly revealed by the microphone and pressed into shellac or plastic for all time, would come back again and again to drive his charges harder and harder toward the never-to-be-achieved goal of perfection. What a responsibility; what a set of fears and obsessions! The results make up, no doubt about it, a recorded legacy of extraordinary documentary value. But are these models for all time, for future generations to marvel at, to study, to imitate? Are these invariably ideal and probing communications of a great cultural heritage clarified and made meaningful for us through the deepest and most universal insight?

I do not believe so.

I HAVE just spent the better part of a week with Arturo Toscanini—or, at any rate, with the Toscanini most of us knew: the man in his seventies and eighties, conductor of "the

greatest orchestra the world has ever known," the Italian with the terrible temper who smashed to bits the watch his musicians had just given him, the great classicist who worshiped Verdi, the past master and the torch bearer. I am old enough to have heard Toscanini in person and young enough not to quite remember what those performances were *really* like. Now I have tried to pick my way through the recordings, those listed here and others, with great care and attention, following even the most familiar pieces with score in hand. I have, in a sense, tried to listen freshly and with open ears—as a young student might today. I have reached a few conclusions and, with all respect, I offer them for what they are worth.

The most obvious thing about these performances is that, despite the written reports of Toscanini's willingness to change his mind, they are all remarkably similar. In the case of works recorded on two different occasions separated by a number of years (as with the Beethoven works recorded with the B.B.C. orchestra in 1937 and again in the late Forties and early Fifties with the N.B.C.), the conceptions remain the same and many interpretive details are identical. And there is no real modification of approach from one work to the next, from one composer to the next, or, for that matter, from one style or period to the next. By the late Thirties, Toscanini had made up his mind.

What is this approach? It has been defined by many writers in many different terms. I would describe it, in a brief phrase, as maximum clarity within the greatest feasible forward impulse. This is by no means merely a matter of fast tempos. Clarity and precision in matters of articulation and a remarkable feeling for phrase and phrase motion account for a good deal. Toscanini was, after all, an Italian and (by birth, so to speak) an operatic conductor. In later years, he nearly strangled his singers, not merely by putting the fear of God and Toscanini into them during rehearsal, but by squeezing the breath out of them in performance—through driving, whiplash tempos that had long since ceased to make sense for real voices. Even so, there was always that old theatrical impulse (more common in Italian operatic tradition than is often realized) to build up drive and excitement and to sustain tension

(Continued overleaf)



Arturo Toscanini (1867-1957)

over long periods—in symphonic as well as vocal music. And, in spite of Toscanini's famous ability to "clarify the inner voices," this is always really top-line conducting, taking shape from a tremendous forward projection of the dominant melody or rhythm. (Compare this with a Klemperer, desperately trying to hear not only inner voices, but harmonic motion as well, and hence constantly trying to slow things down.) I don't mean to imply by this that Toscanini neglected everything but the tune; I am talking about the way these pieces are basically conceived and projected. A Toscanini performance is like a relief map, structured on the big lines and showing contour in precise detail and proportion.

This and, one feels, this alone is the un-failing ideal of these performances. There is, for each score, a total and perfectly ideal sound image, in fact unrealizable, but almost palpable. Each actual performance is a kind of constant, unremitting, intense, unreal striving toward this goal. The qualities of excitement, drive, and tension that resulted (often through the famous head-on collisions in rehearsal between the men and the *maestro*) must have produced a tremendous effect on an audience, and some of this comes through even now in the distant medium of these old recordings. Musically speaking, this expresses itself not only in speed and crispness, but also as a kind of leaning into the phrase (often with an infinitesimal but regular anticipation of the beat), the music being constantly urged forward in a great flow of energy. But, perhaps inevitably, much of the live excitement that these performances generated eluded the microphone. What we have, objectively, are very fast, across-the-top readings, performed with more crackling tension and greater precision than anyone ever achieved before, but not necessarily with any great profundity. There is no quality of reflection. Without a second thought, Toscanini drives his men brilliantly, inexorably, and mercilessly toward that unquestioned sound image, that unrealizable goal long since fixed in his imagination (he could remember perfectly music he had not seen in forty years).

No doubt some of these performances begin to approach the goal. But—one must say it—in terms of sheer perfection of ensemble, many orchestral performances nowadays surpass these. This is not only a matter of improved recorded sound and tape-splicing techniques; it is true of live performances as well. Of course we are all standing on Tos-

canini's shoulders, but that puts us higher up nonetheless. (These recordings are, by the way, very poor even for their day—close-miked, dial-diddled, and ugly in their unbelievably unbalanced acoustic.)

Aside from all the other problems, there is the fact that the one obsessive approach was applied to many different kinds of music. There is the impression that Toscanini never for a moment thought about music as a Schnabel did—in a probing, analytic way; he worked simply, directly, and not a little naïvely from his single-minded aural vision. Sometimes, of course, the piece is right and the men really catch fire. And the fire comes in unexpected places: who, for example, remembers Toscanini as a Shostakovich conductor? And yet the tension, the drive, the nervous, edgy quality of the sound are extremely effective for the Russian composer's music.

In the Classical repertoire the case is more complex. Toscanini certainly performed a great service in clearing out a lot of the thick underbrush that had grown up around these works, obscuring many of their essentials. But again we are standing on Toscanini's shoulders. In our terms, he was not a great Classical stylist and, in fact, his much-vaunted fidelity to the score turns out to be a purely relative matter. Toscanini very definitely *did* follow many traditional alterations and fiddled with details himself, and we now know that playing Classical music in a fast, strict tempo is not invariably a demonstration of fidelity to eighteenth-century ideals. On the other hand, some of the lively, Italianate *buffa* writing that appears so often in the eighteenth-century symphony comes off very well indeed, and the vigorous "lighter" works of Beethoven (the Fourth Symphony, for example) are eminently successful. Perhaps the most important and meaningful performances are those of actual operatic *buffa*—from the Rossini Overtures to *Falstaff*. He must have been an effective Wagner conductor; it's hard now to judge. I have very mixed reactions to most of his non-operatic "Romantic" repertoire; he misses both the poetry and the unique structural qualities of the northern Romantic symphonists, substituting vigor and a sense of linear motion which often seems to be imposed from the outside.

Toscanini's limitations were, I believe, both a matter of temperament and a result of

a lack of contact with the creative side of the musical art. The latter point is not a new one; Toscanini has been criticized for this before—by Virgil Thomson, among others—and not without considerable justice. This was not merely a result of the fact that Toscanini performed little new music, that he was out of touch (why, at the age of eighty, should he have been *in* touch?), or that he did this piece and not that. He was one of the first of the modern virtuosos to be purely and essentially a performer, the prototype, in fact, of the new performer-interpreter specialist. The profession of conducting was invented and brought to its first high estate by composers, and the tradition has been continued by a distinct line of conductor-composers from Mahler to Bernstein and Boulez. Men like Weingartner, Furtwängler, and Klemperer may not be remembered by posterity as composers, but they were actually trained as such and wrote a good deal of music. Even a Stokowski or a Mitropoulos, not creators in the usual sense, always remained close to sources of creative ideals. But Toscanini was an interpreter pure and simple, and he deliberately eschewed any attempt to be "creative." The score was his only authority—the score and his own force of character. Toscanini, the non-creative interpreter, claimed that he was establishing the unique authority of the composer and the score, but in the process he sternly imposed his own brilliant, single-minded, devastating personality on everything he ever did.

Ⓜ TOSCANINI TREASURY OF HISTORIC BROADCASTS: Haydn: *Symphony No. 99, in E-flat; Symphonie concertante, in B-flat, Op. 84*. L. Mozart: "Toy" *Symphony*. Brahms: *Serenade No. 2, in A, Op. 16; Gesang der Parzen, Op. 89; Liebeslieder Waltzes, Op. 52*. Sibelius: *Symphony No. 2, in D, Op. 43; Pohjola's Daughter, Op. 49*. Shostakovich: *Symphony No. 7, Op. 60 ("Leningrad"); Symphony No. 1, in F Minor, Op. 10*. N.B.C. Symphony Orchestra, Arturo Toscanini cond. RCA VICTOR LM 6711 five discs \$23.99.

Ⓜ BEETHOVEN: *Symphonies Nos. 1, 4, and 6; Leonore Overture No. 1*. MOZART: *Overture to "The Magic Flute."* BRAHMS: *Tragic Overture, Op. 81*. B.B.C. Symphony Orchestra, Arturo Toscanini cond. SERAPHIM IC 6015 three discs \$7.47.

Although Toscanini first came to America in 1908 to conduct at the Metropolitan Opera, he returned to Italy for a time. Here he conducts a band on the Italian front in World War I.



COMPARE THESE NEW SHERWOOD S-7800-FET FEATURES AND SPECS! ALL-SILICON RELIABILITY, INSTANTANEOUS OUTPUT OVERLOAD PROTECTION CIRCUITRY, NOISE-THRESHOLD-GATED AUTOMATIC FM STEREO/MONO SWITCHING, FM STEREO LIGHT, ZERO-CENTER TUNING METER, FRONT-PANEL FM INTERCHANNEL HUSH ADJUSTMENT, MONO/STEREO SWITCH AND STEREO HEADPHONE JACK, ROCKER-ACTION SWITCHES FOR TAPE MONITOR, NOISE-FILTER, MAIN AND REMOTE SPEAKERS DISCONNECT, MUSIC POWER 140 WATTS (4 OHMS) @ 0.5% HARM DISTORTION, 1M DISTORTION 0.1% @ 10 WATTS OR LESS, POWER BANDWIDTH 12-35,000 CPS, PHONO SENS. 1.8 MV, HUM AND NOISE (PHONO) -70 DB, FM SENS. (IHF) 1.8 μ V FOR 30 DB QUIETING, FM SIGNAL-TO-NOISE: 70 DB, FM CAPTURE RATIO: 2.4 DB, FM CROSS-MODULATION REJECTION -95DB, DRIFT = .01%, AM SENS. 2.0 μ V, AM BANDWIDTH 7.5 KC, 45 SILICON TRANSISTORS PLUS 16 SILICON DIODES AND RECTIFIERS. SIZE 16 1/2 X 14 IN. DP.

Does Sherwood use F. E. T.'s?

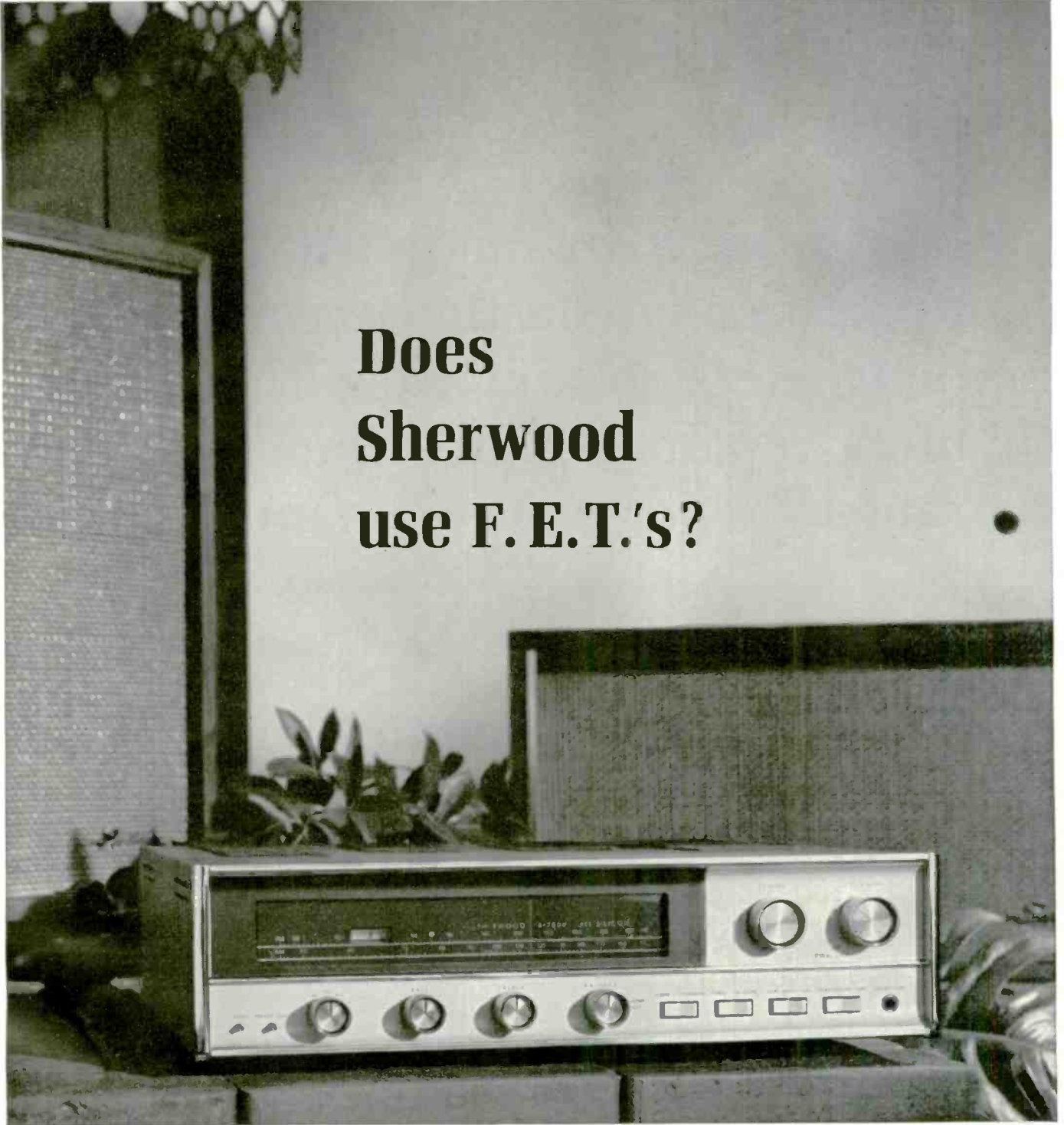

Did you think because Sherwood makes such beautiful receivers we would neglect Field-Effect-Transistor circuitry? The new Sherwood ALL-SILICON Model S-7800-FET FM/AM 140-Watt Receiver shown above has been specially designed for urban strong-signal locations.* This ALL-SILICON receiver offers unexcelled FM reception in areas where powerful local stations can interfere with the reception of distant and weaker stations. The Model S-7800-FET also features two separate front-panel rocker switches for multiple speaker installations throughout your home. Write for a complimentary copy of the new Multiple-Speaker Installation manual.

*Specially-selected Field-Effect Transistors in RF and Mixer stages of S-7800-FET improve cross-modulation rejection almost 10 times (20 db)

S-7800-FET 140-watt FM-AM ALL-SILICON Receiver
\$409.50 for custom mounting
\$418.50 in walnut leatherette case
\$437.50 in hand-rubbed walnut cabinet



Sherwood Electronic Laboratories, Inc., 4300 North California Avenue, Chicago, Illinois 60618. Write Dept. 7R

CIRCLE NO. 47 ON READER SERVICE CARD

Sherwood

from *Testing, Testing* by Ivan Berger in the

March 26, 1966 *Saturday Review*

suggest a cure by mail. At least one manufacturer (Acoustic Research) pays shipping costs to and from the factory on units repaired under their five-year warranty. And many manufacturers

We have heard a rumor that AR's five-year speaker guarantee* (covering all repair costs including freight and a new carton when necessary) doesn't cost us anything because AR speakers never fail. It isn't true.

For example, the return rate of AR-2a's and AR-2a's over the five-year guarantee period has been more than eight-tenths of one per cent. During the two years that we have been shipping AR-4's and AR-4's we have had to repair a full nine-tenths of one per cent of them at the AR plant (or at one of our repair depots in New York, Philadelphia, Chicago, Los Angeles and San Francisco).

These return percentages are actually lower than the figures projected by many carton manufacturers for shipping damage alone. They reflect heavy, over-

designed shipping cartons, and a quality control at AR which borders on the fanatical.

The superior quality of AR speakers and turntables, attested to in almost every review of AR equipment,** is not likely to change after years of use. If the unlikely does occur we take care of it—free during the guarantee period, at moderate cost afterward.

AR speakers are \$51 to \$225; the AR 2-speed turntable is \$78. Literature will be sent on request.

* AR turntables are guaranteed for three years under the same conditions.

** Lists of the top equipment choices of four magazines are available on request. All four chose the AR turntable, and three of the four chose AR-3 speakers.



ACOUSTIC RESEARCH, INC., 24 THORNDIKE ST., CAMBRIDGE, MASS. 02141
CIRCLE NO. 2 ON READER SERVICE CARD



HIFI/STEREO REVIEW presents the ninth article in the series
THE GREAT AMERICAN COMPOSERS

JOHN PHILIP SOUSA

"Any composer who is gloriously conscious that he is a composer must believe that he receives his inspiration from a source higher than himself. . . . Sincere composers believe in God."

—John Philip Sousa

By RICHARD FRANKO GOLDMAN

NOT MANY years ago, if one asked casually anywhere in the world for the name of the most famous American composer, it is likely that the answer would have been John Philip Sousa. Of course, times have changed, and today the answer might very well be

Aaron Copland or George Gershwin or Elliott Carter or Richard Rodgers instead. This is an interesting sidelight on the change of tone in American music: there is at least a chance today that the names of some "serious" composers might turn up in casual talk under almost any



In 1892 Sousa secured his release from the Marine Corps to form his own band, soon the most popular musical organization of its time. It toured everywhere, and the photo above, from the Nineties, may derive from the World's Columbian Exposition of 1893.

kind of circumstances. But, on the other hand, it is only in 1967, in our own time, that it is really possible to include Sousa quite seriously, without condescension or embarrassment, in a series devoted to "great" American composers.

Sousa obviously does not qualify as a "serious" composer any more than Johann Strauss does—rather less so, in fact. But it is on the level best represented by Strauss that Sousa has his secure and honorable place. Any music lover knows that Strauss was the best in his field, with sense enough not to wish or attempt to write symphonies, and that what he accomplished in his own limited musical world earned him the admiration of serious musicians as well as the affection of an enormous public. And so with Sousa. It is reported that Paul Hindemith once called Sousa the greatest American composer; whether the report is true or not, it is at least believable, and everyone can see why it might have been said. For, like Strauss, Sousa was not only the greatest in his own field, but was by and large quite satisfied to be what he was, and—again like Strauss—his name will always be associated with the undisputed mastery of a minor musical form which in a sense was his own creation. He was, so far as the march is concerned, an original as well as an important composer.

The marches of Sousa are part of the great heritage of the world's immortal music. Like the waltzes of Strauss,

they elevate a minor form of the dance to the level of art, and they transcend with the completest success—and apparently with the greatest of ease—the merely functional or the exclusively national. For Sousa's marches, uniquely American as the Strauss waltzes are Viennese, are also international in appeal, and speak in all tongues. They are great American music, but they are also great music.

The march, like the waltz, is a kind of dance, as highly formal as the minuet. This is a fact too often forgotten, perhaps because the steps of the march are so simple, being, in effect, nothing more than walking in time to a regular beat. But the fundamental appeal of the march is nevertheless based on its character as dance. Beyond that, we judge the lasting musical values of any genre by the viability of the music in concert form, and here Sousa's marches, like Strauss' waltzes, speak for themselves. They are part of the concert repertoire, as well as of the marching repertoire, throughout the world.

JOHAN PHILIP SOUSA was born on November 6, 1854, in Washington, D.C., in the southeast section near the Navy Yard, then known as "Pipetown." His father, Antonio, who was born in Seville, Spain, of Portuguese parents, had lived briefly in England and arrived in Washington, via Brooklyn, in the 1840's. His mother, née Elizabeth Trinkhaus, was a native of Bavaria. An-

tonio Sousa played trombone in the Marine Band, although not, apparently, as a full-time occupation; he also worked occasionally as a cabinetmaker. According to John Philip's account, as given in his autobiography *Marching Along* (1928), Antonio was a kindly, intelligent, well-read man, fluent in several languages, but not a technically proficient musician. His mother was totally unmusical. But many musicians, especially from the Marine Band, were among the family's friends, and John Philip began the study of solfeggio at an early age with one of these, a Spanish orchestral player named Esputa. At the age of seven, young Sousa began the study of the violin with Esputa's son, who had organized a music school in the neighborhood. Sousa stated that he was "passionately fond of music" from earliest childhood and never entertained the idea of becoming anything but a musician. He was also fascinated by military bands, of which there were many—good, bad, and indifferent—in Washington in those days. And so, while studying violin and "orchestration and sight-reading" at Esputa's school, he also found time to learn the trombone, baritone horn, and, apparently, the cornet and E-flat alto. His principal instrument, however, was and remained the violin.

By the time John Philip was thirteen, he was earning money as a musician, having organized a small "quadrille band" of which he was violinist and leader. Shortly afterward, he was offered a job playing baritone with a touring circus band, but to prevent the boy's running off with the group, his father had him enlisted, on

Sousa profited from the example of bandmaster Patrick Gilmore (1829-1892), whose band was widely famed for its concert tours.



CULVER PICTURES

Sousa on the March

"Marches, of course, are well known to have a peculiar appeal for me. . . . [they] are, in a sense, my musical children. I think Americans (and many other nationals for that matter) brighten at the tempo of a stirring march because it appeals to their fighting instincts. Like the beat of an African war drum, the march speaks to a fundamental rhythm in the human organization and is answered. A march stimulates every center of vitality, wakens the imagination and spurs patriotic impulses which may have been dormant for years. I can speak with confidence because I have seen men profoundly moved by a few measures of a really inspired march."

June 9, 1868, as an "apprentice boy" in the Marine Band. Here John Philip's duties were fairly light—he passed out music, ran errands, and played the cymbals—and he had plenty of time for further study and for outside engagements as a performer. In his autobiography, Sousa notes that "the first time I heard really fine music (apart from the ordinary orchestra or band programmes) was when the Franko family of five wonderfully talented children came to Washington for a concert." This was in 1869, and Esputa insisted that every student in his school attend the concert. Sousa notes further that this "was the first time I had heard real violin playing."

Sousa was evidently what we would call a "quick study"; in any case, his musical progress was rapid. He joined the Washington Orchestral Union as a first violinist, and studied harmony and violin with its conductor, George Felix Benkert, a solid musician who introduced him to the sonatas of Mozart and Beethoven, and who encouraged him in his early efforts at composition. Benkert, from all accounts, must have been an excellent teacher as well as a fine pianist and competent conductor, and Sousa was fortunate to have found him. Sousa himself was well aware of this, and wrote of Benkert with great affection and admiration in later years. He never studied piano with Benkert; when he asked for some instruction on that instrument, he quotes Benkert as replying: "You seem to have a gift of knowing a composition by looking at it, and you may develop into a very original composer if you follow that line of procedure; whereas, if you become a good pianist you would probably want to compose on the instrument and, if you are not careful, your fingers will fall into pleasant places where somebody else's have fallen before."

Sousa composed a great deal of music while he was still in his teens. His first published work was a set of waltzes entitled *Moonlight on the Potomac*, brought out by J. F. Ellis in Washington in 1872. In the following year appeared a galop, *The Cuckoo*, and a march called *The Review*, the latter listed as Opus 5. These were published by the firm of Lee and Walker in Philadelphia,

and Sousa's remuneration consisted of one hundred copies of each piece. Within the next few years Sousa wrote and published a considerable number of songs, salon pieces, and dance-tunes; by 1881, his catalog had reached Opus 135! After attaining that impressive total at the age of twenty-seven, he abandoned the practice of using opus numbers.

What is interesting in retrospect is that Sousa's early compositions did not include many marches. He seems to have been primarily interested in writing songs, for many of which he wrote his own verses. These songs range from the humorous to the sentimental, and it must be admitted that they are not distinguished. But it is typical of composers to love their least-favored works, and even in his later years Sousa was far more delighted when he heard one of his songs performed than he ever was to hear one of his marches. One wonders whether he ever heard a performance of the *Te Deum* he composed in about 1877, but of which no traces seem to have survived.

In any event, the *Te Deum* appears to be Sousa's only attempt at serious "art" composition. He seems to have been clearly aware that his real interests and talents were in commercial music for entertainment, and in the practical problems of earning a living as a performer. There is no evidence that at any time in his career he deeply cared for, or understood, the great music of the past or of his own time. But such an indifference is probably an asset to a popular composer; it prevents his becoming inhibited and precludes confusion about his musical aims. It must be remembered, too, that Washington in the 1870's was not exactly a cultural paradise, and that the opportunities for a serious musician, whether performer or composer, were pretty much limited to a choice between starvation and exile.

SOUSA re-enlisted in the Marine Band on July 8, 1872, to serve for five years as a principal musician, playing trombone. But he soon saw that there was little professional future for him with the band, and he was lucky enough to secure an early discharge through the good offices of an assistant secretary of state. When free of his Marine Band obligation, he seized an opportunity to conduct the orchestra at Kernan's Theatre Comique, a local variety hall, from which he went on to Ford's Theater, where Offenbach operettas were being performed. His first important experience as conductor came when he was chosen to direct the road company of *Bohemians and Detectives*, a very popular show written by Milton Nobles, who was also the star. On his return to Washington, Sousa was engaged as conductor for a production known as *Matt Morgan's Living Pictures*. This was considered a rather immoral entertainment, for in it appeared, for the first time on an American stage, the "undraped female figure." Show business being show

business, then as now, the production was of course billed as "artistic": the females posed in such edifying tableaux as *The Christian Martyr*, *Phryne before the Tribunal*, *The Destruction of Pompeii*, and other classics of the sort. The girls were nevertheless arrested in Pittsburgh, a city, in those days, apparently impervious to culture. And, as Sousa later related, the crowds grew bigger than ever as soon as the show, undraped female figures and all, went on again.

All of this was the direct method of learning the business. By 1876, Sousa had written and arranged a great deal of light theater music, and was beginning to look about for an operetta libretto for his own use. In that same year, he joined the orchestra conducted by Offenbach at the Philadelphia Centennial Exposition. This was an important experience for Sousa, for there can be no question but that the style of Offenbach made a real and lasting impression on the young violinist—perhaps the greatest single influence in the formation of Sousa's own style.

The Philadelphia Exposition also gave Sousa his first chance to hear Patrick Gilmore's famous band. Gilmore was the first great American band leader and a well-known entrepreneur and entertainer. His band was far superior to anything of its kind that had been heard up to that time. Gilmore had fine musicians, well trained and well directed, and he played a broad repertoire in generally excellent arrangements. Sousa was again at-

As evidenced by this smoking-jacket photo attributed to portraitist John Singer Sargent, Sousa wore his phenomenal success well.



BETTMANN ARCHIVE

VOCAL AND INSTRUMENTAL SELECTIONS



FROM
EL CAPITAN
THE NEW
COMIC OPERA

WRITTEN FOR THE
DeWolf Hopper Opera Co

BOOK BY
CHARLES KLEIN.
MUSIC BY
JOHN PHILIP SOUSA.

A Typical Tune of Zanzibar	Songs	5
Sweetheart In Waiting (Duet & Chorus)		5
El Capitans Song		4
March - Piano Solo		5
Waltz - Piano		7 1/2
Selections - Piano		10
Dancers - Piano		6
VOCAL SCORE (Book) \$2.00		

PUBLISHED BY
THE JOHN CHURCH COMPANY.

EDWIN FRANK GOLDMAN

TO
AUSTIN CORBIN, Esq.

**MANHATTAN
BEACH
MARCH.**

By JOHN PHILIP SOUSA.

PIANO 2 HANDS 20	PIANO 4 HANDS 20	MANDOLIN & GUITAR 60
BAND & HORN 100	PIANO & HORN 100	GUITAR SOLO 40
PIANO & HORN 100	PIANO & HORN 100	GUITAR DUET 30
PIANO & HORN 100	PIANO & HORN 100	BAND SOLO 40
PIANO & HORN 100	PIANO & HORN 100	BAND DUET 30
PIANO & HORN 100	PIANO & HORN 100	MANDOLIN & GUITAR 60
PIANO & HORN 100	PIANO & HORN 100	MANDOLIN & GUITAR 60
PIANO & HORN 100	PIANO & HORN 100	MANDOLIN & GUITAR 60

PUBLISHED BY
THE JOHN CHURCH COMPANY
CINCINNATI. NEW YORK. CHICAGO.

Sousa's publishers lost little time in making sheet-music copies of his latest compositions available in a wonderful variety of arrangements: piano (two-, four-, and even six-hand), mandolin, zither, guitar, and banjo. Would today's equivalent be a rash of L.P.'s?

tracted to the wind band as a performing medium, and when, a few years later, he started on his own sensational career as a bandmaster, the example of Gilmore was of considerable importance to him.

THE preparation for his future success as composer and conductor was, however, still continuing. Remaining in Philadelphia after the close of the exposition, Sousa played in various theaters, did some proofreading for a music publisher, and acquired a few pupils. In 1878, he trained and directed a group of Philadelphia amateurs in a series of performances of Gilbert and Sullivan's *Pinafore*. Innumerable companies were touring the country with this extraordinarily successful operetta, and Sousa soon found himself conducting a professional group performing the piece in New York and elsewhere. It was *Pinafore* that made operetta or musical comedy "respectable" in the United States; an editorial in the Philadelphia *Public Ledger* went so far as to point out the innocence, cleanliness, and purity of the piece, in contrast to the vulgar and improper theatrical entertainments to which no decent person could possibly go.

The experience with Offenbach, followed by that with Gilbert and Sullivan, made Sousa all the more anxious to do an operetta of his own, and early in 1880 he started work on *Our Flirtation*, to a libretto by James B. Wilson. The music was written quickly, and Sousa's first operetta was produced that summer in Philadelphia. It was a moderate success, and Sousa took the company on tour following the Philadelphia run. It was while in St. Louis with *Our Flirtation* that he received the invitation that was to change his career once and for all: to return to Washington as leader of the Marine Band.

Sousa apparently had some hesitation about accepting this post. The Marine Band was then in terrible shape, and the pay was small. He had recently married, and had just seen his first operetta launched. But he found the appeal of bands and of band music irresistible, and, on October 1, 1880, he became the Marine Band's new leader. Having literally grown up with the band, and having acquired considerable and varied professional experience, he was completely aware of what had to be done and how to go about it. He proposed to create a band as good as Gilmore's or better; fortunately, he had a commandant who was in complete sympathy with his aims.

Sousa was then just short of his twenty-sixth birthday, and, like many young men, felt that a beard would make him appear older and give him a more convincing air of authority. He managed to grow a truly terrifying one which he kept, trimmed to various styles and sizes, for a good part of his life. But the beard of the early Marine Band period was far and away the most luxuriant. Whether it helped to establish his authority or not, it certainly helped to establish an image for its wearer; and the authority, in any case, was clearly proved by the very rapid reformation of the band in terms not only of repertoire and musical performance, but also of discipline, morale, and working conditions. Within a remarkably short time, Sousa accomplished a complete reorganization and made the Marine Band a top-notch performing group for the first time in its history.

During his first years with the Marine Band, Sousa continued to compose, and as might be expected, more marches began to appear among his compositions, although they were still outnumbered by songs and salon

pieces. Two more operettas also appeared: *The Smugglers* in 1881, and *Désirée* in 1884. The first was a complete failure, but the second enjoyed a moderate success, and was notable for providing the vehicle for DeWolf Hopper's debut as a musical-comedy star. Sousa noted that *Désirée* was "not exactly a 'knockout,'" but that "it was more or less kindly received as one of the pioneers in American comic operas."

By 1884 or thereabouts, Sousa was able to note with satisfaction that his marches were well received, being played frequently by bands other than his own. These early marches included *Across the Danube* (1879), written in commemoration of the Russian victory over the Turks, *Resumption* (1879), composed to celebrate the Treasury's return to specie payment, and *Our Flirtation*, taken from the operetta of the same name. Of these, *Our Flirtation* is the only one still played occasionally. Wilfrid Mellers, the English music historian, in his book *Music in a New Found Land*, professes to see a touch of Johann Strauss in the *Our Flirtation* march, but I should be inclined to think Offenbach a more likely influence. At any rate, it is one of the best of the early marches.

Across the Danube is one of the very few Sousa marches I have never seen or heard; there is no copyright entry for it in the Library of Congress, and it is quite possible that it was never published, although this would seem to make it unlikely that bands other than Sousa's played it, unless they did so from legally or illegally copied manuscripts. The *Revival* march, one of the very earliest (1876), is a curious but very jolly piece, using as its trio the hymn tune *In the Sweet Bye and Bye*. Whether or not this was composed for some special occasion is unknown, but Sousa occasionally followed the same procedure in later marches, using parts or the whole of well-known tunes—as, for example, *Onward Christian Soldiers* in *Power and Glory* (1922), or *Rule Britannia* in *Imperial Edward* (1902).

THE connection between songs and marches in Sousa's work is always very clear. It is no longer generally remembered that many of the best marches came from operettas, in which they were, of course, sung. But still other marches were adapted from previously composed vocal pieces—*The Free Lunch Cadets* (1877), *We Are Coming* (1918), or *The White Plume* (1884), which derived from a choral piece entitled *We'll Follow Where the White Plume Waves*, to words by Edward M. Taber. For many of these pieces, as we have noted, Sousa wrote his own verses.

Sousa's first great "hit," a piece that is still familiar to anyone who has ever heard a band, was *The Gladiator*, composed in 1886. With this march and *The Rifle Regiment*, written in the same year, the authentic Sousa style became established. *The Gladiator* opens in a minor key, and is rather like a *pasodoble*, but it is full of original

Sousa touches. It is a glorious march and well deserves its immense popularity, but it is surpassed, in my opinion, by *The Rifle Regiment*, which is much less familiar. There are of course good reasons for this, and these reasons bear on the basic nature and uses of the march itself. *The Rifle Regiment*, to begin with, is more difficult to play, a good bit more subtle, and cannot be done effectively by a band on the march. *The Gladiator*, on the other hand, is almost ideal for the marching band; it is straightforward, jaunty, and bold, and not technically impossible to play while parading. It is, however, difficult—as are nearly all of Sousa's marches—to play well!

The Gladiator was sold outright to a Philadelphia publisher for thirty-five dollars, and this remained the price the composer received for most of his famous marches until 1893. Several very lucky publishers thus secured at bargain rates such masterpieces of their kind as *Semper Fidelis* (1888), *The Thunderer* (1889), *The Washing-*

In this pen-and-ink drawing (1905) by J. T. Lemon, the March King needs no identification beyond the titles of some of his works.



BETTMANN ARCHIVE

ton Post (1889), and *The High School Cadets* (1890). All of these were published in piano arrangements as well as band arrangements (and many of them in orchestra arrangements), and piano copies of *The High School Cadets*, for example, were ordered by dealers in lots of 20,000! (The piece, Sousa recalled, was often referred to as "The Ice-Cold Cadets.") The marches made Sousa's name a household word, but they did not make him rich. In 1890, a friend of Sousa's was able to report to him that he had heard no fewer than seventeen different bands playing *The Gladiator* during a single parade in Philadelphia.

The most famous of the early marches was unquestionably *The Washington Post*, named for the well-known newspaper and composed for a ceremony sponsored by that paper on June 15, 1889, "to encourage learning and literary expression in the public schools." The fiftieth anniversary edition of the newspaper recalled that the march "was an instantaneous hit, and soon all the bands in town were playing it." More important, perhaps, for the composer, it was selected by the Dancing Masters of America at their annual convention to introduce their new dance, the "two-step." When Sousa later went abroad, he found that the two-step itself was known as a "Washington Post."

The Washington Post soon was being played not only all over Europe, but also in places as remote as Borneo. Pirated editions rolled off the presses of a dozen countries, and when, at that time, a piece of American music was requested almost anywhere in the world, the chances were that the request would be answered with *The Washington Post*. Present-day march enthusiasts have forgotten that in the 1890's the march was not only a staple of the parade- and concert-band repertoire, but was also a ballroom dance and very often a topical song as well. Sousa thus arrived at precisely the right time to become a "hit" composer, for the circulation and popularity of his marches was vastly increased by the variety of their uses. At this time, it should be noted, when Sousa sold a march to a publisher, he was required to submit it in a version for piano and also to make arrangements for both band and orchestra. All this was included in the munificent purchase price!

BY 1893, Sousa realized that he had given away a fortune, and in that year he reached an agreement with the John Church Company of Cincinnati and elsewhere for the publication of his works on a royalty basis. The first marches published by Church were *Manhattan Beach* and *The Liberty Bell*. *The Liberty Bell* brought Sousa a return of some \$35,000 within a comparatively short time. (And, dear reader, remember that these were pre-1900 dollars, with no income tax!) This sum amounted to about twenty times what Sousa's annual salary had been as leader of the Marine Band before he

realized, in 1892, that he was being grossly underpaid. One can hardly wonder that in that year he arrived at the decision that the time was ripe to launch his own independent "business" band, bearing his own name. He secured his release from the Marine Corps in July, 1892, and on September 26 of the same year Sousa's new band gave its first concert, in Plainfield, New Jersey.

The forty-year history of the Sousa Band, from its founding in 1892 to the death of its conductor in 1932, needs little recounting. It was, as every reader knows, the most popular and successful band in history. It numbered among its members some of the greatest wind-instrument players of its time, and it created an enduring image of what a concert wind band ought to be. The band was never idle: it not only played in every part of the United States—lengthy engagements at fairs and expositions, and one-night stands at whistle-stops—but made four tours around the world. It was easily the best-known musical organization of its time. Sousa was fortunate to have as his manager in the early years of his band David Blakely, who had been manager of the Theodore Thomas Orchestra for a number of years, and who had also managed Patrick Gilmore's Band. Blakely had become acquainted with Sousa when he managed the Marine Band during the two tours that band had been permitted to make during the administration of President Benjamin Harrison. Blakely was also a music publisher, but in this field his judgment seems to have been less sure than it was in concert management. In *Marching Along*, Sousa recounts the following anecdote:

I had understood from Mr. Blakely that he would undertake the publication of my compositions, since he had a large printing establishment in Chicago, so my first piece written after I went with Blakely was offered to him. This was the well-known *Belle of Chicago* March. Blakely rejected it and when I questioned his decision, he wrote me:

"My dear Sousa, a man usually makes one hit in his life. You have made two, *The Washington Post* and *The High School Cadets*. It is not reasonable to expect you to make another, so I am willing to let Coleman publish *The Belle of Chicago*."

Despite the fact that conducting his own band kept him as busy as any two ordinary men, Sousa was still anxious to make his mark as a composer of operettas. In 1895, a libretto was submitted to him by the manager of DeWolf Hopper's "Opera" Company, who reminded Sousa of Hopper's "happy recollection" of *Désirée*. The libretto, by Charles Klein, was that of *El Capitan*, and Sousa found it much to his liking. Klein was not, however, very apt at lyrics, and so Sousa, with the collaboration of a writer named Tom Frost, also provided these. Among the verses composed by Sousa were those for the show's most popular selections: *Sweetheart, I'm Waiting*; *A Typical Tune of Zanzibar*; and, needless to say, the two songs that were combined to form that everlasting

The sound of America is somewhat different now, but the time was not long ago that the Sunday band concert in the park was a significant part of it. Many Americans can still remember the Sousa Band, shown here in one of its numberless appearances, which set the (usually unattainable) standard for others.

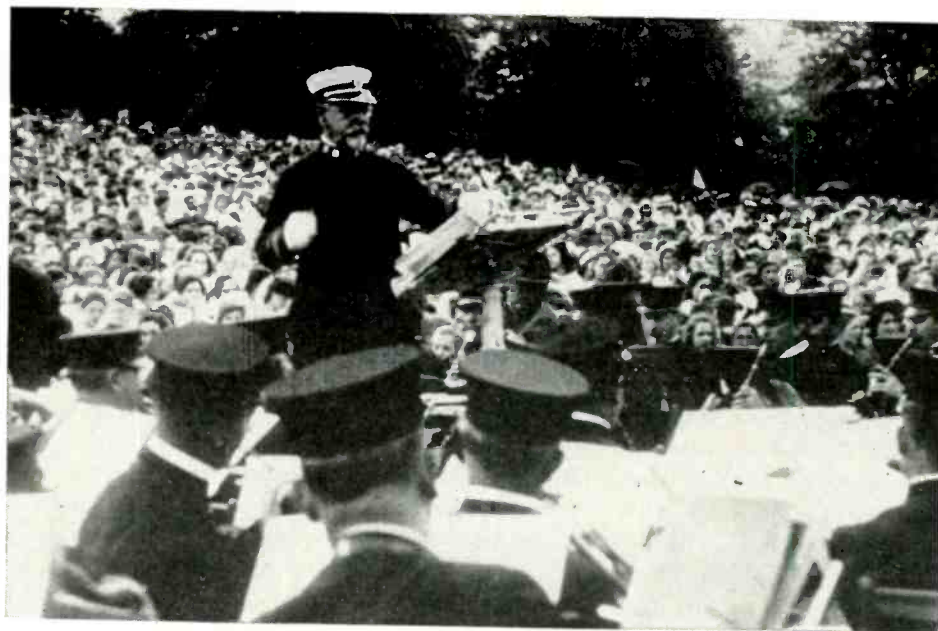

CULVER PICTURES

favorite among all Sousa works, the march *El Capitan*.

The operetta opened in Boston on April 13, 1896, with DeWolf Hopper and his wife Edna Wallace Hopper in the leading roles. It enjoyed a moderate success, and was played on the usual touring circuit of those days; but it did not, as Sousa hoped, compete in popularity with the Gilbert and Sullivan operettas or with that greatest success among American operettas, Reginald De Koven's *Robin Hood*, which had appeared in 1890. *El Capitan* was revived a few years ago by Howard Shanet at Columbia University and proved amusing as a period piece. But its tunes, aside from the marches, simply are not in a class with those of Sullivan or of Victor Herbert, whose first operetta, *Prince Ananias*, was produced two years before *El Capitan*.

The careers of Sousa and Herbert overlapped almost exactly, both in time and in variety of activities. It is not generally remembered that Herbert assumed the leadership of the Twenty Second Regiment Band in 1892 (a post he held for seven years) or that he also wrote some of the finest marches of all time. Herbert is today remembered almost exclusively for the charming tunes from his operettas and Sousa only for his marches. Both might have wished it to be otherwise. At any rate, during the 1890's, both men wrote both marches and operettas, and established enduring places for themselves in American musical history. Herbert's early operettas included *The Serenade* (1896), *The Fortune Teller* (1898), and *Babes in Toyland* (1903), to mention only a few of the best-known. Sousa followed *El Capitan* with *The Bride Elect* (1897), *The Charlatan* (1898), and *Chris and the Wonderful Lamp* (1899).

All that remain from any of the Sousa operettas are the marches. It is a curious thing that, despite constant production of operettas, Sousa was never able to write

a memorable tune that was not a march. On the other hand, it seemed impossible for him to write a march that was not memorable.

It should be noted that Sousa's marches do not all follow one pattern, as is often assumed and frequently stated, apparently by people who do not listen to them. It is true that all marches are in a two-to-a-bar rhythm, and consist for the most part of sixteen- or thirty-two-bar sections which are repeated. But within these patterns considerable variety is possible. The two-to-a-bar beat can be expressed as 2/4, 2/2 (*alla breve*), or 6/8 time, indicating that there are two quarter notes, two half notes, or two triplets to a measure. Sousa is truly the only great master of the 6/8 march, and this is the rhythm of many of his most effective ones: *Semper Fidelis*, *The Liberty Bell*, *King Cotton*, *The Washington Post*, and *Sabre and Spurs*, among others. The 6/8 march has a special swing, but in the hands of an untalented composer it can become a clumsy sort of trot. Sousa is certainly not the only composer to write delightful 6/8 marches (approximately half of all his marches are of the 6/8 type), but he is unquestionably the best and the most prolific.

The operetta marches, including *El Capitan*, *The Bride Elect*, *The Man Behind the Gun* (from *Chris and the Wonderful Lamp*), and *The Free Lance*, are unusual in that they combine the 6/8 and the 2/4. They are, in a sense, composites, but they all work beautifully, and the transition from one rhythm to another provides a mild musical shock that adds to their appeal. In each of these instances, Sousa took two separate numbers from the operetta and put them together for the concert version of the march. In *El Capitan* the opening strain is the song sung on his entrance by Don Medigua (who is also "El Capitan") in the first act. The words, by Sousa, are as follows:

1st strain
16 bars
6/8

You see in me, my friends,
A man of consummate bravery,
My inmost nature tends
To free the world from all slavery.
This thought then cherish,
Though you perish
Crush out Spanish knavery.

Behold El Capitan.
Gaze on his misanthropic stare,
Notice his penetrating glare;
Come match him, if you can,
He is the champion beyond compare!

2nd strain
16 bars
6/8

The second part of the march is taken from the Finale of Act II, and is in 2/4 time. The lyrics:

16 bars
2/4

Against the Spanish army
I must lead them, which is tough
(Chorus): BOOM BOOM
I'll certainly get hurt,
BOOM BOOM
Unless I can desert,
BOOM BOOM
Although in this deception
I have dabbled quite enough
BOOM BOOM
I'll execute another little bluff
BOOM BOOM BOOM

(Chorus)
break strain
4 bars

(Chorus):
16 bars
2/4

He'll lead them to the fray,
They say they'll win the day,
He'll lead them to the gory fray—
Unsheathe the sword and the banners fly,
When duty calls we will win or die;
The trumpet note and the roll of drum
Shall tell the foe the victors come.
(twice)

Sousa was active musically until his death in 1932, and radio was thus important in bringing his music to another generation.



CULVER PICTURES

The *El Capitan* March can thus be seen to consist of four sections (or strains) of equal length, sixteen bars each, with a four-bar introduction and a four-bar "break" or connecting section leading into the final chorus. Properly speaking, this is not a march with trio, but a song with chorus. Sousa used this four-strain form occasionally, as in *The High School Cadets* (which like many others has an eight-bar introduction), but his marches were more usually constructed of "A" and "B" sections, the "B" section being the Trio. Normally the "A" section consists of an introduction of four or eight bars, followed by two strains of sixteen bars each, and each repeated. In most marches Sousa then proceeds directly to the trio, the key of which is almost invariably an interval of a fourth higher. The trio will consist as a rule of a sixteen- or thirty-two-bar tune, repeated once or twice, with a "break strain" between the repetitions. In many marches, notably *The Stars and Stripes Forever*, the break strain is developed into a section of considerable importance, and is one of the highlights of the piece.

This most famous of all marches was composed in 1897, and according to the composer was what one refers to as an "inspiration." Sousa was in Europe when he heard the news of the sudden death of Blakely, his manager. He took the first available steamer back to New York, and tells this story in his autobiography:

Here came one of the most vivid incidents of my career. As the vessel steamed out of the harbor I was pacing the deck, absorbed in thoughts of my manager's death and the many duties and decisions that awaited me in New York. Suddenly I began to sense the rhythmic beat of a band playing within my brain. It kept on ceaselessly, playing, playing, playing. Throughout the whole tense voyage, that imaginary band continued to unfold the same themes, echoing and re-echoing the most distinct melody. I did not transfer a note of that music to paper while I was on the steamer, but when we reached shore, I set down the measures that my brain-band had been playing for me, and not a note of it has ever been changed. The composition is known the world over as *The Stars and Stripes Forever* and is probably my most popular march.

Probably everyone who has ever heard a note of anything has heard *The Stars and Stripes*, and even knows how it goes. Some are also aware that Sousa himself wrote words for it. But there is no question that the best-known lyrics to the tune are not Sousa's ("Hurrah for the flag of the free! . . ."), but those of an unknown parodist ("Be kind to your web-footed friends . . .").

The Stars and Stripes Forever is one of the more characteristic Sousa marches. It consists of a four-bar introduction, two sixteen-bar strains, a twenty-four-bar break strain, and a thirty-two-bar trio, which is played three times. In this trio, the band plays softly the first time through, while on the repetition the piccolos play their famous counter melody, and for the grand finale the trombones thunder out still another counterpoint

against the full force of the rest of the band. But of course the march is familiar to everyone, and needs no description. Sousa himself considered it his best, and the fact that it brought him (reportedly) over \$300,000 in royalties must have added to his satisfaction.

Whether *The Stars and Stripes* is indeed Sousa's best march is a subject for debate among band buffs. Sousa composed about one hundred and forty marches, and not more than two dozen are now familiar to the public. This is a pity, for the quality of the marches is uniformly high, from *The Gladiator* and *The Rifle Regiment* of 1886, to *The Kansas Wildcats* of 1931. The latter is, as a matter of fact, a rip-roaring, rowdy piece, with an intricate and technically challenging *obbligato* for the clarinets (in the second strain), and it is guaranteed to send any audience home whistling and in good humor. There are, in all, perhaps twenty of the Sousa marches that I prefer to *The Stars and Stripes*, and this number would certainly include such magnificent examples as *The Fairest of the Fair* (1908), *Hands Across the Sea* (1899), *The Invincible Eagle* (1901), *The Gallant Seventh* (1922), and of course such beauties as *The Washington Post* and others of the early years.

ONE of the reasons for the general lack of familiarity with so many of the great marches is, as I have suggested above, that they are difficult. Many of them are too difficult to play on parade, and, in fact, most of them are too difficult to be played at all, as they were originally written, by the average high school band, which is now the average American idea of a band. They can, of course, be hacked at; but as every good bandmaster knows—and Sousa most definitely did!—one of the hardest things a band can be asked to do is to play a march well. None of Sousa's marches are simple-minded; they are forthright, which is not the same thing, but they are also full of ingenious touches, and many of them are extremely sophisticated within their self-imposed limits.

The characteristics of the Sousa march that are most immediately apparent are a strong and almost irresistible rhythmic propulsion and a wealth of jaunty and memorable tunes. But there is a good deal more: there is real invention and daring. Sousa's harmony is considerably more wide-ranging than that normally found in marches; he often makes surprising modulations and never confines himself to the simple chordal vocabulary of tonic, dominant, and sub-dominant that forms the basis of most other marches. He uses "color" chords effectively, and is very fond of excursions into the minor keys. All of these technical devices, even when they are not recognized as such by the people who whistle the tunes, contribute enormously to the effectiveness of the marches, and help to make them as interesting as they are.

Sousa also wrote good counterpoint, or, in the popular vocabulary, counter-melodies, but his sense of melodic

movement was not confined to the obvious. The inner voicings in most of his marches are lively and interesting, and this is what is most often lacking in popular music in small forms. His bass lines are always solid and quite a bit more imaginative than the usual tonic-dominant oom-pah. But one of the most remarkable things about Sousa's style, almost unique in the march genre, is his telling use of rests. *The Rifle Regiment* and *Hands Across the Sea* are two fine examples of how effective a complete silence can be. Sousa may have admired and learned something from a famous earlier march, *The Washington Greys*, by Claudio Grafulla (d. 1880), who was bandmaster of the Seventh Regiment, N.Y. National Guard, during the Civil War and after. *The Washington Greys* is in a minor key and also uses rests with great effect; it is one of the few truly great pre-Sousa American marches. But if Sousa knew and admired it, which is probable, he soon surpassed it many times over.

Sousa had definite ideas as to what a march should be, and set them forth in *Marching Along*:

... a march must be good. It must be as free from padding as a marble statue. Every line must be carved with unerring skill. Once padded, it ceases to be a march. There is no form of musical composition where the harmonic structure must be more clean-cut. The whole process is an exacting one. There must be a melody which appeals to the musical and unmusical alike. There must be no confusion in counterpoints. The composer must, to be sure, follow accepted harmonization; but that is not enough. He must be gifted with the ability to pick and choose here and there, to throw off the domination of any one tendency. If he is a so-called purist in music, that tendency will rule his marches and will limit their appeal.

Three Sousa generations: the March King seated between his son John Philip Sousa, Jr., and his grandson John Philip Sousa III.



CULVER PICTURES



Several of Sousa's most famous marches were arranged by Hershy Kay as the score for George Balanchine's popular ballet *Stars and Stripes*. Patricia McBride and Jacques d'Amboise are shown here with the corps of the New York City Ballet in the final scene.

To go from Sousa's marches to his other compositions is a considerable letdown. The operettas and songs have been mentioned briefly, and that mention is sufficient. One should note that Sousa wrote ten operettas in all, and that he had hopes of one day writing a grand opera on an American subject. The last two of his operettas were *The Free Lance*, produced in 1906, with a ridiculous book by Harry B. Smith, the prolific operetta librettist who did *Robin Hood* for De Koven and a number of books for Victor Herbert; and *The Glass Blowers* (1909), with a book by Leonard Lieblich. A study of the scores does not encourage one to think that either could be successfully revived; they are period pieces, but not yet quaint enough to be amusing.

Much the same must be said of the dozen suites and the variety of miscellaneous compositions that Sousa featured on his band programs. Many of these had a considerable vogue, and one or two are still occasionally heard. But such works as *The Chariot Race from Ben Hur* (described rather ambitiously as a "symphonic poem") or the "Scene Historical," *Sheridan's Ride*, are better thought about as belonging to the history of American popular taste than actually heard in concert. The suites, the best known and most popular of which was *The Last Days of Pompeii*, are essentially old-fashioned silent-movie music. Sousa himself thought highly of *The Last Days of Pompeii*, which he wrote in 1893, but which he deliberately withheld from publication until 1912. In an interview of about 1898, Sousa said that he considered it his best work and preferred it to anything else he had done. I have heard it performed as recently as a dozen years ago; it is almost unbelievably naive, but its success in its time, and with the audiences for which it was performed, is quite understandable. It could conceivably be done today for a more sophisticated audience as a first-class specimen of musical "camp."

More interesting, at least from the standpoint of Americana, are the pieces that Sousa wrote for specific social or historical occasions, the grand march for the inauguration of President Garfield, for example, or *The Presidential Polonaise*, written at the request of President Chester A. Arthur for use at indoor ceremonies at the White House. *President Garfield's Inauguration March* was published in 1881 as Opus 131(!), and clearly belongs to the days before processions down Pennsylvania Avenue were motorized. The *Polonaise*, too, evokes a picture of another day, and the idea of seeing it choreographed is one to dwell on.

Like most successful men, Sousa had immense energy. Tours with his band kept him on the road for a great part of each year, and must have been extremely taxing. Yet he found time and strength not only to compose constantly—the complete list of his musical works is quite lengthy—but also to write three novels, an autobiography, miscellaneous magazine articles, and an incredible amount of light verse, including lyrics for some of the operettas. The most successful of the novels is actually no more than a long short story. Entitled *The Fifth String*, it was published in 1902 by the Bobbs-Merrill Company, with illustrations by Howard Chandler Christy. The prose is a very deep purple, appropriate to the tale it unfolds of a great Italian violin virtuoso languishing for love of a haughty American society girl, and it is a bit hard to reconcile this with the style of the man who wrote *The Washington Post*. The meeting of hero and heroine will give an idea:

During one of those sudden and inexplicable lulls that always occur in general drawing-room conversations, Diotti turned to Mrs. Llewellyn and whispered: "Who is the charming young woman just entering?"

"The beauty in white?"

"Yes, the beauty in white," softly echoing Mrs.

JOHN PHILIP SOUSA: A SELECTIVE DISCOGRAPHY

By James Goodfriend

THE following discography of the marches of John Philip Sousa is a selective listing, encompassing the most representative collections presently available on records of performances reasonably true to the composer's intentions. Proper tempo is critical in the performance of a Sousa march, and although a number of different conceptions of tempo are represented here, recordings of those groups that favor the excessively fast tempo typical of between-halves performances at college football games are not included. For the reader in search of a single disc to adequately represent Sousa in his record collection, I could certainly do no better than to recommend that by the Goldman Band (whose association with this music through the years is a matter of history) led by Richard Franko Goldman.

The marches are listed in alphabetical order, and the letters next to each march refer to the records (listed below) on which that particular march may be found. The records are listed in alphabetical order according to performing group; numbers in parentheses in each record listing refer to listed marches.

1. *Ancient and Honorable Artillery Company* (F)
 2. *The Black Horse Troop* (B, E, F)
 3. *The Bride Elect* (H)
 4. *Bullets and Bayonets* (D, E)
 5. *Corcoran Cadets* (B, H)
 6. *Daughters of Texas* (B)
 7. *El Capitan* (A, C, E, G, H, I, J, K)
 8. *Fairest of the Fair* (B, H)
 9. *Free Lance* (H)
 10. *The Gallant Seventh* (D)
 11. *The Gladiator* (G, K)
 12. *The Glory of the Yankee Navy* (F, G)
 13. *Golden Jubilee* (F)
 14. *The Gridiron Club* (F)
 15. *Hands across the Sea* (A, B, E, H, K)
 16. *High School Cadets* (A, D, G, H, I)
 17. *The Invincible Eagle* (A, D, H, I, K)
 18. *The Kansas Wildcats* (E, F)
 19. *King Cotton* (A, C, E, H, I, K)
 20. *The Liberty Bell* (D, E, H, I)
 21. *Manhattan Beach* (B, E, F, I, K)
 22. *National Fencibles* (K)
 23. *The National Game* (F)
 24. *New Mexico* (F)
 25. *Nobles of the Mystic Shrine* (A, D)
 26. *Our Flirtation* (D, G)
 27. *The Picadore* (D, I)
 28. *The Pride of the Wolverines* (F)
 29. *Riders for the Flag* (D, E)
 30. *Rifle Regiment* (B, F, H)
 31. *Sabre and Spurs* (A, D, E)
 32. *Semper Fidelis* (A, B, G, I, J, K)
 33. *Sesqui-Centennial Exposition* (F)
 34. *Solid Men to the Front!* (D)
 35. *Sound Off!* (D)
 36. *The Stars and Stripes Forever* (A, C, G, H, I, J, K)
 37. *The Thunderer* (A, C, G, H, J, K)
 38. *U.S. Field Artillery* (A, C, E, G, K)
 39. *Washington Post* (A, C, E, G, H, I, J, K)
- A. Sousa Marches.** American Legion Band of Hollywood; Decca Band, Joe Colling dir. (7, 15, 16, 17, 19, 25, 31, 32, 36, 37, 38, 39). DECCA Ⓢ DL 8368.
- B. Marches.** Eastman Symphonic Wind Ensemble, Frederick Fennell dir. (2, 5, 6, 8, 15, 21, 30, 32), and including marches by Edwin Franko Goldman, E. E. Bagley, and others. MERCURY Ⓢ MG 50080.
- C. Marching Along.** Eastman Symphonic Wind Ensemble, Frederick Fennell dir. (7, 19, 36, 37, 38, 39), and including marches by E. F. Goldman, F. W. Meacham, and others. MERCURY Ⓢ SR 90105, Ⓢ MG 50105.
- D. Sound Off.** Eastman Wind Ensemble, Frederick Fennell dir. (4, 10, 16, 17, 20, 25, 26, 27, 29, 31, 34, 35). MERCURY Ⓢ SR 90264, Ⓢ MG 50264.
- E. Curtain Up!** Eastman Wind Ensemble, Frederick Fennell dir. (2, 4, 7, 15, 18, 19, 20, 21, 29, 31, 38, 39). MERCURY Ⓢ SR 90291, Ⓢ MG 50291.
- F. Sousa on Review.** Eastman Wind Ensemble, Frederick Fennell dir. (1, 2, 12, 13, 14, 18, 21, 23, 24, 28, 30, 33). MERCURY Ⓢ SR 90284, Ⓢ MG 50284.
- G. Semper Fidelis.** The Goldman Band, Edwin Franko Goldman cond. (7, 11, 12, 16, 26, 32, 36, 37, 38, 39). HARMONY Ⓢ HL 7001.
- H. Sousa Marches in Hi-Fi.** The Goldman Band, Richard Franko Goldman cond. (3, 5, 7, 8, 9, 15, 16, 17, 19, 20, 30, 36, 37, 39). DECCA Ⓢ DL 78807, Ⓢ DL 8807.
- I. The Marches of Sousa.** The Band of the Grenadier Guards, Maj. F. J. Harris, M.B.E., cond. (7, 16, 17, 19, 20, 21, 27, 32, 36, 39). LONDON Ⓢ PS 139, Ⓢ LL 1229.
- J. Stars and Stripes Forever!** Harmony Military Band (7, 32, 36, 37), including marches by E. F. Goldman, R. Hall, and others. HARMONY Ⓢ HS 11076, Ⓢ HL 7276.
- K. Sousa's Greatest Marches.** Warner Bros. Military Band, Henry Mancini dir. (7, 11, 15, 17, 19, 21, 22, 32, 36, 37, 38, 39). WARNER BROS. Ⓢ WS 1465, Ⓢ WB 1465.

Llewellyn's query. He leaned forward and with eager eyes gazed in admiration at the newcomer. He seemed hypnotized by the vision, which moved slowly from between the blue-tinted portières and stood for the instant, a perfect embodiment of radiant womanhood, silhouetted against the silken drapery.

"That is Miss Wallace. Miss Mildred Wallace, only child of one of New York's prominent bankers."

"She is beautiful—a queen by divine right," cried he, and then with a mingling of impetuosity and importunity, entreated his hostess to present him.

And thus they met.

A volume of Sousa's miscellaneous verse, excerpts from interviews, occasional jottings, anecdotes, letters, and magazine articles was published in 1910 by the

Thomas Y. Crowell Company under the title *Through the Years with Sousa*; it gives an indispensable picture of the man, and must be read, along with the autobiography, to appreciate the flavor of Sousa as a person and as a personality. There is as yet no adult biography of Sousa; several books, written for children, or for the lightweight women's magazine trade, have appeared, but these, needless to say, are not entirely reliable. For that matter, Sousa's own *Marching Along* is not free of inconsistencies and inaccuracies. A good full-length book on Sousa, similar to Edward Waters' invaluable book on Victor Herbert, would be a welcome addition to American musical bibliography.

Paul Bierley of Columbus, Ohio, a long-time admirer of Sousa, has been working on such a book for many years, and I am indebted to him for some information about early Sousa Band recordings. The earliest Sousa recordings, according to Mr. Bierley, were made in 1902 (Victor Nos. 242, 660, and 1193), and included the marches *Hail to the Spirit of Liberty* (composed in 1900, and, incidentally, one of the very best), *Semper Fidelis*, and *The Liberty Bell*. Other early recordings were made for the Edison and Monarch labels, but it is difficult to establish the dates with certainty. The majority, in any case, were made for Victor over the span of years from 1902 to 1931. There are not, however, as many as one would imagine, or would wish to have for documentary purposes. Most of the better-known marches were recorded at one time or another, but very few were re-recorded at later dates to take advantage of improved and improving recording techniques.

THE recording business inevitably drew Sousa's attention once again to the economic problems of the composer, as it introduced a new element into the question of copyright protection. No composer at the time benefited in any way (except for publicity) through public performances for profit of his work. And since Sousa, as the most-performed composer in America, had a stake that was obviously very high, he took part in the discussions and activities that led, in February 1914, to the formation of The American Society of Composers, Authors, and Publishers (ASCAP). Sousa was one of the founders and charter members, along with Victor Herbert, and served as a director and vice-president from 1924 until his death. Thus, in a very real way, all American composers, lyricists, and music publishers remain in his debt.

Sousa remained active to the time of his death on March 6, 1932, in Reading, Pennsylvania, where he had gone to conduct a high school band. The Sousa Band stayed in business to the end, and its conductor continued to write new marches. Eleven of these were published in the years 1930 and 1931, and at least two of them, *The Harmonica Wizard* and *The Kansas Wildcats*, although seldom played and apparently not known even to most bandmasters, are especially attractive and can take their places with the best.

It is obvious that the memory of the Sousa Band itself is fading; the few recordings that exist do not do it justice, and there are each year fewer surviving players whose authentic recollections contribute to a real appreciation of the band's style. There are, of course, many thousands who can remember hearing the band, but for most of these it is a legend that they recall. The marches do live on, however, and keep the name of Sousa as well known and popular as ever. No one needs to campaign for their revival or to make a special case for their performance. In a somewhat unblushing statement, Sousa

once declared that the only influence American composers could be said to have had on the international scene was shown in imitations of Stephen Foster's ballads or his own marches. In his lifetime this may even have had a grain of truth; in any case, Sousa understood quite well his originality as a specifically American composer, and was proud of it.

Sousa's own performance of his marches is now the subject of a somewhat confused verbal tradition. His tempos, however, as shown by most of the early recordings and verified by the recollections of his players, were on the whole rather slower than those generally taken by bandmasters today. This surely seems to be the only possible and proper style when one remembers the basic conception of the march as a form of dance. There is a good deal of evidence, however, to indicate that Sousa took slightly faster tempos as he grew older; but there is no evidence to justify the rather hectic speeds one often hears today. The content of the marches, with their genuine musical sophistication and occasional subtlety, also demands a speed at which one can hear distinctly; otherwise much is lost. And much *is* lost too much of the time. The published versions of the marches do not include many of the dynamic indications, accents, and other touches that made Sousa's own performances so distinctive. Sousa as a performer wanted to keep his own little bag of tricks to himself, and requested that completely and properly edited versions of his marches not be published until after his death. Since that time, some attempts have been made in this direction, but proper performance *à la* Sousa must depend today largely on the oral tradition, which is rapidly disappearing. And as the marches come into the public domain (fifty-six years after publication), many of them have been "simplified" for the use of high school bands, and in these versions they lose much of their character. These are counterfeits, but they are, alas, what is often heard and passed off as genuine Sousa.

The American march style, as established by Sousa, has not changed very much, and has certainly not improved since his time. There have been many fine marches written, of course, but in any list of the one hundred best American marches, if one wanted to make one, at least forty and possibly more would have to be by the March King himself. This is an impressive legacy of its kind; and it is, moreover, one that we can perhaps only now begin to estimate at its true value.

Richard Franko Goldman, conductor of the Goldman Band, is the son of Edwin Franko Goldman (founder of the Goldman Band) and grandson of Selma Franko (who, with her four brothers and sisters, toured the U.S. as child prodigies in the late 1860's and 1870's). Mr. Goldman, himself a composer, is a regular contributor to The Musical Quarterly and The American Scholar. His latest books are Harmony in Western Music, and The Mandarin and Other Stories, translations from Eça de Queiroz.



MÜNCHNER STADTTEUFER: WOOD ENGRAVING AFTER POUJOL

THE BASIC REPERTOIRE

UPDATINGS AND SECOND THOUGHTS—PART TWO

By MARTIN BOOKSPAN

THIS month I conclude my annual updatings and second thoughts on recommended recordings of the "Basic Repertoire." I take up the list of works at the point at which the first installment (in last month's issue) ended, and weigh against my previous preferences any new recordings released since last year at this time.

Haydn: Symphony No. 94, in G ("Surprise")—Beecham's performance with the Royal Philharmonic Orchestra (Angel D 36242, 36242; tape Y3S 3658, 3¾ ips, also containing the other five of the first set of Haydn's "Salomon" Symphonies) is still my first choice, with the Turnovsky-Prague Symphony Orchestra performance (Parliament S 609, 609) a good alternative in the budget-price category.

Haydn: Symphony No. 101, in D ("Clock")—Again a Beecham performance (Angel S 36255, 36255; tape Y3S 3659, 3¾ ips, also containing the other five of the second set of Haydn's "Salomon" Symphonies) gets my vote, with Monteux (RCA Victor LSC/LM 2394) and Reiner (RCA Victor LSC/LM 2742) as good alternatives. The "Clock" Symphony also shares a Parliament disc with the Turnovsky performance of the "Surprise" Symphony recommended above.

Mabler: Symphony No. 1, in D—The choice here remains the Solti-London Symphony recording (London CS 6401, CM 9401; tape LCL 80150).

Mabler: Symphony No. 4, in G—Despite primitive recorded sound, Bruno Walter's recording, now available as Odyssey 32 16 0025, is a uniquely caressing account of this score. Among the more contemporary performances, my preference is for the Szell-Cleveland Orchestra recording (Columbia MS 6833, ML 6233; tape MQ 783), with a nod in the direction of the intensely personal performance conducted by Leonard Bernstein (Columbia MS 6152, ML 5485).

Mabler: Symphony No. 9, in D—As before, Bruno Walter's recording (Columbia M2S 676, M2L 276; tape M2Q 516) is the first choice, with Barbirolli's impassioned account (Angel S 3652, 3652) a very good second.

Mendelssohn: Violin Concerto in E Minor—Several very good versions exist: Francescatti (Columbia MS 6758, ML 6158; tape MQ 742); Friedman (RCA Victor LSC/LM 2865); Stern (Columbia MS 6062, ML 5379); Milstein (Angel S 35730, 35730; tape Y2S 36301, 3¾ ips, coupled with Tchaikovsky and Bruch concertos); and Szeryng (Mercury SR 90406, MG 50406). In the low-price department, Laredo's (RCA Victrola VICS/VIC 1033) leads the field.

Mendelssohn: Symphony No. 3, in A Minor ("Scottish")—Maag's performance (London CS 6191, CM 9252; tape L 80083) is pre-eminent.

Mendelssohn: Symphony No. 4, in A ("Italian")—The Casals-Marlboro Festival performance (Columbia MS 6931, ML 6331) moves to the top of the available up-to-date recordings. The Steinberg-Pittsburgh Symphony performance has recently been reissued in the low-price Pickwick line (S 4027, 4027) and is the best of the budget-price recordings. Maazel's (Deutsche Grammophon C 8684) continues to be my choice of the three available tapes.

Moussorgsky-Ravel: Pictures at an Exhibition—The Ansermet performance (London CS 6177, CM 9246; tape K 800054) is my stereo/mono recommendation. Toscanini's account (RCA Victor LM 1838), still supreme for dramatic flair and atmosphere, has recently been deleted from the catalog, but may reappear in an RCA budget line. A wholly different kind of performance is the one conducted by Stokowski (London SPC 21006, PM 55004; tape L 75006), not only because he uses his own orchestral transcription of the piano original, but also because he removes several pictures from the gallery.

Mozart: Clarinet Quintet, in A—I continue to prefer above all others the performance by Alfred Boskovsky and members of the Vienna Octet (London CS 6379, CM 9379; tape 80145).

Mozart: Symphony No. 35, in D ("Haffner")—Walter (Columbia MS 6255, ML 5655; tape MQ 436) and Klemperer (Angel S 36128, 36128; tape Y3S 3662, a set of Mozart's last six symphonies) are my choices here, with Schuricht (Richmond 29062, 19062) a reasonable low-price alternative.

Mozart: Symphony No. 39, in E-flat—Klemperer (Angel S 36129, 36129), Szell (Epic BC 1106, LC 3740) and Walter (Columbia MS 6493, ML 5893) continue to lead the field. Apparently the Angel tape devoted to Klemperer's performances of the composer's last six symphonies remains the only tape version of this masterpiece available.

Mozart: Symphony No. 40, in G Minor—If intensity is what you want in this symphony, Klemperer has it (Angel S 36183, 36183; tape Y3S 3662); if lyrical effulgence is what you want, Walter is your choice (Columbia MS 6494, ML 5894; tape MQ 611).

Mozart: Symphony No. 41, in C ("Jupiter")—Of the available stereo/mono performances, Bruno Walter's is my favorite (Columbia MS 6255, ML 5655; tape MQ 436) for its seasoned nobility. The protean strength of Toscanini's account (RCA Victor LM 1030) is still *sui generis*. Among the bargain-price performances, my choice is Barbirolli's (Vanguard Everyman 180SD, 180).

Prokofiev: Symphony No. 5, in B-flat—New since last year is the Melodiya/Angel performance conducted by David Oistrakh (S 40003, 40003). In my opinion, it does not challenge the supremacy of Ansermet's performance (London CS 6406, CM 9406; tape LCK 80156).

Prokofiev: Peter and the Wolf—I continue to prefer the no-nonsense account of this score conducted by Efrem Kurtz, with narration by Michael Flanders (Capitol SG/G 7211). Among the available tapes, my choice is Sir Malcolm Sargent's (RCA Victor FTC 2204) with Lorne Greene, again because the performance is straightforward and sane.

Rachmaninoff: Piano Concerto No. 2, in C Minor—The best performances are those by Ashkenazy (London CS 6390, CM 9390; tape K 80139), Graffman (Columbia MS 6634, ML 6034; tape MQ 657), and Janis (Mercury SR 90260, MG 50260; tape ST 90260). And while the set is still available, collectors are advised to acquire RCA Victor LM 6123, a three-record album containing the four Rachmaninoff piano concertos and the *Rhapsody on a Theme by Paganini*, all of them played by the composer with the Philadelphia Orchestra.

Rachmaninoff: Piano Concerto No. 3, in D Minor—The lyrical warmth and expressivity of the Cliburn-Kondrashin recording (RCA Victor LSC/LM 2355; tape FTC 2001) keep it foremost in my affections, with the Ashkenazy-Kondrashin reading (London CS 6359, CM 9359; tape K 80125) a solid second and Janis-Munch (RCA Victrola VICS/VIC 1032) a fine budget-price alternative. I must also mention the electric excitement of the Horowitz-Reiner collaboration (RCA Victor LM 1178, mono only).

Ravel: Daphnis and Chloë—Ansermet's (London CS 6456, CM 9456) is the pick of the complete versions, and Monteux's (London L 80034) the better of the two available tapes of the complete score. Of the performances of the Second Suite alone, I prefer Martinon's (RCA Victor LSC/LM 2806; tape FTC 2196), with Barbirolli's (Vanguard Everyman 177SD, 177) a good low-price alternative (the choral parts are included).

Rimsky-Korsakov: Scheherazade—Here there is one performance that dominates the field: Beecham's (Angel S 35505, 35505; tape ZS 35505), one of the peaks of achievement in the recorded literature.

Rossini: Overtures—Until the various Toscanini performances are restored to the catalog, the collections I recommend are those by Bernstein (Columbia MS 6533, ML 5933), Gamba (London CS 6204, CM 9273; tape L 80096), and Reiner (RCA Victor LSC/LM 2318; tape FTC 2021).



Saint-Saëns: Symphony No. 3, in C Minor—The Munch-Boston Symphony recording with Berj Zamkochian as organ soloist (RCA Victor LSC/LM 2341; tape FTC 2029) is, to my ears, unrivalled for dynamic intensity and excitement. (Continued overleaf)

Saint-Saëns: Carnival of the Animals—My preference among the recordings that do not include a spoken narrative continues to be Efrem Kurtz's performance with Hephzibah Menuhin and Abbey Simon as the solo pianists (Capitol SG/G 7211). Ogden Nash's poems are ideally served in the pioneering Kostelanetz recording with Leonid Hambro and Jascha Zayde as the solo pianists and Noel Coward as the speaker (Columbia CL 720, coupled with Prokofiev's *Peter and the Wolf*; ML 4355, coupled with Ravel's *Ma Mère l'Oye*). Among tape versions, Bernstein's (Columbia MQ 498) remains my choice. The new Angel recording with Georges Prêtre conducting the Paris Conservatory Orchestra, and Aldo Ciccolini and Alexis Weissenberg as the pianists, was not available at the time of writing.

Schubert: Symphony No. 8, in B Minor ("Unfinished")—New since last year is the reissue of the splendid performance conducted by Guido Cantelli shortly before his untimely death eleven years ago (Seraphim 60002); this is now the low-price version I prefer. Among the full-price recordings, Walter's (Columbia MS 6218, ML 5618, coupled with Schubert's Fifth; MS 6506, ML 5906, coupled with Beethoven's Fifth; tape MQ 391) has special qualities of geniality and serenity. Tape buffs are referred also to the Klemperer performance on Angel Y2S 3666 (3¾ ips) which shares a reel with two other Schubert symphonies in Klemperer's performances, the Fifth and the Ninth. All told, this reel is an unusual bargain.

Schubert: Symphony No. 9, in C—Among the modern recordings, Krips' performance with the London Symphony Orchestra (London CS 6061, CM 9007; tape L 80043) is still my favorite, with Walter (Columbia MS 6219, ML 5619) and Klemperer (Angel S 35946, 35946; tape Y2S 3666—see above) not far behind. The earlier Krips performance with the Amsterdam Concertgebouw Orchestra is the best of the low-price versions (Richmond 19078).

Schubert: Quintet in A, for Piano and Strings ("Trout")—Unchanged since last year: the account by an ensemble that includes Peter Serkin as pianist and Alexander Schneider as violinist (Vanguard VSD 71145, VRS 1145) possesses a fresh vitality unmatched by any other recording available. It is now also available on tape (Vanguard C 1713). Second choice would be the account by Clifford Curzon with members of the Vienna Octet (London CS 6090, CM 9234; tape L 80092).

Schubert: Quintet in C for Strings—London's performance by members of the Vienna Philharmonic Orchestra (CS 6441, CM 9441; tape L 80183) is my first choice, with the Benar Heifetz-Budapest String Quartet performance a very good second choice (Columbia MS 6536, CM 5936).



Schumann: Cello Concerto in A Minor—Rostropovich (Deutsche Grammophon 138674, 18674; tape C 8674) and Rose (Columbia MS 6253, ML 5653; tape MQ 422) sweep the field here. The idiosyncratic performance Casals recorded some fifteen years ago has recently been reissued by Columbia in its low-price Odyssey series (32 16 0027).

Schumann: Piano Concerto in A Minor—The very intense account by Rudolf Serkin (Columbia MS 6688, ML 6088; tape MQ 707) continues to be my first choice, with special mention, as always, to be made of the superb mono-only account by the much-lamented Dinu Lipatti (Columbia ML 4525).

Schumann: Symphony No. 1, in B-flat ("Spring")—The Kubelik performance (Deutsche Grammophon 138860, 18860; tape C 8860) is still the most persuasive for me; some may prefer the more heroic Klemperer performance (Angel S 36353, 36353).

Sbostakovich: Symphony No. 1—The recent RCA Victor release of a Toscanini broadcast performance (included in LM 6711) does not alter my preference for the Stokowski way with this music (United Artists 8004, 7004). In the budget-price category, the best is Martinon's (RCA Victrola VICS/VIC 1184). There is no tape version currently available, though you may still be able to find Stokowski's (United Artists UATC 2209).

Sbostakovich: Symphony No. 5—To the Melodiya/Angel catalog has recently been added a performance by the Moscow Philharmonic conducted by Kiril Kondrashin (S 40004, 40004). If Kondrashin is correct in broadening the tempo of the concluding pages to half-speed, then every other conductor who has ever recorded or conducted this work has been wrong. For myself, I cannot accept this. The fiery Bernstein performance (Columbia MS 6115, ML 5445; tape MQ 375) is still my number-one choice, with Previn and the London Symphony Orchestra (RCA Victor LSC/LM 2866) a good second.

Sibelius: Symphony No. 1, in E Minor—Situation unchanged: Maazel's (London CS 6375, CM 9375; tape K 80162) is an exciting, taut, beautifully played and recorded performance. In the low-price field, Barbirolli's (Vanguard Everyman 132SD, 132) still stands out.

Sibelius: Symphony No. 2, in D—I do not share the enthusiasm of some for the Toscanini performance included in the recent five-disc set of historic Toscanini broadcasts (RCA Victor LM 6711); Sibelius and the public will be better served when and if RCA gets around to re-releasing the incomparable Koussevitzky performance. Until then, the recording by George Szell and the Amsterdam Concertgebouw Orchestra (Philips PHS 900092, PHM 500092) is my choice among currently available performances, with Maazel's (London K 80162) the preferred tape account.

Sibelius: Symphony No. 5, in E-flat—Bernstein (Columbia MS 6749, ML 6149; tape MQ 765) remains my first choice, with two excellent low-price alternatives: Gibson (RCA Victrola VICS/VIC 1016) and Barbirolli (Vanguard Everyman 137SD, 137).



R. Strauss: *Don Juan; Till Eulenspiegel*—Of recordings that couple these two masterly symphonic poems, Bernstein's (Columbia MS 6822, ML 6222; tape MQ 799) and Szell's (Epic BC 1011, LC 3439; tape EC 805) are the finest; also worthy of mention are those by Klemperer (Angel S 35737, 35737; tape ZS 35737) and Stokowski (Everest SDBR 3023, LPBR 6023; tape EV 3023).

R. Strauss: *Der Rosenkavalier*—Still in a class by itself is the mono-only recording conducted by Erich Kleiber, with a cast featuring Maria Reining, Hilde Gueden, Sena Jurinac, and Ludwig Weber (London 4404). Karajan's (Angel S 3563, 3563; tape Y4S 3563, 3¾ ips, one reel) is my choice in stereo.

Stravinsky: *Petrouchka*—My esteem for the readings by Ansermet (London CS 6009, CM 9229; tape K 80006) and Monteux (RCA Victor LSC/LM 2376) grows with each passing year. Both conductors offer performances of extraordinary dramatic insight and poetic sensitivity. The version by Stravinsky himself (Columbia MS 6332, ML 5732; tape MQ 474) is leaner and more ascetic—he uses the reduced orchestration of 1947—but no less exciting. In the low-price field there is Ansermet's first LP recording of the score (Richmond 19015, mono only).

Stravinsky: *Le Sacre du printemps*—No new versions have been released since last year, leaving Bernstein's passionately committed account of this score (Columbia MS 6010, ML 5277) unchallenged. Stravinsky's own recording (Columbia MS 6319, ML 5719; tape MQ 481) is a taut, elemental, and largely impersonal reading that nevertheless packs a considerable wallop. In the low-price field there is the cool, detached, rarified performance conducted by Pierre Boulez (Nonesuch 71093, 1093).

Tchaikovsky: *Piano Concerto No. 1, in B-flat Minor*—With his recording (Melodiya/Angel SR/R 40016) the winner of the 1966 Tchaikovsky Competition in Moscow, sixteen-year-old Grigory Sokolov, succeeds in nudging from the top position the recording (RCA Victor LSC/LM 2252; tape FTC 2043) made by the winner of the 1958 Tchaikovsky Competition in Moscow, Van Cliburn. Sokolov and his conductor, Neimye Yarvy, contribute a performance of extraordinary poetic introspection and lyricism, at the same time that the bravura qualities of the music receive their due. Sokolov is apparently a pianist and musician of rare gifts. Not far behind the performances of Sokolov and Cliburn is a new one recorded by the second-prize winner in the 1966 Tchaikovsky Competition, Misha Dichter (RCA Victor LSC/LM 2954). His is a virtuoso performance that some listeners may find most exciting of all. And for those to whom

price is always a concern, the splendid Gilels-Reiner performance is enthusiastically recommended (RCA Victrola VICS/VIC 1039).

Tchaikovsky: *The Nutcracker*—The Mercury recording by Dorati and the London Symphony Orchestra (SR 29013, OL 2113; tape ST 29013) is in a class by itself. Leading the low-price field is the Abravanel-Utah Symphony performance (Vanguard Everyman 168/9SD, 168/9).

Tchaikovsky: *Serenade for String Orchestra*—My preference among currently available recordings continues to be the Barbirolli-London Symphony Strings performance (Angel S 36269, 36269); Ormandy and the Philadelphia Orchestra (Columbia MQ 431) still dominate the tape field.

Tchaikovsky: *Symphony No. 4, in F Minor*—Maazel's performance (London CS 6429, CM 9429; tape L 80161) is supremely well played and recorded, one of the finest things we have yet had from this conductor on records. Barbirolli's (Vanguard Everyman 135SD, 135) would be my choice among the low-price recordings.

Tchaikovsky: *Symphony No. 5, in E Minor*—Ormandy (Columbia MS 6109, ML 5435) is still my first choice among contemporary performances, but those to whom the latest recorded sound is not of major consequence are directed to the reissued Koussevitzky recording (RCA Victor LM 2901), a uniquely personal document that sweeps all before it. Again it is a Barbirolli performance (Vanguard Everyman 139SD, 139) that gets my vote among the budget-price versions.

Tchaikovsky: *Symphony No. 6, in B Minor ("Patbétique")*—The Giulini-Philharmonia Orchestra recording (Seraphim S 60031, 60031) is my unhesitating recommendation among the available disc performances. On tape my preference is the Ormandy performance (Columbia MQ 368).

Tchaikovsky: *Violin Concerto in D*—New since last year is the performance by Igor Oistrakh, with his distinguished father, David, conducting (Melodiya/Angel S 40009, 40009). But the performance is pallid, compared with the best currently available: the Heifetz recording (RCA Victor LSC/LM 2129) for virtuosity; the Stern recording (Columbia MS 6062, ML 5379) for a more serene but equally valid approach. Francescatti's silky elegance (Columbia MQ 742) is still the tape performance I prefer, with Szeryng's (RCA Victrola VICS/VIC 1037) the pick of the low-price discs.

Vivaldi: *The Four Seasons*—Presumably Columbia will soon release the stylish Goberman performance in its Odyssey series. Until then, Bernstein's (Columbia MS 6744, ML 6144; tape MQ 736) continues to be my favorite among the many available recordings; its vitality and exuberance are hard to resist. Another worthy performance is the one by Antonio Janigro and I Solisti di Zagreb (Vanguard BG 5001, 564; tape C 1611).

REPRINTS of this two-part review of the "Basic Repertoire" are available without charge. Circle number 179 on reader service card.

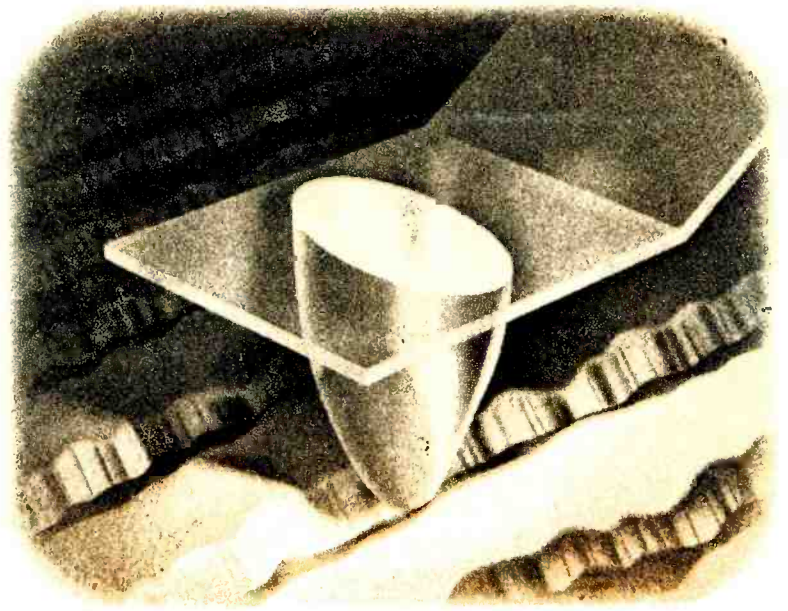

LABORATORY TESTS OF ELEVEN STEREO CARTRIDGES

Cartridges covered in this report:

ADC 220 and 10/E Mk II • Dynaco Stereodyne III
Empire 808 and 888SE • Grado BTR and BTR/LM
Ortofon S-15T • Shure M75-6 and V-15 Type II
Sonotone Velocitone Mk V

By **JULIAN D. HIRSCH** and **GLADDEN B. HOUCK**

TO THE casual observer, it might seem that phono-cartridge development has been stagnant in recent years. The latest really "new" developments were in 1964, which saw the introduction of the 15-degree vertical-tracking angle and the elliptical stylus. Since then, the 15-degree angle has become universal, and most manufacturers are also offering at least the option of an elliptical stylus. In this year of 1967, however, we find no radical cartridge innovations to compare with these.

In view of this, it came as a welcome surprise to discover that many of the newest cartridges are sonically superior to the models they supersede. And several of them, moreover, are audibly superior to the best of last year's cartridges. These really significant advances result from specific engineering improvements rather than from

any industry-wide breakthrough in the state of the art.

One might reasonably expect this dramatically improved performance to carry with it a high price tag. This is partly true, since the two top-ranking cartridges of this year's group cost between \$60 and \$70. However, very nearly the same audible performance can be had for much less than half these prices, and in some cases for as little as \$10. In fact, six of the eleven cartridges tested cost between \$10 and \$25, with the remainder falling between \$40 and \$80. The more expensive cartridges, in general, do offer advantages to the discriminating user, but looking at them solely from a sonic standpoint, there is remarkably little difference between the lowest- and the highest-price cartridges.

Perhaps the most obvious distinction between the cartridges is in their stylus-force requirements. A couple

of them will track, at 1 gram or less, practically any record made. Among the lower-price units, a tracking force of between 2 and 4 grams is required. Since not all tone arms can be used with a 1-gram force, one's choice of a cartridge must be affected by the player setup in which it is to be used.

All of the cartridges were able to track a velocity of 15 cm/sec on a test record with moderately low intermodulation distortion (under 2 per cent) at tracking forces within their rated limits. We also applied a much more severe tracking test (to be described below) that correlated well with listening performance.

This year we modified our test procedure somewhat. Initially, we played the low-frequency and high-frequency bands of the HiFi/STEREO REVIEW Model 211 Test Record, increasing tracking force until there was no obvious audible distortion, and this force was then used for the measurements that followed. The next test used the Shure "Audio Obstacle Course" test record. Although designed specifically to demonstrate the virtues of Shure's V15 Type II cartridge, the record is equally useful in evaluating the merits of any cartridge. This record contains brief selections of musical instruments, including bells, piano, accordion, electric organ, and harpsichord, recorded at four increasingly high levels. At the two lowest levels, almost any cartridge can track the record without difficulty. At the third level, many cartridges experience difficulty with the bells and harpsichord, producing jangling or shattering sounds. And very few cartridges can track the fourth (highest level) bands without distortion.

We listened to all forty-four recorded samples on this record with each cartridge, assigning arbitrary numerical ratings to the several degrees of mistracking that we heard. Adding all the numbers gave us a figure of merit which was clearly related to the cartridge's ability to trace high-velocity recordings at both high and low frequencies. These velocities are not at all atypical, and a

cartridge which cannot trace them satisfactorily will surely sound distorted at times on current commercial stereo discs.

The preceding checks, which require no test equipment, can be performed at home for the modest expenditure of about \$8 for the records. We strongly recommend them to anyone who really wishes to learn how good (or how bad) his cartridge is.

Next, we played the RCA 12-5-39 Intermodulation Test Record. With the aid of an IM distortion analyzer, this provides data on the IM distortion of a cartridge as a function of peak recorded velocity (up to a shattering 27.1 cm/sec) at any desired tracking force. In addition to the normal tracking force, we repeated this test with a force near the rated maximum for each cartridge to see if a worthwhile reduction in distortion would result.

Frequency response and stereo channel separation were measured between 40 and 20,000 Hz using the CBS STR100 sweep-frequency record and a General Radio graphic level recorder. The measurements were concluded with a test of square-wave response using the 1,000-Hz square-wave bands of the CBS STR100 record. Square-wave photos of the oscilloscope screen show the presence of any ringing at the stylus' own resonant frequency. A wave with a rounded top characterizes those cartridges with slightly elevated middle- and low-frequency responses.

NEEDESS to say, we listened to all the cartridges with a variety of records. Having two arms mounted on the turntable, we made A-B comparisons where this seemed appropriate, although the large number of cartridges made it impractical to compare all possible combinations. For listening purposes we used amplifiers and speakers representative of the best modern equipment designed for home use.

It would be fruitless, and probably impossible, to comment in detail on the sound of these cartridges. Without exception, when operated at a tracking force adequate for the particular model, they produced clean, balanced sound free of objectionable coloration or distortion. The top-rated models (the ADC 10/E and the Shure V15 Type II) combined the utmost in tracking ability with the lowest stylus forces. In general, they had an ease and freedom from breakup and strain on loud, high-velocity recorded passages that could be definitely appreciated in comparison with lower-ranking types. However, in extended listening to most records with any one cartridge, we would not have been able to guess whether it sold for \$10 or for many times that price.

The message this year is clear: top-quality recorded sound—from the cartridge point of view—is available to anyone able to invest \$10 or so. For those audiophiles who want "something extra" and are willing to pay for it, there is a wide choice of premium-grade cartridges

STEREO TEST RECORD

Among the test instruments and procedures used by Hirsch-Houck Laboratories in evaluating the cartridges reported on this month was HiFi/STEREO REVIEW's own Model 211 Stereo Test Record. First introduced in 1963, there are now over 50,000 of these records in use by manufacturers, testing labs, and audiophiles throughout the world. The Model 211, which comes with a complete instruction sheet, makes it possible to perform the following tests in the home: (1) speaker phasing and channel identification, (2) channel balance, (3) system frequency response, (4) cartridge tracking ability, (5) stereo separation, (6) stereo spread, (7) effective hum, (8) rumble, and (9) flutter. To get your copy (postpaid), simply send \$4.98 to:

Stereo Test Record
P. O. Box 3110, Church St. Station
New York, N. Y. 10008

(New York State residents please add local sales tax.)

that can extract every bit of performance from the most difficult discs. If your collection includes some "unplayable" records that break up on loud passages, it might pay to invest in one of the top-ranked cartridges. In all probability you will hear a quality of sound that you never suspected was on the discs.

ADC 220

● THE ADC 220, although it sells for one-sixth as much as the deluxe ADC 10/E Mk II, has much in common with it. An induced-magnet design, it is quite similar in construction to the 10/E; it has essentially the same frequency response, the same remarkable smoothness and freedom from resonance in the audible range. What is most remarkable is the fact that it sounds just about the same as the 10/E!

It would be incorrect to assume, however, that the budget-price 220 is the *equal* of the deluxe 10/E Mk II. Its compliance is rated at less than half that of the 10/E, and judging from the tracking force it requires, the difference must be greater than that. We found that the 220 needed at least a 3-gram stylus force to play the test bands of the HF/SR Model 211 test record. At 4 grams, the IM distortion was under 2 per cent up to 19 cm/sec velocity.

The 3-gram stylus force is higher than many audio hobbyists will wish to use. Although the diamond stylus is conical, with a 0.7-mil radius, there can be no doubt that record wear is accelerated by the higher tracking force. However, certain inexpensive record changers may require the use of such forces, and we know of no other cartridge of comparable sonic quality that can operate at a 3-gram force.

The measured frequency response of the ADC 220 was ± 1 db from 20 to 14,000 Hz and about 2.5 db down at 15,000 Hz. The channel separation was not as good as that of the 10/E, but was about 20 to 25 db to 13,000 Hz. Signal output was 7.3 millivolts at 3.54 cm/sec. Square-wave tests showed a couple of cycles of ringing, with fairly low amplitude. After checking the

HOW TO INTERPRET THE CURVES

The upper curve represents the averaged *frequency response* of the cartridge's right and left channels. The lower curve, which starts at 500 Hz, represents the averaged *separation between channels*. The amount of separation at any frequency is indicated by the vertical distance between the upper and lower curves, and is expressed in decibels.

Inset at the lower left of each graph is an oscilloscope photograph of the cartridge's response to a 1,000-Hz square wave on a test record. The shape of the reproduced wave is an indication of a cartridge's overall frequency response and resonances.

cartridge against our full series of test records and listening to various stereo recordings, we had to conclude that the ADC 220 sounded virtually indistinguishable, when tracking at 3 to 4 grams, from the 10/E tracking

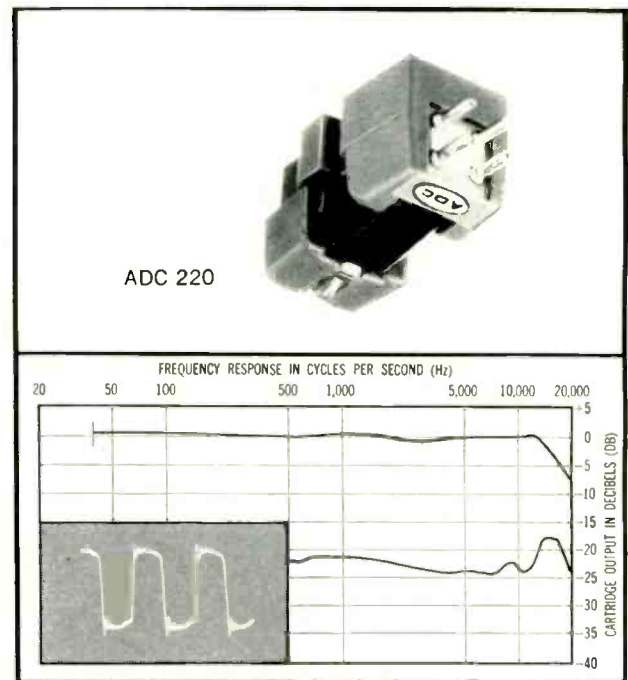

at 1 gram. This was truly amazing performance from a cartridge selling for only \$9.95.

GRADO BTR AND BTR/LM

● AFTER many years of producing moving-coil cartridges of superior quality, Grado Laboratories has changed over to piezo-electric (ceramic) cartridges. Although the generating elements of the Grado Model B are tiny ceramic slabs, the cartridge is designed to be used with conventional amplifiers having magnetic-cartridge preamplifiers and equalization. The necessary shunting resistance and other elements required to convert the amplitude-responding ceramic elements to a velocity response are built into the cartridge, and its outputs are intended to be loaded by the usual 47,000-ohm magnetic-amplifier inputs.

The Grado Model B is housed in a lightweight plastic body having conventional 1/2-inch mounting centers. Its low weight of 3.5 grams gives it the potential of tracking badly warped or eccentric records when installed in a low-mass arm. With many arms, however, it will be necessary to add weight to the cartridge shell to achieve balance with this cartridge, which weighs less than half as much as most magnetic cartridges.

The Grado Model B is available with a choice of several styli: a 0.6-mil spherical, a 0.3- and 0.6-mil elliptical, and a 3-mil spherical for playing 78-rpm records. The

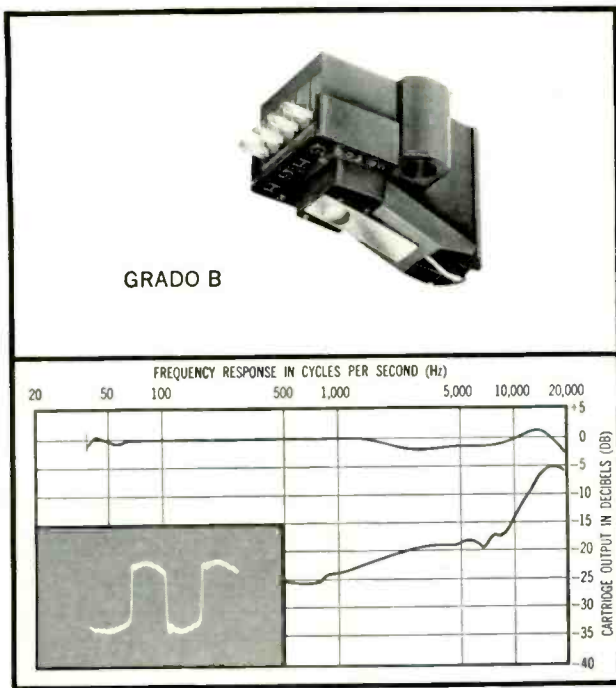

GRADO B

styli may be removed and interchanged quickly without the use of tools. A unique feature of the Grado Model B is the user-adjustable compliance. Simply by sliding the stylus assembly toward the front of the cartridge, the compliance may be increased considerably over the normal setting. This is done by moving the pivot point of the stylus cantilever, thus varying the mechanical advantage between the stylus tip and the yoke which couples the cantilever to the elements.

In our tests, we checked the Grado Model BTR (with a 0.6-mil spherical stylus) and the BTR/LM version with a low-mass stylus. The BTR tracked at 2.5 grams. Its IM distortion at high velocities was low, and marginally lower than the BTR/LM. Frequency response of the Model BTR was virtually identical to that of the BTR/LM, except for a drop of about 2 db between 18,000 and 20,000 Hz. Its channel separation was actually slightly better than that of the BTR/LM, probably owing to normal stylus tolerances. Signal output of the BTR was 5.3 millivolts, slightly less than that of the BTR/LM, and its square-wave response was identical to that of the BTR/LM.

Some differences could be discerned between the two cartridges when tracking the higher-level bands on the "Audio Obstacle Course" record. Although the Grado Model BTR was not quite as good in this test as the BTR/LM, it was better than a number of the magnetic cartridges we tested. Its listening quality was to us identical to that of the BTR/LM on typical stereo records. Given these test results, the \$9.95 price of the BTR must surely qualify it for some sort of "best buy" rating.

The Grado Model BTR/LM is a low-mass stylus version of the standard BTR, with a visibly finer and smaller

stylus structure. In the high-compliance setting, we found that it required 2.5 grams to track the HF/SR Model 211 test record. In the low-compliance-setting, 3.5 grams of stylus force was required. We used the high-compliance setting for our tests.

The IM distortion was very low, under 1 per cent up to about 15 cm/sec velocity. Increasing the force to 4 grams extended the useful range of velocity to over 20 cm/sec, but this would not be required for playing most stereo records. The output of the cartridge was 6.5 millivolts. Being non-magnetic, the cartridge has no susceptibility to magnetically induced hum.

The frequency response of the Grado BTR/LM was very flat, within ± 2 db from 20 to 20,000 Hz. Channel separation was 20 to 25 db at middle frequencies, decreasing to 13 db at 10,000 Hz and 5 db or less above 15,000 Hz. Its square-wave response was very good, with one or two well-damped cycles of ringing visible.

When tracking the "Audio Obstacle Course" record, the BTR/LM proved to be near the top of its group. Its sound was a trifle bright, as compared to the most expensive magnetic cartridges, but the difference could barely be heard in A-B switching comparisons. All in all, this is as clean-sounding a cartridge as any except the top magnetic units, which sell for several times its \$15 price.

DYNACO STEREO DYNE III

- THE Dynaco Stereodyne III cartridge, manufactured by Bang & Olufsen in Denmark, is no newcomer to the American audio scene. Its completely shielded construction makes it especially insensitive to induced hum from

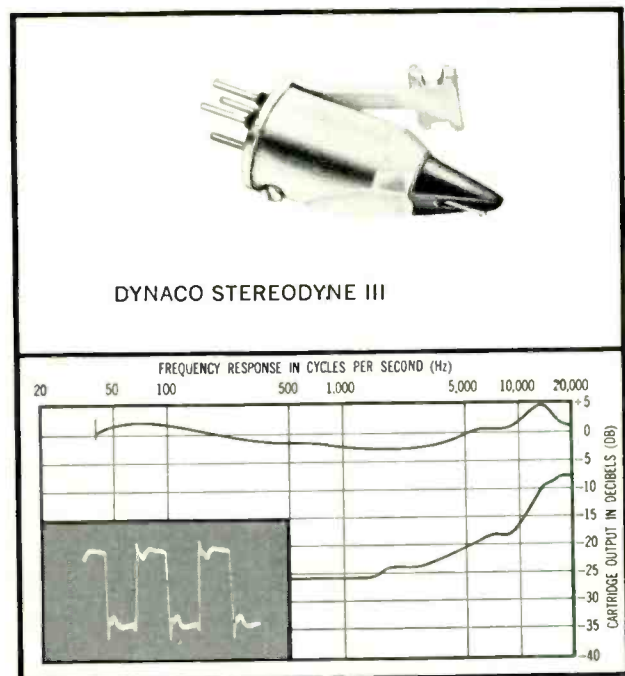

DYNACO STEREO DYNE III

magnetic fields, and the plastic "nose cone" that is its unique identifying feature provides almost total protection for the stylus assembly.

The Stereodyne III is a moving-iron (variable-reluctance) cartridge, with its magnet and four coils embedded in the main body of the cartridge. The replaceable stylus assembly contains a piece of ferrous material that is moved by the pivoted stylus bar to vary the flux impinging on the four pole pieces in accordance with the record-groove modulation.

The cartridge is rated at from 1 to 3 grams tracking force. The latest model tracked the HF/SR Model 211 test record at 2 grams. At that force its IM distortion was about 1 per cent up to 12 cm/sec velocity, increasing to 3 per cent at 15 cm/sec. At a 3-gram tracking force, the distortion reached 3 per cent at 18 cm/sec. The output of the Stereodyne III was 5 millivolts.

The frequency response of the Stereodyne III sloped gently upward below about 400 Hz, to +3 db at 60 Hz. The response between 5,000 and 9,000 Hz was elevated by about 3 db and there was a broad 7-db plateau at about 13,000 Hz. Channel separation was better than 25 db up to 4,000 Hz, 20 db at 10,000 Hz, and about 7 db at 20,000 Hz. The square-wave response had a cycle or two of relatively low-frequency ringing, with very steep rise and fall. The sound of the cartridge was pleasant, unobtrusive, and smooth, without any particular sonic characteristic of its own. The model we tested had a 0.7-mil conical stylus, and is priced at \$19.95.

EMPIRE 808

● THE Empire 808 is a new, low-price version of the 888 series of cartridges. It is similar in appearance and operating principles to the 888, and features a 0.7-mil diamond stylus with a rated compliance of 8×10^{-6} cm/dyne. Its range of tracking forces is from 1 to 6 grams.

As far as we can determine, the 808 allows the basic performance of the 888 series to be realized in the lower-price record changers that might require a tracking force of several grams. We found that it tracked the HF/SR Model 211 test record well at only 3 grams, which was the force used in our tests. At that force the IM distortion was under 2 per cent up to 15.5 cm/sec velocity. Increasing the force to 5 grams (the maximum obtainable with our test arm) allowed the cartridge to track 23 cm/sec at 2 per cent IM distortion.

The frequency response (within ± 2 db from 20 to 19,000 Hz) was quite similar to that of the more expensive Empire 888SE, and in fact was somewhat flatter owing to better damping of the high-frequency stylus resonance. Channel separation was about 30 db or better at middle frequencies, 20 db at 10,000 Hz, and 10 db at 19,000 Hz.

Signal output was 6.1 millivolts at 3.54 cm/sec. Hum

shielding was good, approximately the same as measured on the 888SE. The square-wave response was also virtually identical to that of the 888SE, except that the ringing

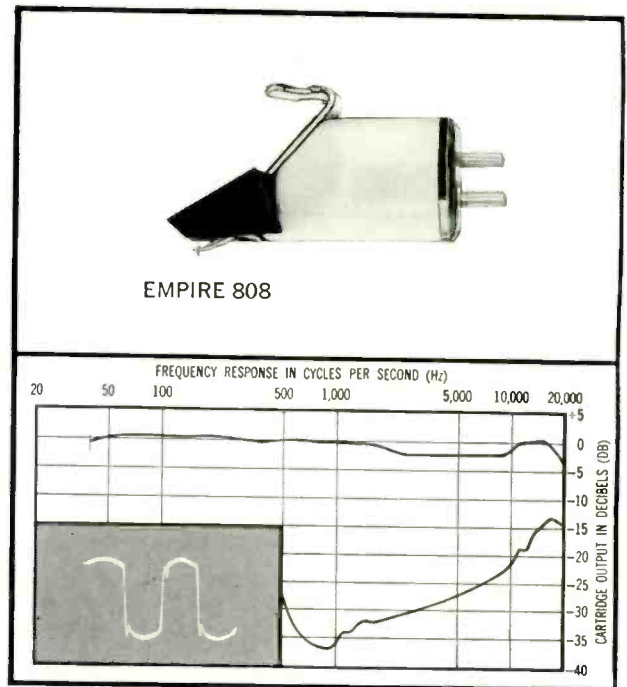

was smaller in amplitude owing to the improved damping of the resonance.

The sound of the 808 was difficult to distinguish from that of the 888SE or several other fine cartridges. It seemed to be a trifle less defined on complex passages than the 888SE, but the differences were so slight as to be difficult to pin down. For all practical purposes, the chief difference between the cartridges, apart from the price, is the two-fold increase in tracking force required by the 808. The Empire 808 sells for \$19.95.

SHURE M75-6

● THE Shure M75 cartridge might be described as a low-price version of the V15 Type II, which Hirsch-Houck Laboratories tests showed to be a cartridge of remarkably high quality. Applying the same design philosophy with perhaps slightly less critical performance parameters, Shure engineers have produced a worthy companion to the V15 Type II.

In its basic form, the M75-6, this cartridge is presented as a "high-trackability" unit. It has a swing-away stylus guard and a stylus assembly that appears to be interchangeable with that of the V15 Type II. The M75-6 has a 0.6-mil conical diamond stylus, rated for tracking forces between $1\frac{1}{2}$ and 3 grams. As with the V15 Type II, Shure provides a specific "trackability" rating that defines the velocities that can be tracked at 400, 1,000, and 10,000 Hz with a 2-gram force.

A family of interchangeable styli are offered for the M75 cartridge. These include the N75E, a 0.2 x 0.7-mil elliptical stylus (\$20), and the N75-3, a 2.5-mil stylus (\$9) for playing old 78-rpm records. The same 2.5-mil stylus is also recommended for use in the V15 Type II cartridge. In our tests, the Shure M75-6 tracked the HF/SR Model 211 test record at 1½ grams, the lower limit of its recommended range of forces. Since its performance is specified at 2 grams, however, we used that force during our tests.

IM distortion of the M75-6 was very low, under 1 per cent up to 18.5 cm/sec velocity. Increasing the tracking force to the maximum of 3 grams kept the distortion below 2.5 per cent up to the maximum of 27.1 cm/sec on our test record. In this respect the M75-6 was one of the two or three outstanding cartridges of this group.

The frequency response of the M75-6 was exceptionally smooth and flat, varying less than ±1 db from 40 to 17,000 Hz. Its channel separation was typically about 20 db in the frequencies below 10,000 Hz. The square-wave test showed only a single small cycle of ringing. The output of the M75-6 was 6 millivolts and its hum shielding was excellent.

Because of the kinship between this cartridge and the V15 Type II, we made critical A-B listening comparisons between them. Any differences that may have existed

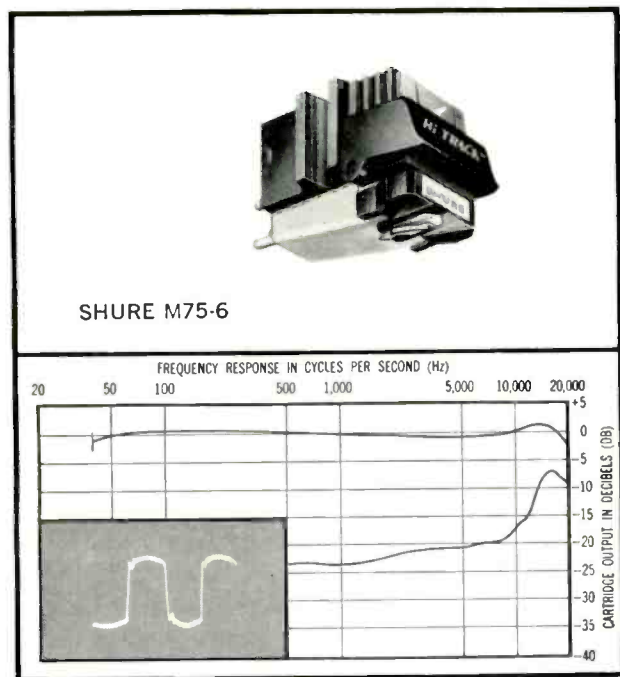

were certainly minute, and the two have basically the same quality, which is effortless and smooth at all times. It seemed to us that the V15 Type II had a slightly "warmer" tone, but even this is debatable.

Clearly the Shure engineers have transferred the es-

sence of the V15 Type II into the M75 with such success that we doubt anyone could tell one from the other except when playing records with high-level, high-frequency transients (such as harpsichord and bells). On Shure's own "Audio Obstacle Course" record, these were the only areas where the superiority of the V15 Type II could be heard. The price of the Shure M75-6 is \$24.50.

SONOTONE VELOCITONE V

● SONOTONE's Velocitone ceramic cartridges have undergone a continuous process of refinement since their introduction several years ago. The latest version, the Mark V (100T) cartridge, is available with a choice of three diamond styli: 0.7 mil, 0.5 mil, and a 0.8 and 0.3 mil elliptical. Except for the tip shapes, all are identical,

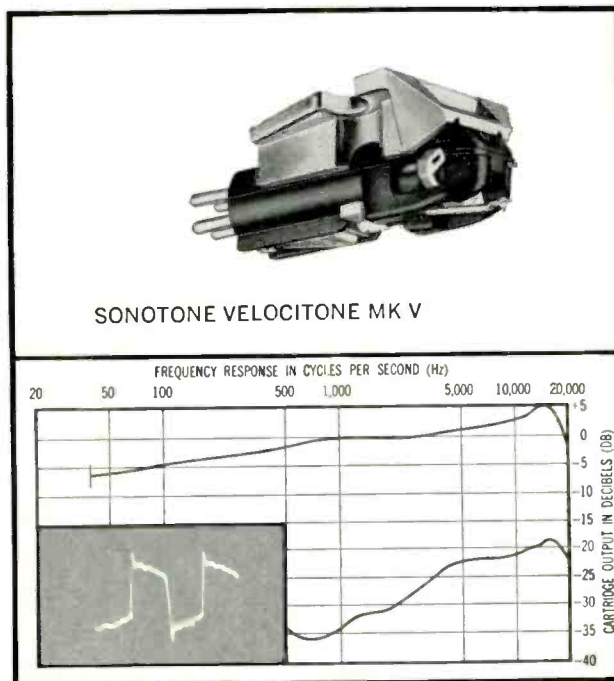

with a compliance of 15×10^{-6} cm/dyne and a rated tracking force of 1.5 to 2.5 grams. A pair of gold-plated plug-in adapters is supplied with each cartridge to convert its normally amplitude-responding characteristic to a velocity basis suitable for connection to the magnetic-phono inputs of any preamplifier.

The "Sonoflex" stylus assembly of the Mark V has a rubber-like section that allows it to be bent as much as 180 degrees in any direction without damage. In fact, it is virtually impossible to damage the stylus accidentally. The cartridge's low mass (only 1.5 grams) makes possible (in a low-mass arm) a worthwhile improvement in the ability to track warped records. However, some tone arms designed for heavier cartridges require additional weight in the cartridge shell in order to achieve balance.

We tested the Mk V Model 100T-DEV fitted with the

elliptical stylus. It tracked our test records at slightly less than 1.5 grams, and we used that force throughout the tests. The frequency response sloped upward at about 4 db per decade from 20 to over 10,000 Hz. It reached a peak of about +6 db at 14,000 Hz, with full response all the way to 20,000 Hz. Channel separation was excellent, averaging better than 30 db at middle frequencies, better than 20 db up to 6,000 Hz, and never less than 10 db up to 20,000 Hz. Output was 6.2 millivolts, and there was naturally no susceptibility to magnetically induced hum.

At its rated minimum tracking force of 1.5 grams, intermodulation distortion was 2 per cent or less for any velocity up to 17 cm/sec. Increasing the tracking force to the upper limit of 2.5 grams kept the IM to 3 per cent at the very high velocity of 27.1 cm/sec.

The sound of the Sonotone 100T-DEV was clean, effortless, and musical, with just a trace of "sparkle." The slight loss of low-frequency response, not particularly noticeable in ordinary listening, could be heard when it was compared to other cartridges with relatively flat bass response. Fortunately, the response of the Sonotone cartridge can easily be compensated with a moderate amount of amplifier bass boost. (Or, alternatively, Sonotone has an application note available that tells the user how to flatten out the bass response without resorting to the amplifier's tone controls.) When this is done, we consider it the sonic peer of any cartridge we have heard in its price range. The Sonotone 100T cartridge sells for \$32.50 with the 0.7-mil stylus, \$34.50 with the 0.5-mil stylus, and \$39.50 with the elliptical stylus.

EMPIRE 888SE

● THE Empire 888 family of cartridges is perhaps the most comprehensive in the industry, from the standpoint of variety of styli and range of tracking forces. Using a common cartridge body, the 888 series takes advantage of the instantly replaceable stylus assembly to, in effect, customize a cartridge for any conceivable record-playing requirement.

Previous models included the 888 (0.7-mil stylus, up to 6 grams of stylus force), the 888E (0.4- and 0.9-mil elliptical stylus, up to 5 grams), the 888P (0.6-mil stylus, up to 4 grams), and the 888PE (0.2- and 0.9-mil elliptical stylus, tracking between 0.5 and 3 grams). The latest, and presumably most refined, version of the 888 is the 888SE, which we tested for this survey.

The Empire 888SE has a 0.3- and 0.7-mil elliptical stylus with a rated compliance of 25×10^{-8} cm/dyne. It is rated for tracking forces between 0.5 and 3 grams. The less extreme ellipse of the stylus seems to be in line with current thinking among cartridge designers, and presumably gives the inherent groove-tracing advantages of the elliptical shape without the need for very careful

alignment. It further reduces the possibility of increased record wear that might result from high unit forces on a very small stylus radius.

The 888 series of cartridges all employ a variant of the moving-iron principle, a small conical piece of ferrous material being mounted near the pivot of the stylus bar. There are three separate magnets within the cartridge body and the motion of the stylus varies the distribution of the magnetic flux between the four pole pieces within the cartridge. Since the entire magnetic structure of the cartridge is enclosed within the mu-metal shielded cartridge case, the sensitivity to induced hum is low.

The 888SE tracked the HF/SR Model 211 test record at 1.5 grams. Its frequency response was within ± 3 db from 20 to 20,000 Hz. Channel separation was approximately 20 db or better over most of the audible range, and was never less than 15 db up to 20,000 Hz. Output

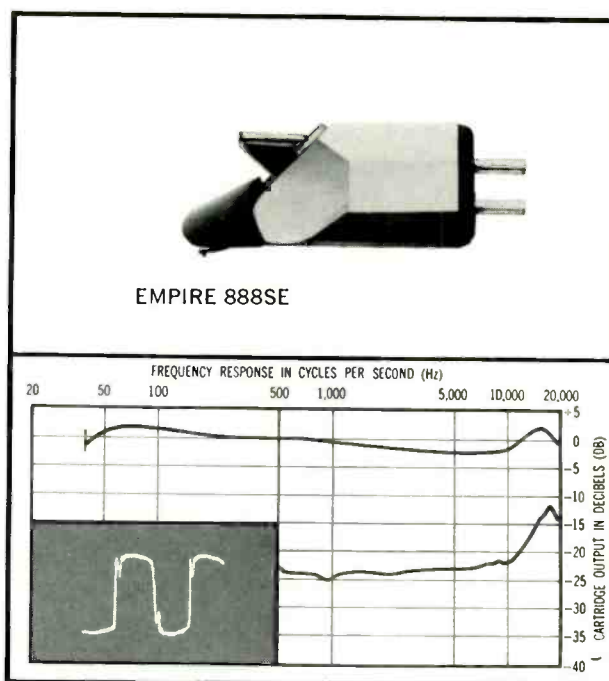

was a relatively low 3.1 millivolts at 3.54 cm/sec and IM distortion at the 1.5-gram test force was under 2 per cent up to 13 cm/sec velocity. At the maximum rated tracking force of 3 grams, IM distortion reached 2 per cent at 24 cm/sec. The square-wave response showed a single cycle of ringing at the stylus' resonant frequency.

The sound of the Empire 888SE was excellent in all respects. We could hear no sign of the 16,000-Hz peak (see graph), either in the program material or in the form of exaggerated hiss. In fact, the sound was almost subdued contrasted with the more bright-sounding cartridges against which we compared it. This may well have been the result of the slightly elevated bass region, which, in spite of its small magnitude, imparted a pleas-

ant solidity and fullness to the sound. This is a very easy cartridge to listen to, and is quite capable of handling almost any record at a 1.5-gram stylus force. The Empire 888SE sells for \$44.95.

ADC 10/E MK II

● THE new 10/E Mk II is the "top of the line" of the ADC cartridge family. Like the other ADC cartridges, it uses the induced-magnet principle. A rectangular fixed magnet is mounted in the replaceable stylus assembly. The stylus-cantilever tube, pivoted at the end nearest the cartridge body in a compliant, rubber-like material, lies close to a "U"-shaped channel in the gold-toned (in the Mk II) magnet. A small piece of magnetically conductive material in the pivoted end of the stylus tube becomes magnetized by induction from the fixed magnet (hence the name "induced magnet"), and as the stylus tube moves, it couples varying amounts of magnetic flux to the four pole pieces of the coils molded into the cartridge body. The stylus is an elliptical diamond with radii of 0.3 and 0.7 mils.

The 10/E Mk II has a very low stylus mass and high stylus compliance, rated at 35×10^{-9} cm/dyne. This

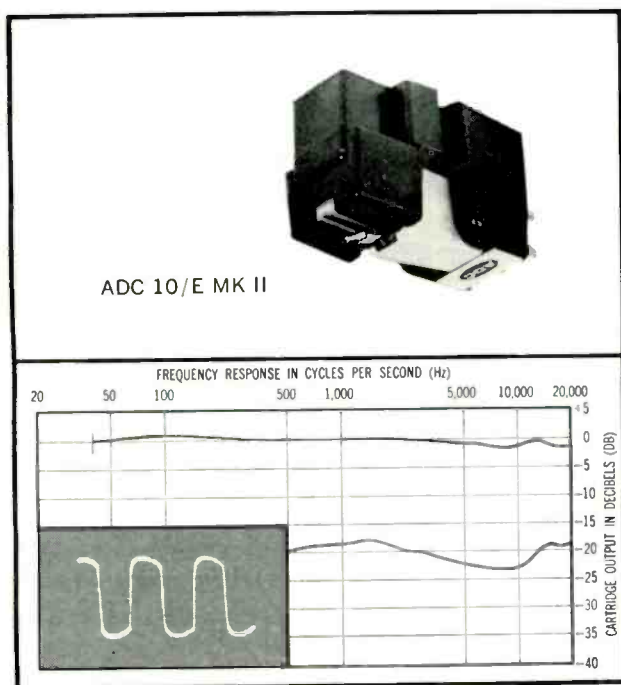

accounts for its ability to trace highly modulated grooves at only 1 gram, a feat achieved by few cartridges in our experience. This is the recommended maximum force, and we found it to be optimum. Higher forces cause the stylus to retract into the cartridge, and cannot be used. We did find that it would track the HF/SR test record at 0.5 gram, lower than any other cartridge tested. However, at a 1-gram force, the higher recorded velocities

on the disc are handled with less audible distortion.

The measured frequency response of the ADC 10/E Mk II was very smooth, within ± 1.5 db from 40 to 20,000 Hz. Channel separation was better than 25 db at mid-frequencies and was 13 db at 20,000 Hz. The square-wave response of this cartridge was outstandingly good, as was its IM distortion, which remained under 1 per cent up to 18 cm/sec velocity. The output was 2.8 millivolts at 3.54 cm/sec—relatively low, but quite adequate for any modern preamplifier.

The ADC 10/E Mk II, as befits a premium-quality cartridge, has a premium price—\$59.50. Its smooth, wide-range sound and freedom from distortion certainly qualify it for a place with other cartridges at this and even higher prices.

SHURE V-15 TYPE II

● THE Shure V-15 Type II cartridge is an improved version of the V-15 reported on previously (July 1964), and which was at that time one of the finest cartridges on the market. The Type II is even better—quite noticeably so, in fact. Like its predecessor, the V-15 Type II is a moving-magnet cartridge with an elliptical-diamond stylus. The original V-15 had a rather extreme pair of stylus radii—0.2 and 0.9 mils. This year, Shure has modified the stylus slightly to 0.2- and 0.7-mil radii. They have also reduced the weight of the cartridge considerably (from 11 down to 6.8 grams) and have added a built-in swing-away stylus guard.

To describe the particular virtues of the V-15 Type II, Shure has coined the word "trackability." This refers to the ability of a cartridge stylus to follow the groove modulation at the high velocities found on modern records. Most cartridges do quite well in this respect at low and middle frequencies, but fail in varying degrees at the very high frequencies.

The Shure V-15 Type II is designed to track at forces from $\frac{3}{4}$ to $1\frac{1}{2}$ grams. We found that it tracked the HF/SR Model 211 test record at 1 gram. Its frequency response, playing the CBS STR100 record, was ± 1.5 db from 20 to 20,000 Hz. The "sway-backed" response (see graph) in the upper frequencies is, to some extent at least, a property of the record; we have observed this in a number of cartridge tests. The resonance of the stylus itself occurs above 20,000 Hz.

Tracking at 1 gram, the IM distortion of the V-15 Type II is extremely low below 15 cm/sec velocity. The 0.5 per cent distortion observed is the lowest we have ever measured with the RCA 12-5-39 test record, and is probably the residual distortion of the record. The distortion rises to 2 per cent at 17 cm/sec, but increasing the tracking force to the maximum rated value of 1.5 grams allows the cartridge to track 22 cm/sec at 2 per cent IM distortion.

(Continued overleaf)

The output of the V-15 Type II is quite low, about 2.7 millivolts, as compared to the 6.1-millivolt output of the original V-15. Most good amplifiers have sufficient gain to operate with the V-15 Type II, but the volume control will have to be advanced somewhat for the same listening level.

The Shure V-15 Type II lives up to its promise of "trackability." We have encountered numerous instances

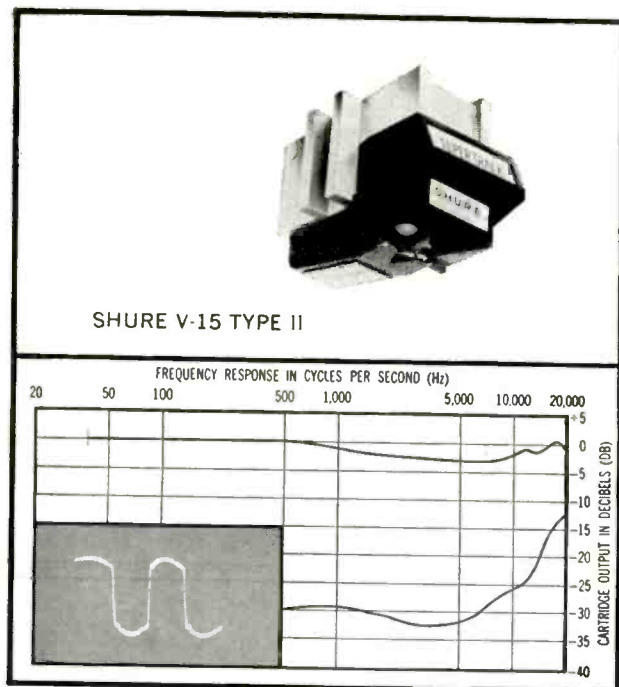

SHURE V-15 TYPE II

where records that sounded distorted on their heaviest passages with any other cartridge sounded clean when played with the V-15 Type II. Shure has issued a test record, dubbed "An Audio Obstacle Course," which contains eleven different velocity levels. This record, obviously intended to demonstrate the virtues of the V-15 Type II, serves as an excellent test for "trackability" with any cartridge, and we made good use of it during this series of tests.

The V-15 Type II did not emerge entirely unscathed from the "Audio Obstacle Course," but it did fare better than any other cartridge we have tested. In listening tests it had a combination of smoothness, low distortion, wide frequency range, and nearly total freedom from breakup on even the loudest passages which in our judgment earn it a top position in the array of altogether outstanding cartridges covered in this year's survey. The V-15 Type II is priced at \$67.50.

ORTOFON S-15T

● THE Ortofon S-15T is the only moving-coil cartridge in the currently tested group, and the only one requiring a return to the manufacturer for stylus replacement. It is

also the largest, heaviest, most expensive, and (last, but certainly not least) had the lowest distortion and one of the widest, flattest frequency-response curves.

The large size and weight (18.5 grams) of the S-15T result from the inclusion of a pair of miniature step-up transformers within the cartridge body. The very low output voltage of the moving-coil system is raised to a substantial 5.7 millivolts at the cartridge terminals.

A stylus force of 2.5 grams was needed to track the HF/SR Model 211 test record with minimum distortion. Frequency response was ± 2.5 db from 20 to 20,000 Hz; channel separation was better than 25 db up to 8,000 Hz, and about 10 db in the 15,000- to 20,000-Hz region. The square-wave response had only a trace of very high-frequency ringing, and a slightly rounded top that related to the 2 to 3 db elevation of the bass region below 200 Hz. (Incidentally, the S-15 we tested is a later version that has been designed for a smoother high-frequency response than the earlier model.)

The IM distortion of the Ortofon S-15T was under 1 per cent up to 22 cm/sec velocity, and was 1.5 per

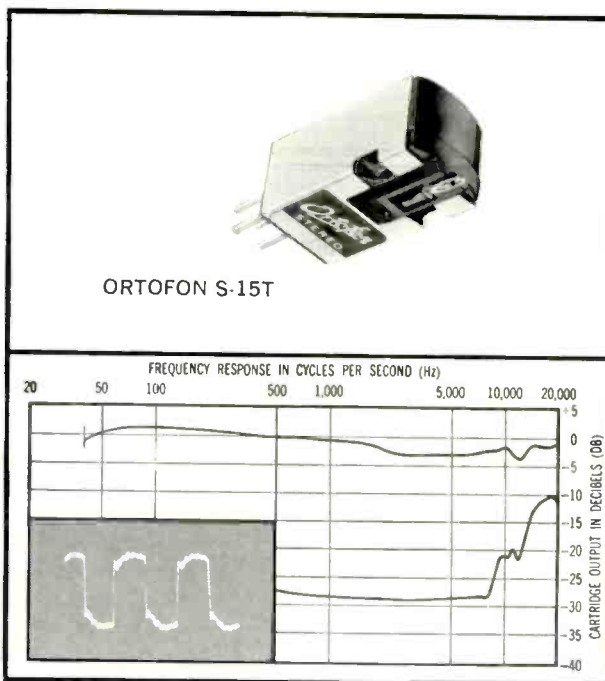

ORTOFON S-15T

cent at the maximum-level band of 27.9 cm/sec on the RCA 12-5-39 test record. In spite of the inclusion of the step-up transformers, the Ortofon S-15T was quite immune to induced hum, measuring considerably superior to most cartridges in that respect.

The S-15T had a clean, balanced sound that differed somewhat from that of the other cartridges in its fuller character. This was probably due to the slight elevation of the bass region, which did not show up as a boom or heaviness, but rather as a more solid and firm sound. The Ortofon S-15T sells for \$80.

HIFI/STEREO REVIEW'S SELECTION OF THE TOP RECORDINGS BEST OF THE MONTH



CLASSICAL

GUSTAV MAHLER'S MONUMENTAL THIRD SYMPHONY

Haitink and the Amsterdam Concertgebouw deliver a stunning performance for Philips

THE Mahler Third is a huge symphonic canvas of proportions ample even for Mahler: six movements (he planned a seventh), an hour and a half running time, and enough scope to match (in any sense) any of his greatest works. Sheer size and a curious and unsettling disposition of its parts have kept the symphony from being performed very often, but true Mahlerites will recognize it as a masterpiece nonetheless in the marvelous new Philips recording with Bernard Haitink and the Amsterdam Concertgebouw Orchestra.

The opening movement, one of Mahler's monumental marches and one of his best (even more sustained in quality than the opening of the Fifth), lasts over half an hour by itself. It is surely the longest march on record. This immense, sprawling fresco is followed by two delicate, moderately moving, and lightly scored scherzos; then a text from *Also Sprach Zarathustra* (!) set as a short, simple, and atmospheric alto solo; a setting from *Des Knaben Wunderhorn* for chorus of children's and women's voices in a highly picturesque folk manner; and a final chorale-like "heavenly" Adagio.

Mahler devised or was inspired by a rather detailed program for this symphony, but he had the good sense to suppress it. Unfortunately, later critics and annotators have not been willing to accept the composer's good judgment in the matter. You will have to check the album notes for more information about "Pan awakes," "What the woodland creatures tell me," and all the rest; you won't get it here. One

program-note annotation, however, will certainly be of interest to those who puzzle over the anticipations of the last movement of the Mahler Fourth that pop up in a number of places in the Third. It concerns the song "*Das himmlische Leben*," which forms the last movement of the Fourth: actually written earlier in 1892, it was to have been the finale (the *seventh* movement!) of the Third. But it must have become apparent to Mahler that nothing could follow that extraordinary Adagio.

Those who like to play the increasingly popular Mahler-as-Prophet game can find plenty of material here. One of the most striking anticipations of things to come is the use of fanfares and drum-rolls out of time (*i.e.*, rhythmically independent of the prevailing meter). Actually, the usual arguments about Mahler's anticipation of and influence on this or that technique or aspect of twentieth-century music seem to me often peripheral. Indeed, in many important respects, Mahler was strikingly without influence, the last composer of the tonal tradition rather than—as is the case with Debussy, Schoenberg, and others—the progenitor of something new. Still, Mahler *does* seem to be an essentially twentieth-century composer, and I think the reason has to be sought in other areas. Mahler's attitude is essentially modern: his self-consciousness; his torturous struggle to achieve a simple, natural expression; his vulgarity—and his refined sophistication; the paradoxes and internal discords; the conflict be-



BERNARD HAITINK
A recording-oriented approach

tween life and art, between intellectual reflection and a simple, natural expression; the scope, big as life itself; the ideas, derived from tradition and experience, but new and "modern" in their contexts. Thus, the composer who really resembles Mahler most closely in these basic respects (although his actual musical substance is of course quite different) is—Charles Ives!

All of these elements are as clearly present in the Third Symphony as in any other by Mahler, and they generate the work's unique form. If this is what interests you about Mahler (to me it is essential), you may prefer Leonard Bernstein's version of this work (Columbia M2S 675, M2L 275). Bernstein's Mahler is successful because he identifies not only with Mahler the man, but also with his view of the world. Haitink, in Philips' new recording of the work, is more detached. I find the performance superb—gorgeous, in fact, and superior in many details to that by Bernstein and the New York Philharmonic. The sound of the Concertgebouw is overwhelming, beautifully wrought in the fine points, and stunning in its overall shape. Its objectivity may at first give the impression that this is a performance *about* rather than *of* the Mahler Third, but this impression must be understood in a certain heretical perspective: the character of a recorded performance need not, and possibly should not, be identical with that of a live performance. Generally, recorded Bernstein performances are versions of what are essentially responses to the conditions of "live" presentation; exciting and valid though they may be, they may also not wear well for home listening. Haitink's performance here, on the other hand, is recording-oriented. It is solid and very authoritative, the music beautifully plotted and excellently played. Philips' engineers, moreover, have complemented this approach with an excellent rich acoustic which is (except for a few quieter "offstage" moments) brilliantly clear, realistic, and rather grand. *Eric Salzman*

© (M) MAHLER: *Symphony No. 3, in D Minor*. Maureen Forrester (contralto); Amsterdam Women's Chorus; Boys Chorus of St. Willibrord Church, Amsterdam; Concertgebouw Orchestra of Amsterdam, Bernard Haitink cond. PHILIPS PHS 2996 two discs \$11.58, PHM 2596 \$9.58.

A BAROQUE MASTERPIECE: MONTEVERDI'S *VESPERS*

Extraordinarily successful use of authentic instruments distinguishes Telefunken release

ITALY'S prodigiously prolific Claudio Monteverdi wrote his massive choral-orchestral *Vespro della Beata Vergine* in 1610 in hopes of obtaining, through Pope Paul V, either a substantial financial reward or a better position in

Rome, his regular work as Master of Music to Vincenzo Gonzaga, Duke of Mantua, having been rather unremunerative. But he received, in fact, neither reward nor position, and three years went by before he found employment worthy of his merit—that of *maestro di cappella* at St. Mark's Church in Venice. The *Vespers*, despite the indifference of the Pope, remains one of Monteverdi's greatest church works, although it is a curious mixture of the modern (the new "operatic" orchestra, the dramatic concentration on text, and the addition of the thorough bass) and the archaic.

There have been at least two previous complete versions of the *Vespers* on disc (the *Magnificat*, which comes at the end, has been recorded a number of times), but these are now quite eclipsed by Telefunken's distinguished new release—and not merely because the others are older, monophonic recordings. The most interesting feature of this new set is its producers' insistence on using original instruments. One has only to listen to the opening section, the beginning of which was lifted from the composer's opera *Orfeo*, to realize that this is an extraordinary sound. If previous attempts at authenticity have not impressed you because the restored or reconstructed instruments sounded ill-tuned or poorly played, just listen to the opening of the *Sonata sopra "Sancta Maria"* and you will know how marvelously effective this music, with its plangent *cornetti* (also called *zinken*) must have sounded to the audiences of Monteverdi's own day.

Nothing seems to have been overlooked in this recording to make the score come to life once again. The Gregorian antiphons have been included, there is an extremely well varied continuo (various combinations of organ, harpsichord, virginals, and even lute, plus the usual viol low strings), and in certain sections (for example, the tenor solo *Nigra sum*) florid vocal embellishments have been added to the score. These are just a few of the innovations. The vocalists are exceptional, the pacing is as vital and yet as liturgically proper as one could wish, and the chorus (though rather more German-sounding than Italian) is expert. To add to all this, the quality of the recorded sound itself could not be bettered. An elaborate and beautiful booklet containing notes on the performance, the instruments, and the text is included, but unfortunately—the single drawback—it is in German only. *Igor Kipnis*

© (M) MONTEVERDI: *Vespro della Beata Vergine (1610)*. Rohtraud Hansmann and Irmgard Jacobbeit (sopranos); Nigel Rogers and Bert van t'Hoff (tenors); Max van Egmond (baritone); Jacques Villisech (bass); soloists from the Wiener Sängerknaben; Choralschola of the Capella Antiqua, Munich, Konrad Ruhland, director; Monteverdi Chor of Hamburg, Jürgen Jürgens, director; Concentus Musicus of Vienna, Nikolaus Harnoncourt cond. TELEFUNKEN SAWT 9501/2 two discs \$11.58, AWT 9501/2* \$11.58.

HAPPINESS IS ENRICO MACIAS

The ebullient artistry of a young singer-guitarist is an irresistible amalgam of musical styles

FRANCE'S Enrico Macias, at the age of twenty-nine, bids fair shortly to become an international star and perhaps, in the process, to bring a whole new set of influences into popular music. So far he has appeared no farther East than Lebanon and no farther West than Belgium. But in France he is already an enormous success, although in a somewhat special way. There, he is the favorite of the hundreds of thousands of French Algerians who have resettled in France since Algeria was given its freedom. Macias' two earlier albums for Pathé (STX 169 and STX 187—mono only), both recorded live at 1964 and 1965 concerts at the famed Olympia Theatre in Paris, are superb examples of one-man showmanship and a performer-audience rapport that is, in my experience, remarkable. His newest album, "*Douze Nouvelles Chansons*," is a triumphant affirmation of his undeniable right to be considered more than a specifically "ethnic" favorite.

Born in Algeria in 1938 of a Provençal mother and an Andalusian father, Macias was already an expert on the guitar at fourteen (his father was also a musician). At eighteen he was singing and playing in Algerian cabarets while studying for his *bachot* (baccalaureate). He taught school for a while at the small Algerian village of Aïn Fraïn, but with the acceleration of the Algerian independence movement he went to France, turning for his livelihood to what he knew best—his music. Success was almost immediate—one of his early partisans was Raymond Bernard, leader of the Gilbert Bécaud orchestra, who opened for Macias the doors to the Pathé-Marconi recording studios.

Happiness and the sheer joy of living are apparent on every band of Macias' latest album, whether it be the cheerful Basque folk rhythms of *Je l'aimerai pour deux* or the innocent sensuality of *Le jour de ton mariage*. The instrumentation and arrangements make full use of the cultural blend that existed in French-held Algeria: the sound is unmistakably North African, but with strong echoes of the traditional French *bal musette* cafe orchestra. Macias himself is just as eclectic in his vocal performances. This eclecticism is perhaps most apparent in his two in-concert albums, where he brings his audiences to fever pitch with such galvanic numbers as *Les Filles de mon pays*, the unforgettable *El Porompompero*, and the rafter-shaking *L'Oriental*. He is just as unselfconscious, however, on many bands of "*Douze*

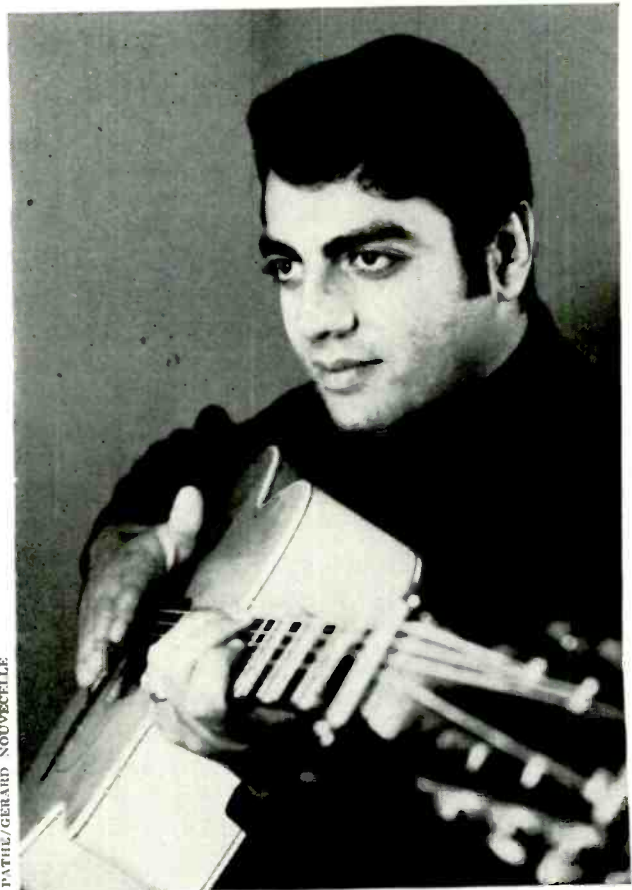

PATHÉ/GERARD NOUVECELLE

ENRICO MACIAS
Triumphant affirmation of life

Nouvelles Chansons," where he is apt to let loose a cry that is almost an exact replica of the Moslem call to prayer as he is to interpolate a sudden, plaintive flamenco wail. When his attention turns to the simple French chanson, as it does in *Les Masques de la comédie*, he performs with a confident mastery that would do credit to a Charles Trenet or a Tino Rossi.

Macias' voice is not quite like that of any popular French singer of recent memory: there's no molasses in it, nor is there any use of stage melodrama to make an emotional point. It is alive and warm, and he uses it with an ease and naturalness and spontaneity that I can only describe as an ebullient crow of pure pleasure.

The majority of the songs Macias sings (for which he often provides words or music or both) reflect the Mediterranean-colonial culture that was North Africa. And as they are concerned with the physical basics of that culture—the sun, the sky, the scorched and beautiful horizons—they are also concerned with the feelings of the dispossessed people who made up that now lost culture. His songs tell of their attachment to the land of their birth, to their families, their friends, and of the bittersweet French-Algerian *émigré* nostalgia for the good old times. He does all this remarkably well, without a trace of self pity. What is even more remarkable,

however, and what should win for him the attention of all lovers of song everywhere, is the vital, bursting optimism of the human spirit to be heard in his voice.

Peter Reilly

® ENRICO MACIAS: *Douze Nouvelles Chansons*. Enrico Macias (vocals); orchestra, Jean Claudric cond. *Non, je n'ai pas oublié; Le Jour de ton mariage; Les Yeux de l'amour; Solenzara*; and eight others. PATHÉ STX 211 \$4.79.

THE RETURN OF SUSAN BARRETT

*The crisp new sound of an amazing vocal
stylist invites comparison with the best*

THERE ARE plain, ordinary girl singers arriving on the musical scene at the rate of about two a week, and then there is the occasional girl singer who somehow transcends the boundaries of mediocrity imposed by current pop trends. But great singers of the latter brand almost never arrive overnight. They learn slowly and painfully, through a series of recorded mistakes, to find their potential—what to discard in the way of material, how to go easy on the higher or lower register, what kind of song to lean on. Susan Barrett, whose first—perhaps premature—appearance on the Capitol label about six years ago apparently sent her scampering back to the drawing board, has learned, and her brilliant re-appearance on the RCA Victor label now gives us ample reason to beat the drums and fly the banners.

Amazing! Miss Barrett is only twenty-three years old, yet she displays, in these swinging sessions, the soul of a Chris Connor, the dynamics of a Sarah Vaughan, the theatrical flair of a Felicia Sanders, the jazzy hipness of a June Christy. I don't really mean to saddle so gratifying a gift to the music world as Miss Barrett with hard-to-live-up-to comparisons, but the girl is *that* good. She steps up to the microphone, tosses her Julie Christie hair back, and *wails*—and the sounds that come out are as astounding as the approach.

Where, for instance, did a girl so young learn to drop the bottom out of her voice on the ends of three-syllable words like June Christy used to do? It's an old trick, but it makes all the difference in a song such as Bobby Hebb's otherwise pedestrian rock-and-roll tune *Sunny*. The point is that she has obviously been listening to all the right people through the years and none of the wrong ones.

Marion Evans, one of the truly original, perceptive, and plugged-in arrangers, has been brought out of semi-



SUSAN BARRETT

A gratifying gift to the music world

retirement by Miss Barrett (another hip move for such a young girl) to weave some of the most exciting arrangements I've heard this year. He works in colors—from the cotton-candy pastels of *The Carnival is Closed Today* (one of the more interesting of the "stayed-too-long-at-the-fair" songs) to the explosive purples and reds of such big-band jump tunes as *Walking Happy* and *Más Que Nada*. And his use of a small combo with strings throughout is sensitive and lyrical without being obtrusive. In every instance, his arrangements provide a strong right arm for Miss Barrett instead of beating her voice to death.

Everything about this album is so fresh, so willowy, so potato-chip crisp, it is a happy thing to hear. At the root of its success, of course, is Susan Barrett, whose extraordinary talents make her undoubtedly the most exciting (re)discovery so far this year. The way she caresses these songs, the way the music caresses *her*—I don't know, but I'd say this album was made with love.

Rex Reed

® SUSAN BARRETT: *Susan Barrett!* Susan Barrett (vocals); Marion Evans, arranger and conductor. *Walking Happy; Sunny; My Man; Bewitched; Every Time We Say Goodbye; Más Que Nada; April Showers*; and five others. RCA VICTOR LSP 3738 \$4.79, LPM 3738* \$3.79.

THE **NEW** KENWOOD TK-88



INTRODUCING A POPULAR PRICED LUXURY RECEIVER WITH UNMATCHED QUALITY, PERFORMANCE AND DEPENDABILITY

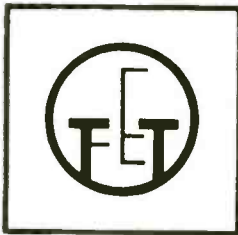

Field Effect Transistor

It's the most . . . the TK-88 tuner section features Field Effect Transistor 4 gang tuning condenser front-end which provides superior sensitivity and image rejection • 5 IF stages with 4 limiters and wide band ratio detector provide high selectivity and freedom from noise and interference • Automatic FM STEREO/MONO silent switching with stereo light indicator • Interstation muting circuit.

The amplifier section features 90 watts music power at 4 ohms • All silicon transistor amplifier provides wide power bandwidth • Blowout-free exclusive automatic circuit breaker protects power transistors (U S Pat.) • 4 sets of output speaker terminals (2 sets of stereo speakers) and front panel speaker selector switch • Front panel stereo phone jack.

The handsome simulated walnut finish cabinet is included in the price of the unit. The TK-88 trouble-free performance is backed by the KENWOOD two year warranty.

No doubt about it . . . the TK-88 is the most stereo receiver you can buy for \$289.95 including cabinet.

Visit your nearest KENWOOD franchised dealer, or write to us direct for complete illustrated brochure.

**90 WATTS
SOLID STATE
AM-FM
STEREO
RECEIVER**

The Sound Approach to Quality...



3700 South Broadway Place, Los Angeles, Calif 90007
69-41 Calamus Avenue, Woodside, New York 11377

Caballé:

**Strauss would have loved her
(and so will you!)**



Here is Montserrat Caballé in a new setting: German lieder. And the acclaimed Spanish soprano is triumphant in bringing her famous pianissimo, melting mezza voce and lyrical gifts to Strauss' enchanting songs. Included in this new RCA Victor Red Seal recording are *Morgen*, *Traum durch die Dämmerung*, *Zueignung* and *Cäcilie*. Hear this new recording soon and discover why *Saturday Review* has called Caballé "an artist of rare refinement."

RCA VICTOR 
The most trusted name in sound

Other distinguished recordings by Montserrat Caballé:



Available on Stereo 8 Cartridge Tape.



Available on Stereo 8 Cartridge Tape.





HIFI/STEREO REVIEW'S CHOICE OF THE LATEST RECORDINGS

CLASSICAL

Reviewed by WILLIAM FLANAGAN • DAVID HALL • GEORGE JELLINEK • IGOR KIPNIS • ERIC SALZMAN

Ⓢ Ⓜ BACH: *Cantata No. 203, "Amore traditore."* Claus Ocker (bass); Martin Galling (harpsichord); Dieter Messlinger (cello). *Cantata No. 211, "Schweiget stille, plaudert nicht" ("Coffee Cantata").* Elisabeth Speiser (soprano); Claus Ocker (bass); Wilfrid Jochims (tenor); Martin Galling (harpsichord); Württemberg Chamber Orchestra, Rudolf Ewerhart cond. TURNABOUT TV 34071S \$2.50, TV 4071* \$2.50.

Ⓢ Ⓜ BACH: *Cantata No. 208, "Was mir behagt, ist nur die muntre Jagd" ("Hunting Cantata").* Helen Donath and Elisabeth Speiser (sopranos); Wilfrid Jochims (tenor); Jakob Stämpfli (bass); Martin Galling (harpsichord); Chorus of the Gedächtniskirche and Chamber Ensemble of the Bach-Collegium, Stuttgart, Helmuth Rilling cond. NONESUCH H 71147 \$2.50, H 1147 \$2.50.

Performance: Each enjoyable
Recording: Very good
Stereo Quality: Fine

The most immediately appealing of these three secular cantatas is No. 211, which humorously depicts an argument between father and daughter over the daughter's fondness for coffee. No. 203, a typically Italian work, deals with unrequited love, and No. 208, containing that old favorite "Sheep may safely graze," is an allegorical birthday salute to Duke Christian of Sachsen-Weissenfels, who was devoted to the hunt.

The "Coffee" Cantata is nicely relaxed and pastoral in feeling, with some excellent characterizations, and it compares favorably with the imported Odeon version (conducted by Karl Forster, and featuring Fischer-Dieskau, Josef Traxel, and Lisa Otto in the "cast"). The bass Claus Ocker is properly dramatic and distraught in the briefer No. 203 and the instrumental playing is very commendable, although the balance stresses a rather too-far-forward harpsichord whose tonal characteristics become somewhat wearing after a while. (Contrary to the notes, incidentally, a cello is used as a supporting continuo instrument.) Again, this performance matches the standard set by Fischer-Dieskau in his Odeon recording.

The Nonesuch interpretation of the "Hunting" Cantata holds its own very nicely with the competing versions (an Odeon import conducted by Forster and a Telefunken

version under Rieu). But it is not an entirely ideal performance, mainly because of a few second-rank voices, and this fault seems to plague the other versions as well. The favorite excerpt, "Sheep may safely graze," which incidentally, and contrary to popular opinion, is purely secular in content—it merely compares the Duke to a good shepherd—is not really satisfactory in any of the versions, either having over-fast tempos or lacking in certain basic stylistic considerations such as ornaments. On the other hand, Nonesuch's performance includes one interesting musicological point: an instrumental movement

cond. COLUMBIA MS 6956 \$5.79, ML 6356 \$4.79.

Performance: Admirable
Recording: High quality
Stereo Quality: Effective separation

The first item here is not a new unknown Bartók concerto but the Sonata for Two Pianos and Percussion arranged by the composer himself in this form. Bartók wrote the Sonata in 1937 for himself and his wife, Ditta Pásztory; he made the orchestral version in 1940, shortly after his arrival in America, in order to give himself and his wife an orchestral showpiece. The orchestra does not really have very much to do except double what is already basically present in the Sonata, and when music is occasionally taken away from the soloists in order to make work for the orchestra, the results seem to me to be almost never a gain. Still, even though I much prefer and certainly recommend the sonata version, I must grant that it was worthwhile to rescue the orchestral version and get it on records. Gold and Fildale are first-rate Bartók pianists, and the percussionists of the New York Philharmonic, led by the redoubtable Saul Goodman, put on a fine show.

The orchestra's strings really show to advantage on the over-side, in this reissue of Bernstein's vibrant performance of the Music for Strings, Percussion, and Celesta. My first experience with this work was a performance led by Bernstein, and I still think he makes an extraordinary effect with the piece. This is a frenetic, breath-taking reading, but I think the music can take it. Bernstein comes closer than anyone I've heard to getting the dazzling confusion of the eccentric finale to cohere. The recording—the piece, with its double string choirs and, of course, prominent percussion, is a natural for stereo—holds up well. I must say I object to the record cover, which announces "A Percussion Spectacular" (surely anyone buying the record for that will only feel cheated) and then bales out Bernstein's name over Bartók's. But I suppose that is what sells records, and this record deserves to sell. E. S.



DIETRICH FISCHER-DIESKAU
A singing encyclopedia turns to Beethoven

(BWV 1040) which, because of its thematic similarity, is used as a ritornello for the soprano aria "Weil die wollenreichen Herden." On the whole, the performance of No. 208 is an enjoyable one, with excellent instrumental playing and solid, though hardly effervescent, conducting.

Both discs, with the exception of the aforementioned harpsichord balance problem in No. 203, are very well recorded; Turnabout's stereo edition features unusually wide separation, Nonesuch's a rather more normal spread. Both records include texts and translations. I. K.

Ⓢ Ⓜ BARTÓK: *Concerto for Two Pianos, Percussion, and Orchestra; Music for Strings, Percussion, and Celesta.* Arthur Gold and Robert Fildale (duo-pianists); New York Philharmonic, Leonard Bernstein

RECORDING OF SPECIAL MERIT

Ⓢ Ⓜ BEETHOVEN: *An die ferne Geliebte; Schilderung eines Mädchens; Als die Geliebte sich trennen wollte; Sehnsucht; Ruf vom Berge; An die Geliebte; Adelaide; Andenken; Zärtliche Liebe; Hoffnung; Liebesklage; Dimmi, ben mio; T'intendo, sì mio cor; L'amante impaziente* (two versions); *La partenza; In questa tomba oscura.* Dietrich Fischer-Dieskau (baritone); Jörg Demus (piano). DEUTSCHE

Explanation of symbols:

- Ⓢ = stereophonic recording
- Ⓜ = monophonic recording
- * = mono or stereo version not received for review

"There are so many recordings of the Beethoven Symphonies available. How do I know which ones to buy?"

Good question.

We assume you're concerned with quality of performance. Of course there are many fine recordings of the Beethoven Symphonies on the market. But none, we think, as historically exciting as those by The New York Philharmonic under Bruno Walter.

These recordings, produced over a little more than a decade (1942-1953), were the result of Dr. Walter's brilliant and renowned Beethoven cycles with the Philharmonic.* Now they are available in a special set for the first time.

You have, therefore, a true collector's item.

And, it is being offered to you at an incredibly low price. (It may be one of the lowest Beethoven offers you'll ever see!)

The Odyssey collection, which is an exciting new budget series from Columbia Records, is also able to bring you other adventures for the connoisseur. Legendary performances by Beecham, Casadesu, Casals, Gieseking, Lipatti, Schweitzer, for example. And Max Guberman's Haydn/Corelli/Vivaldi series. Plus Baroque and Renaissance rarities from the Harmonia Mundi collection.

All at prices so modest that you can afford to have a not-so-modest record library.

The critics agree. "Collectors looking for bargains will be pleased," wrote HiFi/Stereo Review. "Columbia's new budget line offers excellent values for the price," echoed The American Record Guide.

So ask your record dealer for Odyssey. The answer to a collector's dream.



32 66 0001 (A 6-record set in mono only)

*Dr. Walter leads The Philadelphia Orchestra in the Sixth Symphony.

If we count the integral Beethoven concerto sets, there are some sixteen currently available stereo/mono recordings of the Beethoven C Minor Concerto, including Rubinstein's own 1957 performance with Josef Krips and the Symphony of the Air. Few of these are less than good, and some—such as the recent Seraphim issue of the 1959 reading by Solomon and Herbert Menges—are absolutely outstanding. So the record collector may pose the question, why another recording of the C Minor? The answer is that Rubinstein and Leinsdorf have come up with a reading that, instead of trying to outrun the field in fierce dramatic emphasis, searches out the lyrical substance and the details of the textural weaving of inner voices. One senses this most particularly in the developmental episodes of the end movements. The always lovely slow movement is played, by contrast, with great simplicity, and the most ravishing tonal beauty is coaxed from the Steinway by Rubinstein's fingers.

Of meditative readings of the C Minor Concerto, this one surely belongs in the top spot, thanks in no small part to the fullness and transparency of the recorded sound. And those who favor the dramatic approach cannot go wrong with Fleisher-Szell (Epic) or Solomon-Menges (Seraphim). *D. H.*

BEETHOVEN: *Symphonies Nos. 1, 4, and 6; Leonore Overture No. 1* (see page 31)

BRAHMS: *Tragic Overture, Op. 81* (see page 31)

Ⓢ Ⓜ **CHOPIN:** *Waltzes (complete)*. Jeanne-Marie Darré (piano). VANGUARD VSD 71163 \$5.79, VRS 1163 \$4.79.

Ⓢ Ⓜ **CHOPIN:** *Scherzos (complete); Nocturne, in D-flat Major, Op. 27, No. 2*. Jeanne-Marie Darré (piano). VANGUARD VSD 71162 \$5.79, VRS 1162 \$4.79.

Performance: Lots of question marks
Recording: Okay
Stereo Quality: Some problems

I have not heard Mme. Darré's earlier Chopin disc, but I find these two disappointing. There are good things: certain phrases flicked off with just the right combination of light technique, touch, style, and poetic gesture. But there are more misses than hits. I don't mean wrong-note misses, I mean interpretive misses—phrases that simply do not come off. The most obvious cases are in the waltzes, where again and again the shape of a phrase is just not right, the rhythmic lift just a bit—disastrously—misplaced. This is as true (although for somewhat different reasons) of the big glittering, glittering pianistic passages as of the long, reflective lyric lines. There are beautiful things, but somehow they work out wrong: for example, there's no rubato where it's needed, and then—blat—there it is in the wrong part of the bar.

Some of the trouble can be traced, I think, to a curious insensitivity to the harmonic motion and the way the lines phrase and flicker around the subtle motion of the harmonies. In the Scherzos this really robs the music of a sense of direction or shape, and as a result they seem more formless than usual and curiously unpoetic. The expression seems put on from the outside and not a natural part of the music. I realize this is a harsh judgment on a pianist for whom I have elsewhere expressed admiration, but I really think

she misunderstands this music quite badly. Mme. Darré applies expressive and elegant routines without ever catching on to the fact that every time she applies the expression from the outside—no matter how beautifully executed it may be in itself—she takes away that which is distinct and unique about the piece and brings to the surface only those qualities the music might share with any other music.

The recorded piano sound has a lot of presence, but so, I found, does "atmosphere" and hiss. Toward the end of the second side of the waltzes the right channel seemed to weaken considerably, a phenomenon I am at a loss to explain. *E. S.*

Next month in

Hi Fi/Stereo Review

**The Concise Dictionary of
LOUDSPEAKER TERMINOLOGY**
by Victor Brociner

•

**The Revolutionary Speaker Systems
of Yesteryear**
by George Angspurger

•

What's Wrong with Loudspeakers
by Edgar Villchur

•

PLUS
Gustav Mahler, Conductor
by Harold Schonberg

RECORDING OF SPECIAL MERIT

Ⓢ Ⓜ **COPLAND:** *Piano Fantasy; Piano Variations*. William Masselos (piano). ODYSSEY 32 16 0040 \$2.49, 32 16 0039 \$2.49.

Performance: Matchless
Recording: Very good
Stereo Quality: Fine

These performances were originally released by Columbia in commemoration of Aaron Copland's sixtieth birthday in 1960. Since it is difficult to imagine that the record could have been a big seller, it was understandably a Schwann catalog cut-out until now when it is available again, in perfectly modern remastered sound, at the great bargain rate of \$2.49. I couldn't recommend more highly either the music itself or Masselos' performance of it at any price.

No one who is familiar with the history of modern American music has to be told that Copland's Piano Variations (1930) is a legend in its own right and a work of prime significance in the composer's musical development. Its stature as a sort of granitic masterwork has been questioned by virtually no cultivated musician—no matter what his stylistic allegiance—since its composition. Beveridge Webster's recent recording of it for

Dover might conceivably please some listeners more than Masselos', but the contest is close, and there is no other available recorded competition.

The Piano Fantasy (1957) is the most recent of Copland's three major solo piano pieces (the Piano Variations and the Sonata for Piano are the other two), and if it is not the historical landmark the Piano Variations is, it is on many levels a more "gratifying" work and, after its latter-day fashion, quite as courageous. Originally composed for performance by the late William Kapell, it is one of a handful of Copland's more recent works that—in the wake of his widely disseminated and popular tonal style—merges the techniques of Schoenbergian serialism with the composer's essentially tonal bias and his own highly personal style. It differs from his more characteristic keyboard style in that it is less skeletal, less raw-boned, more virtuosic and adorned. Thirty minutes long, composed in a single, unbroken movement, it has a consistent freshness of imaginative impulse that is, by itself, a wonder. Perhaps someone will come along one day to outdo what the in-group of composers has long since recognized as Masselos's classic performance of it, but—as the saying has it—don't hold your breath. *W. F.*

Ⓢ Ⓜ **F. COUPERIN:** *Messe pour les Couvents (complete)*. **L. COUPERIN:** *Allemande in G Minor (No. 92); Sarabande en Canon in D Minor (No. 47); Chaconne in G Minor (1658, No. 122)*. Georges Robert (organ of St.-Merry, Paris). NONESUCH H 71150 \$2.50, H 1150 \$2.50.

RECORDING OF SPECIAL MERIT

Ⓢ Ⓜ **F. COUPERIN:** *Messe pour les Couvents: Premier Kyrie: Couplets 2 and 4; Gloria: Couplets 4 and 8; Offertoire; Elévation; Agnus Dei: Couplet 2. Messe à l'usage des Paroisses: Gloria: Couplets 1, 2, 3, 8, and 9*. Xavier Darasse (organ of Notre Dame de St. Etienne). **LEBÈGUE:** *Magnificat No. 1*. André Isoir (organ of the Cathédrale d'Auch). TURNABOUT TV 34074S \$2.50, TV 4074* \$2.50.

Performance: Both worthy but Turnabout has better style
Recording: Both excellent
Stereo Quality: Both fine

François Couperin's two organ Masses were designed to be played in alternation with the sung portions of the Mass, and their music was based very loosely, if at all, on the chant. Stylistically, there is much similarity to the composer's clavecin works. Georges Robert, who provides a complete *Messe pour les Couvents* (for the use of the nuns and monks of the religious institutions in France), gives a very commendable account of the work on the excellent St.-Merry organ, although he is not quite so imaginative, sprightly, and rhythmically subtle (he does not apply *notes inégales* anywhere) as Xavier Darasse, who performs excerpts from the two Masses. The latter include about half of the *Couvent* Mass plus a good portion of the *Gloria* from the *Messe à l'usage ordinaire des Paroisses*. For fillers, Robert plays the three brief Louis Couperin pieces (really harpsichord works) well enough, but although the fingerwork is facile and the registration well chosen, there are again stylis-

(Continued on page 72)

"Heath In Their Literature Implies Strongly That The AR-15 Represents A New High In Advanced Performance And Circuit Concepts. After Testing And Living With The AR-15 For Awhile, We Must Concur."



Julian Hirsch, noted audio critic, and author of the "Technical Talk" column in Hi-Fi/Stereo Review (May '67 Issue).

"... The Entire Unit Performs Considerably Better Than The Published Specifications"



C. G. McProud, editor and publisher of Audio Magazine (May '67 Issue).

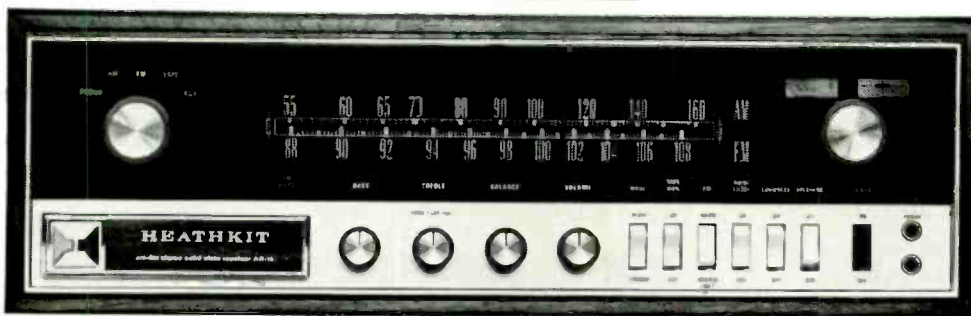

Heathkit® Solid-State 150-Watt AM/FM Stereo Receiver \$329.95†

Mr. Hirsch Went On To Say: "In most respects, it is superior to any manufactured receiver we have tested, and in several respects its FM tuner outperforms any other we know of."

"The FM tuner's front end uses field-effect transistors (FET's) for high sensitivity and freedom from cross-modulation. The FM i.f. amplifier is unique and marks the first use of integrated circuits in a kit receiver. Each IC, about the size of a transistor, contains ten transistors, seven diodes and eleven resistors. Instead of the usual i.f. transformers, which require periodic alignment and have less-than-ideal response characteristics, the Heath AR-15 uses two crystal-lattice filters. Though costly, these have a virtually ideal flat-topped response characteristic, with extremely steep skirts which offer a degree of adjacent channel selectivity unobtainable with conventional i.f. transformers."

"This is the most sensitive FM tuner we have ever tested, and it has by far the best limiting characteristic. Its IHF sensitivity was 1.45 microvolts and limiting was complete at about 2 microvolts. We could not find any stations that did not limit fully, with silent backgrounds. We were also able to receive stereo broadcasts from a distance of 70 miles, only 200 kHz from a powerful local station, without interference, a feat not matched by any other tuner in our experience."

"We found the Heath AR-15 a very easy receiver to use and to listen to. Its enormous reserves of clean power make for effortless

listening at any level, and the FM tuner brought in more listenable FM broadcasts (as many as fifteen to twenty on a single sweep of the dial) than we had realized existed in our area."

"We know of only a few amplifiers that can match or surpass the AR-15 in power or ultra-low distortion, and most of them cost considerably more than the entire AR-15 receiver. No other tuner we have used can compare with it in sensitivity. Considering these facts, the AR-15 is a remarkable value at \$329.95 in kit form. Several people have commented to us that, for the price of the AR-15 kit, they could buy a very good manufactured receiver. So they could — but not one that would match the superb overall performance of the Heath AR-15."

Mr. McProud Went On To Say: "The amplifier provides a continuous average power of slightly better than 60 watts per channel with both channels operating into 8-ohm loads and distortion measuring 0.3 percent; with 4 and 16 ohm loads, the output at the same distortion measured 54 and 47 watts, respectively. At 50 watts output, distortion is less than 0.2 percent at 1000 Hz, and less than 0.5 percent from 8 Hz to 40 kHz; at the 1-watt level, THD is less than 0.1 percent at 1000 kHz, and less than 0.25 percent from 8 Hz to 27 kHz. At full output, IM distortion is less than 0.5 percent, and at 1 watt it is only 0.15 percent."

†Kit AR-15, (less cabinet) 34 lbs. \$329.95
 AE-16, assembled, wrap-around walnut cabinet, 10 lbs. . . \$19.95



FREE! World's Largest Electronic Kit Catalog

Contains full descriptions and specifications of AR-15 and over 250 easy-to-build kits . . . stereo/hl-fi, color TV, electric guitars & amplifier, organs, AM-FM-shortwave radios, test, marine, CB and ham radio. Mail coupon or write Heath Company, Benton Harbor, Michigan 49022.

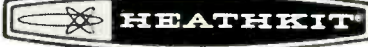

HEATH COMPANY, Dept. 40-7
 Benton Harbor, Michigan 49022

Please send FREE Heathkit Catalog.

Enclosed is \$ _____ plus shipping.

Please send model (s) _____

Name _____

Address _____

City _____ State _____ Zip _____

Prices & specifications subject to change without notice. HF-203

EXCITING RECORD NEWS!

from
**Command
RECORDS**



BRASILIAN IMPRESSIONS DICK HYMAN/PIANO & WOODWINDS

The Brazilian piano, gorgeously free ranging, played by the brilliant Dick Hyman, supplemented by the exotic woodwinds and the rich tones of a flugelhorn... an astonishing musical meeting of the land of Villa-Lobos and the bossa nova with the contemporary pop and jazz world.

SELECTIONS: A TIME FOR LOVE • MAS QUE NADA • JAZZ 'N' SAMBA • A DAY IN THE LIFE OF A FOOL • O BARQUINHO • plus 7 more. Album #911.

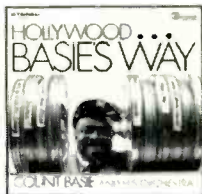

HOLLYWOOD. BASIE'S WAY COUNT BASIE & HIS ORCHESTRA

You've never heard Basie until Command and Basie got together!

FIRST... BROADWAY... BASIE'S WAY
NOW... THE BIG BAND SOUND OF
HOLLYWOOD... BASIE'S WAY

SELECTIONS: SECRET LOVE • LAURA • THE SHADOW OF YOUR SMILE • STRANGERS IN THE NIGHT • CARIOCA • DAYS OF WINE AND ROSES • plus 6 more. Album #912.



ROBERT MAXWELL - ANYTIME

From the composer of the fabulous Shangri-La, from the man whose harp has created a glorious new approach to popular music, comes a unique ensemble specifically designed to make the exciting tonal colors of the harp a part of the Big Sound of unforgettable wonderful songs.

SELECTIONS: I'M GONNA SIT RIGHT DOWN AND WRITE MYSELF A LETTER • ANYTIME • BYE BYE BLUES • SING, SING, SING • THE SHEIK OF ARABY • plus 7 more. Album #913.

WORLD LEADER IN
RECORDED SOUND

**Command
Records**

A subsidiary of ABC RECORDS, INC.

1330 Ave. of the Americas, N. Y., N. Y. 10019

CIRCLE NO. 14 ON READER SERVICE CARD

tic deficiencies. André Isoir, on Turnabout, provides an impressive-sounding *Magnificat* by François Couperin's slightly older contemporary, Nicolas Lebègue (or le Bègue). Both organs on Turnabout, with their reedy quality, are splendid-sounding instruments; the miking is rather more close-up than that heard on Nonesuch. Overall, however, it is the performance of François Couperin's music that should decide between the two discs; Georges Robert's is the best rendition of the complete *Convent Mass* I have heard, but Darasse really makes this music come to life. First-rate sound on both discs, with excellent program notes for each. I. K.

Ⓢ Ⓜ DEBUSSY: *Violin Sonata*. PROKOFIEV: *Five Melodies*, Op. 35. RAVEL: *Violin Sonata in G*. YSAÏE: *Sonata in D Minor*, Op. 27, No. 3. "Ballade" (unaccompanied). David Oistrakh (violin), Frida Bauer (piano). PHILIPS PHS 900 112 \$5.79, PHM 500 112* \$4.79.

Performance: Mostly very beautiful

Recording: Excellent

Stereo Quality: First-rate

As more and more recordings of Debussy's Violin Sonata come my way, played with brilliance, if not to my ideal pleasure, by such violinists as Erick Friedman (recently on RCA Victor) and now David Oistrakh, I guess it is time that I gracefully concede that I am right and the rest of the world is wrong about how this composer's work should be approached stylistically—or, to put it another way, explain my own eccentricities of taste.

In general, it was Debussy's avowed creative aim to break with what we generally think of as the nineteenth-century Romantic expressive gesture, as well as to devastate, by his own very special way of putting a piece together, the ways in which musical continuity had been traditionally achieved. In the latter respect, he was successful to a revolutionary degree. In the former, in the sense that, as the saying has it, "there is a little Massenet in every Frenchman," he was inevitably somewhat less successful.

But how *much* less successful, it seems to me, is a matter of degree conditioned strongly by the approach a performer takes to a work like the Sonata. Turn on the big string sound, overshape the phrases, do lots of very effective throbbing that might be very effective in any one of many Romantics, and you'll turn Debussy's clock back on him. Work for a leaner sound, an understated line—thinking always in terms of the unconventional techniques of phrasal extension that were the composer's own—and you are likely to relate Debussy more to the century he so powerfully influenced rather than the one that preceded it.

Oistrakh, like Friedman before him, takes the first of the approaches I have described—even more so and even more beautifully. I suppose that most concert violinists will continue to take this approach, and I shall continue to complain and wish that it were otherwise.

Curiously enough, the Ravel G Major Sonata is put together in such a way as to obviate such an approach. Its leaner, neo-classic texture is a warning at the outset, and, even at that, were a musician tempted to treat it otherwise, the piece has a way of going wry and sardonic just at the moment when temptation might win out. Oistrakh,

and pianist Frida Bauer, do a beautiful job with this piece.

Prokofiev's Five Melodies are performed with perfection—as well as with an enchanting poise and modesty. I could do beautifully without the Ysaye solo violin sonata with which Oistrakh rounds off his program in an enthusiastic demonstration of technical—but perhaps that is my problem.

The recorded sound is sharp and clean, but full-bodied and handsomely balanced. The stereo treatment strikes me as just a little fussy for an instrumental duo. W. F.

DUTILLEUX: *Symphony No. 2* (see ROUSSEL)

Ⓢ Ⓜ DVORÁK: *Symphony No. 1, in C Minor* ("The Bells of Zlonice," 1865). London Symphony Orchestra, István Kertész cond. LONDON CS 6523 \$5.79, CM 9523* \$4.79.

Ⓢ Ⓜ DVORÁK: *Symphony No. 2, in B-flat, Op. 10; Hussite Overture, Op. 67*. István Kertész cond. LONDON CS 6524 \$5.79, CM 9524* \$4.79.

Ⓢ Ⓜ DVORÁK: *Symphony No. 3, in E-flat, Op. 10; Hussite Overture, Op. 67*. London Symphony Orchestra, István Kertész cond. LONDON CS 6525 \$5.79, CM 9525* \$4.79.

Ⓢ Ⓜ DVORÁK: *Symphony No. 4, in D Minor, Op. 13; In Nature's Realm—Concert Overture, Op. 91*. London Symphony Orchestra, István Kertész cond. LONDON CS 6526 \$5.79, CM 9526 \$4.79.

Ⓢ Ⓜ DVORÁK: *Symphony No. 5, in F, Op. 76; My Home—Overture, Op. 62*. London Symphony Orchestra, István Kertész cond. LONDON CS 6511 \$5.79, CM 9511* \$4.79.

Performance: All excellent

Recording: Good

Stereo Quality: First-rate

Ⓢ Ⓜ DVORÁK: *Symphony No. 7, in D Minor, Op. 70*. Czech Philharmonic Orchestra, Zdenek Košler cond. CROSSROADS 22 16 0098 \$2.49, 22 16 0097 \$2.49.

Performance: Stresses the lyric

Recording: Good

Stereo Quality: Good enough

Ⓢ Ⓜ DVORÁK: *Symphony No. 9, in E Minor, Op. 95* ("From the New World"); *Otbello—Concert Overture, Op. 93*. London Symphony Orchestra, István Kertész cond. LONDON CS 6527 \$5.79, CM 9527 \$4.79.

Performance: Could use more fire

Recording: Excellent

Stereo Quality: Very good

The most important single thing to say about this clutch of Dvořák is that it marks completion of the first integral recording of all nine symphonies by the Bohemian master performed by the same conductor and orchestra—in this instance István Kertész and the London Symphony Orchestra. The Kertész readings for London of No. 7 and No. 8 together with the *Scherzo Capriccioso*, and of No. 6 together with the *Carnival Overture*, have already been reviewed in the pages of HiFi/STEREO REVIEW. In the current release, Mr. Kertész offers not only the five least-known Dvořák symphonies plus the single

(Continued on page 74)

CIRCLE NO. 46 ON READER SERVICE CARD →

Something
for the
Connoisseur...

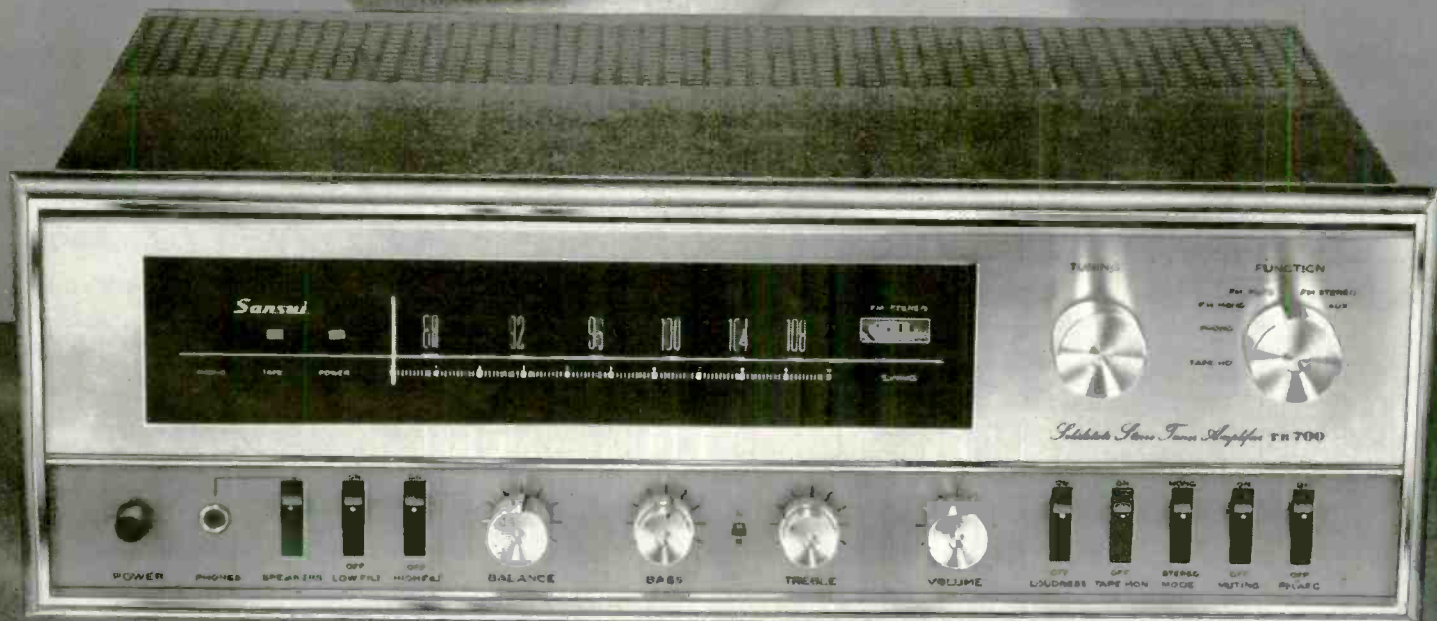

SANSUI MODEL TR-700: SOLID STATE FM MULTIPLEX STEREO / MUSIC POWER: 60 WATTS \pm 1 db / FM USABLE SENSITIVITY: 1.8 μ V \pm 3 db (IHF) — PRICE \$239.95

Stereofidelity® by *Sansui* . . .

For all those features that make a Hi-Fi Stereo System truly great—sensitivity, beautiful never failing balance, crystal-clear selectivity, unmatched sound reproduction—the Sansui TR-700 offers you a new experience in stereo listening. Only Sansui ingenuity could bring you that new sound in sound engineering—*Stereofidelity*®

Ask your audio dealer for a demonstration.

Sansui

SANSUI ELECTRONICS CORPORATION • 34-43 56th STREET • WOODSIDE, N.Y. 11377 • TELEPHONE 446-6300

Sansui Electric Company, Ltd., Tokyo, Japan • Electronic Distributors (Canada), British Columbia

A Season in the Sun with



Deutsche
Grammophon
Gesellschaft

If you can't make it to Europe for the festivals this season, DGG brings you its own summer festival beginning with the history-making recording of *Tristan und Isolde* recorded live at Bayreuth.



39 221-5; Stereo 139 221-5 (5 records)

Wagner: Die Walküre—RéGINE Crespin, Gundula Janowitz, Jon Vickers, Thomas Stewart; Berlin Philharmonic, Karajan, cond. 5 records. 39 299-233; Stereo 139 229-233

Schubert: Die Schoene Muel-lerin/Seven Songs—Fritz Wunderlich, tenor; Hubert Giessen, piano. 2 records. 39 219-20; Stereo 139 219-20

Mozart: The Magic Flute—Roberta Peters, Evelyn Lear, Dietrich Fischer-Dieskau, Fritz Wunderlich in "a splendid production" (High Fidelity). Berlin Philharmonic, Karl Boehm, cond. 3 records. 18 981-3; Stereo 138 981-3

Beethoven: Songs—Dietrich Fischer-Dieskau, "the foremost Lieder singer of the day,"; Joerg Demus, piano. 39 197; Stereo 139 197

Dvorak: Symphony No. 8—(Former No. 4) Berlin Philharmonic; Rafael Kubelik, cond. 39 181; Stereo 139 181

DGG Records are distributed by MGM Records, a division of Metro-Goldwyn-Mayer Inc. Free on request! The new illustrated DGG/Archive Catalog. Write MGM Records/Classical Division, 1350 Avenue of the Americas, New York City, 10019.

CIRCLE NO. 16 ON READER SERVICE CARD

most popular one, but also four relatively unfamiliar overtures—*My Home, The Hussites, In Nature's Realm, and Otello*.

The five early Dvořák symphonies have all been available on the Artia label in wholly idiomatic Czech performances (only Nos. 3 and 4 in stereo), as have the *Hussite* and *Otello* overtures. However, London's stereo recording is vastly superior, and in most respects the London Symphony outstrips in refinement and virtuosity anything that Prague has to offer. Furthermore, Kertész has proved with his recordings of the Sixth and Eighth symphonies that he knows his way with Czech style, too.

Musically, the first four Dvořák symphonies are of interest in demonstrating (a) that the composer was a born melodist, and (b) that his craft had not yet reached full flower. There are lovely moments in the early symphonies: the "New Worldish" oboe solo in the slow movement of No. 1, the unusual scherzo of No. 2, the fiercely militant scherzo and finale of No. 4, and the lovely slow-movement cello melody and flawless dance-scherzo of No. 5. But there are also tiresome redundancies of figuration and rhythm, clumsy transitions, and derivative elements—especially of the Wagner *Tannhäuser-Venusberg* variety—that make one understand why the composer kept the first four out of the canon of his published work during his lifetime. (Indeed, the manuscript of No. 1 was not even discovered until 1923.) Be that as it may, Kertész gives a rousing and affectionate account of all five of the early symphonies, doing especially well with the scherzo of No. 5.

Among the overture performances, the fascinating and dramatic *Otello* comes off best. This is the last of the three concert overtures (*In Nature's Realm* and *Carnival* are the other two) all built around the same motto theme, yet developing from it music of widely disparate expressive content. For my taste, Kertész is a trifle heavy-handed with rhythmic accent in the militant *Hussite* Overture, as well as in the swingingly bucolic *In Nature's Realm*. *My Home* is of some interest because it uses the melody (*Where is my Home?*) that eventually became the Czechoslovak national anthem, but as a whole it is not up to Dvořák's best.

Perhaps not so surprisingly, it is in the most popular of the Dvořák symphonies—"From the New World"—that Kertész fails to score a resounding success. He takes a very studied and deliberate view of the first movement (complete with expository repeat), and though his pacing of the other three movements is wholly just, the performance never takes wing as do those of Toscanini, Szell, and Walter. The orchestral playing and recording are the last word in precision and elegance, but the whole fails to enthral.

Dvořák's first great mature symphony, and the least nationalistic—No. 7 in D Minor—has had some distinguished recorded performances in the past—by Kubelik, Szell, and Monteux. Zdenek Košler and the Czech Philharmonic offer a reading of less turbulent and more lyrical strain than we have become used to in previous recordings. This is especially true of the opening movement, which is made to sound more poignant and less fierce by virtue of slower pacing and somewhat easier phrasing. This is not especially to my taste, but I will give Mr. Košler full marks for the subtle way in which he handles rhythm, dynamics, and internal

balances throughout the irresistible scherzo movement. The recorded sound is warmer and less troubled by excessive room reverberation than has been the case with most orchestral performances taped in Prague. At \$2.49, this record is a good buy, but for the best available disc version, I think it is a toss-up between Szell and Kertész.

Summing up the Dvořák symphonic scene on discs as it now appears, I would say that the first five symphonies are for Dvořák buffs only, and that they are exceedingly well represented in the Kertész-London discs. I would likewise give Mr. Kertész the palm for all the later symphonies except the "New World," but I must point out that the Epic album with George Szell and the Cleveland Orchestra presents a wholly satisfactory alternate for Dvořák's "big three," including a really fine "New World." D. H.

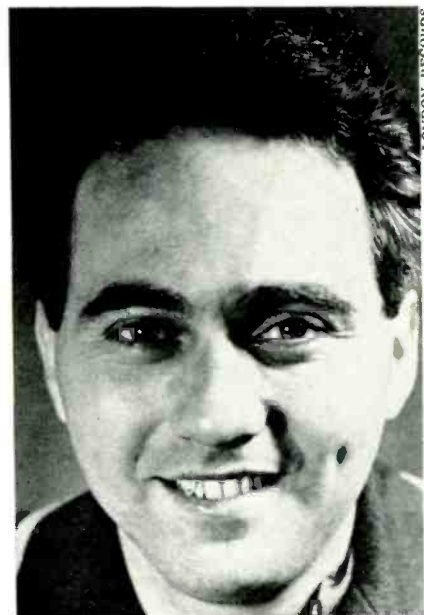

ISTVÁN KERTÉSZ
Early Dvořák symphonies in rousing style

RECORDINGS OF SPECIAL MERIT

⑤ ⑥ HAYDN: *Mass No. 7, Missa in tempore belli* ("Paukenmesse"). *Motet—Insanae et vanae curae*. Heather Harper (soprano), Pamela Bowden (contralto), Alexander Young (tenor), John Shirley-Quirk (bass). Choir of King's College, Cambridge; English Chamber Orchestra, David Willcocks cond. ANGEL S 36417 \$5.79, 36417 \$4.79.

⑤ ⑥ HAYDN: *Mass No. 9, in D Minor* ("Nelson" Mass). Sylvia Stahlman (soprano), Helen Watts (contralto), Wilfrid Brown (tenor), Tom Krause (baritone). Choir of King's College, Cambridge; London Symphony Orchestra, David Willcocks cond. ARGO ZRG 5325 \$5.79, RG 325* \$5.79.

⑤ ⑥ HAYDN: *Mass No. 12, in B-flat* ("Harmoniemesse"). Erna Sporenberg (soprano), Helen Watts (contralto), Alexander Young (tenor), Joseph Rouleau (bass). The Choir of St. John's College, Cambridge; The Academy of St. Martin-in-the-Fields, George Guest cond. ARGO ZRG 515 \$5.79, RG 515* \$5.79.

Performance: All outstanding
Recording: All very good
Stereo Quality: All good

These are three of Haydn's last six Masses,

HIFI/STEREO REVIEW

written between 1796 and 1802, and all three are masterpieces. It is well to remember that by 1796 Haydn was through writing symphonies, after having given himself one hundred and four opportunities to perfect the form he had virtually invented. His symphonic mastery was thereafter lavished on the Masses, which bear the unmistakable mark of symphonic design: the slow introductions (a characteristic Haydn device), the alternating slow and fast movements, and the rousing final *allegros*. It would be easy to enjoy these Masses simply for their extraordinarily inventive and colorful orchestral statements were it not for the magnificence of choral and vocal parts which constantly intrude—if that is the word. The total effect is bold, imposing, exultant with religious feeling, yet somehow more theatrical than ecclesiastical.

All three recordings here originated in Cambridge, utilizing two outstanding choirs and conductors, and solo singers of the first rank. In the "*Paukenmesse*," Heather Harper and John Shirley-Quirk are exceptional. The score's inherent drama is somewhat understated by conductor Willcocks, but this impression may arise because the orchestra appears to be submerged in the reverberant acoustics. For sheer dramatic impact, Kubelik's version (DGG 138881) may be preferable, but this is nevertheless a beautiful and moving performance, and it offers as a bonus the effectively turbulent earlier motet, *In sanae et vanae curae*.

The "Nelson" Mass is a reissue of a performance previously circulated as London 25731. H. C. Robbins Landon calls this Mass "arguably Haydn's greatest composition." I am not inclined to argue the point, least of all with *him*! The intensely dramatic work gets a spirited performance here. Among the soloists, Sylvia Stahlman rates special praise for her exceptional singing of the high and florid soprano part, but mezzo Waits and baritone Krause are also excellent. Here, too, there is strong competition: a somewhat romanticized but very effective account under János Ferencsik (DGG 139195) with fine choral work and Maria Stader's lovely singing in the soprano part. The edition used by Ferencsik calls for woodwinds which, according to Robbins Landon, were not part of Haydn's original design. Thus, seekers for authenticity will prefer the Argo disc.

The "*Harmoniemesse*" (1802) was Haydn's last major work. Its opening *Kyrie* and *Gloria* are absolutely glorious, after which the martial *Credo* brings reminiscences of Haydn's grand Emperor tune ("*Gott erhalte*"). The entire Mass is full of such dramatic contrasts, and the final movement is rousing. The performance is outstanding in every possible way. G. J.

© M JANÁČEK: *From the House of the Dead*. Václav Bednář (baritone), Gorianchikov; Beno Blachut (tenor), Luka Kuzmich; Jaroslav Horáček (bass), Commandant; Ivo Židek (tenor), Skuratov; Přemysl Kočí (baritone), Shishkov; Helena Tattermuschová (soprano), Aleia; others. Chorus and Orchestra of the Prague National Theatre, Bohumil Gregor cond. CBS 32 21 0006 two discs \$11.59, 32 21 0005* \$9.59.

Performance: Authoritative
Recording: Very good
Stereo Quality: Very good

(Continued on page 78)

This is our idea of a well rounded speaker.

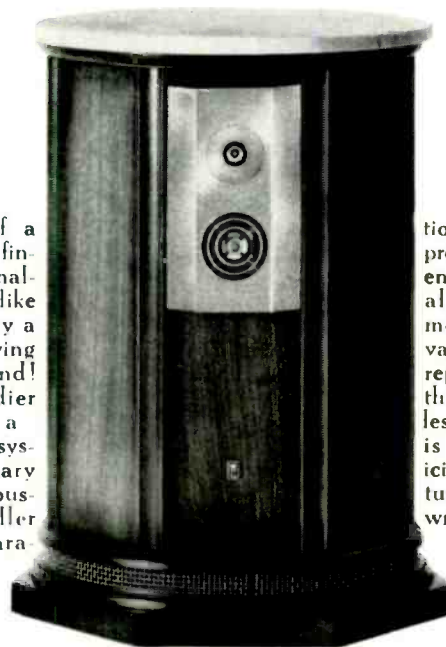

Forget the frills of a hand-rubbed walnut finish, statuesque originality and language like that! When you buy a speaker, you're buying performance. Sound! The Royal Grenadier 9000 is our idea of a true-to-life speaker system. Its revolutionary die-cast divergent acoustic lens assures fuller frequency and separa-

tion, plus broader sound propagation across the entire spectrum. All in all, it rounds out the most significant advances in stereophonic reproduction! The fact that we've added a flawless imported marble top is just so much more icing. For color literature and nearest dealer, write:

EMPIRE
845 Stewart Ave. Garden City, L. I. N. Y.

CIRCLE NO. 22 ON READER SERVICE CARD

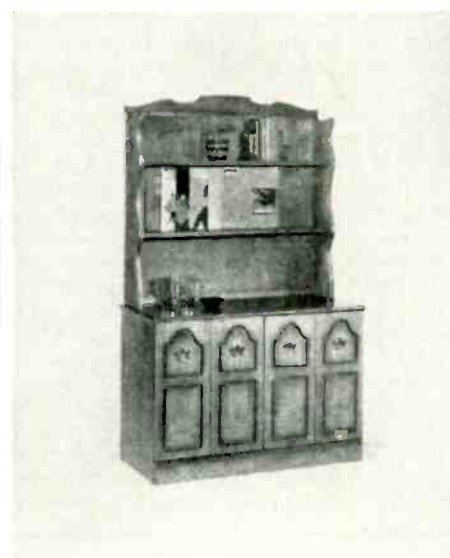
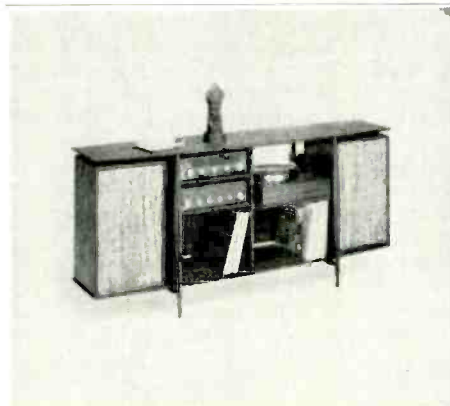

just because we make the largest selection of component furniture, we can't seem to stop designing new and better cabinets. . . have you seen our brochure lately? it's free. for a fast reply, mail this ad with your return address.

audio originals

546 S. Meridian • Indianapolis, Ind.

CIRCLE NO. 5 ON READER SERVICE CARD

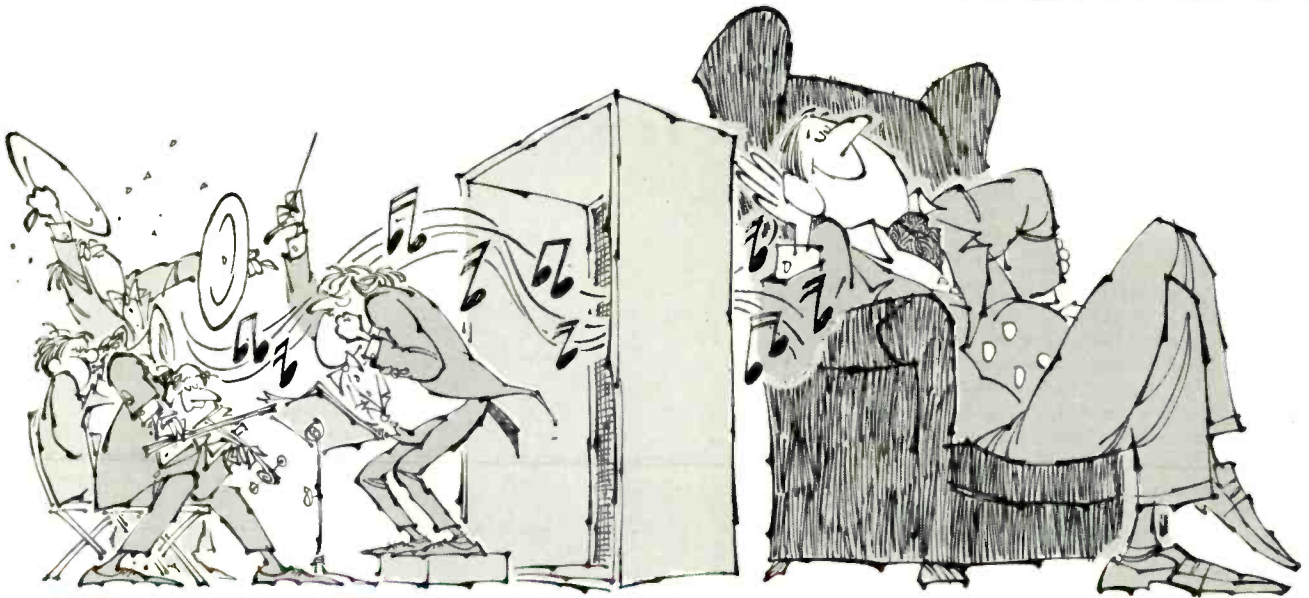

"THE DOLBY" Audio Noise Reduction System

A RECENT ADVANCE IN RECORDING TECHNIQUE PROMISES TO REDUCE STILL FURTHER THE SONIC DISTANCE BETWEEN PERFORMER AND LISTENER

By JOHN MILDER

OVER the past few months, recording engineers and record-company executives have been talking enthusiastically about something called "the Dolby," a new device whose purpose is to reduce the background noise of master tape recordings. According to several reports from the recording industry, the new device has important implications not only for the recording studio and other professional applications, but for the ultimate quality of records to be played in the home. And from the evidence now supplied by the first two "Dolbyized" records produced in this country (one from Vanguard, one from None-such), the reports seem to be justified.

Before describing just what "the Dolby" is and does, I would like to make clear that I feel these two records represent one of the most clearly audible breakthroughs in sound quality in many years. That is not the kind of statement I thought I would be making when given these recordings to evaluate, but the more I have listened to them, the more I have become convinced that the new Dolby system will become a *sine qua non* for recordings of serious musical material—until some entirely new recording medium arrives.

The Dolby A-301 Audio Noise Reduction System is a simple-looking "black box" (engineering jargon for any gadget that has no controls to tinker with) designed for connection to the inputs of a tape recorder during recording and the outputs during playback. The invention of Ray M. Dolby, an American audio engineer now living in England, it is designed to combat not only the high-frequency tape hiss added to any original signal during tape recording, but also many other kinds of background disturbances (including print-through echo, crosstalk, and scrape noise) that inevitably appear during the tape-recording process.

Anti-noise devices of various kinds have been in use for decades in radio and telephone communications, movie sound tracks, and, most recently, tape recording. In all of these media, the primary noise problem is a function of trying to accommodate both the loudest and softest sounds carrying musical information. If you have done any taping at home, you know the problem: set the recording level high enough to make the softest sounds most audible and free of background noise, and you run the risk of severe distortion during loud passages from overloading of the recorder; set the level low enough to avoid distortion during the loudest passages, and the softest ones may be lost in a "soup" of background hiss from the recorder. There is a happy medium, of course. But it is not all *that* happy, particularly for recording engineers, whose original taping of a performance is only the beginning of a chain of processing techniques that eventually produce the finished record.

Most of the anti-noise devices so far invented rely on the techniques of volume compression and expansion. That is, they compress the dynamic range of material during recording or transmission and, hopefully, expand it to the same degree afterward for final listening. But all such devices until now have had severe limitations, and many record companies and radio stations have settled simply for compression—that is, for limiting the final dynamic range of recorded material to the point where the loudest sounds aren't particularly loud or the softest ones particularly soft. In some cases, particularly before the arrival of hi-fi equipment, the use of compression has been accompanied by a disclaimer that no one really wants, or could tolerate, anything approaching the full natural dynamic range of music in a living room. Whatever the merits of that

argument (and there are some fairly persuasive ones), it does not justify the severe volume compression often applied to today's records and broadcasts, and it is a ridiculous rationale for the many records and broadcasts (particularly of the pop variety) whose dynamic range goes simply from loud to slightly louder.

The Dolby system will not decide how wide a dynamic range the listener can tolerate with psychological comfort. But it is bound, I think, to make impossible any future claims that severe compression is needed to combat noise in recordings. These first two Dolbyized records demonstrate conclusively that very soft musical sounds can emerge from the "soup" that previously enveloped them. And they prove that the prominent background noise we have heard for the past few years is *not* from record surfaces—not, at least, when the surfaces have been made of good vinyl. Certain record companies, then, are also going to find it hard from now on to claim that records must be cut "loud" to overcome surface noise.

UNTIL the Dolby system arrived, most devices that attempted to reduce noise by compression-expansion techniques did so, in effect, by lowering the level of the loud passages and then raising the overall average volume level. Alternatively, the volume level of the softer passages could be raised. The result of the compression is the same in either case: the loud passages are just as loud as before, but the soft passages are perhaps 10 db louder than before. When the process is reversed (expansion) and the lower-level passages are cut back 10 db to restore the original dynamic range, then the assorted low-level noises are also cut back by 10 db, thus achieving a 10-db improvement in the signal-to-noise ratio. At least three problems

arise with this technique: (1) it is difficult to reconstitute the original loud-to-soft balance when large amounts of compression are employed; (2) it is also difficult to restore the waveform of high-level signals once they have been compressed; and (3) there is the problem of peculiar volume changes in background noise and low-level signals. The last occurs because the compressor affects the *entire* range of frequencies, although it may be responding to only one segment of frequencies.

The new Dolby system does nothing at all to loud signals. Instead, working in four separate segments of the frequency range, it begins by boosting the level of all signals *below* a certain strength just before they are recorded. Then, during playback, it cuts these boosted signal areas back to their original level, and, in the process, reduces to the same degree any noise that has been added to the signal during the recording process.

THIS "backward" process has been attempted before, but the Dolby system succeeds where previous gadgets have not, and for two reasons. First, by handling four separate frequency bands, it takes care of *all* forms of added noise. If it covered only one area, or handled the entire frequency range at once, a signal loud enough to override the circuitry in recording—and loud enough to "mask" any noise in its segment of the frequency range—would not mask noise added in other areas of the frequency range. Second, and more important, the Dolby system works because its operation is *perfectly* symmetrical in its boosting and cutting of signal strength. This perfection is due both to superb basic design and to the use of semiconductors—more than one hundred transistors and diodes in wide-band, low-distortion circuits that do not change in any parameter of performance from one moment, or one month, to the next. This last factor is what makes the Dolby more than an interesting experimental gadget. It means that a tape can be stored for months or years between the two halves (input and output) of the Dolby's operational cycle, and that all tapes and recorders using the Dolby system are completely interchangeable. In the process, it assures that the print-through noise that often accumulates during the storage of tape will be wiped out when the tape is put through the second (or playback) half of the cycle.

As far as the recording industry is concerned, the big advantages of the system are, first, the tremendous basic gain in signal-to-noise ratio (10 to 15 db, depending on the frequency range) and, second, the ability to re-record ("dub") tapes for processing with virtually no discernible increase in noise from copy to copy. Along with several other things, this second factor means that a record company in one country can buy a dubbing from another company and country with assurance that it is as good as the original recording. That has almost never been the case until now. The few re-releases that have sounded as good as the original with respect to noise have always involved actual borrowing of the original master tape—understandably a rare arrangement in the recording industry.

Although the advantages of the Dolby system are major ones to a record company, they might not seem to be so critical to a listener. Records, after all, are pretty quiet these days. Can you *hear* a 10 or 15 db reduction in noise? Yes, you can, and the results are far more dramatic than you would guess. The outstanding characteristic both of Vanguard's and Nonesuch's first Dolbyized records is *clarity*—to an almost incredible degree. It is not simply the absence of tape hiss or other noises during a quiet passage heard in a quiet room, but the absence of all sorts of effects, inaudible or unidentifiable in themselves, that add a slight haze to the reproduction of musical instruments. The effects of print-through, crosstalk, and other kinds of middle- or low-frequency noise are unquestionably subtle individually or in combination, but there is nothing subtle about their *absence*.

In listening to these records and attempting to come up with a persuasive description of their gain in clarity, I kept thinking of the difference between the usual television picture in a home and that of a perfectly adjusted monitor set in a TV studio. If you have had a chance to observe that difference, or have seen one of the higher-definition television systems used abroad, you will have a good notion of the order of clarity in question.

Aside from clarity—and it's pretty hard to step aside for long—there is also a definite decrease in the amount of distortion perceptible in loud passages. This is a function of the engineer's ability, with the Dolby, to set peak recording levels a bit lower without having to worry about noise in quiet passages. And it is highly noticeable in the undistorted burr of the trombone in Vanguard's *L'Histoire du Soldat* and the unfuzzed *fortissimo* of the piano on the Nonesuch recording.

As for tape hiss as such, for all practical purposes it simply *isn't there*. Late at night, in a quiet room, at a listening level louder than my neighbors will freely tolerate, I couldn't hear the slightest sound of hiss until I came within a foot or two of a loudspeaker. In a direct comparison with the best record I know of, derived from a 30-ips master tape recording on half-inch tape, instead of the usual 15-ips recording on quarter-inch, the difference in favor of the new records was very audible. And after several hours of listening and cross-checking, I became convinced that virtually all of the "material noise" that I—and you—have been hearing from recent discs is actually the result of tape hiss in the master recording. (This is not to say that there can't be a bad pressing made from a Dolbyized master tape.)

THE absence of tape hiss is not nearly as important for most listeners as the question of overall clarity. But it does become important to those who own very-wide-range loudspeakers. Contrary to the effect of surface noise, which tends to be less obtrusive when heard over speakers with a smooth high-frequency response, tape hiss (located in a somewhat higher frequency area than surface noise and to a much stronger and steadier extent) can become more objectionable as a speaker's high-fre-

quency performance gets closer to the ideal of duplication of "live" sound. For those who own perfectionist speaker systems, the absence of hiss on these records in itself may be a revelation.

Finally, it is worth emphasizing that the Dolby system appears to add no distortion of its own worthy of the name. No spurious effects of any kind appear to be added. Aside from Mr. Dolby's thoroughgoing engineering, this seems to be a function of the system's doctoring of *only* the lowest signal levels.

SOME record companies may not rush right out to buy Dolby's "black box." It costs two thousand dollars and has no controls for a virtuoso engineer to manipulate. But until someone develops an entirely new recording medium, by way of the computer, the laser beam, or levitation, the Dolby system can and should help establish a new standard of excellence for recorded sound. I think it will take you no more than five minutes of listening to either of these two records to decide that for yourself.

Fortunately, the musical qualities of both recordings enhance the possibility of their getting the wide notice that the new process deserves. Vanguard's *L'Histoire du Soldat*, facing the sole competition of a superb performance on Philips (with Jean Cocteau and Peter Ustinov in speaking roles and Igor Markevitch conducting), holds its own very well. Stokowski's direction is broader than Markevitch's, but equally effective and idiomatic on its own terms, and the musicians, perhaps delighted by their first hearing of a bit of the master tape, play superbly. The speaking roles are not as incisively performed as on the Philips recording, but they are properly sardonic, and the unusual tactic of presenting *both* French and English versions should forestall the usual argument over original language vs. intelligibility.

The Nonesuch recording of Rachmaninoff's seldom-heard Cello Sonata has no recorded competition, and both Harvey Shapiro and Earl Wild are well up to the demands of this large-scale work. In the Kodály, my musical preference is for the earlier collaboration of Starker and Herz on a Period record, but the margin in performance is small enough for the far better sound on the new recording to be virtually all-important.

Ⓢ Ⓜ RACHMANINOFF: *Sonata in C Minor for Cello and Piano, Op. 19*. KODÁLY: *Sonata for Cello and Piano, Op. 4*. Harvey Shapiro (cello); Earl Wild (piano). NONESUCH H 71155 \$2.50, H 1155 \$2.50.

Ⓢ Ⓜ STRAVINSKY: *L'Histoire du Soldat*. Madeleine Milhaud, Narrator; Jean-Pierre Aumont, the Soldier; Martial Singher, the Devil. Gerald Tarack (violin); Charles Russo (clarinet); Theodore Weis (trumpet); Julius Levine (double bass); Lorin Glickman (bassoon); John Swallow (trombone); Raymond Desroches (percussion); Leopold Stokowski cond. VANGUARD VSD 71165/66 two discs \$5.79, VRS 1165/66 \$5.79. (Available only as a set with both French and English versions).

Introducing
the fabulous
UHER[®]
'DECK 7000'
by **martel**

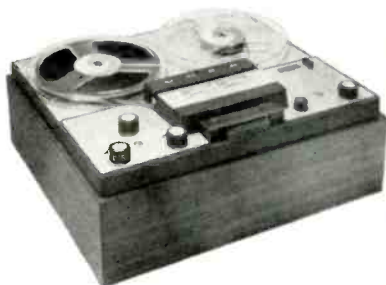

THIS NEWEST MEMBER OF THE FIRST FAMILY OF TAPE RECORDERS BRINGS YOU FULL PROFESSIONAL PERFORMANCE AND **UHER** ENGINEERING AT A MODEST COST. NOW EVERYONE CAN ENJOY **UHER** SUPERIORITY, WITH ITS ABILITY TO PRODUCE FLAWLESS STUDIO QUALITY RECORDINGS.

SOLID-STATE 2-SPEED MONAURAL AND STEREO; AUTOMATIC END-OF-REEL SHUT-OFF; 2 ILLUMINATED VU METERS; 4 DIGIT INDEX COUNTER; PAUSE CONTROL; TUNER, PHONO, AND MICROPHONE INPUTS; 7" REEL CAPACITY; 40-18000 CPS FREQUENCY RESPONSE. IN WALNUT ENCLOSURE. 2 ACCESSORY CABLES INCLUDED.

WHERE THE NEED IS FOR A COMPLETE PORTABLE TAPE RECORDER, THE UNSURPASSED

UHER ROYAL STEREO 8000

IS THE FINAL ANSWER. FEATURES NORMALLY FOUND ONLY IN FULL STUDIO EQUIPMENT MAKE THE 8000 THE ONE TRULY OUTSTANDING PORTABLE STEREO TAPE RECORDER IN THE ENTIRE FIELD.

AND, FOR THE EQUIVALENT SOPHISTICATION IN A TAPE DECK, MASTERS OF RECORDING HAVE PROCLAIMED THE **UHER** 9000 UNEQUALED.

FOR DETAILED INFORMATION ON THESE FINEST OF ALL RECORDING INSTRUMENTS, SEE YOUR **UHER** DEALER, OR USE THE COUPON TO OBTAIN LITERATURE GIVING DETAILED DESCRIPTION.

SOLE U.S. IMPORTERS



martel
ELECTRONICS

2339 SOUTH COTNER AVENUE,
LOS ANGELES, CALIFORNIA 90064
NEW YORK 1199 BROADWAY
CHICAGO: 5445 NO LINCOLN

MARTEL ELECTRONICS, Inc. HSR 7
2339 So. Cotner Ave.,
Los Angeles, Calif., 90064.

Please send me at once literature on the entire Martel product line.

.....
.....
..... Zip.....

CIRCLE NO. 37 ON READER SERVICE CARD
78

From the House of the Dead, Janáček's last opera (1928, posthumously produced in 1930), is based on Dostoyevsky's novel *The Diary from the House of the Dead*. The composer himself supplied the libretto, a terse condensation of the sprawling, partly autobiographical novel. The opera deals with human suffering; it depicts life inside a prison camp in Tsarist Siberia toward the end of the last century. Its pitiable characters, forlorn and forgotten, live in degradation, nursing old hatreds, playing pathetic games, clinging to vain hopes. A phrase written on the title page of the score in Janáček's own handwriting displays the opera's theme: "In every creature there is a spark of God!" And, though the characters in this stark drama reveal few redeeming human qualities, Janáček succeeds in creating compassion for them through his eloquent and emotionally powerful musical setting.

However, I am not prepared to accept the confident assertion found in the album's annotations, that Janáček created "an entirely new opera form—a collective drama." It would be more accurate to say that this panoramic work, in which there are no individual protagonists, defies operatic conventions and manages to succeed—up to a point. Our attention is undeniably held by the intensity of the music, and the elements added in a theatrical performance would make the attraction even more pronounced, but the lack of real *action*, the reliance on long and static narratives, and the fragmentary nature of the libretto limit the work's dramatic effectiveness.

Janáček's vocal writing derives from the Moussorgskian semi-recitative lyrical passages alternate with speech-like declamations with a complete naturalness born of the composer's lifelong preoccupation with speech-patterns and their pertinence in music. His orchestral palette is sonorous, rich in percussion effects, and elaborate in its string writing. There is a Slavic trait in his music, but it is a long way from the rollicking melodies of Smetana and Dvořák. There is nothing startling in Janáček's harmonic idiom, and yet his is daring and "contemporary" music—with an expressive, rugged power and decided individuality—which towers over the effete and characterless outpourings from the temples of modernism.

From the House of the Dead is worth hearing and, I think, would make a powerful impression on stage. The present performance utilizes the leading singers of the Prague National Opera and, while no outstanding individual achievement is discernible, the collective effort is marked by strength and authenticity. Even more impressive is the orchestral execution of this extremely demanding score. Stereo effects have not been employed with great imagination, but the overall sound is sharp and clear. Text and translation are supplied. G. J.

KODÁLY: *Sonata for Cello and Piano, Op. 4* (see page 76)

LEBÈGUE: *Magnificat No. 1* (see COUPERIN)

RECORDING OF SPECIAL MERIT

Ⓜ **LEONCAVALLO:** *1 Pagliacci*. Beniamino Gigli (tenor), Canio; Iva Pacetti (soprano), Nedda; Mario Basiola (baritone), Tonio; Giuseppe Nessi (tenor), Beppe;

Leone Paci (baritone), Silvio. Orchestra and Chorus of Teatro alla Scala, Milan, Franco Ghione cond. *Italian Songs*. Di Capua: *O sole mio*. De Curtis: *Non ti scordar di me; Senza nessuno*. Gibilaro: *Madrigale villereccio*. Di Veroli: *Ritorna amore*. Silver: *Senza te*. Beniamino Gigli with orchestra accompaniment. SERAPHIM IB 6009 two discs \$5.98.

Performance: A classic
Recording: Still serviceable

This is a 1934 recording, and in terms of sonics it can hardly be called a faithful representation of Leoncavallo's opera. And yet, the performance is so vital that within minutes it transports the listener into a world of musico-dramatic truth where the luxuries of stereo become dispensable. Ghione's propulsive pacing ensures excitement throughout. At the head of the first-rate cast is Benia-



CAPITOL RECORDS

BENIAMINO GIGLI
The very essence of Pagliacci

mino Gigli. His Canio is the very essence of the tragic clown, deeply felt, projected with utter conviction, and vocalized with an eloquence and consistent tonal beauty that have remained unsurpassed by his successors to the role. (The list, by the way, includes just about everybody.)

But the excellence is not limited to Gigli. Surely none of the stereo versions offers a Nedda to compare with Iva Pacetti, whose voice of true dramatic qualities is under firm control, with passion and intensity to spare. Basiola's voice lacks sensuous beauty, but it is a vibrant instrument with a firm top, and Paci's smooth, lyrical Silvio is another asset. Only the veteran Giuseppe Nessi seems to have been overmatched by his assignment.

Of the six Italian songs on side four, three were recorded nearly twenty years after *Pagliacci* (1952-1953), but Gigli was still going very, very strong. The musical interest on side four is not too high, though I personally think that Gigli's singing of *Non ti scordar di me* is alone worth the price of this reissue. This being the case, *Pagliacci*, thrown in as a bonus, makes this set the bargain of the year. G. J.

RECORDING OF SPECIAL MERIT

Ⓢ Ⓜ **MAHLER:** *Symphony No. 2, in C Minor ("Resurrection")*. Heather Harper

(soprano); Helen Watts (contralto); London Symphony Chorus and Orchestra, Georg Solti cond. LONDON CSA 2217 two discs \$11.58, CMA 7217* \$9.58.

Performance: High-voltage
Recording: Doesn't miss a thing
Stereo Quality: Surprisingly vivid

Just as with Georg Solti's readings of *Tristan und Isolde* and *Götterdämmerung*, I do not feel that the totality of his performance of Mahler's "Resurrection" Symphony here is the ultimate statement of the music. All these London-label recordings are in a class by themselves for sonic excitement and for detailed exposure of the musical texture; yet, in the case of the "Resurrection," Bruno Walter, Otto Klemperer, and Leonard Bernstein each bring something to the work that I don't find in Solti's interpretation—call it heart, if you will.

But there are marvelous moments here, as well as spectacular sonics. I don't ever expect to hear such a harrowing statement of the closing pages of the first movement as Solti achieves. I also like his light and easy way with the second-movement *Ländler*. Helen Watts sings the *Urlicht* movement with a sweet simplicity that is most convincing, though I would have liked more passion in the "Glaube, mein Herz" episode of the finale; the chorus sings beautifully, and for once virtually every word of the text is intelligible. As for the London Symphony players, they cover themselves with glory. Solti holds a tight rein on every aspect of the performance—pacing, dynamics, internal balances and lines—and London's fabulous recording gives us virtually an X-ray view of what he is doing with the immense and complex score. The use of stereo, in both breadth and depth, is singularly impressive, particularly the contrast of distance and proximity that Mahler calls for in certain episodes of the apocalyptic finale.

If this is not the most eloquent of recordings of the Mahler "Resurrection," it is surely the most exciting. D. H.

MAHLER: *Symphony No. 3, in D Minor* (see Best of the Month, page 61)

MONTEVERDI: *Vespro della Beata Vergine* (see Best of the Month, page 62)

MOZART: *Overture to "The Magic Flute"* (see page 31)

Ⓢ Ⓜ MOZART: *Quartet No. 16, in E-flat (K. 428)*; *Quartet No. 21, in D (K. 575)*. Fine Arts Quartet. CONCERT-DISC 1258 \$5.79, 258* \$5.79.

Ⓢ Ⓜ MOZART: *Quartet No. 22, in B-flat (K. 589)*; *Quartet No. 23, in F (K. 590)*. Fine Arts Quartet. CONCERT-DISC 1259 \$5.79, 259* \$5.79.

Performances: Sharply honed
Recording: Excellent
Stereo Quality: Good

Ⓢ Ⓜ MOZART: *Quartet No. 20, in D (K. 449)*; *Quartet No. 21, in D (K. 575)*; *Quartet No. 22, in B-flat (K. 589)*; *Quartet No. 23, in F (K. 590)*. Roth String Quartet. WORLD SERIES PHC 2-008 two discs (compatible stereo) \$5.00.

Performance: Highly expressive
Recording: Good
Stereo Quality: Electronically reprocessed

These collections of Mozart string quartets overlap in three of the four quartets each includes. But the musical approach each group takes is so markedly different that, even without the side-by-side comparison that this reviewing opportunity offers, the differences would be unmistakable at just about any distance.

Even at that, there is a paradox involved. For each ensemble, in its way, could lay claim to approaching the Mozart manner with a more "modern" view. The Fine Arts Quartet stresses a cleanly articulated, more classically classical reading of the music. Dynamic variation is rather on the narrow side; attacks tend to be sharp and precise, even a little abrasive; the figurational detail is super-clean in articulative impulse (if not always in result); and there is a certain (in

my opinion) over-directness of statement to the whole performance.

The Roth Quartet goes about its business quite differently. The range from loud to soft is far wider, and the string sound is richer, more blended—with resultant loss of sharply profiled figurational detail. Altogether, the playing is more traditionally expressive and romantic.

The paradox to which I have referred becomes obvious. An "old-fashioned" view of Mozart's works as exquisitely composed "pretty" music emerges rather more from the Fine Arts performance; yet the playing itself is crisply "modern" in approach. On the other hand, a "modern" view of Mozart—that the music's expressivity cuts far deeper than its brilliant facade makes evident—
(Continued on page 82)

VANGUARD
RECORDS
is proud to announce
the
**GRAND PRIX
INTERNATIONAL
DU DISQUE—
1967**

has been awarded to



A SONATA RECITAL
by
Joseph SZIGETI
(violin)
& Béla BARTOK
(piano)

Beethoven: Sonata in A major, Op. 47, "Kreutzer";
Debussy: Sonata for Violin and Piano
Bartók: Sonata No. 2 for Violin and Piano; Rhapsody No. 1 for Violin and Piano.
2-disc set VRS-1130/1

"... [rare] evidence of the command that Bartók had over the keyboard."
—Irving Kolodin, Saturday Review



**Mahler
DES KNABEN
WUNDERHORN**

Maureen Forrester, contralto; Heinz Rehfuß, baritone; Orchestra of the Vienna Festival, Felix Prohaska, cond.
VRS-1113 & *VSD-2154

"The recording cannot be praised too highly... the creamy voice of Miss Forrester is a glowing instrument... Rehfuß does his demanding share impressively... Prohaska conducts with vigor and authority."
—HiFi/Stereo Review



**LEOPOLD
STOKOWSKI
CONDUCTS**

Mozart
**SERENADE FOR 13
WIND INSTRUMENTS
IN B FLAT, K. 361**

Wind Players of the American Symphony Orchestra; and assisting artists Arner, Fricker, Lewis, and Howland.
VRS-1158 & *VSD-71158

"The playing is ravishing from top to bottom... breathtakingly beautiful... It is just possible... that American musicians have achieved the highest standard of wind playing ever reached anywhere, anytime."
—HiFi/Stereo Review



**Stravinsky
L'HISTOIRE
DU SOLDAT**
(Original version with dialogue)

Madeleine Milhaud, narrator; Jean-Pierre Aumont, soldier; Martial Singher, the devil; Instrumental Ensemble.
2-disc set containing two complete original versions, one with English dialogue, the other in French, both for the price of one.
VRS-1165/6 & *VSD-71165/6

"... a tremendous impression of youth, freshness and sheer vigor... takes its place among the best available versions... musically, an exemplary job... a Histoire of great lyricism and subtlety."
—World Journal Tribune

New Releases!



**JOHN HAMMOND
MIRRORS**
VRS-9245 & *VSD-79245

"... Hammond has captured the tension, rhythmic drive and emotional anguish of the deep blues... impressive..."
—Robert Shelton, The New York Times



**JIM KWESKIN
JUMP FOR JOY**
VRS-9243 & *VSD-79243

"... Almost impeccable musical taste, and that taste is demonstrated in every song he takes as his own..."
—Dave Wilson, Broadside



**JACKIE WASHINGTON
MORNING SONG**
VRS-9254 & *VSD-79254

"... In the front rank of urban-bred performers. In addition to the unstrained warmth and intimacy of his singing style, his strength includes a self-discipline and taste."
—Nat Hentoff, HiFi/Stereo Review

*Stereo

VANGUARD
RECORDS

EVEREST/CETRA

A HARVEST
OF REISSUES
for
OPERA LOVERS

Reviewed by
GEORGE JELLINEK

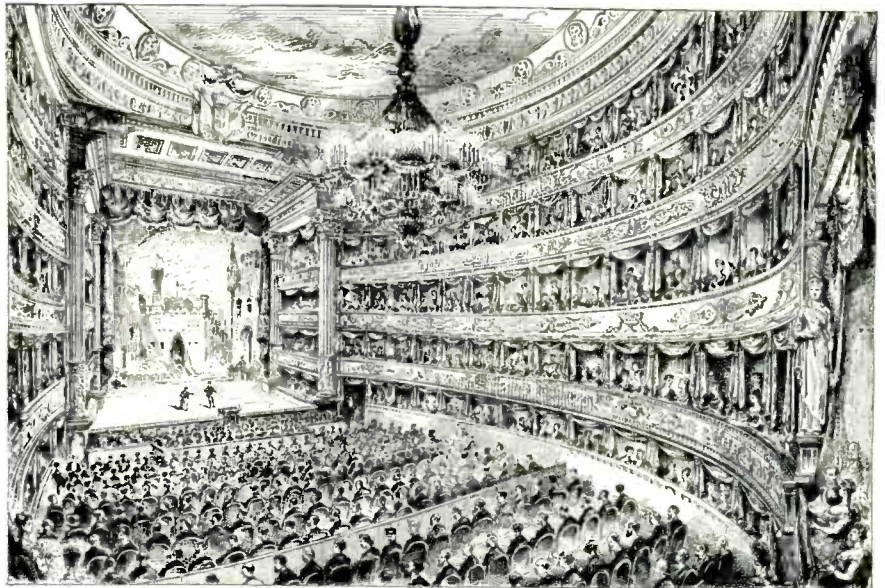

A nineteenth-century sketch of the interior of La Scala, Milan

THE Cetra catalog, the storehouse of operatic riches that contributed so rewardingly to the early, adventurous years of the LP era, has re-emerged from obscurity. One is filled with gratitude in recalling the achievements of this Italian company: not only did it expand our operatic knowledge by presenting many unfamiliar works in complete form, but it introduced us for the first time to the voices of Maria Callas, Ferruccio Tagliavini, Cesare Valletti, Giuseppe Taddei, Carlo Bergonzi, Cesare Siepi, Franco Corelli, and others far too numerous to mention. For some reason, this once dynamic company failed to join the march to stereo when the rush was on. Thus, after 1958, the catalog began to fade, and the once sought-after opera sets eventually disappeared from the market. Their return, under the aegis of Everest Records, is certainly news enough to warrant a re-evaluation.

Though the sets released so far represent only a portion of the erstwhile Cetra-Soria catalog, they are too numerous to be covered by a single review. I have selected eight sets for the present survey; a few others will be reviewed individually. For the record, let me say that the initial Everest/Cetra release consists of the following thirty-six operas: *Aïda*, *La Bohème*, *Don Giovanni*, *Don Pasquale*, *La Favorita*, *Martha*, *Rigoletto*, *Tosca*, *Mefistofele*, *Cavalleria Rusticana*, *Pugliacci*, *André Chénier*, *The Barber of Seville*, *Don Carlos*, *L'elisir d'amore*, *Falstaff*, *The Daughter of the Regiment*, *La forza del destino*, *La Gioconda*, *William Tell*, *Madama Butterfly*, *Il matrimonio segreto*, *Norma*, *Le nozze di Figaro*, *La Traviata*, *Il Trovatore*, *Turandot*, *Un ballo in maschera*, *L'amico Fritz*, *L'Arlesiana*, *La battaglia di Legnano*, *La Cenerentola*, *Luisa Miller*, *Simon Boccanegra*, *La Sonnambula*, and *Werther*.

FIRST, a few general observations. The sets are priced at \$2.50 per disc, and packaged economy-style, but in a sturdy and serviceable fashion. All discs submitted for review are mono pressings; the advertised "stereo" alternates, if and when they ap-

pear, are to be approached with caution. Do not look for the Soria-sponsored librettos which once rated much praise for precision and literary quality. Those enclosed with the present sets look like reproductions from the time that may have been a golden age for everything *except* operatic librettos. No effort has been made to correlate the texts with the performances themselves: cuts are not indicated and, in some instances, the singers perform one Italian version while the booklets show another. As for the so-called English translations, the less said the better. Needless to say, these signs of manifest sloppiness temper my appreciation for Everest's effort, but the richness and fascination of the repertoire are still there, offering a great deal of enjoyment.

Of the eight sets covered here, the oldest recording is of Mascagni's *L'amico Fritz*, conducted by the composer himself in a performance dating from around 1942. This is technically a rather poor accomplishment, even allowing for its age. Balances are erratic, surface noises intrude, and the old 78-rpm side-endings show their ghostly seams on occasion. The singing, however, is outstanding. Ferruccio Tagliavini, at his absolute best, demonstrates the liquid ease and persuasive lyricism that made him a postwar sensation, and Pia Tassinari is equally irresistible as the radiant Suzel. Saturno Meletti completes the excellent trio of principals as the resonant and expertly characterized Rabbi (transformed into a "Dottore" in keeping with the Nazi-Fascist times). The opera itself is light, brimming with the kind of charming melodies that eluded Mascagni in his subsequent fifty years of operatic activity. Poor sound notwithstanding, I suspect we shall have to wait a long time for another recorded version, let alone for one of similar excellence.

In *Werther* (recorded around 1953), the Tagliavini-Tassinari pair is still in good form, though the tenor already shows the forcing for volume that later proved ruinous to his voice. No longer a light lyric

soprano at this stage, Tassinari finds the role of Charlotte perfectly suited to her darkening timbre, and her portrayal is exquisite. Marcello Cortis lends firm support in the role of Albert. The opera is sung in French, but with a noticeable Italian accent—emotional as well as linguistic—that extends also to the conducting of Francesco Molinari-Pradelli. I welcome this Italianate passion applied to *Werther's* lachrymose, self-pitying tale, but Gallic purists may have reservations. Technically, this is a surprisingly wide-range recording, the best of the lot.

FLOTOW'S *Martha* (dating from 1955) shows Pia Tassinari as a full-fledged mezzo who causes a bit of a problem because her portrayal of the secondary role of Nancy overshadows the thin-sounding Elena Rizzieri in the title role. Tagliavini sings unevenly and in a rather casual style. The opera is sung in Italian, but this is no detriment, since one's basic opinion of this melodious but not consistently inspired score is not likely to be altered by the language. There are several cuts and the performance is not the last word in precision. The sound is acceptable for its age.

Tagliavini also appears in Boito's *Mefistofele* (1956). His singing displays some mannerisms, but the old lyric magic is intermittently evident, particularly in the aria "*Giunto sul passo estremo*." The two sopranos are satisfactory and effectively contrasted, but the real star is, appropriately, Giulio Neri in the title role. The late basso was never a subtle vocalist, but a true *profundo* (a rarity among Italian voices), and a fierce-sounding, awesome Devil. The recording shows occasional signs of monitoring, and the singers are favored at the expense of the orchestra, but the overall sound is fairly good.

Of the three operas the incredibly facile Donizetti completed in 1840 (all for Paris), two are released in the Everest Cetra series. *La figlia del reggimento* is a sunny, tripping score full of catchy but not particularly memorable melodies. Lina Pag-

liughi's tones reveal a touch of acid in this 1951 recording, but her singing is still skillful and lively. This was one of Cesare Valletti's first recordings, and it shows the familiar graceful art that was somewhat hampered by a fragile and undersized sound. Sesto Bruscantini contributes a zesty and expertly sung Sulpizio, and Mario Rossi's leadership provides liveliness and authentic style. At this time, no other recording of *La figlia* is available, so the present version may be recommended despite its mediocre sound.

THE Cetra set of Donizetti's *La Favorita* has a richer-sounding rival (London 1310), but the sonic margin is surprisingly small since the two versions are about equally old (1956). While members of the Cetra cast set no high marks for *bel canto* excellence, they contribute to a very strong performance under Angelo Questa's sympathetic baton. Fedora Barbieri's Leonora is a vital and passionate characterization, and the strength of her projection compensates for occasional tonal impurities. Gianni Raimondi's singing is anything but suave, and yet it offers a firm, youthful sound that is more pleasing than that of London's Gianni Poggi. Carlo Tagliabue, no longer commanding the tonal richness of old, is impressively artistic as Alfonso, and the doomsday sonority of Giulio Neri brings rare power to his scenes as the enraged Prior.

Rossini's *William Tell* is a long opera,

plagued by a libretto of considerable ineptitude. Musically, too, it suffers from organizational weaknesses, not the least of which is the fact that the climax is reached in Act Two, with little of musical or dramatic interest to follow thereafter. Flawed though it may be, the opera is a masterpiece, full of unbelievable riches, choruses and ensembles unmatched by Italian opera composers of the time (1829), and inspirations that left a deep impression on Verdi's creative mind. Headed by the imposing Giuseppe Taddei in the title role, with the young Giorgio Tozzi and Fernando Corena in powerful support, the cast is outstanding, and Mario Rossi's conducting is very impressive. Technically, the recording (1952) is barely adequate, but when will we ever get another chance to hear this bountiful opera on records?

La battaglia di Legnano was one of the recorded by-products of the Verdi anniversary year of 1951. Written in 1849, between *Macbeth* and *Luisa Miller*, the opera is of mainly historical interest—an example of Verdi's creative art operating at the white heat of patriotism. The story may have dealt with the Italian resistance to the invading Teutons of the thirteenth century, but Verdi left no doubts about (nor did his audience miss) the true meaning of those fiery exhortations against the *stranieri*. There is a love story, of course, but it is secondary to the national struggle. The performance is unobtrusive, unobtrusive, and sizzling—like the work itself.

Ⓜ **BOITO:** *Mefistofele*. Giulio Neri (bass), Mefistofele; Ferruccio Tagliavini (tenor), Faust; Marcella Pobbe (soprano), Marguerite; Ebe Ticozzi (mezzo-soprano), Martha; Armando Benzi (tenor), Wagner; Disma de Cecco (soprano), Elena; and others. Chorus and orchestra of Radio-Televisione Italiana, Angelo Questa cond. EVEREST/CETRA 409-3 three discs \$7.50.

Ⓜ **FLOTOW:** *Martha*. Elena Rizzieri (soprano), Lady Harriet; Ferruccio Tagliavini (tenor), Lionel; Carlo Tagliabue (baritone), Plunkett; Pia Tassinari (mezzo-soprano), Nancy; Bruno Carmassi (bass), Lord Tristan; others. Same chorus and orchestra as above, Francesco Molinari-Pradelli cond. EVEREST/CETRA 406-2 two discs \$5.00.

Ⓜ **DONIZETTI:** *La Favorita*. Carlo Tagliabue (baritone), Alfonso XI; Fedora Barbieri (mezzo-soprano), Leonora; Loreta di Lelio (soprano), Inez; Gianni Raimondi (tenor), Fernando; Giulio Neri (bass), Baltasar; Mariano Caruso (tenor), Don Gasparo. Same chorus and orchestra, Angelo Questa cond. EVEREST/CETRA 405-3 three discs \$7.50.

Ⓜ **DONIZETTI:** *La figlia del reggimento*. Lina Pagliughi (soprano), Maria; Sesto Bruscantini (bass), Sulpizio; Rina Corsi (mezzo-soprano), The Marchioness; Cesare Valletti (tenor), Tonio; Eraldo Coda (bass), Ortensio. Same chorus and orchestra, Mario Rossi cond. EVEREST/CETRA 417-2 two discs \$5.00.

Ⓜ **MASCAGNI:** *L'amico Fritz*. Ferruccio Tagliavini (tenor), Fritz; Saturno Melletti (baritone), David; Pier Luigi Latinnucci (baritone), Hanezo; Amalia Pini (mezzo-soprano), Beppe; Pia Tassinari (soprano), Suzel. Same chorus and orchestra, Pietro Mascagni cond. EVEREST/CETRA 429-2 two disc \$5.00.

Ⓜ **MASSENET:** *Werther*. Ferruccio Tagliavini (tenor), Werther; Marcello Cortis (baritone), Albert; Pia Tassinari (soprano), Charlotte; Vittoria Neviani (soprano), Sophie; Giuliano Ferrein (bass), the Mayor; others. Same chorus and orchestra, Francesco Molinari-Pradelli cond. EVEREST/CETRA 436-3 three discs \$7.50.

Ⓜ **ROSSINI:** *William Tell*. Giuseppe Taddei (baritone), William Tell; Miti Truccato Pace (mezzo-soprano), Edwige; Graziella Sciutti (soprano), Jemmy; Mario Filipposchi (tenor), Arnoldo; Plinio Clabassi (bass), Melchtal; Giorgio Tozzi (bass), Walter; Fernando Corena (bass), Gessler; Rosanna Carteri (soprano), Matilda; others. Same chorus and orchestra, Mario Rossi cond. EVEREST/CETRA 420-4 four discs \$10.00.

Ⓜ **VERDI:** *La battaglia di Legnano*. Caterina Mancini (soprano), Lida; Amedeo Berdini (tenor), Arrigo; Rolando Panerai (baritone), Rolando; Albino Gaggi (bass), Marcovaldo; Edmea Limberti (soprano), Imelda. Same chorus and orchestra, Fernando Previtali cond. EVEREST/CETRA 431-3 three discs \$7.50.



LONDON RECORDS SALUTES
L'ORCHESTRE DE LA SUISSE
ROMANDE AND ITS
DISTINGUISHED CONDUCTOR

ERNEST ANSERMET

ON THE OCCASION OF
THEIR VISIT TO EXPO '67 AND
LINCOLN CENTER'S FESTIVAL '67

Outstanding recent releases:

Stravinsky: PULCINELLA
Stereo OS-25978 Mono 5978

Bach: CANTATAS NO. 105
& 45
Helen Watts, Tom Krause,
Agnes Giebel, Ian Partridge
Stereo OS-25996 Mono 5996

Haydn: SYMPHONY NO. 22
("Philosopher")
and SYMPHONY NO. 90
Stereo CS-6481 Mono CM-9481

Ravel: DAPHNIS ET CHLOE
Stereo CS-6456 Mono CM-9456

Debussy: LA MER, KHAMMA,
RHAPSODY FOR CLARINET
Stereo CS-6437 Mono CM-9437

Mendelssohn:
ITALIAN SYMPHONY;
HEBRIDES, RUY BLAS,
and FAIR MELUSINE
OVERTURES
Stereo CS-6436 Mono CM-9436

LONDON
RECORDS

emerges from the Roth performance, even though the playing itself is, speaking technically, less of our day.

It becomes, then, a matter of taste in the broadest sense here. Writing as a musician, I find the Concert-Disc releases more penetrating, more illuminating, more instructive. But I must concede at the same time that I am, in large part, more moved by things on the World Series release.

The recorded sound, taken comparatively, might make the difference for some listeners here. Concert-Disc's is bright, live, and uncommonly clean, and the stereo treatment is good. World Series' is less lucid, more on the rich side, and its stereo is electronically reprocessed. W. F.

Ⓢ Ⓜ NICOLAI: *Te Deum*. Evelyn Lear (soprano), Marina Türke (soprano), Raili Kostia (alto), Kathleen Basler (alto), Heinz Hoppe (tenor), Martin Vantin (tenor), Thomas Stewart (bass), Manfred Schenk (bass); Berlin Singakademie and Berlin Radio Symphony Orchestra, Mathieu Lange cond. DEUTSCHE GRAMMOPHON SLPM 139170 \$5.79, LPM 39170* \$5.79.

Performance: Firm and vigorous

Recording: Over-grand

Stereo Quality: Resonant and too uniform

Anyone familiar with *The Merry Wives of Windsor* will be surprised at this very grand essay in late classicism by the same composer. Written in Berlin in the early 1830's (Nicolai was barely past twenty), it belongs to that largely forgotten phase of early-nineteenth-century European music that corresponds to neo-classicism and Empire in art and architecture. Nicolai wrote the work for the Berlin Singakademie, of which he was a member (significantly the Singakademie's new home was by the neo-classic architect Schinkel, who also designed sets for Spontini's popular classical-Empire extravaganzas at the Opera). This *Te Deum* not only reflects classical tradition in a late evolution (as transmitted by Nicolai's teacher, Zelter, also Mendelssohn's master), but also the rediscovery of the great choral works of Bach and Handel—Nicolai breaks into fugue at every possible opportunity—as well as the operatic style of Spontini. The results are grand, with a rather austere, empty beauty—like the pure and rather sterile neo-classicism of much of the contemporary visual arts. The performance here is on a big scale, but the dynamic level is too restricted and the tempos just a bit too much on the brisk, inflexible side to permit the music to expand to its full value. Balance and ensemble are excellent, and the level of the soloists is high. The recording tends towards a pompous and uniform resonance. E. S.

Ⓢ Ⓜ NIELSEN: *Clarinet Concerto, Op. 57; Symphony No. 2, "The Four Temperaments."* Benny Goodman (clarinet); Chicago Symphony, Morton Gould cond. RCA VICTOR LSC 2920 \$5.79, LM 2920* \$4.79.

Performance: Orchestra excellent,

Goodman good

Recording: Good sound

Stereo Quality: Effective

Over a quarter of a century separates these two works, and each shows a different aspect of Nielsen: his origins in the sound, solid, big-orchestra late-Romanticism—the Second Symphony was completed in 1902—

and the much drier "neo-classicism" of the Clarinet Concerto of 1928. Nielsen's late interest in woodwinds, stimulated by an excellent Danish wind quintet, and the rather lean, agile, free-tonal sound of his later style bring him close to certain other early twentieth-century developments. This concerto has certain affinities, for example, with Prokofiev; on the other hand, it also displays an attractive individuality. The outer movements of the symphony show the younger Nielsen at his best, writing vigorous music of considerable character. The latter work's main defect is that it is rather consistently over-scored. I am by no means a Nielsen convert, but this is pleasant enough music; it deals with no really weighty issues, yet it is somehow psychologically apt.

Gould, the Chicago Orchestra, and the RCA Victor engineers are to be congratulated for the clarity they have achieved in

RCA VICTOR



MORTON GOULD
Clarity for Nielsen's Second Symphony

recording this music. The Concerto, a far leaner work, presents fewer problems in this respect. I enjoyed Goodman's performance, although there are clearly a few places where he does not quite cope. All in all, Nielsen's scores benefit from these performances and from a recorded sound that, though it catches a few too many of Goodman's gasps for my taste (ultra-realism, of course), also gets the orchestra across in a clear but rich recorded ambience. E. S.

Ⓢ Ⓜ PROKOFIEV: *Alexander Nersky—Cantata, Op. 78*. Larissa Avdeyeva (mezzo-soprano); RSFSR Russian Chorus, Alexander Yurlov, director; U.S.S.R. Symphony Orchestra, Yevgeny Svetlanov cond. MELODIYA/ANGEL SR 40010 \$5.79, R 40010 \$4.79.

Performance: Super-colossal

Recording: Technicolor

Stereo Quality: Epic scale

This is the remake in Cinemascope. I am not familiar with the "U.S.S.R. Symphony Orchestra," but I suspect that it is simply the Moscow radio orchestra; the chorus is probably also the radio chorus. The singing is hearty, the playing vigorous but not very refined. The whole is polished up with a

fancy Technicolor electronic gloss that undoubtedly glows in the dark. Tempos tend to be slow and heavy (probably a must amid all the reverb, but not always very apt). An annoying effect in the choral recording puts the men on one side, the women on the other. On the plus side, it is a pleasure to hear the sound of Russians singing Russian; also, Miss Avdeyeva sings the beautiful *Field of the Dead* in a very compelling manner. But mostly the music has been blown up out of shape. One of the charms of the *Nersky* score is that it has character and epic quality without extra rhetoric; but this souped-up version comes close to making the whole thing bombastic thud and bluster—Eisenstein into Cecil B. DeMille. E. S.

PROKOFIEV: *Five Melodies, Op. 35* (see DEBUSSY)

RACHMANINOFF: *Sonata in C Minor, for Cello and Piano* (see page 76)

RAVEL: *Sonata for violin in G* (see DEBUSSY)

Ⓢ Ⓜ ROUSSEL: *Suite in F*. DUTILLEUX: *Symphony No. 2*. Lamoureux Orchestra, Charles Munch cond. WESTMINSTER WST 17119 \$4.79, XWN 19119 \$4.79.

Performance: Resplendent

Recording: Excellent

Stereo Quality: Very good

Henri Dutilleux (b. 1916) is a composer of some prominence in France, but his work, except for its American propagation by Charles Munch, has been heard very little on these shores. His Second Symphony (1956), most handsomely recorded and enthusiastically performed for Westminster, suggests to one listener that, while Dutilleux is not the sort of composer who is ever likely to gain much currency or influence with Americans, there is an extraordinarily interesting creative mind at work here.

Hearing the Second Symphony the first time (its idiom is by no means far-out), my feeling was that, although the piece is somewhat over-gestured, it is nonetheless urgent and intensely dramatic—even though its after-effect appeared to be more memorable for its general impact than its musical substance. But something kept drawing me back to it, and its general musical substance grew more compelling. Particularly from about the middle of the slow second movement (there are three, in all) to the end, more pronounced and compelling musical shapes began to emerge from its rather insistently dense polycentric texture. It became apparent that its essential variational continuity is marked by a peculiarly arresting originality. (Its technique is chromatic enough to at least seem to verge at moments on poetically licensed serial procedures.) And it ultimately became clear, after I had better grasped its overall expressive intention, that its closing moments are as moody and haunting as any I have heard in a work that was new to me in a very long time.

The work has been conceived and scored for a "double" orchestra—one of them a full-scale symphony orchestra, the other a twelve-instrument chamber affair that, in live performance, is seated semi-circularly in front of the big band. Even in stereophonic recording, I get no strong impression from the device, so I rather assume that it's one of those ideas composers get that are more

interesting to read about than to experience aurally.

Altogether, it's a curious work—one that I've still not made definitive decisions about. But I quite heartily recommend it to the more adventurous of my readers. Dutilleux apart, Munch's vivid performance of Rous-sel's craggy, sharp-tongued and utterly wonderful Suite in F is worth the price of the record alone.

By an error in disc labeling, Westminster has credited the larger part of the Dutilleux to Rousel, but the company has provided flashily recorded sound and what would appear to be effective stereo treatment. *W.F.*

RECORDING OF SPECIAL MERIT

Ⓢ Ⓜ SCHUBERT: *Octet, in E-flat (D. 803)*. Jacques Lancelot (clarinet); Gilbert Coursier (French horn); Paul Hongne (bassoon); Gaston Logerot (string bass); Pascal String Quartet. MONITOR MCS 2110 \$2.50, MC 2110* \$2.50.

Performance: Delightful
Recording: Good
Stereo Quality: Excellent

Schubert's Octet stands as a halfway mark between the classic divertimento and the Romantic nineteenth-century approach to the serenade. Since the Octet was written for a clarinetist patron, that instrument has a leading role, especially in the lovely second movement. The prevailing mood is carefree, except for two startling outbursts at the beginning and in the middle of the finale. Schubert's "heavenly length" is also a characteristic of the Octet, and indeed the length can become quite earthbound if the performance is anything less than first-rate in technical finesse and natural flow. The Monitor recording has both in the most ample measure, being wonderfully unfussy and yet richly expressive in phrasing, vital in rhythmic thrust, and beautifully recorded in terms of a true *Hausmusik* sound.

I enjoyed this disc thoroughly from beginning to end, as I have all the Monitor recordings featuring the Paris-based Pascal Quartet. This ensemble recorded a notable Beethoven-Mozart chamber series for the now defunct Concert Hall Society label during the pre-stereo era, and it seems the feat is in the process of being repeated for Monitor in terms of the Schubert-Mozart repertoire. If the present high level of recorded performance is maintained, the more records the better. *D.H.*

Ⓢ Ⓜ SCHUBERT: *Winterreise (Op. 89, D. 911)*. SCHUMANN: *Dichterliebe, Op. 48*. Peter Pears (tenor), Benjamin Britten (piano). LONDON OSA 1261 two discs \$11.58, A 4261 \$9.58.

Performance: Good, but . . .
Recording: Good
Stereo Quality: Suitable

If these were the only available versions of the song cycles, they would merit grateful thanks and joyful listening. Pears, never a sensuous-toned singer, is an interesting song interpreter, still capable of expressive pianissimo singing and subtle shifts of vocal color, and he is an astute judge of dynamics. Britten is a perfectly congenial partner, working with the tenor in absolute harmony of phrasing and accents. But the signs of vocal strain are often evident, and audible effort intrudes

on one's enjoyment, particularly if one knows Dietrich Fischer-Dieskau's fine achievement in both cycles. For those who prefer the tenor voice in *Dichterliebe*, Fritz Wunderlich's recording (DGG 139125) presents a more attractive alternate. *G.J.*

Ⓢ Ⓜ SHOSTAKOVICH: *Katerina Ismailova*. Eleonora Andreyeva (soprano). Katerina; Eduard Bulavin (baritone), Boris Timofeyevich; Vyacheslav Radzievsky (tenor), Zinovy Borisovich; Gennady Yefimov (tenor), Sergei; Nina Isakova (mezzo-soprano), Sonyetka; Yevgeny Maksimenko (bass), Priest; others. Chorus and Orchestra of the Stanislavsky/Nemirovich-Danchenko Theater, Moscow, Gennady Provtorenko cond. MELODIYA/ANGEL SRCL 4100 three discs \$17.37, RCL 4100 \$14.37.

Performance: Uneven
Recording: Good
Stereo Quality: Good

It is doubtful that Shostakovich has ever fully recovered from the journalistic castigation and political dishonor that followed the 1934 premiere of this opera, then known under the title of *Lady Macbeth of Mzensk*. To what extent the experience has prevented the composer from fully realizing his enormous promise will remain a mystery, but at least Shostakovich has the satisfaction of knowing that both he and his opera have outlasted the censors.

Shostakovich's descriptive gifts have always been extraordinary, and *Katerina Ismailova* is best in its atmospheric episodes. Some of these are ironic in nature, and the composer displays true mastery in his mocking and impudent musical underlining of the foibles of Tsarist bureaucracy. There is also a brilliant opening scene in Act Four, in which the hopelessness of a Siberian convict camp is powerfully depicted, and the affecting bass solo (excellently sung by Georgy Dudarev) against the chorus of convicts creates an atmosphere of Moussorgsky-like grandeur. Other Moussorgsky-inspired sections are less felicitous, such as the finale of Act Two (re-calling the Varlaam episode in *Boris*) where Shostakovich's handling of the scene is too riotous and overlong. While the level of inspiration is certainly not consistent, and several scenes suffer from awkwardness, padding, or bombast, the vocal writing manages to be continuously effective.

About the book I have mixed feelings. The basic story of *Katerina*, a passionate and frustrated woman who is propelled by an unhappy environment into multiple murders, is strong operatic stuff, but there are several primitive and implausible scenes and a few lines which, when heard in English (as they were when the opera was produced by the New York City Opera Company), are guaranteed to produce unintended mirth.

The performance labors under the burden of an inadequate *Katerina*, for Miss Andreyeva's shrill voice deprives the character of its essentially plaintive undertone, to say nothing of its having, a vibrato wide enough to let a *drosbki* through. Some of the vocalists are acceptable or better: Bulavin is colorful and powerful as *Katerina's* father-in-law whose passion for mushrooms turns out to be fatal; Yefimov characterizes the opportunistic lover plausibly, though he has a tendency to push his voice; and Isakova is a lively and appropriately vulgar Sonyetka.

(Continued on next page)

These fine stores carry Mace Classics.

ARIZONA
SANDYS RECORD—Phoenix
HILLS RECORD—Tempe

CALIFORNIA
CAL RECORDS—Oakland
CAMPUS MUSIC—Berkeley
CHILDRENS MUSIC—Los Angeles
FESTIVAL—Los Angeles
MR. B. FOR MUSIC—Palos Verdes
RECORD CITY—Berkeley
SEA OF RECORDS—San Francisco
TECTRON RECORDS—Los Angeles
THEARLE—San Diego
TOWN & COUNTRY MUSIC—Palo Alto

COLORADO
MUSIC FOR ALL—Denver

DISTRICT OF COLUMBIA
DISC SHOP—Washington
DISCOUNT RECORD—Washington
GLEN MUSIC—Washington
LEARMONT BK. & RECORD—Washington
RECORD CITY—Washington
MUSIC TIME—Washington

FLORIDA
SPA'S RECORD—Coral Gables

ILLINOIS
K.O. ASHER—Chicago
LOWES RECORDS—Chicago
PROFIT VENDERS—Chicago
ROSE RECORD—Chicago
ROSE RECORD—Madison
E. J. KORVETTE—Rockford

LOUISIANA
SHOPPERS WORLD—New Orleans

MARYLAND
GENERAL RADIO—Baltimore
E. J. KORVETTE—Baltimore
RECORD TAPE & SALES
RECORD & TAPE COLLECTOR

MICHIGAN
E. J. KORVETTE—Detroit

MINNESOTA
JATHER—Minneapolis
SCHMITT MUSIC—Minneapolis

MISSOURI
E. J. KORVETTE—St. Louis
E. J. KORVETTE—Sunset Hills

NEW JERSEY
SAM GOODY—Paramus
KLEIN'S—Newark

NEW YORK
SAM GOODY—All greater N.Y. area stores
E. J. KORVETTE—All greater N.Y. area stores
KLEIN'S—Flushing
G. SCHIRMER—New York City
DOUBLEDAY—New York City
RECORD HUNTER—New York City
ALEXANDER'S—Bronx
LINDEN RECORDS—Brooklyn
CHAMBERS—New York City
CHESTERFIELD—New York City
DAYTON'S RECORDS—New York City
KING KAROL—New York City
RECORD & TAPE SALES—New York City
VISCOUNT RECORD SHOP—New York City
MELODY RECORD SUPPLY—Melville
PORTER ELECTRIC—Buffalo

NORTH CAROLINA
KEMAN & ASSOC.—Durham
RECORD BAR—Chapel Hill

OHIO
ALL LABEL RECORD SERVICE—Cleveland
MODERN RECORD SERVICE—Cleveland
RECORD SOURCE—INTERNATIONAL—Cincinnati

OREGON
MUSIC ON RECORDS—Portland
FRANK MEIER—Portland

PENNSYLVANIA
PENN RECORDS—Philadelphia
RECORD MART—Philadelphia

TEXAS
MELODY SHOP #1—Dallas
SAN ANTONIO MUSIC—San Antonio
HOME ENTERTAINMENT—Houston

VIRGINIA
GIANT MUSIC—Falls Church
PATS ONE STOP—Richmond

CANADA
INTERNATIONAL MUSIC STORE—Montreal
SAM THE RECORD MAN—Toronto
A & A BOOKS AND RECORDS—Toronto
SHERMONS MUSIC ENTERPRISES—Ottawa
GLENN'S MUSIC—Vancouver

Extravagant Music For The Parsimonious

MACE
Records

254 W. 54th St., New York, N.Y. 10019
CIRCLE NO. 34 ON READER SERVICE CARD

Characterizations are never a problem with Russian singers, once our ears get adjusted to their timbres and tone production.

The chorus and orchestra are first-rate, and so is the recorded sound, except for occasional distortion in choral passages. The stereo may not be top-grade Western level, but it is getting there. The Melodiya-Angel association augurs well for the future. Has anyone ever contemplated a cultural exchange program wherein good Italian vocal coaches could be sent to Russia in exchange for Russian violin teachers? G. J.

STRAVINSKY: *L'Histoire du Soldat* (see page 76)

Ⓢ Ⓜ **STRAVINSKY: *Pulcinella—Ballet with Song*** (1920, rev. 1949). Marilyn Tyler (soprano); Carlo Franzini (tenor); Boris Carmelli (bass); L'Orchestre de la Suisse Romande, Ernest Ansermet cond. LONDON OS 25978 \$5.79, A 5978 \$4.79.

Performance: Spirited, elegant
Recording: Fine
Stereo Quality: Good

Hard on the heels of Stravinsky's own new recording of his delightful *commedia dell'arte* stage piece comes one by Ernest Ansermet. And as with their previous parallel versions of the same repertoire, Stravinsky's reading has thrust, wit, and bite, while Ansermet prefers to emphasize the lyrical and poetic elements of the music. Stravinsky brings excitement to his *Pulcinella*; Ansermet brings elegance and color to his.

The soloists in both recordings stand about on a par with one another—none being of truly outstanding caliber, though Ansermet's seem to achieve a better blend in the ensemble episodes. Both recordings are of equal excellence, with London having a very slight edge in the matter of tonal warmth. D. H.

Ⓢ Ⓜ **TCHAIKOVSKY: *Piano Concerto No. 1, in B-flat Minor, Op. 23***. Grigory Sokolov (piano), USSR Symphony Orchestra, Neimye Yarvy cond. MELODIYA/ANGEL SR 40016 \$5.79, R 40016* \$4.79.

Ⓢ Ⓜ **TCHAIKOVSKY: *Piano Concerto No. 1, in B-flat Minor, Op. 23***. Misha Dichter (piano), Boston Symphony Orchestra, Erich Leinsdorf cond. RCA VICTOR LSC 2954 \$5.79, LM 2954* \$4.79.

Performance: Both prodigious
Recording: Russia, no; America, si
Stereo Quality: Ditto

Our own little Tchaikovsky competition: Q. Which of the above recordings comes from the city in which this famous concerto had its premiere? A. The Boston disc. Q. What is the main subject of the first movement? A. The little theme introduced by the piano in octaves after about ten minutes (the one that goes di-duh, di-duh, di-duh, di-duh); everything before is slow introduction and generally played about twice too fast. Q. Who was the winner of the 1966 (Moscow) Tchaikovsky Competition? A. Russian Grigory Sokolov, age 16, who edged out Misha Dichter, Shanghai-born (!?) American pianist, age 21.

It is an axiom of the record business that the pieces that have always sold well are the pieces that will continue to sell well, and Tchaikovsky competitions are as good an excuse as any to get out more Tchaikovsky

concerto recordings. The interest of these discs is, of course, pianist-watching, and these are obviously two talented young men who probably ought to be spending their time on more worthwhile projects than rushing into premature recordings of the Tchaikovsky Concerto. I find the Russian disc so heavy and hazy that it is difficult for me to get through to any genuine assessment of Sokolov's talents. The piece sounds as though it were being performed in St. Basil's Cathedral, but with lots of mikes (you can hear the flute player breathe in the second-movement solo); the general approach is portentous. Within this, Sokolov seems to muster a lot of virtuosity and a certain amount of drive and excitement. On the jacket blurb, Gilels is quoted as crediting the young pianist with qualities of "lightness, freshness and youth"; I don't hear the first, and the last two come through mainly in



MISHA DICHTER AND ERICH LEINSDOFF
Tchaikovsky with elegance and style

terms of impetuosity and a kind of massive overwhelm-the-piano sound.

Leinsdorf and Dichter, like their Russian confreres (and almost everybody else), take the introduction twice too fast, but otherwise their playing is much more refined. Dichter turns in some really elegant playing in the second and third movements and these passages, full of character and style, easily provide the best moments on either disc. This does suggest a really musical personality behind the fingers, and that certainly whets the appetite.

The Russian orchestra, hazed in by the smog, never really has a chance; there's a lot of hiss, too, adding to the aural pollution. The Boston reading is reined in by Leinsdorf, who produces a firm, clean, non-Slavic Tchaikovsky. I find the recorded sound a little dullish although reasonably clear. E. S.

RECORDING OF SPECIAL MERIT

Ⓢ Ⓜ **TELEMANN: *Der Tag des Gerichts***. Cora Canne-Meijer (contralto); Gertrud Landwehr-Herrmann (soprano); Kurt Equiluz (tenor); Max van Egmond (bass); four vocal soloists from the Wiener Sängerknaben; Herbert Tachezi (harpsichord); Monteverdi Choir of Hamburg; Concentus Musicus of Vienna, Nikolaus

Harnoncourt cond. TELEFUNKEN SAWT 9484/85 two discs \$11.58, AWT 9484/85* \$11.58.

Performance: Extremely impressive
Recording: Superior
Stereo Quality: Excellent

This unusual oratorio, *The Day of Judgment*, is being released to commemorate the two-hundredth anniversary of Telemann's death, and if it does not entirely disprove the fact that the composer was at times an uneven creator, it at least provides another example of this musician's often startling musical imagination.

The piece is made up of an overture and four "contemplations," with such allegorical characters as Disbelief, Reason, The Mockery, Religion, Devotion, Faith, as well as Jesus, St. John, the Archangel, the Heavenly Choirs, and the Chorus of Vices. Some of the musical scene-painting is undoubtedly naive, some of the effects (including the scoring) are so colorful that I find myself quite fond of certain sections. The Third Contemplation, for example, is certainly one of the highlights, for this scene portrays the actual Last Judgment. The valveless *Naturhorn* (all the instruments are from the period or reproductions) represents the last trumpet, and rather awesomely too.

The performance from every standpoint, including stylistic requirements, is superb. The vocal soloists are for the most part excellent, the instrumental playing equally so, and the conducting quite authoritative. This, then, is an album for the Baroque enthusiast interested in the slightly unusual; it is not a work that will appeal to every listener, but it does have many rewards. An extensive booklet containing notes and texts in both German and English is included. I. K.

YSAÏE: *Sonata in D Minor, Op. 27, No. 3* (see DEBUSSY)

COLLECTIONS

Ⓢ Ⓜ **BATTLE MUSIC**. Biber: *Battalia*. Dandrieu: *Les Caractères de la Guerre (Suite de Symphonies)*. Mozart: *Contretanz, "Der Sieg vom Helden Koburg"* (K. 587). Neubauer: *Sinfonie, Op. 11 ("La Bataille")*. Angelicum Orchestra of Milan, Newell Jenkins cond. NONESUCH H 71146 \$2.50, H 1146 \$2.50.

Performance: Full of gusto
Recording: Excellent
Stereo Quality: Quite satisfactory

Credit Newell Jenkins with a highly intriguing idea in assembling these programmatic pieces. Not all of the music is first-rate; battle music can be embarrassing in its overuse of certain clichés—the trumpet calls, the march to battle, and so forth. After a while the effect is a bit tedious. There are, however, some entertaining moments in the Dandrieu and Neubauer pieces. The Biber is a work of considerable originality: dedicated to Bacchus, it includes some unusual sound effects (the double bass is made to simulate a snare drum) and one movement in which eight ditties are performed simultaneously (not to say chaotically) to represent the soldiers' drinking party the night before the foray. The Mozart piece, like the Neubauer, celebrates the victory of the Russians and the Austrians over the Turks in 1789, and is a minute-and-a-half-long bagatelle but still

worthy Mozart. Sampled in small sections, this program can be fun. The performances are properly energetic, and the recording is excellent in both mono and stereo. *I. K.*

Ⓢ Ⓜ LEONTYNE PRICE: *My Favorite Hymns*. Leontyne Price (soprano); George Decker (organ); Choir of Men and Boys of St. Thomas Episcopal Church, New York; William Self, choirmaster. RCA VICTOR LSC 2918 \$5.79, LM 2918 \$4.79.

Performance: **Opulent**
Recording: **Excellent**
Stereo Quality: **Juxtaposes solo and choir**

This is a pious program that will appeal mainly to those for whom *Lead Kindly Light* is the epitome of the repertoire of religious music. Miss Price sings half a dozen hymns on this level, attributing the selection each time to the taste of some relative or other. She brings to this banal material all the riches of her luxuriant voice, with glowing support from a well-trained choir. But the really exciting moments occur when she and they tackle numbers which are not hymns at all—Schubert's *Ave Maria*, rising incredibly to life once more under her full-throated ministrations; *The Lord's Prayer*, never prayed with more fervor; and *Bless This House*. The program notes by Francis Robinson are informative. *Paul Kresh*

ARTURO TOSCANINI: *Treasury of Historic Broadcasts* (see page 31)

Ⓢ Ⓜ RICHARD TUCKER: *The World's Favorite Tenor Arias*. Verdi: *Aida: Celeste Aida. Il Trovatore: Ah si, ben mio; Di quella pira. Rigoletto: La donna è mobile; Questa o quella*. Puccini: *La Bohème: Che gelida manina. Tosca: Recondita armonia; E lucevan le stelle. Turandot: Nessun dorma. Cilea: L'Arlesiana: Il Lamento di Federico*. Mascagni: *Cavalleria Rusticana: Mamma, quel vino è generoso*. Bizet: *Carmen: Flower Song*. Gounod: *Faust: Salut! demeure*. Richard Tucker (tenor); orchestral accompaniments. COLUMBIA MS 6957 \$5.79, ML 6357 \$4.79.

Performance: **High-powered**
Recording: **Uneven**
Stereo Quality: **Voice favored**

To those wondering why Richard Tucker chose to record such a hackneyed and thoroughly unimaginative program at this stage of his career, the answer is that he didn't. This is a recital drawn from the tenor's Verdi, Puccini, and French aria releases, though four items (the *L'Arlesiana*, *Cavalleria*, and *Faust* arias and *Di quella pira*) seem to be new additions.

Tucker is in his usual dependable form: this is tenor singing of top quality, with passionate expression, clear attacks, and firmly focused tones of sensuous beauty. At times Mr. Tucker seems determined to prove his Italian credentials and resorts to emotional exaggerations which distort his otherwise admirable phrasing, but his singing, in general, is likely to please partisans of the composers involved as well as admirers of Richard Tucker. The orchestral contributions under Messrs. Cleva, Dervaux, and others Columbia prefers to leave uncredited in this instance are fine. The engineering, however, gives too much prominence to the voice, with a particularly unnatural, echo-laden quality in the *Faust* and *Cavalleria* arias. *G. J.*

JULY 1967

Ask this embarrassing question when you're shopping hi-fi:

"Does this automatic have a hysteresis motor?"

If you were a sound engineer selecting a professional turntable or tape transport for the studio, the hysteresis motor would be one of the first features you'd look for. Reason? Speed accuracy.

The hysteresis motor is a synchronous motor. Its speed is locked in by the alternating frequency of the power source. Voltage may surge, or it may drop as you turn on appliances. The hysteresis motor doesn't care. It just keeps going round and round steadily, smoothly, without missing a beat.

Shouldn't you be entitled to this kind of performance when you're shelling out good money for a fine turntable? We think so.

The only automatic with hysteresis motor, and lots of other quality features, is the Miracord 50H.

See it at your hi-fi dealer, \$149.50 less cartridge and base. For details write: Benjamin Electronic Sound Corp. Farmingdale, N.Y. 11736



The Miracord 50H
CIRCLE NO. 6 ON READER SERVICE CARD

Unconditional guarantee on a kit?

Who ever heard of such a thing?

It's a fact. Build any Acoustech kit according to the full color, simple and clear instructions. If it doesn't work to satisfaction, Acoustech will put it in working order at no charge. How can we make such an incredible offer? Acoustech has more experience producing quality solid state kits than any other firm. All the critical circuitry comes pre-wired, pre-tested on plug-in printed circuit boards. We know you can't go wrong. In fact, we guarantee it. Write today for illustrated brochure on the complete line of unconditionally guaranteed Acoustech kits.



ACOUSTECH

Acoustech, Inc., Dept. SR-7
div. Koss Electronics
139 Main Street, Cambridge, Mass. 02142

Export: Koss-Impetus/Lugano, Switzerland
Canada: A. C. Simmonds & Sons, Ltd.

CIRCLE NO. 1 ON READER SERVICE CARD

Before you select an automatic turntable



let us arm you with the facts.

Probably the most critical way to evaluate the quality of any changer is by closely inspecting the tone arm and its capabilities. Let's examine



the tone arm of the BSR McDonald 500 automatic turntable. This is the resiliently mounted coarse and fine vernier adjustable counterweight. It counter-balances the tone arm both horizontally and vertically and assures sensitive and accurate tracking. Here you see the micrometer stylus pressure adjustment that permits $\frac{1}{3}$ gram settings all the way from 0 to 6 grams. This assures perfect stylus pressure in accordance with cartridge specifications. Here's another unique and valuable feature . . .

the cueing and pause control lever that lets you select the exact band on the record, without fear of ever damaging the record or the cartridge. It even permits pausing at any point and then gently floats the tone arm down into the very same groove! Whenever the turntable is in the "off" position the arm auto-

matically returns and securely locks in this cradle to protect it and keep it from movement. This is the low-mass tubular aluminum pick-up arm . . . perfectly counter-balanced both horizontally and vertically to make it less susceptible to external shock. Of course, there are many other quality features



on the BSR McDonald, just as you would find on other fine turntables that sell for \$74.50 and higher. The big difference is

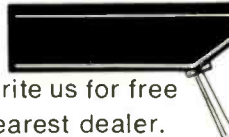

Write us for free literature . . . or see it at your nearest dealer.

that the BSR McDonald 500 sells for much less. Now are you interested? . . .

literature . . . or see it at your nearest dealer.

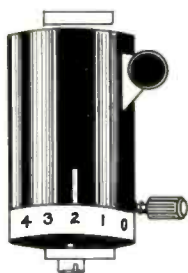

Precision crafted in Great Britain
BSR (USA) Ltd., Blauvelt, N.Y. 10913

CIRCLE NO. 8 ON READER SERVICE CARD



HIFI/STEREO REVIEW'S CHOICE OF THE LATEST RECORDINGS

ENTERTAINMENT

POPS • JAZZ • FILMS • THEATER • FOLK • SPOKEN WORD

Reviewed by NAT HENTOFF • PAUL KRESH • REX REED • PETER REILLY

Ⓜ ADAMO: *Chansons Non Commerciales*. Johnny Adamo (vocals); orchestra, Oscar Saintal cond. and arr. *Le Barbu sans barbe*; *Le Train va*; *Les Mal aimés*; *Nicole Marie*; and eight others. ODEON QELP 8156 \$5.79.

Performance: Good
Recording: Good

Virtually unknown in the United States, Adamo is a top star and something of a pop idol in France. In the French tradition he composes the songs he sings, and in this album we are treated to a fair sampling of them. His voice is quite limited but fashionably rough-hewn, and his songs are good enough, though not sensational in any way. But as a melodist he is practically nonexistent, and one song tends to sound distressingly like another. If you are a Francophile, I suppose you'll want this one. Otherwise, don't bother. P. R.

RECORDINGS OF SPECIAL MERIT

Ⓢ Ⓜ LAURINDO ALMEIDA: *A Man and a Woman*. Laurindo Almeida (guitar); orchestra, Lex de Azevedo cond. *A Man and a Woman*; *Call Me*; *Goin' Out of My Head*; *Bluesette*; *Secret Love*; *Soft Mood*; and five others. CAPITOL ST 2701 \$4.79, T 2701* \$3.79.

Performance: Stirring
Recording: Superb
Stereo Quality: Excellent

Laurindo Almeida plays the guitar the way Rudolf Nureyev dances. His fingers snap, crackle, and pop over clusters of chords with absolute fluency. On this collection he is backed by faint echoes of brass, columns of soft flutes, bells, and an occasional string section. The result is unhampered, polished, and joyous.

The skill of Almeida's playing, combined with the lush richness of the arrangements (silky, but full of ideas) provided by an unknown (to me) arranger-conductor named Lex de Azevedo, makes this album impossible to listen to without full concentration. I played it one evening for a group of friends during a card party. "Listen to that clock ticking," said the dealer during Almeida's extraordinary version of *Here's That Rainy Day*. "What's the name of that beautiful

song?" asked another guest during Almeida's own composition *Soft Mood*. And so it went, until we had abandoned our game and sat enraptured, concentrating on the sound of a man dispensing genius through the placid showcase of popular music. "Genius" is a word I don't toss around lightly, but you don't need a thesaurus to see that it truthfully applies to Laurindo Almeida. This is a great album. R. R.

SUSAN BASSETT: *Susan Barrett!* (see Best of the Month, page 64)



LAURINDO ALMEIDA
Absolute fluency on the guitar

Ⓢ Ⓜ SHIRLEY BASSEY: *And We Were Lovers*. Shirley Bassey (vocals); orchestra, Marty Paich and Ernie Freeman cond. and arr. *And We Were Lovers*; *Summer Wind*; *Big Spender*; *If You Go Away*; and six others. UNITED ARTISTS UAS 6565 \$4.79, UAL 3565 \$3.79.

Performance: Frantic
Recording: Good
Stereo Quality: Good

Miss Bassey likes drama, melodrama even. She performs that otherwise amiable song *Big Spender* with such Medea-like ferocity that any sensible John would surrender his wallet and Lion's Club pin on the spot and run like hell. She is just as harum-scarum in *The Impossible Dream*, where her singing of the song's last word, "star," is so frenzied that it sounds as if she were falling out of a fiftieth-story window. (This song, by the way, is becoming the *I Believe* of the Sixties. It is

cropping up in the acts and recordings of a multitude of performers, generally those in the over-five-thousand-a-week bracket. They seem to feel that an "inspirational" number will explain to a sometimes mystified audience just why it is they receive star billing and salaries. They imply that it isn't really talent, or voice, or in some cases sheer gall that made them into "stars." Unh-unh. It is because they believe in all the *right* things.)

If You Go Away is a nearly five-minute harangue which runs Miss Bassey's emotional gamut—that is, desperate to despairing and back to desperate. In *It Must Be Him* her distress over the fact that her erstwhile lover no longer keeps in touch by telephone causes her to rant "HELLO! HELLO! My dear God, it *must* be HIM, or I shall die, I shall DIE!" every time the phone rings. I find it irresistible to speculate on the chances of its being the telephone company inquiring about the bill.

I have no basic objections to melodrama in popular singing, and Miss Bassey has the necessary vocal equipment to project her hyperthyroidal approach. However, after one or two bands it all begins to sound like a not very pleasant attack of hysteria. Also, Miss Bassey does not seem to be the possessor of an ounce of humor, a condition which only increases the tone of strident complaint.

The liner notes are in the form of a letter from Rod McKuen to Miss Bassey. It begins with the confession that, "It's been a bang-bang day. Too much work. Too much work undone," continues with the revelation that with the help of the test pressings of this record and some scotch she has enabled him to "unwind," and concludes, "Thank you for being beautiful in all ways . . . and tonight, thanks for helping me to let go. I love you."

Not quite up to the level of the Shaw-Terry correspondence, perhaps (in fact Miss Bassey may not be able to calm down long enough to reply, things being so tense over at her place), but you know how those bang-bang days do so take it out of one. P. R.

Ⓜ MAURICE CHEVALIER: *A Musical Tour of France*. Maurice Chevalier (vocals and narration). DISNEYLAND ST 3940 \$3.79.

Performance: Très jolie
Recording: Very good

Let me hasten to assure any worried parents among our subscribers that the contents of this little excursion for undersized tourists are absolutely harmless, and probably guaranteed, as are all products manufactured under the supervision of the late Mr. Disney, not to impair the morals or in any way shake the faith or the delicacy of a minor. In addition, this one is rather charming. M. Chevalier,

Explanation of symbols:

- Ⓢ = stereophonic recording
- Ⓜ = monophonic recording
- * = mono or stereo version not received for review

accompanied by a chorus of children singing in what I suspect are fake French accents, takes his listener-charges over familiar but always attractive musical territory, from *Bon voyage, Monsieur Dumollet* and *Un Oiseau* straight through *Au Clair de la lune, Le Roi Dagobert*, and *Il Etait une bergère*.

Each song is performed in French and again in English, and a pleasant itinerary is provided through a concise narration delivered with infinite good will by the star, who also throws in the merry song *Joie de vivre* from Disney's movie *Monkeys, Go Home!* (naturally) and winds up with the even more optimistic and jolly *There's a Great Big Beautiful Tomorrow* from the same picture. It is all very reassuring. P. K.

RECORDING OF SPECIAL MERIT

Ⓢ Ⓜ CHRIS CONNOR: *Chris Connor Now!* Chris Connor (vocals); orchestra, Don Sebesky cond. and arr. *Goin' Out of My Head; Carnival; You're Gonna Hear from Me; Noubere Man; Shining Sea; Love Life; I'm Telling You Now; Autumn;* and four others. ABC S585 \$4.79, 585* \$3.79.

Performance: Durable
Recording: Good
Stereo Quality: Good

I might as well come right out and admit it: I'm in love with Chris Connor. I always have been. Back in the days when she was really singing jazz fresh from the Kenton school, the way she sang songs as if she were telling stories, the way she phrased slightly behind the beat, and the way she waxed her notes around the musicians like a finely honed sax—well, it was a new discovery for a group of college kids who previously thought music began and ended with Glenn Miller.

Times being what they are, Chris has modified herself, and she's trying not to sing jazz these days. The jazz clubs are dying, the jazz audiences are limited, and quite frankly, there's no money in jazz. So Chris is trying for a hit on the op-pop-flop market, and although I pine for the way she used to sound, I'm pretty content to settle for what I get. In this album, the only thing wrong is some of the material. I won't forgive even so sensitive and intelligent an artist as Chris for including *Strangers in the Night*. And Melina Mercouri is the only woman alive who can sing *Never on Sunday*. The Beatles' *Nowhere Man* and Freddie and the Dreamers' big hit *I'm in Love with You Now*, on the other hand, are major surprises. The best thing in the collection is Alex North's theme from *Who's Afraid of Virginia Woolf*.

Chris sings the songs with much more respect than they deserve and proves once again that great singers can sing just about anything and convince. She has always been an artist with a head for lyrics, the technique to make her ideas come across, and above all, infinite good taste. All of these qualities are present in this current-chart stuff, but I get the feeling from listening that her heart isn't really at home here. Still, I won't quibble. Anything from Chris Connor is better than nine out ten albums from other singers. As the notes on the back of the album hint: "No song ever had a better friend than Chris." I'm inclined to agree. R. R.

Ⓢ Ⓜ THE CRYAN' SHAMES: *Sugar and Spice*. Tom Doody (lead singer), Jim Pilster (tambourine), Dennis Conroy (drums),

Jerry Stone (rhythm guitar), Jim Fairs (lead guitar), Dave Purple (bass, organ, harpsichord). *We Could Be Happy; Ben Franklin's Almanac; Hey Joe; July;* and seven others. COLUMBIA CS 9389* \$4.79, CL 2589 \$3.79.

Performance: Undistinctive
Recording: Good

A rock group composed of electrified minnesingers from eighteen to twenty-one, the Cryan' Shames so far are without a distinctive sound and style. Most of their songs are hollow in content and musically drab. By contrast with the Lovin' Spoonful, the Mamas and the Papas, and Simon and Garfunkel (whom they occasionally try to emulate), the Cryan' Shames are very much apprentices in the rock quarry. N. H.



CHRIS CONNOR
A song's best friend

Ⓢ Ⓜ BOBBY DARIN: *If I Were a Carpenter*. Bobby Darin (vocals); orchestra. Donald Peake cond. and arr. *If I Were a Carpenter; Reason to Believe; For Baby; Red Balloon;* and seven others. ATLANTIC SD 8135 \$4.79, D 8315 \$3.79.

Performance: Imitative
Recording: Very good
Stereo Quality: Excellent

Bobby Darin's career has been in the doldrums of late, and this new release doesn't seem likely to put much steam back into it. The majority of songs here are by Tim Hardin, and Darin just doesn't seem to be able to bring enough sincerity to his performances to make them work. He's good in a fast-paced number such as *Sittin' Here Lovin' You*, but in *Reason to Believe* and the title song, he sounds like a super-hippie trying the folk bag. Speaking of bags, he sounds as if he had one over his head in *Misty Roses*. Striving for what I can only guess he considers an "intimate" sound, he does so much growling and panting into a close-up microphone that the total effect seems not so much intimate as digestive.

If you are a Darin fan (ah, where are the teenyboppers of yesteryear?) then buy this one. If not, skip it. P. R.

Ⓢ Ⓜ PAUL EAKINS: *Big Bertha Band Organ*. Paul Eakins (organ). AUDIO FI-

DELITY AFSD 6145 \$4.79, AFLP 2145* \$3.79.

Performance: Thump, thump, clomp, clomp
Recording: Excellent
Stereo Quality: Deafening

If I am to believe the liner notes, the band organ that throbs and groans and tinkles and buzzes throughout this recording was manufactured in France in the 1800's, served time on a carrousel in Grand Rapids, Michigan, then ruminated in a storage shed in Gulf Shores, Alabama, until 1963, and has since been restored by its purchaser, a Mr. Paul Eakins, in an operation that required "2500 man hours" and probably enough money to have accomplished the successful restoration of the entire South after the Civil War. What comes out of this monstrous apparatus, which "gets its name from the lovely female Director who stands in front and directs as any band or orchestra leader does," is *I Scream, You Scream, We All Scream for Ice Cream; Wedding Bells Are Breaking up That Old Gang of Mine;* and a really rousing rendition of *Away Down South in Heaven*—not to mention *My Melancholy Baby, The Stein Song,* and a *Skater's Waltz* that lasts six minutes and twenty-four seconds. An ideal property, I must say, for anybody planning to go into the merry-go-round business or start an amusement park. The recorded sound is all too real. P. K.

Ⓢ Ⓜ THE GRATEFUL DEAD: *The Grateful Dead*. The Grateful Dead: Bob Weir, Pigpen, Bill the Drummer, Jerry "Captain Trips" Garcia, and Phil Lesh (vocals and instrumentals). *Viola Lee Blues; Cold Rain and Snow; Cream Puff War;* and six others. WARNER BROTHERS WS 1689 \$4.79, W 1689 \$3.79.

Performance: Very loud
Recording: Fair
Stereo Quality: Good

Judging by some of the groups emanating recently from San Francisco, that city must by now not only be swinging but literally rocking. Volume of sound seems to be one of the requisites of acceptance out there. On that basis the Grateful Dead are a smash. On all other counts they are only of moderate interest. The *chef d'oeuvre* of this album, in length anyway, is *Viola Lee Blues*. It is uncompromisingly dull for at least nine minutes of that length, but from time to time it is enlivened by some pleasant work on the electric guitar. (I don't know who to praise by name for this since the album, in common with so many group albums of today, is devoid of liner notes or any other information save the address of the Grateful Dead Fan Club.)

In any event the Grateful Dead are an average psychedelic group which makes a great deal of noise. I know that these frenetic groups are often fun to hear in live performance where the young audiences sit in rigorously concentrated rapture while the uninitiated begin to feel that their sinuses are vibrating like tuning forks. Apart from their ability to produce that effect on recordings, however, I feel there is less to the Grateful Dead than assaults the ear. P. R.

Ⓢ Ⓜ FRANÇOISE HARDY: *Je Vous Aime*. Françoise Hardy (vocals), orchestra. *La Nuit est sur la ville; Et Mème; L'Amour*

s'en va; Tu ne dis rien; Bien longtemps; and seven others. FOUR CORNERS FCS 4238* \$4.79, FCL 4238 \$3.79.

Performance: Fashionable
Recording: Good

After listening to Françoise Hardy, I remain convinced that the two young French singers to watch are Mireille Mathieu and Barbara. I know that Mlle. Hardy is at present more popular with the younger generation in France than the aforementioned two ladies, but I think that may be due to Miss Hardy's super-cool aura, which I would assume the French find rather more exotic than Mathieu's old fashioned gut-busting theatricality or Barbara's essentially traditional "torchy" (there is a word everyone thought died about 1939) approach. This is not to say that Miss Hardy is not a good singer. She is. But not that much better than many others.

Et Môme, with its fashionable triplets and backbeat, is well done, but emotionally Miss Hardy remains so stony throughout it that I found myself paying more attention to the accompaniment than to her singing. In all of the bands I found her much more of a sound than a presence, which is a bit disturbing to an old admirer of Mistinguett, Polaire, Arletty, Jeanmaire, Greco, and Piaf. I suppose I really like French singers who sound French, not like transplanted yé-yé girls. (The French I find notoriously bad at this sort of thing. Have you ever seen a Frenchman dressed in what he considers to be good English taste?) The uncredited arrangements and orchestra are truly the best I have heard in some time—on a recording from anywhere. *Je veux qu'il revienne* is superb and perhaps worth the price of the album itself just to hear this arrangement and orchestra. *Formidable!* P. R.

© ® I, BRUTE FORCE: *Confections of Love*. I, Brute Force (vocals, guitar), unidentified string accompaniment. COLUMBIA CS 9415 \$4.79, CL 2615 \$3.79.

Performance: Crazy
Recording: Excellent
Stereo Quality: Frantic

Here is a fellow with an ear alert to every nuance of the excesses and absurdities of the music that holds the Pepsi generation in its thrall, but I'm afraid his subtle travesties of the rock-and-roll racket will not get through to everyone, and an inattentive listener might even confound these light-handed lampoons with the originals. Mumbling over a messy background of pounding instruments souped up with echo chambers beyond the threshold of endurable pain, he unemphatically slips over lunatic lyrics about spicy doings "in Jim's garage," deploras the laziness of a father who won't leave his TV set to rescue his daughter from a near-rape in the family car, pines away for a wild Latin lass from Tierra del Fuego, and extols the pleasures of sitting "on a sandwich." If this sort of thing catches fire, we may well be in for an era of something that I suppose might be called joke-rock. If so, this lad who calls himself I, Brute Force should easily win a reputation as the Gertrude Stein of the genre. P. K.

© ® TOM JONES: *Green, Green Grass of Home*. Tom Jones (vocals); unidentified accompaniment. *Kansas City; My Prayer; My Mother's Eyes; If Ever I Would Leave*

NEW! Rollei 35 from Honeywell



SHOWN ACTUAL SIZE

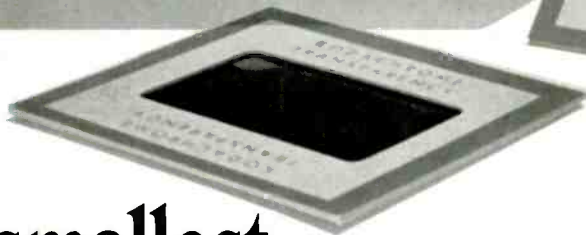

world's smallest camera that takes full-size 35mm pictures!

A little jewel—that's the new Rollei 35! Just a bit larger than a pack of cigarettes, this superb pocket or purse-size 35mm camera has all the features of a big camera *except* size and weight.

There's no other camera like it in the world! You'll carry it everywhere to bring back great pictures. You'll get the same full-size slides that big 35mm cameras make. And, your black and white or color prints will be tack-sharp, even in oversized enlargements.

A fine Carl Zeiss 40mm f/3.5 lens and a highly accurate CdS exposure control system combine to make great results

easy, even for beginning picture-takers. Other big-camera features of the Rollei 35 include a rapid film advance lever, a flash accessory shoe, and nine shutter speeds from 1/2 to 1/500 second.

Priced at just \$189.50, the Rollei 35 is magnificently made in the Rollei tradition to deliver a lifetime of enjoyment. Once you see it, you'll want to pocket it, so ask your Honeywell Dealer for a demonstration soon! Or, for free literature, please mail the coupon below.

Honeywell takes the guesswork out of fine photography

Honeywell Photographic 152
Mail Station 209, Denver, Colorado 80217
Please send Rollei 35 literature to:

Name _____

Address _____

City / State / Zip _____

Honeywell
PHOTOGRAPHIC

CIRCLE NO. 30 ON READER SERVICE CARD

You; and eight others. PARROT PAS 71009 \$4.79, PA 61009* \$3.79.

Performance: **Imitative**
Recording: **Good**
Stereo Quality: **Fair**

Tom Jones was the awful voice behind the credits in the James Bond movie *Thunderball*. He was perfect for that film because his tawdry nasality fit in very well with the camp atmosphere. A forgettable album followed, which included that theme along with assorted other trivia. Now, on his second disc, he is trying hard to sing standards in the way a fellow Britisher, Georgie Fame, does. Fame is a much better singer, but has never caught on in America. Jones sounds like Little Richard on *Kansas City*, like Little Anthony of the Imperials on *Some Day*, like Della Reese on *You Came a Long Way from St. Louis*, like a poor man's Billy Eckstine on *My Prayer*, and like a destitute man's Ray Charles on *Georgia on My Mind*. No matter how you look at it (or from which direction) the news is grim. Tom Jones tries so hard to sound like everybody else that he has no voice of his own. He overphrases, wails, screeches, croons, and wraps the vowels around his tongue like bacon around a fork. The orchestra pumping itself into breakdown behind him is not credited, for what I can only assume to be obvious reasons. R. R.

Ⓢ Ⓜ GERSHON KINGSLEY/JEAN JACQUES PERREY: *The In Sound from Way Out!* Gershon Kingsley, Jean Jacques Perrey (tape machines). *Unidentified Flying Object: Countdown at 6: Girl from Venus: Visa to the Stars*; and eight others. VANGUARD VSD 79222 \$5.79, VRS 9222 \$4.79.

Performance: **Gimmickry and nothing else**
Recording: **Good**
Stereo Quality: **Excellent**

These, we are told, are "electronic pop tunes." Their creators, we are further told, wanted to bring electronic music to a wide public, believing that "it deserves to be raised to the level of a popular music, a music designed for fun and relaxation." Accordingly, they developed a process, "Electronic Sono-syntheses," which uses musical sounds from electronic sources (such as *ondes Martenot*) and sounds of natural origin (*musique concrète*). After being modified and transmuted, "the sonorities were then painstakingly assembled by splicing each bit of tape together manually with micrometric precision to form the 'melodic line' and/or the rhythmic structure of the piece chosen." The resultant tape track was synchronized with music played by live musicians on both electronic and natural instruments as well as with additional electronic sounds (from oscillators, tone generators, and feedback loops). At long last, a final multi-channel tape master was produced through intricate overdubbing. All this required 275 hours of work in the laboratory. And it was all a waste of time. The music is utterly without sustaining interest. It is corny, coy, and rhythmically dead. But perhaps this album should have been reviewed by a computer, for I can think of no other audience for it. N. H.

Ⓢ Ⓜ GERRIE LYNN: *Presenting Gerrie Lynn*. Gerrie Lynn (vocals); unidentified Western accompaniment. *Ain't Had No*

Lovin'; Crazy; Stranger; Once a Day; Pride: I Fall to Pieces; Unloved-Unwanted; and four others. COLUMBIA CS 9385 \$4.79, CL 2585 \$3.79.

Performance: **Lazy**
Recording: **Good**
Stereo Quality: **Good**

Gerrie Lynn is the latest blossom to emerge from the hillbilly orchard. She sounds like a matronly Molly Bee, and on most of the bands on this debut disc, she seems curiously out of place in the idiom. She is really more of a pop stylist, and her slow, bluesy, almost lethargic approach to reading lyrics makes her a very boring interpreter of Nashville sounds. Occasionally there's a good old-fashioned country-and-western sound, but on most of these bands Miss Lynn merely snaps her fingers (there's also a distracting tap-tap

tion; and four others. DUNHILL S 50014 \$4.98, 50014* \$3.98.

Performance: **Jubilant**
Recording: **Good**
Stereo Quality: **Good**

Success has not spoiled the Mamas and the Papas. If anything, they are better than ever, and this is their most joyous recording. Rock-and-roll fans get hysterical when reviewers praise their super-stars for being good musicians; nothing matters less to the followers of the Mamas and the Papas. Still, this fact is an important part of their status. If they were less capable performers, they would be no better than the other ten thousand groups that rise up on the scene in their sandals and Carnaby Street ties and purple ponchos and vanish into the woodwork. No, the Mamas and the Papas are smashingly good musi-



THE MAMAS AND THE PAPAS: *Vocal expertise and the joy of kooky living*

throughout which sounds as though she's keeping time by patting her foot near the mike) with two or three fiddles, an electric guitar, and a slushy Ink Spots chorus humming in the background. The songs are totally banal, with lyrics like "I'm so glad I'm not like a girl I knew one time/She lost her love then slowly lost her mind."

Miss Lynn seems inclined to sing hillbilly music with a pop flair, but there must be a better way to bridge the gap between Nashville and Tin Pan Alley than by changing Roger Miller's *King of the Road* to *Queen of the House*. The lyrics on this one ("I got both floors to scrub, and there's a dirty ring in the tub") are bad enough to make Minnie Pearl blush. R. R.

ENRICO MACIAS: *Donze Nouvelles Chansons* (see Best of the Month, page 63)

RECORDING OF SPECIAL MERIT

Ⓢ Ⓜ THE MAMAS AND THE PAPAS: *The Mamas and the Papas Deliver*. The Mamas and the Papas (vocals and accompaniment) and other instrumentalists. *Dedicated to the One I Love; My Girl; Creeque Alley; Sing for Your Supper; Twist and Shout; Free Advice; String Man; Frustra-*

cians, and they should be proud of it. "When it's all over, we're the ones that will have the legend," they said recently in a *Saturday Evening Post* interview. I think they're smug, but I also think they're right.

In this collection, they really *do* deliver. Electric guitars, vaudeville piano, a carefully controlled sequence of rhythms, and beautifully structured harmonies that threaten to turn into classical chamber quartets on a moment's notice—these are the keynotes of their vocal expertise. But they also bring to their music the joy of kooky living—mink hats and champagne, chauffeured limousines and hop living in their Hollywood mansions (Denny lives in Mary Astor's old mansion, and John and Michelle live in Jeanette MacDonald's old mansion). And underneath it all, a kind of innocence which has won them the fans left behind by Donovan and the Rolling Stones when they turned to LSD and death for inspiration. The Mamas and the Papas sing songs that are all about love and tenderness and all the corny things like that, but with great charm and taste. They even throw in the old Rodgers and Hart evergreen *Sing for Your Supper* with amazing modern results. This is a hot, cool, moving, hip, unpretentious, free, bright, and breezy album. Great stuff. R. R.

Ⓢ Ⓜ FATHER COLUMBA McMANUS: *All About Love*. Father Columba McManus (vocals), unidentified accompaniment. *The Twelfth of Never*; *Guantanamera*; *A Shelter in the Storm*; *Yesterday*; *Ne me quitte pas*; and five others. AUDIO FIDELITY AFSD 6169 \$4.79, 2169* \$3.79.

Performance: Cloying
Recording: Excellent
Stereo Quality: Stiffling

Father McManus sings about love. In the liner notes he says, "... I must contribute to a deeper understanding of human love. I have involved myself in a 'love affair' with God... I have consented to sing these songs because of being a Singing Priest I wish to reaffirm my love for my world, and my deep conviction that I am a part of it and wish to communicate with it..." What all this pompous palaver leads to is a series of dragging amateur renditions of *Guantanamera*, *Ne me quitte pas*, *Try to Remember*, *Where Have All the Flowers Gone*, and other sentimental chestnuts, totally dependent for their ability to move us on the skill of unique vocal resources invested with the ineffable power of emotional inducement. The priest from Montreal brings to them only a good but untutored voice and good intentions—or pretensions. It is not enough. Not even to sing about love. P. K.

Ⓢ Ⓜ ROGER MILLER: *Words and Music by Roger Miller*. Roger Miller (vocals and guitar). *Husbands and Wives*; *Train of Life*; *Billy Bayou*; *Heartbreak Hotel*; *Less and Less*; *Workin' Girl*; *Home*; and five others. SMASH SRS 67075 \$4.98, MGS 27075* \$3.98.

Performance: What you might expect
Recording: Good
Stereo Quality: Good

I don't understand the title of this album, since it includes *Heartbreak Hotel*, which was written by Elvis Presley. But then I don't understand anything about Roger Miller, including the key to why he is so popular. He makes a good living writing songs and has earned the respect of such Buddhas as Johnny Mercer. But even Mercer, who provided the liner notes for this recording, offers no clues. He says he likes Miller because he writes songs about trains, and almost nobody writes songs about trains anymore. Doesn't seem like a very good reason to me.

For my money, Miller is a lousy performer, singing like a yodeler trying to make the big time. There is something distinctly amateurish about his music and something even more talent-night-at-the-neighborhood-picture-show about the way he sings it. There is an occasional flash of insight, present in this collection only in *Husbands and Wives*. But when he tries for self-conscious cuteness, he fumbles ("A chicken ain't chicken till it's lickin' good fried, my uncle used to love me but she died"). Ugh!

He has a long way to go before he catches up with Hoagy Carmichael, who does this kind of thing well. But in the meantime, I admire the sincerity with which he knocks everything off, as though he is singing in his living room for a group of friends who really don't mind the fact that he is as bad as he really is. R. R.

Ⓢ Ⓜ LAURA NYRO: *More than a Discovery*. Laura Nyro (vocals); orchestra,

Herb Bernstein cond. and arr. *Goodbye Joe*; *Billy's Blues*; *Buy and Sell*; *He's a Runner*; and eight others. Verve/Folkways FTS 3020 \$4.79, FT 3020 \$3.79.

Performance: Derivative
Recording: Excellent
Stereo Quality: Excellent

I wanted very much to like this album. Laura Nyro is nineteen years old, and she is a very gifted song writer from whom, I am sure, much can be expected in the future. That much is clearly evident in this new release. However, as a singer Miss Nyro is, at this stage, only a good mimic. The first band, *Goodbye Joe*, is a performance of the song as Dionne Warwick might sing it. *Billy's Blues* is the most accurate imitation of Barbra Streisand that I have ever encountered. A few songs are done in a less identifiable manner, but the majority suffer from the Warwick-Streisand treatment. Occasionally both styles are present in the same song, which only enforces the impression of Miss Nyro's performances as being those of a versatile demo-record singer—albeit one who can sing a mean counterpoint with herself and, on occasion, really swing.

As for the songs themselves—Miss Nyro is a very, very good composer and lyricist. I especially liked *Wedding Bell Blues*, *And When I Die*, and the glowing *I Never Meant to Hurt You*. The arranging and conducting of Herb Bernstein are exemplary, as is the production by Milt Okun.

The most unsettling thing in the album is the quote attributed to Miss Nyro that "I sort of grew up (italics mine) with Bob Dylan's music." It would seem that the generation gap has now accelerated to every five years. Try conjuring with that, all you thirty-year old hippies, as you head toward your favorite discotheque to display your frug and advertise your membership in the Pepsi generation. Don't look now—but there is something sneaking up on you. Like about three generations. P. R.

RECORDING OF SPECIAL MERIT

Ⓢ Ⓜ RAPHAEL: *Canta Raphael*. Raphael Martos (vocals); orchestra, Manuel Alejandro cond. and arr. *Poco a poco*; *El Toreo*; *Mi regalo*; *No Vuelvas*; *Piensalo*; and seven others. UNITED ARTISTS UNS 15514 \$4.79, UN 14514 \$3.79.

Performance: Excellent
Recording: Very good
Stereo Quality: Excellent

Raphael Martos is currently Spain's most popular male singer. It is not difficult to understand why, after listening to this new United Artists release. He has a splendid voice and an exciting presence. *Cuando tú no estás*, the first song on the record, gives notice that you are listening to a spectacular talent. His performance of Aznavour's *El Toreo* is better than any I have heard, and the limpid reading he gives to *Estuve enamorado* makes what is in essence just another Spanish love song into a compelling two-and-a-half minute drama. The only fault I could find with this disc was in the arrangements. Occasionally they smack a little too much of the traditional zarzuela form. Otherwise, I found this to be one of the best albums I have heard in quite a while. P. R.

(Continued on next page)

Live Better Electronically With

LAFAYETTE RADIO ELECTRONICS

Model LR-1200T 120-Watt Solid State FM/AM Stereo Receiver



99-0150WX*

Only **259⁹⁵**

No Money Down

- Powerful 120-Watt Amplifier
- Transistor Overload Protection
- 1.5 μ V FM Sensitivity
- Automatic FM Stereo/Mono Switching
- Variable AFC
- Interstation Muting
- 4-Position Tape Monitor Switch

RK-860 4-Track Solid State Stereo Recorder



99-1530WX*

Only **219⁹⁵**

No Money Down

- 4-Track Stereo and Mono Record/Playback
- Sound-on-Sound
- Sound-with-Sound
- 3 Speeds: 7½, 3¾ & 1⅞ IPS
- Stereo Headphone Monitor Facilities
- Powerful 12-Watt Stereo Amplifier

*Imported



FREE
1967 CATALOG
NO. 670
512 Pages

LAFAYETTE Radio ELECTRONICS
Dept. HMA-7, P.O. Box 10
Syosset, L. I., N. Y. 11791

Send me the FREE 1967 LAFAYETTE Catalog 670 HMG-7

Name _____

Address _____

City _____

State _____ Zip _____

CIRCLE NO. 33 ON READER SERVICE CARD

Ⓢ Ⓜ THE ROLLING STONES: *Between the Buttons*. Rolling Stones (vocals, accompaniment). *Let's Spend the Night Together*; *Yesterday's Papers*; *Ruby Tuesday*; *Connection*; *She Smiled Sweetly*; *Cool, Calm and Collected*; *Who's Been Sleeping Here?*; and five others. LONDON PS 499 \$4.79, LL 3499* \$3.79.

Performance: Unbearable
Recording: Poor
Stereo Quality: Poor

Searching for something nice to say about this collection of dross is like looking for the least offensive worm in a rotten apple. The Rolling Stones make the Beatles (and even less savory groups like the Fugs) sound like a Handel chorus by comparison. There is no allusion to taste, either in material or performance, and any resemblance to genuine talent is purely accidental. The cover of this bizarre disc is a pretty good indicator of what lies within: it looks like an ad for an embalming fluid, with a sneering, half-asleep quintet of washed-out faces peering through a lugubrious blue soup of British fog.

The effect is probably deliberate, because the Stones sing in the same monotonous way, apparently reluctant to give us anything resembling clarity of tone, message, intention, or purpose. Their sound is impossible to describe, because it resembles nothing I've ever heard, but the closest approximation of how they sound can be obtained by playing an LP transfer of Spike Jones' old *Cocktails for Two* at 78 rpm. One song, incidentally, is fun: *Something Happened to Me Yesterday*, a bit of tom-foolery set to a marvelous funky Dixieland beat, with humorous whistles and tuba thumps thrown in. I'd like to hear it sung by a group that knows how to sing. R. R.

RECORDING OF SPECIAL MERIT

Ⓢ Ⓜ ROBERT SHAW CORALE: *Sing unto the Lord*. Sixteen early American folk hymns. Robert Shaw Chorale (vocals). *God Is Seen*; *A Charge to Keep I Have*; *How Firm a Foundation?*; and thirteen others. RCA VICTOR LSC 2942 \$5.79, LM 2942* \$4.79.

Performance: Bright and crisp
Recording: Superb
Stereo Quality: Ingenious

These hymns out of early nineteenth-century America have the austere beauty of Shaker furniture, and although the performances suffer sometimes from the high gloss Mr. Shaw imposes on his interpretations, they make up in animation and fine recording whatever they sacrifice to slickness. If we must have hymns—and some of these, like *Come Ye That Love the Lord*, *Come Away to the Skies*, and *Hark I Hear* are a lot more spirited than the contents of the usual hymnal—then it is certainly good to hear them infused with the freshness and energy that distinguish these performances. There is also a good deal of variety in these songs of praise to God for the wonders of His creation and for the good life that must apparently be led by those who would "with singing to Paradise go." The arrangements, by Alice Parker, together with the suggestion in her excellent notes that hymnbooks of today should be enriched with "this wealth of new-old music," are entirely praise-worthy. P. K.

COLLECTIONS

RECORDING OF SPECIAL MERIT

Ⓜ STARS OF THE SILVER SCREEN 1929-1930. Original recordings by John Boles, Fanny Brice, Maurice Chevalier, Bebe Daniels, Dolores Del Rio, The Duncan Sisters, George Jessel, Helen Kane, Charles King, Dennis King, Jeanette MacDonald, Everett Marshall, Helen Morgan, Gloria Swanson, Sophie Tucker, and Lupe Velez. RCA VICTOR LPV 538 \$5.79.

Performance: Historic
Recording: Excellent remastering

This album makes the fifth release of the RCA Victor Vintage Series, non-jazz division, and it is the third of them that should be in every collection. It is invaluable memorabilia, as are "1928" and "The Kurt Weill

RCA VICTOR



ROBERT SHAW

Freshness and energy for a program of hymns

Classics: *Lady in the Dark/Down in the Valley*. The album is beautifully produced, and seldom have I heard old discs sound as clear and unmuffled in a transfer to LP as here.

The collection contains a number of surprises. These include: Everett Marshall, with whom I was completely unfamiliar (and now I know why), singing *Mr. and Mrs. Sippi* from something called *Dixiana*; the Duncan Sisters, of whom I had dimly heard; Bebe Daniels, also a misty figure (she was pretty good); John Boles (John Boles??); Dolores Del Rio (any woman that beautiful shouldn't be expected to sing well); Lupe Velez, singing a song by Irving Berlin; Charles King, surely immortal as he sings and talks *Broadway Melody*; and Dennis King.

Of course, there are many represented here who fall into the expected category, including Sophie Tucker, Helen Kane, Jeanette MacDonald, Gloria Swanson, and George Jessel. The three heavyweight talents are Chevalier singing *Louise*, the incomparable Helen Morgan singing *What Wouldn't I Do for That Man!*, and Fanny Brice singing *Cooking Breakfast for the One I Love* with all her heart and soul and perceptive magic.

How good it is to hear performances from such an innocently romantic time, and how lucky we are to have such an unfaded souvenir of that era. The liner notes by Miles Kreuger are a model of informed, intelligent, and amusing writing. P. R.

JAZZ



RECORDING OF SPECIAL MERIT

Ⓢ Ⓜ THELONIOUS MONK: *Straight, No Chaser*. Thelonious Monk (piano), Charlie Rouse (tenor saxophone), Larry Gales (bass), Ben Riley (drums). *Locomotive*; *I Didn't Know About You*; *Straight, No Chaser*; *Japanese Folk Song*; *Between the Devil and the Deep Blue Sea*; *We See*. COLUMBIA CS 9451 \$4.79, CL 2651 \$3.79.

Performance: Persistently original
Recording: Excellent
Stereo Quality: Very good

Thelonious Monk has always occupied his own principality in jazz. As has Duke Ellington. And that's why the work of neither ever becomes dated. Both have organized melody, harmony, and rhythm into a totally unified, wholly personal musical language. In this album, Monk is customarily absorbing as a soloist—he has exactly the technique for what he wants to say and as often as one has heard him, he still surprises. I would suggest too that you focus one or more times on Monk as accompanist on these tracks. It is not only his incisive, craggy chord sense that so stimulates his soloists, but also his remarkable rhythmic plasticity. As the only horn soloist, Charlie Rouse indicates here that he has learned well from Monk the values and satisfactions of taut musical logic. (Monk's principality is no place for the sentimentalist or the musical figure skater.) The most delightful track is *Between the Devil and the Deep Blue Sea* in which Monk is alone—an orchestra-of-one. N. H.

RECORDING OF SPECIAL MERIT

Ⓢ Ⓜ OSCAR PETERSON: *Blues Etude*. Oscar Peterson (piano); Ray Brown and Sam Jones (bass); Louis Hayes (drums). *Blues Etude*; *Shelley's World*; *Shadow of Your Smile*; *If I Were a Bell*; *Stella by Starlight*; *Let's Fall in Love*; and three others. LIMELIGHT LS 86039 \$4.79, LM 82039* \$3.79.

Performance: Slick and shiny
Recording: Good
Stereo Quality: Good

When Oscar Peterson broke up with his bassist of fifteen years standing (Ray Brown), he was temporarily lost, because he is a man of such high professional standards that his sidemen work along with him like Charlie Chan's sons. But he soon found a fine Number Two Son in Sam Jones, Cannonball Adderley's bass man, and this album is proof that Peterson never sounded better. I don't quite understand why Gene Lees, in his liner notes, insists that this is a "new" Oscar Peterson. Peterson sounds to me just as he always did, and that's good enough. I've never heard ballads played with such passionate lyricism (witness *Stella By Starlight*)

or sophisticated show tunes swung with such calm but relentless drive (dig *If I Were a Bell*). And I'm happy to see Oscar include Ray Brown's own composition *I Know You Ob So Well*. Brown, by the way, knocks me out with his shattering contrapuntal rhythm shifts on *Bossa Beguine*. This is one of the most hauntingly beautiful and elegant discs of the year. R. R.

Ⓢ Ⓜ SHIRLEY SCOTT: *On a Clear Day*. Shirley Scott (organ), Ron Carter (bass), Jimmy Cobb (drums). *What'll I Do?*; *All Alone*; *Corcovado*; *Instant Blues*; and four others. IMPULSE AS 9109 \$5.98, A 9109* \$4.98.

Performance: Not her best
Recording: Excellent
Stereo Quality: Very good

Shirley Scott is one of the relatively few jazz



FATS WALLER
Infinitely swinging jazz piano

organists who does not exploit the power of that instrument. Her touch and textures are light, her conception is crisp, and her beat is sinewy. Unfortunately, since her conception occasionally flags in inventiveness during this session, she could have used some solo support. And present was one of the most creative of all bass soloists—Ron Carter. Inexplicably, however, he has been confined here to what's essentially a rhythm section role. Accordingly, the proceedings are pleasant—particularly in two Shirley Scott blues—but not memorable. N. H.

Ⓢ Ⓜ THE SWINGLE SINGERS/ THE MODERN JAZZ QUARTET: *Encounter*. John Lewis (piano), Milt Jackson (vibraharp), Percy Heath (bass), Connie Kay (drums), the Swingle Singers (vocals). *Air for G String*; *Ricecave a Six*; *Alexander's Fugue*; and four others. PHILIPS PHS 600-225 \$4.79, PHM 200225* \$3.79.

Performance: Elegant
Recording: Very good
Stereo Quality: Excellent

Recorded in Paris, in vocal and instrumental arrangements by John Lewis, this is the first meeting on records of the Modern Jazz Quartet and the Swingle Singers. The composers include Bach, Purcell, and John Lewis. The performances are graceful, precise, sometimes lovely (as in the *Air for G String*). In

musical temperament, the Modern Jazz Quartet and the Swingle Singers are akin. Both groups are fond of the challenges to improvise in such formal structures as those of Bach and Purcell. Both stress subtlety of dynamics and lucidity of harmonic and melodic development. My only reservation is that much of the music, while elegantly attractive, lacks visceral depth and strength. But one doesn't always want to be shaken by the phonograph, and for those times of placidity, this is a beguiling album. N. H.

RECORDING OF SPECIAL MERIT

Ⓜ FATS WALLER: *Fractions Fingering*. Fats Waller (piano, vocals); Herman Autrey (trumpet); Gene Sedric (clarinet, tenor saxophone); Al Casey (guitar); Charles Turner (bass); Slick Jones, Yank Porter (drums). *The Curse of an Aching Heart*; *Nero*; *My Feelin's Are Hurt*; *Swingin' Them Jingle Bells*; and fourteen others. RCA VICTOR LPV 537 \$4.79.

Performance: High-spirited
Recording: Good

The third album in RCA Victor's commendable vintage series of Fats Waller reissues, this one includes thirteen small-combo sides recorded in 1936 and three 1929 piano solos. (One of the latter, *Gladys*, is a previously unissued take.) It's all quintessential Waller—the mocking vocals; the infectious, robust, two-handed piano swinging; the brio of a compatible combo. And the piano solos reveal again how strong a force Waller was in the evolution of the jazz piano. My own favorite track is the 1929 *My Feelin's Are Hurt*, but there is substance in all the performances. Substance, and an invigorating affirmation of life. N. H.

COLLECTIONS

RECORDING OF SPECIAL MERIT

Ⓢ Ⓜ THE ART OF THE BALLAD, Volume Two. Sonny Stitt, Johnny Hodges, Lee Konitz, Charlie Parker, Stan Getz, Benny Carter, Gerry Mulligan, Art Pepper, Ben Webster, and others. VSP \$38 \$2.49, 38 \$2.49.

Performance: Colossal
Recording: Good
Stereo Quality: Good

Verve deserves congratulations here. The concentration is on the various playing styles of some of the greatest jazzmen ever assembled on one disc, showing off the fine art of how to play ballads. There is one really smashing band by Charlie Parker, live with strings at Carnegie Hall playing *April in Paris*, that is a collector's item. That's not all. Gerry Mulligan and Art Pepper perform a sensuous duet from the neglected score of the MGM film *The Subterraneans* on which they team up with André Previn's trio and a large orchestra of strings. Gorgeous! Stan Getz has always been a king of ballad playing, and his version of *It Never Entered My Mind* recorded with a big band conducted by Russ Garcia in Stuttgart, Germany, has got to be heard to be believed. Simply everything about this collection is the living end and an absolute must for any basic library of jazz. R. R.

(Continued on next page)

sonotone's dynamic cardioid mike for taping

Are unwanted sounds spoiling your home tape recordings? Has everyday household noise got you down? Sonotone has the unidirectional answer: Our CDM80 dual impedance microphone.



This Sonotone microphone features the discriminating cardioid pattern that professional performers prefer. Captures every word, note and nuance directed into it, while suppressing extraneous, distracting noises, boominess and feedback.

Complete with on-off switch, 15-foot cable and shield. Impedances of 200 ohms and 50K ohms. Price: \$43.50



Write
TODAY
for Latest
Catalog on
Sonotone Microphones



ELECTRONIC APPLICATIONS DIVISION
SONOTONE CORPORATION • Elmsford, N.Y. 10523
Exports: Singer Prods. Co., NYC. Cable: Exregnis, N.Y.



It's Smart
To Be Thrifty!

STEREO &
HI-FI BUYERS

BEFORE YOU BUY GET A RABSONS
QUOTE... YOU'LL BE GLAD YOU DID!

At Rabsons Competitive Prices, Reliability and Personal Service have been bywords for over 61 years

It's so EASY and SAFE to deal with Rabsons

• Up to 36 months to pay on Easy Pay Plan • Centrally located—as close as your telephone—as near as your mail box • Free Mail Order-Hi Fi Clinic Service • Fast Air Mail Response on Quotation Requests • Franchised Distributor for Hi Fi Lines • 62 Years of business "Know How" to serve you better • Shipments **DOUBLE PACKED** and **FULLY INSURED** • "Attractive" Prices • Warehouse on premises • Fast Delivery—Large inventory permits processing and shipment promptly • All merchandise brand new in Factory sealed cartons • Save even more on complete system quotes • Export Packing—220 Volts 50 Cycle merchandise a specialty • Free list of monthly specials.



RABSONS

57 ST. INC.
119 West 57th Street, New York, N. Y. 10019
Tel. Area Code 212-247-0070

CIRCLE NO. 42 ON READER SERVICE CARD



SELLING HI-FI
WORLD WIDE
SINCE 1948

COMPONENTS • RECORDERS
KITS • SPEAKER SYSTEMS • TAPE

- LOWEST PRICES
- SAME DAY REPLY TO YOUR INQUIRY
- MFRS. SEALED CARTONS
- DOUBLE BOXED WHEN POSSIBLE
- FAST, INSURED SHIPMENTS
- PACKAGE DEALS SAVE YOU MORE
- FRANCHISED DISTRIBUTORS FOR OVER 50 MFRS.
- OPEN MONDAY THRU SATURDAY
- TEN CENT-ONE HOUR PARKING METERS AT PREMISES

Send for
FREE "MONTHLY SPECIALS"
Components, Tapes, Cartridges



1686-A Second Ave. (Nr. 87), N.Y. 10028

CIRCLE NO. 9 ON READER SERVICE CARD



FOLK

Ⓢ Ⓜ FERNANDO FARINHA: *The Portuguese Hits of Fernando Farinha, Volume Two*. Fernando Farinha (vocals); Conjunto de Guitarras de Raul Nery; orchestra, Joaquim Luis Gomes cond. *There Is but One Mother; The News Boy; Old Lisbon; Life*; and eight others. MONITOR MFS 467 \$4.79, MF 467* \$4.79.

Performance: Ardent
Recording: Good
Stereo Quality: "Enhanced"

At thirty-eight, Fernando Farinha is one of the most popular singers in Portugal and a rising movie star. He has an unusually pliable voice, and, like other superior *fado* singers, he delights in subtleties of phrasing and dynamics. Since Farinha is so compelling a singer of lyrics, it is all the more absurd that Monitor has provided no translations or paraphrases. For this listener, one who understands no Portuguese, the experience is gratuitously frustrating. N. H.

Ⓜ BLIND BOY FULLER: *With Sonny Terry and Bull City Red*. Blind Boy Fuller (vocals, guitar), Sonny Terry (harmonica), Bull City Red (washboard). *Bye Bye Baby Blues; Jitterbug Rag; Careless Love; Big House Bound*; and ten others. BLUES CLASSICS 11 \$4.98.

Performance: Straightforward
Recording: Competent

Brought up in North Carolina, Blind Boy Fuller (Fulton Allen) was a considerable influence on a number of Atlantic-Coast blues singers until his death in the late 1940's. This useful set consists of recordings made by him between 1935 and 1940. His repertoire of blues, rags, and country dances makes for a diversified program; and while I don't find Fuller as deeply affecting as Robert Johnson or some of the other classic blues singers, his singing is forceful and is obviously seasoned by experience absorbed with perception. Sonny Terry's harmonica provides a buoyant and tart commentary. Blues Classics is at P.O. Box 863, Berkeley, California. N. H.

RECORDING OF SPECIAL MERIT

Ⓜ WOODY GUTHRIE: *Bonneville Dam and Other Columbia River Songs*. Woody Guthrie (vocals, guitar, harmonica). *Talking Columbia; End of My Line; This Is Your Land; Goin' Down the Road*; and five others. VERVE/FOLKWAYS FV 9036 \$4.79.

Performance: Triumphant
Recording: Adequate to good

For a time in the 1940's, Woody Guthrie was employed by the Bonneville Power Administration to write songs celebrating the achievements of the men who built the Grand Coulee and Bonneville dams. He

later recorded the songs, and, as he once recalled with pride, "the records were played at all sorts and sizes of meetings where people bought bonds to bring the power lines over the fields and hills to their own little places." Nine of the recordings have been remastered for this album, and the performances remain singular in terms of Guthrie's idiomatic ease and *al fresco* ebullience. The songs, too, have endured, and will continue to be a vital part of the American folk-song heritage because Woody was the most authoritative writer of folk-like material of his generation. In the notes are reproductions of documents concerning the 1966 Interior Department Conservation Award given to Guthrie (a corollary of the award was the naming of a Bonneville Power Administration Substation in the Pacific Northwest the "Woody Guthrie Substation"). Woody was always committed to conservation—of the human spirit as well as our other natural resources. N. H.



DAVE RAY

The finest interpreter of the blues revival

RECORDING OF SPECIAL MERIT

Ⓢ Ⓜ DAVE RAY: *Fine Soft Land*. Dave Ray (vocals, 12-string guitar, harmonica, piano). *Alabama Women; West Egg Rag; Death Valley Blues; You Can't Go*; and twelve others. ELEKTRA EKS 7319 \$5.79, EKL 319 \$4.79.

Performance: Impressive
Recording: Excellent
Stereo Quality: Good

It is the opinion of Paul Nelson, who wrote the notes, that this album represents "the very best work of the finest blues interpreter-creator to emerge from the folk revival." I'd be inclined to agree if Ray were to be called "the finest interpreter of the blues revival." Of all the young white singers and players immersed in the Negro blues tradition, Ray—as of this, his best recording—is pre-eminent in his musicianship, both instrumentally and vocally. His use of a strong, declaratory voice has evolved markedly, and he can now convincingly span a diversity of moods and musical challenges. A superb guitarist and a fine harmonica player, Ray certainly merits an all-instrumental album if he wants it. However, he is still in the black blues tradi-

tion, in his original songs and in those he chooses from the past (by Leroy Carr, John Estes, Arthur Crudup, and Curtis Jones). Accordingly, he remains an interpreter—not a creator. It is certainly an estimable vocation, but I hope that a man with this degree of talent will eventually be driven to create his own material in his own style reflecting who he is in this time and whatever places he explores in this time. In any case, although I have not been enthusiastic about most white blues revival recordings, I strongly recommend this one. N. H.

Ⓜ DUANE STARCHER: *Woods and Water*. Duane Starcher (vocals, banjo, guitar, dulcimer). *The Little Brown Bulls; Red Iron Ore; The Beaver Island Boys; The Jam on Gerry's Rock*; and seven others. WESTERN MICHIGAN UNIVERSITY AURAL PRESS 2000 \$5.00.

Performance: Enthusiastic
Recording: Good

Apparently the major avocation of Duane Starcher, manager of television services at Western Michigan University, is folklore and folk singing. One of his specialties is folksongs from Michigan history, and in this set, he performs eleven that, as the notes say, "tell tales of the people who passed through and around Michigan in the nineteenth century." These are vigorous stories of lumbermen, sailors, farmers, and lovers. They chronicle disaster, protest, hard-drinking, boasting, and various other aspects of the life of nineteenth-century rovers and settlers. Starcher has a strong, clear, pliable voice and a good actor's sense of role-playing. He communicates his enthusiasm for this lore with gusto and affection, and has made a convert of this listener. The record is available from Aural Press, Western Michigan University, Kalamazoo, Michigan. N. H.

Ⓜ JOSH WHITE: *Josh White*. Josh White (vocals, guitar), and various unidentified instrumental and choral accompaniments. *What I Want from You; So Soon; Bury Me High; Go Way from My Window; Evil-Hearted Me; Green Cove*; and two others. ARCHIVE OF FOLK MUSIC FS 209* \$5.79, FM 109 \$4.79.

Performance: Thin
Recording: Below standard

According to the credo of the Archive of Folk Music, a subsidiary of Everest Records, this project is a high-minded attempt to rescue outstanding folk performances of the past from 78-r.p.m. limbo. Something went wrong here. No dates are given for these performances, but my guess is that they're at least twenty years old, and they come from the most expendable commercial period of White's career. His own singing is as if by rote, and the backgrounds couldn't be more inappropriate for what this company calls "indigenous and unselfconscious music of the people." There are syrupy vocal groups and even a soap opera organ behind the once hard-bitten blues *Evil Hearted Me*. According to the label, there is also a stereo version of this disaster, but fortunately it is not at hand. ("Enhanced" mediocrity is just too much of a bad thing.) Total playing time, by the way, is about twenty-three and a half minutes. For once, such parsimony is quite welcome. N. H.

JULY 1967

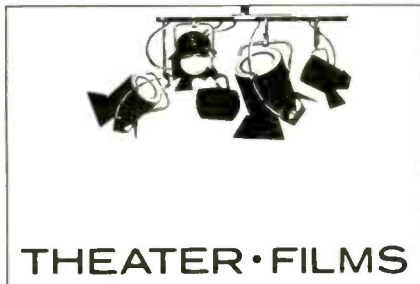

THEATER • FILMS

Ⓜ HOW TO SUCCEED IN BUSINESS WITHOUT REALLY TRYING (Frank Loesser). Original motion-picture soundtrack. Robert Morse, Michele Lee, Rudy Vallee, Anthony Teague, Maureen Arthur, and others (vocals); orchestra, Nelson Riddle cond. UNITED ARTISTS UAS 5151 \$5.79, UAL 4151* \$4.79.

Performance: Fresh-faced
Recording: Good
Stereo Quality: Realistic

Like its slippery hero J. Pierrepont Finch, whose innocent reposeful air belies the deadly malevolence with which he knifes his fellow creatures in his lightning advance to the apex of the industrial pyramid, *How to Succeed in Business* has made its way spectacularly up from book to Pulitzer Prize-winning musical to wildly acclaimed movie. "Nothing succeeds like 'Succeed,'" boast the billboards. They can say that again. And since almost all of the principals who kept the ball in the air on stage have been retained for the screen production, this second album of the songs offers advantages similar to those of the RCA Victor Broadway-cast recording (LOC/LSO 1066).

It offers similar disadvantages too, for the whirlwind cartoon exuberance of the story is not reflected to best advantage in an always apt but not always inventive score. There is still much to recommend several of the songs, and throughout the lyrics are spruce and the tunes are pleasant even if they stand on their own only half-heartedly. I kept wishing that Rudy Vallee had been tossed more material. Things really sparkle when he's doing *Grand Old Ivy*. A word of praise also for the winning voice of Michele Lee who plays Finch's girl friend. For the rest, the disc is to be recommended mainly to those who will enjoy it as a happy souvenir *after* seeing the movie. P. K.

Ⓜ OLYMPUS 7-0000 (Richard Adler). Original-cast recording from the ABC-TV *Stage 67* spectacular. Larry Blyden, Phyllis Newman, Eddie Foy, Jr., Fred Clark, Lou Jacobi, the New York Football Jets (vocals); orchestra, Philip Della Penna cond. COMMAND CS 07 SD \$5.79, CS 07* \$4.79.

Performance: Valiant but in vain
Recording: Terrific
Stereo Quality: Superb

Everything is terrible about *Olympus 7-0000*, most of all the fact that the album was released in the first place. The producers of the ambitious ABC television series *Stage 67*, which has promised so much and come forth with so little, have not as yet recovered from the embarrassment of putting on this vapid hour-long musical about how the god Hermes intervenes in the affairs of a college football team and of an archi-

NOW FREE!

STEREO INFORMATION

FM Station Directory

The directory lists 1571 FM stations in the United States and Canada. All the stations broadcasting in stereo are listed.

Test Reports

Test reports full of facts. The test reports were made by independent laboratories. Tests cover tuners, preamps, power amp/preamps. Read the facts from test experts.

Big 36-Page Catalog

You get a 36 page catalog. It tells you about tuners, power amplifiers, preamplifiers, pre-amp/power amplifier combination and tuner preamps.

ALL FREE McIntosh

PLEASE SEND ME YOUR CATALOG
McIntosh Laboratory, Inc.

1 Chambers St. Binghamton, N. Y. 13903

NAME _____
STREET _____
CITY _____
STATE _____ ZIP _____

CIRCLE NO. 38 ON READER SERVICE CARD

WRITE FOR QUOTATION

FACTORY SEALED CARTONS
FRANCHISED DISTRIBUTOR
QUICK SHIPMENT

WE GIVE DISCOUNTS ON HI-FI COMPONENTS

SOUND REPRODUCTION INC.

34 New Street, Newark, N. J. (07102)
(201) Mitchell 2-6816

CIRCLE NO. 54 ON READER SERVICE CARD

Live it up, Live it over!



...with the most alive color movies ever made... automatically!

Drop in the instant-load film cartridge. Aim and shoot. Nothing else to do... for the sharpest, brightest, most alive color movies you've ever seen! Push button electric power takes care of everything including automatically correct exposure. Less than \$80 at your camera store or write for full color folder today.



FUJICA Single-8

FUJIFILM FUJI PHOTO FILM U.S.A., INC.
U.S. Distributor: Ehrenreich Photo-Optical Ind., Inc.
Dept. 12, Garden City, New York 11533
In Canada: R. & H. Products, Ltd.

CIRCLE NO. 27 ON READER SERVICE CARD

96

teatural student who is in love with the dean's daughter.

The enormously capable Donald O'Connor sings and tap dances his way through some of the dreariest material an entertainer ever had to carry. Here's a sample lyric: "Volcanoes I'll gladly plunge in/ Or rot in a rat-filled dungeon." And tunes to match! Phyllis Newman, another first-rate talent, barely gets by with a couple of other innocuous numbers, indistinguishable one from the other. Command's sound is stunning. P. K.

Ⓢ Ⓜ THOROUGHLY MODERN MILLIE. Original sound-track albums. Julie Andrews, Carol Channing (vocals); orchestra, Andre Previn arr. *Thoroughly Modern Millie*; *Poor Butterfly*; *Rose of Washington Square*; *Baby Face*; *The Tapioca*; and four others. DECCA 71500 \$5.79, 7150* \$4.79.

Performance: Right for this material
Recording: Good
Stereo Quality: Good

Thoroughly Modern Millie is a thoroughly unoriginal movie musical, derivative in almost every way; and much of what's wrong with it is disturbingly in evidence on this sound-track recording. I won't waste space dwelling on the flaws in the movie. But taken on its own terms, the score is flat, dull, and borrowed. This is the Roaring Twenties, yet nobody ever seems capable of writing anything new about the Jazz Age without picking up all the old songs. In abundance here are medleys of orchestral favorites, played in rinky-dink style: *Baby Face*, *Stumbling, Japanese Sandman*. You get the picture. Then there are a couple of numbers thrown in for Julie Andrews, all of which seem taken from her big stage success, *The Boy Friend*. And there's a Jewish wedding dance which has nothing whatever to do with *Millie's* feeble plot and sounds suspiciously like something rejected from the Boston tryout of *Fiddler on the Roof*. The only bright spot in the film—and on this disc—is Carol Channing, who sings a lively bit of memorabilia called *Jazz Baby*. Julie Andrews is her customary vapid self and perfectly cast as a brainless flapper. Beatrice Lillie, who was amusing in the film, is not heard from at all. Simply everything about *Thoroughly Modern Millie* is thoroughly expendable. R. R.

Ⓢ Ⓜ THE 25TH HOUR. Original sound-track recording. Orchestra. Georges Delerue cond. MGM SE 4464 ST \$5.79, E 4464 ST* \$4.79.

Performance: Oversized
Recording: Excellent
Stereo Quality: Dangerous

The 25th Hour is a movie about a simple, stolid, Rumanian schlemiel, a peasant who gets himself packed off to a labor camp at the start of World War II. He is mistaken for a Jew, browbeaten, tortured, and finally put on trial at Nuremberg as a war criminal. This cheerful tale is accompanied by an over-sweetened Enesco-type music track, heavily flavored with ersatz Rumanian overtones. On the record the sections are designated by such captions as "Deportation of the Jews," "Johann in the Wheat Field," and "Arrival of the Germans." The last is a march that tramped out of the stereo speakers and across my living room so heavily that it knocked a copy of *War and Peace* right off a bookshelf. It's a big score. P. K.

SPOKEN WORD



Ⓢ Ⓜ HAL HOLBROOK: *Mark Twain Tonight*. Highlights from the CBS television network special. Hal Holbrook (monologist). COLUMBIA OS 3080 \$5.79, OL 6680 \$4.79.

Performance: A calculated twinkle
Recording: Excellent
Stereo Quality: Superfluous

In presenting his one-man show about Mark Twain, complete with long white mane, beetling brows, moustache, and cigar, actor Holbrook has kept himself on his own toes by varying the material in his presentations from one night to the next. Those who enjoyed the first two superb albums in this series will not be squandering their money, therefore, if they go ahead and acquire the third. This latest disc is based on the contents of a CBS network special presented in the spring of 1967, and it covers such subjects as religion, sunrise on the Mississippi, the United States Congress as a "grand old benevolent national asylum for the helpless," the evils of slavery, and the smugness of men who will defend any war once we're in it—leaving the contemporary listener to draw his own analogies.

It is no secret by now that the magic of Holbrook's success has been his ability to lose himself completely in this character, huffing, hemming, and chuckling his way through a treasury of consistently witty selections. There is no one who can make more of a pause than Mr. Holbrook when he is being Mr. Twain, sometimes so shamelessly that I thought he must have left the cameras altogether—but the audience eats it up every time, and it would be grumpy to deny the effectiveness of this and other devices in the actor's bag of tricks. Yet over the years the use of these has become broad enough to swamp the subject matter at times in mannerisms, especially in the telling of one interminable tale about an old man and a ram, where it became almost impossible to follow the story for the eccentricities of the narrator. Despite the excesses, though, the record is a valuable addition to a delightful set. P. K.

Ⓢ Ⓜ I WERE A HIGH SCHOOL GRADUATE. Kenny Solms, Gail Parent (performers). Epic FLS 15112 \$4.79, FLM 13112 \$3.79.

Performance: Undergraduate
Recording: Good
Stereo Quality: Marked

Lower the hatches. It looks as though we're in for a spell of sophomore humor about the hilarities of high-school years. Not long enough ago there was Sandy Baron's "I Never Let High School Interfere with My Education." Now there's this item, which goes over the same ground more clumsily: the sexy girl who gets all the dates, the

married student couple, the guidance counselor, the prom. Twice I brightened up as Mr. Solms and Miss Parent ("the youngest comedy writing-performing team in the business," boast or complain the liner notes) tackled promising material—once at a father's lecture to his son for failing to wear dirty sweaters or hair long enough to attract attention ("Look at you—you're seventeen and you've never even been arrested yet!"), and again during a casual noontime session in the teachers' lunchroom in the course of a riot. The rest, as the record label warns, is "not recommended for adults." Some of it, in fact, sounded a trifle young for teenagers. P. K.

RECORDING OF SPECIAL MERIT

Ⓢ Ⓜ SOPHOCLES: *Antigone*. Dorothy Tutin, Max Adrian, Jeremy Brett, Eileen



DOROTHY TUTIN
Eloquent as Sophocles' Antigone

Atkins, Geoffrey Dunn, and others; Howard Sackler, director. Dudley Fitts and Robert Fitzgerald (translators). CAEDMON TRS 320S two discs \$12.90, TRS 320M \$12.90.

Performance: Towering
Recording: Excellent
Stereo Quality: Striking

Although he wrote it first, Sophocles intended *Antigone* to serve as the finale of his trilogy of Theban plays, which have been running for some 2,400 years now and seem to have more to say about us and to us than most of the works of our own contemporaries. When *Antigone* opens, Oedipus is dead and Creon has taken power. He rules absolutely over all of Thebes, yet feels that his great might is threatened by the intransigence of one stubborn woman. She is his niece Antigone, who defies Creon's orders not to bury the corpse of her traitorous brother Polyneices. The issue of the drama soon emerges: where does an individual owe allegiance—to state or clan, to society or to self? There are no villains here, nor flawless heroes either. The arrogant Creon shows himself capable of change, and the noble Antigone is revealed as less than reasonable in her contempt for law. All this unfolds like a march of invading forces inexorably storming our emotions. I wish the despoilers of our screens and stages who detain us with

endless sagas could take another look at the economy of Sophocles! In one hour and ten minutes we are hauled up to the heights of tragedy, instructed, shattered, swayed, and dropped back into the world with a new understanding of the twin spirits of defiance and obedience which wrestle eternally in the souls of men.

The present recording flows with the clarity of a crystal stream. Max Adrian as the furious Creon, Dorothy Tutin as the woman who defies and defeats him, Eileen Atkins as her conventional sister Ismene, Jeremy Brett as the ardent Haimon who dies for Antigone, and Geoffrey Dunn as the prophet Tiresias who predicts the downfall of Creon are welded into an ensemble of astonishing eloquence by the directorial genius of Howard Sackler. The chorus, voicing the mundane reactions of the Theban populace, speak with golden tongues from the midst of a discreet and singularly apt fretwork of music. It is they who remind us finally that "there is no happiness where there is no wisdom," and that humility before the gods is all, for "big words are always punished." P. K.

RECORDING OF SPECIAL MERIT

Ⓢ J. M. SYNGE: *The Playboy of the Western World*. Siobhan McKenna, Cyril Cusack, and others; Cyril Cusack, director. SERAPHIM IB 6013 two discs \$4.98.

Performance: Authentic
Recording: Excellent

In addition to all it owes to him for his verse, Ireland must also be indebted to Yeats for the discovery of Synge, who at the turn of the century became the high priest of Irish drama. In *The Playboy of the Western World*, as in his other plays, he brews a wondrous mixture out of all that is romantic in the Celtic tradition and all that is matter-of-fact in hard-headed realism. Here, however, unlike the heartbreaking *Riders to the Sea* or the unfinished *Deirdre of the Sorrows*, he is writing a comedy—the tale of a young nobody named Christy who is able to become the adulated hero of a whole town on the strength of his claim that he has actually murdered his own father. Christy is even about to get the biggest prize in the community—the pub owner's spirited daughter Pegeen as his bride—when his supposedly dead progenitor inconveniently turns up in the neighborhood. Christy tries several times to make good his boast and really murder the old man, but Mahon, the father, like Ireland itself, is indestructible.

Whether or not Synge intended *The Playboy* as a satire on his native land, the real hero is not Christy but the language of the dialogue, earthy as the soil of the Gaelic countryside, and lyrical as a well-wrought ballad. And because the rich allusiveness of that dialogue is what crucially distinguishes this comedy from other attempts in its vein, this performance, thanks to the authoritative presence of Siobhan McKenna as Pegeen and Cyril Cusack as the young parricide *manqué*, surrounded by other Celtic players with a total comprehension of their assignments, is ideal in all respects. The album, a re-release from the vaults of Angel, should exasperate and serve as goad and unattainable model to all those groups forever attempting to stage Synge revivals in little theaters everywhere. P. K.

MORE and BETTER

FM Stereo Multiplex BROADCASTS

FOR YOU

with a

FINCO®

AWARD-WINNING FM Antenna

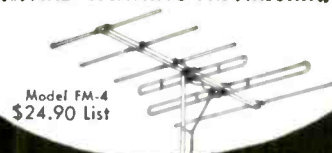

World's Most Complete line of HI-FI Phased

FM ANTENNAS

Write for Catalog 20-213.

THE FINNEY COMPANY
34 WEST INTERSTATE BEDFORD, OHIO 44146
DEPT. H. D.

CIRCLE NO. 24 ON READER SERVICE CARD

Why?

DO THOUSANDS OF HI-FI ENTHUSIASTS BUY FROM AUDIO UNLIMITED

It's Obvious!

- LOWEST PRICES
- FAST SERVICE
- FACTORY SEALED UNITS
- FULLY INSURED SHIPMENTS
- PACKAGE DEALS—SAVE MORE
- FRANCHISED DISTRIBUTORS

Write for **FREE Listing today**

SEND US YOUR LIST FOR OUR AIR MAIL QUOTE TODAY

Visit Our Showroom and Warehouse
CLOSED MONDAYS

AUDIO unlimited, inc.
715-S Second Ave. (Nr. 38), N.Y., N.Y. 10016

The TEAC A-6010:

If all you want is a tape deck, forget about this one.

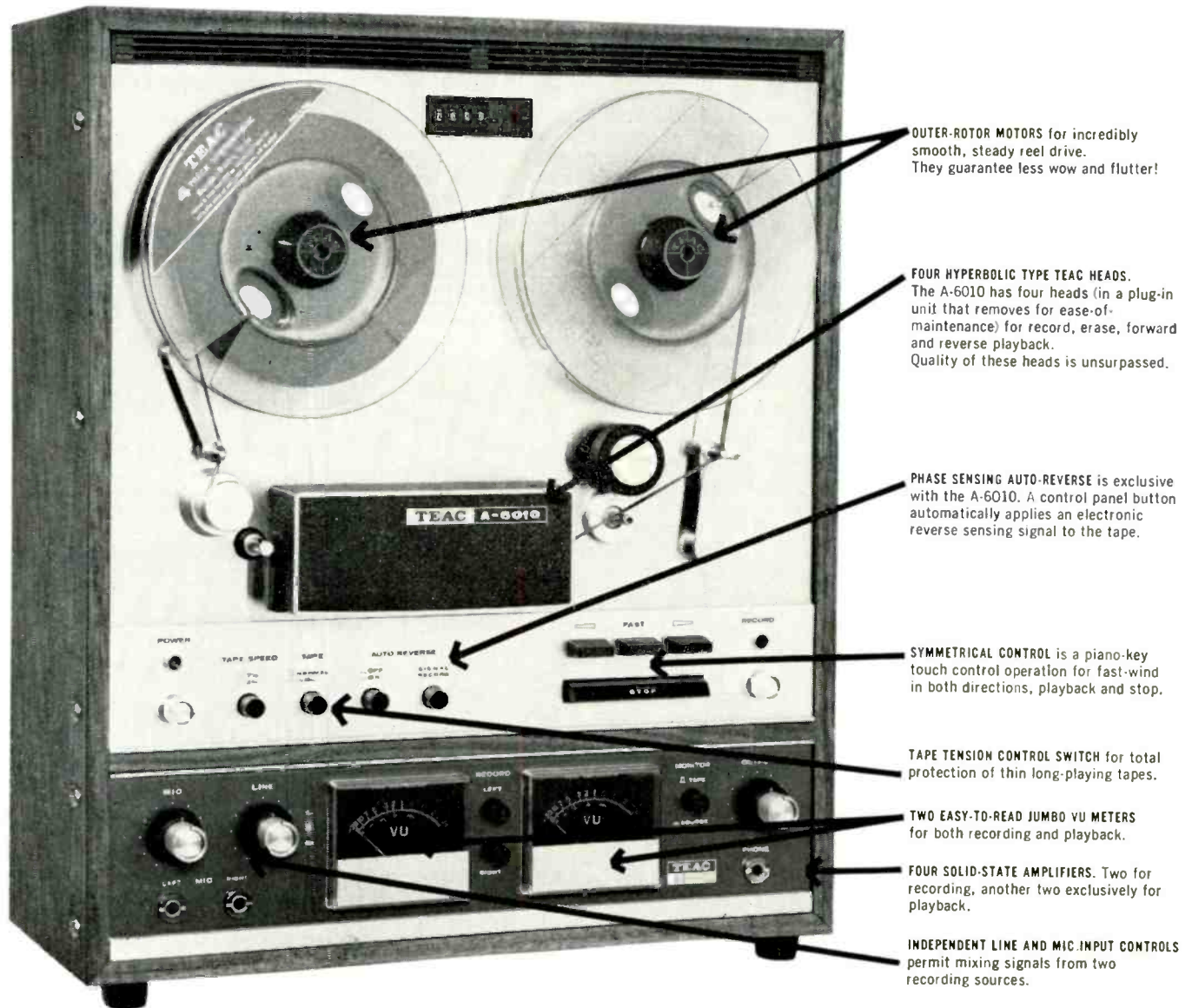

OUTER-ROTOR MOTORS for incredibly smooth, steady reel drive. They guarantee less wow and flutter!

FOUR HYPERBOLIC TYPE TEAC HEADS. The A-6010 has four heads (in a plug-in unit that removes for ease-of-maintenance) for record, erase, forward and reverse playback. Quality of these heads is unsurpassed.

PHASE SENSING AUTO-REVERSE is exclusive with the A-6010. A control panel button automatically applies an electronic reverse sensing signal to the tape.

SYMMETRICAL CONTROL is a piano-key touch control operation for fast-wind in both directions, playback and stop.

TAPE TENSION CONTROL SWITCH for total protection of thin long-playing tapes.

TWO EASY-TO-READ JUMBO VU METERS for both recording and playback.

FOUR SOLID-STATE AMPLIFIERS. Two for recording, another two exclusively for playback.

INDEPENDENT LINE AND MIC INPUT CONTROLS permit mixing signals from two recording sources.

A-6010 Specifications: Four heads, 4 track, 2 channel. 7" maximum reel size. Tape speeds 7½ and 3¼ ips (±0.5%). Dual speed hysteresis synchronous motor for capstan drive, 2 eddy current outer-rotor motors for reel turntables. **Wow and flutter:** 7½ ips: 0.08%; 3¼ ips: 0.12%. **Frequency response:** 7½ ips: 30 to 20,000 Hz (±2 db 45 to 15,000 Hz); 3¼ ips: 40 to 14,000 Hz (±2 db 50 to 10,000 Hz). **SN Ratio:** 55 db. **Crosstalk:** 50 db channel to channel at 1,000 Hz. 40 db between adjacent tracks at 100 Hz. **Input:** (microphone): 10,000 ohms, 0.5 mV minimum. (line): 300,000 ohms, 0.1 V minimum. **Output:** 1 volt for load impedance 10,000 ohms or more.

The A-6010 is what happens when a company with more than 1,000 innovations in the magnetic tape industry decides to create some exciting new standards for the knowledgeable music lover. It has features no other comparably-priced decks have, and to go it one better you'll have to go shopping for studio recording equipment. Isn't this the day to see it?

TEAC®

TEAC CORPORATION OF AMERICA 1547 18th St., Santa Monica, Calif. 90404
CIRCLE NO. 55 ON READER SERVICE CARD



HIFI/STEREO REVIEW'S CHOICE OF THE LATEST RECORDINGS

STEREO TAPE

Reviewed by WILLIAM FLANAGAN • DAVID HALL • IGOR KIPNIS
REFX REED • PETER REILLY

⑤ **BEETHOVEN:** *Missa Solemnis, in D Major, Op. 125*. Gundula Janowitz (soprano); Christa Ludwig (mezzo-soprano); Fritz Wunderlich (tenor); Walter Berry (bass); Vienna Singverein Choir; Berlin Philharmonic Orchestra, Herbert von Karajan cond. DEUTSCHE GRAMMOPHON DGK 9209 \$11.95.

Performance: Intensely lyrical
Recording: Good
Stereo Quality: Excellent
Speed and Playing Time: 7½ ips; 86"

This is the third recording of Beethoven's *Missa Solemnis* to be made available on four-track tape. I have heard neither the disc nor the tape of the performance conducted by Klemperer, but the fact that that tape is recorded at 3¾ ips would most likely put it out of the running from a sonic standpoint. The other 7½-ips reading is Leonard Bernstein's (Columbia M2Q 529). That Bernstein's performance is nearly ten minutes shorter than Karajan's here is a hint at the basic difference in character between the two interpretive approaches. Karajan does not storm the heavens, but rather seeks to expose the lyrical essence of Beethoven's noble and poignant score. This is especially evident in the *Qui tollis* of the *Gloria* and in the *Et incarnatus*.

The solo vocalists are unusually well matched, and meet, with no audible effort, the exacting demands of phrasing and *testitura* imposed by Beethoven. The Vienna Singverein is altogether superb, and the Berlin Philharmonic—particularly solo violinist Michel Schwalbé in the *Benedictus*—is in top form. The DGG recording is eminently satisfactory on the whole, if rather unusually spread out in depth and breadth.

As I have noted with respect to some of Karajan's other recorded performances, the Austrian maestro seems at his best in large-scale choral and operatic works such as this, which emerge without the annoying over-refinements of phrasing that have marred some of his purely orchestral recordings. If Leonard Bernstein's treatment of the *Missa Solemnis* is too high-voltage for your taste, this tape by Karajan represents a fine alternative with first-rate sonics. D. H.

RECORDING OF SPECIAL MERIT

⑤ **IVES:** *Symphony No. 2 (1897-1902); The Fourth of July (1913)*. New York

Explanation of symbols:

- ⑤ = stereophonic recording
- Ⓜ = monophonic recording

Philharmonic, Leonard Bernstein cond.; Seymour Lipkin, asst. cond. (Also included is a discussion of Charles Ives by Leonard Bernstein.) COLUMBIA MQ 857 \$7.95.

Performance: Handsome
Recording: A-1
Stereo Quality: Wonderfully effective
Speed and Playing Time: 7½ ips; 55'17"

With this release, all four symphonies of Charles Ives, the prophet-patriarch of American music, are available on four-track tape. The sprawling yet curiously moving Second Symphony gets a broadly expansive perfor-



JOAN SUTHERLAND AND MARILYN HORNE
As Semiramide and Arsace in Rossini's opera
mance: Leonard Bernstein clearly revels in the rich organ-like sonorities written into the slow sections, and indeed, the lyrical emphasis here makes the "barbaric yawp" of the last movement that much more of a shocker. Some of the popular and patriotic musical materials heard in the Second Symphony also turn up in *The Fourth of July*, the rhythmic complexities of which demand the services of a second conductor (Seymour Lipkin here) for most effective results.

The subtle inner-voice lines of the Second Symphony and the dense texture and conflicting rhythms of *The Fourth of July* are brilliantly set forth by Bernstein and Columbia's recording engineers. The results, to my ears, are clearer on tape than on the corresponding disc. Bernstein's talk on Ives is a welcome and illuminating bonus, and will increase the value of this tape for those who have yet to sample the Ivesian tonal fabric in all its vitality, complexity, and richness of substance. D. H.

RECORDING OF SPECIAL MERIT

⑤ **ROSSINI:** *Semiramide*. Joan Sutherland (soprano), *Semiramide*; Marilyn Horne (mezzo-soprano), *Arsace*; Joseph Rouleau (bass), *Assur*; John Serge (tenor), *Idreno*; Spiro Malas (bass), *Oroe*; Michael Langdon (bass), *Ghost of Nino*; other soloists: Ambrosian Opera Chorus; London Symphony Orchestra, Richard Bonyngue cond. AMPEX LONDON LOR 90123 two reels \$21.95.

Performance: Sutherland's and Horne's show
Recording: Superior
Stereo Quality: First-class
Speed and Playing Time: 7½ ips; 168'27"

Having read a number of reviews of the disc version of this recording, not many of them thoroughly favorable, I rather expected to listen to this tape of *Semiramide* (heavily cut, perhaps advisedly) with something less than total pleasure. It is true, of course, that among the male singers there are some less-than-ideal voices: tenor John Serge gets around the notes very well, but his is not a very attractively produced sound, and of the basses only Spiro Malas makes a satisfactory impression. But when the two leading ladies get going, either in their separate arias or together in duets, one listens with rapt astonishment. Bonyngue does not convey the excitement of a Toscanini, perhaps, but this performance still has much to recommend it. At any rate, I found myself enjoying it thoroughly. The sonic reproduction on tape is full and brilliant. There is a slight tape hiss, but altogether this is sonically a closer match for the disc version than I have heard on tapes over the last year or so. Ampex has always been very good about including librettos with their tape boxes; with this release, for the first time, to my knowledge, they have resorted to the system of including a postcard, not even self-addressed or stamped, requiring the purchaser to obtain the libretto by mail. I. K.

RECORDING OF SPECIAL MERIT

⑤ **SHOSTAKOVICH:** *The Execution of Stepan Razin, Op. 119; Symphony No. 9, in E-flat Major, Op. 70*. Vitaly Gromadsky (bass); RSFSR Russian Chorus; Moscow Philharmonic Symphony Orchestra, Kiril Kondrashin cond. MELODIYA/ANGEL ZS 40000 \$7.98.

Performance: Virile
Recording: Excellent
Stereo Quality: Superior
Speed and Playing Time: 7½ ips; 51'54"

Shostakovich's score *The Execution of Stepan Razin* (1964), based on a poem by Yevgeny

who put the
HIGH in
HI-FI?

FINCO
that's who!

with a FINCO high performance FM Antenna and FM Booster

FINCO
Model
65-7
FM BOOSTER



Increases signal strength. Delivers 20 DB Gain with low noise. Distortion negligible at all frequencies and power levels. Easy indoor key-hole mounting. Factory warranty. \$24.95 list

For additional information write:

THE FINNEY COMPANY

34 WEST INTERSTATE • DEPT. HD
BEDFORD, OHIO 44146

THE WORLD'S MOST COMPLETE LINE
OF FM ANTENNAS AND ACCESSORIES

CIRCLE NO. 25 ON READER SERVICE CARD

We Own The
Sharpest Pencils
In Town!

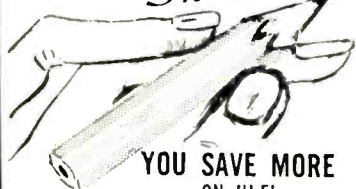

YOU SAVE MORE
ON HI-FI

COMPONENTS & TAPE RECORDERS

- We invite your test of our "We Will Not Be Undersold Policy."
 - 15-day money-back guarantee.
 - 2-yr. unconditional guarantee parts & labor no charge, at local warranty station, factory or our service dept.
 - Trade-ins—highest allow. Send your list.
 - Most items shipped promptly from our 250,000 inventory, fully insured.
 - Our specialty—APO & Export.
 - 21st yr. dependable service world wide.
- RATED #1 SERVICE—SATISFACTION
ACCORDING TO NATION WIDE SURVEY.

Easy-Pay-Plan—Up to 24 mos. to pay.
Write for our price First!

HI-FIDELITY

CENTER

"The House of Low Low Prices"

239-A East 149th St.,
New York, N.Y. 10451

CIRCLE NO. 29 ON READER SERVICE CARD

Yevtushenko, starts off by sounding a little like updated Moussorgsky, but winds up with an impact that seems more than the sum of its musical contents. The seventeenth-century Cossack brigand is presented as an anti-Tsarist revolutionary, a concept that must have obvious appeal for Soviet ideologists. The music, full of insistent hammerings, has a strange fascination, and the performance is extremely effective. The Ninth Symphony, composed in 1945, is, in almost total contrast, light and witty, with a large share of Shostakovich's irony. Here again, the interpretation is excellent and sharply detailed. Certainly this is the most satisfactory recording of the symphony since Koussevitsky's 1946-47 album (recently reissued in mono form in the RCA Victor disc album VCM 6174). The present Russian-made recording has astonishingly good sonic reproduction; orchestral details come through with unusual clarity, brilliance, and presence. The tape version, in comparison with the disc, is slightly lacking in bass, but it also has a brighter-sounding top. Having complained for some time of Angel's practice of not including texts and translations with their tape packages, I must report with pleasure that a text leaflet (including transliteration and translation) is provided here. I hope this is a permanent change of policy. I. K.

COLLECTIONS

⑤ E. POWER BIGGS: *Holiday for Harpsichord*. Schubert: *Marche Militaire, Op. 51, No. 1*; *Moment Musicale, Op. 94, No. 3*. Mozart: *Rondo alla Turca*. Haydn: *Minuet from Symphony No. 104*. Beethoven: *Turkish March from "The Ruins of Athens"*; *Minuet in G Major*. Falla: *Ritual Fire Dance*. Chopin: *Polonaise in A Major, Op. 40, No. 1*; *Preludes in C Minor and A Major, Op. 28, Nos. 20 and 7*. Weber: *Country Dance*. Five other pieces. E. Power Biggs (pedal harpsichord). COLUMBIA MQ 804 \$7.95.

Performance: First-rate
Recording: Excellent
Stereo Quality: Good
Speed and Playing Time: 7½ ips; 39' 03"

If this particular collection of musical bromides is, as the release title would have it, a "holiday"—well, I'll just stay home. And while Biggs' program note suggests that much of it was done as a sort of camp, courtesy of harpsichord-maker John Challis, I do not find myself splitting my sides with laughter at a harpsichord rendition of Schubert's *Marche Militaire*, as Mr. Biggs' liner notes suggest that innumerable people have. Put briefly, I'm not strongly persuaded by concert-hall humor; if I want to laugh, I'll re-read Thurber, have another look at *All About Eve*, or simply think back on either Tallulah Bankhead's or Nancy Walker's revivals of Noel Coward's unforgettable *Private Lives*.

The playing, of course, is absolutely superb. And the recorded sound is excellent, the stereo effect suitable. W. F.

ENTERTAINMENT

⑤ COUNT BASIE: *Broadway Basie's Way*. Count Basie (piano); orchestra. *Hello Young Lovers*; *Mame*; *From This Moment On*; *People*; *A Lot of Livin' to Do*; *Just in Time*; *On a Clear Day (You Can See Forever)*;

and five others. COMMAND CMC 905 \$5.95.

Performance: Powerful but relaxed
Recording: Excellent
Stereo Quality: Very good
Speed and Playing Time: 7½ ips; 34' 52"

A jazz treatment of standards from Broadway shows, this set presents the Basie band—in arrangements by Chico O'Farrill—without gimmicks or intrusive ornamentation. The playing, in the Basie tradition, is straightforward and swinging, with space for such substantial soloists as trombonist Al Grey, tenor saxophonist Eddie Davis, and trumpeter Roy Eldridge. There are two rarities here: the presence of Eldridge, who was a Basie sideman for only a brief time, and of drummer Eddie Shaughnessy. The clarity and presence of the recording are even more satisfying on tape than they were on the Command disc. N. H.

MGM/VEIWE



JACKIE CAIN AND ROY KRAL
Hip, sunny, unbelievably brilliant

⑤ JUDY COLLINS: *In My Life*. Judy Collins (vocals); orchestra, Joshua Rifkin cond. and arr. *Hard Lovin' Loser*; *Pirate Jenny*; *In My Life*; *Sunny Goodge Street*; and seven others. ELEKTRA EKC 7320 \$6.95.

Performance: Cerebral
Recording: Good
Stereo Quality: Good
Speed and Playing Time: 7½ ips; 44'10"

On the cover of this tape box there is a smashing picture of Judy Collins sitting in a surreal garden wearing a long dress and cowboy boots; in it she looks astonishingly like Vanessa Redgrave. On the tape itself, she offers a program that sounds like an updated version of a concert that might have been given by Mother Bloor for a WPA Arts Committee down at the old Union Hall about 1933. Miss Collins, judging by her selection of material, would appear to be as doggedly "liberal" as she is desperately "involved" in "awareness" of herself as an "active member" of a "society in which we all have to struggle to keep our identity but not lose sight of our group goals." The phrases quoted above are interchangeable and, arranged in any order and dropped at will into any conversation, will insure you the attention of any number of attractive young women going through their "socially conscious" phase. Or even better, if you really want to make an impression, give one

of the attractive girls this tape. Her reaction should run something like this:

"Oh, God! You've got to come over some night and listen to it with me. It's devastating! She sings some of those songs from *Marat/Sade*. It's chilling! I saw *Marat/Sade* three times, and it wasn't until the third time that I got the full impact! And she sings two songs by that brilliant Canadian poet-novelist Leonard Cohen! And one by Dick Fariña—you know, the one that got killed on a cycle just before his first novel came out? And she sings *La Colombe* by Brel! What do you mean Brel who? Jacques Brel. I think Judy Collins is marvelous! The way she sings *Pirate Jenny*—that song from *The Threepenny Opera*, you know? Sometimes I think that there is a lot of me in that song. Well . . . oh God! Let's not go into that! Look, I never realized when we met at that awful party with all those old types that you were interested in so many of the important things. Some friends of mine and I are going to an electronic happening tonight and maybe you might like to come along? After that we could come back here and we could listen to the tape together and I could point out some of the really significant things that are in these songs. . . ."

The arrangements here are fine throughout, but someday I'd like to hear Miss Collins sing songs less frightfully fraught with meaning. P. R.

RECORDING OF SPECIAL MERIT

⑤ JACKIE AND ROY: *Changes*. Jackie Cain and Roy Kral (vocals); orchestra, Claus Ogerman, Oliver Nelson, and Charles Calello arrs. *Dedicated to Love; Yesterday; In My Life; Counting; Norwegian Wood; Bye Bye; Changes; The Word*; and three others. VERVE VSTX 368 \$5.95.

Performance: Sensational

Recording: Superb

Stereo Quality: Superb

Speed and Playing Time: 3¾ ips; 29'41"

One icy day last winter, I received an advance copy of a new record album by Jackie Cain and Roy Kral called "Changes," and when I played it I almost could not believe my ears. For longer than I care to remember they have been two of the hippest, sunniest, most unbelievably brilliant musicians America has produced—the two people in jazz who could do anything. Long before the Swingle Singers, the Hi-Los, and Lambert, Hendricks, and Ross, when Jackie Cain was a beautiful young daisy-blonde still in bobby sox, she and Roy were integrating vocal sounds with jazz scored for instruments. Since then, they have sung salutes to classical composer Darius Milhaud (accompanied by a tuba player from the St. Louis Symphony), Miles Davis trumpet solos in fractious big-band arrangements, and everything in between. And I have heard them praised by everyone from Alec Wilder and Richard Rodgers, who flipped when he heard their arrangement of *Mountain Greenery*, to John Sebastian of the Lovin' Spoonful. In Las Vegas, they are the favorite after-hours musicians of such people as Stan Kenton, Frank Sinatra, and Julie London, and once, when they tried to close an engagement that had already been held over six months, Jerry Lewis offered to pay them out of his own pocket to stay.

I tell you all this only because you'll never

Don't fiddle while you roam.

The KODAK INSTAMATIC 804 Camera lets you pay attention to the sights you're seeing instead of the camera. Drop in the film cartridge. Then wind the spring motor—and the film will advance automatically after each shot.

Your 804 adjusts itself for the speed of the film; makes the correct outdoor exposure setting for each picture; warns you when to use flash; switches to flash speed as you load on a flashcube; tells you whether flash is ready; adjusts for flash exposure as you focus; and turns the cube for the next flash. All automatically. The lens is a sharp, fast *f*/2.8, the viewing bright, the range-finding accurate.

See how good the world looks when you have total automation and Kodak dependability going for you. The KODAK INSTAMATIC 804 Camera is less than \$130 at your Kodak dealer's. Price subject to change without notice.

Kodak Instamatic® 804 Camera

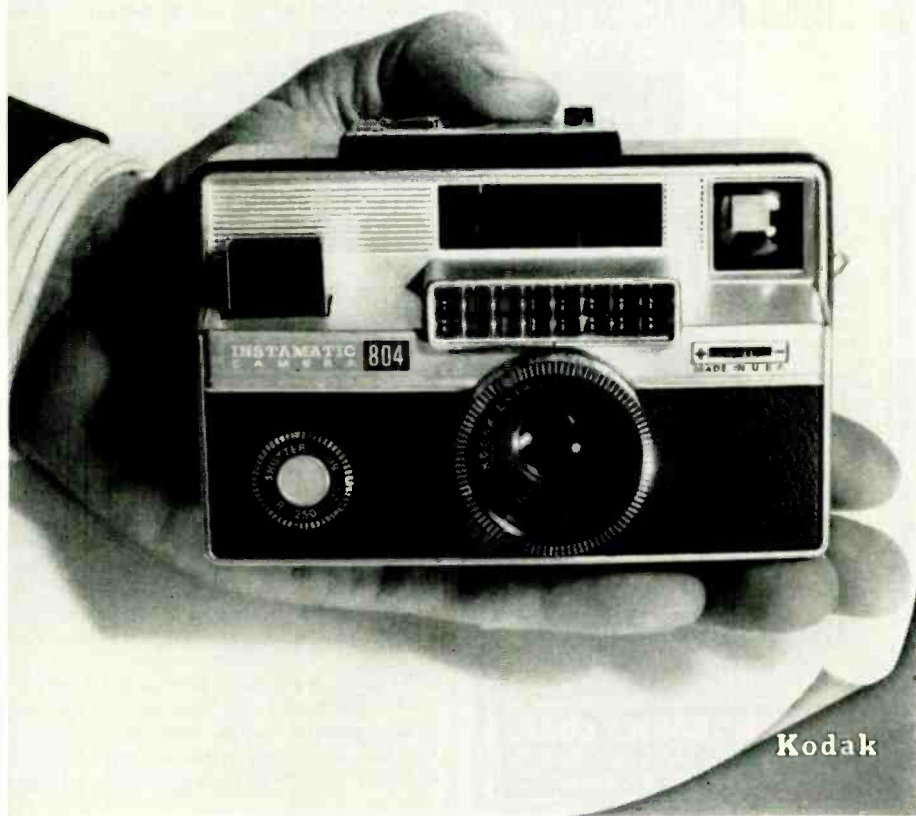

Kodak

HI-FI COMPONENTS TAPE RECORDERS

TAPES, ACCESSORIES
SLEEP LEARN KITS
MERITAPE

SAVE MONEY

- LOWEST PRICES
- INTEGRITY • SERVICE
- FRANCHISED DISTRIBUTORS

WRITE FOR OUR VERY LOW PACKAGE QUOTATIONS
Nationally Advertised Brands
Factory Sealed Cartons

Write for **FREE CATALOG**
Visit Our Showrooms

DRESSNER

1523 G JERICO TPKE.
NEW HYDE PARK, N.Y.
11040

CIRCLE NO. 17 ON READER SERVICE CARD

DEFA ELECTRONICS

STEREO PACKAGE SPECIAL

BOGEN RT 7000 SOLID STATE 65 WATT
ALL TRANSISTOR STEREO RECEIVER

Headphone Jack on Front Panel. Meter, Tape Monitor, automatic stereo switching with the "Stereo-Minder" signal light.



List \$279.95
2 AR 4X SPEAKER SYSTEMS

Acoustic suspension woofer for smoothness & quality. Dispersion cone tweeter gives unmatched power response & dispersion. Finish: oiled walnut cabinetry with grille fabric.
5 Year Guarantee



List \$57.00 ea.
GARRARD NEW 60 MK II
4 SPEED AUTOMATIC
TURNTABLE

Many new features incl: Manual cueing & pause device.
PLUS: SHURE M55E Cartridge with bi-radical elliptical stylus. Fine sound reproduction.



List \$74.50
Base 4.50

YOU SAVE \$158.95 on the Full Package
TOTAL LIST \$508.45
List \$355.50
\$349.50

1 Year Warranty on Components
Please Write For Other Packages

STEREO SYSTEMS—COMPONENTS AT LOW DISCOUNT PRICES

Send For Our Quote Today!
We Carry All the Famous Brands.

DEFA ELECTRONICS CORP.
2207 Broadway, N.Y., N.Y. 10024
PHONE 874-0900 & 874-0901

CIRCLE NO. 15 ON READER SERVICE CARD
102

hear it from Jackie and Roy. They do not blow their own horn or hire press agents. They sing because they love what they do. And what they do has always been ahead of its time.

And now we have "Changes," which shows Jackie and Roy's maturity and keen awareness of the current trends in music and the world around them. There has always been excitement and swing in their work, but here they even interpret the NOW stuff and manage to make it sound humorously gay, with crisp, floating beats and electrifying two-voice counterpoints. They communicate emotionally in such an incredible way that the Beatles' *Norwegian Wood* sounds like a composition for symphony orchestra. Jackie's impeccable solo on *Yesterday* is the grooviest, most soul-stirring vocal I've heard on this song, and I even got involved with John Sebastian's absurd *Can't Buy Me Love*, which has a raunchy rock beat that sounds like a revival meeting and a jam session at the same time. None of the songs are really monumental, yet Jackie and Roy do breath-taking things with all of them.

Jackie and Roy are ahead of their time, but what a wonderful thing to be, considering the time they're in. On this tape they have added the spice, the herbs, and the occasional mushroom to the tasteless brew that passes for NOW music, and they prove that with all our *Kitsch* there's plenty of art around too. You just have to know where to look for it.

R. R.

RECORDING OF SPECIAL MERIT

© MIRIAM MAKEBA: *All About Miriam*. Miriam Makeba (vocals); Harold Dodson (bass); Leopoldo Flemming (drums); Sivuca (guitar). *Ballad of the Sad Young Men*; *Click Song*; *Four-Letter Words*; *Más que nada*; *Mommy, What Is Heaven Like?*; *The Sound of a Drum*; *U Shaka*; *I Think I Ought*; *Yelentu Tizaleny*; *Maria Filo*; and two others. MERCURY STC 61095 \$5.95.

Performance: Stirring
Recording: Superb
Stereo Quality: Superb
Speed and Playing Time: 7 1/2 ips; 34'16"

Every single band on this tape is a knockout. Though I don't think it is Miriam Makeba's greatest collection (she'll have to go a long way to beat "The Magic of Makeba," the last album under her old RCA Victor contract), the whole thing seems happily relaxed. I'm glad to see that she drew upon her marvelous way with American jazz ballads. All the distinctive South African clicking sounds that made her reputation are heard here, but the real marvel is the way she does Tommy Wolf's *Ballad of the Sad Young Men*, which is fast becoming one of the jazz classics of American music. Listening to her bluesy, no-holds-barred voice let go on this mournful and depressing song gave me the same kind of chill I felt when I first heard Ethel Waters sing *Supper Time*. It would be hard to find a more sympathetic rhythm section than the one that backs her up here.

Makeba's voice is by now overly familiar. I wish she would sing more and cut out the tongue-on-palate tricks. Still, in everything she does she shows enormous responsibility to her art. This tape is a valuable experience.

R. R.

PERMANENT PROTECTION!



HiFi/Stereo Review

Deluxe Magazine Files that hold a full year's copies!

Designed to keep your periodicals orderly and easy to refer to. These durable files guard against soiling, tearing, wear or misplacement of issues. They look, feel like leather and are washable! 23kt. gold lettering and exquisite 2-color binding make them highly-decorative additions to your bookshelves.

Shipped POSTPAID! FULLY GUARANTEED!
Only \$3.50 each—3 for \$10, 6 for \$19

Order several today—for HIFI/STEREO REVIEW and all your other favorite magazines.

Jesse Jones Box Corp., Dept. HF

Box 5120
Philadelphia 41, Pa.

Please send me:

TITLE	QTY.	BLACK BACKING/MAROON SIDES	MAROON BACKING/BLACK SIDES
HiFi/Stereo Review	_____	<input type="checkbox"/>	<input type="checkbox"/>
_____	_____	<input type="checkbox"/>	<input type="checkbox"/>

(Other publications shipped in colors available.)

Total amount enclosed \$ _____

name _____

address _____

city _____ state _____ zip-code _____

(Payment Must Accompany Order)

HiFi/Stereo Review SUBSCRIBER SERVICE

Please include an address label when writing about your subscription to help us serve you promptly. Write to: Portland Place, Boulder, Colo. 80302

CHANGE OF ADDRESS:

Please let us know you are moving at least four to six weeks in advance. Affix magazine address label in space to the right and print new address below. If you have a question about your subscription, attach address label to your letter.

TO SUBSCRIBE:

Check boxes below.

- New Renewal
 5 years \$21
 3 years \$15
 1 year \$6

SPECIFY:

- Payment enclosed—
You get 1 extra issue per year as a BONUS!
 Bill me later.

← AFFIX LABEL →

state | city | address | name | If you have no label handy, print OLD address here. | zip-code

Add 1 postage: \$1 per year outside U.S., its possessions & Canada.

0339

name _____ please print

address _____

city _____

state _____ zip-code _____

HIFI/STEREO REVIEW



TAPE HORIZONS

By DRUMMOND McINNIS

TAPES FOR TROOPS

I don't know offhand what military uses there are for tape recorders, but they seem to be extremely important in the leisure-time activities of our servicemen. Judging from the many letters the editors of *HiFi/STEREO REVIEW* receive from soldiers in Vietnam, their two principal uses for the recorder are (predictably) listening to music and corresponding with their families on tape.

Although I am an old hand at corresponding on tape, I have never been more impressed with the effectiveness of this medium than when I heard a tape letter from a soldier in Vietnam to his parents. It was played on a radio station that I happened to tune in by chance, and I have not been able to get it out of my mind. On the night before a planned attempt to capture a hill from which enemy forces had been shelling his unit, the young man obviously felt an urge that must be common to all soldiers who know that they will soon be going on a dangerous assignment—he wanted to send a few words to those he loved. But instead of taking pen in hand, as those of an only slightly older generation would have done, he turned to his tape recorder. There was nothing maudlin on the tape, but the effect of a young soldier's voiced message to his family against the background of shells exploding around him was chilling.

While there seems to be a good bit of this kind of "tapespondence" between the men in Vietnam and home, members of the Indiana Recording Club decided there could be more, and with the praiseworthy community spirit for which this organization is noted they formed what they call a Bridge from Home. Members of the IRC volunteered to record voice letters for local servicemen's families who did not have tape recorders. Newspapers and radio and television stations in several Indiana cities gave the project good coverage, which put the club in touch with a number of families who wished to send tape letters to sons, husbands, or fathers in the war zone. A similarly praiseworthy gesture was made early this year by Charles D. Tandy, president of the Radio Shack chain of electronics stores: he invited the entire public to cooperate in keeping G. I. morale high by sending taped messages. A voice letter to any serviceman in Vietnam can be recorded free at any of Radio Shack's more than 150 retail stores; Radio Shack contributes the tape, the use of a recorder, and even postage.

For those who do not know a serviceman in Vietnam but would like to participate in providing recreation for the men, there is the Tapes for Troops program. Many individuals, tape clubs, church groups, and professional societies send tapes of general interest to Vietnam (via Tapes for Troops, Headquarters 1st Logistical Command Special Services, APO San Francisco 96307). Here variety of material is stressed—comedy, music, excerpts from radio and TV shows, and so forth—because the tapes are passed from unit to unit, and the soldiers have the same variety of tastes that the rest of us do. According to Major M. L. Whiting, a special services officer in Vietnam, one of the principal benefits of the program is that it lets the men there know they have not been forgotten. He adds that stereo equipment is available in most units, but mono tapes are also welcome.

NOW, get even lower price quotes from Connecticut's MR. DISCOUNT

SAVE \$ ON HI-FI EQUIPMENT AND everything else:



- Accessories
- Antennas
- Car Tape Players
- P.A. equipment
- Phonographs
- Radios
- Rotors
- Test equipment
- TV's
- Walkie-Talkies

- FRANCHISED DISTRIBUTOR
- FACTORY SEALED CARTONS
- SAVE MORE ON PACKAGE DEALS

F.E.I.

One of the largest electronic centers in the Northeast. OUR 21st YEAR

565 Long Hill Rd. U.S. Rt. 1
Groton, Connecticut

*Member Chamber of Commerce

CIRCLE NO. 23 ON READER SERVICE CARD

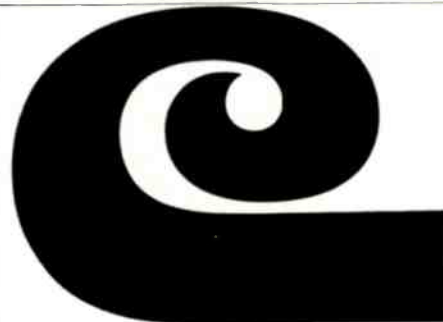

CELANESE

Acetate

When you think high fidelity, think acetate. No other film base has taken the place of acetate for fidelity of reproduction... resistance to stretch... freedom from print through. With all these advantages, acetate based tapes cost less.

Celanese does not manufacture recording tape. It produces and supplies acetate film for this purpose to leading tape manufacturers.



CELANESE

CELANESE PLASTICS COMPANY

CIRCLE NO. 10 ON READER SERVICE CARD

HI-FI/STEREO REVIEW CLASSIFIED

COMMERCIAL RATE: For firms or individuals offering commercial products or services. 75¢ per word (including name and address). Minimum order \$7.50. Payment must accompany copy except when ads are placed by accredited advertising agencies. Frequency discount: 5% for 6 months; 10% for 12 months paid in advance.

READER RATE: For individuals with a personal item to buy or sell. 45¢ per word (including name and address). **No minimum! Payment must accompany copy.**

GENERAL INFORMATION: First word in all ads set in bold caps at no extra charge. Additional words may be set in bold caps at 10¢ extra per word. All copy subject to publisher's approval. **Closing Date:** 1st of the 2nd preceding month (for example, March issue closes January 1st). Send order and remittance to: Hal Cymes, **HIFI/STEREO REVIEW**, One Park Avenue, New York, New York 10016.

EQUIPMENT

WRITE for quotation on any Hi Fi components: Sound Reproduction Inc., 34 New St., Newark, N.J. 07102. Mitchell 2-6816.

KIT Experts—Dynaco Specialists—Kits at reasonable prices are our specialty. Also custom wired kits guaranteed to exceed factory standards at substantial savings. Beautiful handcrafted Walnut cases for complete Dynaco line, plus everything in audio. Kitcraft, Dept. HS767, 738 Washington Avenue, Brooklyn, N.Y. 11238. MA-2-5230.

HI-FI Components Tape Recorders, at guaranteed "We Will Not Be Undersold" prices. 15-day money-back guarantee. Two-year warranty. No Catalog. Quotations Free. Hi-Fidelity Center, 239 (HC) East 149th St., New York 10451.

FREE! Send for money saving stereo catalog #H7R and lowest quotations on your individual component, tape recorder, or system requirements. Electronic Values, Inc., 200 West 20th St., N.Y., N.Y. 10011.

FREE Catalog Electronic parts, tubes. Wholesale. Thousands of items. Unbeatable prices. Arcturus Electronics ZD, 502-22 St., Union City, N.J. 07087.

TAPE recorders. Hi-Fi components. Sleep Learning Equipment tapes. Unusual values. Free catalog. Dressner, 1523R Jericho Turnpike, New Hyde Park, N. Y. 11040.

LONDON CALLING AMERICA! BUY BRITISH HI-FI EQUIPMENT DIRECT FROM THE U.K. HI-FI MAIL ORDER SPECIALISTS AND SAVE UP TO 40%. FREE PRICE LIST AVAILABLE OR MAIL \$1.00 BILL FOR FULLY ILLUSTRATED CATALOG. (\$2.00 AIR POST.) C. C. GOODWIN (SALES) LTD., 7, THE BROADWAY, WOOD GREEN, LONDON, N.22, ENGLAND.

LOW, Low quotes: all components and recorders. HiFi, Roslyn, Penna. 19001.

GOVERNMENT Surplus Receivers, Transmitters, Snooperscopes, Radios, Parts, Picture Catalog 25¢. Meshna, Nahant, Mass. 01908.

SUDYMONT acoustic baffles. Plans \$5.95; Baffle \$26.95; with cabinet for \$39.95. Send speaker size. **SUDYMONT**, 120 Liberty Str., New York City 10006.

EVERYONE can afford **HIGH FIDELITY** components—because of our **DISCOUNT** policy. Insured guaranteed. Send for our **LOW-LOW** quote today. Sound and Sight Audio, Inc. 106 West 32 Street, New York, N.Y. 10001.

DON'T THROW YOUR OLD CARTRIDGE AWAY. Send us \$19.95 and any old cartridge. We will ship **PREPAID** any one of the following top rated elliptical diamond stereo cartridges **NEW:** Pickering V15AME3, Empire 888SE, Shure M55E, Stanton 500E, Shure M80ED (for Lab 80), M80-ED19 (for Dual 1019). **DEFA ELECTRONICS**, 2207 Broadway, New York, N. Y. 10024.

DYNAKIT, ACOUSTIC RESEARCH AND OTHER NAME brand stereo components at 10% over dealer's cost! Interested? Send 10¢ for details to Stereo Club of America. PO Box 2474, Milwaukee, Wisconsin 53214.

RECEIVING & INDUSTRIAL TUBES, TRANSISTORS, All Brands—Biggest Discounts. Technicians, Hobbyists, Experimenters—Request **FREE** Giant Catalog and **SAVE!** **ZALYTRON**, 469 Jericho Turnpike, Mineola, N.Y. 11501.

HI-FI Equipment at largest discount. Catalog. Macalester Corporation, 355 Macalester, Saint Paul, Minnesota 55105.

SEND us \$9.95 and any old cartridge. We will ship you prepaid any one of these cartridges **New—Shure M3D**, Empire 880P, ADC 770, Pickering V15AC2, Empire 808, Pickering V15AT2, Shure M7/N21D, Grado BTR. Write for lowest quotations all stereo components, Defa Electronics, 2207 Broadway, N.Y., N.Y. 10024.

ADC Point 4-E cartridge \$12, Shure M33-5 \$8, M3-21D \$5. Steelman Transistape recorder \$25, Phonotrix 88 with case \$15. Sharp HA-10 headphones \$10, HA-8 \$5. Jack Atkins, 1375 27th, Ogden, Utah 84403.

THE Price Is Right! Hi-Fi Components. J. Wright Co., 65-B Jensen St., East Brunswick, N.J. 08816.

NOW AVAILABLE JAPAN'S FINEST AUDIO EQUIPMENT—Turntables: TEIC (Magnefloat). **KS, NEAT.** Tonearms: Grace, Fidelity Research. Audio Technica, NEAT. Record Players: NEAT, KS, CORAL, CEC. Cartridges: Satin, NEAT, Micro Seiki, Fidelity Research. Amplifiers, Tuners: Lux, CORAL. Receivers: Chryslers, Eroica, Tokai. Speakers: CORAL, Chrysler, Lux, Sonics. Dealer Inquiries invited, direct from importer to you. We can secure special items on request, advise make and model number. Audio Imports, 1415 North Lilac Drive, Minneapolis, Minnesota 55422.

FOR SALE

VIOLIN MAKERS SUPPLIES, Catalog 10¢—Artlar, Box 25, Torrance, Calif. 90507.

ELECTRONIC Bargains—Diodes. Transistors, Tubes, Courses. Free Catalog—Immediate Shipment. Cornell, 4215-H University, San Diego, Calif. 92105.

TELEPHONE RECORDER-ACTUATOR (TWI-007). **SOLID STATE MODULE AUTOMATICALLY TURNS TAPE RECORDER, AMPLIFIER, INDICATOR LIGHT ON WHEN TELEPHONE IN USE. CONNECTED ANYWHERE ON LINE. SIMPLE INSTALLATION INSTRUCTIONS INCLUDED. PREPAID \$22.85. SURVEILLANCE RECORDERS: (TWI-1000), (TWI-1010). TWILIGHT ELECTRONICS, BOX 11595-H, ST. LOUIS, MISSOURI 63105.**

JAPAN & Hong Kong Electronics Directory. Products, components, supplies. 50 firms—just \$1.00. Ippano Kaisha Ltd., Box 6266, Spokane, Washington 99207.

JAPANESE PRODUCTS CATALOG by air mail \$5, sea \$3. Intercontinental, CPO 1717, Tokyo, Japan.

POLICE RADIO. Hear all police calls, fire departments, Sheriffs, taxis, ambulances, Highway Patrol. New 5 band portable radio and direction finder. Free booklet. NovaTech, Dept. 204, Redondo Beach, Calif. 90278.

EICO RP100 Tape Deck. Year old. Perfect condition. With carrying case, \$250. Pickett, 117 Hackberry Avenue, Houma, Louisiana 70360.

ALUMINUM Soldering Handbook—solder aluminum with regular 50/50 wire solder, no special fluxes. Complete step by step instructions. Handbook \$1.00. Non-ferrous Metals, Box 1024, Project City, Calif. 96079.

MESHNA'S TRANSISTORIZED CONVERTER KIT. Converts car radio to receive police and fire. 30-50 MHz and 100-200 MHz (one MHz Tuning). \$5.00 with easy to follow step instructions. Meshna, No. Reading, Mass. 01864.

PHOTOGRAPHY—FILM EQUIPMENT, SERVICES

SCIENCE Bargains—Request Free Giant Catalog "CJ"—148 pages—Astronomical Telescopes, Microscopes, Licenses, Binoculars, Kits, Parts, War surplus bargains. Edmund Scientific Co., Barrington, New Jersey 08007.

MEDICAL FILM—Adults only—"Childbirth" one reel, 8mm \$7.50, 16mm \$14.95. International H, Greenvale, Long Island, New York 11548.

WALL MURALS from your 35mm Black and White negatives 40x60" \$20.00, 60x90" \$40.00. **ENDACOM**, Box 342, East Hartford, Conn. 06108.

HYPNOTISM

FREE Hypnotism, Self-Hypnosis, Sleep Learning Catalog! Drawer H400, Ruidoso, New Mexico 88345.

CLASSIFIED ADVERTISING ORDER FORM

Please refer to heading on first page of this section for complete data concerning terms, frequency discounts, closing dates, etc.

1	2	3	4	5
6	7	8	9	10
11	12	13	14	15
16	17	18	19	20
21	22	23	24	25
26	27	28	29	30
31	32	33	34	35

Words { @ \$.45 Reader Rate }
 { @ .75 Commercial Rate } = \$ _____

Insert _____ time(s) Total Enclosed \$ _____

NAME _____

ADDRESS _____

CITY _____ STATE _____ ZIP _____

SIGNATURE _____

WORD COUNT: Include name and address. Name of city (Des Moines) or of state (New York) counts as one word each. Zone or Zip Code numbers not counted. (Publisher reserves right to omit Zip Code if space does not permit.) Count each abbreviation, initial, single figure or group of figures or letters as a word. Symbols such as 35mm, COD, PO, AC, etc., count as one word. Hyphenated words count as two words. HF-767

MUSICAL INSTRUMENTS

RECORDERS (Flutes), Gambas, Lutes, Catalog—Artlar, Box 25, Torrance, Calif. 90507.

TAPE AND RECORDERS

RENT Stereo Tapes—over 2,500 different—all major labels—free brochure. Stereo Parti, 1616-G Terrace Way, Santa Rosa, California 95404.

BEFORE RENTING Stereo Tapes try us. Postpaid both ways—no deposit—immediate delivery. Quality—Dependability—Service—Satisfaction—prevail here. If you've been dissatisfied in the past, your initial order will prove this is no idle boast. Free catalog. Gold Coast Tape Library, Box 2262, Palm Village Station, Hialeah, Fla. 33012.

RENT 4-TRACK STEREO TAPES—Dependable service our keynote—**ALL MAJOR LABELS—FREE CATALOG** (48 States)—**TRIMOR** Company, P.O. Box 748, Flushing, N.Y. 11352.

STEREO TAPES. Save up to 60% (no membership fees, postpaid anywhere USA). Free 60-page catalog. We discount batteries, recorders, tape accessories. Beware of slogans "not undersold," as the discount information you supply our competitor is usually reported to the factory. **SAXITONE**, 1776 Columbia Road, Washington, D.C. 20009.

TAPE RECORDER SALE. Brand new, nationally advertised brands, \$10.00 above cost. Arkay Sales Company, 1028-A Commonwealth Avenue, Boston, Mass. 02215.

TAPES. Recorders. Stereo Tapes. Catalog—5¢ stamp. Tower, Lafayette Hill, Pa. 19444.

HI-FI Components Tape Recorders, at guaranteed "We Will Not Be Undersold" prices. 15-day money-back guarantee. Two-year warranty. No Catalog. Quotations Free. Hi-Fidelity Center, 239 (HT) East 149th St., New York 10451.

SCOTCH RECORDING TAPE, highest quality, lowest prices. **TAPE CENTER**, 398 National Press Bldg., Wash., D.C. 20004.

RENT STEREO-8 CAR TAPES. 10¢/day. Send refundable \$10.00 deposit and name of first selection. Autotapes, Box 19086-A, Indianapolis, Ind. 46219.

RENT STEREO TAPES—75¢ week. Catalog. Art's, 1442 Blaze, Simi, Calif.

TAPE RECORDERS direct from importer. Three motor, six head, automatic reverse. Famous make. Also battery with A.G.C. All solid state. Write for special prices, duty paid. American Dokorder HF2, Box 2494, Culver City, California 90230.

TWO Track Stereo prerecorded tapes original tapes in original boxes. James Lehman, 741 Belmeade, Corpus Christi, Texas 78411.

BLANK RECORDING CARTRIDGES: 4-Track—30 minutes, \$1.99; 60 minutes, \$3.50. 8-Track—30 minutes, \$1.65; 60 minutes, \$2.99. 30 minute cassette, \$1.55. **CARMASER**, 306 West 100th Street, New York City 10025.

RECORDS

PROTECT YOUR LPs: Heavy poly sleeves for jackets 5¢; poly lined paper sleeves for LPs 10¢; round bottom inner sleeves 3 1/2¢; Record jackets white 20¢, colors 25¢. Minimum order \$5.00. Record Supplies, Hillburn P. O., New York 10931.

RARE 78's. State Category. Write Record-Lists, P.O. Box 2122, Riverside, California 92506

"HARD TO Get" records—all speeds. Record Exchange, 812 Seventh Avenue, New York, N.Y. 10019.

CASH for your unwanted LPs. Reder, 81 Forshay Road, Monsey, New York 10952.

HARD to find collectors LPs. Like new, Lists 25¢. Records, Hillburn, New York 10931.

RENT STEREO RECORDS, \$1.00 three days. **FREE** offer—write **DISCO-TAPE**, P.O. Box 5202-HF, Sta. #4, North Hollywood, California 91604.

COLLECTORS JOURNAL—valuable data, varied record mart. Six issues—\$1.50. Record Research, 131 Hart, Brooklyn, N.Y. 11206.

PLASTIC lined inner sleeves, with identification window. White cardboard covers, 45 and 78 sleeves. Free details, samples 50¢. Cabco, Dept. 119, 89 East Woodruff, Columbus, Ohio 43201.

FREE CATALOGS Broadcasts, Sound Tracks of Thirties. ARG, 341 Cooper Station, New York City 10003.

WANTED

QUICKSILVER, Platinum, Silver, Gold. Ores Analyzed. Free Circular. Mercury Terminal, Norwood, Mass. 02062.

WANTED Sammy Kaye, Columbia LP, Dance Till Tomorrow. McCormack, 4544 Catina, Dallas, Texas 75229.

AUTHORS' SERVICES

AUTHORS! Learn how to have your book published, promoted, distributed. Free booklet "ZD," Vantage, 120 West 31 St., New York 10001.

SHORT STORY Criticism—Lowest rates, expert service. Send stamped envelope for information. Box 1313, Boulder, Colorado 80302.

POEMS WANTED for new song hits and recordings by America's most popular studio. Tin Pan Alley, 1650-ZD Broadway, New York 10019.

RUBBER STAMPS

RUBBER ADDRESS STAMP \$1.50. SIGNATURE \$2.88. FREE CATALOG. JACKSON PRODUCTS, 1433 WINNEMAC, CHICAGO, ILL. 60640.

REPAIRS AND SERVICES

ALL Makes of Hi-Fi Speakers Repaired. Amprite, 168 W. 23 St., N.Y.C. 10011. CH 3-4812.

BUSINESS OPPORTUNITIES

INVESTIGATE ACCIDENTS: Earn up to \$1,000 and more a month in your own business. Work spare time with average earnings of \$5 to \$8 per hour. No selling. Send for **FREE** booklet. No obligation. No salesman will call. Write: Universal Schools, CZ-7, 6801 Hillcrest, Dallas, Texas 75205.

I MADE \$40,000.00 Year by mailorder! Helped others make money! Start with \$10.00—Free Proof. Torrey, Box 318-N, Ypsilanti, Michigan 48197.

FREE BOOK "990 Successful, Little-Known Businesses." Work home! Plymouth-145G, Brooklyn, New York 11218.

MAKE up to \$10,000 a year raising chinchillas, mink, rabbits or guinea pigs for us. We supply breeding stock, equipment and feed. Send \$1.00 for catalog and complete information. Keeney Brothers Farms, Dept. ZE, New Freedom, Pa., 17349.

INSTRUCTION

LEARN Electronic Organ Servicing at home. All makes including transistors. Experimental kit—trouble-shooting. Accredited NHSC, Free Booklet. Niles Bryant School, 3631 Stockton, Dept. A, Sacramento, Calif. 95820.

ASSOCIATE Degree in Electronics Engineering earned through combination correspondence-classroom educational program. Free brochure. Grantham Technical Institute, 1505 N. Western Ave., Hollywood, California 90027.

HIGHLY Effective home study review for FCC Commercial Phone Exams. Free Literature. Cook's School of Electronics, P.O. Box 36185, Houston, Texas 77036.

REI First Class Radio Telephone License in (5) weeks Guaranteed. Tuition \$295.00. Job placement free. (KANSAS CITY) R.E.I., 3123 Gillham Road, Kansas City, Missouri, Telephone WE 1-5444. (SARASOTA) R.E.I., 1336 Main Street, Sarasota, Florida, Telephone 955-6922.

HIGHLY effective home study course in Electronics Engineering Mathematics with circuit applications. Earn your Associate in Science Degree. Free literature. Cook's Institute of Electronics Engineering, P.O. Box 36185, Houston, Texas 77036. (Established 1945).

TUBES

DON'T BUY TUBES—Radio, TV-Xmitting, special-purpose types until you get our price list! Lowest prices in U.S.A. 5,000 types—Guaranteed Brand New. Send postcard for TV—Special Purpose Price List. **UNITED RADIO COMPANY,** P.O. BOX 1000, NEWARK, N.J. 07101.

MOVIE FILMS

16mm SOUND-Projectors, Films, New, Used for Sale, Free Catalog. National Cinema, 333 W. 57 St., N.Y., N.Y. 10019.

EDUCATIONAL OPPORTUNITIES

LEARN While Asleep, hypnotize with your recorder, phonograph. Astonishing details, sensational catalog free! Sleep-Learning Association, Box 24-ZD, Olympia, Washington 98501.

LEARN WHILE ASLEEP. Miraculously build Mind Power, achieve Self Confidence, improve Health, gain Success. Method 92% effective. Details free. ASR Foundation, Box 7021EG Henry Clay Sta., Lexington, Kentucky 40502.

GOVERNMENT SURPLUS

JEEPS Typically From \$53.90 . . . Trucks From \$78.40 . . . Boats, Typewriters, Airplanes, Electronics Equipment, Photographic Equipment, used. 100,000 Bargains Direct From Government. Complete Sales Directory and Surplus Catalog \$1.00 (Deductible First \$10.00 Order). Surplus Service, Box 820-L, Holland, Michigan 49423.

EMPLOYMENT INFORMATION

FOREIGN and USA job opportunities available now. Construction, all trades. Earnings to \$2,000.00 monthly. Paid overtime, travel, bonuses. Write: Universal Employment, Woodbridge, Connecticut 06525.

FOREIGN EMPLOYMENT. Construction, other work projects. Good paying overseas jobs with extras, travel expenses. Write only: Foreign Service Bureau, Dept. D, Bradenton Beach, Florida 33510.

MISCELLANEOUS

WINEMAKERS: Free Illustrated catalog of yeasts, equipment. Semplex, Box 7208, Minneapolis, Minn. 55412.

SPARE TIME OPPORTUNITY—MONEY WE PAY \$10 hr. for NOTHING but your opinions, written from home about our clients' products and publications, sent you free. Nothing to buy, sell, canvass, or learn. **NO SKILL, NO GIMMICKS.** Just honesty. Details from **RESEARCH, ZD-5,** Box 669, Mineola, N.Y. 11501.

AS YOU SCAN THESE COLUMNS, more than 167,000 monthly buyers of HiFi/STEREO REVIEW are doing the same. These readers share with each other the satisfaction derived from active involvement in the enjoyment of recorded music. **HiFi/STEREO REVIEW** readers look to the pages of the **CLASSIFIED** each month for prime sources of products and services of interest to them—Components, Accessories, Tape, Records—everything they need to make their favorite special interest even better. Are they buying from you? They will, you know, if your classified advertising appears regularly in these columns. A handy order form is supplied for your use this month. To appear in the next available issue, September, on sale August 17th, forward copy and payment before July 1st closing deadline to: Hal Cymes, Classified Advertising Manager, HiFi/STEREO REVIEW, One Park Avenue, New York, N. Y. 10016.

EMPLOYMENT Resumes. Get a better job & earn more! Send only \$2.00 for expert, complete Resume Writing Instructions. J. Ross, 80-34 Kent St., Jamaica, N.Y. 11432. Dept. HF.

HI FI/STEREO REVIEW ADVERTISERS' INDEX

READER SERVICE NO.	ADVERTISER	PAGE NO.	READER SERVICE NO.	ADVERTISER	PAGE NO.
1	Acoustech, Inc.	85	31	Kenwood Electronics, Inc.	65
2	Acoustic Research, Inc.	34	32	KLH Research & Development Corp.	21
3	Altec Lansing Corporation	11			
4	Ampeg Corporation	24	33	Lafayette Radio Electronics	91
5	Audio Originals	75	7	Lear Siegler, Inc.	28
	Audio Unlimited	97		London Records	81
6	Benjamin Electronic Sound Corp.	85	34	Mace Records	83
7	Bogen Communications	28	35	Marantz, Inc.	30
103	British Industries—Garrard	2	37	Martel Electronics	78
8	BSR (USA) Ltd., McDonald Division	86	36	Matsushita Electric Corp. of America	2nd Cover
9	Carston Studios	94	30	Minneapolis-Honeywell	89
10	Celenese Plastics Company	103	38	McIntosh Laboratory Inc.	95
11	Citadel Record Club	5	39	Neshaminy Electronic Corp.	26
12	Columbia Records	69			
13	Columbia Stereo Tape Club	7	36	Panasonic	2nd Cover
14	Command Records	72	41	Pickering & Company, Inc.	3rd Cover
15	Defa Electronics Corp.	102	40	Pioneer Electronics Corp.	6
16	Deutsche Grammophon (DGG)	74	42	Rabsons—57th Street, Inc.	94
17	Dressner	102	43	Record Club of America	9
57	Dual	25	44	RCA Victor Records	66
18	Dynaco, Inc.	27	45	Rheem Roberts	10
20	Eastman Kodak Company	101	46	Sansui Electric Co., Ltd.	73
19	Electro-Voice, Inc.	4th Cover	100	Scott, Inc., H. H.	1
21	Elpa Marketing Industries Inc., ReVox Division	8	47	Sherwood Electronic Laboratories, Inc.	33
22	Empire Scientific Corp.	75	48	Shure Brothers, Inc.	19
23	F. E. I.	103	49	Sonotone Corporation	93
24	Finny Company, The	97	50	Sony Corp. of America	29
25	Finny Company, The	100	51	Sony Corp. of America (Radio & TV Div.)	13
26	Fisher Radio Corporation	14, 15	52	Sony/Superscope, Inc.	22
27	Fuji Photo Optical Products, Inc.	96	53	Sony/Superscope, Inc.	23
28	Heath Company	71	54	Sound Reproduction, Inc.	96
29	Hi-Fidelity Center	100	55	Teac Corporation	98
30	Honeywell Photographic Products	89	37	Uher by Martel	78
39	JansZen Loudspeakers	26	56	uniClub, Inc.	12
			57	United Audio	25
			58	Vanguard Records	79

Classified Advertising 104, 105

HI FI/STEREO REVIEW PRODUCT INDEX

As an additional reader service, we list below, by classifications, the products advertised in this issue. If there is a specific product you are shopping for, look for its listing and turn to the pages indicated for the advertisements of manufacturers supplying that equipment.

CLASSIFICATION	PAGE NUMBERS
Amplification Systems	29, 30, 85
Antennas, FM	97
Cabinets	75
Cameras	89, 96, 101
Cartridges	3rd Cover
Catalogs	91, 95
Microphones	93
Music Systems	1, 13
Receivers, Stereo	6, 33, 65, 71, 91, 4th Cover

CLASSIFICATION	PAGE NUMBERS
Records	66, 69, 72, 79, 81, 83
Record and Tape Clubs	5, 7, 9, 12
Speakers and Speaker Systems	11, 21, 26, 34, 75, 4th Cover
Tapes, Recording	103
Tape Recorders and Decks	2nd Cover, 8, 10, 22, 23, 24, 78, 91
Test Records	19
Tuners	15, 27, 30, 73
Turntables and Changers	2, 25, 28, 30, 85, 86



Dustamatic:

the cartridge that cleans the grooves while it plays.

The new Pickering V-15/3 Micro-Magnetic™ stereo cartridge proves that cleaner grooves combined with cleaner tracing result in cleaner sound. The built-in Dustamatic™ brush assembly automatically sweeps dust particles from the groove before the stylus gets there; and the new moving system reduces tracing distortion close to the theoretical minimum, thanks to Dynamic Coupling of the stylus tip to the groove. There are four “application engineered” Pickering V-15/3 Dustamatic models to match every possible installation, from conventional record changers to ultrasophisticated low-mass transcription arms. Prices from \$29.95 to \$44.95. For free literature complete with all details, write to Pickering & Co., Plainview, L.I., New York.

CIRCLE NO. 41 ON READER SERVICE CARD

For those who can **hear** the difference. **Pickering**

Electro-Voice[®]
Stereo
STARTER SET



*sets the
 pace in
 component
 home music
 systems*

E-V Nowhere is the soundness of the component approach to home music better demonstrated than with the new Electro-Voice Starter Set.

The unique value of this system lies—in large part—in the modestly-priced E-V ELEVEN speaker systems. These compact basic starter units offer a most pleasant appearance and surprisingly robust performance... conclusive proof that the advantages of component reproduction need not be expensive.

But the principal unit of the Starter Set is the E-V 1177* FM Stereo receiver... and rightly so. For the future of your stereo system rests on the ability

of this receiver to meet tomorrow's needs. Right from the start you enjoy FM stereo with remarkable clarity. Yet you can expand your musical horizons as you wish, adding any component stereo record player or tape recorder at any time.

But the Starter Set goes further, providing all the power and quality needed to accommodate the very largest—and smallest—component speakers available. If you eventually desire even finer speaker systems, they're easily added. Your E-V ELEVEN's may then be moved to a second listening location where requirements are perhaps less

critical. Nothing has been lost—nothing made obsolete.

In essence, the E-V Starter Set offers you more than the initial pleasure of fine high fidelity. It is designed to grow and change with your personal needs—and without compromising your standards of musical reproduction.

You'll be surprised at the modest initial cost of the E-V Starter Set—and at how much it offers. Take the first step toward a lifetime of musical pleasure. Write today for full details, or listen to the Starter Set at fine high fidelity showrooms everywhere.

**Also available with E-V 1178 AM/FM Stereo Receiver*

high fidelity speakers and systems • tuners, amplifiers, receivers • public address loudspeakers • microphones • phonograph needles and cartridges • organs • space and defense electronics

ELECTRO-VOICE, INC., Dept. 774F, 616 Cecil Street, Buchanan, Michigan 49107

CIRCLE NO. 19 ON READER SERVICE CARD

Electro-Voice[®]