

Stereo Review

14276

OCTOBER 1976 • ONE DOLLAR

Julian Hirsch's
**BUYER'S GUIDE TO
CASSETTE DECKS**

Irving Kolodin's
**BASIC LIBRARY OF
MAHLER SYMPHONIES**

Interviews with
**BILLY JOEL
BONNIE RAITT**

and...
"one of the most beautiful
records of anything ever
offered to the public."

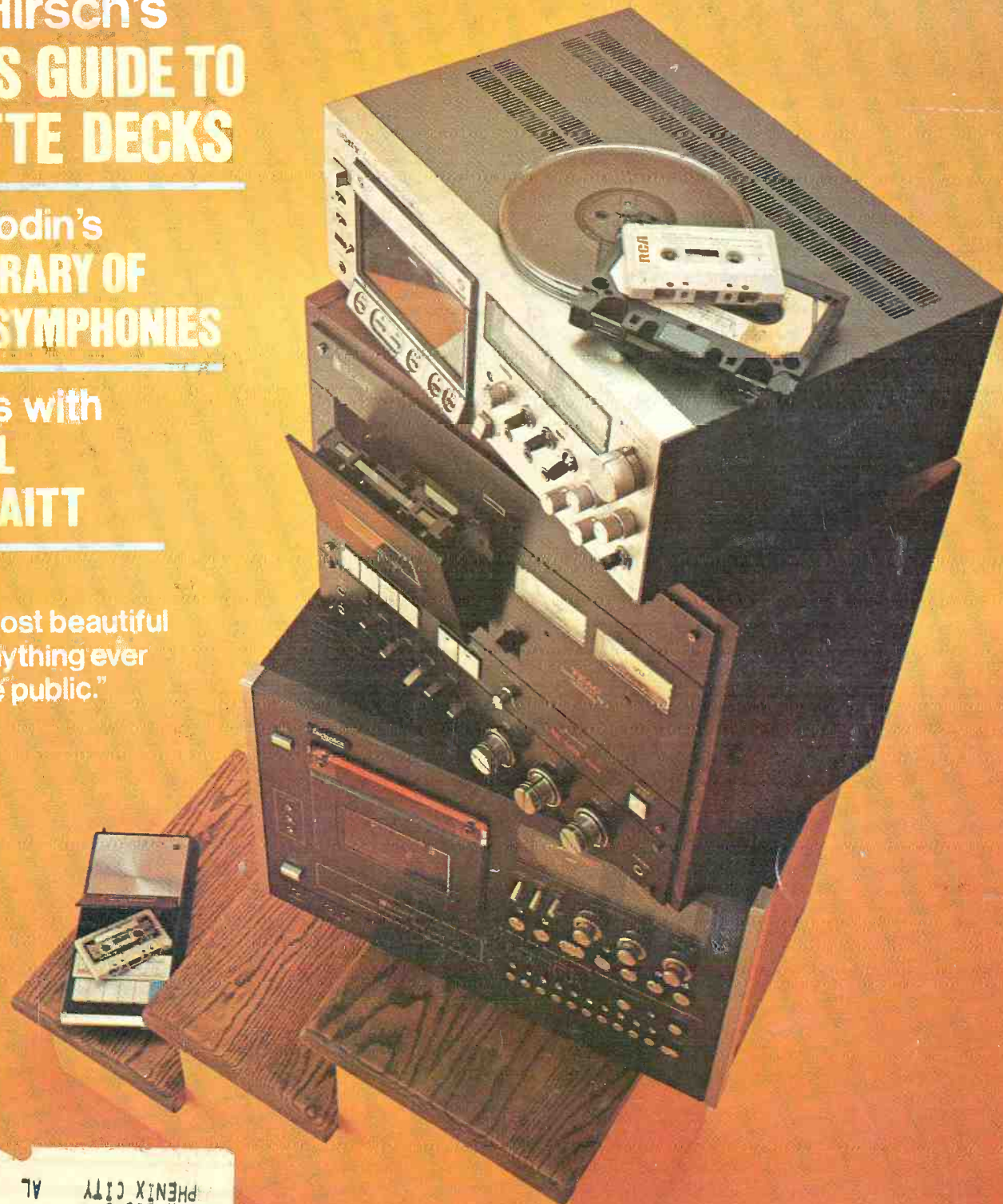

The most extraordinary cassette deck value ever offered.



262912 51T B0268E90 7414 N0V77
E GLENN SMITH
RT 5
BOX 268-C
PHENIX CITY AL 36867

The new 2121. With Dolby* under \$200.†

Ever since the cassette deck stepped into the spotlight with proven high fidelity performance, great advances in tape and cassette deck technology have been made. Despite this progress, most of the high fidelity industry was convinced that it was virtually impossible to build a really superior front-loading, front-control cassette deck equipped with Dolby — that could sell for less than two hundred dollars.

Pioneer thought it might be impossible, too. But we figured it was worth the try.

The engineers at Pioneer were given the 2121 project two years ago. They were asked to build a front-access, front-control cassette deck loaded with features. A deck that would outperform any unit in the two hundred dollar price range that had ever been built before.

The result is the no-compromise CT-F2121 — a cassette deck with enormous capability, performance, reliability and features. Pioneer believes the CT-F2121 has the greatest combination of value ever put into a cassette deck at such an extremely reasonable price.



Switch from one mode to another, bypassing the Stop lever.

Everything's up front for optimum operating convenience.

Pioneer's engineers have designed the CT-F2121 to give you the highest degree of flexibility in use. You can stack it easily with other components in your system because every control function, as well as cassette loading, is operable from the front panel. In addition, the illuminated cassette compartment permits rapid cassette loading at an easy-to-see 30° angle. An LED indicator lets you know when you're in the recording mode. And, as all Pioneer components, the controls are simple to use and logically arranged.

Improved sound reproduction with built-in Dolby B system.

The CT-F2121's selectable Dolby B provides as much as 10dB improvement in signal-to-noise ratio with standard low noise tapes. There's an even greater improvement with chromium dioxide tape. An indicator light tells you instantly when the Dolby system is in operation. And to insure better, interference-free recordings of FM stereo broadcasts, Pioneer has built in a multiplex filter.

Outstanding performance with every type of tape.

Separate bias and equalization switches permit you to use any kind of cassette tape: standard low noise, chromium dioxide — and even the newest ferrichrome formulations. The CT-F2121 brings out the fullest capabilities of each tape. And to produce the best performance, the operating manual of the CT-F2121 gives you a chart listing the most popular cassette tape brands with their recommended bias and equalization control settings. *There's never any guesswork*



Separate bias & equalization switches for any type of cassette tape.

Versatile features increase listening enjoyment and simplify recording.

Pioneer has outdone itself on the CT-F2121 with a host of easy-to-use features. A long life permalloy-solid record and play head and a ferrite erase head insure excellent signal-to-noise ratio. The transport operating levers that permit, direct, jam-proof switching from one mode to another without having to operate the Stop lever, are a great advancement. And, like Pioneer's more expensive cassette decks, the CT-F2121 has a separate electronic servo-system and a solenoid that provides automatic stop at the end of tape travel in play, record, fast wind and rewind.

Twin illuminated VU meters, plus separate input level controls for each channel help you set accurate recording levels. Stereo microphone inputs as well as the headphone output jack are all easily accessible on the front panel.

By any point of reference, compare the CT-F2121's combination of performance and features with cassette decks costing much more. You can come to only one conclusion — at under \$200†, this is the most extraordinary cassette deck value ever offered.

Frequency Response (Chrome Tape):
30-16,000 Hz

Wow & Flutter (WRMS): 0.12%

Signal-to-Noise Ratio (with Dolby): 58dB

Input Sensitivity: 0.3mV — 63mV (mic);
63mV — 12V (line)

Outputs: 450mV (line & DIN); 80mV 8 ohms
(headphones)

U.S. Pioneer Electronics Corp.,
75 Oxford Drive, Moonachie,
New Jersey 07074.

West: 13300 S. Estrella, Los Angeles
90248 / Midwest: 1500 Greenleaf,
Elk Grove Village, Ill. 60007 / Canada:
S. H. Parker Co.



The CT-F2121 comes ready for custom installation. Handsome, optional cabinet with walnut veneered top and sides also available.

PIONEER
when you want something better



*Dolby is a trademark of Dolby Laboratories, Inc. †Optional cabinet with walnut veneered top and sides. Approximate value, \$74.95. Price listed above are manufacturer's approximate V.

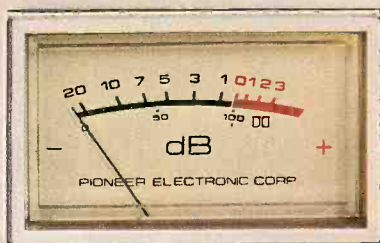

REC



TAPE DOLBY NR
 BIAS EQ

STD STD DFF
 CrO₂ CrO₂/Fe-Cr ON

PHONES L—MIC—R

INPUT
 LEFT — RIGHT

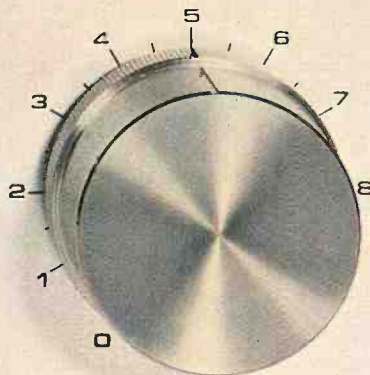

PIONEER STEREO CASSETTE TAPE DECK MODEL CT-F2121



One Clean Investment Saves Many

Playing dirty records—even if they look clean—can permanently ruin your large investment.

So make a single, clean investment.

Discwasher, the Superior Record Cleaner, available worldwide.

 **DISCWASHER**
COLUMBIA, MO 65201

FORMERLY HI FI/STEREO REVIEW

Stereo Review®

OCTOBER 1976 • VOLUME 37 • NUMBER 4

The Equipment

AUDIO BASICS	
<i>The New Angel Cassettes</i>	RALPH HODGES..... 12
NEW PRODUCTS	
<i>A roundup of the latest in high-fidelity equipment</i>	17
AUDIO QUESTIONS AND ANSWERS	
<i>Advice on readers' technical problems</i>	LARRY KLEIN..... 22
TAPE HORIZONS	
<i>Recorded Response</i>	CRAIG STARK..... 26
AUDIO NEWS	
<i>Improving TV Sound</i>	WILLIAM LIVINGSTONE..... 28
EQUIPMENT TEST REPORTS	
<i>Hirsch-Houck Laboratory test results on the Onkyo TX-4500 AM/FM stereo receiver, Jensen Model 24 speaker system, Empire 2000Z phono cartridge, Crown IC-150A stereo preamplifier, and a kit-builder's report on the Heath AA-1640 stereo power amplifier</i>	JULIAN D. HIRSCH..... 31
WHAT TO LOOK FOR IN A CASSETTE DECK	
<i>A short course (with directory) to make you a better shopper</i>	JULIAN D. HIRSCH..... 64

The Music

BONNIE RAITT	
<i>"... what could she know of the blues that wasn't secondhand?"</i>	NOEL COPPAGE..... 74
A BASIC LIBRARY OF MAHLER SYMPHONIES	
<i>The composer who made one of the three B's roll over</i>	IRVING KOLODIN..... 76
BILLY JOEL	
<i>"... perhaps the best keyboard technician on the pop scene"</i>	JOSH MILLS..... 82
BEST RECORDINGS OF THE MONTH	
Vocal: <i>Natalie Cole's second album: Rachmaninoff songs by Elisabeth Söderström; Gordon Lightfoot's "Summertime Dream"</i>	
Instrumental: <i>Bartók's first and third piano concertos</i>	
Operetta: <i>Gilbert & Sullivan's Utopia Limited</i>	85
POPULAR DISCS AND TAPES	
<i>Billy Joel: too tough-minded?</i>	PETER REILLY..... 91
<i>Bing and Fred: Once More, a Third Down</i>	HENRY PLEASANTS..... 96
<i>Waylon Jennings: retrospective on a stubborn survivor</i>	NOEL COPPAGE..... 104
<i>Happy Birthday, Ethel Waters</i>	HENRY PLEASANTS..... 119
CLASSICAL DISCS AND TAPES	
<i>Emanuel Ax: an altogether distinguished Chopin recital</i>	RICHARD FREED..... 121
<i>Gottschalk by Eugene List (and others)</i>	ROBERT OFFERGELD..... 124
<i>Beeson's Captain Jinks of the Horse Marines</i>	PETER REILLY..... 130

The Regulars

EDITORIALLY SPEAKING	WILLIAM ANDERSON..... 4
LETTERS TO THE EDITOR	6
TECHNICAL TALK	JULIAN D. HIRSCH..... 30
THE POP BEAT	STEVE SIMELS..... 56
GOING ON RECORD	JAMES GOODFRIEND..... 60
THE BASIC REPERTOIRE	MARTIN BOOKSPAN..... 62
CHOOSING SIDES	IRVING KOLODIN..... 114
ADVERTISERS' INDEX	141

COVER: Elcaset decks by (top to bottom) Sony, Teac, and Technics. Relative size of units is indicated by the portable cassette deck on the bottom step and by the reel-to-reel, cassette, and elcaset tapes on top. Design by Borys Patchowsky, photo by Bruce Pendleton.

COPYRIGHT © 1976 BY ZIFF-DAVIS PUBLISHING COMPANY. All rights reserved. Stereo Review, October 1976, Volume 37, Number 4. Published monthly by Ziff-Davis Publishing Company; Editorial and Executive Offices at One Park Avenue, New York, N.Y. 10016; Telephone: 212 725-3500. Hershel B. Sarbin, President; Furman Hebb, Executive Vice President; John R. Emery, Senior Financial Vice President and Treasurer; Charles B. Seton, Secretary. Also the publishers of Boating, Car and Driver, Cycle, Flying, Modern Bride, Popular Electronics, Popular Photography, and Skiing. One-year subscription rate for U.S., \$7.98; U.S. possessions and Canada, \$10.98. All other countries, one-year subscription rate \$12.98, cash orders only, payable in U.S. currency. Second-class postage paid at New York, N.Y. and at additional mailing offices. Authorized as second-class mail by the Post Office Department, Ottawa, Canada, and for payment of postage in cash. SUBSCRIPTION SERVICE: Forms 3579 and all subscription correspondence should be addressed to Stereo Review, Circulation Department, P.O. Box 2771, Boulder, Colorado 80302. Please allow at least eight weeks for change of address. Include your old address, as well as new—enclosing if possible an address label from a recent issue. Material in this publication may not be reproduced in any form without permission. Requests for permission should be directed to Jerry Schneider, Rights and Permissions, Ziff-Davis Publishing Company, One Park Avenue, New York, New York 10016.

Editorially Speaking

By William Anderson



WILL THE TORTOISE WIN AGAIN?

At least a half-dozen years ago, over lunch at the (of course) Plaza, one of the recording industry's highly placed deep throats prophesied that within ten years the tape cassette would be the principal format of music reproduction in these United States. Brown Meggs has just retired from his executive aerie in Los Angeles' Capitol Tower to devote himself full-time to a detective-fiction career that has already produced two successful novels (*Saturday Games* and *The Matter of Paradise*, Fawcett Publications), so he won't be on the scene in 1980 to say 'I told you so.' But it does begin to look as if he may have been right. For the past year and more there has been a notable increase in the public's interest in cassette hardware and software, and the audio industry has been responding with a flood of new tape decks, improved oxide formulations for the rapidly expanding and highly competitive blank-tape market, and better sound-processing techniques for prerecorded tape. Some kind of acceleration in the Meggs timetable is clearly

taking place, and a close look at the whole subject is therefore indicated—hence this special Cassette Issue.

I have been a cassette fancier ever since the appearance a decade or so ago of the first cute little Philips "Carycorder." The reason? Simple convenience. The listening facilities in my New York apartment and here in the office permit me to deal with practically any recorded format, but for travel and for weekends in the country it is, by design, cassette or nothing. In the city, it is usually not possible to rustle up the kind of settled, relaxed attention I can lavish on a new release (or, especially, a whole bunch of them) over a weekend, and it is hardly reasonable to lug an armload of heavy, bulky discs on and off the train twice a week either. But a cassette—even several of them—weighs next to nothing, takes up almost no space. If I have only a disc version at hand, I can quickly run off a cassette copy on the deck just behind my desk (as I am doing right now), drop it into my weekend bag, and listen to it later with my sox off. (Interestingly

enough at this time, we have just received a cassette copy of John Denver's new "Spirit" album ahead of the disc version.) Again, when we are lucky enough to get our hands on an advance disc copy (it may be the only one in town) of something that begs for prompt attention, we rush it to the reviewer's turntable pronto—but not without first running off a copy on cassette for reference protection.

That the convenience aspect of the cassette has lately been accompanied by the significant improvements in sound quality made feasible by better machines and better tapes is of course no bad thing, and I have every confidence that the sound will get even better. I do not, however, see the cassette threatening the disc just yet where quality sound is the first consideration—unless disc quality itself continues to deteriorate. In that case I will richly enjoy the irony of watching the lowly 1 7/8-ips tortoise surpass the cocky 33 1/3-rpm hare in the sonic Olympics. And perhaps it's about time: the phonograph disc is (I find it hard to believe too) 75 years old this year, and next year it will be 100 years since Edison was granted a patent on his cylinder.

It will not be lost on American readers that the cassette is taken with greater seriousness abroad than it is here at home—which is as it should be, for the concept was born in Europe. Since Deutsche Grammophon's introduction about a year ago of a luxurious packaging system for multiple-cassette recordings, first London and now Angel have arrived on the American market with a bundle of new releases stressing quality sound. This can best be described as a market challenge, and American cassette producers (who are not deaf to the jingle of the cash register) may be expected to respond. If you strain very hard you can just barely hear "Dolby" being whispered (discreetly, of course) down the echoing halls of RCA's Camden laboratories, and we should begin to hear the results in RCA cassette product before the year is quite out. And now that Angel has dipped a toe into cassette quadrasonics without suffering eternal damnation (see Ralph Hodges' *Audio Basics* this month), can Columbia be far behind?

Stereo Review

PUBLISHER

EDGAR W. HOPPER

EDITOR

WILLIAM ANDERSON

MANAGING EDITOR

WILLIAM LIVINGSTONE

EDITORIAL COORDINATOR

LOUISE GOOCH BOUNDAS

MUSIC EDITOR

JAMES GOODFRIEND

TECHNICAL EDITOR

LARRY KLEIN

ART DIRECTOR

BORYS PATCHOWSKY

ASSOCIATE TECHNICAL EDITOR

RALPH HODGES

POPULAR MUSIC EDITOR

STEVE SIMELS

ASSISTANT MUSIC EDITOR

VIVIANNE WINTERRY GOODMAN

PRODUCTION EDITOR

PAULETTE WEISS

LONDON EDITOR

HENRY PLEASANTS

CONTRIBUTING EDITORS

CHRIS ALBERTSON

MARTIN BOOKSPAN

NOEL COPPAGE

RICHARD FREED

DAVID HALL

ROY HEMMING

JULIAN D. HIRSCH

GEORGE JELLINEK

IGOR KIPNIS

IRVING KOLODIN

PAUL KRESH

STODDARD LINCOLN

J MARKS-HIGHWATER

LINCOLN PERRY

PETER REILLY

CHARLES RODRIGUES

ERIC SALZMAN

CRAIG STARK

JOEL VANCE

ADVERTISING DIRECTOR

JAMES J. SULLIVAN

ADVERTISING SERVICE MANAGER

LINDA BLUM

EXECUTIVE ASSISTANT

PEGI McENEANEY

ASSOCIATE PUBLISHER

STANLEY NEUFELD

Editorial and Executive Offices

Ziff-Davis Publishing Company

One Park Avenue, New York, New York 10016

212 725-3500

Eastern Advertising Manager: Richard J. Halpern

Midwestern Office: The Pattis Group

4761 West Touhy Ave., Lincolnwood, Illinois 60466

312 679-1100

Arnold S. Hoffman

Western Office

9025 Wilshire Boulevard

Beverly Hills, California 90211

213 273-8050; 272-1161

Western Advertising Manager: Bud Dean

Japan: James Yagi

Oji Palace Aoyama, 6-25, Minami Aoyama

6-Chome, Minato-ku, Tokyo, Japan

Telephone: 407-1930/6821, 582-2851

Circulation Office

P.O. Box 2771, Boulder, Colorado 80302

EDITORIAL CONTRIBUTIONS must be accompanied by return postage and will be handled with reasonable care; however, publisher assumes no responsibility for the return or safety of art work, photography, or manuscripts.

Member Audit Bureau of Circulations



ZIFF-DAVIS PUBLISHING COMPANY

Hershel B. Sarbin, President

Furman Hebb, Executive Vice President

John R. Emery, Senior Vice President-Finance/Treasurer

Phillip T. Heffernan, Senior Vice President, Marketing

Edward D. Muhlfeld, Senior Vice President, Sports Div.

Philip Sine, Senior Vice President

Frank Pomerantz, Vice President, Creative Services

Arthur W. Butzow, Vice President, Production

Lawrence Sporn, Vice President, Circulation

George Morrissey, Vice President

Sydney H. Rogers, Vice President

Sidney Holtz, Vice President

Al Traina, Vice President

Philip Korsant, Vice President

Charles B. Seton, Secretary

Edgar W. Hopper, Vice President, Electronics Div.

William Ziff, Chairman

W. Bradford Briggs, Vice Chairman

The Best Way To Show You What You'll Get Out Of An Empire Phono Cartridge Is To Show You What Goes Into One

At Empire we make a complete line of phono cartridges. Each one has



slightly different performance characteristics which allow you to choose the cartridge most compatible to your turntable.

There are, however, certain advantages, provided by Empire's unique design, that apply to all our cartridges.

One is less wear on your records. Unlike other magnetic cartridges, Empire's moving iron design allows the diamond stylus to float free of its magnets and coils, imposing much less weight on your record's surface and insuring longer record life.

Another advantage is the better channel separation you get with Empire cartridges. We use a small, hollow iron armature which allows for a tighter fit in its positioning among the poles. So, even the most

minute movement is accurately reproduced to give you the space and depth of the original recording.

Finally, Empire uses 4 coils, 4 poles, and 3 magnets (more than any other cartridge) for better balance and hum rejection.

The end result is great listening. Audition one for yourself or write for our free brochure, "How To Get The Most Out Of Your Records". After you compare our performance specifications we think you'll agree that, for the money, you can't do better than Empire.

Empire Scientific Corp.
Garden City, New York
11530

EMPIRE

Already your system sounds better.

MODEL & STYLUS COLOR	4000 D/III	4000 D/II	4000 D/I	2000Z	2000 E/III	2000 E/II	2000 E/I	2000 E	2000
FREQUENCY RESPONSE	10Hz-50KHz ± 3 db	15Hz-50KHz ± 3 db	15Hz-45KHz ± 3 db	20Hz-20KHz ± 1 db	20Hz-20KHz ± 2 db	20Hz-20KHz ± 2 db	20Hz-20KHz ± 3 db	20Hz-20KHz ± 3 db	20Hz-20KHz ± 3 db
TRACKING FORCE RANGE	¾-1¼ gm	¾-1½ gm	1-1¼ gm	¾-1¼ gm	¾-1½ gm	¾-1½ gm	1-2 gm	1¼-2½ gm	1½-3 gm
SEPARATION: 15Hz to 1KHz 1KHz to 20KHz 20KHz to 50KHz 20 Hz to 500Hz 500Hz to 15KHz 15KHz to 20KHz	28 db 23 db 15 db	26 db 21 db 15 db	24 db 20 db 15 db	20 db 30 db 25 db	20 db 28 db 20 db	20 db 25 db 18 db	18 db 23 db 15 db	18 db 23 db 15 db	16 db 21 db 13 db
I. M. DISTORTION @ 3.54 cm/sec	.2% 2KHz-20KHz	.2% 2KHz-20KHz	.2% 2KHz-20KHz	.08% 2KHz-20KHz	.1% 2KHz-20KHz	.15% 2KHz-20KHz	.2% 2KHz-20KHz	.2% 2KHz-20KHz	.2% 2KHz-20KHz
STYLUS	.2 mil bi-radial	.2 mil bi-radial	.2 mil bi-radial	.2 x .7 mil elliptical	.2 x .7 mil elliptical	.2 x .7 mil elliptical	.2 x .7 mil elliptical	.3 x .7 mil elliptical	.7 mil radius spherical
EFFECTIVE TIP MASS	.4 milligram	.4 milligram	.4 milligram	.2 milligram	.6 milligram	.6 milligram	.6 milligram	.9 milligram	1 milligram
COMPLIANCE	30x10 ⁻⁶ cm/dyne	30x10 ⁻⁶ cm/dyne	30x10 ⁻⁶ cm/dyne	30x10 ⁻⁶ cm/dyne	20x10 ⁻⁶ cm/dyne	18x10 ⁻⁶ cm/dyne	17x10 ⁻⁶ cm/dyne	16x10 ⁻⁶ cm/dyne	14x10 ⁻⁶ cm/dyne
TRACKING ABILITY	32 cm/sec @ 1KHz @ 1 gm	32 cm/sec @ 1KHz @ 1¼ gm	30 cm/sec @ 1KHz @ 1½ gm	38 cm/sec @ 1KHz @ .9 gm	32 cm/sec @ 1KHz @ 1 gm	28 cm/sec @ 1KHz @ 1¼ gm	28 cm/sec @ 1KHz @ 1½ gm	28 cm/sec @ 1KHz @ 1½ gm	32 cm/sec @ 1KHz @ 2 gm
CHANNEL BALANCE	within 1 db @ 1KHz	within 1 db @ 1KHz	within 1½ db @ 1KHz	within ¾ db @ 1KHz	within 1 db @ 1KHz	within 1¼ db @ 1KHz	within 1½ db @ 1KHz	within 1½ db @ 1KHz	within 1½ db @ 1KHz
INPUT LOAD	100K ohms/channel	100K ohms/channel	100K ohms/channel	47K ohms/channel	47K ohms/channel	47K ohms/channel	47K ohms/channel	47K ohms/channel	47K ohms/channel
TOTAL CAPACITANCE	under 100 pf/channel	under 100 pf/channel	under 100 pf/channel	300 pf/channel	400-500 pf/channel	400-500 pf/channel	400-500 pf/channel	400-500 pf/channel	400-500 pf/channel
OUTPUT @ 3.54 cm/sec	3 mv/channel	3 mv/channel	3 mv/channel	3 mv/channel	4.5 mv/channel	4.5 mv/channel	7 mv/channel	7 mv/channel	7 mv/channel

FREE!

NEW Heathkit Catalog



An audiophile's delight, describing some of the finest hi-fi products you can buy—all with Heathkit build-it-yourself savings and satisfaction. Stereo components including the sensational Modulus™—the system that defies obsolescence because it

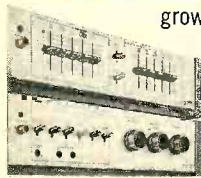

grows as your listening needs change. "Separates" including a Stereo Preamplifier with incredible specifications and an equally incredible low price, and a matching equalizer that gives you far better tone control than conventional bass and treble controls. A complete line of speaker systems including the AS-1373—a three-way system that sets an industry standard for mid-priced speakers. Other products include digital clocks and weather instruments, new audio service gear, Amateur Radio equipment, auto and marine accessories. Nearly 400 kits in all.



Heath Co., Dept. 40-22, Benton Harbor, MI 49022

SEND FOR YOUR COPY TODAY

HEATH	
Schlumberger	
Heath Company, Dept. 40-22 Benton Harbor, Michigan 49022	
Please send me the new Heathkit Catalog. I am not on your mailing list.	
Name _____	
Address _____	
City _____	State _____
HF-310	Zip _____

CIRCLE NO. 25 ON READER SERVICE CARD

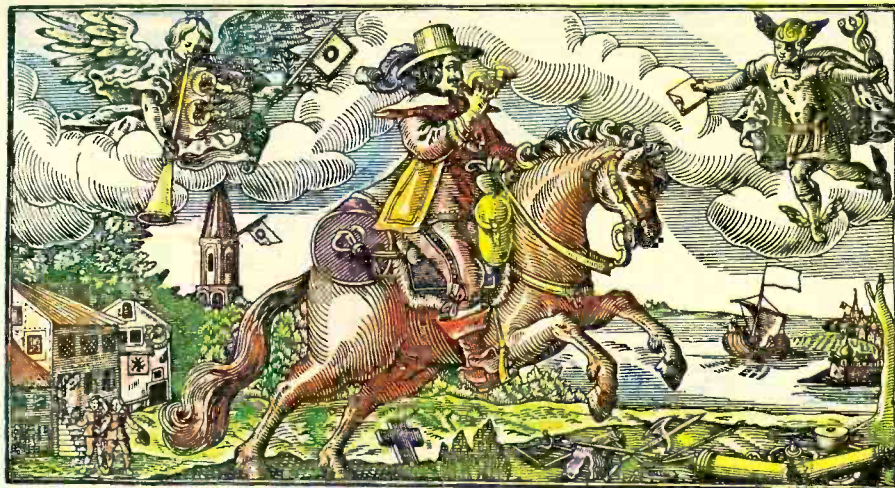

LETTERS TO THE EDITOR

Musk rats in the White House

● Peter Reilly says of the Captain & Tennille's "Song of Joy" in the August issue: "It's obvious that they are both people of taste and elegance." If that is so, how come they sang *Muskrat Love* at an occasion where it was most inappropriate—the White House state dinner for Queen Elizabeth II of England? In that case, Mr. and Mrs. Daryl Dragon came out like Elizabeth and Broderick, their pet dogs.

CHARLES E. EVERETT
Sag Harbor, N.Y.

Audio Lib

● Jacqui Mac made a perfectly legitimate complaint (August letters), and your answer that 95 per cent of your readers are male completely misses the point. The unquestioned belief that hi-fi is the domain of men is precisely why women are not more involved in it. Only an exceptionally strong-willed woman could possibly overcome a lifetime of conditioning by subtle hints that she either cannot or should not be connected with anything requiring technical competence.

JOHN TAIT
San Francisco, Calif.

● Angry Jacqui Mac (August letters) failed to notice that the same opening paragraph (in "Clean Up and Tune Up Your Audio System," June) which "implied that only MEN can clean/have the ability to clean their systems" also relegated these same men to the role of housekeeper. What an arbitrary/insulting assignment of roles! The score is one to one, and let's not be ridiculous.

CLIFTON L. GANUS III
Searcy, Ark.

Classical Rip-offs

● James Goodfriend and Steve Simels both took time in August to grumble about pop composers who plagiarize classical "notes, chords, and rhythms" for their own works and profits. Mr. Goodfriend's disgust seems to stem from his belief that pop listeners are not taking even a passive interest in the classics despite their unwitting introductions. It would be helpful if reviewers would report these "coincidental similarities" between popular and classical works and tell us where we can get hold of the classical "coincidences." For example, Emerson, Lake &

Palmer's *Knife-Edge* occurs in Janáček's *Sinfonietta*, available on London 10222 as performed by the London Symphony Orchestra under Claudio Abbado. The grotesque sums of money spent on sonic enemas of the likes of Chicago prove that there are pocketbooks capable of buying large quantities of classical discs—if only they knew what they were listening to and where to find them.

JAMES PARSONS
Pasadena, Calif.

● I'd like to suggest Eric Carmen's Arista album to James Goodfriend for mention in his next column on classical rip-offs (see "Crossing Over," August), for I was certainly surprised to find that no credit was given on the cover to the composer of the music to *Never Gonna Fall in Love Again*. This music, including bridge material, was taken almost note for note from the adagio of Rachmaninoff's Second Symphony. Symphonic music has been used as the basis of pop songs for many years, but when Mr. Carmen claims creation of the words *and the music*, he is taking more than his due credit.

LARRY W. HOWETH
Sherman, Tex.

The Portable Butterfly

● A Bronx cheer to Vito D'Amato of Brooklyn. He is wrong when he says in your letters column in the August issue that the Metropolitan Opera played Yankee Stadium this past summer. I distinctly remember reading that the performance was canceled.

HAROLD CARLSON
San Francisco, Calif.

There was a great deal of advance publicity for a performance of Madama Butterfly with Anna Moffo, which was scheduled to take place in the stadium in June. But when heavy rains were forecast for the weekend in question, the Yankees were afraid the Met's trucks would do great damage to their turf and withdrew permission for the use of the stadium. The performance was sung, but the venue was changed to Van Cortlandt Park in the Bronx. By then we had long since gone to press.

Kubiak on Disc

● In the August issue George Jellinek wrote of Teresa Kubiak's solo recital album: "This appears to be the first recorded appearance of

Teresa Kubiak." This record is the first one devoted solely to the performance of Miss Kubiak. She was a principal artist on Solti's *Eugene Onegin*, reviewed in the January 1976 issue, and she has recorded Janáček's Slavonic Mass. Both performances are available on London Records.

AMY R. SPERLING
New York, N.Y.

Bo Diddley

After rereading Joel Vance's appraisal of Bo Diddley's first release for RCA in the June issue, I came away with the satisfaction of knowing that someone who writes for an authoritative publication thinks exactly as I do. The entire write-up hit the nail on the head—except for one small error: Bo's first name is not Eugene but Ellas.

I have been a life-long Diddley fan, but the last few years have been rather fruitless ones for anyone longing to hear the sound of the old master at work. When I last talked with Bo during the summer of 1974, I asked when we could expect to hear the old Diddley sound again and he replied, "Well, my old drummer Frank Kirkland is dead, Jerome Green is punching a time clock in New York City, and those days are gone . . . you ain't never gonna hear that sound no more."

JAMES W. KALKA
Binghamton, N.Y.

Glaring Omissions

Although James Goodfriend was careful to provide a built-in, apologetic rationale for the Calendar of American Music's structure and his choice of names to appear on it (July), he cannot be excused for several glaring omissions, most notably the composers Theodore Thomas, Benjamin J. Lang, Mrs. H. H. A. Beach, William W. Gilchrist, and H. Alexander Mathews. If a calendar, even on Mr. Goodfriend's terms, is to have any relevancy at all to the influence on American music, it should be as comprehensive as possible; however, its real value lies not so much in how many it includes but whom it includes. The contribution made by these composers cannot be overestimated—or overlooked.

RALPH G. SWIFT
Vincentown, N.J.

Mr. Goodfriend replies: Sorry. I also left out Henry A. Lang, Charles Naginski, Dr. Edward O. Schaaf, Francesco B. DeLeone, and J. Frank Frysinger! Incidentally, the Calendar of American Music is now available in reprint form; see page 106 for ordering instructions.

Boris the Unfinished

The usually well-informed George Jellinek was not quite on the mark with his comments about Moussorgsky's *Khovantchina* in the July issue. He states that Rimsky-Korsakov "has not been called to task" for his revision and orchestration of this opera. On the contrary, Rimsky's *Khovantchina* has received the same heavy and justified criticism as his version of *Boris Godounov* and for precisely the same reasons. One scholar (Oskar von Riesemann, in his book *Moussorgsky*), has held that Rimsky's alterations of the vocal score and harmonization are even more drastic in *Khovantchina* than in *Boris*.

Mr. Jellinek also states that "no orchestrating sketches by Moussorgsky are known to have survived." According to a recent study of his scores, Moussorgsky orchestrated two

(Continued on page 10)



Rare taste. As you like it.

There is only one Rare Scotch. J&B. But there are many ways to enjoy it. Straight up. With a splash and a twist. On the rocks. In a highball. Or a cocktail. Or dream up an original drink of your own. If it's made with J&B, you're sure to enjoy rare taste precisely the way you like it.

86 Proof Blended Scotch Whisky © 1976 Paddington Corp., N.Y.

J&B
RARE
SCOTCH

Every Dual turntable, from the 1225 to the new CS721, is designed with one concept: to provide more precision than you are ever likely to need. How well groove modulations are converted into music is significantly influenced by each aspect of tonearm design: geometry, balance, mass, resonance, bearing friction and the application of stylus pressure and antiskating. The life of one's records is also determined.

There have never been so many ways to enjoy Dual precision.

All these considerations have been thoroughly fulfilled in every Dual. Thus, if basic excellence in record playback meets your requirements, we would suggest the lowest-priced model. However, if you demand a tonearm that does more to optimize tracking than any other tonearm ever made, nothing less than the top-of-the-line CS721 or CS704 will satisfy you.

All component parts of every Dual turntable are built to the highest standards of precision. For example, the rotor of every motor is dynamically balanced in every plane of motion. Uniformity is checked to within four millionths of an inch; just one of the reasons for the virtual absence of vibration, the primary source of rumble.

Dual turntables are rugged. They need not be babied—by you or anyone else in your family. Chances are that your Dual—any Dual—will outlast all your other components, so you should carefully consider which Dual you want.

There are eight Dual models; some semi-automatic, some fully automatic, some with the option of multiple play. However, there's no need to decide on a specific Dual model right now. You can do that best at your United Audio dealer where he can demonstrate all the differences that Dual precision makes.



United Audio Products, 120 So. Columbus Ave., Mt. Vernon, N.Y. 10553
Exclusive U.S. Distribution Agency for Dual



The Dual 1225.



The Dual 1249.

True, four-point gimbal centers and pivots the tonearm mass at intersection of horizontal and vertical axes. Tonearm is dynamically balanced in all planes. The four needle-point pivots are first hardened, then honed, a process which produces microscopically smooth surfaces. The precision ball-bearing races are only 0.157 inch diameter.

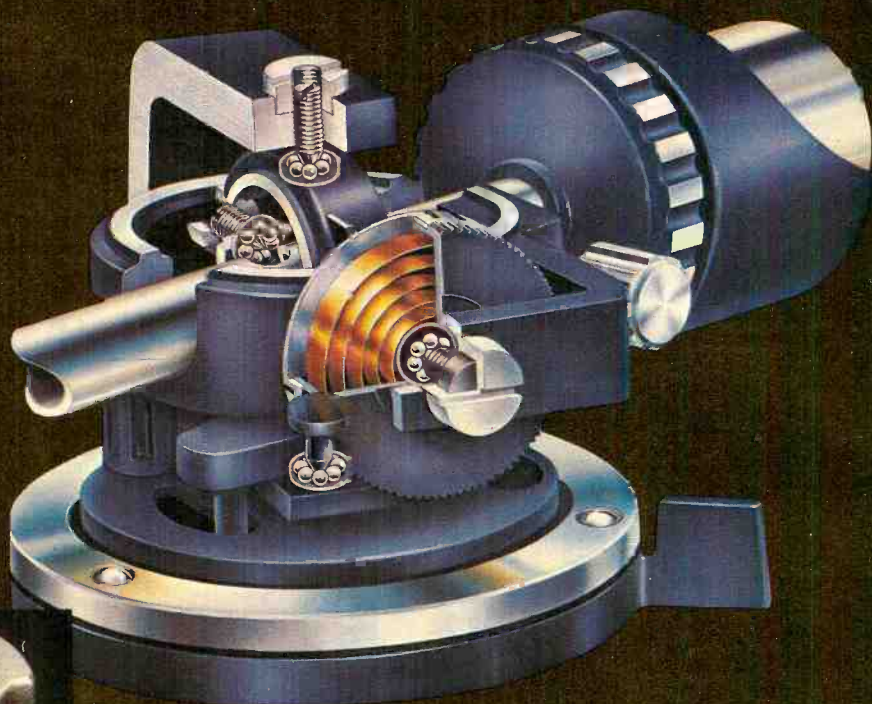

Unique Vario-pulley used in Dual's three belt-drive models is precision-machined for perfect concentricity and balance. Speeds are adjusted by expansion and contraction of pulley circumference; belt is never twisted or distorted.



The unique counterbalance used in Dual's two direct-drive models contains two mechanical anti-resonance filters. These are separately tuned to absorb energy in the resonance-frequency ranges of the tonearm/cartridge system and chassis to minimize acoustic feedback.

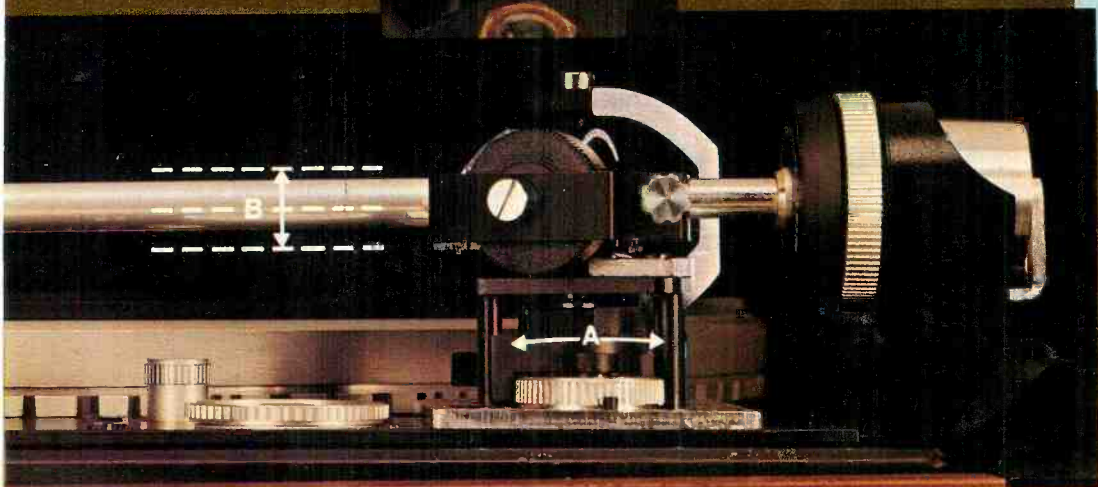
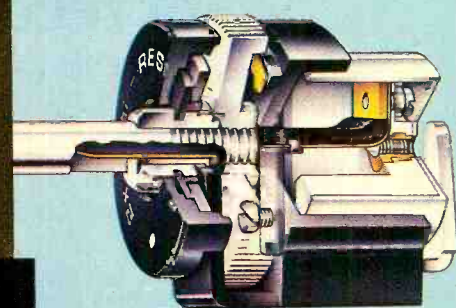

(A) Vertical Tonearm Control used in Dual's two direct-drive models sets and locks tonearm height at any point over an 8mm range (B). Tonearm thus exactly parallels the record with any size cartridge. Result: accurate vertical tracking without the added mass of cartridge spacers.



The Dual CS721.

The Dual 1225. Fully automatic, single-play/multi-play. Viscous-damped cue-control, pitch control. Less than \$140. **Dual 1226,** with cast platter, rotating single-play spindle. Less than \$170. **Dual 1228,** with gimballed tonearm, synchronous motor, illuminated strobe, variable tracking angle, less than \$200.

The Dual 1249. Fully automatic, single-play/multi-play. Belt-drive. 12" dynamically balanced platter. Less than \$280. Other full-size belt-drive models include: **Dual-502,** semi-automatic. Less than \$160. **Dual 510,** semi-automatic, with lead-in groove sensor, less than \$200.

The Dual CS721. Fully automatic, single-play. DC, brushless, electronic, direct-drive motor. Vertical Tonearm Control, adjustable cue-control height and descent speed, electronic pitch control with illuminated strobe. Less than \$400, including base and cover. **Dual CS704,** similar, but with semi-automatic tonearm. Less than \$310, including base and cover.

numbers from Act III: Marfa's song and a chorus of the *streltsy*. The first of these was published in the critical edition of Moussorgsky's works which appeared in the 1930's under the editorship of Pavel Lamm; the second survives in manuscript form (see Edward R. Reilly, "Scorography: The Music of Moussorgsky, Part Two," *Musical Newsletter*, 1976, Vol. V, No. 2, p. 15).

It is worth noting that Rimsky's is not the only available performing version of the unfinished opera. Aside from the 1913 reworking by Stravinsky and Ravel, there is a splendidly effective orchestration by Shostakovich, who restored all the music cut by Rimsky and otherwise maintained a high degree of fidelity to Moussorgsky's nearly complete vocal score.

Mr. Jellinek labels one of the opera's characters, Prince Golitsin, as "the slippery regent," which he is not. The regent is Tsarevna Sofia, the elder half-sister of Peter the Great. She ruled Russia from 1682 to 1689, with Golitsin as her chief collaborator and possibly her lover.

Finally, Mr. Jellinek refers to *Boris* as unfinished. Surely the recent Metropolitan Opera production ought to have laid this misconception to rest forever. Moussorgsky completed and orchestrated *Boris* in 1869, and in 1871-1872 he revised and expanded the opera. Then, in preparation for the 1874 premiere, he made additional minor revisions and substantial cuts.

DANIEL MORRISON
Albany, N. Y.

● George Jellinek unfortunately perpetuates an old myth in his July review when he states that Moussorgsky's *Boris Godounov* was "left unfinished." In fact, it was finished twice—in 1869, in a seven-scene version, and in 1872-1874, in four acts with a prologue, the latter being the basis for Rimsky-Korsakov's "version." This error was all the more unfortunate in that 1975 saw the Oxford University Press publication of a newly edited, full orchestral score of both of Moussorgsky's versions of *Boris*—which, incidentally, is supposed to be recorded in Poland soon.

Mr. Jellinek was also not quite accurate in his statements about *Khovantchina*, for Moussorgsky did orchestrate a few separate numbers. The alternative to Rimsky-Korsakov's version is, of course, Shostakovich's, which is closer to the original material and includes a number of scenes that Rimsky-Korsakov chose to omit.

NICHOLAS DEUTSCH
Boston, Mass.

Free details on a different kind of record club

offering... BACH, BEETHOVEN, BRAHMS,
CHICAGO, JOHN DENVER, EARTH-WIND & FIRE,
C.W. McCALL, FREDDY FENDER, LINDA RONSTADT,
GROVER WASHINGTON JR., DONALD BYRD
and every other composer and artist in print

You can now own every record or tape that you may ever want... at tremendous savings and with no continuing purchase obligations. You can get valuable free dividend certificates, you can get quick service and all the 100% iron-clad guarantees you want.

Now you can stop price increases that leave you with less music for your record and tape budget. You can guarantee yourself more music for less money through membership in Discount Music Club.

Look at these benefits:

TREMENDOUS SAVINGS on every record and tape in print—no "agree-to-purchase" obligations of any kind.

DISCOUNTS OF 43% TO 73% off mfg. suggested list... special catalog features hundreds of titles and artists.

ALL LABELS AVAILABLE including most imports through special custom ordering service. If we don't stock it we'll get it for you.

SCHWANN CATALOG lists thousands of titles; classical, pop, jazz, ballet, opera, musical shows, folk, rock, vocal, instrumental, country.

DISCOUNT DIVIDEND CERTIFICATES. Dividend Gifts—Every shipment carries a dividend gift or dividend certificate. Certificates redeemable immediately for extra discounts.

NEWSLETTERS. Happenings in the world of music; concerts, critiques, new releases... special super-sale discounts of up to 73%.

DISCOUNT ACCESSORY GUIDE. Diamond needles, cloths, tape cleaners, etc. Discount Music Club is your complete one stop music and accessory buying service.

QUICK SERVICE. Same day shipping on many orders... rarely later than the next several days. Partial shipments always made in the event of unforeseen delay... all at no extra cost to you.

100% IRON-CLAD GUARANTEES on all products and services. Everything is guaranteed factory fresh and free of defects or damages of any sort. Your total satisfaction is unconditionally guaranteed.

Discount Music Club is a no-obligation membership club that guarantees tremendous discounts on all stereo records and tapes and lets you buy what you want... when you want... or not at all if you choose.

These are just a few of the money-saving reasons to write for free details. You can't lose so why not fill out and mail the coupon for immediate information.



Discount Music Club
Department 9-106
650 Main St., New Rochelle, N.Y. 10801

NAME _____

ADDRESS _____

CITY _____

STATE _____ ZIP _____

Mr. Jellinek replies: I should have limited my review of Khovantchina to just that, without inserting a careless (and inaccurate) reference to Boris Godounov. The latter was indeed finished by Moussorgsky but, as is well known, did not take hold with the public in that authentic version. Rimsky-Korsakov's revision may have been arbitrary and it may have been "wrong," but it was selfless and nobly intended. Without it, the enjoyment of this masterpiece would have been denied to two generations of opera lovers. This fact is generally overlooked by commentators anxious to join the currently fashionable practice of Rimsky-baiting.

What I said about Khovantchina, however, is substantially accurate. That two isolated scenes exist in Moussorgsky's own orchestration does not alter the fact that the opera was not "finished" from a practical (performance) point of view. And if Rimsky's version was criticized by "one scholar," it still does not alter the fact that, as I said in my review, "it was Rimsky-Korsakov who saved it for posterity by orchestrating the vocal score with certain condensations." That others have subsequently also orchestrated the work has no bearing on a review dealing with this particular orchestration.

Webster defines "regent" as a person "acting in place of a king or ruler." This is precisely what Prince Golitsin does in the opera I reviewed.

Poco and Warren Zevon

● Noel Coppage gave a rather cold review in July to "Poco Live," which I think is their best album yet. I feel that *Ride the Country* is one of the best rock-and-roll songs ever written—the melody, lyric imagery, playing, and singing are all intense (but I'm in love, and I think of her when I hear it). Well, anyway, Mr. Coppage writes nicely. I'd like to add that, having read my first issue of STEREO REVIEW only a few months ago, I'm already hooked. After reading trash reviews for years, I find the objectivity refreshing.

BILL MCMICHAEL
Greeley, Colo.

● The problem with Steve Simels, like so many other "rock critics" (and who invented that aberration, I wonder?) is that he takes his personal opinion and inflicts it upon us as so much gospel truth, as if having a by-line and a typewriter makes one an important observer

of music and/or talent. Case in point: review of Warren Zevon's Asylum album in your August issue. I have listened to the album often in the last ten days and, contrary to Simels' hailing of Zevon as the next big thing, I hear a man lucky enough to have found a forum for his musical endeavors and not much more.

While Zevon makes a wry point or two, he has hardly made an album worthy of such praise. Odd, isn't it, that most "bright new stars" put out albums that boast assistance from at least five other major stars? Except for the fact that the tunes were "composed" by Zevon, it could just as easily have been entitled "Jackson Browne and Friends Present a Musician Who Sings." The bottom line is that there are a million people walking the streets today who are not only wittier, but who probably sing better and write better. The only talent Zevon seems to exude is fortune.

While we're at it, I congratulate Simels on finding a forum for his opinions—personal, and therefore not to be taken any more seriously than mine or yours. Other than that, I love the guy. And you might save this letter for a souvenir, for sooner or later I'll get my forum as well.

SCOTT PHELPS
Nashville, Tenn.

The Editor replies: We are happy to be able to give reader Phelps his forum—while observing that he is at least half right. Criticism in any field must face up, sooner or later, to a simple fact of our common humanity: subjectivity begins where silence ends. Is it not, however, a long jump from that admission to Mr. Phelps' conclusion that all opinions are therefore created equal? Mr. Phelps perhaps proves that they are not, for he considers his opinion of Warren Zevon's debut album superior to that of Steve Simels. In any case, too early to tell. And don't downgrade fortune; it too, as Mr. Phelps points out, is a talent, and this is best demonstrated by the fact that some people seem to have more of it than others!

Imported Schnabel

● In the February issue, Irving Kolodin referred to Schnabel's recording of the Schubert B-flat Sonata (D. 960) as "the—alas—discontinued . . . performance." It is now available, along with D. 850 and D. 959, in a two-record DaCapo album obtainable from import dealers and distributed by Peters International, 619 West 54th Street, New York, N.Y. 10019 (their catalog costs one dollar and is well worth it).

DAVID PIERCE
Vero Beach, Fla.

Discs imported by Peters International are not listed in the Schwann catalog, nor are they, with few exceptions, submitted to STEREO REVIEW for assessment.

Stickup Pickup

● I have a "handy household hint" for anyone who wants his album covers unadulterated with price tags, labels, promotional stickers, and the like, yet wants to keep the cellophane wrapper. First, soak the stickers with a wet sponge until the paper peels away, leaving the sticky gum base. After making sure the gum base is dry, *daub* repeatedly at it with a strip of Scotch tape, pulling up a little each time. This will completely remove the gum without harming the cellophane.

STEVE NEWMAN
Pomona, Calif.



The Powerful Difference.

As speaker specialists, we at Rectilinear know, better than most, that to play music at realistic volume levels requires speakers of extraordinary dynamic range and power handling capacity.

That's why every Rectilinear speaker is designed to handle enormous amounts of power and do it effortlessly.

Two prime examples are the Rectilinear 2 and 4½. Though moderate in size, they can easily reproduce the ear shattering levels of a rock group in full cry and do it with unmatched clarity and precision.

Both the Rectilinear 2 and 4½ use special high reliability drivers and frequency dividing networks backed up by protective circuitry to prevent mechanical damage and burnt

out voice coils.

In addition, a unique cabinet material with a high density fibrous core dramatically reduces cabinet resonances.

Yet in spite of their high power handling capabilities, both speakers are efficient enough to be used with moderately priced and powered amplifiers and receivers.

If your speakers aren't delivering the kind of punch and power you know is in the music, you owe it to yourself to listen to Rectilinear. You'll be impressed with the powerful difference.

Rectilinear speakers from \$169 to \$449.

For complete information write: Rectilinear Research Corporation, 107 Bruckner Boulevard, Bronx, N.Y. 10454. In Canada: H. Roy Gray Ltd., Ontario.

Audio Basics

By Ralph
Hodges



THE NEW ANGEL CASSETTES

At the close of my discussion of the new London cassettes in this column in July, I expressed my conviction that we have yet to explore completely the technical possibilities of the cassette medium, that there is still much room for improvement if only the producing companies would, like London, get in there and try. I did not then think that I would be coming back to this subject so soon, but here we are, only a few months later, confronting the introduction of a new line of pre-recorded cassettes from Angel.

The Angel tapes go by the name XDR, which stands for "Xtended Dynamic Range." The literature describing the XDR process speaks rather generally of "improved tape formulations" and "radically new signal-processing electronics" in the duplicating chain. More specific is the information that the cassettes have been recorded with the Dolby-B noise-reduction system and that the equalization is based on the "standard" 120-microsecond characteristic. The initial release consists of thirteen cassettes, three of them taken up by the Beverly Sills/Janet Baker *I Capuleti e i Montecchi*; a fourteenth cassette, for demonstration, contains excerpts from many of the others. All of these have been evaluated for this survey and compared with their corresponding disc versions.

I should admit right away that this project had its perplexing aspects from the start. There was, first of all, the fact that none of these recordings, tape or disc, was free of what is, by the best modern standards, an uncharacteristically high hiss level. Listening to them all, one after another, was a little like taking a trip back in time to the pre-Dolby era. In several instances the hiss level seemed to be controlled by the signal-to-noise ratio of the original duplicating master tape, which is a bit hard to understand in view of modern technology's ability to keep even second- and third-generation masters impressively quiet. Second, there were frequent instances in which a disc had more hiss than the cassette, which just shouldn't be, assuming that the cassette duplicating master was prepared from the same tape that was used to cut the disc and that the disc processing was carried out properly.

And there were more puzzles. I quickly learned about the perils of excessive skepti-

cism when it became apparent that there is indeed something strikingly exotic (see "radically new signal-processing electronics" above) going on in the processing of these cassettes. To begin with, all evidence indicates that they have been hit hard by some sort of peak limiter. It *sounds* like a compressor, since dynamic range has been sharply abridged relative to the disc in most cases, but it *looks* (on an oscilloscope) like a limiter, and a "smart" limiter at that. The threshold level at which the device "clamps down" seems to dance around, perhaps in response to the frequency content of the material or maybe in response to some even more sophisticated "program." Creditably, it manages to give at least some sense of dynamics even when the limiter—if limiter it is—is constantly at work. (Incidentally, compressors and limiters *both* reduce dynamic range. The difference between them is that a compressor is always "on," while a limiter is only "on" intermittently to reduce peak levels.)

"...in no case could I distinguish a disc from a cassette on the basis of the four-channel effect."

And there is more. The *average* recorded level on a number of these tapes is only trivially below standard Dolby level, which is 0 dB on the Advent cassette deck used for these evaluations. This means that on high-level passages the meter needle spends awesomely long periods of time "in the red." It is common knowledge that you can't treat tape this way when recording without winding up with an unspeakable mess, but with these Angel tapes . . . well, I can't really say that they sound *fabulous* when they get up there into cloud-cuckoo land, but they do sound better than you'd have any right to expect. I have no idea how this is accomplished, but I'm ready to consider the possibility that there is a pre-distorter in the Angel duplicating chain. A "predistorter" is designed to anticipate the type and degree of distortion that will be encountered under given circumstances (the on-

set of tape saturation in this case) and to apply a complementary distortion to the recording signal, thereby undoing in advance some of the damage it "knows" will be done to the recorded waveform. The existence of such a device anywhere in the Angel/Capitol plant is sheer speculation on my part, but it would offer an explanation of sorts.

Altogether, then, we evidently have quite a show of technical ingenuity taking place. How well it works we'll consider in detail in a moment, but first some notes on the conditions and objectives of the evaluations: The playback systems were basically the same as the ones for the London project (see July, page 30), and the efforts made in the interest of matching frequency responses gratifyingly paid off in a statistically good scattering of frequency balances. There were not too many cassettes that were brighter (generally more abundant in high frequencies) than the discs, but there were enough to suggest that the test conditions were reasonably valid. The one large change in the disc-playback system was the substitution of a very sophisticated low-mass tone arm which eliminated the flutter effects I encountered during the London project. It also resulted in a substantially higher arm-cartridge resonance which did much to reduce the audible effects of *mold grain*, the pebbly texture imparted to the surface of some discs which plays back as a nondescript low-frequency noise.

A number of the cassettes and their corresponding discs have been encoded via the SQ matrix system for optional four-channel playback. These were evaluated both as stereo recordings and through the CBS SQL-200 decoder as quadraphonic recordings (though not commercially available, the SQL-200 is said to be a virtual equivalent of the more sophisticated consumer decoders of the full-logic, variable-blend type). Doubt has been expressed for some time about the cassette's ability to accept and reproduce matrixed recordings because of the potential for inter-channel phase shift. While studying stereo oscilloscope displays during the London project I was struck by the remarkable similarity in the waveforms derived from the cassettes and the discs, and felt that this boded well for matrixed cassettes. Because of the unusual processing applied to the Angel cassettes, their waveforms resembled those from the discs only intermittently; however, in no case could I aurally distinguish a disc from a cassette on the basis of the four-channel effect yielded. Since all of the selections are classical or light classical, the rear channels carry only ambiance signals with no specific directionality. But listening to the rear channels alone produced a strikingly good match with the disc in virtually every instance.

The basic criteria applied in these evaluations are noise, distortion, wow and flutter, dynamic range, and frequency response (within the cassette's apparent limitations at high levels). Whereas the London cassettes often seemed a bit bass shy, the Angel cassettes were a good match for the disc-playback system, possibly suggesting a difference in recording equalization. Other anomalies will be mentioned in connection with specific recordings.

1. *Orchestral Music of Ravel—Album 5 (the two piano concertos)*, Angel 37151: One of the
(Continued on page 14)

Power Plus.

The Scott R336 Receiver.

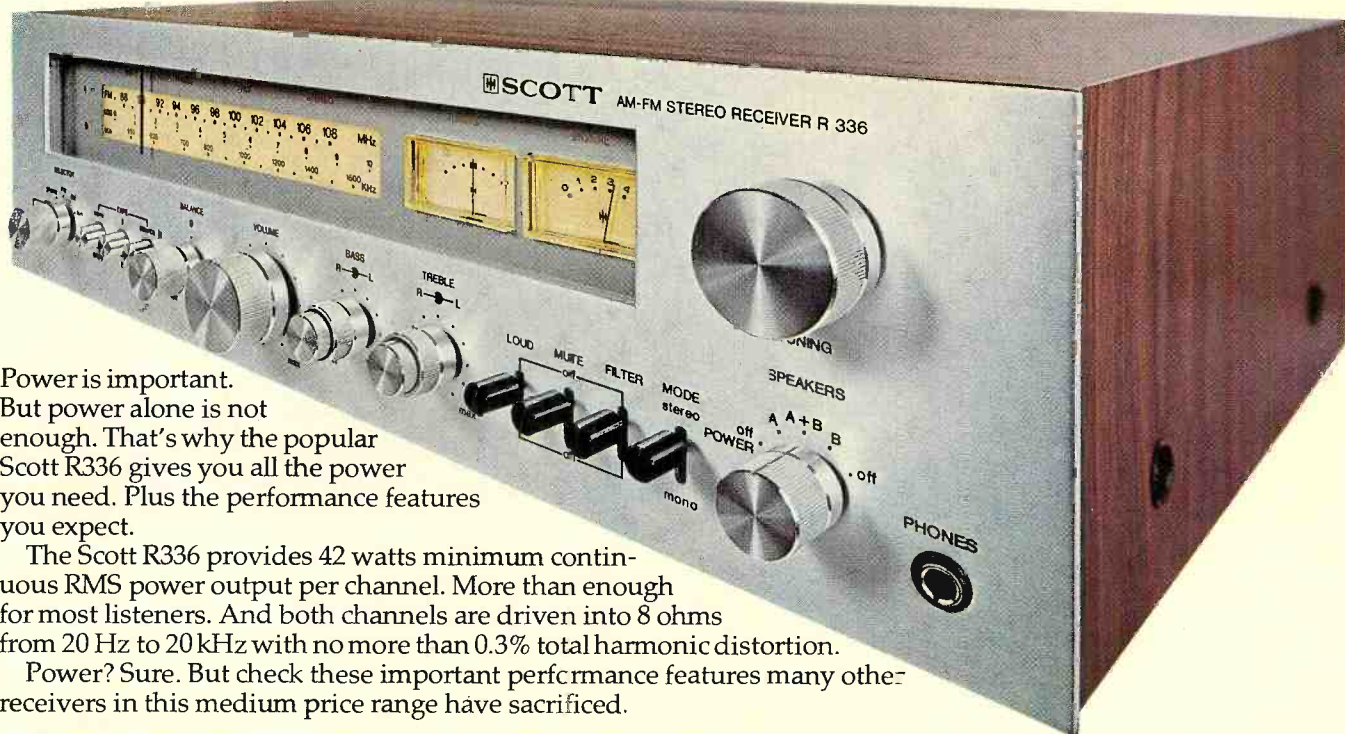

Power is important. But power alone is not enough. That's why the popular Scott R336 gives you all the power you need. Plus the performance features you expect.

The Scott R336 provides 42 watts minimum continuous RMS power output per channel. More than enough for most listeners. And both channels are driven into 8 ohms from 20 Hz to 20 kHz with no more than 0.3% total harmonic distortion.

Power? Sure. But check these important performance features many other receivers in this medium price range have sacrificed.

IM distortion (lower than 0.15%). Far below the average. Provides cleaner sound and eliminates listening fatigue.

Signal strength and center channel tuning meters. Provide simultaneous visual indication of correct tuning and optimum signal strength.

Phase locked loop multiplex section. Maintains superior stereo separation. Remains in alignment for the life of the receiver.

FET RF stage. Assures higher sensitivity and overload immunity.

Log-linear taper volume control with detents. Spreads out volume levels. Provides finer control at low-to-moderate levels.

Clutched bass and treble controls with detents.

Allow altering the frequency response of one channel without affecting the other. Systems can be "custom balanced" to compensate for room acoustics, decor or speaker placement.

Separate high-frequency noise filter. Permits cleaning up of noisy tapes, discs or broadcasts.

Three position FM de-emphasis switch. Permits proper reception of domestic, Dolbyized or European broadcasts.

Two completely independent tape monitors. Allow two tape recorders to be used simultaneously for direct tape-to-tape copying without passing through the receiver's electronics.

FM Muting. Silences interstation hiss while the tuner scans the frequency spectrum.

Pretuned LC notch filters in the multiplex.

Reduce interference to a minimum.

Signal strength meter circuit. Employs two point sampling for wider dynamic range.

Over 120 db IF gain. Assures better limiting and better AM rejection.

Instantaneous electronic protection circuit in the output stage. Employs voltage/current sensing to prevent output transistor failure and speaker damage.

AM section designed around a tuned RF amplifier using J-FET. Improves signal-to-noise ratio.

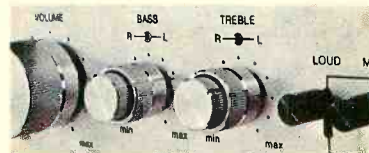

Clutched bass and treble controls with detents.

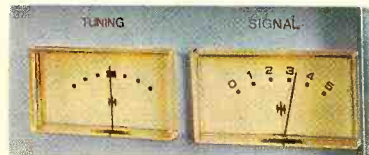

Signal strength and center channel tuning meters.



Two completely independent tape monitors.

And the Scott R336 is backed by a three-year, parts and labor limited warranty. Another very important plus.

For specifications on our complete line of audio components, write or call H.H. Scott, Inc. Corporate Headquarters: 20 Commerce Way, Woburn, MA 01801, (617) 933-8800. In Canada: Paco Electronics, Ltd., 45 Stinson Street, Montreal, H4N2E1, Canada. In Europe: Syma International S.A., 419 avenue Louise, Brussels, Belgium.

SCOTT
The Name to listen to.

Receivers/Tuners/Amplifiers/Turntables/Speakers

CIRCLE NO. 100 ON READER SERVICE CARD

Clearly

Nakamichi proudly introduces

its first all-electronic components, backed by world-famous Nakamichi engineering and manufacture. The 610 Control Preamplifier and the 620 Power Amplifier offer no-compromise performance and flexibility that is clearly Nakamichi. Grouped with the exciting new 600 Cassette Console, they comprise the Recording Director Series — elegantly styled with identical profiles, each is a study in human engineering.

The 610 Control Preamplifier is three devices in one. As a stereo preamplifier its performance and color-free sound invite comparison with the finest units available. It also functions as an advanced test center, with built-in test tones, pink noise generator and precision meters — just to name a few. As a studio-quality mixer, any 5 of 19 different inputs can be selected in many combinations. The creative audiophile will find no end to the 610's capabilities.



Phono S/N Ratio (IHF-A): Better than 80 dB (0 dB=1 mV); THD: Less than 0.005%
Meters: -40 dB to +10 dB range, peak reading; Frequency Response: 5 Hz-150 kHz \pm 0.75 dB

610

THE NEW ANGEL CASSETTES

(Continued from page 12)

best recordings of the lot in both disc and cassette versions; bright and alive, although perhaps a bit too close up for some tastes. The cassette is slightly hissier than the disc, slightly brighter, and compression is often heard.

2. Mozart: The Four Horn Concertos, Angel 36840: Another good recording, with a fine sense of space. The disc is slightly brighter than the cassette and slightly hissier, suggesting that the hiss comes from the master. Barry Tuckwell's horn is recorded at phenomenally high levels at some points on the cassette, but tape-overload effects are only rarely evident (in a sort of "blaart" tone acquired by the instrument) and compression effects do not really stand out.

3. Respighi: Ancient Airs and Dances, Angel 37301: Not as distinguished an example of the recording arts as the above two, but pleasant enough. The disc is slightly brighter than the cassette, and occasionally the cassette sounds just a tad muffled on high-level passages, although effects of gross compression are not very often audible. This is an SQ recording, and during the stereo evaluations I was struck by a hole-in-the-middle discontinuity in the stereo image on both versions.

Listening through the SQ decoder seemed to cure this problem, and the whole thing came off very nicely.

4. Beethoven: The Favorite Piano Sonatas ("Moonlight," "Pathetique," "Les Adieux"), Angel 36424: The tape jammed early in this comparison (my fault, I think) and there was not sufficient time to get a replacement. However, initial impressions were that the cassette was coming out ahead. Both versions exhibited ample hiss, but the cassette seemed to



have somewhat less. Otherwise they appeared generally similar.

5. Pleasures of the Court (dances by Susato and Morley), Angel 36851: Here was an instance in which running the cassette through in fast wind and cleaning the machine's heads helped a little, although the cassette was still

significantly dimmer and more muffled than the disc. The terraced dynamics of the music kept any compression effects from being obnoxiously apparent, although the recorded levels on the cassette were quite high in some places.

6. Itzhak Perlman Plays Fritz Kreisler, Angel 37171: Early twentieth-century works for violin with piano accompaniment, in the romantic and sometimes sentimental vein. The violin is generally too big and too close for comfort, and compression is audible on the cassette. Otherwise, hiss levels and frequency balances are similar to those of the disc.

7. Romantic Orchestral Music (works by Albinoni, Holst, Prokofiev, Rachmaninoff, and Ravel), Angel 37157: The disc is much brighter and much hissier. The average recorded level on the cassette is high, and compression is distinctly audible on the excerpt from Prokofiev's *Romeo and Juliet*.

8. Music for Silent Film Classics (works composed to accompany films by D. W. Griffith), Angel 36092: These efforts on one of the better-known "mighty Wurlitzer" pipe organs do little to elevate either the cassette or the disc, both being plagued with a seasick shudderiness that, while characteristic of the instrument, sounds like a serious case of intermodulation effects as well. The cassette manages to equal the disc in low frequencies most of the time (they are not too demanding, but they are constant), but it is dim and muddy up above. The mighty Wurlitzer exhibits

Nakamichi!

The 620 Power Amplifier boasts harmonic and M distortions so low they cannot be reliably measured with the best test instruments. It is unconditionally stable under any load, including a direct short circuit. The power supply packs more punch than units several times its size. A unique biasing circuit cuts idling current by 1/20 and keeps the bold heat sink fins cool to the touch. Peak indicator lamps glow green or red for each channel at pre-settable power output levels.

For complete information, write Nakamichi Research (U.S.A.), Inc., 220 Westbury Ave., Carle Place, N.Y. 11514 or see your Nakamichi dealer soon and ask for a demonstration of the 610 and 620 together with the incredible 600 Cassette Console (now also available in matte black finish).

620 Power Output: 100 watts per channel min. RMS, 8 ohms, 5 Hz-20 kHz, with no more than 0.01% THD
IM Distortion: Less than 0.002% at 100W/8 ohms (60 Hz: 7 kHz, 4:1); S/N Ratio: Better than 120 dB (IHF-A)

little dynamic range to speak of, and audible compression is therefore not apparent.

9. *Rimsky-Korsakov: Scheherazade, Angel 37061*: Here we enter an area—large-scale orchestral/operatic works—in which the cassette tends to be in over its head. Hiss seemed to be higher on the cassette (there was plenty on the disc too), but frequency balances were in general quite similar. The real trouble occurred with such things as big, hard cymbal crashes—practically absent on the tape but devastating on the disc. Nevertheless, if you can accept the loss of percussion, *Scheherazade* does not require a lot of dynamic range to be appreciated, and the cassette is probably an acceptable substitute for the disc version.

10. *Bellini: I Capuleti e i Montecchi, Angel 3824*: This is a lively, even violent recording on disc and a disappointment on cassette. As levels increase during the overture, the cassette first loses the cymbal crashes (you can sense the “holes” where they should be without hearing them), then the triangle, and in the conclusion of the opening chorus the male voices finally begin to drop out. Switching back to the disc brings all of these back with a vengeance. Compression on the cassette is severe—it ultimately begins to sound quite constricted. Yet overall frequency balance (at less than the higher levels) is similar to that of the disc, as is the noise level, although I found the disc slightly brighter and noisier.

11. *Holst: The Planets, Angel 36991*: The disc copy sent by Angel to accompany the

cassette was so dim and murky in sound that I quickly switched to the British pressing (EMI ASD 3002) acquired for the evaluation of good disc recordings. Arnis Balgalvis and I reported on in our April “Hot Platters” article. It proved to be a good match for the cassette in general frequency balance (it was appreciably less hissy) and ridiculously superior in dynamic range. Since I was quite familiar with the basic recording, I decided to see if I could unlimit the compression on the cassette to approach something of the disc’s character. Us-

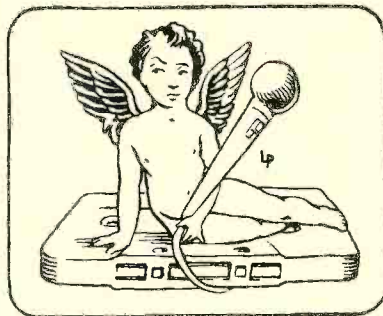

ing a dbx Model 119 in its expansion mode with the threshold set so it began to expand at about 0 dB on the cassette deck’s meter (the Model 119 has a variable threshold, and thus can undo some of the effects of peak limiting), I was just about able to equal some of the disc’s remarkable vigor. But it took literally all the expansion the dbx device could pro-

vide (a rated two-to-one ratio) at the closing moments of the “Jupiter” movement, and it still entailed a “crunching” of cymbals and other high frequencies. However, the tape can be impressive when so processed.

12. *Introducing the Sound of Angel XDR Cassette Tape*: This is the demonstration tape to which I referred earlier. Many of the excerpts from the above recordings seem to have been compressed even more severely, with the idea (I suppose) that if louder is better, constantly loud is better still. I consider the tape nonmusical; fortunately it is also noncommercial, so no one is going to be asked to buy it.

WHAT can be concluded from all this? Certainly that cassettes are getting better; they now actually bear being talked about in the same breath as discs, which was hardly true a rather short time ago. Still, they cannot approach the dynamic range of a good disc recording without serious losses in signal-to-noise ratio or high-frequency response.

Some people have suggested to me that I am too hard on cassettes in comparing them directly with disc recordings, the idea being that they can stand on their own merits when listened to in isolation. I tentatively agree, and I think the above comments indicate what is worthwhile listening fare in the cassette format. But I am not yet convinced that the cassette can, in its present form, give us full satisfaction on heavy orchestral and operatic works. That may soon change, for Angel (and others) can be expected to go on trying. □



Jensen Headphones. Concert halls for your ears.

Discover jazzier jazz. Earthier rock. Classier classical. And bluer blues.

Jensen headphones are your season tickets to stereo enjoyment. They're a completely new dimension for your stereo system, with five decades of Jensen home and auto speaker technology behind them.

Choose from three models with features like patented acoustical driver cavities, liquid filled ear cushions, anti-tangle coil cords, and a moderate price range both you and your wallet can appreciate.

But don't listen to us...listen to our headphones.

For more information and the name of your local Jensen dealer, write Jensen Sound Laboratories, Dept. SR-106, 4310 Trans World Road, Schiller Park, Illinois 60176.



JENSEN
SOUND LABORATORIES
Division of Pemcor, Inc.

CIRCLE NO. 26 ON READER SERVICE CARD

JVC Model JA-S71 Integrated Stereo Amplifier

The Model JA-S71 from JVC is the largest integrated amplifier offered by the company, providing 80 watts per channel continuous into 8 ohms over the full 20- to 20,000-Hz range with no more than 0.1 per cent harmonic or intermodulation distortion. The amplifier provides inputs for two phono cartridges, two auxiliary high-level sources, tuner, and three tape decks with complete tape-monitor facilities and dubbing capability from any one to any other(s). Inputs and outputs for one of the decks are located on the front panel in the form of four standard phono jacks. Switchable high- and low-cut filters act above 9,000 Hz and below 18 Hz. The bass and treble controls can be switched in or out of the circuit by means of a separate switch. A mode selector has positions for stereo, normal and reversed, mono, and either channel alone. Two pairs of speakers are accommodated, with switching to activate either pair alone, both at once, or both off to facilitate headphone listening through the adjacent front-panel phone jack. The large volume control rotates through 22 detented steps, each of which is calibrated in decibels, and its associated loudness compensation can be switched in or out. In an unusual feature, the JA-S71 provides for front-panel switching of both the impedance and the capacitance of the phono inputs, with positions for 100,000, 47,000, and 33,000 ohms, and 330 or 100 additional picofarads.

The signal-to-noise ratio for the amplifier's phono inputs is 65 dB. The filters both have slopes of 6 dB per octave, and the bass and treble controls provide an adjustment range of ± 8 dB at 100 and 10,000 Hz. The phono inputs have a headroom before overload of 210 millivolts. The amplifier measures approxi-

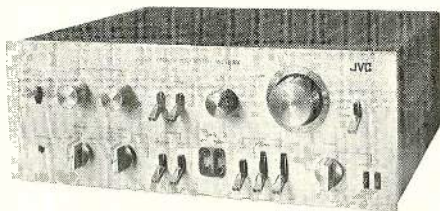

mately 16 $\frac{3}{4}$ x 6 $\frac{1}{2}$ x 15 $\frac{1}{2}$ inches; its weight is just over 35 pounds. Approximate retail value: \$400.

Circle 115 on reader service card

ADS Model 910 Speaker System

The Model 910 from Analog & Digital Systems is the manufacturer's premium speaker, said to be suitable in its power-handling capability and overall performance for professional as well as home applications. It is a three-

way system with a 1-inch soft-dome tweeter, 2-inch soft-dome mid-range, and two 10-inch woofers working in a separate sealed sub-enclosure. The 910's built-in crossover network divides the input frequencies at 450 and 4,000 Hz with slopes of 12 dB per octave. However, the system can also be tri-amplified, and ADS plans to make available a plug-in amplifier module providing 200 watts for the woofers, 50 watts for the mid-range, and 25 watts for the tweeter.

The 910's frequency response is given as 28 to 20,000 Hz ± 3 dB. For an input of 1 watt, the output is a sound-pressure level of 94 dB at a distance of 1 meter. With the conventional crossover network, power requirements into the system's 4-ohm impedance range from a minimum of 15 to a maximum of 300 watts continuous. All drivers employ aluminum voice-coil bobbins to enhance power-handling capability. The Model 910 is finished in walnut with a black removable grille. External dimensions are 33 $\frac{1}{2}$ x 19 x 15 $\frac{1}{4}$ inches; weight is 80 pounds. Price: approximately



\$540 (\$560 in the West). An optional swivel stand that attaches to threaded sleeves in the sides of the Model 910 costs about \$70.

Circle 116 on reader service card

Bang & Olufsen 1900 Turntable

The Beogram 1900 turntable is actually a complete integrated record player consisting of turntable, tone arm, and phono cartridge. The cartridge, B & O's Model MMC 4000, is mounted on the tone arm by means of a plug-in arrangement that greatly reduces effective mass, resulting in an arm-cartridge resonance well above 10 Hz. A lead counterweight is used to permit the center of mass to be located very close to the tone-arm pivots. The arm, which is not intended to accept any other cartridge, has fixed skating compensation pre-adjusted for the cartridge's recommended 1-gram tracking force. However, the tracking force is adjustable by means of a weight that slides along a scale calibrated in 0.1-gram increments.

The turntable itself is a belt-driven, two-speed (33 $\frac{1}{3}$ and 45 rpm) design with a fine-tuning speed adjustment that is variable over a range of ± 3 per cent. The only control on the turntable is a multifunction rocker switch that is flush with the chassis surface. It turns on the unit, selects speed, and activates the fully automatic cycling of the tone arm when rocked in the appropriate direction. Internally

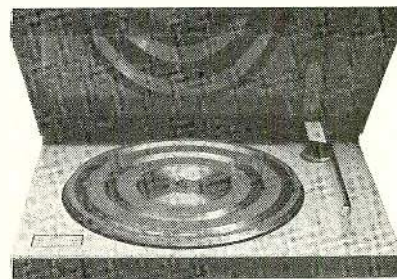

the platter and tone arm share a common sub-frame that is acoustically isolated from the turntable's base and motorboard by means of leaf springs. Rumble, unweighted, is better than -42 dB, and wow and flutter are less than ± 0.035 per cent. The MMC 4000 cartridge has a 0.2 x 0.7-mil diamond elliptical stylus and a frequency response of 20 to 25,000 Hz ± 1.5 dB. Output exceeds 0.6 millivolt for a recorded velocity of 1 centimeter per second.

The Beogram 1900 is supplied complete with wood base and a hinged, tinted dust cover. Overall dimensions are 3 $\frac{3}{8}$ x 17 $\frac{3}{8}$ x 13 inches. Price: \$325.

Circle 117 on reader service card

Advent Model 300 Stereo FM Receiver

The FM-only Model 300 is Advent's first receiver. It provides continuous output of 15 watts per channel into 8 ohms from 40 to 20,000 Hz with less than 0.5 per cent harmonic distortion. Although outwardly simple in appearance, the receiver is said to have been electrically designed on the basis of new investigations into the behavior of audio circuits under typical operating and signal conditions. For example, the phono inputs are immune to response-altering interaction with phono cartridges. Also, pains have been taken to ensure that the amplifier section will deliver full rated power to all loudspeaker loads.

The tuning mechanism of the Model 300 is a rotary vernier knob that works with calibrations marked directly on the receiver's front panel. Associated with it are a stereo indicator light and a channel-center tuning indicator that consists of two LED's that glow with equal intensity when a station is properly tuned in. Knob controls adjust volume, balance, bass, and treble and also select among phono, tuner, or an auxiliary high-level source. There are slide switches for tape mon-

(Continued on page 20)

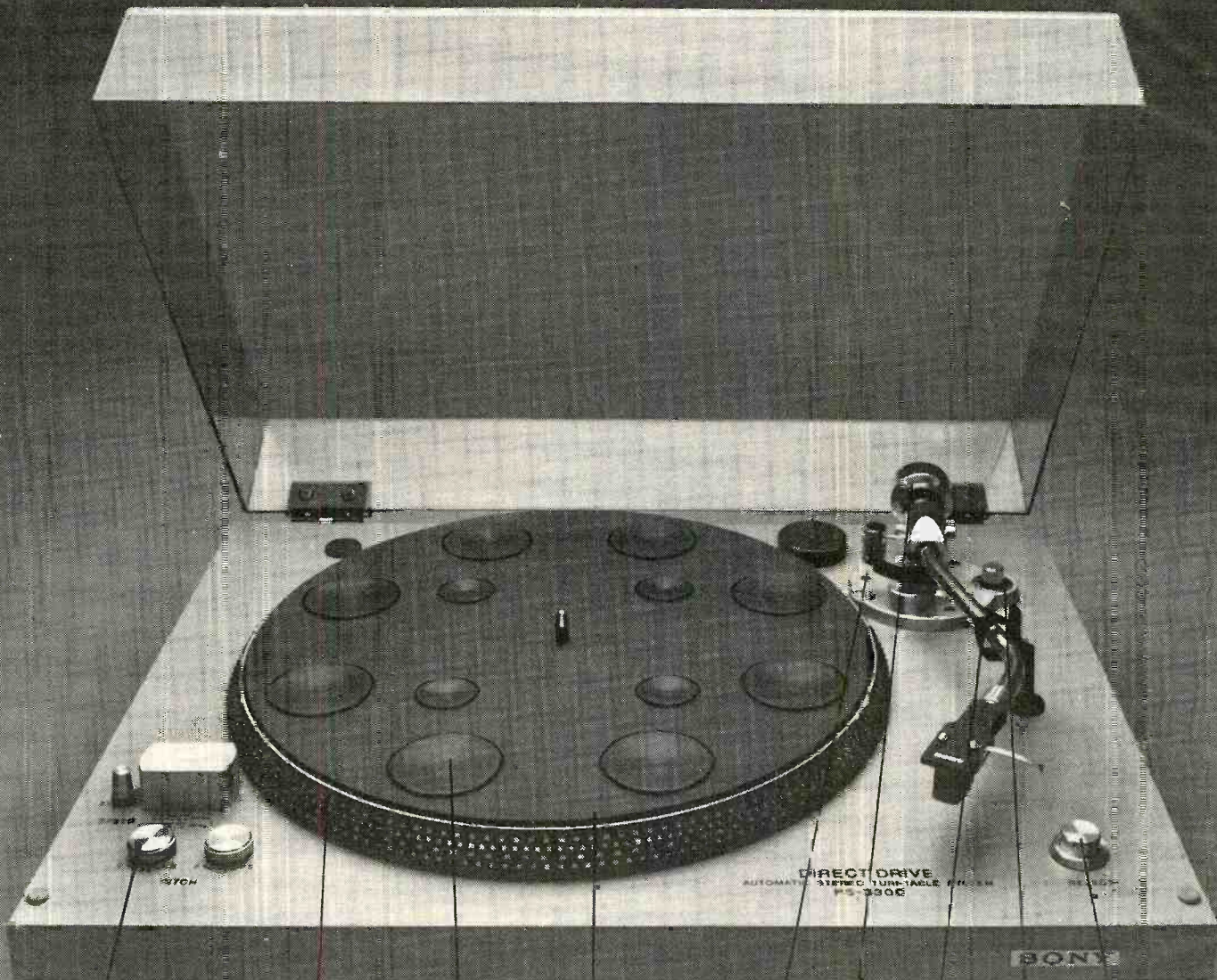

DIRECT DRIVE
AUTOMATIC STEPPED TURN-TABLE MOTOR
PS-200S

SONY

Bell shaped rubber suspension.

Rubber record mat with air-damped record cushions.

Tracking force ring.

Reject button.

Electronically controlled speed selector and pitch controls.

Built-in stroboscope.

Precision machine finished aluminum platter with speed monitor magnetic coating.

Lateral Balancer.

Viscous-damped cueing lever.

Calibrated Anti-skating compensation.

Cartridge not included

Pioneer's publicized \$200 direct drive manual turntable has just been shot down by our semi-automatic.

Sorry, Pioneer. But all's fair in love and product war.

In that spirit, Sony unveils the PS-3300. A \$200 direct drive turntable that's *semi-automatic*.

So the contest between our PS-3300 and their vaunted PL-510 is really no contest. Because in the crassest terms, we give you more: an automatic arm return and a reject button.

And that's a substantial difference, for no difference in price.

What's more, we didn't shave anything to make it possible.

The PS-3300 has a finely crafted direct drive system with a brushless and slotless DC servo-controlled motor.

The PS-3300 innovates with a speed monitoring system that state troopers would love to get their hands on: an electronic process using an 8-pole magnetic pick-up head and a pulse coated platter rim.

Plus there's independent fine speed adjustments, a tonearm that's so sensitive it's almost neurotic, and so on.

And to see the attention to detail that Sony stands for, note what the PS-3300 stands on. Bell-shaped rubber feet that are specially constructed to prevent both acoustic and mechanical feedback. (When it comes to feedback, we put our feet down.)

They absorb vibrations—whether from footsteps bouncing on the floor or sound waves bouncing off the wall. Otherwise, these vibrations would be transferred to the stylus, amplified, and be transferred back to the stylus—creating a vicious cycle.

If you're wondering how we managed to do this—how our semi-automatic shot down their high-flying manual—our response is a brief one.

While Pioneer relied on its reputation, Sony relied on its engineers.

SONY®

RTR unveils aesthetic sound

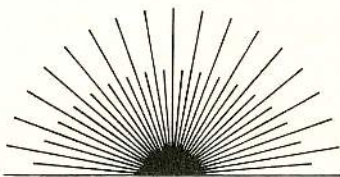

with the EXP bookshelf system

In a typical listening environment, the bookshelf speaker is a perfect design entity. It fits logically, aesthetically within a room. If only the sonic coloration could be eliminated, it would be an ideal loudspeaker.

Now RTR unveils audiophile bookshelf speakers for those who take their music seriously.

The EXP series delivers pure musical reproduction. Free of coloration, full of transparency, they reflect the most critical RTR standards. Wide-band tweeter exhibits the best transient performance from 1,000 to 15,000 Hz of any dynamic tweeter. Woofers deliver hair-line delineation coupled with natural boom-free bass.

All in a bookshelf package and price. Hear a pair of EXP's at your franchised RTR dealer.

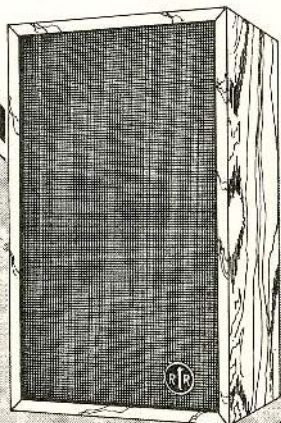

For dealer list and specifications, write RTR, Dept. SR, 8116 Deering Ave., Canoga Park, CA 91304.

CIRCLE NO. 49 ON READER SERVICE CARD

New Products the latest in high-fidelity equipment and accessories

itor, loudness compensation, mono/stereo mode, interstation-noise muting, and speakers (two pairs accommodated). The front panel has a stereo headphone jack. The rear panel, aside from standard inputs and outputs, has phono jacks providing access to the preamplifier outputs and power-amplifier inputs plus an 18-volt d.c. "supply" output that can be used to power such accessories as the Advent microphone preamplifier.

The FM specifications of the Model 300 include a usable sensitivity of 2.2 microvolts, a 50-dB quieting sensitivity of 5 microvolts, and a 1.4-dB capture ratio. Harmonic distortion (mono) is less than 0.2 per cent; image and i.f.



rejection are 53 and 70 dB, respectively; spurious-response rejection is 75 dB; and AM suppression is 55 dB. Frequency response is 20 to 15,000 Hz ± 0.5 dB. The signal-to-noise ratio for the phono inputs is 82 dB. The receiver measures approximately 16 x 3½ x 10¾ inches overall. Price: \$259.95. For a slight additional cost the Model 300 comes fitted with a switching-mode power supply which enables it to operate from a 12-volt storage battery.

Circle 118 on reader service card

Micro-Acoustics 2002-e Stereo Phono Cartridge

The electret transducer introduced to phono cartridges some years ago by Micro-Acoustics has now been applied to a new pickup, the 2002-e. Like previous models, the new cartridge is tolerant of wide variations in loading by preamplifier and interconnecting cables. According to the manufacturer, the 2002-e has been designed for both maximum tracking



ability and maximum transient response. A 0.2 x 0.7-mil elliptical diamond stylus is employed, mounted on a lightweight beryllium cantilever that is said to contribute greatly to low tip mass. Frequency response is 5 to 20,000 Hz ± 1.5 dB, with an output of 3.5 millivolts for a recorded velocity of 3.54 centimeters per second. Recommended stylus force is 1 gram or less; the weight of the cartridge itself, including mounting hardware, is 4 grams. Stereo separation is 30 dB at 1,000 Hz. Price: \$115. User-replaceable styli cost \$42.50 each.

Circle 119 on reader service card

B.I.C. Model 920 Automatic Turntable

At \$79.95, the Model 920 is the least expensive unit in the B.I.C. turntable line. It employs a belt-drive system for its 10½-inch platter and it has the B.I.C. "programming" control that sets the changer mechanism up for automatic play of from one to six records. Speeds of 33⅓ and 45 rpm are provided.

The 920's tone arm is initially balanced with a rotating counterweight, after which a small sliding weight on the calibrated tone-arm shaft is used to set tracking force. Anti-skating compensation is independently adjustable by means of a calibrated knob beneath the arm base. A cueing mechanism, operated by a lever near the tone-arm pivots, is damped in both directions of travel.

Overall dimensions of the Model 920, with base and dust cover, are 15¼ x 6¾ x 13¾ inches. The rumble level is -60 dB or less (DIN B weighting), and wow and flutter are better than 0.12 per cent. Bases and dust cov-

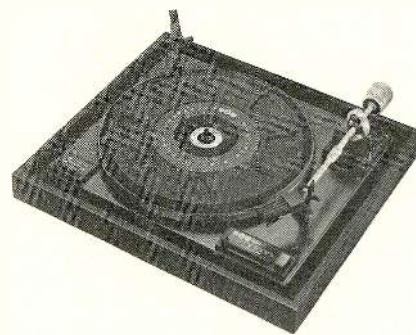

ers are optional at \$14.95 for a wood base, \$4.95 for a plastic base, and \$7.95 for a dust cover.

Circle 120 on reader service card

Aiwa AX-7500 AM/Stereo FM Receiver

As its top-of-the-line receiver, Aiwa has introduced the AM/FM AX-7500, a unit providing at least 30 watts per channel (20 to 20,000 Hz) into 8-ohm loads with a maximum of 0.2 per cent harmonic or intermodulation distortion. Weighted signal-to-noise ratios are 80 dB for phono and the auxiliary high-level input, and 90 dB for the two tape inputs. The amplifier section has a frequency response of 10 to 70,000 Hz $\pm 0, -1$ dB for high-level sources; the phono preamplifier matches the RIAA characteristic within ± 0.3 dB and the phono overload level is 200 millivolts at a frequency of 1,000 Hz.

On FM, the AX-7500 has a usable sensitivity of 1.8 microvolts and a capture ratio of 1 dB. Spurious-response rejection is 75 dB, AM suppression is 50 dB, and stereo separation at 1,000 Hz is 43 dB. Harmonic distortion is 0.25 per cent for mono, 0.4 per cent for stereo, and

the tuner's ultimate signal-to-noise ratio is 70 dB.

Distinguishing features of the AX-7500's control panel are the separate narrow tuning dials for FM and AM, both of which extend the full width of the receiver. Below the dials

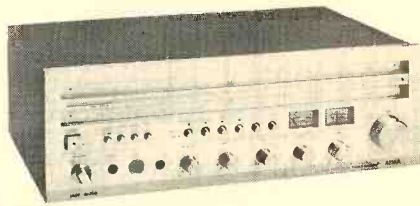

are tuning meters for signal strength and center-of-channel, plus a row of pushbuttons to select program source and tape-monitoring functions (dubbing from one of the tape decks to the other is possible) and to introduce FM interstation-noise muting, loudness compensation, rumble filter, and AFC. The receiver has knob controls for tuning, volume, balance, and bass and treble (± 10 dB at 100 and 10,000 Hz, respectively), and a sixth knob adjusts the level of the front-panel microphone input. Two pairs of speakers are accommodated, and these can be played together, separately, or silenced completely by means of a rotary selector. The front panel has a headphone jack and a DIN connector for one tape deck. Approximate dimensions of the AX-7500: 17 $\frac{3}{4}$ x 6 $\frac{3}{8}$ x 14 $\frac{1}{4}$ inches. Price: \$360.

Circle 121 on reader service card

AKG Microphone Application Guides

AKG has prepared six "application guides" to assist recordists and musicians in selecting microphones for their specific purposes. The situations covered are solo vocalist (with either hand-held or stationary microphones), vocal groups, solo instruments, vocalist with instrument, instrumental groups, and specialized applications such as broadcast work or TV and film sound. The guides cover such considerations as optimum frequency response for different instruments and voices, cardioid vs. omnidirectional microphone response, proximity effect, and microphone placement. The appropriate AKG microphones for each application are described, together with brief specifications, and suitable cables and adapters for various hook-ups are recommended.

The AKG guides are available as a set of six fastened into a blue 9 x 12 binder together with notes on the understanding of technical specifications and a catalog of AKG microphone stands and accessories. Distribution of the guides is through local AKG dealers and representatives.

Micro-Acoustics TT-2002 Test Record

To evaluate the tracking ability, transient response, and stereo separation of phono cartridges, Micro-Acoustics has prepared a test record employing both electronically generat-

ed test tones and natural musical sounds, some of which are said to have been recorded at the highest levels of which modern disc-cutting equipment is capable. Side one is devoted principally to high- and low-frequency test tones, separate and mixed, that are recorded in stereo and shifted progressively between channels, together with some demanding percussion sounds. Side two consists of excerpts from selected commercial recordings, both classical and popular. The record includes complete instructions on how to evaluate the tests as well as advice on what specific things to listen for in the musical selections. It is available by mail from Micro-Acoustics Corp., Dept. SR, 8 Westchester Plaza, Elmsford, N.Y. 10523. Price: \$3.50, postpaid.

Metrosound Discmaster Record Cleaner

Metrosound, a company specializing in adjustment and maintenance accessories for record players and tape machines, has introduced the Discmaster record-cleaning system to be distributed by RNS Marketing in the U.S. The heart of the Discmaster system is a pseudo "tone arm" that plays the record with either of two attachments. One of the attachments is a "wet" cleaner that applies a cleaning solution to the record by means of the capillary action of a special brush-and-pad arrangement. Attachment number two plays the record dry, removing surface dust with a brush and plush-pad assembly. The attachments are meant to be used separately, the dry cleaner for every record as it is played, and the wet system as required. They plug into the arm proper by means of suitable connectors. A reservoir in the wet attachment contains a sufficient amount of fluid for a number of cleanings.

The Discmaster arm has an aluminum counterweight and a weighted base that holds the mechanism on the turntable motorboard; it

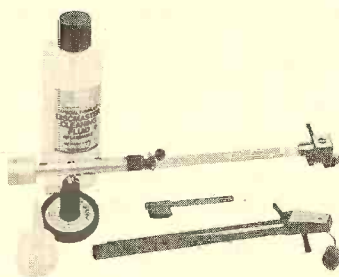

needs no adhesives or fasteners. A height adjustment is provided to bring the arm parallel to the platter surface. Also included with the system are a bottle of cleaning solution, a special nozzle to fit the filling aperture of the fluid reservoir, and a brush to remove dust and deposits from pads and brushes. Price: \$23.49. Refill bottles of cleaning solution are \$3.49.

Circle 122 on reader service card

PUBLISHER'S NOTICE: Recent fluctuations in the value of the dollar will have an effect on the price of merchandise imported into this country. So, please be aware that the prices quoted in this issue may be subject to change.

SONUS



SONUS PHONOGRAPH CARTRIDGES

*In just a few minutes
your "subconscious"
tells you they're the best!*

An insidious form of distortion you may not even be aware of, is causing "listening fatigue" as you play your records. After about 15 minutes of a complex, musically demanding record, it shows up. You feel vaguely anxious, irritable, and ready to turn off the music. That's "listening fatigue"—virtually eliminated at last with the new Sonus phono cartridges.

You can hear and feel the difference in the time it takes to play one side of a record. Sonus has reduced intermodulation and related distortions to previously unachieved levels, reducing these sources of "listening fatigue" to the vanishing point. As you listen, you discover that the emotional tension formerly caused by this distortion is gone. The music comes through with an effortless clarity and definition, as you listen with more attention, more relaxation, and far more pleasure than ever before.

The new Sonus cartridges take you closer to an actual performance than any other cartridges have been able to, until now.

"At one gram, the SONUS Blue Label was audibly superior . . . the sound was excellent in every respect."

Stereo Review/Hirsch-Houck Laboratories

High Definition Phono Cartridges for The Most Accurate Sound Reproduction Possible.

Write for further information

SONIC RESEARCH INC.

27 Sugar Hollow Rd., Danbury, Ct. 06810

"I've got a 60-minute recording studio in my pocket."

It's called the MICROCASSETTE® Pearlrecorder-S®.



A MICROCASSETTE recorder that's so unique, it's like having your own mini-studio in your pocket with remarkably good fidelity for music as well as voice. It's smaller than a checkbook (5¼" from top to bottom, slightly thicker than a pack of cards), and lightweight (12 ounces with batteries), but it's packed with studio precision and professional features:

- 60 minutes recording time.
- Capstan drive for constant tape speed, built-in electret condenser microphone, AC bias, record-warning light.
- All metal construction for years of dependable service.
- One-hand operation; instant loading.
- Fast forward and rapid rewind.
- Automatic level control.
- Connects to your stereo or full-size recorder with a Compacord, for both recording and playback.

The Pearlrecorder-S performs beautifully in an office, in your car, even on airplanes; and it's backed by the reputation of the Olympus Optical Co., Ltd., a company famous for fine cameras, medical and other precision scientific instruments.

The Pearlrecorder-S. Carry one. And have a studio with you.

Available at fine photographic, audio, and A-V dealers everywhere. Or write for our brochure, "Pocket Full of Miracles."

OLYMPUS CORPORATION OF AMERICA
TWO NEVADA DRIVE/NEW HYDE PARK, NEW YORK 11040
In Canada: W. Carsen Co., Ltd., Ont.
60 minutes of sound in this actual-size MICROCASSETTE.®



CIRCLE NO. 41 ON READER SERVICE CARD

Audio Q. and A.

By Larry Klein



Recorders and Dimmers

Q. I have found that a.c.-operated tape recorders will frequently not record when powered from outlets on a circuit with solid-state dimmers. Why is this so, and can the recorder be damaged by the attempt?

MAURICE BULLARD
Corvallis, Ore.

A. Solid-state dimmers operate by, in effect, suppressing a part of the a.c. line's sinusoidal waveform. This works because an incandescent lamp responds (by dimming) only to the lower effective voltage fed to it and doesn't care what the waveform looks like. Such dimmers are popular because they run far cooler than equivalently effective dimmers using resistors; they are also far more compact and less expensive than transformer-type dimmers. However, as said, solid-state dimmers do distort the a.c. waveform, which could cause a motor to react peculiarly (run off-speed, lose torque), and could also introduce considerable noise into sensitive circuits. I'm told that other somewhat mysterious phenomena occur too; everything seems to be normal during recording—except that nothing shows up on the tape. Offhand I can't see how a dimmer in the line could do that, but I guess strange things can happen objectively—as well as subjectively—in the wonderful world of audio. Therefore, in respect to potential damage, it would probably be wise *not* to operate an a.c. recorder on a dimmer-controlled line.

Amplifier-Sound Differences

Q. As one of those equipment reviewers referred to in your Q & A column of June 1976 who is able consistently to hear differences between different power amplifiers, I can assure you that "level differences," minute or otherwise, have nothing to do with it. The matching of output levels when switching between two amplifiers is irrelevant because I do not use fast-switching A-B comparisons. I test an amplifier by installing it in a system where the other components have known characteristics—and it need not be a "super"-system—and listening to it and it alone for anywhere from a day to a month, reproducing a wide variety of recordings.

During that time, certain audible patterns usually emerge. The bass may sound deep and taut in a few recordings and heavy, sodden, and loose in the vast majority of recordings,

leading to the conclusion that the amplifier will under-damp most loudspeakers. The highs may sound steely in most recordings and natural in but a few, indicating that the amplifier itself is "hot" at the top. The sound may be flat and lacking depth, or it may seem slightly veiled rather than lucid and transparent.

There is no attempt to monitor listening levels other than to check periodically to see that, for instance, symphonic music is not exceeding the 95-plus-dB levels of the real thing. Maximum levels are likely to range from 70 to 98 dB during the course of the tests, yet the sonic "flavor" of each amplifier remains audible at all reasonable levels. And if one of them happens to be "compressing dynamics" by sliding into marginal overload at levels which comparably powered units can easily cope with, then that is just as much a "difference" as the other things I listen for.

If this all sounds too personally subjective for people who must cling to measurements like some sort of security blanket, my only defense is that (1) my observations have proved to be consistently repeatable under these conditions, and (2) they have agreed with the findings of other audiophiles who, having purchased the amplifiers in question, had no choice but to form their own opinions in exactly the same manner—by prolonged listening.

J. GORDON HOLT
Stereophile Magazine
Elwyn, Pa.

A. I have the utmost respect for J. Gordon Holt's dedication and seriousness about audio matters as reflected in his publication. However. . . . What I understand him to be saying is that instant A-B switching comparisons of power amplifiers may not disclose some particular sonic characteristic that will nevertheless become audible with long-term listening. I can conceive of this being true *only* when the program material is not varied enough to cover all the areas of concern, such as frequency and transient response, distortion, etc. Obviously, if an amplifier has a "sodden" bass and it is auditioned only with the tester's favorite solo-flute recording, the bass problem may escape notice. Of course, no reviewer would commit that gross an error, but it is possible that there may be certain inadequacies in, say, a particular amplifier's transient response to certain special combinations of signals that may slip
(Continued on page 24)

Technics introduces components designed for professional use only.

The SE-9600P. Regulated stereo power amplifier with a lot more than just power. Like 100% constant-current and voltage power-supply regulation. Which means complete freedom from transient IM distortion. It also means high-level transients introduced in one channel won't affect the other. There's also only 0.08% IM distortion. A frequency response of 5 Hz to 150kHz (+0dB -3dB).

A S/N ratio of 110 dB. A 4-step damping factor control. And 110 watts per channel, minimum RMS, into 8 ohms from 20 Hz to 20 kHz with no more than 0.08% total harmonic distortion.

The SU-9600P. The stereo preamplifier that performs as well as it looks. Starting with an unheard of magnetic phono overload tolerance of more than 1 1/3 volts (1350mV RMS at 3mV sensitivity). An equally impressive phono-2 S/N ratio of 76 dB (referred to 3mV input). Virtually non-existent total harmonic distortion (0.02%). As well as bass and treble negative-feedback tone controls calibrated in 2.5 dB steps. With turnover pushbuttons at 125 Hz and 500 Hz as well as at 2kHz and 8kHz.

The SH-9090P. The Universal Frequency Equalizer that has no equal. You get 12 dB of boost or attenuation for 12 bands (10 Hz to 32 kHz). Plus the center frequency of each band can be continuously shifted by as much as ±1 octave. In addition, the bandwidth (Q) for each of the 12 bands is continuously variable from 0.7 to 7. The result: You have more control over response shaping than with any other single instrument. (Configuration: one in, one out.)

The SP-10MKII. In every respect, it's everything you want in a professional turntable. So much torque it only takes 0.25 of a second to reach the exact playing speed at 33 1/3 RPM. Our lowest wow and flutter (0.025% WRMS) and rumble (-70 dB DIN B). A quartz-locked frequency generator DC servo motor. And, of course, the reliability of Technics direct drive. The system that radio stations use. And discos abuse. Supplied without tone arm.



Panasonic Company
Technics Dept. 810
One Panasonic Way
Secaucus, N.J. 07094

Attention: Sid Silver,
Technical Service Specialist.

- Send me technical information on the Technics Professional Series.
 Have a Technics audio specialist call for an appointment.

NAME _____ TITLE _____
Please Print
COMPANY _____
ADDRESS _____
CITY _____ STATE _____ ZIP _____
AREA CODE _____ PHONE NUMBER _____

Technics
by Panasonic
Professional Series

CIRCLE NO. 61 ON READER SERVICE CARD

The phono cartridge that doesn't compromise any modern record.

AT15Sa

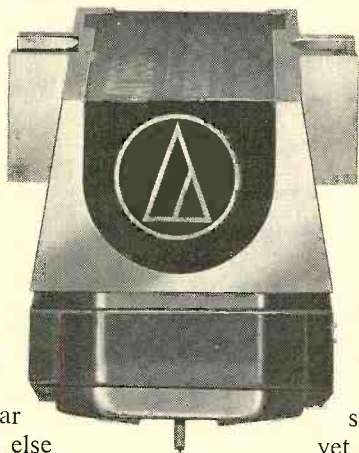

Choosing an AT15Sa can add more listening pleasure per dollar than almost anything else in your hi-fi system. First, because it is one of our UNIVERSAL phono cartridges. Ideally suited for every record of today: mono, stereo, matrix or discrete 4-channel. And look at what you get.

Uniform response from 5 to 45,000 Hz. Proof of audible performance is on an individually-run curve, packed with every cartridge.

Stereo separation is outstanding. Not only at 1 kHz (where everyone is pretty good) but also at 10 kHz and above (where others fail). It's a result of our exclusive Dual Magnet* design that uses an individual low-mass magnet for each side of the record groove. Logical, simple and very effective.

Now, add up the benefits of a genuine Shibata stylus. It's truly the stylus of the future, and a major improvement over any elliptical stylus. The AT15Sa can track the highest recorded frequencies with ease, works in

*TM. U.S. Patent Nos. 3,720,796 and 3,761,647.

any good tone arm or player at reasonable settings (1-2 grams), yet sharply reduces record wear. Even compared to ellipticals tracking at a fraction of a gram. Your records will last longer, sound better.



Stress analysis photos show concentrated high pressure with elliptical stylus (left), reduced pressure, less groove distortion with Shibata stylus (right).

The AT15Sa even helps improve the sound of old, worn records. Because the Shibata stylus uses parts of the groove wall probably untouched by other elliptical or spherical styli. And the AT15Sa Shibata stylus is mounted on a thin-wall tapered tube, using a nude square-shank mounting. The result is less mass and greater precision than with common round-shank styli. It all adds up to lower distortion and smoother response. Differences you can hear on every record you play.

Don't choose a cartridge by name or price alone. Listen. With all kinds of records. Then choose. The AT15Sa UNIVERSAL Audio-Technica cartridge. Anything less is a compromise.

audio-technica 
INNOVATION □ PRECISION □ INTEGRITY

AUDIO-TECHNICA U.S., INC., Dept. 106F, 33 Shiwasssee Ave., Fairlawn, Ohio 44313

by unnoted during a brief A-B comparison. But once the music signal—however special—that discloses the problem is discovered, then it should be easy for anyone to use that particular piece of music in an instant A-B comparison of the reference and test amplifier and hear the difference.

I suspect that two separate issues are being confused: (1) Is there a difference that can be heard under any circumstance? (2) Given such a difference, which sound is closer to the original? Mr. Holt attempts to resolve the second question by listening to a large number of discs and tapes and concluding that if most of them sound a certain way with a given amplifier—the amplifier in and of itself is responsible. However, it seems to me that when it is possible to specify a gross sonic problem such as "heavy" or "hot," it should be easy to measure the electrical factor that is responsible for it. We all agree that it is frequently difficult to measure "transparency" or "lack of depth" since it is not clear which electrical performance factors may be responsible. But with most of the less subtle phenomena it is easy enough to postulate a cause and make a measurement to detect its presence or absence. Measurements, rather than being a "security blanket," can pin-point the electrical-effect responsible for the sonic effect and tell the design engineer what to fix or improve. For a tester, they can help confirm that what he thinks he hears may, in truth, exist.

My approach can be summed up as: (1) If you can hear an effect, it is possible to measure it—which is not the same as saying we know at the moment how to measure everything that can be heard. (2) On the other hand, everything that can be measured does not necessarily have audible effects. (3) Equipment-interface phenomena frequently introduce random elements into a setup that careless observers ascribe to faults in the components. (4) Any sonic phenomenon that is rarely (and inconsistently) heard and cannot be demonstrated to friend and foe alike is more likely to be a product of the listener's biorhythmic cycles than of the equipment.

Finally, the problems of comparison listening tests are obviously complex and certainly require further investigation by all of us who consider both our ears—and our minds—to be open. We welcome further comment.

Wire Recorder

Q. While cleaning up our basement, I found a wire recorder in good working order. My father told me he paid \$650 for it some thirty years ago. I would like to know: (1) Is this an antique? (2) What would be its value today? (3) Who would be looking for such a recorder should I want to sell it?

RICHARD G. GRASS
Cote St.-Luc, Quebec, Can.

A. (1) I'm told that the legal definition of an antique is an artifact over one hundred years old. Therefore, even Valdemar Poulsen's original 1897 wire recorder would not qualify. (2) Value, like beauty, is in the eye of the beholder. (3) If any of our readers express interest, we'll forward their inquiries.

Because the number of questions we receive each month is greater than we can reply to individually, only those letters selected for use in this column can be answered. Sorry!

We pack more features and power into our \$200* receiver than anybody.

The new S100 is a JVC professional.

Which means no other similarly priced stereo receiver approaches its total combination of precision, power and features. So there's no way any other low priced high fidelity receiver can give you the same performance.

Most manufacturers reserve special features and circuitry for their higher priced receivers. But JVC is completely unconventional. The S100 has an expensive phase lock loop circuit for better stereo separation and less distortion. A dual-gate MOS FET and ceramic filters in the FM tuner section provide excellent selectivity and sensitivity. The S100 has two meters—one for signal strength, the other for center-of-channel. You can't get more precise tuning.

The S100 reverses the "low price/low power" trend. It delivers

20 watts per channel minimum RMS, at 8 ohms, from 40 to 20,000 Hz, with no more than 0.5% total harmonic distortion. This is stable power from dual power supplies.

From its extra wide, linear tuning dial to its clean, laboratory styling, the S100 has all the versatility you want in the control center of a fine music system. It has connections for a turntable, tape deck, two pairs of speakers, plus an auxiliary.

Everything is simply controlled with pushbutton selectors and precision, linear slide controls

for bass, treble and volume. Totally functional. Totally professional.

Call toll-free 800-221-7502 for the name of your nearest JVC dealer. He'll show you why he believes people who buy JVC receivers can't get any better for the money.

JVC America, Inc., 58-75 Queens Midtown Expressway, Maspeth, N.Y. 11378 (212) 476-8300

JVC

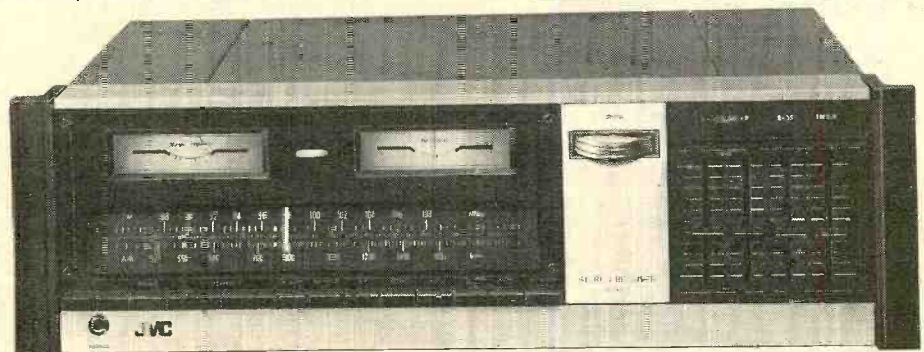

*Approximate retail value.

CIRCLE NO. 27 ON READER SERVICE CARD

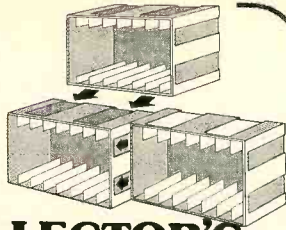

COLLECTOR'S ITEM

A GREAT WAY TO START YOUR EXPANDABLE CASSETTE STORAGE SYSTEM

It's Add 'N Stac[®], the world's only *expandable* cassette and 8-track storage system. Expandable because it provides as much tape storage as your collection calls for. Add 'N Stac[®] is a module, so you can buy only one or a few at a time. Each module has a patented interlocking device on all four sides. As your collection grows you simply lock one module into the next and — Presto! — expansion space.

Add 'N Stac[®] is available in either cassette or 8-track size. Both come in a selection of colors to help you match your decor or color-code your collection by category. Pre-drilled mounting holes let you create a striking wall unit, or if you prefer, stack an arrangement on a table or shelf.

Store, organize and protect your expanding tape collection with the world's only *expandable* system. At under \$2.00 a module, it's definitely . . .

. . . a collector's item.

"... all in all this is the best storage system we know of for the serious collector."

— HIGH FIDELITY

Add 'n Stac[®]

a product of



ROYAL SOUND
COMPANY, INC.

For information ask your dealer or write:

Royal Sound Co., Inc.
248 Buffalo Avenue
Freeport, N.Y. 11520 USA
Registered U.S. Patent Office
U.S. and Foreign Patents

Tape Horizons

By Craig
Stark



RECORDED RESPONSE

IN my June column, in discussing the bass-boost/treble-cut nature of playback equalization (EQ), I noted that the official curves for NAB open-reel and Philips cassettes produce a 3-dB loss at 50 Hz (100 Hz for older ferric-oxide cassettes) and fall off below this at a 6-dB-per-octave rate. Recorder manufacturers who want to maintain flat response at the very low end must therefore incorporate a small but specific bass boost in the *recording*-equalization circuitry of their machines. Some commercial duplicators omit this boost, but most high-quality tape decks do provide it.

At all frequencies above this bottom octave or so, however, there's nothing fixed or official about recording equalization curves per se. Playback EQ must be standard so that tapes made on one deck can be successfully played on another. But recording EQ, by contrast, can be defined simply as whatever treble tinkering needs to be done in a specific machine to achieve a flat playback response through a regulation, standardized playback section.

Even this broad way of putting it brings up a point about what recording equalization is *supposed* to do that sometimes causes confusion. When you check the test reports in this or other magazines you are primarily interested in the graph showing a recorder's *overall* record-playback performance. And if the "playback-only" curves don't look quite as impressive, don't you say to yourself, "Well, at least the machine's overall response is flat"?

This is certainly a natural reaction, but let me pose a problem by means of an example. Let's say that the high-frequency playback response of your open-reel deck (measured using a standardized test tape) is ± 1 dB from 400 to 10,000 Hz, with a gradual roll-off to -2.5 dB at 15,000 Hz. This is within NAB standards for $7\frac{1}{2}$ -ips operation. But if the same machine has an *overall* record-playback

frequency response that is absolutely flat (± 0 dB) from 400 to 15,000 Hz, it is *not* within NAB specifications. Why? Because, in this case, the *recording* response of your machine is up 2.5 dB at 15,000 Hz, which is 1.5 higher than the standard permits. This has come about because the manufacturer has *compensated* for the slight but allowable treble loss in playback by boosting his record equalization a bit. The standard, on the other hand, calls upon him to adjust the recording EQ so that the overall record-playback response *matches* the playback-only curve. Any "improvement" on the playback response is the result of introducing an *error* in the recording response that would of course show up if tapes made on that machine were to be played on a perfectly flat reproducer.

To most audiophiles, of course, this may seem a distinction without a difference, for they never anticipate playing self-made tapes on any other deck than the one they own. But some among you do record "demo" or "audition" tapes for burgeoning music groups and/or occasionally have a tape aired on local FM stations. Further, nearly all of you will, at some point, be getting a new recorder, and you will have a library of tapes already made on the old deck. So consider this rather typical situation: your machine's playback curve shows a gradually rising response at the high end, but a flat record-playback response. In this situation, all the tapes you're making now are actually treble-shy, lacking in proper record equalization, and will therefore sound dull when you play them on a new, properly adjusted deck. So, while test reports almost never show it directly, it's a good idea to investigate a deck's *recording* response. To do so, simply take the *difference* between the record-playback and the playback-only curves.

There are problems here, too, but at least this simple comparison of curves gives you something to go by.



KLH Research Ten Column Bookshelf Loudspeakers: For people who care more about music than money.

You are looking at three pairs of truly unusual loudspeakers. From left to right, they are the CB-10, CB-8, and the CB-6. What makes them so unusual is that each pair is capable of reproducing an amount and quality of sound that has heretofore been impossible to achieve from such modest sized devices. They are efficient and can be driven effectively by any reasonable power source (the CB-6 and CB-8 need as little as 8 watts per channel; the CB-10 will do quite nicely with as little as 10 watts per side). Yet all three pairs have the ability to handle as much as 100 watts RMS per channel! Their performance is perhaps best characterized as uncommonly open and airy,



with notably good bass response. Indeed, the CB-8 and CB-10 use our famous Megaflux Woofer™; the CB-6 has a "special six"—a new woofer that is easily among the best used in today's smaller loudspeakers. The CB-6, the smallest of the series, delivers about a third of an octave less bottom than the CB-8; the CB-8 about a third of an octave less than the CB-10. But all three models share exceptional smoothness and perfect musical balance. They also share something else. They are incredibly inexpensive.

Which can be a problem. Unfortunately there's a sizeable number of people who believe that if a speaker

doesn't cost a lot of money, it can't deliver a lot of sound. But if you trust your ears more than your checkbook, we suggest you listen to our CB loudspeakers soon. We think you'll love them *and* their sensible prices a lot.

For more technical information, visit your KLH Research Ten dealer. Or write to KLH Research & Development Corp., 30 Cross St., Cambridge, Mass. 02139. (Distributed in Canada by The Pringle Group, Ontario, Canada.)



KLH Research Ten Division
KLH Research & Development Corp.
30 Cross St., Cambridge, Mass. 02139

Audio News Views and Comment

By William Livingstone

IMPROVING TV SOUND

THE latest official call for the improvement of the quality of sound on television has come not from the Federal Communications Commission, the Institute of High Fidelity, or the Audio Engineering Society, but rather unexpectedly from an arts organization, the National Council on the Arts. Appointed by the President, the Council is a body of prominent Americans who advise the National Endowment for the Arts on planning and policy.

In a recent statement the Council recommended that the National Endowment join the Public Broadcasting Service in developing a new system for delivering greatly improved network-television sound. The Council also urged manufacturers, common carriers, broadcasters, and the FCC to cooperate in improving TV audio both in the studio and in the home. The statement said, in part, "Improvement of sound is essential if the potential of arts programming on television is to be realized."

The statement was issued after a meeting at which officials from the Public Broadcasting Service briefed Council members on PBS's new system known as Digital Audio for Television (DATE). According to representatives of PBS, the DATE system, a result of several years' research and experimentation, would enable networks to distribute to TV stations stereophonic high fidelity audio along with the picture or video portion of the program over most of the present microwave circuits of the telephone company. A system such as DATE cannot be activated at present, however, because its use is not yet permitted on AT&T video circuits, and there is no home TV equipment to receive stereo. But Hartford N. Gunn, Jr., vice-chairman of PBS, stated that if some system such as DATE is implemented, "TV set manufacturers will realize that there is a sizable and growing market for TV sets with good sound built in."

The involvement of the National Endowment in this area of broadcasting was explained by that institution's deputy chairman Michael Straight, who said, "The Endowment has long been committed to stimulating the use of television in making the fine arts available to all Americans. It has lent its support to such fine cultural programs on PBS as Great Performances and Live from Lincoln Center. But however splendid these programs, the full impact of a performance can only be grasped when sound matches video quality."

The Great Performances that Straight referred to are a continuing series of music, dance, and drama specials shown on PBS. All are funded in part by Exxon, and some receive financial aid from the Ford Foundation, the National Endowment, the Corporation for Public Broadcasting, or the Charles A. Dana Foundation. PBS has not waited for approval of its DATE system, but for the present it is using other means to provide good stereo

sound with the "fine music specials" in the Great Performances series and with the Live from Lincoln Center series. This is done by the system of "simulcasting," broadcasting the audio portion of the program in stereo over FM stations while the video portion and mono audio are transmitted by normal TV methods. The telecast of the American Ballet Theatre's performance of *Swan Lake* at Lincoln Center this summer was distributed via the largest live stereo network in broadcasting history, using microwave, land line, and satellite facilities.

To supervise the audio portion of such programs PBS has generally sought the top pro-

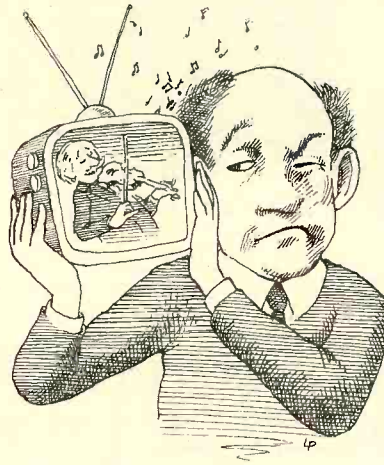

ducers of classical recordings. One of these, Max Wilcox, commented recently that in recording the soundtrack of a musical TV program he applies the same philosophy of sound that has guided him throughout his career in making records. Seated at a \$121,000 console in an RCA studio, he was editing the tape of a Great Performances special featuring Sir Georg Solti and the Chicago Symphony to be aired next season, a special for which he was the audio producer. Wilcox said, "In Chicago we made a sixteen-track tape, and it's of recording-session quality, in no way compromised because it's for TV. A soundtrack should be valid by itself. It should certainly reinforce the picture, but I do a minimum of editing for that. I do not boost the sound of a particular instrument when it is shown on the screen, but try to maintain the integrity of the balance the conductor gave us. This tape has a very big dynamic range, which I will have to compress as subtly as I can for a mono track for TV sets, but the mix-down for the simulcast will have the full dynamic range. Really, the best thing that could happen to home TV would be for sets to come equipped with decent sound."

Similar views were also expressed by Andy Setos, Chief Engineer of Design and Quality

Control at PBS member station WNET/New York, and by producer David Griffiths (winner of this year's Emmy Award for the best classical program), who coordinates the Live from Lincoln Center shows and produces many of the Great Performances specials. Setos explained that PBS's DATE system is a method of "piggybacking" improved audio along with the video signal, using existing video circuits. "PBS proposes that we could duplex or combine audio of high quality in the unused upper-spectrum space of the video circuits, but such practice has not yet begun because of AT&T's intent to increase its rates if PBS implements DATE. PBS, the Corporation for Public Broadcasting, and WNET/New York are working separately and in cooperation with Lincoln Center to provide a viable system for national distribution of TV audio with a frequency range of up to, say, 15,000 Hz instead of the normally available 5,000-Hz channels. I wish there were a TV set manufacturer working with us, but there isn't."

"The next big contribution to the art of television sound must come from manufacturers. They've made tremendous strides in improving the quality of video reception in the home—their advertising claims are not empty statements, but represent real advances. But they are not yet convinced that improving the audio portion of their sets would be a marketable thing and therefore economically profitable for them.

"Public broadcasting is not alone in this field. The commercial networks all have their laboratories involved in audio improvement—ABC, for example, is working very hard to improve the quality of TV sound fed to the country. We'd all now like to see some commensurate effort on the part of the television set manufacturers."

Griffiths is convinced that transmission will be made a great deal simpler when more communications satellites are available, and he thinks the audience for music on TV will force the issue of improved sound. "The viewers of our musical programming form a loyal and devoted minority audience. They are people already predisposed to pay attention to music and other arts programming. This audience will demand better sound, and PBS will give it to them. If the various factions could get together on the technical and legal requirements of stereo broadcasts, we could have it on the air next season."

THERE are also commercial interests hard at work in the area of improved sound. One of these is Home Box Office, a subsidiary of Time Inc. A pay-TV network that programs mostly current movies and major sports events, HBO has 450,000 subscribers in thirty-one states and expects to reach one million by the end of 1977. According to HBO's Director of Operations/Engineering, George Gilbert, "HBO has had under consideration since the inception of its satellite-transmitted signal (that is, September 29, 1975) the delivery of stereo audio with many live, recorded, and film features. Our operations/engineering department has been in conversation with HBO's satellite common carrier—RCA Americom—as well as numerous suppliers of home terminal equipment to the cable-television industry. HBO plans a demonstration of the stereo audio capability, originating from its network control studio in Manhattan to its satellite-fed cable TV affiliates, by the fall of this year (October or November)."

If you can see a difference, imagine what you'll hear.

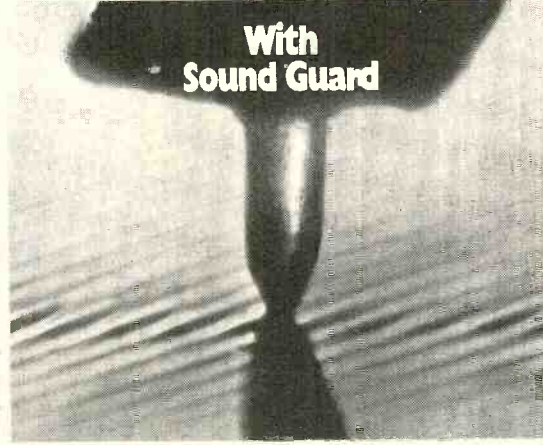

Magnified, you can see record vinyl wearing away.

With same magnification, record vinyl shows no wear.

You're looking at the solution to one of the oldest problems in audio—how to protect records from wear, while at the same time preserving full fidelity.

It's called Sound Guard,* and it's remarkable.

Independent tests show that discs treated with Sound

distortion as "mint condition" discs played once.

A by-product of dry lubricants developed for aerospace applications, Sound Guard preservative is so smooth it reduces friction, yet so thin (less than 0.000003") it leaves even the most fragile groove modulations unaffected.

Len Feldman in Radio Electronics reports "At last! The long awaited record-care product has arrived.

It preserves frequency response

in a kit complete with a non-aerosol pump sprayer and

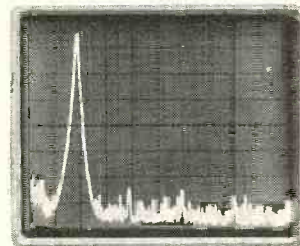

Test record played first time.

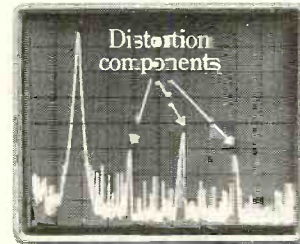

After 100 plays without Sound Guard.

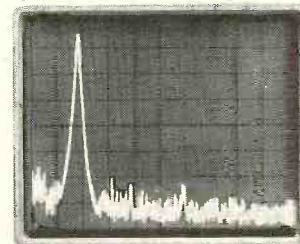

Identical test record after 100 plays with Sound Guard.

Guard preservative played 100 times display the same full amplitude at all frequencies and the same absence of surface noise and harmonic

while reducing distortion and surface noise." It's effective and safe for all discs, from precious old 78's to the newest LP's.

Sound Guard preservative,

velvet buffing pad, is available in audio and record outlets.

Sound Guard™ keeps your good sounds sounding good.

*Sound Guard is Ball Corporation's trademark for its record preservative. Copyright © Ball Corporation, 1976.



CIRCLE NO. 6 ON READER SERVICE CARD

Technical Talk

By Julian D. Hirsch



● METERS IN AUDIO COMPONENTS:

At one time, meters were rarely used in consumer hi-fi products. To some extent, this was an economic decision, for they were expensive and relatively fragile, and perhaps it was felt that they imparted a "professional" look that might discourage laymen from buying a product. Today, the situation is reversed, with inexpensive, fairly rugged meters readily available and with stylists striving mightily to suggest that a product is "professional" (whatever that might mean) in its design and performance. Not only is it commonplace for receivers to have as many as four meters (more if they are quadraphonic models), but we have even seen a *tuner* with four meters adorning its front panel, and all of them useful.

The most common—and probably the most important—use for a meter in a high-fidelity component is as an FM tuning aid. The most useful type is the channel-center indicator whose pointer is normally at rest in the center of its scale. This is also the condition of correct tuning, when the tuner is set exactly to the center of an FM channel—if the tuner is correctly aligned. Sometimes a circuit misadjustment results in an off-center meter reading when the station is correctly tuned (or in incorrect tuning when the meter is centered). In case of such a discrepancy, get your tuner adjusted—and meanwhile trust your ears.

More commonly seen on one-meter tuners, though not as effective, is the signal-strength indicator. This reads a maximum when the station is tuned in, but since the maximum reading is usually obtained over a wide tuning range, it is a less accurate indication of correct tuning. It can be useful for orienting an antenna for maximum signal strength, to the extent that the meter reading continues to rise in proportion to the signal strength reaching the tuner's antenna terminals. Unfortunately, many meter circuits hit maximum at a relatively low

signal level and do not respond to further increases.

Some FM tuners and receivers now have "multipath" meters that can be more meaningful guides to correct antenna orientation. In most cases, higher signal strength per se is less important than the rejection of signals arriving from different directions, for these can cause severe distortion of the tuner's audio output. The distortion is associated with the amplitude modulation (AM) the multipath interference produces in the tuner's circuits, so that a meter capable of showing the degree of AM is an excellent indicator of multipath distortion. The meter pointer usually "kicks" with program modulation when AM is present, and the antenna should be adjusted for minimum meter movement. Often a button or switch converts the signal-strength meter to a multipath indicator, but sometimes a separate meter is used. These, too, vary widely in their effectiveness, the best ones rivaling an oscilloscope in sensitivity to multipath, and the worst being virtually useless.

Outside of the tuner, meters are generally used as indicators of audio level. Unlike tuning meters, which are *relative* reading devices, an audio-level meter usually carries some calibration that implies a reading of absolute program level. In tape recorders, for example, the

"0-dB" meter reading normally corresponds to the maximum recording level that should be used with *that* machine, though it is not necessarily equivalent to a similar reading on another recorder. An exception is the Dolby calibration mark; it corresponds to a specific recorded flux level on the tape and its accuracy is vital for interchangeability of Dolby-encoded tapes between recorders.

Most tape-recorder meters are linear devices capable of displaying only about a 10 to 1 ratio of signal levels (20 dB). Frequently, when the program peaks reach 0 dB, the quieter portions of the program barely register on the meters. Recently meters have become available with expanded logarithmic scales calibrated over a range of 40 to 50 dB. These are much more informative than the linear types, and in addition they are generally fast-responding peak-reading instruments (about which more later).

Some power amplifiers (and integrated amplifiers) are equipped with output meters. Often the calibrations are in decibels relative to rated power, but sometimes the scales are calibrated directly in watts. In either case, the meters read only the amplifier's output voltage, so the power readings are accurate only for 8-ohm resistive loads (though for practical purposes they are useful with speakers nominally rated at 8 ohms). The user must remember to double the meter readings with 4-ohm speakers and to halve them with 16-ohm speakers.

The accuracy of the power meters on amplifiers is usually sufficient, on steady-state (continuous-tone) signals, to inform the user of the approximate average power output. The better ones, used on some expensive amplifiers, are often within 5 to 10 per cent of the correct power near their maximum readings. Bear in mind that any meter of the type we are considering becomes progressively less accurate at less than full scale readings and may easily be in error by 15 to 20 per cent or more at the power levels

Tested This Month

Onkyo TX-4500 AM/FM Receiver
Jensen Model 24 Speaker System
Empire 2000Z Phono Cartridge
Crown IC-150A Stereo Preamp
Kit Report Addendum on the
Heath AA-1640 Power Amplifier

commonly used for listening. This does not, of course, impair its usefulness as a rough indicator of power output.

Finally, meters are used in a number of accessory devices (such as CD-4 demodulators, Dolby units, and dynamic expanders) to indicate that the unit is being operated with the proper input and output levels. Except for the Dolby units, these devices rarely have critical level requirements, so that one can assume that the meter indications are correct in the absence of other evidence.

A very important aspect of audio level meters is their *ballistic* response. This refers to the reaction and damping times of the meter pointer when driven by a transient or other rapidly changing signal. The fact that a meter is accurately calibrated for continuous steady-state signals does not mean that it will give correct indications under dynamic signal conditions. A true VU meter represents an attempt to standardize the characteristics of meters used professionally to monitor program levels. It is calibrated in decibels (though they are identified as VU or volume units), with 0 VU equal to 1 milliwatt at a 600-ohm impedance level. VU meters have specific and stringent accuracy, frequency-response, and ballistic-response requirements. Practically none of the meters in consumer audio equipment carrying VU markings are really VU meters; almost all should more correctly be called "dB meters."

Most audio-level meters respond relatively slowly to a transient signal and have a correspondingly slow decay. A tone burst or some other signal with a short duty cycle will read low on such meters, often by many decibels. This is one reason why "average" recording levels on many cassette machines, because of their limited headroom, must be kept several decibels below the 0-dB meter indications. Occasionally, a meter is underdamped, with the result that it overshoots the steady-state reading and oscillates unpredictably on transient material. This is an equally undesirable condition.

The standard VU meter, however, is required to read within ± 1 per cent of the steady-state value when driven with a 0.3-second, 1,000-Hz tone burst at a repetition rate of once per second. This speed is not only faster than that of many audio meters, but it has the advantage of being standardized so that levels measured on the same program with instruments in different studios will correspond closely. Since the meters in many consumer audio products—especially the tape recorders—have been designed to have the ballistic response of VU meters (if not all their other properties), we normally check them with the prescribed tone-burst signal.

In spite of its relatively fast response, a standard VU meter will not respond completely to peak program levels. A

much more useful indicator is the peak-responding meter, found on a growing number of home tape recorders (and in professional equipment as well). A typical peak meter will respond to a pulse as short as 100 *microseconds* with only a moderate error, and it will decay over a period of about 1 second. Its ability to follow peaks and "hang" on them long enough to be read makes the peak meter invaluable to the home recordist, who no longer has to allow an uncertain safety margin of 5 to 10 dB for tape overload.

Although it is a far less critical application, the peak-responding meter has been used in at least one high-power amplifier (the Heath AA-1640), where it indicates the actual power output on peaks and makes it possible to operate the amplifier close to its maximum capability without undue risk of peak clipping. A similar result has been achieved in amplifiers by Bose, Harman-Kardon, Phase Linear, and others with a series of light-emitting diodes (LED's) calibrated to act like a voltmeter with instantaneous response. Lux even has an add-on LED accessory for the same purpose.

It might seem that meters have been overapplied in modern consumer products (a well-equipped four-channel setup can confront its owner with as many as eighteen to twenty meters), but most of them are really informative and are well worth the modest amount they add to the cost of a product.

Equipment Test Reports

By Hirsch-Houck Laboratories

Onkyo TX-4500 AM/FM Stereo Receiver



● THE Onkyo TX-4500 is a medium-price stereo receiver featuring what the manufacturer calls "Quartz-Locked" tuning. In its basic receiver functions, the TX-4500 is a full-feature, handsomely styled product whose performance is typical of the highest standards achieved in modern stereo receivers.

The FM tuner section has a rated usable

sensitivity of 1.8 microvolts (μV) or 10.3 dBf in mono and 19.2 dBf ($5 \mu V$) in stereo. The tuner distortion is rated at 0.2 per cent in mono and 0.4 per cent in stereo, and the image rejection and alternate-channel selectivity are each rated at 70 dB.

The audio amplifiers are rated to drive 8-ohm loads at 55 watts per channel, from 20 to

20,000 Hz, with less than 0.1 per cent total harmonic distortion (THD). The TX-4500 has provision for two magnetic phono cartridges and three tape decks. Any of the tape inputs can serve as an AUX (high-level) input since the input selector has no position designated for this purpose.

The bass and treble tone controls have twenty-one click-stop positions, and the volume control has forty-one. The balance control has a center detent. A speaker-selector switch energizes any of three pairs of speakers or two combinations of two pairs at a time, plus shutting them all off for headphone listening through an adjacent jack.

Completing the front-panel controls, which occupy the lower half of the satin-finish aluminum panel, are a number of pushbutton switches. These activate the low and high filters, loudness compensation, FM interstation-noise muting (the Quartz-Lock circuit switches on with the muting), and mono/stereo switching. A DOLBY FM ADAPTER but-

(Continued on page 33)

From the company that's brought new thinking to speakers, come new speakers that think.

In a field where most of the leading brands have been established for decades, B·I·C VENTURI™ speaker systems have achieved eminence overnight.

In sales, where we are rapidly closing in on first place.

But, more importantly, in speaker technology.

At a time when most believed the technical frontiers had been thoroughly explored, B·I·C VENTURI speakers have been awarded two basic design patents in the space of six months.

#3,892,288 for the application of the 'venturi' principle to acoustics, which revolutionized bass reproduction.

And #3,930,561 for the BICONEX™ horn, which combined the virtues of conical and exponential flare rates.

The resulting gains in efficiency, bass response and dynamic range have established new performance/value criteria.

And, already, many long-time leaders in speaker design are attempting to follow our lead.

Thinking defined.

Now B·I·C VENTURI introduces two new high-efficiency speakers, that go on to do what no others have ever attempted.

They're called the Monitor Series.

And, by any definition, they're the first speakers that can think.

Both the Formula 5 and Formula 7 are equipped with electronic circuitry capable of taking measurements, displaying information, even initiating specific action.

For example, they can tell when your amplifier is 'clipping,' and signal you.

They can warn when they're being overloaded, and protect themselves.

They can automatically adjust their frequency response to match the aural response of the human ear.

And the Formula 7 can even let you see what you're hearing.

These unique abilities elevate the loudspeaker to a new role in the stereo system. That of a system monitor, which can literally help you hear better.

Get 'clipped' no more.

Until now, there has been no way for the user to accurately identify amplifier distortion due to clipping, or the precise point at which it occurred.

But the new B·I·C VENTURI Monitor Series speakers come with a test record

that lets you pinpoint the output level at which your amplifier begins to clip the peaks of the waveform.

Each speaker has a Clipping Indicator lamp, and a control that adjusts lamp sen-

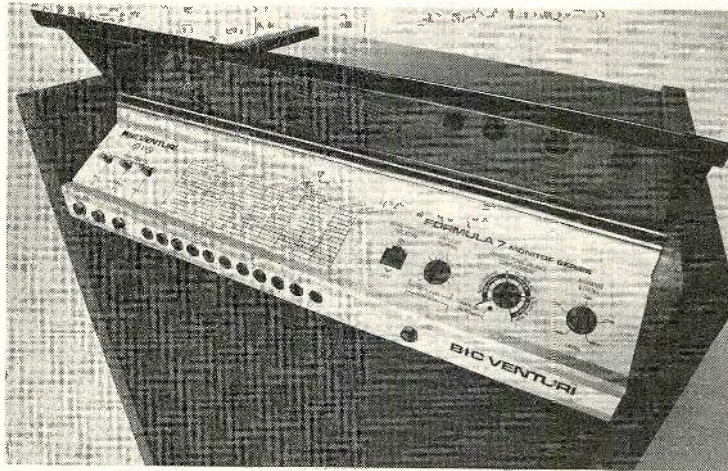

sitivity to your amplifier's maximum 'clean' output.

Once matched to your amplifier, the indicator will stay lit when clipping occurs. Lowering your amplifier until the lamp just flickers will allow musical peaks to be perfectly reproduced.

What's more, this circuit can be used to indicate speaker overload in those few instances where an amplifier has a power rating *higher* than the Formula 5 or 7 it's being matched with.

And, if overloaded, the speakers protect themselves by shutting off power to the stressed component. Individual indicator lamps (left above) signal you, and can also help isolate the problem.

Improving on nature.

One of the curious facts in acoustics is that the ideal in musical reproduction has long been 'flat' response.

Curious, because only at very high levels can the human ear hear flat. As listening levels decrease, the ear quickly loses bass and treble tones.

That's why our exclusive Dynamic Tonal Balance Compensation circuit (patent pending) was developed.

The idea is to improve on nature.

And by automatically compensating for what the ear can't normally hear, today's B·I·C VENTURI speakers bring you music that's music to the ears.

A balanced performance.

The Formula 7 takes the monitor concept an interesting step further.

A bank of Sound Pressure Level Indicators light in sequence, as speaker output increases. This visual display covers the range from 75db (normal speech) to 117db (jet engine at 70 feet).

A reference chart on the display panel further interprets the information.

Interesting in themselves, the SPL readings can also help you fine-tune your system to room acoustics, and compensate for imbalanced output levels in amplifier and tuner channels, tape heads and phono cartridges.

Tomorrow's technology today.

Once again, B·I·C VENTURI has extended the limits previously envisioned for speaker design.

These two new Monitor Series speakers take speaker technology an innovative step into the future. They establish a new, and larger, role for the loudspeaker.

And we confidently predict that they presage the speakers of tomorrow.



B·I·C VENTURI
Westbury, N.Y. 11590.
B·I·C, B·I·C VENTURI and
BICONEX are trademarks of British
Industries Co. Division of Avnet, Inc.
In Canada, C.W. Pointon, Toronto.

B·I·C VENTURI SPEAKER SYSTEMS
TOMORROW'S TECHNOLOGY TODAY

CIRCLE NO. 9 ON READER SERVICE CARD

ton changes the FM de-emphasis to 25 microseconds and connects an external Dolby adapter into the circuit through special jacks in the rear of the receiver. Each of the tape-recorder circuits has its own monitor switch.

Across the upper half of the panel is a large tuning dial with linearly spaced FM markings at 0.2-MHz intervals, plus an AM tuning scale. Illuminated legends above the dial calibrations show which input source has been selected. To the left are two large tuning meters, a signal-strength indicator for AM and FM, and a channel-center FM meter. To the right is a large tuning knob that operates a smooth flywheel mechanism.

The rear apron of the TX-4500 carries all the signal inputs and outputs, plus PRE OUT and MAIN IN jacks normally joined by jumper plugs. There is a 4CH FM OUT jack for use with any future discrete quadraphonic FM adapter and a three-position slide switch controlling the sensitivity of the Quartz-Lock tuning system. Antenna inputs provide for 75- or 300-ohm FM antennas and a wire AM antenna, and there is a hinged AM ferrite-rod antenna supplied. The speaker connectors are insulated spring clips, and one of the three a.c. convenience outlets is switched.

Quartz-Locked tuning is a new system that completely eliminates tuning errors in FM reception. To the user, its action is much like that of an extremely effective AFC system. When an FM signal is tuned in (more or less accurately), a red LOCKED indication appears on the dial face above the calibrations. A second or so after the tuning knob is released, the word TUNED appears in green next to LOCKED. Touching the tuning knob disables the Quartz-Lock circuit and extinguishes the TUNED marking.

The difference between Quartz-Locked tuning and AFC is that the latter merely reduces the tuning error, usually by a factor of only two or three times. As anyone who has made distortion and stereo-separation measurements on FM tuners knows, the tuning point that provides optimum performance is often very narrow and extremely critical. It is quite possible—even probable—that a tuner will be "locked on" to a signal with AFC, or with the meter indicating correct tuning, and yet be far from realizing its full performance capabilities.

Quartz-Lock, on the other hand, compares the average frequency of a received FM signal (converted to the receiver's 10.7-MHz in-

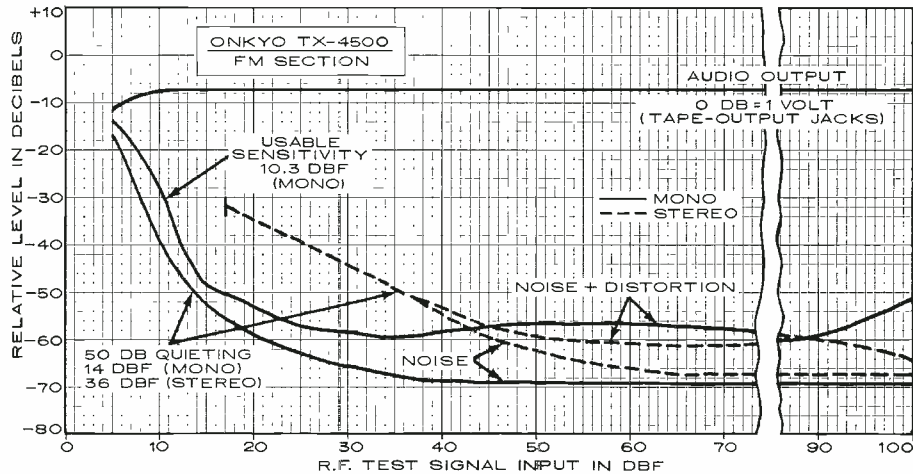

intermediate—or i.f.—frequency) to an internal 10.7-MHz quartz-crystal oscillator. The slightest difference between the two frequencies creates a d.c. control voltage that shifts the local-oscillator frequency to bring the two frequencies into coincidence. It is not easy to analyze the performance of the circuit from the schematic diagram alone, but its operation is so effective that zero tuning error is achieved when the TUNED light is on. It is literally impossible to have the slightest mistuning when Quartz-Lock is used, which is not true of any AFC system we have encountered in the past.

A touch on the tuning knob (or even bringing the hand within a few inches of the knob) disables the Quartz-Lock so that tuning in a weak signal adjacent to a strong one is no more difficult than with any ordinary tuner. A switch in the rear of the receiver merely adjusts the sensitivity of the disabling circuit; it has no effect on the operation of the Quartz-Lock. When the FM muting is off, the Quartz-Lock is also switched out.

The Onkyo TX-4500 is supplied in a walnut-grain, vinyl-clad wood cabinet, and it measures approximately 21¼ inches wide, 6½ inches high, and 17 inches deep. Weight is 36.5 pounds. Price: \$450.

● **Laboratory Measurements.** The FM tuner section of the TX-4500 matched its rated usable sensitivity of 10.3 dBf (1.8 μV) in mono,

and stereo sensitivity was 17 dBf (4 μV), as determined by the stereo/mono switching threshold. The 50-dB quieting sensitivity was considerably better than rated, measuring an excellent 14 dBf (2.7 μV) in mono with only 0.5 per cent THD. The stereo 50-dB quieting sensitivity was 36 dBf (34 μV) with 0.36 per cent THD. The signal-to-noise ratio (S/N) at a 65-dBf (1,000-μV) input was 69 dB in mono and 68 dB in stereo; the respective distortion levels were 0.15 and 0.09 per cent.

It is interesting to note that the stereo distortion, measured with a difference (L - R) signal, was different in the two channels. The figure given above was from the *worst* channel, with the distortion in the other being about half as much (below the rated distortion of our Sound Technology signal generator). The stereo distortion was 0.44 per cent at 100 Hz and 0.14 per cent at 6,000 Hz.

The FM frequency response was within ±1 dB from 30 to 14,000 Hz (-1.5 dB at 15,000 Hz), and the channel separation was outstanding both in its magnitude and in its uniformity over the frequency range. It was about 46 dB through most of the mid-range and bass, and still an excellent 33 dB at 15,000 Hz.

The capture ratio was about 1.8 dB, and AM rejection was 58 dB. The image rejection and alternate-channel selectivity were almost identical at about 74 dB. Adjacent-channel se-

(Continued on page 40)

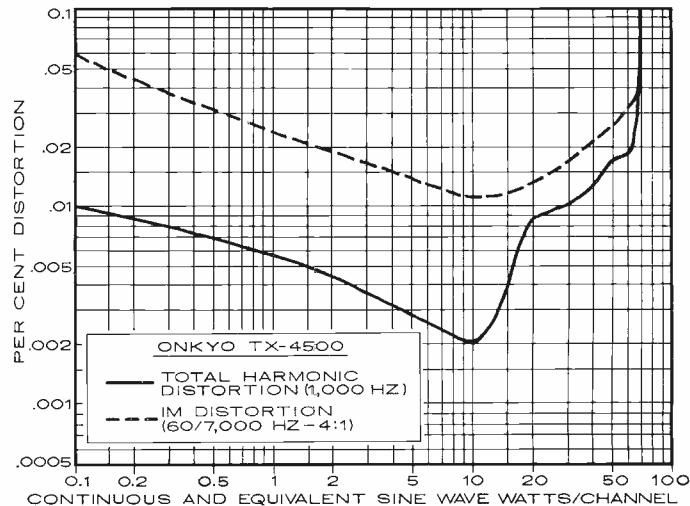
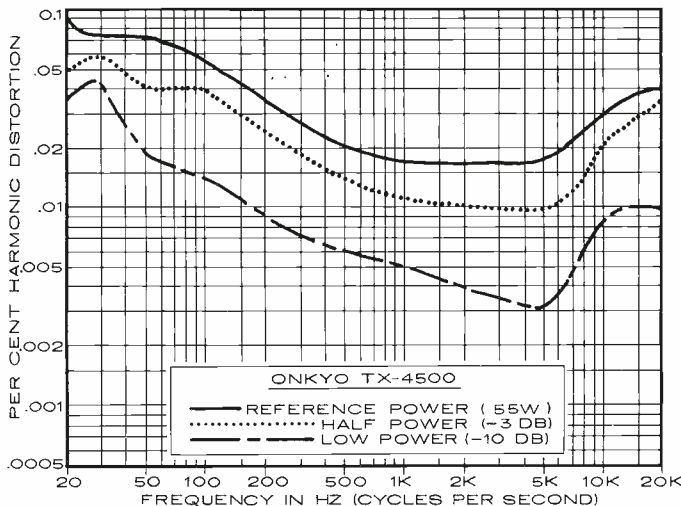

Only three turntables in
the world offer

True Tangent Tracking.

Bang & Olufsen, Rabco,
and the new Garrard GT55.

They play your records
precisely the way the
original masters were cut,
with the stylus held at a
90° tangent to the groove.
They eliminate harmonic
distortion caused
by tracking error.

One of the three is
also fully automatic in
both single and multiple
play. Its tonearm is low-
mass magnesium, balanced
on jewel pivots.

Yet it sells for the lowest
price of all three —
as much as \$400 lower!

The new GT55.

By Garrard.





The discount came off before the price went on. But that's not the only powerful reason for buying the Realistic 2000 at the nationwide supermarket of sound.



75 watts per channel min. RMS at 8 ohms from 20-20,000 Hz

Five More New-for-'77 Realistic Stereo Component Receivers



STA-16 119.95*



STA-21 159.95*



STA-52 199.95*



STA-64 239.95*



STA-235 399.95*

Built in our own factory, the Realistic STA-2000 will change quite a few notions about what an American company can do on its own. Even a 55-year-old American company. Even a company that has been designing Realistic audio equipment for 22 years. Have another think if you've been thinking Realistic is great only in the middleweight division. We've printed a big picture so you can clearly see what we mean. And if your notion of price is something like \$5 per watt per channel, kindly remember that Realistic's is \$3.33. We may not always have a rug on the floor. But we have taken the "hi" out of hi-fi. And the Realistic 2000 is thundering proof-positive of our attitude about watts, quality, features, cost, and credibility.

Realistic, Radio Shack, and Nationwide Supermarket of Sound are registered trademarks ®.



with no more than 0.25% total harmonic distortion. Under \$500*.

SOLD ONLY WHERE YOU SEE THIS SIGN

Radio Shack®

A TANDY COMPANY • FORT WORTH, TEXAS 76107

*Prices may vary at individual stores and dealers.

CIRCLE NO. 46 ON READER SERVICE CARD

lectivity was 6.4 dB. The muting and stereo switching thresholds were both 16 dBf (3.5 μ V). The 19-kHz pilot-carrier leakage was 66 dB below full modulation. Only the frequency response was measured on the AM section; it was down 6 dB at 65 and 3,000 Hz.

All the FM measurements were made with the Quartz-Lock (and muting) switched off. With it on, the tuner *always* matched the best measured performance we were able to obtain by manual tuning. We found that the effective selectivity of the tuner was increased enormously by the use of Quartz-Lock. Even an adjacent-channel signal (200 kHz from the desired signal) produced absolutely no sign of interference at the maximum level of our signal generator, which was about 80 dB greater than the signal to which the receiver was tuned. Unlike AFC systems, which are often subject to "pulling" by very strong adjacent-channel signals, the Quartz-Lock makes the TX-4500 almost totally immune to off-channel interference.

The audio amplifier section of the TX-4500 was also outstanding. The output with a 1,000-Hz test signal clipped at 70.2 watts into 8 ohms, 87.4 watts into 4 ohms, and 42.3 watts into 16 ohms. At 1,000 Hz, the total harmonic distortion (THD) was under—and typically well under—0.01 per cent up to about 25 watts output, reaching 0.02 per cent at 65 watts and 0.11 per cent at 70 watts just before it clipped.

The intermodulation (IM) distortion was 0.06 per cent at 0.1 watt, less than 0.03 per cent from less than 1 watt to nearly 60 watts, and 0.043 per cent at 70 watts.

At the rated 55 watts output, the THD was less than 0.09 per cent from 20 to 20,000 Hz and less than 0.04 per cent from 170 to 20,000 Hz. At lower power levels the distortion was always lower, typically measuring between 0.003 and 0.02 per cent at most listening levels and frequencies.

The tone controls had conventional characteristics, with a sliding bass turnover frequency and a treble response hinged at about 2,000 Hz. The loudness compensation boosted both low and high frequencies to a moderate degree. The filters had gradual 6-dB-per-octave slopes, with the -3-dB frequencies being about 50 and 9,000 Hz. RIAA phono equalization (extended) was accurate within ± 0.5 dB from 35 to 20,000 Hz. It was totally unaffected by cartridge inductance.

The high-level input signal (through one of the tape-recorder circuits) required for a 10-watt reference output was 61 millivolts (mV), with a 76-dB S/N. The phono sensitivity was 1 mV, with a 75.5-dB S/N, and the phono circuits overloaded at a very high 225-mV input level.

● **Comment.** Judged by its measured performance, the Onkyo TX-4500 is obviously

one of the finest receivers available today at any price. Both its FM tuner and audio amplifier performance are in almost every respect far above the norm for receivers, especially in this price range, and in some areas the performance rivals that of the most highly regarded separate components.

The "feel" of the TX-4500's controls is as elegant as its performance. They are smooth, light, and completely positive, with none of the tactile anomalies that sometimes detract from one's enjoyment of an otherwise excellent product. We were also pleased to find that the interstation-noise muting action is totally free of noise or transient effects.

Until now, the only way one could have any assurance of optimum tuning was to use the expensive frequency-synthesizing tuner or receiver. Onkyo is to be congratulated for having achieved the same caliber of tuning precision with a much less expensive technique. We were also pleased to find that the accurately calibrated dial, with its 200-kHz marking intervals, enabled us to tune to any desired channel without ambiguity.

Over the years, we have found that most competitively priced receivers are fairly equal in their overall performance characteristics. It appears to us that the Onkyo TX-4500 may be just a little bit *more* equal than its peers, so to speak.

Circle 105 on reader service card

Jensen Model 24 Speaker System

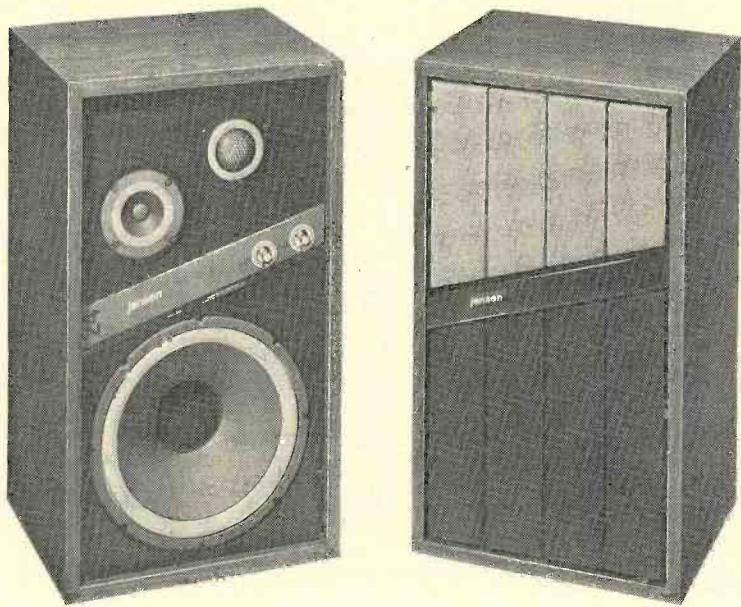

● **JENSEN'S** Model 24 speaker is a three-way floor-standing system that includes a 12-inch "Flexair" long-throw woofer in a sealed enclosure, a 3-inch cone mid-range driver, and a 1½-inch dome tweeter. The crossover frequencies are 1,000 and 5,000 Hz.

The Model 24, which weighs almost 50

pounds, stands 26 inches high, is 15 inches wide and 13 inches deep, and is covered in wood-grain vinyl veneer. The snap-in grille, in two shades of brown, is formed of perforated plastic. The upper and lower grille portions are separated by an easily removable section of translucent brown plastic, through which

can be seen the mid-range and treble balance control knobs. The insulated push-type binding posts are recessed into the rear of the cabinet. The Model 24, whose nominal impedance is 8 ohms, is designed to be driven by amplifiers delivering from 10 to 75 watts. Price: \$179.

● **Laboratory Measurements.** We measured the output of the Model 24 with both controls set to maximum. Joining the semi-reverberant room-response measurement of the high frequencies to the separately measured close-miked bass response revealed an unusually well-balanced, wide-range frequency response, uniform within ± 4 dB from 20 to 17,000 Hz. Because the balance controls are able to cut off their respective drivers completely, this curve could easily be tailored to meet almost any requirement.

The bass output of the Jensen Model 24, unlike that of most speakers, did not fall off rapidly below the point of maximum output, which occurred at about 60 to 70 Hz. In fact, the woofer output could be described as a smoothly decreasing response, dropping about 4 dB from 500 Hz down to 20 Hz, but with a broad peak of about 5 dB maximum amplitude lifting the response in the octave from 50 to 100 Hz. The low-frequency distortion at a 1-watt nominal input was under 3 per cent down to 32 Hz, reaching 5 per cent at 28 Hz and 10 per cent at 24 Hz. At 10 watts in-

(Continued on page 44)

Introducing an evolutionary idea.

The New Empire 698 Turntable

Great ideas never change radically.

Instead, they are constantly being refined to become more relevant with time.

So it has been with Empire turntables. Our latest model, 698, is no exception. Basically, it's still the uncomplicated, belt-driven turntable we've been making for 15 years. A classic.

What we're introducing is improved performance.

The lower mass tone arm, electronic cueing, quieting circuitry and automatic arm lift are all very new.

The rest is history.

The Tonearm

The new 698 arm moves effortlessly on 32 jeweled, sapphire bearings. Vertical and horizontal bearing friction is a mere 0.001 gram, 4 times less than it would be on conventional steel bearings. It is impervious to drag. Only the calibrated anti-skating and tracking force you select control its movement.

The new aluminum tubular arm, dramatically reduced in mass, responds instantly to the slightest variation of a record's movement. Even the abrupt changes of a warped disc are quickly absorbed.

The Motor

A self-cooling, hysteresis synchronous motor drives the platter with

enough torque to reach full speed in one third of a revolution. It contributes to the almost immeasurable 0.04% average wow and flutter value in our specifications. More important, it's built to last.

The Drive Belt

Every turntable is approved only when zero error is achieved in its speed accuracy. To prevent any variations of speed we grind each belt to within one ten thousandth of an inch thickness.

The Platter

Every two piece, 7 lb., 3 inch thick, die cast aluminum platter is dynamically balanced. Once in motion, it acts as a massive flywheel to assure specified wow and flutter value even with the voltage varied from 105 to 127 volts AC.

The Main Bearing

The stainless steel shaft extending from the platter is aged, by alternate exposures to extreme high and low temperatures preventing it from ever warping. The tip is

then precision ground and polished before lapping it into two oilite, self-lubricating bearings, reducing friction and reducing rumble to one of the lowest figures ever measured in a professional turntable; -68 dB CBS ARLL.

The Controls

Electronic cueing has been added to the 698 to raise and lower the tone arm at your slightest touch. Simple plug-in integrated circuitry raises the tone arm automatically when power is turned off.

A see-through anti skating adjustment provides the necessary force for the horizontal plane. It is micrometer calibrated to eliminate channel imbalance and unnecessary record wear.

Stylus force is dialed using a see-through calibrated clock mainspring more accurate than any commercially available stylus pressure gauge.

A new silicon photocell sensor has been added to automatically lift the arm at the end of a record.

New quieting circuitry has also been added. Now, even with the amplifier volume turned up, you can switch the 698 on or off without a "pop" sound to blow out your woofers.

At Empire we make only one model turntable, the 698. With proper maintenance and care the chances are very good it will be the only one you'll ever need.

EMPIRE



The Empire 698 Turntable

Suggested retail price \$400.00

For more information write:
EMPIRE SCIENTIFIC CORP.
Garden City, New York, 11530.

How to mix power

The power of your amplifier is one of the most important elements in the performance of your high fidelity system. It gives your amplifier sufficient power to drive your speakers. And you need well engineered power to give you the instantaneous burst that music may require.

The pleasure of your tuner is fullest when properly matched with its power supply; when it is sensitive and highly selective, and offers noise- and distortion-free sound. In short, an instrument attuned to your musical pleasure.

Sansui Amplifiers and Tuners: Our newly expanded complete line of powerful amplifiers and beautifully designed tuners are engineered and matched to give you the full pleasure of power. From the fabulous AU 20000 with a striking 170 watts per channel, min. RMS, both channels driven into 4 and



...with pleasure.

8 ohms, from 20 to 20000 Hz with no more than 0.05% total harmonic distortion at about \$1000* to the AU 3900 with 22 watts per channel, min. RMS, both channels driven into 8 ohms, from 40 Hz to 20 kHz, with no more than 0.15% total harmonic distortion at less than \$160*, every AU amplifier is loaded with features designed for creative listening. The fully matched TU tuners from less than \$160* to about \$450* all feature appropriately low distortion, fine sensitivity and high selectivity. For example, the TU 3900: sensitivity, 11.2 dBf (2.0 μ V); selectivity better than 60 dB (at 400 kHz). TU 9900: sensitivity, 8.8 dBf (1.5 μ V); selectivity from 20 dB at 200 kHz to 90 dB at 400 kHz. The TU 9900 offers a choice of wide and narrow bandwidths for selection of individual stations even in crowded areas.

Your nearest franchised Sansui dealer will be happy to demonstrate any in this fine series to you. Your powerful pleasure awaits.

* Approximate nationally advertised value. The actual retail price will be set by the individual dealer at his option.

Buy Sansui.



Sansui

SANSUI ELECTRONICS CORP. Woodside, New York 11377 • Gardena, California 90247
SANSUI ELECTRIC CO., LTD., Tokyo, Japan • SANSUI AUDIO EUROPE S.A., Antwerp, Belgium • In Canada: Electronic Distributors

CIRCLE 32 ON READER-SERVICE CARD

The tone-burst response of the Jensen Model 24 appears in the upper traces for frequencies of (left to right) 100, 1,000, and 10,000 Hz.

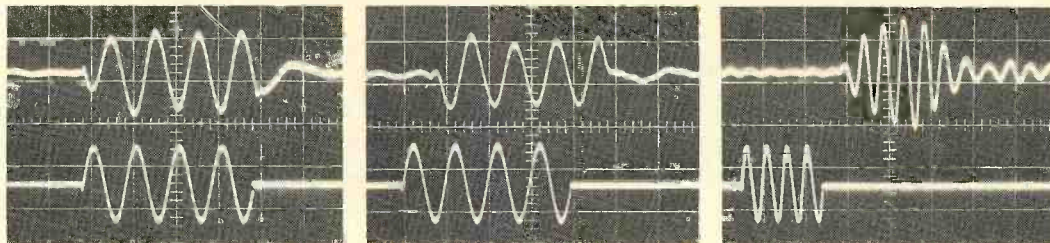

put, the distortion was 5 per cent at 40 Hz and 10 per cent at 23 Hz.

The system impedance was 8 ohms at the usual rating frequency (the first minimum above the bass resonance) of 100 Hz. The impedance was about 5 ohms from 5,000 to 15,000 Hz with the level controls at maximum, but it increased considerably when the control settings were reduced. The low-frequency resonant peak was at 50 Hz, where the impedance reached 25 ohms. The system efficiency was unusually high for an acoustic-suspension design. A sound-pressure level of 94 dB was measured at a distance of 1 meter from the speaker with a 1-watt input in the octave centered at 1,000 Hz.

The tone-burst response of the system was good throughout its range. Most of the slight modifications of the burst waveform resulted

from crossover-network characteristics except at 10,000 Hz, where about 3 cycles were required for the burst to build up or decay fully.

● **Comment.** With the mid-range and tweeter controls at maximum (giving the flattest measured frequency response), the Jensen Model 24 proved to be a highly accurate reproducer in our simulated live-vs.-recorded test. It imitated the sound of the reference program with almost perfect accuracy except for a trace of "forwardness" in the mid-range and a hint of dulling of wire-brush sounds in the uppermost register. In normal operation, depending upon the listening-room acoustics, it may be necessary to reduce the mid-range and tweeter outputs slightly for optimum balance.

Because of the large variations in response

that may be produced by the controls, it is not as easy to characterize the sound quality of the Jensen Model 24 as it is some other system whose frequency response is set at the factory. Even a slight readjustment of the balance controls made an appreciable change in sound quality. If care is used in balancing the speaker's response to that of the listening-room environment, it should be possible to make it as accurate as any conventional three-way system of comparable size (and, in many cases, of considerably higher price).

As a bonus, the high efficiency of the Model 24 makes it possible to enjoy the dynamic range usually available only to users of super-power amplifiers while driving the speakers with any good receivers in the 30- to 60-watt range.

Circle 106 on reader service card

Empire 2000Z Phono Cartridge

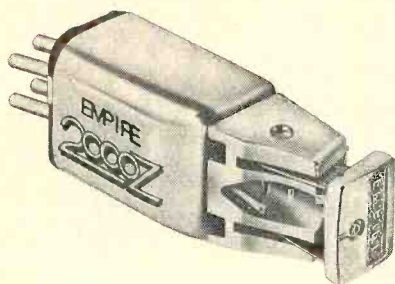

● EMPIRE SCIENTIFIC CORPORATION's newest and finest stereo cartridge, the 2000Z, is noteworthy both for what it does and for the manner in which its performance is specified. Empire's stated goal was to make a cartridge whose frequency response was as flat as possible and which possessed the channel separation, channel balance, and tracking ability necessary to reduce its contribution to the final sound quality to a minimum. These are impressive goals—all the more so because Empire's advertised ratings are more complete than we have ever seen presented for a stereo cartridge, going so far as to state the test conditions and the specific test records.

Since the complete specification sheet has been used by Empire in their advertisements for the 2000Z, we will not repeat the ratings in detail. In brief, the cartridge has a frequency response of 20 to 20,000 Hz ± 1 dB, based on the CBS STR 100 record, a 47,000-ohm load

resistance, and a circuit capacitance of 300 picofarads. The output is 3.5 millivolts at a velocity of 3.54 centimeters per second (cm/sec), with channels balanced within 0.75 dB. The 0.2 x 0.7-mil elliptical diamond stylus is rated to track between 0.75 and 1.25 grams, with 1 gram being the recommended force. The stylus compliance is 30×10^{-6} cm/dyne, both laterally and vertically, and the effective tip mass is 0.2 milligram.

Physically the cartridge resembles some other Empire models. It is finished in gold, with a hinged stylus guard on its replaceable stylus assembly. It is a moving-iron cartridge with a newly designed laminated pole structure that is largely responsible for its flat response. Its hum-canceling design employs four coils and three magnets. Price: \$99.95.

● **Laboratory Measurements.** Measured with the CBS STR 100 test record, the frequency

response of the Empire 2000Z was very nearly a horizontal straight line, with a variation well within ± 1 dB from 40 to 20,000 Hz (the CBS record goes down only to 40 Hz, although Empire's ratings imply that it is used down to 20 Hz). In the tone arm of the Dual 510 we used for this test, the low-frequency arm resonance was at 7 Hz with an amplitude of 8 dB.

The channel separation was 26 dB at mid-frequencies, about 13 dB at 10,000 Hz, and 9 dB at 20,000 Hz. The vertical stylus angle was exactly 20 degrees, the current industry standard, and the channel outputs were identical at 3.35 millivolts for a 3.54-cm/sec velocity. The square-wave response with the CBS STR 111 record was practically perfect, with a flat top and only a trace of overshoot.

At a 1-gram vertical tracking force the 2000Z tracked our Cook 60 and Fairchild 101 records, although the 30-cm/sec, 1,000-Hz tones of the latter were clipped symmetrically. The 60-micron level of the German Hi-Fi Institute record was played without distortion at 1 gram. The intermodulation (IM) distortion with the Shure TTR-102 record was between 1 and 2 per cent up to a velocity of 18 cm/sec, and it rose sharply at higher velocities owing to mistracking. Increasing the force to the rated maximum of 1.25 grams resulted in a gradual increase of distortion with velocity, to a maximum of 5 per cent at 27.1 cm/sec. The 80-micron band of the German record was

(Continued on page 48)

Beauty in sound. By Fuji.

Every Fuji cassette means beauty and purity in sound. No hiss, no dropouts. Widest frequency response and dynamic range. Total reliability. Fuji high-fidelity cassettes such as the FX will give you the best performance possible on your tape recorder. Already widely recognized by experts as the finest cassette in the world. Fuji. The cassette of the pro.



FUJI

Fuji Photo Film U.S.A., Inc., The Empire State Building, New York, N.Y. 10001
CIRCLE NO. 18 ON READER SERVICE CARD

New. Diverse. Consistent.

The instruments in this advertisement are new and diverse. They are also selective, deliberately. This is consistent with our attitude — to make components only where we feel we have something to contribute. Then, to give them the finest expression of which we are capable.

Our 330c stereo receiver is the most recent in a series that opened the world of true high fidelity to the music lover with a modest budget. Its predecessor, the 330B, earned extraordinary reviews and recommendations from the leading magazines and the most respected consumer organizations. Nevertheless, when improvement was practical, we replaced it.



The 330c has increased power, tighter phase linearity and wider bandwidth than its immediate predecessor. Yet it is offered at virtually the same price as the original 330, introduced seven years ago.

In its review of the HK1000 stereo cassette deck, *High Fidelity* said, "The HK1000 is the best so far . . . A superb achievement."

We've gone beyond it. With the HK2000.

Performance specifications of the HK2000 are impressive. For example, wow and flutter: 0.07% (NAB) WRMS. The HK2000 is so sensitive to low frequencies that a subsonic filter has been incorporated which can be used to remove unwanted signals from warped records. But just as in all

Harman Kardon amplifiers and receivers, wide band design in the HK2000 produces sound quality that transcends its impressive specifications.

When we introduced our straight line tracking turntable, the ST-7, it was recognized at once as the definitive way of playing records. Precisely as the master was recorded. Without tracking error. Without skating.

The ST-7 was designed for the music lover who had to have the very best—and could afford it.

The ST-6 now joins the ST-7. Straight line tracking, with the demonstrable benefits it offers, is now available to a wider audience—without compromising performance.

The two turntables are virtually identical in appearance and operating capability. They use the same tonearm and straight line tracking mechanism. They are both belt driven and use the same platter and support bearing. Yet the ST-6 is available for little more than the cost of a deluxe record player of conventional design.

We'd like to tell you more about our new instruments and, equally important, about the point of view they represent. Write to us directly—without impersonal reply cards or coupons. We'll respond in kind with full information. Harman Kardon, 55 Ames Court, Plainview, New York 11803.



harman/kardon

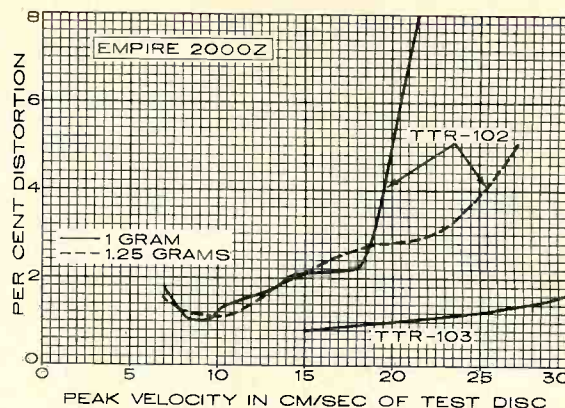
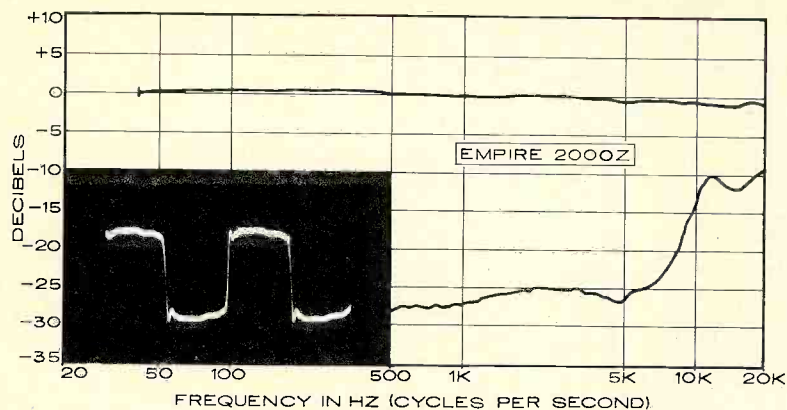

In the graph at left, the upper curve represents the smoothed, averaged frequency response of the cartridge's right and left channels; the distance (calibrated in decibels) between it and the lower curve represents the separation between the two channels. The inset oscilloscope photo shows the cartridge's response to a recorded 1,000-Hz square wave, which gives an indication of resonances and overall frequency response. At right is the cartridge's response to the intermodulation-distortion (IM) and 10.8-kHz tone-burst test bands of the TTR-102

and TTR-103 test records. These high velocities provide a severe test of a phono cartridge's performance. The intermodulation-distortion (IM) readings for any given cartridge can vary widely, depending on the particular IM test record used. The actual distortion figure measured is not as important as the maximum velocity the cartridge is able to track before a sudden and radical increase in distortion takes place. There are very few commercial phonograph discs that embody musical audio signals with recorded velocities any higher than about 15 cm/sec.

played at 1.25 grams, and only a slight "buzzing" marred the 90-micron band. The high-frequency tracking of the 10.8-kHz tone bursts on the Shure TTR-103 record was good, with the distortion increasing slightly from 0.8 to 1.5 per cent as the velocity increased from 15 to 30 cm/sec with a 1-gram force.

When we played the Shure "Audio Obstacle Course Era III" record at 1 gram we noted the onset of mistracking at the highest levels of the sibilance and bass-drum sections. The improvement at 1.25 grams was slight.

● **Comment.** To the extent that available test records permitted, and with due allowance for manufacturing tolerances, our tests confirmed Empire's claims for the 2000Z. We would agree that 1 gram is the best tracking force for the cartridge, although it could not quite cope with some of our most severe tests (few cartridges can handle all of them). The very small improvement when we increased the force to

1.25 grams suggests that the cartridge is performing within its design limits at the lower force rather than operating on the "ragged edge" as sometimes happens when a manufacturer rates a cartridge's recommended force too optimistically. Considering the usual errors in setting the tracking force of a tone arm (errors of 0.1 to 0.2 gram are common) this is a distinct advantage.

Empire has certainly made the frequency response of the 2000Z as flat as could be hoped for, and the selection of 300 picofarads as the load capacitance is a wise one. This is probably close to the average circuit capacitance found in audio-system phono wiring, so there is no need to "pad" the capacitance to obtain the 400 or 500 picofarads required by some cartridges.

Phono-cartridge performance has come a long way in recent years, as can be judged from the 2000Z's measured frequency response. Including the effect of arm resonance in a typical tone arm, and combining the

measurements from a couple of records, the response could honestly be described as ± 1 dB from 15 to 20,000 Hz. This is comparable to the flatness of most amplifiers, especially if the tone controls cannot be bypassed.

We did not really expect to hear any special qualities in the sound of the 2000Z, since that would be inconsistent with the performance we measured, to say nothing of Empire's ratings. We were not surprised, therefore, to find that it is a totally neutral-sounding cartridge in every sense. It is no easier to describe its "sound" than it is to describe the "sound" of a good amplifier. Doubtless it has some qualities which could be interpreted as characteristic sound, but they are of such subtlety that we would not attempt to define them. Suffice it to say that the Empire 2000Z is well qualified to head the current Empire line, and it easily rates a place in the select group of truly exceptional cartridges available to today's audiophile.

Circle 107 on reader service card

Crown IC-150A Stereo Preamplifier



● THE Crown IC-150A preamplifier/control center is an updated version of the IC-150 originally introduced in 1971. The basic features and styling of the IC-150 have been retained, with minor cosmetic changes and numerous internal circuit modifications.

The upper two-thirds of the front panel, finished in satin aluminum, contains the six control knobs. The input selector provides a choice of PHONO 1, PHONO 2, TUNER, AUX 1, AUX 2, AUX 3, TAPE 1, and TAPE 2 sources. A larger volume-control knob operates a thirty-one-position step switch. The volume can be adjusted in precise 2-dB steps down to -60

(Continued on page 53)

DYNAMIC DUO

Power and performance to equal the best, in a new state-of-the-art tuner and amplifier from KENWOOD



KT-7300 Stereo Tuner
(Handles optional)

KA-7300 Stereo
Amplifier (Handles
optional) 65 watts
per channel min.
RMS, 8 ohms.
20-20k Hz, with no
more than 0.1% total
harmonic distortion.

An AM/FM tuner so sophisticated FM-stereo reception is brought to new highs of high fidelity. A stereo amplifier so advanced, a complete new concept of audio power unveils the hidden beauty you never knew existed in stereo reproduction. Together the new KT-7300 and the KA-7300 continue the tradition of KENWOOD, bringing you stereo at its finest.

DUAL POWER

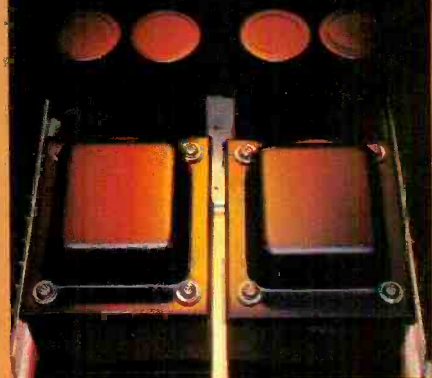

Independent power supplies for each channel eliminate dynamic crosstalk distortion in the superb KA-7300 Amplifier.

For complete information visit your nearest KENWOOD Dealer, or write:

 **KENWOOD**

15777 S. Broadway, Gardena, CA 90248 72-02 Fifty-first Ave., Woodside, New York 11377 In Canada: Magnasonic Canada, Ltd.

CIRCLE 30 ON READER-SERVICE CARD

Mustang II for 1977

Sweet-handling SuperCoupe

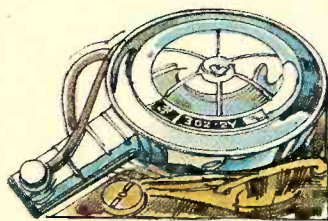

Everyone's got a favorite stretch of road. One that sings through the countryside with sweeping bends, and corners that require just that little extra concentration. Mustang II is going to make that special bit of road even more interesting in 1977. That's because this year Mustang II is even more driver responsive. You'll notice it the second you take off. Thanks to new carburetor linkage, things happen "right now." Your right foot seems to be directly connected to an overhead

cam, four-cylinder engine that revs like mad. If you want even more excitement, there's a compact optional 2.8 liter V-6 or a very strong optional

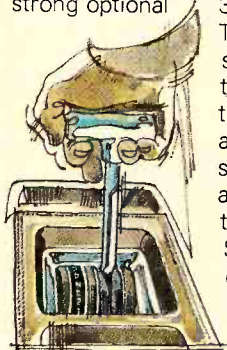

302-cubic inch V-8. To match these razor-sharp power plants there are two smooth transmissions. A slick and quick do-it-yourself four-speeder, and a very crisp optional three-speed Select-Shift. Both are mounted on the floor right next to your throttle leg.

And be sure to give the SelectShift a try before you decide. It's put together very much with the driver in mind. It not only shifts for

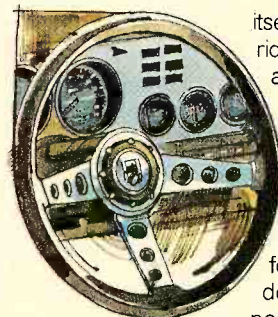

itself, you can override the machinery and shift for *yourself*. Another must-try option is the four-way adjustable driver's seat. It goes back and forth, *plus* up and down. It's got a position that's just

right to keep you in touch with the road and all those gauges keeping track of amps, oil pressure, revs, fuel and speed. Other things that make Mustang II very much a driver's car are rack and pinion steering, front disc brakes, staggered rear shocks, close-ratio four-speed gearbox, no-slop throttle linkage, and low-friction gearshift

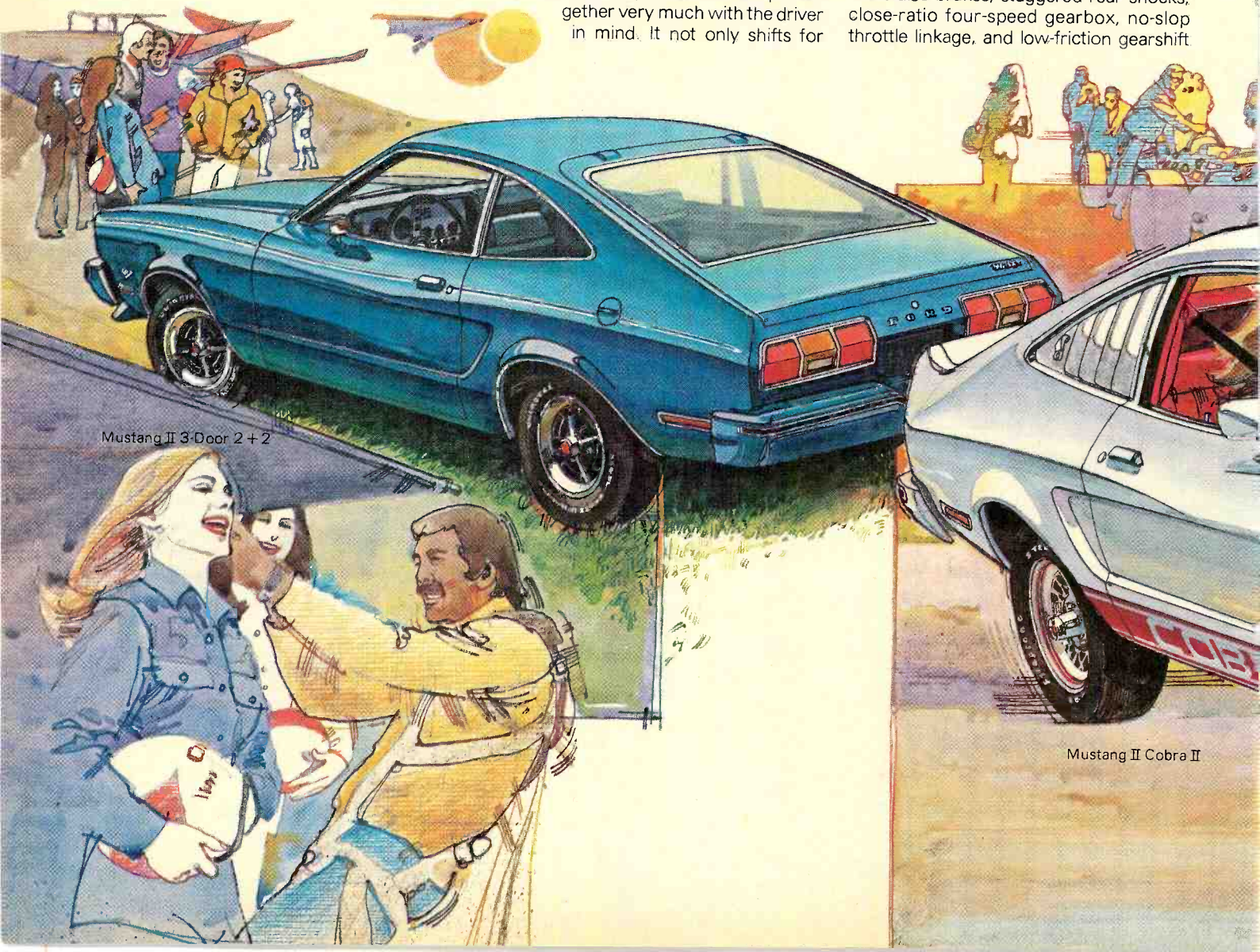

Mustang II 3-Door 2+2

Mustang II Cobra II



Mustang II Mach 1

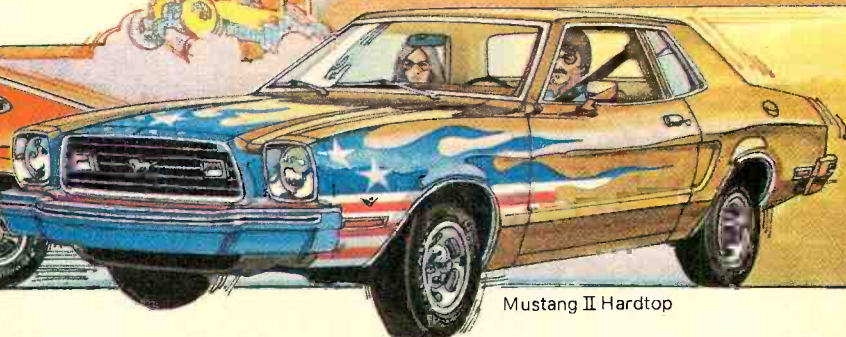

Mustang II Hardtop

linkage. Put them all together and they spell Mustang II. A machine that handles with great snap and precision.

Once you've decided on Mustang II, your decisions have just begun. Mustang II's sweet handling comes in five flavors. There's the hardtop ... sweet handling and low priced. The 2+2. Which also gives you a fold-down rear seat and wide-opening hatchback. There's the Mach 1 and its striking cousin: Cobra II. Both with slippery looks to match their smooth performance.

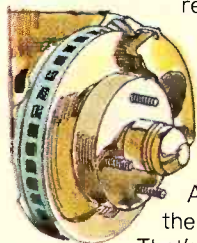

And the most formal of the five.

That's Mustang II for 1977. Fun

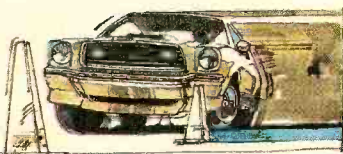

to drive, comfortable to ride in as a passenger, and built to live a long time. If you're a driver you'll love

Mustang II. If you're not, we can't think of a better way to learn what driving's all about.

Is that it? Not hardly. Because Mustang II is the kind of car that invites customizing... that welcomes your personalizing touch. Paint. Special wheels. Special equipment. Whatever it takes to make your Mustang II the car you've always wanted. Come on in and try a 1977 Mustang II.

FORD When America needs a better idea, Ford puts it on wheels.

ENGINE SPECIFICATIONS

	4 In-Line	V-6	V-8
Cylinders	4 In-Line	V-6	V-8
Displacement	2.3 Liter (140 cu. in.)	2.8 Liter (170.8 cu. in.)	302 cu. in.
Bore	3.78"	3.66"	4.00"
Stroke	3.126"	2.70"	3.00"
Carburetion	2-Barrel	2-Barrel	2-Barrel
Exhaust			
Valve Lifters	Single	Single	Single
Valve Lifters	Hydraulic	Mechanical	Hydraulic

TRANSMISSIONS

Rear Axle Ratios	4-Speed Manual	SelectShift Auto.
4-Cylinder	3.18	3.18
V-6	3.00	3.00
V-8	3.00	3.00

DIMENSIONS

	HARDTOP	3-DOOR
Wheelbase	96.2"	96.2"
Overall Length	175.0"	175.0"
Overall Height	50.3"	50.0"
Overall Width	70.2"	70.2"
Tread, Front	55.6"	55.6"
Tread, Rear	55.8"	55.8"
Luggage Capacity (cu. ft.)	6.7	—
Cargo Volume (cu. ft.) w/Seat Folded Down	—	22.8
Fuel Capacity (gal.) w/302 V-8	16.5	16.5
Curb Weight (lbs.) Base Vehicle	2,735	2,768

FORD MUSTANG II

FORD DIVISION





The component look.

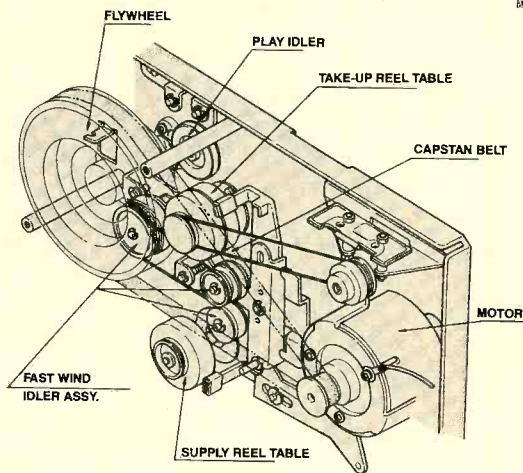

Rather than adapt one transport design to fit another need, we produced a completely new, highly streamlined mechanism. From the inside out. It's called the A-400.

Since the cassette loads vertically, the adverse effect of gravity on the cassette itself is eliminated. Thus tape jams are prevented and smooth, even tape

packs are predictable.

A completely new DC servo controlled motor has been designed to keep wow and flutter to a minimum. It operates

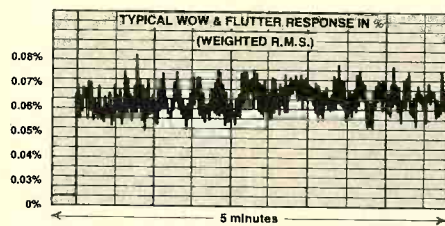

on a frequency generated feedback principle and is unaffected by line voltage fluctuations. The result is quiet, smooth and precise movement of tape.

Twin rotary levers control the transport functions with smooth, positive cam action. Which means unnecessary mechanical linkages have been eliminated. Fewer moving parts assure greater reliability and long term dependability.

If new design concepts, superbly executed, appeal to you, put an A-400 through its paces. Just call (800) 447-4700* toll free for the name and location of your nearest TEAC retailer. You'll find that the A-400 delivers definitive TEAC performance with the added convenience of a front load component. All by design.

*In Illinois, call (800) 322-4400.

By design.

A-400

TEAC® The leader. Always has been.

TEAC Corporation of America
7733 Telegraph Road, Montebello, Calif. 90640
©TEAC 1976

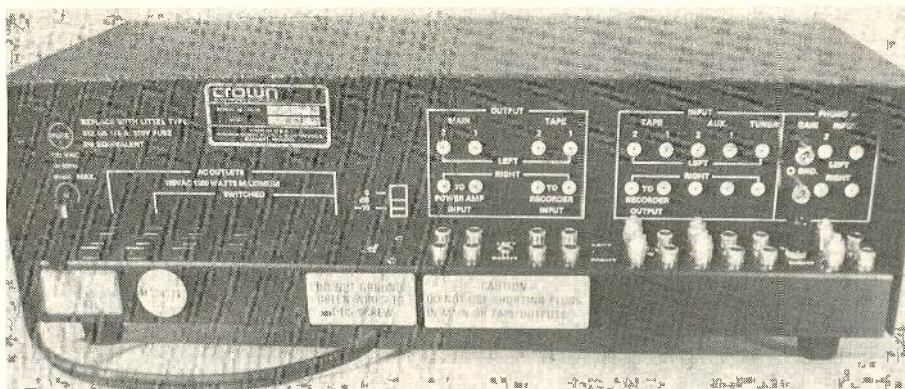

The Crown IC-150A has a rear-panel shelf that accepts all the input and output connectors. The jacks are identified by a diagram immediately above. Shorting plugs are shown inserted into some of the unused inputs to eliminate noise. Note the sensitivity controls on the phono inputs.

dB, with the final position being fully off. Precision resistors in the volume-control circuits maintain channel balance within 0.2 dB at all settings. An adjacent pushbutton engages the loudness compensation.

The balance control is conventional, and is followed by the PANORAMA control, a feature of the original IC-150 preamplifier. This continuously variable control gives full stereo separation and normal left-right channel orientation when set to NORMAL (counterclockwise), and it blends the channels to mono at its center position—which then eliminates the balance-control function. As the PANORAMA is moved to the clockwise limit, the output returns to stereo with left and right channels interchanged. The control is aptly named, since it gives the user complete control over the lateral distribution of the stereo image.

The BASS and TREBLE controls, concentrically mounted for the two channels, can be bypassed entirely by pressing a FLAT button located between them. The charcoal-gray bottom third of the panel contains two mono phone jacks for the left- and right-channel AUX 3 high-level inputs and a single stereo phone jack labeled MONITOR. This can be used to supply signals from the preamplifier outputs (after the volume and tone controls) to a third tape recorder or to high-impedance headphones. Five pushbutton switches control TAPE MONITOR functions for the two decks connected to the rear of the IC-150A, switch in the LOW and HIGH filters, and switch the power to the preamplifier. A small orange pilot lamp glows when the unit is turned on.

The inputs and outputs are on a horizontal section of the chassis and recessed into the rear of the cabinet. A slide switch attenuates the preamplifier outputs (which are provided in duplicate) by 10 dB to accommodate power amplifiers with high sensitivity and no input-level controls. Five of the six a.c. outlets are switched and can handle a total of 1,200 watts.

Like all Crown products, the IC-150A comes with a very comprehensive spiral-bound instruction manual. Not only are all performance specifications spelled out in detail, but the text could serve as a handbook for high-fidelity amplifier installation. To lighten its message, Crown has even interspersed welcome touches of humor.

The general caliber of the IC-150A performance specifications can be judged from its distortion ratings (at the rated maximum output of 11 volts into a high-impedance

load): less than 0.002 per cent intermodulation distortion (IM) and less than 0.0005 per cent harmonic distortion (THD) at 1,000 Hz. Special test equipment would be needed to verify these claims, especially the latter.

As the nomenclature of the IC-150A suggests, its design is based largely on the use of integrated circuits. This makes its circuitry seem deceptively simple, with a single IC (per channel) supplying all the normal gain and tone-control functions. The phono preamplifier uses one IC coupled with a pair of complementary-symmetry transistors. A relay mutes the audio outputs for a few seconds after power is applied (and when the unit is shut off) to prevent switching transients from reaching the speakers.

The Crown IC-150A is furnished in a black wrinkle-finish metal cabinet. It measures 17 inches wide x 8½ inches deep x 5¼ inches high and weighs 10 pounds. Price: \$399. An optional walnut cabinet is \$45 additional.

● **Laboratory Measurements.** The maximum 1,000-Hz output before clipping was 11.7 volts into a standard IHF-specified load of

100,000 ohms in parallel with 1,000 picofarads, and 4.8 volts into a 600-ohm load. A high-level input of 0.18 volt drove the preamplifier to a standard 1-volt output, with a signal-to-noise ratio (S/N) of 80 dB (unweighted).

The phono preamplifier gain can be varied over a 20-dB range by means of screw-slot controls in the rear of the preamp. The factory setting (recommended for normal use) requires 1 millivolt (mV) input for 1 volt output and gave a very good 76.5-dB S/N. The phono sensitivity can be varied from 0.27 mV to 3.1 mV with relatively little effect on S/N. The phono-overload level varied with sensitivity from 40 to 400 mV, with 140 mV being the value at nominal settings. With this design, phono overload is highly unlikely.

Distortion measurements across the audio-frequency range were made with a 600-ohm load (the worst-case condition) at the rated maximum output of 2.5 volts. The THD was 0.018 per cent at 20 Hz and 0.05 per cent at 20,000 Hz and measured less than 0.01 per cent from 100 to 10,000 Hz (over most of that range it was below our 0.003 per cent measurement capability). The IM distortion, measured on a Crown IM analyzer, was less than 0.005 per cent from rated output to -20 dB (250 mV) and was typically at the barely detectable value of 0.002 to 0.003 per cent. It rose slightly, to 0.012 per cent, at the minimum measurable output level of 80 mV.

The frequency response varied less than ±0.25 dB from 20 to 20,000 Hz. The treble tone-control response hinged at 1,000 to 1,500 Hz, and the bass turnover frequency varied from below 50 Hz to about 300 Hz as the control was varied. By design, the cut-off frequency of the LOW filter shifts upward as the volume control is raised. At maximum, where we made our measurements, it was down 3 dB at 90 Hz and had a 6-dB-per-octave slope. The HIGH filter, which had a 12-dB-per-octave slope, was 3 dB down at 6,000 Hz. The loudness compensation produced only a mild boost of the frequencies below 100 Hz, and it did not affect the highs. (Continued overleaf)

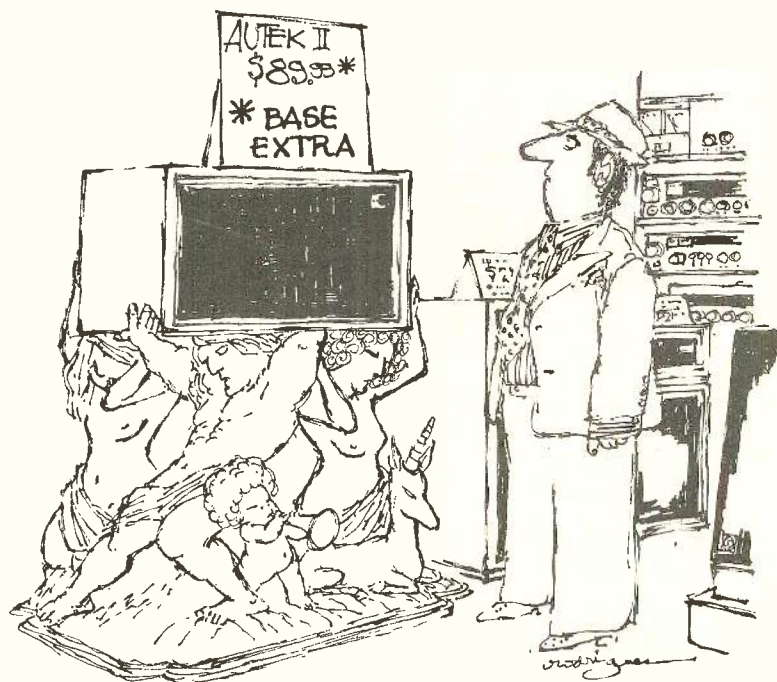



In a class by itself.

The Phase Linear 400 Power Amplifier has only one serious competitor when it comes to advanced design, superior performance, made-one-at-a-time craftsmanship, proven reliability, elegant appearance . . . and incomparable value. And that's the Phase Linear 700B. Hear them both at your dealer soon.

Phase Linear 400

THE POWERFUL DIFFERENCE

201 watts per channel, min. RMS at 8 ohms from 20 Hz-20 kHz with no more than .25% total harmonic distortion.

PHASE LINEAR CORPORATION
20121 - 48th Avenue S.W.
Lynnwood, Washington 98036
CIRCLE NO. 43 ON READER SERVICE CARD

The RIAA phono equalization was within ± 0.5 dB from 70 to 20,000 Hz, with a slight rise of about 1.5 dB in the 25- to 30-Hz region. The equalization was affected only slightly when the measurement was made through the inductance of a phono cartridge, and it remained within the ± 0.5 -dB limits up to 20,000 Hz. The square-wave rise time was 2 microseconds and the slew rate was 6 volts per microsecond.

● **Comment.** Our measurements show that the frequency response, distortion, and noise characteristics of the Crown IC-150A are about as close to perfection as one can expect to find in today's audio components. It performed exactly as expected, with impressively low noise levels, smooth and noise-free control operation, and all the sonic virtues one would expect of a really distortionless audio preamplifier.

The unit's few idiosyncrasies are all stated clearly in the instruction manual. For exam-

ple, when a tape recorder is connected to the preamplifier, one must be careful not to leave the *tape recorder's* monitor switch in its "source" position, for if the input SELECTOR is then turned to the corresponding tape-input position, a violent oscillation results. For the same reason, accessories such as graphic equalizers, noise reducers, speaker equalizers, and the like should not be connected to the IC-150A's tape-monitoring circuits in lieu of a recorder. They will work perfectly well, but one runs the risk of being sonically zapped if the input SELECTOR is inadvertently turned to one of the TAPE settings.

The many inputs and outputs suggest great operating versatility, and this the IC-150A certainly has. Overall, the Crown IC-150A is an impressive example of the degree of refinement available in modern audio circuits. It is difficult to imagine how its electronic performance could be improved in any significant respect.

Circle 108 on reader service card

Kit Report Addendum on the Heath AA-1640 Stereo Power Amplifier

● IN order to provide an evaluation of the Heath AA-1640 stereo power amplifier as soon as possible, STEREO REVIEW printed a report on a factory-assembled version of the unit in May 1975. Since then we have acquired a kit version of the amplifier and had it built by a volunteer. The remarks below are abstracted from his comments.

The Heath AA-1640 kit went together beautifully in a little under thirty hours of methodical work. The kit follows the Heath philosophy of having the kit builder assemble everything. None of the printed-circuit boards are prewired. The excellent kit manual is an example of how a fairly complex commercial product can be made manageable by a person with average dexterity and soldering experience. Large fold-out diagrams clarify the carefully laid-out step-by-step instructions. After the kit is finished, the rest of the manual serves as a trouble-shooting guide should something malfunction. X-ray-view drawings of all circuit boards, voltage charts, a parts-substitution list, a schematic, and a verbal description of all circuits are included, together with a troubleshooting chart.

Instructions are given for testing all electrical portions of the amplifier immediately upon completion. This is accomplished with a volt-ohmmeter tester that is part of the kit and a supplied earphone that permits the builder to trace signals within the amplifier by ear and thus to locate any problem area quickly.

Along with the AA-1640 amplifier, the optional peak-reading output-level meters (Kit AAA-1640-1) for the front panel were also assembled and installed. This required just over an hour and a half, including calibration, and presented no special difficulties.

All in all, the Heath AA-1640 is a well-designed if lengthy project very much in the

Heath tradition. It is obviously not intended for a complete novice, but anyone with a modicum of kit-building experience who thinks he is ready for bigger things should find it just about right.

If you missed the original test report on the AA-1640, copies of the May 1975 issue are available at \$1.50 each from Ziff-Davis Service Division, Dept. BCSR, 595 Broadway, New York, N.Y. 10012. Space does not permit reprinting the entire report, but the following excerpts will serve as a summary:

"... In every respect it [the AA-1640] ranks with the finest high-power amplifiers on the market. We were constantly impressed with the conservatism of its construction and ratings. This is one amplifier that simply cannot be overheated under home music-listening conditions, as we verified by an afternoon of auditioning with a pair of Ohm F speakers while the amplifier meters read almost constantly between 0 and -10 dB. After a few hours of this sort of use, the AA-1640's heat sinks were cooler than the FM tuner and tape deck we were using as signal sources!

"... It is interesting to note that in our listening tests with the Ohm speakers we were regularly delivering over 400 watts per channel on peaks to their 4-ohm impedance, and we never had the sense that the amplifier was nearing the end of its capability.

"The meters are by far the most useful we have seen on an audio amplifier . . . since they constantly show how close the amplifier is coming to its real limits and readings are unencumbered by the sluggish indications of averaging-type meters."

The Heath AA-1640 kit is priced at \$439.95; the optional meter kit is \$69.95. Bought together, the two cost \$489.95.

Circle 109 on reader service card

What It's All About

Dolby FM is multi-faceted.

It's about FM transmitting.

It's about FM receiving.

But more than that, it is about signal integrity.

About the possibility of total recoverability, by the listener at home, of the frequency response and dynamic range of the source material used at the station.

Right now, listeners who really enjoy wide dynamic range high-fidelity sound are often pretty discouraged by what they hear on FM. For instance, the sounds that are supposed to be quiet are almost indistinguishable from those that are supposed to be loud. Of course, these signal leveling practices arise because of station "ratings" and the belief that a signal which always sounds loud or brilliant keeps ratings high. The Top Forty stations probably always will broadcast in this way—and perhaps they should, if that's the sound their particular listening audience really prefers.

One station would be enough

We think it's time for some improvements for more discriminating radio listeners. Such individuals would be served well if, in each geographic territory, they could have just one quality conscious and embellishment-free station in each of the format categories that people really listen to, such as classical, folk, jazz, and progressive rock. The food business learned long ago that every town needs at least one gourmet restaurant.

We know that in the long run we are talking about only a fraction of all stations. But that would be enough. It would take care of the quality oriented radio listeners we are interested in. And those listeners are the ones who are most likely to buy receivers with built-in Dolby FM decoding.*

How you can help improve FM

You can help improve FM. First listen critically to the best FM stations in your area. If the contrast between loud and soft sounds is markedly less than you hear when playing your own records, and this bothers you, then write to these stations and offer your views. We'd appreciate it if you would point out that extra signal treatment is theoretically unnecessary when Dolby encoding is used (see explanation at right). You might even declare that you are as dismayed by the use of traditional limiting, compression, and equalization on these stations as you would be if the waiter in a fine restaurant poured ketchup and mustard all over your food before serving it to you.

If you know that your station is already Dolby encoding, and you still hear disturbing manipulations of the signal, then we are especially concerned that you should write. We know well that some of the 140 Dolby FM stations carry on using various types of conventional signal treatment in spite of the fact that our encoder unit removes the basic problem of high frequency overmodulation. But it's hard to change the habits of an industry overnight. It would help if you could assure these well meaning—but fearful of "ratings"—stations of your continued support if they would simply broadcast accurately the dynamic range and frequency response of the source material.

If we all care, we *can* have better FM broadcasting. At least from the stations we listen to. And that would be enough.

That's what Dolby FM is all about.

The reason for Dolby FM

Why Dolby FM encoding and decoding anyway? Why not just a high fidelity, wide dynamic range FM signal by itself? Because this is a technical and practical impossibility. If the FM station broadcasts at a reasonably high signal level, then the high frequencies have to be limited (due to historical reasons relating to the standard 75 microsecond boost employed at the transmitter). The station can reduce its level and use no signal treatment, but this wastes transmitting capability and reduces geographical coverage. Therefore, practically all stations employ high frequency limiting.

The inevitability of signal degradation apparently affects the thinking of many station personnel. Since it is already necessary to limit the signal somewhat, perhaps it seems defensible to experiment further with signal processing. This results not only in an effort to compensate for the sparkle lost in high frequency limiting, but also in an attempt to make the signal seem even more energetic and brilliant than the original. There seems to be a general belief among many broadcasters that listeners really prefer this kind of altered sound.

In comparison with many of these signal modification practices, Dolby FM encoding is rather unexciting. Basically, it amounts to a gentle form of high frequency limiting, but the difference is that it is done in a way which permits the listener at home to "un-limit" or to recover the signal. About half of the Dolby B-Type compression and expansion capability is used, together with a 25 microsecond boost, to solve the station's high frequency overmodulation problem (which gives a distortion-free channel between the transmitter and receiver); the other half is used to improve the signal to noise ratio.

** July 1976. Thirty-three different models are available from Dolby licensees. These products are tuners, receivers, and music centers with designed-in Dolby decode circuits, requiring no extra wiring, adaptors, or calibration procedures. Write for the latest list. Technical information on Dolby FM is also available.*



Dolby Laboratories Inc

'Dolby,' 'Dolbyized' and the double-D symbol are trade marks of Dolby Laboratories Inc.

731 Sansome Street
San Francisco CA 94111
Telephone (415) 392-0300
Telex 34409
Cable Dolbylabs

346 Clapham Road
London SW9
Telephone 01-720 1111
Telex 919109
Cable Dolbylabs London

**SPECIAL
PRE-PUBLICATION
OFFER FOR READERS
OF STEREO REVIEW
MAGAZINE**



**THE 1977
STEREO DIRECTORY
& BUYING GUIDE**

*is scheduled to go on sale
nationally October, 1976*

This all-new edition will feature the latest information on stereo systems and components, including four-channel—more than 1500 products in all—listed by manufacturer, each with model number, complete specifications, descriptions and prices.

**YOU CAN RESERVE
YOUR COPY NOW
AT THE**

**SPECIAL
PRE-PUBLICATION
PRICE OF ONLY \$1.25,
POSTPAID.**

This offer is being made to readers of STEREO REVIEW Magazine only. Regular price is \$1.95; mail order price \$2.25. Reserve your copy now by completing the Reservation Form and returning it promptly along with your remittance. STEREO DIRECTORY & BUYING GUIDE will be mailed to you from first-off-the-press copies when published.

PRE-PUBLICATION RESERVATION FORM
Stereo Directory
& Buying Guide
Consumer Service Division
595 Broadway, New York, N.Y. 10012

Enclosed is \$1.25* Please reserve my copy of the 1977 STEREO DIRECTORY & BUYING GUIDE to be mailed to me from first-off-the-press copies when published. SR106

Print Name _____

Address _____

City _____

State _____ Zip _____

*Residents of Cal., Col., Fla., Ill., Mich., Mo., N.Y. State, D.C. and Tex. add applicable sales tax.

The Pop Beat

By Steve Simels



A SHOT OF RHYTHM-AND-BLUES

WHEN I was going to school (at what I hope soon to stop referring to as "an unidentified college on Long Island") various student organizations used to hold dances in the Commuters Cafeteria, a place with an ambience only slightly more appetizing than that of a typical restroom at the Port Authority Bus Terminal. Hippies like me were not supposed to attend these affairs, partly because of our then-fashionable distaste for folks who consumed alcoholic beverages (remember that?—if you do, you're showing your age) and partly because the music played at those bacchanals had little in common with the kind played in darkened dorm rooms while the incense burned.

But I used to go anyway. The bands were invariably of two types—either ersatz Vanilla Fudges, heavy on Baroque organ stylings and lugubrious tempos, or interracial horn outfits emulating Memphis soul groups. The first didn't interest me much except in a perverse how-awful-can-it-get sort of way, but the others (several were very good indeed) simply delighted me. It was like seeing Otis Redding or Sam and Dave in my own neighborhood, without the psychic unease that can come from realizing you're the only white person at the Apollo.

That particular kind of funky little band has been pretty much an anachronism for years, and I'd almost forgotten they ever existed. But as the Seventies glittered their way everywhere except into my heart, as the absence of any discernible human emotion in 95 per cent of the rock-and-roll being played today became obvious even to its most autistic addicts, and as the computerized transmogrification of soul into disco created a backlash that enabled a difficult-to-dance-to variant of r-&b called reggae to flourish (if only in a less than overwhelmingly commercial way) . . . well, 'way out in the boondocks, in Asbury Park, New Jersey, *they still remembered*. In fact, they still *have* bands like those I used to groove to from a seat somewhere to the left of the coke machine. One of them, a collection of former associates of Bruce Springsteen called Southside Johnny and the Asbury Jukes, has just emerged from the swamps, and they are the most compelling rockers to come along in geological epochs—or at least since Bruce and the E Streeters.

The connection with Springsteen is, of course, what made it possible for the Jukes to come to national prominence initially, but beyond the fact that they're all pals, there re-
(Continued on page 58)

Front man Southside
Johnny Lyon in
beautiful downtown
Asbury Park, N.J.



Epic Records

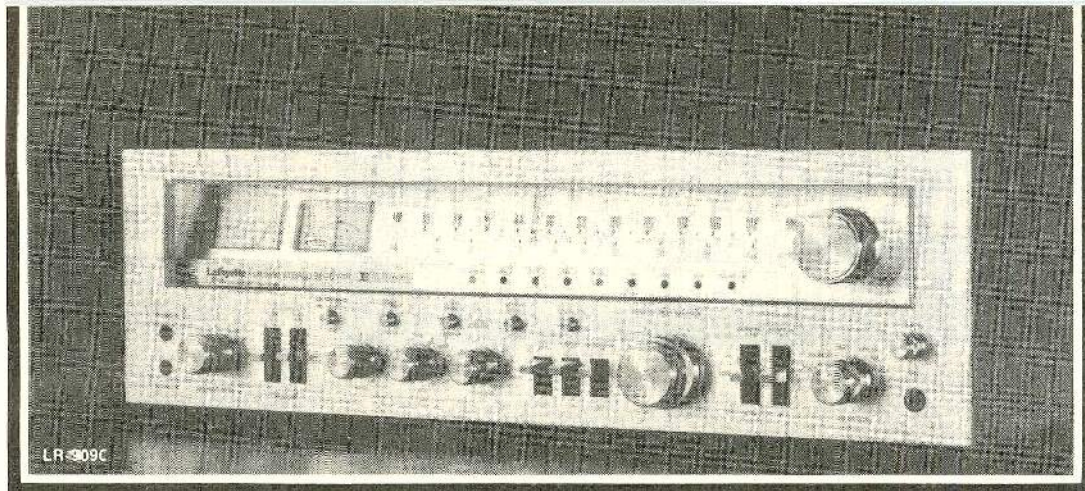

Our new Powerhouse receivers outpower the competition.

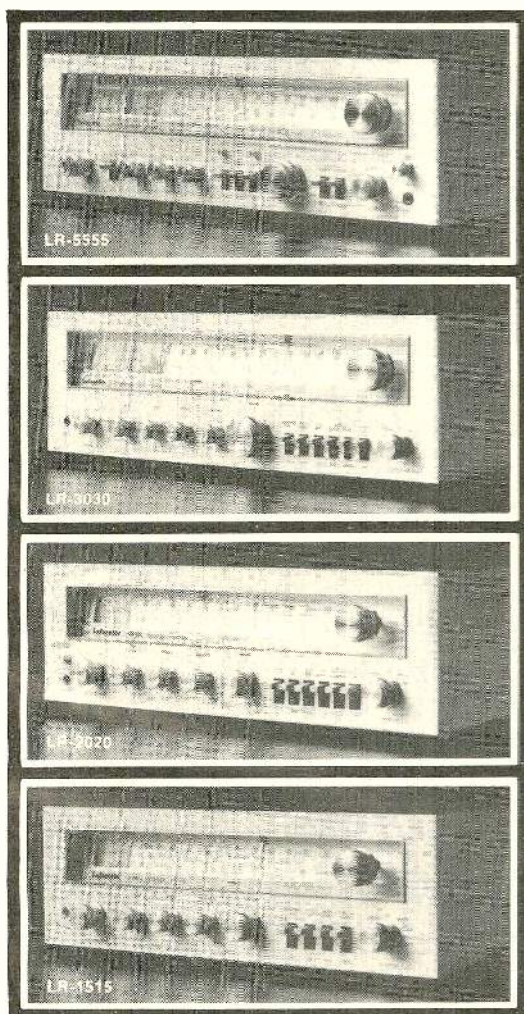

Lafayette's new Powerhouse receivers have the power, the features and the performance you want. And the competition only promises.

Just check our spec chart. We deliver. With no gimmicks or technical tricks.

Besides incredible specs our new Powerhouse receivers have some features you've never had on any receiver before. Stop in at any of the Lafayette stores or dealers coast to coast and hear what Dolby® FM noise reduction, mike mixing and detent controls can do to give you clean, distortion-free sound.

Lafayette performance goes far beyond sound. We back you up with warranties, in-store service and people who can talk stereo in plain, simple language.

Our new line of Powerhouse receivers was built with power and backed up with consumer services to outpower the competition. Now where does the competition stand?

Specifications	LR-9090	LR-5555	LR-3030	LR-2020	LR-1515
Power Min. RMS 20-20,000 Hz	90+90	55+55	30+30	20+20	15+15*
Total Harmonic Distortion (Less Than)	0.1%	0.5%	0.5%	0.6%	0.7%
Input Sensitivity: phono/Aux/Mike mV	2.5/150/6	2.5/150/6	3.5/150/	4.0/150/	4.0/150/
Tone	Bass/Mid/ Treble	Bass/Mid/ Treble	Bass/Mid/ Treble	Bass/Treble	Bass/Treble
Speakers	A, B, C	A, B, C	A, B, 4/ch	A, B, 4/ch	A, B, 4/ch
FM Sensitivity (Stereo)	21.0 dBf (1.8 μV)**	21.0 dBf (1.8 μV)**	23.0 dBf (2.0 μV)**	23.0 dBf (2.0 μV)**	25.0 dBf (2.2 μV)**
Selectivity	80dB	80dB	70dB	70dB	60dB
Capture Ratio	1.25 dB	1.25 dB	1.5 dB	1.5 dB	2.0 dB
Price	\$599.95	\$399.95	\$299.95	\$249.95	\$199.95

* @ 40-20,000 Hz ** IHF ('58) Sensitivity (Mono)

Lafayette

There is no competition.

For more information and a free catalog please write: Lafayette Radio Electronics, Box 120, 111 Jericho Tpke., Syosset, N.Y. 11791
Copyright 1976 Lafayette Radio Electronics

CIRCLE NO 52 ON READER SERVICE CARD

BSR. Finally, turntables worth building your whole system around.

When most people consider buying a stereo component system, they usually build it around either the receiver or the speakers. But when serious music lovers choose a system, they should think of the turntable first. Because the turntable dictates what comes out of the speakers. And when it comes to turntables, BSR offers more than Dual, BIC or Garrard.

First of all, the new BSR turntables are *belt-driven*, so they're engineered to be smooth, quiet and virtually trouble-free. They play automatically *and* manually. And to really turn the tables on our competitors, BSR includes the revolutionary ADC induced magnetic cartridge, the base *and* the dust cover in the price of the turntable.

BSR gives you still more. Like a *locking umbrella spindle*

that holds up to six records. A rotating single play spindle. A continuous repeat spindle so you can play your favorite record over and over again. And a *viscous damped cueing mechanism* that's smooth and precise to help protect your records.

What's more, BSR turntables are *pre-tested* and *pre-assembled*. So you can get down to the serious business of listening to your favorite music right away. And also enjoy another special feature; the price.* Under \$140 for the 200 BAX, \$110 for the 100 BAX and under \$100 for the 20 BPX automated single play turntable.

If you consider yourself a serious music lover who wants brilliant sound reproduction, consider BSR first. For full details see your dealer or write: Consumer Products Group, BSR (USA) Ltd., Blauvelt, N.Y. 10913.

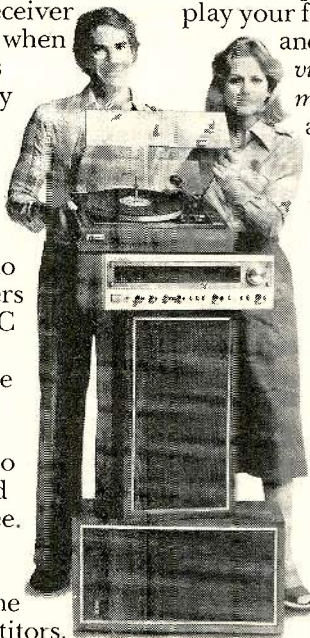

*Suggested manufacturer's retail prices including ADC induced magnet cartridge, base and dustcover.

BSR THE HEART OF YOUR SYSTEM.



CIRCLE NO. 10 ON READER SERVICE CARD

ally isn't that much similarity between the two bands. I hope that fact will serve to shield the Jukes from the anti-Springsteen cabal that developed last year when some of the sniffer New York critics reacted to what they considered an unwarranted hype. True, many of their influences are shared, but Bruce is something of an Anglophile (it's hard to imagine the Jukes doing Searchers stuff), and Johnny's interests are more hard-core.

To put it simply, the Jukes are an r-&-b band in the old style: a four-piece horn section along with the standard instrumental complement, plus Johnny, the front man, singing, dancing, and playing (extremely well) blues harp. Their repertoire consists of a few originals that draw without self-consciousness on older models and just about every good soul song from 1954 to 1968. The pacing of the act is incredibly fast, and Johnny is a mesmerically funny showman, but for all their professional polish I've rarely seen musicians more passionately committed to what they're doing.

If you're going to make it in South Jersey you have to be—passionately committed, that is. Asbury is hardly the media capital of the Western world, and successful bar engagements down there are not likely to get you rapturous write-ups in the *Village Voice* or the *Soho News*, at least not without the connivance of a big, fat record company. But this relative isolation does allow a band to develop at its own speed and without any particular compulsion to follow current trends. It also keeps you honest; you're playing for *dancing*, after all.

The Stone Pony, where the Jukes had a recent three-night-a-week residency (even after that fabulous album was released) is a joint in point: friends of mine who grew up in the area and who have been back recently tell me that it's a hangout for the kids at Monmouth College—who don't give a hoot whether the Jukes are associated with the area's first superstar or not; they go to drink, have a good time, and *dance*. Contrast that with the aura of a fashionable gloom-trap such as New York's C.B.G.B., where any sort of spontaneous gesture on the part of the audience is regarded as fatally unhip. At the Stone Pony, Johnny and the boys play from eight to three in the morning, and their success is measured not by how many encores they get but by how long they keep everybody on the floor.

WELL, perhaps sadly, the Jukes aren't going to be playing that kind of place much longer; very shortly they are going to Belong to the World. They have already played their first concerts, and I am happy to report that they are just as satisfying that way, something you should shortly be able to verify for yourself. I am also heartened by this evidence that so old-fashioned an approach to music-making can be successful in this day and age. It would not even surprise me if they were to turn out to be rather influential. In the Sixties, you'll remember, we got a long line of white blues bands that developed initially as a reaction to the vapidness of most commercial pop. Something similar may be happening now; if Johnny and the boys are not the only musicians fed up with the soullessness of current FM fodder and the depressing cookie-cutter sameness of disco, then perhaps more of them will begin turning to American rhythm-and-blues as an alternative. It's an enormous untapped field, and I'll lay you odds it won't stay that way for long.

The Sherwood HP 2000: It adds a new high to performance.

If power and versatility are the essential elements of high performance, the HP 2000 is unquestionably the high performance amplifier you've been waiting for.

This new top-of-the-line Sherwood amplifier puts you in full command of your sound system.

Consider the credentials:

Power: 120 watts per channel [minimum RMS at 8 ohms from 20-20,000 Hz] with no more than 0.08% Total Harmonic Distortion.

This rating is ensured by massive 16,000 μ f filter capacitors, backed by a zener regulated dual secondary power supply. The full complementary direct-coupled OCL output circuitry employs output transistors with the largest S.O.A. [safe operating area] of any consumer device currently available. Dual power meters [which feature selectable sensitivity: normal, or

-10dB] and LED power limiting indicators precisely monitor power output at all times. And rear-panel switching permits the independent operation of the pre-amp and power amplifier sections.

Precision: The film resistor step Loudness [Volume] control features 22 accurately calibrated positions [both channels matched within 0.5dB in all steps]. Eleven position Variable Loudness Contour, Bass, Treble and Midrange controls have 11 detented positions each. Resetting to your exact acoustic preferences is never a matter of guesswork.

Master Tone Defeat, High and Low filters, and -20dB Audio Muting are controlled by convenient front panel switches.

Operational Flexibility: The HP 2000 can accommodate two turntables [Phono inputs are selected with IC analog

switching, and feature a front panel level control]; two tape decks [tape-to-tape duplication is accomplished with the Tape-1, Tape-2 Monitor circuits]; and a pair of professional-caliber microphones [mixing level determined by a separate front panel control]. Additional source capabilities include a Tuner; two Auxiliary components; and a 4-Channel Adaptor [which also serves as a third Tape Monitor, if needed].

All Sources and Functions are activated by front panel push switches. ["On" position is indicated by color change]

The highest quality componentry: The HP 2000 has been meticulously engineered for durability, consistent performance standards, and ease of servicing; the mark of Sherwood design for over 20 years. All componentry

has been selected to meet or exceed posted specifications. The P.C. boards and inter-board ribbon cable connectors plug into a "mother-board," for reliable operation.

The HP 2000 is the first in a new, highly sophisticated line of tuners and amplifiers from Sherwood Electronics.

Other units in this new High Performance Series will be available soon.

See the HP 2000 soon. And treat yourself to performance that's as high as your expectations have always been.



SHERWOOD

Everything you hear is true.

Sherwood Electronic Laboratories, Inc.
4300 N. California Ave.
Chicago, IL 60618

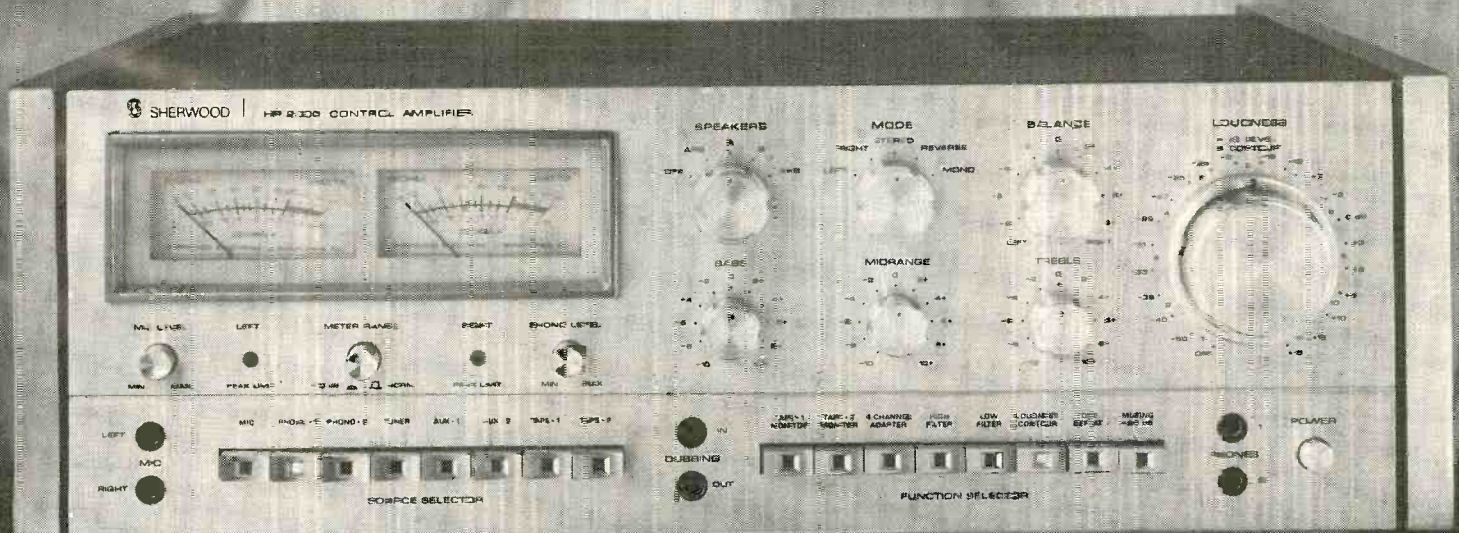

Going on Record

By James Goodfriend



SECOND COMINGS

THE myth of eternal return is not something that was created to explain the classical record business, but there have been days when you couldn't prove that around here. No sooner do you bid a grudging farewell to a disc whose availability can no longer be commercially rationalized than another one you said goodbye to some time ago comes parading through the door in new dress, with a new number, and sometimes on a new label. Such goings on may raise hell with the collectors' cut-out market, but it's nice to be able to greet old friends again.

I remember distinctly when Erich Kleiber's recording of Beethoven's Ninth was first released. It came on the market at exactly the same time as recordings of that work by Toscanini and Scherchen, and for a while the comparative critical assessments ran wild with superlatives. Kleiber's set suffered commercially because it was spread over four sides (the other two versions gave an additional symphony as bonus), but there were people who thought it was the best of the lot.

Now it has come back, all on a single disc (London R 23201), and its lineup of participants is still impressive: Hilde Gueden, Sieglinde Wagner, Anton Dermota, Ludwig Weber, the Vienna Philharmonic, and the Chorus of the Gesellschaft der Musikfreunde. On rehearsing, it strikes me still as a sane and civilized performance, eminently musical, and with excellent vocal contributions—but lacking fire. Interestingly, I still prefer it to both the Toscanini and the Scherchen performances, but decidedly not, among performances of similar vintage, to the Walter or the Furtwänglers.

In the early days of LP, the name Clemens Krauss was virtually synonymous with ideal performances of music by anybody named Strauss. Through years of technical improvements in recording, I have retained my old mono *Also Sprach Zarathustra* as a prime example of state-of-the-art musical accomplishment. It is still state-of-the-art. And it is now available once again (London R 23208) with the added bonus of Krauss' equally fine *Till Eulenspiegel* (of which I also still own the original). Sound buffs will cringe at the recording's technical crudities, but those who are looking for music rather than sound-demonstration material will find it here.

Over the years, Columbia records found

numerous occasions and ample reasons to record works as played or conducted by their composers. The Stravinsky documentation is well known, as is that of Copland and Bernstein, but many collectors may not remember that Columbia also recorded Francis Poulenc as a pianist, Darius Milhaud as a conductor and as a pianist, and Paul Hindemith and Arnold Schoenberg as conductors. Columbia has now embarked on an informal series of reissues called "The Composer as Performer," and records by those four are among the first releases.

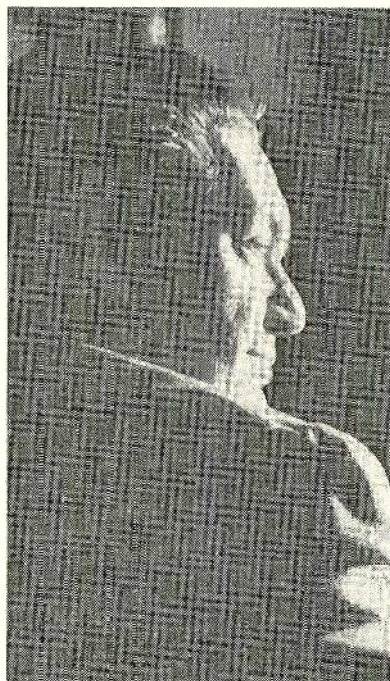

DARIUS MILHAUD
A twentieth-century French Schumann

Certainly, Milhaud's contribution (Odyssey Y 33790) is more interesting for the music he presents than for any special interpretive insights. The *Cantate de l'Enfant et de la Mère* has never been recorded elsewhere, and *La Muse Ménagère* (*The Household Muse*) has only recently appeared elsewhere. But the

music is really charming. It shows Milhaud very much as a sort of twentieth-century French Schumann—rather than as *enfant terrible* of "modern music"—a fluent and spontaneous writer with a natural and almost inexhaustible lyrical gift and a great sentiment for the small, important things of life.

Granted, *La Muse Ménagère* offers more to one who plays the music himself than to those who hear even the composer play it, but there is pleasure to be gleaned from even passive listening. The *Cantate* offers the wonderfully musical voice of Madeleine Milhaud reading the poems by Maurice Carême together with Leonid Hambro, pianist, and the Juilliard Quartet. It is and always has been, I suppose, a record for the few—but they are a lucky few.

Poulenc's record (Odyssey Y 33792), on the other hand, is notable because it is Poulenc playing—both his own works and pieces by Erik Satie. The music is all rather well known now, and justly appreciated or impatiently dismissed, as you please. But there is, in Poulenc's renditions, just a touch *more* of that peculiar Parisian perfume, just a bit more richness of color in that tattered wisp of a street song, just a little more depth in the seemingly surface emotions than in anyone else's performance. Strange, how close the *feeling* can get to Mahler.

Schoenberg was never really documented as an interpreter of his own works, and that is a pity, for on the evidence of his *Pierrot Lunaire* he might have given us *different* views on his music than have been expressed by others. *Pierrot* has achieved an almost Gallic tradition of performance—clarity, color, very nearly charm. Schoenberg's own performance (with Erika Stiedry-Wagner intoning the *Sprechstimme*) is, on the contrary, an expressionist nightmare, grim, upsetting, almost terrifying. Perhaps not *the* recording to live with, it is still an almost vital counterbalance to the current tradition.

THE Institute of American Music of the University of Rochester has taken over distribution of most of the Mercury records that featured Eastman-Rochester groups, and among these are recordings of John Alden Carpenter's *Adventures in a Perambulator* and Deems Taylor's *Through the Looking Glass*. Carpenter was once considered one of the big guns of American music (the other was MacDowell), but today he would be more correctly placed as a sort of American Roger Quilter (no disrespect intended). *Adventures in a Perambulator* is a piece of American impressionism, pleasant, mildly whimsical, eminently listenable—*light* music. It gets a fine performance here (ERA 1009).

Deems Taylor never really had to live up to the reputation of being an important composer (even though he did have two operas produced at the Met), but he was widely recognized as a critic and became world famous as the commentator in Disney's *Fantasia*. *Through the Looking Glass* (ERA 1008) is probably his best-known piece, and, though it is by no means important music and is probably never heard outside the U.S.A., the Victorian conundrums of Lewis Carroll have never found a more sympathetic musical partner. True, one might read the book while the music was playing and not be distracted, but even that implies a certain measure of worth. To me the disc is another old acquaintance not forgot. Nice to see you *all* again. Come again—and bring some friends.

Micro-Acoustics 2002-e cartridge.

Because good tracking isn't enough.

Tracking is just the beginning.

While good tracking ability is vital, it's only an indication of how well the stylus keeps contact with record grooves on louder, harder-to-follow passages, at stylus pressures low enough to minimize wear. *But surprisingly, tracking ability tells almost nothing about how well a cartridge reproduces most musical sounds.*

Transient ability is just as important.

After all, transients are what music is made of: sudden start-and-stop bursts of sound at all frequencies. From the attack of a low organ note to the bite of a plucked string. Transient information is essential to differentiate the sound of one instrument from another, and in stereo, to localize instruments in space. That's why *without good transient ability, no cartridge can reproduce music with really lifelike clarity.*

Until now, it was simply one or the other.

Tracking or transient ability. Popular high-compliance cartridges, on the one hand, offered good tracking ability and low record/stylus wear, but sacrificed transient ability. And low-compliance cartridges provided good transient ability at the expense of tracking ability and increased wear.

A new technology.

Micro-Acoustics, the world's leading manufacturer of record-mastering styli, has combined for the first time superb transient *and* tracking ability. In the radical design of the 2002-e (patent pending), direct-coupled electrets and critical damping provide optimized transient ability, as shown in the graph. While an ultra-low-mass beryllium stylus bar and high-compliance dual-bearing suspension provide maximum tracking ability at 1 gram, for lowest possible record and stylus wear.

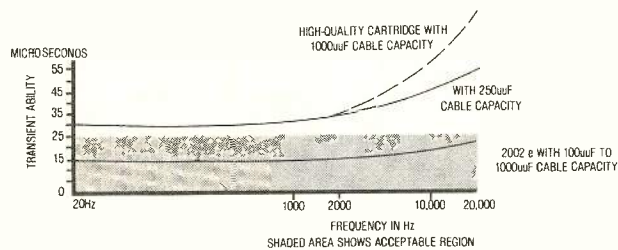

Transient ability best defines how accurately a cartridge can reproduce a musical burst at different frequencies. (Note that the 2002-e's results are independent of cable capacity!)

A simple way to convince yourself.

Micro-Acoustics has prepared a unique demonstration record to help you evaluate and compare cartridge transient and tracking ability. Just send \$3.50, and we'll mail you a record postpaid. For free information and the name of your nearest dealer, just complete and return the coupon.

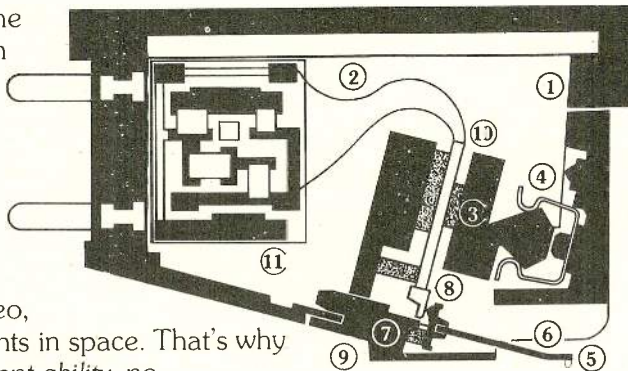

- ① Low mass body (4.0 grams) reduces warp flutter
- ② pure gold connecting wires
- ③ mechanical damper (one of 8) helps optimize transient and tracking ability
- ④ retainer spring for precise stylus assembly alignment
- ⑤ elliptical diamond stylus ground with the same precision as our famous Micro-Point recording styli
- ⑥ beryllium stylus bar 35% lower mass than aluminum; for optimum high-frequency tracking and transient ability
- ⑦ dual bearings and resolver for optimum tracking ability and precise signal resolution
- ⑧ direct coupling of stylus bar to electret for lossless transmission of groove undulations to transducers
- ⑨ user-replaceable stylus assembly
- ⑩ electret transducer permanently-polarized dielectric generator, linear from 5Hz-50kHz
- ⑪ microcircuit, passive circuit makes cartridge output impedance fully resistive, eliminating effect of cable capacity; shunts preamp input; reducing thermal noise

ma MICRO-ACOUSTICS CORPORATION

MICRO-ACOUSTICS CORPORATION List Price: \$115.00
8 Westchester Plaza
Elmsford, N.Y. 10523

- () Please send me free information on the 2002-e cartridge, and the name of my nearest dealer.
- () Enclosed is \$3.50. Please send me a postpaid copy of your stereo transient/tracking ability test record.



NAME _____
 ADDRESS _____
 CITY _____ STATE _____ ZIP _____

SR1076

The \$750 alternative.

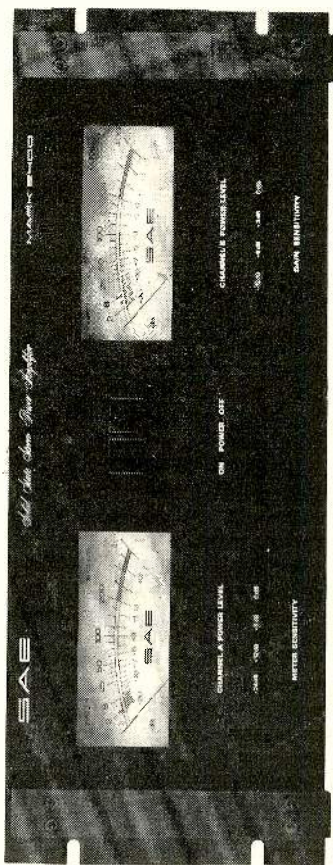

SAE 2400 Professional Dual-Channel Power Amplifier

- 200 Watts RMS, per channel, both channels driven into 4 or 8 Ohms from 20Hz to 20KHz at no more than 0.05% Total Harmonic Distortion.
 - 0.05% IM into 4 or 8 Ohms
 - (signal to noise) greater than 100dB
 - plug-in board modules
 - forced air cooling
 - only 11" deep
 - weighs less than 42 lbs.
 - superb construction using only the finest materials and component parts
 - available in black rack mount (as shown) or our traditional satin gold and black
- You'd have to look a long time to find a power amplifier that delivers this much value.



Scientific Audio Electronics, Inc. SR 10/76
 P.O. Box 60271, Terminal Annex
 Los Angeles, California 90060
 Please send me the reasons (including available literature) why the SAE 2400 Professional Amplifier is the "\$750 Alternative."

NAME _____
 ADDRESS _____
 CITY _____ STATE _____ ZIP _____

CIRCLE NO. 51 ON READER SERVICE CARD

The Basic Repertoire

By Martin Bookspan

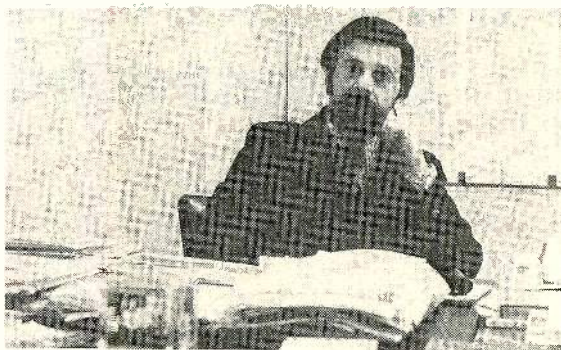

SCHUBERT'S TROUT QUINTET

I HAVE had occasion previously in these pages to remark that the pieces I consider ideal introductions to the chamber-music literature are not string quartets but works for piano and strings or for clarinet, oboe, or flute and strings. In this regard I have already discussed Mozart's A Major Quintet for Clarinet and Strings. Another masterpiece that will probably tilt the uninitiated toward small-ensemble music is Franz Schubert's *Trout* Quintet, scored for violin, viola, cello, double bass, and piano.

The circumstances that produced the *Trout* Quintet were extremely casual. Schubert, then-twenty-two, was spending the summer of 1819 on a walking tour of Upper Austria. It was only the second time he had been out of Vienna, the place of his birth, and his companion was Johann Vogl, the famous baritone of Vienna's Imperial Opera. Everywhere they went Schubert was enchanted—by the beauty of the countryside, the conviviality of the people, the challenge of discovery.

In the little town of Steyr, Vogl's birthplace, they decided to linger a while, and they quickly became leading participants in the town's intellectual life. Sylvester Paumgartner, the assistant manager of the local mines and an amateur cellist, held regular gatherings of musicians at his home, and he asked Schubert to compose a work for such an occasion. His one specification was that one of the movements should be a set of variations on *Die Forelle* (*The Trout*), an ingratiating song Schubert had written two years earlier.

Soon after his return to Vienna in the autumn, Schubert set to work fulfilling Paumgartner's commission. Still glowing from his pleasant summer, he proceeded to create a work that was the perfect mirror of his warm memories. It is probable that he composed the quintet with specific performers from the Steyr circle in mind, for the only other work for the same combination of instruments that comes readily to mind is a quintet by the Bohemian-born composer, Johann Nepomuk Hummel. At one time musicologists theorized that Schubert knew the Hummel piece, that indeed it had been one of the works played at Paumgartner's house. More recent research, however, shows that the Hummel quintet was not published until 1821, and then in Vienna. The likelihood of a performance from manuscript two years earlier in the small town of

Steyr seems extremely unlikely. More probably, Schubert's quintet served as a model for Hummel rather than vice versa.

It is the fourth movement of the *Trout*, by the way, that meets Paumgartner's stipulation: five variations and a coda based on the original song give the quintet its name. By and large Schubert uses in this movement the technique of embellishment and decoration.

MANY excellent recordings of the *Trout* Quintet have been issued over the years, beginning with a classic performance from the 1930's by pianist Artur Schnabel with members of the Pro Arte Quartet and bass player Claude Hobbday (once available as an LP reissue in Angel's Great Recordings of the Century series). Of all the presently available recordings, my favorite remains the performance recorded more than a decade ago by pianist Peter Serkin, still a teenager then, with two members of the about-to-be-formed Guarneri Quartet (Michael Tree, viola, and David Soyer, cello), Alexander Schneider, violin, and Julius Levine, double bass (Vanguard 71145, cassette M 51145). The playing is the finest kind of ensemble collaboration: every one of the five instrumentalists is a vital thread in a sensitively woven fabric, and there is all about the performance a feeling of vitality and invention. The recorded sound is still mint-fresh and vibrant.

Another admirable recording is the one by Jörg Demus with the Collegium Aureum (BASF 20314). All the instruments used are of Schubert's period, and the clarity of sound is remarkable. But the exuberance and extroversion of Peter Serkin and company still carry the day for me. RCA has in its vaults a new recording, for imminent release, of the *Trout* Quintet with Peter Serkin and another distinguished group of collaborators. It will have to be really extraordinary to surpass the effort of his teens.

The 1976 UPDATING OF THE BASIC REPERTOIRE is now available in convenient pamphlet form. Send 25¢ and a stamped, self-addressed No. 10 envelope (9½ x 4½ in.) to Esther Maldonado, Stereo Review, 1 Park Avenue, New York, N.Y. 10016 for your copy.

The New AIWA AD-6500:

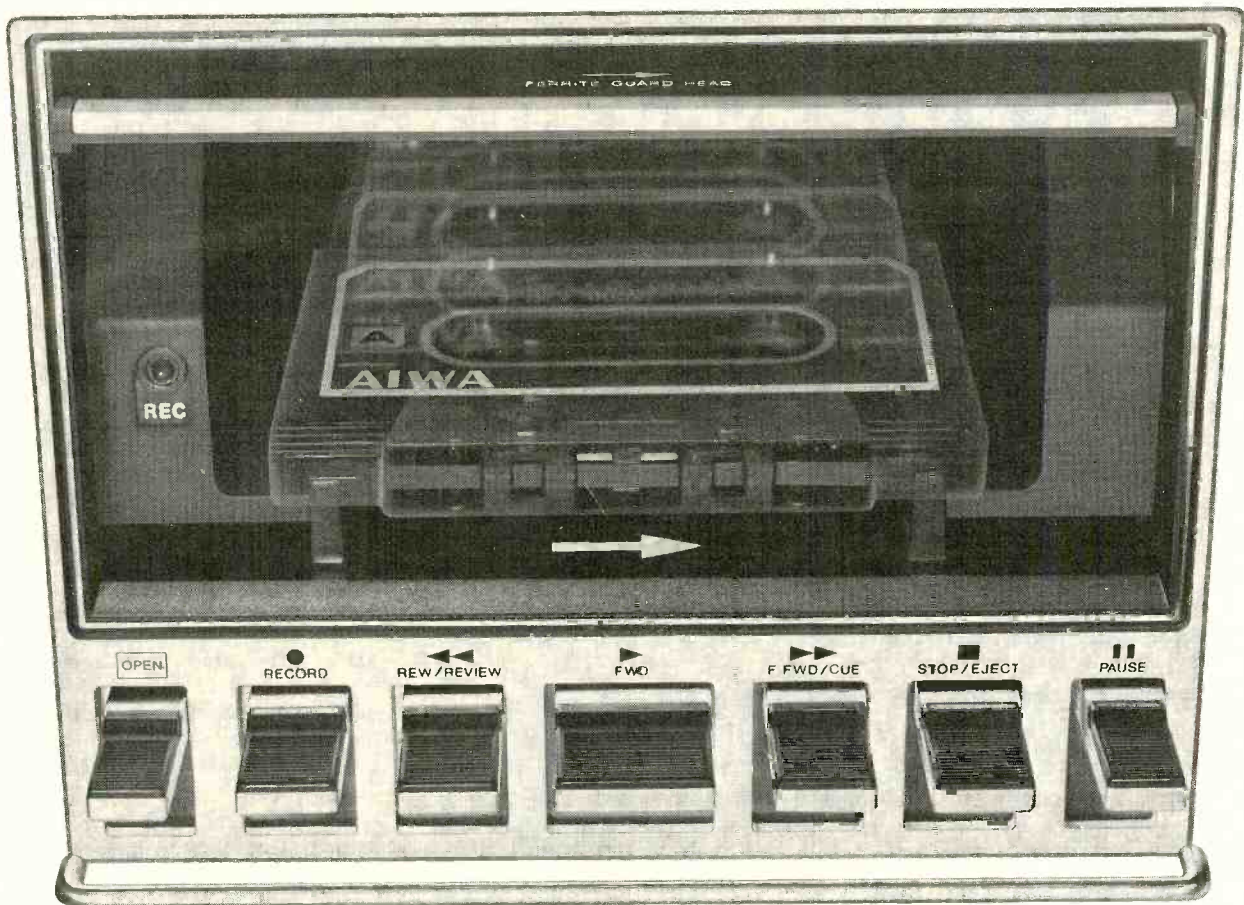

NOW YOU CAN GET LOADED AUTOMATICALLY.

Up to now loading a cassette into a front loading cassette deck was a little like putting a square block into a round hole. But now there's the AIWA AD-6500. The world's first cassette deck with automatic cassette loading. So you can play any cassette quickly, easily and precisely.

But there's a lot more to the AD-6500 than how you get a cassette into it. There's also the music that comes out of it. Like a frequency response of 30Hz to 17kHz with FeCr tape. Musically speaking that means hearing all the music—not just part of it.

And because we used Dolby* we also improved the S/N ratio to 62 dB. So you can listen

to the music instead of tape hiss.

You won't have to listen to speed variations either. Because the AD-6500 has a frequency controlled servo-motor as well as inaudible wow and flutter (0.07%).

And with the AD-6500 you can see as well as hear what you're listening to. With 2 VU meters complete with 2-step peak level indicator lights. There's also memory rewind and quick review/cue system for easy, efficient use. Three-step tape selector for the 3 different kinds of tape. Fully automatic stop.

A Ferrite Guard Head (FGH) and more.

So get the AIWA AD-6500. Because the only thing easier than loading it is listening to it.

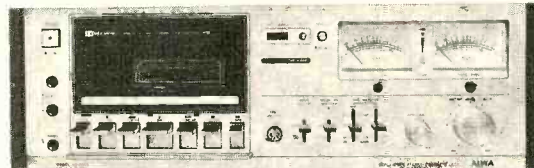

*Dolby is a Trademark of Dolby Laboratories, Inc.

AIWA®

Distributed in the U.S. by: **MERITON ELECTRONICS, INC.**, 35 Oxford Drive, Moonachie, N.J. 07074

Distributed in Canada by: **SHRIRO (CANADA) LTD.**, Canada

CIRCLE NO. 35 ON READER SERVICE CARD

Julian Hirsch tells you what to look for in a **CASSETTE DECK**

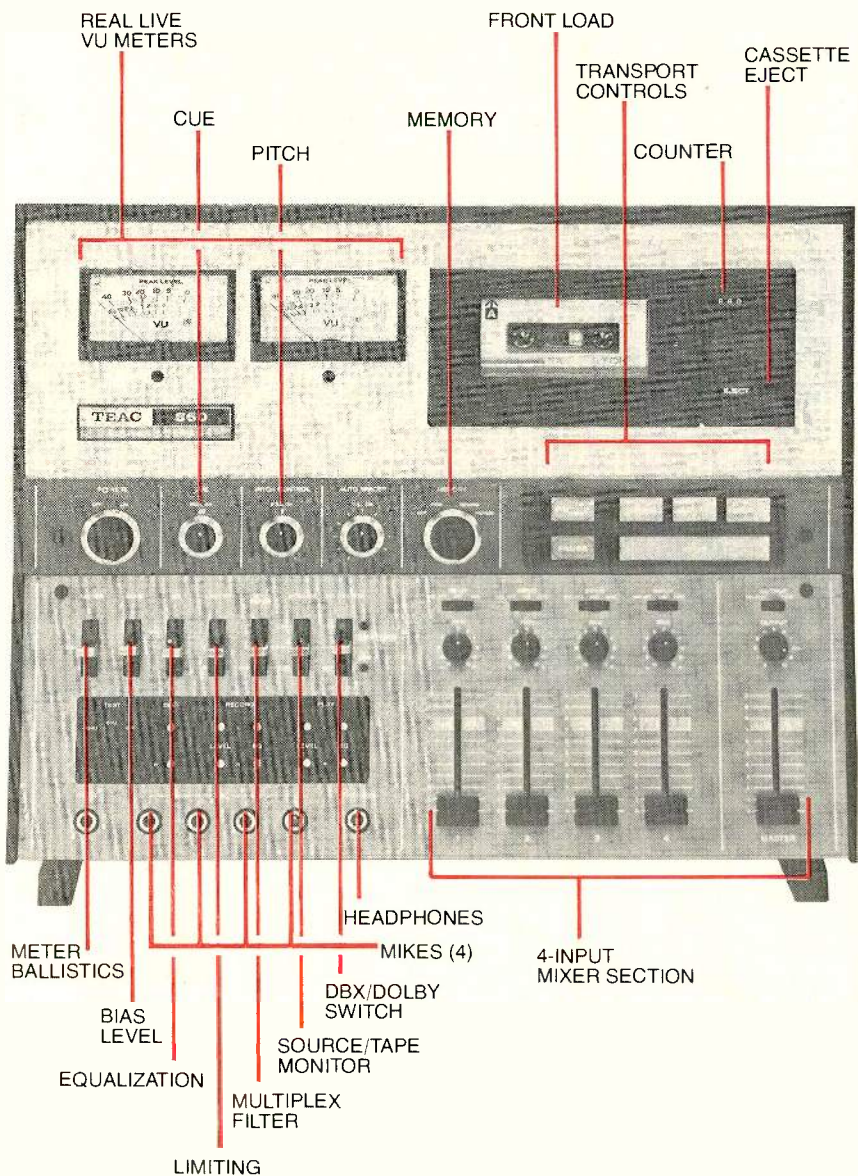

The Teac 860 cassette deck: what \$1,600 looks like

IF YOU number yourself among those who are planning to add a cassette deck to an existing setup or to include one in a brand-new system, you may already have discovered that they come in so bewildering a variety of sizes, shapes, and prices that even the most experienced audio shopper can easily find himself confused. To get right to the heart (which is to say the *pocketbook*) of the matter, what is one to make of a component whose price range covers a spread from about \$100 to \$1,600? Well, what one does first is to simplify: decide what you *need* in a cassette deck so you will know roughly where within that broad range to concentrate your shopping energies.

Cassette machines, like other audio components, can be classified according to both their performance specifications and their operating features. The two are not necessarily related, although both can affect the price. The key performance specifications of a recorder are its frequency response, signal-to-noise ratio (S/N), and flutter. The first two of these are closely related to the machine's mechanical alignment, the kind of tape being used, and how closely the bias and equalization circuits have been adjusted to the needs of that tape. Flutter, however, is primarily a function of how well the tape-transport mechanism works.

As might be expected, all aspects of cassette-deck performance tend to improve with increasing price. And, as usually happens with other components, once a certain level of performance is achieved, the law of diminishing returns begins to assert itself and large cash outlays yield only small increments of performance improvement. The question, then, is how *good* does a recorder have to be to satisfy your needs? Suppose we look for the answer to that question by examining typical performance specifications within the various price categories.

Frequency Response

Home cassette recorders are often used to tape radio broadcasts or to make copies of phono discs. Even the least expensive decks usually have a frequency response of 50 to 12,000 Hz ± 3 dB with "standard" ferric oxide tape, and this is usually adequate for making faithful copies of FM broadcasts or records. The upper frequency limit may be extended to about 14,000 or 15,000 Hz with chromium-dioxide (CrO₂) tape or with a premium tape that takes the same bias and equalization. Fortunately for the tightly budgeted consumer, this level of performance is found in virtually every deck priced at \$100 or more. The *best* tapes, however, cannot be used to full advantage on decks priced under \$150.

Recorders in the over-\$300 price range usually have an extended high-frequency response, often reaching 15,000 Hz with ferric tapes and 16,000 to 18,000 Hz with chrome-bias tape. With the extended response, not too important in itself, comes improved flatness at lower frequencies, and this minimizes the slight sonic coloration caused by small response variations within the audible range. Almost all recorders over the \$300 level (and many between \$200 and \$300) can, given the proper conditions, copy a record or FM broadcast so faithfully that it would be very difficult to hear a difference between the original program and the tape playback.

For those who are totally uncompromising or who plan to do live music recording, the best machines have a frequency response up to 18,000 Hz with ferric tape and to 20,000 Hz or beyond with CrO₂ or other premium tapes such as ferrichrome or the new TDK Super Avilyn. This slightly wider range is found in machines selling for \$500 or more.

Flutter

Flutter, once a major limitation of cassette mechanisms; arises from the difficulty of moving the tape smoothly past the heads. Improved tape-drive systems as well as better mechanical construction in the cassettes themselves have reduced flutter in today's machines to acceptable levels, even in some relatively low-price models. In the \$100 class, machines tend to have a flutter specification of 0.2 per cent or more. This may be good enough for most home-recording purposes, but its effect will be audible in music with sustained notes, such as strings, piano, or organ. In the range from \$200 upwards, flutter is usually not more than 0.15 per cent, and above \$400 it is generally 0.1 per cent or less. The best machines claim (and probably deliver) flutter levels as low as 0.08 per cent or less, rivaling the figures for open-reel decks.

Considering the total electromechanical performance of a cassette recorder, it is reasonable to conclude that a machine priced from \$100 to \$150 will be adequate for non-critical recording, while those in the range from \$150 to \$400 will provide progressively better quality for more demanding uses. The audible improvements with *still* more expensive machines may not always be so obvious, but they are real and will prove their worth in the most difficult recording tasks.

Signal-to-noise Ratio

In general, the signal-to-noise ratio (S/N) is probably a more important specification than frequency response, since a quiet recording is going to sound better overall than one with an audible noise level regardless of the frequency response of the machine or the program. The S/N is the difference between the maximum recorded signal level (defined as that which produces distortion of 3 per cent in playback) and the playback noise from a section of tape recorded with no input signal. It is expressed in decibels

(dB), and it generally involves a measurement that includes both hum and hiss.

The specific S/N of a cassette machine is a property of its electronic circuits and of the tape used, as well as the specific adjustment of the machine and, to a slight extent, the heads. Low-price decks (\$100 to \$150) may have a 48-dB S/N, while 50- to 55-dB specifications are more usual at prices of \$200 or more. A few of the finest recorders have S/N ratings as good as 60 dB with their Dolby circuits switched out (note that the accompanying tabulations of selected available cassette machines list S/N with the Dolby circuits *in*). Since few records or FM transmissions have an S/N exceeding 50 dB, most medium-price machines can do a fine "noise-free" job of recording from these sources. In addition, most of them have Dolby noise-reduction circuits that can improve their basic S/N as much as 10 dB.

For serious recording of live music on cassettes, even the best machine is marginal. Even so, one is more likely to be limited by the quality of the microphones than that of the recorder, and good microphones can cost more than the recorder itself—a whole 'nother story! For live recording, the best possible S/N is a "must," and the 65 to 70 dB achieved by a few very expensive machines with the aid of Dolby circuits or other noise-reduction devices may well justify their cost.

Features and Functions

A recorder's features, whether standard or special, are not necessarily related directly to its sound, but they can be every bit as important as its electrical performance. Often they account for a large percentage of the price, especially in the range from \$500 to \$1,000 or more, but in terms of record/playback utility and performance it is money well spent. Let us examine the contributions of the most important of these features.

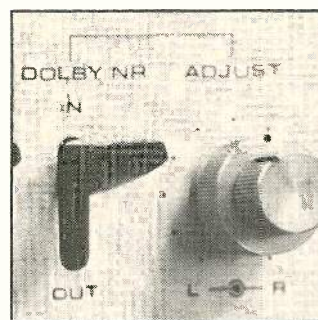

- **Noise Reduction.** Noise—or, more specifically, *hiss*—is one of the fundamental problems in cassette recording. The narrowness of the recorded tracks and the slowness of the tape speed are of course responsible. Fortunately, there are relatively inexpensive ways through which noise can be reduced to a level acceptable to most users.

The circuits used to accomplish noise reduction do not affect the noise that is present in the incoming signal; what they do is

reduce the noise that is normally *added* by the recording and playback processes. The best known and most widely used system is the Dolby "B" device (the "A" system is used in professional recording). Originally found only in the more expensive machines, the Dolby system is now built into almost every deck priced at more than \$150 or so. This advance has been facilitated by the development of inexpensive integrated circuits (IC's) that replace a large number of discrete components and transistors in the Dolby circuits.

The Dolby technique involves using complementary compression and expansion (during recording and playback, respectively) that affect only the higher frequencies and vary with the signal level. The recording and playback characteristics and the operating signal levels are standardized so that tapes made on one machine can be played back on another with correct frequency response and a noise reduction of up to 10 dB (compared with the noise that would have been present without Dolby processing).

Some FM stations use Dolby encoding on their broadcasts, and when the output of an FM tuner is processed by the Dolby playback system the S/N of the FM program is improved just as it is with tape. A few cassette recorders (usually priced above \$350) have Dolby circuits that can be switched in for use in decoding FM, with or without simultaneous taping of the program.

Some cassette decks made by JVC employ their proprietary Automatic Noise Reduction System (ANRS). Its action is somewhat similar to that of the Dolby system, and it is sufficiently compatible with Dolby that tapes recorded with one system can be played back through the other with good results. Another noise-reducing system, the Philips Dynamic Noise Limiter (DNL) is a signal-controlled low-pass filter that reduces hiss already present in the program—unlike the Dolby and ANRS systems. However, it is not as sophisticated a system as either Dolby or ANRS. The DNL system is found in a few cassette recorders. *Both* the dbx and Dolby systems are present in Teac's \$1,600 machine.



- **Tape Compatibility.** Early cassette decks were designed to work with the available ferric-oxide tape formulations, which were considerably inferior to the newer tapes. Some time later, and almost simultaneously, high-performance ferric-oxide and chromium-dioxide (CrO₂) tapes appeared on the market. The CrO₂ tapes require about 30 per cent more recording bias than other tapes, and some of the premium ferric tapes



CASSETTE DECKS

also require more bias than the earlier "standard" tapes. As a result, cassette decks almost immediately appeared featuring two-position bias switches to accommodate ferric-oxide and chrome tapes (these days only the least expensive machines lack this facility). However, a single bias adjustment was still expected to serve with widely varying ferric-oxide formulations. This situation still exists to some extent, but many manufacturers now have switch positions for "normal" and "low-noise" tapes, and a growing number recommend specific tapes for which their machine's bias-switch settings are useful. And in many cases, the "super" tapes of a few years ago have become today's "normal" tapes.

To exploit the full noise-level and frequency-response potential of CrO₂ tapes and some other types, both the recording and playback equalization (as well as the bias) should be changed from the values used with ferric-oxide tapes. After a few years without standard equalization characteristics, the industry situation became stabilized, and on most machines a single switch now optimizes both bias and equalization for the two major tape types. A few machines will even switch *automatically* to CrO₂ bias/equalization when a CrO₂ cassette with the special coding notch is inserted. On some older machines the bias or the equalization could be switched, but not both. Such machines can give fairly satisfactory results with tapes both recorded and played back on them, but the tapes will not be fully compatible for playback on other recorders—and vice versa.

A couple of years ago a new tape formulation appeared with characteristics midway between those of ferric oxide and CrO₂. Called *ferrichrome* (FeCr for short), this tape is actually a two-layer product, with ferric oxide next to the backing and a thin layer of chromium dioxide on the outside. The tape was first introduced by Sony, and for a time their recorders were the only ones with the necessary bias switching for its use. A good many manufacturers now include FeCr bias and/or equalization, principally on decks selling for \$250 or more. The 3M "Classic" cassette tape is also a ferrichrome formulation, but it is not exactly the same as the Sony FeCr. However, when the bias and equalization switches are separate on a machine, as they often are, it is frequently possible to find a combination of settings that will permit the machine to perform at close to its optimum with almost any type of tape. A few tape decks have user-adjustable bias controls (accessible through holes in the case so they will not be inadvertently disturbed) that make it possible to adjust them for almost any tape.

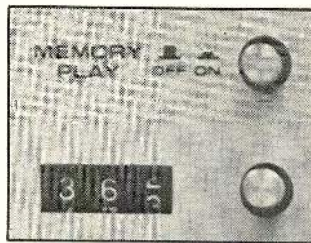

• **Memory Rewind.** A popular feature on cassette machines in the over-\$300 class is a memory rewind. The index counter is set to 000 at the beginning of a recording (or at any other point on the tape). When the tape is rewound, it stops automatically at the preset point (more often just before it at the 999 counter reading). Some recorders can be set to go automatically into the PLAY mode after stopping. The memory feature is an obvious convenience, for it returns the tape swiftly to the beginning after recording for a playback check.

Within this same utility area, a few decks are now beginning to appear that have the ability to sense blank segments between musical selections even in the fast-wind mode. Some can be programmed to play any sequence of selections desired. As of this writing, Optonica's APFS (Automatic Program Find System) is the only one to have reached the market.

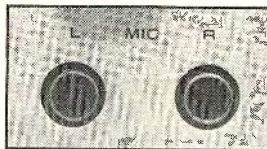

• **Microphone Inputs.** Most decks have input jacks for two microphones. Lower-price units have a switch to select either line or microphone inputs, or in some cases plugging in a microphone disconnects the line input for that channel. On many machines selling for \$350 or more, mixing inputs are provided so that both line and microphone sources can be used simultaneously with independent control of their levels. A few machines have an input for a third microphone which feeds both channels, thereby providing a "center" channel signal. And a couple of decks approach the complexity of semiprofessional mixers in their input and level-control facilities.

Cassette-deck microphone inputs are usually designed for medium-impedance dynamic microphones, and microphones are not included as standard equipment with any but the cheapest machines (too, such microphones are always of low quality). The quality of any "live" cassette recording (and of any open-reel recording, for that matter) is determined more by the microphones than by the recorder, and top-quality microphones can easily cost more than the recorder itself. For this reason, machine manufacturers have wisely left the choice of a microphone to the user, who is thus not burdened with an extra expense if he does not plan to make live recordings.

A few deck manufacturers, recognizing the limitations of a typical cassette recorder's microphone-amplifier circuits, do not

provide them on some of their machines. Instead, they offer separate optional microphone preamplifiers with the low noise and freedom from high-level overload that make full use of the recorder's basically good performance when doing live recording.

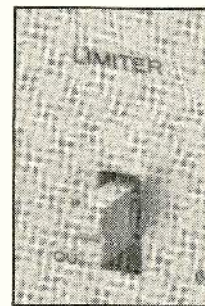

• **Peak Limiters.** Peak limiters go into action only when program levels exceed the 0-dB mark on the recorder's meters. If the average recording level is kept several decibels below that point (as it should be with most machines), the limiter has no effect. However, an instantaneous and unexpected peak that would otherwise drive the recorder—or more likely the tape itself—into distortion is limited by the circuit to an acceptable value. The limiter recovers almost immediately, and in situations where one does not have full control over the incoming signal it can prevent distortion with no detectable side effects. Peak limiters are found in a number of cassette decks beginning at about the \$200 level, and they operate with varying degrees of effectiveness. Those used in the \$400 class of machines are excellent, and all decks with this feature have a switch with which it can be disabled.

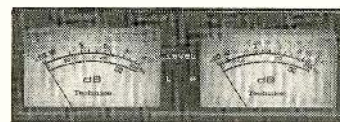

• **Meters.** One of the most important factors in making good cassette recordings is close control of the recording level. Virtually all recorders have meters to monitor input levels on the two channels; the playback level will also generally register on these meters. Most machines show the recording level *before* the recording equalization is applied, and this can be misleading if the program contains abnormally high levels of high-frequency material. A couple of units connect the meters after the equalization so that they can show the true program level reaching the recording head. Normally, 0 dB is the recommended maximum for a distortion-free recording, but there are exceptions to this rule.

Recorder meters differ widely in their size and legibility. Not so visible, but perhaps even more important, are the great differences between them in accuracy and speed of response time. Meters respond relatively slowly to rapid changes in signal level, and at best can indicate only a rough average program level. To make sure that program peaks will rarely, if ever, exceed 0 dB, it is

best to record with maximum meter readings well below that level. Meters vary widely in their ballistic characteristics—how fast they rise and fall on transient waveforms and how much their pointers overshoot the correct reading. As one becomes familiar with the behavior of a given machine, however, it is easy to make good recordings with almost any type of meter system.

Many cassette recorders have meters marked "VU," but none meets the total specification for a true VU meter, which is a professional signal-monitoring device built to stringent response and ballistic specifications. On some of the better meters, however, the ballistic characteristics do correspond closely to the VU specifications.

Recently, several decks, principally in the over-\$400 range, have appeared with fast-acting meters driven by electronic circuits that can sense a transient as short as a millisecond and "hold" it long enough for a meter to read its true value. The decay time of these meters is an appreciable fraction of a second, so they tend to follow the peaks of a program without excessive pointer movement. On some machines, the meter response can be switched from average to peak reading.

One variation of the peak-reading meter features an expanded scale covering 40 to 50 dB instead of the usual 20 to 25 dB. This type of meter gives a very clear picture of the program dynamics, and it virtually guarantees a good recording when it is properly used.

Sometimes one or two peak-indicating lights (fast-responding light-emitting diodes) are used in conjunction with a meter that reads the "average" levels of the program. The peak light flashes when a program peak reaches a preset level, usually about 5 dB above the meter's 0-dB level. Some lights are set to flash at too high a level (such as +7 dB), so that distortion has already occurred by the time it flashes.

The Advent 201 and Nakamichi 350 machines are unusual in having only a single meter to monitor the levels of both channels, indicating the higher of the two at all

times. This gives a very easily interpreted display that many people find more useful than trying to follow two independently swinging meter pointers. However, if one channel is missing or becomes disconnected, the meter will not warn the user of the fact (although on the Advent machine it can be switched to read either channel individually as well as both together).

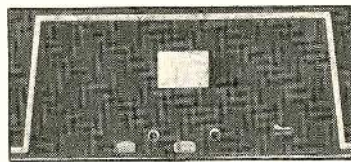

• **Tape-drive Systems.** No cassette recorder can be any better than the mechanical "transport" system that moves the tape. Constant speed, with a minimum of short-term fluctuations (flutter) is a fundamental requirement. Since the tape speed is controlled by the capstan that presses against it, the capstan drive system is basic to the recorder's performance.

Also important are the hub drives, which correspond to the supply and takeup reels of an open-reel deck. They must have sufficient torque to wind the tape smoothly under constant tension, but not so much as to place an undue stress on the very thin tape used in cassettes. The type of drive system used on the hubs also determines how fast a cassette can be wound from one end to the other in fast-forward or rewind modes.

Cassette mechanisms, like those of open-reel recorders, can use one, two, or three motors. The large majority of low- and medium-price decks use a single motor for all transport functions. Mechanical clutches, idler wheels, and belts are used to reduce the motor speed to that required by the capstan and to drive the hubs at varying speeds and with constant torque. Many single-motor machines use a d.c. servo-controlled motor whose speed is determined by a stable reference voltage in the electronic cir-

uits. Internal adjustments set the speed, and one or two models (principally in the over-\$400 range) even have a user-adjustable speed vernier that affects only playback speed. This type of recorder drive can also be designed to operate from a low-voltage d.c. source such as an automobile battery or a built-in battery pack; it is therefore found in all recorders intended for use away from commercial power lines.

A different approach to single-motor drive uses a synchronous motor like the ones used to power many record players. These motors are usually more powerful than the d.c. servo motors, and their speed is fixed by the a.c. power frequency. The greater power and torque of a.c. synchronous motors usually enables them to move the tape more rapidly in fast-forward and rewind modes.

A two-motor drive system has a constant-speed motor for turning the capstan and a separate "torque" motor for driving the hubs. Some two-motor machines use a direct-drive capstan motor similar to those found on some turntables. A few of the most advanced cassette decks use three motors so that each hub is driven by its own motor. One of the more obvious characteristics of three-motor transports (but not exclusive to them) is their very fast winding speed. Some models can wind a C-60 (60-minute) cassette fully in under 40 seconds.

A growing number of machines in the over-\$350 price range feature closed-loop dual-capstan drives. This system reduces flutter to a minimum by driving the tape with two capstans on opposite sides of the heads. The trailing capstan (nearest the supply hub) is driven at a slightly lower speed than the forward capstan, placing the tape under a controlled tension as it passes over the heads.

Auto-reverse operation, which eliminates the need to turn the cassette over at the end of a side, is offered on a few machines, including models from Akai, Dual, and Uher. This often involves a dual-capstan drive, with the roles of leading and trailing capstans being interchanged when the tape reverses. The reversal is initiated automatic-

(Continued on page 70)

THREE-HEAD CASSETTE DECKS

Manufacturer	Model	Approximate price (\$)	Approximate dimensions (in.)	Frequency response (±3 dB)	Wow and flutter (per cent)	S/N (dB, Dolby on)	Loading top (T) or front (F)	Tapes accommodated	Special features (see footnotes on page 69)
Akai	GXC-325D	\$475	17½x5½x12	30-15k (19k, FeCr)	0.05	61	T	CrO ₂ , FeCr	A, B, H, K, N, R
	GXC-740D	495	17½x5½x12	30-15k (18k, FeCr)	0.07	60	F	CrO ₂ , FeCr	A, B, D, E, G, H, K, N, R
	GXC-760D	595	17½x5½x12	30-15k (19k, FeCr)	0.06	61	F	CrO ₂ , FeCr	A, B, D, E, G, H, J, K, N, P, Q, R
	GXC-570D	800	17½x10x9	30-15k (16k, CrO ₂)	0.06	62	F	CrO ₂ , FeCr	A, B, D, E, G, H, J, K, N, O, P, Q, R
									A, C, K
Fisher	CR5110	200	17½x6½x15	50-12k	0.1	50	F	CrO ₂ , FeCr	K
	CR5115	400	17½x6½x15	40-12k (15k, CrO ₂)	0.07	58	F	CrO ₂ , FeCr	C, K
	CR5120	n.a.	18½x6x15½	30-12k (16k, CrO ₂)	0.07	58	F	CrO ₂ , FeCr	A, C, K
Hitachi	D/3500	450	17x5½x12	20-15k (20k, CrO ₂)	0.05	63	T	CrO ₂	A, B, E, G, K
	D/800	480	17x5½x12	20-15k ±5 dB (20k, CrO ₂)	0.05	63	F	CrO ₂ , FeCr	A, C, D, E, K, N
Lenco	C-2003	695	18½x3½x11½	30-18k	0.16	65	T	CrO ₂ , FeCr	B, D, H, I, L, N, O
Nakamichi	700	850	20½x10½x5½	35-20k	0.1	65	F	CrO ₂	A, B, D, E, G, H, I, L, M, O, P, Q
	1000	1,300	20½x11½x8½	35-20k	0.1	65	F	CrO ₂	A, B, D, E, G, H, I, L, M, N, O, P, Q, S
Sony	TC-177SD	750	17½x6½x12½	30-13k (17k, CrO ₂)	0.07	59	T	CrO ₂ , FeCr	A, B, C, D, E, G, H, L, M, P, Q
Tandberg	TCD-330	1,000	18½x9½x4½	30-18k	0.12	65	F	CrO ₂	A, B, C, D, H, J, L, M, N, P, Q
Teac	860	1,600	17½x14½x9½	31-16k (18k, CrO ₂)	0.04	70 (dbx)	F	CrO ₂ , FeCr	A, B, C, D, E, F, G, H, J, K, P, Q, T

TWO-HEAD CASSETTE DECKS

Manufacturer	Model	Approximate price (\$)	Approximate dimensions (in.)	Frequency response (±3 dB)	Wow and flutter (per cent)	S/N (dB, Dolby on)	Loading, top (T) or front (F)	Tapes accommodated	Special features (see footnotes below)
Advent	201	\$240	13½x9¼x5	35-14k ±2 dB	0.15	64	T	CrO ₂	A, W
Aiwa	AD-1250	230	15½x11x5¼	30-14k (16k, CrO ₂) *	0.09	60	T	CrO ₂ , FeCr	D, F
	AD-6300	250	16½x11½x6¼	30-14k (16k, CrO ₂) *	0.09	60	F	CrO ₂ , FeCr	D, F
	AD-1600	360	16½x11½x6	30-14k (17k, CrO ₂) *	0.07	62	T	CrO ₂ , FeCr	B, D, F
	AD-6500	370	17½x11½x6¼	30-14k (17k, CrO ₂) *	0.07	62	F	CrO ₂ , FeCr	B, D, F, V
	AD-1800	450	16½x11½x6	30-14k (17k, CrO ₂) *	0.05	65	T	CrO ₂ , FeCr	B, F, S
Akai	CS-34D	200	15x9x4½	40-13k (15k, CrO ₂)	0.13	62	T	CrO ₂	
	GXC-39D	275	17½x9x4¾	30-14k (17k, FeCr)	0.08	57	T	CrO ₂ , FeCr	B
	GXC-310D	375	17½x11½x5½	30-14k (17k, FeCr)	0.07	60	T	CrO ₂ , FeCr	A, B, R
	GXC-710D	395	17½x12x5¾	30-14k (17k, FeCr)	0.08	60	F	CrO ₂ , FeCr	A, B, D, R
	GXC-75D	450	18x12x5½	30-14k (16k, CrO ₂)	0.1	58	T	CrO ₂ , FeCr	A, B, R, U
Bigston	BSD-300	170	14½x10½x5½	30-13k (16k, FeCr) *	0.12	55	F	CrO ₂	B, F, G
	BSD-230	210	13½x9½x4¼	30-13k (16k, CrO ₂) *	0.15	58	T	CrO ₂	B, C
Bang & Olufsen	2200	485	19½x9x3	30-14.5k *	0.12	61	T	CrO ₂	B
Clarion	MD-7800	595	8½x9x8¼	20-15k (18k, CrO ₂) *	0.07	63	F	CrO ₂	B, G, I, P, Q, S
Craig	2712	140	11½x9x3	40-12k *	0.25	50	T	"Special"	
	5201	250	17x11½x6¼	35-14k (16k, CrO ₂)	0.1	60	F	CrO ₂	B, C
Dokorder	MK-610	250	17x12¼x5½	30-15k *	0.1	60	F	CrO ₂	B, F
	MK-550	260	16x11½x4	30-12k (14k, CrO ₂)	0.15	50	T	CrO ₂ , FeCr	A, C, D, F, G
Dual	C919	450	17x10x5	20-16.5k (17k, FeCr)	0.07	61	T	CrO ₂ , FeCr	A, B, C, G
	Auto Reverse	500	16½x11½x4¼	20-16.5k (17k, FeCr)	0.07	61	T	CrO ₂	E, U
Harman-Kardon	HK2000	400	15x10½x5½	20-16k	0.07	62	T	CrO ₂	A, B, D, E, F
Heath	AD-1530	280 (kit)	14x9½x5½	40-12k (14k, CrO ₂)	0.25	58	T	CrO ₂	
	AD-110	130 (kit)	13½x11x3	30-12k	0.25	45†	T	CrO ₂	E (internal)
Hitachi	D/2330	150	13½x8¾x3¾	40-12k (14k, CrO ₂)	0.18	58	T	CrO ₂	
	D/410	200	16½x10x5¼	30-13k (16k, CrO ₂)	0.08	60	F	CrO ₂	A, C
JVC	CD-1740	200	17x9x4	40-12k (14k, CrO ₂)	0.13	60	T	CrO ₂	
	CD-1920	250	15½x12½x6	40-15k (16k, CrO ₂)	0.09	62	F	CrO ₂ , FeCr	X
	CD-1770	300	16½x11x3¾	40-15k (16k, CrO ₂)	0.05	62	T	CrO ₂	A, G, X
	CD-S200	300	19½x12½x6	40-15k (16k, CrO ₂)	0.09	62	F	CrO ₂ , FeCr	A, X
	CD-1970	400	16½x11½x6¼	40-15k (16k, CrO ₂)	0.09	62	F	CrO ₂	A, B, G, X
	CD-1669-2	500	16½x12½x5½	30-13k (16k, CrO ₂)	0.05	63	F	CrO ₂	A, B, E, I, X
	CD-1636 (port.)	350	14½x9½x4	45-15k (16k, CrO ₂)	0.08	64	T	CrO ₂	X, Y
Kenwood	KX-620	220	17x11½x5½	40-11k (12k, CrO ₂)	0.09	61	F	CrO ₂ , FeCr	B
	KX-720	260	16x10x5	40-13k (14k, CrO ₂)	0.08	62	T	CrO ₂ , FeCr	A, B, C, F
	KX-920	300	16x10x5	40-13k (14k, CrO ₂)	0.08	62	T	CrO ₂ , FeCr	A, B, C, F
Lafayette	RK-D100	160	14x9½x3¾	50-12k *	0.25	55	T	"Special"	
	RK-D200	200	17½x12x7	30-13k *	0.25	60	F	CrO ₂	C
Marantz	5020	270	17½x11½x5½	45-13k (16k, FeCr)	0.08	58	F	CrO ₂ , FeCr	C
	5120	330	16x11x5½	45-13k (16k, FeCr)	0.08	58	T	CrO ₂ , FeCr	A, C, G
	5220	370	16½x12½x5¼	45-13k (16k, FeCr)	0.08	58	F	CrO ₂ , FeCr	A, B, C, G
	5420	430	17½x12½x6½	45-14k (17k, FeCr)	0.07	60	T	CrO ₂ , FeCr	A, B, C, G
Meriton	HD-500	110	14x9½x3¾	30-12k (15k, CrO ₂)	0.22	45†	T	CrO ₂	
	HD-520	170	14x9½x3¾	30-10k (12.5k, CrO ₂)	0.15	58.5	T	CrO ₂ , FeCr	D
Nakamichi	500	400	15x10x4½	40-15k (17k, CrO ₂)	0.13	63	T	CrO ₂	A, B, E, G
	600	500	15½x9½x6¼	40-18k	0.12	68	T	CrO ₂	A, B, D, E
	350 (port.)	350	7½x9½x3¾	40-15k	0.08	58	T	CrO ₂	W, Z
	550 (port.)	500	12½x3¾x3¾	40-17k	0.13	65	T	CrO ₂	A, E
Neal	103	600	13½x9½x5½	35-12k	0.09	64	T	CrO ₂	A, E, G
Olson (Invicta)	RA-294	120	12½x9½x4	60-9k +6 dB (14k, CrO ₂)	0.3	42	T	CrO ₂	
Optonica	RT-2050U	300	18½x14x5¾	30-13k (15k, CrO ₂)	0.058	62	F	CrO ₂ , FeCr	A, B, a
	RT-3535	430	18½x14x5¾	30-15k (17k, CrO ₂)	0.058	58	F	CrO ₂ , FeCr	A, D, a
Panasonic	RS-268US	180	14½x9½x3¾	30-13k *	0.12	57	T	CrO ₂	
	RS-260US	100	n.a.	n.a.	n.a.	n.a.	n.a.	n.a.	
Pioneer	CT-F2121	200	13½x11½x5½	40-11k (12k, CrO ₂)	0.12	62.5	F	CrO ₂	D
	CT-F4141A	250	15½x9½x3¾	63-10k (12k, CrO ₂)	0.13	62.5	T	CrO ₂	A, F
	CT-5151	270	15½x9½x3¾	63-12k (13k, CrO ₂)	0.13	62.5	T	CrO ₂	A, B, F
	CT-F7272	320	16x13½x7	40-13k (15k, CrO ₂)	0.2	66.5	F	CrO ₂ , FeCr	A, B, D
	CT-F8282	400	17½x13½x7¾	30-13k (15k, CrO ₂)	0.07	67.5	F	CrO ₂ , FeCr	A, B, I
	CT-F9191	450	18x12½x8	35-13k (14k, CrO ₂)	0.07	66.5	F	CrO ₂ , FeCr	A, B, D, G, I
Quadraflex	307	370	16½x12½x5½	20-14k *	0.08	62	F	CrO ₂ , FeCr	A, B
Realistic	SCT-10	100	15x8¾x4	40-10k *	0.25	48†	T	CrO ₂	A
	SCT-14	150	11½x9x3¾	40-13k *	0.2	55	T	CrO ₂	
	SCT-9	200	14½x9½x4¼	30-15k	0.14	54	T	CrO ₂	A, B
	SCT-11	230	15½x10½x5¼	30-15k	0.2	58	F	CrO ₂	A, C

(Researched by Arnis Balgalvis)

Manufacturer	Model	Approximate price (\$)	Approximate dimensions (in.)	Frequency response (± 3 dB)	Wow and flutter (per cent)	S/N (dB, Dolby on)	Loading, top (T) or front (F)	Tapes accommodated	Special features (see footnotes below)
Rorel	RD-12F	340	19 $\frac{1}{2}$ x9 $\frac{1}{2}$ x4 $\frac{1}{2}$	30-14k (16k, CrO ₂)	0.09	60	F	CrO ₂ , FeCr	A, B, F, G
	RD-20	370	18x9 $\frac{1}{2}$ x3	30-15k (16k, CrO ₂)	0.07	60	T	CrO ₂	A, B, F, G
Sankyo	STD-1410	170	15x10x3	40-14k*	0.2	55	T	CrO ₂	A
	STD-1510	200	15x10x3	40-14k*	0.12	55	T	CrO ₂	A
Sansui	SC-636	280	16x11 $\frac{1}{2}$ x4 $\frac{1}{2}$	35-10k (13k, CrO ₂)	0.12	58	T	CrO ₂	A
	SC-2000	290	18 $\frac{1}{2}$ x11 $\frac{1}{2}$ x6 $\frac{1}{2}$	35-11k (12k, CrO ₂)	0.1	60	F	CrO ₂	A
	SC-2002	300	18 $\frac{1}{2}$ x11 $\frac{1}{2}$ x6 $\frac{1}{2}$	35-11k (12k, CrO ₂)	0.1	60	F	CrO ₂	A, B, G
	SC-3000	360	17 $\frac{1}{2}$ x11 $\frac{1}{2}$ x6 $\frac{1}{2}$	35-11k (13k, CrO ₂)	0.09	60	F	CrO ₂	A, B, G
	SC-3003	370	17 $\frac{1}{2}$ x11 $\frac{1}{2}$ x6 $\frac{1}{2}$	35-11k (13k, CrO ₂)	0.09	60	F	CrO ₂	A, B, G
Sanyo	RD 4135	130	11 $\frac{1}{2}$ x9x3 $\frac{1}{2}$	50-12k*	0.2	45 [†]	F	CrO ₂	A
	RD 4553	170	13 $\frac{1}{2}$ x10 $\frac{1}{2}$ x4 $\frac{1}{2}$	30-13k*	0.2	60	F	CrO ₂	A
	RD 5300	200	16 $\frac{1}{2}$ x10 $\frac{1}{2}$ x6	30-14k*	0.1	63	F	CrO ₂	b
	RD 8400	200	21 $\frac{1}{2}$ x9 $\frac{1}{2}$ x6 $\frac{1}{2}$	60-12k*	0.25	45 [†]	F	CrO ₂	b
Sharp	RT-1155	170	16x9 $\frac{1}{2}$ x6 $\frac{1}{2}$	40-10k (12k, CrO ₂)	0.1	60	F	CrO ₂	B, a
	RT-2000U	180	16x10 $\frac{1}{2}$ x4 $\frac{1}{2}$	45-10k (12k, CrO ₂)	0.15	60	T	CrO ₂	A, B, a
	RT-2500U	200	17x10 $\frac{1}{2}$ x4 $\frac{1}{2}$	45-12k (14k, CrO ₂)	0.13	62	T	CrO ₂	A
	RT-3500U	260	17x10 $\frac{1}{2}$ x4 $\frac{1}{2}$	45-13k (15k, CrO ₂)	0.13	62	T	CrO ₂	A, B, a
Sonab	C500	400	15x10x4	30-15k (16k, CrO ₂)	0.13	58	T	CrO ₂	A, B
Sony	TC-117	150	14 $\frac{1}{2}$ x9 $\frac{1}{2}$ x4 $\frac{1}{2}$	40-10k (13k, CrO ₂)*	0.2	56	T	CrO ₂ , FeCr	C, E
	TC-118SD	200	14 $\frac{1}{2}$ x9 $\frac{1}{2}$ x4 $\frac{1}{2}$	40-10k (13k, CrO ₂)*	0.15	60	T	CrO ₂ , FeCr	C, E
	TC-135SD	230	15 $\frac{1}{2}$ x9 $\frac{1}{2}$ x4 $\frac{1}{2}$	50-14k	0.1	64	T	CrO ₂ , FeCr	C, E
	TC-136SD	300	15 $\frac{1}{2}$ x9 $\frac{1}{2}$ x5	40-15k	0.1	64	T	CrO ₂ , FeCr	D, G
	TC-186SD	300	16 $\frac{1}{2}$ x11 $\frac{1}{2}$ x6 $\frac{1}{2}$	40-15k	0.09	67	F	CrO ₂ , FeCr	C, D
	TC-206SD	350	17x12 $\frac{1}{2}$ x6 $\frac{1}{2}$	30-15k	0.08	65	F	CrO ₂ , FeCr	A, C, D, E, G
	TC-138SD	400	16 $\frac{1}{2}$ x11 $\frac{1}{2}$ x5 $\frac{1}{2}$	30-15k	0.07	65	T	CrO ₂ , FeCr	A, B, D, G
	TC-209SD	500	17 $\frac{1}{2}$ x12 $\frac{1}{2}$ x6 $\frac{1}{2}$	30-17k	0.07	65	F	CrO ₂ , FeCr	A, B, D, G
	TC-153SD (port.)	370	15x9 $\frac{1}{2}$ x4 $\frac{1}{2}$	40-14k	0.15	65	T	CrO ₂ , FeCr	D, Y
Superscope	CD-301A	140	12 $\frac{1}{2}$ x9x3 $\frac{1}{2}$	40-10k (14k, CrO ₂)*	0.2	51 [†]	T	CrO ₂	C
	CD-302A	190	12 $\frac{1}{2}$ x9x3 $\frac{1}{2}$	30-15k (18k, CrO ₂)*	0.12	61	T	CrO ₂	C
Tandberg	TCD-310	500	17x9x4 $\frac{1}{2}$	40-13.5k (± 2 dB)	0.15	63	T	CrO ₂	H, J, P
Teac	A-100	200	16 $\frac{1}{2}$ x12x6 $\frac{1}{2}$	30-11k (14k, CrO ₂)*	0.1	60	F	CrO ₂	B, G
	A-150	250	16 $\frac{1}{2}$ x12x6 $\frac{1}{2}$	30-12k (15k, CrO ₂)*	0.09	60	F	CrO ₂	A
	A-170	250	17x10x5 $\frac{1}{2}$	30-13k (16k, CrO ₂)*	0.09	60	T	CrO ₂	A
	A-400	300	17 $\frac{1}{2}$ x11 $\frac{1}{2}$ x6 $\frac{1}{2}$	30-13k (16k, CrO ₂)*	0.08	65	F	CrO ₂	A
	A-420	350	17 $\frac{1}{2}$ x11 $\frac{1}{2}$ x6 $\frac{1}{2}$	30-13k (16k, CrO ₂)*	0.07	65	F	CrO ₂ , FeCr	A, G
	A-650	550	17 $\frac{1}{2}$ x12 $\frac{1}{2}$ x7	30-13k (16k, CrO ₂)*	0.06	67	F	CrO ₂ , FeCr	A, B, C, D, G, I, P
	PC-10 (port.)	500	11 $\frac{1}{2}$ x9 $\frac{1}{2}$ x3 $\frac{1}{2}$	40-12.5k (14k, CrO ₂)*	0.07	68	T	CrO ₂	Y
Technics	RS-263AUS	200	13 $\frac{1}{2}$ x9 $\frac{1}{2}$ x4 $\frac{1}{2}$	30-13k (14k, CrO ₂)*	0.15	57	T	CrO ₂	A, B
	RS-630US	250	17 $\frac{1}{2}$ x12 $\frac{1}{2}$ x5 $\frac{1}{2}$	30-14k (16k, CrO ₂)*	0.09	63	F	CrO ₂	A
	RS-625US	300	15 $\frac{1}{2}$ x11x5	40-11k (12k, CrO ₂)	0.1	57	T	CrO ₂	A, B
	RS-640US	350	17x12x5 $\frac{1}{2}$	30-14k (16k, CrO ₂)*	0.08	64	T	CrO ₂	A, B, D
	RS-671US	400	17 $\frac{1}{2}$ x13x5 $\frac{1}{2}$	30-15k (17k, CrO ₂)*	0.075	65	F	CrO ₂	A, B, I, P
	RS-677US	500	17 $\frac{1}{2}$ x13x5 $\frac{1}{2}$	30-15k (17k, CrO ₂)*	0.07	65	F	CrO ₂	A, C, D, E, I, P, Q (incl.)
Toshiba	PC-3060	200	15 $\frac{1}{2}$ x11 $\frac{1}{2}$ x5 $\frac{1}{2}$	40-12k (15k, CrO ₂)*	0.09	67	F	CrO ₂	C, F
	PC-4030	230	15 $\frac{1}{2}$ x11 $\frac{1}{2}$ x5 $\frac{1}{2}$	40-12k (15k, CrO ₂)*	0.09	67	T	CrO ₂	A, F
	PC-5060	320	17 $\frac{1}{2}$ x13 $\frac{1}{2}$ x5 $\frac{1}{2}$	40-12k (15k, CrO ₂)*	0.08	68	F	CrO ₂	A
	PC-6030	750	16x7 $\frac{1}{2}$ x10	20-15k (17.5k, CrO ₂)*	0.07	70	F	CrO ₂	A, D, E, H, I, P
Transaudio	3500	150	n.a.	40-12k (14k, CrO ₂)*	0.18	57	T	CrO ₂	
	4500	200	n.a.	40-12k (14k, CrO ₂)*	0.18	58	T	CrO ₂	
Uher	CG-320	505	16x11x4 $\frac{1}{2}$	30-16k*	0.1	60	T	CrO ₂	A, B, I, S, Y
	CG-362	1,065	15 $\frac{1}{2}$ x11 $\frac{1}{2}$ x4	20-14k (18k, CrO ₂)*	0.15	68	F	CrO ₂ , FeCr	D, J, P, Q, S
	CR-210 (port.)	590	7x7x2	20-15k ± 2 dB	0.12	56 [†]	F	CrO ₂	A, B, U, Y, Z
Yamaha	TC-511S	260	17 $\frac{1}{2}$ x13x6 $\frac{1}{2}$	30-13k (15k, CrO ₂)*	0.07	58	T	CrO ₂ , FeCr	
	TC-800D	310	12 $\frac{1}{2}$ x12 $\frac{1}{2}$ x3 $\frac{1}{2}$	30-13k (16k, CrO ₂)*	0.06	58	T	CrO ₂ , FeCr	B, O
	TC-800GL	390	12 $\frac{1}{2}$ x12 $\frac{1}{2}$ x3 $\frac{1}{2}$	30-13k (15k, CrO ₂)*	0.06	58	T	CrO ₂ , FeCr	A, B, O, Z

NOTES: All specifications are as reported by the manufacturer. Different standards are frequently used in deriving the flutter and noise figures, so these specifications may or may not be directly comparable. All machines are compatible with low-noise ferric-oxide tapes. Other tapes for which specific bias and equalization settings appear to be provided are shown in the *Tapes accommodated* column. With many of the machines, the user is instructed to set up for ferrichrome (FeCr) tape by using chromium-dioxide (CrO₂) bias and "normal" equalization. However, since this does not constitute a specific and individual ferrichrome adjustment, FeCr generally does not appear in the column in such cases. A number of manufacturers providing CrO₂ bias and equalization do not recommend chromium-dioxide tape, usually preferring some ferric-oxide formulation designed to take chromium-dioxide adjustments (and sometimes labeling the appropriate switch positions on their machines "Special" (or some other designation) instead of "CrO₂"). However, since these machines will work properly with chrome tape (as well as with the tapes specifically recommended for them), note is taken of the fact in the tables.

A—output-level control(s), which may be on the front panel or elsewhere. B—memory rewind. C—machine's Dolby circuits can be switched to decode Dolbyized FM broadcasts. D—FM multiplex filter (to eliminate the 19-kHz stereo pilot-carrier signal) can be switched in or out. E—user-adjustable Dolby calibration controls, generally accompanied by a Dolby-level test-tone oscillator. F—cue

and review; the machine will switch automatically into play when fast-forward or rewind is disengaged. G—microphone/line mixing provided (some of these facilities are considerably more elaborate than others). H—dual-capstan tape drive. I—two-motor transport. J—three-motor transport. K—three-head machine with record and play heads in a single housing. L—three-head machine with record and play heads in separate housings. M—readily accessible record-head azimuth adjustment (found only on three-head machines with separately housed record and play heads and generally accompanied by some sort of test system to assist the user in making the adjustment). N—separate Dolby circuits for recording and playback ("Double Dolby") on three-head machines only. O—pitch control. P—solenoid-switched transport functions. Q—remote control possible. R—Akai's "Automatic Distortion Reduction" system (ADR). S—Philips' "Dynamic Noise Limiter" system (DNL). T—the dbx II noise-reduction system. U—automatic reverse (may function in both recording and playback or in playback only). V—automatic cassette loading. W—single meter normally registers the higher of the two channels. X—JVC's ANRS noise-reduction system. Y—built-in speaker(s). Z—portable machine adaptable for car or other mobile installations (in which case it can be powered from a 12-volt storage battery). a—automatic program seeking, sometimes with switching to enable user to select any program in a sequence desired. b—machine records and plays eight-track cartridges as well as cassettes. [†]—dB tolerances not specified. †—machine lacks Dolby circuits. n.a.—not available.



CASSETTE DECKS

ly by a motion-sensing or optical system, or it can be made manually at any time. Since a bidirectional mechanism is inherently more expensive than a conventional type, this feature is found only in recorders in the \$400 and higher price range.



• **Heads.** The heads of a tape recorder share with the tape transport the major responsibility for its overall quality. The cassette was originally designed to employ an erase head and a single combination recording/playback head contacting the tape through two small openings in the cassette case. Most recorders currently manufactured employ a single record/playback head. However, the requirements for optimum performance of a recording head and a playback head are quite different, so a combination head must involve some performance compromises. Specifically, a recording head should have a fairly *wide* gap to transfer the maximum amount of energy to the tape's magnetic coating, while the playback head needs a very *narrow* gap to respond to the extremely short high-frequency wavelengths on the slow-moving cassette tape.

When a combination head is used, it is necessary to employ greater amounts of high-frequency boost (equalization) to achieve the required high-frequency response. This in turn hastens the onset of tape saturation, with the result that the impressively flat frequency response achieved by most cassette recorders can be realized only at lower recording levels such as -20 dB. At higher signal levels the high-frequency response drops off markedly.

If the head functions could be separated, each could be optimized for its function—erase, record, or playback—and the problems considerably reduced. By the exercise of a great deal of ingenuity, several manufacturers have done just that, adapting the three-head configuration of reel-to-reel to the cassette format. The first to do so was Nakamichi in the very expensive models 1000 and 700 (\$1,300 and \$850, respectively). These machines use completely separate recording and playback heads, with the former contacting the tape through a narrow opening in the cassette somewhat ahead of the pressure pad. Because of the critical requirement for parallelism between the separate recording- and playback-head gaps, it was necessary to make the record-head azi-

muth adjustable so that it could be precisely matched (given the tape skew likely to occur between the two heads) to the actual azimuth of the playback head.

Another solution to the azimuth problem is to be found in machines made by Akai, Fisher, Hitachi, and Teac. Separate record- and playback-head parts are permanently built into a single housing, their gaps optimized and permanently aligned to each other at the time of manufacture. The combination head fits through the normal head opening in the cassette and contacts the pressure pad in the conventional way. This is a much less expensive technique than using physically separate heads, and it is naturally reflected in the modest prices of machines using "two-in-one" heads—they generally range from \$200 to \$600. Since the gaps are so close, tape skew between them is negligible, and complex and expensive head-alignment adjustment systems can be done away with.

With either approach to the head packaging, a three-head machine uses separate electronic sections for recording and playback so that the program can be monitored from the tape an instant after being recorded. When the heads are in a common housing, the distance between their gaps is so small that no audible time lag is heard when switching from the incoming signal to the playback-head output.

Not all three-head recorders have equal capabilities, however. Aside from the normal differences one would expect in transport quality and basic head performance, there is the matter of the Dolby circuits, which appear in all these machines. Even in IC form Dolby circuits cost money, so the less expensive three-head machines use a single pair of Dolby circuits switched between recording and playback functions just as in the case of a two-head machine. The monitor output from the playback head is not decoded and so does not have the correct frequency response and noise level; it is therefore not fully effective as a check on a recording in progress. Machines selling for more than \$400 use a "double Dolby" system with four separate Dolby circuits so that simultaneous encoding and decoding can take place. The program can be monitored and compared with the incoming program with the assurance that any differences are caused by the taping process (these differences are usually very small in machines of this quality).



• **Miscellaneous Features.** There are numerous operating features that can make one machine preferable to another for a specific application, even though they may not have any significant effect on its sonic fidelity. For example, many (but not all) cassette decks have headphone outputs. They are found on machines at all price levels, and their presence or absence is not an indication of quality but merely of the designer's philosophy. Tape-recorder headphone

outputs are usually meant to drive low-impedance phones (8 to 16 ohms) and often cannot give sufficient volume with the higher-impedance (200 to 600 ohms) phones. Most machines with headphone outputs do not provide a separate volume control for headphone listening, but excessive volume is not likely to be a problem with them in any case.

A number of machines also do not offer any control over their output level in playback. The output is generally matched to the input recording level, so a 0-dB recording level will result in playback at a 0-dB meter reading. This may be acceptable, but it is usually more desirable to be able to match the playback level to the incoming signal level present at the tape-output jacks of an amplifier or receiver, and this is best done with a separate playback-level control.

Portability, including battery operation, is sometimes necessary for some cassette users. There are several portable machines of excellent quality available from JVC, Nakamichi, Sony, Teac, Uher, and Yamaha, all of which can also be operated from an a.c. power source. They are not to be confused, however, with the small *mono* portables that sell for \$100 or less, for these are full-feature stereo decks, usually with noise reduction and full metering. Their prices (in the \$300 to \$600 range) reflect their quality.

Most cassette transports have mechanical controls in the familiar "piano-key" configuration. Usually they are interlocked so that the STOP lever must be pressed before going from playing speed to one of the fast speeds or vice versa. Sometimes a fairly high finger pressure is required to operate these controls, and remote control is not possible. There is, however, a strong trend in higher-price machines to use electromechanical solenoids to operate the controls. These are actuated by light-touch pushbuttons or similar controls, and internal logic systems ensure that the tape won't be mistreated when switching between operating modes. Many of these recorders can be controlled remotely through accessory devices.

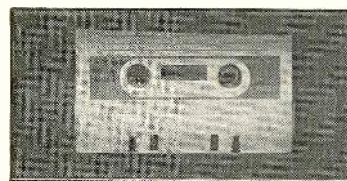

• **Front vs. Top Loading.** The locations of the cassette opening and of the machine's controls are probably its most obvious external features. So-called "front-loading" decks have become very popular in recent years, but most manufacturers of a broad line of recorders produce both front-loading and top-loading models. There are no inherent performance advantages (or disadvantages) in either loading style; choice should be made simply on the basis of where the recorder is to be located and to some degree on your own sense of "human engineering" efficiency. When the machine is to be installed at waist level, the top-loading design is superior, since the cassette and all of its controls are visible from the operating posi-

(Continued on page 72)

ALTHOUGH it won't be available until well into 1977, you'll be hearing more and more over the next several months about a new tape format called the *elcaset*. No, it was not designed in Mexico or in Spain; it originated in Japan, and as of the moment it has the support of Sony, Teac, Technics, Akai, and JVC.* To appreciate where the *elcaset* is coming from—technically, rather than geographically—you first have to understand some things about the conventional cassette format.

At the time of the cassette's birth a dozen or so years ago, its parents (Philips of the Netherlands) never thought that it would one day grow up to be a high-quality recording medium. As I remember the early ads, there were frequent references to a "sound-camera" concept. The "compact cassette" (as it was, and is, known formally) was intended merely to duplicate the convenience and simplicity of the Brownie box camera, to provide *sonic* "snapshots" of a quality no higher than the Brownie's visual ones. The cassette's subsequent history proves that one *can* make a sonic silk purse out of a sow's ear—if enough talented engineers are put on the job. However, from the purist's point of view, the cassette still suffers, when compared to the reel-to-reel format, from a variety of inherent technical handicaps.

THE first of these is that there are just too many *mechanical* tape functions built into the cassette itself. ("Cassette" means, literally, "little box," but in the audio sense it refers not to the container, but to the tape unit contained.) Everything from the tape-to-head contact, through the friction of the feed hubs, to the guidance of the tape as it passes over the heads is determined, for better or worse, by the individual cassette and not by the machine playing it. Thus *each* cassette is a separate potential source of mechanical (and therefore sonic) variables. Other problems: the cassette's size and its single, slow playing speed (1½ ips) are fixed: Philips has been rather rigid in refusing to license any variations on their original patented scheme. (As a matter of fact, there was for a time some question even about whether the Dolby-B system was "compatible" enough for Philips.)

The 1½-ips playing speed is the source of a variety of interrelated technical problems: low overload margin, high-frequency distortion, and inadequate high-frequency response. These, together with the cassette's narrow

*The three *elcaset* units on the cover were introduced at the June Consumer Electronics Show in Chicago (see September cover story). They are, top to bottom, Sony's Model EL-5, the Teac prototype, and the new machine from Technics.

tape and track width, also make a relatively high hiss level almost inevitable.

Nonetheless, it is clear that today's cassette machines work well, and, when tape of the highest quality is individually and carefully recorded and played back on the best available machine, it is frequently impossible to tell a duplicated program from a high-quality original. However, for optimum results, everything has to be close to the



state of the art—including the user's recording technique. There is very little margin for error, and the errors that do occur are not easily edited out. The better cassette machines and tapes certainly fulfill the recording needs of the vast majority of home tapers, but for the purist and the live recordist, open-reel is still the preferred format for the reasons mentioned above and for several more as well.

The promoters of the *elcaset* format have it as their intention to profit (in both senses) from the shortcomings of the cassette by combining the convenience of the cassette with the technical advantages of open reel. How? First of all, by increasing the tape width to ¼ inch and the tape speed to 3¾ ips. The wider recording track and the faster speed are tremendously helpful in providing greater recording-overload headroom and reducing both distortion and noise level. They do, however, make for a larger (see photo above) cartridge—6 inches wide, 4½ inches deep, and ¾ inch thick—and (for the moment, at least) a maximum playing time of 45 minutes per side.

An additional, though not visible, benefit of the *elcaset* system is that the tape is actually drawn *out* of its shell during play. This means not only that the tape is handled by the playing machine in much the same way as open reel, but that it can be edited easily. There is also accurate tape guidance, precisely controllable tape-to-head "wrap," and full support to prevent

skewing and help provide a smooth wind. The same open-reel head configurations—and the same high-quality heads—that have served with distinction for many years can now be built into a cartridge-format machine. And, since the *back* of the tape is now accessible, use of a crossfield-bias head becomes feasible.

Almost all users are aware that the compact cassette has knock-out tabs on the rear to prevent accidentally re-recording over an already recorded tape. In addition, some cassette manufacturers supply another notch that provides (on some machines) automatic switching to CrO₂ bias and equalization. *Elcaset* has these same coding slots and notches plus several more, including one with tabs that are labeled *noise reduction*.

Track arrangement on the *elcaset* is the same as for the compact cassette (two adjacent parallel tracks in each direction), except that there is also provision for a pair of novel "control" tracks running right down the middle of the tape, separating the two tracks of side one from those of side two. Each control track is less than half the width of an *elcaset* audio track. As of the moment, the projected purpose of the control tracks has not been made explicit, but they could serve for slide synchronization, cueing, or even selection finding if the appropriate sensing electronics are built into the player.

As a prerecorded-music format, the *elcaset* appears to be ideal. It should be far easier for a duplicator to turn out high-quality copies in *elcaset* form than in cassettes. And, as mentioned above, some sort of automatic selection-cueing signal could be recorded on the control tracks along with the music on the other four tracks. The advantages of the *elcaset* as a home-recording medium, however, are not quite that clear-cut. For example, at the moment the *elcaset* has a 45-minute maximum playing time per side; a standard 1,800-foot, 7-inch open-reel tape operating at 3¾ ips will provide 90 minutes per side. The question, then, is not whether the *elcaset* can match open-reel quality (it is safe to assume it can), but whether those tapers who are really concerned about recording quality are also terribly bugged by the several inconveniences of open reel.

It is clear that the designers of the *elcaset* have fulfilled their intention to provide in one format both the technical advantages of open reel and the convenience advantages of the cassette. Now it is up to time and the tape consumer to determine whether the *elcaset* is a superbly designed solution to a nonexistent problem or whether it is the format breakthrough the tape world has been waiting for. How do you feel about it? —Larry Klein

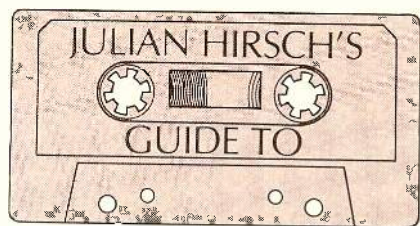

CASSETTE DECKS

tion. On the other hand, if the machine is to be stacked with other components on a shelf or placed near eye level, a front-loading design is easier to use.

There are numerous variations on the front-loading recorder. In some, the cassette winds up in a nearly horizontal position for play, and a mirror and internal illumination are needed to make the cassette visible (this works with varying degrees of success). Others place the cassette at a more upright angle or even vertically so that it can be seen directly. Several decks (Dual, Tandberg, Yamaha) are really top-loading types, but they are so designed that the entire deck can be installed standing on its front edge, giving these decks some of the advantages (if needed) of true front-loading designs. However, these machines cannot be stacked with other units or placed on a shelf with limited vertical clearance.

• **Distortion Reduction.** Although distortion in the recording process can be minimized by careful attention to biasing, equalization, and recording levels, it is still an ever-present risk with cassettes, sometimes emerging in tapes of demanding musical material to a degree that would probably not be encountered with a good open-reel machine operating at $7\frac{1}{2}$ ips or faster.

Two cassette-deck manufacturers have taken steps to reduce distortion in very different ways. Hoping to prevent the distortion from being recorded on the tape in the first place, Akai has incorporated what they call "Automatic Distortion Reduction" (ADR) in their cassette decks priced at \$350 and higher. Little information is given about the feature's operating principles, but apparently the level of excessive high frequencies in the signal to be recorded (as indicated by the overall signal level) is reduced to forestall tape saturation, the major cause of distortion in recording.

Nakamichi, in its new Model 600 recorder, features an "Intermodulation Suppressor" circuit that can be switched in during playback. Since the distortion characteristics of any tape can be predicted quite accurately, it is possible to create an equal and opposite nonlinearity in the playback process. In effect, this "straightens out" the curvature in the record signal caused by tape saturation. Although this distortion correction can be most effective only with certain tape types, it is at least partly effective with others having similar magnetic properties. The effect of the Nakamichi Intermodulation Suppressor is to permit recording at a level 4 dB higher for the same distortion percentage on playback, or to reduce slightly the playback distortion in a signal recorded at a more normal level.

What to Expect for Your Money

Our emphasis in the foregoing discussion has been on what features are available and in what price ranges they are most likely to be found. Obviously, there is an inexact relationship between many features and the price of a cassette deck, for no machine has all of them and each manufacturer has elected to provide some features in a given price class while omitting others.

One approach for the prospective buyer, therefore, is to discover what overall level of performance, in addition to features, he can expect to find in each of the major price ranges. The least expensive decks, priced between \$100 and \$150, are very few in number and rather basic both as to operating features and technical specifications. They usually have bias switching for ferric and chrome tapes, level meters, and perhaps microphone inputs, but rarely any noise-reducing circuits. You can expect an S/N rating of approximately 45 to 50 dB and perhaps a frequency response from 50 to 12,000 Hz ± 3 dB (slightly wider with CrO₂ tapes). The flutter is always higher on low-price machines, and whether or not it is acceptable depends on what kind of recording you plan to do. Even 0.25 per cent flutter will not be noticeable on voice and most popular or rock recordings. If you plan to record (or play) piano music, however, these machines are not likely to prove satisfactory.

Between \$150 and \$200, expect to find Dolby noise reduction, which may improve the S/N to 56 dB or better. Some machines in this price range have limiters. Their frequency responses will often not be much different from those of the lower-price recorders, but flutter should be in the 0.15 to 0.2 per cent range—sometimes even lower. Specifications tend to vary considerably from manufacturer to manufacturer at this level, sometimes reflecting differing priorities on the part of the designers, sometimes different ways of rating the same specification. In any case, many of these machines are quite satisfactory for *non-critical* music recording and playback.

At higher prices you will find more features—memory rewind, front loading, better heads (which sometimes extend the upper frequency limit a bit), and facilities for using a greater variety of tapes (frequently even ferrichrome). Again, lower flutter is the most audible advantage of these machines, with ratings as low as 0.15 or 0.1 per cent. In this price class (\$200 to \$300) there are

relatively few compromises with the standards of true high-fidelity performance. From \$300 to \$400, recorders have wider frequency response, reaching 15,000 to 16,000 Hz with standard tape and 18,000 Hz with better tape. Flutter is typically 0.1 per cent or even significantly lower—figures that are completely negligible for most purposes. The noise level may also be slightly lower, thanks to better heads and electronics, with the S/N surpassing 60 dB (with Dolby). Solenoid-operated controls may be found in machines near the upper end of this price range. Microphone/line input mixing is common, as are peak indicator lights and memory rewind.

Above \$400, the cassette recorder becomes a very refined device indeed. Features, as such, may not differ much from those offered in some lower price categories, but their performance will be better by a small but definite margin. There is probably little advantage in a cassette recorder's having a response extending beyond 16,000 or 18,000 Hz (although some of the best recorders can comfortably surpass these limits), but modest improvements in dynamic range, distortion, and flutter figures are possible—and they are achieved in the most expensive machines. Flutter, for example, can be as low as 0.06 or 0.07 per cent in a number of recorders priced near \$500.

Peak-reading wide-range meters, three heads, and three-motor transports are available in a number of recorders in the \$500-and-up bracket. Owing to the variety of special qualities offered by some of these high-price machines, it is fruitless to generalize. If you are serious enough about cassette recording to consider spending from \$500 to \$1,600, study the available machines in this delightful neighborhood and make your own choice. They are all beautiful products whose precision of construction and overall performance rivals many of the better home open-reel tape recorders.

KNOWING your budget limitations and your performance requirements, you should be in a position to pay your money and make your choice—or vice versa. Given the speed at which the field is expanding, that choice may be somewhat larger than the accompanying tables indicate, but the information presented will provide a uniquely useful understanding of a complicated subject. Good shopping. □

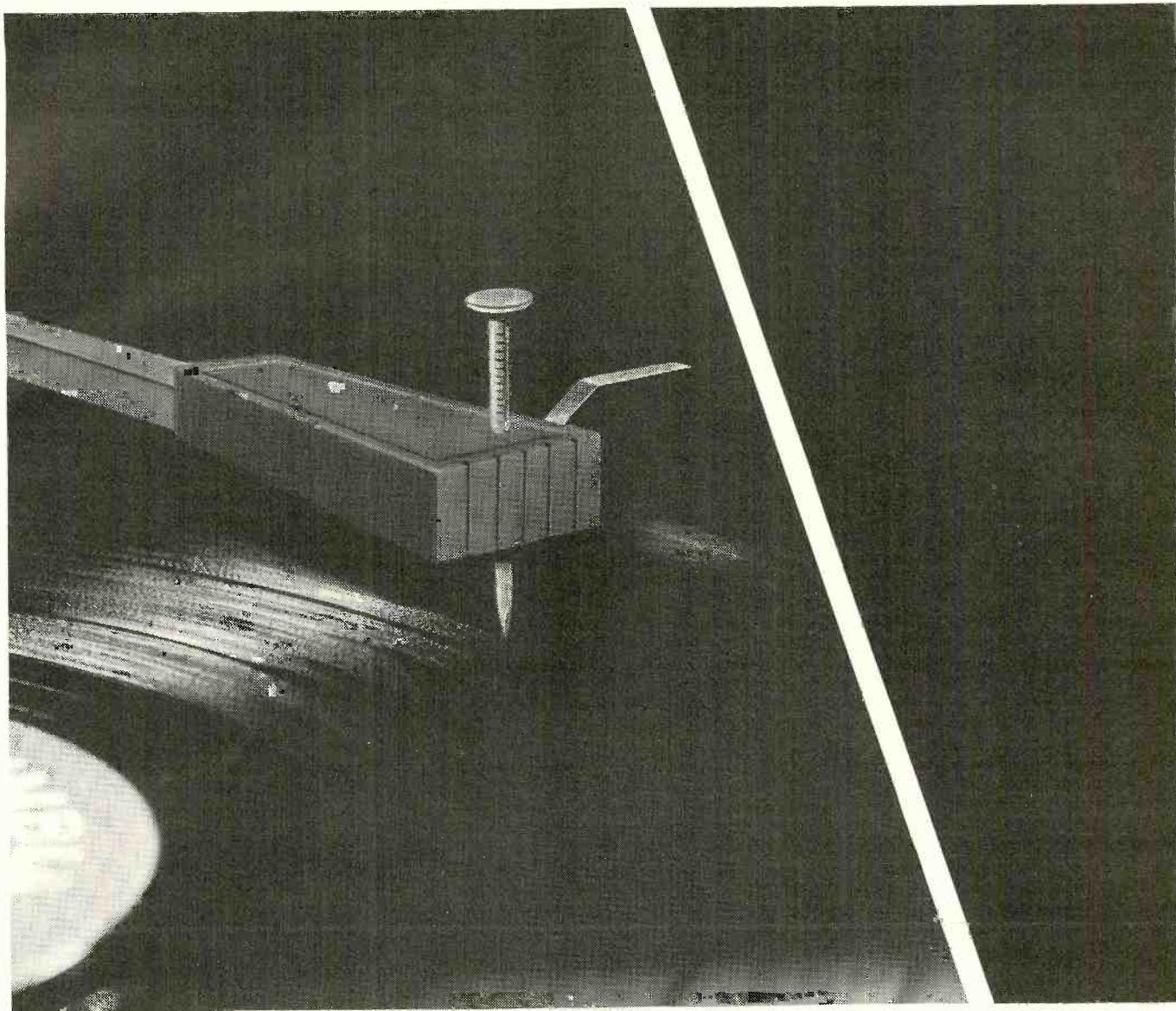

This is no way to nail down a hi-fi bargain.

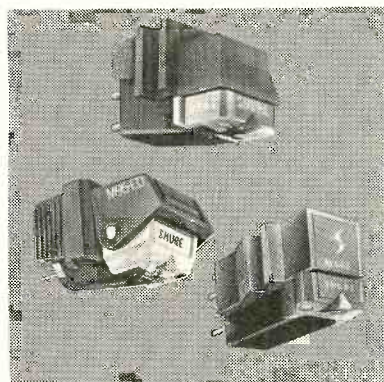

Some stores think that one of their cost-cutters in assembling a "bargain" stereo system is to install a run-of-the-mill, inexpensive cartridge. After all, who's going to notice a tiny cartridge when it's surrounded by powerful speakers and a dynamite turntable? Unfortunately, some shoppers are reluctant to insist on a better cartridge when buying one of these package specials. But *you* are made of sterner stuff! And if you insist on a Shure cartridge, "better" doesn't have to mean more expensive. Time and time again, consumer magazines have rated Shure cartridges the best in their price category. As the source of sound for the entire system, that tiny Shure cartridge and its critical stylus determine what you'll ultimately hear. And as bargains go, that's the best tip you'll hear today—or any day!

Shure Brothers Inc.
222 Hartrey Ave., Evanston, IL 60204
In Canada: A. C. Simmonds & Sons Limited



Manufacturers of high fidelity components, microphones, sound systems and related circuitry.

CIRCLE NO. 54 ON READER SERVICE CARD

WILL success spoil this person? That's a question always in the back of the mind in this quick-fame era, but with Bonnie Raitt the damned question slips away unnoticed, sort of turns smoky and dissipates. Days pass before you even miss it. Bonnie Raitt turned out to be one of the nicest famous persons I ever expect to meet, and of course it threw me off. I hadn't expected her to be *not* nice, but I wasn't prepared to have being nice seem so *natural* to her.

Most celebrities are at least civil to journalists, and most celebrities Act Themselves nowadays—just look at the four-letter words they utter in the presence of *Rolling Stone* and *Playboy*—but most of the ones I've met were trying a little too hard at both. A few seemed as if they might be capable of bringing off the acting part with some style if they'd study the role a little more, but several were being both Civil and Natural to the point of making everyone in the room hyperconscious of it. And few of them had what you'd call Bonnie Raitt's "credibility problem" to start with: she was a privileged kid, daughter of famous and presumably affluent Broadway star John Raitt (*Carousel*, *Pajama Game*, and others), and she was singing the blues, seeming to claim a kinship with rheumy-eyed old black blues singers who had trouble their whole lives rustling up even the price of a bottle of cheap wine . . . and what could she *know* of all that that wasn't secondhand? What could she know of a life like that of old Bullet Wilson, whose way of getting alcohol into his head cheap was to drink shoe polish strained through bread? I liked, with a degree of fanaticism, her voice, but still one expected to retain some skepticism beyond her first smile and her first few words ("Do you want some coffee?"). It was to be a rough time for skepticism.

IN the time it takes for three-quarters of a cup of forgotten coffee to turn cold, she told me about how Mississippi Fred McDowell, dead and gone now, surprised her toward the end of his life with a birthday cake, which he brought out on stage where she was playing and set down on top of her National guitar.

"That *Kokomo* on 'Takin' My Time' album was supposed to be him and me," she said. "I still have trouble listening to one of his records. It was a long time before I could sing one of his songs." And I thought she was going to cry, and I must have said something in body language to change the subject.

I had come into this with considerable respect for her as a musician. I think her voice is quite something, lovely and at the same time salty; I

knew she'd been interested enough in McDowell and others to study their guitar styles, and that she played a pretty mean *slide* guitar, something few women seem to try. I'd been a little dismayed to see her do a bit of Ms. Entertainment jumping up and down on

"The only time I ever took voice lessons," Bonnie said, "was fairly recently, when I had trouble with my throat—actually, I had walking pneumonia. The voice teacher said, 'Well, you might last another two years doing it this way, but you've got to start using your

BONNIE RAITT



"... turned out to be one of the nicest famous persons I ever expected to meet, and of course it threw me off."

stage recently—hers, I thought, was a talent of subtlety and ought to assume it had, or would find, an audience that appreciates nuance, not flash and bombast—but I was also trying to keep in perspective the good news, which was that at least eighty per cent of her act seemed at peace with the personality her singing projected.

Technically, it turns out, the part I was so impressed with in the first place—the voice—is "all wrong."

"Bonnie's like me," her father said. "We're both singing in lower ranges than we should be. I should be a tenor, and she should be a soprano."

diaphragm or you're going to burn your cords out."

"... It's funny. I'd gotten this far without thinking anything *about* the diaphragm, me the daughter of a trained singer and all. But I found when I tried to do it the right way I didn't sound like *me*—I sounded like Vikki Carr. Whatever I'm doing wrong is what gives me my sound."

She's keeping her sound.

Where that really comes from, bluesmen have long suspected, is beyond anatomy anyway. "What comes out is what you *feel*," Sonny Terry once told me. "You don't know what it's going

to be beforehand." A certain character probably started edging into the Raitt voice as long ago as her teenage years. Being, like all teenagers, reactionary to some degree, she trained her early skepticism not so much on other generations as on that middle-class wallow-

and Bonnie spent several summers in a Quaker-run camp (the Raitts were Quakers, she says, in a philosophical rather than a passionately religious way) in the Adirondack Mountains. Her political consciousness, a factor implicit in her dislike of "all that L.A. plastic," was raised there in quick, long steps. "That camp," she said, "was really an uncompetitive, liberal place. Civil rights had come along, and the counselors there, mostly from Antioch and Swarthmore, were into the civil-rights movement. They were people who knew about freedom marches and sit-ins and all that."

A lot of her friends, she noticed, were older than she was. "I couldn't wait to get to Cambridge, but by the time I could manage it the folk clubs were closing. I couldn't go to Selma. I couldn't be Joan Baez. I was too late for everything, and there were times when I was bitter."

SHE is still political. Last year she was coordinating a series of benefit concerts to raise funds for Tom Hayden's attempt to win a U.S. Senate seat in the 1976 California election. Hayden, a figure in both the civil-rights movement and in the political spasm of the late Sixties, is a neighbor of hers in Santa Monica. But some who know her say she's mellow now (perhaps we all are); her father, for example, tells me that "Bonnie has become quite a *graceful* advocate of women's lib" [emphasis his]. And, while she never seems guarded in her opinions or about the facts of her personal life, she does give the impression of working on a certain amount of privacy; her relationship with Gary George, the tall, bearded fellow from Texas who shares a home with her—when they have time to be at home—is not a secret, but neither is it something she would have publicized like, say, the continuing public saga of Johnandyoko.

And her way with music, when you reflect on it, listen to her albums, has not been to wag the blues around like a political weapon, or to burden it with attempts at sacred heaviness. Back in 1973, she had to tell people through the *New York Times*, "I'm not unhappy all the time. I really like sad songs, but sometimes it's like getting paid to split yourself open, like people were paying to see me bleed." Now she has a backlog of albums that say for her that she is not simply stuck on how hard life is for some people in twelve measures in the key of E. Each of those recordings, in fact, has a definite high-spirited streak in it. And in person she seems to have considerable pep, flopping school-girl-on-the-phone style on a couch one minute, bounding off somewhere the

next, but without restlessness. She looks good enough in still photographs, but they misrepresent how animated she is, and she looks better in person.

Bonnie Raitt is the sort who would fascinate you even if she were mute or you were deaf. "I'm just naturally energetic," she says, "like my dad. It's rare that I don't have enough energy to do what I want to do. I don't think I could stand to take speed—it would be just too much. Of course, I have been known to take now and then . . . and I'd never take a drink!" Wink, grin. Taking an occasional swig of the hard stuff and "telling a salty story" are activities one finds reported on in handouts publicizing her, but she did not impress me as one likely to follow her folk heroes into a long-term reliance upon the demon painkiller. Her relationship with the blues, I think, is an example of how empathy can work when it's clicking on all cylinders, which it rarely does; here is this voice with a certain Scotch-plaid boldness to it that may be connected to the self-assurance that comes with being secure amongst middle-class comforts at an early age. But "lucky" kids have life-facing to do too, and they may in many cases have to face the "Am I a Loner?" question earlier than their hard-scrabbling counterparts do, so there is also in this voice some sadness.

And Bonnie Raitt, political in a *Highschool!* ambiance, late for everything, seems to have taken up with music not because it represented pop stardom or a better life in terms of things it could provide, but because it represented involvement in changes she thought, or felt, ought to be made.

"A big influence at a time when I was ripe to be influenced," she said, "was the album 'Blues at Newport, 1963,' with John Hurt, John Hammond, Sonny and Brownie. . . . I sat down and tried to play all the stuff on that record."

"But I never really planned to do it for a living. One time when I was about nineteen, I was in a club in Massachusetts, I think it was, and there was a girl singer there, and I suddenly realized that I could sing at least as well as she could. And I thought, well, why not give it a try? If she could get paid money for singing *Five Hundred Miles*, maybe I could make a living at it. I was always singing for myself anyway."

SHE'S making a living at it, only now she's singing for me—or so I am frequently able to feel. I also have a feeling that talking with her would be pretty much the same experience if she were still playing small clubs in Cambridge and being paid with wallet-rotting beer-soggy currency. Those are both good feelings. □



By Noel Coppage

ing her peers were doing in, to use Stan Freberg's word, *Highschool!*, and all the manic irresponsibility that word meant in L.A. in the middle Sixties.

"Surfing," Bonnie says. "Surfing was big in those days, and I never did like that kind of music. Maybe living up in the hills away from the malt-shop hangouts had something to do with it—I was the first kid to get on the school bus in the morning and the last one off in the afternoon. Anyway, I always liked what turned out to be what you would call today the soul groups."

Her father's involvement in summer theater meant travel and separations,

A Basic Library of Mahler Symphonies

By Irving Kolodin

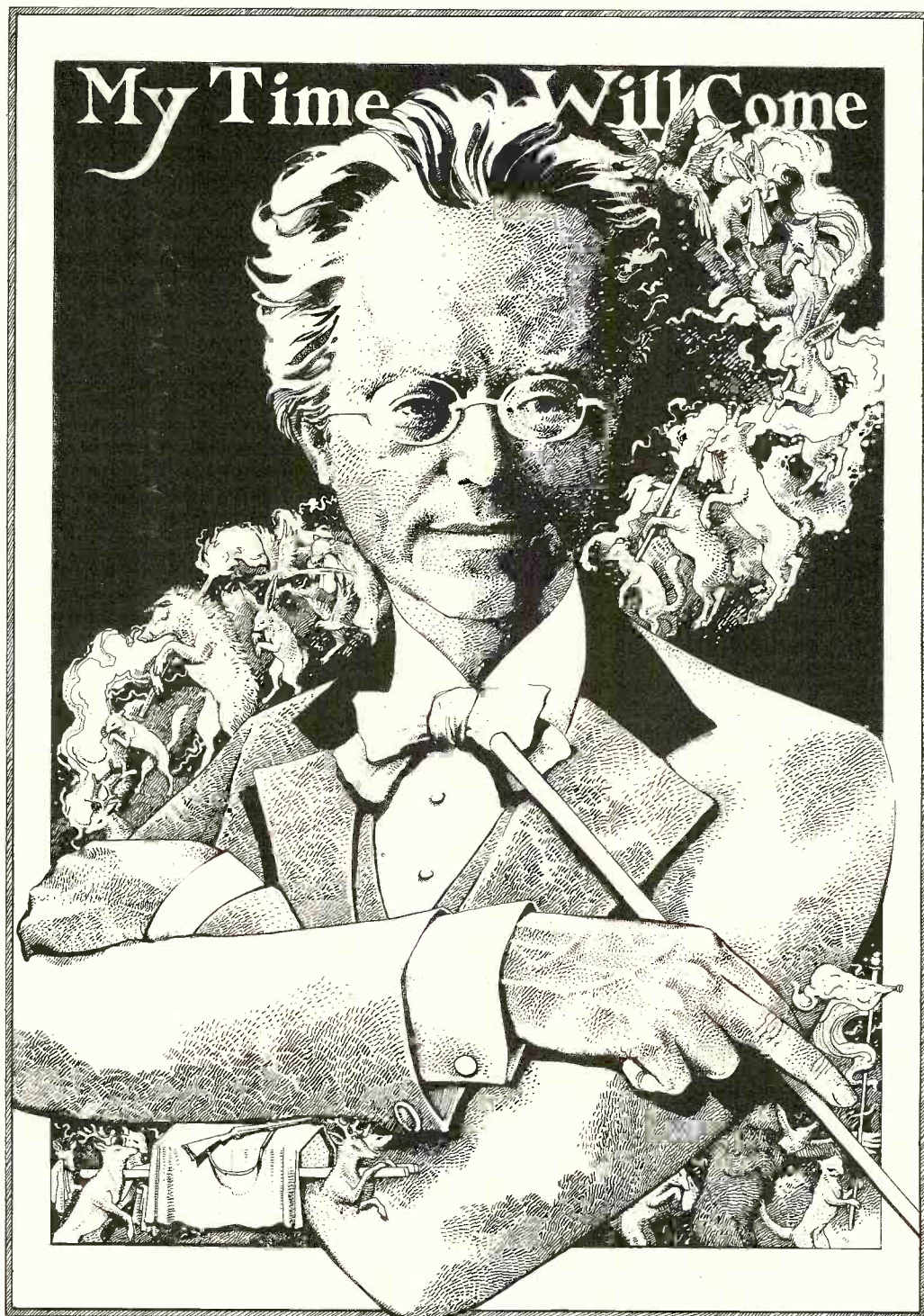

Take it from one who saw and heard it happen: the rise from obscurity to prominence of the nine complete—and one incomplete—symphonies of Mahler is the most remarkable phenomenon of public musical life in America in the mid decades of the twentieth century.

MEASURED by any conceivable standard—quantity of performances, number of recordings, or merely the abundance of his interpreters—the transformation of Gustav Mahler from one of the least favored to one of the most favored of symphonic composers in the last thirty years is an event that even the composer himself could not have anticipated. He is famous for having said, “My time will come.” But at the expense of Brahms and Tchaikovsky? Who would have thought so?

There were, to be sure, places where Mahler was a deity even while he was alive and producing—Holland primarily, where the yearly crop of Mahler performances was as dependable as the tulip tonnage, but also in Munich and, to a lesser degree, Vienna. But in New York, the scene of the last act of Mahler’s life (as a conductor at the Metropolitan and as music director of the New York Philharmonic), the verdict on his music was swift and direct: a great conductor, of course, but who ever heard of a great conductor who was also a great composer? Certainly not the much respected critic who insisted, in the mid-Twenties, that Mahler was a “conductor’s composer” whose name was kept alive by such “imported conductors” as Stokowski, Muck, Bodanzky, Gabilowitch, and particularly that arch-villain Willem Mengelberg of Amsterdam.

But the upheaval of the Thirties that dislocated thousands from their familiar musical haunts and habits in Central Europe had its effect world-wide. Many, having left everything else behind, brought at least their habits to the New World. The First Citizen among them musically was certainly Bruno Walter, but the list included such other Mahlerites as Otto Klemperer, Dimitri Mitropoulos, William Steinberg, Fritz Stiedry, and Stiedry’s close friend Arnold Schoenberg.

Walter’s habits, as Mahler’s oldest and most distinguished interpreter, became New York’s. His haunt, no longer Vienna’s Musikverein but Carnegie Hall, became the new “scene” for hundreds of the transplanted faithful, and their enthusiasm infected others. Among the converts was a young assistant conductor of the New York Philharmonic, and what Leonard Bernstein adopted as his own in the later Forties and on into the Fifties became gospel for the new generation of conductors for whom he was the prototype.

Concert-hall acceptance alone, however, could hardly have established this music in American ears so quickly.

What can best be described as a rising tide of Mahler on disc was also enormously influential in creating a climate of understanding and appreciation. The appearance, in the mid-Fifties, of *Lieder und Gesänge aus der Jugendzeit* on the Vanguard label (in a sequence that had already produced a substantial number of *Wunderhorn* songs) convinced me that Mahler was, at the very least, a great songwriter. Others will surely remember with affection the famous recording by Kathleen Ferrier of the *Kindertotenlieder* (last available on Seraphim 60203). The subsequent accumulation of recorded symphonies on LP demonstrated that there was both a

background and a foreground for *Das Lied von der Erde*, always esteemed a masterwork. Here was the long awaited opportunity to savor the man’s unique art, to understand what he was doing, to appreciate why.

For today’s listeners, much of that is academic. Questions of what and why may be readily resolved by recourse to the extensive recorded literature. Some opinions on such questions may find their way into the symphonic survey I am about to undertake, but my attentions will be largely centered on determining *who* among the legion of Mahler interpreters best knows, in each case, *how*.

The first sizable object in the mountainous landscape of Mahler recordings is a five-pointed promontory made up of the complete sets of Mahler symphonies under the baton of a single conductor. In alphabetical order and with labels appended they are: Maurice Abravanel (Vanguard), Leonard Bernstein (Columbia), Bernard Haitink (Philips), Rafael Kubelik (Deutsche Grammophon), and Georg Solti (London). A stubby little bump to one side of this geography denotes another nine from Everest, but it represents the work of a miscellany of conductors, including several members of the famous clan Anon.

FOR those seeking an inclusive answer to the question of which of these five (or six) complete sets is recommended for the greatest justice to *all* the works, my answer is: none. The reason relates less to the qualifications of the conductors than to the magnitude of the composer. Unlike Beethoven, Schubert, and Brahms, who were *born* into a tradition (and, however much they digressed from the art as they found it, remained substantially the same kind of composers they started out to be), Mahler evolved a tradition of his own. Comprehended within it, eventually, was a world of spiritual, philosophic, and aesthetic allusion ranging from Nietzsche to the Bible, from Rembrandt to Moritz von Schwind, from Goethe to Klopstock, conveyed through a musical language as new as some still unexploited aspects of the third act of Wagner’s *Tristan und Isolde* and as old as the medieval hymn *Veni creator spiritus*. Above and beyond all else, his achievement embodied a devotion to, and love for, the art of music that extorted from him a demanding double existence, a hundred years of work compressed into but fifty-one years of life.

(Continued overleaf)



THE NEW YORK PHILHARMONIC
A Mahler Festival
 at Carnegie Hall Sept 26-Oct 25

One measure of Mahler's concert-hall popularity: the New York Philharmonic honors him this fall with a festival devoted to his works. It is the first time an American orchestra has performed all nine symphonies, as well as the uncompleted Tenth, in such a short period of time. The festival performances will take place in Carnegie Hall, where Mahler conducted the Philharmonic from 1909 to 1911, when he was the orchestra's music director. Conductors are Pierre Boulez, Erich Leinsdorf, and James Levine. Participating vocal soloists include Frederica von Stade, Jessye Norman, Teresa Zylis-Gara, Gwendolyn Killebrew, Yvonne Minton, and Donald McIntyre.

Mahler



KUBELIK

DG

Symphony No. 1, in D Major

Every music lover should own at least one recording in which Mahler's musical essence is conveyed as closely as humanly possible to his own precepts and practices by the man who was so close to him as to become his physical and spiritual link to the world. Bruno Walter's version of the First

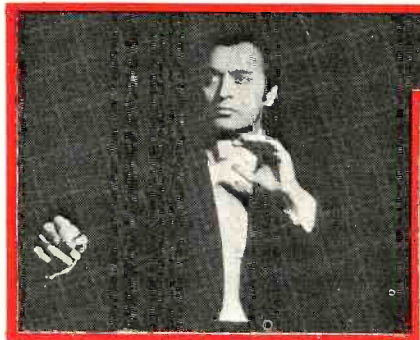

MEHTA

Scavullo/London

Symphony (Odyssey Y 30047) is a perfect point at which to begin, combining as it does a maximum of pleasure with a minimum of misrepresentation. Walter's management of stresses and subtleties, of the all-important tempo modifications that became so important a part of the composer's musical vocabulary, of the proper weight for a *glissando* (as light as the fall of a flower petal), or the right stroke to use to make the timpani a melodic instrument are, in effect, an aural lexicon of Mahlerian do's and don't's. Proper

attention to it will form taste, improve judgment, and enable the listener to distinguish the truly stylistic from the merely stylized.

For those who already have Walter's No. 1 at hand and are eager to acquire a version in which higher-fidelity sound does not mean lessened fidelity to the score, my choice is the Kubelik/Bavarian Radio Orchestra version (DG 139331, cassette 923-070). The work's content caters to Kubelik's Bohemian background, and his performance includes graceful adjustments to such unusual directions as *Plötzlich viel schneller* (suddenly much faster) in the third movement. Taken together, the work is an Old (rather than a New) World symphony, and I feel that the American efforts of Bernstein (Columbia MS 7069) and James Levine (RCA ARL1-0894, quadrasonic CRD3-1040) tend to overpower rather than woo the content. The version by Sir Adrian Boult with the London Philharmonic (Everest 3005), a reminder of this conductor's broadly sympathetic sense of what is suitable for Mahler, is better sounding than one would expect at the price.

In a category all their own are those recordings of No. 1 that include the recently rediscovered "Blumine" movement deleted by Mahler from the published score. For my taste, the movement *belongs* between movements 1 and 3, especially since it contains material that reappears at a later point. The best of these recordings is the one by Wynn Morris, a conductor with high Mahlerian qualifications, and the New Philharmonia on an English label (Virtuoso TPLS 13037). If that one cannot be located, the "Blumine" movement is also beautifully played by the



BERNSTEIN

Exxon

Philadelphia Orchestra under Eugene Ormandy (RCA LSC 3107, cassette RK 1133), though the other movements there have more the finish of fine silk than homespun.

Symphony No. 2, in C Minor

Mahler's great forward leap (between the year 1888, when he rounded out the First Symphony, and 1894, when he finished the Second) converted him from a pastoral draughtsman with the talent to parallel in musical imagery Moritz von Schwind's famous woodcut "The Huntsman's Funeral" to a sophisticated muralist with the genius to evoke a Day of Judgment for which there is no adequate graphic counterpart. A conductor who can combine the surging strength necessary to bring off the Day of Judgment—and the Resurrection that follows—with the lightness to make Mahler's setting of *St. Anthony Preaching to the Fishes* suitably sardonic is among the elite of his time.

My *eliminations* from the candidates for this select company include a superb early Klemperer set (last available on Turnabout 34249/50) that is sonically inferior by today's standards; a Bruno Walter performance (Odyssey Y2 30848) that also suffers from technical insufficiency; a Bernstein (Columbia M2 32681, quadrasonic M2Q 32681) that contains so many highlighted "events" along the way that the thunderous Resurrection comes as something of an anticlimax; a superbly recorded Stokowski of recent date (RCA ARL2-0852) that gets off to a rather slow-motion start and is beset by other inequalities on the way to a stunning climax; and a generally overstated Kubelik (DG 2707043) with inadequate solo voices.

Among the honorable mentions are the performance by Haitink (Philips 802884/5), especially for the playing of the Amsterdam Concertgebouw Orchestra and the rare vo-



MAAZEL

Jacoby/DG

cal artistry in Aafje Heynis' *Urlicht*, and the more recent one by Zubin Mehta (London CSA 2242), more for the Vienna Philharmonic's superb sound and Christa Ludwig's singing of *Urlicht* than for the conducting. Mehta strives constantly for effect rather than permitting Mahler's eloquence simply to *accumulate*.

The prize of the lot among recordings of this work, still unsurpassed for its life-giving sense of forward movement, its unflinching grasp of the symphony's huge dimensions, and (therefore) comprehension of its form and content, is Solti's interpretation (London CSA 2217, cassette H 10187) with the London Symphony Orchestra and Chorus.

Symphony No. 3, in D Minor

Mahler's spiritual volatility is as much a part of his temperament as his disposition to use sudden alterations of tempo. In his Third Symphony he turns his back on the faith in the Resurrection proclaimed at the end of the Second and, continuing his unending quest for an answer to the riddle of life and death, looks to God in Nature, to pantheism. In the process he also turns his

back metaphorically on the many conductors for whom pantheism is at least as mystifying a concept as the philosophy of Nietzsche. That puts him face-to-face with Leonard Bernstein, however, who reveals (on Columbia M2S 675) a total sense of location, of artistic oneness with Mahler in this score. When the composer demands *Schwung* (propulsion), Bernstein's response is lifting but not unruly; the amusement he discovers in the setting of *Ablösung in Sommer* is wholly appropriate; and Martha Lipton's well-articulated *O Mensch* is entirely in character. Indeed, *character* is the distinctive trait of the performance, which attains its greatest fulfillment in the long, intricate, and marvelously Beethovenian variations/adagio with which the work concludes. These variations are also well served in the

out of place in a work in which euphony, fluidity, and homogeneity are an inseparable trinity.

A kind of family affinity may be involved in a sequence of Mahler Fourth's performed over several decades by the Concertgebouw Orchestra. The earliest was assembled (on Philips 500 040, withdrawn) from "live" concerts under Mengelberg in his later (1939-1940), more wayward years. But, among the languishing ritards and stately rather than sprightly tempos, it is absorbing to find a prime example of how to treat a group of Mahler's multiple accelerations. The secret: each of the sudden leaps ahead is to be played, for the *duration* of the change, in strict metronomical measure, as an island of stability in a sea of change.

Among the few to master this subtlety was Mengelberg's successor with the Concertgebouw, Eduard van Beinum, who died in 1961 at fifty-nine. Margaret Ritchie is not the best of soprano soloists for the finale (that honor belongs to Reri Grist with Bern-

sive and satisfying as Bernstein's mastery of the Third. The extraordinary string basses of the Berlin Philharmonic have never sounded weightier, and the ensemble rips into and out of Mahler's *wild* passage in the first movement in total fulfillment of its German meaning, which is something rather more than our English "wild." At the other extreme, Karajan knows exactly what to do with that moment in the fifth movement in which Mahler tosses the serene theme of the adagietto into the air like an unresisting rag doll: he makes it truly *grazioso*, as Mahler directs. Haitink reacts to the same moment with a Dutch gravity (Philips 6700 048), and Kubelik proceeds cautiously (DG 2707056), as if not quite sure whether Mahler was joking or not.

Over the years, I have enjoyed the Solti recording (London 2228), esteemed the Walter (Odyssey 32260016E) even though it



VON KARAJAN

Exxon

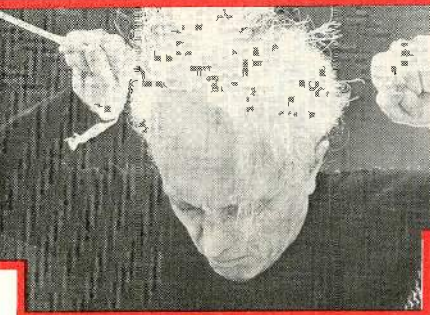

HORENSTEIN

Nonesuch



SOLTI

Lightfoot/London

versions by Solti (London 2223), Kubelik (DG 2707036), Haitink (Philips 802711/2, in which Maureen Forrester is her unexcelled self in *O Mensch*), and Jascha Horenstein (Nonesuch 73023, Advent cassette E 1009). The reason? The variations are squarely in the middle of a much-traveled musical highway these conductors know very well—but none of them leads us so skillfully into the byways of Mahler's digressions, none has so sure a sense of direction and ultimate goal as Bernstein.

Symphony No. 4, in G Major

To judge from the dozen-plus versions of the Fourth Symphony currently available (I have recently heard and reheard more than thirteen), one has to conclude that this is the Mahler symphony *par excellence* for the non-Mahler conductor. It is an attraction that would appear to be based on a fallacy—that something so transparent cannot have hidden depths. But try looking sometime for the bottom of a mountain lake in Canada.

Among those misled by this misconception of simplicity are the late David Oistrakh (Melodiya/Angel SR 40076, now withdrawn), who diligently follows all the printed instructions only to find that they take him into, rather than out of, the labyrinth; and James Levine (RCA ARL1-0895), whose insertions of a pizzicato plink in the topmost violin register or a percussive plunk in the bottom-most timpani range are clearly

stein on Columbia MS 6152), but overall the recently reissued performance on London 23211 shows both Mahler's Fourth and Van Beinum at their most appealing. The additional Concertgebouw versions are a rather stiff, pre-Chicago Solti (London 6781) and a meticulous, cool Haitink (Philips 802 888). The most congenial of the others (they include a ponderous Klemperer on Angel S35829, Elisabeth Schwarzkopf as soloist; a finicky Szell on Columbia MS 6833; and the over-intellectualized Bernstein previously noted) is a version by Lorin Maazel and the Berlin Radio Orchestra (Nonesuch 71259).

Symphony No. 5, in C-sharp Minor

Of the nine complete symphonies of Mahler, the Fifth is the most ambivalent, even schizoid. The first two funeral sections and the only half-happy scherzo were written before the composer met Alma Schindler; the blissful adagietto and the riotously exuberant finale were completed after they were married. This new element in Mahler's creativity is rather interestingly paralleled by the appearance in this listing of the *re-creative* efforts of a new partnership: Herbert von Karajan and the Berlin Philharmonic (DG 2707081).

On what Karajan's affinity with this work is based I have no knowledge, but the outcome of his involvement with it is as persua-

lacks the *snarl* Mahler wrote into the first movement, and respected the Bernstein (Columbia M2S 698). But Karajan's is on a new, higher plane of clear thinking, clean ensemble coordination, and evenly balanced reproduction.

Symphony No. 6, in A Minor

This is the work with the hammerblows of fate, the soaring first-movement melody officially labeled the "Alma" motif, and the cross-currents that subsequently ensue. It was written during a harried time in Mahler's life; he lacked the leisure to write out the repetition of the exposition in the first movement, and so risked a misunderstanding of his intentions. A conductor who takes the view that the repetition is optional (as Sir John Barbirolli does on Angel S 3725) cannot be said to understand a work in which it is a structural necessity.

All the work's necessities and problems are thoroughly understood by Solti (London 2227), however; he brings to it the physical and intellectual energy needed to pick up loose threads and weave them into the tonal fabric. Bernstein comes close to this same understanding (Columbia M3S-776), but he indulges himself with a third hammerblow in the finale, one that Mahler himself had deleted from the published score. Following at more than a little distance from these is a brittle rendition by Szell, derived from a live performance (Columbia M2 31313); an earnest, rather plodding one by Kubelik (DG 2707037); and a spirited effort by Horenstein

Mahler

(Nonesuch 73029) that is let down by what sounds to me like an undersized Stockholm Philharmonic.

Symphony No. 7, in E Minor

In any set of ten works, one is surely destined to be on a lower level of inspiration than the others. To me, this is the fate of the Symphony No. 7, which tails off into non-conviction in the essays of even the most distinguished interpreters, those by Solti (London 2231, cassette H 10249) and Bernstein (Columbia M2S 739) as well as the defiantly anti-Romantic one of Klemperer (Angel S 3740).

In the interest of completeness, I invested some listening time in an out-of-print version by the late Hans Rosbaud (Vox 2008) that I have long had on my shelves but had not previously heard. I found myself increasingly absorbed by it. Rather than looking for a conventional symphonic discipline in the Seventh (which its two lightly scored inner movements and three enveloping movements for large orchestra clearly lack), Rosbaud searched for—and found—a wholly unconventional symphonic *discourse* whose two participants are tempo and texture. This does not make this weak work into a strong one, but it does define it as a productive and prophetic experiment rather than a bizarre and laborious failure.

Symphony No. 8, in E-flat Major

Mahler's musical regeneration only months after the low point of creative effort marked by the finale of the Seventh is evident not only in the awesome flood of music released in the *Veni creator spiritus*, but also in the sweeping away of conceptual barriers to the realization of a whole new symphonic scheme. Thus, though the symphony begins and ends with choral sections in which a "cast" of solo voices is utilized, and though it follows a section in Latin with the conclusion of Goethe's *Faust* in German, it pursues a clear, four-part symphonic sequence. Here again I find Solti's conception second to none, the Chicago Symphony "on location" in Vienna (with local choral forces) representing the ultimate in ensemble sound (London 1295, cassette H 31211). A dream team of soloists (Martti Talvela at the bottom of the tonal scale, Lucia Popp and Heather Harper at the top, and René Kollo and John Shirley-Quirk in between) completes a set that is the best money can buy.

The other inspiring performance (RCA CRL2-0359, cassette CRK2-0359) has an entirely different kind of richness to recommend it: the apparently unwavering conviction of conductor Wynn Morris that Mahler was a prophet whose musical oratory demands an evangelical fervor. John Mitchinson, who also appears as Doctor Marianus in the Bernstein recording (Columbia M2S 751), sings with greater freedom and ease for Morris; Joyce Barker, Elisabeth Simon, and Norma Burrowes (wife of tenor Stuart) shine with the glitter of emerging stars.

There are other efforts of interest (of which the Dimitri Mitropoulos on Everest 3189E is a superheated affair, inadequately reproduced from a Vienna concert performance), including those of Kubelik (DG 2707062) and Haitink (Philips 6700049). But

enlightenment, of conviction, was so great in that performance that only another version by Walter could extend it. That can be found in the latest reissue (Odyssey Y2 30308) of the Ninth as performed in California in 1961, a year before Walter died. Is it possible that a conductor of eighty-four still had something to say on this matter to his juniors? It is not merely possible; it is demonstrable. In its incisiveness, its probing for details, its arrangement of sound on levels of sonority in the orchestral matrix, the musical *sense* Walter's performance conveys is unmistakable.

Postlude: Symphony No. 10

Mahler's next steps in the new direction set in the Ninth were sure and unflinching: the textures of the Tenth are thinner, but they are tightly stranded; melodic lines soar

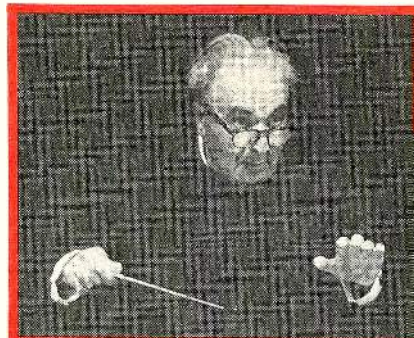

WALTER

Columbia



SZELL

Epic

Dietrich Fischer-Dieskau (in the former) and Hermann Prey (in the latter) contribute more to box-office appeal than to musical satisfaction: both voices are light for the needs of Pater Ecstasticus.

Symphony No. 9, in D Major

Symphonies Nos. 8 and 9 are separated not only by the passage of time, but by an artistic voyage through which Mahler reached the safe haven of his perfect work, *Das Lied von der Erde*. For my taste, the greatest interpreters of *Das Lied* are also the most successful with Symphony No. 9, which arises out of the repeated "ewig" at the end of *Das Lied*. Performance of the four-movement work (which ends, in the manner of No. 3, with a slow movement in variation form) still requires its measure of intuition, perhaps even of divination. Both Solti (London 2220) and Bernstein (Columbia M3S 776) do well with the outer movements, less well with the others, especially the Rondo Burlesque.

Looking for guidance, I went back to one of the first of all performances of a complete Mahler Ninth perpetuated on discs: that derived from a concert conducted in Vienna by Bruno Walter on January 16, 1938 (ten days before the Nazis marched into Austria). More than just a moment in history is captured in this recording, and in its reappearance (on Turnabout THS 650008/9E) it is vastly superior in sound to the 78's (Victor M-726) on which it first circulated in America thirty-five years ago. The sense of

and plunge across wider intervals; inversions are curiously congruent with a theme's first form, likewise its mirror (retrograde) image. The two movements most nearly complete in the score as Mahler left it (the *adagio* and *Purgatorio*) have gradually become established in the orchestral literature. They have yielded the most of what they contain to the penetrating eye of George Szell (Columbia M2 31313, which also contains his version of Symphony No. 6).

And so we come, finally, to the much discussed "performing version" of the other movements of the Tenth as realized by Deryck Cooke. I do not find that his treatments of the two scherzo movements have sufficiently either the shape or the sound of Mahler to be convincing. But I do find that the last of the five movements is one of the greatest of all Mahler's slow movements, that the original short score (which can be studied in facsimile) gave Cooke as much as he needed to send those turbulent, anguished, eventually consoling measures straight to the heart of the listener. Ormandy throbs a little too agonizingly over them in his version with the Philadelphia Orchestra (Columbia M2S 735), but Wynn Morris (using Cooke's revised text) scales every note of them exactly to the capacities of the New Philharmonia (Philips 6700067). Together, conductor and players give dignity and a heart-rending grace to the parting utterance of a man who still needs no more than sympathetic fulfillment of his clearly stated musical purpose to assure its grateful understanding. □

The Sensuous Speaker.

Yamaha's new two-way beryllium dome NS-500.

A very responsive speaker with a rich, luscious sound. A deeply involving sound. Highly defined, finely detailed.

The NS-500 is created from the same advanced beryllium technology that's made Yamaha's revolutionary NS-1000 Series speakers in the eyes and ears of many audio experts, the highest standard of sound accuracy. (Specific benefits of Yamaha's beryllium technology have been documented in a paper presented to the 52nd Convention of the Audio Engineering Society.)

With the NS-500, you get all of beryllium's advantages (transparency, detail, and lack of distortion that go beyond the best electrostatic speakers), but at a price roughly half that of the NS-1000. Only \$500 the pair, suggested retail price.

The joy of beryllium.

The ideal dome material for a high frequency driver must respond instantly to changes in amplitude and frequency of the input signal. So the ideal dome material must be virtually weightless as well as extremely rigid.

Beryllium is the lightest and most rigid metal known. Its density is less than two-thirds that of commonly used aluminum, and its rigidity is almost four times as great — thus preventing dome deformation and consequent distortion. What's more, beryllium's sound propagation velocity is twice that of aluminum.

The beryllium dome found on the NS-500's high frequency driver is the world's lightest — about half the weight of one petal of a small sweetheart rose. Which is one of the reasons for this speaker's exceptional sensitivity and response. And for its sensuous sound.

A closer look.

To be able to offer the sophistication of beryllium at a more affordable price, without sacrificing quality of performance, Yamaha designed the NS-500 as a two-way bass reflex system.

This gives the NS-500 a trace more erosion at the low end than the resolutely objective NS-1000. But it also gives the NS-500 more efficiency (91dB SPL at one meter with one watt RMS input). Which means you don't have to invest in the highest powered amplifiers or receivers in order to drive the NS-500 to its full rated output.

For an optimum match with the beryllium tweeter, Yamaha developed a very light, very rigid "shelf" woofer. And a special hermetically-sealed air core LC crossover with a carefully selected 1.8kHz crossover point.

As a result of these design parameters, the NS-500 boasts an insignificant 0.03% THD below 50 dB SPL, from 40 Hz to 20 kHz, making it the perfect complement

to Yamaha's state-of-the-art low distortion electronics.

Underneath the sleek monolithic styling of its solidly crafted enclosures, the NS-500 is full of many exclusive Yamaha features and distinctive Yamaha touches of craftsmanship.

But to fully appreciate the beauty of the NS-500, you really should visit your Yamaha Audio Specialty Dealer.

Which brings us to something else.

Something more than just another speaker pamphlet.

Yamaha's *Reference Handbook of Speaker Systems* is a very thorough guide encompassing all aspects of speaker design, performance, and evaluation. Starting with a detailed explanation of speaker design principles, the discussion then turns to a solid base of objective criteria, written in easily understood language, to help you properly evaluate any speaker in any listening environment. Already a much sought-after reference work among audio professionals, Yamaha's *Reference Handbook of Speaker Systems* is available at your Yamaha Audio Specialty Dealer. At \$5.00 a copy, it's well worth the cost.

However, if you clip out the coupon in the bottom corner of this page, take it to your Yamaha Audio Specialty Dealer and hear a demonstration of the exciting NS-500 or any other Yamaha speaker, the book is yours for half the price.

And if you're not familiar with the name of your local Yamaha Audio Specialty Dealer, drop us a line. In turn, we'll also send you a free preprint of the Audio Engineering Society paper on Yamaha beryllium technology mentioned above.



This coupon is worth \$2.50 off the \$5.00 suggested retail price of Yamaha's *Reference Handbook of Speaker Systems*, when presented to any participating Yamaha audio dealer, with a demonstration of any Yamaha speaker system. Offer expires March 1, 1977. S



YAMAHA

P. O. Box 6600, Buena Park, CA 90622

CIRCLE NO. 63 ON READER SERVICE CARD

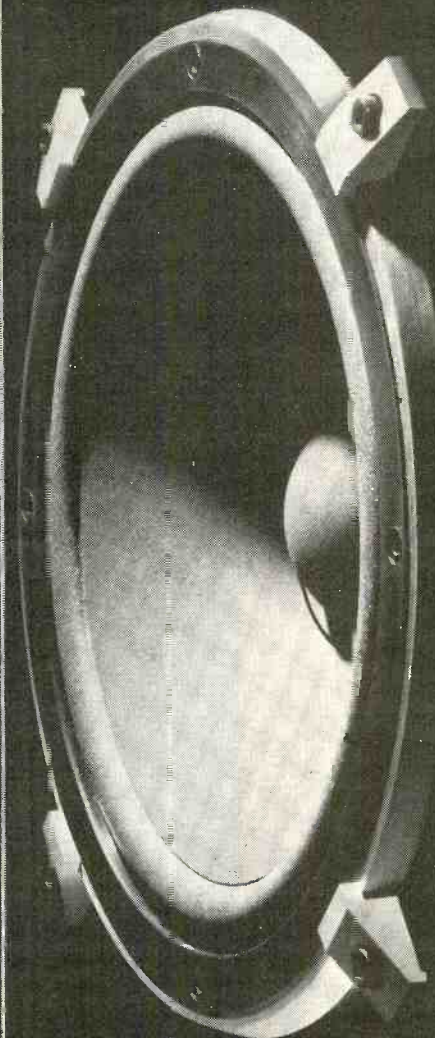
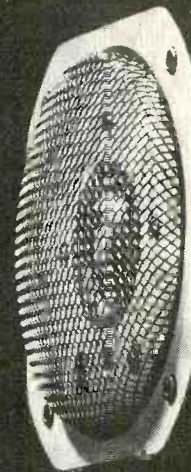

BILLY JOEL IS A CUTIE PIE...



... To see him in concert is to see the under-thirty Paul Anka. But that's an unfair comparison in a way, because Billy Joel is also a marvelous pianist, perhaps the best keyboard technician on the pop scene (fans of Rick Wakeman, Nicky Hopkins, and Leon Russell please note). Still, what comes across most of all when Billy Joel is performing is his cuteness. And the boys and girls respond.

"My fans cover all ages," Billy Joel says, but the crowds on his last tour were decidedly young, the type who *squee-ee-al*. Billy Joel plays up to them and they love him. My, how they love him. During one show he was handed at least eighteen flowers, a hat, and two embroidered pillows. The note with one pillow says: "We love you from your first visit here, Billy Joel, and we hope you remember us, we're the couple that threw the chrysanthemum at you." And it's signed, "Darlene (and love from her boyfriend Rob) and Jeff (and love from his friend Debbie) and hello from Sandy who couldn't be here tonight cause she's sick, but she loves you."

Billy Joel gave a kitten away during one concert, a kitten he had found wandering the streets of Manhattan, grimy and homeless. He took it with him to his next gig and gave it away, making the announcement during the show and admonishing his fans not to rush onto the stage and tear the kitten apart, but to line up outside the stage door. Sure enough, some young'uns left to line up, even though it was only one-third of the way through the set. That's cute, you must admit. And the crowd loves it. Billy Joel is playing *ballads* and the crowd is dancing. They scream for the songs they love.

When he's on, when he's entertaining the crowd with a genuinely funny story, he is like Paul Anka or Jim Croce—polished, charming, story-telling entertainers who could make any big hall feel like a small club. But occasionally, when he's not just *right*, he may seem self-indulgent or stale, like the time he said, "I've been playing this song for a long time, and I may be playing it for the rest of my life."

In a very noisy dressing room between shows one night, Billy Joel said, "I don't really know what I'm doing when I'm on stage. I have this theory that when I go on stage, I go into a special state, and when I come off, I go out of it. It's like a trance." When he drops

his defenses, it's clear that his cuteness on stage is essentially a cover for his fear—it's effective as entertainment, but it's a kind of defense just the same.

"Whenever I've snapped out of that trance. I just sat there on the stage and said to myself, 'What am I doing here? There are thousands of people out there who've paid money to see me.' I can't say I *like* the trance, but I can't analyze what I'm doing on stage or how it looks. I just do what I do." He paused, shrugged sheepishly, and flashed a (cute) grin. "It's like sex. When you make love, you go into a whole different trip. You're not your everyday shmuck self, you become Superlover. It's like that at pretty much every performance."

But Billy Joel is not just an automaton making love to his audience each night. He knows—perhaps intuitively or perhaps through the experience of touring for eighteen months in three years—how important it is to *move* the audience. They're the folks who buy the records and tell their friends and come back for more, and it's on that kind of word-of-mouth that Billy feels he's built what success he's had.

"Mostly I've got the strongest followings in places where I've played before. Whatever I have in other places is probably an FM audience because I don't get much Top Forty airplay. There's no pattern I can discern about my 'following,'" he said, laughing at the term. "I'm strong in Memphis—which seems weird because to me Memphis means Otis Redding and Elvis Presley—and in Vancouver, Saint Louis, Denver, and Birmingham, Alabama. And in New Jersey because there they can dig my New York roots, my 'Hey, how ya doin' man?'"

BILLY'S New York roots sprouted in Oyster Bay, a snug, maybe even posh, upper-middle-class suburb on the North Shore of Long Island. "I didn't even graduate from high school," he said. "I knew I was gonna be a musician from the time I was eleven or twelve, you know, so I thought, 'Why get into school?' I moved away from the house when I was eighteen, but I still lived in Oyster Bay, and I was still living there when I was recording stuff for my first album."

He was reticent and a little vague about his childhood. After fumbling with a cigarette, he mumbled, "I started when I was four—both my parents

were musicians and that's why I had to take piano lessons. I took lessons on and off for about eleven years. When I was supposed to be playing Beethoven, I used to fool around with things like stride piano and boogie-woogie. And my old man didn't want to hear it. 'What's that he's playing in there?' he would yell."

LIKE so many other young musicians, he was drawn to rock-and-roll by the sound of the Beatles on his radio. "I first really got out of classical music and into pop when the Beatles came. I was a Beatles freak. I loved them," Billy said, sitting up and obviously excited by the memory. "Everybody had a band, and since I could play the piano, some guys asked me to be in their band. I was about fourteen, and the band was called the Echoes. Then I was in a lot of local bands, one after the other. I even cut a couple of records."

"Paul McCartney was the one who turned me around. He's my main man, by far my biggest influence—as a writer, as a singer, as a musician. I haven't modeled myself after him, but he opened the door. I admire him more than anybody. I think he's great, just really great, and when I think of him, I think more about what I can do with my music."

"People don't know me all *that* well. I don't get the airplay. I'm not a superstar like McCartney, of course, and that was never my intention. I intended to be a writer. From there, the progression for the young musician is to do an album, then you have credibility. And from that, well, the best way to promote your album is to go on the road. So here I am!" He waved an arm half-contemptuously at the dim, dingy room where he was sitting on an old couch.

A progression? It can also be like falling into a laundry chute. The options expire. One thing leads to another, and there's less and less choice for the artist. Billy Joel nodded vigorously and said, "I signed a lot of stupid contracts a few years ago, particularly publishing contracts. Fortunately, I wound up with a good record company, Columbia. But those other deals! Phew! But I don't know—I have a good time, I make a good living."

"I don't make money off writing because of bad deals I made. But let's look at that progression thing again. I don't make money off records, but I make money from touring, and I'm

touring to publicize my albums, right?"

He was trying hard to be nonchalant, but Billy Joel was getting cranked up. "I listen to AM radio a lot when I'm on the road because we always get rent-a-cars, and that's all they've got, AM radio. At home, though, I listen to certain records, and I put on the radio—FM—maybe two hours a day, but not as background music. I don't listen to music that way. I make time to listen to music each day, not to hear what's going on, but because I *like* it!"

To put it all in perspective, Billy Joel is twenty-six years old and has released four albums [the latest, "Turnstiles," is reviewed in this issue] and a few singles, one of which, *Piano Man*, sold very well. He has to tour six months a year to make a living, and he's married but his wife doesn't tour with him. So it's not by chance that his songs and manner smack of vagabonding.

"I don't live anywhere right now," he said. "I'm on the road again, and I've moved away from California. I'll live back East, wherever a house turns up. I'll live in a Howard Johnson's. You know, the road is Disneyland. I can't write when I'm on the road. There's nothing for me to write about unless I want to do 'another empty bottle, another empty bed,' and that's all been done before. I'd prefer to get off the road and do a little living and *then* write some. I don't have a concept in mind—it will be whatever it is."

"I've moved back East to look for a different type of vibe. I've written a California album, but I don't have the feel for it like, say, Jackson Browne does. Those Southern California writers, they've lived there all their lives, and they get more out of it than I can."

BILLY JOEL was restless in California (he was also on the road half the time). He tried North Hollywood, Malibu, Hollywood, and nothing worked. "The myth of the L.A. music community is exaggerated. I couldn't get into hanging out or into the star scene, which is what it was. I mean, I lived in Hollywood, but . . . I don't know . . . I would say to myself, 'I'm a rock-and-roll star living in Hollywood.' But I didn't *feel* it."

Perhaps that almost sums him up. A composer, a stylist, a perfectionist, an entertainer, a lonely young man, yes. A Rock-And-Roll Star, no. □

By Josh Mills

"I can't write on the road. There's nothing to write about unless I want to do 'another empty bottle, another empty bed,' and that's been done before."

The Beogram[®] 4002. If music in your home is important to you, it should begin here.

The Beogram 4002 is a fully automatic turntable which exhibits a level of creativity and engineering skill unequalled in the field of audio components. Its tangential tracking permits the record to be played back in exactly the same manner that the master disc was cut. Electronic logic circuits, activated by a single light touch on the control panel, automatically select the record size and correct

speed, cue the stylus, and turn off the unit when the selection is finished.

Furnished with Bang & Olufsen's finest cartridge, in itself an acknowledged masterpiece of audio engineering.

Request our product brochure and the name of your local Bang & Olufsen dealer. For our detailed, full color catalog, please enclose one dollar to cover postage and handling (available free at your local Bang & Olufsen dealer).

Rarely has technology
served music so well.



Bang & Olufsen

Bang & Olufsen of America, Inc., Dept. 12E, 515 Busse Road, Elk Grove Village, Illinois 60007

CIRCLE NO. 7 ON READER SERVICE CARD

STEREO REVIEW'S SELECTION OF RECORDINGS OF SPECIAL MERIT BEST OF THE MONTH



The Arrival of Singer Natalie Cole: In Every Way, Her Illustrious Father's Daughter



NATALIE COLE, daughter of the late and very great Nat "King" Cole, made one of the most impressive recording debuts in recent memory last year, and her new Capitol release "Natalie" is joyous proof that she is neither a fluke nor one of those carefully constructed show-biz Olympians the entertainment industry likes to send out among the general population every so often to confirm their cynical view that it is easy to manipulate a mass audience. No, Natalie Cole is not just the bearer of a famous name, but a genuine and worthy singer of taste and talent.

What she seems to share innately with her illustrious father is an ease and elegance of approach and projection in her singing. As he was a born musical gentleman, so she seems a born musical lady—and a precocious one at that. It is to be hoped that her arrival signals a new trend toward style and—to put it bluntly—class in the younger generation. Just as Janis Ian's *I Really Would Like to Dance* on her "Aftertones" album, with its suave echoes of the work of Porter and Fields and Schwartz, gives me hope that elegance is no bad thing for the under-thirty generation of composers to aim for, so Natalie Cole's new album reassures me that the thirst for the sublime in performance can never be quenched by mere camp.

Take, for instance, the satisfying way she tackles her big hit here, *Sophisticated Lady (She's a Different Lady)*, with its doo-wah chorus and corny arrangement: she glides smoothly along with it, half amused, half serious, but never out of step with the fact that it is material that *works*—she is not about to give the impression that she is having anything less than real fun, that

NATALIE COLE: *elegance is no bad thing for the under-thirty generation to aim for*

she is anything less than eager to share it with you. Or listen to *Mr. Melody*—clean, vibrant, and musically fastidious—and *Touch Me*—sad and wise and knowing.

Everything she does here she does awfully well, coolly and wisely not pushing any one facet of her talent harder than the others. Natalie Cole has made it in an astonishingly short time; with those genes that shouldn't be such a surprise. But that she has made it without compromising what these days has to be called an "old-fashioned" musical integrity most certainly is.

Peter Reilly

NATALIE COLE: *Natalie*. Natalie Cole (vocals); orchestra. *Mr. Melody; Heaven Is with You; Sophisticated Lady; No Plans for the Future; Can We Get Together Again; Keep Smiling; Good Morning Heartache; Not Like Mine; Touch Me; Hard to Get Along*. CAPITOL ST-11517 \$6.98, © 8XT 11517 \$7.98, © 4XT 11517 \$7.98.



STEPHEN BISHOP:
gorgeously earthy,
yet never earthbound

Bartók's First and Third Piano Concertos: Inspired Performances By Stephen Bishop

ABOUT six years ago Philips released a stunning recording of Bartók's Second Piano Concerto and the Stravinsky Concerto, both played by Stephen Bishop with the BBC Symphony Orchestra under Colin Davis (839.761LY). The Bartók in particular was so vivid, so insightful, so thoroughly and uniquely right that it seemed nothing less than a revelation. Bishop and Davis have by now collaborated in more than a dozen concert recordings, and they have demonstrated an exceptional rapport in all of

them. In none, however, has their mutuality of approach seemed so remarkably complete as in that early Bartók, a recording which seemed also at least an implicit promise on Philips' part to give us the rest of the Bartók concertos with the same executants. That promise is now fulfilled, and the new disc of the First and Third Concertos (this time with the London Symphony Orchestra) is possibly even closer to perfection than the earlier one was. Technically, it definitely is: it is brighter in sound, and the soloist and orchestra are better balanced (the piano was a bit too forward in No. 2). What is less easily measurable by any mechanical means or objective standards is the musical impact of these performances, powerful enough that one turns without embarrassment to the term "inspired."

The exuberance of the First Concerto as realized here is at once gorgeously earthy yet never earthbound; it is a vital performance that has nothing whatever to do with mere athleticism. The slow movement of the Third, perhaps the most difficult movement in the three concertos to bring off convincingly,

has an aura of real enchantment about it: the "night music" just seems to "happen." Everything, in fact, seems so self-generating that if one were to think about the performers at all it would not be in terms of what they are doing with the music, but what they are letting it do with them as they probe and celebrate the Bartók essence. This is my nomination right now for Concerto Record of the Year. *Richard Freed*

BARTÓK: *Piano Concertos Nos. 1 and 3*. Stephen Bishop (piano); London Symphony Orchestra, Colin Davis cond. PHILIPS 9500 043 \$7.98.

Exceptional Soprano, Outstanding Pianist For the Late Songs Of Rachmaninoff

Now is the time to hear the songs of Rachmaninoff on records. They are richly represented in the catalog, but who knows how long this temporary largesse will last? And largesse it is when we have two artists as fine as Elisabeth Söderström and Vladimir Ashkenazy: a welcome pairing of this exceptional soprano and one of the world's outstanding pianists in a recent release duplicates only six songs from the Nicolai Gedda/Alexis Weissenberg program on Angel S-36917 and only one from the Irina Arkhipova/John Wustman collection on Melodiya

ELISABETH
SÖDERSTRÖM
AND VLADIMIR
ASHKENAZY:
a welcome pairing
of fine artists



London Records

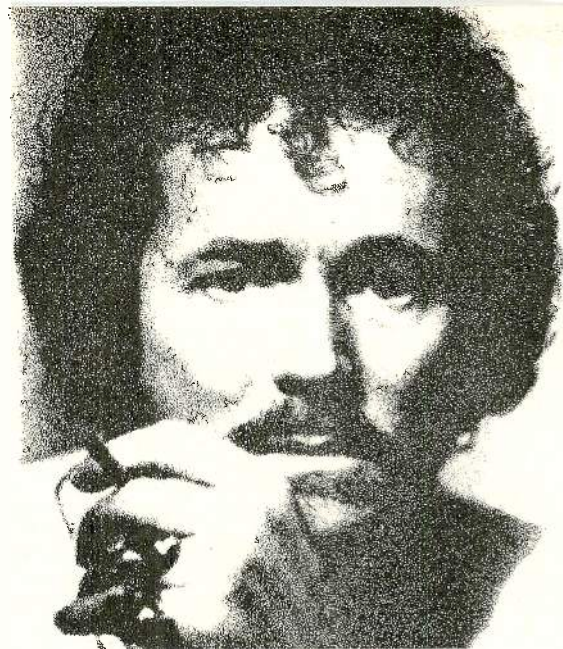

GORDON LIGHTFOOT:
demonstrating that
the popular song
can actually amount
to something

Reprise Records

40198; that one is the sumptuous *Oh, never sing to me again*, which can safely take a duplication.

Only three of Miss Söderström's choices are early Rachmaninoff songs; for the rest, we have seven songs from Op. 34 and all six of Op. 38, the last group, dating from 1916. Aside from their advanced harmonic idiom and frequent impressionist infusions, these later songs are more concise and more concerned with moods and colors than were the early Tchaikovsky-inspired songs, in which sensuous melody was paramount. They suit Elisabeth Söderström's artistry very well because expressiveness and color shadings are her forte. She is a fine vocalist, too, though her sustained notes reveal a touch more vibrato than perfectionist standards will admit. And yet she offers beautiful vocal effects in her secure and shimmering high register, particularly in *How fair this spot!* Moreover, while the great Antonida Nezhdanova (1873-1950), the dedicatee, may have performed the famous *Vocalise* more spectacularly, Söderström's rendition certainly holds its own against any current version.

The songs of Op. 34 and Op. 38 combine virtuosic singing with virtuosic pianism, and it is not surprising that the likes of a Weissenberg or an Ashkenazy are challenged by the bold and cascading piano music of *A-oo* and *What wealth of rapture*. Ashkenazy's playing is deliberate, rich, mellow-sounding, and altogether masterly; the engineering combines voice and piano in effective balance. *George Jellinek*

RACHMANINOFF: *Songs. Oh, never sing to me again; The Harvest of Sorrow; How fair this spot!; In my garden at night; To her; Daisies; The Pied Piper; Dreams; A-oo (The*

Quest); The Muse; The Storm; The Poet; The Morn of Life; What wealth of rapture; Dissonance; Vocalise. Elisabeth Söderström (soprano); Vladimir Ashkenazy (piano). LONDON OS 26428 \$6.98.

Gordon Lightfoot's "Summertime Dream": Running Over With Poetry

THERE is a *literati* in popular music, a group of people with refined musical taste, education, and judgment, and my contention that Gordon Lightfoot is at the head of it just keeps getting more plausible with every record he makes. Lightfoot imposes increasingly tougher standards upon himself, and his albums consistently add poetry to the mostly commercial form in which he works. In short, he keeps adding songs to that precious five or so per cent of everything new that is worth keeping.

Technically, his work is excellent; he's every bit the craftsman the old boys were before rock-and-roll made amateurish writing and performing the most profitable kind. Yet he is a *folk* artist in the sense that he works down among the people instead of in an ivory tower overlooking Broadway and Twenty-eighth Street (Tin Pan Alley, that is). He's relevant, accessible, and all that, working in three-chord patterns a normal person can decipher and strum for himself and in verses that deal with what really happens rather

than what's supposed to in idealized boy-meets-girl fairy tales. And so his new "Summertime Dream" for Reprise is a remarkably direct, trimmed-down, person-to-person album, and it is running over with poetry.

Not the least of its achievements is that it manages—according to my grasp of the whole of it—to wish the other person well, to realize how *complicated* it is for all of us (most of us?) to confer more dignity, wish less guilt, lend a little encouragement. That's extremely hard to do without fawning or sounding stuffy; it's much easier to cheer our side and boo theirs. The songs have a variety of interior messages of their own, of course, and so many of them are superb that I hate to single out any. *Never Too Close*, though, with its sense of what to remember about a so-called "failed" relationship—"That is all right/We meant no one no harm"—and with the nice surprises in the way it is constructed, is hard to beat. Most of the songs talk in common language edited in that expert, subtle way that makes it elegant; the melodies are both simple and fresh, and the instrumentation (no strings this time) is notably free of frills and gewgaws. A man like Lightfoot, and an album like this, can cut through the cynicism we've understandably fortified ourselves with and show us the popular song can actually amount to something. *Noel Coppage*

GORDON LIGHTFOOT: *Summertime Dream.* Gordon Lightfoot (vocals, guitars); Terry Clements (guitars); Rick Haynes (bass); Pee Wee Charles (steel guitar); Barry Keane (drums). *Race Among the Ruins; The Wreck of the Edmund Fitzgerald; I'm Not Supposed to Care; I'd Do It Again; Never Too Close; Protocol; The House You Live In; Summertime Dream; Spanish Moss; Too Many Clues in This Room.* REPRISE MS 2246 \$6.98, © M8 2246 \$7.98, © M5 2246 \$7.98.

Attention Savoyards: *Utopia Limited* Has at Last Been Recorded Completely

AT long last the D'Oyly Carte Company and London Records have favored us with a recording of *Utopia Limited*, the penultimate collaboration of Gilbert and Sullivan, the most elaborate of all their operettas, and a work too long downgraded and neglected. *(Continued overleaf)*



Mr. W. S. Gilbert reading "Utopia (Limited)" to the actors at the Savoy Theatre.
That's Sir Arthur Sullivan to the immediate left of the MS, Mr. and Mrs. D'Oyly Carte to the right.

There have been other recordings of this musical satire set on a South Pacific isle that decides to model its ways on those of Great Britain, but they have been pretty much in the amateur-fiasco category.

Having heard a tape of the complete BBC production master-minded by Stanford Robinson, this Savoyard has known for some time how effective the work can be in performance, and a program of five excerpts rounding out an earlier recording of *Trial by Jury* by the D'Oyly Carte under Isidore Godfrey hinted strongly at what that company might do with the rest of the material. It must be said at once that the new recording, based on the version staged at the Savoy Theatre in London in 1975, lives up to all expectations. It is a bit puzzling why the D'Oyly Carte should have chosen to limit the dialogue to a few scattered passages, but one must be grateful that they undertook to record the work at all.

Utopia Limited, or *The Flowers of Progress* brought Gilbert and Sullivan back together some five years after the success of *The Gondoliers*. When the curtain went up at the Savoy on October 7, 1893, the audience was treated to a grand and costly production with a huge cast and the most complicated plot Gilbert had ever devised. The story of how the innocent denizens of Lazyland abandon their indolent ways to become "Anglicized completely" sets the arrows of Gilbertian satire flying in all directions—at the demureness of well-bred young English ladies, the pomposity of the military, the hypocrisy of politicians, the deviousness

of British business practice (you perhaps thought we had invented all that ourselves?).

The score is a rich one, replete with comic songs like *First You're Born*, an answer to Shakespeare's description of the seven ages of man in *As You Like It*; the Utopian anthem, *Eagle High*; the virtues of healthy English girls in *A Wonderful Joy*; Captain FitzBattleaxe's lament on the problems of love-lorn tenors in *Oh, Zara, My Beloved One*; the affecting *Words of Love Too Loudly Spoken*; the music for the first Utopian drawing room, when the natives dress up in the formal English manner; and even a tarantella. Most exhilarating of all is the exhibition put on by the imported British advisers in *Society Has Quite Forsaken*, in which Sullivan anticipates Scott Joplin with a minstrel show that is a breathtaking surprise. And since the overture to *Utopia* itself is a rather short one, it was a happy thought to open this recording with the composer's *Imperial March* of the same period.

The audiences of 1893 evidently grew restive at the length and complexity of *Utopia Limited* and the critics were cool. But the show ran for 245 performances and George Bernard Shaw was pleased. So were the audiences at the 1975 revival, and so should be all G&S enthusiasts who acquire the album recorded (like the rest of the series) under the supervision of Dame Bridget D'Oyly Carte. The cast is huge and the whole company sounds in excellent shape, but it is only right to single out for special praise Kenneth Sandford's King Paramount, John

Reed's Scaphio, John Ayldon's Phantis, Meston Reid's love-shattered tenor Captain FitzBattleaxe, Lyndsie Holland's haughty Lady Sophy, Pamela Field, Julia Goss, and Judi Merri as the demure princesses with their chic Kodaks, and Michael Rayner as Mr. Goldbury, representing the British business establishment. The chorus under Glyn Hale and the Royal Philharmonic conducted by Royston Nash offer ringing support to the principals, and the recorded sound is simply glorious.

Devotees of late-blooming Gilbert and Sullivan can now only hope that a satisfactory album of *The Grand Duke*, the pair's final collaboration, will find its way here soon. Meanwhile, I heartily recommend London's fine new recording of the very first G&S, *Trial by Jury*, reviewed in this issue on page 121.

Paul Kresh

GILBERT & SULLIVAN: *Utopia Limited*, or *The Flowers of Progress*. Kenneth Sandford (bass-baritone), King Paramount; John Reed (baritone), Scaphio; John Ayldon (baritone), Phantis; Jon Ellison (baritone), Tarara; Michael Buchan (baritone), Calynx; James Conroy-Ward (baritone), Lord Dramaleigh; Meston Reid (tenor), Captain FitzBattleaxe; John Broad (bass-baritone), Captain Corcoran; Michael Rayner (bass-baritone), Mr. Goldbury; Colin Wright (baritone), Sir Bailey Barre; David Porter (baritone), Mr. Blushington; Pamela Field (soprano), Princess Zara; Julia Goss (soprano), Princess Nekaya; Judi Merri (mezzo-soprano), Princess Kalyba; Lyndsie Holland (contralto), Lady Sophy; Rosalind Griffiths (soprano), Phylla. D'Oyly Carte Opera Company; Royal Philharmonic Orchestra, Royston Nash cond. LONDON OSA-12105 two discs \$13.96.

NATIONAL RECORD PLAN (not a "club")

FOR 14 YEARS WE'VE FILLED MAIL ORDERS THE WAY CUSTOMERS LIKE.

We send fresh, perfect records or tapes, packed so that damage seldom occurs. We double-check to prevent errors. We send CASH refund if (on rare occasions) we can't deliver. Prices, tough to beat, anywhere! Sale ends October 31, 1976.

RECORDS SUPER-SPECIALS UP TO 50% OFF

Featuring all these great Labels
COLUMBIA—ODYSSEY—CAPITOL—ANGEL
SERAPHIM—WARNER—REPRISE
ELEKTRA—NONESUCH—ASYLUM
ATLANTIC—ATCO—LONDON
LONDON IMPORTS—STEREO TREASURY
HI-PARROT—ABC—IMPULSE
AUDIO TREASURY—BLUE THUMB

Every Category: Classical, Pop, Blues, Soul, Disco, Show, Jazz, Rock, Opera, etc., Top Names, Top Hits.

Any Record or tape on above labels

List price per LP	\$6.98	NOW ONLY	\$3.69	per LP
	\$7.98	NOW ONLY	\$4.19	
	\$3.98	NOW ONLY	\$1.99	

Any other list price 47% off for these labels only.
 TAPE: \$7.98 list NOW ONLY \$4.69, above labels only.
 Any other list price, 40% off.

Need Catalog? Send \$1 for Schwann (records) or Harrison (tapes) or \$1.50 for both. If you order catalog, we extend sale ending date so you can order. You may deduct the price of the catalog(s) from your first order if over \$20.

SPECIAL ON ALL OTHER LABELS NOT LISTED ABOVE—
 Dazzling Discount:

If list price per LP is	\$3.98	During Sale	\$2.29
	\$6.98	During Sale	\$3.99
	\$7.98	During Sale	\$4.59

Any list price not listed here 43% off.
 TAPE: \$7.98 list NOW ONLY \$4.99. Any other list price 33-1/3% off.
 Above offers LIMITED TIME ONLY. Sale Ends October 31, 1976.

NATIONAL RECORD PLAN, Dept. SR2,
 44 West 18th St., New York, N.Y. 10011
 Our Guarantee: Record or tape replaced at no charge, after one play, if defective.

GEORGE BENSON
BREEZIN

 Includes: The Mainwacke
 Six to Four/Afternoon/Lady

HAPPINESS IS BEING WITH THE SPINNERS

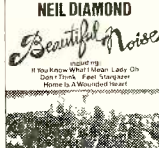
NEIL DIAMOND
Beautiful Noise

HELEN REDDY
 Music, Music

ITZHAK PERLMAN
 plays Fritz Kreisler
 CAROL MORGAN - LINDSEY FIELD
 SCHON ROSSINI - TAMARQUE CHIMOS
 SPANISH DANCE FROM "LA VIDA BREVE"
 (PALLAS - TANGO ALLIANCE) - MORE
 SANDERS

PORGY and BESS

THE GENTLE SIDE OF JOHN COLTRANE

WARNER
 George Benson-Breezin: W.B. 2919 \$ 3.69*
 Fleetwood Mac-Fleetwood Mac: Rep. 2225 \$ 3.69*
 Gary Wright-Dream Weaver: W.B. 2868 \$ 3.69*
 Alice Cooper-Goes To Hell: W.B. 2896 \$ 3.69*

ELEKTRA-NONESUCH
 Vaudeville-Songs Of The Great Ladies Of The Musical Stage: None. 71330 \$ 1.99
 Orleans-Walking and Dreaming: Elek./Asy. 7E-1070 \$ 3.69*
 Linda Ronstadt-Hasten Down The Wind: Elek./Asy. 7E-1072 \$ 3.69*
 Eagles-Eagles Greatest Hits: Elek./Asy. 7E-1052 \$ 3.69*

ATLANTIC
 Spinners-Happiness Is Being With The Spinners: Atl. 18181 \$ 3.69*
 The Selma Album-Original Cast Album: The Life Of Martin Luther King. 2 L.P.'s; Coti. 2-110 \$ 5.29*
 Jon Anderson-Olias of Sunhollow: Atl. 18180 \$ 3.69*
 Manhattan Transfer-Coming Out: Atl. 18183 \$ 3.69*

COLUMBIA-ODYSSEY
 Neil Diamond-Beautiful Noise: Includes If You Don't Know What I Mean, others. Col. PC 33965 \$ 3.69*
 Chicago-Chicago X: Brand new release. Col. PC 34200 \$ 3.69*
 Lou Rawls-All Things In Time: Includes You'll Never Find Another Love Like Mine. Col. PC 33957 \$ 3.69*
 The Concert Of The Century-Celebrating The 85th Anniversary Of Carnegie Hall: Recorded LIVE. 20 Famous Artists. Extraordinary! 2 L.P.'s. Col. M2X 34256 \$ 7.68
 Lazar Berman Plays Liszt Sonata In B Minor: Col. M 33927 \$ 3.69
 Gershwin-Rhapsody In Blue: Original Version. Col. XM 34205 \$ 2.99*
 Kurt Weill-Three Penny Opera In German: Starring Lotte Lenya. 2 L.P.'s & Libretto. Ody. Y2-32977 \$ 4.19
 Sidewalks Of New York: Nostalgic music rolls on the Wurlitzer 164 Band Organ. Col. M 34159 \$ 3.69

CAPITOL
 Helen Reddy-Music, Music: Cap. 11547 \$ 3.69*
 Wings-At The Speed Of Sound: Cap. 11525 \$ 3.69*
 Beatles-Rock And Roll Music: 2 L.P.'s; Cap. 11537 \$ 5.82*
 Natalie Cole-Natalie: Cap. 11517 \$ 3.69*
 Beach Boys-Endless Summer: 2 L.P.'s; Cap. 11307 \$ 3.69*

ANGEL-SERAPHIM
 Itzhak Perlman-Plays Fritz Kreisler: Angel 37171 \$ 3.69*
 Berlioz-Requiem: Robert Tear(Tenor). 2 L.P.'s; Angel SB 3814 \$ 7.38
 Haydn-Cello Concerto In D Major & C Major: Rostropovich: Angel 37193 \$ 3.69
 Karajan Conducts Music Of Johann Strauss: Angel 37222 \$ 3.69
 Beethoven-Missa Solemnis: Featuring Harper, Baker, Tear. 2 L.P.'s Angel SB 3836 \$ 7.38

LONDON-IMPORTS-STEREO TREASURY
 Gershwin-Porgy And Bess: Maazel and The Cleveland Orch. 3 L.P.'s. Lond. OSA 13116 \$11.07*
 Bizet-Carmen: Featuring Troyanos, Domingo. 3 L.P.'s. Lond. OSA 13115 \$11.07*
 Haydn-String Quartets: Vol. 1, Op. 71 & 74. Aeolian Qt. 3 L.P.'s. Lond. STS 15325/7 \$ 5.97
 Verdi-Luisa Miller: Caballe, Milnes. 3 L.P.'s. Lond. OSA 13114 \$11.07*
 Bach-Cantatas: Vol. XIV, Harnoncourt. 2 L.P.'s. Tele. 2635304 \$ 7.38
 Tchaikovsky-Symphony No. 5: Solti and the Chicago Symphony. Lond. CS 6983 \$ 3.69*

ABC IMPULSE
 John Coltrane-Gentle Side Of John Coltrane: 2 L.P.'s. Imp. 9306/2 \$ 3.69*
 John Klemmer-Bearfoot Ballet: Brand new release. ABC 950. \$ 3.69
 John Handy-Hard Work: ASD 9314 \$ 3.69*
 Keith Jarrett-Mysteries: ASD 9315 \$ 3.69*
 Bobby Bland & B.B. King: ASD 9317 \$ 3.69*
 The Crusaders-Those Southern Knights: BTSD 6024 \$ 3.69*

*Also Available In 8 Track/Cassette — add \$1 per L.P.

NATIONAL RECORD PLAN
 Dept. SR-2, 44 West 18th St., New York, N.Y. 10011

Name _____
 Address _____
 City _____
 State _____ Zip _____

AMERICAN EXPRESS, BANKAMERICARD or MASTER CHARGE accepted — give name on card, number, expiration date and sign order. Minimum credit card order, \$10

NO LIMIT. ORDER ALL THE RECORDS AND TAPES YOU WANT WHILE SALE IS IN EFFECT
 Send me the following at Sale prices advertised: **SALE ENDS OCT. 31, 1976**

OFFICE USE ONLY	DESCRIPTION, ARTIST.	LABEL & NO. (IF KNOWN)	CHECK ONE			LIST	AD PRICE
			LP	8-TR	CASS		

FOR MORE RECORDS AND TAPES ATTACH YOUR OWN SHEET.

MAIL YOUR ORDER TODAY! Add 85¢ for first record or tape, 20¢ for EACH additional PLUS 40¢ insurance for entire order.
 NYC residents, add 8% Sales Tax; others, applicable tax
 CHECK or MONEY ORDER (no C.O.D.) enclosed for total

CIRCLE NO. 39 ON READER SERVICE CARD



POPULAR DISCS AND TAPES

Reviewed by CHRIS ALBERTSON • NOEL COPPAGE • PAUL KRESH • PETER REILLY • JOEL VANCE

RECORDING OF SPECIAL MERIT

PETER ALLEN: *Taught by Experts*. Peter Allen (vocals); orchestra. *This Time Around; Harbour; Planes; Back Doors Crying; I Go to Rio*; and six others. A&M SP-4584 \$6.98, © 4584 \$7.98, © 4584 \$7.98.

Performance: **Stylish**
Recording: **Good**

Peter Allen writes awfully good lyrics. *Quiet Please, There's a Lady on Stage*, for instance, should be a real weeper, but, oddly enough, it isn't; instead, it is a moving, serious look at the audience's (any audience's) responsibility to a once great performer now on her Garlandish last legs. "So put your hands together and help her along/ All that's left of the singer/ All that's left of the song/ Stand for the ovation/ And give her one last celebration." There's a certain touch of elegant empathy, peculiar to Allen, that gives the song its class. Or there is the brisk irony of *She Loves to Hear the Music*, which is about a secretary in a small record company who is so "into" music that she's letting her own life slip past her, barely noticing the departed suitors: "She didn't love them anyway/ Not like she loves the men who play." Allen has written everything here except the old Mack Gordon/Harry Warren classic *The More I See You*, and he gives it all very stylish, suave performances. Not as stylish and suave, perhaps, as his lyrics, which have some of the same smoky, wry romanticism of Lorenz Hart's work, but enough to give you a good idea of the general

direction in which he's headed—which is probably his own Broadway score. Good chance he'll write an excellent one. P.R.

THE BEATLES: *Rock 'n' Roll Music*. The Beatles (vocals and instrumentals). *Twist and Shout; I Saw Her Standing There; You Can't Do That; I Wanna Be Your Man; I Call Your Name; Boys; Long Tall Sally; Rock and Roll Music; Slow Down; Kansas City; Money; Bad Boy; Matchbox; Roll Over Beethoven; Dizzy Miss Lizzie; Any Time At All; Drive My Car; I'm Down; Helter Skelter; Taxman; Get Back*; and seven others. CAPITOL SKBO-11537 two discs \$10.98, © 8X2K-11537 \$12.98, © 4X2K-11537 \$12.98.

Performance: **Narrowly edited**
Recording: **Variable**

That rare bird, the thoughtful science-fiction writer, will tell you that messing with time machines is not all fun and games. We're all involved with one now: television, the medium that keeps reissuing the past—from D. W. Griffith to Boston Blackie to the Gold Diggers—with the same methodical hoopla that attends your eleventh chance of the week to catch the latest boorishness of *Special* (meaning common, overexposed) *Guest Star Don Rickles* . . . the medium of the Offers, blitzkrieg "four-wall" advertising for thrown-together movies about men living with bears, and thrown-together record albums. I'm not sure this is one of those, but the commercial for it reminds me of Robert Klein's "every record ever recorded" routine. And about this whole matter of instant and not-so-instant replays: the idea seems to be that if you ever missed out on anything as it went by, you can get it now. Well, it doesn't work; you can't now be part of the audience *Gold Diggers of 1933* was made for, you can't simulate the beat of those times, can't reproduce the feel of it, and I don't think you can put an album like this into a perspective that makes much sense. What is happening is that the memory of a fine group is being trivialized.

And distorted: the vacuum in which you're asked to consider it notwithstanding, it isn't even fair to say this *is* (was?) the Beatles. True to the most simplistic interpretation of the album's title, Capitol has presented only

one aspect of the Beatles, a string of hard-edged, primitive tunes the boys wouldn't have grouped together like this. They had a way with these tunes, too, of course, but they did not stick their heads in juke boxes and hide out from lyricism and sophistication as this collection suggests they did. I wonder which came first—the idea for this package or the idea for a TV ad campaign. N.C.

JEFF BECK: *Wired*. Jeff Beck (guitar); instrumental accompaniment. *Play with Me; Head for Backstage Pass; Goodbye Pork Pie Hat; Blue Wind; Sophie*; and three others. EPIC PE 33849 \$6.98, © PEA 33849 \$7.98, © PET 33849 \$7.98.

Performance: **Very good**
Recording: **Very good**

Jeff Beck seems to have made his transition from rock to jazz about 90 per cent official. The selections here that can be classified as "jazz/rock" tend to combine the worst excesses of both—the notion that a riff is a tune, abrupt changes of tempo, obnoxious drumming, and long solos which, since they can't make reference to a nonexistent melody, remain mere pyrotechnics. But those selections that are most nearly jazz or all jazz show Beck to be a guitarist of taste, thought, and delicacy. The electric guitar is more a machine than an instrument; Beck is one of the few players able to personalize it without becoming part of the machinery.

Beck's near-complete transition to jazz is understandable: he is simply too good a musician to remain restricted by rock's leaden simplicities and fuzzy pretensions. If he can avoid the flap-doodle complications of the Mahavishnu school, his complete transition may make him a complete guitarist. J.V.

THE BECKIES. The Beckies (vocals and instrumentals). *Right by My Side; River Bayou; Midnight and You; Fran; Other Side of Town; Song Called Love*; and five others. SIRE SASD-7519 \$6.98.

Performance: **Uninspired**
Recording: **Good**

Sire's "S" label insignia, actually the space between yin-yang curved-droplet symbols,

Explanation of symbols:

- Ⓜ = reel-to-reel stereo tape
- Ⓢ = eight-track stereo cartridge
- Ⓒ = stereo cassette
- Ⓛ = quadrasonic disc
- Ⓡ = reel-to-reel quadrasonic tape
- Ⓟ = eight-track quadrasonic tape

Monophonic recordings are indicated by the symbol Ⓜ

The first listing is the one reviewed; other formats, if available, follow it.

seems to snake around the circle with a life of its own if you put this on the turntable and stare at it. To avoid unnecessary distractions, it's better if you don't put the needle down on the record—although what happens if you do is so predictable and run-of-the-mill it shouldn't distract you much. The liner notes seem to suggest it's going to sound like the Beatles (the man behind the Beckies is Michael Brown of Left Banke and later of Stories, a group that surely tried to sound like the Beatles), but it just sounds familiar. The songs have nothing to say, which probably is the number one problem. Beyond that, it's a competent job of playing the same old stuff. Staring at the label is more fun. N.C.

BELLAMY BROTHERS: *Let Your Love Flow*. Bellamy Brothers (vocals, guitars); instrumental and vocal accompaniment. *Satin Sheets*; *Nothin' Heavy*; *Let Your Love Flow*; *Livin' in the West*; *Hell Cat*; and five others. WARNER BROS. BS 2941 \$6.98, © M8 2941 \$7.98, © M5 2941 \$7.98.

Performance: **Fair**
Recording: **Good**

Let Your Love Flow was a top-ten single hit, one of those blowsy appeals to gosh-all-hemlock sentiment that juveniles of all ages consider major spiritual statements. Although that song is well produced and cleanly performed here, the rest of the cuts on the album are without substance. Unless you like hearing acoustic guitars twanged symmetrically with slightly over-recorded bass and drums plod-plod-plodding along, there isn't much to attract you. I kept waiting for something—*anything*—to happen, and it never did.

The performances sound like a computer readout looks on paper. Some of the material contains good lines, as from *Nothin' Heavy*: "We were sixteen at the most/McCartney was the Holy Ghost/ . . . Eighteen caught us pretty fast/Legal to make love at last/ Something we'd been playing at for years." But the delivery is so bland and bloodless that such lines are wasted. Hi-ho and ho-hum; the Bellamy Bros. are just a few more victims of Los Angeles ennui. J.V.

THE CARPENTERS: *A Kind of Hush*. Richard and Karen Carpenter (vocals and instrumentals); orchestra. *I Have You*; *Boat to Sail*; *Sandy*; *Goofus*; *You*; and five others. A&M SP 4581 \$6.98.

Performance: **For fans**
Recording: **Superb**

Here's another bowl of quickly congealing mush served up with all of their customary twinkle by Richard and Karen Carpenter. This latest affront to decadence contains such MOR classics as Sedaka's *Breaking Up Is Hard to Do*, the old Herman's Hermits hit *There's a Kind of Hush*, and (surprise!) Wayne King's moldy oldie from 1930, *Goofus*. As usual, the production, the charts, and the engineering are all absolutely superb and sound like a cool million—a figure that the Carpenters probably have an easy familiarity with by now. Their fans—and oh man, are they legion—will eat it up, of course. But, even served in the finest bone china, it's still m-u-s-h. P.R.

JOHNNY CASH: *One Piece at a Time*. Johnny Cash (vocals); the Tennessee Three (instrumental accompaniment). *One Piece at a Time*; *Let There Be Country*; *In a Young Girl's*

“...different rhymes for different times”



Columbia Records

Billy Joel: too tough-minded?

TURNSTILES” is an intelligent, perceptive airing of young middle-class values and attitudes in 1976, though there's not nearly as much sentiment or drama here as in Billy Joel's earlier work. The pervading mood is one of exhausted malaise. *All You Wanna Do Is Dance* is a deftly aimed shot at the Beatles generation, baffled and resentful at the party's end; *James* is the male equivalent of the girls Janis Ian was talking about in *At Seventeen* (play by Their Rules and you still end up loser); *I've Loved These Days* is a sour paean to Life at the Top; and *Miami 2017* is a description of a future time when New York has long since been dismantled completely, we are all living in Florida, and “the Mafia took over Mexico.” (The Mafia, in the Seventies, seems to have taken over as the detested Establishment symbol, replacing the Pentagon of the Sixties.) *Angry Young Man* is the toughest, best, most mordant piece here. The lyrics have a bitter wisdom that contrasts sharply with so much of the complaint, no matter how trenchant, that has gone on before. “There's always a place for the angry young man/With his fist in the air and his head in the sand . . . And he's fair and he's true and he's boring as hell/And he'll go to the grave as an angry old man.” Joel's own place in this is

defined: “I believe I've passed the age of consciousness and righteous rage/I found that surviving was a noble fight. . . .” Yes, indeed, 'tis better to have loved and lost.

JOEL's tunes are just that, tunes, but they serve him well enough as a setting for his ideas. “Turnstiles” is a mildly depressing but, I think, valid glimpse into under-thirty thinking today. Unfortunately, it's probably too tough-minded for the audience that it's aimed at, yet not shrill enough to entice the older I-told-you-so contingent who, no matter what their age, remain as anti-youth as ever. And there is, too, something rather Dylanesque about it all—not an imitation, of course, but more of an updating, different strokes for different folks, different rhymes for different times. Billy Joel therefore still bears close watching. —Peter Reilly

BILLY JOEL: *Turnstiles*. Billy Joel (vocals and keyboards); orchestra. *All You Wanna Do Is Dance*; *James*; *Summer*, *Highland Falls*; *Miami 2017*; *Prelude/Angry Young Man*; *I've Loved These Days*; *Say Goodbye to Hollywood*; *New York State of Mind*. COLUMBIA PC 33848 \$6.98, © PEA 33848 \$7.98, © PET 33848 \$7.98.

Mind; Mountain Lady; Michigan City How De Do; and five others. COLUMBIA KC 34193 \$5.98, © CA 34193 \$6.98, © CT 34193 \$6.98.

Performance: **Excellent**
Recording: **Clean**

As a writer, Johnny Cash has a commendable ability to portray characters and situations with brevity and depth; his stories may be short, but they aren't thin. With three exceptions (one of them the title tune, a talking blues about a General Motors worker who decides to steal all the parts of a Cadillac by the time he retires), Cash wrote all the songs here, and some of them are first-rate.

Michigan City How De Do details a long-term convict's first steps on the streets outside the day his sentence is up; *Sold Out of*

JOHNNY CASH:
country music giant
and national asset

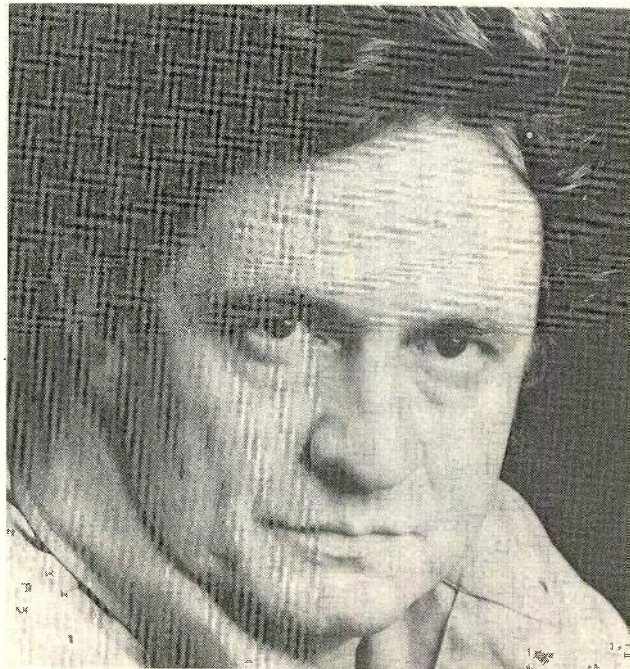

Columbia Records

Flagpoles, another talking blues, is a dialogue between two small-town friends, one of whom is palpably nuts and eminently sane all at once; *Committed to Parkview* is an eerie catalog of the patients in a mental hospital who are victims of country music. The instrumental backings are lean and spare, as they usually have been throughout Cash's recording career. The Tennessee Three aren't identified individually, but it sounds as though Charlie McCoy, the great harmonica player and studio session man, has been added as a Tennessee Fourth on some tracks.

Cash's ability to bring his songs home is, of course, aided by his familiar baritone-bass. He has a comfortable and comforting voice, though like most country singers he works within a limited range and substitutes personality and drawl for phrasing. But he is a genuine artist; like the country music he serves so well, John R. Cash is a national asset. J.V.

NATALIE COLE: *Natalie* (see *Best of the Month*, page 85)

BILL COSBY: *Bill Cosby Is Not Himself These Days, Rat Own, Rat Own, Rat Own.* Bill Cosby (vocals); vocal and instrumental accompaniment. *Yes, Yes, Yes; Chick on the Side; Shift Down; I Luv Myself Better Than I*

Luv Myself; Do It to Me; and four others. CAPITOL ST-11530 \$6.98, © 8XT-11530 \$7.98.

Performance: **Good news, bad news**
Recording: **Excellent**

First, the good news. The opening cut, *Yes, Yes, Yes*, is a hilarious and devastating satire on Barry White—goopy strings, sighing females, echo-chambered blockhead tunes, kissie-poo vocal drivel, and all. James Brown also gets his in *I Luv Myself Better Than I Luv Myself*, a six-minute parody of Brown's formula, which is to have his whipped-up band play riffs while he indulges in I-am-funky spoken and screeched vaudeville hambone.

Now the bad news. It's a two-joke album. The other cuts are mostly devoted to further burlesques of White that aren't as funny as

the first and that grow less amusing as the idea is milked dry.

Bill Cosby, generally regarded as a star comedian, is in fact an accomplished humorist. Like Mark Twain, he bases his comedy on creating or recalling characters who represent the human animal at his most "civilized" or idiotic, and I suspect that he has just about as little tolerance for mediocrity as Twain did. So I have my doubts about the official disclaimer on the back-liner of the album to the effect that Cosby's satires are "all in good fun, of course, with no harm meant to any of these fine artists whom Bill greatly admires." But, having only recently boiled my grandmother for sport, I may be cynical.

Cosby, with his long list of best-selling spoken-word comedy LP's, has made only three albums on which he attempts to sing; this is the third. He probably does not attach much importance to them, any more than the former King of Thailand, an amateur jazz saxophonist, would worry about getting a recording contract. But as long as he made the album at all, he could have made it funnier by paying more attention to it instead of casually tossing it off as a lark. J.V.

THE CHARLIE DANIELS BAND: *Saddle Tramp.* The Charlie Daniels Band (vocals and

instrumentals). *Dixie on My Mind; Wichita Jail; It's My Life; Sweet Louisiana;* and three others. EPIC PE 34150 \$6.98, © PEA 34150 \$7.98, © PET 34150 \$7.98.

Performance: **Synthetic**
Recording: **Good**

For all its down-home country flavor, this album leaves a synthetic, overprocessed aftertaste. Charlie Daniels and his group boom and thwack their way through several of their own tunes, including *Dixie on My Mind* and *Sweetwater Texas*, with all the correct nuance and suspender-snappin', but somehow it-ain't-quite-just-right. More on the order of Omar Sharif playing Dan'l Boone with a voice overdub by John Wayne, or Catherine Deneuve ascending to them pearly gates as Little Eva. Anyways, them city slickers can't fool me and I doubt they'll fool you either. P.R.

NEIL DIAMOND: *Beautiful Noise.* Neil Diamond (vocals and guitar); orchestra. *Stargazer; Street Life; Jungletime; Signs; Lady-Oh;* and six others. COLUMBIA PC 33965 \$6.98, © PCA 33965 \$7.98, © PCT 33965 \$7.98.

Performance: **Commercial**
Recording: **Very good**

Neil Diamond, who just signed one of those astronomical Vegas deals for a price that probably makes every girl want to be his best friend, has a musical brow that stretches so serenely and contentedly across the middle of his forehead that it seems almost cavalier to breathe the dreaded phrase "soap opera" when discussing his work. (Middle brows have conditioned themselves, along with the help of such brilliant goads as Norman Lear's *Mary Hartman, Mary Hartman*, into laughing at soap opera and banishing it to the world of the blue-collar housewife.) But the fact remains that for over ten years now Diamond has been vending soap opera of the hokiest sort under the label of "slice of life."

This latest highly glossy effort is Diamond's salute to his own early years as "a young songwriter making his way through the streets of New York City's tin pan alley in the early 1960's." It's pretty stagey stuff. *Jungletime, Surviving the Life,* and *Street Life* are all solidly in the Oh-What-I've-Survived category; *Lady-Oh, Stargazer,* and *Home Is a Wounded Heart* are Diamond as Pop-Poet-Storming-Your-Heart-And-Mind. The other songs, such as the archetypal *Don't Think . . . Feel*, are the kind of thing that's always made it difficult for me to separate most of Diamond's work from the more coherent efforts of Rod McKuen. Bosh, you say? Well, just give something such as *Don't Think . . . Feel* the daylight test and see if you don't come up with much the same cozy narcissism, the same humorlessness, and the same adolescent yearning to find the commonplace extraordinary and revealing as is found in McKuen's work. Diamond is a much more skilled and vital performer than McKuen, and his songs have a surface veneer of contemporary attitudes, but, at bottom, he's working the same dreary vein of solipsistic threnody as McKuen, Melanie, Melissa Manchester, and practically everyone else who sidles up to a microphone these days.

As is to be expected of any Diamond album, it is beautifully put together, with fine production work by Robbie Robertson, and Diamond's performances are smoothly expert. But as to any Really Deep Meaning

(Continued on page 94)

Stanton Stereo Wafers™

The livest sound, the highest fidelity
...plus the livest look.

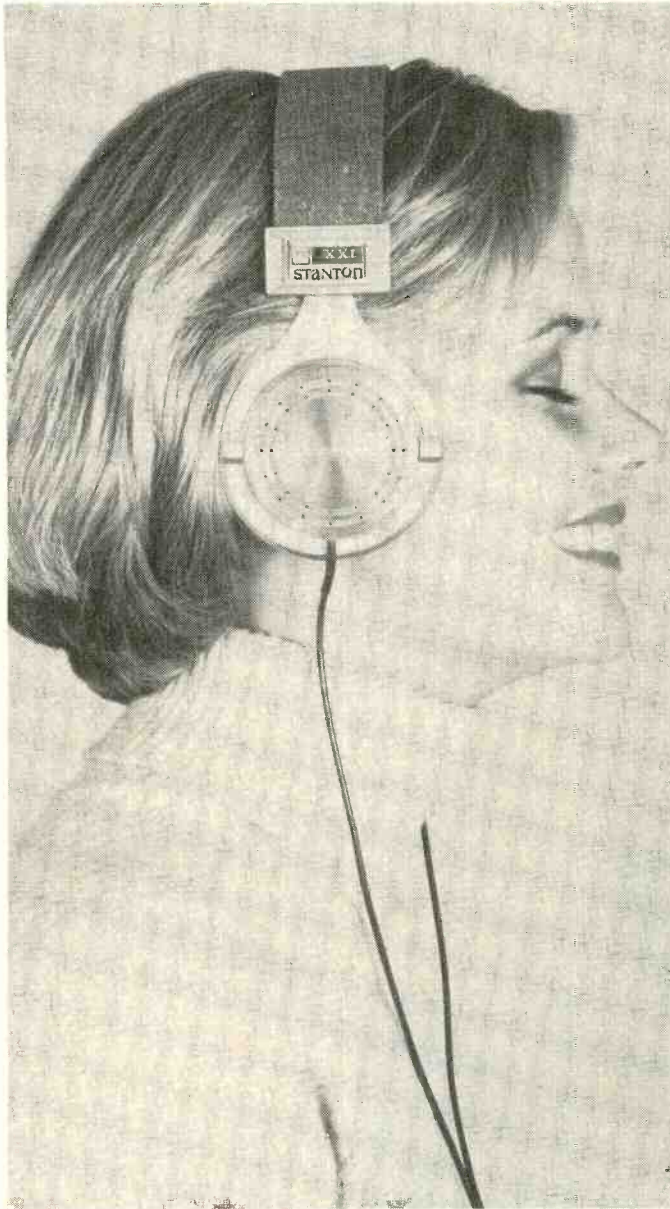

Looks Just Great...

Hail to a totally new concept and technology in headphones. And hail to an Open Audio design that gives you the lightest weight comfort you've ever experienced with headphones that possess truly top quality sound.

These ultra thin headphones have been designed and engineered to meet important professional needs: extreme comfort over long listening periods, a particular wide frequency response, and a broad dynamic range. A major factor in the success of the design is the use of rare earth elements in the compound of the permanent magnets of each earpiece. Besides having superior magnetic properties, these magnets



...Any Way You Look At It!

are also of much smaller size, while still allowing Stanton to achieve an improved response over headphones incorporating conventional permanent magnets.

The soft foam cushioned headband is exceptionally comfortable and has a trendy brushed denim fabric covering. The earpiece yokes incorporate specially designed pivots which allow the earpieces to fit perfectly against the ear, whatever the shape of the head.

Write us for the specs — they're magnificent! And ask for a demonstration as soon as possible at your Stanton dealer.



Write today for further information to Stanton Magnetics, Inc., Terminal Drive, Plainview, N.Y. 11803.

CIRCLE NO. 44 ON READER SERVICE CARD

... well, you'd probably do just as well with a deck of Tarot cards. P.R.

DR. HOOK: *A Little Bit More*. Dr. Hook (vocals and instrumentals). *More Like the Movies; A Little Bit More; Only Sixteen; What About You; Bad Eye Bill*; and five others. CAPITOL ST-11522 \$6.98, Ⓢ 8XT-11522 \$7.98, © 4XT-11522 \$7.98.

Performance: **Gushing**
Recording: **Very good**

Dr. Hook scored big around 1973 with *Sylvia's Mother* and *The Cover of Rolling Stone*, both written by cartoonist and iconoclast Shel Silverstein, who hovers somewhere between mawkish sentiment and hip vulgarity. Shortly afterward, fortune ceased to favor the band, which was, and probably still is, a rowdy, giggly bunch of lads afflicted with what seemed to be a permanent case of Excess on stage and in recordings. They have lately reappeared with a—for them—modest and respectful version of Sam Cooke's fine tune about kid love, *Only Sixteen*. They have also changed their recording locale and style from New York to Nashville, where this album was done.

Silverstein wrote four of the tunes; they lean more to the mawkish than to the vulgar. Lead singer Dennis Locorriere collaborated with Silverstein on two of them, as well as offering one of his own. The band now presents itself as born-again converts to the gooi-er aspects of Nashville pop, and it's all pretty much applesauce and butter cookies; the only time the proceedings get interesting is when Waylon Jennings, one of the supremos of

country music, shows up as a background singer on *What About You* and overpowers the lead voice. After that, things get sugar-sweetum again. J.V.

GOOD RATS: *Ratcity in Blue*. Good Rats (vocals and instrumentals). *Does It Make You Feel Good; Boardwalk Slasher; Ratcity in Blue; Almost Anything Goes; The Room*; and five others. RATCITY RCR 8001 \$6.98, Ⓢ 8331-8001 H \$7.98.

Performance: **Angry**
Recording: **Good**

The Good Rats are a New York—no, strike that—a *Greater* New York City Band that started out in Queens around 1967 and edged onto the best-seller charts. Since then they have earned their living from extensive tours; for a group that was never *that* commercially successful it is surprising that they've survived and even mildly prospered. Of course they've paid a price. A certain amount of bitterness comes to a band that knows it will have to keep touring the provinces to be able to exist at all. The Good Rats' reaction to their fate is to write a series of morose songs delivered with hostile gusto. They are a little too good for themselves and—in all fairness—a little too good for the towns they play.

The program here is the same program I heard them play at a summertime concert near Wilton, Connecticut, in 1975. Though they had top billing, it was a local band (a good one) that drew the hearts and feet of the audience. Backstage I listened to the Rats spin out their stories of the slights and insults

they had suffered at the hands of second-line club managers. I then went to the bandstand and watched the Rats' roadies set up the equipment. There was a lot of it, including two bass drums for the drummer. When the Rats finally took the stage, they crashed into their program with precision and skill. But they were obviously bored, and the listeners—by this time drunk, stoned, or bloated on cheeseburgers and soda—were already thinking of the local bars. Besides, the mosquitoes had begun to swoop and bite. The citizens began to wander toward their cars, but the Rats played on relentlessly.

"*Ratcity in Blue*," the band's third and latest album, contains some graceful and intelligent hard rock delivered with considerable panache. But, for all its bluster, it reflects the same air of worldweariness I sensed that day in Connecticut. The Road is long, and the Road is hard. J.V.

GUESS WHO: *The Way They Were*. Burton Cummings (vocals, keyboards); Randy Bachman (guitar, vocals); Jim Kale (bass, vocals); Garry Peterson (drums, vocals). *Silver Bird; Species Hawk; Runnin' Down the Street; Miss Frizzy; Palmyra; The Answer; Take the Long Way Home*. RCA APL1-1778 \$6.98, Ⓢ APS1-1778 \$7.98, © APK1-1778 \$7.98.

Performance: **Okay**
Recording: **Clean**

The recently disbanded Guess Who was a Canadian group which, from the mid-Sixties on, had several successful records (*Laughing, These Eyes, Undun, American Woman*) and went through several personnel changes dur-

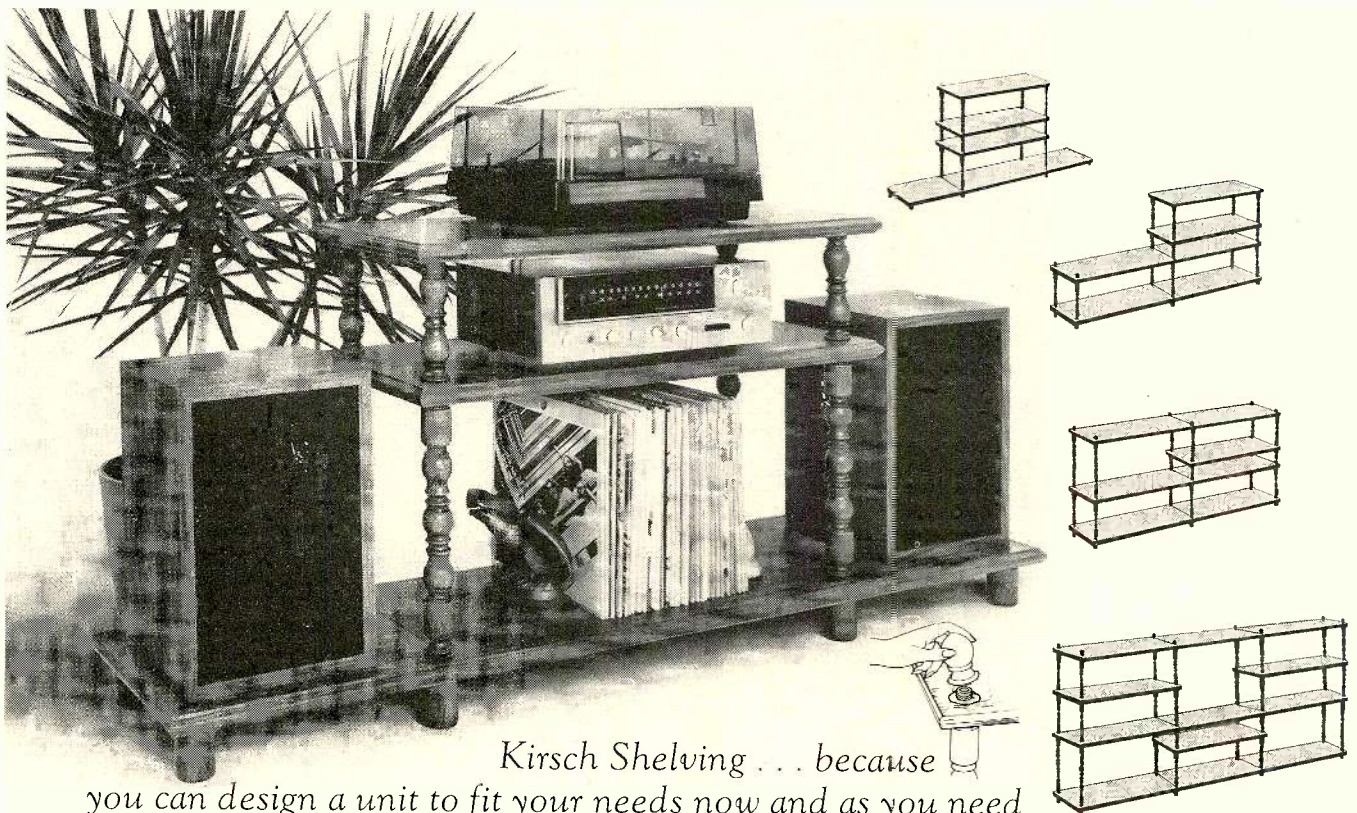

Kirsch Shelving . . . because
you can design a unit to fit your needs now and as you need
more you can add to it. For folder and dealer near you, write
Kirsch Co., Dept. DR-1076, Sturgis, Mich. 49091. **Kirsch**

ing its life span. The seven selections here, dating from the spring of 1970, were made shortly before Randy Bachman left the group. Bachman was serving as guitarist, back-up vocalist, and co-writer, with lead singer Burton Cummings, of many of the songs. The Guess Who's material, then and later, was always somewhat murky and confusing. Much of it seemed to be used for paying off private scores with acquaintances of the band, and one was never sure what or who the songs were about, although there were some good lines in the lyrics now and then.

The performances here are neither awful nor wonderful, which is why they have lain in the RCA vaults for six years. Presumably they weren't issued at the time because of Bachman's departure (he went off to form the loud and beaty Bachman-Turner Overdrive) or because there were better cuts available. The album may be a collector's item, but only for devout Guess Who fans. *J. V.*

JOHN HARTFORD: *Mark Twang*. John Hartford (vocals); instrumental accompaniment. *Skippin' in the Mississippi Dew; Long Hot Summer Days; Let Him Go On Mama; Don't Leave Your Records in the Sun; Tater Tate and Allen Mundy*; and five others. FLYING FISH 020 \$6.98.

Performance: **Easy on the ears**
Recording: **Very good**

John Hartford, with his nimble picked-a-peck-of-pickled-peppers tongue and infectious enthusiasm for all things earthy, offers a program here made up mainly of his own ballads about Midwestern rivers. There's the



CHRIS HILLMAN
The Young Sound

tongue-twister *Skippin' in the Mississippi Dew*; the *Julia Belle Swain*, a ballad about a Chattanooga-bound paddle-wheeler; and songs about the Illinois, Tennessee, and Ohio Rivers as well as the Father of Waters. They're all upbeat, unselfconsciously idiomatic, easy on the ears. Interludes of fiddle music enliven the estuary atmosphere, but such items as the nonstop nonsense-syllable number and one about what happens to phonograph records if you leave them in the sun tend to dilute the impact of the total effort. By and large, though, *Mark Twang* offers a shipshape, watertight ride. *P. K.*

CHRIS HILLMAN: *Slippin' Away*. Chris Hillman (vocals, guitar, mandolin, bass); Al Perkins (guitar, steel guitar); Paul Harris (keyboards); Jim Gordon (drums); other musicians. *Step On Out; Slippin' Away; Falling Again; Take It on the Run; Witching Hour*; and five others. ASYLUM 7E-1062 \$6.98.

Performance: **Good**
Recording: **Lush, but tasteful**

Harry Chapin, bless his heart, recorded what we'd noticed but maybe hadn't said about disc jockeys—they sound younger than they used to, had damned well *better* sound young if they want to work in certain desirable "markets"—and it seems to me we ought to set down somewhere that Sounding Young has been important with singers, too, even before the days of Danny and the Juniors. Identification is that big a deal, apparently, the majority of record buyers being young. Chris Hillman, who isn't all *that* young, having come up through the ranks, probably having seen things on the road that would curl your hair, etc., has one of those boyish voices. Instead of sitting back and enjoying this pleasant-sounding album as a normal person would, I've been wondering about the implications of performers' consciences, faces, attitudes, and everything else about them aging while their voices retain the sound of their Clearasil years. How can this be?

Very little about this album actually summons up such a question; mostly, it does very conventional youthful-commercial things and does them well. But there's a Hillman song called *Blue Morning* that talks about being
(Continued on page 98)

MUCH ADO ABOUT SOMETHING

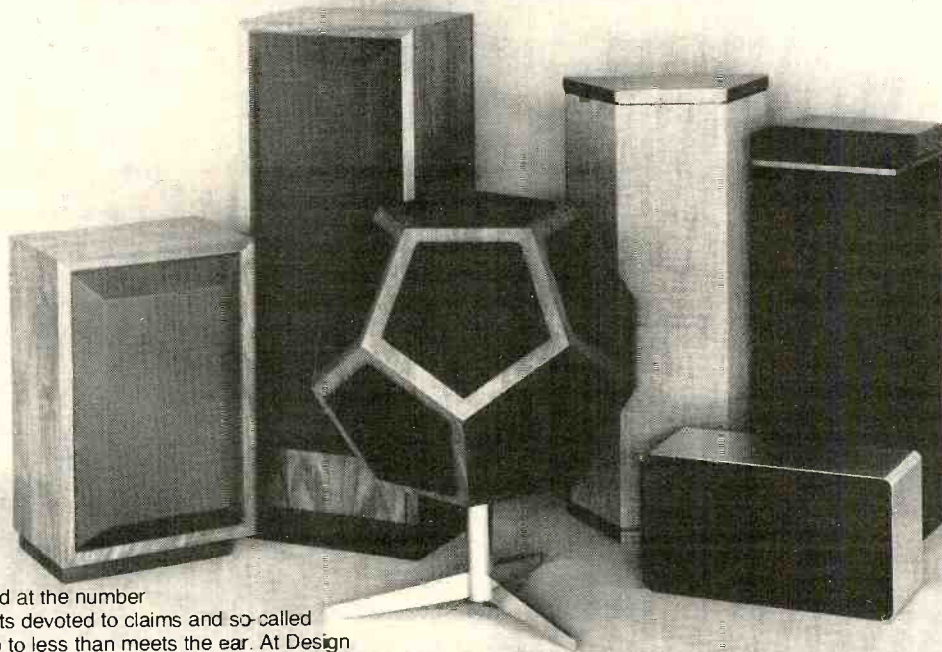

We're continually amazed at the number of speaker advertisements devoted to claims and so-called breakthroughs adding up to less than meets the ear. At Design Acoustics we concentrate on technological advances you can hear. Wide dispersion and flat power response, so the music you get from records and tapes is the music that was put there in the first place.

The fact is, too many aspects of loudspeaker design being bandied about these days add absolutely nothing to a speaker's actual performance. They may make for enticing advertising copy, but isn't that just so much ado about nothing? We'd rather bring you better music.

Design Acoustics, Inc., 2909 Oregon Court,
Torrance, CA 90503, (213) 320-4981.



Please send brochure and test reports to:

Name _____
Address _____
City, State, Zip _____ SR

“Two septuagenarian swinging singers—or singing swingers”



Bing and Fred: Once More, a Third Down

LISTEN to the albums they made in London last summer, then remind yourself—and it won't be easy—that Fred Astaire was seventy-seven on May 10 of this year and that Bing Crosby was seventy-two or seventy-four, depending on which lexicon you read, on May 2.

The recent photos on the album sleeves reveal two benign gentlemen obviously getting on, although neither really looks his age. The voices don't sound their age at all, nor does the manner in which they are used. Time, in each case, has lowered the comfortable pitch by about a major third, but without shortening what has always been an effective range of about an octave and a fifth. Astaire, for instance, sang *Isn't This a Lovely Day?* in B-flat when he introduced it in *Top Hat* forty years ago. He sings it in G-flat now, and he sings it better. Indeed, the lower keys bring to both voices, and especially to Astaire's, a body and richness they didn't always have when those voices were young. Listening to these albums, I couldn't help wondering how much longer-lived operatic voices might be if their owners had the popular singer's privilege of choosing congenial tonalities.

Producer Ken Barnes' plan in laying out this series of five albums (of which, alas, only three are available in American pressings) was to surround one album of duets with two solo albums for each singer, one album for each to be devoted to new—or newer—songs, the other to more familiar material. Of the latter, Bing's songs were to be favorite show tunes, Fred's to be songs associated with him from films, most of them written specifically for him, tailored by supreme craftsmen to his vocal and communicative nature and to his

unique way of making a melody talk. It is especially unfortunate, then, that these two are not scheduled for release in this country, since they are in some ways more representative of the singers' special gifts than are the more "commercial" American discs.

With the duet album Barnes had a bit of a problem, he told me, in reconciling the working habits of his two singers. With Bing, you agree on a tempo and that's pretty much that. He reckoned on about half an hour for rehearsal. Astaire, ever the worried perfectionist, wanted six hours, which collided with Bing's summer project of playing every reputable golf course in the British Isles. But a compromise was reached easily enough. The spoken ad-libbing on several tracks, by the way, was, according to Barnes, just that. And the tap break on the title song is by none other than Fred Astaire, done reluctantly when various substitute devices failed, in his critical view, to measure up to the real thing.

OF the solo albums, predictably, I think, those devoted to the older material come off best. If this is especially true of Astaire's, it is simply because the identification of song and singer is stronger, and the songs better. There is much to admire and enjoy in Bing's way with *How Are Things in Glocca Morra?*, *Something to Remember You By*, *With a Song in My Heart*, and *Great Day*. But I could have done without *Cabaret*, *Hello Dolly!*, *Heat Wave*, and *I Got Rhythm*—and so, I think, could Bing. They are identified with other singers who have sung them more idiomatically. A pleasant surprise, however, is his light-hearted, light-voiced account of Burt Bacharach's *I'll Never Fall in Love Again*.

As for Astaire's "They Can't Take These Away from Me" album, it's all pretty much as he says in *Cheek to Cheek*, pure "heav'n," and it has left me kicking myself for not having devoted a chapter to him in my book *The Great American Popular Singers*. With Astaire it has always been, I think, much as it was with Louis Armstrong. As Louis was thought of primarily as a trumpet player, so Fred has been thought of primarily as a dancer, the singing accepted in each case, and rather taken for granted, as a secondary accomplishment or as a pleasing extension of the primary gift and accomplishment.

I came early to the conclusion that Armstrong's trumpet playing was really an extension of his singing, and it strikes me now that the same is true of Astaire, that his dancing has been a terpsichorean extension of an essentially lyrical nature. Such speculation is encouraged by the fact that so many of his best dances were choreographic elaborations of fine songs, sung as only he could sing them—or swing them.

And it is the *swing* in his singing, I think, that accounts for the extraordinary clarity and eloquence of his enunciation. The words are so nicely placed to sublimate the natural rhythm of speech, not sustaining the melody, nor ever lost in melody or voice, but sustained by melody and voice. This contributes to a kind of intimacy that makes almost every song sound as if whispered in the ear of a cherished partner while dancing. It is the ultimate *tempo rubato*—in the literal sense of time not changed, but *stolen*. This is characteristic of all the greatest American popular singers. What distinguishes Astaire's *rubato* from others' is its irrepressible buoyancy.

This is, to a large extent, true also of Bing. It is a fact perceptively appreciated by Ken Barnes and catered to in Pete Moore's arrangements and in the solo bits by some of London's finest session men, notably Don Lusher on trombone, Tony Fisher on trumpet, and Keith Bird on tenor. There are moments on some up-tempo numbers where the percussion becomes cluttered and obtrusive, and there are some dispensable measures of vocal-group backing. But for the rest, all is wonderfully discreet, fastidiously scored, swinging support for two incredible septuagenarian swinging singers—or singing swingers, whichever you prefer.

—Henry Pleasants

BING CROSBY: *That's What Life Is All About.* Bing Crosby (vocals); Johnny Mercer (vocals, in medleys); Pete Moore Orchestra. *That's What Life Is All About; Breezin' Along with the Breeze; No Time at All; I Love to Dance Like They Used to Dance; Have a Nice Day; Medley—The Pleasure of Your Company/Roamin' in the Gloamin'; The Best Things in Life Are Free; Some Sunny Day; Bon Vivant; Medley—Good Companions/And Points Beyond; Send In the Clowns; The Good Old Times.* UNITED ARTISTS UA-LA-554-G \$6.98, © EA-554-H \$7.98.

FRED ASTAIRE: *Attitude Dancing.* Fred Astaire (vocals); Pete Moore Orchestra. *That Face; My Eyes Adored You; (I'm) Building Up to an Awful Letdown; Wailing of the Willow; You Worry Me; I Love Everybody but You; Attitude Dancing; City of the Angels; The Old Fashioned Way; Life Is Beautiful; Wonderful Baby.* UNITED ARTISTS UA-LA-580-G \$6.98, © EA-580-H \$7.98.

BING CROSBY AND FRED ASTAIRE: *A Couple of Song & Dance Men.* Fred Astaire and Bing Crosby (vocals); Pete Moore Orchestra. *Roxie; Top Billing; Sing; It's Easy to Remember; In the Cool, Cool, Cool of the Evening; Pick Yourself Up; How Lucky Can You Get; I've a Shooting Box in Scotland; Change Partners; Mr. Keyboard Man—The Entertainer; Spring, Spring, Spring; A Couple of Song and Dance Men; Top Billing—Finale.* UNITED ARTISTS UA-LA-588-G \$6.98, © EA-588-H \$7.98.

FRED ASTAIRE: *They Can't Take These Away from Me.* Fred Astaire (vocals); Pete Moore Orchestra. *A Fine Romance; Cheek to Cheek; One for My Baby; Night and Day; A Foggy Day; Top Hat, White Tie and Tails; I Wanna Be a Dancin' Man; They Can't Take That Away from Me; Something's Gotta Give; Isn't This a Lovely Day; They All Laughed; That's Entertainment.* UNITED ARTISTS UAS 29941 (English; address inquiries to Henry Stave & Co., 9 Dean Street, London W1).

BING CROSBY: *At My Time of Life.* Bing Crosby (vocals); Pete Moore Orchestra. *Cabaret; My Heart Stood Still; How Are Things in Glocca Morra?; I Got Rhythm; Thou Swell; Heat Wave; At My Time of Life; Something to Remember You By; Razzle Dazzle; Hello Dolly; Looking at You; I'll Never Fall in Love Again; With a Song in My Heart; Great Day.* UNITED ARTISTS UAS 29956 (English; address inquiries to Henry Stave & Co., 9 Dean Street, London W1).

(You Can Spend Two or Three or Four Times As Much And Not Do Better.)

The Advent Loudspeaker.

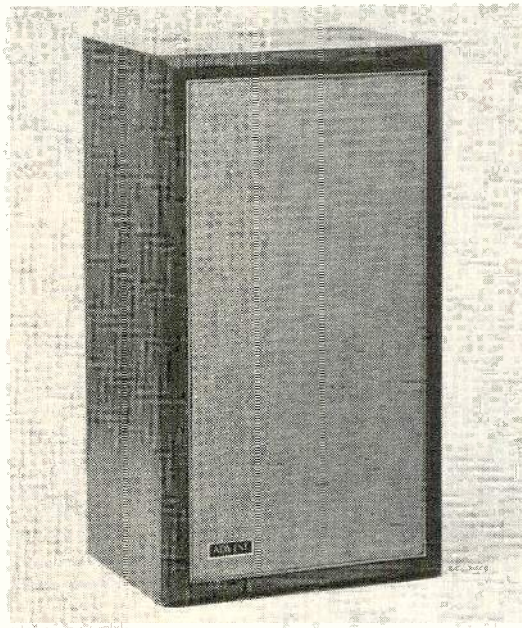

According to the best information we have, from magazine surveys and other sources, the Advent Loudspeaker is the best-selling speaker system in the United States—as it has been for the past three years.

We think the reason is that it offers the highest level of audibly useful speaker performance at a fraction of the usual cost.* Its usable frequency range is as wide as any speaker's (with bass response that is not only unsurpassed but mostly unapproached). Its distortion is very low at all listening levels likely to be tolerable in a home. And its musical balance is convincing with any kind of music or recording technique.

If you listen to speakers on a wide range of musical material before you buy, so that you can gauge the kind of satisfaction you might get in day-after-day listening to different kinds of music and recordings, we think you won't easily find a reason to spend more money on a loudspeaker.

For more information on the Advent Loudspeaker, please send us the coupon.

Thank you.

To: Advent Corporation, 195 Albany Street, Cambridge, MA 02139

Please send more information on the Advent Loudspeaker and a list of Advent dealers.

Name _____ Address _____

City _____ State _____ Zip _____

Advent Corporation,

195 Albany Street, Cambridge, Massachusetts 02139

*The suggested price of the Advent Loudspeaker, subject to change without notice, ranges from \$121 to \$149, depending on cabinet finish and where it has been shipped. The cabinet shown is finished in genuine walnut veneer.

the Static Eliminator

To PROTECT YOUR RECORDS

Non-penetrating alpha particles ionize air near the record, completely eliminating static, while a soft brush of natural hair whisks away dust and lint.



3" Model 3C500
\$14.95

Available at your audio dealer or write to:

staticmaster

P.O. Box 5178/El Monte, California 91734

CIRCLE NO. 58 ON READER SERVICE CARD

Hi-Fi Buys

ON PIONEER

AT WAREHOUSE TO YOU PRICES

RECEIVERS

SX-1250	\$575
SX-1050	\$475
SX-950	\$409
SX-850	\$349
SX-750	\$279
SX-650	\$210
SX-550	\$175
SX-450	\$149

AMPS & TUNERS

SA-9900	\$495
SA-9500	\$330
SA-8500	\$264
SA-7500	\$198
SA-6500	\$123
TX-9500	\$264
TX-7500	\$165
TX-6500	\$123

TURNTABLES

PL71	\$198
PL530	\$170
PL510	\$136
PL117D	\$119
PL115D	\$91
PL112D	\$74

DOLBY CASSETTE DECKS

CT-F9191	\$308
CT-F8282	\$272
CT-F7272	\$218
CT5151	\$184
CT4141A	\$164
CT-F2121	\$149

SPEAKERS

HPM200	\$330	CS630X	\$185
HPM100	\$165	CS99A	\$159
HPM60	\$124	CS700G	\$132
HPM40	\$83	CS500G	\$99

Save on other famous brands. Quotations answered same day. Write or call for free catalog. All units factory sealed. Full manufacturer's warranty. CB's also available at tremendous savings.

PHONE TO ORDER BY COD, BANKAMERICARD, MASTER CHARGE

For shipment within 48 hours send money order or certified check. Two week delay on personal checks. 20% deposit requested on C.O.D. shipments. \$1.25 handling fee on all orders. Shipping cost are collected C.O.D. unless paid in advance.



Hi-Fi Buys



1362 HOLTON LANE
LANGLEY PARK, MD. 20783
(301)434-5330

CIRCLE NO. 20 ON READER SERVICE CARD

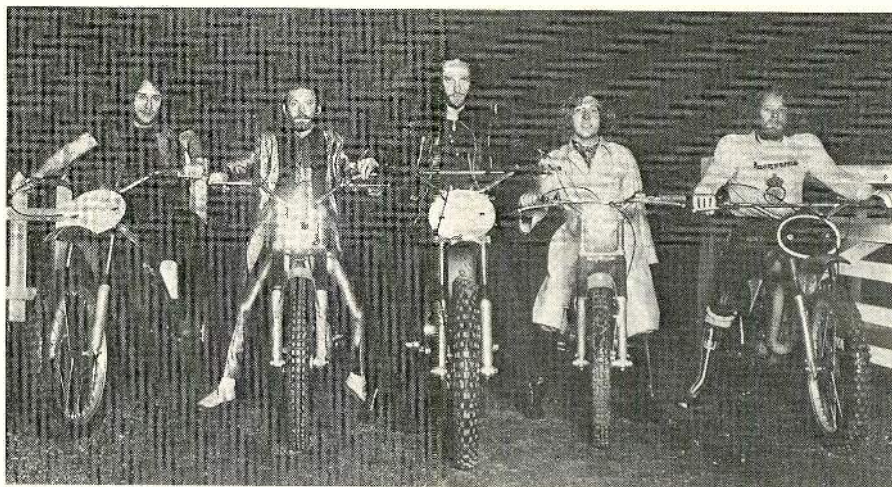

Chrysalis Records

JETHRO TULL
Still one of the best groups working

"down by the river in a cold, damp room, watching your life go by . . . maybe just a little too soon" that seems to suggest a sense of irony about how we stay young longer in some ways nowadays and at the same time we age faster in some ways than people ever did. I wish Hillman had done more reflecting (of that or any other sort) and less fabrication of interchangeable Eagles-Burritos-Poco-Manassas post-teen pleasantries (and pining), but most of this slips into your FM rock programming as if it had always been there, and you can hang your own ideas on it. N.C.

IAN HUNTER: All-American Alien Boy. Ian Hunter (vocals, guitar, piano); Chris Stainton (keyboards); Jaco Pastorius (bass); Aynsley Dunbar (drums); Gerry Weems (guitar); other musicians. *Letter to Britannia from the Union Jack; All-American Alien Boy; Irene Wilde; Restless Youth;* and four others. COLUMBIA PC 34142 \$6.98, © PCA 34142 \$7.98, © PCT 34142 \$7.98.

Performance: **Very good**
Recording: **Good**

"Apathy's at fever pitch," Ian Hunter says here. "There ain't no rock and roll no more—just the music of the young . . . just the sickly sound of greed . . . just the music of the rich." This is a *rather* political album, and I think it's about time we had some more of those. In places, this seems almost a throw-back to the protest album when it started to mature (and die out) around '67, and I find I pay a lot more attention to the words than to any other part of it. Protesting probably has less effect now than at any time in recent memory, but apathy isn't the only thing on a rampage—greed is on the biggest one I ever noticed—and Hunter has my political endorsement. Aesthetically, he hasn't made poetry; he isn't smooth and eloquent but keeps hacking and slashing until he turns up a phrase now and then. The musicians he employs here are pretty good; the music is adequate but not memorable. It isn't simply a *tract*, of course, as much of it has to do with one's own internal struggle with human nature, but it does attempt to look at life beyond the environment of the popular song and to come up with something beyond meaningless "I love you"s and "Yeah, yeah"s. N.C.

JEFFERSON STARSHIP: Spitfire. Jefferson Starship (vocals and instrumentals). *Hot Wa-*

ter; Big City; Switchblade; Cruisin'; Love Lovely Love; St. Charles; and four others. GRUNT BFL1-1557 \$6.98, © BFS1-1557 \$7.98, © BFK1-1557 \$7.98.

Performance: **Dancing sideways**
Recording: **Average**

There's something to be said for noticing the obvious—there must be, since so many people miss it—and one of the things that stands out here is the proposition that seven's a crowd in a rock band. It isn't so much that the arrangements are too full, it's the management that has to be asserted to prevent that, a mixture of traffic-directing, factor-weighting, and ego-nursing that siphons off energy the album's music could have used. Spontaneity would have happened with passion, of course, overcoming all this as it did to a fair degree in "Red Octopus." The Airplane-Starship needs to have key members agitated about something. This time, it feels more like a bag of tricks being dipped into, production being slicked down (yet, some sounds don't have the bite they could use), and if you can see through the fancy footwork, what's there is time being marked. The vocals, of course, are particularly long on expertise, but Marty Balin and Grace Slick are both transparent when they have to fake excitement. So'm I, so I don't dare go through the motions of jumping up and down over this. N.C.

JETHRO TULL: Too Old to Rock 'n' Roll; Too Young to Die! Jethro Tull (vocals and instrumentals). *Quiz Kid; Taxi Grab; Big Dipper; Pied Piper;* and six others. CHRYSALIS CHR 1111 \$6.98, © M8C 1111 \$7.98, © M5C 1111 \$7.98.

Performance: **Very fine if you ignore the words**
Recording: **Excellent**

Jethro Tull is still one of the best groups working. Ian Anderson is, of course, the mainspring, and his songs and vocals have enough of that bitterly, viciously disillusioned quality about them to please his "heaviest thinking" fans. The title song is a good enough proletarian melodrama, and several of the songs here are benign enough, but there are a couple that acted as giant turn-offs for me. *Bad Eyed and Loveless*, for instance, contains a line describing its heroine which will have to stand, until a better one comes

(Continued on page 100)

TDK SA. WE DEFY ANYONE TO MATCH OUR VITAL STATISTICS.

Manufacturer	Brand	MAGAZINE A		MAGAZINE B	
		S/N Ratio Weighted in dB	Output @ 3% THD	S/N in dB (re: 3% THD)	THD at 0 dB (%)
TDK	SA	66.5	+4.2	66.0	0.9
AMPEX	20:20+	56.4	+1.9	—	—
FUJI	FX	60.0	+2.3	—	—
MAXELL	UD	—	—	58.5	1.1
MAXELL	UDXL	62.5	+2.7	—	—
NAKAMICHI	EX	60.0	+2.3	55.0	1.1
SCOTCH	CHROME	—	—	64.0	1.3
SCOTCH	CLASSIC	62.5	+2.0	—	—
SONY	FERRICHROME	64.0	+2.1	64.0	1.8

Decks used for tests: Magazine A-Pioneer CT-F9191 (cross-checked on DUAL 901, TEAC 450); Magazine B-NAKAMICHI 1000.

Two leading hi-fi magazines working independently tested a wide variety of cassettes. In both tests, TDK SA clearly outperformed the other premium priced cassettes.

The statistics speak for themselves. TDK SA provides a greater S/N ratio (66.5 dB weighted and 66.0 dB @ 3% THD), greater output sensitivity (+4.2 dB @ 3% THD), and less distortion (THD 0.9%) than these tapes.

When you convert these statistics into sound, TDK SA allows you to play back more of the original signal with less distortion and noise.

Put these facts and figures together and TDK SA adds up to the State of the Art because it provides greater dynamic range. This means cleaner, clearer, crisper recordings, plain and simple. Sound for sound, there isn't a cassette that can match its vital statistics.

Statistics may be the gospel of the audiophile, but the ultimate judge is your own ear. Record a piece of music with the tape you're using now. Then record that same music at the same levels using TDK SA. You'll hear why TDK SA defies anyone to match its sound.

Or its vital statistics.

TDK Electronics Corp., 755 Eastgate Boulevard, Garden City, New York 11530. Also available in Canada.



Wait till you hear what you've been missing.

along, as the ultimate expression of post-Existentialist, pre-Clockwork Orange contempt: "She's a warm fart at Christmas." *Pied Piper* is another little journey into a kind of smirking, wise-ass juvenility that Anderson, chronologically at least, ought to have grown out of by now.

But the album is a beautifully made piece of pop music no matter how repugnant or childish the ideas often are. Anderson truly is an artist, and technically, in every department, he is above reproach. Now, if only he'd drop some of the nastiness I might be able to appreciate everything else—singing, arranging, producing—that he does so well. P.R.

RECORDING OF SPECIAL MERIT

ELTON JOHN: *Here and There*. Elton John (vocals and piano); other musicians. *Skyline Pigeon*; *Border Song*; *Honky Cat*; *Love Song*; *Crocodile Rock*; *Funeral for a Friend*; and four others. MCA MCA-2197 \$6.98, © T-2197 \$7.98, © C-2197 \$7.98.

Performance: **Outrageous**
Recording: **Very good**

Well, here he is again, folks. This time he's pictured perched atop a piano, wearing a fox-trimmed coat that looks like it was left over from an old Marlene Dietrich movie, peering owlishly at the world through yet another pair of outrageous shades, and welcoming you to another outing in his vastly talented company. Who else could it be but Elton John? "Here and There" is a recording of two live performances, one in London, a benefit "in the presence of Her Royal Highness Princess Margaret" (you were expecting maybe Marie of Roumania?), and the other in New York at Madison Square Garden in the presence of twenty thousand screaming fans. Both sides are pure Elton John and purely fabulous entertainment.

I lost my credibility among the rock literati so long ago that I don't even bother to defend my position on Elton John any more. No, he doesn't have a serious or meaningful bone in

his body; no, he certainly is not a sincere or "creative" performer; and no, he's not particularly original. But. . . . But when he sails into something such as *Skyline Pigeon* or *Honky Cat*, as he does here on the "Live in London" side, I seem to lose whatever tidy equanimity I have and regress back into (ugh!) fandom—a pernicious state indeed for A Critic. Nor does the "Live in New York" side bring me much beyond adolescence in my gooney, totally undemanding enjoyment of it. But you see, folks, I've Been Thinking A Lot these days, and it's wonderful to lighten up once in a while. Elton John helps me do this better than almost anyone around, as he obviously does for millions of others.

Both sides have surprisingly smooth sound for live recordings, though Elton perhaps sounds in slightly better, fuller voice on the New York side. But the actual point of any Elton John release is not the songs, the band, or the production. It is John himself: mercurial, vital, funny, and sad. He's a true pop artist-as-entertainer, limited perhaps, but then so were the great silent movie clowns, and he moves within his medium, the recording, with all of the same outrageous valor, unabashed sentimentality, and breathtaking assurance. Not to enjoy him because of some kind of "intellectual" standards would be a cop-out and would be to ignore the most direct message of pop culture: if it stimulates any true gut feelings, then it's working. The gut feeling that I get, again and again, from Elton John's work is a good one. It makes me feel very good indeed. P.R.

IRENE KRAL: *Where Is Love?* Irene Kral (vocals); Alan Broadbent (piano). *I Like You*, *You're Nice*; *When I Look in Your Eyes*; *A Time for Love/Small World*; *Love Came on Stealthy Fingers*; *Never Let Me Go*; and four others. CHOICE CRS 1012 \$6.98.

Performance: **Soporific**
Recording: **Good**

Irene Kral, the sister of Roy (of Jackie and . . .), has a dreamy, soothing way with a

song, and here she is accompanied by Alan Broadbent in a record of wistful vehicles prescribed for playing "during that quiet time of the day, preferably with someone you love, when you can sink into your favorite chair, close your eyes, and let in no outside thoughts to detract." The only trouble is, this particular day never ends. La Kral is relentless in her swooning torch-song approach to everything, from *Love Came on Stealthy Fingers* (!) to Lionel Bart's *Where Is Love?* from *Oliver*, which has never been sung more ruefully—or more funereally. Where indeed? I had hoped things might perk up with the two tuneful selections from Leonard Bernstein's *On the Town*, but they didn't. The singer's approach to these was as draggy and tearful as it was to everything else, making you want to spring up the way Nancy Walker did in the night-club scene of that very show and shout "This is too depressing!" An occasional change of tempo might help this lady's cause. P.K.

GORDON LIGHTFOOT: *Summertime Dream* (see *Best of the Month*, page 87)

PATRICK MORAZ: "i". Patrick Moraz (vocals and keyboards); orchestra. *Dancing Now*; *Reflection*; *Another Dog*; *Warmer Hands*; and three others. ATLANTIC SD 18175 \$6.98, © TP 18175 \$7.98, © CS 18175 \$7.98.

Performance: **"u" wouldn't believe it**
Recording: **Grandiose and silly**

This is a nonsensical, pretentious piece of claptrap masterminded by Patrick Moraz, who wrote, arranged, and conducted everything here and whose adoration for the supposed possibilities of the synthesizer apparently knows no bounds. Now, if only he'd learn how to write music, sing in something above a dreary whine, and get some sound out of the various electronic instruments which resembles a note of music, perhaps he might be of some interest. Meanwhile, "i" is a colossal waste of time for everyone concerned—on both sides of the speaker. P.R.

MAXINE NIGHTINGALE: *Right Back Where We Started From*. Maxine Nightingale (vocals); orchestra. *Good-Bye Again*; *Love Enough*; *Bless You*; *Reasons*; *One Last Ride*; and eight others. UNITED ARTISTS UA-LA626-G \$6.98, © UA-EA626-H \$7.98, © UA-CA626-H \$7.98.

Performance: **Very good**
Recording: **Excellent**

There's total professionalism here, from the silky, flexible voice of Maxine Nightingale to the glittering string arrangements by Wilf Gibson and Gerry Shurry to the spit and polish of Pierre Tubbs' luxurious production. As to how involving all of this surface meticulousness will be to you—well, that's a matter of taste. The closest anyone ever gets to getting down with anything here is in *Right Back Where We Started From*, the hit single. On this track, Nightingale does her loosest, most appealing work, and the production only adds to the fun. Even in the glossy overstylizations of such things as *(I Think I Wanna) Possess You* or *In Love We Grow* she maintains a consistent level of vocal quality that is impressive. But it's a recording that will probably be of more interest to people who make recordings than to the general public. It's got everything but guts and feelings. P.R.

(Continued on page 102)

ELTON JOHN:
outrageous valor,
unabashed sentimentality,
and breathtaking
assurance



Odd Couple.

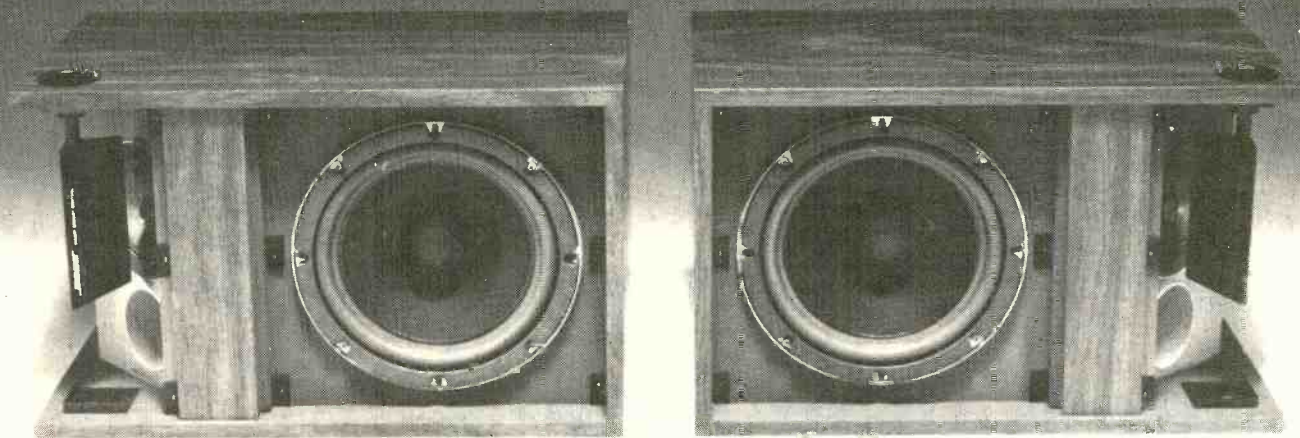

This is a pair of Bose Model 301 Direct/Reflecting® bookshelf speakers with their grilles removed.

What's odd about them might not be immediately obvious, but it's very significant. Unlike most pairs of speakers, they're not identical. Instead, the left-hand speaker is a mirror image of the right-hand speaker.

Bose goes to the extra trouble and expense of making the two speakers of the pair you buy different to provide the proper proportion of reflected and direct sound at high frequencies, a feature unique among bookshelf speakers.

To accomplish this, each speaker is of an "asymmetrical"

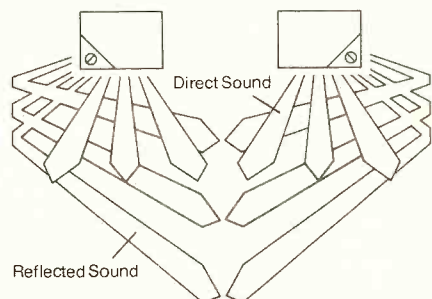

design. As a result, a pair of Model 301s has woofers pointing straight ahead and tweeters angled outward. A large proportion of the high frequency energy is reflected off the side walls and then into the center of the listening room, rather than being aimed directly at the listener. As in a live performance, the listener is surrounded with a balance of reflected and direct sound. This is the same principle used in the Bose 501 and in the legendary Bose 901® Direct/Reflecting speaker system. The result is extraordinarily open, natural, and spacious sound.

In addition, the Model 301 Dual Frequency Crossover™ network causes the woofer and tweeter to operate simultaneously for more than an octave, providing exceptionally smooth midrange response and an open spatial quality.

With the unique Direct Energy Control, the Model 301 provides excellent performance in a wide variety of rooms, including small apartments and dormitory rooms. And it is truly small enough to fit in a bookshelf.

These features make the Model 301 an unusual speaker with unusually fine performance. Its suggested retail price—less than \$100 per speaker—makes it an extraordinary value.

You already know the Model 301 looks different from other bookshelf speakers. Now visit a Bose dealer and hear how different it sounds.

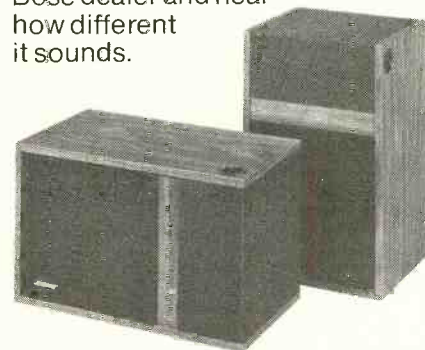

BOSE®

**The Mountain
Framingham, Mass. 01701**

Patents issued and pending.

For a full-color brochure on the Model 301, write: Bose, Dept SR1D, The Mountain, Framingham, Mass. 01701.

RAMONES. Johnny Ramone (guitar); Joey Ramone (vocals); DeeDee Ramone (bass); Tommy Ramone (drums). *Blitzkrieg Bop; Beat on the Brat; Judy Is a Punk; I Wanna Be Your Boyfriend; Chain Saw; Now I Wanna Sniff Some Glue;* and eight others. SIRE SASD 7520 \$6.98, © 8147-7520 H \$7.98.

Performance: **Strange, but lousy**
Recording: **Semi-dank**

You couldn't make a recording this dumb by accident, not even in the new disco age—someone is up to something here, but I can't figure out what. It could be a parody of punk-rock imaging, but it isn't funny or even marginally competent. The guitar, electric of course, seems to be turned all the way up and just plays chords, in a way that makes them

sound like white noise. The "songs" mostly say things like "You're a loudmouth, baby . . . I'm gonna beat you up." Maybe it is meant straight. Who knows? Who cares? *N.C.*

TODD RUNDGREN: Faithful. Todd Rundgren (vocals, guitar); instrumental accompaniment. *Happenings Ten Years Time Ago; Good Vibrations; Rain; Most Likely You'll Go Your Way and I'll Go Mine; If Six Was Nine;* and seven others. BEARSVILLE BR 6963 \$6.98, © M8 6963 \$7.98, © M5 6963 \$7.98.

Performance: **Untouched by human hands**
Recording: **Likewise**

I see Todd Rundgren as a child of the times, a technocrat with a good sense of pitch. His vi-

sion seems to have more to do with working "studio magic" than anything else—his songs (all of side two here) seem quite modern and synthetic, as if most of the experiences they were based on came in via the media. They feel air-conditioned, their windows sealed shut. I could be wrong, of course, as my view of Rundgren has been casual, but I just can't see much point to this album, unless it's an exercise in producing records. There's a certain brashness, I suppose, in the way he almost re-creates the Beach Boys' arrangement of *Good Vibrations* (which, incidentally, is instructive; one can't help noticing how he's scrubbed off all the Beach Boys' rakishness, without which their style is about as interesting as Lawrence Welk's) and then mimics Dylan's inflections. But you can get a certain brashness almost anywhere you turn these days, and the *other* side is all these fiberglass-bodied "originals" that absolutely refuse to be remembered one moment after they stop . . . and yet don't sound all that bad while they're going. Hmph. I think I'll stay casual about this act. *N.C.*

BOB SEGER & THE SILVER BULLET BAND: 'Live' Bullet. Bob Seger (vocals, guitar, piano); other musicians. *Nutbush City Limits; Travelin' Man; Beautiful Loser; Jody Girl; I've Been Working; Turn the Page;* and eight others. CAPITOL SKBB-11523 two discs \$7.98, © 8XVV-11523 \$8.98, © 4XVV-11523 \$8.98.

Performance: **Narrow, noisy**
Recording: **Very good**

Detroit, for some reason, prides itself on being the rockiest, rolliest town in the country; perhaps the boosterism comes from Motown Records' having started there. But all the rock (including a good deal of Motown) that I ever heard from Detroit—the unlamented MC5, Suzi Quatro, Flaming Ember, and others—has been long on screaming vocalists and short on anything above mere competence. The only exception I can think of is guitarist Dennis Coffey, who had an instrumental hit called *Scorpio* in 1971.

Bob Seger has been a local hero in Detroit for ten years. He gained national attention recently with a version of *Nutbush City Limits*, a song written—and incomparably better sung—by Tina Turner. Capitol has seen fit to issue this double-disc live set of a Seger concert recorded last year in Cobo Hall, where 24,000 locals screamed their appreciation for Seger's abrasive and insubstantial singing, his thin material, and his band's attempts to copy whatever bands are playing in New York, L.A., Philadelphia, Atlanta, or London. The album is proof positive that the present "Detroit Sound" is a hallucination of the local citizenry. *J.V.*

RAY STEVENS: Just for the Record. Ray Stevens (vocals); orchestra. *Cornball; Gimme a Smile; Can't Stop Dancin'; Once in a While; Om;* and five others. WARNER BROS. BS 2914 \$6.98, © M8 2914 \$7.98, © M5 2914 \$7.98.

Performance: **For his fans**
Recording: **A Stevens Production**

When last encountered, Ray Stevens was busily "rearranging" a bucketful of pop classics almost out of recognizability. This trip, Stevens seems content to operate on some of his own work—a move which will probably come as a great relief to a lot of ASCAP members. And anything, anything at all, that has

Great PIONEER Values!

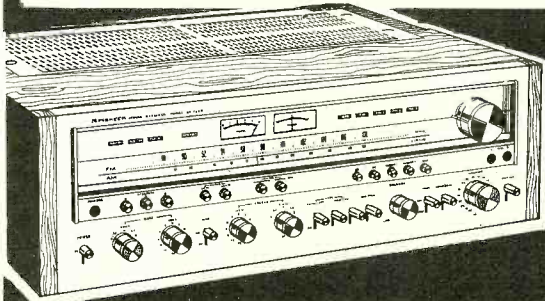

SX-1250
AM/FM STEREO RECEIVER
S.R. Price
\$567
List \$900

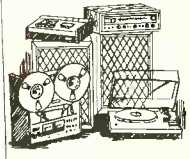
RECEIVERS			POWER/PRE-AMPLIFIERS		
MODEL NO.	LIST	S.R. PRICE	MODEL NO.	LIST	S.R. PRICE
SX 1050	700	478	SPEC 2	900	594
SX 950	600	409	SPEC 1	500	330
SX 850	500	352	GRAPHIC EQUALIZER		
SX 750	400	282	SG-9500	300	198
SX 650	300	212	DYNAMIC EXPANDER		
SX 550	250	176	RG1	175	120
SX 450	200	150	CASSETTE DECKS		
QX 949 Quad	750	495	CT F9191	450	307
TUNERS			CT F8282	400	273
TX 9500	400	264	CT F7272	320	218
TX 7500	250	165	CT 5151	270	185
TX 6500	175	124	CT 4141A	250	164
INTEGRATED AMPLIFIERS			CT 2121	200	150
SA 9900	750	495	<div style="text-align: center;">  <p>Our 20th Year SOUND REPRODUCTION Catalog No 48</p>  </div> <p>SEND FOR CATALOG ON PIONEER AND FORTY OTHER BRANDS FEATURING A COMPLETE LINE OF AUDIO COMPONENTS TO SUIT EVERY BUDGET</p>		
SA 9500	500	330			
SA 8500	400	264			
SA 7500	300	198			
SA 6500	175	124			
TURNTABLES					
PL-71	300	198			
PL-55X	250	165			
PL-530	250	171			
PL-510D	200	137			
PL-117D	175	119			
PL-115D	125	91			
PL-112D	100	74			

Order Now By Mail From..

SOUND REPRODUCTION

460 CENTRAL AVE., EAST ORANGE, N.J. 07018

(201) 673-0600

been done for such songs as *Cornball* and *Om* one ought to be grateful for. Stevens' vocals are, as usual, impeccably nondescript. His producing and arranging gifts burst forth spectacularly in a unique arrangement of Paul Craft's *Honky Tonk Waltz*. P.R.

ELLY STONE: *The New Legend of the Ancient Mariner*. Elly Stone (vocals); instrumental accompaniment. *The Old Soldiers in the Chinese Restaurant; The Late Late Show; Middle Class; Mister Williams*; and six others. EEBEE 001 \$8.00 (from Eebee Records, c/o Astor Place Theatre, 434 Lafayette Street, New York, N.Y. 10003).

Performance: **A downer**
Recording: **Very good**

Elly Stone has one of the most arresting styles of any singer alive. Her throbbing voice is not only an attractive instrument in itself but can handle even slight material with such force and persuasion as to set an audience on its ears. She did just that some years ago in *Jacques Brel Is Alive and Well and Living in Paris*, and in fact it was Stone and one of her lyricists, Eric Blau, who brought Brel himself to America for his first New York appearance. Now, on a new independent label, she is heard in a program of songs so dreary that they challenge even her ability to transform musical dross into gold. Most of the lyrics are by Blau, or translated from Brel's French by Blau. They're all downbeat, and so are the tunes—some by Brel, some by his followers Ralph Affoumado, Robert Kessler, and Mort Shuman (who was the musical conductor of *Alive and Well*).

It's a dreary hour and not alive or well at all, including such as a morose dirge about the piggishness of the middle class and a rueful item about how threadbare life is when all that's left to look forward to is the late, late show. We meet the Ancient Mariner disguised as a Bowery bum, encounter four war veterans wallowing in self-pity at a Chinese restaurant while their wonton soup grows cold, and see Jesus in a bar on MacDougal Street. Not to mention the finale, *My Death*. This album is the saddest thing since *Gloomy Sunday*, which during the Depression was banned from the air for a while because it was encouraging too many suicides. P.K.

HOUND DOG TAYLOR: *Hound Dog Taylor and the House Rockers*. Theodore Roosevelt "Hound Dog" Taylor (guitar and vocals); guitar and drum accompaniment. *She's Gone; It's Alright; 44 Blues; It Hurts Me Too*; and eight others. ALLIGATOR 4701 \$6.98 (from Alligator Records, P.O. Box 11741, Chicago, Ill. 60611).

Performance: **Grade B**
Recording: **Grade C**

Theodore Roosevelt Taylor, now sixty, had only four selections released prior to this album. Recorded in 1960 and 1962, they have long since become as obscure as the labels they were released on. If you want to know why Hound Dog Taylor is only now re-emerging on records, listen to this album; except for the horrendous technical sound, you will have a feeling that you've heard it all before, and I don't think you'll want to hear it again. C.A.

JAMES TAYLOR: *In the Pocket*. James Taylor (vocals, guitar); Lee Sklar (bass); Russ Kunkel (drums); Danny Kortchmar (guitar, mandolin); other musicians. *Shower the Peo-*

ple; A Junkie's Lament; Money Machine; Slow Burning Love; Daddy's All Gone; Family Man; Golden Moments; and five others. WARNER BROS. BS 2912 \$6.98, © M8 2912 \$7.98, © M5 2912 \$7.98.

Performance: **Good**
Recording: **Excellent**

Same old complaint: a James Taylor song works for me when it comes reasonably close to having a tune, and usually it doesn't. Taylor is almost uncanny in that he can somehow fit four or five chords into a drone that has to be talked rather than sung, while plenty of people regularly get plenty of melody out of three chords. The songs I like here, then, are the hit *Shower the People*, bubblegum lyrics and all, *Nothin' Like a Hundred Miles*, and

Money Machine. Most of Taylor's lyrics this time are not particularly intense, but they're pretty good. They tend to be cryptic, grab-bag referential, and understated. Something subtle would tell you, if you didn't already know, that *A Junkie's Lament* was written from firsthand experience. Taylor has quite a good head for words, and I'd like to see him try it out on a book of poetry sometime. Here you have a fair example of what he can do with words, a few tunes, several droning non-tunes, and some fine production that is civilized but not rigid. N.C.

THE TROGGS: *The Trogg Tapes*. The Troggs (vocals and instrumentals). *Get You Tonight; Gonna Make You; Walkin' the Dog; A Differ-* (Continued on page 107)

QUALITY

A TRADITION FOR OVER 90 YEARS



It all started in 1883 in St. Croix, Switzerland where Herman Thorens began production of what was to become the world's renowned Thorens Music Boxes.

For almost a century Thorens has pioneered in many phases of sound reproduction. Thorens introduced a number of industry firsts, a direct drive turntable in 1929, and turntable standards, such as the famed Thorens TD 124 Model.

Over its long history Thorens has learned that an exceptional turntable requires a blend of precision, refined strength, and sensitivity. Such qualities are abundantly present in all five Thorens Transcription Turntables. Speaking of quality, with Thorens it's the last thing you have to think about. At Thorens it's always been *their first* consideration. So if owning the ultimate in a manual turntable is important to you, then owning a Thorens, is inevitable.

THORENS®
The Accent is on Quality

ELPA MARKETING INDUSTRIES, INC.
EAST: New Hyde Park, New York 11040
WEST: 7301 E. Evans Rd., Scottsdale, Arizona 85260

PICTURED ABOVE: lower left—TD-126 C • lower right—TD-145 C • top left—TD-160 C • top right—TD-165 C.

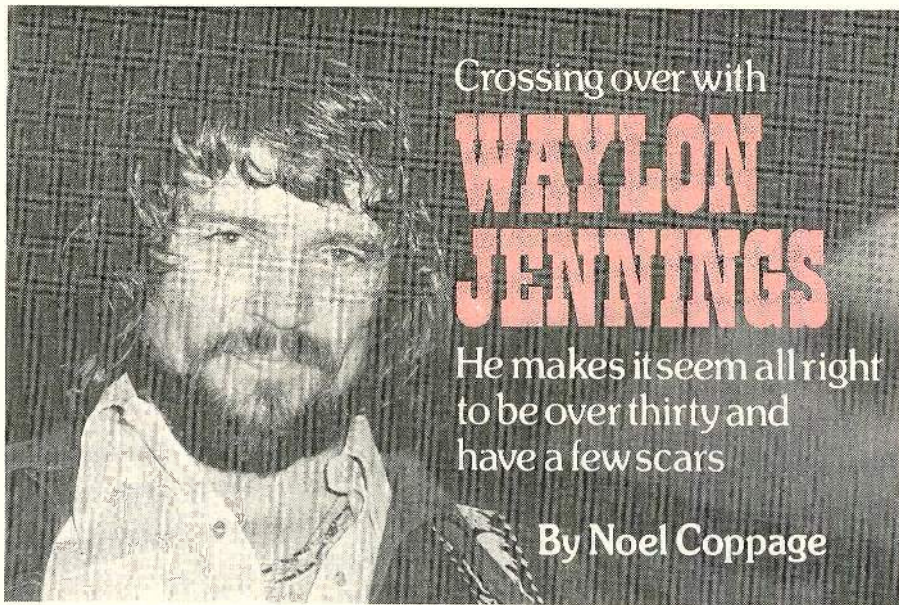

RCA

Crossing over with

WAYLON JENNINGS

He makes it seem all right to be over thirty and have a few scars

By Noel Coppage

MAN Fights City Hall; Man Wins. Now there's the kind of news we Americans are always looking for, and—since what we mean by Bureaucracy and what we mean by Plastic aren't that far apart—we'll gladly take the variation that has Man fighting a decent skirmish against Modern Times. Charlie Chaplin is still collecting royalties on just that, we made a hero of John Henry for whipping a machine (knowing all the time that in the long run he didn't), and now we are honoring Waylon Jennings for messing up the works of the Nashville Sound. Not for whipping a machine, exactly, but for fighting it instead of joining it.

And no sooner have we raised our Lone Star bottles for the toast than along come the revisionists, the would-be myth-busters—making an appearance that couldn't be more routine if they were just a cog and the whole culture a machine—to attack all the imaging and posing that goes with this music Jennings

is identified with, called "redneck rock" or "progressive country." Cynical dollar-chasers are said to be invading Austin, which Jennings' friend Willie Nelson made the capital of this "movement." Excesses, such as the way David Allen Coe talks up violence as a part of his act, are earnestly documented. "The Outlaws," another term that tries to name the mystique surrounding Jennings, are found on closer inspection to be much more domesticated than it says in their songs. And so on.

This is all worth pointing out, perhaps, but it need not be done so breathlessly, as the discoveries in it are not all that amazing (when, for example, did the wheeler-dealers *not* move into a place that seemed to be onto something fresh that was selling?), and it ought to be done with a sense of the difference between literal truth and literary truth.

A place to start on that distinction might be the realization that hearing is at least as im-

portant as seeing when you're dealing with music. It's easy enough to react, to lump all the "redneck rock" practitioners together, when you see one after another of them wearing a cowboy hat, boots hand-stitched by Charlie Dunn, a beard, and a beer gut. The very label "redneck rock" seems to have been thought up by a looker, not a listener, as it more nearly describes the audience than the music; Jennings, Nelson, Jerry Jeff Walker, and a few others have brought together what were called good old boys and what were called hippies. The instrumentation behind any one of these "outlaws," considering the hybridization that had already taken place in the music, doesn't take "country" toward "rock" by as much as the big-beat sound of Buck Owens took it years earlier.

And calling the music "progressive" is downright confusing, since some people presumably continue to think of "progress" as advancement, something good, and other people recoil at the word, thinking of ticky-tacky suburbs, garish colors in fast-food/fast-buck joints, the increasing mechanization and patterning of life.

LUMPING Jennings with, say, David Allen Coe or Asleep at the Wheel or Michael Murphy or any of the other "movement" entities is a mistake in the first place, as the whole idea with Jennings is going it *alone*. The way he, specifically, has elected to sound does not extend The Way Things Are Going (the old definition of "progress") but goes against it.

"The old-timers *like* Waylon and Willie because they're always going back and recording those old, hard-core country songs, like *Blue Eyes Crying in the Rain*," Neil Reshen, who manages both Nelson and Jennings, once told me. "People are looking for some human thing to relate to, someone to one-on-one with," Jennings says, and seems to see his burgeoning popularity of the last couple of years as at least in part a reaction of the people against the complexity of the times: "Every time you turn around, you have to deal with a machine."

So Jennings' cowboy clothing is a good

THE BEST OF WAYLON JENNINGS. Waylon Jennings (vocals, guitar); instrumental accompaniment. *The Days of Sand and Shovels; MacArthur Park; Delia's Gone; Walk On Out of My Mind; Anita, You're Dreaming; Only Daddy That'll Walk the Line; Just to Satisfy You; I Got You; Something's Wrong in California; Ruby, Don't Take Your Love to Town.* RCA LSP-4341 \$6.98, © APS-1577 \$7.98.

WAYLON JENNINGS: Singer of Sad Songs. Waylon Jennings (vocals, guitar); unidentified accompaniment. *Singer of Sad Songs; Sick and Tired; Time Between Bottles of Wine; Must You Throw Dirt in My Face; No Regrets; Ragged but Right; Honky Tonk Women; She Comes Running; If I Were a Carpenter; Donna on My Mind; Rock, Salt and Nails.* RCA LSP-4418 \$6.98, © APS-1625 \$7.98, © APK-1625 \$7.98.

WAYLON JENNINGS: The Taker/Tulsa. Waylon Jennings (vocals, guitar); unidentified accompaniment. *The Taker; You'll Look for*

Me; Mississippi Woman; Lovin' Her Was Easier; Six White Horses; Tulsa; Casey's Last Ride; A Legend in My Time; Sunday Mornin' Comin' Down; Grey Eyes You Know. RCA LSP-4487 \$6.98, © APS-1695 \$7.98, © APK-1695 \$7.98.

WAYLON JENNINGS: Good Hearted Woman. Waylon Jennings (vocals, guitar); unidentified accompaniment. *Good Hearted Woman; The Same Old Lover Man; One of My Bad Habits; Willie and Laura Mae Jones; It Should Be Easier Now; Do No Good Woman; Sweet Dream Woman; Unsatisfied; I Knew You'd Be Leavin'; To Beat the Devil.* RCA LSP-4647 \$6.98, © APS-1886 \$7.98, © APK-1886 \$7.98.

WAYLON JENNINGS: Ladies Love Outlaws. Waylon Jennings (vocals, guitar); Billy Sanford (guitar); Ralph Mooney (steel guitar); Pig Robbins (piano); Ken Buttrey (drums); other musicians. *Ladies Love Outlaws; Never Been to Spain; Sure Didn't Take Him Long; Crazy*

Arms; Revelation; Delta Dawn; Frisco Depot; Thanks; I Think It's Time She Learned; Under Your Spell Again. RCA LSP-4751 \$6.98, © APS-2016 \$7.98, © APK-2016 \$7.98.

WAYLON JENNINGS: Lonesome, On'ry and Mean. Waylon Jennings (vocals, guitar); Billy Reynolds (guitar); Ralph Mooney (steel guitar); Norbert Putnam (bass); Don Brooks (harmonica); other musicians. *Lonesome, On'ry and Mean; Lay It Down; Freedom to Stay; Gone to Denver; Good Time Charlie's Got the Blues; You Can Have Her; Pretend I Never Happened; Frisco Mabel Joy; Sandy Sends Her Best; Me and Bobby McGee.* RCA LSP-4854 \$6.98, © APS-2136 \$7.98, © APK-2136 \$7.98.

WAYLON JENNINGS: Honky Tonk Heroes. Waylon Jennings (vocals, guitar); Billy Sanford (guitar); Ralph Mooney (steel guitar); Don Brooks (harmonica); David Briggs (piano); other musicians. *Honky Tonk Heroes; Old Five and Dimers; Willie the Wandering*

stage outfit, a good image outfit, goes with such words as "Don't mess around with a ramblin' man." But then, in view of the fact that the nudists still haven't gotten the upper hand, he'd have to wear *some* kind of clothing, and if your clothing doesn't suggest you're playing cowboy, it's going to suggest you're playing something else. In fact, you, he, I, everybody plays at being *something*.

On another level, the pose Jennings strikes is symbolic, a truth-in-fiction device. He doesn't ask you to take him literally and go up against the computers with six-guns blazing. The point he's making visually is literary and relates to the point he's making musically: remember the poor cowboy, the romantic misfit; have a kind thought for those who can't or won't constantly adapt to The Way Things Are Going.

JENNINGS' long-running feud with the Nashville establishment was, as a practical matter, over presentation, accompaniment, matters of style. Behind that, though, was the question of whether the music was an individual's or a bureaucracy's. The power in his voice was readily detected, but that only complicated matters. The craggy magnificence of that voice and its obvious technical capabilities, together with his background in rock-and-roll as Buddy Holly's bass player, suggested all kinds of "crossover" possibilities—selling in the vast, sprawling pop-music market as well as what was then the comparatively tidy though not so little country market—and it just so happened that lusting after crossovers was the way Nashville was going. Jennings found the Nashville Sound provided much slicker arrangements for him to sing into than he'd had in mind; he had come to a city famous for fiddles and now he couldn't get away from violins.

Exactly what that was like is no longer documented in recordings you can buy firsthand, as RCA has pulled most of what Jennings calls "those turkeys I made for Chet" off the market in favor of a "Best of" collection of ten songs from the Sixties, produced by Chet Atkins with a little help from

Nashville Brass-man Danny Davis. It is not spiritually the "oldest" Jennings album you can buy now, as it was put together more recently, profiting from hindsight, and sounds more like what Jennings does today than do a couple of turkeys he made early in the Seventies, "Singer of Sad Songs," produced by Lee Hazlewood, and "The Taker/Tulsa," produced by Danny Davis and Ronnie Light. Mel Tillis' *Ruby, Don't Take Your Love to Town* in the "Best of" collection was actually recorded (as today his albums regularly are) with his road band, the Waylor, instead of studio musicians, and the arrangement of *Delia's Gone* has what we've come to recognize as his signature (what he calls "my footprints") on it—plus a little choral cooing presumably ordered by the bureaucracy.

"Singer of Sad Songs" is a little more interesting than "Tulsa/The Taker" if only because Hazlewood's cuteness (well, it worked all right with Nancy Sinatra) makes it just slightly bizarre. "Tulsa" is just a mediocre



NELSON



WALKER

"Jennings, Nelson, Jerry Jeff Walker, and a few others have brought together what were called good old boys and what were called hippies."

example—mainly a me-too cover of Kristofferson—of a good singer's being misunderstood and misused. Both of those are radically different from Jennings' later albums, but not so radically different from the few that followed them. Development of his signature was not a radical act, and no single album is in a pivotal spot insofar as demonstrating where the man socked it to the machine is concerned. The background voices in the older albums tend to be feminine and sweet—they sound almost angelic as late as "Ladies Love Outlaws," which, nevertheless, has plenty of Jennings' footprints on it. Later, the voices are more likely male, guarded against being too pretty, and more often silent. This parallels what has happened with the instrumentals. Chet, Danny, and the other early producers seemed to hear Jennings' voice and go looking for complementary colors. Running his own show, Jennings has steadily shifted the theme from contrast over toward harmony: the Waylor are rakish, smoked, whiskied, lined, weathered like the voice.

THE Waylor seem to have infiltrated the Nashville Sound in Jennings' albums like guerrillas. And, of course, the crossovers really started happening after they became dominant, the way he'd wanted to do it all along. Artistically, Jennings went on a winning streak with parts of "Good Hearted Woman," "Lonesome, On'ry and Mean" and "Ladies Love Outlaws" and then hit his stride, leather flapping, turquoise flashing, with what is still the heart of his work so far: "Honky Tonk Heroes" (which is all Billy Joe Shaver image-conscious songs but one), "This Time," "The Ramblin' Man," and "Dreaming My Dreams." The archetypal Waylon Jennings album, I think, is "This Time." It carries the life-style thematics that translate so readily into the visual, but it is essentially about feelings—which is what the experience, the aging in that big, textured voice is about—and it eloquently asserts that it's all right for cowboys to have them. Also it catches Waylon at his sharpest musically; the

(Continued on next page)

Gypsy and Me; Low Down Freedom; Omaha; You Ask Me To; Ride Me Down Easy; Ain't No God in Mexico; Black Rose; We Had It All. RCA APL1-0240 \$6.98, © APS1-0240 \$7.98, © APK1-0240 \$7.98.

WAYLON JENNINGS: *This Time.* Waylon Jennings (vocals, guitar); Willie Nelson (guitar, vocals); Ralph Mooney (steel guitar, dobro); Don Brooks (harmonica); Duke Goff (bass); other musicians. *This Time; Louisiana Woman; Pick Up the Tempo; Slow Rollin' Low; Heaven or Hell; It's Not Supposed to Be That Way; Slow Movin' Outlaw; Mona; Walkin'; If You Could Touch Her at All.* RCA APL1-0539 \$6.98, © APS1-0539 \$7.98, © APK1-0539 \$7.98.

WAYLON JENNINGS: *The Ramblin' Man.* Waylon Jennings (vocals, guitar); Dave Dirby (guitar); Joe Allen (bass); Ralph Mooney (steel guitar); other musicians. *I'm a Ramblin' Man; Rainy Day Woman; Cloudy Days; Midnight Rider; Oklahoma Sunshine; The Hun-*

ger; I Can't Keep My Hands Off of You; Memories of You and I; It'll Be Her; Amanda. RCA APL1-0734 \$6.98, © APS1-0734 \$7.98, © APK1-0734 \$7.98.

WAYLON JENNINGS: *Dreaming My Dreams.* Waylon Jennings (vocals, guitar); Ralph Mooney (steel guitar, dobro); Jim Colvard (guitar); Richie Albright (drums); other musicians. *Are You Sure Hank Done It This Way; Waymore's Blues; I Recall a Gypsy Woman; High Time (You Quit Your Low-Down Ways); I've Been a Long Time Leaving; Let's All Help the Cowboys; The Door Is Always Open; Let's Turn Back the Years; She's Looking Good; Dreamin' My Dreams with You; Bob Wills Is Still the King.* RCA APL1-1062 \$6.98, © APS1-1062 \$7.98, © APK1-1062 \$7.98.

WAYLON JENNINGS: *Are You Ready for the Country.* Waylon Jennings (vocals, guitar); Ralph Mooney (steel guitar, dobro); Richie Albright (drums); Duke Goff (bass); other mu-

sicians. *Are You Ready for the Country; Them Old Love Songs; So Good Woman; Jack a Diamonds; Can't You See; MacArthur Park; I'll Go Back to Her; A Couple More Years; Old Friend; Precious Memories.* RCA APL1-1816 \$6.98, © APS1-1816 \$7.98, © APK1-1816 \$7.98.

Also appearing in:

WANTED: THE OUTLAWS. With Willie Nelson, Jessi Colter, and Tompall Glaser. Jennings sings: *My Heroes Have Always Been Cowboys; Honky Tonk Heroes; Suspicious Minds; Good Hearted Woman; Heaven or Hell.* RCA APL1-1321 \$6.98, © APS1-1321 \$7.98, © APK1-1321 \$7.98.

MUSIC FROM MACKINTOSH & T. J. Starling Roy Rogers; music prepared by Waylon Jennings. Jennings sings: *All Around Cowboy; Ride Me Down Easy; Bob Wills Is Still the King.* RCA APL1-1520 \$6.98, © APS1-1520 \$7.98, © APK1-1520 \$7.98.



A Selective
Calendar
of
American Music
1612-1976
prepared for
STEREO REVIEW
by James Goodfriend
1976

REPRINTS NOW AVAILABLE

This useful, information-packed, and attractive (suitable for framing) feature from our July 1976 Bicentennial Issue is printed in four colors on 11" x 16" stock and includes Music Editor Goodfriend's introduction. For your copy send 25¢ to: American Music Calendar, Stereo Review, 1 Park Avenue, New York, N.Y. 10016.



Waylon Jennings
and wife
Jessi Colter

WAYLON...

(Continued from page 105)

chemistry resulting from Willie Nelson's presence as co-producer and laconic, surprising guitar soloist is a factor you can hear.

The latest album, "Are You Ready for the Country," is not a safe spot from which to launch guesses into Jennings' latest assessment of his role or how he's playing it. He seems to have cruised through it without concentrating as intently as he did during that string of really good ones. *MqcArthur Park*, recorded a second time, *his way*, still doesn't fit him very well and doesn't fit the Waylors at all, and anyway it seems to be there mainly to buoy up the album melodically—the voice seems to hang, mostly unused, over most of the other tunes, which are derivative and lack boldness.

Yet the album has its own integrity, and some characteristic Jennings quirks. The rhythm section in *Old Friend* (addressed to Holly) doesn't quite hold a steady speed. That's not itself characteristic, but what it represents—that the production will have scuff marks visible on it somewhere—is, being parallel to what happened to the vocal mix in a couple of songs in "Dreaming My Dreams" and to odd moments in several other albums. Aesthetically, none of this is very serious. It seems to go with the slightly erratic judgment Jennings exercises in choosing what songs to sing. Some people claim he makes *any* song his own, but I don't think so; I think there is such a thing as a Waylon Song, as there used to be such a thing as a Weavers Song. *Lonesome, On'ry and Mean*, written by Steve Young, is one, and Neil Young's *Are You Ready for the Country* (to say nothing of the Rolling Stones' *Honky Tonk Women*) is not, but the reasons why have little to do with how country or non-country or how cowboy or non-cowboy the song is, or with any of that image stuff.

What seems crucial, rather, is some sort of resonance with the experience you can hear in

Jennings' voice and with the literary statement he is trying, with his whole life-style, to make. A voice like that is partly but not entirely a matter of luck and technique. He has learned a thing or two about technique—notice the "trained" way he squeezes out high notes, yet keeps them in character with the easier, more natural way he makes lower notes. But what really shapes his sound is the awareness he soaked up through experience and the memory he kept of how it felt. He makes it seem all right to be over thirty and have a few scars—and maybe that, too, helps explain his popularity just now; maybe there's a reaction against the youth-worshipping that sold like McDonald's hamburgers a few years back. He advocates, mostly in indirect ways, *finding out for yourself*, winning a few and losing a few in your own human and therefore fumbly way. Subtle things about a song convey whether it knows about this in its bones, the way he does.

His own writing, while he still isn't prolific, is increasingly a factor. It is simple, but when it works (as in *Waymore's Blues*, a two-chord song), it suggests something about a background of old Southern-poverty folkways careening around in the same head with modern doubts and stresses. And Jennings bridges those worlds, along with the generation gap and several other paradoxes. One thing I suspect he is wary of now is the idea of leading this "redneck rock" thing, for you can't go your *own way* leading a counter-establishment any more than you could by following the old one.

Jennings hasn't beaten the machine, of course; the machine will be back, outlasting him as it outlasted John Henry. But he is still good news: as a practical matter, it isn't the next thousand years but what's left of one's own lifetime that counts most, and, with the kind of encouragement Jennings lends, maybe one can manage to beat back the uglier tentacles of progress for that long. "Nothing is relevant any more," Gore Vidal said. "What the individual has to do now is order his own survival." Waylon Jennings, in his own style, seems to have said that first. —Noel Coppage



DOUBLE SAVINGS

FEATURING
Technics by
Panasonic



MODEL
SL-1500

Mail order shopping is made easy the
AUDI EXPO
way. Freight and insurance are already
included in low Audio-Expo price.

**THE PRICE YOU SEE IS THE
PRICE YOU PAY!!**

AUDI EXPO
701 E. Gude Drive
Rockville, Md. 20850
301-340-7707
SEND FOR PRICE QUOTES

ent Me: *Supergirl: I'll Buy You an Island*; and five others. PRIVATE STOCK PS 2008 \$6.98, © 8300 2008 H \$7.98, © 5300 2008 H \$7.98.

Performance: **Good**
Recording: **Clean**

My review of the Troggs' last album (November 1975) was unnecessarily harsh and, worse, half-accurate. I believed they meant to satirize rock's silly sexual machismo—the yearnings of male adolescents to be stallions when they're really titmice—but I thought the band was clumsy about it, and not that funny. Shortly after writing the review I met the Troggs and found them delightful. Lead singer Reg Presley—a bright, talented comedian—told me he selected *Wild Thing*, their most famous number, out of various songs submitted to the band in 1966 because "it was so dreadful I thought it had to be the worst dud ever or an absolute smash." When I went home and played that last album (Pye 12112) again, it all made much more sense: the satire was funnier, and I found their version of *Memphis* quite good on its own terms.

On this present album the stretched-out *Gonna Make You*, with a Bo Diddley rhythm figure and good guitar solos, and their version of Rufus Thomas' old wowsler, *Walkin' the Dog*, are both very danceable and foot-tappable. The Troggs are a hard-working, experienced, unpretentious club and pub band, and that they are playing for the sheer pleasure of it all comes across very well in "The Trogg Tapes." J.V.

COLLECTION

WESTERN SWING. Tune Wranglers: *Up Jumped the Devil*. Jimmie Revard: *Blues in the Bottle*; *My Little Girl I Love You*. W. Lee O'Daniel: *Don't Let the Deal Go Down*. Milton Brown: *Hesitation Blues*; *Garbage Man Blues*. Light Crust Doughboys: *Gin Mill Blues*; *Weary Blues*. Adolph Hofner: *Brown Eyed Sweet*. Cliff Bruner: *Milk Cow Blues*; *Tequilla Rag*. Rambling Rangers: *Gettin' Tired*. Washboard Wonders: *Feather Your Nest*. Bob Willis: *Liza Pull Down the Shades*. OLD TIMEY © LP 116 \$6.98.

Performance: **Hoe-down down home**
Recording: **Good mono transfers**

The country fiddling of the Tune Wranglers' Tom Dickey which opens side one of this album is misleading because most of the selections that follow have little or nothing to do with white country music. True, some of the performers represented are identified with hillbilly music, but what they play on these sides—made between 1934 and 1941—has its roots in black music. *Garbage Man Blues*, played by Milton Brown and His Musical Brownies, is a Cab Calloway-sized version of *Garbage Man*, recorded two years later by the Harlem Hamfats, but probably originating in the Twenties as a bit of humor injected into such numbers as Luis Russell's *Call of the Freaks*. Musically, the Russell and Hamfats recordings are of considerably more interest, but jazz listeners should not dismiss the Musical Brownies lightly. The same goes for most of these sides, but I am puzzled by the inclusion of *Up Jumped the Devil*, the aforementioned first track, and Cliff Bruner's *Tequilla Rag*, neither of which seem to fit into this collection. Despite the Grand Ole Opry-type humor, there is much worth listening to. C.A.

(Continued overleaf)



**The only thing better than being there
is being there again**



Music. Record it right. On the only premium blank tape good enough to wear the name—The Music Tape™ by Capitol®. It's designed specifically to record music with wide frequency response, low noise and low distortion. Nobody knows music better than Capitol...

... knows the subtle colors of treble, bass and mid-range.

Listen. Record. Listen. The Music Tape by Capitol takes you there again and again and again.



the music tape™
BLANK CASSETTES, CARTRIDGES & REEL TO REEL
BY CAPITOL

records music

CAPITOL MAGNETIC PRODUCTS A DIVISION OF CAPITOL RECORDS, INC., HOLLYWOOD, CA

JAZZ



ELVIN JONES: *The Main Force*. Elvin Jones (drums); Pat LaBarbera, Dave Liebman, Frank Foster, Steve Grossman (reeds); Albert Dailey (piano); Ryo Kawasaki (guitar); Dave Williams (bass); Angel Allende, Dave Johnson (percussion). *Mini Modes; Sweet Mama; Salty Iron*; and two others. VANGUARD VSD 79372 \$6.98.

Performance: **Excellent**
Recording: **Very good**

This is Elvin Jones' second album for Vanguard, and, because it has no special electronic effects, it represents a vast improvement over his first. Some of the same musicians are on hand—a good bunch, as you can see from the above listing—and the creative juices are flowing freely throughout. Most interesting is *Song of Rejoicing After Returning from a Hunt*, which takes up most of side two and is a piece adapted by Jones from the Djiboko rhythm of the Ba-Benzele pygmies, arranged by bassist Gene Perla. With raspy reeds, raspy percussion, hand claps, and strategically placed bass notes, it may not bear much resemblance to anything produced by the obscure tribe that suggested it, but it could, itself, easily become a source of inspiration. Elvin Jones spent part of his career drumming for John Coltrane, and the traces of that experience are now diminishing as he comes into his own. This is Jones' most personal statement so far.

C.A.

THAD JONES/MEL LEWIS: *New Life*. Thad Jones/Mel Lewis Orchestra. *Greetings and*

Salutations; Cherry Juice; Forever Lasting; and four others. HORIZON SP 707 \$5.98.

Performance: **Well oiled**
Recording: **Very good**

The Thad Jones/Mel Lewis Orchestra is still one of the finest big bands around, but I must confess that my taste buds have recently been sharpened by the Toshiko Akiyoshi/Lew Tabackin band (see my August review), and I find faults with the Jones/Lewis aggregation that hitherto have escaped me. Though it abounds in enormously talented individuals, including its co-leaders, there is a stiffness about the band, especially the brass section, that leaves me with the impression that its members no longer really enjoy what they are doing. The arrangements—especially those by Thad Jones, which is most of them—are lifeless compared to those of Toshiko, and they belong back in the late Fifties.

This album is a good one, but it does not begin to approach the "Potpourri" album, and I'm afraid Ms. Akiyoshi has left Jones and Lewis in the dust.

C.A.

JOHN KIRBY: *Biggest Little Band in the Land*. John Kirby (bass); Charlie Shavers (trumpet); Russell Procope (alto saxophone); Buster Bailey (clarinet); Billy Kyle (piano); O'Neil Spencer (drums). *B-Flat Special; Old Fashioned Love; The Peanut Vendor; Bugler's Dilemma; Sextet from Lucia di Lammermoor*; and nineteen others. CLASSIC JAZZ © CJ 22 two discs \$9.96.

Performance: **Organized swing**
Recording: **Good mono**

The John Kirby band heard in this set began recording for Decca in 1938 and later moved out to Vocalion, Okeh, Columbia, and Victor. The war forced changes in personnel, and—although some of the replacements were actually better musicians—the band's popularity began to decline. By the mid-Forties, Kirby was recording for such minor labels as Asch, Disc, Apollo, and Crown (a 1946 session for the last represents Sarah Vaughan's recording debut), but, though he continued leading bands for another four years or so, he never recovered from the decline begun in 1942,

when this particular band broke up. He died in 1952.

Besides its many commercial recordings, the Kirby band made numerous radio transcriptions. I suspect the material in this album comes from such transcriptions, but there is something not quite right about the dates, given as 1941, 1943, and 1944. In fact, annotator Nat Hentoff seems to be deliberately vague about the source of these recordings, and one has to wonder why, particularly since the Classic Jazz label seems to have sprung from nowhere. Be that as it may, the tight little Kirby band was often too heavily arranged, but it was capable of considerable swing, and much of its output bears repetition. Its members were all outstanding musicians of proved improvisational skills, though inflexible arrangements often stifled their individuality and made them sound more like a good but dull society band—especially when they tackled the classics, which they frequently did. Thus, the twenty-four selections in this double album are a mixture of the dull and the delectable, but there is enough of the latter to make this a fine acquisition.

C.A.

MICHAEL MANTLER/EDWARD GOREY: *The Hapless Child and Other Inscrutable Stories*. Carla Bley (keyboards); Terje Rypdal (guitar); Steve Swallow (bass guitar); Jack DeJohnette (drums, percussion); Robert Wyatt (vocals); three speakers. *The Sinking Spell; The Doubtful Guest; The Insect God*; and three others. WATT/4 \$6.98 (from Watt Works, Inc., 6 West 95th Street, New York, N.Y. 10025).

Performance: **Annoying**
Recording: **Very good**

Edward Gorey's little stories are wonderfully whimsical and full of the sort of absurdities that are the hallmark of English humor, but Robert Wyatt's chanting of them is about as easy on the ears as a steam drill at close range, and whatever merit there might be to Michael Mantler's music is voided by Wyatt's inglorious interference. The six stories so desecrated here are from Gorey's collection *Amphigorey*, published by G. P. Putnam's Sons, 1972—I recommend the book.

C.A.

GEORGE MURIBUS: *Brazilian Tapestry*. George Muribus (piano); other musicians. *The Dolphin; Night Flower; Alon*; and four others. CATALYST CAT-7602 \$6.98 (from Springboard International, 947 U.S. Highway 1, Rahway, N.J. 07065).

Performance: **Half an earful**
Recording: **Very good**

I was unfamiliar with the work of pianist George Muribus until I heard this album, and I didn't really get interested until I played side two. Mind you, my ears didn't exactly prick up, but, dulled by the almost twenty minutes of monotonous electronic tinkling of side one, they realized—a minute or so into *Pocrasni*, the reverse side's opening track—that Mr. Muribus in an acoustical trio setting is worth lending an ear or two to. Before I dismiss the first side entirely, let me say that Muribus alone is not to blame for its unprepossessing quality—his sin is merely that he plays the electric piano; the sins of saxophonist Vince Denham and guitarist Michael Howell are that they play at all. Muribus atones for his sin with both imagination and virtuosity on the trio side, but I am most impressed by that

(Continued on page 110)

ELVIN JONES
Freely flowing creative juices



Vanguard Records

some straight talk about loudspeaker accuracy from the people who invented it

Of over 100 speaker brands advertised on the market, all claiming supremacy for their product based on the kind of sound they produce, one leading company stands apart. It is Acoustic Research. We design, build and test our products to accurately reproduce all the sound information contained on your records, tapes and radio broadcasts, but no more. What you want from a loudspeaker is a precise recreation of what the recording engineer placed on your disc or tape, be it good, bad or mediocre. Only AR loudspeakers can guarantee you this kind of accuracy.

The most important contributors to AR loudspeaker accuracy are an original design with inherently flat frequency response (the ability to reproduce faithfully the complete range of musical sounds, including harmonics, without emphasizing or subduing any of them) and a rigorous testing program to insure that this ideal specification is fully realized in every product shipped. The flatness of AR response curves is an accepted fact. Perhaps not so well known is our insistence that every individual AR driver, and every completed system, perform to within ± 1 dB of this response curve before it may be shipped to your dealer.

We'd like you to know much more about accuracy in sound reproduction and have prepared a 36-page brochure on loudspeaker design and selection which will help you to make the most informed choice among the many options offered in the marketplace. For \$1.00 we'll send you a copy by first class mail. Or you may obtain your copy free by visiting your AR dealer. While you're there ask for an A-B demonstration of AR speakers using music with which you're familiar, against any other speakers in his showroom. We think you'll find our accurate sound the one you want to live with. For a list of AR dealers serving your area, circle reader service number or contact:

 **TELEDYNE ACOUSTIC RESEARCH**
10 American Drive, Norwood, Massachusetts 02062

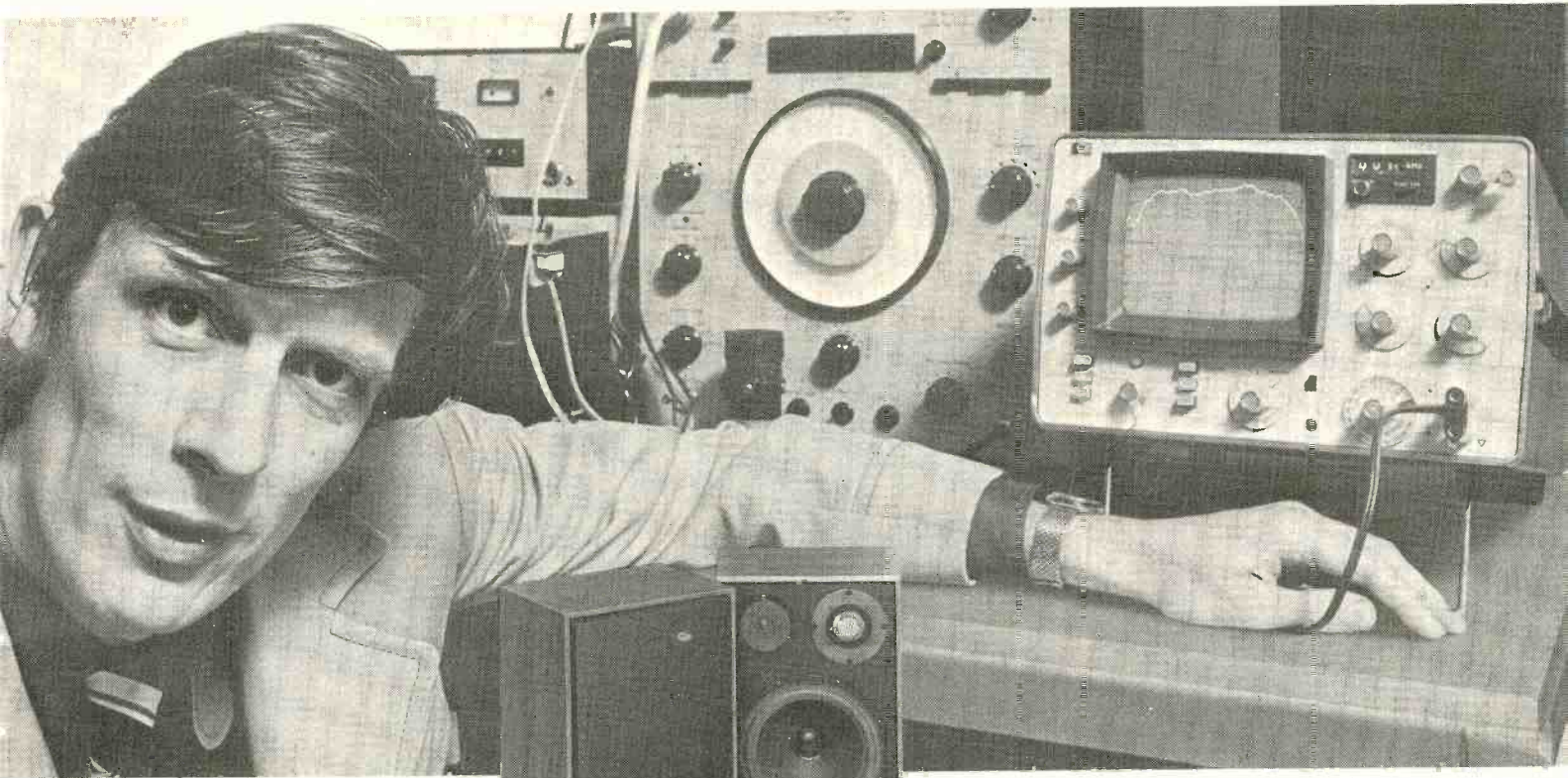

Tim Holl, Director of Engineering at Acoustic Research



AR-11 three-way loudspeaker system \$325

AR accuracy is available in speakers selling from under \$100 to \$425.

CIRCLE NO. 2 ON READER SERVICE CARD

SAVE!

MONEY • TIME • FREIGHT

QUALITY STEREO EQUIPMENT AT LOWEST PRICES.

YOUR REQUEST FOR QUOTATION RETURNED SAME DAY.

FACTORY SEALED CARTONS—GUARANTEED AND INSURED.

SAVE ON NAME BRANDS LIKE:
A.D.C. KLH
A.R. SHURE
DYNACO KOSS
SONY FISHER

PIONEER
AND MORE THAN 50 OTHERS
BUY THE MODERN WAY
BY MAIL—FROM

illinois audio

Department 217S
12 East Delaware
Chicago, Illinois 60611
312-664-0020

CIRCLE NO. 23 ON READER SERVICE CARD

SAVE

TOP QUALITY GEAR
LOWEST PRICES
PROMPT DELIVERY
SAVE ON FREIGHT
SELECTION

ROYCE CB PANASONIC
KENWOOD DYNACO
PIONEER SANSUI
DUAL BIC
and more than 50 others

PLEASE REQUEST PRICE QUOTATIONS ON YOUR CHOICE OF QUALITY STEREO GEAR

Component Discounters

DEPT. 1017SR
17565 Meadowood
Lathrup Village, Mich. 48076
313-559-1270

side's bassist, Len Lasher, who not only contributes three excellent tunes but plays so well that my other ear hasn't let his performance out yet. C.A.

PIANO RED: *Ain't Goin' to Be Your Low Down Dog No More!* William "Piano Red" Perryman (piano and vocals). *Corrine, Corrina; Do She Love Me; Please Baby, Come On Home; Everyday I Have the Blues;* and six others. BLACK LION BL-311 \$6.98.

Performance: **Fine**
Recording: **Good remote**

Piano Red was sixty-three in 1974 when he recorded this album at the Montreux Jazz Festival, but he doesn't sound a day older than he did twenty-five years ago when he began recording hit singles for RCA Victor. He has a stomping, rollicking style that can make even the most finely tuned piano sound off, but he knows what he is doing and what he does obviously comes from deep within. This album proves that some things never change, and perhaps some things ought not to. C.A.

IRA SULLIVAN. Ira Sullivan (trumpet, flute, Afuche, soprano and tenor saxophones); others. *Jitterbug Waltz; Dove; Finlandia; Slightly Arched/Spring Can Really Hang You Up the Most;* and four others. HORIZON SP-706 \$5.98.

Performance: **Antiseptic**
Recording: **Excellent**

To read the liner notes for this album is to be told that Ira Sullivan is some sort of jazz Garbo, a star about whom superlatives are whispered, whose name evokes awe, a man—no, legend—who apparently no longer wants to be alone. We are also told that Mr. Sullivan sounds much better in person—I hope that's true. Not that he sounds bad here, but what they give you to listen to is disappointing after you have read what they give you to read.

Actually, Ira Sullivan, at the age of twenty-one, became a member of the house band at Chicago's Bee Hive, where for a little over two years he helped accompany jazz stars of the caliber of Lester Young, Roy Eldridge, and Charlie Parker. He played briefly with Art

Blakey in 1956 and retired to Florida in the early Sixties, and that's about it. Granted, he made a name for himself on the local Chicago scene twenty-five years ago, but to package him as some sort of saint is both ludicrous and a disservice to him. This is a very nice album—no more than that. C.A.

SPOKEN WORD



RECORDING OF SPECIAL MERIT

MONTY PYTHON: *Live! At City Center.* Graham Chapman, John Cleese, Terry Gilliam, Eric Idle, Terry Jones, and Michael Palin (performers). ARISTA AL 4073 \$6.98.

Performance: **Disgusting!**
Recording: **Audible, unfortunately**

That motley crew, Monty Python's Flying Circus, is up to their squalid, sordid little tricks in another hilariously funny album. This is a recording of what, essentially, went on at the scene of the crime during their engagement earlier this year at New York's City Center. While some of the best lines are overlapped by audience laughter, there is enough classic Pythonomania intact to make it required listening. My all-time favorite is included: *The Death of Mary Queen of Scots*, a pseudo-BBC radio drama introduced by one of those appallingly jaunty, Britannic airs that the likes of Eric Coates used to specialize in. It opens with an inquiry as to whether the lady is indeed Mary, Queen of Scots, and, when the reply is in a heavily burred affirmative, the next minute or so is spent on the noisiest

MONTY PYTHON

Up to their usual squalid, sordid tricks on another hilarious album



Arista Records

sound effects heard since World War II to indicate Mary's dispatch. After a brief silence one of her assaulters comments, "She must be dead." "Oh no, I'm not!" is her game retort, and the noises continue into fadeout. This is Episode Two of the serial, and to me represents the specially endearing looniness of the Python style: the mere thought of a supposed audience sitting down week after week in front of the "wireless" to hear Mary being pursued around her castle by what sounds like half of the English army, exchanging wise nods with each other as sound effect piles upon sound effect, is to me what makes Python as incisive about mocking the English character as anyone since Shaw.

As usual, the members of the company treat each other with the astonished outrage of a Colonel Blimp propositioned at a Patagonian wedding. Very funny stuff indeed. P.R.

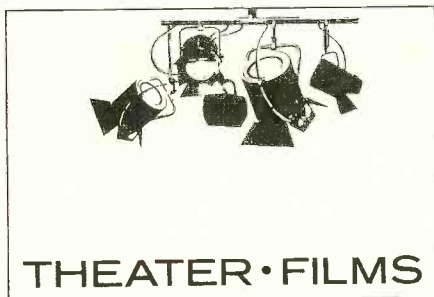

THEATER • FILMS

SHIRLEY MACLAINE: *Live at the Palace.* Shirley MacLaine (vocals); Shirley's Gypsies (instrumentals). *If My Friends Could See Me Now; My Personal Property; Remember Me?/Big Spender; Irma La Douce/I'm a Person Too;* and five others. COLUMBIA PC 34223 \$6.98, © PCA 34223 \$7.98, © PCT 34223 \$7.98.

Performance: **Bring on the videodisc!**
Recording: **Very good**

In his liner notes for this album, Elton John tells how he finally twisted the star's arm to get him two tickets to her show and found the lady's performance "quite simply a lesson in professionalism." But in the final paragraph he pleads, "Bring on the videodisc!" I'm inclined to agree with him. The vivacious, red-headed MacLaine is hard not to love as she warms up her audience, reminds them how she rode to fame "on Carol Hainey's broken leg" when she first appeared during the run of *The Pyjama Game*, bursts into autobiographical song ("Seems every time I take a trip I write a book . . ."), and knocks herself out singing songs from *Sweet Charity* and *Irma La Douce*. But the sparkling-eyed, energetic, high-kicking soul that is MacLaine in performance really has to be seen as well as heard. Just singing, even when accompanied by her team of Shirley's Gypsies, she isn't exceptional enough to rivet one's attention for a whole LP—although her version of *The Donkey Serenade* as *The Rudolf Friml Hustle* is almost enough to save the day. But not quite. Judy Garland she ain't. In the end, Shirley as voice alone wears out the listener—and a little of her own welcome. P.K.

MY FAIR LADY (Alan Jay Lerner-Frederick Loewe). Original 1976 Broadway-cast recording. Ian Richardson, Christine Andreas, George Rose, Robert Coote, others (vocals);

OCTOBER 1976

let's make it dynakit

Stereo components . . . easy to make kits or assembled.

Write for free 24 page color catalog **DYNACO**
Dynakit

Made in AMERICA Dept. R, Box 88, Blackwood, N.J. 08012

The Avid 103.

Few people would expect more in a loudspeaker.



For most people, the Avid Model 103 really is the ultimate speaker.

Not that you can't pay more for a speaker. You can. A lot more.

But, for most audio enthusiasts any difference between the Avid 103 and more expensive speakers just isn't going to justify the added cost. As it is, the 103 clearly outperforms speakers costing up to twice their price.

The Avid 103.

You owe it to yourself to find out why it is rapidly becoming the popular new reference standard for 3-way systems. For your nearest Avid dealer, please write:

AVID
CORPORATION

10 Tripps Lane, East Prov., R.I. 02914

Sound products for Avid listeners.

CIRCLE NO. 5 ON READER SERVICE CARD

LOW PRICES & RELIABILITY

DISCOUNT HI-FI STEREO COMPONENTS

- RECEIVERS • SPEAKERS • TURNTABLES
- CARTRIDGES • TAPE RECORDERS

The stereo system you have long admired but just couldn't afford, may well be within your price range. DISTRICT SOUND sells to you at DISCOUNT PRICES. We have at DISTRICT SOUND most of the leading brands, and can provide one of the best selections at the best prices.

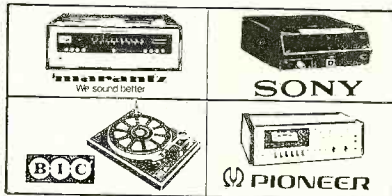

These and hundreds of other items are listed at our low discount prices in our FREE catalog. Send for catalog today.



CIRCLE NO. 15 ON READER SERVICE CARD

Save by mail on Music Systems.

Our Big Catalog Shows How!

Send today for your FREE copy of our 68-page catalog. It's value-packed with complete music systems, top-brand components, accessories, plus hundreds of unique items—and more. There's a handy "Hifi Primer," feature articles, all to help you have better sound.



Our big centrally located warehouse will serve you fast and keep freight low; and, your US and Canadian Bank-Charges are welcome.

Midwest Hifi® Wholesale and Mail Order Division

1626 Ogden Avenue (US 34)
Downers Grove, Illinois 60515
(312) 852-5885

Call for a quote. Lines open 1-4 p.m. C.T.
Mail this coupon for your FREE catalog.

Mail to: Midwest Hifi, P.O. Box 567, Downers Grove, Illinois 60515

NAME _____
ADDRESS _____
CITY/STATE _____ ZIP _____ SR10-6

orchestra, Theodore Saidenberg cond. Columbia □ PS 34197 \$6.98, © KSA 34197 \$7.98, © KST 34197 \$7.98.

Performance: **Superb**, for them as likes it
Recording: **Fabulous**

My Fair Lady has been so lavishly acclaimed and adored by audiences and critics all over the world, and its recent revival on Broadway proved such a success, that to murmur a word against it at this point might seem churlishly perverse. Yet this particular musical, for all the skill with which it weds the wit of Shaw to the songwriting talents of Lerner and Loewe, has always left this particular customer in a state of something less than enchantment. The music is just too English-music-hall hearty for me, the lyrics too glib, too facile. One original-cast album of the show and another from the movie version, therefore, have seemed quite enough for me.

Having thus laid myself open to enraged assault by the show's legion of admirers, I hasten to add that Goddard Lieberson, who had much to do with bringing *My Fair Lady* to Broadway in the first place and with the earlier, excellently crafted Columbia album, has outdone himself in the sequel. It is refreshing to hear Ian Richardson, who *does* know how to sing, making his own the Henry Higgins ballads *Why Can't the English?*, *I'm an Ordinary Man*, *A Hymn to Him*, and *I've Grown Accustomed to Her Face* even after they have become so firmly associated in our minds with the *sprechstimme* approach of the indefatigably charming Rex Harrison. Christine Andreas is more of a spitfire in Eliza's songs than Julie Andrews ever was, and she is especially intriguing, after her transformation, in *I Could Have Danced All Night*. George Rose as her pragmatic father makes the most of his big numbers *A Little Bit of Luck* and *Get Me to the Church on Time*, and Robert Coote, back in the role of Colonel Pickering, is excellent in the fleeting seconds when he is heard. As Freddy, Jerry Lanning has his big moment in *On the Street Where You Live*, and measures up beautifully. *The Rain in Spain* gets, if anything, an even more spectacular tango production than it did in the earlier recording, and everything is here, *Embassy Waltz* and all, up to and including the complete finale. Loyal fans of Harrison and Andrews may find it takes a bit of an adjustment to get used to Higgins and Eliza in their new, more full-bloodedly musical embodiments, but the recording is in every way first-rate, and those who think of *My Fair Lady* as the beginning and end of musical comedy should find the album exactly their cup of tea. For all its good qualities, though, it just isn't mine. P.K.

ARTHUR SCHWARTZ: *From the Pen of . . . Arthur Schwartz.* Arthur Schwartz (vocals); instrumental accompaniment. *Love Is a Dancing Thing; You and the Night and the Music; A Rainy Night in Rio; If There Is Someone Lovelier Than You; Alone Together; That's Entertainment;* and eight others. RCA LPL1-5121 \$6.98.

Performance: **Painful**
Recording: **Good**

Max Dreyfus, the Broadway music publisher, listened to a couple of tunes by a lawyer named Arthur Schwartz and told him to go back to practicing law. Then Schwartz met Howard Dietz and they collaborated on the score for *The Little Show*, and we've all been the better for it. *You and the Night and the*

Music, Dancing in the Dark, A Rainy Night in Rio—a Dietz-Schwartz song is the next best thing to a walk on air. (One would never guess how many of the lyrics Dietz wrote on MGM stationery while serving as vice president of the movie company.) Their songs were introduced by singers like Fred Astaire, Bing Crosby, Danny Kaye, Ella Fitzgerald, Judy Garland, and Frank Sinatra. Anybody lucky enough to have heard Libby Holman sing *You and the Night and the Music* in the original Broadway production of *Revenge with Music* knows what a great performer can do with a Dietz-Schwartz song.

Not long ago, the composer was in London and was lured into a studio to record a program of his own numbers. He should never have consented. Crooning tunelessly, he makes a shambles of some of the loveliest popular ballads ever penned. In *By Myself*, the tune isn't the big thing and he's rather touching, though certainly no Astaire; the rest is simply painful. Please, Mr. Schwartz, give us more great tunes—but let somebody more qualified sing them. P.K.



HUNGARIAN FOLK MUSIC. Sebö Ensemble (vocals and instrumentals). *Love, Love; Where Were You at Night, Titmouse?; Play the Bagpipe. Uncle John; Harvest, My Sweetheart, Harvest; The Monks Are Walking in Clogs; Jew's Harp Music;* and fifteen others. PEPITA SPLX 17482 \$6.98.

Performance: **Happy**
Recording: **Very good**

The Sebö Ensemble of Budapest opens its lively program with folk music from various regions of Hungary sung and played on traditional instruments with style and gusto. The voices are young, clean, and beautifully trained, and when the four members of the ensemble—Ferenc Sebö, Béla Halmos, Gergely Koltay, and Péter Éri—chant some time-honored Hungarian melody in unison, they produce an especially luminous tone that does honor to their material. Here are love songs, shepherd songs, folk dances quick and slow, dances of swineherds, a czardas played on a Hungarian bagpipe to make you feel you're in some Magyar section of Scotland, a quadrille, a "double walk and twirl," all executed with remarkable verve and musicianship. Side two, devoted to Sebö's own music in settings of verses by contemporary Hungarian poets, is harder to appreciate, especially since no text is supplied, but the music does come across as bright and attractive. Sebö's tunes, owing a bit more to Bartók's treatment of folk material than directly to folk music, maintain the freshness he brings to his arrangements of traditional material here as he pours new ideas into old musical molds. Worth hearing. P.K.

If our tape sounds bad on your hi-fi system you need a better hi-fi system.



Maxell tapes are the best way to see just how good or bad your hi-fi system is. Because Maxell tapes are made to stricter standards than many hi-fi systems.

To begin with, only the highest quality materials go into Maxell tapes. The finest polyester, screws, hubs and pressure pads.

Every batch of magnetic oxide we use gets run through an electron microscope. If every particle isn't perfect, the sound you hear won't be either.

Since even a little speck of dust can make a difference in what you

hear, no one gets into our plant until they've been washed, dressed in a special dust free uniform, even vacuumed.

The fact that we're such fanatics about making Maxell tapes pays off for you in the enjoyment of superior sound. And in the Maxell guarantee.

Which says if you ever have a problem with any Maxell tape, send it back and we'll send you a new one. No questions asked.

Naturally, a product this good doesn't come cheap. In fact, a single reel of our best tape costs more than

many inexpensive tape recorders.

So if you don't have a good hi-fi system, save yourself some money and buy cheaper tapes.



Maxell. The tape that's too good for most equipment.

Maxell Corporation of America, 130 West Commercial Ave., Moonachie, N.J. 07074

CIRCLE NO. 37 ON READER SERVICE CARD

Choosing Sides

By Irving Kolodin



OLD MAN DISC VS. KID CASSETTE

WHATEVER happened to the marvelously noise-free sound that impressed us so when Dolbyized discs first came to town? To judge from industry trends of recent months, those super-quiet discs have metamorphosed into an advanced new breed of cassette. To be sure, the actual physical transmutation of a flat round disc into a neat oblong cassette is rather more of a miracle than even our best merchandising minds could accomplish. But improving one system to equal or to surpass the capabilities of the other as the preferred carrier of quality sound is as easy as, oh, hitting Mars with a space probe—just a matter of technology, old man.

The old man in this instance appears to be Mr. Disc himself, now approaching his ninth-tieth year on the world market and finally beginning to show his age. There are some who say that his aches and pains, the creaks and groans that are being heard lately when he is asked to get up and perform his old tricks on the turntable, are not entirely the results of advancing age. He is not getting the kind of nourishment that kept him going for so long in good style, they say; the vinyl diet that so successfully took the place of his old soul food, shellac, is simply not what it used to be, leaving him more vulnerable than before to that old team of ailments, the Crackles and the Pops.

Were Emil Berliner, who devised the flat disc in 1887, alive today to enter a plea for his brain child, he could very well contend that it is therefore not the fault of the system itself, but of the way it is being administered. And he would very likely be right. But, for better or for worse, disc dissatisfaction definitely seems to have set in, and the air is rife with suggestions that turntable speed be cut down so that we could get a really *long* long-playing disc, that videodisc techniques be applied to audio, and even that the very means of information storage be changed from the present physical analog of the sound signal to some binary-coded system that would make it possible to get *all* the Beethoven symphonies on a single flat surface.

Such possibilities, if they are realizable, appear to be far in the future. Right now it is much easier just to take the musical track off that flat disc, stretch it out lengthwise on a reel of tape, put the result in a box hardly bigger than a cigarette case, and eliminate in the process the stylus, the friction it engenders in the groove, surface noise, scratches and other damage, turntable rumble, and virtually everything else that is irritating about Old Man Disc.



Does all this spell the end for a system whose products over the past nine decades must number in the trillions? Not likely. But if the improved cassette can sustain quality in comparable quantity without the crushing

counteracting weaknesses that inhere in the system's mechanical aspect (tape hiss, wow and flutter, snagging or breaking of the tape itself, malfunctioning of the tape guides, spindles, etc.), it may level a challenge such as the disc has never before encountered.

Has the cassette, then, finally emerged from the chrysalis stage? Can it qualify as a true tonal butterfly? The first calculated answers to these questions I encountered were presented in a series of demonstrations by London/Decca in New York last January. London disdained anything so mundane as a simple A-B test of cassette against equivalent disc; only the original master tape (or a first-generation copy of it) would do. The listener was encouraged to do his own A-B-ing and then decide which was which—master tape or cassette (the order was altered with each selection). After a few trials I thought I could detect a *slight* degree of attenuation in some frequency ranges of the cassette that was not present on the master tape, and on this slight basis of difference I made my judgment. Either my method was very accurate or the folks from England were very kind: in a majority of instances my judgment was pronounced correct.

I was by no means completely convinced, however, that a cassette was, even to that degree, indistinguishable from a master tape. Demonstrations are notoriously preplanned to produce the desired result (otherwise why give them?), and though I was by no means distrustful of London's engineers, gentlemen all, I still felt the best place to judge is at home, using equipment with whose performance one is familiar in surroundings to which one is, so to speak, attuned.

I WON'T say that I have been listening to cassettes every week since January, but I have heard a *lot* of them, not only samples sent me by half a dozen manufacturers but others chosen at random from dealers' shelves. My far from guarded comment is simply this: if the discs from the same master-tape sources were as noise-free, as well defined in transients, and as lacking in overall distortion as the cassettes I heard, nobody would be searching for an alternative system—which is *not* the same thing, of course, as saying that there are no cassette problems.

Solo-piano recordings are historically among the better challenges to the integrity of any sound system. I don't know how the cassette reproduction of Vladimir Ashkenazy's performance of the Chopin *Études* (Opp. 10 and 25) on London CSS-6844 checks out on the measuring instruments (whatever they might be), but on my personal two-ear rig it is convincingly what piano reproduction ought to be—deep, steady in sound, true and full at both ends of the scale, honestly illustrative of everything this super-talented, Russian-born Icelandic citizen has represented on the world's musical stage for a decade and a half. *Étude No. 5*, in E Major, did have a quaver in some sustained passages; I have yet to determine whether it was in the cassette itself or in the way it was being unspoiled on my cassette player.

I have not, to be sure, forgotten the con-

(Continued on page 116)

"A challenge such as the disc has never before encountered..."

We told the truth. Almost.



We erred on the side of modesty when we published the specifications and performance data of our Quartz Locked AM/FM Stereo Receiver.

Then Hirsch-Houck, a famous independent audio testing lab*, put our TX-4500 through the mill on their own. You know who they are . . . possibly the best known in the business. They said and we quote:

" . . . virtually impossible to incorrectly tune in an FM station."

" . . . sound quality in FM reception with the TX-4500 will be determined only by the quality of the broadcast program."

" . . . when playing records the sound had a definition and clarity that were unmistakable."

In fact, they compared the TX-4500 favorably with component tuners and amplifiers, and we didn't lose. While we claimed the TX-4500 would deliver 55 watts per channel, minimum RMS at 8 ohms, both channels driven, from 20 Hz to 20 kHz with no more than 0.1% Total Harmonic Distortion, they found Total Harmonic Distortion less than 0.02% at middle frequencies; 0.09% at 20 Hz, and 0.04% at 20 kHz.

We said IM distortion was 0.1% at 1 watt. They found it between 0.01% and 0.02% at most power levels from 1 to 40 watts.

You should also know about our FET/4-gang variable capacitor front end. Our circuitry with 70

transistors, 8 IC's and 59 diodes, plus the FET. About provision for three sets of speakers and three tape recorder circuits, each controlled by its own pushbutton.

You might also be interested in detented tone controls and center detent balance control. Phase Locked Loop Multiplex.

But mostly, you have to see what Quartz Locked tuning does, verified by the lab that the system invariably resulted in the lowest possible distortion and noise and best stereo separation the receiver is capable of.

There's no way we can tell you everything about our "Studio on a Shelf". There's too much, and we're too modest. But, you can find out at your Onkyo dealer. He may even have a copy of the lab report. If not, write us for a copy.

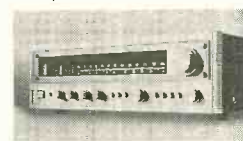

While you're at it, look into the TX-2500 also. It costs a little less than the TX-4500 and performs almost as well. Instead of Quartz Locked

tuning, the TX-2500 features Servo Locked tuning. In our own modest way we have to say it's pretty good.

So, if you can't go for the top of our line, you can come pretty close. And the best place to start is with an Onkyo dealer.

*Popular Electronics, August, 1976.

ONKYO®

ONKYO U.S.A. CORPORATION Eastern Office: 42-07 20th Ave., Long Island City, N.Y. 11105, 212-729-2323
Midwest Office: 935 Sivert Drive, Wood Dale, Ill. 60191, 312-595-2970 Canada: Sole Distributor, TriTel Associates Ltd., Ontario, Canada
CIRCLE NO. 42 ON READER SERVICE CARD

32 Page Lab Report

The most definitive and comprehensive test report ever conducted on high powered audio amplifiers—reprinted from the prestigious English journal, *Hi-Fi For Pleasure*. The spiral bound, hard-cover report presents readable research data taken from exhaustive subjective listening panel evaluations corroborated by standard laboratory tests. Some of the products reviewed in this Spring '76 report:

- Accuphase P250 • Crown D150A
- BGW Model 250 • Lux M6000
- Yamaha B1

Mailed first class upon receipt of two dollars and your full address.
Amplifier Reports, P.O. Box 3742, Dept. SR Beverly Hills, Ca., 90212

17 Amplifiers taken to task

venience angle: you can't stop the music just before Étude No. 12, say, and go back instantly to No. 6 as you can on a disc. Sorry about that; the disc does set the sundry études apart by bands, and this is handy for those who want to listen to them in some personal order. I will say, however, that searching out the precise band to repeat the sixth—rather than the fifth or the seventh—in a series of twelve is one of the best ways I know to mar a record surface and to add your own personal click to those already present when the record was unwrapped (an increasingly frequent irritation for me). You can't do that with a cassette, of course!

ANOTHER participant in the resurgence of interest in the cassette is Angel, who announced the introduction of their new XDR (which translates, so help me Noah Webster, into Xpanded Dynamic Range) cassettes with an old-fashioned demo tape. Unlike the brewer who imaginatively describes his product as "everything you want in a beer—and less," Angel apparently believes that what you want from a music system is not less (noise, distortion, wow and flutter) but more—volume, that is. And so the demo cassette begins with a nice blast by "Mars, Bringer of War" from Gustav Holst's *Planets* and continues with the snare-and-bass-drum introduction to the piano part in the finale of Ravel's *G Major Concerto* before relenting when an Albinoni adagio and a Mozart horn-concerto movement. I doubt that Fritz Kreisler would have relished his *Caprice Viennois* in the overblown sound of Itzhak Perlman's violin—but then, come to think of it, I didn't miss at all on the cassette the two solos by Pops and Crackles that marred the very first groove of the disc equivalent I just then opened for purposes of sound comparison.

All such demo material is further too reminding of the record and tape manufacturers' habit of looking to the past rather than to the future for criteria by which to guide their use of new systems. In this case, the new, improved cassette is generally being treated as just another variant, side-for-side, of the disc, a Procrustean bed in which to lay down only as much music as is contained on the corresponding twelve-inch platter. This, if perpetuated, would be a classic case of *mortem-main*, with Old Man Disc reaching out from the grave to deny forever any freedom of programming to Kid Cassette.

FORTUNATELY, an innovational attitude is being taken in this respect by a relatively recent addition to the manufacturers' ranks—the appropriately named Advent. As every user of unrecorded cassettes knows, tapes can be purchased in lengths ranging from fifteen to ninety minutes *per side*. What they may not know is that on Advent D1016 the Cantata Singers, John Harbison directing, may be heard in Bach Cantatas Nos. 7, 44, and 101 on a single cassette with a playing time of 72 minutes (29'44" on side one and an epoch-making 42'33" on side two). The sound is of excellent quality, gratefully noise-free. On another Advent cassette (D1005), Carl Nielsen's *Symphony No. 5* is followed by his *Saga-Dream* on a single side of 44 minutes. Side two is *blank* and may be used to record what you wish. Which, in the cassette world, is a reminder that if you don't like Ashkenazy's Chopin you can erase it and replace it with a recorded performance of your wife. No disc can make the same claim.

PRICE WAR

AMERICA'S #1 VALUE LEADER

STEREO CORPORATION OF AMERICA

TEAC	PIONEER	SHURE
WRITE US NOW FOR LOWEST PRICE QUOTE		
MARANTZ	E.P.I.	B.I.C.

AUDIO DISCOUNTING STARTED IN NEW YORK & NOW WITH THE END OF FAIR-TRADE WE ARE SURE THAT NO ONE CAN BEAT OUR PRICES:

- We Discount Over 70 Major Brands
- Over 10 Years Of Reliable Service In The Mail Order Field
- Largest Inventory/Lowest Prices!

We Get The Best Deals From The Manufacturers. You Get The Best Deal From Us!

SHOP BY PHONE!

(212) 253-8888
 9-5 Mon. thru Sat.
 Use Your Charge Card

WRITE OR CALL!

FREE Stereo Price Catalogue

STEREO CORPORATION OF AMERICA

S-R 1629 Flatbush Ave.

Brooklyn N.Y. 11210

Tel: (212) 253-8888

CIRCLE NO. 59 ON READER SERVICE CARD

HI-FI SAVE ON

Brand Name Audio Components

BY MAIL

Write Today for Our FREE Audio Catalog

DIXIE is one of the oldest and largest audio component mail order houses in the country. Our prices on brand name components are actually LOWER than "Discounters". See our new catalog or call us for a price quote. Everything shipped factory-sealed with full manufacturer's warranty.

Master Charge / BankAmericard honored on mail orders		KOSS
PIONEER	MARANTZ	SHURE
SONY	DUAL	DYNACO

DIXIE HI-FI

SR-10

2040 Thalbro Street, Richmond, Va. 23230
 Phone: (804) 257-4241

Please rush me your FREE Audio Catalog and complete information. I understand there is no obligation.

Name _____
 Address _____
 City _____
 State _____ Zip _____

TOP Discount AUDIO

Your NATIONAL HEADQUARTERS

For Famous Brand Electronics By Mail

1150 N. Powis Rd., West Chicago, Ill. 60185 • (312) 293-1825

All Orders Shipped In Factory-Sealed Cartons

Write Or Call For The Lowest Prices Anywhere!

MILLION \$\$\$ INVENTORY

LOWEST PRICES ON

- | | | |
|-------------|------------|------------|
| RECEIVERS | TURNTABLES | TUNERS |
| SPEAKERS | CHANGERS | CARTRIDGES |
| TAPE DECKS | AMPLIFIERS | HEADPHONES |
| CALCULATORS | COMPACTS | CAR AUDIO |

Top Discount Audio 1150 N. Powis Rd. West Chicago, Ill. 60185
 SR-10 (312) 293-1825

We honor Master Charge and Bank Americard. Date _____
 Please send me a quote on: _____

MR.
 MS.
 (First) (Initial) (Last)
 (Number And Street)
 (City) (State) (Zip Code)

CIRCLE NO. 62 ON READER SERVICE CARD

“...no other singer so moving, so delightful, or so important”



Harper & Row

Happy Birthday, Ethel Waters

ETHEL WATERS will be eighty on October 31, and on that day I shall no doubt be recalling how, during the several years of study and research I put into my book *The Great American Popular Singers*, I found the work of no other singer at once so moving, so delightful, so instructive, and so important.

Moving. I cannot, to this day, listen to her 1933 recording of *Stormy Weather*—and I have played it hundreds of times—without choking up. The sense of personal tragedy, despair, and wretchedness that she brought to “Can’t go on”—digging into that final consonant—and to the improvised sobbing cadence on “keeps rainin’ all the time” is matched for heart-rending eloquence in my own experience of American popular singers only by Fanny Brice’s *Secondhand Rose* and Hank Williams’ *Ramblin’ Man*.

But she could be just as amusing as she was moving. Her 1931 recording of *You Can’t Stop Me from Loving You*, a hit for her in Lew Leslie’s show *Rhapsody in Black*, is a

comedy masterpiece, joyously memorable for her own obvious joy in tackling one of the most outrageous rhymes ever perpetrated in English: “[You can] even put a thistle where I sit/You can make me take vanilla when you know I’m crrrrazy about choco-lit.” Her send-ups of Josephine Baker in *Harlem on My Mind*, of Rudy Vallee in *You’re Lucky to Me*, and of Al Jolson in *Memories of You* are parody and mimicry of the highest order.

She was so much more than simply a singer of songs. She was essentially (and this is true, too, I think, of Peggy Lee) an actress, a singer for whom song was a means of characterization. Listening to her records is like going to the theater. There is always a situation—sometimes tragic, sometimes comical—and a character, a person, reacting to that situation just as that sort of person would react.

Not surprisingly, she carried this theatrical flair into the real theater, and so successfully that she is now remembered primarily as the great actress whose Hagar in *Mamba’s*

Daughters, Petunia in *Cabin in the Sky*, and Berenice Sadie Brown in *The Member of the Wedding* rank among the glories of American theater history.

Those theater triumphs rather overshadowed her earlier achievements as a singer, and I have always felt this to be unfortunate. They may have been her greatest, but they were not, in a historical sense, her most important. What Ethel Waters meant to American culture is evident today not in the work of American actors and actresses, but in the work of the singers who were her contemporaries and successors—Mildred Bailey, Connie Boswell, Lee Wiley, and Billie Holiday among the ladies, Bing Crosby, Perry Como, Tony Bennett, and Frank Sinatra among the gentlemen. They all knew her, admired her, and learned from her.

SHE was a transitional as well as a seminal figure, her career covering and, to a large extent, exemplifying and even inspiring the emergence of the black artist/entertainer from the segregated world of black vaudeville, black clubs, and race records into the mainstream of American musical and theatrical culture. The breakthrough came in 1933 when Irving Berlin, having heard her sing *Stormy Weather* at the Cotton Club, recruited her for his satiric review, *As Thousands Cheer*, starring Marilyn Miller, Clifton Webb, and Helen Broderick. True, Bert Williams had starred in the *Ziegfeld Follies* when Ethel Waters was growing up in the slums of Chester, Pennsylvania, and South Philadelphia. But Bert Williams appeared in blackface.

Her legacy of records on LP provides an instructive chronology of her development as an artist from the insouciant “cake-walking baby” and sometime soft pornographer (*My Handy Man*, for example) of the Twenties race records to the eloquence and elegance of *Stormy Weather* and *Taking a Chance on Love*. On “Oh Daddy” (Biograph BLP-12022) she can be heard singing some of the songs she recorded for Harry Pace’s Black Swan label beginning in 1921. A wider selection, covering the decade 1925-1934, is provided by the two-disc album “Ethel Waters—Greatest Years” (Columbia KG 31571); it has excellent notes by Frank Driggs. But I have found the best cross-section, in terms of the quality of both material and performance, to be “Ethel Waters—On Stage and Screen 1925-1940” in the Columbia Hall of Fame series (CL-2792).

IN 1957 Ethel Waters emerged from a physical (the former Sweet Mama Stringbean was tipping the scales at 350) and spiritual crisis to take up a new career as a member of evangelist Billy Graham’s Crusade, singing a new gospel repertoire abundantly represented on Word W-3100 and W-3173. A discography by George Finola listing 259 recordings, most of them now collectors’ items, is summarized as an Editor’s Note at the end of Ethel Waters’ second autobiographical book, *To Me It’s Wonderful* (Harper and Row, 1972).

To you, Miss Waters, It; to me, You. Happy birthday!



CLASSICAL DISCS AND TAPES

Reviewed by RICHARD FREED • DAVID HALL • GEORGE JELLINEK • PAUL KRESH
STODDARD LINCOLN • ERIC SALZMAN

J. S. BACH: *Prelude and Fugue in D Major (BWV 532); Wir glauben all' an einem Gott (BWV 740); Bist du bei mir (BWV 508); O Gott, du frommer Gott (BWV 64, No. 4); Chorale Fantasia (BWV 129, No. 5); Vom Himmel hoch, da komm' ich her (BWV 738; 606; and 248, No. 9); Nun komm' der Heiden Heiland (BWV 659); Jesu, joy of man's desiring (BWV 147, No. 10); Herzlich tut mich verlangen (three settings, BWV 727; 161, No. 6; and 248, No. 64). **REICHE:** *Abblasen.* Don Smithers (clarino trumpet, piccolo trumpet, cornetto, and trumpet); William Neil (organ); Clarion Consort. PHILIPS 6500 925 \$7.98.*

Performance: **Excellent**
Recording: **Resonant**

Beginning with the premise that the performance of music for trumpet and organ is comparatively recent and that the best repertoire for the combination comes from the Baroque era, Don Smithers has recorded an album of arrangements drawn largely from the chorale preludes of Bach and logically called "Bach's Trumpet." The results are entirely convincing, as the trumpet, in this velvety combination, takes on the function of a richly over-toned organ stop. Moreover, Mr. Smithers is a first-class performer on those terrifying Baroque trumpet types, the clarino trumpet and the piccolo trumpet. In his hands these instruments stop being freaks and turn into vehicles of musical expression. One forgets his technical prowess as one more beautifully melodic line after another drops from his lips. He is

amply supported by William Neil and the Clarion Consort, which includes more trumpets, violin, viola, and kettledrums. **S.L.**

BARBER: *Adagio for Strings, from Op. 11* (see **IVES**)

BARTÓK: *Piano Concertos Nos. 1 and 3* (see **Best of the Month**, page 86)

BEETHOVEN: *Symphony No. 9, in D Minor* (see **Going on Record**, page 60)

RECORDING OF SPECIAL MERIT

BERLIOZ: *Overtures: Le Corsaire; Béatrice et Bénédict; Les Francs-Juges; Benvenuto Cellini; Le Carnaval Romain.* London Symphony Orchestra, Andre Previn cond. ANGEL □ S-37170 \$6.98.

Performance: **First-rate**
Recording: **Outstanding**

BERLIOZ: *Le Carnaval Romain: Overture. Les Troyens: Royal Hunt and Storm. Roméo et Juliette: Queen Mab Scherzo; Love Scene. La Damnation de Faust: Menuet des Follets; Danse des Sylphes; Marche Hongrois.* John Alldis Choir; London Symphony Chorus; London Symphony Orchestra; Orchestra of the Royal Opera House, Covent Garden, Colin Davis cond. PHILIPS 6580 116 \$7.98.

Performance: **Good**
Recording: **Good to excellent**

As far as I can determine, this is André Previn's first disc excursion into the Berlioz repertoire, and he gives us stylish readings abounding in both musicality and panache. In my opinion the finest thing in his collection is a badly needed, up-to-date version of the *Francs-Juges* Overture (a Solti/Chicago Symphony performance has yet to be issued here by London). I have always regarded this piece as one of the most brilliant achievements of the young Berlioz, marked among other things by extraordinarily resourceful use of bass drum and timpani in a suspenseful *sotto voce* development episode. Moreover, Angel's producing-engineering team has come up with striking sonics. No less excellent are Pre-

vin's treatments of the *Corsaire*, *Beatrice and Benedict*, and the overworked *Roman Carnival*, though I would have liked a bit more fire and brimstone in *Benvenuto Cellini*.

The Colin Davis assemblage, derived from earlier recordings, has its special fine points, in particular the *Romeo* excerpts. It is good to have the Love Scene available apart from the complete album, and I was pleased to see that the opening off-stage choral bits for the guests leaving the Capulets' ball are included. The 1966 *Roman Carnival* performance is still splendid, and, after a somewhat bland first half, Davis works the Royal Hunt and Storm up to a rousing climax. The sound is good throughout, if somewhat variable in accord with recording date and locale. The *Romeo* and *Roman Carnival* tracks fare best. **D.H.**

BRAHMS: *Symphony No. 2, in D Major, Op. 73; Variations on a Theme of Haydn, Op. 56a.* Concertgebouw Orchestra, Amsterdam, Bernard Haitink cond. PHILIPS 6500 375 \$7.98, © 7300 375 \$7.98.

BRAHMS: *Symphony No. 2, in D Major, Op. 73.* Vienna Philharmonic Orchestra, Pierre Monteux cond. LONDON STS 15192 \$3.49.

Performances: **Splendid Haitink, vintage Monteux**
Recordings: **Haitink has it**

The particular splendors of Bernard Haitink's disc are to be found in his reading of the Haydn Variations, which offers momentum and excitement together with gorgeous orchestral playing and superb sonics. The symphony performance is no less lovely, but for my taste could do with more intensity than it gets here.

The late Pierre Monteux recorded Brahms' Second Symphony twice in the early Sixties. This is the earlier of the two; it made its initial appearance over here on RCA's budget Victrola label. The London Stereo Treasury reincarnation offers a somewhat richer sound but is still to my ears a little heavy in the bass and, as a partial consequence, a mite thin in the violin sound. The reading is spacious in phrasing and unhurried in tempo, the sense of am- pleness being reinforced by the seldom-used

Explanation of symbols:

- Ⓡ = reel-to-reel stereo tape
- Ⓢ = eight-track stereo cartridge
- ⓐ = stereo cassette
- = quadraphonic disc
- Ⓡ = reel-to-reel quadraphonic tape
- Ⓢ = eight-track quadraphonic tape

Monophonic recordings are indicated by the symbol Ⓜ

The first listing is the one reviewed; other formats, if available, follow it.

exposition repeat in the first movement. There is formidable competition in the budget-price division for this Monteux reading, most especially from Steinberg, Beecham, and Walter. *D.H.*

CARPENTER: *Adventures in a Perambulator* (see *Going on Record*, page 60)

COPLAND: *Quiet City* (see *IVES*)

COWELL: *Hymn and Fuguing Tune No. 10 for Oboe and Strings* (see *IVES*)

CRESTON: *A Rumor* (see *IVES*)

RECORDING OF SPECIAL MERIT

DEBUSSY: *Études for Piano*. Paul Jacobs (piano). NONESUCH H-71322 \$3.96.

Performance: **Suave**
Recording: **Sonorous**

Paul Jacobs is probably best-known as an interpreter of contemporary music both in Europe (where for a number of years he was the new-music pianist) and in this country (where he has appeared in innumerable new-music performances; he is the pianist and harpsichordist of the New York Philharmonic as well). Like many such artists, however, his range is wider than his reputation. His affinity for Debussy is clear. Debussy is the real starting point for much twentieth-century music, and the particular qualities of his art have an obvious appeal for a pianist who lived in France for many years and who has many connections with French culture and musical life.

The Debussy *Études* are unusual works—even in the composer's unusual output. They were written in 1915, close to the end of Debussy's career, and, along with the late sonatas, they represent a series of forays into new territory. They are personal, varied, difficult, unpredictable, polished, and intimate—late Debussy, and not crowd-pleasing.

They are ear-pleasing, though, especially in the intimacy of recordings. In these suave, elegant, insightful performances, they have a hard yet sensuous, precious glow. The piano sound is something special: gentle, full, not at all clangorous, just right for the music. *E.S.*

FALLA: *El Amor Brujo*. **GRANADOS:** *Goyescas*, *Intermezzo*. **RAVEL:** *Alborado del Gracioso*; *Pavane pour une Infante Défunte*. Nati Mistral (mezzo-soprano, in Falla); New Philharmonia Orchestra, Rafael Frühbeck de Burgos cond. LONDON STS 15358 \$3.98.

Performance: **Superb**
Recording: **Very good**

For anyone who cares for Spanish music this is an important record. Falla composed *El Amor Brujo*, a ballet with three vocal movements, for the gypsy dancer Pastora Imperio, who had considerable success with it in staged performances, as did La Argentina and Argentinita. But opera singers have appropriated the work in the concert hall and on recordings. In their efforts to convey gypsy passion they (and their conductors) usually give wildly exaggerated interpretations. Seeking a more authentic voice, Frühbeck de Burgos invited Nati Mistral, a popular singer with classical training, to record it with him, and the result was a brilliant performance, issued here by London Records (CS 6521) in the late 1960's. Out of the catalog for several years, it

has now been reissued in the Stereo Treasury Series.

The Granados and Ravel pieces that fill out the disc are well played, particularly the *Alborado del Gracioso*, but the Falla is of principal interest. Frühbeck sacrifices nothing in sensuousness and tonal color but maintains the restraint and rhythmic stability necessary for Spanish music. Nati Mistral's familiarity with the gypsy idiom, her excellent diction, and her ability to color her voice to express the meaning of words make her the ideal interpreter of this music. With her simple, direct approach she conveys more feeling than the whooping and growling opera singers. When she sings "*Soy la mar en que naufragas!*" ("I am the sea in which you are drowning"), I believe it. Hearing this work sung by the kind of voice for which it was written is like first hearing Soler played on the harpsichord when you have known him only on the piano.

I don't know all of the early 78-rpm record-

“ . . . one of the most beautiful records of anything ever offered to the public.”



THERE are more involved ways of saying this, but dozens of prefatory paragraphs would not alter the conclusion: this is simply one of the most beautiful records of anything ever offered to the public. Mr. Ax is a poet, with Chopin in his blood and most assuredly in his fingers. The program may not be a convenient one for encyclopedic-minded collectors, but it is one that makes eminently good sense for listening, and the fine piano sound is a further enhancement of an altogether distinguished presentation. —Richard Freed

CHOPIN: *Andante Spianato and Grande Polonaise Brillante, Op. 22; Nocturne in B Major, Op. 62, No. 1; Scherzo No. 4, in E Major, Op. 54; Polonaise-Fantaisie, Op. 61*. Emanuel Ax (piano). RCA ARL1-1569 \$6.98.

ings of this work, but I find it hard to believe it has ever been better performed on records. This is certainly the best *Amor Brujo* currently available. *William Livingstone*

FAURÉ: *Cello Sonata No. 1, in D Minor, Op. 109; Cello Sonata No. 2, in G Minor, Op. 117; Sicilienne, Op. 78; Élégie, Op. 24*. Thomas Igloi (cello); Clifford Benson (piano). CRD 1016 \$7.98.

Performance: **Good**
Recording: **Excellent**

Thomas Igloi was, I believe, still under thirty when he died last spring. His performances in this country and his playing in the Schubert C Major Quintet on CRD 1018 (Best of the Month, March 1976) gave notice of a major talent which might have risen to the very highest level; the timing would suggest this collection of Fauré's luminous works as a most touching valedictory, but Igloi is at a bit less than his best in these performances. He and his equally youthful associate play very smoothly, leaving no question about their technical assurance; they miss, I think, the essential spirit that stamps the music as Fauré's. The warmth and mellowness that so enhanced the Schubert recording mentioned above are not in evidence here, and their absence is felt. The Musical Heritage Society performance by Paul Tortelier and Jean Hubeau (MHS 833 and in the set of Fauré's chamber music, MHS 1286/90) is the one to have; it is less than half the price of the CRD, and will probably remain the classic recording of the Fauré sonatas for some time. *R.F.*

RECORDING OF SPECIAL MERIT

GILBERT AND SULLIVAN: *Trial by Jury*. John Reed (baritone), Judge; Michael Rayner (baritone), Counsel; Colin Wright (tenor), Defendant; John Ayldon (bass), Foreman; Kenneth Sandford (bass), Usher; Julia Goss (soprano), Plaintiff. D'Oyly Carte Chorus; Royal Philharmonic Orchestra, Royston Nash cond. **SULLIVAN:** *Macbeth Overture; Henry VIII—Incidental Music*. Royal Philharmonic Orchestra, Royston Nash cond. LONDON OSA 1167 \$6.98.

Performance: **Verdict favorable**
Recording: **Excellent**

Since two perfectly good D'Oyly Carte recordings of *Trial by Jury* under Isidore Godfrey's alert baton—one in stereo on London and a reprint of his old mono version on the bargain Richmond label—are currently still available, it seems rather surprising that the company should put yet another one up for sale. The art of recording has advanced so rapidly, however, and the D'Oyly Carte is in such fine condition these days that the album justifies its existence by proving to be the best *Trial by Jury* on records to date. The satirical operetta about the judge and jury who fall madly in love with the plaintiff in the course of a wildly biased breach-of-promise suit is the one that brought the collaborators together when Richard D'Oyly Carte was looking for a short work that could serve as a curtain-raiser for Offenbach's *La Perichole* in 1871. Gilbert's background as a lawyer made the setting an ideal one for his wit. Sullivan's score abounds in charm, and *Trial by Jury* has been delighting audiences ever since it opened.

Trial by Jury is the only G&S product that has no dialogue at all; the flow of the score is

A NEW RECORDING (OR 2) FOR EVERYONE.

Sills' newest portrayal.



MASSENET
THAIS
SILLS
MILNES
GEDDA

New
Philharmonia
Orchestra
MAAZEL

*SCLX-3632 (LP & Cassette)

A new Martinon classic.



BERLIOZ: SYMPHONIE
FANTASTIQUE
Orchestre National de l'ORTF
MARTINON

*S-37138 (LP & Cassette)

New Rachmaninoff LPs from Previn.



RACHMANINOFF
THE ISLE OF THE DEAD
SYMPHONIC DANCES
London Sym.

*S-37158



RACHMANINOFF
THE BELLS
VOCALISE
Sheila Armstrong · Robert Tear
John Shirley-Quirk
London Symphony Orchestra & Chorus
PREVIN

*S-37169

A bouquet of "standards" from Sir Adrian.



Tchaikovsky
CAPRICCIO ITALIEN
Marche slave · Gopak from "Mazeppa"
Rimsky-Korsakov
CAPRICCIO ESPAGNOL
Procession of the Nobles from "Mlada"
London Philharmonic
Bout

S-37227

*compatible Stereo/SQ quad



CIRCLE NO. 3 ON READER SERVICE CARD

seamless, and so, in this case, is the execution of it. Royston Nash proves a limber interpreter of its delights, and the luxury of having the Royal Philharmonic on hand for the performance doesn't hurt at all. The album also offers a bonus in the form of several selections from Sullivan's incidental music for the plays of Shakespeare—the almost too murky *Macbeth* Overture of 1888 and two delightful pieces from his *Henry VIII* suite of 1877. P.K.

GILBERT & SULLIVAN: *Utopia Limited*, or *The Flowers of Progress* (see Best of the Month, page 87)

GRANADOS: *Goyescas, Intermezzo* (see FALLA)

RECORDINGS OF SPECIAL MERIT

GRANADOS: *Twelve Spanish Dances, Op. 37*. Gonzalo Soriano (piano). CONNOISSEUR SOCIETY CS 2105 \$6.98.

Performance: **Highly poetic**
Recording: **Excellent**

GRANADOS: *Twelve Spanish Dances, Op. 37*. Thomas Rajna (piano). CRD 1021 \$7.98 (from HNH Distributors. P.O. Box 222, Evanston, Ill. 60204).

Performance: **Extroverted**
Recording: **Crisp and brilliant**

The late Gonzalo Soriano (d. 1972) will be well remembered from London's fine series of recordings of Spanish music done in the late 1950's. He brings to Granados' justly popular Spanish Dances all of the fine poetic sense, stylistic know-how, and fleet-fingered virtuosity needed to communicate the music and to present it not merely as picturesque exotica, but as the work of a truly creative spirit. Indeed, I have long considered Granados the Chopin of Spain. Like the Polish master, he was a first-rate pianist in his own right; he also was well able to compose music of superb quality not dependent on national coloration—as in the tone-poem *Dante*, recorded in 1971 by the Louisville Orchestra.

On the British CRD label, we have a brilliant rendering of the Spanish Dances by Budapest-born Thomas Rajna, whose readings reflect Liszt as much as Soriano's do Chopin. In contrast to the rich and intimate sonics of Connoisseur Society's French Pathé taping, CRD has produced a decidedly more Lisztian brilliance in its sound in keeping with Rajna's essentially bravura treatment of the music. *Chacun à son goût*—but both recordings are first-rate. D.H.

HAYDN: *The Creation*. Helen Donath (soprano); Adalbert Kraus (tenor); Kurt Widmer (bass); South German Madrigal Choir; Orchestra of the Ludwigsburger Schlossfestspiele, Wolfgang Gönnenwein cond. Vox QSVBX 5214 three discs \$10.98.

HAYDN: *The Seasons*. Helen Donath (soprano); Adalbert Kraus (tenor); Kurt Widmer (bass); South German Madrigal Choir; Orchestra of the Ludwigsburger Schlossfestspiele, Wolfgang Gönnenwein cond. Vox QSVBX 5215 three discs \$10.98.

Performance: **Bavarian bourgeois**
Recording: **Good**

These three-disc sets are billed as Volumes I and II of "The Complete Oratorios"—presumably the complete oratorios of Haydn (to

my knowledge, there is only one other true dramatic oratorio plus the choral version of *The Seven Last Words*). The performances apparently stem from a summer festival in southern Germany. The director, Wolfgang Gönnenwein, is essentially a choral director and conductor of the South German Madrigal Choir (if that is the correct translation of the German name, this may be the largest madrigal choir in the world). He has a much less deft hand with the orchestra, and there is a certain eighteenth-century spirit and polish that I miss in these good, competent performances. Haydn's music is, among other things, a conjunction of the finest aristocratic and intellectual taste of his day mixed with a deep feeling for some of the humbler things of the earth and the folk who live close to it. This



GONZALO SORIANO
Granados as the Chopin of Spain

typical Enlightenment mixture (and Haydn, who could mix Baroque counterpoint, Rococo trills, and folk music, is the perfect Enlightenment composer) is just what these solidly *burgerlich* (I almost wrote *hausfrau*) performances lack.

Only one of the soloists, the soprano Helen Donath (who is, by the way, American), creates a fully realized performance; she is an outstanding artist. The tenor, Adalbert Kraus, has a beautiful lyric tenor voice of a distinctly German type; much of his singing is highly praiseworthy, but there are a few musical (and, once or twice, technical) problems. Kurt Widner's bass sounds unpleasantly strained.

I should add that all concerned are much more at home with the homely virtues of *The Seasons*; the solo parts in this work are highly characterized, like personages in an opera, and thus they fit the personal quirks of the singers far better than the abstract Biblical personages of *The Creation*. Incidentally, wonderful as *The Creation* is, it is even surpassed by *The Seasons*, one of those great, late masterpieces with an ultimately simple exterior and all kinds of depths. Although this performance hardly plumbs those depths, it has a certain Central European simplicity and assurance that are not unpleasing. E.S.

HAYDN: *Trumpet Concerto in E-flat Major*.
NERUDA: *Trumpet Concerto in E-flat Major*.
HUMMEL: *Trumpet Concerto in E-flat Major*.
William Lang (trumpet); Northern Sinfonia

Orchestra, Christopher Seaman cond. UNICORN RHS 337 \$7.98 (from HNH Distributors Ltd., P.O. Box 222, Evanston, Ill. 60204).

Performance: **Suave**
Recording: **Good**

The Haydn and Hummel pieces on this disc have served as splendid recording vehicles for trumpet virtuosos over the past dozen years or so, but, to the best of my knowledge, the concerto by one Jan Křitel Neruda (c.1708-1780), a Czech-born, Dresden-based contemporary of Carl Philipp Emanuel Bach, is new to records. It is pleasant fare, cast in the transitional manner characteristic of the period between the glory of Bach and Handel and what was to come in the mature Haydn and Mozart.

In general, the suave performance style espoused by soloist William Lang, playing what sounds like a standard modern instrument, is most effective in the 1804 Hummel work, whose splendid slow movement, beautifully played here, is endowed with a decidedly Romantic aura. For myself, I prefer a more incisive and brilliant style in the Haydn than what comes forth here. Excellent sound, good orchestral backing. *D.H.*

RECORDING OF SPECIAL MERIT

HINDEMITH: Sonata for Horn and Piano; Sonata for Bass Tuba and Piano; Sonata for B-flat Trumpet and Piano; Sonata for E-flat Alto Horn and Piano; Sonata for Trombone and Piano. Glenn Gould (piano); members of the Philadelphia Brass Ensemble. COLUMBIA M2 33971 two discs \$13.98.

Performance: **Excellent**
Recording: **Brilliant**

The most unexpected moment on this double album of Hindemith's complete sonatas for brass instrument and piano comes just before the finale of the Sonata for Alto Horn and Piano. Mason Jones and Glenn Gould read aloud a poem—apparently written by the composer (in English?) and intended to be read by the performers—entitled *The Post-horn*. The final lines are: "Your task it is, amid confusion, rush and noise/To grasp the lasting, calm, and meaningful,/And finding it anew, to hold and treasure it." It is about as good a statement of Hindemith's credo as you could want. The fact that the sonata is written for the old-fashioned horn in E-flat is in itself significant.

Hindemith, who could play almost everything, wrote a sonata for virtually every one of the standard Western orchestral instruments and some not-so-standard ones. All of this was part of the way music oozed out of Hindemith and also part of his music-for-use philosophy. In a way, these sonatas have triumphantly vindicated his *Gebrauchsmusik* ideals since many—perhaps most—of them are now cornerstones of the repertoires of the instruments involved. Walk into a graduate recital at any conservatory or school of music in the country and it is odds on that you will hear a Hindemith sonata.

That does not mean that these sonatas are ultra-familiar to the general public. It is unusual to find them as prominently displayed as they are here; the reason is, of course, the advocacy of Glenn Gould. But a jolly set they are. With one or two exceptions (notably the "Mourning Music" that closes the trumpet sonata), this is bouncy, careful/carefree music in the unmistakable, Germanic Hindemi-

thian manner. The performances are excellent. The beauty of the brass tone is consistent and a striking illustration of the high state of brass playing in this country; Gould's playing is both uneccentric and beautiful. Excellent recordings. *E.S.*

HUMMEL: Trumpet Concerto in E-flat Major (see HAYDN)

RECORDING OF SPECIAL MERIT

IVES: Symphony No. 3. BARBER: Adagio for Strings, from Op. 11. COPLAND: Quiet City. CRESTON: A Rumor. COWELL: Hymn and Fuguing Tune No. 10 for Oboe and Strings. Celia Nicklin (oboe, English horn); Michael Laird (trumpet); Academy of St. Martin-in-

the-Fields, Neville Marriner cond. ARGO ZRG 845 \$6.98.

Performance: **Topnotch**
Recording: **Crisp and airy**

This album is a delightful Bicentennial tribute of classics and near-classics from the American chamber repertoire played by one of England's finest performing ensembles. The Ives Symphony No. 3, which fares best when played by a smallish body with impeccable intonation, gets its crispest and most outdoorsy performance on records yet—even though some of the marching hymn-tunes could be a bit looser for my taste. Barber's Adagio for Strings gets its best recorded performance ever, excluding not even the celebrated read-

(Continued on page 126)

Could the ultimate system be all Crown?

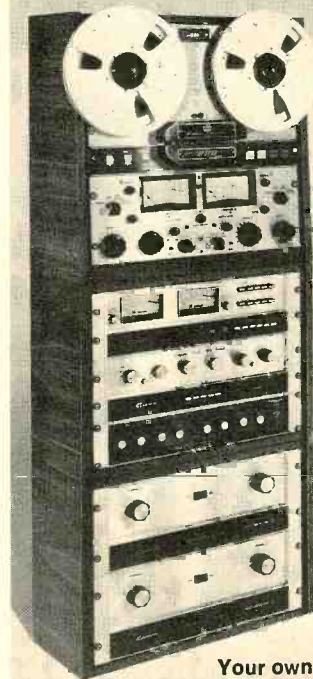

It depends on how you define "ultimate." But Crown may be the only top-quality, state-of-the-art manufacturer whose components could build a complete, ultimate hi-fi system.

For instance: A CX-824 tape deck, world-renowned for reliable performance. Connected to an IC-150 pre-amp. With the signal amplified by a DC-300A power amp, proved in many thousands of hours of professional use. Output controlled, monitored and switched by an OC-150. Possibly a VFX-2 for personal control of crossover points. And sound faithfully reproduced by ES-212 electrostatic speakers.

All Crown. We think that system would be somebody's ultimate. Certainly ours. Maybe yours.

Your own system, ultimate or not, might include one of the Crown product alternatives. The D-150A and D-60 amps offer the same low distortion as the DC-300A, with less power. All Crown recorders have the same quality sound, but you select the transport, electronics, accessories, heads or tracks you need.

For fast information, fill out the coupon below and send it directly to Crown. Or circle the number below. Or visit your Crown dealer, ultimately.

Fast playback coupon

Send me information on amplifiers
 recorders control centers everything

When listening becomes an art,

Name _____

Address _____

City _____

State _____ Zip _____



CROWN

Box 1000, Elkhart IN 46514

SR-7

CIRCLE NO. 12 ON READER SERVICE CARD

A new Vanguard album brings the Gottschalk revival full circle.

THE NINETEENTH century dearly loved piano duets, and I say no wonder. For one thing, four hands can obviously make twice as much noise as two. For another (and though you may find it a logical impossibility), four hands playing really *pianissimo* are twice as soft as two hands are . . . or thereabouts. Moreover, if the arranger knows his business and divides his difficulties properly, it *sounds* as if the duo performing were playing twice as fast as they are known to be able to (the duo I have in mind is playing in somebody's parlor, not Carnegie Hall, and this music is an honest-to-God *duet*, not a late Beethoven quartet arranged for four hands).

Finally, the nineteenth century had a far juicier visceral response to the perfect *togetherness* of disparate forces performing in unison than does, let us say, a John Cage audience to their eternal alienation from each other. And when you add to all that the spectacle *a tempo* of four hands elegantly crossing and weaving between each other, you give a touch of something as physically vivid as ballet or military drill to a musical genre that is already replete with pictorial effects of its own.

You will find all of these images—except, of course, the athletic ones—done to a turn by Eugene List, assisted alternately by Cary Lewis and Joseph Werner, in a new release from Vanguard called “Gottschalk/Music for Piano, Four Hands, and Two Pianos.” In addition to three recording firsts (*Orfa*, *Tremolo*, and *Printemps d'Amour*), the album contains nine things that have been done elsewhere in other versions by Mr. List or others—two Spanish and two Cuban pieces, the Ossianic *Marche de Nuit*, a modern version by Mr. List of Gottschalk's Civil War epic *The Union*, plus three numbers in a remarkable group of two polkas, two mazurkas, and a waltz that deserves special comment. If you're counting on your fingers, this list of course adds up to fourteen numbers, not twelve—the reason being that one of the mazurkas, *Printemps d'Amour*, and one of the polkas, *Orfa*, are also among the recording firsts noted above. In any case, it is when we hear these last two pieces in the more familiar company of the waltz (*Radieuse*), the other mazurka (*L'Étincelle*), and the other polka (*Ses Yeux*) that we realize how triumphantly Mr. List has brought off one of the most venturesome programs of stylistic rehabilitation in the whole Gottschalk revival.

I refer of course to the program he began some years back when he recorded without apology such deceptively simple little period pieces as *The Maiden's Blush* and *Tournament Galop*. Only professionals can know the sheer labor involved in bringing to life for modern ears anything that transparent (as in Mozart, there is simply no place to hide) and that dated. For dated they undeniably are—but dated in a peculiarly illuminating way that can only be understood in terms of the poetry of high fashion. This is precisely the poetry at issue when Proust labors to capture the dated elegance of one of the Princesse de Guermantes' hats—or, even more to the point, when Baudelaire tells his contemporaries that if they want to grasp the real character of

their world they should forget the Great Masterpiece art of the museums and consult the little fashion drawings of Gavarni.

It is to Mr. List's great credit that he obviously saw from the first—which is to say, long before anyone else did—that Gottschalk's waltzes, polkas, and mazurkas are important in exactly the same way. They are at the same time small but flawlessly crafted works of real art and the wittiest kind of comment on the elegant mid-century American society for which they were produced. It is the gaiety and



Louis Ouzier/Eastman School

Gottschalk by Eugene List (and Others)

stylishness of Newport, Saratoga, and New York's Fifth Avenue that we hear echoed in them, and their unique authenticity derives from the fact that the bright particular star of that incredibly fresh and youthful world was Gottschalk himself.

A different kind of authenticity comes into question with two of the big concert numbers on this program, for they have undergone considerable contemporary reworking. *La Jota Aragonesa* as originally published in arrangements for two and four hands was Gottschalk's own reworking of his 1852 original for ten pianos. In 1969 Mr. List reportedly commissioned Samuel Adler to prepare a new ten-piano version, and the liner notes for the present performance seem to credit still another ten-piano version to “Victor Savant”—a version from which, in turn, Mr. List and Cary Lewis have adapted the four-hand version used here.

The second contemporary arrangement is Mr. List's two-piano version of *The Union*, which is here given a properly grandiose performance both as to its conception and its

sound. The thunderous battle effects are none the worse for the chromatic scales and virtuosos double notes that Mr. List has added to the general uproar. However, he has also added considerable ornamentation to Gottschalk's version of *The Star-Spangled Banner* . . . and I for one happen to believe that the peculiar reticence of the original contributes greatly to its poignancy. It is true that the additions heard here are made *con amore*, and with stylistic as well as dynamic discretion. But additions they are, and as such they will necessarily remain a subject for debate. There is considerable evidence that Gottschalk himself used more or less elaborate versions of the same piece, depending on the abilities of his assisting pianists. If this in principle justified textual emendation by anyone today, it would certainly do so in the case of Mr. List, who is not only a dedicated Gottschalkian of many years' standing but the most persistent single force on several levels in the Gottschalk revival. I feel, however, that even under the best auspices the practice is a dangerous one and really must be discouraged—more than ever when it contributes to performances as persuasive as the one heard here.

WHAT really clinches the matter is the fact that Mr. List himself has proved such additions unnecessary. You can discover that for yourself in the glittering version of *Souvenirs d'Andalousie* that opens this program. Allowing for the necessary distribution of material between four hands, it is note-for-note faithful to the two-hand original. And it also happens to be an immaculate example of the kind of duet playing—graceful, fastidious, and polished beyond belief—that Gottschalk himself probably seldom got to hear after he left Paris. It's true that various members of the Spanish royal family played duets with him in Madrid and Andalusia—including almost certainly this very piece. But I doubt that they ever got it to sound nearly as splendid as this, even though they did have a family tradition of keyboard accomplishment going back to Scarlatti!

—Robert Offergeld

GOTTSCHALK: Music for Piano, Four Hands, and Two Pianos. (1) *Souvenirs D'Andalousie, Caprice de Concert, Op. 22* (RO 242); (2) *La Gallina, Danse Cubaine, Op. 53* (RO 100); (3) *Orfa, Grande Polka, Op. 71* (RO 186); (4) *Marche de Nuit, Op. 17* (RO 151); (5) *Printemps d'Amour, Mazurka, Caprice de Concert, Op. 40* (RO 214); (6) *The Union, Paraphrase de Concert, Op. 48* (RO 269); (7) *Radieuse, Grande Valse de Concert, Op. 72* (RO 217); (8) *Réponds-moi, Danse Cubaine, Caprice Brillant, Op. 50* (RO 225); (9) *Tremolo, Grande Étude de Concert, Op. 58* (RO 265); (10) *L'Étincelle, Mazurka Sentimentale, Op. 21* (RO 80); (11) *Ses Yeux, Celebre Polka de Concert, Op. 66* (RO 234); (12) *La Jota Aragonesa, Caprice Espagnol, Op. 14* (RO 131). Pianists: Eugene List (primo 1, 2, 3, 6, 11, 12; secondo 4, 5, 7, 8, 9, 10), Joseph Werner (primo 4, 7, 10; secondo 1, 2, 11), and Cary Lewis (primo 5, 8, 9; secondo 3, 6, 12). VANGUARD VSD 71218 \$6.98.

"I TESTED OUR NEW FM CAR RADIO IN THE HEART OF THE JUNGLE."

by Steve Tillack

When I said "Take me down to Wall Street," the cabbie thought I was nuts.

Then when I pulled out an FM car stereo and started testing it, he knew I was bananas. *Until* he heard the terrific music I got.

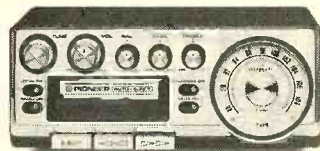

It all started two years ago. Pioneer wondered what would happen if you designed a car stereo to high fidelity specs. Nobody ever did that before. So Pioneer engineered the Supertuners. Four of them. With built-in cassette or 8-track. Muting. Local/distance switch. And a 1.8 dB capture ratio that pulls in FM stations like you never heard before.

Even on Wall Street.

Everybody knows those tall buildings are murder on FM reception. Signals bounce around like ping-pong balls.

But not our Supertuner. While the other FM radios were full of interference and stations piled on top of each other, Supertuner came in loud and clear.

The specifications say it's the best line of car radios ever built.

The cab driver says he's buying one. He gets enough static from his customers.

**THE PIONEER
SUPER TUNERS**

Pioneer Electronics of America, 1925 East Dominguez Street, Long Beach, California 90810

CIRCLE 40, 45 ON READER SERVICE CARD

Save Money Phillips GA 212 semi-auto turntable . . . \$117.00

Discounts on all major brands of stereo equipment & accessories

Write for our price sheet and quote

Michigan Audio Discounters, Ltd.
286 Wolverine Dr.
Walled Lake, Mich. 48088
313-474-4430

Time **Freight**



CIRCLE NO. 36 ON READER SERVICE CARD

ing by Toscanini, who premiered the music in its string-orchestra version. Here is not only the Toscaninian flawless intonation, but also superb modern recording and rock-steady, unhurried pacing, a combination that makes for a realization of hair-curling intensity. Copland's *Quiet City* is beautifully executed but doesn't quite match Copland's own recording for Columbia in the phrasing of the solo trumpet and English horn. The Cowell Hymn and Fuguing Tune—one of a series of eighteen composed between 1944 and 1964 under the stimulus of research into the eighteenth-century hymn-tunes of the Edsons, father and son, of Shady, N.Y.—is a precious minor masterpiece, and Paul Creston's virtuosic and witty *A Rumor*, appropriately built up in polyphonic texture with jazz overtones, makes for a fine closing piece.

Despite minor reservations as noted, this disc afforded me enormous pleasure in its felicitous choice of repertoire, in its superb quality of performance, and in recording that is a model of clarity and pleasing acoustic ambience. I recommend it enthusiastically. *D.H.*

LASSUS: Les Larmes de Saint Pierre. Raphaël Passaquet Vocal Ensemble, Raphaël Passaquet cond. HARMONIA MUNDI HMU 961 \$7.98 (from HNH Distributors, P.O. Box 222, Evanston, Ill. 60204).

Performance: **Smooth**
Recording: **Clear and rich**

The Tears of Saint Peter, the last work of Roland de Lassus (to use the version of his name presented on this album), is a cycle of twenty-one spiritual madrigals dealing with Saint Peter's denial of Christ. As the subject suggests, the cycle is a somber one indeed, but the key word here is "madrigal": the master's approach is that of a madrigalist, not that of a writer of motets. The listener who has heard Lassus' austere Penitent Psalms will find this music far more accessible. Written for seven parts, an inherently dense texture, the music makes the most of the contrast between the upper three voices and the lower four. Add to this a variety of contrapuntal devices, homophonic richness, and Italianate word painting, and it becomes evident that, despite the slow unfolding of an unrelievedly tragic narrative, this is music of great interest which takes the listener through a highly personal spiritual experience. It is all the more pity, then, that the text is given here only in the original Italian with a French translation.

Raphaël Passaquet's vocal ensemble produces a rich, warm sound—velvety and buttery. The director is obviously more interested in choral sonority and contour than in the articulation of individual lines and diction. The result is striking in the chordal and antiphonal sections, but one wishes for a crisper approach in the many contrapuntal sections. Nonetheless, Passaquet's seriousness and even pacing bring the performance off in such a way that we realize that this is one of Lassus' most profound utterances—one that should be heard more often. *S.L.*

MACDOWELL: Sonata Eroica, Op. 50; Woodland Sketches, Op. 51. Clive Lythgoe (piano). PHILIPS 9500 095 \$7.98.

Performance: **Charming Woodland; solemn Eroica**
Recording: **Splendid**

Edward MacDowell, born in 1861, was one of those nineteenth-century American compos-

PLANNING TO MOVE?

Let us know 8 weeks in advance so that you won't miss a single issue of **STEREO REVIEW**. Attach old label where indicated and print new address in space provided. Also include your mailing label whenever you write concerning your subscription. It helps us serve you promptly.

Write to: P.O. Box 2771, Boulder, CO 80302, giving the following information:

Change address only Extend my subscription

ENTER NEW SUBSCRIPTION

1 year \$7.98 Payment enclosed (1 extra BONUS issue)
Allow 30-60 days for delivery. Bill me later

AFFIX OLD LABEL

If you have no label handy, print OLD address here.

Name _____ please print

Address _____

City _____

State _____ Zip _____

NEW ADDRESS HERE 0288

Name _____ please print

Address _____

City _____

State _____ Zip _____

Additional postage per year: For Canada add \$3. For countries outside U.S. and Canada, add \$5—cash in U.S. currency only.

FREE McIntosh CATALOG and FM DIRECTORY

Get all the newest and latest information on the new McIntosh Solid State equipment in the McIntosh catalog. In addition you will receive an FM station directory that covers all of North America.



MX 113

FM/FM STEREO - AM TUNER AND PREAMPLIFIER

SEND TODAY!

McIntosh Laboratory, Inc.
East Side Station P.O. Box 96
Binghamton, N.Y. 13904
Dept. SR

NAME _____

ADDRESS _____

CITY _____ STATE _____ ZIP _____

If you are in a hurry for your catalog please send the coupon to McIntosh. For non rush service send the Reader Service Card to the magazine.

CIRCLE NO. 34 ON READER SERVICE CARD

ers who learned his musical language on the other side of the Atlantic, so that the accent of his style remained European—in fact, Teutonic—all his life. Yet he wrote some of the sturdiest, sanest, best constructed music of his time in America, and if the accent was alien, the subject matter was frequently native enough. In any case, to have *Woodland Sketches*, with their haunting melodies and gently impressionistic harmonic hues, back in the catalog is a welcome event. (Disneyland has an orchestral version for children, arranged and conducted by Camerata, but it cloys.) They have never been treated more expertly and affectionately than they are here by the English pianist Clive Lythgoe, whose approach to them was inspired by a visit to MacDowell's house in New Hampshire.

The *Sonata Eroica* is something else again. The architecture is admirable and the writing a challenge to any keyboard artist, but, though Lythgoe makes more sense of it than most pianists manage, the work—with the outstanding exception of its lighthearted second movement, marked "elf-like"—remains a ponderous and pompous, rather drawn-out exercise. The composer said he "had in mind the Arthurian legend when writing this work," but knowing that doesn't help a listener when the going gets long-winded and oppressively solemn. There seems more in the piece to admire by way of carpentry than to enjoy as music. But this album is worth acquiring for *Woodland Sketches*—as charming a set of musical impressions as ever was composed. And the Philips surfaces are noiseless.

P.K.

MENDELSSOHN: *Symphony No. 3, in A Minor, Op. 56* ("Scotch"); *Overture, Calm Sea and Prosperous Voyage, Op. 27*. New Philharmonia Orchestra, Riccardo Muti cond. ANGEL □ S 37168 \$6.98.

Performance: **From the classic mold**
Recording: **Very good**

MENDELSSOHN: *Symphony No. 3, in A Minor, Op. 56* ("Scotch"); *Overture, The Hebrides, Op. 26*. Baltimore Symphony Orchestra, Sergiu Commissiona cond. TURNABOUT □ QTV-S 34604 \$3.98.

Performance: **Zestful**
Recording: **Very, very good**

Mendelssohn's *Scotch* Symphony has not lacked for first-class recorded performances in stereo. The Peter Maag version, which is now coupled with the *Hebrides* Overture on London's budget-price Stereo Treasury label, still holds up very nicely, and Karajan's reading of the same two works is still tops in my book. Both of these new recordings, however, are among the best in their respective price brackets. Riccardo Muti offers a fastidiously classic, yet warmly lyric reading of the symphony, together with a most welcome, up-to-date recording of the ceremoniously atmospheric *Calm Sea and Prosperous Voyage* Overture. Like Karajan, Muti favors a broodingly contemplative treatment of the adagio—one of Mendelssohn's finest slow movements—but Karajan, to my mind, still has the edge in terms of a genuinely fiery performance from the classic mold, especially in the always problematic final pages.

Sergiu Commissiona and his Baltimoreans take a more romantically impetuous view of the music and do an altogether splendid job. Granted that the Baltimore Symphony is not the equal of Karajan's Berlin Philharmonic,

More bang than a Wallbanger, more fire than a Sunrise.



GREEN FIRE

The power behind Swampwater is Green Chartreuse, 110 proof. It has no mercy, that's why it's called Green Fire.

To sample this powerful drink, (legal in all 50 states) ask any bartender to fix a batch. He may say, "What's Swampwater?" Give him the recipe!

To each 1½ ounces of Green Chartreuse, add 6 ounces pineapple juice, ¼ lime and ice. Stir.

Note: For do-it-yourselfers, one bottle of Green Chartreuse makes one gallon of Swampwater.



**GREEN CHARTREUSE
110 PROOF**

IMPORTED BY SCHIEFFELIN & CO., N.Y.

the quality of orchestral performance in this instance need defer to none. The *Hebrides* music is a bit fast-paced for my taste, but it effectively maintains the same aura of impetuosity. A major contribution to the whole is truly excellent recording, which offers precise instrumental localization (not so evident in Angel's ambient quadraphonics) and a fine sense of the orchestral body as a whole, as well as a very pleasing feeling of spatial surround. I do hope, however, that Turnabout's other pressings are a little less noisy and swishy than this one. *D.H.*

RECORDING OF SPECIAL MERIT

MESSIAEN: *Quartet for the End of Time*. Tashi (Peter Serkin, piano; Ida Kavafian, violin; Fred Sherry, cello; Richard Stoltzman, clarinet). RCA ARL1-1567 \$6.98.

Performance: **Gorgeous**
Recording: **Outstanding**

Tashi must have been formed to play the Messiaen *Quatuor pour le Fin de Temps*. The contemporary and mystical qualities of this music are perfectly suited to the temperament and musicality of this young and dynamic group, and, after all, how many major works exist for this combination of instruments? I am no connoisseur of Messiaen's stylistic mélange, but this beautiful recording could almost reconcile me to the *longueurs* of the music. The *Quartet for the End of Time* was written in a German concentration camp and is an intense, contemplative, apocalyptic response to that experience. The name Tashi refers to the enlightenment of Sakyamuni Buddha, which in itself gives an idea of where these young performers are at. They take this music—performed surprisingly often nowadays—up onto a plane of serenity and sensuous spirituality it very rarely attains. *E.S.*

MILHAUD: *Cantate de l'Enfant et de la Mère; La Muse Ménagère* (see *Going on Record*, page 60)

RECORDING OF SPECIAL MERIT

MOMPOU: *Fêtes Lointaines; Charmes; Canço i Danza No. 1; Variations on a Theme by Chopin*. Pierre Huybregts (piano). ORION ORS 76234 \$6.98.

Performance: **Sympathetic**
Recording: **Good**

Federico Mompou (b. 1893) is a Catalan composer whose name may be familiar from occasional performances of some of his *Scènes d'Enfants* for piano, a few of his exquisite songs, or his guitar pieces. His most important work has been for the piano, and it is gratifying to have a disc devoted to it at last. Various commentators in the last six decades have spoken of Mompou's style as that of "a slender Debussy," and he has been compared with Satie as well. While the music on this record supports such observations, what makes it worthwhile is Mompou's individuality, which comes through subtly but strongly enough to make one wonder how such music could have been so totally unknown for so long. The two short fantasy-suites composed in 1920 and 1921 and the folk-inflected *Canço i Danza* are more immediately appealing than the elaborate set of variations (on Chopin's famous A Major Prelude, Op. 28, No. 7, with the *Fantaisie-Impromptu* cited along the way), but all the material wears extremely



TASHI: *Messiaen on a plane of serenity and sensuous spirituality*

well in Pierre Huybregts' able, sympathetic performances, and the piano sound, though a little clanging in spots, is generally quite good. *R.F.*

MOZART: *Piano Concerto No. 21, in C Major (K. 467); Piano Concerto No. 23, in A Major (K. 488)*. Ilana Vered (piano); London Philharmonic Orchestra, Uri Segal cond. LONDON SPC-21138 \$6.98.

Performance: **Mostly fine**
Recording: **Very good**

RECORDING OF SPECIAL MERIT

MOZART: *Piano Concerto No. 21, in C Major (K. 467); Piano Concerto No. 23, in A Major (K. 488)*. Jörg Demus (piano); Collegium Aureum. BASF KHB-22477 \$6.98.

Performance: **Stylish**
Recording: **Very good**

RECORDING OF SPECIAL MERIT

MOZART: *Piano Concertos: No. 21, in C Major (K. 467); No. 22, in E-flat Major (K. 482); No. 23, in A Major (K. 488); No. 24, in C Minor (K. 491); No. 25, in C Major (K. 503); No. 26, in D Major (K. 537, "Coronation"); No. 27, in B-flat Major (K. 595). Rondo in D Major (K. 382)*. Daniel Barenboim (piano); English Chamber Orchestra, Daniel Barenboim cond. ANGEL SDC-3830 four discs \$20.98.

Performance: **Splendid**
Recording: **Very good**

Since Ilana Vered's earlier account of K. 467 was released on London less than two years ago (improbably coupled with the *Yellow River* Concerto), it is surprising that the company would have her redo it so soon, but the remake is a good deal more persuasive than its predecessor. Vered plays both Mozart concertos very well; she may not be burdened with an excess of originality, but she gives good, clean, crisply articulated performances, and she has a first-rate partner in Uri Segal. In K. 467, she plays Dinu Lipatti's cadenzas, heretofore recorded only by Lipatti himself. What spoils the otherwise attractive package is Vered's stolid approach in the slow movement of K. 488, in which her response to the marking *adagio* seems related more to a metronome setting than to the eighteenth-century spirit of such a designation. Neither Segal's fine conducting nor London's fine sound (not

so conspicuously "Phase Four-ish" here) can make it sound other than lifeless.

Jörg Demus' interpretation has deepened since he recorded K. 467 on a modern piano for Westminster in the early Fifties. Here he plays a *Hammerflügel*, made by Johann Georg Gröber of Innsbruck about 1800, which is of course much more like the instruments Mozart himself played. Its tonal quality, in consort with the period instruments of the Collegium Aureum, enhances a pair of performances that strike me as models of style and balance with an abundance of both vigor and sensitivity. The partnership between soloist and ensemble is exemplary, and the sound has a lovely bloom on it. I do wish the stuffy annotation included identification of the cadenzas in K. 467 (Busoni's, I believe), but, given a clean copy (the disc I received for review is marred by extremely crunchy surfaces), the recording itself is just about irresistible.

Barenboim's set, which Angel is offering at a special price, is pretty irresistible, too. Some of his playing is a little fussy, but in general it is of a very exalted order, and so is his conducting. There is not a superficial bar throughout the eight sides, and only one or two performances among the eight in the set would not be reasonable candidates for first choice among all current recordings of the respective works. The only part of the set that has been available before in this country is K. 467, a handsome version Angel has released earlier in two different combinations. Among the most impressive components of the set are K. 482 and K. 503, which are remakes for Barenboim. In K. 482 he apparently still works from a flawed edition, and his own cadenza in the first movement is a bit too sprawling and unfocused, but his expansive, grand-scale realization is nevertheless glorious beyond any other version of this work known to me (the cadenza in the finale, a shortened version of one by Edwin Fischer, is just right). The great K. 491 and the lesser K. 537 are extraordinarily compelling, too. What concentrated power and poetry there are in K. 491, and what a substantial work the festive K. 537 is, after all!

Except for K. 595, which seems a little bland here compared with the Brendel, Boegner, Gilels, and Serkin versions, and the finale of K. 488, which tends to become a bit of a scramble, nothing in this set is less than magnificent, and the fine presentation of the K. 382 Concerto Rondo that fills out the second

side of K. 482 is especially welcome. The recordings are not brand-new, some going back as far as 1967, but the sound is uniformly good. (The newest item, I believe, is K. 503, which is a conspicuous improvement over Barenboim's earlier version with Klemperer—but more in terms of interpretation than of sonics.) The ample documentation includes identification of all cadenzas, as well as excellent notes by Robin Golding. *R.F.*

NERUDA: *Trumpet Concerto in E-flat Major* (see HAYDN)

POULENC: *Piano Music* (see Going on Record, page 60)

RECORDING OF SPECIAL MERIT

RACHMANINOFF: *Prelude in C-sharp Minor, Op. 3, No. 3; Preludes, Op. 23, Nos. 1-10; Preludes, Op. 32, Nos. 1-13.* Vladimir Ashkenazy (piano). LONDON CSA 2241 two discs \$11.96.

Performance: **Nonpareil**
Recording: **Splendid**

RACHMANINOFF: *Preludes, Op. 32, Nos. 1-13; Prelude in D Minor, Op. Posth.; Fragments.* Ruth Laredo (piano). COLUMBIA M 33430 \$6.98.

RACHMANINOFF: *Eight Études Tableaux, Op. 33; Fantasy Pieces Nos. 1 and 2; Variations on a Theme by Corelli, Op. 42; Lilacs, Op. 21, No. 5; Daisies, Op. 38, No. 3; Oriental Sketch.* Ruth Laredo (piano). COLUMBIA M 33998 \$6.98.

Performances: **Aristocratic**
Recordings: **Clean, a bit stark**

The twenty-four Rachmaninoff preludes for solo piano have been documented on records in several distinguished and knowledgeable readings. But in my opinion Vladimir Ashkenazy's traversal of the whole series now pretty well eclipses all other competitive versions, including even the superbly controlled reading of Op. 32 that completes Ruth Laredo's set of the preludes. The excellence of the piano sound in the Ashkenazy album is another major point in its favor.

The key to Ashkenazy's interpretive approach is set at the very beginning with his reading of the notorious C-sharp Minor Prelude, from which he seems determined to extract every ounce of substance. His treatment is thoughtful, intensely dramatic, and wholly fresh. So it is with all the more lyrical preludes, which Ashkenazy makes somewhat more ruminative than some of us may be used to; only in Op. 23, No. 4 (the D Major), though, do I feel a miscalculation in pacing that borders on the somnolent. There is certainly nothing somnolent in the way Ashkenazy reveals the turbulence of Op. 32, No. 1, or the violence of No. 6. But it is in the last four of Op. 32, considered by many the peak of Rachmaninoff's creation for solo piano, that he really achieves the heights. The tender masculinity he brings to the intimate utterance of the B Major and the ethereal quality with which he endows the wonderful following piece in G-sharp Minor are the high points of an altogether remarkable album.

Ruth Laredo scores her innings in her sharply characterized and incisive treatment of the Op. 33 *Études Tableaux*. An interpretive comparison with André Collard on Connoisseur Society in the sternly somber No. 1

is interesting: Laredo employs rubato contrast to striking dramatic effect, while Collard develops a steady, relentless flow. There is much to be said for both readings. In the often impressive Corelli Variations, Laredo has formidable recorded competition from both Collard and Ashkenazy, but, despite the rather lean recorded piano sonics, her performance holds its own excellently. The exquisite song transcriptions *Lilacs* and *Daisies* are among the high points of the recording, for the essentially aristocratic quality of Laredo's pianism—most akin here to the composer's own—comes impressively to the fore. If the two Fantasy Pieces from 1899 seem rather minor, the *Oriental Sketch*, in what appears to be its first stereo recording, is a highly effective and by no means negligible "ostinato étude." Of

special note on the Laredo disc of the Op. 32 Preludes are first recordings of two brief, bleak pieces Rachmaninoff wrote at the time of his flight from Russia—the *Fragments* and a D Minor Prelude.

On both these two new discs and her previous one Ruth Laredo certainly gets high marks for musicianship and pianistic prowess, but I do feel that Columbia can and should do better by her in terms of fuller-bodied piano sound (unless this lean-clean sound is her preference). As matters stand, the full measure of what she can do is best revealed in the remarkable Scriabin sonatas she recorded for Connoisseur Society and the set of preludes issued by Desto. *D.H.*

(Continued on page 131)

Creative Technology! The MXR StereoGraphic Equalizer

The Technical Equalizer

The MXR Equalizer is a 2-channel frequency equalizer that offers 10 bands of discrete adjustment on each channel. Nominal center frequencies are: 31hz, 62hz, 125hz, 250hz, 500hz, 1khz, 2khz, 4khz, 8khz, and 16khz. Each of these octave bands may be cut or boosted independently to plus or minus 12 decibels by using the slide controls. The MXR StereoGraphic Equalizer features a bypass switch which enables the user to switch the equalization in and out of the signal path for instant sound comparison. The unit has an internal power supply and is designed to work into output loads of 600 ohms or higher. These input and output characteristics make the MXR StereoGraphic Equalizer compatible with any stereo Hi-Fi equipment.

The Creative Equalizer

Become creative with the MXR StereoGraphic Equalizer whether you want to decrease the "boomy" mid-bass sounds or increase the deep-bass sounds, decrease nasality, harshness or shrillness or move the sound source closer or further away. It's all at the touch of a slide control. Tailor your playback to suit any number of variables and develop the mood you want to hear.

The MXR StereoGraphic Equalizer is compact, stylish and handsomely packaged in brushed aluminum with walnut side panels. Its design and circuitry will complement any modern Hi-Fi system at the attractive price of \$199.95. At MXR, we combine engineering excellence and creativity to provide you with superior products. For more information, see your nearest MXR dealer or direct inquiries to MXR, 277 N. Goodman St., Rochester, New York 14607, (716) 442-5320.

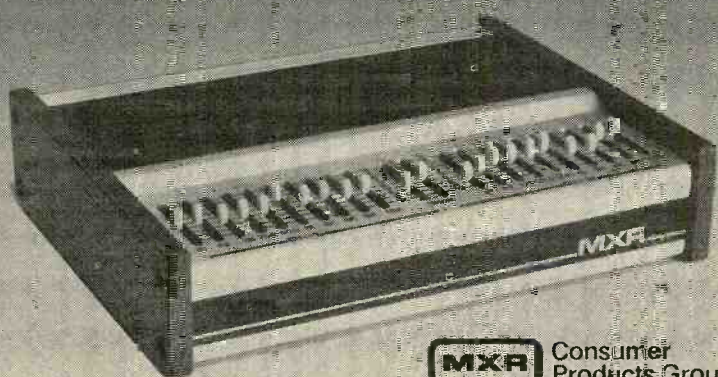

MXR Consumer Products Group

CIRCLE NO. 38 ON READER SERVICE CARD

"Episcopalian farce, genteel, gentlemanly, and fuzzily benign"

Carol Wilcox (Aurelia Trentoni),
Carolyn James (Mrs. Greenborough),
and gentlemen of the press in the
Kansas City Lyric Theater
production of Captain Jinks

Captain Jinks of the Horse Marines



Kansas City Lyric Theater

CHARM is the most elusive and perishable of qualities, on or off the stage. Inevitably it seems to have a "period" character to it, at least in the lyric theater. It has made its appearance so rarely in contemporary American opera—*The Ballad of Baby Doe* and *Vanessa*, for instance, are at bottom as bleak and as chill as a rainy day on a moor—that when it does, as it does so consistently and abundantly in the new RCA release of Jack Beeson and Sheldon Harnick's *Captain Jinks of the Horse Marines*, it is a cause for celebration.

This is the recording of the Kansas City Lyric Theater production that had its world première in September of 1975 and about which William Livingstone reported favorably in these pages shortly thereafter. Based on the turn-of-the-century boulevard comedy by Clyde Fitch (it made a star of Ethel Barrymore in that long, long ago), it is a high-style romp intended, in composer Beeson's words, as "an opera about an opera, *La Traviata* in particular, others in passing, and a love letter to Italian opera and the English language." When it succeeds in these several aims—and it does so often—it is also a tribute to the growing musical sophistication of American audiences. This production, like all productions of the Kansas City Lyric Theater, has not only been performed during the Kansas City "season" but has been heard in such unlikely locales (at least to this Eastern snob's provincial ear) as Missouri, Oklahoma, and South Dakota (hmm . . . they're probably still thinking that one over down at the Russian Tea Room).

The plot is an old one—one of those bits of fluff that have been around since Shakespeare's day—about a wager between friends as to whether or not one of them (in this case Jonathan Jinks) can seduce the glamorous opera star Aurelia Trentoni (*née* Johnson in Trenton, New Jersey), who has returned to America for her stateside debut in *La Travia-*

ta. Before the finale the hero has come to realize the heroine's True Inner Beauty, reneged on his dastardly bet out of respect for her, lost her, and then Regained Her As His Bride. Leisurely room is made for a comic turn or two by a large cast, including five reporters of wildly varying degrees of integrity, Aurelia's dowager mother, a stray policeman, a kindly but shrewd impresario, and a bevy of other characters out on mildly farcical errands—one such is the "Ladies' Anti-French Literature League." It is, in short, Episcopalian farce, genteel, gentlemanly, and fuzzily benign. Probably its leading (and last) exponent was the late, great P. G. Wodehouse, whose librettos for so many musicals in the Twenties often read like Fitch work sheets.

Jack Beeson sees the thing as "a romantic comedy in music," and most of his work delightfully bears out that conceptual statement. There are some lovely floating arias for Carol Wilcox in the role of Aurelia; some graceful and expert fooling around with serial procedures based on a twelve-tone row for the Policeman and the Customs Official; a liberal use of quotes from Verdi's *Traviata* itself, not merely for amusement but to advance the action and strengthen the dramatic structure; and, smashing, a finale, a paean to music and its power, sung by the whole company.

Composer Beeson has insisted that character, in his operas, spring from the music itself. "We know the characters of an opera from their words," he says, "but we believe them because of what they sing. The music will appear to reflect them, as in an enlarging mirror; rather, as though the music were a magic mirror, it will appear to create them." Well said—and truly accomplished in *Captain Jinks*.

None of this is meant to imply that lyricist Sheldon Harnick has, in his first attempt at opera (a flier he can probably easily afford on the basis of, say, this year's royalties from

Fiddler on the Roof), done anything less than a noble job of taking some of the more obvious creaks and wheezes of Fitch's plot and converting them into singable situations. He's a pro, and though he seems at times to have the shade of Thornton Wilder or Maxwell Anderson (at his blank-verse flattest) hanging over his shoulder, he delivers a brisk, no-nonsense libretto that gives Beeson all the musical latitude he needs.

The recording is beautifully produced (by Jay David Saks) with a spacious, slightly dry sound that is just right for the material—one needs a bit of concentration to get the point of the playful, but fairly cerebral, music-making. Miss Wilcox is pure delight as Aurelia—wistful, willful, seductive, and taunting—making the character jump joyously to life. Eugene Green as Colonel Mapleson (he of the famous Metropolitan Opera cylinder recordings) and Robert Owen Jones as Jinks are both outstanding and sing with a musicality seldom heard these days—at least in contemporary American opera. The smaller roles are all beautifully rehearsed and performed; there isn't a tentative attack or characterization in the whole recording. *Captain Jinks* is what charm, turn-of-the-century American style, is all about, and it makes one wonder what that foxy, *lustige* Hannah Glawari might have thought of him.

—Peter Reilly

BEESON: *Captain Jinks of the Horse Marines*. Libretto by Sheldon Harnick. Carol Wilcox, Aurelia Trentoni; Robert Owen Jones, Jonathan Jinks; Brian Steele, Willem Van Bleecker; Ronald Highley, Charles LaMartine; Eugene Green, Colonel Mapleson; Walter Hook, "Papa" Belliarti; Karen Yarmat, Mrs. Jinks; Linda Sisney, Mrs. Stonington; Carolyn James, Mrs. Greenborough; others. Members of the Kansas City Philharmonic, Russell Patterson cond. RCA ARL2-1727 two discs \$12.98.

RACHMANINOFF: *Songs* (see Best of the Month, page 86)

RAVEL: *Alborado del Gracioso; Pavane pour une Infante Défunte* (see FALLA)

REICHE: *Abblasen* (see BACH)

RECORDING OF SPECIAL MERIT

SAINT-SAËNS: *Symphony No. 3, in C Minor, Op. 78 ("Organ")*. Gaston Litaize (organ); Chicago Symphony Orchestra, Daniel Barenboim cond. DEUTSCHE GRAMMOPHON 2530 619 \$7.98, © 3300 619 \$7.98.

Performance: **Very fine**
Recording: **Excellent**

I have not heard every one of the eleven current recorded performances of Saint-Saëns' Third Symphony, but most of those that have been recorded since Pierre Coppola's memorable version of the 1930's have passed across my turntable at one time or another. And since its release in 1959 I have clung stubbornly to the immensely exciting and still remarkable Munch/Boston Symphony recording on RCA.

Now I think I'm ready to relent, for Daniel Barenboim and the Chicago Symphony Orchestra, with a bit of technological assistance that has made possible a very successful overdubbing of the Chartres Cathedral organ, have come up with a quite different reading—with, of course, the benefit of the very best of contemporary recording technique. Barenboim's performance is distinguished by the romantic fervor he injects into the adagio introduction and the slow movement, thus alleviating the bland aspect these pages often take on. Furthermore, there is none of the exaggeration that has marred some of Barenboim's other readings, such as those of the Elgar symphonies. Add excellent pacing of the faster movements, topnotch orchestral performance, and first-rate, well-balanced recording, and you have a real winner. Munch's recording stays in my collection, but this one gets added. *D.H.*

SCHOENBERG: *The Book of the Hanging Gardens, Op. 15* (see SCHUBERT)

RECORDING OF SPECIAL MERIT

SCHOENBERG: *Moses and Aaron*. Günter Reich (speaker), Moses; Richard Cassilly (tenor), Aaron; Felicity Palmer, Jane Manning (sopranos); Gillian Knight, Helen Watts (mezzo-sopranos); John Winfield, Philip Langridge (tenors); John Noble, Roland Hermann, Michael Rippon (baritones); Richard Angas, Denis Wicks (basses); BBC Singers; Orpheus Boys' Choir; BBC Symphony Orchestra, Pierre Boulez cond. COLUMBIA M2 33594 two discs \$13.98.

Performance: **Excellent**
Recording: **Excellent**

Moses and Aron—Schoenberg's spelling of Aron is not preserved here—is the last Wagnerian music drama, a kind of philosophical *Tannhäuser* whose marginal existence in the modern opera house is largely due to its mildly pornographic "Venusberg." It is not the first nor the last example of sex and violence made respectable by a heavy dose of redeeming artistic and philosophical value. Indeed, anyone who can sit through two hours of heavyweight philosophizing in tone-row style

OCTOBER 1976

What you don't know about effective tip mass won't hurt you, just your records.



You can find out
what you don't know
by contacting us for our
comprehensive
cartridge brochure.

Bang & Olufsen

Bang & Olufsen of America, Inc., Dept. 12E
515 Busse Road, Elk Grove Village 60007

CIRCLE NO. 8 ON READER SERVICE CARD

BIG DISCOUNTS

STEREO COMPONENTS

Largest selection of top name
brands... try us and see...

It's worth a call
(301) 488-9600

INTERNATIONAL HI-FI DISTRIBUTORS

6330 Frankford Ave.
Baltimore, Md. 21206

All mail answered within 24 hours

Phone Daily 9 AM to 9 PM
Saturday 9 AM to 4 PM
Phone (301) 488-9600

CIRCLE NO. 24 ON READER SERVICE CARD

OUR NAME WON'T FOOL YOU ...

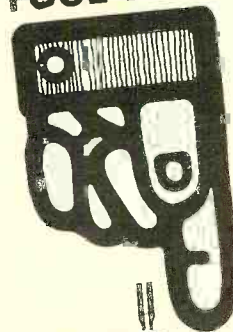

STEREO DISCOUNTERS

Our volume buying power enables us
to pass our discount prices on to you.
Send for your Free Hi-Fi and CB
Catalog ... or call for a price quote on
our "Super Service" line ...

301-252-6880

Name _____
Address _____
City _____ State _____ Zip _____
STEREO DISCOUNTERS
7A Aylesbury Rd.
Timonium, Md. 21093

CIRCLE NO. 60 ON READER SERVICE CARD

("Moses and Aron" or "The Rows of Aron" we used to call it) has really earned his voyeur thrills at the sex orgy. Maybe that wasn't actually Schoenberg's idea, but in actual practice that's the way it comes out.

Unfortunately, there are few voyeur thrills in a record album, although the orgy music almost recaptures the true sensuality of Schoenberg's early (c. 1900) music. I was once fairly sympathetic to the mixture of intensity and control that reaches its highest point of expression in this opera. Now it seems to me, for all its abstract greatness (Schoenberg was a great master in the great tradition, and *Moses und Aron* is his masterpiece, Amen), it is fundamentally an elitist work about an elitist and antihumanist view of life and art to which I cannot subscribe.

Well, never mind. *Moses und Aron* is a landmark, and it is exactly the sort of work that Boulez and the English can do to perfection when they set their minds and talents to it. Boulez is sometimes said to be a cold conductor, but I do not find the expressionist aspects slighted here at all. Indeed, the combination of clarity and intensity is by far the most striking and involving aspect of this work and performance. The playing and singing are excellent—Schoenberg's difficulties are by now almost part of the common practice—and the recording compares very favorably with the recent Gielen/Philips entry. The program booklet includes texts, translations, and a long, interesting, somewhat debatable essay by Harry Halbreich. E.S.

SCHOENBERG: *Pierrot Lunaire* (see *Going on Record*, page 60)

SCHUBERT: *Quintet in A Major, Op. 114, "Trout"* (see *The Basic Repertoire*, page 62)

RECORDING OF SPECIAL MERIT

SCHUBERT: *Songs. Schäfers Klage lied; Rastlose Liebe; Blondel zu Marien; Der Musensohn; Lied der Mignon; Heidenröslein; Sprache der Liebe; An mein Herz; Ganymed.*
SCHOENBERG: *The Book of the Hanging Gardens, Op. 15.* Jan DeGaetani (mezzo-soprano); Gilbert Kalish (piano). NONESUCH H-71320 \$3.96.

Performance: **Beautiful**
 Recording: **Excellent**

Everyone expects Jan DeGaetani and Gil Kalish to be outstanding Schoenberg interpreters. What is perhaps less expected is the beauty of the Schubert performances on this album. The purity of Ms. DeGaetani's tone and the lyric intensity of her style is perfect for Schubert, and these performances are nothing less than superb. Ironically, they far overshadow the Schoenberg on the reverse. Schoenberg's *Book of the Hanging Gardens* is a set of decadent, turn-of-the-century settings—some of the earliest truly atonal music ever written—of some equally decadent Stefan George poetry. Since there is nothing in the world less decadent, less expressionistic than Ms. DeGaetani's singing style, the whole emerges as a kind of Beauty and the Beast mismatch. Stripped of its essential neuroticism, this agonizingly sparse atonal music is slow going indeed. In short, I am recommending this recording by two specialists in the twentieth century for its Schubert! E.S.

SCHUBERT: *Wanderer Fantasy in C Major, Op. 15 (D. 760).* SCHUMANN: *Sonata No. 2, in G Minor, Op. 22.* Bruno-Leonardo Gelber (piano). CONNOISSEUR SOCIETY CS 2085 \$6.98.

Performance: **Strong**
 Recording: **Strong**

These are good, strong performances. Gelber is particularly effective in the *Wanderer Fantasy*; Schubert's more reticent, lyric romanticism seems more up his alley. The difficult Schumann G Minor Sonata is very well played, but it rarely moved me. The recording, from Pathé-Marconi, has a solid, clean piano sound. E.S.

R. SCHUMANN: *Sonata No. 2, in G Minor, Op. 22* (see **SCHUBERT**)

SCRIABIN/NEMTIN: *Universe.* Aleksei Lyubimov (piano); Irina Orlova (organ); Yurlov Chorus of the R.S.F.S.R.; Moscow Philharmonic Orchestra, Kiril Kondrashin cond. MELODIYA/ANGEL SR-40260 \$6.98.

Performance: **Astonishing**
 Recording: **Grandiose**

Scriabin's last work, like Ives', was a grandiose, universal symphony that he was destined never to finish. Ives, of course, never really intended to finish his "Universal" Symphony. He even had the idea that other composers might contribute to it and perhaps put it in performable shape, but that hasn't happened yet. How ironic that Scriabin's utterly personal, mystical concept has been taken over—some sixty years after his death!—by another

the \$15 solution...

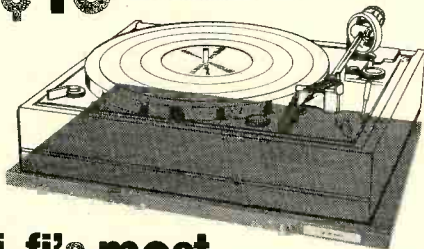

to hi-fi's most unrecognized problem.

The Problem: acoustic feedback
The Solution: Netronics Acousti-Mount

Feedback may be the mysterious reason why your sound is muddy, your turntable rumbles, and in severe cases, you can't turn up the bass or volume controls without speaker howl. Designed specifically to accommodate today's fine turntables, the Netronics Acousti-Mount sub-base platform suppresses acoustic feedback by effectively decoupling the entire turntable assembly from structure-borne vibration. A computer designed high-Q conical-spring suspension achieves a system resonance of approximately 4 Hz in both the horizontal and vertical planes. The apparent simplicity of the Acousti-Mount belies the sophistication of its design and the effectiveness—up to 30 dB!—of its isolation. The better your system, the more you may need Acousti-Mount.

Julian Hersh's test report: "We doubt that any other \$15 investment could make such an improvement in a record-playing system."

Please Send **ACOUSTI-MOUNTS** @ 15.00 (16 x 13 1/2) } Post Paid
 U.S. and foreign patents applied for. 17.50 (19 x 13 1/2) }

Canadian residents add \$1.00 Conn. residents add 7% tax

Name _____

Address _____

City _____ Zip _____

Deluxe walnut grain vinyl finish. Money back if not delighted.

I am also interested in receiving information on your new turntable kits.

NETRONICS R&D LTD. ROUTE 6, BETHEL, CONN 06801
 CIRCLE NO. 40 ON READER SERVICE CARD



BACK by popular demand and updated from its original (1966) printing, Music Editor James Goodfriend's *Calendar of Classical Composers* is a listing of the most important composers from the year 1400 to the present, grouped according to the stylistic periods—Renaissance, Baroque, Classic, Romantic, etc.—in which they worked. This 12 x 24-inch aid, guide, and complement to your music listening is printed in color on heavy, nonreflecting stock suitable, as they say, for framing. A key to the calendar, consisting of capsule accounts of the principal stylistic characteristics of each musical period, is included. The whole will be sent rolled in a mailing tube to prevent creases; we pay postage. All you do is send 25¢ to:

Calendar of Classical Composers
 Stereo Review, 1 Park Avenue, New York, N.Y. 10016

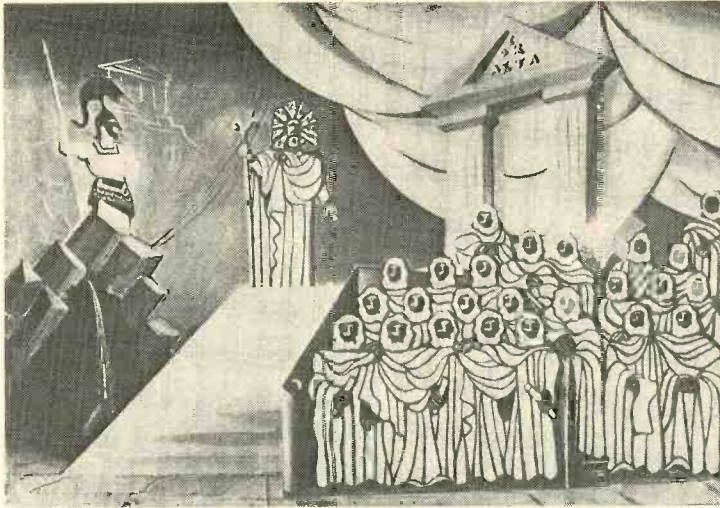

OEDIPUS REX:
drawing by
Théodore
Strawinsky
for the opera by
Igor Stravinsky

The Bettmann Archive

nothing less. Well, I *am* overwhelmed—for five minutes. After that I want to fight back.

E.S.

R. STRAUSS: *Also Sprach Zarathustra*; **Till Eulenspiegel** (see *Going on Record*, page 60)

STRAVINSKY: *Oedipus Rex*. René Kollo (tenor), Oedipus; Tatiana Troyanos (mezzo-soprano), Jocasta; Tom Krause (baritone), Creon; David Evitts (baritone), Messenger; Frank Hoffmeister (tenor), Shepherd; Ezio Flagello (bass), Tiresias; Michael Wager, Narrator; Harvard Glee Club; Boston Symphony Orchestra, Leonard Bernstein cond. COLUMBIA M 33999 \$6.98.

STRAVINSKY: *Oedipus Rex*. Peter Pears (tenor), Oedipus; Martha Mödl (mezzo-soprano), Jocasta; Heinz Rehfuss (baritone), Creon, Messenger; Otto von Rohr (bass), Tiresias; Helmut Krebs (tenor), Shepherd; Jean Cocteau, Narrator; Cologne Radio Symphony Orchestra and Chorus, Igor Stravinsky cond. ODYSSEY @ Y 33789 \$3.98.

Performances: **Stravinsky over Bernstein**
Recordings: **Modern stereo vs. good old mono**

The idea of an up-to-date stereo version of *Oedipus Rex* with Bernstein, the Boston Symphony (his alma mater and an orchestra long associated with Stravinsky's work), and an excellent cast was obviously a good one. It was not such a good idea to release it simultaneously with a rerelease of Stravinsky's own German radio performance of the work
(Continued on page 136)

composer and is being realized on a huge scale.

It is odd that, through all the years of experimentalism, Stalinism, and socialist realism, the Soviets have never gotten Scriabin out of their, um, collective system. Even the younger avant-garde composers in Russia still look back to Scriabin. Aleksander Nemtin, born in 1936, has particularly identified himself with his predecessor in a series of works based on various sketches and themes of Scriabin. Now, however, he has taken the fifty-three pages and the ideas of Scriabin's last work and developed them into large-scale vocal/orchestral compositions. *Universe* is

Part I of *Prefatory Action* (Part II, for solos, chorus, and orchestra, should be along shortly). It is a huge, sensuous instrumental mass—there is an Alfred Newman/Miklós Rózsa choral part near the end, and Nemtin has also “composed” a part for Scriabin's famous color organ—in what might be regarded as a possible extension of the Scriabin style. This is an astonishing idea, both in conception and in execution, highly recommended if your idea of the ultimate musical experience is a sensuous bath. My own musical sensibilities are not so passive. I want to participate, and that is the one thing that Scriabin/Nemtin will not permit; the listener must be overwhelmed,

Our studio monitor is so accurate, some people insist on taking it home.



Ever since we introduced our Sentry III loudspeaker, recording studios have been in love with it.

To tell the truth, we have too. Sentry III is family. It was conceived from the same Thiele based parameters as our vented, equalized Interface systems. Which put a premium on accurate, efficient reproduction and innovative design.

Same holds true for Sentry III, only on a performance scale fit for a studio, or perhaps, you.

Sentry III is the only studio monitor we know that combines accurate, flat response *and* high efficiency—easily 8 dB above the usual bookshelf system. That's like getting more than six times the amplifier power. And delivering the sound pressure levels of a live performance in a typical listening room—up to 115 dB, long-term average.

Dispersion is equally sensational. It's the only speaker in the world we've seen with uniform 120° horizontal dispersion at all frequencies, between 6 dB down points.

And as far as innovation goes, our midrange and tweeter horns represent the first new professional horn design in 25 years.

It only stands to reason a studio monitor this responsive will wind up in someone's living room. If you insist on superb sound at original performance levels, insist on Sentry III.



Optional SEQ Equalizer

Sentry® III

Electro-Voice, Inc., a Gulton company
616 Cecil Street, Dept. 1064F, Buchanan, Michigan
49107

LOOK AT US NOW

Hitachi introduces the first receiver with a Class G* amplifier.

It's been a long time coming, but it has arrived. The Hitachi "Series E" amplifier.* As the innovators of this unsurpassed amplifier, we are proud to offer it to you for the first time in our SR/903 Stereo Receiver.

Why is this amplifier unique?

Stated simply, the "Series E" amplifier supplies additional power... up to 160 watts per channel for short periods of time. This is the power you need to reproduce musical peaks that can cause distortion and clipping. The "Series E" amplifier changes from 75 watts RMS per channel both channels driven into 8 ohms at no more than 0.3% total harmonic distortion... up to an amazing 160 watts per channel instantly and automatically. *And this is 160 watts per channel within rated distortion. Power increases. Distortion doesn't.*

With the Hitachi SR/903 you get all the power you need... when you need it.

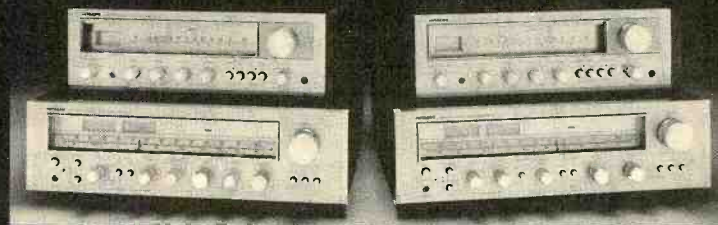

Hitachi "Series E" has been designated as Class G by the IEEE. For additional technical information and a professional review of our "Series E" Amplifier in Radio Electronics, write to Audio Component Division, Hitachi Sales Corporation of America, 401 West Artesia Blvd., Compton, California 90220.

HITACHI AM-FM STEREO RECEIVER SR-903

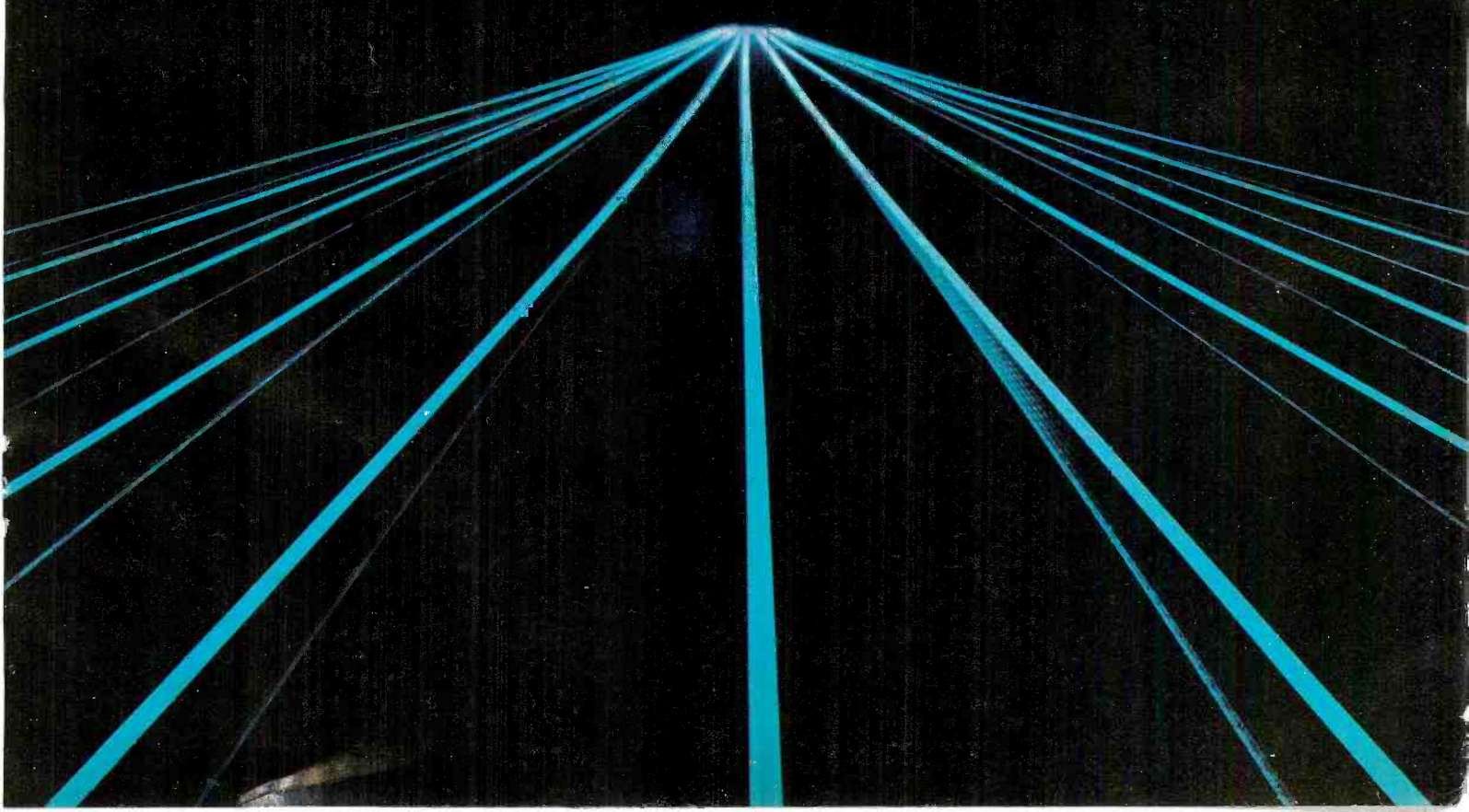
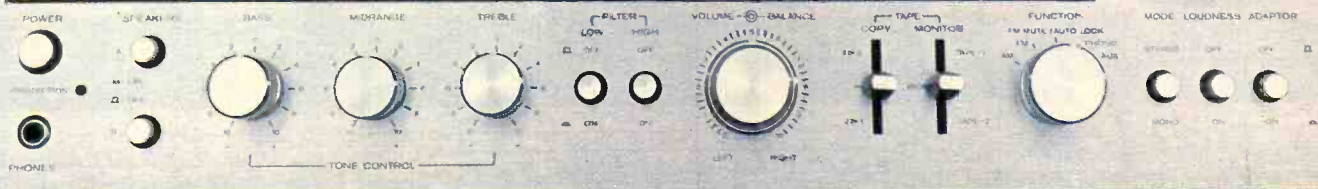
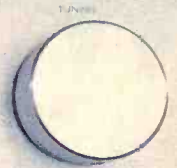

INTRODUCING THE STRAWBERRY MARGARITA



WELCOME TO

on *Odyssey*, which is one of the best recordings Stravinsky ever made and one of the great recordings of the century. *Oedipus*, a masterpiece of Stravinsky's neo-Classical period, has an incredible tension and monumentality in this performance, which also has the advantage of Cocteau himself reading his own narration (dubbed into the original recording and as marvelous-sounding as ever).

It is true that Stravinsky and Cocteau had the idea that the narration should be given in the local language—and I am certainly no language snob. But, if I'm not mistaken, someone has been mucking about with e. e. cummings' translation, and Michael Wager, who is a sophisticated actor with a terrific voice and style, is lost in the naïve, flat narration needed here. The level of singing in the new recording is very high, but the old cast was (is) dramatically, vocally, and expressively virtually unbeatable. The Boston playing and choral singing are excellent, but it seems to take Bernstein and his forces a little longer to get warmed up. The devastating impact of Stravinsky's own opening is one of the great moments in the history of recorded music, and, remarkably, the level of tension and excitement never lets up.

The old set is mono, of course, but the sound is really very fine and has a crispness that matches the piece and the performance very well. But even if it didn't, it would still be precious. The Bernstein version is good, but the combination of Stravinsky and Cocteau themselves is still the best. E.S.

TAYLOR: *Through the Looking Glass* (see *Going on Record*, page 60)

RECORDING OF SPECIAL MERIT

TIPPETT: *String Quartets Nos. 1, 2, and 3.* Lindsay String Quartet. L'OISEAU-LYRE DSLO 10 \$6.98.

Performance: **Committed**
Recording: **Excellent**

Michael Tippett's three quartets, composed between 1935 and 1946, make a very full disc, having a total playing time of seventy-one minutes. It is very full in a more meaningful sense, too: these are fascinating, challenging, important works, and their cumulative impact is rather awesome. The disc represents the recording debut of yet another young English quartet, in this case one that has had the advantage of working with Tippett (as the Fitzwilliam did with Shostakovich). I am told that a 1956 Amadeus recording of the Second Quartet made an even stronger case for that work, but the composer has expressed himself as happy with this new package ("splendidly fulfilled" is his term), and I can't imagine any listener's being unmoved by these deeply felt and committed performances. The monumentally proportioned Third Quartet (an unusual five-movement layout, with three fugal movements spaced by two lyrical slow movements) is split for turnover, "sandwiched" between No. 2 and No. 1; this is an inevitable compromise if the three works are to fit on a single disc, and in this case it is not at all objectionable. The sound is excellent throughout both long sides, and a trilingual insert includes a concise background piece on Tippett as well as the composer's own notes on the quartets. R.F.

VERDI: *Luisa Miller.* Montserrat Caballé (soprano), Luisa; Sherrill Milnes (baritone), Miller; Bonaldo Giaiotti (bass), Count Walter; Luciano Pavarotti (tenor), Rodolfo; Richard Van Allan (bass), Wurm; Anna Reynolds (mezzo-soprano), Federica; Annette Celine (soprano), Laura; Fernando Pavarotti (tenor), a peasant. London Opera Chorus; National Philharmonic Orchestra, Peter Maag cond. LONDON OSA 13114 three discs \$20.94.

Performance: **Good**
Recording: **Very good**

Luisa Miller represents an important milestone in Verdi's development. It was his first opera dealing with middle-class society after an unbroken string of Biblical and historical subjects involving mighty rulers (Nabucco, Attila, Macbeth, Charles of Spain, Frederick Barbarossa) and such world-shaking events as the Crusades (*I Lombardi*), a major war (*Giovanna d'Arco*), and a power struggle for the rule of Venice (*I Due Foscari*). The musically more intimate scaling of *Luisa Miller* was a natural consequence of dramatic conditions not calling for rousing marches and choruses and various heroic gestures. Apart from all that, *Luisa Miller* (1849) is a very fine opera, and its substantial values are nobly captured in RCA's ten-year old recording (LSC-6168) with Anna Moffo, Carlo Bergonzi, and Cornell MacNeil in the principal roles, Fausto Cleva conducting. London's new effort, a good one in nearly all respects, falls short of RCA's earlier achievement.

Peter Maag secures a correct performance that is more painstaking and polished in orchestral execution than Cleva's was, but it

lacks the degree of urgency Cleve supplied. There is a certain rigidity in Maag's approach that makes me think the music has been tamed by an excess of Swiss sensibility and needs a transfusion of hot Italian blood.

Montserrat Caballé's creamy tone and secure technique would seem to suit the role of Luisa to perfection. She does achieve some spectacular results, particularly in the closing scenes, but she does not always execute the florid passages with full care or attentiveness. By contrast, and despite her less sumptuous timbre, Moffo offers an exceptionally committed performance and is in prime vocal form, so I find the achievements of the two sopranos just about even.

Sherrill Milnes is very fine in the soft passages and dignified aspects of the father's role, but he is less successful in the moments of passion, when his tone becomes unsteady and his top notes effortful. Cornell MacNeil's admirable performance on RCA is preferred. Both Count Walters are very good: London's Bonaldo Giaiotti is more sonorous, RCA's Giorgio Tozzi more interesting dramatically. In the role of Federica, Anna Reynolds sings very well indeed, but Shirley Verrett (RCA) is more intense as "the woman scorned."

There is no contest insofar as Wurm, the despicable villain, is concerned: RCA's Ezio Flagello is excellent; London's Richard Van Allan tries to substitute a permanent snarl for the weight his tone lacks, and it doesn't work. RCA also scores clear superiority in the small roles of Laura and the peasant.

And that leaves the part of Rodolfo, sung by Luciano Pavarotti with ardor, sensitivity, and great tonal beauty. Not only did I find no

fault with it, I relished every well-turned phrase. So it should not detract from Mr. Pavarotti's contribution if I say I think that Carlo Bergonzi's singing in the RCA set gave me even more pleasure. *G.J.*

RECORDING OF SPECIAL MERIT

WALTON: *Façade*. Tony Randall (reader); Columbia Chamber Ensemble, Arthur Fiedler cond. COLUMBIA M 33980 \$6.98.

Performance: **A triumph of timing**
Recording: **Excellent**

On June 12, 1923, the curtain went up in Aeolian Hall in Bond Street, London, on a production that seemed specifically calculated to enrage and insult its audience. Behind that first curtain hung another, displaying an open-mouthed face, and behind that stood Edith Sitwell, who spoke her verses into a megaphone while six musicians played the mocking score of *Façade* by the twenty-one-year-old William Walton. *Façade*—an *Entertainment* was not found entertaining by either its hooting audience or its scathing critics. But it has outlived both, and later performances have been more cordially received. Dame Edith called the poems in the suite "abstract," but they also make up a kind of stinging satirical travel folder, twitting the dreariness of a weekend spent with a hunting party in the Scottish highlands, the hollow aspects of poster-pretty Spain, the lumbering efforts of a bear-like creature to dance a polka. There are astonishing images—the "blue decks" of the sea, "vanilla-colored ladies" who pluck a "white satin bouquet of foam" at the sea-

shore, and less savage, more lyrical interludes where thwarted lovers wander through a December snowscape or the poet feeds her words "by the rivers of the sun." And the music scrupulously matches every turn of phrase, including a breath of Rossini at the mention of William Tell.

There have been quite a few recordings of *Façade*, the most outstanding being the poet's own, on both the London and Columbia labels, and a composer-conducted collaboration by Peggy Ashcroft and Paul Scofield on Argo. Tony Randall's claim in the competition is not so much his skill as an actor, which is not always in great evidence here, but his care in following the composer's specific instructions on the phrasing of every syllable—instructions Dame Edith herself completely ignored. Randall tries at times to squeeze more charm out of these verses than is implicit in the icy lines, but by sticking close to the Walton scenario he realizes more than most performers the coordination between the words and the music, and he never falls into the trap of mouthing the poems as mere nonsense verses—which they aren't. Especially useful is the glossary of obscure terms and mythological references he has compiled for this release, while his album notes are a model of lucidity. And Arthur Fiedler, who introduced the music of *Façade* to American audiences in 1925, but who might have been expected to apply a somewhat heavy hand to the musical end of things, coaxes an exceptionally adroit and apt performance from the Columbia Chamber Ensemble. *P.K.*

(Continued on page 140)

THE CLUB



A one of a kind drink.
Luscious, spunky and ready
to go.

The Strawberry Margarita
is only one of 12 terrific drinks
from The Club®. Try it, and you'll
want to try them all.

WELCOME TO THE CLUB

The Club® Strawberry Margarita, 25 Proof. © 1976, The Club Distilling Co., Hartford, Conn., Mento Pl., Ca.

STEREO REVIEW MARKET PLACE

NON-DISPLAY CLASSIFIED: COMMERCIAL RATES: For firms or individuals offering commercial products or services, \$2.10 per word (including name and address). Minimum order \$31.50. Payment must accompany copy except when ads are placed by accredited advertising agencies. Frequency discount: 5% for 6 months; 10% for 12 months paid in advance.

READER RATE: For individuals with a personal item to buy or sell, \$1.25 per word (including name and address). No minimum! Payment must accompany copy. **DISPLAY CLASSIFIED:** One inch by one column, \$265.00. Two inches by one column, \$530.00. Column width 2-1/4". Advertiser to supply film positives. Please write or phone for frequency rates.

GENERAL INFORMATION: First word in all ads set in caps at no extra charge. All copy subject to publisher's approval. All advertisers using Post Office Boxes in their addresses **MUST** supply publisher with permanent address and telephone number before ad can be run. Ads are not acknowledged. They will appear in the first issue to go to press after closing date. Closing Date: 5th of the 2nd month preceding cover date (for example, March issue closes January 5th). Send order and remittance to: Classified Advertising, STEREO REVIEW, One Park Avenue, New York, New York 10016, Attn: Hal Cymes.

EQUIPMENT

WRITE for quotation on any Hi-Fi components: Sound Reproduction Inc., 460 Central Avenue, East Orange, N.J. 07018. 201-673-0600.

NO fair trade laws in D.C. Write for discount prices on your choice of components. District Sound, Inc., 2316 R.I. Ave. N.E., Wash., D.C. 20018. (202) 832-1900.

Listen to TELEVISION IN STEREO



The **TE 200 TELEDAFHEP** EASILY CONNECTS TO ANY TV & STEREO SYSTEM. Using our exciting and matrix circuit, TeleDaph takes a low impedance output from the television and delivers true HIGH IMPEDANCE CHANNELS OF SIMULATED STEREO to drive any amplifier. Frequency response is maintained so you can hear the tinkle of bells or booming bass sounds as it happens on TV. With service warranty and hookup instructions \$16.95 ppd. Guaranteed to make your TV 100% more enjoyable.

OUR NEW TE 300 VHF UHF HI-FI TUNER IS NOW AVAILABLE. A complete and self contained 110 volt tuner VHF UHF antenna connections. Recording and amp output jacks. Five year service warranty \$149.95 ppd. From our factory.

SEND CHECK MASTER CHARGE NO. for TE 200 TE 300 or \$6.00 for C.O.D. TO RHOADES NATIONAL CO. DEPT SR P.O. BOX 817 HENDERSONVILLE, TENNESSEE 37075

NAME _____

ADDRESS _____

CITY _____ STATE _____ ZIP _____

SEND COMPLETE CATALOG

DIAMOND NEEDLES and STEREO CARTRIDGES at DISCOUNT PRICES for SHURE, PICKERING, STANTON, EMPIRE, GRADO and ADC. Send for free catalog. LYLE CARTRIDGES, Dept. S, Box 69, Kensington Station, Brooklyn, New York 11218.

ABSOLUTELY THE LOWEST PRICES on name brand stereo components. Send for our free catalog to **BOSTON AUDIO EXCHANGE**, 472 Massachusetts Ave., Cambridge, Mass. 02139.

DON'T PAY the high mail order prices. Thieves Warehouse of Tampa, 1531 South Dale Mabry, Tampa, Florida 33609.

CANADIAN Discount Catalog. Name brand stereo and 4-channel gear. Eico-3, 521 5th Ave, NYC 10017.

DON'T PAY the high mail order prices. Thieves Warehouse of Sarasota, 6564 Gateway Avenue, Sarasota, Florida 33581.

DON'T PAY the high mail order prices. Thieves Warehouse of Ft. Walton Beach, 652-D Beal Parkway, N.W., Ft. Walton Beach, Florida 32548.

CROSSOVERS—Custom designed; fully tested; guaranteed quality. Free Brochure. Write: Crossovers, Box 458, Placentia, CA 92670.

LOWEST PRICES on many brands of stereo components — 4 day delivery, write for same day quotes. University Stereo Cooperative, 57 E. Ridgewood Avenue, Ridgewood, N.J. 07450.

DON'T PAY the high mail order prices. Thieves Warehouse of Mobile, 1770 Bellline Highway, Mobile, Alabama 36609.

STEREO NEEDLES and CARTRIDGES—ADC, Audio Technica, B&O, Empire, Grado, Micro Acoustics, Pickering, Ortofon, Shure, Sonus, Stanton, Supex, BSR, G.E., RCA, Sony, Panasonic and others. For **FREE CATALOG**, write: **NEEDLE IN A HAYSTACK, INC.**, P.O. Box 17436, Washington, D. C. 20041.

DON'T PAY the high mail order prices. Thieves Warehouse of Pensacola, 3731 Navy Boulevard, Pensacola, Florida 32507.

DON'T PAY the high mail order prices. Thieves Warehouse of Atlanta, 3164 Peachtree Road, N.E., Atlanta, Georgia 30303.

DON'T PAY the high mail order prices. Thieves Warehouse of Atlanta, 1080-3 Cherokee Road, Smyrna, Georgia 30080.

DON'T PAY the high mail order prices. Thieves Warehouse of Atlanta, 4166 Buford Highway, N.E., Atlanta, Georgia 30345.

DON'T PAY the high mail order prices. Thieves Warehouse of Atlanta, 4162 Jonesboro Road, Zayre Center, Forest Park, Georgia 30050.

DON'T PAY the high mail order prices. Thieves Warehouse of North Tampa, 1441 East Fletcher Avenue, Tampa, Florida 33612.

DON'T PAY the high mail order prices. Thieves Warehouse of Atlanta, 2769 Lakewood Avenue, S.W., Atlanta, Georgia 30315.

DON'T PAY the high mail order prices. Thieves Warehouse of Montgomery, 3386 Norman Bridge Road, Montgomery, Alabama 36105.

DON'T PAY the high mail order prices. Thieves Warehouse of St. Petersburg, 9151 Park Boulevard, North Largo, Florida 33037.

DON'T PAY the high mail order prices. Thieves Warehouse of North Miami Beach, 1807 N.E. 164th Street, Miami Beach, Florida 33162.

DON'T PAY the high mail order prices. Thieves Warehouse of Panama City, 5220 West Highway 98, Suite D, Panama City, Florida 32401.

DON'T PAY the high mail order prices. Thieves Warehouse of Atlanta No. 6, Belvedere Plaza Shopping Center, 1203 Columbia Drive, Decatur, Georgia 30032.

DON'T PAY the high mail order prices. Thieves Warehouse of Knoxville, 5710 Kingston Pike, Knoxville, Tennessee 37919.

DON'T PAY the high mail order prices. Thieves Warehouse of Birmingham, 123 Roebuck Plaza Drive, Birmingham, Alabama 35206.

DON'T PAY the high mail order prices. Thieves Warehouse of Orlando, 1915 East Colonial Drive, Orlando, Florida 32803.

DON'T PAY the high mail order prices. Thieves Warehouse of Miami, 1756 S. W. 8th Street, No. 201, Miami, Florida 33135.

DON'T PAY the high mail order prices. Thieves Warehouse of Jacksonville, 1239 Arlington Road & Lone Star, Jacksonville, Florida 32211.

"DUBIE CD-5 RECORDING SYSTEM IS A MUST FOR THE SERIOUS HOBBYIST" or anyone owning two or more recorders. Dubie CD-5 allows you to be more creative in multiple taping, mixing, dubbing and editing. Available at Olson and Team Electronics stores for only \$59.95. Or write Dubie, Rt. 4, Box 98, Stigler, Okla. 74462.

DON'T PAY the high mail order prices. Thieves Warehouse of Jacksonville, 6078 Old St. Augustine Road, Jacksonville, Florida 32217.

DON'T PAY the high mail order prices. Thieves Warehouse of Clearwater, 1502 A Gulf To Bay Boulevard, Clearwater, Florida 33515.

DON'T PAY the high mail order prices. Thieves Warehouse of Birmingham, 103 South 18th Street, Birmingham, Alabama 35233.

DON'T PAY the high mail order prices. Thieves Warehouse of Mobile/Village Square, 301 South Craft Highway, Mobile, Alabama 36610.

SAVE UP TO 69% on over 100 top brand audio components from Carston Studios, New England's Audio Supermarket, one of the oldest mail order firms (Est. 1952) and certainly one of the most reliable. All orders shipped from stocked warehouse. Send for price quote and price list. Carston Studios, Old Brookfield Rd., Danbury, Conn. 06810.

PROFESSIONAL HI-FI COURSE—Instructors include Len Feldman, Julian Hirsch, Larry Klein, and Larry Zide. Home study course also available. Send \$1.00 for audio primer and full information on joining Society Audio Consultants (SAC) 49 E. 34th St., New York City 10016.

PERFECTIONISTS PREFER DYNAKITS. Before Purchase You Owe Yourself Our Quote. Mainline Ilr. 971 Fronheiser, Johnstown, PA 15902.

NO GIMMICK! Buy new components at 50% discounts using highly innovative purchasing methods. Fully legal. Request **FREE** information packet. Stereo Cost Cutters, Box 8014, Canton, Ohio 44711.

NO SACRED COWS. Top Discounts on BOSE, Infinity, Hegeman, ADS, Dual, Dyna, Sansui, Sony, Marantz, Yamaha, SAE, Klipsch, B&O, Teac, McIntosh, Citation, others. Seriously Audio Sales, 2126 Faulkner, Atlanta, GA 30324. (404) 325-7353.

DON'T PAY the high mail order prices. Thieves Warehouse of Ft. Lauderdale, 3347 North Federal Highway, Ft. Lauderdale, Florida 33306.

DON'T PAY the high mail order prices. Thieves Warehouse of Pensacola No. 2, 3820 North 9th Avenue, Pensacola, Florida 32503.

DON'T PAY the high mail order prices. Thieves Warehouse of Tallahassee, 1119 Apalachee Parkway, Parkway Shopping Center, Tallahassee, Florida 32301.

DON'T PAY the high mail order prices. Thieves Warehouse of Plantation, 231 South State Road 7, Plantation, Florida 33317.

DON'T PAY the high mail order prices. Thieves Warehouse of Hialeah, 6741 West 4th Avenue, Hialeah, Florida 33012.

BUILD YOUR OWN SPEAKERS AND SAVE UP TO 50%



You can assemble your own high quality, multi-element stereo speakers in a few hours and save up to half the cost of comparable speakers. Send for our free 32-page catalogue of speaker kits, raw speakers and accessories.

SPEAKERLAB
Dept. SR-7, 5500-35th N.E.
Seattle, Washington 98105

FANTASTIC DISCOUNTS on Hi-Fi Components. Write for **FREE** catalog! Gochenour's Sound House, P.O. Box 86, Eden, N.C. 27288.

DON'T PAY the high mail order prices. Thieves Warehouse of Hollywood, 5719 Hollywood Boulevard, Hollywood, Florida 33021.

DON'T PAY the high mail order prices. Thieves Warehouse of Ridgewood, 25 Godwin Avenue, Ridgewood, New Jersey 07450.

DON'T PAY the high mail order prices. Thieves Warehouse of Gainesville, 434 N.W. 13th Street, Gainesville, Florida 32601.

DON'T PAY the high mail order prices. Thieves Warehouse of Fair Lawn, 34-09 Broadway, Fair Lawn, New Jersey 07410.

DON'T PAY the high mail order prices. Thieves Warehouse of Dumont, 78 Washington Avenue, Dumont, New Jersey 07628.

DON'T PAY the high mail order prices. Thieves Warehouse of Boca Raton, 499 N.E. 20th Street, Boca Raton, Florida 33431.

DON'T PAY the high mail order prices. Thieves Warehouse of Atlanta No. 7, 215 Copeland Road, Atlanta, Georgia 30342.

DON'T PAY the high mail order prices. Thieves Warehouse of Jacksonville No. 3, Cedar Hills Shopping Center, 3716 Blanding Blvd., Jacksonville, Florida 32210.

BUY HI-FI COMPONENTS THE MODERN WAY:

PHONE & MAIL

Call TOLL FREE or write for LOW PRICES

Nationwide **800/854-7769**
California **800/472-1783**

Approved by Phone

MCK SALES
250 N THOMAS, PO BOX 2100
POMONA CA 91766

BIGGEST DISCOUNTS on stereo high-end components. Over 125 brands. Audio Unlimited, 466 Hawthorn, Sunnyvale, CA 94086. (408) 737-0828 evenings.

ESOTERIC AUDIO PRODUCTS — ARC, Magneplanar, Nakamichi, IMFried, Ampzilla, Quatre, Luxman, others. **STEREO (phile) SHOP**, 107 Third Ave. SE., Cedar Rapids, Iowa 52401/Village Shopping Center, Davenport, Iowa 52806.

DYNAKITS, DYNASPEAKERS, SHURE, SME—lowest prices. **FRIED LOUDSPEAKERS** (not discounted). Perfectionist modifications. Underground HIFI Sales, 324a Broadway Road, Arnold, MD 21012. (301) 647-0919.

DON'T PAY the high mail order prices. Thieves Warehouse of Biloxi, 441 Porter Avenue, Biloxi, Mississippi 39530.

DON'T PAY the high mail order prices. Thieves Warehouse of Ft. Myers, 3081 Cleveland Avenue, Ft. Myers, Florida 33901.

DON'T PAY the high mail order prices. Thieves Warehouse of Daytona, 1769 South Ridgewood, South Daytona, Florida 32019.

DON'T PAY the high mail order prices. Thieves Warehouse of Birmingham No. 3, 2134 A & B Warrior Road, Birmingham, Alabama 35208.

AUDIO RESEARCH, MAGNEPLANAR, DAHLQUIST, LUX, QUAD and other supreme quality audio components available from DKL SOUND LAB, 804 Burlington Ave., Silver Spring, Maryland 20910. (301) 588-6257. We ship anywhere in U.S. Prepaid and Insured.

TIRED OF THE SAME OLD SQUARE BOX?

DESIGN YOUR OWN SPEAKERS!
Send us your design. Our engineering staff will send you an estimate on the best components to use. You then order those parts from us in a kit. Send for our free catalog and design form.

HAVE A BALL!

WITH OUR CORNERBALL-8 SYSTEM

- 50 Watts RMS
- Omnidirectional Features
- 25 Colors to Choose From
- 5-Year Guarantee
- Complete System

2475 DEXTER AVE. N. Priced Like a Kit
SEATTLE, WA 98109 (Patent Applied For)
(206) 282-2069

RACK LABS active 3-way stereo crossovers, \$200. Write: 136 Park St., New Haven, Conn. 06511.

SOUND ADVICE FOR AUDIOPHILES. Over 70 brands, low prices. Write for quotes. Sound Advice, 18506 N.E. 5th Ave., N. Miami Beach, Fla. 33179. (305) 652-7610.

FORMULA 4 PLS4/D the best sounding universal tone arm, available U.S. dealers. Literature \$1 (bill). Mayware Ltd., 15 Heather Walk, Edgware, Middlesex, England.

RECORDS

SHOW ALBUMS, Rare, Out-of-Print LP's. 52 pg. list. 50 cents. Broadway/Hollywood Recordings, Georgetown, Conn. 06829.

PROTECT your LP'S—Poly sleeves for jackets 8 cents; Round Bottom Poly Inner sleeves 7 cents; Poly lined paper 15 cents; white jackets 35 cents. Postage \$1.50. Record House, Hillburn, N.Y. 10931.

THOUSANDS like new LP's and prerecorded tapes. Catalogue \$1.50. Records, Hillburn, New York 10931.

COLLECTORS' Soundtracks. Mint. List 50 cents (refundable). Jemm's, P.O. Box 157, Glenview, Ill. 60025.

SOUNDTRACK RECORD ALBUMS—Mail Auction—Free List. Whalon, 2321D Hill, Redondo Beach, Calif. 90278.

QUADRAPHONIC RECORDS AND TAPES—World's largest selection — all labels, over 1000 titles — at discount prices! For your free illustrated quad catalog, write: SOUND CONCEPTS, Box 654-A, Peoria, IL 61601.

RECORD RATERS WANTED! Anyone qualifies. We ship you nationally released LP's to rate. We pay postage and handling. You pay nothing for LP's. All you pay is small membership fee. Applicants accepted "first come basis." Write: E.A.R.S., Inc., Dept. SR, Box 10245, 5221 W. Center Street, Milwaukee, WI 53210.

OLDER JAZZ, Swing, LP's — lowest prices. Monthly lists. Soundtracks, Auctions! Records, Box 1138R, Whittier, Calif. 90609.

SOUNDTRACKS, ORIGINAL CASTS, PERSONALITIES — Free Newsletter/Auction. RTSR, 3700 Plaza, F211, Santa Ana, California 92704.

CASH for unwanted LP's and pre-recorded reel-to-reel tapes. TAPES, Hillburn PO, New York 10931.

HARD-TO-FIND Soundtracks, Shows, Nostalgia. Superb Imported, Domestic selections. Catalog \$1.00 (refundable). List Communications, P.O. Box 916-x, NYC 10023.

OLDIESoldies, 45rpm. Also current hits. Free Catalog. Corry's Record Shop, Box 166HJ, Mason, Ohio 45040.

RARE RECORDS, 45's, 78's, 33's. Soundtracks, Original, Cast Personalities, all kinds, mostly mint, 5,000 record lists, \$2.00. Refundable. Dealers Welcomed. Gurley, Box A72, Princeton, N.C. 27569.

CAPITOL, COLUMBIA, MCA LP Sale; Cutout, Import, Current LP-Tape Catalogs \$1. 60-page Oldie 45 catalog \$2. NERT, Box 268SR, Lawrence, Mass. 01842.

IMPORTED CLASSICAL RECORDS. Unusual symphonic repertoire on nearly 100 import labels, including Alpha, Electrecord, Norsk Kulturraad. Many exclusives. Free Bulletin, Records International, Box 1904, Los Angeles, CA 90028.

AUCTION — Classical Record Collection — Free Lists. Brian O'Flaherty, P.O. Box 5892, San Francisco, Calif. 94101.

FREE RECORD CATALOG — Pop, classics, jazz, shows, opera. Wide selection, low prices, prompt service. Write for latest catalog. Rose Records, 214 S. Wabash, Chicago, Ill. 60604.

HARD TO GET Soundtrack, Show, Personality, Jazz, LP's. Free List. Davidson, 6114 Gist, Baltimore, MD 21215.

Louisville Orchestra

First Edition Records

Now in Retail Stores! For Catalogue, write:

The LOUISVILLE ORCHESTRA

333 W. Broadway, Louisville, KY 40202

RECORD COLLECTION. List 25 cents. Mulvaney, 7620 Third Avenue, Brooklyn, New York 11209.

ADVENT RECORDS Superb recordings for the discriminating audiophile. Free Catalog. 4150 Mayfield Road, Cleveland, Ohio 44121.

PROTECT YOUR ALBUMS. White cardboard replacement jackets 35 cents. Plastic lined inner sleeves 15 cents. Postage \$1.25. Record boxes and 78 sleeves available. CABCO, 400-1, Box 8212, Columbus, Ohio 43201.

TAPE AND RECORDERS

RENT 4-track open reel tapes—free brochure. Stereo-Parti, P.O. Box 7, Fulton, California 95401.

THRIFTIEST "Live"—Operatic, Symphonic—Tapes & Cassettes. P.O. Box 1101, Woodhaven, New York 11421.

OPERA TAPES—Open Reel and Cassettes—Historical performances of past 40 years. Unbelievable treasures and rarities. Also LP records. Ed Rosen, 66-33 Saunders St., Rego Park, N.Y. 11374.

GOLDEN AGE RADIO—your best source for radio tapes. Box 25215-T, Portland, Oregon 97225.

OLD RADIO PROGRAMS on tape. Thousands available. Six hours. \$8.00. Catalogue, 50 cents. Nostalgic Radio, Box 29-B, Peoria, IL 61601.

1930-1962 RADIO PROGRAMS. Reels, \$1.00 hour! Cassettes, \$1.00 show!...Mammoth Catalog, \$1.25. AM Treasures, Box 192SR, Babylon, New York 11702.

TAPE RECORDERS

40 MODELS AS LOW AS... ABOVE DEALER COST

Send for discount sheets — also see our giant ad in next week's New York Times mail order section.

SAXITONE

1776 Columbia Rd. NW Wash. D.C. 20009

YESTERDAY'S RADIO PROGRAMS on Tape. Catalog \$1.00 refundable first order. Reel-Cassette. ADVENTURES, Box 4822-S, Inglewood, California 90302.

OPERA CLASSICAL MUSIC Open Reels. Rare mostly live free catalogue. K. Lohan Tapes, P.O. 298, Mastic Beach, N.Y. 11951.

TDK, BASF, Memorex, Maxell, cassettes, reels, 8-tracks. Lowest prices, new guaranteed. S&S Audio, P. O. Box 56039, Harwood Heights, Ill. 60656.

OLD RADIO PROGRAMS. Two Catalogs \$1.50, Cassettes \$1.59 hour, Reels four hours \$5.00. Nostalgia Sounds, 4151 Florence, Santa Susana, California 93063.

40,000 OLD RADIO SHOWS on Tape Jazz/Big Band remotes, Country/Western, discographies, anthologies, chronologies. Send \$2 for huge catalog (refundable). McCoy's Recording, Box 1069S, Richland, Washington 99352.

SCOTCH RECORDING TAPE, exclusively, all new, lowest prices. TAPE CENTER, Box 4305, Washington, D.C. 20012. BASF TAPE: New Stock. 40—50% Savings! Cassettes, Reels, GUARANTEED! Write Larry or Mike, INTERGALACTIC, 1047 Kirts, No. 134, Troy, Michigan 48084.

THRILLING Live Opera Tapes. Enormous Free Catalogue. Live Opera, P.O. Box 3141, Steinway Station, L.I.C., N.Y. 11103.

3600' FRESH Low Noise, High Output Ampex tape. 10-1/2" metal reel, 6 for \$35.00 plus \$3.50 UPS. Other tapes also on special, write for catalog. S.I.C., P.O. 88338, Atlanta, GA 30338.

OLDTIME RADIO PROGRAMS—your favorites on quality tapes. Free Catalogue. Carl R. Froelich, Route One, New Freedom, Pennsylvania 17349.

RADIO SHOWS! Top sound quality only. Cassettes or reels. Virgo House, Box 1060-S, Des Moines, Iowa 50311.

WE WILL BEAT any distributor, wholesaler, jobber, or dealer in America. Featuring TDK, BASF, AMPEX, and others. Tape World International, Box 231, Butler, PA 16001.

RARE BROADWAY Shows on tape including private and live recordings. Catalog \$1.00. David Hummel, 2820 South Memorial Highway, Traverse City, Michigan 49684.

SPECIAL OFFER—Professional Scotch tape. Low noise / Dynarange series. Used once by Hollywood studio. Splice free — 1/4" x 1-1/2 mil. 600' on 5" — \$2.50; 1200' on 7" — \$3.50; 2500' on 10-1/2" — \$6.00. Crosby Enterprises, Box 976, Newbury Park, CA 91320.

MANY Superb Operatic Tapes. Bargain Prices. Complete Operas, Recitals, Galas, Free Catalog From J. A. George, Box 601, STEREO REVIEW, Classified, 1 Park Ave., NYC 10016.

SONAR'S OPEN REEL TAPES. Duped one-to-one from master. Quad, stereo, 1/4, 1/2 track; 7-1/2, 15 IPS; 7", 10-1/2" reels. Highest quality anywhere! Send for catalog. Sonar Records, P.O. Box 455S, Kingsbridge Sta., Bronx, N.Y. 10463.

TUBES

TV and Radio Tubes 36 cents. Free 48 page color catalog. Cornell, 4215-H University, San Diego, California 92105.

FOR SALE

TEAC — Dust Cover, never used. (313) 835-0707. MD-TZ101.

METAL CASSETTES. C-60's/\$5.00. Fairstone, 102-25 67th Dr., Forest Hills, N.Y. 11375.

BIOFEEDBACK: High Performance EEG, EMG instruments. Assembled or low cost kit form. Write for complete specifications. EDC, Box 9161, Berkeley, CA 94709.

PLANS AND KITS

EXCLUSIVE U.S. Made, CBS Licensed SQ Decoder Kit. Full logic, wave matching and/or variable blend. SQ-1 (fixed blend), \$40.00. SQ-3 (variable blend), \$55.00. Knobs, cases not supplied. Regulated power supply available only with the decoder, \$5.00. Postpaid USA, Canada. Information available. Photolume Corporation, Dept. S-510, 118 East 28 Street, New York, N.Y. 10016.

INSTRUCTION

LEARN Electronics Organ Servicing at home. All makes, including transistors. Experimental Kit—trouble-shooting. Accredited NHSC, Free Booklet. Niles Bryant School, 3631 Stockton, Dept. A, Sacramento, Calif. 95820.

RADIO BROADCASTING: Become DJ! Get free tapes — records — equipment. Start own station! Learn how. "Radio!", Box 5516-RJ, Walnut Creek, CA 94596.

MUSICAL INSTRUMENTS

UP TO 60% DISCOUNT. Name brand instruments Catalog. Freeport Music, 114 Q. Mahan St., W. Babylon, N.Y. 11704.

WANTED

GOLD, silver, platinum, mercury wanted. Highest prices paid by refinery. Ores assayed. Free circular. Mercury Terminal, Norwood, MA 02062.

HYPNOTISM

FREE Hypnotism, Self-Hypnosis, Sleep Learning Catalog! Drawer H400, Ruidoso, New Mexico 88345.

SLEEP LEARNING. Hypnotic Method. 92% effective. Details free. ASR Foundation, Box 23429 EG, Fort Lauderdale, Florida 33307.

AMAZING self-hypnosis record releases fantastic mental power. instant results! Free trial. Write: Forum (AA10), 333 North Michigan, Chicago 60601.

RUBBER STAMPS

RUBBER address stamps. Free catalog. 45 type styles. Jackson's, Dept. K, Brownsville Rd., Mt. Vernon, Ill. 62864.

BUSINESS OPPORTUNITIES

I MADE \$40,000.00 Year by mailorder! Helped others make money! Free Proof. Torrey, Box 318-NN, Ypsilanti, Michigan 48197.

MAILORDER MILLIONAIRE helps beginners make \$500 weekly. Free report reveals secret plan! Executive (1K10), 333 North Michigan, Chicago 60601.

HI-FI ENTHUSIASTS WANTED!! Earn more than just spare money in your spare time. We need campus representatives to sell name brand stereo components at discount prices in your area. High commission, no investment required. Serious inquiries only, please. Contact: Alan Weisberg, K&L Sound Services Co., 75 No. Beacon St., Watertown, Mass. 02172. (617) 787-4073.

GET RICH with Secret Law that smashes debts and brings you \$500 to \$5 Million cash. Free report! Credit 4K10, 333 North Michigan, Chicago 60601.

FREE SECRET BOOK "2042 UNIQUE, Proven Enterprises." Fabulous "Little Knowns." Work Home! Haylings-B, Carlsbad, Calif. 92008.

STEREO REPRESENTATIVES NEEDED!!! Sell 100 brands!! Lowest Possible Prices!! Krasco, 623 Campbell Ave., West Haven, Conn. 06516.

AUDIO BUFFS. You don't have to be on a college campus to enjoy a good income selling high fidelity equipment. If you have a small circle of friends or work in an office of a dozen or more people, you have all the contacts you need to make extra income recommending and selling hi fi equipment. And it's fun. No investment. All the selling material you need. Call Internation Hi Fi in Baltimore, MD 21206, and ask for Mike Krizman. Tell him you'd like to be a campus rep. without a college. Call (301) 488-9600 — Daily between 11 A.M. — 7 P.M.

CAMPUS AUDIO DEALERS WANTED. We need people to help sell our high quality audio components at huge discounts. Sell in your area or on campus. Earn big bucks, no capital outlay required, no experience necessary. For complete information write to: ABCO, Dept CD, 915 Grand Avenue, New Haven, Conn. 06511.

CAMPUS REPRESENTATIVES wanted to sell name brand Hi-Fi components at discount prices in spare time. Write: Sound Savings, 18506 N.E. 5th Ave., N. Miami Beach, Florida 33179. (305) 652-7610.

EMPLOYMENT INFORMATION

AUSTRALIA—NEW ZEALAND WANT YOU!!! 50,000 Jobs! Paid Transportation! Latest Information and Forms. \$1.00. Austco, Box 3623-SR, Long Beach, California 90803.

OVERSEAS JOBS—Now Hiring, 103 Countries. All Occupations, High Pay, Free Transportation, Tax Benefits. Latest Computerized Reports—\$2.00. TRANSWORLD, International Airport, Box 90802-SR, Los Angeles, California 90009.

INTERNATIONAL TRAVEL ESCORT REPORT. All Expenses. Salary. Free Transportation. To Escort Groups Worldwide. Complete Employment Guide. \$5.00 (Satisfaction Guaranteed). Escort, 1210-H Howard Circle, Wheaton, Ill. 60187.

MOVIE FILMS

16mm SOUND Features. Shorts, New, Used for Sale. Free Catalog. National Cinema, 333 W. 57th St., N.Y., N.Y. 10019.

EDUCATIONAL OPPORTUNITIES

LEARN WHILE ASLEEP. Hypnotize! Astonishing details, strange catalog free! Autosuggestion, Box 24-ZD, Olympia, Washington 98597.

PUBLICATIONS

THE AUDIO AMATEUR—A quarterly publication for the serious audio constructor. Free prospectus. The Audio Amateur, Box 176Z, Peterborough, N.H. 03458.

PERSONAL COLLECTION 1942-1973. Jazz, electronics, etc. Mrs. Sam Lane, 1972 St. Mary, San Angelo, TX 76901.

SERVICES

PREWRITTEN RESEARCH, Thousands of topics. Computerized Catalog, \$1.00. Information Clearinghouse, Box 4391, Washington, D. C. 20012 (202) 723-1715.

PERSONALS

MAKE FRIENDS WORLDWIDE through international correspondence. Illustrated brochure free. Hermes-Verlag, Box 110660/Z, D-1000 Berlin 11, Germany.

MISCELLANEOUS

WINEMAKERS. Free illustrated catalog of yeasts, equipment. Semplex, Box 12276Q, Minneapolis, Minn. 55412.

FREE! Consumer Service Division Catalog. Includes a wide variety of products associated with the special interests of readers of Ziff-Davis magazines — PSYCHOLOGY TODAY, POPULAR PHOTOGRAPHY, STEREO REVIEW, POPULAR ELECTRONICS, BOATING, FLYING, CAR & DRIVER, CYCLE, SKIING. Send for YOUR free catalog today. Consumer Service Div., 595 Broadway, Dept. CL, N.Y., NY 10012.



WILLI BOSKOVSKY: the lilt of a Viennese waltz, the brio of a Tyrolean march

RECORDING OF SPECIAL MERIT

ZELLER: *Der Vogelhändler* (highlights). Anneliese Rothenberger (soprano), Princess Mary; Renate Holm (soprano), Christel; Walter Berry (bass), Baron Weps; Gerhard Unger (tenor), Count Stanislaus; Adolf Dallapozza (tenor), Bird Seller; Wolfgang Anheisser (baritone), Village Mayor; Gisela Litz (contralto), Lady-in-Waiting. Vienna State Opera Chorus and Vienna Symphony Orchestra, Willi Boskovsky cond. ANGEL S-37165 \$6.98.

Performance: **Vintage champagne**
Recording: **Excellent**

Der Vogelhändler (*The Bird Seller*) is one of those countless operettas the Viennese produced, first for home consumption and later for export, in the second half of the last century. The big names were Suppé and Strauss, but the operettas of Carl Millöcker, Josef Lanner, and Carl Zeller were also well known. Zeller was a part-time composer who had studied law and who worked as an official in the Imperial and Royal Ministry of Information in Vienna. He wrote three works for the stage before he wrote *Der Vogelhändler*, which became an instant hit in January 1891 at a time when the Viennese seemed to be growing weary of operetta. Zeller's music brought them back to the days of Strauss and they loved it.

Der Vogelhändler, set in the eighteenth century, has a libretto (by Moritz West and Ludwig Held) about Adam, a Tyrolean bird seller, and his girlfriend Christel, a postmistress in a village on the Rhine, who, after mind-boggling complications and misunderstandings, are, of course, united. Today nobody would remember *Der Vogelhändler* at all but for the series of hummable waltzes, marches, and lively ballads that occur in the course of the muddled action. These are what the Vienna State Opera can be heard performing on this record of highlights. Though the going in musical terms is at times dangerously close to pedestrian, there are enough bubbly moments for the album to be recommended to all who are susceptible to the flavor of vintage Viennese music. Particularly memorable are Adam's *Nightingale Song*, the march that spells out the moral of the play, *Never Fight with Women*, and the big hit, the duet *Schenkt Man sich Rosen in Tirol*. Anneliese Rothenberger makes a delightful soprano princess, Walter Berry a properly uberbearing baron,

Gerhard Unger a lusty, wily nephew. Adolf Dallapozza's tenor charms the air in the role of the bird seller, and Renate Holm projects a postmistress worthy of all the hero must go through to win her favors. Most charming of all are the contributions of the chorus and orchestra under Willi Boskovsky, a man who knows how to convey the lilt of a Viennese waltz and the brio of a Tyrolean march better than almost anyone alive. P.K.

COLLECTION

NATHAN LAM: *Recital*. Braun: *Psalm 98*. Berlinski: *Kol Nidre*. Rossi: *Kaddish*. Lewandowski: *Zocharti Loch*. Nieman: *Nine Israeli Folk Songs*. Handel: *Arias from Esther, Israel in Egypt, and Judas Maccabeus*. Nathan Lam (baritone); David Tilman Choir; Max Walmer (piano). SERENUS SRS 12039 \$6.98.

Performance: **Ambitious**
Recording: **Very good**

Nathan Lam started singing cantorial music in a synagogue at the age of eight, when he was hired by a Los Angeles congregation for the Jewish High Holy Days. Today, after years of training and performing in operatic roles as well as in houses of worship, he is cantor of a congregation in Syosset, Long Island. For his recording debut, the young (he's twenty-nine) Lam has certainly chosen an ambitious program. Here are settings of liturgical texts by Israel's Yehezkiel Braun, the American composer Herman Berlinski, and Italy's greatest Jewish composer of the Renaissance, Salomone Rossi, as well as a choral setting by Louis Lewandowski of passages from the Psalms. There is a performance of the English composer Alfred Nieman's Israeli folk-song cycle, and, just to make sure every facet of Lam's talent is explored, there are passages from the Old Testament oratorios of Handel. Unfortunately, as the program goes on, its rigors prove the singer's undoing. He is quite equal to the considerable melodic and rhythmic charms of the folk songs, and he is unaffected and moving in the *Kaddish*, *Kol Nidre*, and Psalms. Here is cantorial singing of a new kind—stripped of the sobs and ornamental cantillations of Eastern Europe, a clean and forthright approach to liturgy that is admirable. But when Lam tries to come to grips with the demands of Handel, his inadequacies are all too apparent. An agreeable voice, but not a great one. P.K.

Introducing the Staff . . .

When a personal opinion, particularly a publicly expressed one, grates on our nerves, one of the commoner responses is to ask, either under or at the top of our voices, just who that so-and-so thinks he or she is. The question is asked of STEREO REVIEW with respect to our regular contributors and staff many times each month, and in this column we endeavor to supply the answers. —Ed.



Contributing Editor

Peter Reilly

I WAS born during the Great Depression in Morristown, New Jersey—and at times it seems like it's been downhill ever since. The first song I ever memorized completely was *An Actor's Life for Me*, it having been brought to my attention by that magnificently raffish duo of the Fox and the Cat in Walt Disney's *Pinocchio*, one of the first films I ever saw. In truth, I "came to music" mainly through films: I found the combination of the darkened theater, the gigantic image, and the pulse-rattling soundtrack irresistible.

For some reason (now made apparent when I see them on TV: superior sound recording and massed orchestral effects by "symphonic" composers), I always chased down Warner Bros. films for a second, third, or even fourth viewing. The gut punch among these was a film called *King's Row*, which featured one of Erich Wolfgang Korngold's yeastiest scores. Meanwhile, I was listening at home mostly to Boston Pops recordings, a series of rafter shakers I still remember in their 10-inch, 78-rpm incarnations. When played at

full volume—how could one resist doing anything else with such sophisticated gems as Fiedler's oompah renditions of *The Continental* and *Jalousie* and *Jamaican Rhumba*?—they added, for a while, a certain *je ne sais quoi* to the tone of my North Jersey neighborhood.

It wasn't until my early teens that I really got down to the *serious* side of music and its appreciation. I decided the only thing that would do full justice to my elevated tastes was a Magnavox radio-phonograph advertised in the *New Yorker*. By working and saving all one summer I was finally able to install one in my room that September. Among the first things I played on it was Ravel's *Le Tombeau de Couperin*, a work I had known before only as the boring flip side of *Le Boeuf sur le Toit*, Milhaud's dizzy, rickety, but immediately entertaining collage of tunes. Goes to show you how wrong you can be: I don't listen to the Milhaud any more, but my fondness for Ravel remains—I still think, for example, that his Quartet in F is the sexiest piece of music ever written.

I grew up to spend most of my adult life in one aspect or another of the entertainment business, an education in itself. Several years in the press department of a major record company, for example, gave me a chance to see the Music Biz from the inside—and you wouldn't believe me if I told you. Let me just say that the Borgias would be hard put to survive in it for any length of time, and that any artist who makes it has generally done so against horrendous odds. I subsequently entered the film industry, where I found the rough ethical standards of the record business refined into a code of conduct so without redeeming social value that it would have made Jeeter Lester wince.

It was during this period that I came to the attention of STEREO REVIEW through a trial piece I had done on Peggy Lee. My association with the magazine and its readers—particularly those kind enough to write when they like something I've done—has since sustained me through some of life's drearier trials. Right now I live in the Catskills, work on an erstwhile comic novel, do a great deal of walking, and am getting it together slowly.

As a reviewer, I take it as my duty to warn the record buyer away from the cynical commercialism that plagues so many release lists, and at the same time to maintain my enthusiasm for the genuinely creative popular artists. My reputation as a negative-thinking spoilsport comes from my simple inability to go along with the record industry's more blatant snow jobs. Who can ever forget Moby Grape? I have, and I hope you have too. I hope that, like me, you are rejoicing instead in the new work of Janis Ian and other Real People. A reviewer's greatest satisfaction comes from being given the freedom to say what he thinks. His greatest pleasure comes not from pointing out that the emperor is naked but that there are others in the passing parade who are very well dressed indeed—and will you please pay a little attention to *them*! When you do, I find that I very much enjoy my work. —Peter Reilly

STEREO REVIEW ADVERTISERS' INDEX OCTOBER 1976

READER SERVICE NO.	ADVERTISER	PAGE NUMBER
2	Acoustic Research	109
	Advent Corporation	97
3	Angel Records	122
4	Audio Expo	106
5	Audio Technica, U.S., Inc.	24
	Avid Corporation	111
6	Ball Corporation	29
8	Bang & Olufsen of America, Cartridge Division	131
7	Bang & Olufsen of America, Turntable Division	84
	BGW Systems	116
	Bose Corporation	101
9	British Industries Co., BIC Venturi	32
10	BSR	58
11	Capitol Magnetic Devices	107
	Component Discounters	110
12	Crown International	123
13	Design Acoustics	95
14	Discount Music Club	10
	Discwasher	2
15	District Sound	112
	Dixie HiFidelity	116
	Dolby Laboratory	55
50	Dual	8, 9
	Dynaco	111
16	Electro-Voice	133
	Elpa Marketing	103
21, 99	Empire Scientific Corporation	5, 41
17	Ford Motor Company	50, 51
18	Fuji Photo Film, USA	45
19	Garrard	34 thru 37
	Harman Kardon	46, 47
25	Heath Company	6
	Heublein	136, 137
20	Hi Fi Buys	98
22	Hitachi	134, 135
23	Illinois Audio	110
24	International Hi Fi Distributors	131
	J & B Scotch	7
26	Jensen	16
27	JVC America	25
30	Kenwood	49
28	Kirsch & Company	94
29	KLH Research & Development	27
31	Koss Electronics	Cover 4
52	Lafayette Radio Electronics	57
	Marantz	142 & Cover 3
37	Maxell	113
34	McIntosh Laboratory	126
35	Meriton Electronics	63
36	Michigan Audio Discounters	126
	Micro-Acoustics Corporation	61
	Midwest Hi-Fi Wholesalers	112
38	MXR Innovations	129
	Nakamichi	14, 15
39	National Record Plan	89
40	Netronics Research & Development	132
41	Olympus Corporation	22
42	Onkyo	115
43	Phase Linear	54
45	Pioneer Electronics	125
46	Radio Shack	38, 39
47	Rectilinear Research Corporation	11
48	Royal Sound	26
49	RTR Industries	20
51	S.A.E.	62
32	Sansui Electronics Corporation	42, 43
	Schieffelin	127
100	Scott, Inc., H. H.	13
53	Sherwood	59
54	Shure Brothers	73
55	Sonic Research, Inc.	21
56	Sony Corporation of America	18, 19
57	Sound Reproduction	102
44	Stanton	93
58	Static Master	98
59	Stereo Corporation of America	116
50	Stereo Discounters	131
	TDK Electronics	99
	Teac Corporation	52
61	Technics by Panasonic	23
62	Top Discount Audio	116
50	United Audio	8, 9
1	U.S. Pioneer	Cover 2, 1
63	Yamaha International Corporation	81

THE MARANTZ

FOR THE BUDGET-MINDED PERFECTIONIST. THE 6100.

High on performance, the belt-drive 6100 features a super-dependable AC synchronous motor. The convenience of auto return and shut off. Plus full protection of your valuable records with a precision S-shaped tone arm, gentle-action viscous-damped cueing and anti-skate.

FOR THE BUTTON-PUSHER. THE TOTALLY AUTOMATIC 6200.

It's auto-everything. Auto start. Auto return and shut off. Auto repeat. Operates manually, as well. A servo motor, coupled

with belt drive, assures optimum speed accuracy. Stroboscopic pitch control "fine-tunes" speed to compensate for off-pitch records or for playing along with a musical instrument. The 6200 cares for your records, too, with a precision S-shaped tone arm, gentle-action viscous-damped cueing and anti-skate.



Model 6100/\$129.95*



Model 6200/\$199.95*

*Suggested list prices. Actual selling prices at dealer's discretion. All models come complete with anti-static turntable mat, plastic hinged dust cover, base enclosure, and low capacitance phono cables that assure 4-channel capability whenever you need it. The base enclosure for the 6300 is constructed of plywood, finished in genuine walnut veneer. The enclosures for the 6200 and 6100 are finished in walnut grain vinyl veneer.

TURNTABLES

FOR THE TOP-OF-THE-LINER. THE DIRECT DRIVE, OPTO-COUPLED AUTO LIFT 6300.

Features and technological excellence galore. Starting with **absolute speed accuracy** assured by a combination of **direct drive** design and **DC servo motor** that automatically compensates for voltage/speed fluctuations. Of course, there's **auto lift** and **shut off**, but on the 6300 it's **opto-coupled** — a significant Marantz exclusive. It means no tracking distortion caused by mechanical linkage between auto mechanism and tone arm. The secret: a tiny beam from a light-emitting diode maintains constant contact with a photo transistor during play.

At record's end, a sliding blade cuts contact, activating a circuit that lifts the tone arm and shuts off the motor. There's more. **Stroboscopic pitch control** "fine-tunes" speed to your personal preference. And **viscous damped cueing** gently, smoothly lowers the precision **S-shaped tone arm** onto the sensitive disk surface. **Vertical/lateral counterbalancing** and **anti-skate** result in lowest distortion and tracking error.

marantz,[®]
We sound better.



Model 6300/\$269.95

Come and sit inside a song.



Your favorite tapes and records are loaded with intricacies of sound that most speakers don't let you in on. But the Koss HV/1LC's deliver your song the way the musicians played it. All the delicious touches of musical perfection unfold around you, putting you deep inside the tune. Taking you to a place where the honey-smooth power of the lead singer's voice is in delicate balance

with the instruments and back-up chorus. So that you're presented with every colorful spark of talent, from all angles—the way you'd hear it if you were standing in just the right spot on stage. And Koss HV/1LC's deliver all ten audible octaves, bringing you every ounce of everything from the low-down throb of the bass, to the up-sweeping highs of the violin section.

And while the HV/1LC Stereophones bring you every note, their hear-thru design lets you catch every comment from people around you. Which in many cases may go like this: "let me try them."

So why not visit your audio specialist and slip into the exciting Sound of Koss: the HV/1LC's with volume balance controls, or the HV/1's and HV/1a's. Or write us,

c/o Virginia Lamm for a free full color catalog of all our products. Get a pair of Koss High Velocity phones and come inside. The music's fine.

© Koss Corporation



 **KOSS** stereophones
from the people who invented Stereophones.

KOSS CORPORATION, 4129 N. Port Washington Ave., Milwaukee, Wisconsin 53212 • Koss International/London, Milan, Dublin, Paris, Frankfurt • Amsterdam • Koss Limited/Burlington, Ontario
CIRCLE NO. 31 ON READER SERVICE CARD