

HOW MUCH
DISTORTION
CAN YOU HEAR?

Stereo Review

JUNE 1977 • ONE DOLLAR

Bette Midler: Little Orphan Annie Without the Sanctimony
Herbert von Karajan: Red Baron of the Berlin Philharmonic

EQUIPMENT TEST REPORTS: Lafayette LR-9090 AM/FM Stereo Receiver
Ohm Model L Speaker System • Sherwood HP 2000 Integrated Stereo Amplifier
Tandberg TCD 330 Stereo Cassette Deck • Thorens TD-126C Turntable



MOST \$600 RECEIVERS SOUND AS GOOD AS THIS ONE.



The average \$600 receiver sounds as good as the new Pioneer SX-650 until you start listening to prices.

If \$600 is your kind of price, an SX-650 should qualify as your kind of receiver. Not only will it give you the kind of features and sound quality you'd expect for that kind of money; it'll also leave you with roughly half your receiver budget unexpectedly unspent.

But suppose your idea of a receiver price is somewhere under \$300*. The SX-650 is going to sound better to you than anything you thought you could afford. Because it has more power, a wider frequency range, less distortion, and far greater versatility than most other receivers in that category.

All this might sound a little extravagant; but an authentic breakthrough, an achievement like the SX-650, doesn't happen often. We've learned that when our promises seem to sound especially rich, the best thing to do is simply review the facts.

It's a fact that the SX-650 provides a continuous power output of 35 watts per channel, min. RMS into 8 ohms, from 20 to 20,000 Hz, with no more than 0.3% total harmonic distortion. It also delivers each instrument and voice at its intended level, balanced within ± 0.3 dB of the RIAA curve.

The facts of its stereo separation, selectivity and sensitivity, however, must be experienced: numbers are impressive, but sometimes only hearing is believing.

You'll also be impressed by what you don't hear from the SX-650. You won't hear an assortment of background noises, or the thousand miscellaneous acoustic devils that live in the limbo between FM stations on lesser receivers.

On your next visit to a high fidelity dealer, listen to a Pioneer SX-650 with any reasonably accurate speakers.

You'll find either its price or its performance amazing. Depending on which you hear first.

PIONEER

U.S. Pioneer Electronics Corp., 75 Oxford Drive, Moonachie, New Jersey 07074.

*The value shown in this ad is for informational purposes only. Actual resale prices will be set by the individual Pioneer dealer at his option.

© U.S. PIONEER ELECTRONICS CORP. 1977

CIRCLE NO. 60 ON READER SERVICE CARD

UNFORTUNATELY FOR THEM, THIS ONE SELLS FOR UNDER \$300.*

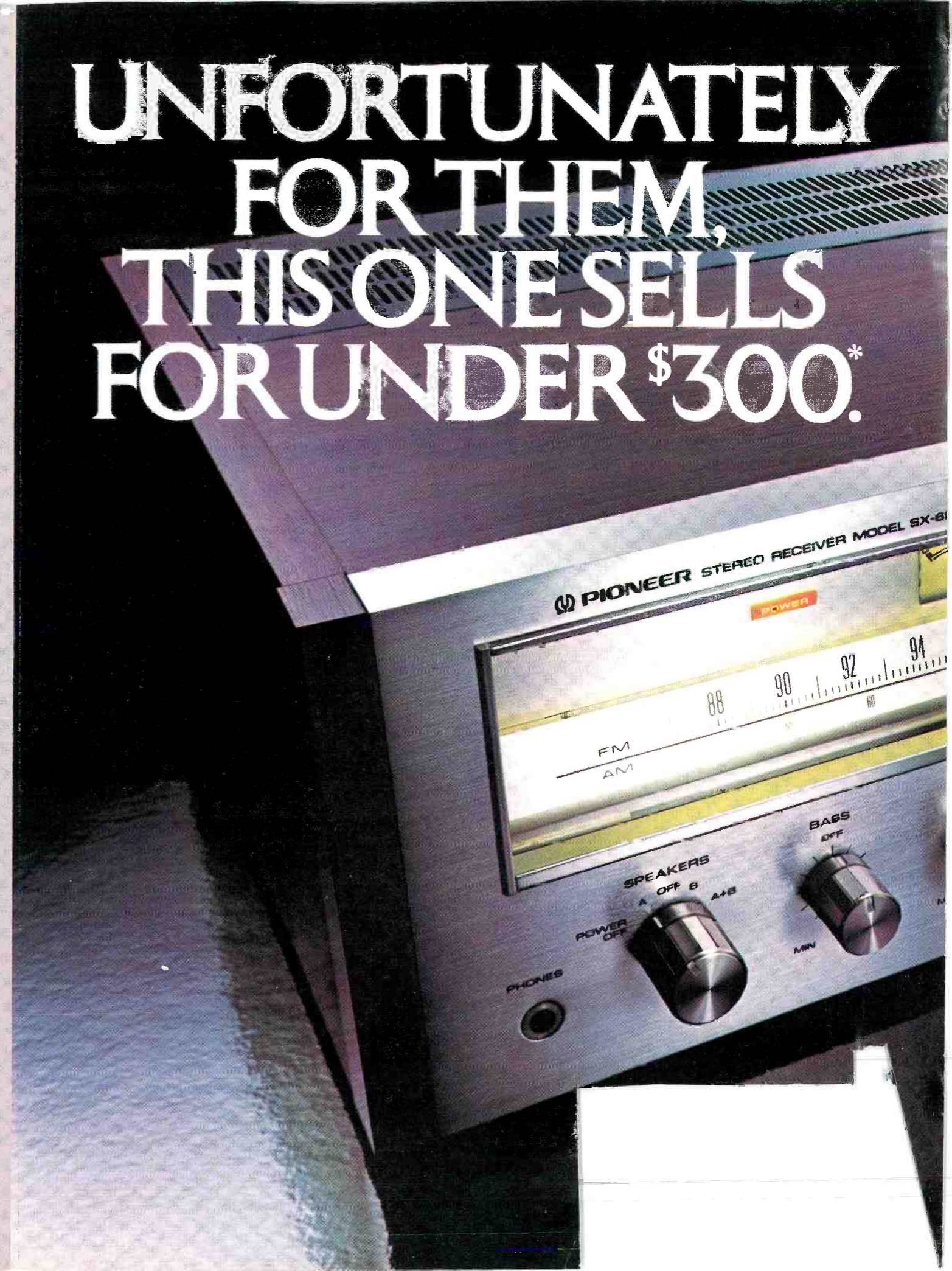



**People who've
bought them
love them.
People who
sell them
love them.
Critics love them.
You could be next.**



There's a lot to love here. Five turntables with low speed (300 rpm) motor, program system, superior tone arm. Performance that ranks with the best single play units. Yet multiple-play capability when and if you need same. For details pick up our "bee eye cee" 5 Turntables folder at high-fidelity dealers or write to British Industries Co., Dept. PR, Westbury, N.Y. 11590.

5 Turntables B I C™

Model 920 about \$79 - 940 about \$109 - 960 about \$159 - 980 about \$199 - 1000 about \$279. ©1976 British Industries Co. A Division of Avnet Inc.

CIRCLE NO. 10 ON READER SERVICE CARD

FORMERLY HI FI/STEREO REVIEW

Stereo Review®

JUNE 1977 • VOLUME 38 • NUMBER 6

The Equipment

NEW PRODUCTS	
<i>Roundup of latest audio equipment and accessories</i>	17
AUDIO QUESTIONS AND ANSWERS	
<i>Advice on readers' technical problems</i>	LARRY KLEIN 24
AUDIO BASICS	
<i>Glossary of Technical Terms-31</i>	RALPH HODGES 28
TAPE TALK	
<i>Theoretical and practical tape problems solved</i>	CRAIG STARK 35
EQUIPMENT TEST REPORTS	
<i>Hirsch-Houck Laboratory test results on the Lafayette LR-9090 AM/FM stereo receiver, Thorens TD-126C turntable, Ohm L speaker system, Tandberg TCD 330 stereo cassette deck, and Sherwood HP 2000 integrated stereo amplifier</i>	JULIAN D. HIRSCH 37
HOW MUCH DISTORTION CAN YOU HEAR?	
<i>It depends, apparently, on the kind of signal you are listening to</i>	PAUL MILNER 64

The Music

BETTE MIDLER	
<i>"I've gotten everything I wanted. Isn't that wonderful?"</i>	RICK MITZ 72
HERBERT VON KARAJAN	
<i>"...we need at least thirty or forty young conductors right now"</i>	ROY HEMMING 80
BEST RECORDINGS OF THE MONTH	
<i>Opera: Virgil Thomson's The Mother of Us All, Ermanno Wolf-Ferrari's The Secret of Susanna</i>	
<i>Keyboard: Colin Tilney's Clavichord Fantasias</i>	
<i>Vocal: Natalie Cole's "Unpredictable"</i>	
<i>Jazz: Gary Lawrence and His Sizzling Syncopators, Joel Shulman and friends</i>	89
POPULAR DISCS AND TAPES	94
<i>Bette Midler's Very Latest: "Live at Last"</i>	PETER REILLY 77
<i>Richard Thompson Live!</i>	STEVE SIMELS 95
<i>Janis Ian: the Girl Most Likely</i>	PETER REILLY 100
<i>The McGarrigles Again</i>	RICK MITZ 106
<i>The Ramones: the Laser-thin Line</i>	LESTER BANGS 114
<i>Phil Spector's Greatest Hits</i>	STEVE SIMELS 118
CLASSICAL DISCS AND TAPES	126
<i>King of the Steel Piano</i>	JOEL VANCE 127
<i>Kurt Weill: Instrumental and Theater Works</i>	ERIC SALZMAN 130
<i>Prodigy Ana-Maria Vera</i>	ERIC SALZMAN 134
<i>The Young Pianists</i>	ERIC SALZMAN 136

The Regulars

EDITORIALLY SPEAKING	WILLIAM ANDERSON 4
LETTERS TO THE EDITOR	6
TECHNICAL TALK	JULIAN D. HIRSCH 36
GOING ON RECORD	JAMES GOODFRIEND 60
THE POP BEAT	PAULETTE WEISS 62
ADVERTISERS' INDEX	148

COVER: Portrait of Bette Midler by Frederic Marvin

COPYRIGHT © 1977 BY ZIFF-DAVIS PUBLISHING COMPANY. All rights reserved. Stereo Review, June 1977, Volume 38, Number 6. Published monthly by Ziff-Davis Publishing Company; Editorial and Executive Offices at One Park Avenue, New York, N.Y. 10016; Telephone: 212 725-3500. Hershel B. Sarbin, President; Furman Hebb, Executive Vice President; John R. Emery, Senior Financial Vice President and Treasurer; Charles B. Seton, Secretary. Also the publishers of Boating, Car and Driver, Cycle, Flying, Modern Bride, Popular Electronics, Popular Photography, and Skiing. One-year subscription rate for U.S., \$7.98; U.S. possessions and Canada, \$10.98. All other countries, one-year subscription rate \$12.98, cash orders only, payable in U.S. currency. Second-class postage paid at New York, N.Y. and at additional mailing offices. Authorized as second-class mail by the Post Office Department, Ottawa, Canada, and for payment of postage in cash. SUBSCRIPTION SERVICE: Forms 3579 and all subscription correspondence should be addressed to Stereo Review, Circulation Department, P.O. Box 2771, Boulder, Colorado 80323. Please allow at least eight weeks for change of address. Include your old address, as well as new—enclosing if possible an address label from a recent issue. Material in this publication may not be reproduced in any form without permission. Requests for permission should be directed to Jerry Schneider, Rights and Permissions, Ziff-Davis Publishing Company, One Park Avenue, New York, New York 10016.

Editorially Speaking

By William Anderson



A ROCK THROUGH THE WINDOW

GOT another of those "I dare you to print this" letters the other day, but I didn't dare—the message was far too salty for the pages of what is still, at least as far as language is concerned, a "family magazine."

When it comes to letters columns, there must be as many policies, rules, and even "philosophies" governing how they are run as there are publications that run them. And there are those that *don't* run them too, either because they genuinely don't need them or because they have worked up a cute rationale to excuse themselves from the bother. The *New Yorker* is perhaps one of the latter, though it does have a "department of further amplification" that is used to pick up a loose stitch from time to time, giving it not only the *last* word but the word after it as well. The *London Times Literary Supplement* prints reader letters (they are occasionally the better part of an issue's reading), but it is a form of shadow boxing: the *Times'* reviews are often unsigned (there's another rationale for that), and a nameless target is no target at all.

It seems to me that journals of opinion (of which this is one) owe it to their audiences to identify those whose opinions they present, and to offer a forum for a reasonable rebuttal of those opinions. But since forums are busy, noisy places, not everyone gets to be heard over the uproar. How, then, does one go about improving his chances of being heard? Not, certainly, by *daring* an editor to print a letter. Most publications receive more reader mail than they can read or answer, let alone publish, so the first step is to winnow out what will not be used. In the case of *STEREO REVIEW*, these are the first to go:

1. *Long letters*: though they are often interesting, sensible, and civilized, space limitations forbid their inclusion. We try to cover as many subject areas in each column as possible, and concision simply has to count.

2. *Letters on more than one subject*: these are usually double-damned by being too long in the first place, and they are also a form of filibustering, unfairly monopolizing a floor that many others are clamoring for.

3. *Letters of mere disagreement*: this is the largest category, and the least interesting. If Joe Blow of Chagrin Falls, Walla Walla, or Tallapoosa has opinions at odds with those of Joel Vance, Noel Coppage, or Peter Reilly, he must not expect to see them in print unless they are expressed with a witty brilliance that puts their inspiration to shame.

4. *Unsigned (or patently pseudonymous) letters*: these deserve and get no more respect than a rock through the window (I wonder whether the *London Times* entertains them?).

5. *Late letters*: since many copies of *STEREO REVIEW* are passed down from hand to hand, some correspondence deals with matters raised (or exhausted) four or five months previously. Water over the dam.

6. *Esoterica*: subjects—shall we say the isorhythmic motet?—that are "caviare to the general" must find their audiences elsewhere.

So much for the wastebasket (well, not exactly, for we do acknowledge receipt of most of our mail after reading). What kind of letter is deemed worthy of being published?

1. *Letters of correction*: if we make an error of fact (there are no errors of opinion, only differences) and a reader catches it, we expect him to correct us—and to be generous when he does so.

2. *Letters of amplification*: we like to help expand the sum of the world's knowledge. If you know something we don't, or think we omitted something we shouldn't have, tell us about it or address a query that will give us the opportunity to amplify.

3. *Complaints*: we are happy to air grievances about shady-shoddy marketing practices, poor record quality, and the like, but they must be general—remember that this is a national magazine, and a ripoff on your block is not likely to be of interest even across town, let alone across the country.

4. *Letters of disagreement*: only if they are short, sweet, or (best of all) entertaining. That great American music critic Henry L. Menck-en once observed that criticism is nothing but prejudice made plausible. If you are going to disagree with our reviewers in print, you must be at least as plausible as they. So keep those cards and letters comin' in.

Stereo Review

PUBLISHER

EDGAR W. HOPPER

EDITOR

WILLIAM ANDERSON

MANAGING EDITOR

WILLIAM LIVINGSTONE

EDITORIAL COORDINATOR

LOUISE GOOCH BOUNDAS

MUSIC EDITOR

JAMES GOODFRIEND

TECHNICAL EDITOR

LARRY KLEIN

ART EDITOR

BORYS PATCHOWSKY

ASSOCIATE TECHNICAL EDITOR

RALPH HODGES

POPULAR MUSIC EDITOR

PAULETTE WEISS

ASSISTANT MUSIC EDITOR

VIVIENNE WINTERRY GOODMAN

PRODUCTION EDITOR

JOHN HARRISON

ASSISTANT EDITOR, RESEARCH

RICHARD SARBIN

EDITORIAL ASSISTANTS

BARBARA AIKEN, DIANE NAKAMURA

LONDON EDITOR

HENRY PLEASANTS

CONTRIBUTING EDITORS

CHRIS ALBERTSON

NOEL COPPAGE

RICHARD FREED

DAVID HALL

ROY HEMMING

JULIAN D. HIRSCH

GEORGE JELLINEK

IGOR KIPNIS

IRVING KOLODIN

PAUL KRESH

STODDARD LINCOLN

J. MARKS-HIGHWATER

LINCOLN PERRY

PETER REILLY

CHARLES RODRIGUES

ERIC SALZMAN

STEVE SIMELS

CRAIG STARK

JOEL VANCE

ADVERTISING DIRECTOR

JAMES J. SULLIVAN

ADVERTISING SERVICE MANAGER

LINDA BLUM

EXECUTIVE ASSISTANT

PEGI McENEANEY

ASSOCIATE PUBLISHER

STANLEY NEUFELD

Editorial and Executive Offices
Ziff-Davis Publishing Company
One Park Avenue, New York, New York 10016
212 725-3500
Eastern Advertising Manager: Richard J. Halpern

Midwestern Office: The Pattis Group
4761 West Touhy Ave., Lincolnwood, Illinois 60466
312 679-1100
Arnold S. Hoffman

Western Office
9025 Wilshire Boulevard
Beverly Hills, California 90211
213 273-8050; 272-1161
Western Advertising Manager: Bud Dean

Japan: James Yagi
Oji Palace Aoyama, 6-25, Minami Aoyama
6-Chome, Minato-ku, Tokyo, Japan
Telephone: 407-1930/6821, 582-2851

Circulation Office
P.O. Box 2771, Boulder, Colorado 80323

EDITORIAL CONTRIBUTIONS must be accompanied by return postage and will be handled with reasonable care; however, publisher assumes no responsibility for the return or safety of art work, photography, or manuscripts.

Member Audit Bureau of Circulations



ZIFF-DAVIS PUBLISHING COMPANY
Herahel B. Sarbin, President
Furman Hebb, Executive Vice President
John R. Emery, Senior Vice President-Finance/Treasurer
Phillip T. Heffernan, Senior Vice President
Edward D. Muhlfeld, Senior Vice President, Sports Div.
Philip Sine, Senior Vice President
Frank Pomerantz, Vice President, Creative Services
Arthur W. Butzow, Vice President, Production
Lawrence Sporn, Vice President, Circulation
George Morrissey, Vice President
Sydney H. Rogers, Vice President
Sidney Holtz, Vice President
Albert S. Traina, Vice President
Philip Korsant, Vice President
Paul H. Chook, Vice President
Edgar W. Hopper, Vice President
Charles B. Seton, Secretary
William Ziff, Chairman
W. Bradford Briggs, Vice Chairman

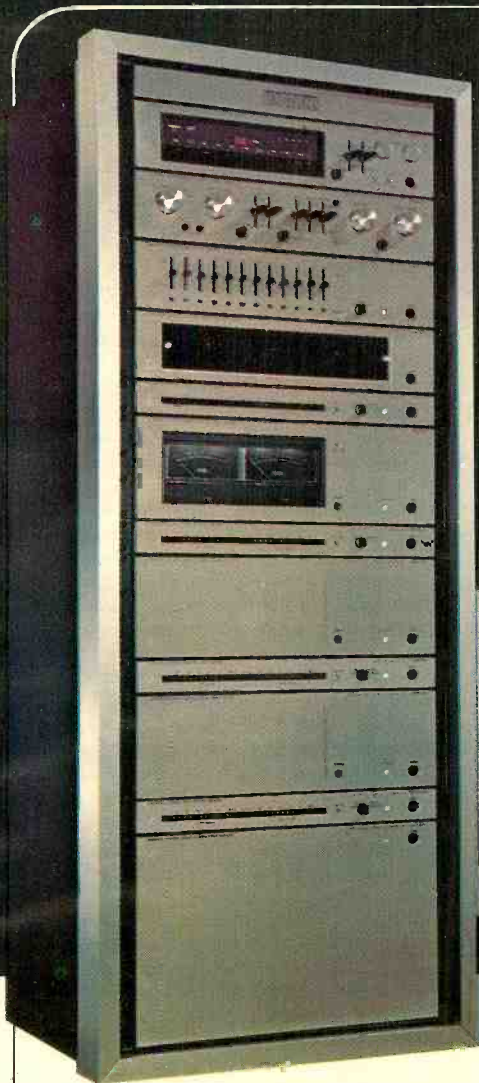

LUX

proudly introduces the

Laboratory Reference Series.

...resolving elusive problems of distortion with innovative new techniques.

Current and future LRS products are shown in this rack.

- 1) 5T50 frequency-synthesized digital stereo FM tuner, with DCI by and 7-station memory. \$1,495.
- 2) 5C50 DC control preamplifier with linear equalizer, but without tone controls. \$845.
- 3) 5G12 twelve-band stereo parametric graphic equalizer with switchable range and frequency contours. \$645.
- 4) 5E24 LED peak indicator. \$295.
- 5) 5M21 direct-coupled DC power amplifier; 100 watts per channel continuous power, with no more than 0.008 per cent total harmonic distortion, both channels driven into 8 ohms, 20 to 20,000 Hz. Transient intermodulation distortion: 0.05 per cent. \$1,195.

Below the 5M21 are seen additional peak indicators and power amplifiers without meters. These amplifiers, a crossover network, switching facilities and tone controls are among future LRS products. All LRS models have metal enclosures designed for compact stacking. Optional vinyl-clad, wood-grain enclosures are also available.

The newly developed Laboratory Reference Series comprises a coordinated system of components whose performance characteristics represent a significant step forward in the state of the audio art.

Consider, for example, just two specifications of the direct-coupled DC power amplifier. At full rated power, intermodulation and total harmonic distortion are no more than 0.008 per cent, a figure previously associated only with the finest preamplifiers.

Even more significant, the various sources of the elusive—but audibly crucial—transient intermodulation distortion (TIM) have been isolated and dealt with. As part of the LRS research program, LUX audiophile/engineers developed an innovative technique for precise measurement of TIM. With the LRS amplifier, it is 0.05 per cent.

THD and IM distortion are conventionally measured with sine waves, which are inherently symmetrical and repetitive, unlike musical signals which are irregularly shaped, rapidly changing transients.

The large amounts of negative feedback normally used to reduce THD and IM distortion actually worsen TIM.

Negative feedback involves returning a portion of the output signal—out of phase—to the input. When the signal is a sine wave, generated and measured by test instruments, this technique is effective.

However, with the constantly changing transients typical of music, the feedback signal returns to the input too late for the desired effect. It either "corrects" the wrong part of the waveshape or—far worse—fails to provide the instantaneous reduction of the signal required by the feedback-controlled circuits.

Result: the amplifier is driven into momentary clipping and overload—the aspect of TIM that is most audible and disturbing.

A reduction of the feedback and signal transit time so that TIM distortion effects would be significantly reduced is precisely what LUX sought, and has now achieved, with the LRS amplifiers.

LRS vs. TIM.

Capacitors are necessary in conventional circuits to avoid bias-upsetting DC. However, they slow the audio signal

(appearing as phase-shift lag), particularly in the lower bass range. A new type of solid-state device developed for the LRS amplifier—a Dual Monolithic Linear Integrated Circuit—has enabled LUX to eliminate all capacitors from the signal path.

The transistors commonly found in even the finest amplifiers are too slow (usually 4 microseconds) to cope adequately with transients. The recently developed (and very expensive) transistors in the LRS amplifier can switch in 0.5 microsecond.

Class B and Class A amplifiers have well-recognized limitations: Class B introducing "crossover" distortion; Class A with power limitations and gross inefficiency. The LRS amplifier, is able to employ a bias point (in effect, Class AB) that achieves the best of both operating modes.

For more on LRS

All of the above are just high points of one LRS component, the Luxman 5M21 power amplifier, shown above with other current and future models.

We invite you to write for the new LRS literature. In the near future only a few audiophiles are likely to own these newest LUX achievements. But all can appreciate what they represent.

LUX Audio of America, Ltd.

200 Aerial Way, Syosset, New York 11791 • In Canada: White Electronics Development Corp., Ontario

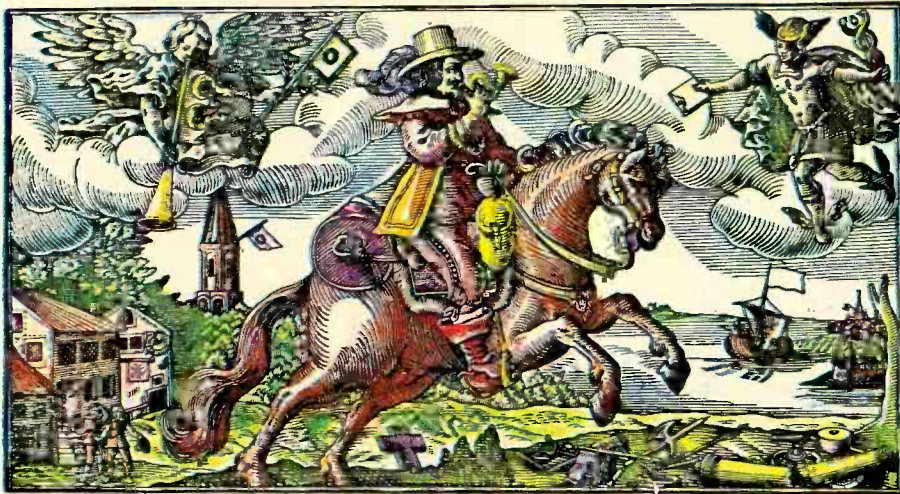

LETTERS TO THE EDITOR

Singspiel mit Freckles

● In the April issue, I read, first with puzzled amusement, then with growing annoyance, Roger C. Dettmer's vivisection of *Die Drei Pintos*, Carl Maria von Weber's unfinished *opera buffa* completed and considerably changed about by the young Gustav Mahler. Not only did I notice a singular lack of humor on Mr. Dettmer's part, which makes me wonder about his appropriateness as a reviewer of this sort of work, but also what seemed to me to be a determination to avoid compromising his negative position by letting slip one good word about it.

Die Drei Pintos is quite a lively work, full of bursting with bumptious goings-on that smack of *Die Lustigen Weiber von Windsor*. Hermann Prey's falsetto antics—several minutes of mock *Frauengesang*—are too funny to believe, and the spirit(s) of the male ensembles (and their equally various virtues) is nothing short of uproarious. That the work's very "flaws" (the inconsequence of the libretto, the obvious Mahler touches, etc.) are part of its charm and frivolous appeal has escaped Mr. Dettmer.

Mr. Dettmer consistently ignored those very qualities that will please many in *Die Drei Pintos*. Also, he reviewed RCA's German release of the recording; he was obviously unaware or unconcerned that RCA was to issue the opera in this country in March. The superbly written and researched notes in the domestic set are by Jack Diether, possibly America's finest authority on Mahler. Where Mr. Dettmer was openly unimpressed with the trilingual notes and German-only libretto in the Hamburg *Pintos*, he will certainly have more and better information in the hefty, thoughtfully documented new notes. Mr. Diether helps set at rest old arguments about the "whence" and "who" of each bit of music: a detailed table of the provenance of melodies, etc., is included. Veteran translator Gustl Breuer was specially commissioned to provide an English libretto, which appears side-by-side with the original German (whose wit Mr. Dettmer was apparently not able to savor).

I don't think Mr. Dettmer understands the peculiarly German humor and nature of the work. It's hardly a Weber or Mahler *magnum*

opus . . . of that be assured! But it is a delightful pastiche, a sort of *Singspiel* with freckles needing no apology for its modest, innocently illegitimate state.

CHRISTOPHER GREENLEAF
New York, N.Y.

Mr. Dettmer replies: My feelings about the work are as I stated them in the review. However, apropos the domestic RCA issue, the following changes should be mentioned:

(1) RCA has remastered the tape, which is all to the good, for all traces of distortion have been eliminated—no more buzzing at levels louder than mezzo-forte. However, the character of the sound is unchanged. The high end is still limited, the bass end still rumbles.

(2) RCA has created a new presentation box and booklet that includes a virtually literal, side-by-side translation into English of the German text. Kudos to Gustl Breuer. An admirably comprehensive essay and musical analysis of the entire work by Jack Diether has replaced Franz Willnauer's German-edition notes. The only point of debate is the number of years that Meyerbeer kept the *Pintos* sketches sent to him by Carl Maria von Weber's widow. Diether says twenty, based on John Warrack's biography of Weber. Willnauer (with whom Henri-Louis de la Grange in his book *Mahler concurs*) puts the figure at twenty-six. Diether makes no mention of Frau von Weber's ultimatum that Meyerbeer return her husband's sketches, thereby implying that he puzzled over them for two decades and then returned them voluntarily and apologetically.

(3) Except that RCA persists in literally "boxing" its discs—I find the box inherently inferior to the albums of yesteryear—the domestic edition of *Die Drei Pintos* is altogether an improvement on the German import set. More's the pity, therefore, that the original producers could not have recruited for the performance a conductor of more finesse, humor, and imagination than Gary Bertini, or that the recorded sound could not have bettered German standards of fifteen years ago.

Auto Shortwave

● I just got my first issue of *STEREO REVIEW* (April) and enjoyed it very much, especially the article on car stereo by Ivan Berger.

Some years ago, I saw an AM-FM short-wave radio (a Sanyo?) in a Rolls Royce, no less. Do you know if anyone makes short-wave radios for cars? If so, I would like the names and addresses of the companies.

GAREY W. BANKS
Roswell, N.M.

Ivan Berger replies: Becker (613-19 S. 24th Street, Philadelphia, Pa. 19416) has shortwave radios available on a special-order basis, and they also make a shortwave converter that can be used with other radios. I believe Blaupunkt (2800 S. 26th Avenue, Broadview, Ill. 60153) has shortwave models, too. And though I don't recollect a shortwave Sanyo, you can write the company (1200 W. Artesia, Compton, Calif. 90120) and ask. If all else fails, check your local Rolls-Royce dealer.

Try to get a demonstration before you buy, if possible. Though I've never tried an in-car shortwave, I have a niggling suspicion that they may not work as well in the U.S. as they do in Europe, where shortwave broadcasting seems to be more prevalent and shortwave transmitters would be closer together.

In answer to the many requests I've gotten for addresses of car-stereo companies, I'd like to point out that *STEREO REVIEW*'s Tape Recording and Buying Guide for 1977, due on the stands about mid-August, will have a substantial car-stereo section.

Car Stereo from Detroit

● "Car Stereo" by Ivan Berger (April) was an interesting and instructive article, but in his desire to describe what is currently available from equipment manufacturers, Mr. Berger neglected to mention some of the excellent custom installations available from car dealers.

My 1970 Ford Country Squire LTD station wagon came factory-equipped with a four-channel, matrix-type stereo system with the means to balance the speakers for either encoded or normal program material. The bass is excellent since the speakers in the front are door-mounted and the back ones face each other in the large cavities on either side of the car. It uses both eight-track tape and pushbutton radio program sources.

My daughter has an excellent factory-installed, four-channel/stereo system in her Chrysler Town and Country station wagon. It is similar to mine except that it uses cassettes (which I find superior to eight-track tape) and has an excellent system for either "off the air" stereo recording or voice recording through a plug-in mike (supplied).

The advantage of both these systems is that they are practically theft-proof—it would be just too much trouble to get them out. However, Jensen's new Triaxial speakers would improve either system.

H.R. EDMUND AUSTIN
Bridgehampton, N.Y.

Shifting Ears

● James Goodfriend's April column concerning the introduction of classical buffs to pop music got me thinking again about that interesting problem. Several times I, a classical buff, have asked friends to play their favorite pop records for me. I listen intently and carefully, but I'm always disappointed. Mr. Good-

(Continued on page 10)

WANT THE BEST SPEAKER FOR ALL TYPES OF MUSIC?



No matter how versatile they tell you other speaker systems are.

only Marantz has a speaker system specifically designed to play all kinds of music equally well. Here's why. Virtually all speaker systems — no matter how good — are designed one of two ways. Either "air suspension" — best for movie albums, jazz, folk, opera, symphony, country. Or they're designed "ported" — super for handling the punishing dynamic levels of today's electronic rock music.

But Marantz and only Marantz gives you both, the best "air suspension" system and the best "ported" system in one incredible speaker system. The HD-88, HD-77 and HD-66 are designed to deliver the very best sound with every type of music. Frampton or Hampton. Punk Rock or Puccini. What's the secret? Vari-Q*! It's an exclusive Marantz

Look 'em straight in the eye and say,

"I want Marantz!"

feature, found in the models HD-88, HD-77 and HD-66. Vari-Q is simply a high density foam plug that snugly inserts into the hole or "port" in the speaker baffleboard. With the plug in, the speakers are "air suspension." And they add or subtract nothing — and that's perfect for classical, easy listening and most jazz. BUT. If you want the most fantastic, gutsy, low-end you've ever heard for rock, just pull the plug. The system is "ported." And it belts out a big

three to four decibels more "oomph" in the bass. Perhaps

the most compelling reason for owning any Marantz stereo product — is the true musical sound of Marantz. Marantz really does sound better. Don't let anyone tell you any different. See your nearest Marantz dealer now. He's in the Yellow Pages.

marantz.
We sound better.



*Patent pending.

Prices, models and specifications subject to change without notice.

The luxury a difference:

Sansui's new 9090DB top-of-the-line receiver adds Dolby to its other luxury credentials — big power, an extremely fine tuner section and great versatility. The Dolby circuitry will not only decode Dolby FM broadcasts; it can also encode and decode tape

recordings for reduced noise and hiss.

And, of course, with the Sansui 9090DB you can creatively determine just how you like your music. In addition to bass and treble controls, with turnover selectors for 150 Hz/300 Hz and 1.5 kHz/3 kHz respectively,

The Sansui 9090DB.

AUDIO SECTION

POWER OUTPUT

125 watts per channel, min. RMS,
both channels driven into 8
ohms from 20 Hz to 20,000 Hz,
with no more than 0.1% total
harmonic distortion.

FM SECTION

FM SENSITIVITY

9.8 dB μ V (1.7 μ V).

SELECTIVITY

better than 85 dB.

SIGNAL TO NOISE RATIO

better than 70 dB.

SPURIOUS

RESPONSE REJECTION

better than 85 dB.

* Dolby is a trademark of
Dolby Laboratories Inc.

Simulated woodgrain cabinet.



A whole new world of beautiful sound.

Sansui

SANSUI ELECTRONICS CORP.

Woodside, New York 11377 • Gardena, California 90247

SANSUI ELECTRIC CO., LTD., Tokyo, Japan • SANSUI AUDIO EUROPE S.A., Antwerp, Belgium • In Canada: Electronic Distributors

CIRCLE NO. 34 ON READER SERVICE CARD

receiver with Dolby.*

there is also a midrange control. High and low filters. A tone defeat for bass and treble. A loudness switch and 20 dB audio muting switch. For added creative freedom, two tape monitors and a mic mixing circuit with separate level control. Two tuning meters,

as well as twin power meters that also serve for Dolby tone calibration.

Listen to the 9090DB. Handle its superbly smooth controls. See how they respond to your slightest command. We know you will fall in love with Sansui.



The Beauty



AIWA's AD-1250 is so beautifully built it makes the other decks look flat. Its new ultra-modern slant backed deck with its 20° angle stands out in a crowd. And up. So you can see what you're doing. And of course underneath all this streamlined beauty, lies the pride and joy of our AIWA engineers. The technical genius that has made AIWA famous for quality worldwide. Our built-in Dolby* and interlocked Dolby-MPX filter switch have a 60dB S/N ratio. The 30Hz to 16kHz (Fe-Cr tape) fre-

quency response insures vividness and clarity of sound. The oil-dampened cassette elevation and ejection feature, pioneered by AIWA, handles your cassettes with kid gloves. The AIWA AD-1250. The body beautiful.

*Dolby is a Trademark of Dolby Laboratories, Inc.

friend put his finger on the reason for my let-down: I have been listening in the wrong way. For instance, after one such listening session, my friend turned to me expectantly. "He sings flat, has little sense of rhythm, mumbles, and uses only two chords," I complained. My friend acted as if my criticisms were irrelevant. I guess that Mr. Goodfriend would agree.

Now, tell me if a further hunch is correct. The reason such criticisms are irrelevant is that the popular music listener does not hear, or at least listen for, these qualities. He slides along on the surface of the music (my friend talked during the record). The classical buff, on the other hand, must lock onto each detail of the music for maximum enjoyment, riding the crests and valleys of the performance (to paraphrase Leonard Bernstein). When listening to pop music correctly, it seems, one should not even notice that the singer is "glossing over the notes," or "paying no attention to the words." Does this also explain why so much popular music has such low density of information?

I would be intrigued to read a description of the way Mr. Goodfriend changes his listening habits when he switches from classical to pop, because he clearly enjoys both. Does one need two sets of ears?

CHARLES LONG
Minneapolis, Minn.

At least!

● In reference to James Goodfriend's "Going on Record" column in April: I went from classical to rock music. With the music of

Beethoven in my soul, I learned that Böhm interprets better than Karajan or Haitink. So why not, after hearing the sounds of Jefferson Starship, gravitate toward a guest guitarist like Jerry Garcia? Following Mr. Garcia, I could discover another band, the Grateful Dead, and with the purchase of a Garcia solo album, move on to Ron Tut, who, in turn, plays with Elvis. But wait! Didn't Ron Tut play with Buckingham-Nicks, who are now with Fleetwood Mac? And what of producers? Didn't Al Schmitt, who did those Airplane albums, help Jackson Browne and Linda Ronstadt do theirs? It seems all I have to do is follow a name and, with luck, I'll get a pop-music education. As for Mr. Goodfriend's closing remarks: remember, don't trust Grace Slick—she's over thirty.

JAMES RAINS
Jolon, Calif.

Griffes

● In his December review of the new Philips recording of the Griffes sonata, Richard Freed states, "There has not been a recording of the sonata in well over twenty years. . . ." There is a fine stereo recording of the work that I bought new in a major record outlet in Sacramento about three years ago. It is Lyrichord LL 105, produced by Lyrichord Discs, Inc., 141 Perry Street, New York, N.Y. The album also contains Griffes' *Roman Sketches*, Op. 7. Both works are played by Leonid Hambro.

DENNIS DUNNETT
Elk Grove, Calif.

Enlightened

● I was happy to see that Electric Light Orchestra's latest release, "A New World Record," was reviewed in your February Best of the Month section. Being an avid Move and Electric Light Orchestra fan, I rejoiced over the favorable review. My favorite magazine has finally seen and heard the Light.

PAUL R. SECUNDE
Seven Hills, Ohio

De Gustibus

● Thank you for the editorial on "Critical Infallibility" in the April issue. Judging from the letters many of your readers write, I should think this piece is badly needed. The terrible anger some of these letters display is a constant source of amusement to me.

Something over fifty years ago I came to the conclusion that there is no such thing as an absolutely bad or an absolutely good critic in any of the arts. They are only relatively good or bad. The bad ones are the ones with whom you disagree; the good ones are the ones whose tastes are about the same as your own. I learned this about the same time I learned that there was no point in telling a barber how I wanted my hair cut. I looked for a barber whose natural inclination was to cut hair the way I liked, and then I kept going to him without giving him any instructions.

Once I've found a critic of any of the arts whose opinions are for the most part the same as mine, I follow those opinions and rarely go wrong. Why should I waste time writing ti-

& The Best



AIWA's AD-1800 is the cassette deck that other machines are trying to measure up to. Check our extra large flywheel which no other deck this size has, and our spec all oil-dampened cassette elevation and ejection feature. Along with our Solid Stabilized Transport System (SST) and AC hysteresis synchronous motor, the wow and flutter is kept

inaudible at only .05% WRMS. Our biggest competitor can only claim a .07% wow and flutter level. Our built-in Dolby* and DNL noise reduction systems have a better than -65dB S/N ratio. The 30Hz to 18k-Hz (Fe-Cr tape) frequency response insures that the multitude of sound colors reproduced are kept vivid and alive. Every sound, from a violin to a drum roll is definitive. The AIWA AD-1800. The superior one.

AIWA®

Distributed in the U.S. by: MERITON ELECTRONICS INC., 35 Oxford Drive, Moonachie, N.J. 07074 - Distributed in Canada by: SHIRO (CANADA) LTD. CIRCLE NO. 6 ON READER SERVICE CARD

grades against critics with whom I disagree? I just ignore them, and I'm a much happier man for it.

SIDNEY FRANK, JR.
Manchester Center, Vt.

● If James Goodfriend wants to say that he does not like *Scheherazade* because it has little structural complexity or development of musical ideas, no one can quarrel with him (see "Going on Record," March). His likes and dislikes are not to be disputed, and his reasons are perfectly sound. But when he says that *Scheherazade* is a second-rate piece of music on this account, he should be made to stand in the corner. It has proved an enduring work of art for the very good reason that it is richly endowed with four of the main ingredients of music: melody, harmony, rhythm, and color.

Mr. Goodfriend then goes on to call *Carmina Burana* a public nuisance. The arrogance and snobbism of that remark are infuriating and must be counted as one of the reasons why classical music cuts itself off from so many people. *Carmina Burana* has given pleasure to a great many people, including me, not all of them ignorant or stupid, and some of them—Eugen Jochum for one—distinguished musicians. Like *Scheherazade*, it will probably be around to enrich our musical lives for a very long time.

JOHN HOLT
Boston, Mass.

Mr. Goodfriend replies: I still continue to be amused by people who tell me that I can't say this or I can't say that. I can say it and, in-

deed, I have said it. If Beethoven's Fifth is a first-rate piece of music, then—it seems quite obvious to me—*Scheherazade* is no better than a second-rate one, its popularity notwithstanding. (I did not say that in my column, but I'm perfectly willing to say it now!)

One of the major points of my column was to point out that popularity and quality have little to do with each other. Mr. Holt, I'm sure, knows too much about music really to disagree with that. So far as *Carmina Burana* is concerned, to say that it is the *Scheherazade* of its day would be, if anything, to compliment it. I too find its tunefulness appealing and its devices effective, but it is, and always has been, an assemblage of musical clichés repeated over and over, each time louder. Even chocolate ice cream palls after too much repetition, and *Carmina Burana* has earned the sobriquet of "public nuisance" through constant repetition, in concert halls and on records and radio, of what is in itself twice repetitive. I dare say it will enrich many peoples' lives for a time, but even those who dote on ice cream admit, at some point, that enough is enough.

Disc Quality

● William Anderson's editorial on disc quality (March) is perhaps the most accurate discussion of this problem to date. As manufacturers of stereophones we are keenly aware of the problems of poor pressings. Anyone who dons a pair of headphones can readily hear the clicks and smudge marks on a virgin recording (yes, the smudge marks made by

whoever handles the discs when they are packaged).

I would recommend some research into this matter by some responsible body of the audio industry so that we can work with the recording industry in solving some of these problems. We must examine not only the pressing process, but also the distribution patterns, as I suspect that therein lies a major source of the warpage so prevalent today. In the meantime, any audiophile who has complaints can send them to me; I will be happy to send them *en masse* to the recording industry.

MICHAEL SOLOMON, Marketing
Superex Electronics Corporation
151 Ludlow Street
Yonkers, N.Y. 10705

Lyrics: Who Listens?

● After reading that Gerry Goffin wonders if people even listen to rock lyrics at all ("Who Writes All Those Rock Lyrics," February), I felt compelled to write and reassure all you great lyricists. YES! We do listen to the lyrics, of course! Speaking for myself and the people I know, we love listening to the lyrics, especially meaningful ones, whether the meaning is obvious or something that means different things to different people. The first thing I do when I buy an album is look for the printed words to all the songs and then read them and everything else on the cover. (I wish more record companies would put the lyrics on the album cover.)

I would like to see STEREO REVIEW do an article on how different lyricists got started:

The Sound Shaper. Because all rooms are not created equal.



You can own the finest component system and still be getting inferior sound.

Because unless you happen to have an acoustically perfect listening room, your system and space probably don't match. Hard walls, soft carpets, glass tables, even the size of a room can change sounds.

So ADC developed the new ADC 500 Sound Shaper Frequency Equalizer.

By adjusting the twelve frequency levels you can actually shape your sound to fit the shape of the room, and compensate for spaces and textures that interfere with sound. You can even tinker with the sound just for the fun of it: bring up a singer, lose a violin, actually re-mix your recording.

The new ADC 500 Sound Shaper can get your system into great shape.

ADC

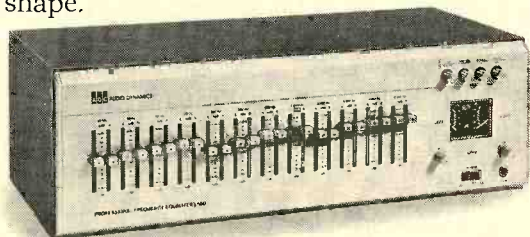

The Sound Shaper

ADC Professional Products Group. A division of BSR (USA) Ltd., Route 303, Blauvelt, N.Y. 10913

CIRCLE NO. 4 ON READER SERVICE CARD

for instance, did most of them have connections in the music industry? Did any of them start as nobodies, not having any idea who to send their lyrics to? Do they have any specific advice for the aspiring lyric writer?

J.C. WILLIAMS
Bellflower, Calif.

We're working it up.

The Hiss Case

● Regarding Al Stewart's "villainous hisses," I have found that your guess (April letters) is correct: Al Stewart hisses. I went back to his second album, "Love Chronicles," released on Epic in 1969, and, sure enough, there was the same sssss as on the later records.

JOHN SKELSON
Staten Island, N.Y.

Dynamic Range

● Daniel Queen's March article, "Noise Dilemma," mentions the use of compressors to make tapes or records more listenable under certain circumstances. This is an application that has been largely ignored by manufacturers of expander-compressors, yet playback compression is the sole reason I use one.

It is well known that as people pass middle-age the minimal sound-pressure level required for satisfactory listening increases. This change is usually dismissed without further analysis as "natural loss of hearing acuity." What is not generally recognized is that the SPL required to cause acute discomfort or pain does not necessarily undergo a corresponding increase. Thus the tolerable breadth of dynamic range noticeably decreases. But within this reduced *objective* range, the *subjectively* perceived dynamic range seems at least as great as ever.

For me, nearly all records in the symphonic repertoire require compression in playback to keep the dynamic range within tolerable limits. When overall volume is controlled to keep soft passages audible, the dynamic range must be compressed 20 to 40 per cent to keep loud passages from being uncomfortable or painful to hear. Thus, regarding Mr. Queen's concluding question of choice, the answer for me and my category of listeners is that if the recorded dynamic range were significantly increased, the problem would then be to compress it into tolerable limits without thereby introducing a new source of distortion.

WILLIAM N. HARRISON
Washington, D.C.

Daniel Queen replies: Mr. Harrison is describing a problem that an increasing number of people—not necessarily only "past middle age"—are now experiencing. Unfortunately, the subjective effect of "the dynamic range . . . as great as ever" may be an obstacle that makes it difficult to design a compressor suitable for all such problems. Mr. Harrison is probably describing "recruitment," which accompanies hearing impairment and which has been the stumbling block for development of truly effective compression-type hearing aids. Nevertheless, thousands of listeners would undoubtedly benefit from a readily available device whose characteristics the individual could easily tailor to his needs and comfort. Is anybody listening?

Introducing an evolutionary idea. The New Empire 698 Turntable

Great ideas never change radically.

Instead, they are constantly being refined to become more relevant with time.

So it has been with Empire turntables. Our latest model, 698, is no exception. Basically, it's still the uncomplicated, belt-driven turntable we've been making for 15 years. A classic.

What we're introducing is improved performance.

The lower mass tone arm, electronic cueing, quieting circuitry and automatic arm lift are all very new.

The rest is history.

The Tonearm

The new 698 arm moves effortlessly on 32 jeweled, sapphire bearings. Vertical and horizontal bearing friction is a mere 0.001 gram, 4 times less than it would be on conventional steel bearings. It is impervious to drag. Only the calibrated anti-skating and tracking force you select control its movement.

The new aluminum tubular arm, dramatically reduced in mass, responds instantly to the slightest variation of a record's movement. Even the abrupt changes of a warped disc are quickly absorbed.

The Motor

A self-cooling, hysteresis synchronous motor drives the platter with

enough torque to reach full speed in one third of a revolution. It contributes to the almost immeasurable 0.04% average wow and flutter value in our specifications. More important, it's built to last.

The Drive Belt

Every turntable is approved only when zero error is achieved in its speed accuracy. To prevent any variations of speed we grind each belt to within one ten thousandth of an inch thickness.

The Platter

Every two piece, 7 lb., 3 inch thick, die cast aluminum platter is dynamically balanced. Once in motion, it acts as a massive flywheel to assure specified wow and flutter value even with the voltage varied from 105 to 127 volts AC.

The Main Bearing

The stainless steel shaft extending from the platter is aged, by alternate exposures to extreme high and low temperatures preventing it from ever warping. The tip is

then precision ground and polished before lapping it into two oilite, self-lubricating bearings, reducing friction and reducing rumble to one of the lowest figures ever measured in a professional turntable; -68 dB CBS ARLL.

The Controls

Electronic cueing has been added to the 698 to raise and lower the tone arm at your slightest touch. Simple plug-in integrated circuitry raises the tone arm automatically when power is turned off.

A see-through anti skating adjustment provides the necessary force for the horizontal plane. It is micrometer calibrated to eliminate channel imbalance and unnecessary record wear.

Stylus force is dialed using a see-through calibrated clock mainspring more accurate than any commercially available stylus pressure gauge.

A new silicon photocell sensor has been added to automatically lift the arm at the end of a record.

New quieting circuitry has also been added. Now, even with the amplifier volume turned up, you can switch the 698 on or off without a "pop" sound to blow out your woofers.

At Empire we make only one model turntable, the 698. With proper maintenance and care the chances are very good it will be the only one you'll ever need.

EMPIRE



The Empire 698 Turntable
Suggested retail price \$400.00

For more information write:
EMPIRE SCIENTIFIC CORP.
Garden City, New York, 11530.

We build the others

TAPE RELOADING **L** Super ANRS KD-95 STEREO CASSETTE DECK

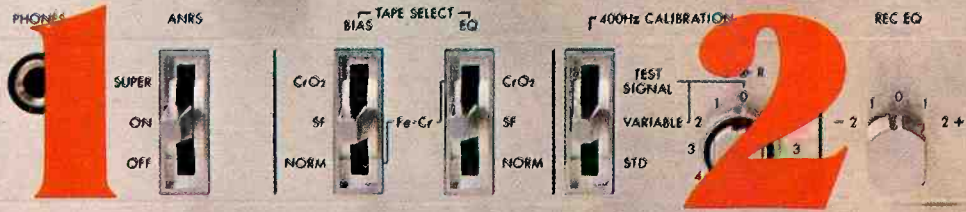
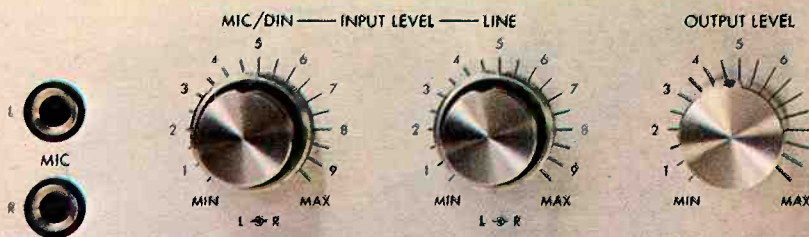
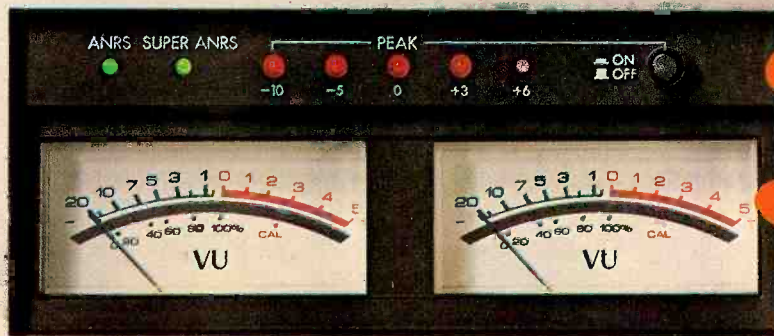

KD 95



CD-S200



KD-75

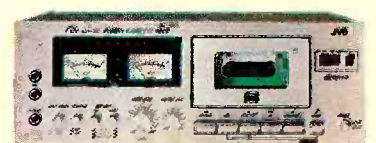

KD-35

in what leave out.

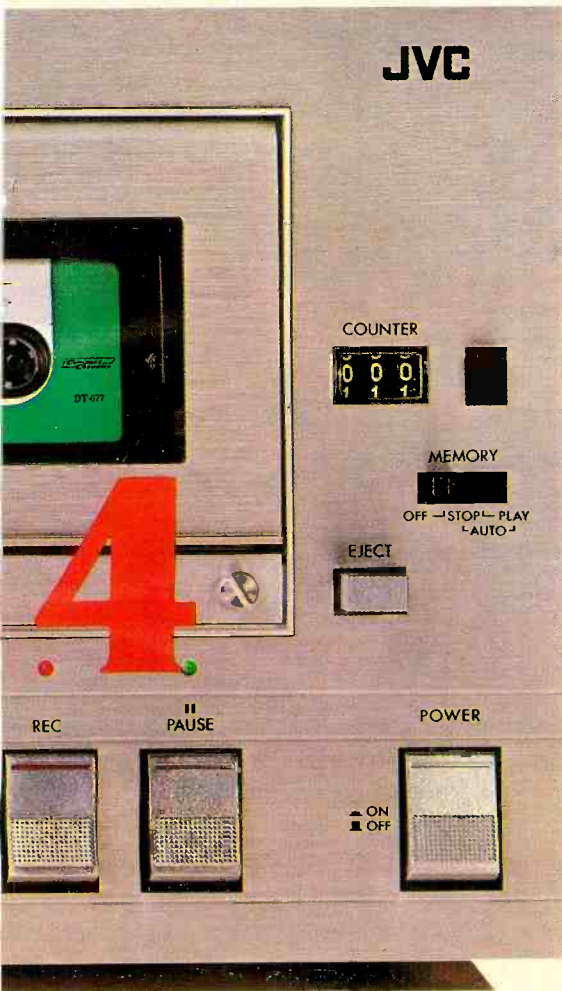

Only JVC gives you improved recording with Super ANRS, Recording/EQ switch, 5 Peak Reading LED's and SA heads.*

The measure of fine cassette deck performance is the sound of the recordings you make. JVC's extensive line of high fidelity decks features these exclusive contributions to cassette deck technology.

1 Our Super ANRS gives you efficient noise reduction, with the added plus of extra-low distortion at high-level high frequencies. And you can switch to our regular ANRS for making recordings to be played using other noise reduction systems. **2** In addition, our extra Recording/EQ switch helps you to precisely adjust the high frequency response of your deck to match any tape you care to use.

3 The entertaining LED's you see on our decks actually help you make better recordings. They're easier to read than VU meters by themselves, so you can record at higher levels without fear of tape saturation.

4 And our SA (Sen-Alloy) heads offer the sensitive performance of permalloy, plus the long life of ferrite in one design. These heads are so excellent in their performance and durability that other manufacturers are buying them from us to use in their decks.

There are a variety of other features to simplify your cassette recording. And our specifications are equal to or better than machines that cost much more.

Once you've seen the things we build in, you'll wonder why the others leave them out.

JVC America Company, Division of US JVC Corp. 58-75 Queens Midtown Expressway, Maspeth, New York 11378 (212) 476-8300. Canada: JVC Electronics of Canada, Ltd., Scarborough, Ont.

For your nearest JVC dealer, call toll-free (outside N.Y.) 800-221-7502.

*Not all features in all decks.

CIRCLE NO. 26 ON READER SERVICE CARD

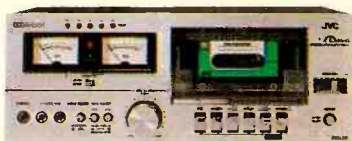

KD-15



CD-1770



CD-1636



KD-2

JVC



THE INTEGRATED DC AMPLIFIER HAS ARRIVED.



Gone is phase distortion. Gone is time-delay distortion.

The Kenwood KA-9100 integrated DC amplifier is here.

Its response is flat down to 0 Hz. It has three power supplies. The Total Harmonic Distortion is 0.03% over the full frequency range of 20-20k Hz. The Signal-to-Noise ratio is 83 dB at 2.5 mV. It has the best phono sensitivity (0.8 mV) of any integrated amplifier. For better heat dissipation, the KA-9100 has large heat sinks on either side.

It is an amplifier so advanced even the pre-amp has its own power supply.

It is the next generation Kenwood. The unit all others will be measured against. Just as they were when we pioneered dual power supplies.

The KA-9100 integrated DC amplifier. With 90 watts per channel, minimum RMS, at 8 ohms from 20 to 20,000 Hz with no more than 0.03% Total Harmonic Distortion.

And, as if all that wasn't enough, it costs less than \$500*.

KENWOOD

15777 S. Broadway, Gardena, CA 90248 · 72-02 Fifty-First Avenue, Woodside, NY 11377

Handles optional

*Suggested resale price. Actual prices are established by Kenwood dealers.

New Products latest audio equipment and accessories



**Ariston's New
Semi-automatic
Turntable**

□ Ariston's RD11E is the first turntable from the Scottish company to offer automatic end-of-record shutoff triggered by a photoelectric system. If desired, the automatic mechanism can be disabled for fully manual operation. The 5-pound aluminum platter (belt-driven by a d.c. servomotor) is independently adjustable in pitch over a range of 8 per cent for the two operating speeds of 33½ and 45 rpm. A stroboscope display indicates speed accuracy. The platter and tone-arm platform are joined by an internal sub-frame suspended on damped springs within the turntable base.

The RD11E's tone arm has an S-shaped shank, detachable head shell, damped cueing, and an adjustable string-and-weight antiskating mechanism. Stylus force is applied by means of a calibrated counterweight. Specifications include 0.04 per cent wow and flutter and a rumble level of -74 dB (weighted). The base (supplied) is finished in rosewood with a hinged Plexiglas dust cover. Overall dimensions are 18 x 14 x 7 inches. Price: \$329.95.

Circle 115 on reader service card



**New Ferrichrome
Cassette from 3M**

□ Scotch Master III is 3M's name for its new ferrichrome cassette tape, which provides a 3-dB increase in low-frequency output and a

2-dB gain in sensitivity at high frequencies. Results are said to be a good match for the bias and equalization characteristics of existing cassette machines designed to use ferrichrome (FeCr) tape. A new binder system improves the durability of the two-layer oxide coating, while a recently designed translucent cassette shell with special rotating tape guides adds to motional stability and correct tape alignment.

Scotch Master III is available in 45-, 60-, and 90-minute lengths at prices of \$3.69, \$3.99, and \$4.99, respectively. The C-60 and C-90 cassettes are also available in the 3M "C-Box" storage-system modules at \$4.39 and \$5.39.

Circle 116 on reader service card



**Setton Audio
Line Announced**

□ Setton International, a new company, makes its debut with a line of receivers, integrated amplifiers, automobile sound amplifiers, and a unique audio-control center (soon to be followed by turntables, a tuner, and a cassette deck, among other products). Setton's finest stereo receiver, the Model RS 660, has a power-output rating of 100 watts per channel into 8 ohms, 20 to 20,000 Hz, with 0.07 per cent harmonic and intermodulation distortion. The metal-finish control panel has an ample number of both controls and indicator lights. There are mid-range, bass, and treble controls, the last two with two switch-selectable turnover points each. Another pushbutton switch defeats the tone controls. Low- and high-frequency filters (12 dB per octave) also provide a choice of two turnover points each. Two tape decks (with full facilities for dubbing from one to another) and three pairs of speakers can be accommodated, plus two pairs of stereo headphones and a stereo microphone with its own level control.

The RS 660 has indicator lights for selected input, selected speaker systems, and mode. Three other indicators monitor the thermal and overload-protection circuits and provide warning of amplifier clipping. A special switchable circuit permits the connection of an external Dolby processor for FM. Specifications for FM include a usable sensitivity of 10.3 dBf (1.8 microvolts) and a 50-dB quieting sensitivity of 16 dBf. Capture ratio is 1.25 dB; alternate-channel selectivity is 80 dB. Image, i.f., and spurious-response rejection are

rated at 85, 95, and 100 dB, respectively. The tuner section has an ultimate signal-to-noise ratio of 72 dB and a frequency response of 30 to 15,000 Hz +0.5, -1.5 dB. Signal-to-noise ratios for the amplifier section include 90 dB for high-level inputs and 65 to 70 dB for the phono inputs, depending on the sensitivity selected.

The Setton RS 660 has approximate dimensions of 22½ x 6¾ x 13¾ inches. A pair of handles attached to the front panel assist in carrying the receiver. Suggested price: about \$800. The two other Setton receivers are rated at 55 and 40 watts per channel and carry approximate price tags of \$580 and \$500.

Circle 117 on reader service card



**Modified Heil Device
In ESS Monitor**

□ The newest ESS amt Monitor speaker system features a slightly modified Heil air-motion transformer, said to result in superior mid-range and high-frequency performance. The Heil device is active from approximately 1,000 Hz to beyond audibility. It occupies a chamber, which is open on all four sides, at the top of the Monitor's columnar enclosure. For frequencies below 1,000 Hz, the system has a 12-inch woofer with a Bextrene diaphragm and a 12-inch passive radiator.

An input of 1 watt drives the ESS Monitor to a sound-pressure level of 87 dB, measured at a distance of 1 meter. Power-handling ability is 375 watts music power into the loudspeaker's minimum impedance of 6 ohms. The frequency response is given as 30 to 23,000 Hz ±3 dB. The system has a level control for the Heil driver acting above 1,200 Hz over a range of +3 dB to off. The Monitor has side panels of oiled walnut and a black-brown cloth grille covering top and front. Dimensions are 39¼ inches high by about 16 inches square. Suggested price: \$566.

Circle 118 on reader service card

(Continued on page 18)

New Products latest audio equipment and accessories

JVC Booklet Explains CD-4

□ A brief and very basic introduction to CD-4 quadraphonic sound is offered in a free JVC pamphlet, "Join the Four-Channel Family." The seventeen-page publication describes the necessary components for a CD-4 four-channel system, discusses cartridge requirements, and suggests several speaker arrangements. There is also a partial listing of available CD-4 equipment and current CD-4 recordings. Write: JVC Cutting Center, 58-75 Queens Midtown Expressway, Dept. SR, Maspeth, N.Y. 11378.



Most Powerful Marantz Receiver

□ At 185 watts per channel into 8 ohms (20 to 20,000 Hz) with a maximum of 0.05 per cent harmonic or intermodulation distortion, the Marantz 2385 is that company's most powerful stereo receiver. Its amplifier circuits have a signal-to-noise ratio of 92 dB (106 dB for the phono section at maximum output). The FM usable sensitivity is rated at 1.5 microvolts with a 50-dB quieting sensitivity of 2.2 microvolts. The FM tuner's ultimate signal-to-noise ratio is 80 dB. It has a 1-dB capture ratio, 60-dB AM suppression, and 85-dB alternate-channel selectivity. Image, i.f., and spurious-response rejection are all 120 dB.

The 2385's bass and treble controls (with pushbutton-selectable turnovers of 100/500 Hz and 2,000/4,000 Hz) are augmented by a mid-range control centered at 1,000 Hz. The filters, acting at 15 and 9,000 Hz, have 18-dB-per-octave slopes. The receiver accepts two tape decks with full inter-machine dubbing capability, and dubbing jacks are provided on the front panel. A special feature of the 2385 is a rear-panel slot that accepts a small optional Dolby module for the decoding of Dolbyized FM broadcasts; the module also provides the proper 25-microsecond de-emphasis. Indicator lights show the selected input and also monitor the power-supply circuits to detect amplifier overload.

The Marantz 2385 has dimensions of 19¼ x 7 x 17½ inches and a weight of about 59½ pounds. Price: \$1,100. An optional walnut cabinet is available.

Circle 119 on reader service card

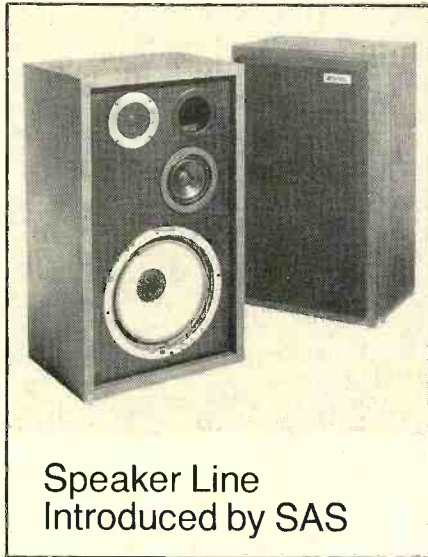

Speaker Line Introduced by SAS

□ SAS has announced a substantial line of new speaker systems, among which is the Spectrum I, a three-way design in a ported enclosure. The 10-inch woofer of the Spectrum I crosses over at 1,800 Hz to a 5-inch mid-range; the 1¾-inch tweeter is active above 5,000 Hz. The recommended range of amplifier power for the system spans 6 to 55 watts per channel into the nominal impedance of 8 ohms. Self-resetting circuit breakers protect against thermal damage. The finish of the enclosure is walnut-grain vinyl with a dark grille held in place by Velcro fasteners. It measures 24 x 14 x 11¼ inches. Price: \$175.

Circle 120 on reader service card



Single-play Turntable from Elac

□ The PC870 employs a combination of belt and idler drive to rotate a 12-inch platter at the two operating speeds of 33⅓ and 45 rpm. The outer edge of the platter is a perforated flange that (along with a strobe lamp that shines through it from below) forms a stroboscopic indicator for speed adjustment. A vernier control varies speed continuously over a ±3

per cent range. Wow and flutter are 0.08 per cent and rumble is -64 dB, both DIN weighted. The synchronous motor does not vary in speed with line-voltage changes.

Aside from the speed selector and fine-tuning knob, the operating controls of the PC870 consist of a tone-arm cueing lever (with the cueing mechanism damped in both directions of travel) and a single control plate to initiate or interrupt the fully automatic playing cycle. The arm has a straight metal shank and employs ball races in its pivot assembly. Controls for applying tracking force and antiskating (a rotating collar around the arm base) are fully calibrated, the latter for conical, elliptical, and CD-4 styli. A walnut base and hinged dust cover come with the PC870, resulting in overall dimensions of 18½ x 14½ x 6¼ inches. Price: about \$220.

Circle 121 on reader service card



Philips Preamplifier Features Illuminated Function Indicators

□ Approximately one-quarter of the front panel on the Philips 572 stereo preamplifier is devoted to an illuminated "flow chart" for the unit's internal circuits, showing the selected input and the status of the tape-monitor, mode, and output switching. In addition, most of the switching functions have LED's to show when they are activated. These switches—including tone-control defeat, high- and low-frequency filters, audio muting, loudness compensation, and tape monitor—are capacitive devices that respond to simple finger contact. Knob controls adjust volume (with twenty-three detents), balance, bass and treble (also detented), and select input, mode, and tape-monitor functions. Two tape machines are accommodated, with dubbing possible from either one to the other. The front panel has two microphone inputs with their own level control, plus a stereo headphone jack.

At a 2-volt output the 572 has no more than 0.009 per cent harmonic distortion and 0.02 per cent intermodulation distortion. Signal-to-noise ratios are 70 dB for the two phono inputs and 80 dB for high-level inputs. Both phono inputs have adjustable sensitivity. The overall dimensions of the preamplifier are 18 x 5¾ x 15 inches. Approximate price: \$600.

Circle 122 on reader service card

(Continued on page 20)



Accutrac. The turntable with eyes.



Introducing Accutrac.

The only turntable in the world that lets you tell an LP which selections you want to hear, the order you want to hear them in, even how many times you want to hear each one.

Sounds like something out of the 21st century, doesn't it? Well, as a result of Accutrac's electro-optics, computer programming and direct drive capabilities, you can have it today.

Just imagine you want to hear cuts 5, 3 and 7 in that order. Maybe you even want to hear cut 3 twice, because it's an old favorite. Simply press buttons 5, 3, 3 again, then 7. Accutrac's unique infra-red beam, located in the tonearm head, scans the record surface. Over the recorded portion the beam scatters but over the smooth surface between selections the infra-red light is reflected back to the tonearm, directing it to follow your instructions.

What's more, it can do this by cordless remote control, even from across the room.

The arm your fingers never have to touch.

Since Accutrac's tonearm is electronically directed to the record, you never risk dropping the tonearm accidentally and scratching a record, or damaging a stylus.

And, since it cues electronically, too, you can interrupt your listening and then pick it up again in the same groove, within a fraction of a revolution. Even the best damped cue lever can't provide such accuracy. Or safety.

What you hear is as incredible as what you see.

Because the Accutrac servo-motor which drives the tonearm is decoupled the instant the stylus goes into play, both horizontal and vertical friction are virtually eliminated. That means you get the most accurate tracking possible and the most faithful reproduction.

You also get wow and flutter at a completely inaudible 0.03% WRMS. Rumble at -70 dB (DIN B). A tracking force of a mere 3/4 gram. And tonearm resonance at the ideal 8-10 Hz.

The Accutrac 4000 system. When you see and hear what it can do, you'll never be satisfied owning anything else.

**Its father was a turntable.
Its mother was a computer.**

The Accutrac™ 4000



ADC Professional Products Group, A Division of BSR (USA) Ltd, Route 303, Blauvelt, N.Y. 10513

CIRCLE NO. 2 ON READER SERVICE CARD

New Products latest audio equipment and accessories

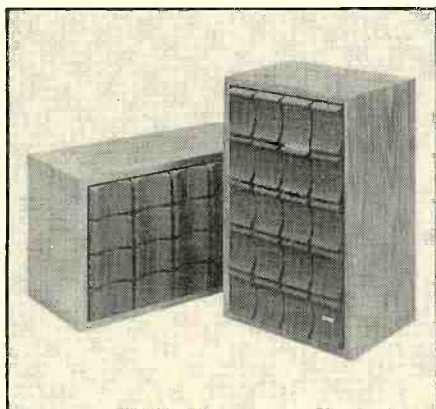

Superscope's Quartet of Speaker Systems

□ A quartet of new Superscope speaker systems consists of models ranging from a larger bookshelf three-way design (12-inch woofer, 4½-inch mid-range, and 3-inch cone tweeter) called the S-312A (shown) to the somewhat smaller S-208A, which employs a single 8-inch driver with a high-frequency "whizzer" cone. One of the systems, the S-310A, employs a ported cabinet for its 10-inch woofer, along with a 4½-inch mid-range and a 3-inch cone tweeter. Like the sealed-enclosure S-312A, it has crossover frequencies of 2,000 and 6,000 Hz.

All the Superscope systems have nominal impedances of 8 ohms. Their power-handling abilities range from 50 to 30 watts of "integrated program material." Finish is walnut-grain vinyl with acoustically transparent foam grilles. Dimensions span 26 x 15 x 10¼ inches (the S-312A) to 21 x 12 x 7 inches (the S-208A). Prices range from about \$120 to \$40.

Circle 123 on reader service card



Yamaha's Latest Amplifier

□ The CA-2010 integrated stereo amplifier is now the most powerful product of its type in the Yamaha line. The amplifier provides two switch-selectable modes of operation. In the conventional Class-B mode maximum power

output is 120 watts per channel into 8-ohm loads (20 to 20,000 Hz) with 0.03 per cent harmonic distortion. In the less efficient Class-A mode, which results in a minimum of low-level distortion, the corresponding power output is 30 watts per channel. According to the manufacturer, total noise and distortion, measured from the phono inputs to the speaker outputs at typical volume-control settings, do not exceed 0.1 per cent over the full usable dynamic range of the amplifier.

The CA-2010 has two sets of phono inputs, one of which is switchable in input impedance and in gain, enabling moving-coil pickups as well as more conventional cartridges to be plugged in directly. In addition to an input selector, the amplifier has a rotary switch that determines what program source will be present at the two sets of tape-output jacks. The switch also facilitates dubbing between two tape machines in either direction, and it provides an OFF position as well. Volume, bass, and treble controls have calibrated detents; the tone controls have switchable turnover frequencies of 500 and 125 Hz (bass) and 2,500 and 6,000 Hz. Two peak-reading front-panel meters show either power-output levels or signal strengths at the tape-output jacks. The A-weighted signal-to-noise ratio for the phono inputs is 96 dB (71 dB for the moving-coil input). Switching between Class-B and Class-A operation is possible with no audible change in output level. The amplifier's measurements are approximately 18¼ x 6¾ x 14¼ inches. A wood-finish cabinet is supplied. Price: \$750.

Circle 124 on reader service card



Speaker Attenuator Provides Unusual Flexibility

□ The Amtech loudspeaker attenuator employs a resistive "T-pad" configuration to provide passive control of loudspeaker output levels. The attenuator presents a maximum source impedance of 8 ohms to the speaker system being controlled, preserving as much of the amplifier's damping on the speaker as possible. The device has outputs for both controlled and uncontrolled speakers, arranged so that the load impedance on the amplifier does not fall dangerously low. A sealed rotary

switch with silver-plated contacts selects the degree of attenuation; it has positions spanning the range of 0 (no attenuation) to -30 dB in 3-dB increments.

Internally, the Amtech unit contains fifty high-power-handling resistors embedded in heat-conducting cement, surrounded by an aluminum heat sink and walnut trim. Two versions are available: a stereo design able to handle 50 watts per channel and a mono design able to handle twice as much. Dimensions are 4¾ x 3¼ x 8½ inches. Prices: stereo, \$69.95; mono, \$54.95.

Circle 125 on reader service card



Minimum Negative Feedback in RAM Power Amplifier

□ A new power-amplifier design from RAM Audio Systems places particular emphasis on a minimum of negative feedback, presumably resulting in a reduction of transient-induced distortions. The Model 512 amplifier is rated at 170 watts per channel (8 ohms, 20 to 20,000 Hz) with 0.08 per cent harmonic and 0.1 per cent intermodulation distortion. Its signal-to-noise ratio is 100 dB at rated output. The 512's input impedance is 47,000 ohms, into which a signal of 1.65 volts produces full output. Damping factor, based on 8-ohm loads, exceeds 1,000 throughout the full audio range, and phase shift is under 10 degrees.

The amplifier contains a relay to prevent potentially destructive signals from reaching the loudspeakers, as well as speaker fuses. Two large peak-reading output-level meters, calibrated from -40 to +3 dB, adorn the front panel. There are also light-emitting diodes to indicate program peaks and the activation of the protective relay. Dimensions are 17½ x 5¼ x 14 inches, and weight is 45 pounds. Price: \$1,150.

Circle 126 on reader service card

NOTICE: All product descriptions and specifications quoted in these columns are based on materials supplied by the manufacturer.

Recent fluctuations in the value of the dollar will have an effect on the price of merchandise imported into this country. Please be aware that the prices quoted in this issue may be subject to change.

Some \$5 blank cassettes have the nerve to tinker with Beethoven. We think it's outrageous.

Beethoven, even when he was deaf, knew exactly how a piccolo sounded in relation to the rest of the orchestra. Some cassette manufacturers would just as soon forget. Their cassettes give the piccolo and other high frequency sounds a distorted prominence. They appear to do this deliberately, regarding absolutely natural sound as raw material to be improved upon.

At BASF, we think this is an abomination. We're purists; we stake everything on total accuracy of sound reproduction. You will never encounter artificially enhanced high frequencies in our cassettes. We believe that if you care enough to buy an expensive audio system, the last thing you need is a cassette that imposes its own dubious tastes upon your sensitive ears.

Faithful reproduction entails more than miracle ingredients and fanciful initials on a cassette label. At BASF, we begin with the best quality ferric oxide. We mill it by a patented process to

achieve maximum packing density and uniformity of coating. We use an exclusive chemically cross-linked polymer binding which will never deteriorate and cause head-related frictional noise or wow and flutter.

We use a unique multi-stage polishing process, and our slitting technique results in an edge that's clean even when viewed under a microscope. Even our cassette case is different, incorporating our patented Special Mechanism, designed to assure smooth tape feed for years of dependable performance.

Is completely natural sound worth that kind of effort? To people who know the difference, it is.

At BASF, we're purists. We've been obsessed with total accuracy since we invented magnetic tape back in 1932. There are no shortcuts to perfection. But you knew that when you planned your own audio system. We'll give you no reason to compromise when you buy our cassettes.



 **BASF The Purist**

Our Promise: the purest, most accurate sound that tape can reproduce.

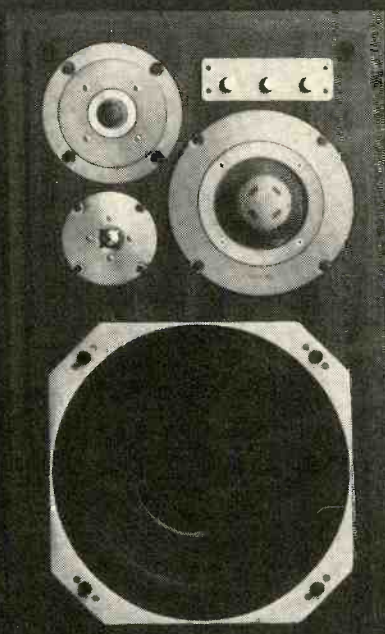
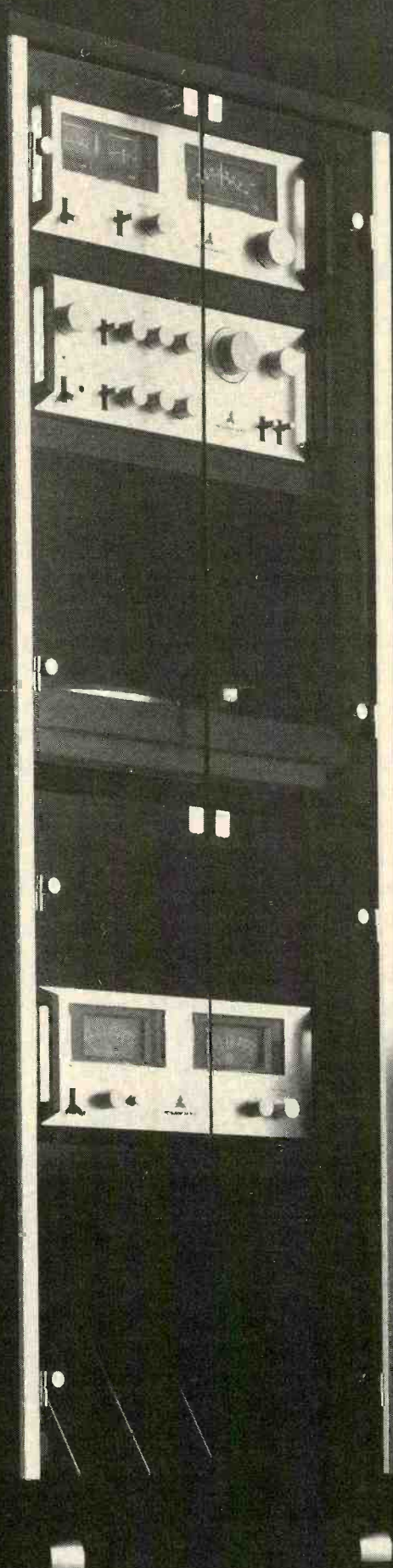
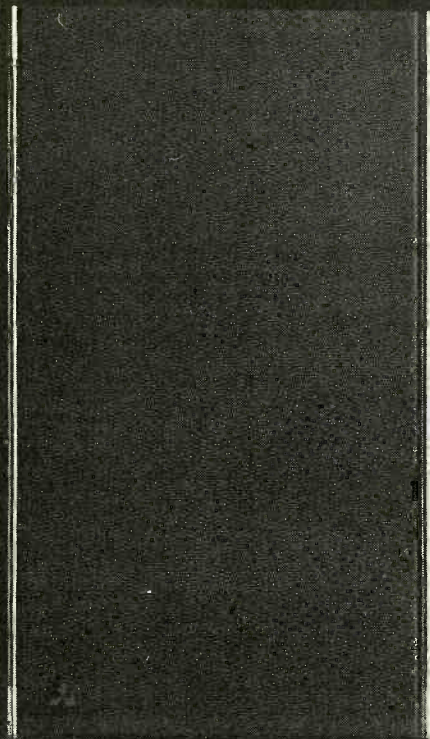

You can't beat The System. You can only change it.

The System, from Mitsubishi.

The only one-name, one-look, high-performance system with speakers as good as the amplifier. An amplifier as good as the pre-amp. A pre-amp as good as the turntable. A turntable as good as the tuner. A tuner as good as the speakers.

And no weak links.

So, no matter how much you care to spend on alternatives, you simply cannot improve The System. You can only make it different.

Consider the loudspeakers, for example. You could substitute other legendary names in the speaker business. But none are so legendary as Mitsubishi, whose speakers are noted for superb design, meticulous construction and testing, and absolutely faultless response.

Or amplifiers. You could substitute others. But none would give you the 80dB inter-channel separation of the Mitsubishi dual-monaural amplifier in The System.

Or turntables. You could substitute something else. But something else wouldn't give you the benefit of our 3 years' exhaustive testing—covering all aspects of performance—that gave our Mitsubishi Logic Control Turntable its superb audio

quality and foolproof operation.

So, what all other names do for music, the one Mitsubishi name does for music. Without the time and trouble of collecting 7 different components from 7 different manufacturers with 7 different warranties to confuse you.

And since The System comes from one company, with one design philosophy and one standard of quality—it has to look better than any diverse assembly of components. (One Mitsubishi equipment rack is worth a thousand words.)

Still, The System isn't inflexible. You can tailor one to your needs, and your available funds. At prices ranging from about \$1,600 to about \$3,000.

Your audio dealer will be happy to audition all the possibilities for you.

All-Mitsubishi.

Or partly Mitsubishi, and partly alternatives.

And we think you'll agree. There aren't really any alternatives.



For more information write Melco Sales, Inc., Dept. S, 3030 East Victoria Street, Compton, California 90221.

By Larry Klein

Technical Editor



Railroad Tracking

Q. *I live near a railroad line and vibration from the passing trains causes my new turntable to mistrack. My old turntable must have been preset at a very heavy weight, because my new turntable is tracking at four grams and I have trouble even at that setting. What can I do?*

BOB BAUMANN
Rego Park, N.Y.

A. What you have to do is “decouple” your turntable as best you can from the vibration caused by the passing trains. Make sure that your turntable is not installed on a surface or in a cabinet that picks up and resonates with the train vibrations, for this would certainly aggravate your problem. Assuming that the vibratory energy is broad-spectrum and not limited to subsonic (seismic) frequencies, it is likely that an isolating turntable mounting such as is sold by Audio-Technica and Netronics would help.

Raw-speaker Tests

Q. *Your magazine continually evaluates new products and reports its findings, but why are no reports made on raw speakers? It seems easy enough to build the recommended enclosure(s) for specific woofers and to test mid- and high-frequency units separately and directly. If I am wrong and such reports are in print, please tell me where.*

MYRON S. OTTLEY
Takoma Park, Md.

A. Mr. Ottley, have you taken a good, hard look at what's been happening in the speaker market recently? Or counted the number of new speaker companies advertising their systems in the pages of the various hi-fi magazines? On a cork-covered wall in my office I have lined up the manufacturers' requests for test reports under their various product categories: receivers, power amplifiers, turntables, cassette decks, etc. Each category has perhaps five or six models listed—except speakers. As of this moment, sixteen (!) different companies are anxiously awaiting Julian Hirsch's test results on their loudspeaker systems.

Once a set of speakers arrives at Hirsch-

Houck Labs it's a simple (ha!) matter to go through the various separate test procedures designed to gather information on impedance variation vs. frequency, tone-burst response, sensitivity (efficiency), distortion, high-end frequency response (measured at several axes), and bass frequency response. The various curves and other data derived by the test procedures must then be integrated and inter-related. In addition, of course, many hours are spent listening to each system (1) with a simulated live-vs.-recorded setup, (2) in comparison with other systems, and (3) by itself. To ask a test lab to build enclosures and then precisely adjust them for the individual drivers of each system *before* going through the test procedure would be, to put it mildly, a bit much!

Popular Electronics and some other magazines have published build-it-yourself speaker-system articles from time to time, but I imagine that's not what you had in mind. In any event, raw-speaker testing would be a difficult and time-consuming task producing unreliable results that would be of interest to comparatively few readers. And *that's* why no one does them.

Vertical Tracking Force

Q. *Despite considerable discussion by yourself and others about tone-arm vertical tracking force (VTF), I have never seen a description of the audible effects of insufficiency in this respect. What can the listener hear that would reveal this condition? Hissing, buzzing, inadequate high frequencies? Naturally, I would like to use the minimum suitable VTF. What do you advise?*

HENRY K. KRAUSKOPF
Hamden, Conn.

A. I find it hard to believe that none of us writing about turntables have ever dealt with the audible consequences of inadequate VTF, but. . . . As may be self-evident, tracking force makes it possible for the stylus to maintain contact with the rapidly undulating groove walls. To understand why such a task is not as simple as it seems, imagine a gigantic tilted washboard (the record groove) down which you are rolling a ping-pong ball. The greater the tilt of the washboard, the faster the ball rolls and hence the greater the like-

hood that it is going to bounce out of the washboard's grooves.

The degree of washboard tilt corresponds to the “velocity” of the record-groove modulation. The greater the groove velocity (which is determined by the frequency and strength of the recorded signal), the greater the difficulty in tracking the groove. If we substitute a heavy metal ball bearing for the lightweight ping-pong ball, washboard groove-tracking is improved and, up to a point, greater tilt can be used without loss of contact. Here, however, our analogy breaks down. Whereas a metal washboard surface is not likely to be damaged by a rolling ball bearing, the delicate plastic grooves of a record can easily be beaten out of shape by a hard diamond bearing down with excessive force.

It should be clear, then, that the problem is to find the best compromise between the too-little VTF that causes the stylus to literally rattle around in the groove and the too-much VTF that results in the stylus' plowing its way through the groove. No definitive *specific* recommendation for VTF is possible—even for a given cartridge model—because the physical characteristics of the tone arm become part of the equation. Therefore, the best the manufacturers can do is give a recommended *range* of VTF's for their cartridges. If your chosen cartridge requires a higher-than-recommended VTF in order to track properly, then something is wrong with it, or the tone arm, or the match between them.

Which brings us, finally, back to the question: how can a listener tell if the VTF is adequate for a given cartridge/tone arm? Assuming that the stylus doesn't “stick” or skip (which indicates either a gross defect somewhere or a VTF that's much too low), play some discs with female singing voices, tambourines, cymbals, sibilants, etc. Listen for “vibration” or a “shattering” or “breaking up” quality on loud passages. Rather than a loss of highs, you may actually hear increased but spurious highs resulting from excessive vibrations of the stylus. If any of these phenomena are heard, increase the VTF by a gram—or slightly less—and see if they go away. You can make a simple test device that will allow you to add tracking force while the disc is playing. Tie a thread to a small metal nut or screw to form a 1-gram test weight. (You can use a stylus-force gauge to measure the weight.) If necessary, bring it up to 1 gram by adding a glob of rubber cement, epoxy, or whatever. Whenever a record is playing and you hear sounds that lead you to suspect that the VTF is too low, use the thread to lower the 1-gram weight gently to the tone-arm head. If things do get better, it could be that adding a little more tracking force will help.

A final note: since the ability to reproduce loud high-frequency sounds at a low tracking force is a major factor separating a fine cartridge from a lesser one, don't expect miracles from a cheapie. And the same goes for turntable arms. The best cartridge made will mistrack in an inadequate tone arm, no matter how high the VTF applied.

Private Labels

Q. *I recently purchased two speakers from Brands Mart, located in Long Island City, New York. The speakers, which are BMI Audio Model 5's, seem to be sold only by Brands Mart. This seems funny because the* (Continued on page 26)



"Not the loudest sound in town, but the best quality" claims WXRT, Chicago, longtime Stanton user . . .



Daniel Lee, President and General Manager, discussing Stylus Replacement Policy with Howard Williams, Chief Engineer and Ken Rasek, Audio Engineer.

WXRT is a progressive rock, FM station that is unique in many ways. Its whole operation, including Administration, Sales, Engineering, Programming, Broadcasting, Transmitting (even the tower itself), is located in one place . . . a highly unusual set-up for a major market.

In a market crowded with as many radio stations as Chicagoland, the excellence of sound can make or break the station, especially a station like WXRT . . . which plays no tapes . . . has no record commercials . . . and goes totally with disc-to-air and live copy.

Since WXRT uses no limiters and no compression to magnify the level of their signal, their turntables and cartridges are absolutely crucial to the quality of their sound.

For over 10 years, the station has used the Stanton product in its turntables. Today, it even uses the 681 Triple-E for disc-to-air playback and, although this stylus was not designed for back-cueing, the engineers and announcers report no problem (they even use them on their AM operation, WSBC).

Leading radio stations around the nation depend on Stanton 681 Calibration series cartridges, because they offer improved tracking at all frequencies . . . they achieve perfectly flat frequency response to beyond 20 kHz. Its stylus assembly, even though miniaturized, possesses greater durability than had been thought possible to achieve.

Each 681 Triple-E is guaranteed to meet its specifications within exacting limits, and each one boasts the most meaningful warranty possible . . . an individual calibration test result is packed with each unit.

Whether your usage involves recording, broadcasting or home entertainment, your choice should be the choice of the professionals . . . The Stanton 681.



John Bell hands new record to Scott McConnell.



Air personality, John Bell prepares to play a record.

For further information, write to:
Stanton Magnetics, Terminal Drive,
Plainview, N.Y. 11803.

© Stanton Magnetics Inc., 1977



Yes you can

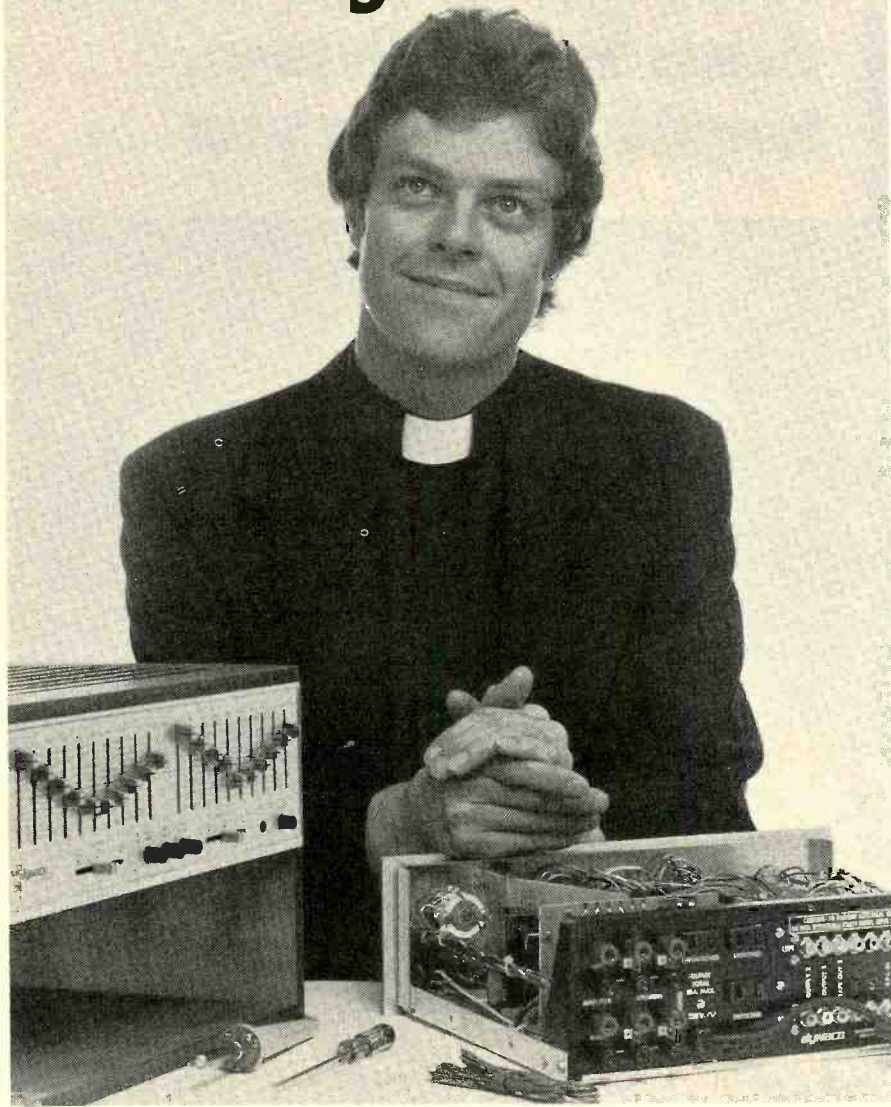

build a dynakit.

Even 'churchmice' want the finest high fidelity, but when funds are scarce you take things into your own hands. We did and built Dynakits. It was surprisingly easy, the simple step-by-step instructions in their illustrated manual didn't let us go astray. A few evenings of my time and the church had a music system of the finest quality — and a saving of over \$600. My only question—when 'work' is so much fun, is it sinful?

Write for free 24 page catalog of Dynakits and Dynaco components and loudspeakers.



Dept. R-4, Box 88
Blackwood, NJ 08012

dynaco
dynakit



CIRCLE NO. 18 ON READER SERVICE CARD

salesman told me he would refund the difference if I found them any cheaper elsewhere. I paid \$100 per speaker. Can you find out if I was railroaded?

JERRY PERVIL
Brooklyn, N.Y.

A. It seems to me that if a company called Brands Mart Inc. sells speakers labeled BMI Audio, even non-paranoids might suspect that the BMI does not stand for Broadcast Music Inc. Although it is likely that you could have found a better pair of speakers for your \$200 if you had checked the equipment reviews in STEREO REVIEW and other hi-fi magazines, I wouldn't say that you were "railroaded." It appears to me that you voluntarily purchased a ticket and cheerfully climbed aboard.

Multiplex Filters

Q. I have a new cassette deck with a built-in multiplex filter. The manual states that this filter is effective for preventing disturbances caused by the 19-kHz pilot signal during stereo FM broadcast recording with the Dolby system. I have read of the multiplex filter and its effectiveness in reducing the 19-kHz signal, but no mention of Dolby. Would you enlighten me, please? Also, if I tape on my reel-to-reel machine from a stereo FM source, do I need to use the multiplex filter when dubbing to the cassette deck, or does the reel-to-reel need a multiplex filter?

WILLIAM MITCHELL
Burlington, Ontario, Canada

A. In the old days (ten or twelve years ago) I usually received two or three questions a week from readers asking why their off-the-air tapes had whistles that weren't heard at the time of taping. It seems that the 19- and 38-kHz tones (which are used as part of the multiplex process that provides a two-channel program facility from a single FM transmitter) came through the tape outputs along with the audio signal. Although the tones were suppressed well enough not to be audible, they nevertheless were of sufficient strength at the tape-output jacks to interact (beat) with the open-reel recorder's bias oscillator and produce tones smack in the middle of the audio range.

Some recorders of the day were made with built-in "multiplex" filters that provided a "whistle-stop," so to speak. The problem ultimately disappeared as a result of moving the recorders' bias-oscillator frequencies up to 100 kHz and higher, as well as the improved suppression of the 19- and 38-kHz signals in tuners and receivers. The proliferation of Dolby cassette decks revived the FM-multiplex problem, but for a different technical reason. This time the problem arose because Dolby encoding circuits are designed to respond to low-level, high-frequency signals—which is a pretty good description of the 19-kHz component riding in along with the audio signal. Since the amount of 19-kHz residual signal appearing at the tape-output jacks varies from one component to another, the designers of the cassette decks felt it best to avoid trouble—when economics permitted—by incorporating a multiplex filter. As far as dubbed copies are concerned, once an FM program has been taped without problems, it is very unlikely that trouble will occur when making copies of the tape.

THE OPTIMUM.



The first turntable that's as steady as a rock.

Turntables shouldn't cause howling and screeching through the night. But that's exactly what happens, thanks to mechanical and acoustic feedback caused by loudspeakers vibrating an insecure turntable.

Since most turntable bases have been made of laminated plywood, beech, die-casting or plastic, howling has been a problem that just wouldn't go away.

Until today, that is.

Announcing the Optonica RP-3636 Direct Drive Turntable. We built the ideal turntable, literally as solid as a rock because it's built on 15.8 pounds of Mikage granite stone. Which means that vibrations from the speakers are absorbed, reducing acoustical feedback and

maintaining maximum signal to noise ratio.

The Optonica RP-3636 also features a highly sensitive S-shaped tonearm. Which means that the stylus will pick up subtle sound signals as accurately as the cutter stylus that recorded them. And an oil-damped cueing control that gently lifts and lowers the tonearm so your records will be protected from damage.

We invite you to test the Optimum turntable at one of the select audio dealers now carrying the full line of Optonica stereo compo-

nents. Call toll-free 800-447-4700 day or night (In Illinois dial 1-800-322-4400), for the name and address of your nearest Optonica showroom, where you can see the complete Optonica line and pick up your free copy of our catalog. Or for further information, write Optonica, Dept. T6A, 10 Keystone Place, Paramus, New Jersey 07652.

From our unique turntable built as steady as a rock to our cassette deck that automatically finds your selections, find out why throughout Europe and Japan, Optonica is one of the fastest selling lines of stereo components on the market today.

OPTONICA THE OPTIMUM.

FREE

details... A DIFFERENT KIND OF RECORD CLUB

You can now own every record or tape that you may ever want... at tremendous savings and with no continuing purchase obligations. You can get valuable free dividend certificates, you can get quick service and all the 100% iron-clad guarantees you want.

Now you can stop price increases that leave you with less music for your record and tape budget. You can guarantee yourself more music for less money through membership in Discount Music Club.

Look at these benefits:

TREMENDOUS SAVINGS

on every record and tape in print—no "agree-to-purchase" obligations of any kind.

DISCOUNTS OF 43% TO 73%

off mfg. suggested list... special catalog features hundreds of titles and artists.

ALL LABELS AVAILABLE

including most imports through special custom ordering service. If we don't stock it we'll get it for you.

SCHWANN CATALOG

lists thousands of titles; classical, pop, jazz, ballet, opera, musical shows, folk, rock, vocal, instrumental, country, etc.

DISCOUNT DIVIDEND CERTIFICATES

Dividend Gifts—Every shipment carries a dividend gift or dividend certificate. Certificates redeemable immediately for extra discounts.

NEWSLETTERS

happenings in the world of music; concerts, critiques, new releases... special super-sale listings at discounts of up to 73%.

DISCOUNT ACCESSORY GUIDE

Diamond needles, cloths, tape cleaners, etc. Discount Music Club is your complete one stop music and accessory buying service.

QUICK SERVICE

same day shipping on many orders... rarely later than the next several days. Partial shipments always made in the event of unforeseen delay... all at no extra cost to you.

100% IRON-CLAD GUARANTEES

on all products and services. Everything is guaranteed factory fresh and free of defects or damages of any sort.

Your total satisfaction is unconditionally guaranteed.

Discount Music Club is a no-obligation membership club that guarantees tremendous discounts on all stereo records and tapes and lets you buy what you want... when you want... or not at all if you choose.

These are just a few of the money-saving reasons to write for free details. You can't lose so why not fill out and mail the coupon below for immediate information.

dmc DISCOUNT MUSIC CLUB, INC. DEPT. 9-0677
650 Main Street, New Rochelle, N.Y. 10801

NAME _____

ADDRESS _____

CITY _____

STATE _____

ZIP _____

CIRCLE NO. 13 ON READER SERVICE CARD

Audio Basics

By Ralph
Hodges

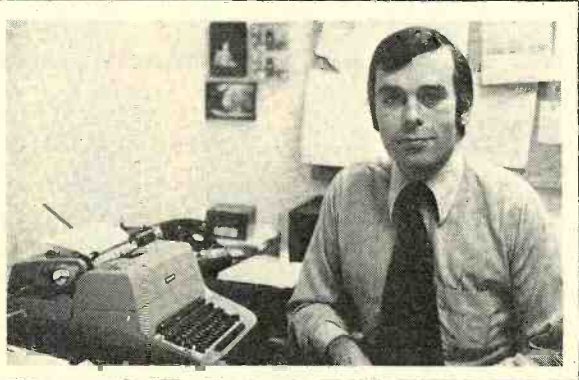

GLOSSARY OF TECHNICAL TERMS-31

⊗ **Separation** or **stereo separation** refers to the electrical isolation maintained between the various channels in a stereo or four-channel system. In a conventional stereo setup, the two components likeliest to exhibit marginal or inadequate separation are the phono cartridge and the FM tuner. In a four-channel system, especially of the matrix type, electronic processing (or lack of it) within the decoder may also introduce audibly degraded separation. Tape machines can have inadequate separation as well, but this is usually the result of poor alignment between the tape tracks and the head gaps.

Separation is tested by feeding a signal at a certain reference level into one channel only and measuring the other channel(s) to see how much of the signal "leaks" into them. The result of the measurement is usually expressed as the difference (in decibels) between signal levels in the driven and undriven channels, with a large value being desirable. The audible effects of inadequate separation (significantly less than 15 dB) are various. For example, the separation provided by a phono cartridge may change—or seem to change—with recorded frequency and level, and with the stability (or lack of it) of the tone-arm/cartridge combination. In this case, voices or instruments in the stereo panorama will seem to wander or "smear" in their positions, blurring the image and making precise localization difficult. Poor separation overall will ultimately diminish the spread and sense of space in the stereo panorama. ("Crosstalk" is a term for the inter-channel leakage that is responsible for poor separation.)

⊗ **Skating force** is a torque tending to swing a conventional tone arm in toward the center spindle as it plays a record. On a grooved record, the arm is prevented from actually swinging inward because the stylus is lodged in the groove. But the skating force does result in greater stylus pressure on the inner wall of the groove, and there is for that reason the possibility of uneven stylus wear and of outer-groove-wall mistracking. (Some sideways displacement of the stylus bar is also usual, although this rarely produces obvious ill effects.)

The direction and the magnitude of skating force is determined by the geometry and length of the tone arm. Most high-quality

arms have antiskating mechanisms designed to counter the skating force with an equal but oppositely directed force that puts the arm in a balanced condition. However, since the magnitude of the skating force is affected not only by stylus tracking force but by the varying stylus-groove friction produced by different recorded passages and differing record materials, any single setting for the antiskating compensation is at best a compromise. Fortunately, a small error in antiskating almost never audibly impairs record reproduction. A few arms—the radially tracking types—exhibit no skating force because of their geometry.



⊗ **Solenoid** is an electromagnet with a moveable core that moves in or out of the body of the magnet when current is applied or removed. As it moves, this core pushes or pulls on a cam or lever to switch or shift some mechanical assembly. For audio applications, solenoids are used mostly in tape machines, where (in conjunction with electronic relay switching) they make possible the light-touch pushbuttons and remote-control features of

(Continued on page 30)

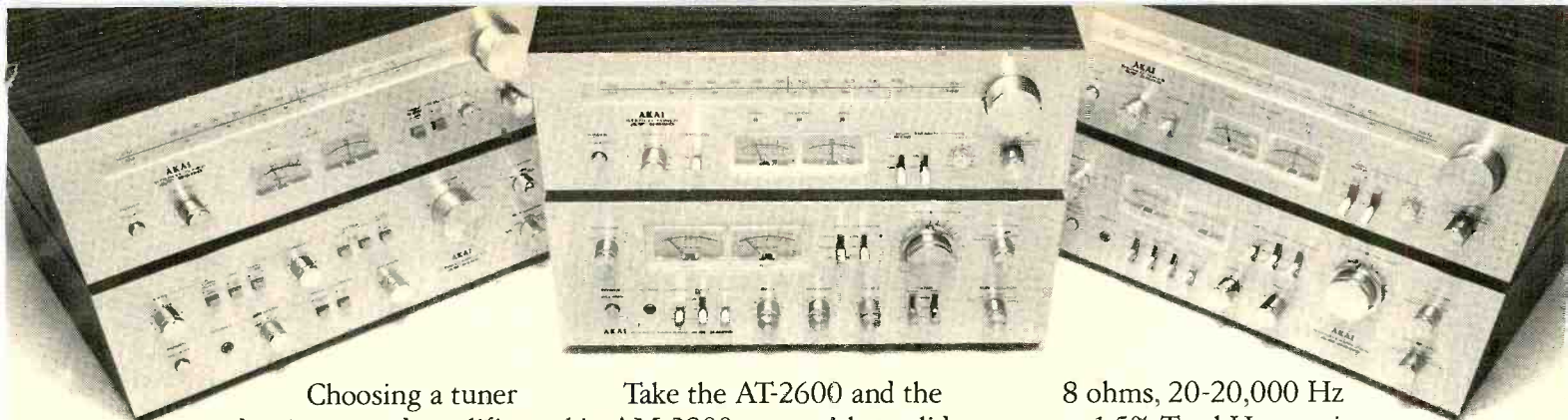

Choosing a tuner and an integrated amplifier is a lot like choosing a mate. You look for things like compatibility, performance, appearance and, of course, fidelity.

AKAI just made the process of matching component separates foolproof with a new line of tuners and integrated amplifiers. Paired on the grounds of total compatibility. And priced to be affordable.

Take the AT-2600 and the big AM-2800 amp, with a solid 80 watts, RMS per channel, 8 ohms, 20-20,000 Hz at .08% Total Harmonic Distortion.

Or the AM-2600 amp at 60 watts, RMS per channel, 8 ohms, 20-20,000 Hz at .1% Total Harmonic Distortion. And match it with the AT-2600 tuner.

Or maybe the AM-2400 amp at 40 watts, RMS per channel,

8 ohms, 20-20,000 Hz at 1.5% Total Harmonic Distortion. And the AT-2400 tuner.

No matter which of the perfect AKAI couples you choose, you get specs and features not found on all-in-one receivers in the same price category. Improvements you can hear. With clean, clear power per channel.

To hear the new separates, see your AKAI dealer. And live in perfect harmony.



For a 18" x 24" poster of this Charles Bragg etching, send \$2 to AKAI, Dept. SR, 2139 E. Del Arno Blvd., P.O. Box 6010, Compton, CA 90224, ATTN: Couples.

AKAI INTRODUCES THE PERFECT COUPLES.

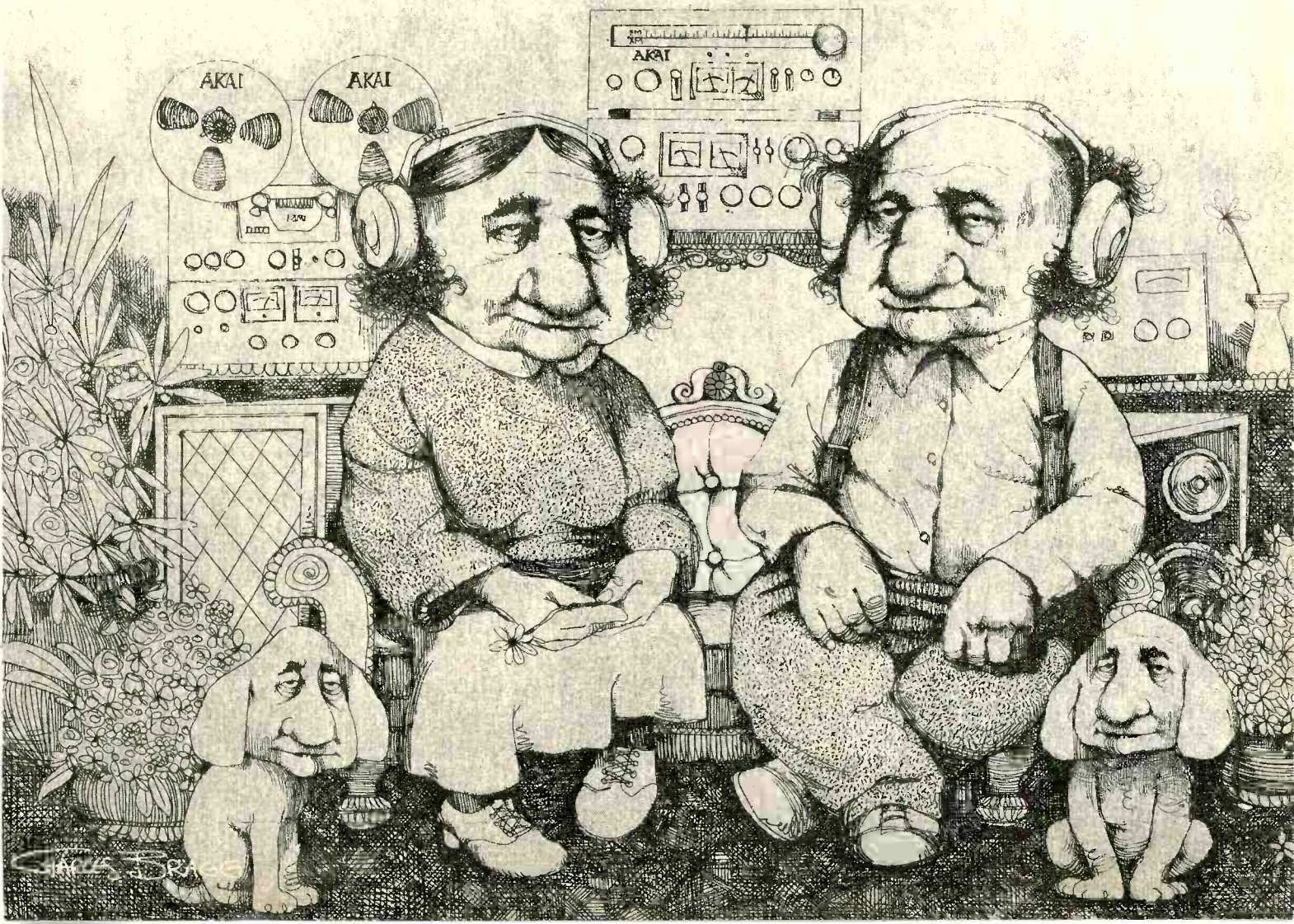

WHY SPEND MORE MONEY? CALL US FOR FREE! DIAL 800-638-6666

Call 800-638-6666 for price quotes on over 40 brands

If you want the lowest possible price plus the fastest delivery you can't afford to pass us by!

PIONEER

SX-750

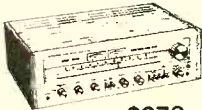

\$279

HPM-100

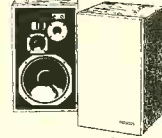

\$330 pr.

We discount the full line of Pioneer receivers, tape decks, turntables, amps, tuners, and speakers.

MARANTZ RECEIVERS

2385 2265
2330 2252
2285 2238

CALL
800-638-6666
FOR PRICES!

We discount the full line of Marantz receivers, tape decks, turntables, amps, tuners, and speakers



301-881-8890
800-638-6666

5618 RANDOLPH RD., ROCKVILLE, MD. 20852 All orders shipped immediately • Phone orders accepted • Use your BankAmericard or Master Charge • Call or write for price quotes on all the top audio brands • Write for free catalog • All merchandise in factory sealed cartons with full manufacturer's warranty.

CIRCLE NO. 14 ON READER SERVICE CARD

certain machines. Solenoids also provide the force that pushes the pinch roller up against the capstan to drive a tape. In eight-track cartridge machines, a solenoid shifts the head to a new position to engage a new set of tape tracks.

● **Servo control** is a (usually) electromechanical technique used to ensure stability and accuracy in the movement of some mechanical element or system. It is actually a type of feedback control that compares a motion (or its effects) with some reference and applies a correction as required. A relatively simple servomechanism is used in radially tracking tone arms to propel the arm across the record in constant tangency with the groove. In some elaborate tape machines a servo built into the tape guides senses tape tension and adjusts the hold-back and take-up torque of the reel motors accordingly. And, of course, many turntables are servo-controlled, usually by means of a device that senses the rotational rate of the platter and compares it with the frequency of a fixed oscillator, changing the drive to the motor as necessary in order to bring the two signals into synchronism. Servo techniques have even been used with loudspeakers to control or correct cone motion.

● **Short circuit** is the result when a circuit is accidentally or deliberately bridged across so that the circuit's path literally becomes "shorter" than it was. If a short circuit takes place at a point where significant voltages are present, circuit components in the vicinity of the short may be damaged. Short circuits occur through improper connections or the failure of an electronic part. However, there are deliberate and beneficial short circuits as well. For example, an input-selector switch may "short" all unused inputs to prevent their circuits from contributing noise or interference.

The opposite of a short circuit is an "open" circuit—an interruption (through a part failure or similar cause) of a circuit path, so it is no longer complete.

● **Signal**, in audio, is the desired information (music, voice, sound effects) in electronic form. It could consist of a variation (modulation) in the frequency of a radio wave (FM) or a variation in voltage, current, or magnetic field in the different components of an audio system. On a disc recording, the signal is represented by the microscopic undulations in the groove; on a tape it is the magnetic pattern imposed on the oxide coating.

● **Signal-to-noise ratio (S/N)** is a specification that relates the signal level in an audio component or recording/broadcast medium to its noise level; it is therefore an index of the available dynamic range. In measuring the S/N, a signal is applied to the component or medium at a specified level and its output is measured. Then the signal is removed and what remains in the output (the noise) is measured. The difference, in decibels, is the ratio of the signal to the noise; this is often "weighted" to reflect the annoyance value of different noise frequencies.

For measuring tape and/or tape machines, the specified signal level is usually the one that will result in 3 per cent distortion when the tape is played back; for amplifiers, it is the signal that will produce full rated output (although Hirsch-Houck Labs refers S/N measurements to a 10-watt output).

There are many reasons why DISTRICT SOUND IS THE LEADER IN MAIL ORDER

BIC is one of them!



940 CHANGER/
SINGLE PLAY



960 CHANGER/
SINGLE PLAY



24-pole synchronous motor; belt drive; multiple-play; die-cast 12" platter; Programmer cycle button; tonearm with gimbaled pivot ring; up/down cueing; anti-skating adjustment; 10-spoke turntable mat.

Record-changing turntable with belt drive; features 24-pole, low-speed synchronous motor; vibration freq. 5 Hz. 12" cast single-piece platter, isolated tonearm counterweight; 10-spoke turntable mat.



BIC VENTURI
FORMULA 4
Formula 4 Speaker System

With 10" woofer; response 25-23,000 Hz; and 100 W/ch max. rms amplifier power. Has removable reticulated foam grille available in black, brown, burnt orange, or blue.

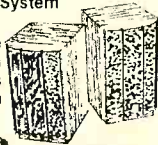

BIC VENTURI
FORMULA 7

12" Hi Flux, Heavy Duty woofer 8" upper bass/lower midrange cone, and Heavy Duty Dynamic Compression Driver on T-Slot Horn vertical element.



THERE IS ONLY ONE
SEND FOR FREE CATALOG TODAY!

District Sound Inc.

2316 RHODE ISLAND AVENUE N.E.,
WASHINGTON D.C. 20018



CIRCLE NO. 17 ON READER SERVICE CARD

8 sound reasons to buy our new receiver. Plus its sound.



Sony's new, more powerful STR-6800SD receiver should get a warm reception. Because it not only looks different from other receivers, it *is* different.

It has some features found in more expensive separate components—and other features found nowhere else at all.

1. The most-used controls all in one place. The level control, muting switch, tuning knob and input and tape selectors are all in the upper right-hand corner.

2. A dial pointer that doubles in length when it's close to a station. Together with the signal strength meter and the center channel meter, this Sony exclusive helps you tune more accurately.

3. A stepped level control to keep both channels equal. It guarantees unprecedented accuracy—to within 1/2 db over the whole volume range.

4. MOS FET front end electronics unitized tuning. Because it's unitized, the receiver tunes the same whether it's cold or warmed up.

And MOS FET gives it a very wide dynamic range.

5. Dolby noise reduction system. So you can benefit from Dolby broadcasting. Instead of being an extra, it's built in—operated from the front panel.

6. Phase locked loop. It gives you better stereo separation and less distortion.

7. LEC (low emitter concentration) transistor. This Sony exclusive in the preamp phono stage yields tight RIAA equalization, low noise, low distortion and a wide dynamic range.

8. Sony's most powerful receiver. It delivers 80 watts minimum RMS continuous power per channel at 8 ohms from 20 Hz to 20,000 Hz with no more than 0.15% total harmonic distortion. It has a direct-coupled power amplifier with true complementary symmetry output stages.

And more. To these specifications (remember, we state

them conservatively), add Sony's proven reliability. And you get a receiver that produces a sound that'll make you understand why you have ears.

That's the STR-6800SD at \$600. Or, for less power and a few less features—but no loss of fidelity—the STR-5800SD at \$500 and the STR-4800SD at \$400 (all suggested retail prices).

A sound investment.



SONY®

©1976 Sony Corp. of America.
Sony, 9 W. 57 St., N.Y., N.Y. 10019. SONY
is a trademark of Sony Corp.



THE NEW REVOLUTION FROM DISCWASHER.

DiscTraker is a revolutionary pneumatic damping device that provides a critical protective cushion so badly needed with state-of-the-art tonearms and cartridges.

- effectively reduces tonearm/cartridge resonance at low frequencies.
- drastically and listenably reduces record-warp resonance (woofer flutter).
- allows badly warped records to be played with fidelity and without record wear or stylus damage.
- applicable to any tonearm.
- patented in all industrialized countries.

DiscTraker greatly enhances the performance of fine record playback systems; another example of Discwasher's leadership and innovative technology.



DiscTraker™

 discwasher®, inc.
1407 N. Providence Rd.
Columbia, Missouri 65201

CIRCLE NO. 15 ON READER SERVICE CARD

Tape Talk

By Craig Stark



Too Good a Tape?

Q. *Is there any sense in using a high-quality tape capable of, say, a 65-dB signal-to-noise ratio when the tape deck it's going to be used on (for both recording and playback) is rated at, say, a 50-dB S/N?*

MIKE JUNOT
Houma, La.

A. There could well be, since the signal-to-noise ratios you cite may have been obtained using very different measuring methods. Much of what is measured as "noise" in a recorder, for example, could consist of very low-frequency hum, which can reach relatively high levels (in decibels) without becoming audibly obtrusive. Further, unless you know the spectral frequency distributions of the noises, you can't be sure that hiss from a poor tape would be fully masked by the recorder's own electronic noise. So try a sample of the good tape before you assume that your recorder is worthy only of a lower-quality Brand X.

Airport Erasure

Q. *I'm going to England for an indefinite stay and have put my records onto about 150 cassettes to take with me. A friend returning from overseas with prerecorded cassettes found that the airport electronic security scanners partially erased some of his recordings. How can I prevent erasure of my cassettes in shipping?*

BRUCE KROHN
Sandy, Ore.

A. I've talked with several airline representatives about this, and find that the biggest problem is that most airline people don't know there is a problem with magnetic tapes. According to the best story I can piece together, most airport magnetic metal detectors are "low-level" devices that (they say) won't harm tapes. A few older "high-level" metal detectors will, however, and if luck isn't with you, your tapes might pass through one of these.

My best advice is to take advantage of the fact that airport security people, while they may not know about tapes, are very conscious of the dangers that X-ray scanners

pose to film. (Ironically, X-rays wouldn't hurt your tapes, and metal detectors wouldn't seem to realize all this.) When they see a package marked "film," they know enough to inspect it visually, not by machine. So put a roll of film in each of your packages of cassettes, and mark the packages "Photographic film and magnetic tapes—inspect visually only." Or send your cassettes by sea. I always carry tapes as hand baggage when I fly so I can be sure they're kept away from scanners, but that might not be practicable in your case.

Upgrading Heads

Q. *I have an older-model open-reel tape deck and would like to upgrade the tape heads. The audio dealers I've tried have only original replacements, not heads with improved frequency response. Where can I get better ones?*

B. MEARNS
New York, N.Y.

A. Actually, you're lucky to be able to find exact replacements! Before trying to improve on the manufacturer's head selection, write him and find out: (1) the nominal gap length (the distance between the two magnetic poles of the head, also called the "gap width"); (2) the rated impedance and inductance of the head at 1,000 Hz; and (3) the d.c. resistance of the head winding. You need this information because the record/playback frequency response of a recorder isn't determined by the heads alone. Your recorder's electronics are designed to work into a "load," and if the replacement head doesn't match the electrical requirements of the tape amplifiers, even a premium head could give problems with frequency response and signal-to-noise ratio. Playback-head gap length can be a limiting factor in high-end response, though you can't be sure that your machine's recording electronics were designed to provide enough treble boost to record the extra couple of kilohertz that a shorter-gap playback head could pick up.

At any rate, when you have the necessary information, you might write to Nortronics, Inc., 8101 10th Avenue North, Minneapolis, Minn. 55427. They're the largest manufactur-

er of replacement heads I know of, and they might possibly have a suitable, upgraded substitute available.

Cassette Treble Distortion

Q. *I own a top-rated cassette deck which has been checked out and meets or betters all its factory specifications. I nonetheless hear a bit of distortion in the upper registers, especially with the strings in classical recordings. I've been using a premium ferric-oxide tape. Would switching to one of the cobalt-treated cassettes solve the problem, or are my ears simply too sensitive for cassettes to measure up to?*

ELLIOT A. BERLIN
Appleton, Wisc.

A. It sounds to me as if you have, indeed, run right up against the current "state-of-the-art" limitations of the cassette. The distortion you are hearing is the result of trying to put more high-frequency energy on the cassette tape than it can hold. The graph below will help clarify the problem.

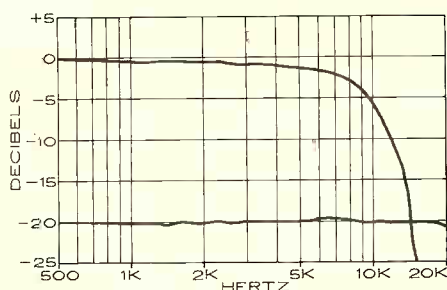

At high recording levels (0 db and even considerably below) high-frequency losses can be large, as indicated by the upper curve. The losses are accompanied by severe distortion.

The lower line on the graph is recorded at -20 VU, and shows the record-playback frequency response of a highly regarded cassette tape from 500 to 20,000 Hz. The upper line is for the same tape, but it was recorded at a 0-VU level. The treble fall-off at the higher recording level is accompanied by a severe increase in distortion. By the time you get even a couple of decibels of fall-off due to overloading, the distortion has hit very high levels—over 10 per cent and rising fast.

You might get a very slight improvement from using one of the new cobalt-treated tapes, but it won't be much. This is because the very "hot" high end of chromium-dioxide—and of the ferri-cobalt tapes that use CrO₂ bias and equalization—is used primarily to achieve lower noise, not to produce greater treble "headroom." With CrO₂ and the cobalt-treated ferrics, a cassette recorder could be set up to use CrO₂ bias, very little record equalization, and the "ferric" (or "standard") playback equalization, in which case the treble overload problem would be ameliorated, but at the cost of increased noise. Similarly, lowering the record level by 10 or 12 dB would solve the high-frequency distortion problem, but with unacceptable consequences in terms of signal-to-noise ratio.

Technical Talk

By Julian D. Hirsch

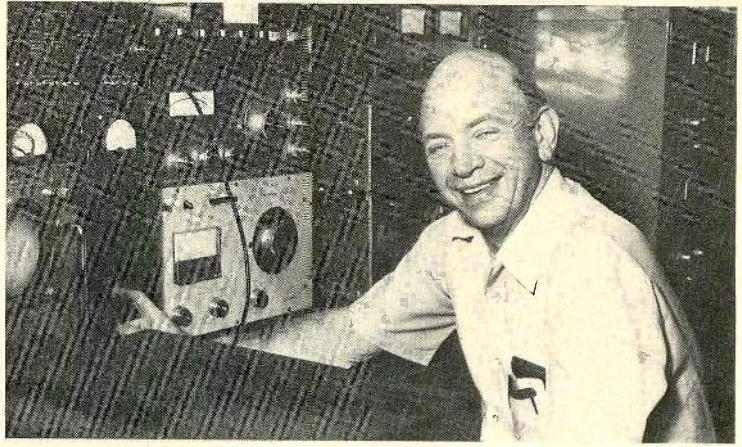

● SPECS VS. SPECSMANSHIP—FM

TUNERS: Every now and then it's worth our while to take a hard look at the real meaning of hi-fi specifications and to consider the ill-defined distinction between using really meaningful performance data and employing mere "specsmanship." I define "specsmanship" as the use of impressive figures or special technical approaches to argue that a product is superior to its competition *when those figures or approaches have little or nothing to do with the practical or audible performance of the product.* Note, please, that the *accuracy* of the figures and the *reality* of the techniques are not in question—merely their relevance. I suspect that, along with manufacturers and dealers, there are more than a few audio enthusiasts who also engage regularly in a form of specsmanship—with the significant difference that they are their own victims.

Let me say at the outset that I'm aware that some of my opinions differ radically from those held by a sizable number of audiophiles, to say nothing of many manufacturers. Further, in the examples that follow, no reference, oblique or otherwise, to specific products or manufacturers is intended (readers are free, of course, to fit the shoe onto any foot that seems appropriate). And although my comments may seem to be of a "debunking" or critical character, no malice is intended. I am merely trying to shine a little light into the murky world of technical jargon and to draw a distinction between *objective* and *subjective* performance qualities (after all, the end result of the whole high-fidelity process is necessarily a subjective one).

Let us begin with a key FM-tuner specification, "sensitivity." This is commonly understood to be a numerical rating of a tuner's ability to receive weak signals. For many years it was taken to be the unmodulated input signal level required to "quiet" the tuner's hiss by

some modest amount, such as 20 or 30 dB. It was easy to come up with an impressively low number by restricting the tuner's bandwidth (which reduces noise). This was fine until one noticed that the distortion was quite audible when listening to a fully modulated signal—a result of narrow bandwidth.

In their measurement standards, the IHF quite rightly decided to rate sensitivity in terms of the signal (100 per cent modulated) that resulted in a -30 -dB level of noise and distortion. In no time at all, tuners began to have sufficient bandwidth to receive stations without excessive distortion, a significant triumph of reason over pure specs.

The victory was partial, however. A program with a -30 -dB noise level is too noisy to listen to, and a -30 -dB distortion level (3.2 per cent) is hardly of hi-fi quality. In short, it mattered not that one tuner could boast a 1.5-microvolt sensitivity while another could manage only a 3-microvolt rating, for neither figure really told how effectively the tuner would produce a good sound from a weak signal. The definition, in other words, had little relationship to the actual *sound* of the product.

Recently, the IHF revised its tuner standards, and the old "usable sensitivity" rating (a misnomer if ever there was one—it should have been called "unusable sensitivity") was supplemented by a

50-dB quieting sensitivity rating. This resembled the old, obsolete specification, being based on the noise output of the tuner with an unmodulated signal. (A -50 -dB noise level is at least listenable, however, even if a trifle hissy.) At the same time, the old microvolt ratings were replaced with the "dBf" unit, a logarithmic measure that put relative signal levels into a better perspective (although for some reason it is still not used by all manufacturers).

Let us consider two tuners with 50-dB quieting sensitivity ratings of 3 and 6 microvolts (15 and 21 dBf) in the light of this change. On the face of it, the first one is significantly more sensitive. Why, then, when they are connected to the same antenna system, do they sound identical in respect to background noise? The answer is that although there are certainly remote areas where a few microvolts may be hard to come by, in most areas the stations we listen to supply the tuner with hundreds or thousands of microvolts. Is it any wonder that even appreciable differences (3 as opposed to 6 microvolts) in tuner sensitivity, however measured, cannot be heard in the real-world situation? Nevertheless, tuner manufacturers continue to play up the sensitivity ratings of their products (which is understandable), and a sizable segment of the public continues to buy—or at least judge—tuners *only* by that rating, which is not so understandable.

What are some of the things that *do* make a difference in tuner sound? Such obvious characteristics as distortion and frequency response come to mind (you might be surprised at the number of tuners whose response rolls off audibly at high and low frequencies). One of the few audible differences I have been able to clearly identify is the residual background hiss level heard even with a strong signal input. Unfortunately, this does not necessarily correlate with the *measured* S/N, probably because of spectral-energy differences in the noise

Tested This Month



Lafayette LR-9090 Receiver
Thorens TD-126C Turntable
Ohm L Speaker System
Tandberg TCD 330 Cassette Deck
Sherwood HP 2000 Integrated Amp

produced by different tuners. A minute amount of hiss usually causes the tuner to sound bright even though its frequency response is flat or even rolled off at high frequencies. This is not necessarily a flaw, but it is one of the few audible differences between apparently similar products.

In general, however, there is not much difference in the sounds heard from various tuners, assuming they are of reasonable quality. This is not because they are all alike—far from it—but because of the nature of the programs broadcast. The source material is, of course, mostly records, with their inherently compressed dynamic range plus other problems. The sound is further limited and/or compressed in the transmission process. Live music broadcasts provide the best chance we get to hear whether one FM tuner is really better than another, but not many of us get that chance. In our tuner evaluations we often “transmit” our best records via our Sound Technology stereo FM signal generator and modulator. In effect, this provides a low-power stereo FM broadcast station of superlative quality. Although differences between tuners do not necessarily show up in this test either, the quality of the audio sent out by commercial broadcasters is clearly revealed—to its discredit—by the comparison.

Recently, perhaps because of the growing use of test instruments such as the spectrum analyzer, tuner distortion has received greater attention. As a result, there has been a phenomenal improvement in that aspect of FM tuner performance. Tuners are now available that cost considerably less than a king's ransom and yet have lower distortion than many other parts of the hi-fi chain. This is impressive to me both as an engineer and as an audiophile.

Unfortunately, extraordinary tuning precautions are usually needed to achieve these low distortion levels in practice. With most tuners, this can be done only with a distortion analyzer con-

nected to the tuner output (and, of course, with a very-low-distortion FM signal generator). A degree of mistuning that can hardly be detected on the tuner's meters (let alone heard) can easily increase the distortion by many times. In most cases there is a similar effect on stereo channel separation, with the 40 to 50 dB obtainable on some tuners falling to 25 or 30 dB with only a slight tuning error. By a “slight” tuning error I mean one with the indicated “correct tuning” segment on a channel-center meter—and there is no reason to believe that the exact center is the optimum.

The end result is that, even if a tuner is capable of less than 0.2 per cent distortion (a reasonably good figure by today's standards), the chances are remote that you will ever realize that condition in your own home. More likely you will be listening to perhaps 0.5 per cent distortion instead of that 0.2 per cent you thought you were buying (and which the tuner *can* deliver). This is not “bad” if the distortion cannot be heard; usually it can't.

In my view, there are a few *really* important properties of a tuner that in most cases are not really “specifications.” I'll admit to being hung up on some of these factors, but they really matter to me, and consequently affect my total appraisal of a product.

First, FM should be *easy* to tune. This may seem obvious, but why are so many tuners designed so that one has to guess which station is being received? Why are they adorned with impressive-looking meters which accurately define a tuning condition that assures several times as much distortion as the specifications guarantee? Why must one squint to read a dial scale, assuming that its calibration accuracy makes that effort worthwhile? In this country, FM channels are assigned at 200-kHz intervals. How many tuner dials have you seen that can actually be read to that degree of resolution and accuracy? It is not uncommon, even at high prices, to find tuner dials calibrat-

ed every 1 or 2 MHz—too imprecise.

Almost every tuner has a “muting” circuit to silence interstation noise. Most do that quite well. But why must we put up with a raucous burst of noise when tuning on or off a signal? Or a “thump” that threatens the safety of the speakers, to say nothing of the insult it delivers to one's sensibilities?

A relative-signal-strength meter, supposedly an indicator of correct tuning in many tuners, is supposed to give higher readings as the signal strength increases. This would make it suitable for orienting an antenna, for example. Unfortunately, the indications of many meters bear little relationship to signal strength. I have seen some that read full scale on *every* received signal! On the other hand, there are some good ones that will produce a visible indication with an input of a few microvolts (sorry, 10 to 15 dBf!) and still show the difference between 10,000 and 20,000 microvolts (85 to 91 dBf). As for multipath meters, some work superbly, but most are hardly worth the effort of pushing the button to switch them in.

Of course, the examples I have given are representative of the worst features of the many tuners and receivers I have tested; if a single product had all of them it would receive short shrift from me—and, I would hope, the buying public as well. There are even a few that are virtually free of these flaws. My point is that, if most tuners sound pretty much alike on today's broadcasts (and if you disagree with that premise, you certainly will not agree with my conclusions), then the real differences between them—the ones that would make me choose one over another—relate to how well they do their job of receiving FM stations in a useful and enjoyable manner. This is in contrast to how impressive their *numerical* specifications may be. As I have said, I am as impressed by numbers as anyone (probably more than most, since I know how difficult it is to achieve that performance and then measure it), but real performance goes beyond numbers.

Equipment Test Reports

By Hirsch-Houck Laboratories

Lafayette LR-9090 AM/FM Stereo Receiver

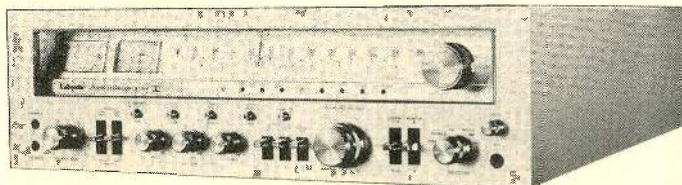

LAFAYETTE's restyled and redesigned line of stereo receivers is headed by the LR-9090, a unit rated to deliver 90 watts per channel to 8-ohm loads from 20 to 20,000 Hz with less than 0.1 per cent total harmonic distortion. The amplifier section features switchable turnover frequencies for its low-

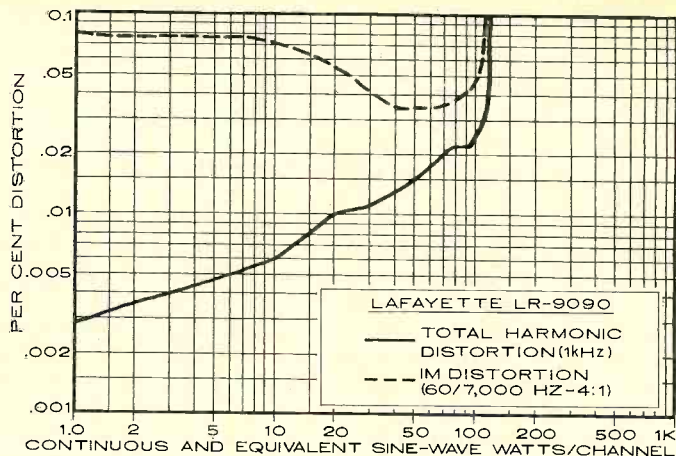
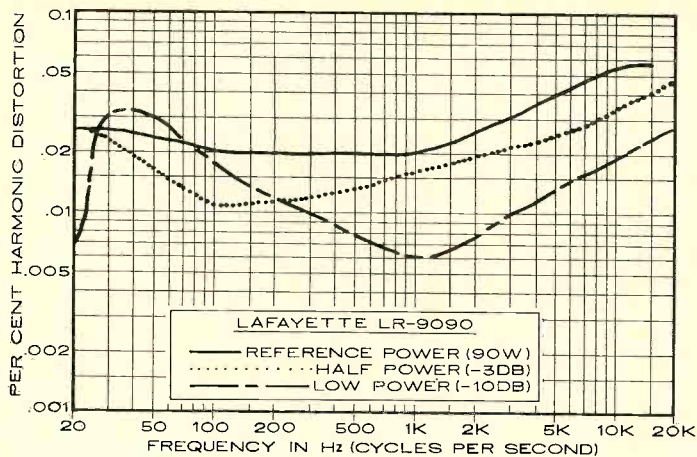

high-cut filters and bass and treble tone controls, the option of complete bypassing of tone controls and filters, and a third mid-range tone control.

The amplifier is teamed with a high-performance FM tuner (it includes built-in Dolby B decoding circuits) and an AM-tuner section. The styling of the LR-9090 follows current trends, with a silver-finish front panel across whose upper portion are the dial scales, meters, and tuning knob. The dial area is covered by a clear glass window.

The FM dial calibrations are linearly spaced, with index marks at 1-MHz intervals. Below the dial scales is a row of red LED lights (including a stereo FM indicator) plus lights that show which of the three sets of speaker outputs is activated and whether the phono, FM, AM, or auxiliary inputs have been selected. Another light indicates when the Dolby FM system is in use. The tuning meters show center of channel for FM and relative signal strength for both AM and FM.

At the lower left of the panel are two stereo headphone jacks and a speaker selector that connects speaker outputs A, B, C, A + B, or A + C as well as shutting them all off for headphone listening. This control also switches the power to the receiver. Three-position lever switches control the filters, with a choice of 15- or 40-Hz cut-off frequencies for the low filter and 7,000 or 12,000 Hz for the high filter. All filters have slopes of 12 dB per octave and are bypassed when the levers are centered.

Each of the three tone controls has eleven detented positions, the center being "flat." Pushbuttons above these controls select bass turnover frequencies of 500 or 250 Hz, treble turnover frequencies of 2,500 or 5,000 Hz, or bypass the tone circuits entirely. Other buttons select stereo or mono operation and turn on the Dolby system (simultaneously changing the FM de-emphasis from 75 to the required 25 microseconds).

Three lever switches control FM muting, audio muting (a 20-dB reduction in listening level for temporary interruptions), and loudness compensation. The volume control is detented at forty positions, and concentric with it is a ring (for balance adjustment) detented at its center position. The next two lever switches control tape-recording functions. The DUBBING switch cross-connects two tape decks for dubbing from either one to the other without necessarily interrupting the normal operation of the receiver. The MONITOR switch channels the selected program source,

or the playback from either deck, to the receiver's audio circuits.

The input selector has positions for two magnetic phono cartridges, FM, FM with MPX (a filter that reduces noise at the expense of some high-frequency separation), AM, and AUX. Finally, there is a stereo microphone jack for one or two medium-impedance dynamic microphones. Above it is a small microphone LEVEL knob. The signals from the microphones can be mixed with any other program source in the receiver's outputs (but not in the tape outputs). If a single microphone is plugged in, its sound appears in the left channel only; a pair of microphones must be combined through a single stereo phone plug to drive both channels.

In the rear of the receiver are insulated spring clips for the three pairs of speaker outputs, plus phono jacks for all other signal connections. There are binding-post terminals for 75- and 300-ohm FM antennas and a wire AM antenna. A hinged AM ferrite-rod antenna is also provided. A slide switch next to the phono inputs selects HI or LO gain in the phono preamplifiers, and there are three a.c. outlets, one of them switched.

The Lafayette LR-9090 is supplied with walnut side plates. It is about 21 inches wide, 15½ inches deep, and 6½ inches high; it weighs 38 pounds. Price: \$599.95.

● **Laboratory Measurements.** After the LR-9090 had been thoroughly warmed up by a one-hour preconditioning period, its amplifier outputs clipped at 108 watts per channel into 8

ohms at 1,000 Hz. The 4-ohm output was 156 watts per channel, and into 16 ohms it was 68.5 watts. The total harmonic distortion (THD) at 1,000 Hz was less than 0.01 per cent up to 20 watts output, reaching 0.022 per cent at the rated 90 watts and 0.027 per cent at 110 watts just at the onset of clipping. The IM distortion was about 0.1 per cent at 0.1 watt output, decreasing gradually to about 0.035 per cent between 40 and 80 watts, 0.04 per cent at the rated output, and 0.05 per cent at 110 watts. At very low outputs (in the order of milliwatts) the IM rose to several tenths of a per cent.

At rated power, the distortion was about 0.02 per cent over much of the audio-frequency range, climbing to 0.056 per cent between 10,000 and 15,000 Hz. A full-power measurement at 20,000 Hz could not be made because the amplifier's protective relay cut in before that point was reached. At lower power levels distortion was typically in the range of 0.01 to 0.02 per cent between 20 and 20,000 Hz.

To drive the amplifier to a reference output of 10 watts, an AUX input of 54 millivolts (mV) or a phono input of 0.83 or 1.7 mV was needed, depending on the setting of the phono-sensitivity switch in the rear of the receiver. The respective signal-to-noise ratios (S/N) for AUX and phono inputs were 77 and 71 dB referred to 10 watts. There was less than 1 dB of difference in S/N between the two phono-sensitivity settings. The phono input overloaded at a very high 170 or 350 mV, again depending on the sensitivity-switch position.

(Continued on page 42)

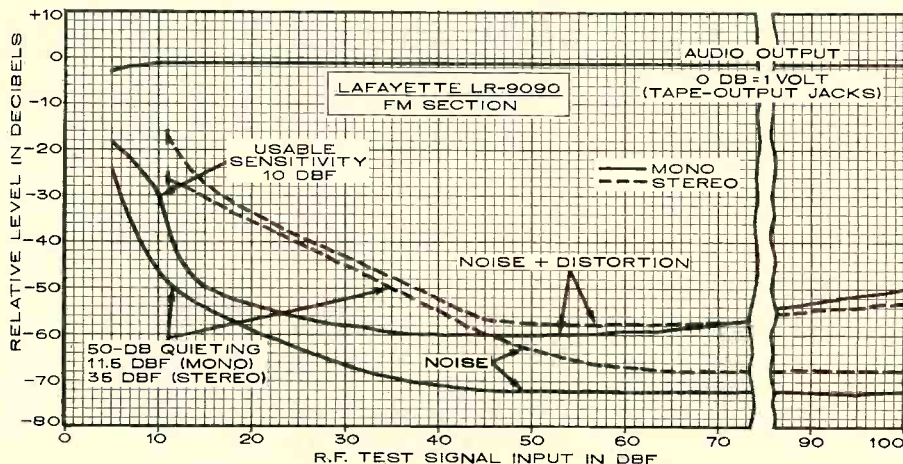

**Dymistatic by RTR Introduces
the Direct Drive Electrostatic DR-1.**

Never have you experienced a speaker like the DR-1. Nothing is comparable.

Consider the patented elemental systems—electrostatic, amplifier, woofer. Direct-drive, cylindrical electrostatics mate with a dual tandem-driven, three woofer system. A true cylinder, the electrostatics are capable of perfect dispersion over a full 360 degrees. This complex array is driven by a full-range internal amplifier which controls both audio output and vertical dispersion. Designed into an exclusive negative enclosure, the woofers are a sonic match to the ultra-fast electrostatic.

All impedance matching components in the internal amp are contained within the feedback loop—cancelling their distortion-producing effects. For the first time you hear only the electrostatics.

In all respects an impeccable system incorporating the most advanced Dymistatic technology. The DR-1 is available now for audition at prime dealers. Write for specifications and a dealer list.



RTR Industries, Dept. SR,
8116 Deering Ave.,
Canoga Park, CA 91304



Now...nothing stands between
you and the music.

You've never heard anything like it. Not from us. Not from anyone. JBL's new L212: a totally new picture of high performance sound, from the people who wrote the book.

You hear the whole sound first.

And when you catch your breath you search for words to describe the depth, the detail, the etched precision of the music.

That stunning pair of three-way speakers is sending clean, undistorted sound to every corner of the room. At every frequency. At every level. Loud or soft. High or low. It doesn't matter. The energy is constant.

You're experiencing three-dimensional imaging: Vocal up front. Lead guitar two steps back and one to the left. Drums further back. The piano closer, almost off the right edge of the sound.

Suddenly you're aware of a fullness in the music that you've heard before but never associated with recorded sound.

The bass! You've been hearing all of the bass, all of the fundamental tones you couldn't bring home from the concert. It's not only everything you've heard before. It's everything you haven't. The music is rich with sound at the lowest limit of your hearing.



Then you see the third speaker. The hero of the piece: The Ultrabass.

The Ultrabass is a system in itself—woofer, amplifier, equalizer and enclosure—designed, mated, blended to do one thing perfectly: reproduce sound at the threshold of sub-sonic frequencies.

It brings all the low frequency music within audible range, balancing it perfectly with the rest of the music. Without boominess. Without resonance. It also electronically sums left and right signals below 70 Hz—virtually eliminating turntable rumble and record warp noise. And, because of the non-directional character of the low frequency sound, the Ultrabass can be placed almost anywhere in the room. Without any loss of three-dimensional imaging.

The Ultrabass pays one final dividend: it allows the two three-way speakers to be specialists, too.

They can concentrate on the top 95% of the music. (Listen to the whole system, and you'll hear what that means. Even at a rug-curling, rock concert loudness, you'll get a clarity, a smoothness, an enthusiasm for detail you've never heard before.)

Finally, you look for the monster amplifier that's driving all that sound. There isn't one. The L212 takes one fourth the power you'd need with a conventional low efficiency loudspeaker.

That's the story. What you've been reading about is, essentially, a no-trade-off loudspeaker system. Now we'll tell you the trade-off: The price is \$1740. (The L212 may take a little while becoming a household word.)

In the meantime we have two suggestions:

If you'd like a lot more technical information, write us and we'll send you an engineering staff report on the L212. Nothing fancy except the specs.

Or call your JBL dealer and ask him when you can hear the L212. You've never heard anything like it. Not from us. Not from anyone.

Frequency Dispersion

~~~~~ at 400 Hz  
~~~~~ at 2 kHz  
~~~~~ at 10 kHz

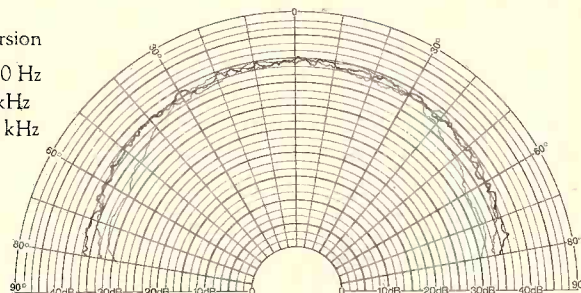



JBL CHANGES THE  
PICTURE OF SOUND.

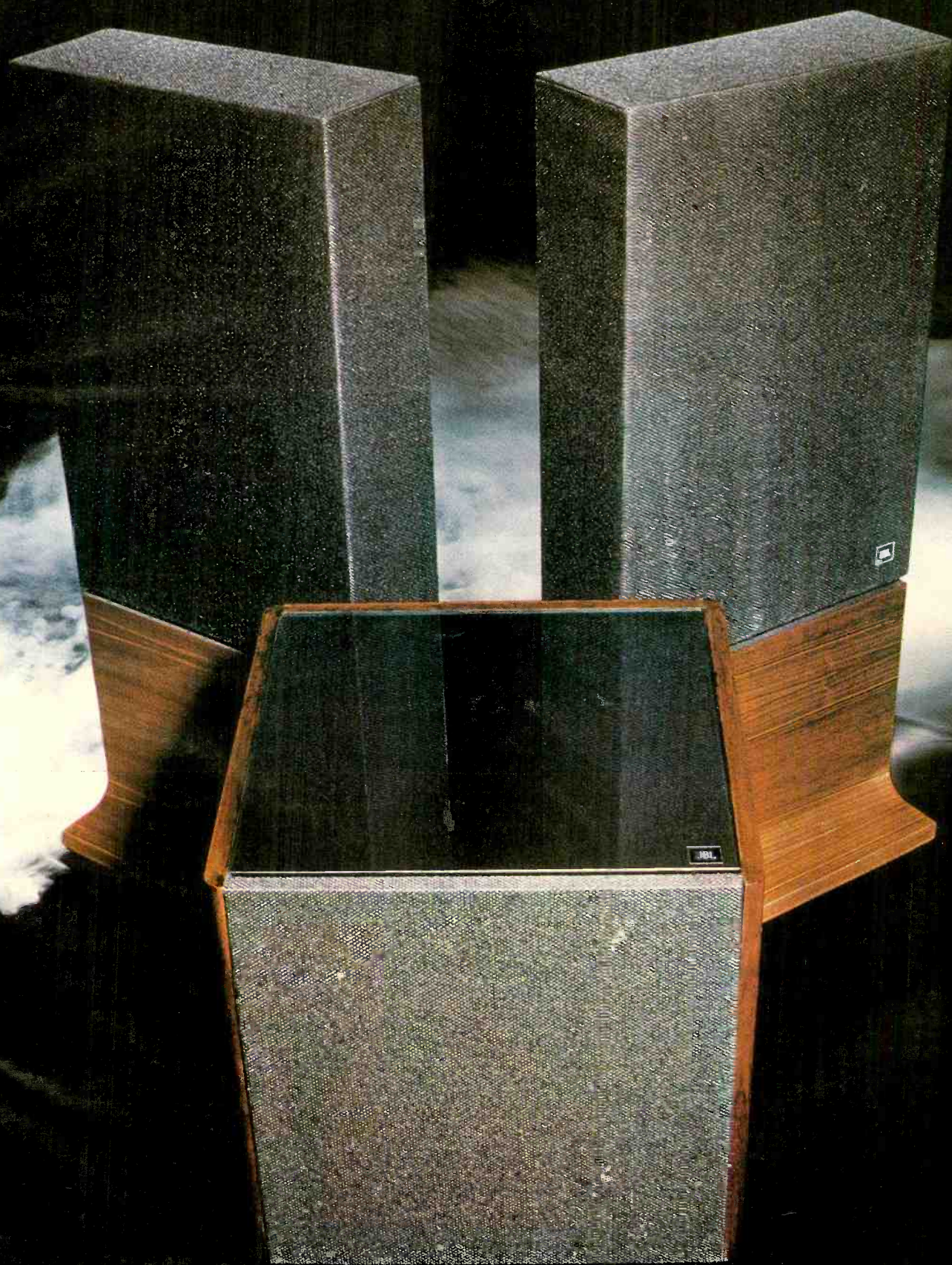

As might be expected from the choice of bass and treble turnover frequencies and the provision of a mid-range tone control, the frequency response of the LR-9090 could be adjusted to just about anything one might desire. The loudness compensation boosted both lows and highs as the volume-control setting was reduced. The low-cut filters had approximately the rated characteristics, but we found the cut-off frequencies of the high-cut filters to be much lower than the manual or the panel markings indicated. The 7,000-Hz filter response was down 3 dB at about 2,800 Hz, and the 12,000-Hz filter was down 3 dB at 5,000 Hz. However, both had the rated (and highly desirable) 12-dB-per-octave slopes beyond their cut-off frequencies. The RIAA phono equalization was accurate to within  $\pm 1$  dB from 30 to 20,000 Hz, and it was totally unaffected by phono-cartridge inductance.

The measured performance of the FM tuner section surpassed—usually by a comfortable margin—all of the published ratings for which we were able to test. This may seem to be a perfectly reasonable thing to expect, but in our experience it is relatively rare. The usable sensitivity was 10 dBf or 1.7 microvolts ( $\mu\text{V}$ ) in mono and 15 dBf ( $3 \mu\text{V}$ ) in stereo. The 50-dB quieting sensitivities were, respectively, 11.5 dBf ( $2.1 \mu\text{V}$ ) with 1 per cent THD and 35 dBf ( $30 \mu\text{V}$ ) with 0.45 per cent THD in mono and stereo modes. The S/N of the FM tuner section was 72 dB in mono and 67.5 dB in stereo, and distortion at an input of 65 dBf ( $1,000 \mu\text{V}$ ) was 0.12 per cent in mono and 0.14 per cent in stereo. The stereo distortion with out-of-phase (L - R) modulation was 0.3 to 0.32 per cent from 100 to 6,000 Hz.

The FM frequency response was flat within  $\pm 0.1$  dB over most of the audio band and within  $+0.5$ ,  $-1.0$  dB from 30 to 15,000 Hz.

Unlike most receivers with low-pass filters to remove 19-kHz pilot-carrier signals from their audio outputs, the LR-9090 showed absolutely no drop at the high-frequency end of its FM frequency response. In spite of this, the 19-kHz leakage was a very satisfactory  $-66$  dB. The stereo channel separation was exceptional, comfortably exceeding 45 dB from 100 to 10,000 Hz and still a strong 42 dB at 15,000 Hz and 38 dB at 30 Hz.

The capture ratio was 1.2 dB for a 65-dBf input, and it was a remarkable 0.9 dB at 45 dBf. The AM rejection at these respective levels was 68 and 70 dB. The image rejection was a very good 92 dB, and alternate-channel selectivity was 83 dB. Adjacent-channel selectivity was minimal, measuring about 3.5 dB. The FM muting and stereo-switching thresholds were identical at 7 dBf ( $1.2 \mu\text{V}$ ), considerably lower than the rated 14 dBf but perfectly satisfactory from a user standpoint. The only measurement made on the AM tuner section was of its frequency response, which was down 6 dB at 60 and 3,300 Hz.

● **Comment.** Comparing the performance and features of the Lafayette LR-9090 with those of other receivers with similar power ratings, we found that it generally holds its own with any of them and clearly excels in certain respects. The only significant omission we found was the lack of separate preamplifier-output/power-amplifier-input jacks. But, on the whole, and considering that it has built-in Dolby decoding circuits, the LR-9090 is priced very competitively.

Although we usually do not delve too deeply into the circuit details of a product, it is instructive to see how Lafayette has achieved this level of performance at the price of the LR-9090. As might be expected, extensive

use is made of recently developed IC's. For example, a single IC serves as the FM i.f. amplifier, limiter, quadrature detector, tuning-meter driver, and muting circuit. The latter, incidentally, is one of the best we have seen, with its muting action determined not only by signal strength but by how closely the tuning is set to the signal frequency. It mutes and unmutes, without transient noises, well before the tuner is out of the normal listening tolerance for low-distortion tuning. There is enough time lag in its action that the flywheel dial can be given a single spin, carrying it across the full FM band with not a sound emerging from the speakers.

Other IC's serve as Dolby decoders (judging by listening only, they did an effective job of frequency-response correction and noise reduction), the multiplex demodulator (a phase-locked-loop device which doubtless must be credited with much of the receiver's outstanding stereo FM performance), the entire AM-tuner section, and the phono preamplifiers. Nevertheless, there is much that remains to be done by discrete circuits, and the LR-9090 contains some forty-nine transistors and forty-one diodes in addition to its eight IC's.

Using the Lafayette LR-9090 for some time left us with a definite feeling that it has been designed and constructed to the highest current standards for a high-power stereo receiver. It has the smoothness and freedom from handling quirks that we like—and expect—to find in a de luxe stereo component. For example, centering the needle of the FM tuning meter always resulted in the lowest noise and distortion, without any sense of its being a "touchy" or critical setting. Needless to say, it sounded as good as it looked and felt.

Circle 105 on reader service card

## Thorens TD-126C Turntable



**T**HE new Thorens TD-126C record player features the very low-mass "Isotrack" tone arm in combination with an electronic belt-driven three-speed turntable. The platter

and arm are coupled and isolated from the base (on which the motor and controls are mounted) by a highly compliant, damped spring suspension.

The basic arm design looks conventional but has many refinements. The gimbal pivots support a straight, 9-inch tubular tone arm of lightweight aluminum construction. Antiskating compensation is applied by opposing magnetic fields, adjusted by a knob on the side of the pivot housing. Four antiskating scales provide for the use of conical and elliptical styli on dry or wet (lubricated) record surfaces.

A large part of the effective mass of a tone arm is in the plug-in cartridge shell and its locking hardware. Thorens has eliminated the usual cartridge shell, and the end of the arm carries only a plastic "T" large enough to mount the cartridge (through its  $\frac{1}{2}$ -inch-spaced holes) and a light metal finger lift.

For cartridge installation and interchangeability, the entire arm plugs into a socket resembling the four-pin bayonet locking type used on most conventional arms. The socket is located only about  $2\frac{1}{2}$  inches from the pivots, where its mass is much less significant than it would be at the end of the arm. The removable arm (additional arms are available

(Continued on page 46)

# Learn today's newest skills from the ground up.

You've got to be good to get in. But you'll be one of the best.

When you join the Air National Guard, you can learn to operate, maintain and repair some of the most sophisticated equipment in existence today.

Step by step you'll be trained in a career skill you'll be able to rely on for a lifetime.

From the basics right up to the professional level. The best Air Force technical schools are available

to you. And you won't have to lay out a lot of money to attend. You'll be the one who's paid. Well paid.

After training, just one weekend a month is all it takes to add to your skills. And your earnings.

Fill out and mail the postcard for details or call us toll free at 800-336-0423 anytime of the day or night. (In Virginia call 703-756-2430. In other areas consult your white pages under "State Government.") CIRCLE NO. 59 ON READER SERVICE CARD



The most important part-time job in America.



The Guard belongs.

for installing other cartridges) is furnished in a plastic storage case that also serves as a jig for cartridge alignment.

The 7-pound nonferrous platter is driven by a sixteen-pole synchronous motor. The motor speed is controlled by the frequency of a stable Wien bridge oscillator that drives it through a power amplifier. A vernier control adjusts the speeds (33 $\frac{1}{3}$ , 45, or 78 rpm) over a nominal  $\pm 6$  per cent range.

The controls of the TD-126C form a row across the front top of the base. The suspended portion of the player lies behind the controls so that their operation will not jar the pickup. A knob at the left turns on power to the TD-126C, and the speed is selected by a light pressure on one of three flat rectangular plates. The outer edge of the selected plate is illuminated (when the unit is first turned on, the 33 $\frac{1}{3}$ -rpm speed is automatically selected).

To the right of the pressure plates is the stroboscope window (for viewing the illuminated markings under the platter) and a speed vernier knob. Each speed has a separate ring of strobe dots, although a single vernier speed control affects all speeds (when one speed is set accurately, the others are also correct). The next knob is a mode selector that provides a choice of fully manual operation, automatic arm lift at the end of a record, or automatic arm lift combined with motor shut-off.

Following these controls are three flat plates like the speed selectors. The first, whose edge is lit when the power is first applied, is a shut-off control that turns off the motor and lifts the arm when it is pressed. The next plate turns on the motor, but it does not lower the arm (it can be used for a cueing arm lift when a record is being played); the third plate turns on the motor and lowers the pickup (it is the cueing descent control when a record is on the turntable). Very little force and almost no motion is required to activate any of these functions. For the automatic end-of-play arm lift an electronic velocity sensor detects the rapid arm movement in the run-out grooves and triggers the lift circuit without imposing any additional load on the tone arm or the cartridge.

The Thorens TD-126C is supplied on a black base with silver accents (the suspended board carrying the platter and arm is finished in black also), and there is a hinged plastic dust cover. The unit's dimensions are about 20 by 15 $\frac{1}{2}$  by 6 $\frac{3}{4}$  inches, and it weighs 34 pounds. Price: \$625. Additional plug-in arms are \$15 each.

● **Laboratory Measurements.** We tested the Thorens TD-126C with a Shure M95ED cartridge installed in its Isotrack arm. The cartridge installation was quite tricky, though the problems may have been accentuated by the unusual nature of the arm case/jig combination. A rewritten instruction manual for this portion of the installation is supplied by Elpa Marketing, which imports the Thorens line of turntables.

We adjusted the cartridge as accurately as possible with the jig, but because of the special cartridge mounting used in the TD-126C, it was difficult to measure tracking error by our normal techniques. Our best guess is that the Thorens arm has a near-zero error over most of the record surface and a maximum of about 0.5 degree per inch near the outside of the record.

When the arm was balanced so that the stylus was just above the record surface (according to instructions), the tracking force was high by a slight 0.25 gram at all settings. We readjusted the balance for a correct reading with the force dial set to 1 gram and found that the calibration was then accurate over the 0.5- to 3-gram range of the dial. However, the arm now balanced with the stylus about  $\frac{1}{2}$  inch above the record.

The arm mass was measured by a new test device that employs a driven and calibrated spring and was found to be 9.8 grams (after subtracting the 6-gram mass of the cartridge). This is substantially lower than the mass of a typical record-player tone arm.

The low-frequency resonance of the M95ED cartridge in the Isotrack arm fell at 10 Hz instead of the less desirable 8 Hz or so typical of other arms. The capacitance of the tone-arm wiring and the integral signal cables was 190 picofarads per channel, suitable for

stereo cartridges but obviously not intended for CD-4 use.

The turntable rumble was very low: -42 dB in a lateral unweighted measurement and -64 dB in a vertical-plus-lateral measurement with ARLL weighting. Spectrum analysis showed the rumble to be mostly at 6 Hz. Flutter was a low 0.035 per cent, and the wow varied at a slow rate (with a period of several seconds) between 0.02 and 0.08 per cent, with the average being about 0.06 per cent. The principal flutter component was at 50 Hz. The turntable speeds were exact and did not change over time or with line-voltage shifts. The vernier speed control had a range of  $\pm 9$  per cent, slightly wider than usual.

The antiskating calibration was correct, giving equal distortion in both channels of the cartridge output when the control was set to match the tracking force. When the antiskating was set to its minimum, there was sufficient residual force to swing the arm outward when it was floated in a balanced condition. The arm descent during cueing was slightly influenced by the antiskating, drifting outward enough to repeat a couple of seconds of the record.

The isolation of the record player from base-conducted acoustic feedback and vibration was excellent. There was only a single resonant transmission peak, between 40 and 50 Hz, and at this frequency the sensitivity of the TD-126C to external vibration was 10 to 30 dB lower than we have tested with any other record player. At other frequencies the isolation was as much as 50 dB better than with other players. The self-resonant frequency of the player on its springs was about 3 Hz; it was somewhat sensitive to jarring, but not at all to normal handling.

● **Comment.** The Thorens TD-126C represents a substantial advance in record-player performance, even though most of its design features are not unique to this unit. The justification for this statement becomes apparent when one examines its performance in detail.

First, and probably most important, its tone-arm mass is the lowest (by far) that we have seen on a record player with a pivoted, offset tone arm. Its ability to track severely warped records appears to be fully equal to that of any of the low-mass radial arms we have tested. The antiskating compensation is correct, which is most unusual in our experience. The turntable flutter is low, though not unusually so, but the rumble is on a par with that of some of the best direct-drive turntables and lower than we have previously measured on any belt-driven turntable. It is also one of the very few modern turntables to offer a 78-rpm speed. The operation of the record player is simple and logical, with a choice of partial automation or none at all. It is, for all practical purposes, immune to acoustic feedback conducted through its base.

We note that the same arm and basic turntable system are used in some lower-price models of the current Thorens line, and these should be able to deliver much of the fine performance of the TD-126C at a substantially reduced price (though without such niceties as electronic speed control, pushbutton operation, and the 78-rpm speed). The TD-126C is a truly fine machine that will surely appeal to discriminating phonophiles, especially those who have collections of 78-rpm records.

Circle 106 on reader service card

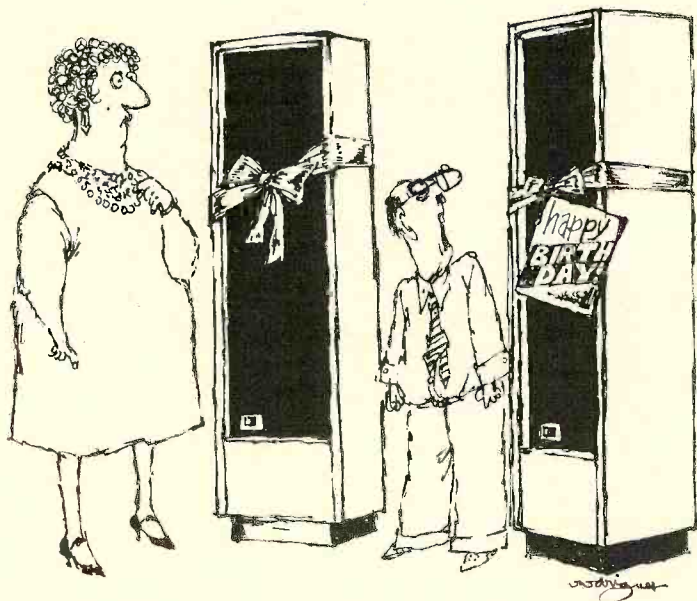

“... Think you're smart, Evelyn?”

(Continued on page 50)

**The engineers who conceived the state-of-the-art DDX 1000 are pleased to announce the MB 15.**

**At less than one fourth the price.**

With its three-tonearm capability, its \$600 nationally advertised value,\* and its optional highly-acclaimed MA 505 tonearms, the Micro Seiki DDX 1000 has been accepted as one of the unique advances in turntable concept and design.

Using the same technology, our engineering team has crafted the MB 15 to achieve economy, while preserving musical accuracy.

Elegant and understated, its economy of design reveals not one extra line — contains not one unnecessary part.

An electronic sensor controls shutoff and arm-lift operation: a Hall-effect IC sensor detects a change in tonearm speed at the end of the record and activates a viscous-damped device which lifts the tonearm and shuts off power.

Its diecast aluminum platter is driven by a 4-pole synchronous motor coupled with a precision-polished belt that effectively acts as a damping device; wow and flutter is less than 0.06%.

A solenoid-activated cueing system and an easy-to-adjust anti-skating control are among its attractions. The MB 15 tonearm headshell is detachable for ease in mounting cartridges.



DDX 1000

MB 15

At \$150 (nationally advertised value)\* you can considerably enhance the enjoyment of your records with Micro Seiki purity of sound.

Isn't it time to upgrade your pleasure?

**MICRO SEIKI**

Advanced engineering in turntables.



MA 505

Distributed by TEAC Corporation of America, 7733 Telegraph Road, Montebello, California 90640. ©TEAC 1977. Actual resale prices will be determined individually and at the sole discretion of authorized Micro Seiki dealers.

CIRCLE NO. 33 ON READER SERVICE CARD

"...in the same class with a number of more expensive products, including many of the direct-drive record players we have seen."

This quote, from the Hirsch-Houck Labs' report in *Stereo Review*, refers to the Dual 510, a semi-automatic belt-drive turntable. Considering that direct-drive models (especially our own) are widely accepted as the standard of performance, Hirsch-Houck's comparison is not to be taken lightly.

The 510 also benefits from comparison with other semi-automatic turntables.

**We'll let someone else tell you how good our belt-drive turntables really are.**

Dual's unique sensor locates the 12-inch and 7-inch lead-in grooves for you. You don't have to guess where they are. And there's no way to drop the tonearm accidentally; the cue-control lifts it automatically at the end of play and supports it until you release it. Every Dual tonearm benefits from comparison with curved tonearms. Even though the shortest distance between two points is a straight line, some designers are more concerned with appearance. Hence, the curved tonearm—whose departure from a straight line between pivot and stylus simply adds mass, reduces rigidity, and increases the likelihood of resonance. And fails to take advantage of the high compliance of the finest cartridges.

You might keep all this in mind when considering your next turntable. Chances are you'll want it to be a Dual.



**United Audio Products**, 120 So. Columbus Ave., Mt. Vernon, N.Y. 10553  
Exclusive U.S. Distribution Agency for Dual

Dual 510. Semi-automatic, single-play. True four-point gimbal tonearm suspension. Synchronous motor, precision-ground belt, unique Vario-pulley, dynamically-balanced platter. 6% pitch-control, illuminated strobe. Lead-in groove sensor. Cue-control viscous-damped in both directions. Less than \$200.

Dual 502. Similar except less sensor and strobe. Less than \$160.

Dual 1249, fully automatic single-play/multi-play. Less than \$280.



Specifications (DIN B): Rumble, >66 dB; Wow and flutter, <math>\pm 0.05\%</math>.

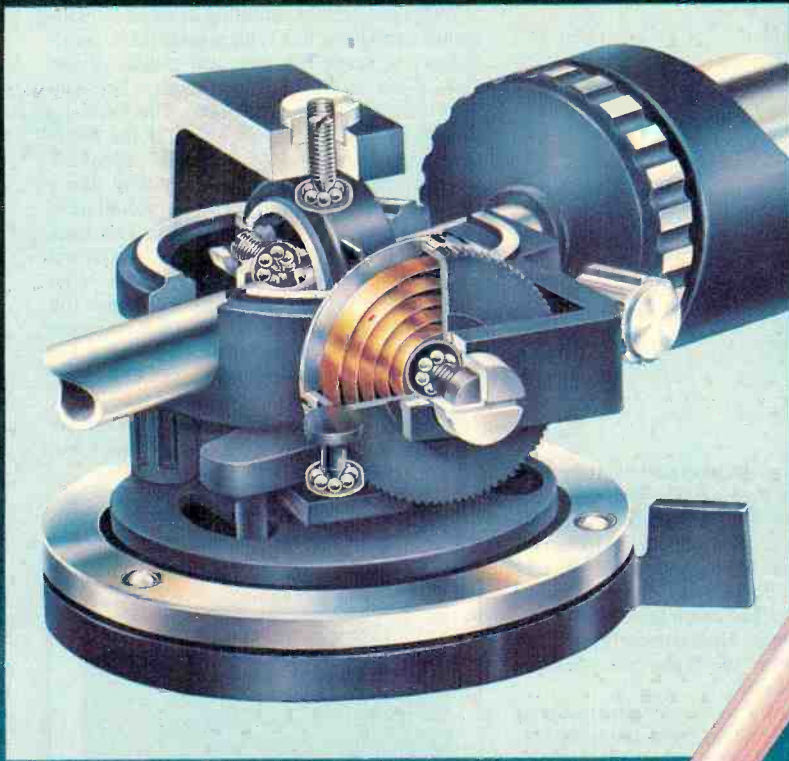

True four-point gimbal centers and pivots the tonearm mass at intersection of horizontal and vertical axes. Tonearm is dynamically balanced in all planes. The four needle-point pivots are first hardened, then honed: a process which produces microscopically smooth surfaces. The precision ball-bearing races are only 0.157-inch diameter. Bearing friction: vertical, <0.007 gram; horizontal, <0.015 gram.

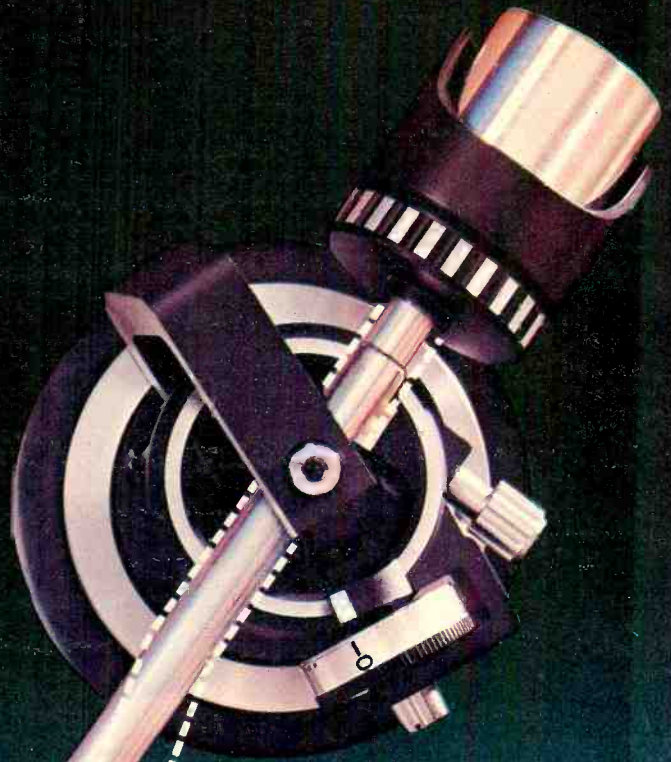

The curved tonearm may appear longer than the Dual tonearm, but both actually have the identical effective length and horizontal tracking angle.

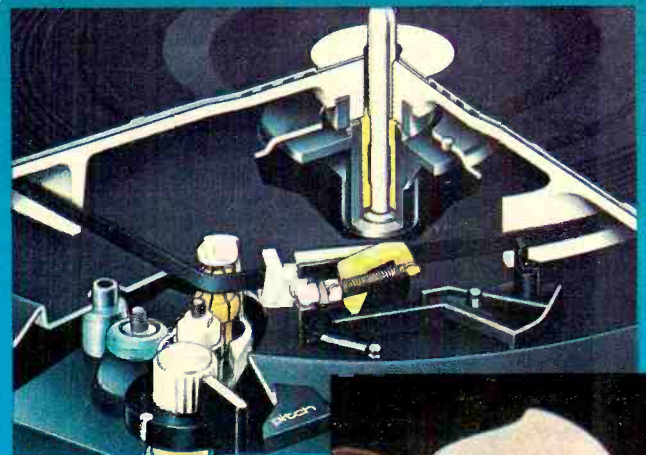

Speed changes can be made while platter is rotating; belt is never twisted or distorted. Precision-grinding of belt maintains speed constancy and eliminates weak spots that shorten life.

Vario-pulley is individually machined for perfect concentricity and balance. Speeds are adjusted by expansion and contraction of pulley.

# Ohm L Speaker System

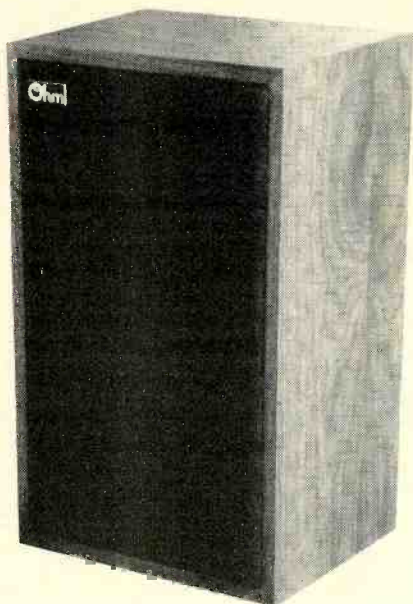

**T**HE Ohm L is a compact, three-way speaker system using a ducted-port enclosure for its 8-inch woofer. The middle and high frequencies are handled by small cone drivers approximately  $2\frac{1}{4}$  and  $1\frac{3}{4}$  inches in diameter. The crossover frequencies are 1,700 and 5,000 Hz, and the nominal system impedance is 8 ohms.

The cabinet, finished in oiled walnut, is approximately 20 x 12 x 10 inches; it weighs 28 pounds. The black cloth grille, mounted on a wooden frame, is held at its corners by Velcro fasteners and is easily removed. Next to the input terminals, which are recessed in the rear of the cabinet, is a three-position slide switch for adjusting the tweeter and mid-range level. The maximum (0 dB) setting gives the flattest response, and attenuations of 3 and 6 dB are available. The mid- and high-frequency drivers are controlled simultaneously. Price: under \$150.

● **Laboratory Measurements.** The averaged frequency response in the reverberant field of the test room was relatively uniform from several hundred hertz to the 15,000-Hz upper limit of our measurement. The output variation was less than  $\pm 4$  dB over that range when the tweeter-level switch was set to 0 dB.

As is our practice, we measured the woofer response with a closely spaced microphone to eliminate room effects. The response at the port opening was measured in the same manner, corrected for its diameter relative to that of the cone (3 vs. 7 inches), and summed to obtain a total bass-response curve, which was then spliced to the high-frequency curve.

The resulting composite frequency-response curve was uniform within  $\pm 4$  dB from about 50 to 15,000 Hz. There was a slight increase of output (about 3 dB, relative to the average mid-range level) in the 11,000- to 13,000-Hz range, but this was judged to be minor. The tweeter level switch had the specified effect, reducing the output by either 3 or 6 dB at frequencies above 1,500 Hz or so.

The bass distortion was also measured with a closely spaced microphone, using drive levels of 1 and 10 watts. Measurements were made from 100 Hz down until a rapid increase in distortion was observed. In a ported enclosure

such as this, with the port contributing most of the output below 60 Hz, this measurement can be somewhat misleading. The woofer output drops off rapidly at low frequencies, resulting in a relatively high measured distortion. This is not audible since the port radiation dominates and has much lower distortion in its operating range. Unfortunately, it is not practical to combine the distortion measurements for port and cone.

The cone distortion at 1 watt was an almost constant 2 to 2.5 per cent from 100 to 55 Hz, increasing to 5 per cent at 50 Hz. Not surprisingly, in view of the 7-inch effective diameter of the woofer cone, the distortion was much greater at 10 watts. It was about 8 per cent at 100 Hz, fell to 2.3 per cent at 60 Hz, and rose sharply at lower frequencies.

The sensitivity of the Ohm L was fairly high, though not unusually so for a ported system. When driven with 1 watt of random noise in the octave centered at 1,000 Hz, it produced a sound-pressure level of 90 dB at a distance of 1 meter from the grille. The tone-burst response was quite good at low and high frequencies, but in the vicinity of the crossover from the woofer there was some extended ringing between bursts. The impedance of the system was 50 ohms (and still rising) at the lower measurement limit of 20 Hz. It fell to 8 ohms at 50 Hz, rose to a peak of 25 ohms at 72 Hz, and dropped to 6 ohms at 150 Hz before increasing to nearly 20 ohms at 1,000 Hz. It fell again at higher frequencies, with the minimum impedance of 4 ohms occurring between 10,000 and 20,000 Hz. Overall, we would consider the manufacturer's 8-ohm rating to be reasonable from the standpoint of interface with an amplifier.

● **Comment.** In the simulated live-vs.-recorded listening test, the Ohm L proved to be a highly accurate reproducer of music, especially with the tweeter level set to -3 dB. Its highs were strong, and even in our well-damped listening room the crispness imparted to vocal sibilants and instrumental sounds such as wire brushes and triangles could be plainly heard. On many recordings we preferred the slight emphasis of frequencies above 10,000 Hz when the full tweeter output

was used, but the comparison to the original "live" sound showed that it was excessive. With a 3-dB attenuation, the upper mid-range and high frequencies were virtually perfect. The high-frequency dispersion, judged by walking past the speaker while it reproduced pink noise, was good though not exceptional.

With the speakers mounted in a mid-wall location equivalent to a typical bookshelf installation (to which the size and weight of the Ohm L are well suited), the balance between lows and highs was excellent. The Ohm L, though diminutive beside many of the floor-standing or oversize "bookshelf" speakers we have seen, sounded in every way like a full-size system. Blindfolded, one would never guess its compact dimensions. The bass was relatively free of the resonant emphasis that mars the sound of many speakers large and small. Evidently, Ohm designed the speaker to deliver a reasonably flat response down to 50 Hz or so rather than reach for another half octave of low bass. The latter could have been obtained in this small box only at a sacrifice of efficiency or of response flatness in the mid-bass; we think that Ohm made the correct choice.

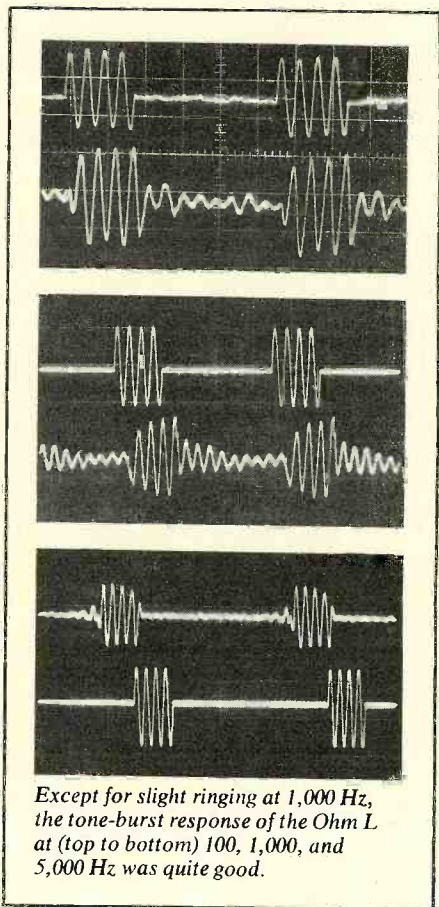

Except for slight ringing at 1,000 Hz, the tone-burst response of the Ohm L at (top to bottom) 100, 1,000, and 5,000 Hz was quite good.

At the time we tested the Ohm L, complete specifications were not available to us. In the absence of specific information, we approached the maximum power capabilities of these speakers with some trepidation. Driving them with a 200-watt-per-channel amplifier, we regularly came within a few decibels of the

(Continued on page 53)



# Only Hitachi's SR/903 Receiver has Class G, "the very newest class in amplifier operation."

Stereo Review  
January, 1977



Stereo Review went on to explain that this exclusive circuitry "uses...a low power and a high power output stage operating together... At low signal levels the lower power stage drives the speakers. The transition to the more powerful output transistors...takes place smoothly at the point where it becomes advantageous to do so."

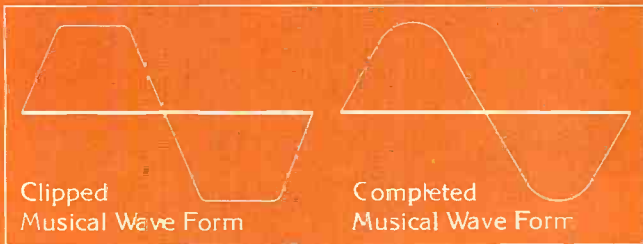

The point they're talking about, of course, is where certain portions of the music you listen to demand more than the rated output to sound like they should. (Rated output on the Hitachi SR/903 is 75 watts continuous power per channel, both channels driven into an 8 ohm load, 20 to 20,000 Hz with no more than 0.1%

total harmonic distortion.) So when your music really gets thrilling, Class G cuts into a standby amplifier. Then, for just a moment, the SR/903 can pump out a lusty 160 watts per channel—without clipping.

One look at comparison wave forms will show you what we mean. See how the sound from the conventional amplifier has the top of its natural arc clipped off. That's when you'd get clipping distortion. But the same musical peak graphed on the Hitachi SR/903 is complete. So the sound you'd hear would be clean and crisp.

As a wrap-up, Stereo Review said Class G delivers "much higher overall efficiency than a conventional device, and this brings immediate dividends...in reduced weight, size and power consumption!"

All they neglected to mention was that Class G doesn't cost you any more.

## Hitachi SR/903 Typical Specifications

| Amplifier                                       | Rating                |
|-------------------------------------------------|-----------------------|
| Power, minimum RMS, at 8 ohms, 20 to 20,000 Hz  | 75 watts              |
| Total harmonic distortion at rated power output | 0.1%                  |
| FM Tuner                                        | Rating                |
| Usable sensitivity (IHF) 300 OHMS               | 1.6 $\mu$ V (9.3 dBf) |
| 50 dB quieting sensitivity                      | 3.1 $\mu$ V (15 dBf)  |
| Signal/noise ratio 100% mod                     | 74 dB                 |

 **HITACHI**  
When a company cares,  
it shows.

# Performance. Scott Stacks Up.

Every serious listener knows that separate tuners and amplifiers offer greater system versatility and flexibility than the all-in-one receiver. But Scott separates stack up where it really counts — performance.

Every one of Scott's complete line of tuners and amplifiers is engineered and designed to give you all the performance features you expect, at a price no higher than many receivers currently on the market.

Scott's T 526 AM/FM Stereo Tuner and A 436 Integrated Power Amplifier provide such important performance features as front panel Dolby de-emphasis switching, a phase locked loop multiplex section and linear motion calibrated controls.

And that's only part of the story. Compare these important performance features with any other medium-priced tuner and amplifier on the market today.

## The Scott T 526 Tuner

IHF sensitivity rated at  $1.9 \mu\text{V}$ , S/N ratio 68 dB and a capture ratio of 1.5 dB.

Signal strength and center channel tuning meters.

Four gang tuning capacitor for better image rejection.

AM section designed around a tuned RF amplifier using J-FET for improved signal-to-noise ratio.

AM noise suppression circuitry.

## The Scott A 436 Amplifier

42 watts RMS per channel, driven into 8 ohms from 20 Hz to 20 kHz with no more than 0.3% THD.

True logarithmic meter amplifier obviates the need for range switching.

Individual channel power level meters calibrated in % of full power output capability eliminates confusing dB and VU readings.

Two completely independent tape monitors allow two tape recorders to be used simultaneously for direct tape-to-tape copying.

Instantaneous electronic protection circuit in the output stage.

IM distortion lower than 0.15% for a cleaner sound without listening fatigue.

High and Low filters, two auxiliary outlets and mic inputs.

And the Scott T 526 and A 436 come complete with professional rack-mount handles, and are backed by a three-year, parts and labor limited warranty.

For specifications on Scott's complete line of audio components, write or call H.H. Scott, Inc., 20 Commerce Way, Woburn, Mass. 01801. (617) 933-8800. In Canada: Paco Electronics, Ltd., Quebec, Canada. In Europe: Syma International S.A., 419 Avenue Louise, Brussels, Belgium.



 **SCOTT**  
The Name to listen to.

Receivers / Tuners / Amplifiers / Turntables / Speakers

CIRCLE NO. 100 ON READER SERVICE CARD

amplifier's limits without damage to the speakers and without any audible sounds of distress from them. Though efficient enough to be driven successfully from a low-power receiver, they apparently can withstand the

onslaught of a "super amplifier"—at least if the playback levels are not carried to ridiculous extremes.

In summary, the Ohm L joins the growing ranks of small, moderately priced speakers

whose sound is easily good enough to meet the sort of critical standards usually applied to much larger and considerably more expensive speaker systems.

Circle 107 on reader service card

## Tandberg TCD 330 Stereo Cassette Deck



**T**ANDBERG tape recorders, both open-reel and cassette, have long been noted for their extended frequency response, very low noise levels, and attractive styling. In their Model TCD 330, Tandberg has set itself the goal of making a true state-of-the-art cassette deck.

The TCD 330 is a three-head machine, and its three-motor transport features a dual-capstan, closed-loop system that maintains a uniform tension on the tape as it passes over the heads. All transport functions are solenoid-controlled through light-touch pushbuttons. A foolproof logic system interlocks the controls so that they can be operated in any sequence without risk to the tape. Each button has its own indicator light, either within it or just above it, so that the operating status of the machine can be seen at a glance.

The TCD 330 can be operated either horizontally or vertically. The cassette door, which opens sideways (when the machine is vertical) is at the right of the silver-colored panel. It is opened by touching a nearby EJECT button which acts through a solenoid so that the door will not open unless the machine is turned on (there is a mechanical release in the rear, however). The cassette loads through the right side of the door and is positively retained in the loading tray, where the entire tape pack can be seen through a tinted plastic window.

What appears to be a solid trim plate to the right of the cassette door is actually the cover for the record head's azimuth-adjustment system. It is opened by pressing down on its top edge (there is no external indication of this facility, but it is, of course, discussed in the instruction manual). The panel then opens slowly, under hydraulic damping, revealing the instructions for the head adjustment printed on its inside.

In order for a three-head cassette machine to have a proper high-frequency record-playback response, it is necessary that the azimuths of the record and playback heads be matched exactly. (Actually, this is true of any three-head tape machine, but it is much more critical in the case of cassettes.) Because of the normal skewing of the tape within a cassette, this adjustment is usually required every time a cassette is inserted or even when it is turned over to record on the other side.

The TCD 330's playback head is a fixed azimuth "reference," having been factory aligned. Under the adjustment panel is a small knob that adjusts the azimuth of the recording head to match it to that of the playback head. A slide switch turns on a 10,000-Hz signal to be recorded on the right channel (closest to the center of the cassette tape) at a fixed level. The machine is put into the record mode with the monitor switch set to TAPE so that the playback from the 10,000-Hz tone is indicated on the right-channel meter. The record-head azimuth knob is then slowly adjusted for a maximum reading, indicating that the recording and playback heads are in alignment for a particular cassette.

The upper portion of the panel contains the two large meters flanked by two pairs of slider controls for setting recording and playback levels. The meters follow Tandberg's practice of indicating peak program levels *after* the recording equalization so that the true program levels applied to the tape are shown. Since they can respond to transients shorter than 50 milliseconds, the meters eliminate the need for the auxiliary LED peak lights that are sometimes used to supplement slow-responding meters on other cassette decks. The meters are electronically switched to read incoming program levels when recording and line output levels when playing back, regardless

of what the particular setting of the monitor switch may be.

Seven black pushbutton switches form a row under the meters. From left to right, they are the POWER switch, DOLBY NR, FM DOLBY, tape bias and equalization selector (marked NORMAL and SPECIAL), MEMORY (which stops the tape in rewind when the index counter reaches 000), MONITOR (which supplies either the incoming SOURCE or the TAPE playback signals to the line outputs), and a REC. PRESET button that must be engaged in order to make a recording. The last is a necessary safety feature, since the transport of the TCD 330 does not require simultaneous operation of two buttons in order to enter the recording mode.

Across the lower portion of the panel are flat switch plates that control all tape-transport functions. They are PLAY, REWIND, STOP, WIND, and RECORD, each having a colored light on its surface to show when it has been engaged. Completing the front-panel features are jacks for headphones and two microphones, the cassette EJECT button, and the index counter. Inserting a microphone plug into one of the microphone jacks disconnects that line input and replaces it with the microphone signal.

The line inputs and outputs are recessed into the top (or back, if the machine is positioned horizontally) together with a DIN socket and a socket for an optional remote-control accessory. There is also an MPX FILTER switch, used when making Dolbyized recordings from stereo FM broadcasts.

There are several facets of the operation of the Tandberg TCD 330 that are not immediately obvious but which contribute greatly to its versatility and general utility. As on other Tandberg recorders, the gain of the input amplifiers, used for both line and microphone inputs, is automatically adjusted according to the impedance of the program source to optimize the S/N of the machine and to make high-level signal overload of the electronics a practical impossibility.

The Dolby FM switch is used when recording a Dolbyized program through an FM tuner having the standard 75- $\mu$ sec de-emphasis. It converts the signal to a 25- $\mu$ sec characteristic and records it directly without Dolby decoding. During playback, the recorder's Dolby circuits restore the signal to its proper frequency response with full Dolby noise reduction. With this button engaged the TCD 330 also serves as a Dolby decoder, for listening to broadcasts without recording them, simply by setting the amplifier or receiver to its tape-monitor mode. For proper operation, of course, the recording-level controls should be set so that the Dolby-level tone transmitted

(Continued overleaf)

periodically by the station gives a meter indication at the Dolby mark (-2.5 dB relative to the recorder's 0-dB calibration).

When a cassette is inserted into the TCD 330, any slack in the tape is automatically taken up before the machine goes into operation. This eliminates the problem of tape wrapping around a capstan, as sometimes happens when the tape pack is loose inside the cassette. To either record or play the tape, the appropriate button(s) is pressed. At any time during recording, touching the PLAY button restores the machine to the playback mode without interrupting the tape motion. Similarly, a "flying-start" recording can be made at any time while playing a tape by holding down the PLAY button while the RECORD button is pressed. The transition is always smooth and free of clicks or thumps, making easy editing possible while assembling a tape from other program sources.

The REWIND or WIND modes can be engaged at any time, and one can go directly from either of them to PLAY (the tape comes to a stop swiftly and pauses a moment before going into PLAY). However, the EJECT button will not function unless the tape is at a stop.

The electrical performance specifications of the Tandberg TCD 330 are as impressive as its other features. The TAPE switch optimizes the machine for high-performance ferric-oxide tapes or chromium-dioxide tapes (or equivalents such as TDK SA and Maxell UD-XL II). With either category of tape, the rated frequency response is at least 20 to 20,000 Hz, the weighted rms flutter is less than 0.12 per cent, and the A-weighted signal-to-noise ratio (S/N) is better than 65 dB (with Dolby). The TCD 330 is a surprisingly compact machine considering its features. It is approximately 18½ by 9¼ by 4¼ inches, and it weighs 15¾ pounds. Price: \$999.

● **Laboratory Measurements.** The Tandberg TCD 330 was delivered with its bias set for Maxell UD-XL-I (NORMAL) and Maxell UD-XL-II (SPECIAL) tapes, and these were used in our tests. With the input signal supplied from a 600-ohm generator impedance, the line and microphone sensitivities for a 0-dB meter

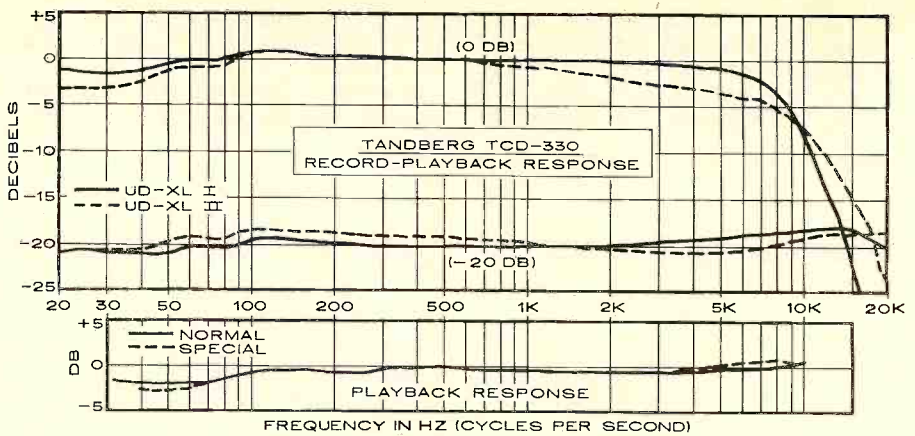

reading were, respectively, 83 and 0.16 millivolts, with the microphone input overload being 23 millivolts (different source impedances would affect all these readings).

The maximum playback output from a 0-dB recorded level was 1.28 volts. The meters had a fast rise time and a slight overshoot of about 5 per cent. The headphone output level (controlled by the playback level sliders) was fully adequate with medium-impedance as well as low-impedance phones.

The TCD 330, unlike most cassette recorders, is designed so that a 0-dB recording input is approximately the maximum permissible level, giving 3 per cent playback distortion. This was the case with the UD-XL-II tape, 2 per cent distortion being measured at 0 dB and 3 per cent at +1 dB. With the "normal" UD-XL-I tape, the 0-dB distortion was only 0.8 per cent, and it reached 3 per cent at +5 dB. With both tapes, the playback distortion with recording levels of -10 dB was about 0.2 per cent, and with -20 dB it was unmeasurable, being less than 0.1 per cent and masked by noise even when examined with a spectrum analyzer.

The S/N of the TCD 330, referred to the 3 per cent distortion signal level, was fairly similar with both tapes. Unweighted, it was about

51 dB; it improved to 57 dB with IEC "A" weighting and to 54.8 dB with CCIR weighting. When the Dolby system was used, the XL-I tape gave a slightly better S/N—66 dB with "A" weighting and 64.8 dB with CCIR weighting. The measurements with XL-II tape were both 64 dB. The unique nature of the Tandberg input circuit was emphasized by the noise performance through the microphone circuit at maximum gain. With the inputs open-circuited (corresponding roughly to the use of a high-impedance microphone) there was no increase in noise compared with the line-input noise level. With a 2,200-ohm input termination, the noise increase was 2 dB, and with the input short-circuited (worst case) the noise increased 4.5 dB. These figures should be compared with the 10- to 20-dB noise increases we usually measure on other cassette and open-reel tape decks at full gain settings.

The playback frequency response, using the Nortronics AT 200 test tape with NORMAL equalization, was  $\pm 0.5$  dB from 100 to 10,000 Hz and  $\pm 1$  dB over the full 31.5- to 10,000-Hz range of the tape. The SPECIAL equalization, tested with the Teac 116SP tape, was  $\pm 1$  dB from 90 to 10,000 Hz and better than  $\pm 2$  dB from 40 to 10,000 Hz. The crosstalk between channels was -53 dB at 1,000 Hz.

The record-playback frequency response for a -20-dB recording level with UD-XL-I tape was  $\pm 1.5$  dB from 20 to 20,500 Hz. With UD-XL-II tape it was  $\pm 1.5$  dB from 20 to 22,000 Hz. The tracking of the Dolby circuits on a combined record-playback measurement was checked at recording levels of -20, -30, and -40 dB. There was a net response change of 2 to 3 dB centered at about 3,500 Hz at -20 and -30 dB, and a somewhat higher error at -40 dB centered at about 1,700 Hz. But in no case could the effects of the mistracking be heard.

The tape transport had extremely low flutter, measuring 0.06 per cent unweighted rms. In fast wind it moved a C-60 cassette from end to end in 48 seconds; in rewind it took 50 seconds. This places the TCD 330 among the fastest-winding units available.

● **Comment.** The performance of the TCD 330 speaks eloquently for the success of the Tandberg effort to reach the "state of the art" in cassette performance. When a cassette deck combines a virtually flat response from 20 to 20,000 Hz and beyond, an unweighted flutter of 0.06 per cent, and an S/N of 65 to 66 dB, it is in very select company indeed.

(Continued on page 56)

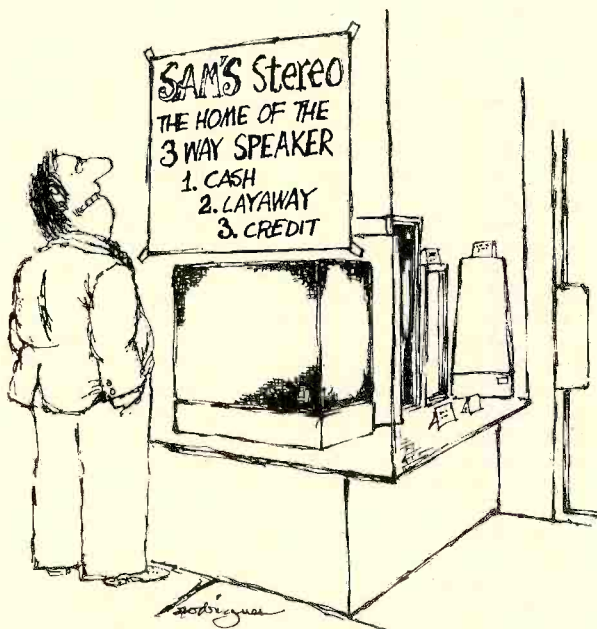

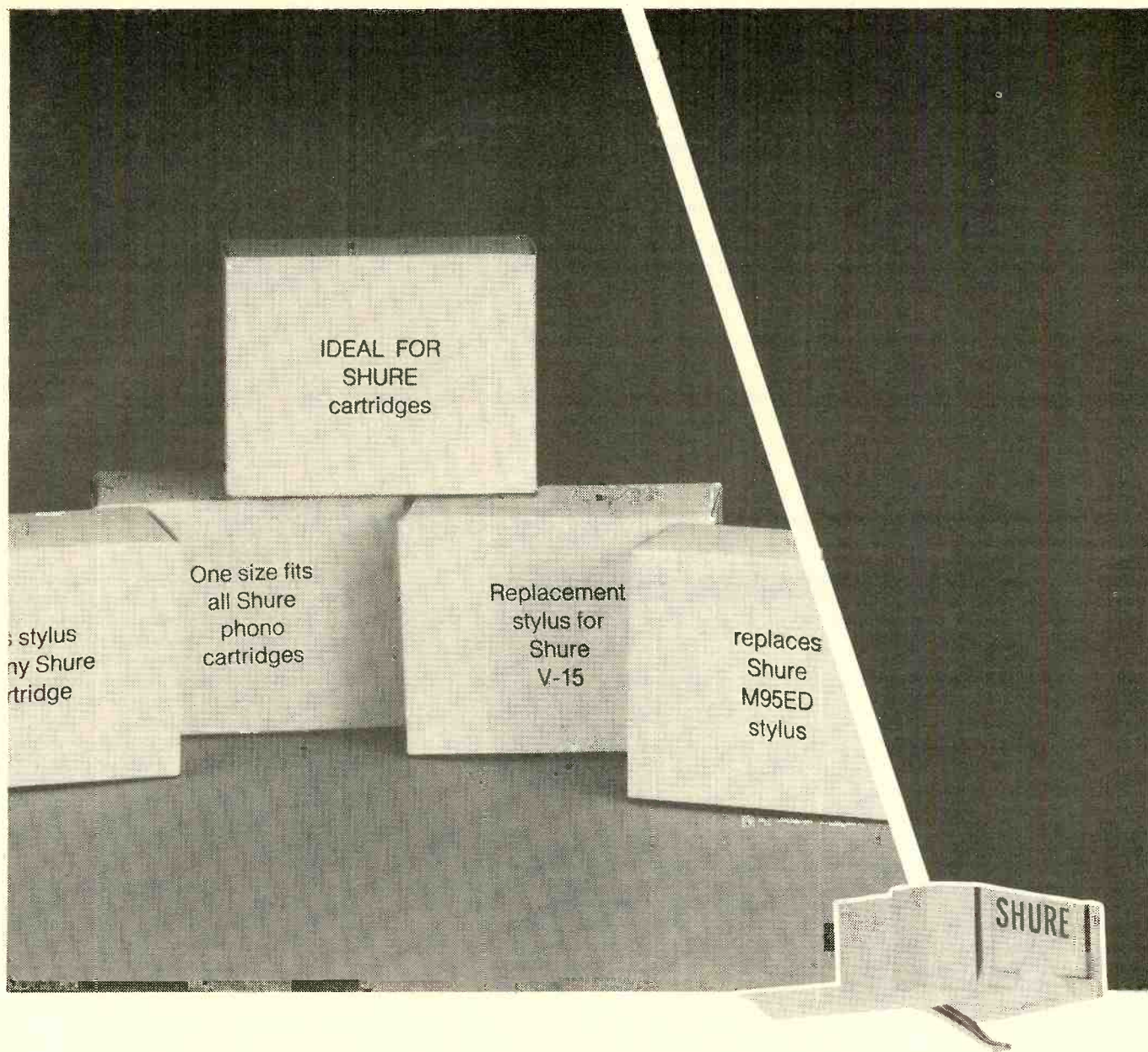

IDEAL FOR  
SHURE  
cartridges

One size fits  
all Shure  
phono  
cartridges

Replacement  
stylus for  
Shure  
V-15

replaces  
Shure  
M95ED  
stylus

stylus  
ny Shure  
rtridge

## Needle in the hi-fi haystack.

*Even we were astounded at how difficult it is to find an adequate other-brand replacement stylus for a Shure cartridge. We recently purchased 241 random styli that were not manufactured by Shure, but were being sold as replacements for our cartridges. Only ONE of these 241 styli could pass the same basic production line performance tests that ALL genuine Shure styli must pass. But don't*

*simply accept what we say here. Send for the documented test results we've compiled for you in data booklet #AL548. Insist on a genuine Shure stylus so that your cartridge will retain its original performance capability—and at the same time protect your records.*

Shure Brothers Inc.  
222 Hartrey Ave.,  
Evanston, IL 60204  
In Canada:  
A. C. Simmonds & Sons Limited

### TECHNICORNER

*The criteria for these tests involved the eight standard production line inspections used for all Shure styli: Visual and mechanical inspection, tip configuration, trackability, vertical drift, 1,000 Hz output level measurement, channel separation at 1,000 Hz, channel separation at 10,000 Hz, and frequency response.*

*Only genuine Shure styli have the name SHURE on the stylus grip and the words "This Stereo Dynetic® stylus is precision manufactured by Shure Brothers Inc." on the box.*



Manufacturers of high fidelity components, microphones, sound systems and related circuitry.

CIRCLE NO. 47 ON READER SERVICE CARD

For all its remarkable performance, the TCD 330 is very comfortable in the home, handsome enough to occupy a prominent place in one's living room and quite easy to use once one becomes familiar with its special characteristics.

The record-head azimuth adjustment system serves as an evaluator of tape quality and of head cleanliness in addition to its primary function. The playback reading from the 10,000-Hz tone shows whether a tape is compatible with the recorder's bias setting. If it reads appreciably over 0 dB it is probably underbiased, and if it fails to reach 0 dB it is

either overbiased or is simply not a very good tape. If the meter reading fluctuates, the tape may have excessive drop-outs or a bad cassette shell. If one notes the maximum reading with a given tape formulation when the machine is new, a future drop in maximum output may indicate a need for head cleaning.

The process of aligning the heads for every cassette insertion (only for recording, though) is basic to the operation of all three-head cassette machines that have physically separate recording- and playback-head structures. In actual practice, it takes less time to do than to describe.

The Dolby FM decoding provided by the TCD 330 was excellent, and by using it we were able to hear a consistent and worthwhile improvement in the S/N of some of the Dolby FM broadcasts in the New York area.

It is difficult to criticize the performance of a machine as refined as the TCD 330, and, frankly, we found nothing significantly amiss or not to our liking. The Tandberg TCD 330 is obviously a worthy addition to available cassette decks in every respect. It is expensive, but we know of nothing at a lower price that can match it or even come close.

Circle 108 on reader service card

## Sherwood HP 2000 Integrated Stereo Amplifier

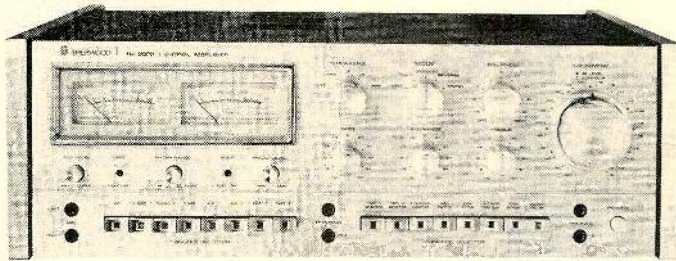

**T**HE Sherwood HP 2000 is a de luxe stereo amplifier rated to deliver 120 watts per channel to 8-ohm loads between 20 and 20,000 Hz with less than 0.08 per cent total harmonic distortion (THD). The input source and many of the control functions are selected by two groups of pushbuttons along the bottom of the panel. The buttons operate with very little effort and are engaged by a momentary pressure (they do not remain in after being pressed). When one of the buttons is engaged a black square in its center changes to red.

The input-source buttons are labeled MIC, PHONO 1, PHONO 2, TUNER, AUX 1, AUX 2, TAPE 1, and TAPE 2. Normally only one source can be selected at a time, but the microphone signal can be mixed with any other. The microphone inputs are two phone jacks to the

left of the selector buttons, and a small knob above the jacks adjusts the gain of the microphone amplifiers. A similar knob adjusts the phono level (simultaneously on both inputs) to match any of the high-level sources.

The FUNCTION SELECTOR buttons include TAPE 1 MONITOR, TAPE 2 MONITOR, 4-CHANNEL ADAPTER, HIGH FILTER, LOW FILTER, LOUDNESS CONTOUR, TONE (CONTROL) DEFEAT, and MUTING (which gives a 20-dB reduction in audio gain). The 4-CHANNEL ADAPTER button activates corresponding jacks on the amplifier's rear panel, to which a four-channel decoder (such as an equalizer or noise reducer) can be connected. It can also be used for a third tape deck. To the right of the buttons is a pushbutton power switch and two stereo headphone

jacks driven from separate source resistors so that the volume level in one set of phones will not be affected by the insertion of a second pair. Between the two groups of pushbuttons are two jacks marked DUBBING, IN and OUT. They permit a tape deck that is not normally part of the system to be plugged in for either recording or playback purposes.

At the upper left of the panel are two large illuminated power-output meters plus an LED PEAK LIMIT light designed to flash on momentary peak overloads too brief to register on the meters. Between the lights is a METER RANGE button that increases the meters' sensitivity by 10 dB.

In the center of the panel are six control knobs. The SPEAKERS switch connects either, both, or neither of two pairs of speakers to the amplifier outputs. In addition, the switch has an ARS ("Ambience Retrieval System") position that connects the B speakers (which should be in the back of the room for this purpose) to reproduce the left-minus-right content of a stereo program for a simulated four-channel effect. The MODE switch selects either the left- or right-channel input through both outputs, normal or channel-reversed stereo, or mono (L + R). To its right is the balance control knob.

Each of the three tone controls (bass, mid-range, and treble) is an eleven-position de-

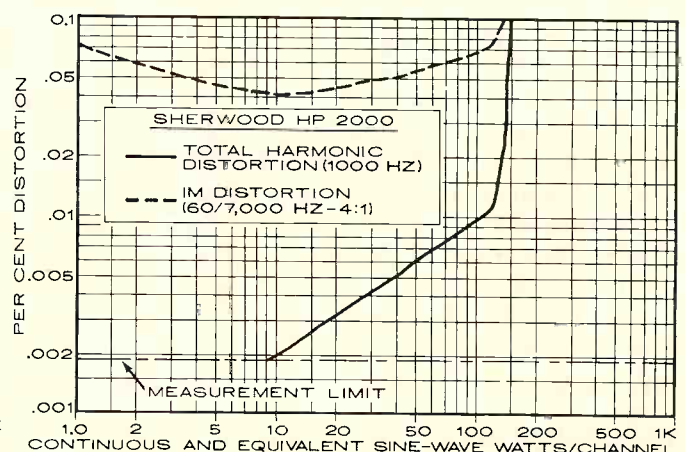
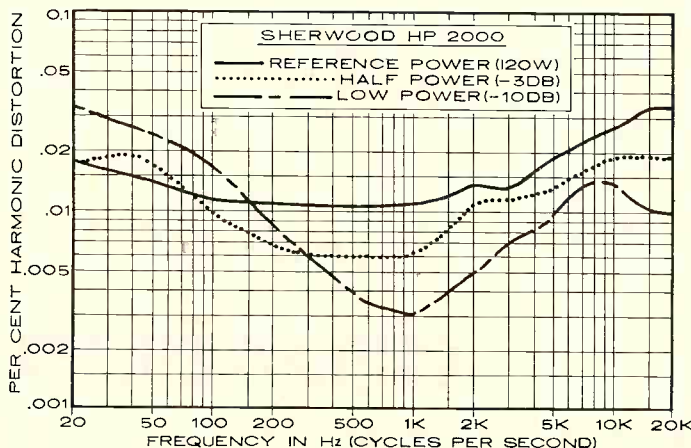

tented potentiometer. At the right of the panel is a very large loudness control consisting of a knob marked LEVEL surrounded by a ring marked CONTOUR. These controls make it possible to adjust the loudness compensation to any desired degree. When the LOUDNESS CONTOUR pushbutton is engaged, and the CONTOUR ring is fully counterclockwise, only the high frequencies are boosted. As the ring is advanced through its eleven positions, progressively greater amounts of bass boost are inserted at any given setting of the LEVEL knob. As with other loudness-compensation systems, reducing the setting of the level control increases the relative proportion of bass in the signal. The high-frequency content also varies with the level-control setting, but not with the position of the contour ring.

The level control of the HP 2000 is a step attenuator, but it is not a detented potentiometer like those used on many amplifiers. It is a true twenty-two-position selector switch on which are mounted precision thick-film resistors that maintain channel balance within 0.5 dB over the full control range of more than 65 dB. At the amplifier's rear is a shallow horizontal ledge on which are mounted the various input and output jacks. The speaker outputs are through heavy-duty insulated binding posts on 3/4-inch centers. The preamplifier outputs and the power-amplifier inputs are brought out separately and are normally joined by a slide switch. There are six a.c. outlets, three of which are switched.

The Sherwood HP 2000 is a large amplifier measuring about 20 inches wide, 15 1/4 inches deep, and 6 3/4 inches high. It weighs 42 pounds. It is supplied with wooden side panels. Price: \$700.

● **Laboratory Measurements.** The Sherwood HP 2000 became very warm during the FTC-mandated one-hour preconditioning period. However, the thermal protective system never tripped during our testing program. In normal use, the amplifier never became more than faintly warm.

Driven into 8-ohm loads with a 1,000-Hz test signal, the amplifier outputs clipped at 149 watts per channel. The maximum output into 4 and 16 ohms was, respectively, 172 and 89 watts per channel. The THD at 1,000 Hz was too low to measure (under 0.003 per cent) until the power output exceeded 10 watts. It increased to about 0.01 per cent at the rated 120 watts and 0.025 per cent at 140 watts. The intermodulation distortion (IM) was between 0.04 and 0.07 per cent from 1 to 120 watts output and 0.22 per cent at 140 watts.

At the rated 120 watts, the THD was between 0.01 and 0.02 per cent from 20 to 6,000 Hz, reaching 0.034 per cent at 20,000 Hz. It was slightly less at half power, and at one-tenth power-output level it varied from about 0.003 to 0.034 per cent (at 20 Hz). The tone controls provided a maximum boost or cut of about  $\pm 18$  dB at the frequency extremes. The mid-range control affected almost the entire audio range, peaking broadly at 1,000 Hz with a maximum variation of about  $\pm 6$  dB.

The filters had excellent characteristics, with 12-dB-per-octave slopes and almost perfectly flat response up to their cut-off frequencies. The filters' -3-dB response points were 33 and 7,000 Hz. The loudness contours were as specified, with almost any desired response obtainable through appropriate settings of the LEVEL and CONTOUR controls.

The RIAA equalization was accurate within  $\pm 0.5$  dB from 20 to 20,000 Hz and within

$\pm 0.25$  dB from 20 to 15,000 Hz. When it was measured through the inductance of a typical phono cartridge, there was a slight rise in high-frequency response, beginning at about 2,000 Hz, to a maximum of about +2 dB in the 10,000- to 15,000-Hz range (depending on the specific cartridge). The frequency response through the microphone input was down 1 dB at 100 and 12,000 Hz and down 3 dB at 45 and 20,000 Hz.

The HP 2000 had very high gain through all inputs. For a 10-watt reference output, only 31 millivolts (mV) was needed at the high-level inputs, 0.64 mV at the phono inputs, and 0.69 mV at the microphone inputs. The respective signal-to-noise ratios, also referred to 10 watts, were 73, 70, and 53.5 dB. The phono inputs overloaded at a very safe 158 mV, and the overload point of the microphone input varied with its level setting to a maximum of 8.5 volts with the control set to minimum gain.

The meter-scale calibrations were accurate at 120 watts (and at 12 watts with the -10-dB button engaged). At lower readings, the meters typically read 20 to 50 per cent higher than the actual power into 8-ohm loads. The meter response was too slow to follow program peaks, and the underdamped movements let the pointers swing wildly. Essentially, the meters can be considered cosmetic features. The PEAK LIMIT lights, on the other hand, began to glow at the onset of clipping (about 150 watts) and served as very accurate and useful indicators of the amplifier's maximum power limits.

● **Comment.** The HP 2000's volume control operates in steps of 2 to 4 dB over most of the range below -18 dB (about 12 o'clock on the knob setting). Above that point the next step is 6 dB, followed by a 5-dB step, after which the intervals decrease to about 2 dB. The practical effect of this is that the volume changes in small but definitely audible steps over most of the range of the control, but near its center there are a couple of large jumps.

As with some other equipment we have tested, the HP 2000 has the playback output from a tape machine fed both through the input-selector pushbutton and through the tape-monitor switch. This makes it possible to dub from one deck to another, though not as conveniently as with other common tape-switching systems. However, it also makes the system subject to violent speaker-stressing oscillation if both buttons are engaged at the same time. Our early copy of the HP 2000 manual does not mention this possibility.

The multiple protective circuits built into the HP 2000 make it about as immune to damage as any amplifier we have seen. For example, when we inadvertently operated it at full power into a short circuit on one channel, the PEAK LIMIT light for that channel blinked insistently, but there was no effect on the other channel. Removing the short circuit (with an impressive flaming arc from the wires) restored the amplifier to normal operation with no ill effects.

When it comes to power, distortion, and noise levels, the Sherwood HP 2000 is clearly as fine an amplifier as one could wish for. It also boasts an impressive array of selectable input sources sufficient for the most advanced audio system. Its sound is never marred by unwanted noises as the controls are operated, and our listening tests confirmed that it sounds as good as it measures.

Circle 109 on reader service card

## ALLISON: ONE

### Press comment:

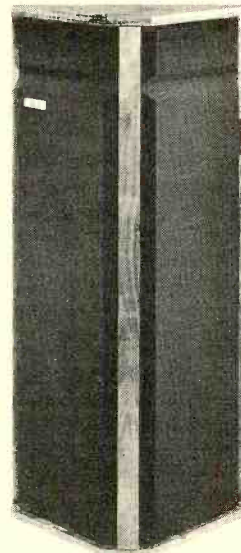

ALLISON:ONE \$360\*

## Stereo Review

NOVEMBER 1975

By Hirsch-Houck Laboratories

"Laboratory Measurements. The averaged frequency response in the reverberant field of our test room, with the speakers installed as recommended, was within approximately  $\pm 2$  dB from 35 to 15,000 Hz, with the slope switch set for flattest response. The woofer response matched Allison's published curves within better than 0.5 dB over its operating range, and its overall response was a startling — and excellent —  $\pm 1$  dB from 40 to 400 Hz."

"Judging only from its sound and the measurements we made, the Allison:One easily merits a place among today's finest speaker systems."

## HIGH FIDELITY

OCTOBER 1975

"The prevailing impression is one of transparency, minimum coloration effects, and a broad sound-front — in short, the kind of highly accurate sound-reproducer that would attract the serious listener who is both musically oriented and technically astute enough to appreciate really fine sound. In our view, the Allison One is among the best speaker systems available."

Descriptive literature on ALLISON loudspeaker systems which includes technical specifications is available on request.

ALLISON ACOUSTICS INC.  
7 Tech Circle, Natick, Massachusetts 01760

\*Higher in West and South

CIRCLE NO. 7 ON READER SERVICE CARD

*A New Version of This Country's Most Popular  
And Most Imitated Speaker System.*

# The New Advent Loudspeaker.

Over the past few years, the Advent Loudspeaker has gone into more people's homes in the United States than any other speaker system. It has been imitated over and over, and has been used consistently as a standard of performance (even by salesmen and companies trying to sell other speakers). It has also prompted an almost incredible number of unsolicited praise letters from satisfied owners.

The new Advent Loudspeaker sounds very much like the original. It should, since the frequency balance, clarity, and neutral, "open" quality that contribute to the sound-character of a really excellent speaker shouldn't need much alteration—and shouldn't be subject to change for the sake of change.

But the New Advent Loudspeaker is audibly different at the high end of the frequency range. The change has been made possible, and worth making, by improvements in the high-frequency capabilities of tapes, broadcasts, and—most of all—records.

## **About Speaker Design.**

Despite all the advertising to the contrary, it is not hard to design a good loudspeaker. The necessary knowledge and materials have been available for quite a while, and any of many design concepts can produce excellent sound.

But the trick, to our way of thinking, is to produce a balanced product. One that doesn't lead the customer to pay unnecessarily for an overelaborate design concept, or for a "solution" to a nonexistent problem. And one that sounds good not just under "ideal" conditions or in an artificial laboratory environment, but under the widest range of actual conditions in people's homes.

Knowing that complexity has often been a substitute for good design in speakers, and that a great deal of speaker design doesn't have all that much to do with the requirements for home listening, we designed the original Advent Loudspeaker to fit at the lowest possible cost into the "best" category in speaker performance in a home. Its success has been underlined for us not just by the number of original

Advents sold (half a million), but by the *kind* of satisfaction people have continually reported—to us, and to their friends.

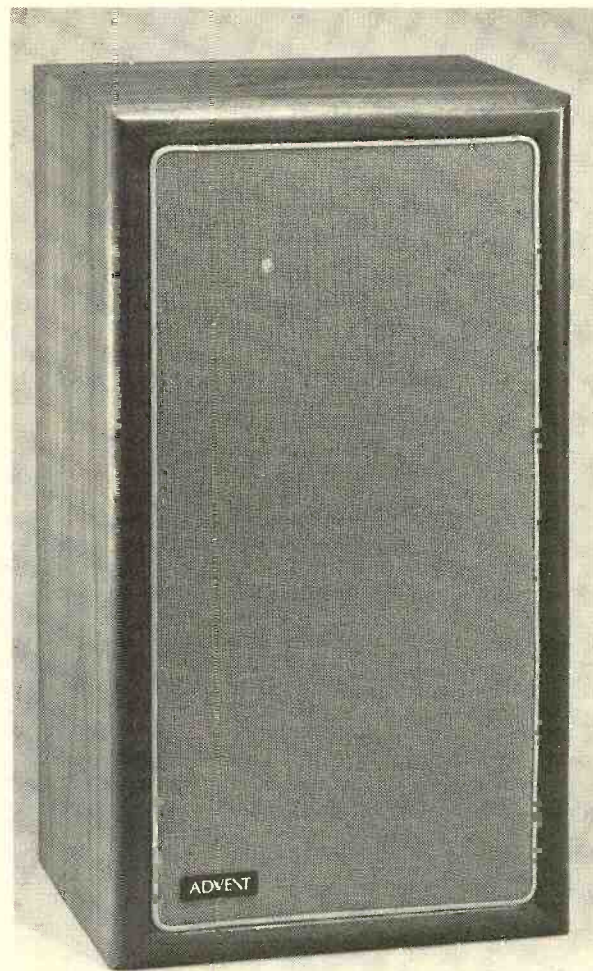



## The Difference And How It Came About.

A vital part of designing a speaker for use in the real world is to consider the capabilities and limitations of recording and broadcasting processes at a given moment. For most of the high-fidelity era, the most important limitation on actual usable performance in a speaker has been the high-frequency limits of recordings.

Almost twenty years ago, for instance, some of us now at Advent were involved in a live-vs-recorded test of an "ideal" tweeter design that could, and did, sound identical to the live source. But this same tweeter was absolutely unlistenable for playback of recordings, particularly for LP records. It mercilessly revealed the tremendous residual noise and distortion (from tape hiss, cutter limitations, vinyl imperfections, and other sources) present on records at high frequencies.

By the time we designed the original Advent Loudspeaker in 1969, tremendous improvements had been made in recordings and broadcasts. But there were still important limitations, and the total high-frequency energy output of the Advent was balanced to suit that reality and match well with the mixture of new, not-so-new and old LP's in most people's record collections.

In the 1970's, however, two very important improvements have been made in the high-frequency capabilities of recordings and broadcasts:

■ The almost universal adoption of the Dolby® system and other noise reduction measures for recordings has reduced background tape hiss and residual "hash" at high frequencies by a tremendous amount. The entry of the Dolby system into FM broadcasting is also beginning to be felt.

■ A new generation of record-cutting equipment has made it possible to put more essentially undistorted output onto records in the 10,000 Hz region. And a new generation of phono cartridges has been designed to take advantage of the opening for cleaner high-frequency response.

These factors add up to more *recoverable, usable* high-frequency content in source material than ever before—more clean sound above the noise and distortion in the recording process.

With these improvements, and influenced by the fact that most people's record and tape collections now date mainly from the early 1970's onward, we decided to change the high-frequency capabilities of the Advent Loudspeaker. Also involved in the decision was the knowledge that we could make use of developments like ferro-fluid damping for the tweeter to come up with a higher-output design of very high reliability at very little added cost.

The New Advent Loudspeaker, then, can radiate significantly more energy at 10,000 Hz than our original design—more than enough to reveal the cleaner high-frequency output on records. The audible difference is subtle on most recordings (a slightly more open and defined quality) and most noticeable on recordings that have a heavy content of brass, snares,

cymbals, and other demanding high-frequency material.

We don't believe that the difference is great enough to make more than a tiny percentage of present Advent Loudspeaker owners want to trade in their speakers. (We don't design any of our speakers, including the least expensive, to make people want to trade them in after the honeymoon, however long, is over.) But the change is the kind we think should be made in a speaker designed to compete in the "best" category without compromise. And we think it will be appreciated by today's and tomorrow's speaker and record buyers.

## What Stays The Same.

Like the original Advent, the New Advent Loudspeaker is the best answer we know how to make to two fundamental questions:

■ What is the highest level of performance that has real meaning for the great majority of truly critical, demanding listeners?

■ How do you get that performance at a cost low enough to make it available to the widest number of people who would like it?

We realize that it is hard to believe, especially when speaker advertising consistently suggests that more dollars and more complexity and more novelty are the key to speaker performance, that a relatively simple two-way speaker system can really fit into the very highest performance category. Especially a speaker that costs only \$129 to \$159\* (depending on cabinet finish and how far we have shipped it).

But it can and does.

The New Advent Loudspeaker has a useful frequency range as wide as that of any speaker at any price. Its bass response is approached by few speakers at any price. It will fill a large living room with a satisfying amount of undistorted sound. And it doesn't require a super-power amplifier or receiver.

It also has an all-important octave-to-octave tonal balance that's based on long experience with the performance both of equipment and of recordings in the real world. We don't have enough room left here to explain the full implications of that statement, and to explore the design of the New Advent Loudspeaker in full detail. But if you will send us the coupon, we will be happy to provide full information on what the New Advent Loudspeaker is and how it does what it does.

Thank you.

■ To: Advent Corporation, 195 Albany Street,  
■ Cambridge, Massachusetts 02139  
■ Please send full information on the New Advent  
■ Loudspeaker, and a list of your dealers.  
■ Name \_\_\_\_\_  
■ Address \_\_\_\_\_  
■ City \_\_\_\_\_  
■ State \_\_\_\_\_ Zip \_\_\_\_\_

\*Suggested price, subject to change without notice.

"Dolby" is a trademark of Dolby Laboratories Inc.

**Advent Corporation, 195 Albany Street, Cambridge, Massachusetts 02139.**

©Advent Corporation 1977

# Going on Record

By James Goodfriend



## OTHER DOORS

SUPPOSE it could be proved statistically that of those who have joined the mother church of classical music, something like 95 per cent came in by way of doors marked "Beethoven's Symphony No. 5," "Rimsky-Korsakov's *Scheherazade*," "Sibelius' *Finlandia*," and the like. Those are, for sure, the largest, most popular entrances, and the fact that as many as a million people have previously found themselves moved and overwhelmed in some totally new way on hearing the Grieg Piano Concerto in A Minor for the first time cannot make that experience any the more (or any the less) profound for the million-and-first who is about to undergo it. The love we read about and the love we experience do not strike with the same degree of force.

But I am convinced that those great doors are not for everybody. Certainly, those pieces have an immediate appeal, a quality that, under the right circumstances, can touch the person who has never before responded to classical music. But it seems foolish to deny that other musical compositions may have that appeal as well and that they—again, under the right circumstances—might be even more compelling. The past success of the better-known works rested partially upon their very ubiquity, which in turn was the result of a concert-directed musical scene. That situation no longer exists. It is records rather than

concerts that furnish the majority of musical experiences today, and on records Telemann is quite as available as Tchaikovsky.

The process of grasping classical music bears a rather apt resemblance to the process of procreation. It requires, basically, a ripe and receptive mind and a piece of music to impregnate it. The change that results from such a meeting is comparable to that which results from the miraculous meeting of sperm and egg. Once its attitude is changed by the experience, any logical mind concludes that if such pleasure can be imparted by one piece of music there must certainly be other pleasures to be gotten from other pieces of music, and that is as correct a conclusion as one can draw in this world. It is crucial, though, that the mind be ready for the experience. One can throw *Finlandias* in abundance against an unreceptive brain and get no more for the pains than expressions of impatience. But once ripeness has been achieved, the effect the right piece of music can have is startling. I wonder only if the right pieces for some people may not be quite different from those that seem, or have seemed in the past, to be right for the majority.

It is with that thought in mind that I propose here some other doors of access to the sanctum, pieces that may not necessarily be masterworks (though some are) and may, in fact, be considered "difficult" works by those who

know classical music through following more conventional lines. Still, neither music nor life is today what it once was. Some of these pieces may speak, particularly to young people, a more accessible and inviting language than the better-known works. If you are one who has found himself impervious to Tchaikovsky, you might try the following:

FROM its very opening notes, Bach's Chromatic Fantasy and Fugue is the sort of work that seems, quite literally, to be saying something, for the drama of the opening Fantasy rests substantially on the rhythms of verbal declamation. It is difficult not to be stopped quite short by that opening, equally difficult not to be held by the ensuing free flights of fancy. Both the emotional and formal characteristics of the Fantasy are then balanced by the Fugue. It makes little difference (on first hearing) if you don't know what a fugue is; you will *feel* it. I would tend to recommend a piano performance of the work for a first experience, but there are many who might actually prefer the more exotic sound of the original harpsichord.

George Crumb's *Night of the Four Moons* is, as virtually all his works are, a "sound piece," which is to say that a listener need not concern himself with the many technical devices of music (which are all there) but has only to concentrate on the sounds as aural experience, forgetting even that what he is hearing is music. That may not be as easy as it sounds, but a little abandonment of preconceived notions about music and other things is good for the soul and worth a little effort.

Charles Ives' *Unanswered Question* offers a musical experience that has been compared to biting, for the first time in one's life, into a sour pickle. One really cannot predict what any given person's reaction is likely to be. The difficulties of the piece are all in its composition and its performance, not in the listening. The statement made is simple and the taste is not disguised. Many may hate it, but others will find in it just the astringency for which they have unknowingly been searching for years.

Some people can come to music only by way of pictures, real or imagined, and they are often those who finally find themselves espousing the cause of film music. Much film music is merely serviceable trappings, useful in context, meaningless to all but diehards out of that context. An apt stepping stone from that particular enthusiasm to a more abstract and ultimately more valuable musical genre is afforded by that masterpiece among film scores, Prokofiev's *Alexander Nevsky*. If one is initially captivated by the successful translation of picture into sound, one also learns to be captivated by the sound without the pictures, and it is then but a small step to the concert Prokofiev and the rest of music.

WHAT I have proposed in these few instances goes against the grain of every lecture in music appreciation I've ever heard—almost enough recommendation in itself. And these are not isolated instances: others might include the piano music of Erik Satie or Alexander Scriabin, Britten's *Ceremony of Carols*, Bartók's *Dance Suite*, Messiaen's *Quartet for the End of Time*, Berio's *Sinfonia*, Mayuzumi's *Nirvana Symphony*, and Telemann's *Paris Quartets* among many others. None is a proved cure for musical anemia, but any one of them *might* work, and they could not, in any case, hurt.

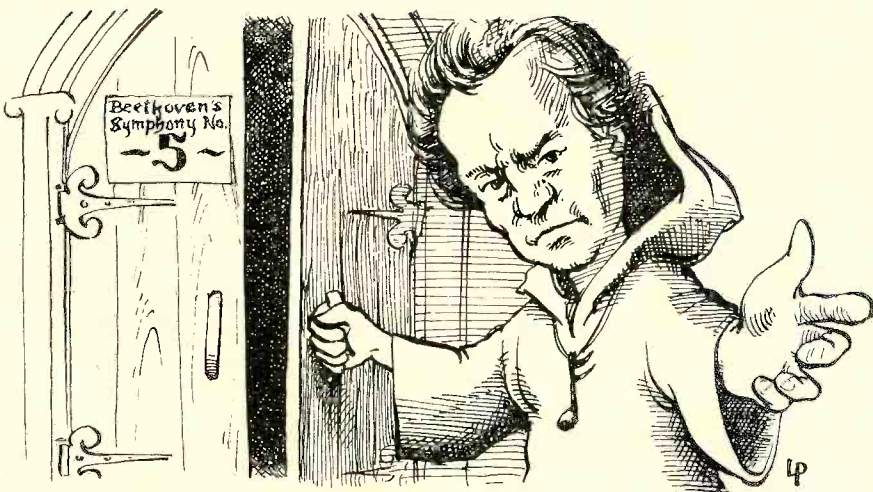

Lincoln Perry

# ARE YOU BLAMING YOUR TAPE RECORDER FOR PROBLEMS CAUSED BY YOUR TAPES?

Every day people all over the country go into hi fi dealers with complaints about their tape recorders.

When in reality what they should be complaining about is their tapes.

Because the fact is, a lot of the problems that plague tape recorders can be attributed to bad tape.

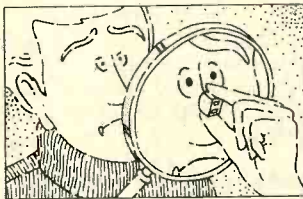

**HEAD WEAR IS CAUSED BY YOUR RECORDER. OR IS IT?**

If you have to clean your tape heads more than usual, for example, it could be your tape doesn't have a special nonabrasive head cleaner.

Maxell has one.

If your recorder jams, it can be any number of things. Maxell does something to prevent all of them.

We make our cassette shells of high impact polystyrene. And then so they won't crack

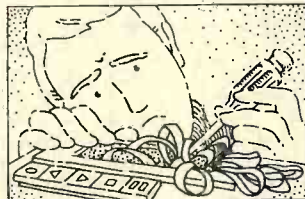

**JAMMING IS CAUSED BY YOUR RECORDER. OR IS IT?**

even after years of use, we finish them to tolerances as much as 60% higher than industry standards.

Inside, we use free rolling Delrin rollers so the tape doesn't stick.

And finally, we screw instead of weld everything together because screws make

for stronger cassettes.

If your recorder frequently suffers lapses in sound, it could be the tape is of inferior quality. And nobody's bothered testing the tape for dropouts before it leaves the factory.



**DROPOUTS ARE CAUSED BY YOUR RECORDER. OR ARE THEY?**

Maxell tape is made of only the finest polyesters. And then every



**POOR TRACKING IS CAUSED BY YOUR RECORDER. OR IS IT?**

step of the way it's checked for even the slightest inconsistencies.

So if you're having problems with your recorder, try a Maxell cassette, 8-track or reel-to-reel tape.

You might find there's really nothing wrong with your tape recorder, just with your tape.



**MAXELL. THE TAPE THAT'S TOO GOOD FOR MOST EQUIPMENT.**

Maxell Corporation of America, 130 West Commercial Ave., Moonachie, New Jersey 07074

CIRCLE NO. 30 ON READER SERVICE CARD

# The Pop Beat

By Paulette  
Weiss

Stereo Review's Pop Music  
Editor welcomes British  
rocker John Miles, whose  
"Stranger in the City"  
album on London  
introduces him to  
American audiences.



## DIGGING ROCK ROOTS

A SHORT ten years ago, Friday night was Fillmore night for New York rock fans. After a mind-bending, kidney-straining, four-hour concert featuring Janis or Jimi, we'd pick our way past the drug casualties nodding out in the lobby and head for Ratners, the only restaurant functioning on Manhattan's Lower East Side at such an ungodly hour. Its elderly waiters were openly hostile to the hippy hordes, and a Fillmore night was for that reason somehow incomplete without their insults, sneers, and neglect. Well, the Fillmore and Ratners are *both* gone now, but the music and the times live on, richly chronicled for those who were either too young to get in or living in Boise at the time.

The flood of memoirs, biographies, autobiographies, histories, and reissues of classic rock recordings reflects the new respect rock-and-roll has been getting lately. One of the least respectful but most entertaining of these backward glances is Al Kooper's book *Backstage Passes* (Stein and Day, 1977). Kooper takes the reader along on his ten-year lark through the golden Sixties of the music biz. A restless, feisty kid just naturally open to the siren wail of the electric guitar, he became one of the shapers of the decade. His off-the-cuff (and frequently off-the-wall) anecdotes of life on the inside convey the excitement of the time as no mere historical study can.

A member of the Royal Teens in the late Fifties (their hit *Short Shorts* was recently resuscitated for a TV depilatory commercial) and author of Gary Lewis and the Playboys' smash *This Diamond Ring*, Kooper moved on to a place in the sun on two classic Bob Dylan albums, "Highway 61 Revisited" and "Blonde on Blonde," and he was with Dylan's band when the Master went electric at the 1965 Newport Folk Festival. He later fathered both the Blues Project and Blood, Sweat & Tears, the group that introduced the jazz flavor of horns to rock. The sharp, intimate glimpses of people behind the scenes—Kris Kristofferson as a Nashville recording-studio janitor, Kooper and Paul Simon as kid musicians in daddy Jerry Simon's society orchestra, Judy Collins as earth mother and friend of troubled musicians—lay bare the human nerve and muscle that powered the achievements of the era. This is the kind of stuff that often disintegrates in our fallible memories, leaving only the bare bones of fact

for posterity, so it is good to get it all down in "I was there" form.

There are those who are incurably fact-hungry, however, and for them *Rolling Stone* magazine has published an illustrated history of rock and roll, an oversize volume that concentrates on the fertile stretch between 1950 and 1970. Be warned that this is a *critical* study based on unblushingly subjective obser-



Jim Marshall/Stein and Day

AL KOOPER

One of the shapers of the Sixties

vations of the events concerned by the numerous writers involved. For statistics shorn of such prejudice, the *Encyclopedia of Pop, Rock, and Soul* by Irwin Stambler (St. Martin's Press, 1977) is a valuable reference. I gave a copy of each to a budding rock enthusiast of fifteen who had the mistaken notion that Sha Na Na was one of the original Fifties doo-wop groups. Besides setting him straight on that little matter, the books whetted his appetite for recordings he knew about but had never heard. I was hard pressed to supply most of the discs or even information about where to get them.

This desire to trace rock's twenty-years-deep roots is a passion spreading among those who are, like my friend, too young to have experienced the times firsthand, those who were too old (or too foolish) to take them seriously, and those who lived them, took them for granted, and now want to figure out what in the world was really going on back then. The K-Tell organization and other TV-oriented record packagers have picked up on this need, and the major record labels are now following suit with reissues of out-of-print recordings of "essential" rock from their archives.

Among the recent rereleases, the most carefully conceived is Sire Records' "Vintage Years" series. Started about three years ago, it now includes double albums by the likes of Duane Eddy, Fleetwood Mac, and Del Shannon, plus anthologies of British rock and blues; it is noteworthy for its literate liner notes and discographies. The generous number of selections per album and the avoidance of artificial stereo reprocessing make these discs particularly valuable acquisitions.

London Records and RSO, each with a "Collector's Series," have just undertaken rock-roots explorations of (so far) limited scope. I'm particularly delighted with RSO's nine-album "Landmark" presentation of two of my favorite supergroups, Cream and Blind Faith, both featuring guitarist supreme Eric Clapton. The packages are faithful reproductions of the Atco originals, and if they're not on your shelves now, go get 'em.

Of the five available albums of London's proposed series of nine, two are especially noteworthy: "The History of Them" (LC 50001), a collection of early British-invasion-era Van Morrison, and "Primal Solos" (LC 50003), a presentation of taproot British blues performances by John Mayall, Eric Clapton, and Mick Taylor.

HAVE some words of caution for those planning a semi-serious foray into rock history. (A *serious* foray involves hunting down original recordings, an undertaking recommended for the dedicated collector only, for they are as rare as the smile of a Ratners waiter and heart-rendingly expensive to boot.)

1. Watch for alterations on look-alike reissues. Songs will often be simply dropped or replaced by others. Faithful reissues—same cuts, same cover art, same liner notes (additional updated notes are acceptable and usually helpful) as the original—are *almost* as good as the real thing.

2. When a "Best of" collection is offered, be sure the artist (or the group, as the case may be) recorded his really important work for the label presenting the album. Artists often start with one label and go on to produce their best music on others. Collections of early, late, or negligible works can be interesting, but passing them off as Golden Hits isn't cricket.

3. Beware the hit package containing the work of numerous artists spanning a period of several years. Unless you're lazy, strapped for cash, or really very much taken with the selections and the sequencing, these can be disasters of spotty, arbitrary programming. Collections of this kind are recommended only for hits by groups of the Fifties. The reason: *singles* were the heavy sellers of that period. Many groups produced one or two adorable sides and then drifted off into doo-wop heaven, never to be heard from again.

So, happy hunting, *caveat emptor*, and . . . rock on.

If you've been thinking Realistic is great only in the middleweight division, the STA-2000 is going to take you by surprise. We designed and manufactured it in our own factory to deliver quality beyond reproach, and judging from critical acclaim, we succeeded. The fine styling and precision controls are obvious. But the heart of this receiver is in its circuitry . . . the extra-low-

noise phono stage . . . the sensitive dual-gate MOSFET tuner with PLL. Come by your nearby Radio Shack for a free copy of the reviews. And hear for yourself what all the excitement's about. You'll be amazed at just how far \$499.95\* can go. The Realistic 2000. 75 watts per channel, min. RMS at 8 ohms from 20-20,000 Hz, with no more than 0.25% total harmonic distortion.

"noise figures rivaling those of many a separate (preamp) . . . If any part approaches over-achiever status, it is the power amplifier . . . The controls are unusually flexible"

High Fidelity Magazine,  
March 1977

"separation at mid-frequencies was an incredibly high 54 dB . . . usable (FM stereo) sensitivity point was reached with a signal of only 5.0  $\mu$ V . . . excellent basic circuit design"

Audio Magazine,  
March 1977

# The Rave-Reviewed Realistic® 2000

STA-2000 AM/FM STEREO RECEIVER

**Now playing at a Radio Shack near you**

SOLD ONLY WHERE YOU SEE THIS SIGN:

## Radio Shack®

A TANDY COMPANY • FORT WORTH, TX 76107 • 5000 LOCATIONS IN 9 COUNTRIES



These two credit cards honored at most Radio Shacks.  
\*Price may vary at individual stores and dealers.

**D**istortion is one of those specifications that everyone talks about but few really seem to understand." I made that point four years ago in a preface to an article (actually a kind of test report) on the audibility of distortion in amplifiers. The "golden ears" assembled for the listening-test part of that distortion-perception project belonged to Craig Stark, Julian Hirsch, Ralph Hodges, and me. We were surprised to find that our ears were in almost total agreement throughout the tests, but we were absolutely amazed to discover that, on certain types of complex program material, distortion went undetected even when it was as high as 6 per cent!

As might have been predicted, the publication of these results (in May 1973) created quite a stir, and the article was quoted from and commented upon by a variety of audio publications around the world. In the 'U.S., audio pundits seemed to be torn between outrage and amusement by our test findings. The hi-fi fundamentalists asserted that even if the tin-eared editors at STEREO REVIEW couldn't hear 6 per cent distortion, they knew damn well that they themselves regularly detected distortions in the range of a fraction of 1 per cent. Nonetheless, even the

harshest of these critics failed to come up with any experiments or data that contradicted our results. There has been a lot of talk and a little—very little—research since that report. And, judging from what I read, audiophiles remain as confused as ever on the question of the audibility of distortion.

A year or so ago, Paul Milner, a psychoacoustician by profession, was asked by Acoustic Research to prepare (for in-house use) a research report on the perception of distortion in loudspeakers. I was fortunate enough to see a copy, and I felt that the data presented in it would make a useful updating of our own four-year-old findings. Mr. Milner obliged by writing up his conclusions in the accompanying report for the benefit of STEREO REVIEW's readers. In reading it, keep certain facts in mind. It is clear, first of all, that distortion is a very complex matter, if only because of the multitude of its causes and the variety of its effects. It has long been suspected, for example, that the sine-wave test signals used in conventional harmonic and intermodulation testing do not necessarily provoke the sort of amplifier misbehavior music signals do. It has been suggested that although an amplifier's measured distortion on test tones could well be below 1

per cent, the actual distortion on music signals might be five or even ten times as much. And only insofar as music and sine waves provoke the same sort of amplifier misbehavior is it possible to correlate audible performance with measurement numbers. Many engineers therefore believe that the information provided by sine-wave testing—however sophisticated the instruments used—is inadequate as a predictor of ultimate tonal quality. This is not to say that an amplifier that provides poor test results on sine waves won't also sound bad, but only that good measurements are no guarantee of good sound.

Given all this, it may be that those designers who are pursuing ever lower distortion levels (as revealed by conventional measurements) in their products are obliquely dealing with distortions that are not yet readily measurable or specifiable. In any case, it is becoming increasingly difficult for all of us dealing with complex audio questions and elusive aural perceptions to know whether we are pursuing the bluebird of hi-fi realism or merely chasing a wild goose. Ultimately (and unfortunately) it is our own fallible ears, informed by the available data, that will have to be our guides—at least for now.

—Larry Klein, Technical Editor

# How Much Distortion Can You Hear?

By Paul Milner

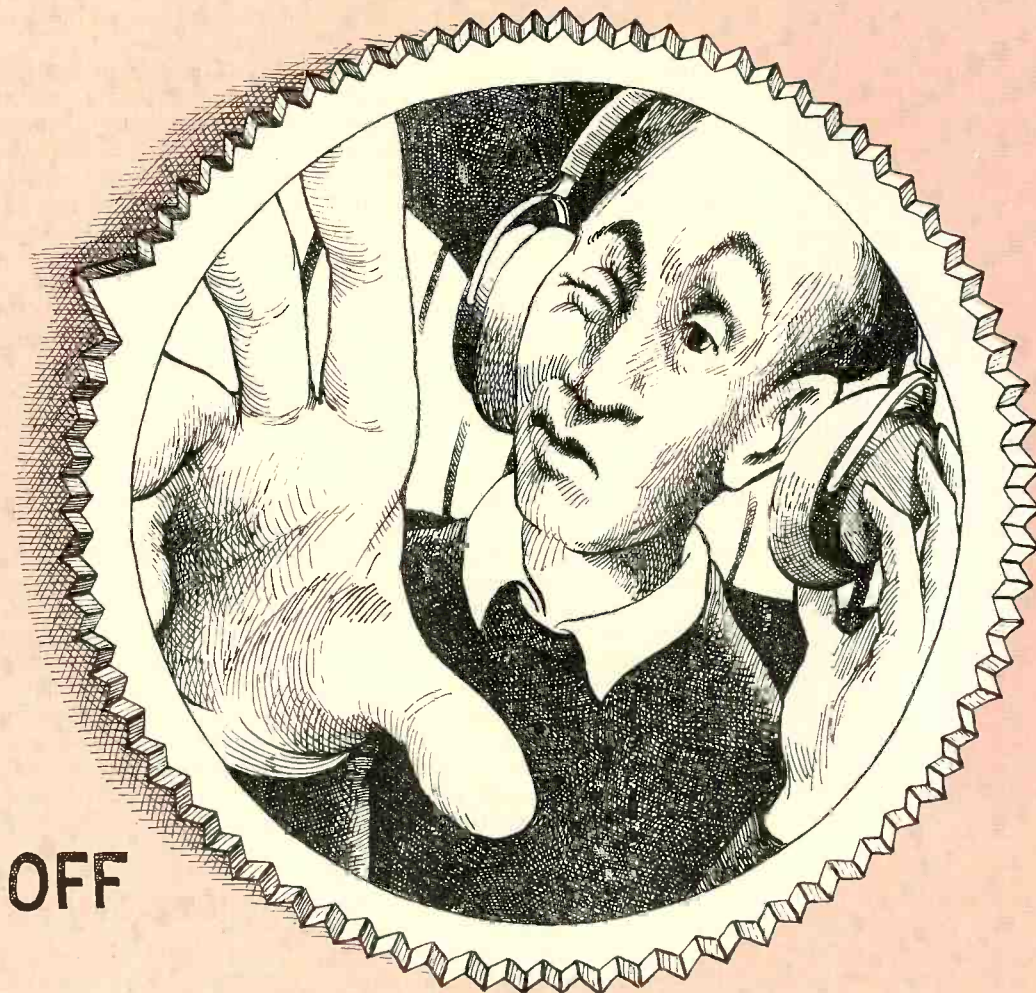

**H**ow important are distortion specifications in hi-fi equipment? Where does distortion come from, and how much of it can we really hear? Such questions, involving as they do the interactions of the acoustically objective and the aurally subjective, fall in the province of the science of psychoacoustics. According to the definition in the American National Standard on Psychoacoustical Terminology, psychoacoustics is "the science that deals with the psychological correlates of the physical parameters of acoustics."

In any psychoacoustic experiment, a number of steps must be taken to insure valid and meaningful results. These include precise control of the stimulus, proper selection and training of subjects, clear instructions and response format, a proper test environ-

ment, a good statistical model with which to evaluate the results, and measures to remove as much subjective bias and individual variation in the response as possible. It has been demonstrated repeatedly that, with training and carefully controlled conditions, people can be taught to detect extremely small differences in auditory stimuli. Furthermore, people accustomed to performing critical listening tasks—the so-called "trained listeners"—do better than those less experienced. But no matter how golden the ears involved, certain psychoacoustic and physiological realities prevent some "sounds" from being perceived by *anyone*.

One of these limitations in human hearing—and the one probably most important in respect to the audibility of distortion—is auditory masking. *Masking* is the inability to hear a given sound

in the presence of another of sufficient intensity. It is, in fact, a breakdown of the ear's extraordinary ability to analyze sound. As we will see, it is the main reason why distortion is much easier to hear with pure tones than with complex sounds. But before examining some of these psychoacoustic aspects of distortion perception, let's take an analytic look at the stimulus we are referring to: distortion itself.

## What Is Distortion?

In the psychoacoustical-terminology standard referred to earlier, distortion is defined as "... an undesired change in waveform. Noise and certain desired changes in waveform, such as those resulting from modulation or detection, are not usually classified as dis-

## DISTORTION

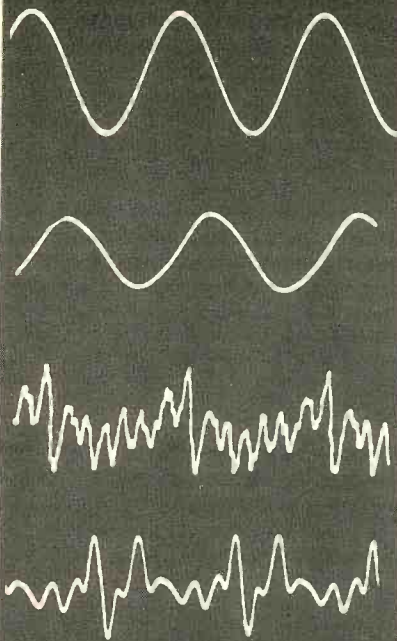

Oscilloscope traces of notes of the same pitch show the difference between (top to bottom) a pure tone, a tuning fork, a violin, and an oboe.

ortion." The key word here is *undesired*. Today, rock musicians spend lots of money on flangers, phasers, peak clippers, and what-have-you to fold, spindle, and otherwise mutilate the waveform of the "natural" musical sound. The object is to create new sounds and musical experiences. Distortion here is used to provide special effects, much like putting a picture out of focus to create a certain mood.

Recording companies add carefully controlled distortion to the audio signal to compensate for limitations of transducer systems and to transfer signals from one medium to another more efficiently. In the 1960's RCA created some controversy when it announced the newly developed Dynagroove process, part of which was a technique that predistorted the signal being recorded with the *inverse* of the distortion caused by playback tracing and tracking error, the idea being that the "pre" and "post" distortion components would cancel each other. Furthermore, equalization, which as we know is applied to *every* program source in audio—discs, tapes, and broadcasts—can be considered spectral distortion. However, there is an

important difference between the corrective distortions and special effects generated specifically to be heard. Special effects are intended to become part of the desired waveform; corrective distortion, on the other hand, is generated so that the *end* result is a waveform which is as much like the sonic original as possible.

Our interest here, then, is the undesirable distortion added to the original waveform as a result of imperfections in the complex procedure that brings a reasonable facsimile of the original sound to our living rooms.

### Sources of Distortion

It is worth examining some of the common sources of distortion briefly to see if they provide any clues as to where psychoacoustic limits rather than measurement limits might apply. Distortion in playback of source material can occur as a result of physical limitations in the transducers used to convert the stored acoustic information into the electrical waveforms that are amplified and ultimately converted back into acoustic energy. In disc playback, distortion arises because of a multitude of electromechanical factors that include the differences in the tracking and geometry of the cutting and playback apparatus for records, the elasticity of the record material (vinyl), the mass and compliance of the stylus, the tone-arm design, and the electronic interface between cartridge and phono preamplifier.

In tape systems, distortion results from overloading the tape, improper recording bias, poor tape-head alignment, and transport faults. Intermodulation and harmonic distortion are the common results of these problems.

The amplifying part of the system presents new sets of problems, but usually in different degrees than in transducer systems. With today's advanced electronic technology, distortion in amplifiers is much less a problem than distortion caused by transducers—including loudspeakers. Good design can reduce distortion levels to well below audibility—but, again, not necessarily below *measurability*. Despite this, we keep hearing about differences in the "sound" of amplifiers. There are ongoing studies attempting to define and measure these differences—assuming that they exist in the component and either do not arise in the component's interface with other components or are a purely perceptual phenomenon. One recently discovered possibility as a source of sonic differences is transient intermodulation distortion (TIM), for which a satisfactory mea-

surement technique did not exist until last year. TIM is still the subject of much controversy, but several people claim that it is responsible for the audible differences between components that have similar sine-wave test performance (TIM is described in the accompanying glossary).

Loudspeakers are the final link in the reproduction chain and are probably the greatest potential source of distortion. Distortion results even in reasonably good speakers when we try to make them exceed their physical capabilities. Harmonic distortion, for example, is caused mostly by forcing a speaker cone to operate beyond the linear elastic limits of its mechanical suspension. Other distortions arise from using a driver to cover a wider frequency range than it was intended for.

There's an important difference in the distortion products of a loudspeaker compared with those of an amplifier. Distortion in an amplifier usually occurs over its entire frequency range and is reasonably independent of operating level as long as the ultimate output limits are not exceeded. In a speaker, distortion is more selective, occurring at specific frequencies and resulting from cone breakup, resonances, and energy storage. Distortion is usually greatest at low frequencies where a speaker's excursion is the greatest. At high volume levels, distortion products may exceed 10 per cent.

### Auditory Inadequacies

The human ear and brain work together to form a sound analyzer without peer. Among the many incredible capabilities of our built-in auditory system is a dynamic range of 120 dB, a frequency range of about ten octaves, and the ability to discriminate direction, tone color, and melodic detail amidst the massed sound of a hundred-piece symphony orchestra. But just like any transducer system, our ears have practical performance limits. If our ears were more sensitive, we would be bothered by the noise of the blood coursing through our circulatory system and the sounds of a whole host of other internal physiological processes. Some of this noise can be heard when you block your ears tightly with your fingers. This doesn't change the absolute sensitivity of the ears, but the low-level acoustic energy that would otherwise escape through the ear canal is now trapped and adds to the energy available through the conductive mechanism. (Audiologists refer to this phenomenon as the "occlusion effect." It causes an increase in the loudness of a test tone presented by bone conduction



when the ear canal of the ear being tested is blocked or "occluded" by an earphone or even ear wax.)

To protect itself from being overloaded by dangerously loud sounds, the ear has a sort of a built-in protective circuit called the "acoustic reflex." This is a system of two tiny muscles, activated by the facial nerve (*not* the acoustic nerve), that contract when sound levels exceed 80 to 90 dB. These muscles are connected to the tiny mechanical system of three bones in the middle ear (the ossicular chain) which transfer movement of the eardrum to the inner ear. The acoustic reflex heavily damps or stiffens the entire mechanical system to prevent excessive motion of its parts. Much research is being carried out on the functioning of the acoustic reflex, and it is important from our standpoint as listeners to know about this nonlinear behavior and realize that what we hear may be directly affected by it.

Other characteristics of the ear point to other performance limitations. Some are a direct result of the operational limits of the mechanics or fluidics of the inner ear; some are related to the neurological limitations in the transmission of information to the brain. One result of these nonlinearities is that the ear generates its own distortion, known as *aural harmonics* and *difference*

*tones*. These effectively correspond to harmonic and intermodulation distortion, but they are generated within the ear itself.

There is one more important auditory limiting factor pointed out earlier: auditory masking, which results in a breakdown of the ear's analytical ability. And it is masking that has the greatest effect on the perception of distortion. So, despite all its wonders, the human ear nevertheless has its faults. How do these various inadequacies affect our overall perception of sound and sensitivity to distortion?

## Audibility of Distortion

Some of the earliest reported studies in the perception of distortion were done by Harry Olson at RCA. He found that for a "wide-band" system (meaning a response up to 15,000 Hz), harmonic-distortion levels of 1 and 2 per cent were audible. On the other hand, researchers at Shure Brothers in 1964 found that as much as 5 per cent total harmonic distortion was just barely perceptible for some recorded music. In 1960, Bryan and Parbrook, two researchers at the University of Liverpool, conducted some very elaborate distortion-detection experiments. They used pure tones generated by means of

Helmholtz acoustic resonators to assure an absolute minimum of electrical or externally generated distortion. When they added small amounts of the second harmonic to a 357-Hz tone, they found that the distortion threshold level (the amount of distortion that could just barely be detected) was less than 0.5 per cent. Higher-order harmonics were heard at even lower levels, since masking is normally greatest when two frequencies are closest and gradually disappears as frequencies become more distant from each other. In addition, a low-pitched tone more easily masks a high-pitched tone than the other way around.

Bryan and Parbrook examined only a single harmonic of a pure tone. Most of us, however, spend our time listening to things other than pure tones, so we must now journey to Sweden to find a study that examines complex tones that more closely resemble musical sounds as well as pure tones. In 1972, Gabrielson and Sjogren published the results of a study in which they generated what they called "quadratic" and "cubic" distortion with an analog computer. The distortion contained both harmonic and intermodulation components. Two experiments were conducted. The first was to determine detection thresholds for both pure tones and the steady-state (continuous) portion of a

## DISTORTION GLOSSARY

- **Crossover distortion** (see illustration below) is a discontinuity in the output waveform of a push-pull amplifier. It generally occurs at the point where the waveform is changing from positive to negative or vice versa. It is measurable as an increase in both harmonic and intermodulation distortion.

- **Doppler distortion**, encountered only in speakers and similar transducers, involves the modulation of a higher frequency by a lower one when a speaker cone (or other moving element) is trying to respond to or reproduce both. (In another area of audi-

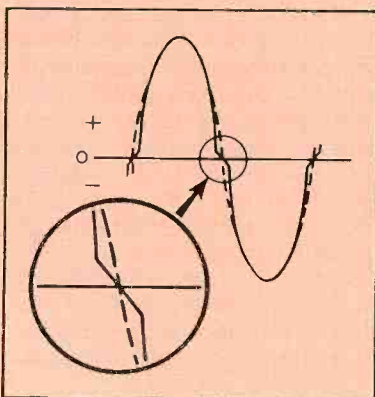

tory experience, the Doppler effect is demonstrated by the way the pitch of a train whistle shifts as a result of a locomotive's velocity toward or away from an observer.)

- **Harmonic distortion (HD)** is the addition of spurious harmonics (by an audio component) to a signal that either lacked harmonics originally or did not have them in such strength. It is expressed as a percentage of the total signal at the point of measurement.

- **Intermodulation distortion (IM)** results from the undesired interaction of two or more frequencies in a signal, creating new frequencies that are the mathematical sum and difference of the original frequencies. It is expressed as a percentage of modulation of the high-frequency test signal.

- **Overload distortion** or "clipping" (see illustration at right) occurs when an input signal is too large for an amplifier to handle properly. When the limit of the amplifier's signal-handling capability is reached, the tops and/or bottoms of the signal's waveform are simply chopped off or "clipped." It too is measurable as an increase in both IM and HD.

- **Spectral distortion** describes an irregular or "non-flat" frequency response that causes some tones to be under- or over-emphasized relative to others. It may reflect frequency-

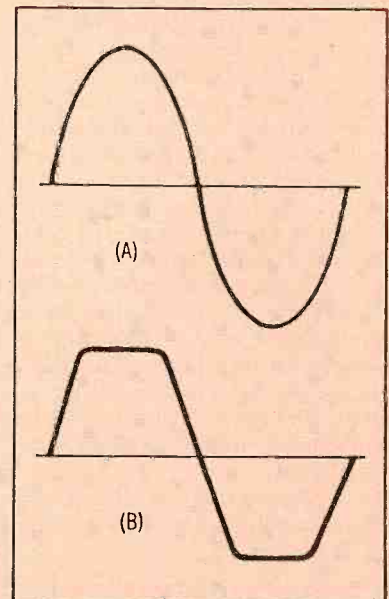

response limitations or resonances in speakers and other transducers.

- **Transient intermodulation distortion (TIM)** embraces a number of things that may happen when a very abrupt signal (transient) exceeds the "response" or "reaction" time of an amplifier's circuits. The importance and frequency of occurrence of this type of distortion are controversial.

# DISTORTION

recorded clarinet tone. The second was an extension of the first. Clarinet and flute tones were used, including the natural attack transient as well as the steady-state portion. Parameters in the experiment included level, distortion type, fundamental frequency and attack mode, and the characteristic harmonic structure of the particular instrument (flute or clarinet). Subjects for the experiments included a group of audio engineers and musicians and a larger group of subjects who had no special experience in audio or music.

Their first experiment indicated that the threshold of distortion detection when pure tones were involved was one-tenth that for the clarinet tones. In addition, detection thresholds for ear-phone listening were generally lower than for loudspeaker listening, and the distortion was detected at lower levels by the engineer/musician groups than by the inexperienced listeners. In the second experiment they found that threshold-detection levels became higher (the ear was less sensitive) for both types of distortion when musical-instrument tones were used. The more complex the harmonic structure or "spectrum" of the sound, the greater the masking of distortion products. There was also an interesting interaction between the type of distortion and the spectrum of the test signal. Distortion that emphasized overtones of the flute or clarinet that were part of their natural spectrum was less detectable than distortion which generated frequency components that were not. For example, the flute's characteristic spectrum has a preponderance of even-numbered harmonics. Quadratic distortion acted to change the relative amplitudes of these harmonics, but cubic distortion generated odd-numbered harmonics and therefore caused audible changes in the tone color of the instrument. The reverse was true of the clarinet's tone, since it had stronger odd harmonics.

This important study points up several significant facts about the perception of distortion:

1. Distortion of pure tones is heard far more easily than distortion of complex musical-instrument tones.
2. The more complex the frequency spectrum, the greater the masking of distortion components.
3. The specific changes in spectral-energy distribution produced by a particular type of distortion play a significant role in its audibility. Distortion that changes the amplitude of harmonics normally present in the sound

of a musical instrument is less detectable than distortion that introduces or emphasizes harmonics that are not significant in the undistorted spectrum of the instrument.

These conclusions were reiterated by Robert Carver in his report on the perception of crossover distortion in the May 1973 issue of *STEREO REVIEW*. Crossover distortion represents what might be termed a "worst-case" condition since it generates many spectral components that do not diminish in intensity as frequency increases.

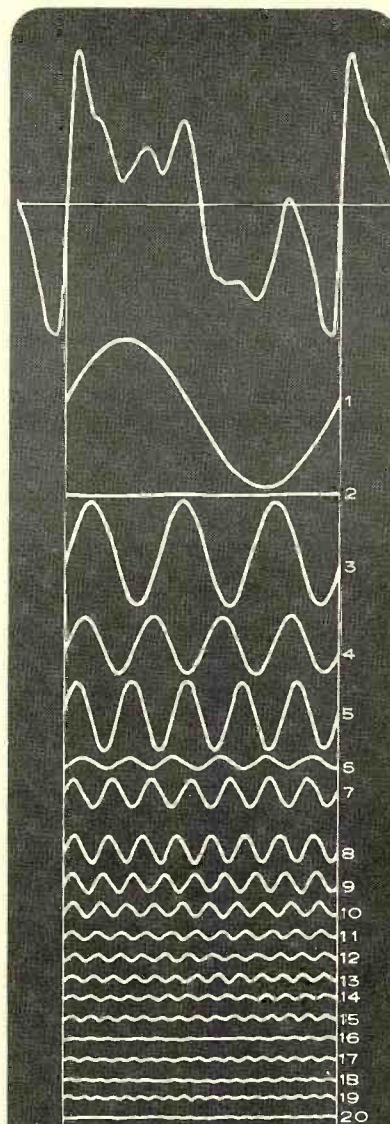

The upper curve represents the sound wave of a clarinet as described in 1916 by Professor Dayton C. Miller of the Case School of Applied Science (now Case Institute of Technology). The twenty harmonic components shown were determined by harmonic analysis. Professor Miller developed a harmonic synthesizer that enabled a specific harmonic-content analysis to be checked by "reassembling" the harmonics into a duplicate of the original.

Carver used a single pure tone, two- and three-tone combinations, and music as his test signals. As might be expected in the light of the data from other experiments, the threshold of distortion perception for the single pure tone was very low—between 0.15 and 0.2 per cent. As the complexity of the test signal increased, so did the threshold of audibility of distortion. For the two-tone signal, distortion became audible at just over 2 per cent; for the three-tone complex the distortion threshold was about 4 per cent; and finally, for some of the musical material, distortion was just evident at 6 per cent!

At Rank-Wharfdale in England, Peter Fryer has conducted extensive research on the audibility of intermodulation distortion. At a 1975 meeting of the Audio Engineering Society he reported that, again, the difference in distortion detectability between pure tones and music was in a ten-to-one ratio. For pure tones varying from a low to a high frequency, distortion thresholds ranged from 0.25 to 3 per cent. For music, distortion thresholds ranged from 2 to 10 per cent. But note that as the fundamental frequency of a pure tone is raised beyond 4,000 Hz or so, the higher-frequency distortion components will begin to fall outside the normal range of human hearing.

What does all this mean? First of all, the audibility of distortion is not determined by simple relationships, nor is it entirely predictable for any given type of distortion. But one important point emerges from all the experiments: the perceptual threshold of distortion in music or other complex sounds is at least ten times that for pure tones. For pure test tones, the best listeners can hear about 0.1 per cent, but for complex waveforms such as symphonic music or hard rock, distortion levels significantly higher than 1 per cent are typical thresholds.

**W**HAT steps can we take toward resolving the most pressing questions about distortion that remain? Studies must be performed under controlled conditions using naive as well as highly critical listeners. They must be tested under conditions that are exactly the same, and precautions must be taken to prevent subjective biases and interactions. No prior assumptions should be made about the subjective performance of either subjects or equipment, and real sounds such as music and speech should be used as signal sources, not just pure tones or relatively simple complex tones of a few selected frequencies. Only in this way will we learn what parameters of objective performance truly correlate with the subjective listening experience. □

# The new Bose 901 Series III. Life-like, spacious sound unmatched by any other speaker.

The original Direct/Reflecting® Bose 901® has been described by music critics as "the only speaker to pour forth in true concert hall fashion" and "the speaker system to own, regardless of price, if one wants the ultimate in listening pleasure."\*

Now, in the new 901 Series III, Bose has introduced a speaker that clearly surpasses, in all important performance characteristics, the high standards set by its legendary predecessor.

## Spaciousness and Realism

The spaciousness and presence so characteristic of the original 901 are even more extraordinary in the 901 III: sound seems to come, not from the speakers, but from a space in

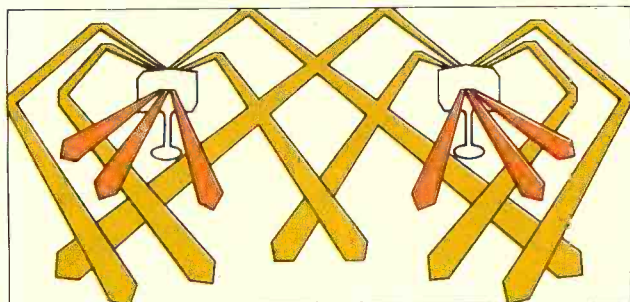

To achieve its extraordinary spatial properties, the Direct/Reflecting 901 Series III reflects most sound off back and side walls of the listening room, re-creating the balance of reflected and direct sound heard at a live performance.

front of you that actually seems deeper and wider than the room. Each instrument is easily localized, and the stereo effect is dramatically life-like almost anywhere in the room. Equally startling are the realism and accuracy with which the 901 III reproduces the unique details, textures, and sonic impact of each instrument.

The unique injection-molded Acoustic Matrix™ enclosure forms a semi-isolated air cell behind each driver, along with three reactive air columns. The result is dramatically reduced cone motion at low frequencies, yielding clean, undistorted deep bass, even at very high volume.

## Efficiency and Power

At the same time, the 901 Series III is so efficient it requires less than 1/3 as much power as the original 901. It approaches the impact of the live performance with an amplifier with as little as 15 watts of power per channel. In fact, we suggest that anything over 70 watts per channel is simply unnecessary.

## Concepts and Technology

The spectacular performance of the 901 Series III results from combining proven concepts with new technology.

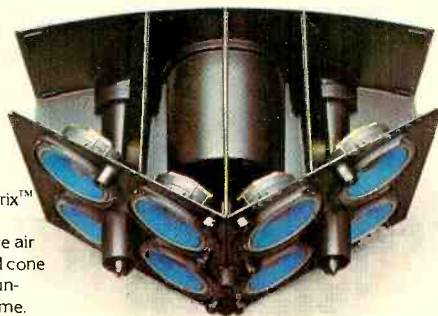

Like the original 901, it utilizes a balance of reflected and direct sound, active equalization, and nine matched, full-range drivers. Beyond this, it incorporates major technological innovations, including the unique Acoustic Matrix™ enclosure and a new ultra-high-efficiency driver.



A new high-performance driver with injection-molded frame and all-aluminum, helically wound voice coil is the key to the efficiency of the 901 Series III.

No advertisement can describe fully the 901 Series III and the technology behind it. So we've put together a comprehensive literature package that includes

a detailed 16-page color brochure, a 20-page owner's manual, and a copy of Dr. Amar Bose's paper on "Sound Recording and Reproduction," reprinted from *Technology*



The electronic active equalizer assures more accurate frequency balance and wider range than are possible with conventional speakers.

*Review*. To receive this literature, send \$1.00 to Bose, Dept. SR6, The Mountain, Framingham, Mass. 01701.

Even better, visit a Bose dealer and ask him to play the 901 Series III in comparison to any other speaker—regardless of size or price. That should tell you everything you need to know.

# BOSE®

Better sound through research

\*Copies available on request. Patents issued and pending. Cabinets are walnut veneer. Pedestals are optional at extra cost.

# It's time for everybody else to

From the very beginning, Yamaha receivers have set new laboratory standards. Our achievements in low distortion engineering, superb signal-to-noise, as well as high sensitivity and selectivity throughout the line have yet to be duplicated by any other manufacturer.

Now we've raised our standards even higher, beyond the laboratory and into the home. The result is the CR-2020: the pinnacle of a new line of advanced performance Yamaha receivers, rated to meet the more critical demands of real life.

**Real Life Rated™** While traditional laboratory measurements provide a good relative indication of receiver performance, they simply don't tell you how a receiver will sound in your living room in actual operation.

For example, in the lab, each receiver component is tested separately. At home, you hear them together as a single unit.

In the lab, distortion is measured at full-rated amplifier output. At home, you rarely, if ever, use the amplifier's full-rated power.

In the lab, power and distortion measurements are made with the volume control at maximum. At home, maximum volume would be painfully loud to listen to.

In the lab, noise and distortion are measured separately. At home, you hear them together.

Clearly a new standard is needed for evaluating overall receiver performance under real life conditions. Yamaha's new standard is called **Noise-Distortion Clearance Range (NDCR)**. No other manufacturer specifies anything like it, because no other manufacturer can measure up to it.

We connect our test equipment to the phono input and speaker output terminals, so we can measure the performance of the entire receiver. We set the volume control at -20dB, a level you're more likely to listen to than full volume. We measure noise and distortion together, the way you hear them.

On each of our new receivers, Yamaha's Noise-Distortion Clearance Range assures no more than a mere 0.1% combined noise and distortion from 20Hz to 20kHz at any power output from 1/10th watt to full-rated power.

**Component-by-Component Excellence.** By all conventional laboratory standards, as well as Yamaha's more stringent standards, the CR-2020 offers a new level of receiver performance.

At full-rated output, the 100 watt-per-channel power amplifier reduces total harmonic and intermodulation distortion to a new absolute low—a mere .05% from 20Hz to 20kHz into 8 ohms.

The CR-2020's exceptionally fine preamplifier is largely responsible for an incredible -95dB signal-to-noise ratio, from moving magnet phono input to speaker output.

The CR-2020's tuner makes FM reception up to 18kHz possible for the first time with unique negative feedback and pilot signal cancellation circuits (patents pending).

What's more, Yamaha's patented use of special ceramic and LC filters (developed for our revolutionary CT-7000 tuner) provide the highest selectivity and lowest distortion available.

**Built-In Moving Coil Head Amp.** Today, more and more people are discovering the superior performance of the moving coil phono cartridge. While

# Real Life Rated™

# .05%

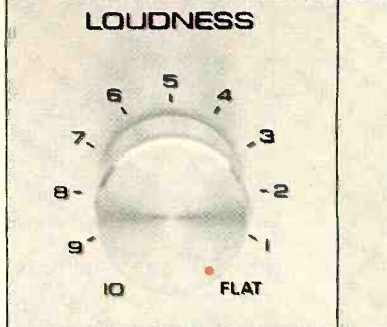
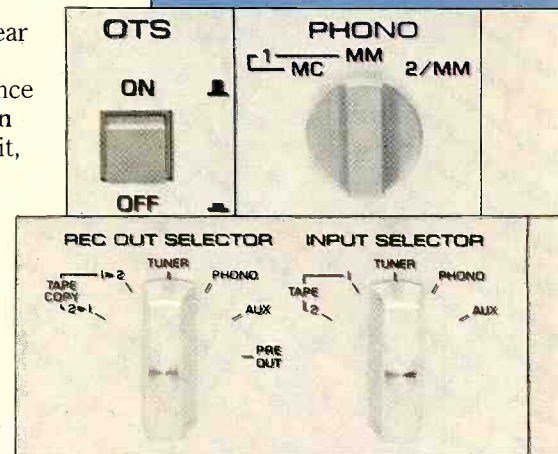

# start playing catch-up. Again.

other receivers require an expensive preamplifier or step-up transformer, which can compromise sound quality, the CR-20 already provides for it—the same solid-state device first developed for our superlative C-2 preamplifier.

**Input/Rec Output/Pre Out Selectors.** Here's extra convenience for tape recording enthusiasts. Record any source while listening to another. For example, copy a tape or disc at the same time you're enjoying an FM program. When you're in the mood to play recording engineer, you can use all the tone controls and filters to compensate for poor quality sound sources.

**Fast Rise, Slow Decay Power Meters.** The CR-20's large, accurately calibrated power meters, with fast rise, slow decay characteristics, make accurate readings possible from 1/10th watt to 200 watt peaks without switching ranges.

**Multi-Function Signal Quality Meter.** When tuning, the right channel power meter automatically converts to a signal quality/strength meter. Needle oscillation indicates the degree of multipath present, while the meter calibrations indicate the strength of the signal. After tuning, the needle automatically reverts to power reading.

**Optimum Tuning System.** Yamaha takes the problem of inaccurate tuning out of human hands. After you manually locate the desired station, OTS automatically fine tunes it to the single point that gives maximum stereo separation and minimum distortion. A defeat switch is provided for special applications.

**Built-In Equalizer.** Think of the CR-20's tone control circuitry as a small multi-band equalizer. Feedback bass and treble controls have selectable turnover frequencies. A midrange presence control adds more flexibility. Two-position low and high filters have 12dB/octave slopes. For the purist, a defeat switch removes the effect of the tone control circuitry entirely.

**The Best Is Yet To Come.** Now that you know about Real Life Rated, you'll want to hear a real life performance. At your Yamaha Audio Specialty Dealer, you'll find uncommon dedication to faithful music reproduction and genuine customer service.

If your Yamaha Audio Specialty Dealer is not listed in the local Yellow Pages, just drop us a line. Along with his name, you'll get complete details about this unprecedented receiver.

© 1977 YAMAHA INTERNATIONAL CORP.



# YAMAHA

Audio Division, P.O. Box 6600, Buena Park, CA 90622

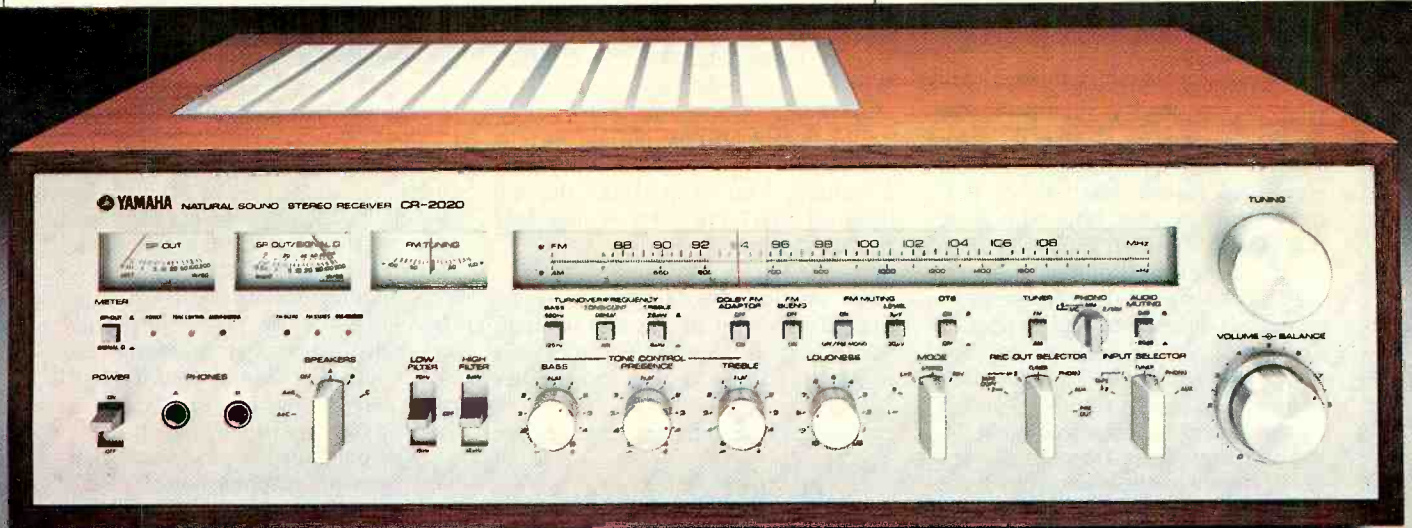
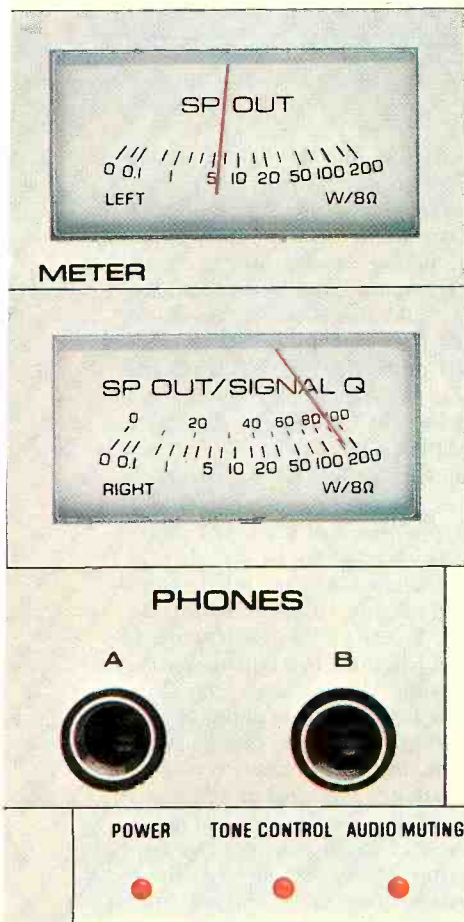

# BETTE MIDLER

"I have been known, you know, to sacrifice beauty for my art."

**B**ETTE MIDLER has more projects going these days than she has fingers on which to count them. Let's see, she thinks: I've got two albums coming out any minute now—a live-in-concert one and a studio one. Then there's the ballet project for next season; Balanchine wants me to sing the lead in the New York City Ballet's production of *The Seven Deadly Sins*, and I've already started studying up for it. Got that March Bing Crosby TV special over with, and then there's my own special that will be on the tube in the fall. Yeah. Then I just signed this three-movie contract with Columbia Pictures. Then there are the concerts and . . .

Bette Midler is torn. What *is* she these days, anyway? She's a star, that's for sure, but what kind? A movie star? A recording star? A concert star? A *ballet* star?

"Ai, ai, ai, ai, ai, I don't know," she wails in a voice that could cut glass. "It's another *thing*. Is it gonna be fun? Who knows? What's gonna happen to me now? What'll I do?" She lifts a hand to her brow in a gesture half Olivier (Laurence) and half Olive (Oyl). "But I'll do it. I'll do it all. 'Cause you have to."

People who are torn can also find themselves ripped. So Bette Midler is ripped: ripped into by critics who thought her latest bit of bad taste wasn't up to last year's bit of B.T.; ripped into by her fans who worry that she'll move to Hollywood and forget them; ripped into by stargazers who have focused their telescopes in numerous directions and expect her to shine equally everywhere. But mostly it's *Bette* who rips into Bette—she sets sky-high standards and expects to measure up to each one. She has somehow leapt from dingdong to diva, from supernumerary to superstar in the course of a swiftly rising

career that's had quite a few pitfalls as well as pratfalls.

From the Tubs to the clubs, from gold lamé to gold records, from the Carnegie Delicatessen to Carnegie Hall, Bette Midler is *the* star of the Seventies, an exuberant entertainer who is both tuned in to and turned on by what she's doing. She is the Emily Post of the camp crowd, having brought such terms as *trash*, *flash*, and *tacky* to our everyday vocabulary as she transported us to and from a magical place she calls *the pits*. Along with her three gum-chewing Harlettes, Midler is beauty *and* the beast in the on-stage persona of The Divine Miss M. She wears raunchy Forties gowns or too-tight gold lamé treader pants or maybe just her silky slip. On stage, she'll do *anything* to entertain. She pants and rants and rages outrageously, singing in and out of loony-tune. She is so high-energy that it would be only a minor surprise to see her go into orbit over the audience. Her humor is self-mocking—as though she were making fun of herself before anyone else got a chance to. She is at once an absurd cross between Helen Morgan and Helen Kane, Mary Hartman and Mary Worth, and she is oddly affecting as all of them.

"I am living out my fantasy life," she declares. "I've gotten everything I wanted. Yup. Yup. What do you think of that? Isn't that wonderful? So far, so good."

**T**HE public Bette Midler is a larger-than-life blowup of the real woman, so it's a surprise when you meet her in private. She's smaller and prettier

than expected, and the loud, raucous stage voice is surprisingly soft in normal conversation. She's full of contradictions as she speaks gently about herself, taking careful aim to shoot down a few misconceptions. Midler doesn't talk much these days—at least not for publication. She doesn't need to and she doesn't want to. Members of the media haven't always treated Miss M so divinely, and she's wary of their questions.

"I am very dedicated to my work," she says. "I really *love* my work. I look at pictures and films and other performers—anything to get ideas. I try constantly to keep my mind going. As soon as my mind has stopped working, I feel as though I've *died*. My mind has to be in a constant state of agitation. I'm always thinking, what can I do? What is going to surprise? What will I enjoy doing? What will uplift, instruct? I know it sounds corny, but it's the kind of training I got when I was a student, and I never got over it. I never got over the *serious* nature of work and, I think . . . ooh. I'm not making any sense, am I? I'm just running on and on and . . . you know, everything I say dribbles away after the first idea. Let's just say I'm very serious about it. Not the dribbles. About my work. I'm not saying this right, am I?"

The indecision, the vulnerable insecurity, is a large part of Midler's appeal. Her sad songs have a raw, hurt edge to them, and even her funny songs have a sort of pathetic, Daffy-duck diffidence about them. On stage, she's all over the place, physically and spiritually. And anything that comes into her head is very likely to come out of her mouth. "I like to think I am an *artiste*," Midler says.

"The only Jewish girl in an otherwise Samoan neighborhood," Bette grew up in Honolulu, her daily diet

By Rick Mitz

FREDERIC MARVIN



BETTY  
MIDLER

# BETTE MIDLER

consisting of pineapples and old movies. A bit part in the film epic *Hawaii* gave her enough courage (and money) to move to Manhattan. After a while she landed a part in *Fiddler on the Roof* (as the eldest daughter Tzeitl) and began to sing after hours in several of New York's small showcase night spots. Soon she landed her now-legendary job singing for towel-clad men at Manhattan's Continental Baths. It may have been the ultimate fulfillment of many a singer's fantasy—getting paid for singing in the shower—but it didn't last. Following several successful appearances on Johnny Carson's *Tonight Show* as her self-created alter ego The Divine Miss M ("trash with flash, sleaze with ease," as she would describe it), Bette Midler freed herself from the steamy but limiting embrace of The Boys in the Baths and bolted to stardom.

"I think I am a little bit of a schizo-

the girls—you know, the cheap girls, the *bad* girls in the night. I'd watch them flirt with the sailors. I thought those girls were the *best*. I thought they were *great*. I never got over them, I never did, I never did. Many of them were red-headed like me, you know. And they all wore real tight skirts with flounces on the bottom, pointy shoes and pointed bras and sweaters buttoned down the back. And they all had filthy, *filthy* mouths. Sometimes I would follow them and listen to their conversations. They would talk about their boy friends and who was doing what to whom—and it always made me laugh. Because I was a very *good* girl, you know. I was! I mean, I was very, *very good*." She was raised "very strictly, very rigidly," she asserts.

"I still talk to my family in Hawaii every week. My mother is a great show-business mother. She really carries on. My father still hasn't seen me work. I don't mind. It's better that way. Oh, yeah, he's seen a couple of my things on television. He didn't care for them. He likes Lawrence Welk,

hole—and it brought down the classroom! It was so strange. It was real strange! People were laughing at something I did . . . it was a real nice feeling, though. I never forgot it and I never got over it either."

Obviously not. Today the only thing Bette Midler takes seriously is humor. "I think there's a real dearth of humorous, novelty-type songs on the scene today. Even my stuff. My last single wasn't meant to be funny, though it was probably a real howl! Anyway, after *Boogie Woogie Bugle Boy*, I got away from humor, and I just recently realized that humor is one of my strongest suits. I'm very slow about myself. It takes me a long time to figure out what's right and what's wrong for me. But finally I figured it out: people really *love* funny, strange stuff. People love to be amused, to smile. The Beatles were very, very funny; they could really turn a phrase. And I can do it too. I mean, I know I'm not the Beatles, but I know that I can do it, even in my own little way; I can do it and—God, *do I ramble on!*"

" . . . I have a lot of little characters who live inside me . . . "



Robert Chiarello



phrenic, because I have a lot of little characters who live inside me and they all have different voices and they all pop out at strange times. It's as much a surprise to me as it is to anybody else. But it's very entertaining. You see, I try never to—not ever—be bored. Oh, yes, dahling, one must *nevah, nevah*, *nevah* be bored."

As a child in Hawaii, she kept herself from getting bored by looking out her window at a real-life movie screen. "When I was young," says Bette (who is not so old—about thirty-two, although she's not telling for sure), "I used to look out the window and watch

you see. And organ music. He's a nice man." She changes the subject.

"I first realized I was funny in fifth grade. Me and this girl, Barbara Nagy—I remember *everybody*—we decided to put on a skit for the class. I don't know why. Anyway, she was the man, I was the woman—Herman and Oysterbee (I don't know where the hell *that* name came from). But when we got up to give the sketch, we couldn't remember any of the stuff we rehearsed, so we wound up improvising the whole thing. She was wearing her father's shoes and one of them had a hole in it and I put my finger in the

Her newest album, "Live at Last" (Atlantic SD2-9000, reviewed on page 77), which she describes as "fairly whimsical," contains a number of funny songs, including one she wrote, a single called *You're Moving Out Today*. She glows. "I have never been prouder of anything I did in my whole life than I am of that single. It's scary and exciting, and it's all the nicest things you hope will happen. You ring up the record company and ask, 'Oh, how's my little record doing?' And you look at the charts, and it's really great. I tell ya, it's like the pros."

Now that she has become one of the



pros herself, she realizes what a vulnerable position it is. "People have said nice things about me and incredibly nasty things about me. It's hard for me—I won't say it isn't. But in this business, you can't play it safe. You have to take a lot of risks. You have to take your lumps. You do your best. Some people are gonna love it, some people are gonna hate it, you know? That's the game." She has become a little too serious and so she changes tones—as she often does when she finds herself getting too earnest—from straight-ahead to campy-corn. She switches to her Sophie Tucker voice: "If you play with the Big Boys, you have to be prepared to *Pay the Price*. I tell ya, playing with the Big Boys is rough-rough-rough, 'cause the Big Boys, they don't care, just so they don't lose their own jobs. They don't care about *your* job. Who? Who do I mean? A-ha, I name no names. That's part of the way you play with the Big Boys. *You never mention their names!*"

But now that Bette's become one of the Big Boys herself, "the little peo-

ple" that much to you. Getting free is the message." Her *first* movie, she says, will probably be a musical comedy called *The Tour*, about a rock superstar. "I hope it's in the tradition of extravaganzas," she says. "You know, with feathers and elephants and production numbers."

It's a lot for a girl who, just a few years back, was canning pineapples on a Hawaiian assembly line. But she says she constantly reaches back to her roots—and she doesn't mean the ones under her "dyed to death" red hair. In her case, her roots are her instincts.

"I pick all my own songs. A song has to strike me—either the melody has to catch my ear, or the message and the lyric have to catch my attention. I try to relate a song to my own experience. Do I understand this song? If I sing it, what do I want to communicate to the audience that is relative to *me*? It all happens in a flash, but it's all there.

"All of my records have atmosphere. When you put one on, you know it's me. Because there ain't no-

But I don't do a lot with my money. It just sort of dribbles away. I buy books and records and go to the movies—and shoes! I have *thousands* of pairs of shoes. I don't know why. I guess because I only had one pair when I was growin' up."

Back in 1974, when Bette was still growing up, she took a big chunk of time off from her career. It was a controversial thing to do. Many of her detractors (and former fans) thought it was a mistake to abandon her career, even temporarily, at such a crucial time.

"Yeah, I know all about what people said. They talk about the builds and crescendos and peaks and leveling off and plateaus and all that crap in a career—how you're supposed to make an album at a certain time and tour at a certain time, which I haven't been too good about. But I don't regret it. I don't think of anything as a mistake. You're gonna learn something from it—if you survive.

"I don't think the year off set me back. It was something I had to do. I



"... and they all have different voices ..."

ple" have been pursuing her. "Yeah. I don't like 'em knockin' on the door, but *everyone* seems to know where my door is. Occasionally someone will knock on my door when I'm wearing my fuzzies and my bathrobe. It's not my fault. I live in Greenwich Village and one of the newspapers printed my address once. I had to put bars on the windows. It's too bad. I had a nice little view, but I don't any more."

One of her Columbia movies will be about such things. It's called *Autographs*, the story of a girl autograph hunter. "It's about finding out that the things you want don't have to mean all

body else in the world who's gonna make records like that—*nobody* makes them. They're either not interested or they don't know how. It hasn't been easy for me, actually. It's been hard to get myself together. I like to record a whole range of possibilities, then pick. Unfortunately, it's an expensive, time-consuming process. You can wind up spending a lot of money doing an album and you have to pay for it out of the old royalties. Then you look at your little royalty check—\$2.55. Hey! Where did all the money go?

"I'm well off, though. Oh, I ain't no Elton John, but I'm very comfortable.

was beat. I was at my wit's end. I was very, very irritable and desolate, mostly from exhaustion. I became pretty nasty. I had a lot of energy, but it wasn't joyful energy. It was very negative sometimes.

"Once I was in St. Louis and I was on stage for three and one-half hours. And I was bombed, just bombed. I was angry and unhappy and I took it out on this poor audience in St. Louis. I was discombobulated. The longer I would ramble on, the worse it got. At one point, I jumped into the audience, ran up the aisle, went to the candy counter in the lobby and bought a candy bar. I

# BETTE MIDLER

walked back into the audience, had a dialogue with some shoe salesman, and then I started talking to the crowd in my whiney, wasted little voice. *Oh, God!* They had to pull me back on stage. One guy was pushing me by my buns and the stage manager was pulling me up and I was just like this [she strikes a zombie pose] and you know, no one laughed because they couldn't believe what they were seeing. When it was over, everyone, *everyone*, called everyone else and it was a Crisis. But I thought it was a ball. I liked it."

Maybe it was something of a catharsis, for in her mind's memory book it was a good time. Another good time was the night she recorded Bob Dylan's *Buckets of Rain* with Dylan himself. "He is the greatest," Bette attests. "He has a wicked sense of humor and loves a good joke. I wanted him to like me because I've always liked him. He was a prime mover in my life. You know," she says in a considerate aside, perhaps not realizing that the same thing applies to herself as

though Midler had also recorded it with him. She is miffed. "I was pretty sure it was gonna go," she says, "but it didn't. Is he hard to work with? You didn't hear that from *my* mouth, remember that. But if he doesn't hear what he wants to, he'll go somewhere else to find it. He's very particular about what he does, and nothing gets past him. I never really did find out what happened. . . ."

**A**NOTHER disappointment was the cancellation of the Bertolt Brecht/Kurt Weill theater piece *The Seven Deadly Sins* because of the New York City Ballet's orchestra strike. It had been scheduled for a late January premiere. "Maybe we'll do it next year. I learned the score, which was not easy. We had just started staging it. At first, I was a little timid about it. But the more I learned it—well, it's just terrific! Atlantic records wants me to record it. I'm not sure about that—I don't think it's in the popular taste. If, by some chance, it doesn't work out, Jerry Robbins said he'd put me in something like *The Concert*, which is a comic ballet. I *looooooove* comic ballet, comic dance, comic anything."

how to get *up* Fifth Avenue. Not bad." [Fifth Avenue is one-way down.]

She sits quietly for a moment and then with a twitch announces: "I am insecure." Silence. "Oh, I don't mean that as a joke. I *am* insecure," she says, secure in the fact that she's insecure. "But I have my good days and I have my bad days. Like . . . these days, I like the way I look—sometimes. I mean, right now, I'm all right. I've got my little hat on so you can't see my hair. Oh, I've thought about *changing* it all, but I don't really know. If I make any changes in my appearance for the movies, it won't be because of vanity. I *have* been known, you know, to sacrifice beauty for my art!" And then suddenly she's serious again. "Part of my problem—sometimes I have it more than others—is that people tend to give me their opinions. Almost anybody at all feels it's okay to tell you what to do. If you have courage and trust in yourself and your instincts, then you can tell them all to go to hell. If, on the other hand, they come down on you very, very hard, then the game gets a little rougher."

She lights a cigarette and announces that it will be her last. Pretty soon she has to rediscover the way to go *down* Fifth Avenue and back to her Greenwich Village apartment to pack for a morning flight to L.A. ("the home of absolutely nothing," she would later call it on the televised Grammy Awards), where she'll tape her first network TV special. She sits back and exhales a cloud of smoke. Then she exhales a few more words, quietly, almost to herself.

"The saga of Bette Midler. You know, it really *is* a saga. Oh," she mugs, "I haven't changed really. I am very much the same. This hat is the *same* hat, although this is a new sweater. Do you like it?" she asks, perhaps remembering when she appeared on the Worst Dressed list. Her style, they said, was "potluck in a laundromat."

"You know, I like people to make me laugh. It's the only way to survive. The whole thing, after all, is one big joke. So, whatever anyone wants to think about me is fine. That's what I'm here for, that's my role. I can be an object of love, hate, it doesn't matter. As long as I like myself." A smirk. "Although I *do* want people to know that I have red hair . . . well," she shrugs, "the intention is all there."

She puts the cigarette out and pockets the rest of the pack. "What do I think of me? Oh, gee, I don't know. I can't make any sense out of it. I'm trying, though. But, you know, I think it's kind of . . . wonderful." She puts on her coat and walks toward the door. "Kind of wonderful." □

" . . . and they all pop out at strange times."



Photos courtesy Rogers and Cowan

well, "it must be hard for people like Dylan to find out that they're prime movers in other people's lives. It must astonish them. Anyway, I came to New York because I wanted to meet Bob Dylan. I spent a lot of time lookin' for him too. He didn't let me down at all."

Paul Simon is another mover she's worked with, although the world may never hear the musical result. Simon originally wrote *Gone at Last* for Midler, but for some reason Phoebe Snow ended up in the final version, even

All this activity has been a lot for her to keep track of, and she's had to make some changes in her business affairs. "I've had to become professionally organized and together. It was something I had to learn. Everything started out as a lark for me, but when push comes to shove, you have to get *organized*. I still work at it. I take the learning part of this business very seriously. Every day I try to learn something: a little bit of business or a delivery of a line of a song. Today, for example, I learned

**B**ETTE MIDLER's new two-disc album "Live at Last," recorded by Atlantic at the Cleveland Music Hall, is a gorgeous, fun-fun-funny evening with a lady who takes justifiable pride in defining what she has to offer as "trash with flash." It's all here—the uncalled-for grossiosity (to coin a Midlerism), the campy strut, the sea-salty delivery, the *really* bad jokes fired off with the nervous *chutzpah* of a Catskill comedian, and the impish desire to offend, one at a time or all together, just about everyone—but paradoxically it all comes nicely together as elegant, superprofessional entertainment by a star performer.

Midler has always kidded around a lot, in her relentlessly self-deprecating way, about "The Divine Miss M" and being a living legend, but now she honest-to-God *is* a star, and for reasons that don't have much to do with her early cult success. It's all in her oddly cockeyed vibes, I think, and what those vibes communicate to an audience: the warmth that she generates, enormous and all-encompassing; the lonely spinster At Last Let Loose that lies just below the surface of even her most outrageous moments, making them endearing rather than vulgar or grubby; and, most of all, the *need* she has for that audience and for its approval. There is about her an indefinable *humanity*, the brave and spunky vulnerability of Little Orphan Annie ("Who's the little chatterbox, the one with pretty auburn locks . . .") without, thank God, all the sanctimony.

**O**NCE in the course of this splendid evening she reveals herself in an affecting way that few performers can manage. In introducing Tom Waite's *Shiver Me Timbers* in what sounds like a more-or-less ad-lib way—"This is a song about trying to get *someplace*, get out of it . . . just get *away*"—she utters the last three words with a sigh of such yearning that it just about tears you up with its *realness*. That stunning moment happens in the middle of side two. Up until then she's been wonderfully entertaining, throwing one-liners, parodies, and patented outrageousness around with the abandon of a Mardi Gras drag queen—playing, in short, the Midler(s) we all know: the female Milton Berle with the rapid-fire delivery ("I'm so organic that last week I ate an Earth Shoe"), the superb parodist of her own late-Sixties generation ("Sometimes I feel so *heavy* . . . so *heavy* and so *laid back*"), and the world's foremost *campereuse* imitating Eartha Kitt imitating Nellie Lutcher in *Hurry On Down*.

After *Shiver Me Timbers*, however, the atmosphere changes: the girlish show-off departs, leaving behind a very womanly artist-performer. What follows is a fourteen-minute tour de

force of performing brilliance, a one-act musical playlet called *The Vicki Eydie Show*. In it Midler plays the role of one Ms. Vicki Eydie, a female Pal Joey with a *halcon* like two dirigibles that are twins, an ego to match, and no more musical talent than it takes to power a calliope. Ms. Eydie sweeps onto the floor of the Motor Lodge she's appearing at and proceeds to give an interpretation of *Around the World* that features such treasures as her rendition of *Istanbul* ("Yes, Vicki Eydie goes preposterous on the Bosphorus"—Ms. Eydie always speaks of herself in the third person), *Fiesta in Rio*, a *South Seas/Hawaiian War Chant* in which she bamboozles her audience into the most hilarious "audience participation" gig since John Mitchell's appearance before the Watergate committee, and a smasheroo windup with *The Lullabye of Broadway*. It is the kind of sadly accurate, too-true comic vision out of which legends *really are* made, and Midler is simply superb, working with sureness in a style that owes more to the theater of the absurd than it does to the stale popcorn of camp.

After such a *coup*, Midler can do no wrong, and of course she doesn't in performances of such things as *Delta Dawn*, *Long John Blues*, *The Story of Nanette* (a collage of songs about boozers that runs a bit dry toward the end), a gloriously ribald reprise of *Those Wonderful Sophie Tucker Jokes*, and a finale that includes her inimitable *Boogie Woogie Bugle Boy*. It is roses all the way, and all on an energy level—high and unrelenting—that should leave no one feeling short-changed.

**A**s if the live performance were not enough, there is a bonus in the "Intermission" on side three, a studio-recorded hit single called *You're Moving Out Today* that Midler wrote in collaboration with Carole Sager and Bruce Roberts. It is the most amusing/touching song since *Second Hand Rose*, and it is as irresistible as its singer. "Live at Last," funny, warm, and—every once in a while—heart-breaking, is certain to be the watershed album in Midler's career. She is quite simply where the musical audience is at right now—or at least that portion of it that *pays* for its entertainment. How nice that they can get so much for their money.

—Peter Reilly

**BETTE MIDLER:** *Live at Last*. Bette Midler (vocals); orchestra. *Friends/Oh My My; Bang, You're Dead; Birds; Comic Relief; In the Mood; Hurry On Down; Shiver Me Timbers; The Vicki Eydie Show; You're Moving Out Today; Delta Dawn; Long John Blues; The Story of Nanette; Fried Eggs; Hello in There; Finale*. ATLANTIC SD 2-9000 two discs \$11.98.

## Bette Midler's Very Latest: "Live at Last"



Rogers and Cowan

"... a style that owes more to the theater of the absurd than to camp"

# Onkyo—A step ahead

State-of-the-Art is for everyone else. Onkyo design and construction is for tomorrow. Today.

We don't just claim innovation, quality and value. We prove it when independent test laboratories publish their unbiased reports in your favorite audio magazines.

Of our TX-4500, one test report said, "...one of the finest receivers available today at any price."

Of our TX-2500, another said, "...sounds a good deal better than the data suggest—and better than one has a right to expect at \$300."

If the data don't suggest the total quality, it may be we're too cautious in our claims. But, we have other equipment too new to have been reported on as yet. All are built to the same exacting standards, featuring exclusive Onkyo advances. We'll try to be a bit less modest as we tell about:

**Quartz-Locked Tuning**—This is the tuning system of which the most famous testing lab said, "...a new system that completely eliminates tuning errors in FM reception." This is done by using a quartz crystal oscillator which takes advantage of the unique capability of precisely ground quartz to maintain a fixed frequency.

The Quartz-Locked circuitry compares the tuner's IF frequency with the frequency generated in the Quartz-Locked oscillator, continually compensating for frequency differences that would cause distortion or poor reception, and additionally compensating the FM tuning meter at the same time.

**Servo-Locked Tuning**—An economy version of the Quartz-Locked system with similar characteristics in a different configuration. While essentially an automatic frequency control circuit, Servo-Lock is more sophisticated in design and performance and in actual lab tests has held stations for at least 24 hours without perceptible drift.

## Quartz-Locked AM/FM Stereo Receiver

**TX-8500**—Power output 110 watts per channel, minimum RMS at 8 ohms, both channels driven from 20 Hz to 20 kHz with no more than 0.1% Total Harmonic Distortion.

Direct coupled differential pure complementary main amplifier with ultra wide frequency response, 2 Hz to 60 kHz  $\pm$  1 dB at main amp. Total Harmonic Distortion less than 0.1% at rated output; 0.08% at 1 watt output. Rated FM sensitivity 1.7  $\mu$ V (mono), 4  $\mu$ V (stereo). 50 dB quieting sensitivity 3  $\mu$ V (mono), 35  $\mu$ V (stereo). Image rejection ratio 83 dB; alternate channel selectivity 70 dB; IF rejection ratio 100 dB. S/N ratio 70 dB (mono), 65 dB (stereo).

**TX-4500**—Power output 55 watts per channel, minimum RMS at 8 ohms, both channels driven from 20 Hz to 20 kHz with no more than 0.1% Total Harmonic Distortion.

Direct coupled differential complementary main amplifier with ultra wide frequency response, 2 Hz to 80 kHz  $\pm$  1 dB at main amp. Rated FM sensitivity 1.8  $\mu$ V (stereo). Image rejection and alternate channel selectivity 70 dB. IM distortion 0.3% at rated power; 0.1% at 1 watt output.

## Servo-Locked AM/FM Stereo Receivers

**TX-2500**—Power output 27 watts per channel, minimum RMS at 8 ohms, both channels driven from 40 Hz to 20 kHz with no more than 0.5% Total Harmonic Distortion.

Direct coupled differential main amplifier with frequency response of 2 Hz to 60 kHz  $\pm$  1 dB. Total Harmonic Distortion no more than 0.5% at rated output; 0.2% at 1 watt output. IM distortion 0.5% at rated power; 0.3% at 1 watt output. Usable sensitivity in FM, 2  $\mu$ V (mono), 5  $\mu$ V (stereo). Image rejection 45 dB; alternate channel attenuation 60 dB; S/N 65 dB (mono), 60 dB (stereo). IF rejection 80 dB.

**TX-1500**—Power output 15 watts per channel, minimum RMS at 8 ohms, both channels driven from 20 Hz to 20 kHz with no more than 0.5% Total Harmonic Distortion.

Direct coupled differential amplifier with overall frequency response 20 Hz to 20 kHz  $\pm$  1 dB. Total Harmonic Distortion no more than 0.5% at rated power; no more than 0.3% at 1 watt output. Usable FM sensitivity 2.3  $\mu$ V (mono), 5  $\mu$ V (stereo). 50 dB quieting sensitivity 4.5  $\mu$ V (mono), 50  $\mu$ V (stereo). S/N ratio 65 dB (mono), 60 dB (stereo). IF rejection 80 dB. Alternate channel attenuation 60 dB.

All of Onkyo's receivers feature multiple speaker outputs as well as multiple tape inputs and outputs including tape to tape dubbing. All are built to specification which often exceed their price ranges with special features, including Phase Locked Loop Multiplex.

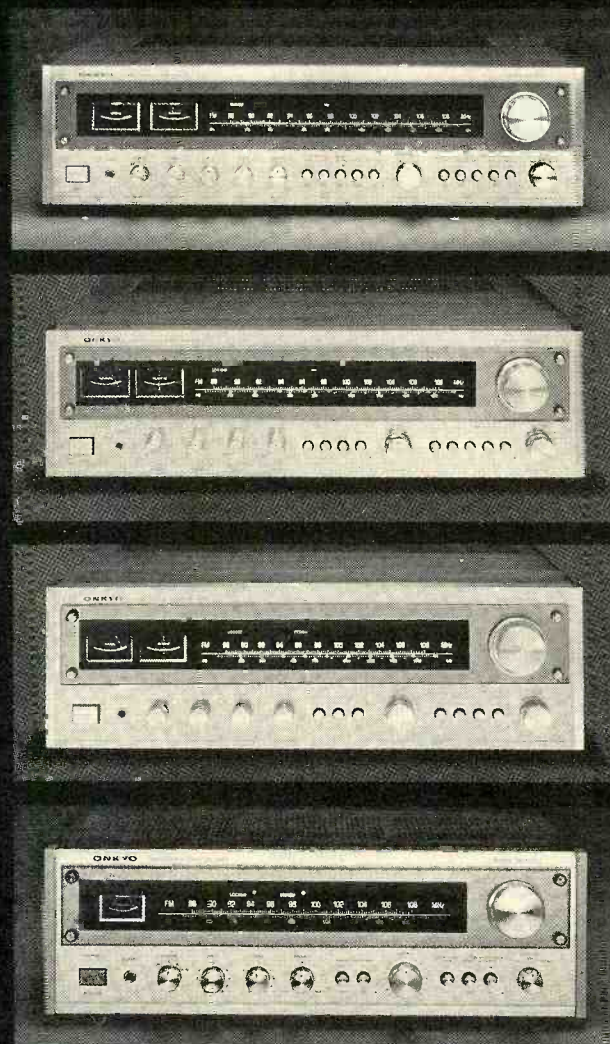

# of State-of-the-Art.

## Quartz-Locked AM/FM Stereo Tuner

For those who are satisfied with their present amplifier but want the distinct benefits of Quartz-Locked tuning, Onkyo offers the T-9, the only component tuner in the world that has Quartz-Lock.

In addition to the precision tuning capabilities of the T-9, it features a dual gate MOSFET/4 gang-variable capacitor front end with usable sensitivity 1.7  $\mu$ V, 50 dB quieting sensitivity of 3  $\mu$ V, 83 dB image rejection and 73 dB S/N in stereo.

The T-9 uses Phase Locked Loop Multiplex for low distortion, high separation stereo reception. At 1 kHz, stereo separation is 40 dB; at 100-10,000 Hz, separation is 35 dB.

Assuring continuous, drift-free tuning, the FM oscillator circuitry is hermetically sealed to prevent environmental influence on the components.

Other specifications include an IF rejection ratio of 100 dB and AM suppression ratio of 50 dB. In addition to Quartz-Locked tuning and exceptional performance characteristics, the Onkyo T-9 provides a special feature for tape recording directly from the tuner.

Known as the Tape Recording Level Check Switch, activation injects a 440 Hz tone, which corresponds to the 50% modulation of the FM signal and enabling the recording level of the tape deck to be accurately set, as well as preventing overloading and distortion. Onkyo's T-9 provides some of the cleanest tape recording possible.



## Solid State Integrated Amplifiers

Having the only Quartz-Locked Tuner in captivity, Onkyo felt the need to provide amplifiers capable of delivering the same quality. There are, at present, two amplifiers in this series... A-5 and A-7. Both have been designed for their power handling quality, featuring reserve power for optimum sound reproduction with absolutely minimum distortion.

Because of this basic, very low distortion design, these amplifiers require exceptionally muscular and stable power supplies with more power than needed for normal operation, and a lot available when needed for peak demands. These needs are met through massive transformers and oversized electrolytic capacitors. Thus, an extremely stable power supply is assured for hours of continuous operation. Further, specially selected power transistors are mounted in oversized heat sinks and the entire unit is enclosed in a more than ample cabinet which allows for the flow of cooling air.

A final Onkyo touch for clear, clear highs and deep-down lows is design approach and construction that approaches the theoretical zero point in equivalent series resistance (ESR). Through circuitry which uses copper plates instead of wires called the bus feeder-ground system, and unusually heavy gauge wiring to the power transformer the overall frequency response is greatly enhanced. Because of these and other considerations the following ratings are established conservatively:

**A-5**—Power output of 45 watts per channel, minimum RMS into 8 ohms, both channels driven, from 20 Hz to 20 kHz with no more than 0.1% Total Harmonic Distortion.

Onkyo avoids the primary distortion found in solid state amplifiers with Class A, push-pull driver stage differential direct coupled, pure complementary circuitry. The A-5 delivers exceptional frequency response of 2 Hz to 70 kHz  $\pm$  1 dB, with system square wave response showing less than 5% tilt at 50 Hz. S/N ratio is extraordinary at 110 dB (IHF A Network).

Features include two Phono inputs and two tape monitors and dubbing, as well as tone controls and defeat, muting and a subsonic filter plus transient killer circuitry.

**A-7**—Power output 65 watts per channel, minimum RMS at 8 ohms, both channels driven, from 20 Hz to 20 kHz, with no more than 0.1% Total Harmonic Distortion.

Onkyo's A-7 integrated amplifier also uses a Class A driver stage differential direct-coupled pure complementary circuitry. The A-7 frequency response is 2 Hz to 80 kHz  $\pm$  1 dB with square wave response showing less than 5% tilt at 50 Hz. At no point does the A-7 exceed 0.1% Total Harmonic Distortion at rated power, and at 1 watt output, Total Harmonic Distortion is as low as 0.08%.

In the amplifier section the phono equalizers are based on Class A, differential push-pull circuitry with exceptionally low noise characteristics. e.g., the A-7 shows an impressive S/N ratio of 110 dB.

A number of special features are included, such as a subsonic filter and a high frequency filter as well as transient killer circuitry. Stepped tone controls are provided with two turnover frequency switches and tone control defeat. Phono overload is exceptional at 230 mV RMS at 1 kHz, 0.1% Total Harmonic Distortion, and the RIAA Curve Deviation of  $\pm$  2 dB, 30 Hz to 15 kHz produces superb reproduction of your records.

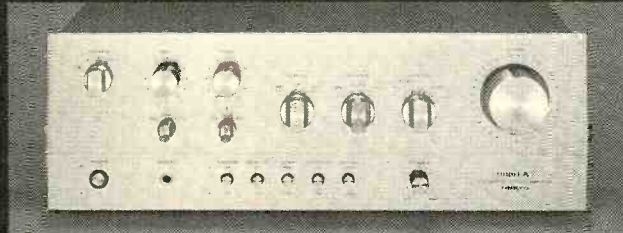
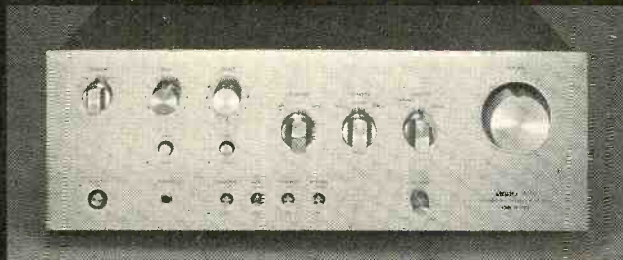

## What does it all mean?

You've read a lot of our claims—understated though they may be—and some of the claims made for us. But the best test is still your own ears. And the only way to use them is at your local Onkyo dealer. If you want more information, including reprints of independent test reports...or the name of your nearest Onkyo dealer, drop us a line. After all, a thirteen cents stamp is a lot better than guesswork.

Artistry in Sound **ONKYO**

Eastern Office: 42-07 20th Ave., Long Island City, N.Y. 11105, 212 728-463E Midwest Office: 935 Sivert Drive, Wood Dale, Ill. 60191, 312 595-2970  
Canada: Sole Distributor, Tri-Tel Associates Ltd., Ontario



# HERBERT VON KARAJAN

---

An interview with the Red Baron of the Berlin Philharmonic

---

**P**ERFORMING with him is like a flight into space. To me, he's the culmination of everything exciting, exhilarating, and as near performance perfection as possible. He brings out the absolute best in you." The speaker is Leontyne Price, answering my question about what she thinks of Herbert von Karajan.

"His greatest asset," says pianist Alexis Weissenberg in answer to the same question, "is his capacity for concentrating, even in rehearsal. This is something quite spectacular with Karajan. His concentration is so deep—and contagious—that you're suddenly attuned to a certain telepathy which makes you *perform* in the most acute sense of the word. And it's without words on his part. His silence and his energy next to you, and his conviction about what he is performing, are such that you just give the best of yourself."

Grace Melzia Bumbry puts it this way: "I think Maestro Karajan is certainly one of the greatest if not *the* greatest Maestro we have today. You know with Karajan that a performance is going to have a certain high standard. A singer might not sing well on a particular day, as can happen with any performer in any opera house, but you can be 100 per cent sure

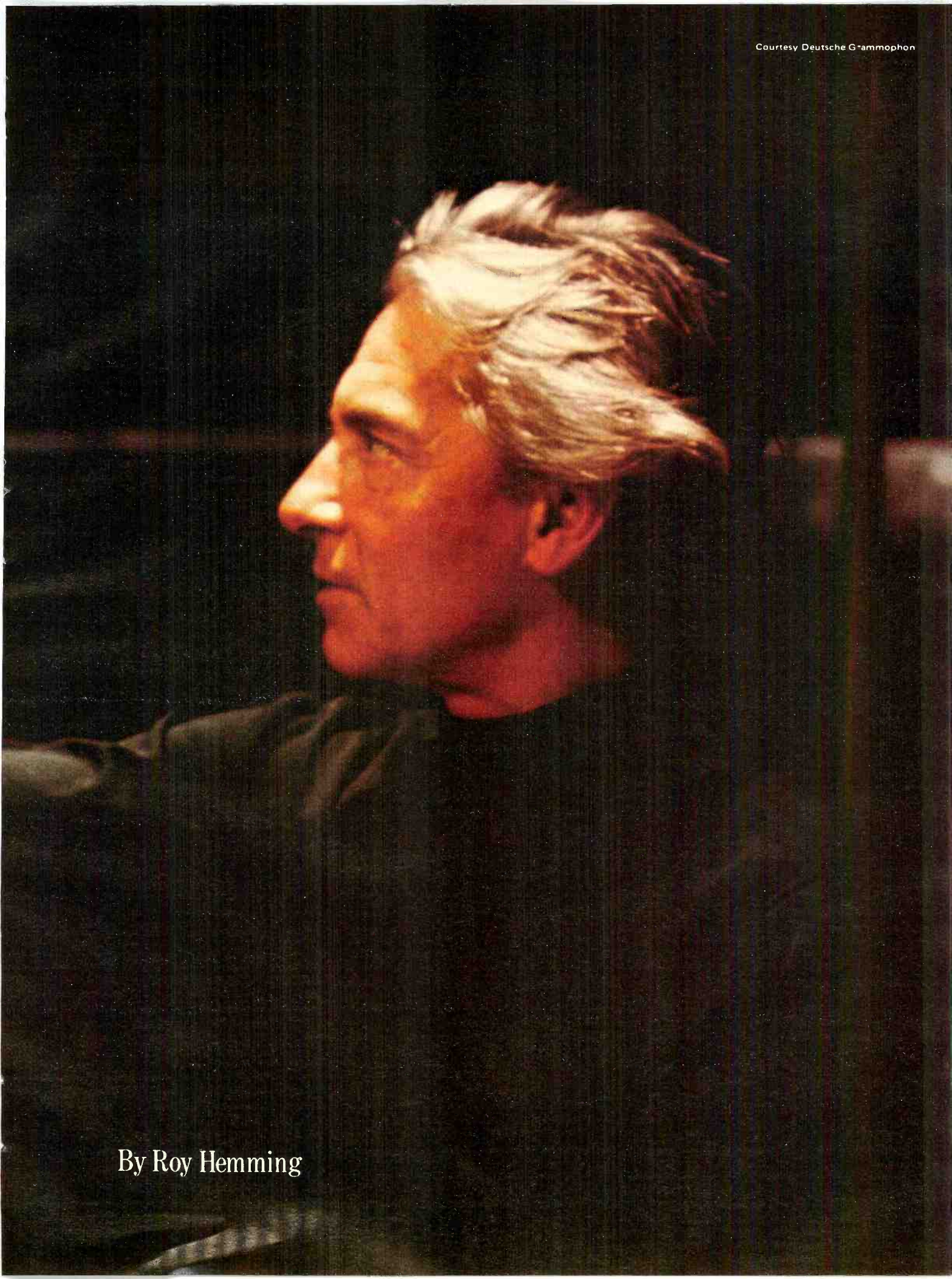

By Roy Hemming

# KARAJAN

Karajan will strive to get the best he possibly can get out of everybody."

"He may act like the Red Baron and he is authoritarian," admits violinist Erick Friedman, "but underneath it all he's really very considerate and shows tremendous respect for the individual musician."

And Elisabeth Schwarzkopf adds: "If Karajan likes a singer, he's the best accompanist in the world. You feel you're swimming in salt water. I think I could not have sung many roles that I did sing were it not for Karajan being in the pit and keeping the orchestra down so that I could really paint with a very fine brush, as if I were singing in a recital."

All of these performers stressed to me that they owe much to Karajan for his help at key points in their careers. "I've always made it perfectly clear," said Leontyne Price, "that it was under his baton that I was first introduced to Europe, which directly catapulted me to La Scala and straight to the Metropolitan Opera."

But for all the warm praise of such artists, Karajan at sixty-eight remains an enigma to many, a controversial personality to others. Some of the controversy, of course, has nothing to do with his music-making. To some, he is too much of an elitist in the musical world. To others, he is a vain power seeker who has never really been in touch with the broadest musical forces of his time—the way Boulez, Bernstein, and others have been. But even Karajan's severest critics will admit his eminence and acknowledge the extraordinary way he has rebuilt the Berlin Philharmonic since 1955 into possibly the world's finest orchestra. And there is no denying the charismatic impact Karajan has on concert-goers—and on record buyers.

Walter Legge, the retired director of artists and repertoire for EMI/Angel Records in England and the man most responsible for Karajan's postwar international career, put it this way to me: "Karajan has raised orchestral playing to a higher state of polish than anyone before him. Toscanini gave it hard brilliance, Furtwängler his particular Romantic elasticity, and Stokowski his special lushness. Karajan's preoccupation has always been to make things sound as beautiful as possible, and to train an orchestra to do just that."

"Karajan's sound," says Michel

Glotz, the Frenchman who has produced almost all of Karjan's recordings since 1969, "is a very special and personal concept of sound. It goes far beyond the technical aspects of whether you increase the bass or the *fortissimi*, or diminish the *diminuendi* or *pianissimi*. It has more to do with the beauty of the sound and the way it's shaped. It's like a sculptor. Two sculptors may work from the very same materials, but what they produce will be completely different."

Because of the long string of major musical posts he has held in Vienna, Milan, London, Paris, Berlin, and his native Salzburg over the past thirty years, Karajan was long ago dubbed Western Europe's "Herr Generalmusikdirector." And his more than eight hundred recordings—especially an impressive series of mono and early stereo releases on Angel in the Fifties with the Philharmonia Orchestra of London, and later an even more extensive stereo series with the Berlin Philharmonic on both Angel and Deutsche Grammophon—have made him one of the world's most-recorded musicians. Royalties from his complete recording of Beethoven's nine symphonies (for DG in the mid-Sixties) are reputed to have been enough to pay for one of Karajan's private jet airplanes.

Karajan's personal appearances in the U.S. have been few and far between. Of our major symphony orchestras, he has guest-conducted only the New York Philharmonic (in 1958) and the Los Angeles Philharmonic (in 1959). A project to direct the complete Wagner *Ring* at New York's Metropolitan Opera in the late Sixties got only as far as *Das Rheingold* and *Die Walküre*, principally because of the Met's labor problems. And his several U.S. tours with the Berlin Philharmonic have taken him to only a few major American cities.

Yet, this past year, probably no musical light shone as brightly in the U.S. as did Karajan's. One of the reasons for this was a series of much-acclaimed, European-made TV films shown throughout the U.S. on PBS stations, some in simulcasts with local FM stations. Then there was a spectacular series of live Karajan concerts in New York's Carnegie Hall with the Berlin Philharmonic, the Vienna Singverein, and an impressive list of soloists (including Price, Freni, and Pavarotti) in the Verdi *Requiem*, the Mozart *Requiem*, Brahms' *German Requiem*, Bruckner's *Te Deum*, and Beethoven's Ninth Symphony—all within a one-week period!

While in New York, the boundlessly energetic Karajan also led an extensive three-day series of master classes at

Facing page: top, Karajan with baritone Dietrich Fischer-Dieskau during the 1968 recording of *Das Rheingold* (DG 2709023); center, the Salzburg Music Festival director with his wife and Sir Rudolph Bing, then director of New York's Metropolitan Opera, at the festival's 1960 opening; bottom, with tenor Werner Hollweg at the recording session for *Lehár's Merry Widow* (DG 2707070).



Above: top, Karajan with Russian pianist Lazar Berman at the recording session for Tchaikovsky's Piano Concerto No. 1 (DG 2530677); center, Karajan greets conductor Karl Böhm at a party celebrating the latter's eightieth birthday in Salzburg; bottom, with mezzo-soprano Christa Ludwig at *Götterdämmerung* playback (DG 2716001).





the Juilliard School of Music, a series that had musicians young and old talking as excitedly about him as they had about his Berlin Philharmonic concerts in Carnegie Hall. Wearing a casual turtle-neck shirt and sitting in the midst of the Juilliard orchestra, Karajan spoke quietly and directly to the student conductors—unconcerned whether or not his comments reached the ears of the large number of visitors (including several musical superstars) jammed along the side of the auditorium. Perhaps because of his strikingly handsome face, most people seemed surprised at his harsh, raspy voice (it sounds almost as if someone had just tried to strangle him).

Concentrating on rehearsal technique, he stressed rhythmic clarity and fluent dynamics—Karajan trademarks. He chided several young conductors for their flamboyant podium manner, urging them to use their ears instead of their arms and bodies. At one point, he interrupted one heaven-storming youngster to show how he could get the desired orchestral response by moving no more than his index finger. While some of his remarks were short and even cutting, Karajan was generally courteous, and he even joked occasionally with some of the student players.

Among those watching the classes was Walter Legge. "Karajan is a born teacher," Legge commented to me. "It's evident not only in the way he trains an orchestra, or in these master classes, but also in the way he's brought up his two daughters—to self-reliance, to a variety of interests, to marvelously disciplined behavior. And notice how he teaches everything simply and quietly. He never raises his voice."

**T**HE Juilliard master classes showed a more human, down-to-earth side of Karajan than most Americans had seen before, for among today's leading jet-set conductors Karajan has remained the most aloof. He gives few interviews. He never meets admirers in the Green Room of a concert hall or opera house following a performance; in fact, an aide is always waiting in the wings with his coat ready as Karajan takes his final bows—and Karajan is usually out the door and into a waiting car before the audience has begun to leave the hall. He prefers, he says, to let his music-making speak for itself.

Michel Glotz contends that many people mistake Karajan's basic shyness for arrogance. "He is absolutely *not* arrogant," Glotz says. "And his human curiosity about everything—whether it be scientific, literary, or artistic—is endless."

When he is not conducting, Karajan

and his third wife (a former French fashion model) usually divide their time among their home near Salzburg, their house and racing yacht off fashionable St. Tropez, and their house near the ski slopes of St. Moritz. Whenever he can, Karajan flies his own jet (his latest: a Dassault Falcon 10). "Flying helps me keep my brain ticking over," he once told a London interviewer. "It's the control that's required—the control that comes from planning everything well ahead. You plan for all the difficulties which may happen. You calculate what the plane must do." His passion for flying is so great that he managed to find time in his crushing New York schedule of performances, rehearsals, and classes to spend a morning taking a flying lesson in one of the newest U.S. jet simulators. He also agreed to squeeze in a twenty-minute interview with STEREO REVIEW—provided the questions be restricted to his recording career.

On the afternoon of his first Juilliard master class, I joined Karajan and Angel's New York representative John Coveney for tea in the office of Juilliard president Peter Mennin. Karajan, speaking in the most lightly accented English, was cordial and direct in his answers, although there was no mistaking his nervousness about being interviewed and his relief when the time was up.

I started out by asking him whether he regards his recent recordings as better than his earlier ones, especially since he has re-recorded so many of the same works. Karajan, sipping his tea, seemed reluctant to answer. "A recording represents your opinion about a work only at the moment you record it," he finally ventured. "I leave it to others to say which may be the better." Would he, then, be willing to name three, four, or more of his recordings that he was proudest of or happiest with? "I must say I love them all. I cannot make a preference," he said, smiling. "But recording technique—that is constantly improving.

"You know," he went on, "when we began recording after the war, there was still the old system of recording on wax, with each side having a duration of only three and a half minutes. That made recording very hard—really very hard. I remember we needed thirteen sessions for my first recording with the Vienna Philharmonic. It was the Beethoven Eighth Symphony. Today, with my Berlin Philharmonic and with tape, I would say give me an hour and a half—and there you have it. Recording today is a sort of perfection—not that it can't get better, for we can always become better. But tape has made recording much easier. Let's say an oboe

# KARAJAN

player misses two times what we all know he can do in his solo, and the third time there's an airplane flying by. Then the time is up, we can't do any more that day. But tomorrow, we can re-record that section and insert it. Normally, we don't do so unless we have to. But the possibility, the knowledge that we *can* do it, gives us a kind of assurance we never knew in the earlier days. When I step on the podium today in our Berlin studio, which is our Philharmonie Hall, I can concentrate not on the stopwatch but on making music. There is also the fact that we know the hall so well—the technicians, the orchestra, and myself. We know it now from five years' experience. Before that, we recorded in a church in Berlin."

Karajan believes that the art of recording has advanced so much in recent years that "you can get some things clearer than you ever could in the concert hall." He cites as an example his recent DG recording of Schoenberg's *Variations for Orchestra*. "I swear to you, I would never *dream* of doing it in a concert hall. It's a very complicated thing to do right. Schoenberg's demands are abnormally high. He was so exuberant that he wrote too much into the piece. Sometimes he asks high-pitch piccolo and flute players to play *pianissimo*, yet everything is covered up in a way you cannot do anything against in the hall. But in a recording we *can* do something. We

played each variation with the orchestra arranged differently, so that we could get the right orchestral presence and balance for each."

What about those who say that such manipulation of music for recordings is contrary to a composer's intentions? "I always say it's wrong if you criticize people because things are being manipulated," Karajan replied. "Because what in music is *not* manipulated? The moment the inner thought of the composer is transmitted by a pen or a pencil, it's already manipulated. Then it goes into the hands of musicians to play on their instruments, and the conductor manipulates the musicians, and when the sound comes out it's still not exactly as the audience hears it, for, first, it's manipulated by the acoustics of the hall. There are not two halls in the world that have the same sound with the same piece of music! So it's completely useless to criticize 'manipulation.' I think the only thing is that the music come out as clearly in structure and beauty as we can make it. And that is what we can achieve best today through recordings.

"I never listen to a recording of mine right after the session," he continued. "I get what might be called a 'first edition,' usually six or eight weeks after the recording session. That way there is a certain distance—a distance that enables me to see if something is not quite right—and then we may do a section or two again. When this is finished, then there's a second or third 'mixing' because of the many channels we have today. I consider this mixing very important. Through it you can get balances and make things clearer than you ever could in a concert performance. I must have the final control on this."

(Karajan's recording producer Michel Glotz later confirmed this working procedure, adding a few interesting details: "In the six-week period after the recording session, I do the first editing of the 'takes' Karajan has approved. Then the technicians make a reduction from quad to stereo, and make a cassette tape for both Karajan and myself. We each have exactly the same type of cassette instrument to listen to it on, so that way we can compare our feelings on the telephone or when we see each other. Most of the time, he approves the tapes with only minor changes in the mixing. Never has he asked me for a change of 'takes.'")

Does he listen to other people's recordings? "Oh, yes, all the time," Karajan responded. What are some he's heard lately that he particularly admires? He begged off: "If I named one by one person, then another would be offended." He was less reluctant, however, to admit a preference for listening to vocal records more than instrumental or orchestral ones. "I try to hear all the soloists coming up, especially the young singers. This is, for me, the most interesting. I get tapes all the time, and from them you can get some idea of how a singer could be in a particular role."

Since Karajan has recorded with and served as music director of orchestras in England and France as well as Austria and Germany over the years, I asked if he felt there are still any national differences in the sounds orchestras create. Is there, for example, a French sound in performing Debussy that is unique with the *Orchestre de Paris*, that can't be secured from, say, the Berlin Philharmonic? "No," he answered without hesitation. "It's only the quality of the players today. If they can play a *pianissimo* that is really a *pianissimo*, then they can play a piece of Debussy as well as anyone else." After a pause, he added, "You must not forget that the Berlin Philharmonic is now almost exclusively my orchestra. It is a collaboration of some twenty-two years of work, so what I get from them can't be compared with anything I have done or might do elsewhere."

UNLIKE most other great conductors, Karajan has not been closely identified either on records or in the concert hall with a particular composer whom he has championed the way Walter did with Mahler, Ansermet with Stravinsky, Beecham with Delius, Toscanini with Puccini and Respighi. I asked Karajan about this, and he shrugged and declined to comment specifically, going on instead to note that he performed many different com-

The parallel between manipulating the controls on an aeroplane . . .



W. E. Baur/Angel/EMI Records

## KARAJAN ON DISC

SINCE Karajan has more than eight hundred recordings to his credit, it is not easy to select just a handful of his best or most representative performances. But here are a few that have given me particular pleasure:

● **Beethoven:** *Symphony No. 3, in E-flat Major, Op. 55 ("Eroica")*. Berlin Philharmonic. DEUTSCHE GRAMMOPHON 138802.

● **Bruckner:** *Symphony No. 8, in C Minor (1887 version)*. Berlin Philharmonic. DEUTSCHE GRAMMOPHON 2707085 two discs.

● **Prokofiev:** *Symphony No. 5, Op. 100*. Berlin Philharmonic. DEUTSCHE GRAMMOPHON 139040.

● **Puccini:** *Tosca*. Price; Di-Stefano; Vienna Philharmonic. LONDON CS-1284 two discs.

● **Shostakovich:** *Symphony No. 10, in E Minor, Op. 93*. Berlin Philharmonic. DEUTSCHE GRAMMOPHON 139020.

● **Sibelius:** *Symphony No. 5, in E-flat Major, Op. 82, Finlandia*. Philharmonia Orchestra. ANGEL S-35922.

● **Strauss:** *Der Rosenkavalier*. Schwarzkopf; Ludwig; Edelman; Philharmonia Orchestra. ANGEL SDL-3563 four discs.

● **Tchaikovsky:** *Symphony No. 4, in F Minor, Op. 36*. Berlin Philharmonic. ANGEL S-36884.

● **Wagner:** *Tannhäuser: Overture and Venusberg Music. Lohengrin: Prelude to Act I. Tristan und Isolde: Prelude and Liebestod*. Berlin Philharmonic. ANGEL S-37097.

posers from different musical periods. When I mentioned this later to one of Karajan's record-industry associates, he smiled and said, "Ah, I can give you an answer to that one. He's been too busy championing Karajan. That's an absolutely honest answer, but, for God's sake, please don't say I said it!"

The many different composers Karajan has recorded cover a wide range of nationalities—German, Austrian, Hungarian, Czech, Finnish, Norwegian, English, French, Spanish, Italian, and Russian—but, to my knowledge, no American composers. When I asked Karajan about this, he looked surprised and a bit wounded. "No, no, I do perform American composers," he insisted. "I have done Ives' *Unanswered Question*" [a seven-minute work—*Ed.*]. But not on records, I persisted. Karajan reached for his tea cup. "Perhaps later I will record some," he said.

The success of his recent TV films, especially of Puccini's *Madame Butterfly*, clearly pleases Karajan.

"I'm told you had an audience of some eight per cent for it here in America," he noted. "In terms of the total audience, that's some two and a half million viewers. I once made the calculation that if I would repeat just the nine symphonies of Beethoven in the concert hall in order to equal the number of people who watched my performances of them on TV, I would have to play nothing but Beethoven symphonies all my life! When I was a boy in Salzburg, about three hundred people would attend a concert. Today, through records and films, you can get an audience of ninety or a hundred million—just for one concert."

I asked Karajan if there was any truth to the rumor that the soundtrack for his *Madame Butterfly* film was actually the same as the London/Decca recording he made except for the scenes involving Lt. Pinkerton (the casts for that recording and the TV film were the same except for the tenor singing Pinkerton—Luciano Pavarotti in the recording, Placido Domingo in the film). "Yes, that's correct," Karajan replied, adding that for all his films he uses a previously recorded soundtrack and then has his performers synchronize their movements to it.

It costs nothing to watch a performance on TV, but the price of good tickets to a live performance—especially one with Karajan—keeps going up (\$60 or more for a Salzburg performance, and up to \$35 for one of Karajan's recent Carnegie Hall programs). Was this, I asked Karajan, making concert-going more of a social event than a musical one? And was it especially keeping away young music-lovers? Karajan answered without hesitation: "I'm quite sure there are many young people

who buy recordings who *never* go into a concert hall because they don't want to be disturbed by people around them, people who speak during the music or make other noise. I myself prefer, if I really want to *listen* to music, to listen to recordings—and with earphones—so no one can disturb me."

Since Karajan has been widely credited with discovering or giving significant "early breaks" to so many young artists (some of them through his Karajan Foundations), I asked him what *composer* now under forty he felt might eventually be recognized as one of the century's major ones. After all, most of the great composers throughout history had written works now recognized as masterpieces before they were forty. "I don't like making prophecies," Karajan replied. "What did people say of Beethoven in his own time, for example? No, you cannot say who will survive and who will not. So many things can make it turn out to the contrary. All we can do is play the music and let time decide."

Our conversation turned to the speed with which some young conductors today get to conduct major international orchestras early in their careers, in contrast to the way Karajan and others rose from lesser orchestras to major ones. Is there, I asked, perhaps too much pressure on young conductors today to reach the top faster? "That's *their* problem," Karajan shot back. "One thing is sure: many more conductors are needed. That's why I make such great efforts to find young talents and encourage them, because we need at least thirty or forty right now."

Karajan added that he believes "most definitely" that European opera houses, especially those in Germany,

... and the members of a large orchestra is a tempting one to draw



Hans Wild/London Records

# KARAJAN

will continue to be a place where young American talent can go to be nurtured. "They have constant performing opportunities," he said. "In America you usually have just a few performances of something, with insufficient rehearsal time. But if you're a member of a good German theater, you have all the rehearsal time you need, plus someone to really work with you and train you. I think it's a marvelous, unequaled proving ground."

Alexis Weissenberg points out that "certainly Karajan himself has been the discoverer of an enormous number of talented people—of diverse racial, ethnic, and national backgrounds. Perhaps along with Toscanini and Mitropoulos in their time, Karajan is one of the very few conductors who has been directly responsible for a number of major careers." Among them is that of Weissenberg himself. "Yes," he said, "Karajan was totally responsible for my comeback to the concert stage" (after Weissenberg's much-discussed "sabbatical" during the late Fifties and early Sixties).

I asked Weissenberg, who as a teenager escaped from a Nazi concentration camp in his native Bulgaria toward the end of World War II, about the criticism that continues to plague Karajan, particularly among Americans, for his rise to conducting fame within Nazi Germany. Although Karajan was officially cleared by the Allied Occupation Forces in 1948, some Jewish musicians (such as Isaac Stern, Artur Schnabel, Itzhak Perlman, and Pinchas Zukerman) resolutely refuse to perform with him. But others, such as Weissenberg and Erick Friedman, do.

Weissenberg answered, "I would not be able physically or emotionally to be involved musically or any way with anyone I thought was a Nazi during the war. I know that Karajan was *not* a Nazi. People who say he was don't know the facts or grossly misuse them. It's too easy to say of someone who remained in Germany during the war that he was a Nazi. One should not forget that Karajan was in his early twenties and relatively unknown when the Nazis came to power. I can't think of many young people in a similar situation, given the opportunity to conduct and work with an orchestra the way he was, who would leave this for an unknown land, where he would not know when or even *if* he'd get a chance to conduct."

Said Erick Friedman: "If Karajan

was guilty of anything, I think it was of career opportunism. To leave Germany at that time would have meant giving up his career. So I think he just chose to close his eyes to the non-musical world around him at that time—just as he closes his eyes when he conducts. He just put his head into his music scores. His is certainly not the first case where opportunism reared its ugly head, nor the last. How many in our own country shut their eyes to Viet Nam or to civil rights? We shouldn't forget that there were many in Germany at that time who didn't have the means to get out even if they wanted to. All of us make mistakes, and I think it's part of the Judeo-Christian tradition to forgive. Whatever Karajan's political or moral mistakes of this period, I think he's tried to atone for them over the years by the way he's helped and encouraged young performers of so many different backgrounds."

Grace Melzia Bumbry told me she believes the outcome of the war affected Karajan directly in that "perhaps he learned from it that there are other people on the face of this earth besides those who were supposed to be 'the superior race.' I've never had any reason to think he's invited me to perform with him just to appease or placate anything or anybody. I think he's essentially concerned with *talent*, whether it's white or black or whatever."

**O**NE other question I couldn't resist asking others about Karajan: Does he have a sense of humor? "Oh yes," answered Walter Legge, "but not about himself. There was one occasion, however, in the early days, when Karajan said to me: 'Always remember, the

Balkans begin in Salzburg, and I come from Salzburg.' The significance of that, of course, is that 'the Balkans' has long been a term of contempt in most of Europe. To say someone is a Balkan means he's swift, artful, and possibly a crook."

Legge and Elisabeth Schwarzkopf also recalled one night when they gave a party for Karajan in London shortly after he'd been named music director of the Vienna State Opera. "We had just finished recording Verdi's *Falstaff*," Legge said, "and I decided to carry the comic mood a bit further and get a print of the Marx Brothers film *A Night at the Opera*, and show it that evening. In the film, as I'm sure you know, everything that can possibly go wrong during an opera performance happens—in the most hilarious manner. Well, Karajan literally rolled on the floor with laughter. At one point, he begged me, 'Stop it. Stop it. I can't breathe!' I think he saw all the things he knew might be waiting for him when he got to Vienna."

Leontyne Price had this anecdote to add: "Even though I'm in awe of him, I'm not afraid of him—and I think he rather likes that. For instance, no one would dare correct him when he makes a mistake in his English. But a few years back, I couldn't resist doing so when he said one day that the next rehearsal would take place at 'noon-thirty.' I stared at him and said, 'Oh, for Heaven's sake, Maestro. We say "twelve-thirty." Whatever is the problem here?' Well, we both just looked at each other for a second or two—and broke out laughing. Anyone who says he doesn't have a sense of humor doesn't *know* him." □

... all the things he knew might be waiting for him when he got to Vienna"



MGM/courtesy Movie Star News



# Our new AD cassette takes the normal bias position to extremes.

We made a name for ourselves by creating the world's first non-chrome, "high" (CrO<sub>2</sub>) bias/EQ cassette tape, TDK Super Avilyn (SA). The state-of-the-art tape that has quickly become the standard of reference for cassette tape performance.

Our latest innovation is called AD (ay-dee), and we predict it will soon become the standard of performance and economy in the "normal" bias/EQ position.

We produced the first high fidelity ferric oxide cassette tape some ten years ago, and we've been perfecting the formulation ever since. Our new AD delivers superior performance, especially at the critical high-frequency range (7kHz to 20kHz), where many mid-priced cassette decks and even premium-priced cassettes tend to fall off too quickly.

AD is our ultimate ferric oxide tape designed for the "normal" bias/EQ position. Overall, it provides the lowest noise, highest frequency response and widest dynamic range of any pure ferric oxide cassette tape. In 45, 60, 90 and 120 minute lengths, AD has the same super-precision cassette mechanism found in TDK SA, in a new blue-gray shell.

And AD brings its audible benefits to all cassette decks, with and without switchable bias/EQ, including those found in cars, portables and home stereo systems. So the music you love can travel with you, with all of the clear, crisp, brilliant sounds that make music so enjoyable.

AD is the finest pure ferric oxide cassette tape you can buy at any price. And it has TDK's full life time warranty. Give our new high-fidelity, moderately-priced AD a try—it's anything but normal.

TDK Electronics Corp., 755 Eastgate Boulevard, Garden City, New York 11530. In Canada: Superior Electronics Industries, Ltd.

 **TDK**

The machine for your machine.



CIRCLE NO. 54 ON READER SERVICE CARD

# Now we've mastered a Scotch® cassette for every switch position.



**Introducing the Master™ Series.** Three totally different tapes. Each developed to deliver the truest, clearest sound possible at each tape selector switch position.

Our Master I cassette is for normal bias recording. It features an excellent dynamic range, low distortion, uniform high frequency sensitivity and output that's 10 dB more than standard tapes.

Our new Master II replaces chrome cassettes and is designed for use on hi-fi stereo systems with chrome bias (70 microsecond equalization). It features some spectacular performance characteristics, including a special coating that gives it a 3 dB better signal-to-noise ratio at low and high frequencies than chrome cassettes, yet it's less abrasive.

Our new Master III is for the ferri-chrome setting. It's formulated with the most advanced technology available, giving a 3 dB output improvement at low frequencies and 2 dB at high frequencies. And the unique dual layer construction increases both low and high frequency sensitivity over chromium dioxide and ferric oxides.

**All this, plus unique inner workings you can actually see.** Our new Master line has a special bonus feature. A precision molded clear shell that allows you to monitor the inner workings of the cassette. You can actually see the recorder head penetration and the unique roller guides in action. Look closely at the transparent shells above and you'll see the water wheels which were specially designed to move the tape evenly across the head, reducing friction and noise. And two radially creased shims insure smoother wind, improved mechanical reliability and reduced wow and flutter.

Enough said. Now it's time for you to take the true test. Match up the right Master cassette with the bias you prefer. Then just listen.

You'll find that whichever switch position you use, a Scotch Master is the way to get the most out of it.

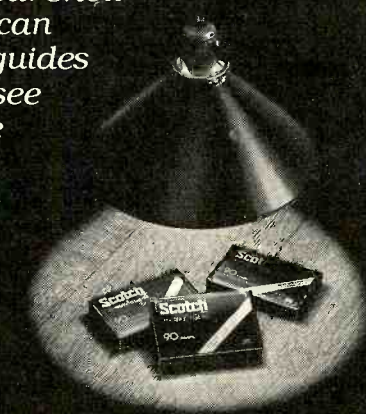

**Scotch Recording Tape.  
The truth comes out.**

# STEREO REVIEW'S SELECTION OF RECORDINGS OF SPECIAL MERIT BEST OF THE MONTH



New World Records

Virgil Thomson's  
Fresh and Audacious  
*The Mother of Us All*:  
A Vital New Release  
By New World Records



Composer Thomson confers  
with librettist Stein

**V**IRGIL THOMSON first met Gertrude Stein in Paris in 1925, and the result of that meeting between the composer from Missouri and the iconoclastic writer from Baltimore was a stormy friendship that lasted twenty years. During those years, the pair collaborated on two astonishing operas. After setting three of Stein's poems, Thomson went on to compose first the score of *Four Saints in Three Acts*, a cubistic valentine to the world based on the lives of Saints Theresa of Avila and Ignatius Loyola. Then, in October 1945, armed with a commission from Columbia University's Alice M. Ditson Fund, he went to Paris to discuss another opera with Stein, this time using nineteenth-century politics as a theme. Stein promptly chose Susan B.

Anthony, the celebrated champion of women's rights, as her subject.

The libretto for *The Mother of Us All*, though far from conventional (not least because of its curious parallels between the lives of Susan B. and her companion Anne and Stein and her companion Alice B. Toklas), followed a more coherent pattern than *Four Saints* had. Nonetheless, the result is still more a patriotic pageant than a plotted play, the stage crowded with incidental figures of the period—Daniel Webster, Lillian Russell, Ulysses Grant, John (probably Quincy) Adams, Anthony Comstock—singing snatches of words they actually said along with others the librettist made up for them. Also on hand are various Civil War veterans, suffragettes, citizens, and loiter-

ers—plus two narrators. Gertrude S. and Virgil T. It's fun, but it's serious too—especially in Susan B.'s long, emotional monologue toward the end, a manifesto for the rights of women. For his part, Thomson laid out a stained-glass window of a score, brightly colored, fragmented in its parts but unified in the whole, "a memory-book of Victorian play-games and passions . . . gospel hymns and cocky marches . . . sentimental ballads, waltzes, darned-fool ditties and intoned sermons . . . a souvenir of all those sounds and kinds of tunes that were once the music of rural America."

*The Mother of Us All* has had a thousand performances in this country, from opera houses to church basements, since its Columbia University

première at the Brander Matthews Theater in May 1947, but it has never been recorded in its entirety (an orchestral suite drawn from it was briefly in the catalog). Now New World Records, busy building a hundred-record library of musical Americana under a Rockefeller grant, has stepped outside its usual distribution channels (music libraries and schools) to place before the general public a 1976 performance by the Santa Fe Opera. And a splendid performance it is, with Raymond Leppard (who made his reputation here by committing innumerable Baroque works, operas among them, to records) proving that he knows exactly how to communicate the drama, warmth, and theatrical vitality of this remarkable work to his listeners.

As fresh and audacious as the score itself are the excellent soloists who sing English so well that you can understand it without having to consult the handsomely set text; they blend expertly in the many ensemble passages as well. Mignon Dunn is perhaps a mite overemphatic in the title role, a little less concerned with the language of the piece than she might be, but impressive nonetheless. This is a well-recorded, well-packaged version of an opera that has been too long in getting to us on discs. Listener involvement is increased through the use of photographs from the Santa Fe production, the text of Maurice Grosser's scenario of the visual action, and the complete libretto (which you will need to sort out the many characters). One can only hope that *The Mother of Us All* receives the

kind of reception on the part of the listening public that will encourage someone to mount and record *Four Saints in Three Acts* so that it too can take its proper place on the ever-expanding shelf devoted to recordings of natively produced and natively appreciated masterworks.

—Paul Kresh

**THOMSON: *The Mother of Us All*.** Mignon Dunn (soprano), Susan B. Anthony; Batyah Godfrey (contralto), Anne; Aviva Orvath (soprano), Gertrude S.; Gene Ives (baritone), Virgil T.; Philip Booth (bass), Daniel Webster; James Atherton (tenor), Jo Loiterer; Joseph McKee (baritone), Chris the Citizen; Linn Maxwell (contralto), Indiana Elliot; Ashley Putnam (soprano), Angel More; other soloists. Santa Fe Opera Orchestra, Raymond Leppard cond. NEW WORLD RECORDS NW 288/289 two discs \$15.96.

---

## *Il Segreto de Susanna:* First Recording in Twenty-five Years of a Charming Opera Buffa

**C**OMIC OPERA, which Italian composers cultivated and audiences enjoyed continuously and enthusiastically from Pergolesi's *La Serva Padrona* (1733) to Verdi's *Falstaff* (1893),

went into something of an eclipse with the all but explosive arrival of *verismo* on the opera stage. Mascagni tried his hand at comedy unsuccessfully (*Le Maschere*, 1901), Leoncavallo and Giordano had no interest in the genre, and Puccini did not get around to his marvelous *Gianni Schicchi* until 1918.

Ermanno Wolf-Ferrari (1876–1948) was the exception to the general rule. He championed the *opera buffa* against the prevailing trend, with the result that his works were more appreciated abroad than they were in his homeland. We now have the first recording in some twenty-five years of his *Il Segreto di Susanna* (1909), a one-acter with a slender Pergolesian plot involving two characters and the traditional mute servant in a musical setting reminiscent of the dramatic sparkle and harmonic sophistication of *Falstaff*.

The story—a charming young Countess' secret passion for smoking causes her husband to suspect she is hiding a lover—is treated by the composer with lightness, skill, and economy of expression. The brightly melodic music resists the temptation to linger over a stroke of sentiment, pursuing instead a firm and winning course through alternating romantic and hectic (*Falstaff* again!) episodes. Lamberto Gardelli paces the whole with a masterly touch in a glittering performance.

Maria Chiara as Susanna is sweet and charming throughout, and her delightfully sensuous "smoking scene" is worthy of being compared to those of her great recorded predecessors, Geraldine Farrar and Lucrezia Bori. Bernd

"Mother" playback:  
front, soprano Mignon Dunn,  
conductor Raymond Leppard,  
and New World Records'  
Andrew Raeburn. Standing,  
recording engineers Wade  
Williams and Jerry Bruck.







COMPOSER ERMANNO WOLF-FERRARI



SOPRANO MARIA CHIARA



CONDUCTOR LAMBERTO GARDELLI

Weikl tends to overload his bright and attractive tone, but his singing is always vigorous and dramatically alert. The once timely but now hopelessly passé subject matter (you've come a long way, Susanna) limits this delightful opera's chances on today's stages, but this triumphant recording should vastly increase the number of its turntable partisans. —George Jellinek

**WOLF-FERRARI:** *The Secret of Susanna*. Bernd Weikl (baritone), Count Gil; Maria Chiara (soprano), Countess Susanna. Orchestra of the Royal Opera House, Covent Garden, Lamberto Gardelli cond. LONDON OSA 1169 \$6.98, © OSA 5-1169 \$7.95.

## A Must for Keyboard Fans: Colin Tilney Reveals the Beauties Of the Clavichord

**T**HE ultimate test of a good keyboard player is his performance on the clavichord—a monstrous little instrument so soft it can hardly be heard, with an action so light it is all but nonexistent, but capable nonetheless of the subtlest nuances of expression. It can also, unlike any other keyboard instrument, be played out of tune. Furthermore, capturing the sound of this machine accurately is the supreme test of a recording engineer's skills—which is why I take great pleasure in reporting

that Deutsche Grammophon's new release of fantasias by three Bachs and one Mozart is one of the few clavichord recordings I have heard in which both player and engineer have passed difficult trials with flying colors.

Colin Tilney has chosen the best possible repertoire (the moody, capricious world of the "fantastic") to reveal the secret beauties of the clavichord. He follows the moods of the pieces exquisitely, vaulting easily from the depths of pathos to the heights of comedy. His articulation is clear and historically accurate, embodying the precepts of C. P. E. Bach, the master of the instrument, whose keyboard music forms the core of the repertoire for it.

Of particular interest is Mr. Tilney's truly idiomatic (the clavichord idiom, that is) interpretation of J. S. Bach's Chromatic Fantasy and Fugue. Harpsichordists quite rightly play it as a virtuosic vehicle, but on the clavichord it takes on intimate, even tragic, overtones. Brilliant figurations become carefully wrought small gestures, chords become sharp stabs of feeling, and the counterpoint creates high tension between tortuous lines. The work thus takes on a completely different "affect," and Mr. Tilney has caught it perfectly. The same is true of the Mozart Fantasy: in Mr. Tilney's hands it becomes a little operatic *scena* that moves from tragic beginning to joyful conclusion.

I do not hesitate to call this disc a must for all keyboard players. It will offer them new and exciting repertoire, shed new light on a few standard works, and above all, reveal why the clavichord is the soul of all truly great keyboard playing. —Stoddard Lincoln

**COLIN TILNEY:** *Fantasias*. J. S. Bach: *Chromatic Fantasia and Fugue in D Minor (BWV 903)*. C. P. E. Bach: *Fantasia in C Minor (Wq 254)*; *Fantasias in C Major (Wq 59, 6 and Wq 61, 6)*. W. F. Bach: *Fantasia in D Minor (Falck 19)*. Mozart: *Fantasia in D Minor (K. 397)*. Colin Tilney (clavichord). DEUTSCHE GRAMMOPHON ARCHIVE 2533 326 \$7.98.

## Natalie Cole: A Big, Spangly Voice And an Enchanting Way with a Lyric

**O**KAY, everybody, you can relax now. Douse those candles, uncross those fingers, and smile. The kid has made it. Natalie Cole's newest Capitol release, "Unpredictable," is a dazzler, proof that the potential she showed in her two earlier albums has been realized, that the daughter of Nat "King" Cole has come securely into her own as a performer of quality.

Natalie Cole is a *singer-type* singer, and to be accepted as such is no mean accomplishment these days when belt and blast are still so much in fashion. Perhaps her biggest plus as a performer is her ability to be absolutely convincing no matter what she is singing. There is a baleful stretch of lyric toward the end of *I'm Catching Hell*, for instance, where she is called upon to deliver some Dear Abby-ish advice of that tire-

some straight-from-the-shoulder, look-here-girl-don't-let-your-man-go variety. Now, most of the time this sort of thing (unless it is safely in the hands of, say, Pearl Bailey or Dinah Shore) can drive us listeners of high sensitivity and low upchuck level in the direction of drink. Not so with Ms. Cole: she handles all this sticky stuff so suavely, with such casual grown-up grace, that you will find yourself nodding in complete agreement.

However enchanting her way with a lyric may be, it is of course much easier to succumb to that big, spangly voice she tosses about as effortlessly as a balloon. It must be sheer delight to be on the *inside* of such an instrument. It has been known to make some performers (no names, please!) unattractively full of themselves, but Ms. Cole seems rather to be "into herself" in the nicest possible way, bursting with feelings she is eager to communicate to and share with her listeners, but without any pestering insistence that we simply *have* to listen.

NATALIE COLE: *it must be sheer delight to be on the inside of such an instrument.*



Capitol Records

A bit of a bonus here is Ms. Cole's contribution as a songwriter. She wrote *Peaceful Living* and *Your Eyes*, and both are very fine, made even finer by her performances. There are not many stars of this magnitude in the pop galaxy, which means we must treasure them all the more. I certainly plan to.

—Peter Reilly

**NATALIE COLE: *Unpredictable.*** Natalie Cole (vocals); instrumental accompaniment. *This Heart; Still in Love; Party Lights; I've Got Love on My Mind; Unpredictable You; Peaceful Living; Be Mine Tonight; I Can't Break Away; Your Eyes; I'm Catching Hell.* CAPITOL SO-11600 \$6.98, Ⓜ 8XO-11600 \$7.98, © 4XO-11600 \$7.98.

## Re-creating the Spirit And the Professionalism Of the Twenties: Gary Lawrence & Co.

KNOW no more about Gary Lawrence and His Sizzling Syncopaters than the fact that they are responsible for a delightfully jovial yet deadly serious collection of period tunes all done up in Twenties and Thirties orchestral sty-

True, true. But there was also something else: musicians, arrangers, and orchestra leaders of that decade were thorough professionals all, with basic and even advanced training in music theory, harmony, and composition. They understood both their music's limitations and its possibilities, and when they set out to break the rules they always knew just what they were doing. That's why they accomplished so much, and why they had so much fun doing it.

American musical activity in the Twenties may be looked upon as pop music's Renaissance, a period of experiment, discovery, and adventure made possible by the commercial appeal of the versatile, flexible dance-band orchestra—now, alas, vanished. Lawrence has gone to considerable pains to re-create this period in music, to demonstrate that the spirit that made it move is still very much alive, still capable of energizing whatever it touches—the opening selection here, for example, a medley of Barry

White's *You're the First, the Last, My Everything* and Van McCoy's *The Hustle* in which both these pieces of plastic are made to sound like the real thing, plus a vocal in the delightful manner of Fats Waller sending up a tune he didn't think much of.

Although most of Lawrence's arrangements are basically original (with

Although most of Lawrence's arrangements are basically original (with

Although most of Lawrence's arrangements are basically original (with

the stated exception of *Sugarfoot Stomp*, transcribed from a Fletcher Henderson recording), there are other selections that show their derivation plainly. *Crazy Words, Crazy Tune* owes quite a bit to the 1927 recording by Irving Aaronson & His Commanders, a vaudeville and theatrical pit band; *Doin' the Raccoon* comes from the 1928 original by George Olsen and His Music; and *Clementine (from New Orleans)* retains some of the relaxed "head" arrangement used by the personnel of the Jean Goldkette Orchestra in their 1927 recording. *The Mooche*, Duke Ellington's early, eerie masterpiece, is taken from the Ellington band's 1928 performances (Duke made three of them in that year, all for different labels).

Mr. Lawrence's prime concern throughout the album is the listener's enjoyment, and he succeeds so completely in insuring this that formal words of praise go stale. It's much better to listen to this gorgeous, snappy, beautifully disciplined program and

*Crazy Words, Crazy Tune (Vo-Do-De-O-Do); Clementine (from New Orleans); Shim-me-sha-wabble; The Breakaway; Croonin' a Tune about June; Here Lies Love; The Charleston; When the Moon Shines on Coral Gables; Thinking of You; Doin' the Raccoon; Sugarfoot Stomp.* BLUE GOOSE 2020 \$6.98.

## Joel Shulman and Friends Present a Family Album of Jazz Without Artificial Ingredients

THROUGH the courtesy of Attic Records of Canada there has appeared on my turntable a kind of family album, a series of candid, aural snapshots of pianist Joel Shulman and musician

make appearances one at a time.

Moe Koffman—best remembered for his 1957 hit *Swingin' Shepherd Blues*—is the only performer previously known to me. His flute work on the 1942 Ram Ramirez standard *Lover Man* is better than anything I've heard him play before (and I've heard him play very well indeed), but it would be as unfair not to mention that each of Mr. Shulman's three other collaborators gives equally effective performances as it would be not to record that the album itself is a standout among the releases I have heard thus far this year.

Pianist Shulman is not the kind of keyboard dazzler who will leave you breathless with his technique or style, but he has a wonderful feeling for his material, a feeling that makes the Garden Party sound like an idyllic spot for those who like their music prepared without any artificial ingredients.

—Chris Albertson

**JOEL SHULMAN: *Nowhere but Here.*** Joel Shulman (piano); in duets with Guido Basso



GARY LAWRENCE AND HIS SIZZLING SYNCOPATORS: a snappy, beautifully disciplined program.

simply whoop for joy. Bravos to leader Lawrence and to his musicians and singers as well. —Joel Vance

**GARY LAWRENCE AND HIS SIZZLING SYNCOPATORS.** Gary Lawrence (piano, arr., and cond.); instrumental and vocal accompaniment. *You're the First, the Last, My Everything/The Hustle; The Mooche;*

friends who regularly drop in at the Garden Party, a combination plant-shop/restaurant operated by Shulman and his wife in a Toronto basement. There is a very warm feeling about the forty or so minutes of music captured, a quiet, relaxed mood set by Shulman's own lyrical piano style and maintained by his very compatible cohorts, who

(flugelhorn), Moe Koffman (flute), Don Thompson (vibraphone, bass), and Ada Lee (vocals). *Lover Man; Eleanor Rigby; After You've Gone; Sunshower; Entrance; Trust in Me; Once upon a Summertime; Sea of Tranquility; When the World Was Young; Nowhere but Here; We'll Make Our Garden Grow.* ATTIC LAT 1014 \$7.98 (from Attic Records, Ltd., 350 Davenport Road, Toronto, Canada M5C 1S6).



# POPULAR DISCS AND TAPES

Reviewed by CHRIS ALBERTSON • NOEL COPPAGE • PAUL KRESH • PETER REILLY  
STEVE SIMELS • JOEL VANCE

**THE BABYS.** John Waite, Walt Stocker, Mike Corby, Tony Brock (vocals and instrumentals). *Looking for Love; If You've Got the Time; I Believe in Love; Wild Man; Laura;* and five others. CHRYSALIS CHR 1129 \$6.98.

Performance: **Competent**  
Recording: **Excellent**

Bob Ezrin is a brilliant producer. His track record, especially in heavy-metal rock, has been impeccable: Alice Cooper, Mitch Ryder, and Lou Reed are in his stable, and last year he pulled off what may have been the feat of his career—he made Kiss sound so clean and respectable on "Destroyer" that the album was furiously rejected by most of their fans.

Clearly the man is a miracle worker, so is it any wonder that I don't believe his latest charges, the Babys, have any real magic of their own? This album is a fine mixture of driving metal and wistful ballads, often within the same song. Needless to say, the dynamics are flawless, and Ezrin obviously knows how to get a superbly resonant sound out of these boys. The trouble is that it's the same sound he got out of Kiss, Cooper, *et al.* Once you get past the surface flash to the actual songs and performances, there's nothing much that sticks in the memory, which leads to the inevitable question of just what the Babys would be without their sitter. Not much, I'm afraid; just another competent hard-rock band. Competent heavy metal is the ultimate bore, and perhaps it's true that in the age of specta-

cle the music all belongs to the producers and technicians. That's certainly who stars here.

Lester Bangs

**THE BAND: *Islands.*** The Band (vocals and instrumentals). *Right as Rain; Street Walker; Let the Night Fall; Ain't That a Lot of Love; Christmas Must Be Tonight;* and five others. CAPITOL SO-11602 \$6.98, Ⓢ 8XO-11602 \$7.98, Ⓒ 4XO-11602 \$7.98.

Performance: **Languid**  
Recording: **Good**

Well, what did you expect from an outfit that has officially broken up as a live performing unit—a masterpiece? As a matter of fact, this new Band album is *exactly* what you'd expect from them, given that everyone involved is obviously more interested in getting his individual career launched and consequently is saving his good material for forthcoming solo LP's. "Islands" is a rushed, uninvolved effort from a group that no longer plays like a coherent unit.

With the exceptions of an occasional dollop of the inimitably intense, strangled-sounding guitar of Robbie Robertson and the usual lovely keyboard bits from Garth Hudson, there is absolutely nothing on this record to recommend. There's no theme, no passion, no interplay, no anything at all—unless you like the idea of a Band album that sounds as bland as, say, the Eagles or David Gates and Bread. Buy "The Best of the Band" and hope they start playing behind Dylan again; this one is a waste of your time and theirs. S.S.

**BARCLAY JAMES HARVEST: *Octoberon.*** Barclay James Harvest (vocals and instrumentals). *The World Goes On; May Day; Ra;* and four others. MCA-2234 \$6.98, Ⓢ MCAT-2234 \$7.98.

Performance: **Pretentious**  
Recording: **Good**

It's hard to believe that a group like Barclay James Harvest has been around half a decade without either breaking through to mass popularity or fading from sight. Their imitation Crosby, Stills, Nash, and Young vocal harmo-

nies date them as surely as their *Lord of the Rings* cover art, and their instrumental sound consists entirely of riffs looted from the Moody-Blues/Yes bag of English art-rock clichés. The lyrics deserve special mention for pretension beyond the call of duty (*Ra*: "Burning fiery furnace in the sky/Burns the ground around us where we lie/Sad old black faced thunder will you rise . . ."). Just what the world needs more of: second-rate kitsch.

Lester Bangs

## RECORDING OF SPECIAL MERIT

**JIMMY BUFFETT: *Changes in Latitudes, Changes in Attitudes.*** Jimmy Buffett (vocals, guitar); Fingers Taylor (harmonica); Michael Utley (keyboards); Harry Dailey (bass); Michael Gardner (drums); Michael Jeffrey (lead guitar); other musicians. *Changes in Latitudes, Changes in Attitudes; Wonder Why We Ever Go Home; Banana Republics; Tampico Trauma; Lovely Cruise; Margaritaville;* and four others. ABC AB-990 \$6.98, Ⓢ 8020-990H \$7.98, Ⓒ 5020-990H \$7.98.

Performance: **Different**  
Recording: **Good**

I guess the point to make here is that Buffett in transition is still more satisfying than most people snuggled in on a comfortable plateau. The old Buffett swagger is muted here, though there's not much in the words or tunes to suggest why. The arrangements put a little more emphasis on the Caribbean aspect of his peculiar Nashville-Caribbean mix, but they hardly do anything radical. Buffett just sounds a little less sure of himself. Still, he sings well—doesn't even do badly by Jesse Winchester's *Biloxi*, considering that the unbeatable Tom Rush version is called up in my mind and calmly stares down this and other upstart versions. And Buffett has come up with some good songs of his own. A couple are very good: (*Wastin' Away in*) *Margaritaville*, a wry Buffett special of a downer, and *Miss You So Badly*, a sort of rhapsody on the theme of *Come Monday*. I wouldn't give Buffett a gold star for this one, but he's in solid in the "acquits himself nicely" column. N.C.

### Explanation of symbols:

- Ⓡ = reel-to-reel stereo tape
- Ⓢ = eight-track stereo cartridge
- Ⓒ = stereo cassette
- = quadraphonic disc
- Ⓡ = reel-to-reel quadraphonic tape
- Ⓢ = eight-track quadraphonic tape

Monophonic recordings are indicated by the symbol Ⓜ

The first listing is the one reviewed; other formats, if available, follow it.

**GLEN CAMPBELL:** *Southern Nights*. Glen Campbell (vocals); instrumental accompaniment. *Southern Nights*; *This Is Sarah's Song*; *For Cryin' Out Loud*; *God Only Knows*; *Sunflower*; and five others. CAPITOL SW-11601 \$6.98, ⑧ 8X0-11601 \$7.98, ④ 4X0-11601 \$7.98.

Performance: **Glen grows up**  
Recording: **Very good**

Glen Campbell's sixth release for Capitol finds him still singing songs in praise of Southern nights, sunflowers, and sexy women who love him, leave him, and sometimes practically drive him to tears. He doesn't really need to be accompanied by anything more than his own adroitly self-strummed guitar, but of course he's surrounded here by gigantic orchestral arrangements that unfold like the petals of great plastic orchids in the climaxes singers these days seem to think they have to achieve to impress upon us that they're in excellent form, thank you, and that rumors of decline from the full vigor of their talents are premature if not downright false. Campbell's voice and his once unlined country-boy face have lately lost more than a little of their freshness and open innocence. What he offers now instead is a growing skill at handling the emotional content of a ballad, making even the moist humility of a song like *God Only Knows* sound more sincere than most country singers are ever able to manage with such contrived glop. And when he lowers his voice to a hush to handle a less pretentious love song like *Guide Me*, it is obvious that Glen Campbell knows how to transform the cheap raw material of a popular ballad into heartfelt music. It's reassuring. P.K.

**VALERIE CARTER:** *Just a Stone's Throw Away*. Valerie Carter (vocals); instrumental accompaniment. *City Lights*; *Cowboy Angel*; *Face of Appalachia*; *So, So, Happy*; *Back to Blue Some More*; and four others. COLUMBIA PC 34155 \$6.98, ⑧ PCA-34155 \$7.98.

Performance: **Routine**  
Recording: **Good**

Valerie Carter has a rather "in" air about her—folks like Linda Ronstadt fill in as background vocalists while Jackson Browne and John Sebastian, among other musicians, make up the orchestra—but her album is thin, routine stuff. *Face of Appalachia* is stylishly mournful, depleted-sounding, and very, very tasteful. Things get a lot better in *So, So, Happy*, in which she really swings out, but then it's right back to sensitive murmurs in *Cowboy Angel*. Valerie Carter is one of those girls whose friends seem a lot more interesting than she does. P.R.

#### RECORDING OF SPECIAL MERIT

**JOHNNY CASH:** *The Last Gunfighter Ballad*. Johnny Cash (vocals, guitar); instrumental accompaniment. *I Will Dance with You*; *The Last Gunfighter Ballad*; *Far Side Banks of Jordan*; *Ridin' on the Cotton Belt*; *Give It Away*; *You're So Close to Me*; *City Jail*; *Cindy*; *I Love You*; *Ballad of Barbara*; *That Silver-Haired Daddy of Mine*. COLUMBIA PC-34314 \$6.98, ⑧ CA-34314 \$6.98, ④ CT-34314 \$6.98.

Performance: **On target**  
Recording: **Very good**

Talk about native intelligence. John R. Cash not only has it but knows how to let those in

his audience who value intelligence see it while not flaunting it at those in his audience who fear it. He's a mess of contradictions, Cash is, and appeals to the damndest cross-section of people. He's figured out how to layer his projections of himself so that each image can be appreciated on various levels. For this Columbia album, "The Last Gunfighter Ballad," he's written some wryly comical liner notes, and the songs he wrote and chose include something for just about every facet of his audience. It's surprising to me how many facets I seem to fit into. The title song by Guy Clark, for instance, can be taken as straight romantic drivel about cowboys or it can be taken as black humor—and Cash teases the question a bit further with his album-jacket poses. There's a really fine song about his father, *Riding on the Cotton Belt*, and there are all kinds of semi-hokey things and a few rather sophisticated ones.

So it goes. I wouldn't care to get into a poker game with this guy. He's also done a great

job of making an album, too, by the way, in case you were wondering. It's Cash in good form, something unique. There are no *Look at Them Beans* excesses in this one, just the regular endearing excesses that make Cash Cash. N.C.

**THE CENTRAL PARK SHEIKS:** *Honeysuckle Rose*. John Caruso (bass); Matt Glaser (violin); Bob Hipkens (dobro, trumpet, vocals); Bert Lee (vocals, guitar); Richard Lieberson (vocals, guitar); other musicians. *Shipwrecked Man*; *I Was Doing All Right*; *The Prize*; *Way Down Yonder in New Orleans*; *Stomping at the Savoy*; *San Antonio Rose*; and six others. FLYING FISH 026 \$6.98.

Performance: **Cold**  
Recording: **Very good**

Some songs probably *can't* be done with feeling, and never could—consider *San Antonio Rose*. Others on this record can be done with feeling but aren't, as the Central Park Sheiks

## Richard Thompson Live!



Island Records

**RICHARD THOMPSON LIVE!** (More or Less)" is the long-awaited United release of Richard and Linda Thompson's "I Want to See the Bright Lights Tonight," one of the greatest pieces of recorded music since . . . oh, the Crusades, at the very least. It is padded out with some studio out-takes and one complete side of live stuff (all quite compelling), so if you're a Thompson fan salivating at the prospect of two solid discs of him live, be advised that the "more or less" part of the title is accurate.

"Bright Lights," released in the U.K. in 1974, is one of the finest things to come out of the British folk movement, an honest excursion into the depths of a tormented soul, couched in some of the most beautifully textured, melodically rich, and exquisitely played rock-and-roll you will ever be privileged to hear. Linda is one of the most moving

singers around, in any style, and Richard's guitar work is slashing and innovative. Describing his style is a bit difficult; the closest I can come is to say that he puts me in mind of a sixteenth-century Jeff Beck—if such a thing is possible. He has done for English folk music and guitar playing what Roger McGuinn has done for their American counterparts—made it electric, made it contemporary, and then used it as a transmission line for a unique, personal vision.

The back-up band, all graduates of the Fairport Convention floating musical crap game, sound as if they've been playing together for years; they're at least as good in their own way as the superb group Rod Stewart assembled for his first solo LP. The Stewart comparison is actually quite apt; if his album was, as many critics have asserted, the culmination of the British blues school, then this is certainly the English folk-rock equivalent in terms of both emotional impact and maturity.

If you buy no other album this year, this is the one you should invest in; it's as close to a masterpiece as anything you'll ever have in your collection. And if you think that's mere hyperbole, then you're going to be pleasantly surprised. —Steve Simels

**RICHARD THOMPSON:** *Richard Thompson Live! (More or Less)*. Richard Thompson (guitar and vocals); Linda Thompson (vocals); Timi Donald (drums); Pat Donaldson (bass); other musicians. *When I Get to the Border*; *Calvary Cross (two versions)*; *Withered and Died*; *I Want to See the Bright Lights Tonight*; *Down Where the Drunkards Roll*; *We'll Sing Hallelujah*; *Has He Got a Friend for Me*; *The Little Beggar Girl*; *The End of the Rainbow*; *The Great Valerio*; *The Ballad of Easy Rider*; *Poor Will and the Jolly Hangman*; *A Heart Needs a Home*; *The Dark End of the Street*; *The Pitfall/The Excursion*; *Flee as a Bird*; *Night Comes In*. ISLAND 9421 two discs \$7.98, ⑧ Y81 9421 \$7.98, ④ ZC1 9421 \$7.98.



Epic Records

**MARSHALL CHAPMAN:**  
good tunes and lyrics  
with a quality  
of toughness

are on a slick nostalgia trip only a cut or so above that of Manhattan Transfer. Everything here is squeaky clean, including, I assume, the expressions on the faces of the people playing this stuff. There's a lot of dehydrated competence (maybe if you added boiling water?), but it doesn't work as straight cuteness and it doesn't work as camp. You can't set out to make camp. Trying to is what makes the Seventies such a dud culturally.

N.C.

#### RECORDING OF SPECIAL MERIT

**MARSHALL CHAPMAN:** *Me, I'm Feelin' Free*. Marshall Chapman (vocals, guitar); Reggie Young (guitar); Buddy Emmons (dobro, steel); Pig Robbins (piano); other musicians. *Somewhere South of Macon; Know My Needs; Five O'Clock in the Morning; Between Carolina and Texas; What I'd Give; Crystal Clear*; and four others. EPIC KE 34422 \$6.98, © EA-34422 \$6.98.

Performance: **Very good**  
Recording: **Good**

Marshall Chapman is a privileged kid who sings and writes country-flavored songs about hard living, and she's more convincing than some country women who've had firsthand experience with hard times. She is not, of course, the greatest thing since chocolate chip cookies, as the hype that's building up behind her tends to suggest. My favorite blues singer who was born rich is still Bonnie Raitt, by a long shot. But Chapman writes (usually with someone else) good tunes and better than average words, and there's a quality of toughness in both her songs and singing. Authority, too. The thing that's missing, if she's looking to get into the Raitt-Ronstadt-Harris-Baez class, is a high degree of stylishness. Not every song clicks, either. *Rode Hard and Put Up Wet* is just there to pick up the pace, and it

might have been better to put in another slow one, something on the order of *A Woman's Heart (Is a Handy Place to Be)* if she has any more of that caliber. Chapman has a kind of drive and some real talent that are going to get her somewhere, though, in spite of a few slip-ups here and there.

N.C.

**NATALIE COLE:** *Unpredictable* (see Best of the Month, page 91)

#### RECORDING OF SPECIAL MERIT

**PAULINHO DA COSTA:** *Agora*. Paulinho da Costa (miscellaneous percussion instruments); Frank Rosolino (trombone); Larry Williams (flute, saxophones); Lee Ritenour (guitars); others. *Simbora; Belisco; Terra*; and three others. PABLO 2310-785 \$7.98, © S10-785 \$7.98, © K10-785 \$7.98.

Performance: **Hypnotic**  
Recording: **Very good**

Since the bossa nova craze of the early Sixties a number of Brazilian musicians have made their way to this country, bringing with them a rich rhythmic heritage and a colorful array of percussion instruments. The most successful of these men has been Airtó Moreira, but in this album twenty-nine-year-old Paulinho da Costa, who has been with the pop-oriented Sergio Mendes group for the past three years, promises to give Mr. Moreira a good run for his money.

Having previously recorded with both Dizzy Gillespie and Milt Jackson, Da Costa is no stranger to jazz. The band here is good and precise, and there are excellent performances by trombonist Frank Rosolino and saxophonist Larry Williams. But it is the last track, *Ritmo Number One*, featuring eight overdubs by Da Costa, that really makes this an outstanding album. Using everything from spoons to a frying pan, Da Costa gives us an eight-and-a-

half-minute impression of the rhythms that fill the streets and alleys of Rio de Janeiro at carnival time—it is hypnotic, infectious, and simply marvelous. For having given us Paulinho da Costa, I am now ready to forgive Brazil for unleashing Flora Purim on us.

C.A.

**NEIL DIAMOND:** *Love at the Greek*. Neil Diamond (vocals); orchestra. *Streetlife; Beautiful Noise; Stargazer; Glory Road; Surviving the Life*; and eleven others. COLUMBIA KC2-34404 two discs \$11.98, © CAX-34404 \$11.98, © CTX-34404 \$11.98.

Performance: **Heavy, man, heaveee . . .**  
Recording: **Boomish**

Here's Neil Diamond, the Bard of the American middle class (the "feeling" part, that is), throwing his considerable box-office weight around in another garish album, this one recorded before a packed audience at the Greek Theatre in Los Angeles. The warmth of the appreciation from Diamond's pin-drop-quiet audience as he slobbered his way through something like his five-song tone poem *Jonathan Livingston Seagull* was probably enough to melt a box of opera creme chocolates on that historic night. Just listening to it after the fact, on a recording, can give you the shivers of one sort or another. Diamond also runs through such of his other lollipops as *Stargazer* and *The Last Picasso* to the uproarious delight and deep-deep feeling of his audience. Just think, they've banned saccharin and let Neil Diamond go absolutely free! There is no justice.

P.R.

**YVONNE ELLIMAN:** *Love Me*. Yvonne Elliman (vocals); instrumental accompaniment. *Hello Stranger; I Know; Good Sign; I'd Do It Again; She'll Be the Home*; and four others. RSO RS-1-3018 \$6.98, © 8T-1-3018 \$6.97, © CT-1-3018 \$6.97.

Performance: **Good**  
Recording: **Good**

A thoroughgoing pro, Yvonne Elliman has the ability to make do no matter how lackluster the material. The strain shows here, however, in material that is dim-dimmer-dimmest—in particular, in the five dismal songs by B. J. Verdi and Chris Yarian. Elliman's own *I Know* isn't much above the level of passing-grade either. The only thing that does give her a chance to show off her sexy, hard-edged style is the title song, *Love Me*, by Barry and Robin Gibb of Bee Gee fame, and it's a fine, solid performance. Otherwise, there's not much going on here.

P.R.

**FLAMIN' GROOVIES:** *Still Shakin'*. Flamin' Groovies (vocals and instrumentals). *Teenage Head; Evil Hearted Ada; Comin' After Me; Have You Seen My Baby; Walkin the Dog; Doctor Boogie*; and eight others. BUDDAH BDS 5683 \$6.98.

Performance: **Okay**  
Recording: **Variable**

The Groovies had the misfortune to be the only mainstream rock band in San Francisco during that city's psychedelic musical heyday. They played old-fashioned, no-bones-about-it rock-and-roll (with a real stage act, no less) and were consequently pretty much ostracized at home. When they came to New York in the early Seventies, they were befriended by the city's critics, who have a habit of overreacting (the Groovies were hardly an

(Continued on page 100)

# Who says you can't

*match the quality of your home stereo in your car, truck or van?*

- Extra thick mounting gaskets permit long cone excursions, assure long life free of friction against mounting surfaces.
- 6" x 9" air suspension woofer delivers deep, rich bass tones.
- 3" distortion-free tweeter assembly delivers sparkling highs.
- Powerful, precision-ground molded ferrite magnet provides peak flux density and uniquely high efficiency.
- 1 1/4" high temperature voice coil provides high power handling capability and continued reliable operation.
- 20 oz. magnet.
- Speaker design assures consistently smooth frequency response throughout the audible spectrum and performance stability in all weather conditions.

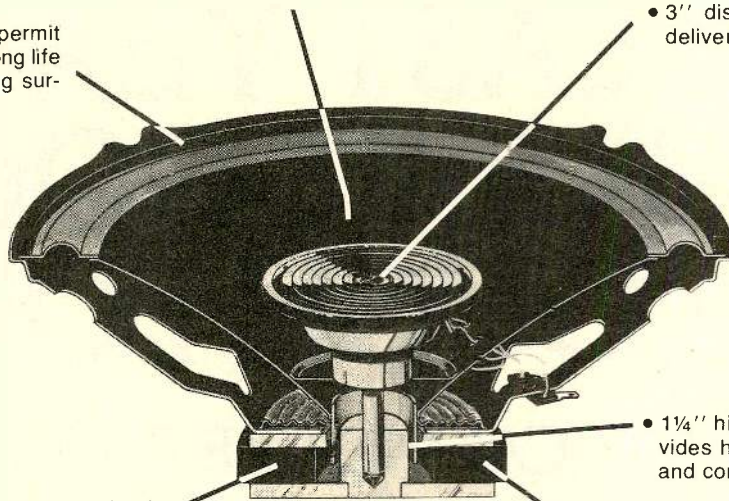

## **EVERYBODY EXCEPT AFS—makers of the KRIKET® KLASSIC™**

### **“Perfect Balance”™ car stereo speaker**

Here's what the features of our 6" x 9" coaxial speaker, Model 8972, mean to you. Our woofer captures all the low and midrange tones worth hearing. Our highly sensitive tweeter mounts independent of a bulky superstructure known to shield wanted sound in speakers of the past. A full 20 oz. magnet (not two stacked 10's) and aluminum voice coil assure efficiency and superb sound definition from the smallest units to the large 60 watt power boosters so popular today.

Outstanding sound reproduction and rugged, long lasting performance are standard in all KLASSIC™ speakers. Frequency response, power handling and efficiency are balance-blended in a unique new way.

Because the art of speaker making is compromise. When you add to the bass, for example, you must compensate for loss in the high end. We have. Every component in every KLASSIC™ speaker has been exhaustively tested to work in harmony, each with the other.

The result is sheer, unadulterated, pure music reproduction. Put our KLASSIC™ speaker to the test. Let your ears be the judge of all we say. If you listen to a KLASSIC™ speaker, you'll buy it.



Available at car stereo dealers everywhere.

**afs/Kriket**

Acoustic Fiber Sound Systems, Inc.  
Indianapolis, Indiana

All afs®/Kriket® products are manufactured in the U.S.A.

Copyright 1977, Acoustic Fiber Sound Systems, Inc.

CIRCLE NO. 5 ON READER SERVICE CARD

# WHAT THE EXPERTS CALLED THE BEST LAST YEAR WASN'T GOOD ENOUGH FOR US.

**"IT CANNOT BE FAULTED."**

*SA9500 — Stereo Review*

**"AS NEAR TO PERFECT  
AS WE'VE ENCOUNTERED."**

*TX9500 — Popular Electronics*

**"CERTAINLY ONE OF THE BEST...  
AT ANY PRICE."**

*TX9500 — Modern Hi Fi*



SA9500II



Last year, the experts paid Pioneer's integrated amps and tuners some of the highest compliments ever.

The challenge was obvious: to build even better amps and tuners. Amps and tuners that would not only surpass anything we'd ever built before, but anything anyone ever built before. Here's how we did it.

**THE NEW PIONEER TX9500II TUNER:  
EVEN CLOSER TO PERFECT.**

When Popular Electronics said our TX9500 tuner was "as close to perfect" as they'd encountered, they obviously hadn't encountered our TX9500II. It features technology so advanced, some of it wasn't even perfected until this year.

Our front end, for example, features three newly-developed field effect transistors that work to let you pull in beautiful FM reception no matter how far you live from the transmitter. And no matter how much interference there is in your neighborhood.

Where most tuners give you one band for all FM stations, the TX9500II gives you two. A wide band with a new surface acoustic wave filter to take advantage of strong stations, and a narrow band with five ceramic filters to remove the noise and interference from weaker ones.

And where conventional multiplex circuits accidentally cut out frequencies that add depth and presence to music, the multiplex circuit in the TX9500II doesn't. It features a Pioneer-developed integrated circuit that's far more accurate than anything else around. So the music begins to sound as if it's coming live from your living room, instead of from some radio station miles away.

**THE NEW SA9500II AMPLIFIER:  
HOW TO GET THE MOST OUT OF THE BEST.**

After building one of the world's best tuners, we had no choice but to create an amplifier that could match it.

The result is the new SA9500II. An 80\* watt integrated amp that was designed to let you get every-

thing out of your tuner. Perfectly.

Our output stage, for example, features a new parallel push-pull circuit that reduces total harmonic distortion to less than 0.1%. Well below the threshold of human hearing.

To all but eliminate cross-talk, the SA9500II comes with a separate power transformer for each channel, instead of the usual single transformer for both.

And where some amps give you two, or three tone controls, the SA9500II gives you four. Two for regular treble and bass, and two for extended treble and bass. They're calibrated in 2 dB click stops, which means you have a virtually endless variety of ways to get the most out of your music.

Obviously, both the SA9500II and the TX9500II are very sophisticated pieces of equipment. But all of the engineering skill that went into making them has gone into every tuner and amplifier in our new series II. No matter what the price, no matter what the specifications.

And that's something you don't have to be an expert to appreciate.

**SA9500II—TX9500II**

|                                    |       |                             |                                |
|------------------------------------|-------|-----------------------------|--------------------------------|
| POWER MIN. RMS,<br>20 TO 20,000 Hz | 80    | SIGNAL TO NOISE<br>RATIO    | Mono 82dB<br>Stereo 77dB       |
| TOTAL HARMONIC<br>DISTORTION       | 0.1%  | FM SENSITIVITY<br>(IHF '58) | 1.5uV                          |
| PHONO OVERLOAD<br>LEVEL            | 300mV | SELECTIVITY                 | (wide) 35dB<br>(narrow) 85dB   |
| INPUT: PHONO/AUX/<br>TAPE          | 2/1/2 | CAPTURE RATIO               | (wide) 0.8dB<br>(narrow) 2.0dB |

\*Minimum RMS continuous power output at 8 ohms, from 20 to 20,000Hz, with no more than 0.1% total harmonic distortion.

High Fidelity Components

**PIONEER®**  
WE BRING IT BACK ALIVE.

U.S. Pioneer Electronics Corp., 75 Oxford Drive, Moonachie, New Jersey 07074

© U.S. PIONEER ELECTRONICS CORP. 1977

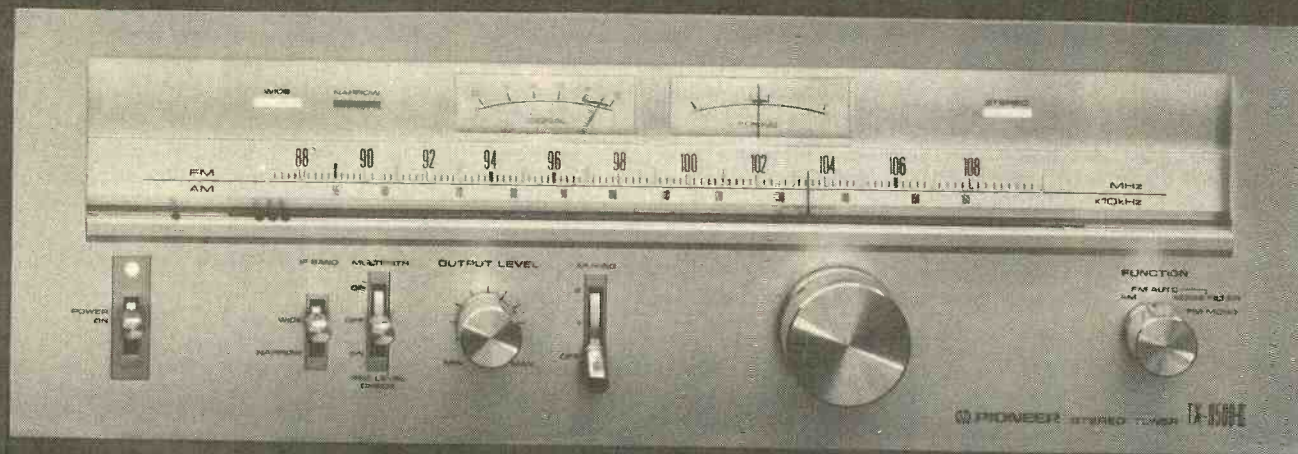

**TX9500II**

CIRCLE NO. 61 ON READER SERVICE CARD



Stuart G. Lieber

## Janis Ian: The Girl Most Likely

JANIS IAN is for the trendies one of the most exciting, red-hot writer/performers in pop at the moment; for the rest of us she's definitely here to stay. With "Miracle Row," her latest album on Columbia, she has seized for herself the title of Girl Most Likely to Get Pop off Its Moribund Ass in the Late Seventies.

Like the lady herself, "Miracle Row" exudes theatricality. It has equal amounts of the high romance of the low life and the jaded, dark-red-nail-polish lows that accompany the high life. Ian's theatricality, like that of another Great Proletarian, Bertolt Brecht, may not be immediately discernable, but it is there. She, too, chooses street argot as her lyric form, and the nonchalant gut punch seems to be her favorite device. But she is more than an artistic descendant of Brecht in her sardonic, toughly humorous acceptance of an existential world in which the cunning, the avaricious, and the brutal all too often float to the top while the *Lumpen* below devour each other in desperation—she is also Brecht's Pirate Jenny come to stinging, poignant, poetic life.

Like Brecht, Ian is an angry artist. In the years succeeding *Society's Child*, her first musical outburst at the age of sixteen, it was touch and go as to whether or not the anger would consume the artist. At *Seventeen*, that bitter little paean to the arid joys of "settling for" (from "Between the Lines," her second "comeback" album) gave notice that the old fire could still scorch its subject despite its de-

ceptively gentle melody. With "Aftertones," however, the mature Ian emerged. She kept traces of the daydreaming, slightly murderous gamine—the Pirate Jenny—that she'd always been, but she was now in control of herself and her enormous talents. Instead of blindly flailing at the objects of her scorn and only sometimes hitting the mark, she projected a serene self-confidence. This sense of assurance came through not only in her angry moments such as the hilarious and raucous *Boy, I Really Tied One On* (probably the best song of its kind since *It Was Just One of Those Things*), but also in her ability to be unabashedly and yearningly romantic as in *I Really Would Like to Dance*.

The songs in "Miracle Row" are chiaroscuro sketches in both words and music. Ian uses the technique masterfully in *Party Lights*, for instance. She sheds equal amounts of intense light ("Party lights/Champagne and caviar/Cocaine and Shalimar . . .") and the most chilling darkness ("People tell me that/I'm fading fast/But I can't last/The whole night through . . .") in telling the story of someone who has Made It, the guest of honor at one of those grotesque Marvelous Parties designed to show the world you've arrived. Ian's caustic advice: "Don't lose your head/Remember all those things your mama said/But every vampire here appears well-fed/You look half-dead/They like you, kid." All of this is set to a mordantly bouncy little tune that can freeze your blood.

THE most ambitious track here is *Miracle Row/Maria*, two related songs about summer in a ghetto and a girl with "eyes like a demon lover's child." It succeeds admirably on every professional level, particularly in the stunning guitar arrangements by Jeff Layton, but it fails ultimately because it is theatrical in the wrong context—*Mother Courage* playing Radio City Music Hall. Absolutely on target in every way, however, unique and securely in Brecht-Ian territory, is the bloodcurdling Spanish-flavored serenade *Will You Dance?* Two ladies, probably standing on a balcony, await "the revolution" and muse about "How romantic to be whoring/Boring though it may be/Who'll survive if you and I should fall?" And then, riding on the lightest of tunes, Ian's voice as dainty and ultra-refined as Lucrezia calling for the after-dinner mints or Jenny savoring her macabre triumph, comes the final chorus: "Someone is bleeding/Crimson in the night/Strangers, in the light/A sudden meeting/Greeting one by one/Every life runs flashing/Before those dashing eyes/Will you dance?/Will you dance?/Take a chance on romance/And a big surprise."

Ian produced "Miracle Row" along with Ron Frangipane, and it is a lovely exercise in seriousness without a trace of grandiosity. It's an album by a real person about real things.

—Peter Reilly

**JANIS IAN: *Miracle Row*.** Janis Ian (vocals, guitar, keyboards); Claire Bag (vocals); Jeff Layton (guitar); other musicians. *Party Lights; I Want to Make You Love Me; Sunset of Your Life; Take to the Sky; Candlelight; Let Me Be Lonely; Slow Dance Romance; Will You Dance?; I'll Cry Tonight; Miracle Row/Maria*. COLUMBIA PC 34440 \$6.98, © PCA 34440 \$7.98, © PCT 34440 \$7.98.

important band, and certainly they never had what could be termed a personal style), and went on to become cult figures.

Last year, with a new and vastly superior line-up and the benefit of Dave Edmunds' production skills, they made their first really good record, "Shake Some Action." This current release is a shabby attempt to ride on the back of that success. Side one is a compilation of the better tracks from the two albums on the Groovies' second label (they're currently on their third); side two is a live-in-studio jam session, hitherto unreleased, that features the original group running through a series of rock standards with about as much panache and polish as the average teenage garage band. The whole thing is capped with incredibly self-serving liner notes by their original producer. This stuff is for cultists only.

S.S.

**FLEETWOOD MAC: *Rumours*.** Fleetwood Mac (vocals and instrumentals). *Second Hand News; Dreams; Never Going Back Again; Don't Stop; Go Your Own Way; You Make Loving Fun*; and five others. WARNER BROS. BSK 3010 \$7.98, © M8 3010 \$7.97, © M5 3010 \$7.97.

Performance: **Better than the material**  
Recording: **Clean**

Last year's extraordinary Fleetwood Mac comeback LP was not only one of the pleasanter surprises of 1976, but also one of the most solid and attractive bits of pop rock since the dawn of the decade. Without indulging in the widespread speculation about the band's personal problems which has already appeared in the pop press, let's just say that "Rumours," the long-awaited follow-up, is a distinct letdown. Christine McVie, the major creative talent of the band, has taken even more of a back seat than usual to the lesser efforts of her co-workers Lindsey Buckingham and Stevie Nicks. Further, the band's decision to produce themselves this time was a mistake; too many of the songs here sound like they were done in a Phil Spector echo chamber at the bottom of the Grand Canyon, which is particularly effective in sabotaging a voice like Christine's.

The only really successful track here is Buckingham's hit *Go Your Own Way*, as catchy and energetically performed a rock single as we are likely to hear in the immediate future. It jumps off the turntable in the same way it jumps off the radio; you want to hear it again immediately. The rest is all solidly crafted and certainly pleasant, but it seems rather pointless to shell out \$7.98 for what is essentially a one-song album. *Caveat emptor*.

S.S.

**DEAN FRIEDMAN.** Dean Friedman (vocals, guitar, piano); Jim Ryan (guitar); Tony Levin (bass); other musicians. *Company; Ariel; Solitaire; Song for My Mother; Woman of Mine; The Letter*; and four others. LIFESONG LS 6008 \$6.98.

Performance: **Strange**  
Recording: **Good**

Dean Friedman's melodies here tend to be dull to ill-advised, his voice is thin and medium uninteresting, and, although he has a knack for words, he's trying to be gimmicky with them. He uses simple, plain, direct language, fairly effectively sometimes, and it reads like prose. It is also set like prose, in

(Continued on page 102)



**Now  
you can help  
your music  
for a song.**

As an imaginative tool for overdub sessions, for demos and for experimentation, the TEAC A-3340S is the most popular multi-track tape recorder in the world.

Since it was designed to expand your imagination, imagine this: participating TEAC dealers are having a special sale on the A-3340S.

So for everyone who's ever dreamed of owning an A-3340S, it's now priced lower than you ever dreamed possible. But you have to hurry. You have to get into your TEAC dealer before he's out of the A-3340S.

And while you're there, check his prices on the Model 2 Mixer and other multitrack studio accessories.

**THE  
FIRST & ONLY  
A-3340S SALE!**

**TEAC®**

The leader. Always has been.

TEAC Corporation of America  
7733 Telegraph Road  
Montebello, California 90640

In Canada TEAC is distributed by White  
Electronic Development Corporation (1966) Ltd.  
©TEAC 1977



Model 2

"I've got a 60-minute recording studio in my pocket."

It's called the MICROCASSETTE® PearlCorder-S®



A MICROCASSETTE recorder that's so unique, it's like having your own mini-studio in your pocket with remarkably good fidelity for music as well as voice. It's smaller than a checkbook (5¼" from top to bottom, slightly thicker than a pack of cards), and lightweight (12 ounces with batteries), but it's packed with studio precision and professional features:

- 60 minutes recording time.
- Capstan drive for constant tape speed, built-in electret condenser microphone, AC bias, record-warning light.
- All metal construction for years of dependable service.
- One-hand operation; instant loading.
- Fast forward and rapid rewind.
- Automatic level control.
- Connects to your stereo or full-size recorder with a Compaicord, for both recording and playback.

The PearlCorder-S performs beautifully in an office, in your car, even on airplanes; and it's backed by the reputation of the Olympus Optical Co., Ltd., a company famous for fine cameras, medical and other precision scientific instruments.

The PearlCorder-S. Carry one. And have a studio with you.

Available at fine photographic, audio, and A-V dealers everywhere. Or write for our brochure, "Pocket Full of Miracles."

**OLYMPUS CORPORATION OF AMERICA**

TWO NEVADA DRIVE/NEW HYDE PARK, NEW YORK 11040

In Canada: W. Carsen Co., Ltd., Ontario

60 minutes of sound in this actual-size MICROCASSETTE.®



CIRCLE NO. 38 ON READER SERVICE CARD



A & M Records

GALLAGHER & LYLE: combining the Ink Spots and the Andrews Sisters

paragraph form, in the notes. He has to convolute his tunes something fierce to fit this stuff, of course, and they get stretched pretty thin some places and wadded up an awful lot in others. There's a good line here and there, though, and some promise. Make a note to look him over again in his junior year. N.C.

**GALLAGHER & LYLE: Love on the Airwaves.** Benny Gallagher and Graham Lyle (vocals); instrumental accompaniment. *The Runaway; Street Boys; Dude in the Dark; Head Talk; Had to Fall in Love;* and five others. A & M SP-4620 \$6.98, © 8T-4620 \$7.98, © CS-4620 \$7.98.

Performance: **Fair**  
Recording: **Good**

Gallagher and Lyle write all their own material. Their writing has the tang of iconoclastic juvenilia ("They've been fed with promises and lies/They've been led till every tear runs dry . . . ." from *Street Boys*; or "He's been from the headlines/Down to the breadlines . . . ." from *Dude in the Dark*) that just might endear them to the Heavy Thinkers out there, and their vocal pairings seem to be some attempt to combine the sounds of the Ink Spots and the Andrews Sisters for whatever remains of the nostalgia market. It's all pleasant enough in its low-standard way but I can think of better ways to spend a lazy afternoon. P.R.

**GENESIS: Wind & Wuthering.** Genesis (vocals and instrumentals). *Eleventh Earl of Mar; One for the Vine; Wot Gorilla?; All in a Mouse's Night;* and four others. ATCO SD 36-144 \$6.98, © TP 36-114 \$7.97, © CS 36-144 \$7.97.

Performance: **Bard thou never wert**  
Recording: **Very good**

If you're an intelligent person and a song's lyrics sound like gobbledygook to you, then as a practical matter they are gobbledygook. The onus to say clearly what is meant is on the writer. From the sound of it, Genesis continues to write with its thumbs and then sits up all night stretching melodic lines all out of shape to fit this stream of self-consciousness. The one thing they do pretty well, better than the songs deserve, is play. They've settled into a recognizable, stylized, but not too restricted sound, and they're looser than other nether-nether glitter groups. Still, their writing is the dregs. N.C.

**MICKEY GILLEY: Gilley's Smokin'.** Mickey Gilley (vocals, piano); instrumental accompaniment. *Don't the Girls All Get Prettier at Closing Time; There's a Song on the Jukebox; L-O-V-E; What Is It; My Babe; How's My Ex Treating You?;* and four others. PLAYBOY PB-415 \$6.98, © PBT-415 \$7.98, © PBC-415 \$7.98.

Performance: **Semi-rote**  
Recording: **Very Good**

I find Gilley's popularity as mystifying as it is annoying. What he does is rehash old songs—not old half-forgotten ones but new old ones, just old enough to be stable. And they become hits: *Room Full of Roses, The Window Up Above, Bouquet of Roses, I Overlooked an Orchid,* and so on. This time the program includes Sam Cooke's venerable *Bring It On Home to Me* (which, incidentally, you can hear redone well, believe it or not, by Sonny Terry, Brownie McGhee, and Sugar Cane Harris), *Lawdy Miss Clawdy,* the creaking Lloyd Price tune one can get tired of by age five nowadays, and the Milt Gabler/Bert Kaempfert atrocity *L-O-V-E*. Gilley isn't bad technically; if he were a real dodo like Sonny and/or Cher, I could come closer to understanding his popularity. But neither is he about to attach himself to the song he sings. He keeps clear of any emotional entanglements with it, and this kind of treatment works to somebody's benefit only once in a blue moon. Other times it can give you a chill. N.C.

**HENRY GROSS: Show Me to the Stage.** Henry Gross (vocals, guitar). *Show Me to the Stage; String of Hearts; Painting My Love Songs; Come Along; Help!; What a Sound;* and four others. LIFESONG LS6010 \$6.98.

Performance: **Feeble**  
Recording: **Flabby**

Beware of packaging. This particular album is another example of how brilliant cover graphics can be used to create an image of the performer before the listener has heard the album, to convince the listener before stylus ever touches groove that the artist is someone special.

Ah, but there is an old saying in the music industry: "If it's not in the grooves . . ." And there it ain't, in this case. This is an average rock album by an ambitious fellow with a voice that only a personal manager could

(Continued on page 104)

Now \$139 makes you an audiophile.

A remarkable new speaker, the Q<sub>a</sub> is the realization of our long-held dream: a modestly-priced speaker employing Infinity state-of-the-art technology.

We state flatly: there is no other speaker in its price category with such spatiality and depth of imaging; with such clarity and transparency over the entire frequency spectrum.

The reason: Infinity state-of-the-art advances are built into the Q<sub>a</sub>.

Our exclusive EMIT, for instance — the Electromagnetic Induction Tweeter. Magnetic counterpart of the finest electrostatics, with far better dispersion and none of the problems.

What's an EMIT doing in a \$139 speaker? Same thing they're doing in

our \$1200 Quantum Line Source: delivering accurate, transparent mid and high frequencies as high as your ear can follow — and beyond — to 32,000 Hz.

Bass driver is a remarkable new performer with lightning-fast transient response; another example of Infinity technology. Its phosphor-bronze voice-coil former and other advances result in a high-excursion driver that delivers extended and startlingly accurate bass. Down to 40 Hz. The kind of bass previously heard only in much more expensive Infinity speakers.

Efficiency? You can drive it with as little as 15 watts per channel. And it will take all the power you can pour on — up to 150 per channel!

Test Q<sub>a</sub>. Softly or loudly. On

the stabbing electronic attack of the Pousette-Dart Band or the warm delicacy of Janet Baker.

Remarkable thing happens: other speakers under \$200 that used to sound good or even great, suddenly sound wrong. The sheer realism of the Q<sub>a</sub> is a whole new musical experience.

And you can afford it.

The pedestal shown, by the way, is optional. Around \$40 a pair.

What's more, Infinity also introduces another gem, with an additional driver (a midrange). At \$180. It's called Q<sub>b</sub>. Like Q<sub>a</sub>, it has spatial imaging and depth as exact as our most expensive speakers.

Listen and prove it: Here's everything you'd expect from Infinity. Except the price.

**Now.**

**Infinity brings high technology  
to a new low.**

**Under \$140.**



 **Infinity · Q<sub>a</sub>**

We get you back to what it's all about. Music.

love. With the exception of *Help!*, by Lennon-McCartney, all the material is Henry Gross' own, and it is thin and pedestrian. The most notable achievement on the album is the cover concept (for which Gross gives himself credit on the inner sleeve). I'm casting my vote, however, for Robert Paul Monkton, the photographer. J.V.

**JACK JONES: *The Full Life.*** Jack Jones (vocals); vocal and instrumental accompaniment. *You Make It Easy; L.A. Break Down; You Need a Man; Once in a While; Send In the Clowns; God Only Knows;* and five others. RCA APL1-2067 \$6.98, ® APS1-2067 \$7.98, © APK1-2067 \$7.98.

Performance: **Nice but tired**  
Recording: **Good**

Jack Jones, son of Allan, the tenor who used to pour his heart out in the Hollywood musicals of yesteryear, seems to be contending for the Perry Como crown in the musical relaxation department. The cover of "The Full Life" shows Jack squatting in the prow of a sailboat with the blue sea all around him, smiling away for all the world like a man who has no difficulty falling asleep. The trouble is, this attribute might be contagious, and I would hate to think that this album might wind up on sale alongside those black satin masks in a local sleep shop instead of in a record store. The voice is true and honey-sweet, but mostly it's wasted on corn, including several songs impossible to remember even a minute after you've heard them. Only when he tackles the challenge of a real song like *Send In the Clowns* does Jones seem to grow quite wide awake, and by then it's almost too late. Still, gentleness is not so easy to come by in the pop marketplace these days, and there must be reasons why this singer looks and sounds so enviably relaxed. Adding to the soporific ambiance are "background vocals" by four other singers—all sighers, all superfluous. P.K.

**ALBERT KING: *Albert Live.*** Albert King (guitar, vocals); instrumental accompaniment. *Watermelon Man; Blues at Sunrise;*

*That's What the Blues Is All About; Stormy Monday; Kansas City; I'm Gonna Call You As Soon As the Sun Goes Down;* and six others. UTOPIA CYL2-2205 two discs \$9.98, ® CYS2-2205 \$11.98, © CYK2-2205 \$11.98.

Performance: **Industrious**  
Recording: **Variable**

I have great admiration for Albert King, who is a master blues guitarist. His solo conceptions are clean and subtle, and just when he is about to go into one of his own clichés (which nearly all the best guitarists have, no matter what the style), he saves and resolves the solo with something unexpected and delightful. But, no matter how fine a musician may be, if he tours as often and at as great a length as King does, he and his backing band are bound to sound as though they are chugging through selections to expedite matters rather than seeking artistic fulfillment. Then too, "live" albums are always suspect. True, the interaction between a performer and his audience may spark the artist into doing something extraordinary, something wonderfully animal that he is not likely to do in the recording studio, but it's a long-shot chance. What passes for "the immediacy of communication" between a performer and the paying customers is usually nothing more than the entertainer's giving the people their money's worth.

This set was recorded at the Montreux Festival in Switzerland. King on an average night is better than most other people on their best nights, but I don't hear anything here that King hasn't equaled or bettered in his studio recordings. Nor is the technical sound what it could be; tonal qualities are often lost, and on some tracks it sounds as though King is playing half a mile away from where the band is blowing. While this album isn't exactly a disservice to the artist, it is a relatively pedestrian documentary of a night on the road. J.V.

**LONE STAR.** Kenny Driscoll (vocals); Dixie Lee (drums, vocals); Peter Hurley (bass); Paul Chapman (guitar); Tony Smith (guitar, vocals); Rick Worsnop (keyboards, vocals). *She Said, She Said; Lonely Soldier; Flying in the Reel; Spaceships;* and three others. CO-

LUMBIA PC-34475 \$6.98, ® PCA 34475 \$6.98, © PCT-34475 \$6.98.

Performance: **Good**  
Recording: **Very Good**

This is old-time hard rock, and pretty well done. Nothing large or radical happens, but nice small things do. Lone Star sounds a little like the early Guess Who except LS is tighter on the instruments and less stylish on the vocals. The tunes are a little above average and the band's overall taste is reasonable. The music and the style are, however, distinctly old-fashioned. N.C.

**RECORDING OF SPECIAL MERIT**

**MARY MACGREGOR: *Torn Between Two Lovers.*** Mary Macgregor (vocals); instrumental accompaniment. *Mama; Good Together; The Lady I Am; For a While; Take Your Love Away;* and five others. ARIOLA AMERICA SMAS-50015 \$6.98, ® 8XT-50015 \$7.98, © 4XT-50015 \$7.98.

Performance: **Excellent**  
Recording: **Very good**

The blitzkrieg success of her giant hit, *Torn Between Two Lovers*, first issued as a single, may keep some of Mary Macgregor's other efforts in shadow for a while, at least until the public cools down about that simple, enormously affecting, and effective ballad. But, as this album shows, Macgregor has genuine talent both as a performer and as a writer-composer. Her voice (as everyone in the world must know by now) is a light, finely spun, expressive instrument that she uses with great skill to achieve small but telling dramatic points.

The songs in this album are actually short musings on different aspects of romantic love as experienced by a girl growing into womanhood. Although none of the others have the quiet power of the title song, they all reflect a natural and observant sensibility of a high order. The production by Peter Yarrow (formerly of Peter, Paul, and Mary, and her discoverer) and Barry Beckett is especially fine, allowing Macgregor plenty of room to breathe as an artist but not missing a trick in making her sound her best. Highly recommended. P.R.

**AL MARTINO: *Sing My Love Songs.*** Al Martino (vocals); vocal and instrumental accompaniment. *Sing My Love Song; Volare; Dream of Me; My Thrill; The More I See You;* and five others. CAPITOL ST-11572 \$6.98, ® 8XT-11572 \$7.98.

Performance: **Sticky**  
Recording: **Very good**

Al Martino's love songs are surrounded by a big, slick orchestra, sighing singers, and a wealth of thick black hair (not necessarily in that order of proximity). Martino now and then dips into such Italian standbys as *Volare* and *O Sole Mio*, but he doesn't come on strong like Tony Bennett. Instead, he wades with a certain languor through a repertoire apparently designed to make a matron sigh: *My Thrill, The More I See You, Sing My Love Song* (borrowed shamelessly from the end of Moussorgsky's *Night on Bald Mountain*)—all this to murky arrangements heavy on the high strings. Syrupy stuff. P.K.

**LETTA MBULU: *There's Music in the Air.*** Letta Mbulu (vocals); vocal and instrumental  
(Continued on page 109)

MARY MACGREGOR:  
a light, finely spun  
voice skillfully used



# Credentials Like These Are Worth Reading



When you're buying speakers, you want to talk specs. And we don't blame you. In fact, we encourage it. Because when you invest your good money in a pair of speakers, you want more than just a pretty cabinet.

Consider the new Jensen Spectrums. These good sounds didn't just happen. They're the result of extensive engineering efforts and exhaustive testing. Testing that ranged from exacting measurements in laboratory "live" rooms and anechoic chambers to in-depth consumer surveys.

Examine our Spectrum Model 540. It's an excellent example of the superb specs you'll find throughout the Jensen Spectrum Series.

The Spectrum 540 is a 3-way, 4 element system that is so efficient it can be driven with as little as 10 watts continuous power. Its maximum power rating is 75 watts continuous.

The woofer is a 12" long-throw, high compliance design. Special acoustic suspension and infinite baffle enclosure give you extremely low distortion. And a high temperature voice coil affords high power handling. Magnet structure weight is a hefty 4½ lbs. with a Gap Flux Density of 10,000 Gauss.

Two 3½" cone midranges give excellent power handling and eliminate break-up in the critical midrange region. Tuned isolation chambers control response at the low end of the midrange spectrum. They also provide acoustical isolation in the cabinet between the midranges and the woofer. An edge damped rim suspension with specially treated molded cone offers sharp, clear, midrange reproduction.

A 1½" Mylar® rear damped hemispherical dome tweeter offers a disper-

sion of 170°. Its large, lightweight voice coil gives high power handling, yet maintains a low mass for good high frequency reproduction.



Tweeter and midrange controls allow you to adjust your Spectrum System to room conditions and listening preferences; controls are front mounted for convenience, continuously variable, calibrated in db attenuation from a maximum, or flat, response.

## FREQUENCY RESPONSE

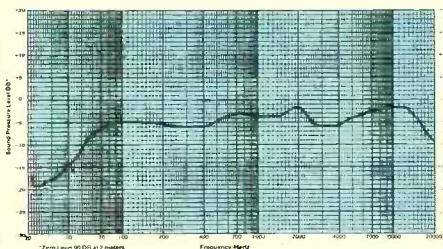

About as flat as you can get... and that's good. The Frequency Response Range is an admirable 25 to 25,000 Hz.

## TONE BURSTS

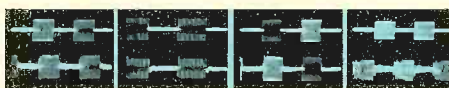

"Blurring" and "Overshoot" are reduced to a minimum in this acid test of transient response. The Spectrum 540 re-

produces each waveform accurately with low distortion.

## TOTAL HARMONIC DISTORTION

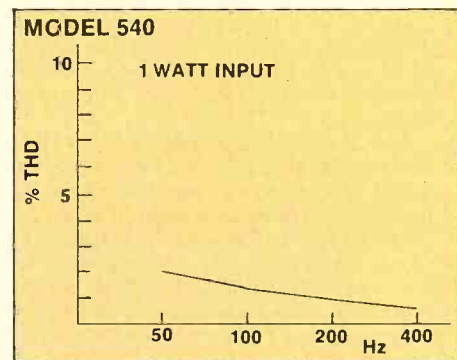

Distortion is kept to a minimum in Jensen Spectrum Speaker systems.

The cabinet is built with solid walnut front moldings and walnut veneer on wood composition panels. All walnut surfaces are hand rubbed for a rich luster and beauty. The baffle is finished in an attractive, durable black pebble grain.

In short, Jensen Spectrum speakers aren't designed to put out the most amount of bass or the most amount of treble. They're designed to put out the right amount. We consider them to be the best speakers we've produced in 50 years. Simply because when it comes to sound reproduction, they're extraordinarily accurate. And that's what specs are all about.

For further information and name of your nearest authorized Spectrum Dealer, write to: Jensen Sound Laboratories, Dept. SR-67 United Parkway, Schiller Park, Illinois 60176.

# JENSEN

## SOUND LABORATORIES

Division of Pemcor, Inc. Schiller Park, Illinois 60176



## The McGarrigles Again

David Gahr/Warner Bros

**H**ow much easier it would be if recording artists could go right from their first album to their third—and do the second album sometime later. Because that second album is the hardest, especially if the first received a lot of praise. It's a sort of Second Coming, and everyone has appropriate expectations for it.

Kate and Anna McGarrigle's debut album was what is called a "critics' album"—which means that the critics loved it but nobody much seemed to buy it (perhaps if all the critics who loved it had actually *bought* it, the record might have gone gold in a week, but everybody knows that critics don't buy records). The "Kate and Anna McGarrigle" album won praise and awards (it was a *STEREO REVIEW* 1976 Record of the Year) and was one of those records that was elevated to Living Legend status shortly after it passed away commercially.

Well, here's some good news for music lovers: the McGarrigle sisters' second album is their third album. "Dancer with Bruised Knees" is not a follow-up to their spectacular debut album—it's a follow-through. Warm, familiar, cozy as an aged afghan, this album is more pussy cat than copy cat. It simply continues on from where the first album left off. It's an equal, not a sequel. It's the further adventures of Anna and Kate.

What the McGarrigles do is dip back into their musical roots (they are French-Canadian and have been performing since 1958), stir around a little, add a few dashes of every musical spice from Stephen Foster to Broadway, and come up with a delectable home-cooked banquet. Their songs are full of contradictions, at once sophisticated and innocent, pleading and demanding, witty and solemn. Like so many other performers who have trouble finding an audience, the McGarrigles are beyond categorization: they are folk and country, they are blues and pop, they are Tin Pan Alley and the Delaware Water Gap.

The first time I heard them sing, about a year and a half ago, I didn't like them. I thought their music was too simple and direct.

But the more I listened, the more they grew on me—to the point where any removal of them now would have to be surgical—*because* their music is so simple and direct.

As singers, they work magic. Not the way a Streisand or a Cleo Laine works magic, but in a more essential way. They have a style—Kate's pained and anguished sounds, Anna's sleepy-time tones—that transcends the limitations of the microphones they sing into. I listen to them sing, and I am taken back to quiet nights around a roaring fire, singing songs with my family—which is interesting, because my family never sang songs or even lit a fire. The gift, the Crackerjack surprise that comes with the McGarrigles, is that they can help you remember experiences you never even knew you had.

they help you remember experiences you never even knew you had. . . .

The man behind the scenes—the one holding the strings and the mirrors for the magical McGarrigles—is producer Joe Boyd. He seems to understand the subtleties of recording the female voice so well that, as with a good dentist or analyst or hairdresser, I can think of at least a dozen singers I would like to send to him for help. In this album, it's not so much what he's done as what he hasn't done: he's left the McGarrigles' pure and simple arrangements intact and hasn't tried to obscure them with a lot of overdubbing and cheap bids for instant commerciality. He avoids heavy metal and chooses flesh and blood instead—the only electricity on this album comes from the energy of the music itself, leaping out of a

blue sea of banjos, marimbas, and button accordions.

The McGarrigles write simple songs, not autobiographies or dirges or Powerful Statements for These Troubled Times. They don't tell us about the truth they learned at seventeen or that, hey, it's good to know that they've got a friend. They don't sing torchy love songs either; their tunes are more like safety matches. One of the loveliest on this album is Kate's *First Born*, a simple song about how the first-born son is special—"the family's the oyster and he's the pearl. . . ." *Kitty Come Home* is Anna's haunting, angelic plea for the return of a long-lost somebody (I suspect it's Kate). The title track is an ambitious, infectious mixed-marriage of hillbilly and Hollywood, with a special vocal calliope of *toots* that would put even an Elton John to shame.

It doesn't *all* work out that well, of course. I find that the wonderful lyrics to *Walking Song* don't quite fit the equally wonderful melody. And side two doesn't measure up to side one—the sense of playfulness, of adventure, seems to be missing. But the biggest sin of all is not the McGarrigles' but Warner Bros.: there are no lyrics included, just an ad for a \$2 album called "Supergroup"—which is a good deal, though not as good a deal as the McGarrigle lyrics would have been. But this is a wonderful second (third) album anyway, a fusion of both musical and lyrical strengths. Kate and Anna McGarrigle prove that Sisterhood Is Indeed Powerful. —Rick Mitz

**KATE AND ANNA MCGARRIGLE: *Dancer with Bruised Knees*.** Anna McGarrigle (vocals, piano, button accordion, recorder); Kate McGarrigle (vocals, piano, button accordion, organ); other musicians. *Dancer with Bruised Knees; Southern Boys; No Biscuit Blues; First Born; Blanche Comme la Neige; Perrine Était Servante; Be My Baby; Walking Song; Naufragée du Tendre (Shipwrecked); Hommage à Grungie; Kitty Come Home; Come a Long Way.* WARNER BROS. BS 3014 \$6.98.



# Tannoy

## INTEGRATED SPEAKER SYSTEMS

At first glance, the Tannoy appears to be a loudspeaker. *It is more.* It is in fact a completely integrated loudspeaker system. Sound is reproduced, phase coherent throughout the entire audio range, from one transducer matrix. The high frequency (HF) tweeter and low frequency (LF) woofer are combined within a single, powerful magnetic structure. Sound is collected by a unique multi-throated phase compensating unit and fed into a short exponential horn. The curvilinear LF diaphragm ensures wide dispersion of high frequencies and an unbroken audio spectrum.

□ The LF diaphragm acts as a true piston from the lowest bass up to 1kHz. The tweeter handles frequencies from 1kHz to beyond 20kHz. The crossover network ensures smooth transition between the woofer and horn-loaded tweeter. A superb, level response curve is achieved throughout the low, mid-range and high frequencies by an ingenious combination of the extended LF direct radiator, crossover network and wide range HF driver. A dynamic balance and roll-off control is incorporated for adjustments to personal taste or room acoustics. The Tannoy is exceptionally efficient. It can handle high powered amplifiers with ease, yet can be driven to high levels by moderately powered units. Equally important, music can be played at low volume without any compromise of musical quality.

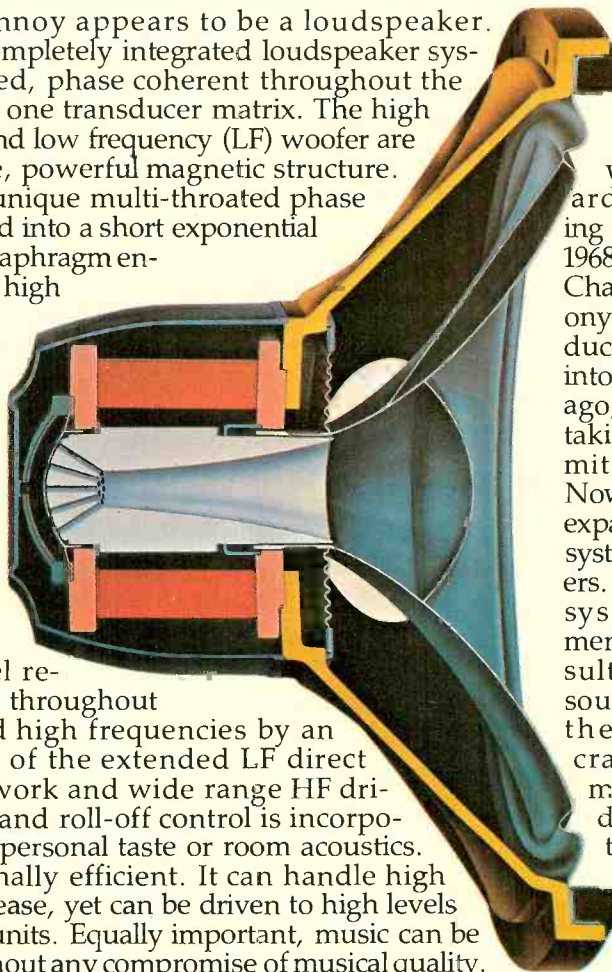

Tannoy has been engaged in continuous research and production of high quality transducers for half a century. From the outset, its products were adopted as a listening standard by broadcasting and recording companies all over the world. By 1968, the term, "Tannoy" was in the Chambers English Dictionary as synonymous with the art of sound reproduction. □ Tannoy was introduced into North America more than 26 years ago, but modest facilities and painstaking standards of production permitted only limited distribution. Now...new techniques, materials and expanded facilities have made Tannoy systems available to many more listeners. □ The Tannoy integrated speaker system is the crowning achievement of generations of acoustic consultants, researchers, designers, sound engineers, and produced in the best traditions of British craftsmanship. The hand of the master cabinetmaker is immediately apparent in the system's exquisitely finished enclosure. The Tannoy will provide the maximum quality your electronic equipment is capable of delivering.

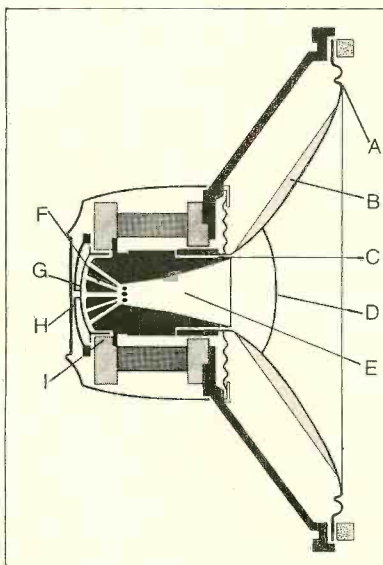

- A Rolled surround for stability in low bass response
- B Unique ribbing virtually eliminates cone break-up ensuring smooth response and extraordinary high power capacity
- C High temperature voice coil
- D Dustproof, acoustically transparent sealing dome
- E Concentric HF horn (completed by curved LF cone)
- F Phase-compensating multiple throat for extended and smooth HF response
- G Acoustic balance cavity for reduced distortion
- H Aluminum voice coil conductor for high power capacity and superb HF response
- I Exclusive magnetic shunt for increased LF flux

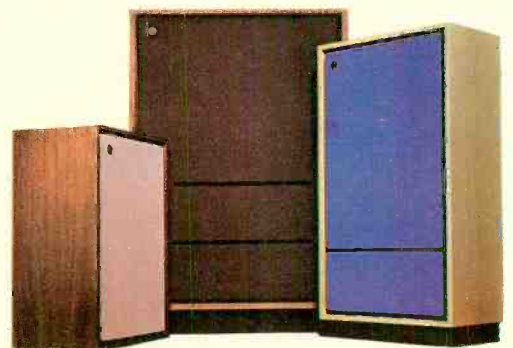

For additional information:

# TANNOY®

122 Dupont Street, Plainview, N.Y. 11803

# HOW NOT TO RUIN YOUR RECORDS

## PART II

### *Avoid sticky coatings*

#### THE PROBLEM:

No vacuum device, duster machine or wonder cloth can remove fingerprints, jacket particles or dust containing smog/smoke from your records. Yet such contamination ruins records.

A chemically correct fluid can pull these ruinous contaminations into solution, but record preservation requires lifting both fluid and problems off the record without leaving residues.

#### COMMON ERRORS:

In spite of much written advice and wild claims, most disc cleaning liquids (also soap and water) gum up record grooves. This sticky problem has two origins: high dry weight residue in the fluids; plus the actual chemical affinity of most cleaners for vinyl. Even the use of tap water causes a deposit on vinyl and a loss of high frequency definition.

#### AN ANSWER FROM RESEARCH:

Use a system that cleans and removes contamination safely. The most researched and chemically non-adhering fluid is D3 by Discwasher, which includes an anti-static formulation that does not stick. See the table for actual dry weight residues of tap water and "record cleaners" costing over \$11 each. D3 is chemically "active" only against common record contaminants—not the vinyl, and D3 literally lifts contamination off the record surface without coating.

Properly used as a system, D3 and the Discwasher brush draw all contaminants and fluid off the disc by the capillary action of micro-fibers into the absorbent fabric backing. Nothing is left on the record except encoded sound.

#### COMPARATIVE DRY WEIGHT RESIDUES

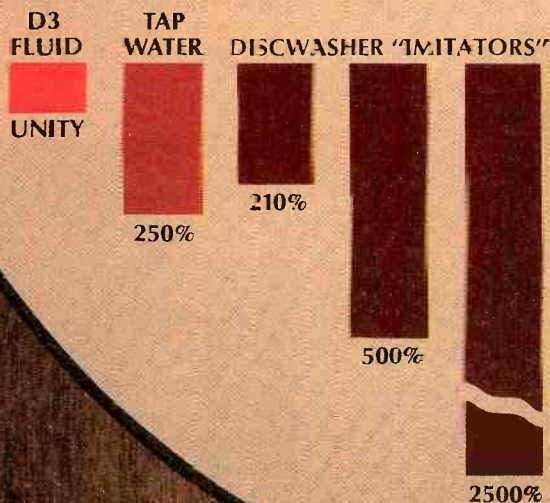

 **Discwasher Group**

1407 N. PROVIDENCE RD.  
COLUMBIA, MISSOURI 65201

CIRCLE NO. 16 ON READER SERVICE CARD



MBULU: glittering sonic mirrors

accompaniment. *Music Man*; *Tristêza*; *Let's Go Dancing*; *You've Lost That Lovin' Feelings*; *Sacred Drum*; *Ain't No Way to Treat a Lady*; and four others. A&M SP 4609 \$6.98.

Performance: **Gifted but overwrought**  
Recording: **Very good**

Letta Mbulu is an energetic lady from South Africa with a strong voice and a flair for languages and drama. She sings in the tribal vocabularies of the Bantus and other black South Africans (Xhosa and Sepedi), in Portuguese, and in the kind of clipped South African English made familiar by such mistresses of that idiom as Miriam Makeba. Unlike Makeba, however, Mbulu tries to work into relatively simple melodies about rainy days and rejection a kind of soul-lashed frenzy that most of her songs are simply too frail to bear. On top of this, her efforts are undermined at times by a too-large array of accompanying forces—keyboards, guitar, flugelhorn, percussion—and by such trick effects as intrusive echoes. It would be interesting to hear her in a scaled-down presentation that would not force her voice and the material she sings to glitter quite so spectacularly in a succession of sonic mirrors. *P.K.*

**LARRY McNEELY: *Rhapsody for Banjo*.** Larry McNeely (banjo); Charlie Collins (guitar); Jethro Burns (mandolin); Roy Husky (bass). *Black Room*; *Slipped Disc*; *To Django*; *Honeysuckle Rose*; *Blue Jazz*; *Banjo Nova*; *Limehouse Blues*; and six others. FLYING FISH 025 \$6.98.

Performance: **A keeper**  
Recording: **Very good**

Man, there are some sharp pickers assembled here. McNeely plays fluid, graceful, and extremely swift banjo, and he plays with a light touch. Sounds like a natural. Just as good, though, and featured almost as prominently, is Jethro Burns on the mandolin. He's the Jethro of the Homer and Jethro comedy team that used to satirize popular (not country) hits in a cornpone accent delivered in marvelous and sophisticated two-part vocal harmonies and backed by that hot mandolin. The guy who played Homer died a few years ago. Nice of McNeely to give Jethro such a forum here, and it doesn't hurt McNeely's album either. Whether you like it may depend upon how you feel about bluegrass instrumentation do-

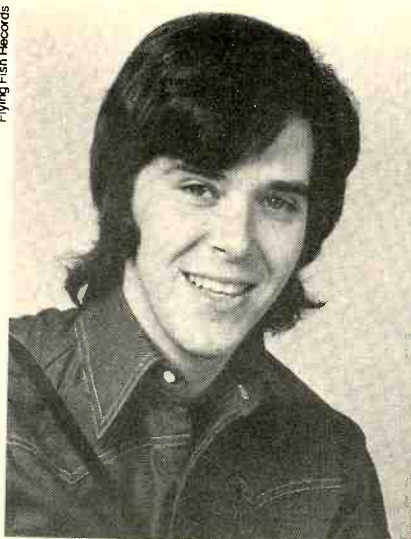

McNEELY: a dead-on natural

ing decidedly non-bluegrass things, a couple of which are downright weird. There's nothing unmusical about it, though, no gratuitous sound effects, no waffling, no posturing, no fooling around; however offbeat the material, the picking is dead on and superb. I don't play many nonclassical instrumental albums on my own time, but I could see giving this one a few spins. *N.C.*

**JOHN MILES: *Stranger in the City*.** John Miles (vocals, guitar, piano); Bob Marshall (bass); Barry Black (drums); Gary Moberley (keyboards). *Stranger in the City*; *Slow Down*; *Stand Up*; *Time*; *Manhattan Skyline*; and four others. LONDON PS 682 \$6.98, © PS8-682 \$7.95, © PS5-682 \$7.95.

Performance: **Plastic**  
Recording: **Good**

Sounds as if John Miles is *acting* excited rather than *being* same much of the time here; if he and this recording are the vanguard of it, I wouldn't brace too hard against a new British invasion. Miles has a fairly pliant, pleasant enough voice, but there's rock-star puffery in his delivery (his is, according to the press, an up-and-coming name in Britain), and the album—not helped much by songs that are just average—isn't very colorful. I suspect the real Miles is more interesting than the one he projects. May that suspicion someday visit him too. *N.C.*

**PABLO CRUISE: *A Place in the Sun*.** Pablo Cruise (vocals and instrumentals). *A Place in the Sun*; *Whatcha Gonna Do?*; *Raging Fire*; *I Just Wanna Believe*; *Tonight My Love*; and four others. A&M SP 4625 \$6.98, © 8T-4625 \$7.98, © CS-4625 \$7.98.

Performance: **Inoffensive**  
Recording: **Fine**

It says in their bio that the members of Pablo Cruise chose that peculiar name for themselves because they wanted to put across a concept: "For them, the word 'Pablo' suggests an everyman commonality, while 'Cruise' connotes strong and fluid movement." Now I have always had this theory that you could pretty much judge how much imagination a group would bring to its music by how much it brought to naming itself. Thus, you would know up front that the Rolling Stones, Big Brother and the Holding Com-

Bev Bevan with the  
Electric Light Orchestra in  
performance at the  
Boston Garden 1977.

# AR

## loud and clean

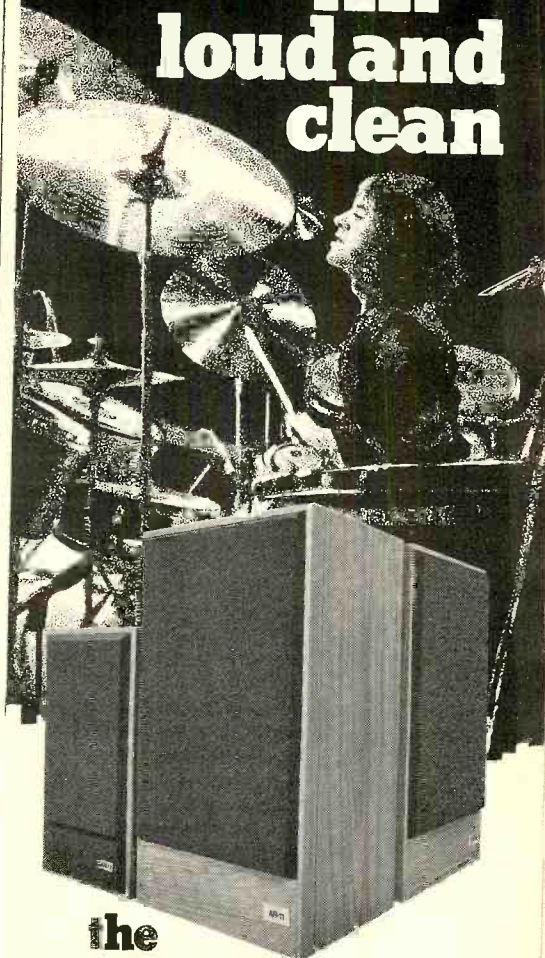

the  
new sound  
you'll want to  
live with

If it's loud music you want, it has to be clean. Without clean it's just noise. And clean is just what the new AR speakers give you.

AR acoustic suspension woofers reach down to the loudest, lowest notes in recorded music without boominess or distortion.

Energy absorbent dome midranges and tweeters give you crystal-clear highs. And AR tweeters use a unique magnetic fluid to drain away heat and increase power handling ability.

The new AR speakers easily accommodate the loud levels required by today's modern music. AR smallest, least expensive speaker system, the AR-17, will handle the power of 100 watt per channel receivers or amplifiers. The AR-14 will handle amplifiers up to 150 watts per channel, and our widely acclaimed AR-11 will handle the output of today's most powerful superamps.

For complete product information and a list of AR dealers, write to:

**AR**  **TELEDYNE  
ACOUSTIC RESEARCH**  
10 American Drive  
Norwood, MA 02062  
In Canada: AC Simmonds & Sons Ltd  
CIRCLE NO. 1 ON READER SERVICE CARD

maintained throughout testing. The upper curves represent the frequency response of the right (black) and left (grey) channels. The distance between the upper and lower curves represents separation between the channels in decibels. The inset oscilloscope photo exhibits the cartridge's response to a recorded 1000 Hz square wave indicating its resonant and transient response.

For more information on the Empire 2000Z, and our free brochure "How to Get the Most Out of Your Records," write: Empire Scientific Corp., Department ±1 dB, 1055 Stewart Avenue, Garden City, N.Y. 11530.

# EMPIRE

# SUPER TUNE!



Jaz Records, 1112 Mount Lowe Drive, Altadena, Calif. 91001.

Performance: **Erratic**  
Recording: **Good**

Johnny Guarnieri was once told by James P. Johnson, the dean of Harlem stride-style pianists, "You're number three. After me and Fats (Waller), you're number three." James P. was always a generous encourager of talent. Forty years later Guarnieri still has remarkable technique and precise execution, along with a nice sense of whimsy and a poignant touch on ballads.

The only drawback here is that Guarnieri crowds too much into a performance on up-tempo numbers, throwing in everything he knows or remembers. It's like asking a fellow

pany, and Buffalo Springfield would have something going for them, whereas Tucky Buzzard, Grootna, and Public Foot the Roman would obviously be a waste of time. Going by that admittedly arbitrary criterion, the purchaser of a Pablo Cruise album deserves exactly what he gets.

to tell you the most memorable experience of his life and having him respond by telling you his whole life story. Guarnieri's playing, then, contains some wonderful flashes but also a lot of boilerplate. He does calm down on ballads, where his performances are cohesive, respectful of the tune, and very tasty; *Mean to Me* is a fine example. And in the ballads you get the opportunity to hear what Guarnieri himself sounds like. It's too bad that he spends most of his time on this album recalling the styles and techniques of Johnson, Waller, Earl Hines, Erroll Garner, and others. He's best when he's playing and sounding like himself. J.V.

**CLEO LAINE & JOHN WILLIAMS: Best Friends.** Cleo Laine (vocals); John Williams

(guitar); John Dankworth (soprano sax, violin); Paul Hart (electric piano, violin); other musicians. *Feelings*; *Time Does Fly*; *My Day Has Started with You*; *Eleanor Rigby*; and eight others. RCA APL1-1937 \$6.98, © APS1-1937 \$7.95, © APK1-1937 \$7.95.

Performance: **Often lovely**  
Recording: **Excellent**

Cleo Laine and her husband John Dankworth maintain a music center at their home in Wavendon, Buckinghamshire. Among the many artists who visit there on a regular basis is John Williams, one of the great contemporary guitarists, classical division. This album is the result of several informal music-making sessions with Dankworth, Laine, and Williams. It's an often lovely, always expert job. But there is a weighty, premeditated, rather precious texture to the complex interplay between Laine's voice and Williams' guitar. The level of musicianship is always impeccable, but Lord, it does get flossy!

Everything is just fine when Laine and Williams bear down on such overexposed things as *Eleanor Rigby*, *Feelings*, and *Killing Me Softly with His Song*. Here they are able to put some of the crackle and snap back into what has become very soggy corn flakes indeed. But when they do a fine new song, such as Brian Gascoigne's setting of the poem *Sleep Now*, it becomes difficult to perceive the composer's intentions, what with Cleo swooping around in her usual vocal imitation of a bird of paradise and Williams' guitar, also as usual, sounding as if it had a maniacal life of its own. It is rather like asking Thomas Mann for directions to the rest room: I'm sure he would have described it beautifully and reflected expertly on its convenience but probably would have forgotten to tell you where it was. If you know the way, Cleo and John can be dazzling, but in unfamiliar territory they can be just plain mystifying. P.R.

**GARY LAWRENCE AND HIS SIZZLING SYNCOPATORS** (see *Best of the Month*, page 92)

## RECORDING OF SPECIAL MERIT

**MEL LEWIS: Mel Lewis and Friends.** Mel Lewis (drums); Freddie Hubbard (trumpet, flugelhorn); Michael Brecker (tenor saxophone); Hank Jones (piano); Ron Carter (bass); others. *De Samba*; *Sho' Nuff Did*; *Moose the Mooche*; and four others. A&M/HORIZON SP-716 \$6.98.

Performance: **Light 'n' lively**  
Recording: **Very good**

Though Mel Lewis has been on the scene for thirty years and has played with some of the top bands in the business, he is probably best known as the co-leader of the Thad Jones/Mel Lewis band, which will celebrate its twelfth anniversary this December. Lewis is a propulsive drummer whose ability to transcend mere rhythm is admirable, and he's as effective in a small group setting as he is with a big band.

Here he has surrounded himself with some formidable colleagues for a couple of informal sessions of a kind all too infrequently held today. One of the album's most salient features is the presence of trumpeter Freddie Hubbard, whose own records these days are too disco-oriented to be taken seriously as listening music. Hubbard appears on all but one track, playing with fiery imagination and dazzling technique on such fast numbers as Thad

# Sometimes it just doesn't add up

What you want is better sound. But, the expense of replacing your whole system just isn't reasonable. MXR has a way to upgrade your sound significantly, without starting from scratch. MXR's Stereo Graphic Equalizer and Compander can give you the right sound at a cost that is much easier to take.

The MXR Compander can double the dynamic range of most open reel and cassette tape decks to allow professional results in home recording. The Compander increases the overall fidelity of your system while reducing noise. The softest sounds can be heard, while musical peaks can be reproduced without distortion.

The Compander compresses the dynamic range of the signal going onto the tape and expands it upon playback at a two to one ratio. The resulting increase in dynamic range allows your present system to produce the depth of sound that you want to have when you record.

A natural companion, the MXR Stereo Graphic Equalizer is designed to provide precise compensation for aural discrepancy that may be caused by room acoustics, speaker inadequacies or program source. The Stereo Graphic Equalizer allows you to tailor your sound to your own tastes.

At the touch of a slide control, you can customize your playback to suit any number of variables. It can provide you with enough control over your present system to give you the sound that you want to hear.

The Compander, at \$129.95, and the Stereo Graphic Equalizer at \$199.95, with the equipment you already have, can add up to the sound that you want, at a reasonable price.

For more information see your nearest MXR dealer or direct inquiries to MXR Innovations Inc., 277 N. Goodman St., Rochester, New York 14607, (716) 442-5320.

**MXR** Consumer Products Group



Jones' *Ain't Nothin' Nu* and Charlie Parker's *Moose the Mooche*, and with soulful simplicity on Jones' *A Child Is Born*. Hank Jones, a pianist of exquisite taste, leads the way on a trio version of *Windflower* (a ballad by the late Sarah Cassey, who contributed many tunes to Riverside artists back in the early Sixties) and does much to enhance these forty-five minutes of excellent, free-wheeling, and totally acoustic jazz. C.A.

**HERBIE MANN: *Bird in a Silver Cage*.** Herbie Mann (flute); rhythm section; Munich Studio Choir; string ensemble of the Munich Philharmonic Orchestra, Fritz Sonnleitner cond. *Aria; Fly, Robin, Fly; The Piper*; and three others. ATLANTIC SD 18209 \$6.98, © TP-18209 \$7.97, © CS-18209 \$7.97.

Performance: **Soporific**  
Recording: **Good**

I thought Herbie Mann's last album, "Gagaku and Beyond," was a bit on the bland side, but it was wine compared to this water. Lots of lazy, hazy strings and soft voices in the background make this pleasant enough to listen to, but Herbie Mann is a damned good musician who just isn't saying anything here that's worth repeating. C.A.

**JIM ROBINSON: *Economy Hall Breakdown*.** Jim Robinson (trombone, vocals); Johnny Wiggs (trumpet); Raymond Burke (clarinet); Bob Greene (piano); Allan Jaffe (tuba); Yoichi Kimura (drums). *Economy Hall Breakdown; 2:19 Blues; Right Now Is the Right Time; St. Peter Street Breakdown; Pallet on the Floor*; and three others. PEARL PS-5 \$6.98.

Performance: **Fair**  
Recording: **Fair**

I am a New Orleans jazz fan from 'way back, but I am compelled to say that this album is for uncritical true believers only. Recorded in August of 1965 at Preservation Hall—with a foggy, lopsided aural quality—the music doesn't so much move as lurch. The unfortunate and uncomfortable fact is that some of the gentlemen in the group are victims of age—bless their hearts, they don't have the chops any more. A will, yes; a way, no.

The bright spots on the album are contributed by pianist Bob Greene, playing in the manner of Jelly Roll Morton. Greene's emulation is impressive, but the piano is out of tune and sounds tinny, so that his recollections of the master's thought and technique lose an important part of their charm and power. J.V.

**JOEL SHULMAN: *Nowhere but Here* (see Best of the Month, page 93)**

**HORACE SILVER: *Silver 'n Voices*.** Horace Silver (piano); Tom Harrell (trumpet, flugelhorn); Bob Berg (tenor saxophone); Ron Carter (bass); Al Foster (drums); voices, Alan Copeland dir. *Out of the Night; Mood for Maude; Togetherness*; and five others. BLUE NOTE LA708-G \$6.98, © EA708-H \$6.98, © CA708-H \$6.98.

Performance: **Beauty and the beastly**  
Recording: **Very good**

If there were some way to eliminate the voices, this could be a very fine Horace Silver album. The voices *are* there, though, six of them, sounding like rejects from the Norman Luboff Choir as they sing Silver's own dull lyrics: "When cough drops and rag mops and bus stops are new, I will always love

you. . . . You figure it out. It's really a shame because the quintet plays so well here, and—if you can stand the context—there are noteworthy solos by leader Bob Berg and trumpeter Tom Harrell, a fiery bopster. Remix, anyone? C.A.

**ZOOT SIMS: *Hawthorne Nights*.** Zoot Sims (tenor saxophone); big band, Bill Holman arr. and cond. *Main Stem; The Girl from Ipanema; Fillings*; and five others. PABLO 2310-783 \$7.98, © S10-783 \$8.98, © K10-783 \$8.98.

Performance: **Solid**  
Recording: **Good**

Tenor saxophonist Zoot Sims—erstwhile member of the Woody Herman, Benny Goodman, and Stan Kenton bands—has been label-

hopping lately, recording mostly for small, dedicated independent labels whose budgets rarely allow more than a handful of players in the studio at one time. Norman Granz's Pablo label has no such problems, of course, so here we have Zoot with ten top West Coast-based musicians playing arrangements by another big-band alumnus, Bill Holman. The result is a very straightforward session set, stylistically somewhere in the Fifties, with appealing solo work by trumpeter Oscar Brashear, trombonist Frank Rosolino, saxophonist Jerome Richardson, and Zoot himself. Drummer Nick Ceroli weighs things down a bit, and Zoot's vocal on *Dark Cloud* struck me as gratuitous, but this is otherwise a rather nice, unpretentious album by a man whose skill and taste have never faltered. C.A.

# About damping, bi-amping and the Crown DC-300A

Because of inertia, speaker transducers over-react to amplifier signals. This can be minimized by speaker design, but it can't be eliminated entirely. In the process, the transducers feed spurious signals back into the signal processing units.

A good amplifier is designed to control excessive transducer excursions by reducing — and absorbing — the unwanted signals generated by such excursions. It's part of a process audio engineers call damping. The Crown DC-300A power amplifier, in addition to its other well-known specifications, has a damping factor of 700, which means it should easily control speaker excursions. (A rating of 400 is considered good.)

But in a standard hi-fi stereo system, the DC-300A can't do all the damping it was designed for. The sound is a little muddier than it should be.

Why? Because the speaker crossovers — with their own impedance — get in the way. The amp is not directly

hooked up to the transducers.

Solution? Move the crossovers back between amp and pre-amp. Add another DC-300A and bi-amp the speakers.

The DC-300A now damps excessive transducer excursions efficiently. Which can mean crisper, cleaner sound.

Each transducer now has 155 watts of power available to drive it, and is limited only by its own characteristics. Which can mean more sound pressure.

There can also be less distortion since harmonics of low-frequency distortion cannot feed to high-frequency transducers through the crossover.

Are you interested in how to use all the power and performance of a Crown DC-300A amplifier? Write. We'll send you information about the Crown VFX-2A, a two-channel variable-frequency crossover that makes bi-amping easy. Plus reprints of some articles that may help you decide if bi-amping is for you.

## Crown VFX-2A

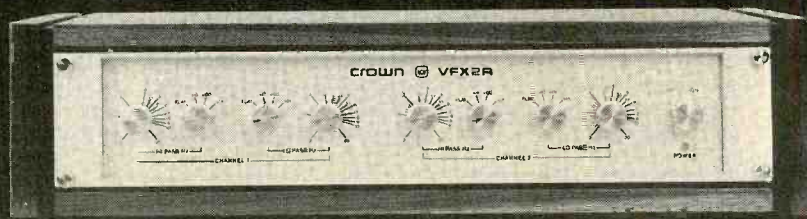

**crown**

Box 1000, Elkhart IN 46514



# CLASSICAL DISCS AND TAPES

Reviewed by RICHARD FREED • DAVID HALL • GEORGE JELLINEK • PAUL KRESH  
STODDARD LINCOLN • ERIC SALZMAN

## RECORDING OF SPECIAL MERIT

**BACH:** *Prelude and Fugue in E Minor (BWV 548); Pastorale in F Major (BWV 590); Trio Sonata in E-flat Major (BWV 525); Passacaglia and Fugue in C Minor (BWV 582)*. Hans Fagius (organ). B1s LP-63 \$7.98 (from HNH Distributors, Ltd., P.O. Box 222, Evanston, Ill. 60204).

Performance: **Powerful**  
Recording: **Excellent**

Hans Fagius is a marvelous organist who plays with both brilliance and taste. He understands the music of Bach and is able to present it in a manner that is intelligent and at the same time exciting. Perhaps his greatest achievement on this record is the way he distinguishes between the passage work that is written to animate chordal progressions, as in the great E Minor Prelude and Fugue, and that which is linear and needs to be articulated for clarity, as in the Trio Sonata. Fagius also understands the art of playing the instrument lyrically, as attested in the *Pastorale*, and he is a master of registration, which he uses for both coloristic and structural purposes.

The organ Fagius uses for his fine performance is the one at Vimmerby, built in 1956 by Marcussen and Son of Aabenraa, Denmark. The sound is a Baroque one, capable of rich, massive sonorities and with exotic solo stops. The action is tracker, and the engineers have beautifully caught the chuff, which lends so

much color to Baroque organ music. Be advised: here *full* justice is done to Bach by both performance and instrument. S.L.

**BALAKIREV:** *Piano Concerto No. 2, in E-flat Major*. **LIAPUNOV:** *Rhapsody on Ukrainian Themes, Op. 28*. Michael Ponti (piano); Westphalian Symphony Orchestra, Recklinghausen, Siegfried Landau cond. TURNABOUT □ QTV-S 34645 \$3.98.

Performance: **Piano good**  
Recording: **Good**

Balakirev's Second Piano Concerto is a mid-nineteenth-century piece that was left unfinished by the composer at his death in 1910 and had to be completed by his younger friend and protégé Sergei Liapunov. There is an explanation. Mily Balakirev was the organizing force and spiritual father of the Russian Five, even though he was only a few years older than the others. His composing prime was not long after the middle of the nineteenth century; the Second Concerto was actually begun in 1861 and then abandoned until 1909 when he completed the first two movements. Another odd feature is that the music does not sound strongly nationalistic but is close to the Central European mainstream—more so than, say, Tchaikovsky's work. It is, at any rate, brooding in tone and darkish in coloration, and the piano writing is strong and busy in the required manner. I'm afraid, however, that you come away from listening to this music with the impression of having eaten a hearty meal but finding it hard to recall just exactly what was on the menu.

Liapunov's rhapsody was written in 1908 and dedicated to Busoni. It is a more obviously Slavic work and much more brilliant although equally *rétardaire*. Both works are convincingly represented (especially by Ponti's playing) and will recommend themselves to Slavophiles and lovers of the Romantic concerto. E.S.

## RECORDING OF SPECIAL MERIT

**BEETHOVEN:** *Cello Sonatas: No. 1, in F Major, Op. 5, No. 1; No. 2, in G Minor, Op. 5, No. 2; No. 3, in A Major, Op. 69; No. 4, in C*

*Major, Op. 102, No. 1; No. 5, in D Major, Op. 102, No. 2*. Daniel Shafran (cello); Anton Ginzburg (piano). ODYSSEY/MELODIYA Y2 34645 two discs \$7.98.

Performance: **Sturdy**  
Recording: **Good**

Soviet cellist Daniel Shafran has been recording since the middle Forties, and his performances—chiefly of Russian repertoire—have appeared intermittently on a variety of American labels, most notably on RCA, for whom he recorded the Schubert *Arpeggione* Sonata and the Shostakovich cello sonata while on an American tour.

Not the least asset of Mr. Shafran's present traversal of the Beethoven cello sonatas, aside from the set's attractive price, is the excellence of his collaborator, pianist Anton Ginzburg, whose contribution is intensely musical and rhythmically alive. Ginzburg and Shafran are heard here together as true equals, and the sonatas sound the way Beethoven intended them to. In the two late sonatas of Op. 102, Shafran gives his very best, both musically and in terms of technique. Sweeping virility is the hallmark of the C Major, and in the D Major Shafran and Ginzburg do a delightfully lightfooted exposition of the fugue, prefaced by a truly moving realization of the slow movement. The early sonatas do not come off quite as well. Shafran's upper-register intonation is somewhat less than impeccable in both the introduction of the F Major and the opening of the A Major, and in the former work he adopts a rather fast vibrato that seems to me out of character with the nature of the music itself—but this is a matter of taste. The sound is excellent throughout the album. D.H.

**BEETHOVEN:** *Piano Sonata No. 22, in F Major* (see LARSSON)

**BENNETT:** *The Fun and Faith of William Billings, American* (see BILLINGS)

**BILLINGS:** *Three Hymns*. **BENNETT:** *The Fun and Faith of William Billings, American*. **SCHUMAN:** *New England Triptych*. University of Maryland Chorus; National Symphony

### Explanation of symbols:

- Ⓡ = reel-to-reel stereo tape
- Ⓢ = eight-track stereo cartridge
- ⓐ = stereo cassette
- Ⓛ = quadraphonic disc
- Ⓡ = reel-to-reel quadraphonic tape
- Ⓢ = eight-track quadraphonic tape

Monophonic recordings are indicated by the symbol Ⓜ

The first listing is the one reviewed; other formats, if available, follow it.

Orchestra, Antal Dorati cond. LONDON OS26442 \$6.98.

Performance: **Spirited**  
Recording: **Superb**

This handsomely decorated album from London Records, billed as "the official souvenir recording of the John F. Kennedy Center," is devoted in one way or another to the music of William Billings, a colonial musician and one of America's first big songwriters. What Billings wrote were hymns and anthems with sturdy tunes. He often set Biblical texts, and when the colonies won the Revolutionary War, he responded to the news with an appropriate anthem (called, naturally, *Independence*). This concert opens with an ambitious setting by Robert Russell Bennett of lines drawn from various religious texts Billings put to music. It is presented in an elaborate arrangement for chorus and orchestra, and Bennett, the orchestrator of many a Broadway show (*Showboat*, *South Pacific*, *My Fair Lady*, *The Sound of Music*), spared no equipment in his instrumental arsenal to convey the "fun and faith" of Billings. The trouble is, as Bennett himself admits in his interesting notes, that Billings abhorred instrumental music, which he categorized as "just noise," and would probably have felt particularly uncomfortable hearing his tunes laid out in so lush and overingenious a fashion.

William Schuman's *New England Triptych*, though it uses no words at all, is far closer in spirit to the original, for Schuman has clothed Billings' settings of *Be Glad Then*, *America*, *When Jesus Wept*, and *Chester* in strong, sinuous, orchestral dress quite free of frills. Best of all, though, is the section devoted to Billings' own *cappella* chorus settings of these same hymns, crude in their way but honest, direct, powerful, and original. The whole program receives a straightforward, spirited performance from the University of Maryland Chorus directed by Paul Traver and the National Symphony Orchestra under Antal Dorati, and the recorded sound is just fine. P.K.

#### RECORDING OF SPECIAL MERIT

**BRAHMS: Piano Concerto No. 1, in D Minor, Op. 15.** Artur Rubinstein (piano); Chicago Symphony Orchestra, Fritz Reiner cond. RCA ARL1-2044 \$7.98.

Performance: **Peak Rubinstein-Reiner**  
Recording: **Good early stereo**

Last January, in a review of Artur Rubinstein's 1976 recording of Brahms' youthful concerto masterpiece, I noted that the 1954 RCA recording Rubinstein made with Fritz Reiner and the Chicago Symphony was the most truly representative documentation of the pianist's way with this score. To my very pleasant surprise, RCA has now reissued that 1954 performance, and in stereo. Sonic considerations aside, it is still one of the epochal readings of the music. There is eloquence in the slow movement (just as in the later version), but it is the end movements that provide the musical and pianistic thrills here; "fire-eating" was the adjective I believe I used in my earlier commentary. As for the sound, direct comparison of the 1955 mono issue and the new stereo disc reveals pronounced differences. The early issue favored the bright, almost brittle sonics common to many American piano-orchestra recordings of the period, while the stereo issue is far warmer in sound but also rather "blanketed" in the

upper mid-range. For those who have the requisite controls, a slight boost at 2,000 Hz will open things up effectively enough. The solo piano seems a trifle outside in terms of lateral "spread," but a judicious adjustment of blend control will take care of that. These are minor problems, so far as I am concerned. We should simply be very grateful for the resurrection of this major recording. D.H.

**DOWLAND: First Booke of Songes 1597.** Consort of Musicke, Anthony Rooley cond. L'Orseu-Lyre DSLO 508-9 two discs \$15.96.

Performance: **Stylish**  
Recording: **Adequate**

This album is the first of a projected eight that will encompass the complete works of this exquisitely melancholy composer. The project is certain to be a worthwhile one for music libraries and all those interested in the English lute song.

The *First Booke of Songes* consists of twenty-one masterpieces with fine lyrics (texts are supplied). They have been performed as colorfully as possible here by making use of four singers and various instrumental combinations drawn from a consort of viols and lute. The performances are on a high level, and the voices are pleasing and suitable for the music. Stylistically they seem at home, but I cannot help feeling that their style

has been applied wholesale rather than to the requirements of each particular setting. Perhaps this is inevitable when artists are faced with so large a project. S.L.

**FRANCK: Symphonic Variations; Les Djinns.** Aldo Ciccolini (piano); Orchestra de Liège, Paul Strauss cond. **D'INDY: Symphony on a French Mountain Air, Op. 25.** Aldo Ciccolini (piano); Orchestre de Paris, Serge Baudo cond. ANGEL □ S-37247 \$6.98.

Performance: **Franck best**  
Recording: **Franck better**

**FRANCK: Symphonic Variations; Les Djinns; Les Éolides.** Mark Westcott (piano); Royal Philharmonic Orchestra, Paul Freeman cond. MUSICAL HERITAGE SOCIETY MHS 3515 \$3.50 (plus 95c handling charge from the Musical Heritage Society, Inc., Oakhurst, N.J. 07755).

Performance: **Warmly lyrical**  
Recording: **Clear and bright**

**FRANCK: Symphonic Variations; Symphony in D Minor.** Ilse von Alpenheim (piano); Royal Philharmonic Orchestra, Antal Dorati cond. TURNABOUT TV-S 34663 \$3.98.

Performance: **Romantic/businesslike**  
Recording: **Fair to good**

At first glance, there would appear to be a rich

## King of the Steel Piano



Brady is their king. Brady does not play the ordinary steel drum. He has what is called a "steel piano," a chromatic instrument with a three-octave range, fashioned for him by one Ellie Manette. When an individual note is struck, the vibration of the drum touches off harmonically related notes as well.

After all that explanation, two questions remain: is this instrument worth hearing, and is Brady good at playing it? The answer to both is yes, although I think you will probably find that the best way to listen to this album—until your ears become accustomed to the sound—is one or two tracks at a time.

**B**RADY'S decision to interpret classical selections and themes stems from a desire to be taken seriously and simultaneously to demonstrate his musicianship. Thus, some of the performances are a trifle overbearing, but they're still well worth the hearing because Brady is unique at his craft. He is also an exploratory, adventurous musician who deserves a fair hearing. If you are looking for the most unusual album of the year, this is probably it. —Joel Vance

**VICTOR BRADY: Classical Soul.** J.S. Bach: *Jesu, Joy of Man's Desiring*. Tchaikovsky: *Theme from Piano Concerto No. 1*. Beethoven: *Minuet in G*; *Ode to Joy*; *Für Elise*. Schubert: *Serenade*. Chopin: *Etude in E Major, Opus 10, No. 3*. Rubinstein: *Melody in F*. Brady: *Easy and Hold On*; *Rosebud*. Victor Brady (steel piano). INNER CITY IC 1006 \$6.98.

# In The Company Of Great Conductors

## ANDRÉ PREVIN

S-37260  
His Rachmaninoff is sensuously devastating. For *The Bells* (S-37169)—a '76 Grammy Award. Here, completion of the three unit Symphony Cycle. No other can withstand the comparison.

RACHMANINOFF  
SYMPHONY  
NO. 3  
London Symphony  
Orchestra  
PREVIN



## RICCARDO MUTI

S-37230  
In two years—he's mastered three complete operas, symphonies by Tchaikovsky, Mozart and Mendelssohn, and the Cherubini Requiem. If you've yet to meet him, let this new issue be your introduction.

DVORAK  
SYMPHONY NO. 9  
New Philharmonia Orchestra  
MUTI

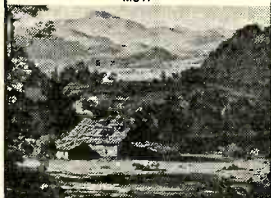

## WILLI BOSKOVSKY

S-36826  
Without question, he's champion of the Viennese style. With hands of magic the infectious tunes are made into dazzling delights. Six such Angel albums are now available.

Music of Vienna  
The Johann Strauss Orchestra of Vienna  
Boskovsky  
Conducting

Johann Strauss Sr.: Radezky March & Sighs (Polka)  
Johann Strauss Jr.: On the Beautiful Blue Danube & Champagne Polka  
Josef Strauss: Chatterbox Polka  
Lanner: The Romantics (Waltz)  
Suppe: Boccaccio (Overture) & Fatinitza (March)  
Millocker: Postscript Polka



## SIR ADRIAN BOULT

S-37211  
As a Vaughan Williams authority he is unique. At 88, his recordings continue to defy superlatives. "A distinguished release, surely as close as we shall come to a definitive statement of these works" *Stereo Review*.

String Music Of  
VAUGHAN WILLIAMS  
Fantasia on a Theme by Thomas Tallis  
Concerto Grosso  
Partita for Double String Orchestra  
London Philharmonic Orchestra  
BOULT



## HERBERT VON KARAJAN

SB-3838  
In the art of music-making, he is rivaled by few, perhaps none. Perfection is again his in this winning conjunction of magnificent voices, unparalleled orchestral playing and resplendent sonics.

BRAHMS  
A GERMAN REQUIEM  
TOMOWA-SINTOW - VAN DAM  
Vienna Singverein  
Variations on "St. Antoni Chorale"  
Berlin Philharmonic Orchestra KARAJAN



Scotto, Domingo, and Milnes at Andrea Chénier recording session

RCA Records

harvest of Symphonic Variations here, with the not overly recorded D'Indy symphony with piano *obligato* as a most attractive extra. But in the listening it is the up-dated recordings of *Les Djinns* and *Les Éolides* that stand out as the major elements of interest.

Though *Les Djinns* lacks the sparkle and somewhat more virtuosic appeal of the Symphonic Variations, it remains an intriguing bit of musical drama, evoking mankind's struggle against the spirits of evil depicted in Victor Hugo's poem. The tonal texture follows in its layout the lozenge-shaped typographical layout of Hugo's poetic text. *Les Éolides* is something of a trifle, but a lovely trifle when treated with a light hand and avoidance of sentimentality. I am partial to Paul Strauss' lean and taut conducting in *Les Djinns*, a style that matches Ciccolini's bright, clean pianism well. Paul Freeman takes a more expansive approach to both works, similarly matching young Mark Westcott's solo style in *Les Djinns*. The sonics in the Musical Heritage Society disc are unusually clean, bright, and full-bodied. But I am not sufficiently enamored of any of the other performances here to want to replace such existing versions as the Monteux/Chicago recording of the Franck symphony, the Cziffra father-and-son collaboration or the Watts/Leinsdorf version of the Symphonic Variations, or the oldish but lively Henriot-Schweitzer/Munch reading of the D'Indy.

In my estimation, Dorati's reading of the D Minor Symphony lacks genuine ardor, but in the Symphonic Variations Ilse von Alpenheim's romantically styled solo work provides a leavening influence. Heard next to the MHS disc, also with the Royal Philharmonic, the sound seems in less than perfect focus in the orchestral department. The Westcott/Freeman teamwork is openheartedly lyrical in spirit, but Ciccolini and Strauss provide the most enlivening reading of the three. Regrettably, the Ciccolini disc is spoiled for me by a decidedly less enlivening treatment of the D'Indy score; the somewhat over-reverberant ambiance tends to muddy up an already intrinsically dense musical texture. Even quadrasonic playback is not much help here.

If you have the earlier Ciccolini recording of *Les Djinns* (Angel S-36151), which is conducted by Cluytens and also includes *Les Éolides*, hang onto it. If, however, you are for some reason forced to choose from among these three discs, Ciccolini's is it. *D.H.*

### RECORDING OF SPECIAL MERIT

**GIORDANO: Andrea Chénier.** Plácido Domingo (tenor), Andrea Chénier; Renata Scotto (soprano), Maddalena; Jean Kraft (mezzo-soprano), Comtesse de Coigny; Sherrill Milnes (baritone), Gérard; Allan Monk (baritone), Roucher; Enzo Dara (bass), Mathieu; Gwendolyn Killebrew (mezzo-soprano), Madelon; Maria Ewing (mezzo-soprano), Bersi; Piero de Palma (tenor), Abbé; Michel Sénéchal (tenor), Spy; others. John Aldis Choir; National Philharmonic Orchestra, James Levine cond. RCA ARL3-2046 three discs \$23.94.

Performance: **Good**  
Recording: **Excellent**

Giordano's *Andrea Chénier* seems to be steadily gaining in popularity—this despite those critics of the Anglo-Saxon world who have been influenced by the kind of stuffy pontification with which R.A. Streatfield dismissed Umberto Giordano in a few condescending lines in the "old" *Grove's Dictionary* ("... His scores lack solidity, and in his music the usual theatrical tricks for extorting applause too often take the place of a sincere expression of emotion"). I never went along with that attitude, having been an enthusiastic partisan of this opera's throbbing passion and fascinating array of personalities for decades.

Fortunately, *Andrea Chénier* has fared well on records. The classic mono set of 1941 with Beniamino Gigli, Maria Caniglia, and Gino Bechi in the principal roles (still available on Seraphim 6019) paved the way. After two uneventful mono efforts, the catalog gained two fine stereo versions, London OSA 1303 in 1958 and Angel S-3645 in 1963. RCA's brand new recording, surpassing them in some if not all respects, is a strong challenger.

It benefits from vivid sonics, especially in the lively presentation of the revolutionary scenes, and James Levine's characteristically vital leadership. With judicious tempos (better judged than Gabriele Santini's occasionally languid pacing in the Angel set) and always firm rhythmic underpinning, Levine points up certain details in the orchestration that previous treatments have not revealed so clearly. At times, the orchestra sounds excessively loud (this has been a persistent problem with Mr. Levine in the theater), and the open-

(Continued on page 132)



# THE ADC CARTRIDGE CAUSES NO PERCEIVABLE WEAR OVER THE LIFE OF YOUR RECORDS.

MKII is different, because our engineers found a way to detach the magnet and reposition it above the stylus, so the stylus applies less pressure against the groove.

Less pressure means less wear.

The fact is, of all the leading brands, ADC cartridges have the lowest mass moving system you can buy. That means better sound and superior performance.

The XLM frequency response is exceptionally flat, from 15Hz to 24KHz  $\pm 1.5$ dB. And for the ultimate in stereo reproduction, it has a minimum of 28dB of channel separation.

Think about it. In the long run you'll probably spend more on your record collection than you will on your whole stereo system. So it makes sense to buy a cartridge with proof that it makes your records sound better and live longer.

# THE ADC LOW MASS CARTRIDGE.

IT HELPS YOUR RECORDS LIVE LONGER.

Unbelievable? Believe it. A series of tests conducted by a leading independent audio-testing laboratory prove it. The tests show that the ADC XLM-MKII cartridge causes no perceivable wear until after 60 plays. Industry sources estimate the "life of a record" (the average number of times a record is played) to be 40 to 50 plays.

Other cartridge manufacturers may talk about less record wear, but ADC has proven *no wear over the life of your record.*

The reason for this is our unique patented design. It's patent #3294405.

We call it the "induced magnet" cartridge.

Most cartridges are designed so that a heavy magnet is part of the moving system.

The ADC XLM-

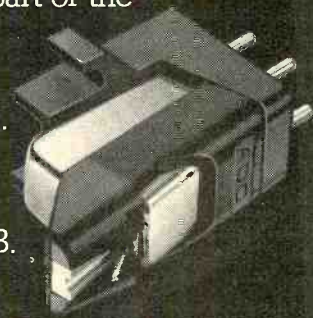

A BSR COMPANY

ADC Phone Cartridges

A D vision of

BSR Consumer Products Group

Rte. 303, Blauvelt, N. Y. 10913

## THE PROOF:

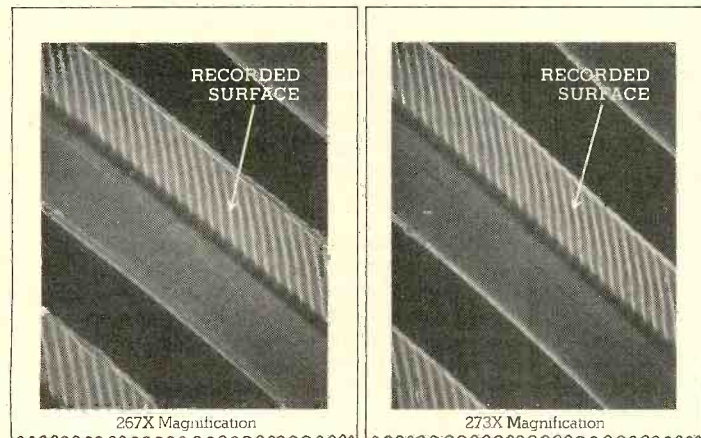

This is a photomicrograph of a 20kHz record groove that has never been played before.

This is a photomicrograph of a similar 20kHz record groove played 75 times with an ADC XLM-MKII cartridge. As you can see there is no difference.

If you'd like your own personal copy of the test result, write to ADC at address shown above.

CIRCLE NO. 3 ON READER SERVICE CARD

## THE DIFFERENCE:

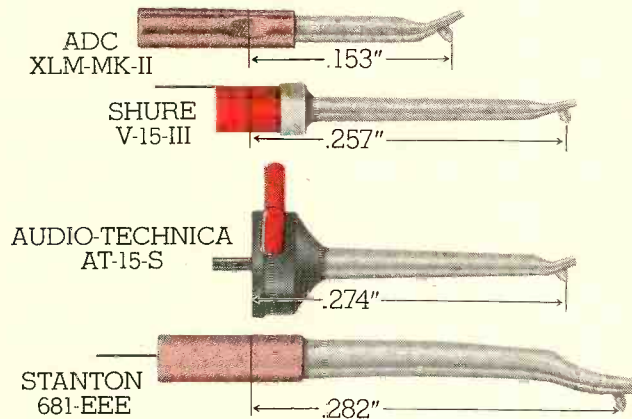

The way to get the most accurate reproduction of sound is to lower the total effective mass of the moving parts of the stylus. And that's exactly what

our engineers did. In fact, of all the leading brands, ADC cartridges have the lowest mass moving system you can buy.

INDUCED MAGNET

MAGNET



THE significance of Deutsche Grammophon's new three-record Kurt Weill set is suggested by the cover design of a crumpled sheet of paper burning away to reveal a memorial tablet underneath inscribed with Weill's name. How ironic that Weill, the only really important modern Central European composer to break away from the "masterpiece complex" that has haunted so much of modern music, should now be enshrined, memorial tablet and all, as a Great Master. And the circumstances of the recording are remarkable: a British modern-music ensemble went to Berlin with two Weill programs devised by a distinguished British critic and then recorded the music for the German record company.

Well, it was probably inevitable and it could have been a lot worse. David Drew, the man who has fought the good fight for Weill as a composer of major stature, is a critic of great sensitivity and knowledge, and he has excellent collaborators here. We are far from being stuck in the modern-music masterpiece mud. This is a serious sort of Kurt Weill, but it has musical distinction without losing touch with the vulgar, low-down, pop, comic-ironic-epic elements through which the composer renewed his artistic strength.

What's all the fuss about? After all, Weill is not exactly an obscure composer. In fact, he is probably better remembered in this country than anywhere else, principally for his songs and musicals. *Three Penny Opera* recently had a very successful revival (complete with new recording) at Lincoln Center, and a new production of *Happy End* ought to be going by the time this appears in print. An evening of Kurt Weill theater songs had a good run not too long ago. Some of the Brecht-Weill collaborations are still performed in European theaters and opera houses—notably *Three Penny Opera* and *Mahagonny*.

But Drew still has a point. In Europe, especially, Weill's fame is widely regarded as a kind of appendage to that of Bertholt Brecht. Drew's aim has been to re-establish Weill's independent reputation as an artist of the first rank by resurrecting his instrumental works, his theater collaborations with others, and his lesser-known work with Brecht, and also by performing everything exactly as he wrote it; Weill's own instrumentation is nearly always superior to the arrangements in which we usually hear his songs.

ALTHOUGH all the works on this recording date from a remarkably short and prolific period (between 1924 and 1929), all of the above categories are in fact represented. The pantomime music from the opera *The Protagonist*, after George Kaiser's play, was composed in 1924, just after the strange and compelling *Concerto for Violin and Winds*. All the other works, however, are imbued with the tremendous presence of Brecht. *The Mahagonny Songspiel*, usually known in English as "The Little Mahagonny," is the first version of what later was to be expanded into a three-act opera. It was commissioned for a modern-music festival where it caused a great stir. Brecht had published five *Mahagonny* songs with music a year or so earlier, and Weill reset these with a kind of finale added on. (Weill used Brecht's music as the basis of two of his settings, including the famous *Alabama Song*,

but the difference is between musical doggerel and real musical poetry.) The numbers, connected by modern-music interludes, were performed with a symbolic staging that included projections. The score is written for trained

## Kurt Weill: Instrumental and Theater Works



Columbia Records

"... Weill's own instrumentation is nearly always superior to the arrangements."

voices, and this carries over into the operatic version, one of the main reasons why *Mahagonny* has never had a successful production in this country. It needs acting singers, not singing actors, and it gets what it needs in this smashing performance.

The other major production here is that of the music to *Happy End*. With a story aston-

ishingly like *Guys and Dolls*—Salvation Army lass tries to convert gangster—*Happy End* was as much of a flop in 1929 as *Three Penny Opera* had been a success a year earlier. *Happy End* was more of a musical-comedy entertainment, but in the not-so-happy end it turned out to be more obviously political; there was something in it to offend everybody. It will be interesting to see if the modern revivals succeed in re-establishing this work, which has some of Weill's most wonderful music. The version here is a kind of *Songspiel* devised not by the composer but by David Drew. Rather inexplicably, the best-known number of the show, the *Billbao Song*, is missing. All the rest of the music is included but not in show sequence, nor do the notes give much of a clue as to what is going on (texts and translations are included for every individual number, but the stage action is not described). This is one way that Drew has of keeping our attention fixed on Weill and not Brecht.

BECAUSE much of the music is written for show performers, two of the singers, Meriel Dickinson and Benjamin Luxon, come to the fore since both have strong show or cabaret styles. Even so, the demands are considerable, everything being performed exactly as Weill wrote it (original high keys as well as original instrumentation). The big challenge is Ms. Dickinson's; she has no less than five major solos and makes a remarkable impression, singing very effectively in German in a manner obviously patterned on—but not purely an imitation of—the great old German show/cabaret style of Lotte Lenya and others. Ms. Dickinson is perhaps more of a team player than a knock-down, drag-out, gut performer, but she does an exceptional job in a language and style that are certainly not native to her. Indeed, the same can be said for everyone, and the fact that Deutsche Grammophon was convinced speaks for itself.

*Vom Tod im Wald (Death in the Forest)*, for bass and winds, is a rather lugubrious setting of a powerful Brecht poem. *The Berlin Requiem*, a "small cantata" for three male voices and winds that was commissioned by Berlin Radio in 1929, is not lugubrious at all but a strong and stirring setting of five rather political poems of Brecht. Finally, the Suite for Winds from *Three Penny Opera*, premiered at the Berlin Opera Ball in 1929 under the direction of Otto Klemperer, is a wonderful rediscovery destined to become a pops concert standard. Everything is brilliantly played and produced, and the usual three-language program booklet is chock-full of everything you want to know—except the plot of *Happy End*. —Eric Salzman

WEILL: *Mahagonny, Songspiel; Pantomime 1, from Der Protagoniste, Op. 14; Vom Tod im Wald, Op. 23; Happy End; Das Berliner Requiem; Kleine Dreigroschenmusik, Suite for Wind Orchestra from Three Penny Opera; Concerto for Violin and Wind Orchestra, Op. 12.* Meriel Dickinson, Mary Thomas (mezzo-sopranos); Philip Langridge, Ian Partridge (tenors); Benjamin Luxon (baritone); Michael Rippon (bass); Nona Liddell (violin in concerto); London Sinfonietta, David Atherton cond. DEUTSCHE GRAMMOPHON 2709 064 three discs \$23.94.

# THE TUNER/AMPLIFIER FROM TOSHIBA.

THE WAY WE PUT OUR RECEIVER TOGETHER, IT SOUNDS LIKE SEPARATES.



The goal of most receivers is to sound like a good receiver. But when we set out to build the Toshiba SA 620, we set our goals a little higher:

To sound like a separate tuner and amplifier.

**We started at the bottom.**

We began by building an amplifier. An amplifier strong enough to drive even the biggest speakers. Without strain. Yet clean enough to keep distortion to a minimum.

An amplifier with 50 watts minimum RMS per channel (both driven into 8 ohms speakers, from 20Hz to 20kHz, and only 0.3% total harmonic distortion).

And when we were through we had a sound quality that virtually achieves the sound of separates. But we were still only half way there.

**Our engineers topped themselves.**

Using the latest advances in audio technology, Toshiba engineers developed a tuner with specs and features good enough to stand up to separates.

A special high density Toshiba PCT-type IC ensures high IF stage performance and reliability. While our three, two-element ceramic filters

and six stages of amplification give razor-sharp selectivity.

IF sensitivity is rated at  $1.8\mu\text{V}$ . Conservatively. Selectivity an impressive 65dB. And signal to noise ratio a super clean 70dB.

**If we didn't tell you it was one unit, you wouldn't know it.**

Since our receiver didn't sound like most other receivers, we decided it shouldn't look like them either.

So working closely with our engineers, Toshiba designers created our unique "double-decker" look.

Giving our receiver the look of a separate tuner and amplifier. To match its sound.

**You can afford a Toshiba Tuner/Amplifier.**

Since every music lover has different needs, we took everything we learned from the 620 and applied it to a whole line of Tuner/Amplifiers.

So now everyone can have a receiver that looks and sounds like separate units. Without having to pay for separate units.



SA 220C



SA 320

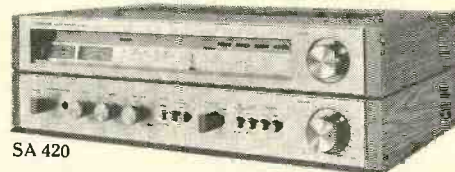

SA 420

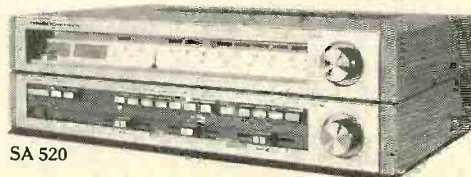

SA 520

## TOSHIBA

Toshiba America, Inc. 280 Park Ave., New York, N.Y. 10017

# SAVE!

MONEY • TIME • FREIGHT

QUALITY STEREO EQUIPMENT AT LOWEST PRICES.

YOUR REQUEST FOR QUOTATION RETURNED SAME DAY.

FACTORY SEALED CARTONS—GUARANTEED AND INSURED.

SAVE ON NAME BRANDS LIKE:

|        |        |
|--------|--------|
| A.D.C. | KLH    |
| A.R.   | SHURE  |
| DYNACO | KOSS   |
| SONY   | FISHER |

PIONEER AND MORE THAN 50 OTHERS BUY THE MODERN WAY BY MAIL—FROM

## illinois audio

Department 217S  
12 East Delaware  
Chicago, Illinois 60611  
312-664-0020

CIRCLE NO. 23 ON READER SERVICE CARD

## Save by mail on Music Systems.

### Our Big Catalog Shows How!

Send today for your FREE copy of our 68-page catalog. It's value-packed with complete music systems, top-brand components, accessories, plus hundreds of unique items—and more. There's a handy "HiFi Primer," feature articles, all to help

you have better sound. Our big centrally located warehouse will serve you fast and keep freight low; and, your US and Canadian Bank Charges are welcome.



## Midwest HiFi<sup>®</sup>

Wholesale and Mail Order Division

1626 Ogden Avenue (US 34)  
Downers Grove, Illinois 60515  
(312) 852-5885

Call for a quote. Lines open 1-4 p.m. C.T.  
Mail this coupon for your FREE catalog.

Mail to: Midwest HiFi, P.O. Box 567, Downers Grove, Illinois 60515

NAME \_\_\_\_\_  
 ADDRESS \_\_\_\_\_  
 CITY/STATE \_\_\_\_\_ ZIP \_\_\_\_\_ SR-6-7

ing of Act II is perhaps a shade too frantic, but the overall leadership is admirable in its vitality and commitment.

Plácido Domingo is the first Chénier since Gigli to suggest the hero's poetic qualities in the sensitive modulation of his tones and elegance of his phrasing. This said, however, I must confess that Franco Corelli (Angel) imparts more thrilling vocalism to the role, partly through his vibrant enunciation of the text and partly through his more exuberant singing style. Without a doubt, Domingo is the more musicianly singer, but Corelli, in this instance at least, is not easily surpassed.

The exalted standard for the role of Madalena was established by Renata Tebaldi in the London set, and that remains unchallenged by Renata Scotto's singing here—sensitive, poignant, and intelligently characterized as her portrayal is. Likewise, the subtle and dramatically altogether convincing Gérard of Sherrill Milnes cannot match Ettore Bastianini (London) or Mario Sereni (Angel) in tonal smoothness and polish.

One of the most fascinating aspects of this opera is its gallery of unforgettable characters briefly etched against the turbulent panorama of the French Revolution: the haughty Countess, the oily Spy, the fanatic Madelon, the sardonic Fléville, the zealous Mathieu, and so on. Thoughtful casting is essential for these cleverly drawn vignettes, and particularly noteworthy here are Enzo Dara's sonorous Mathieu, Allan Monk's admirable Roucher, Piero de Palma's expert Abbé, and Maria Ewing's somewhat overdrawn but still impressive Bersi. The other interpreters, too numerous to mention, are at least competent, except for the amateurish-sounding representation of Fouquier-Tinville (of all people!). This formidable figure has only a few phrases, but those phrases are delivered on the Seraphim set by Giuseppe Taddei and by artists of comparable worth on London and Angel. A small matter, perhaps, but a damaging miscalculation on RCA's part. Still, this is a praiseworthy treatment of an exciting and rewarding opera. G.J.

**GRIEG: Peer Gynt, Suite No. 1, Op. 46, and Suite No. 2, Op. 55; Four Norwegian Dances, Op. 35.** English Chamber Orchestra, Raymond Leppard cond. PHILIPS 9500 106 \$7.98, ©7300 513 \$7.95.

Performance: **Attractive**  
Recording: **Very good**

"A pink bonbon filled with snow" was the way Debussy once described Grieg's music,

and such a diet sooner or later is bound to be deficient in nourishment. Yet, audiences go on delighting in the suites drawn from Ibsen's *Peer Gynt*, which Grieg had a terrible time composing and which Ibsen never really cared for in terms of his own dramatic objectives. In truth, the moods and melodies of this music are hard to resist, even when one has heard them a thousand times, though I find the music far more interesting when heard in full in the original arrangements for chorus and orchestra.

Of the countless performances of the suites on discs, Leppard's is among the most attractive. There is no attempt to force the climaxes or underline dramatic moments; crescendos swell as though propelled by a natural force. The program is nicely balanced by the familiar yet always attractive suite of Norwegian Dances (orchestrated by Hans Sitt). This work, like the *Peer Gynt* music, was composed while Grieg was still in his thirties, and it thoroughly reflects his admiration for the national music of his own land. P.K.

**HAYDN: Piano Concerto in D Major (see MOZART)**

**HAYDN: Piano Sonata No. 12, in A Major (see LARSSON)**

**D'INDY: Symphony on a French Mountain Air (see FRANCK)**

**LARSSON: Piano Concertino, Op. 45, No. 12.**  
**MOZART: Fantasia in C Minor (K. 396).**  
**HAYDN: Piano Sonata No. 12, in A Major (Hob. XIV:12).**  
**BEETHOVEN: Piano Sonata No. 22, in F Major, Op. 54.** Hans Pålsson (piano); Musica Sveciae, Sven Verde cond. BIS LP-36 \$7.98 (from HNH Distributors, P.O. Box 222, Evanston, Ill. 60204).

Performance: **Lively Larsson and Haydn**  
Recording: **Good**

Hans Pålsson is one of the crop of young (under thirty) Scandinavian pianists who have begun to come into the European limelight over the past five years, though thus far his fairly extensive list of recordings has been confined to Swedish labels. One of Pålsson's best performances in the present collection is his spirited account of the Haydn A Major Sonata from the middle 1760's. Particularly striking is the *Menuetto*, with its highly individual trio episode, that forms the centerpiece of the work. Less happy is Pålsson's way with the brief and delightful Beethoven



COLIN DAVIS AND THE BOSTON SYMPHONY: pure and transparent sound, muscular and audacious conducting

Zamini/Photogram

sonata and with the dark-hued Mozart Fantasia in C Minor. Compared with Richter's performance of the former and Brendel's of the latter, Pålsson's versions seem heavy-handed and lacking in nuance.

The Lars-Erik Larsson concertino is a charming and beautifully crafted lightweight piece, a kind of Swedish cousin to the Francaix piano concertino. It is one of twelve works Larsson wrote during the 1950's for different solo instruments, designed for professional soloists and semiprofessional or amateur performing groups. All but those for trumpet, violin, and cello have been recorded on various Swedish labels. As in the Haydn sonata, Mr. Pålsson's pianism here is elegant and lively, and is backed by expert playing by the chamber ensemble. Excellent recording throughout. *D.H.*

**LIAPUNOV: Rhapsody on Ukrainian Themes, Op. 28 (see BALAKIREV)**

**RECORDING OF SPECIAL MERIT**

**MENDELSSOHN: Symphony No. 4, in A Major ("Italian"). A Midsummer Night's Dream: Overture, Op. 21; Scherzo, Op. 61, No. 1; Nocturne, Op. 61, No. 7; Wedding March, Op. 61, No. 9.** Boston Symphony Orchestra, Colin Davis cond. PHILIPS 9500 068 \$7.98, © 7300 480 \$7.95.

Performance: **Serene and noble**  
Recording: **Excellent**

Mendelssohn never was entirely happy about his *Italian* Symphony. He felt he could have done more with the *saltarello* that constitutes the finale of the work, and he wouldn't allow his Fourth Symphony to be published while he was alive or to be performed after the 1833 première in London. Orchestras have been making up for this situation ever since the composer's death in 1847, and there are now some twenty recorded versions listed in Schwann. The record-buying public may not have been starving for still another *Italian*, but Colin Davis' new performance certainly justifies its existence. The sound of the Boston Symphony is exceptionally pure and transparent, the treatment muscular and audacious. Particularly fine is the handling of the musical sunshine in the finale of what Mendelssohn did admit was "the merriest piece I have yet composed": no measure sounds hurried or fevered, yet everything shimmers and sparkles to the joyous end.

The magical music for *A Midsummer Night's Dream* has suffered almost as much as the *Italian* Symphony from overexposure on records (a dozen of them are listed in Schwann), yet the overture remains one of the most inventive short works of the nineteenth century, and it is difficult today to think of the scenes in Shakespeare's youthful fantasy without hearing in one's head the marvelous incidental music Mendelssohn composed for it. Included here are only the most popular segments, but again the performance is outstanding. I enjoy this particular music more, however, when the entire suite is played, including the graceful vocal sections and the changes worked on the themes for the final moments when Puck and the woodland creatures enter the Athenian palace after the merely mortal revelers have departed. In those moments there is a kind of musical sorcery of which I never tire, and I miss them in this abridged presentation. A splendid, light-handed one it is, though, and the Philips sur-

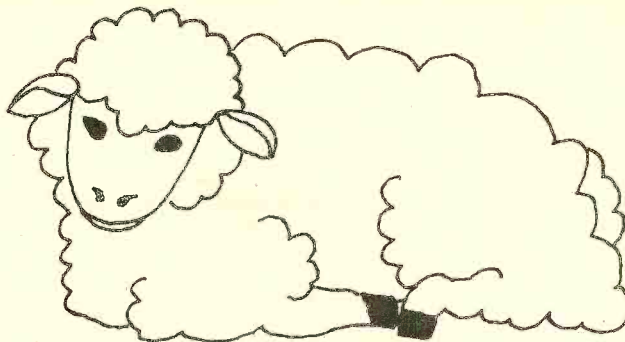

## What has this Animal to do with Cambridge/Cybervox Speakers?

Everything!  
Science tells us that one of the best damping materials in the world is teased lamb's wool. So we lined a 7 foot tapered duct with teased lamb's wool in increasing density along the length of it. The transmission line loaded speaker is just the beginning of the careful engineering in the TL200. There is no equal to the neutral uncolored, high definition sound achieved by it.

Four closely matched drive units, and precision closely toleranced crossover elements, enables a very wide smooth response.  
You can own a British made Cambridge/Cybervox TL200 with the full knowledge that you're ecological—the lamb grows the wool back again!

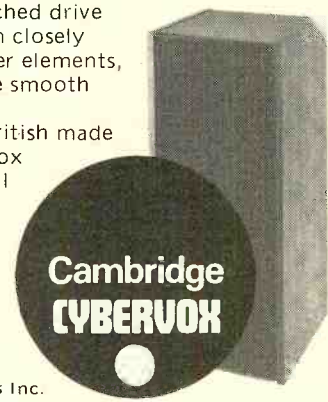

**Cambridge/Cybervox** A Div. of Hammond Industries Inc.  
155 Michael Drive, Syosset, NY 11791 (516) 364-1900  
CIRCLE NO. 11 ON READER SERVICE CARD



## The New Basic Repertoire

STEREO REVIEW again presents the annual revision of the Basic Repertoire. In pamphlet form, it includes 1977 disc and tape recommendations for 173 standard musical works. For your copy, send 25¢ in coin, plus a stamped, self-addressed No. 10 envelope (9 1/2 x 4 1/8 in.), to Esther Maldonado, STEREO REVIEW, 1 Park Avenue, New York, N.Y. 10016.

## DIXIE HI-FI SAVE ON

### Brand Name Audio Components

**BY MAIL**

Write Today for Our **FREE Audio Catalog**

DIXIE is one of the oldest and largest stereo mail order houses in the country. Our lower prices on brand name components can save you real money. Call us today for a price quote, toll free (800)446-7925. In Virginia call (804) 257-4241. Everything shipped in factory sealed cartons with manufacturer's warranty.

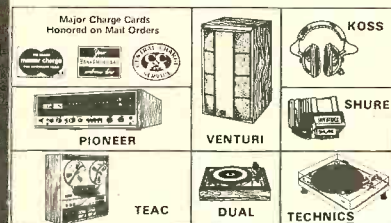

### DIXIE HI-FI

P.O. Box 6496  
Richmond, Va. 23230

SR-6

Please rush me your **FREE Audio Catalog** and complete information. I understand there is no obligation.

Name \_\_\_\_\_  
Address \_\_\_\_\_  
City \_\_\_\_\_ State \_\_\_\_\_ Zip \_\_\_\_\_  
Phone (\_\_\_\_) \_\_\_\_\_

faces are, as usual, almost incredibly free of noise. P.K.

**MONTEVERDI: *Lamento d'Arianna; Lettera Amorosa; Partenza Amorosa; A Quest'Olmo; Questi Vaghi.*** Hertha Töpper (alto); vocal and instrumental soloists. MUSICAL HERITAGE SOCIETY MHS 3457 \$3.50 (plus 95¢ handling charge from Musical Heritage Society, Inc., Oakland, N.J. 07755).

Performance: **Dull**  
Recording: **Flat**

Hertha Töpper's voice is rich and velvety, and she takes great pains to produce nothing but sounds of great beauty. Why she has chosen to display this lovely instrument in three works by Monteverdi written "in genere rappresentativo" is a mystery. This theatrical style is dependent on a rapid delivery of the text in an almost spoken manner. Natural word rhythms, subtle inflection, and coloration alone will blend words and music into the dramatic line Monteverdi spent his life creating. There is no time or place for studied vocal production. Also, Miss Töpper sings in the exact written rhythms rather than the Italian speech rhythm, maintains a steady tempo, and offers none of the ornaments the style requires. The works offered by the vocal ensemble suffer from the same affliction. The sound is lovely, but there is no line, no sense of urgency or lightness. S.L.

**MOZART: *Bastien und Bastienne.*** Edith Mathis (soprano), Bastienne; Claes H. Ahnsjö (tenor), Bastien; Walter Berry (bass), Colas; Leopold Hager (harpsichord); Mozarteum Orchestra, Salzburg, Leopold Hager cond. BASF G22772 \$6.98.

Performance: **Mozart to a T**  
Recording: **Good**

The views of Jean-Jacques Rousseau about nature and "natural man" were widespread and popular in the eighteenth century. It is not well-known today that Rousseau wrote the words and music to one of the most successful musical comedies of all time, a trifle called *Le Devin du Village* that was a hit all over Europe for half a century and, more than anything else, established the vogue for shepherds, shepherdesses, and the pastoral life that, in one form or another, is with us yet.

How appropriate, then, that the twelve-year-old Mozart, Nature's little musical nobleman, should make a new version of Rousseau's little musical play. This is no coincidence, of course; Leopold Mozart always played the game shrewdly. The actual text of *Bastien und Bastienne* is a German translation of a French version of the story, which was more or less pirated from Rousseau's original (no copyright laws then). It is one of the few stage works that Mozart set in his own native language, although, unlike his other *Singspiele*, all or most of the dialogue seems to have been set in recitative (this record is billed as the first from the New Mozart Edition, encompassing the recitatives). There is some doubt about the circumstances of the first performance, but it was apparently given in the house of Dr. Mesmer, the famous hypnotist and, no doubt, himself a thoroughgoing Rousseauian!

What can one say about a work like this? The premise is as thin as thin can be, and the twelve-year-old's music, rococo-pastorale to perfection, is a parody of mid-eighteenth-century style—but a parody that outshines the

originals in most respects. It is played and sung to perfection here—Mozart to a T, one might say. "M-T," a cynic might add. Indeed, this little re-creation shows both the advantages and disadvantages of Salzburgian hero-

## Prodigy Ana-Maria Vera



Philips Records

**A**NA-MARIA VERA was ten or eleven years of age when she made this recording. She is the daughter of a Bolivian father and a Dutch mother resident in Washington, D.C. She plays this simple music perfectly—with style and apparent poetic feeling. The best thing about her playing is the sense of naturalness and joy; she never sounds studied, as if she has learned the music by rote. If Ms. Vera is as good as she sounds—and I tend to believe the evidence of this recording—then she is a prodigy indeed; the fact is that you don't have to know the young pianist's age to enjoy the performances. —Eric Salzman

**MOZART: *Piano Concerto No. 8 in C Major (K. 246).*** **HAYDN: *Piano Concerto in D Major (Hob. XVIII: 11).*** Ana-Maria Vera (piano); Rotterdam Philharmonic Orchestra, Edo de Waart cond. PHILIPS 6833 199 \$7.98.

worship. Everything is full of studied lightness and perfection, pointed charm and grace. Yet, somehow, one wishes for a bit of vigor, individuality, quirkiness. There are no ornaments, only carefully planned ritards, and there's no feeling of spontaneity at all. Surely the life of the "natural man" was not all this studied; in this style one should at least pretend to break loose and feel deeply now and then. Anyway, the performance is appropriate: good singing and playing in a precious style of a precious, precocious work. E.S.

**MOZART: *Fantasia in C Minor*** (see LARSON)

### RECORDINGS OF SPECIAL MERIT

**OFFENBACH: *La Vie Parisienne.*** Michel Trempont (baritone), Bobinet; Michel Sénéchal (tenor), Gardefeu; Régine Crespin (soprano), Métella; Luis Masson (baritone), Baron de Gondremarck; Christiane Chateau (soprano), Baroness de Gondremarck; Jean-Christophe Benoît (baritone), Brazilian, Frick, Prosper; Mady Mesplé (soprano), Gabrielle; Eliane Lublin (soprano), Pauline; Michel Jarry (baritone), Urbain, Alfred; other soloists. Orchestra and Chorus of the Capitole of Toulouse, Michel Plasson cond. ANGEL □ SBLX-3839 two discs \$16.98.

Performance: **Jolly**  
Recording: **Good**

**OFFENBACH-ROSENTHAL: *Gaité Parisienne.*** **OFFENBACH: *La Fille du Tambour-Major; Overture.*** Monte Carlo Opera Orchestra, Manuel Rosenthal cond. ANGEL □ S-37209 \$7.98.

Performance: **Rosenthal's own**  
Recording: **Excellent**

*La Vie Parisienne* is nothing less than an outrageous pot-boiler Offenbach cooked up for the Universal Exhibition of 1867. Paris was full of tourists—potential customers for a bit of risqué French musical theater. For the Variétés, Offenbach produced *Barbe-bleu* and then *La Grande Duchesse de Gérolstein*, both tremendous successes. In the meantime, the Palais-Royal, anxious to get in on a good thing, asked Offenbach for something suitable for an acting company. The librettists Meilhac and Halévy promptly came up with a piece that made fun of the very people who were supposed to be patronizing it: foreigners in Paris, the Swedes and Brazilians who came for the wine, women, and song.

The people—French or foreign—in *La Vie Parisienne* want only to eat (which they do constantly), to drink, and to be entertained, in and out of bed. The Parisians themselves, a race of fops, dandies, and conniving servants, have an additional aim: to take the foreigners for everything they've got—to the tune of the loudest, liveliest music possible. Everyone was sure this was a formula for an instant flop: an operetta performed by non-singers, with no coherent plot, that tweaked the noses of the rich foreigners who were supposed to patronize it. It was, of course, an enormous success.

More than any other work (at least until *La Bohème*) *La Vie Parisienne* created or perpetuated the myth of wicked Paris, capital of worldly pleasures and sins, pandering to the follies and weaknesses of the world, safety valve for the severe, bourgeois industrial society that dominated northern Europe. Lascivious immorality presented in the guise of moral satire and adorned with good, simple tunes and loud, lively orchestration was and always will be the perfect formula. The premise that the only important things in life are sex, food, belly laughs, and bouncy music is what audiences have always been willing to buy.

In *La Vie Parisienne* Offenbach did not try to mix up the tomfoolery and the musical high kicks with anything so serious as political or social satire (except perhaps in the scene where the servants pretend to be Parisian high  
(Continued on page 138)



# Sankyo auto-loading

The tape goes in perfectly every time and ends torn tape worries for all time.

This isn't just another deck. It's the Sankyo STD-2000. And for a lot of reasons it's one of a kind.

Reason number one: the automatic front loading system. It practically takes the cassette out of your hand and glides it into the perfect playing position. Torn tapes and damage head problems are now a thing of the past.

Reason number two: our one-year full warranty. It lets you buy with confidence.

Reasons three to six: the STD-2000 has a S/N 66 dB at 5kHz with Dolby. Wow and Flutter at less than 0.65% WRMS. A total harmonic distortion that's less than 1.5%. And a frequency response of 30-17,000 Hz with CrO<sub>2</sub> and FeCr tapes. And there's much more.

All these reasons and a price that's still under \$300 makes the Sankyo STD-2000 truly one of a kind.

Write to Sankyo, Dept. B, for the name of your nearest dealer.

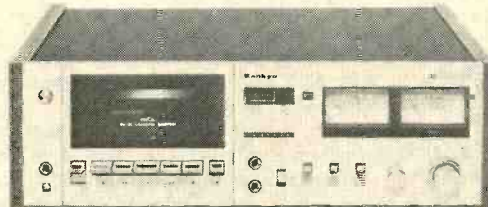

**No other deck offers all these features for under \$300.**

- Dolby noise reduction system with MPX filter switch
- Automatic front loading
- Total automatic shutoff
- 3-digit memory counter
- Separate 3 position bias and equalizer switches
- Peak indicator
- Twin VU meters
- Record, Dolby and tape running indicator
- Permalloy head
- Rich wood cabinetry with chrome accents

If the others had quality like ours, they'd have a Full Warranty like ours.

 **Sankyo**  
Sankyo The Full Warranty Company

Sankyo Seiki (America) Inc., 149 Fifth Avenue, New York, N.Y. 10010

# The Young Pianists

THE internationalization and modernization of the keyboard repertoire is demonstrated in a remarkable way by several recent recordings by talented young pianists from all over making impressive solo appearances in lively, off-beat repertoire. Idil Biret is Turkish, Klára Kõrmendi is Hungarian, Hans Pålsson is Swedish, Paulina Drake is from Hong Kong, Paul Jacobs and Frederic Rzewski are Americans with considerable European reputations, and David Dubal, a student of Arthur Loesser, is well known in New York as the director of a classical-music radio station. Their repertoire is so refreshingly diverse that it defies categorization, but most of it is twentieth-century and all of it is worth attention.

The common notion that twentieth-century composers neglected the piano after the triumphs of the Romantics is, of course, fallacious. The piano music of Debussy and Ravel easily ranks with the great nineteenth-century works, and the latter's most original contributions can be found in his keyboard pieces. *Gaspard de la Nuit*, one of the great landmarks of early twentieth-century music, is wonderfully revealed in Idil Biret's visionary performance on Finnadar. The other Ravel piece in Biret's collection, the *Sérénade Grotesque*, was the composer's earliest piano work (only recently rediscovered) and prefigures *Gaspard* in its harmonic originality.

Stravinsky is not a composer one associates very much with the piano, but the sound of the instrument actually suited his taste very well; he often used it orchestrally (*Petrouch-*

tions to an already attractive disc of music.

The Stravinsky *Etudes* were written in Russia in 1908, just before the famous ballets. These are strong, effective, post-Romantic pieces, and they are well played by Paul Jacobs in his Nonesuch survey of the piano etude in the first part of the century. Along with early Stravinsky we have late Busoni, neo-Classic (really neo-Baroque) and quite dark and intense in mood. The Bartók *Etudes*—little-known, hard-driving, colorful, and very effective—were written in 1918, four years earlier than the Busoni set. Olivier Messiaen, one of the most influential figures in later twentieth-century music, wrote his *Quatre Etudes de Rythme* in 1949-1950, using themes from New Guinea, complex rhythmic permutations, twelve-tone sets as well as tone clusters, an Indian raga, and a bit of bird song. One of the pieces is credited with starting the vogue for total serialization in European avant-garde music. All of this is played to perfection: Jacobs plays Busoni and early Stravinsky so well that his Messiaen *must* be equally true.



Jacobs

The *Serenade in A* (usually macaronically called "Serenade in La") is the most important and attractive of Stravinsky's later, neo-Classical piano music. Its mood is surprisingly close to that of French and Russian salon music, and it is both ironic and charming to hear it played right up against Swedish serial music, as it is in Hans Pålsson's recital disc. Gustaf Paulson, an older composer little known even in Sweden, writes quietly intense twelve-tone music; Bo Nilsson, one of the early *Wunderkinder* of the European avant-garde, wrote in the Fifties' serial style—highly abstract and off-putting. After all that, the simple appeal of the Schumann *Kinderszenen* gives a measure of Pålsson's versatility. This young pianist has a quiet, unflashy, but highly musical style.

Hungary is an unexpected source for the kind of repertoire performed by Klára Kõrmendi, whose Hungaroton disc probably demonstrates that the European avant-garde—I almost said *former* avant-garde—is now safe and acceptable everywhere. Perhaps it is my advancing age or the times we live in, but this music does seem to have lost a lot of its sting. Of the five pieces here, the vigorous and rhythmic Messiaen *Cantéyodjayá* makes the strongest impression, and it is excellently performed. Indeed, all of Ms. Kõrmendi's performances have real strength; if the music seems to have lost some of its old power, the fault is certainly not hers.

Frederic Rzewski's *Variations on "No Place to Go but Around"* gives one answer to the question of where the avant-garde is go-

ing. It is a twenty-minute, super-tonal, wonderfully eclectic Mahlerian structure whose form follows that of an abortive Living Theater project called *The Tower of Money*. A big contrapuntal superstructure is woven out of themes that represent the various classes of society. In the middle there is a longish improvisation based mostly on the Italian revolutionary song *Bandiera Rossa*. If I invoke Scriabin, Mahler, and Busoni to suggest the character of this music, I am not referring to a merely spiritual affinity. Previously known for electronic music and various other kinds of fearsome far-out modernity, Rzewski has here turned his creative and pianistic skills in an astonishing direction, fashioning a piano work with impact that is "monumental" in the old-fashioned sense.

The other two works on the Rzewski disc are quite different in feeling. The piece by Anthony Braxton, whose oddly titled compositions are more usually found in the jazz review section of this magazine, is one of those avant-garde works in which the performer participates in shaping the material. Hanns Eisler's Third Piano Sonata, written during his exile in the United States, is not much like the Brechtian songs for which he is now best remembered. A strong, highly dissonant, and clean version of the traditional sonata, it has a very individual sound—Classical and modern at the same time, yet not neo-Classical—that is particularly effective in Rzewski's excellent performance.

David Dubal is best known, in New York City at least, as the director of WNCN, the all-classical-music radio station that turned into a rock station and then, after a great to-do, back again. Dubal plays the piano well, but I remain unconvinced about Khatchaturian as a composer for the instrument. There is a mixture of old and new on this Genesis release—shorter pieces from the Twenties and Thirties (including the famous *Toccata*), the odd little neo-Classical *Sonatina* of 1959, and the full-fledged *Sonata* of 1961, which has two excellent movements and an awkward finale.



Dubal

The album is definitely a musical mixed bag for me, but I give high marks to Mr. Dubal for presenting these works so persuasively.

With Ethelbert Nevin and Edward MacDowell, Paulina Drake takes us back to the polite drawing rooms of the previous century. The contrast between the two is amusing. Nevin, the inimitable author of *Narcissus* and *The Rosary* (both included in this album, the latter in Nevin's own arrangement for piano), was an avowed composer of drawing-room miniatures. MacDowell, on the other hand, had much grander aspirations; yet, amidst all his sonatas and concertos, it is his slight *To a*



Biret

*ka, Les Noces*) as well as creating effective solo music for it. The *Petrouchka* scenes are the high-water mark of pianism in Stravinsky's work, and they are brilliantly played here in a performance that rivals the drama and color of the orchestral original. *Les Cinq Doigts* and *Valse pour les Enfants* are low-profile pieces (the latter published in a newspaper in 1922!), but they are pleasant addi-



Wild Rose that is now most remembered. (When I was in grammar school, several of these composers' minor gems were prime exhibits in those music-appreciation courses where you were supposed to identify a dozen or so "masterpieces" from memory. Try it on your friends today. It is astonishing how everyone still recognizes this music even though no one any longer knows whose it is; it has, in effect, entered the collective unconscious.)



Drake

Nevin's *Water Scenes* and MacDowell's *Woodland Sketches* deserve the fame of their best-known sections. They are charming collections of simple, sweet, lyric poems, perfectly unaffected and musical in that wonderful old "semi-classical" genre. This is really music meant to be played at home, but even in recorded form it has many charms—especially as played by Ms. Drake, a Hong Kong-born, American-trained pianist with an elegant and lyrical style. —Eric Salzman

**IDIL BIRET.** Ravel: *Sérénade Grottesque; Gaspard de la Nuit.* Stravinsky: *Les Cinq Doigts; Valse pour les Enfants; Three Scenes from Petrouchka.* Idil Biret (piano). FINNADAR SR 9013 \$6.98.

**PAUL JACOBS.** Busoni: *Six Short Pieces for the Cultivation of Polyphonic Playing.* Stravinsky: *Four Etudes, Op. 7.* Bartók: *Three Etudes, Op. 18.* Messiaen: *Four Rhythmic Studies.* Paul Jacobs (piano). NONESUCH H-71334 \$3.96.

**HANS PÅLSSON.** Stravinsky: *Serenade in La.* Nilsson: *Quantitäten.* Paulson: *Modi, Op. 108b.* Schumann: *Kinderszenen, Op. 15.* Hans Pålsson (piano). CAPRICE CAP 1079 \$7.98 (from HNH Distributors, P.O. Box 222, Evanston, Ill. 60204).

**KLÁRA KÖRMENDI.** Boulez: *Sonata No. 1; Sonata No. 3; Trope.* Holliger: *Elis.* Berio: *Rounds.* Messiaen: *Cantéyodjayá.* Klára Körmendi (piano). HUNGAROTON SLPX 11771 \$6.98.

**FREDERIC RZEWSKI.** Rzewski: *Variations on "No Place to Go but Around."* Braxton: *P-JOS 4K-D-(MIX).* Eisler: *Third Piano Sonata.* Frederic Rzewski (piano). FINNADAR SR 9011 \$6.98.

**DAVID DUBAL.** Khachaturian: *Sonata; Poem; Fughetta; Sonatina; Dance in G Minor; Valse Caprice; Toccata.* David Dubal (piano). GENESIS GS 1062 \$6.98.

**PAULINA DRAKE.** Nevin: *Un Giorno in Venezia; Songs; Water Scenes, Op. 13.* MacDowell: *Woodland Sketches, Op. 51; Two Fantasy Pieces.* Paulina Drake (piano). GENESIS GS 1067 \$6.98.

# FREE McIntosh CATALOG and FM DIRECTORY

Get all the newest and latest information on the new McIntosh Solid State equipment in the McIntosh catalog. In addition you will receive an FM station directory that covers all of North America.



## MX 113

FM/FM STEREO - AM TUNER AND PREAMPLIFIER

**SEND TODAY!**

McIntosh Laboratory, Inc.  
East Side Station P.O. Box 96  
Binghamton, N.Y. 13904  
Dept. SR

NAME \_\_\_\_\_

ADDRESS \_\_\_\_\_

CITY \_\_\_\_\_ STATE \_\_\_\_\_ ZIP \_\_\_\_\_

If you are in a hurry for your catalog please send the coupon to McIntosh.  
For non rush service send the *Reader Service Card* to the magazine.  
CIRCLE NO. 31 ON READER SERVICE CARD

A Selective  
**Calendar  
of  
American Music  
1612-1976**  
prepared for  
**STEREO REVIEW**  
by James Goodfriend  
**1976**

**REPRINTS NOW AVAILABLE**

This useful, information-packed, and attractive (suitable for framing) feature from our July 1976 Bicentennial Issue is printed in four colors on 11" x 16" stock and includes Music Editor Goodfriend's introduction. For your copy send 25¢ to: American Music Calendar, Stereo Review, 1 Park Avenue, New York, N.Y. 10016.

# BIG DISCOUNTS

**STEREO COMPONENTS**

Largest selection of top name brands... try us and see...

It's worth a call  
**(301) 488-9600**

**INTERNATIONAL  
WIRE  
DISTRIBUTORS**

**HF**

6330 Frankford Ave.  
Baltimore, Md. 21206

All mail answered within 24 hours

Phone Daily 9 AM to 9 PM  
Saturday 9 AM to 4 PM  
Phone (301) 488-9600

CIRCLE NO. 25 ON READER SERVICE CARD

# Hi-Fi Buys

ON PIONEER  
AT WAREHOUSE TO YOU PRICES

### RECEIVERS

|         |       |
|---------|-------|
| SX-1250 | \$575 |
| SX-1050 | \$475 |
| SX-950  | \$409 |
| SX-850  | \$349 |
| SX-750  | \$279 |
| SX-650  | \$210 |
| SX-550  | \$175 |
| SX-450  | \$149 |

### AMPS & TUNERS

|         |       |
|---------|-------|
| SA-9900 | \$495 |
| SA-9500 | \$330 |
| SA-8500 | \$264 |
| SA-7500 | \$198 |
| SA-6500 | \$123 |
| TX-9500 | \$264 |
| TX-7500 | \$163 |
| TX-6500 | \$123 |

### TURNABLES

|        |       |
|--------|-------|
| PL71   | \$198 |
| PL530  | \$170 |
| PL510  | \$136 |
| PL117D | \$119 |
| PL115D | \$91  |
| PL112D | \$74  |

### DOLBY CASSETTE DECKS

|          |       |
|----------|-------|
| CT-F9191 | \$308 |
| CT-F8282 | \$272 |
| CT-F7272 | \$218 |
| CT5151   | \$184 |
| CT4141A  | \$164 |
| CT-F2121 | \$149 |

### SPEAKERS

|        |       |        |       |
|--------|-------|--------|-------|
| HPM200 | \$330 | CS63DX | \$185 |
| HPM100 | \$165 | CS99A  | \$159 |
| HPM60  | \$124 | CS700G | \$132 |
| HPM40  | \$83  | CS500G | \$99  |

Save on other famous brands. Quotations answered same day. Write or call for free catalog. All units factory sealed. Full manufacturer's warranty. CB's also available at tremendous savings.

PHONE TO ORDER BY COD,  
BANKAMERICARD, MASTER CHARGE

For shipment within 48 hours send money order or certified check. Two week delay on personal checks. 20% deposit requested on C.O.D. shipments. \$1.25 handling fee on all orders. Shipping cost are collected C.O.D. unless paid in advance.



Hi-Fi Buys



1362 HOLTON LANE  
LANGLEY PARK, MD. 20783  
(301)434-5330

CIRCLE NO. 20 ON READER SERVICE CARD

# SAVE

TOP QUALITY GEAR  
LOWEST PRICES  
PROMPT DELIVERY  
SAVE ON FREIGHT  
SELECTION

ROYCE CB PANASONIC  
KENWOOD DYNACO  
PIONEER SANSUI  
DUAL BIC  
and more than 50 others

PLEASE REQUEST PRICE QUOTATIONS ON YOUR CHOICE OF QUALITY STEREO GEAR

## Component Discounters

DEPT. 617SK  
17565 Meadowood  
Lathrup Village, Mich. 48076  
313-559-1270

society). The piece has all the elements of a good operetta plot without, however, making anything but the most desultory pass at a story line. The results are almost surrealistic: a series of more or less disconnected acts—a railroad station with arriving tourists, a town house disguised as a hotel, another town house full of servants pretending to be nobility, a masked ball at the Café Anglais. Along this thin line are strung the Offenbach pearls—a bit of a glow for everybody. Although Régine Crespin and Mady Mesplé have the featured billings, the major role is really Gardefeu, neatly done by Michel Sénéchal. Crespin seems to be a bit overcast for the rather thin role of Métalla, but Mady Mesplé, the last and best of a certain type of French singer, is a perfect Offenbach soprano. The supporting cast is fine, and Plason leads a provincial theater orchestra and chorus in the best style. In the end, one must admit that *La Vie Parisienne* is a piece with nothing going for it except the music of Offenbach, some delicious foolery, and an almost abstract perfection of style. I don't know if this explains why it is so wonderful, but its capacity for bewitchment seems to be almost infinite.

*Gaîté Parisienne* was created for the choreographer Massine and the Ballets Russes de Monte-Carlo by Maurice Rosenthal in 1937. The story and some of the music are taken from *La Vie Parisienne*; other sources include *La Belle Hélène*, *Orphée aux Enfers*, *La Périochole*, *Tales of Hoffmann*, and half a dozen others. Rosenthal did far more than arrange this music; in effect, he concocted a new work with Offenbach's themes, sometimes contributing an original tune of his own. I myself much prefer the simpler quality of Offenbach's own version of his tunes, but there is no denying the whimsical effect of Rosenthal's score, particularly in this version performed by the originators: the Monte Carlo Orchestra directed by Rosenthal himself. Rosenthal is an excellent conductor, and it is surprising that he is not better known to a wider public. At any rate, this recording is not likely to pass unheard.

E. S.

diversified ways: Wagnerian melodic declamation, fervent lyric eruptions à la Richard Strauss, brooding impressionistic touches, and terse chromaticism of the Hugo Wolf variety. His vocal melodies are expertly and considerably singable, and he follows Wolf's admirable example in allowing the poetic text to determine the way in which the song is set. There seems to be a predilection in his output for profound, philosophical poems with authors like Nietzsche, Strindberg, Björnson, and the like—and he serves them faithfully. I find this an absorbing recital without suggesting that it will take audiences by storm. Discriminating song specialists should certainly investigate it.

Both singers are fine, especially Briotho, who keeps his Wagnerian voice under sensitive control and achieves delicate *piano* effects when needed. The piano parts are



Angel Records

MADY MESPLÉ  
*A perfect Offenbach soprano*

quite substantial and are sensitively rendered. In its choice of repertoire, sound reproduction, and visual presentation I have found the Bis/HNH catalog exemplary, and this latest release confirms my high opinion. I wish only that the informative annotations were in larger type.

G. J.

**PUCCHINI: *Tosca*.** Montserrat Caballé (soprano), Tosca; José Carreras (tenor), Cavardossi; Ingvar Wixell (baritone), Scarpia; Piero De Palma (tenor), Spoletta; Samuel Ramey (bass), Angelotti; William Elvin (bass), Sciarone, Jailor; Domenico Trimarchi (baritone), Sacristan; Ann Murray (soprano), Shepherd. Chorus and Orchestra of the Royal Opera House, Covent Garden, Colin Davis cond. PHILIPS 6700 108 two discs \$15.96.

Performance: **Well sung**  
Recording: **Excellent**

Technically, this is a fine performance. From the opening, stunningly reproduced "Scarpia chords" to the final orchestral outburst, the rich sound and exemplary balance between voices and orchestra command admiration. Surely, the producer and engineer should have been named and given credit for their achievement.

There is much to be said for the singing, too. I have no reservation whatever about the

### RECORDING OF SPECIAL MERIT

**PETERSON-BERGER: *Songs. Marit's Songs; Four Poems by Ricarda Huch; Five Poems by Friedrich Nietzsche; Two Poems by August Strindberg***; others. Margareta Jonth (soprano); Helge Briotho (tenor); Sven Alin (piano). Bis LP-42 \$7.98 (from HNH Distributors, P.O. Box 222, Evanston, Ill. 60204).

Performance: **Good to very good**  
Recording: **Very good**

Wilhelm Peterson-Berger (1867-1942), along with his fellow neo-Romantics Wilhelm Stenhammar and Hugo Alfvén, spearheaded Swedish music around the turn of the century, when Jean Sibelius and Carl Nielsen (both composers of more individual character) dominated the scene in Finland and Denmark. Peterson-Berger was the composer of Sweden's national opera *Arnljot* (1910), with which I am not familiar, a number of symphonies, and a very attractive violin concerto that occasionally turns up in my radio broadcast activities.

In this generous representation, the composer's songs reveal an indebtedness to the German school, particularly Wagner. Peterson-Berger's style, however, is not imitative. In fact, his expression follows remarkably



**TAMÁS VÁSÁRY**  
*Brilliant, glittering Rachmaninoff*

Cavaradossi, which is another triumph in José Carreras' growing list of recorded portrayals: bright in tone, secure in delivery, tasteful, and knowingly characterized. Some of Montserrat Caballé's top notes are not freely produced, and there are some marginal pitch uncertainties, but her Tosca is still impressive in its combination of lovely tone and passionate conviction. The Scarpia of Ingvar Wixell is intelligently conceived along traditional lines, and it is sturdily sung, but the tone is not sufficiently centered for my taste. Samuel Ramey contributes an excellent Angelotti, and Ann Murray (instead of the traditional boy soprano) sings the music of the Shepherd well. The other supporting singers are adequate.

If there is a lack of enthusiasm in this review for the enterprise as a whole, the reason is the conducting. Colin Davis secures brilliant orchestral playing and maintains clear textures throughout, but what he achieves is more like a meticulous *reading* than a spontaneous-sounding, pulsating *performance*. He rushes through certain scenes of seemingly minor interest (Scarpia and Spoletta in the first act) and then paces certain high points slowly enough to rob the drama of its crucial momentum. The Tosca-Cavaradossi scenes in both Acts I and III lack flow and continuity. This is not an eccentric performance (like the Rostropovich-led one on DG), but neither is it idiomatic. *G.J.*

**RACHMANINOFF: Piano Concerto No. 1, in F-sharp Minor, Op. 1; Piano Concerto No. 2, in C Minor, Op. 18.** Tamás Vásáry (piano); London Symphony Orchestra, Yuri Ahronovitch cond. DEUTSCHE GRAMMOPHON 2530 717 \$7.98, © 3300 717 \$7.98.

Performance: **Brilliant pianism**  
Recording: **Good**

The opening measures of the F-sharp Minor Concerto emerge here in singularly arresting fashion, but all the brilliance and glitter of Vásáry's pianism and the passionate involvement of Soviet conductor Ahronovitch (spelled Aranovich on the Angel/Melodiya label) are not sufficient to make the score a convincing musical whole comparable to Rachmaninoff's C Minor and D Minor concerto masterpieces. Even so, this is definitely the more successful of the two performances  
*(Continued on page 143)*

# Stereo Testing! Spectacular Sound!

**NEW STANDARD  
in  
Stereo Testing!**



**Model SR12  
STEREO TEST RECORD**

The most complete . . . most sophisticated . . . most versatile Test Disc available today. Whether you're an avid audiophile who'll settle for nothing but peak performance from his stereo components . . . a casual listener who'd like more insight into the challenging world of stereo reproduction . . . or a professional technician who needs precise standards for lab testing . . . the SR12 is a must for your record collection.

Make these important stereo checks BY EAR . . . Frequency response • Separation • Cartridge tracking • Channel balance • Hum and rumble • Flutter • Cartridge and speaker phasing • Anti-skating adjustment • "Gun shot test" for stereo spread • Multi-purpose musician's "A." Equal-tempered Chromatic octave • Guitar-tuning tones.

7 critical TEST EQUIPMENT checks . . . Attention professionals: SR12 is also designed to be used as a highly efficient design and measurement tool. In the following tests, recorded levels, frequencies, etc. have been controlled to laboratory tolerances—affording accurate numerical evaluation when used with oscilloscope, chart recorder, output meter, intermodulation-distortion meter and flutter meter.

- 1,000-Hz square waves to test transient and high-frequency response of phono pickups.
- 500 to 20,000 Hz frequency-response sweep.
- Sine-wave tone-bursts to test transient response of pickup.
- Intermodulation test using simultaneous 400-Hz and 4,000-Hz signals.
- Intermodulation sweep to show distortion caused by excessive resonances in tone arm and cartridge.
- 1,000-Hz reference tones to determine groove velocity.
- 3,000-Hz tone for flutter and speed tests.

Sample waveforms—illustrating both accurate and faulty responses are provided in the Instruction Manual for comparison with the patterns appearing on your own oscilloscope screen.

**FREE**—An informative manual which includes charts, tables and diagrams.

CHARGE YOUR ORDER TO YOUR AMERICAN EXPRESS, BANKAMERICARD, MASTER CHARGE OR DINERS CLUB ACCOUNT.



Ziff-Davis Service Division, Dept. R, 595 Broadway, New York, N.Y. 10012. SR-67

Please send the following:

SR12 Stereo Test Record @ \$6.95, postpaid (\$8.95 outside U.S.A.).

Stereo Demonstration Record @ \$6.95, postpaid (\$8.95 outside U.S.A.).

For Demonstration Record only check one:

33 1/3 RPM     45 RPM

Stereo Demonstration Cassette @ \$7.95, postpaid (\$8.95 outside U.S.A.).

Print Name \_\_\_\_\_

Address \_\_\_\_\_

City \_\_\_\_\_ State \_\_\_\_\_ Zip \_\_\_\_\_

Enclosed is \$ \_\_\_\_\_ (Residents of Calif., Col., Fla., Ill., Mich., Mo., N.Y. State, D.C. and Tex. add applicable sales tax.)

CHARGE:  
 BankAmericard     Master Charge  
 American Express     Diners Club

Account # \_\_\_\_\_ Exp. Date \_\_\_\_\_

Master Charge Interbank # \_\_\_\_\_  
(4 numbers over your name)

Signature \_\_\_\_\_

**The Most Spectacular  
Sound Exhibition of  
STEREO FIDELITY  
Ever Available on  
Disc and Cassette**



**STEREO DEMONSTRATION RECORD  
AND CASSETTE**

The result of two years of intensive research in the sound libraries of Deutsche Grammophon Gesellschaft, Connoisseur Society, Westminster and Cambridge. The Editors of Stereo Review have selected those excerpts that best demonstrate the many aspects of the stereo reproduction of music. The record offers you a greater variety of sound than has ever before been included on a single disc.

**ELECTRIFYING EXPERIENCE IN LISTENING**

The Record is a series of independent demonstrations designed to show off one or more aspects of musical sound and its reproduction. Entirely music, the Record has been edited to provide self-sufficient capsule presentations of an enormous variety of music arranged in a contrasting and pleasing order. It includes all the basic musical and acoustical sounds that you hear when you listen to records, isolated and pointed up to give you a basis for future critical listening.

**WIDE RANGE OF DEMONSTRATIONS**

- Techniques of separation and multiple sound sources
- Acoustic depth
- The ambiance of a concert hall
- Sharp contrasts of dynamics
- Crescendo and diminuendo
- Very high and very low pitched musical sounds
- Polyphony (two or more melodies going on at once) with both similar and contrasting instruments
- Tonal qualities of wind, string and percussion instruments
- Sounds of ancient instruments
- Sounds of oriental instruments
- Sound of the singing voice, both classically trained and untrained
- Plus a large sampling of finger snapping, hand clapping, foot stamping and other musical and percussive sounds.

**13 SUPERB SELECTIONS:**

STRAUSS: Festive Prelude, Op. 61 (excerpt) DGG • DEBUSSY: feux d'artifice (excerpt) Connoisseur Society • BEETHOVEN: Wellington's Victory (Battle Symphony) (excerpt from the first movement) Westminster • MASSAINO: Conzona XXXV à 16 (complete) DGG Archive • CORRETTE: Concerto Comique Op. 8, No. 6, "Le Plaisir des Dames" (third movement) Connoisseur Society • KHAN: Raga Chandranandan (excerpt) Connoisseur Society • RODRIGO: Concerto—Serenade for Harp and Orchestra (excerpt from the first movement) DGG • MANITAS DE PLATA: Gypsy Rhumba (complete) Connoisseur Society • MARCELLI: (arr. King) Psalm XVII "The Heavens are Telling" (complete) Connoisseur Society • PRAETORIUS: Terpsichore: La Bourrée XXII (complete) DGG Archive • BERG: Wozzeck (excerpt from Act III) DGG • BARTOK: Sonata for two pianos and Percussion (excerpt from the first movement) Cambridge • BEETHOVEN: Wellington's Victory (Battle Victory) (excerpt from the last movement) Westminster.

**FREE**—Booklet which discusses and describes each of the selections performed.



# At Technical Sound Industries there's never a day without music.

## Our Fully Transferrable Speaker Warranty

Technical Sound Industries, Inc. warrants its products to be free of defects in materials and workmanship unconditionally for a period of five years from the date of purchase. The only exception to this warranty is that the product be used under normal operating conditions and that the warranty is void if the product is abused. The cabinet finish is under warranty for defects in materials and workmanship. The owner may also bring back his speakers to any Technical Sound Industries, Inc. Dealer Speaker Clinic. It will be repaired to specifications at no charge to the



customer, for the life of the speaker. This warranty also applies to any owner of record and is fully transferrable within the five year period.

Warranty service is available at any authorized Technical Sound Industries, Inc. Warranty Station. Call Factory Service Information toll free (800/241-0914) for directions to the nearest Technical Sound Industries, Inc. Warranty Station. Send this ad and \$2.00 (check or money order) to: Technical Sound Industries, Inc., 1435 Jacqueline Drive, Columbus, Georgia, 31906, for a 23 x 35 lithographic print of the above photograph.

**Technical Sound Industries, Incorporated**  
1435 Jacqueline Drive, Columbus, Georgia 31906

CIRCLE NO. 55 ON READER SERVICE CARD

# Stereo Review's 'HOW TO' REPRINT SERIES

Whether you are about to buy your first high-fidelity component or your fifteenth, you need to have all the facts you can get your hands on if you want to insure your complete satisfaction. Yes, the audio field is a complicated one, but *Stereo Review* has been running a kind of monthly seminar on the subject for almost two decades now, furnishing the kind of basic buying, installation, and operating guidance you can get nowhere else. Today, over 450,000 readers use it monthly as the first, best textbook in their on-going audio educations. If you have come a little late to class, here's your chance to catch up. Any questions you may have about *How to Buy*, *How to Set Up*, *How to Use*, or *How to Understand* audio equipment are probably answered in one or more of the reprints listed below.

1. ROOM ACOUSTICS  
(How to Correct Your Room Acoustics)
2. GUIDELINES TO SPEAKER SHOPPING
3. RECORD DEFECTS (Their Causes & Cures)
4. LOUDSPEAKER POWER NEEDS  
(How Much Power Do You Need for Your Speakers)
- \* 5. HOW IMPORTANT IS AUDIO-COMPONENT COMPATIBILITY?
6. GUIDE TO UPGRADING YOUR COMPONENTS
7. HOW TO SELECT A MICROPHONE
8. HOW TO CHOOSE AN AMPLIFIER
9. HI-FI TROUBLESHOOTING CHARTS
10. SPEAKER MYTHS  
(How to Avoid Bad Choices)
11. TURNTABLE BASICS  
(How to Buy a Turntable)
12. HOW TO SELECT AN FM TUNER
13. HI-FI DEMONSTRATION DISCS
- \* 14. AUDIO EQUALIZERS  
(Understanding and Choosing Equalizers)
15. CLEAN UP AND TUNE UP YOUR AUDIO SYSTEM
- \* 16. HOW TO BUY A CASSETTE DECK
17. USING FM INTERSTATION HISS TO TEST RECORDERS AND SPEAKERS
18. HOW TO BUY A RECEIVER
19. HOW TO BUY A PHONO CARTRIDGE

\* Reprints marked with Asterisk \$1.50.  
All others, \$1.00. Minimum order \$2.00.

Stereo Review Information Center SR67  
Consumer Service Division  
595 Broadway, New York, N.Y. 10012

Please send the reprints circled below:

\$1.00 each \_\_\_\_\_

1 2 3 4 6 7 8 9 10 11 12  
13 15 17 18 19

\$1.50 each \_\_\_\_\_

5 14 16

NUMBER OF REPRINTS ORDERED:

@ \$1.00 \_\_\_\_\_ @ \$1.50 \_\_\_\_\_

TOTAL ENCLOSED (MINIMUM ORDER \$2) \_\_\_\_\_

† Residents of CA, CO, FL, IL, MI, MO, NY, D.C., and TX add applicable sales tax.

Print Name \_\_\_\_\_

Address \_\_\_\_\_

City \_\_\_\_\_

State \_\_\_\_\_ Zip \_\_\_\_\_

here, and probably as good a one of Op. 1 as we're likely to get.

In the C Minor Concerto, I sense a mismatching of musical styles between pianist and conductor. Ahronovitch is all passion and expansive lyricism in his handling of the orchestra, while Vásáry essays a cool Lisztian glitter—and what glitter!—throughout most of his solo role. The combination is oddly fascinating, but also a bit unsettling. Special credit is due the London Symphony's principal clarinet, by the way, for the exquisite nuances of his slow-movement solo. The recording is clean and bright. D.H.

**SCARLATTI: *La Griselda*.** Daniel Collins (countertenor), King Gualtiero; Carole Bogard (soprano), Queen Griselda; Kari Windingstad (mezzo-soprano), Princess Costanza; Riccardo Cascio (tenor), Prince Corrado; Judith Nelson (soprano), Roberto; members of the University of California, Berkeley, Orchestra, Lawrence Moe cond. CAMBRIDGE CRS 2903 \$6.98.

Performance: **Special**  
Recording: **Splendid**

Staged performances of Baroque operas are rare indeed today, and the staging of an opera by Alessandro Scarlatti, the father of the Neapolitan school, is virtually unique. Thus, the performance of *La Griselda* given at the University of California, Berkeley, was a very special event, and Cambridge Records showed commendable enterprise in recording it and issuing a disc of arias and ensembles.

*La Griselda* is probably the last of the surviving operas of Scarlatti's 115 stage works, and, judging from the music presented here, it is a masterpiece. The arias are melodically and harmonically exciting and cover a wide range of emotions. The three ensembles (a type of music usually thought not to exist in Neapolitan opera) are effectively written for the voices.

The Berkeley performance, on the whole, is a fine one. Carole Bogard's voice is beautifully focused and agile, and her musicianship is superb as she works her way through one aria more difficult than another. Kari Windingstad is her equal. The castrato part of Gualtiero is taken by Daniel Collins. His voice is a piercing one with a cutting edge to it, and the results he produces are brilliant in the extreme. Although there is nothing remarkable about the rest of the cast, they all sing well, and the ornamentation of the da capos is handled with imagination and taste. The weakest element of the disc is the student orchestra, which sounds tentative and a little intimidated playing in Baroque style with modern instruments. Grab it anyway. S.L.

## RECORDINGS OF SPECIAL MERIT

**SCHUBERT: *Schubert on Stage*.** *Der Vierjährige Posten* (D. 190): *Overture*. *Die Freunde von Salamanka* (D. 326): *Gelagert unter'm hellen Dach*. *Claudine von Villa Bella* (D. 239): *Hin und wieder fliegen die Pfeile*; *Liebe schwärmt auf allen Wegen*. *Die Bürgschaft* (D. 435): *Die Mutter sucht ihr liebes Kind*; *Welche Nacht hab' ich erlebt*; *Horch die Seufzer uns'rer Mutter*. *Alfonso und Estrella* (D. 732): *Von Fels und Wald umrungen*; *Wer bist du, holdes Wesen*; *Freundlich bist du mir erschienen*; *Könnst' ich ewig hier verweilen*; *Lass dir als Erinnerungszeichen*. *Die Verschworenen* (D. 787): *Ich schleiche bang und still herum*. *Die Zwillingbrüder* (D. 647): *Der Vater mag wohl*

## PRICE WAR

AMERICA'S #1 VALUE LEADER  
STEREO CORPORATION OF AMERICA

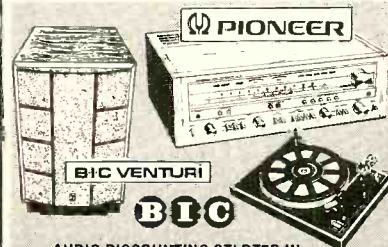

AUDIO DISCOUNTING STARTED IN NEW YORK & NOW WITH THE END OF FAIR-TRADE WE ARE SURE THAT NO ONE CAN BEAT OUR PRICES:  
● WE DISCOUNT OVER 60 MAJOR BRANDS  
● OVER 10 YEARS OF RELIABLE SERVICE IN THE MAIL ORDER FIELD.  
● LARGEST INVENTORY / LOWEST PRICES!  
WE GET THE BEST DEALS FROM THE MANUFACTURERS; YOU GET THE BEST DEAL FROM US. DON'T DELAY!!!

WRITE US NOW FOR LOWEST PRICE QUOTE

WRITE  
OR CALL  
For FREE  
STEREO  
PRICE CATALOG

SHOP BY PHONE!  
(212) 253-8888  
N.Y. TIME  
9-5 MON. THRU SAT.  
Mastercharge/BankAmericard

STEREO CORPORATION OF AMERICA

S-R 1629 Flatbush Ave.,  
Brooklyn, New York 11210

CIRCLE NO 52 ON READER SERVICE CARD

immer Kind mich nennen. Elly Ameling (soprano); Claes H. Ahnsjö (tenor); Rotterdam Philharmonic, Edo de Waart cond. PHILIPS 9500 170 \$7.98.

Performance: **Winning**  
Recording: **Effective**

**SCHUBERT: *Rosamunde von Cypern, Incidental Music (D. 797); Overture, Die Zauberharfe (D. 644)***. Rohangiz Yachmi (contralto); Vienna State Opera Chorus; Vienna Philharmonic Orchestra, Karl Münchinger cond. LONDON OS 26444 \$7.98, © OS5-26444 \$7.95.

Performance: **Warm**  
Recording: **Very good**

Franz Schubert wrote music for no less than

seventeen stage works, many or most of them full-fledged operas. Nearly everything has been forgotten except for bits of *Rosamunde* and a few tunes that he salvaged for use elsewhere. Schubert, so gifted in other ways, did not really have a talent for the theater, or, at least, he never had a real opportunity to develop it. Most of his librettos are dreadful, and the music, whatever its intrinsic quality, rarely gets a chance to function dramatically. Nevertheless, it has long been known that there are precious gems in them that hills and it is a pleasure to find some mined and set as attractively as they are in this new Philips album called "Schubert on Stage." The record begins with a youthful overture that is a garden of delights and continues with charming settings based on Goethe and Schiller. Unfortunately,

the operas *Claudine von Villa Bella* (Goethe) and *Die Bürgschaft* (Schiller) survive only in part. The music recorded here whets one's appetite for more. The arias from Goethe's text and the ensembles from *Die Bürgschaft* (apparently not to Schiller's own texts) for Anna and her children are exquisite. Nor is lyricism the only note here; Anna's aria "Welche nacht" is as impassioned and dramatic as anything from *Fidelio* or *Freischütz*.

*Alfonso und Estrella*, one of Schubert's most ambitious operas, is represented by a major scene made up of two arias enclosed by three duets. The scene is one of those pastoral moments beloved of the age; two star-crossed lovers (yes, another Romeo and Juliet story) meet and fall in love in the middle of the woods. There is nothing in the world more ingratiating and more impossible to put on the stage than this glorious, romantic/lyric music. The other arias, although charming, are relatively minor.

Claes H. Ahnsjö is a rare classical tenor, perfect for this music. But the recording is principally constructed around the charms and skills of Elly Ameling, who is assisted in fine style by the Rotterdam Philharmonic and the clean, attractive direction of Edo de Waart. A wonderful and very welcome new recording.

Schubert's best-known music for the stage is not an opera at all but an incidental score for *Rosamunde, Queen of Cyprus*, an utterly forgotten melodrama by Helmina von Chézy, who, among other things, wrote the libretto that doomed the theatrical fortunes of Weber's beautiful *Euryanthe*.

An oddity relating to *Rosamunde* is that it has an overture attached that was not written for it and never had anything to do with it (it was written for another obscure work, an opera-pantomime by the name of *Die Zauberharfe*, and became attached to the *Rosamunde* score only many years later). This amiable confusion is perpetuated here, giving us the opportunity to get a lively performance of a wonderful piece of music. The actual incidental music includes a Romanze—not attractively sung here—and three short, effective choruses. The rest is instrumental and at Schubert's highest level of inspiration. The three entr'actes include the famous *andantino*, better known as a piano impromptu and a variation movement in a string quartet; it is ravishing in its orchestral guise. The other interludes are powerful and dramatic in the mood (and key!) of the *Unfinished* Symphony. Two movements, almost equally beguiling and also partly familiar, are labeled *Ballet*. What wonderful music! The performances are not as neat as those from Holland or, indeed, what we are used to from Münchinger. To compensate, though, Viennese *Gemütlichkeit* takes over and, on the whole, makes for warm, romantic Schubert that is simply hard not to love. E.S.

**SCHUMAN: *New England Triptych*** (see BILLINGS)

#### RECORDING OF SPECIAL MERIT

**JOHANN STRAUSS: *Wiener Blut***. Klaus Hirte (baritone), Prince Ypsheim-Gindelbach; Nicolai Gedda (tenor), Count Zedlau; Anneliese Rothenberger (soprano), Countess Zedlau; Renate Holm (soprano), Franzi; Gabriele Fuchs (soprano), Pepi; Heinz Zednik (tenor), Josef; others. Chorus of the Cologne Opera; Wiener Schrammeln; Philharmonia

## Phase Linear FM Tuner with exclusive Dynamic Range Expander.

With the new Phase Linear 5000 FM Tuner you can actually improve FM broadcasts to rival that of tapes and records. Advanced electronics combine excellent reception capabilities with a unique Dynamic Range Expander that restores compressed

usual features not available on most conventional tuners, including an L.E.D. Multipath Distortion Indicator that identifies this type of distortion, thus simplifying its removal; a Variable Muting Control; De-emphasis; and more.

*Phase Linear*  
The Powerful Difference

See your dealer and listen to this remarkable tuner.

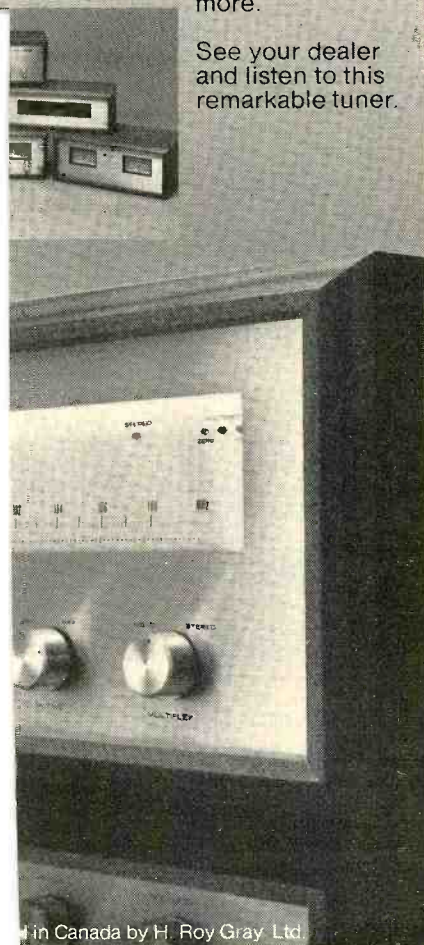

In Canada by H. Roy Gray Ltd.

STEREO SERVICE CARD

STEREO REVIEW

Hungarica, Willi Boskovsky cond. ANGEL □ SBLX-3831 two discs \$16.98.

Performance: **Flavorful**  
Recording: **Very good**

*Wiener Blut* is not, strictly speaking, an authentic Johann Strauss operetta. While it consists entirely of Strauss melodies, it was woven together by a fellow-composer, Adolf Müller, Jr., when the Waltz King was too old and tired to carry out the commission from the Carltheater. Strauss, in fact, died before the operetta's première in 1899. In all likelihood, he was pleased with Müller's expert and loving treatment of his music and the skillful libretto of Victor Leon and Leo Stein, librettists-to-be of Franz Lehár's then as yet unwritten *The Merry Widow*.

*Wiener Blut* is a typical Viennese operetta. The characters and situations are familiar, the point of view optimistic though a shade cynical. Through it all, Vienna pays eloquent homage to itself, and audiences, enchanted by Strauss' music and by the vicarious enjoyment of operetta's unique mode of life, are left in a sunny glow. This particular plot—whose "hero" is a debonair womanizer at the time of the famous Congress of Vienna of 1815—undergoes some delicious twists to reach a level of total complication by the end of Act II. Then, in a manner also genuinely Viennese, it runs out of steam, lets the champagne and the music wash over the complications, and the devil take the loose ends.

The music is delightful. Some of Strauss' most engaging waltzes and polkas greet us at every turn, reaching the height of melodic ingenuity in the ensembles of the second act. The singers are ideal, the orchestra and chorus perform with zest and polish, and conductor Boskovsky guarantees the proper Viennese spirit. The spoken and sung portions do not always correspond to the printed libretto, but, in any case, I must single out Hilde Hendl's singable English translation for special praise. Record companies have not been paying too much attention to Viennese operetta of late. This sparkling exception ought to be snapped up by followers of the genre. *G.J.*

**THOMSON:** *The Mother of Us All* (see Best of the Month, page 89)

**VIVALDI:** *Six Sonatas for Cello and Continuo*. Yehuda Hanani (cello); Lionel Party (harpsichord); Christine Gummere (cello). ORION ORS 76246 \$6.98.

Performance: **Good**  
Recording: **Good**

Although Yehuda Hanani points out in his jacket notes that these delightful sonatas are performed in this recording from the original edition (Paris, 1740), that ornaments and continuo realizations have been improvised, and that expressive devices have been added at the performers' fancy—in short, that this is a truly Baroque performance but not a museumly slavish reproduction—the result is not Baroque at all. True, the use of a proper continuo is Baroque, and so are the notes and ornaments. But Mr. Hanani is a performer in the Romantic tradition, albeit a fine one, and this is a Romantic performance. The cello's tone is too tense, too many slurs are used, and any sense of Baroque articulation is covered by an all-pervasive legato. Also, there is no free ornamentation of the slow movements, which is sorely needed. There is nothing wrong with a romantic approach when finely

executed, as it is here, but let us not cry Baroque and play Romantic. *S.L.*

**WOLF-FERRARI:** *The Secret of Susanna* (see Best of the Month, page 90)

## COLLECTIONS

### RECORDING OF SPECIAL MERIT

**MONTSERRAT CABALLÉ:** *Dramatic Soprano Arias*. Verdi: *Macbeth: Vieni! T'affretta . . . Or tutti sorgete. Il Trovatore: Tacea la notte . . . Di tale amor*. Mascagni: *Cavalleria Rusticana: Voi lo sapete*. Puccini: *Turandot: In questa reggia*. Catalani: *La Wally: Ebben, ne andrò lontana*. Ponchielli: *La Gioconda: Suicidio*. Giordano: *Andrea Chénier:*

*La mamma morta*. Montserrat Caballé (soprano); Juan Pons (bass, in *Macbeth*); Cecilia Fondevila (soprano, in *Trovatore*); Orquesta Sinfónica de Barcelona, Armando Gatto and Anton Guadagno cond. LONDON OS 26497 \$7.98.

Performance: **Very good—or better**  
Recording: **Not up to London's best**

For a soprano best known for her *bel canto* attainments Montserrat Caballé has always exhibited a remarkable catholicity, what with the Marschallin and even Salome among her roles. However, as Gerald Fitzgerald reminds us in his annotations, with Caballé, as once with Callas, universality came first and *bel canto* specialization second, as an aftermath (Continued on page 148)

we've got  
equalization  
all together—

Soundcraftsmen

and all of us are dedicated to helping you improve the sound of your fine stereo system.

Equalizers are used everywhere in the music-making chain: by live performers, recording studios, mixing consoles, AM and FM stations, and so on. In every step, each of the engineers use equalizers to make the music sound the way they think it should sound. So after everyone else makes the music sound the way they like it, it's up to you to use that same instrument—the equalizer—to make the final adjustment, and make the music sound the way you like it to sound in your own home.

We also include all the accessories and features that are a must to make equalizing easy, as well as an amazingly rewarding new experience . . . An Environmental Do-it-yourself Test Record edited and announced by Soundcraftsmen especially for use with the Soundcraftsmen equalizer . . . Computone Charts for making a record of, and resetting in seconds, any desired EQ curve . . . a Full-Channel Frequency Spectrum Level Control on each channel for instant "no distortion" in/out balancing . . . Light-Emitting Diodes for precise visual signal level balancing . . . A Graphic Display of each EQ curve . . . And a minimum 24dB range of adjustment for each octave . . . Specifications: S/N: better than 106dB at full output . . . THD: less than .05% @ 1v . . . Filter type: Toroidal and Ferrite Core.

FREE 6-PAGE BROCHURE

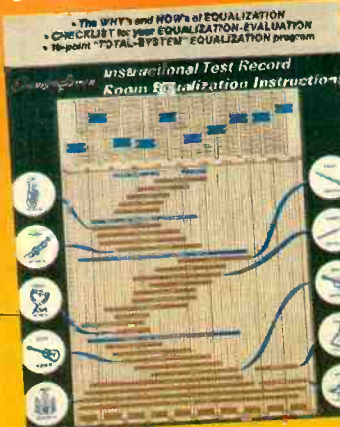

SOUNDCRAFTSMEN POWER AMP  
MODEL MA5002, 250 w/ch.  
COMING TO CES  
JUNE 5, 1977

a NEW CLASS amp

Manufactured in California, U.S.A. by Soundcraftsmen, 1721 Newport Circle, Santa Ana, CA 92705 . . . For name of your nearest dealer, phone us at (714) 556-6191 . . . Suggested Prices (top to bottom): PE2217 — \$529.50, SG2205 — \$370.00, RP2212 — \$369.50, RP2204 — \$329.50, 20-12A — \$299.50 (Includes cabinets shown). TG2209 — \$550.00 (Case extra).

# STEREO REVIEW MARKET PLACE

**REGULAR CLASSIFIED: COMMERCIAL RATES:** For firms or individuals offering commercial products or services, \$2.10 per word. Minimum order \$31.50. **EXPAND-AD CLASSIFIED RATE:** \$3.15 per word. Minimum \$47.25. Frequency discount: 5% for 6 months; 10% for 12 months paid in advance. **READER RATE:** For individuals with a personal item to buy or sell. \$1.25 per word. No minimum! **DISPLAY CLASSIFIED:** One inch by one column, \$265.00. Two inches by one column, \$530.00. Column width 2-1/4". Advertiser to supply film positives. Please write or phone for frequency rates.

**GENERAL INFORMATION:** Payment must accompany copy except when ads are placed by accredited advertising agencies. First word in all ads set in caps. All copy subject to publisher's approval. All advertisers using Post Office Boxes in their addresses MUST supply publisher with permanent address and telephone number before ad can be run. Ads are not acknowledged. They will appear in the first issue to go to press after closing date. Closing Date: 5th of the 2nd month preceding cover date (for example, March issue closes January 5th). Send order and remittance to: Classified Advertising, STEREO REVIEW, One Park Avenue, New York, New York 10016, Attn. Hal Cymes.

## EQUIPMENT

WRITE for quotation on any Hi-Fi components: Sound Reproduction Inc., 460 Central Avenue, East Orange, N.J. 07018. 201-673-0600.

NO fair trade laws in D.C. Write for discount prices on your choice of components. District Sound, Inc., 2316 R.I. Ave, N.E., Wash., D.C. 20018. (202) 832-1900.

### STEREO TV



The TE-200 TELEDAPTER EASILY CONNECTS TO ANY TV & STEREO SYSTEM. Using our complex and intricate circuit, teledapter takes a low impedance output from the television and delivers two HIGH IMPEDANCE CHANNELS OF SIMULATED STEREO, to drive any amplifier. Frequency response is maintained so you can hear the tinkle of bells or booming bass sounds as it happens on TV. With service warranty and hookup instructions \$19.95 plus. Guaranteed to make your TV 100% more enjoyable.

OUR NEW TE-300 VHF-UHF TELEVISION High Fidelity AUDIO TUNER is now available. Completely solid-state Recording and amp output jacks - Anodized Aluminum front panel and simulated Walnut Cabinet. 110 volt operation. \$169.95 plus.

SEND CHECK, M.O., MASTERCARD or BANKAMERICAN NO and Expiration date TO: RHODES NATIONAL CORP. DEPT. NO. 5F BOX 817, HENDERSONVILLE, TENNESSEE 37075.

NAME \_\_\_\_\_

ADDRESS \_\_\_\_\_

CITY \_\_\_\_\_ STATE \_\_\_\_\_ ZIP \_\_\_\_\_

**SEND COMPLETE CATALOG**

DIAMOND NEEDLES and STEREO CARTRIDGES at DISCOUNT PRICES for SHURE, PICKERING, STANTON, EMPIRE, GRADO and ADC. Send for free catalog. LYLE CARTRIDGES, Dept. S, Box 69, Kensington Station, Brooklyn, New York 11218.

CANADIAN Discount Catalog. Name brand stereo and 4-channel gear. Ecto-3, 521 5th Ave, NYC 10017.

LOWEST PRICES on many brands of stereo components — 4 day delivery, write for same day quotes. University Stereo Cooperative, 57 E. Ridgewood Avenue, Ridgewood, N.J. 07450.

STEREO NEEDLES and CARTRIDGES—ADC, Audio Technica, B&O, Empire, Grado, Micro Acoustics, Pickering, Ortofon, Shure, Sonus, Stanton, Supex, BSR, G.E., RCA, Sony, Panasonic and others. For FREE CATALOG, write: NEEDLE IN A HAYSTACK, INC., P.O. Box 17436, Washington, D.C. 20041.

SAVE UP TO 69% on over 100 top brand audio components from Carston Studios, New England's Audio Supermarket, one of the oldest mail order firms (Est. 1952) and certainly one of the most reliable. All orders shipped from stocked warehouse. Send for price quote and price list. Carston Studios, Old Brookfield Rd., Danbury, Conn. 06810.

PROFESSIONAL HI-FI COURSE—Instructors include Len Feldman, Julian Hirsch, Larry Klein, and Larry Zide. Home study course also available. Send \$2.00 for full color AUDIO PRIMER and full information on joining Society Audio Consultants (SAC), 49 E 34th St., Dept. SR, New York, New York 10016.

PERFECTIONISTS PREFER DYNAKITS. Before Purchase You Owe Yourself Our Quote. Mainline Iir, 971 Fronheiser, Johnstown, PA 15902.

## BUILD YOUR OWN SPEAKERS AND SAVE UP TO 50%.

Send for our free, fact-packed 40 page catalog/manual and learn how to assemble your own multi-element stereo speakers from scratch or from kits. Our catalog includes chapters on design, construction, covers, enclosures, midranges, woofers, tweeters and horns. Write us today!

SPEAKERLAB  
Dept. SR-A, 5500 35th N.E.  
Seattle, Washington 98105



DYNAKITS, SHURE, SME—lowest prices. FRIED LOUD-SPEAKERS (not discounted). Perfectionist modifications. Underground HiFi Sales, 324a Broadwater Road, Arnold, MD 21012. (301) 647-0919.

STEREO CO-OP — We're back, now purchase Pioneer, B.I.C. and E.P.I. directly from a manufacturers co-op and realize substantial savings. Guaranteed lowest prices and full service. Write for specific price quotes. 5631 Balto. Nat'l. Pike, Balto., MD 21208.

**SUBSTANTIAL SAVINGS** on most High-End lines. The Sound Affair, 364 Mission Court, St. Louis, MO 63130.

AUDIO STEREO COMPONENTS and SONY TV's at rock bottom prices. Why pay up to 40% more? Arkay Audio, 68-A Watertown Street, (Route 16), Watertown, Mass. 02172.

WE PAY SHIPPING! Name brand Hi-Fi. Write for price list. Sohn & Associates, 616 W. 35th St., Davenport, Iowa 52806.

SAVE ON SACRED COWS — Bose, SAE, JBL, Thorens, Philips. Over 50 top brands. Write for quotes. SOUTHBOUND SOUND, P.O. Box 52508, Atlanta, Georgia 30355.

SANSUI and PICKERING! BELOW mail order prices! Send to: GSH Super Savings, P.O. Box 86, Eden, N.C. 27288.

WHY SPEND MORE!! Purchase any brand at dealer cost. Comprehensive report reveals distributors. \$5.00. Audio Contacts, 102 Charles Street, Suite 212, Boston, Mass. 02114.

GUARANTEED LOWEST Prices on Raw Speakers, Woofers, Midranges, Tweeters, Musical Instrument and Automotive Stereo OEM speakers. This month special Phenolic Ring Tweeter, \$4.95; Bose Type 4-1/2 inch mid-range, \$6.95. 8-inch rubber surround Woofer with Alnico Magnet, \$8.95 ea. Allow 10% for each order for freight and handling in USA. Payment money order, certified check, BAC or MC. Send account number. Make payable to Sound Distributors, Inc. Write for specific quotes for other units to Sound Distributors, Inc., 5353 Mayfield Road, Lyndhurst, Ohio 44124.

LOWEST PRICES on stereo-esoteric components!!! Over 150 brands. Audio Unlimited, 3386B Golf, San Jose, CA 95127. (408) 251-8776.

TASCAM, Sound Workshop, dbx, MXR, Otari, Eventide, etc. Send for price quotes. ZIMET PRO AUDIO, Dept. SR, 1038 Northern Blvd., Roslyn, N.Y. 11576.

STEREO TIMER ELECTRONIC DIGITAL CLOCK PCB, \$9.95. Kit \$99.95. Complete \$149.95. Cosmos Electronics, P.O. Box 33278, Seattle, WA 98133.

## The Comfortable Alternative to Headphones

YEAPLE  
**Stereopillow™**

Model 900—reviewed in  
High Fidelity, \$79.95  
Stereo Review

Model 400—New  
compact version  
\$34.95

FREE reviews and dealer list from:  
Yeaple Corp., Dept. SR, 1255 University Ave., Rochester, NY 14607



NEW SCOTT R-306: \$149. NEW SCOTT R-326: \$216. SHIPPING INCLUDED anywhere in continental U.S. For savings like this and more on major brand components: write for quote. PIRATE'S DEN, Box 10091, Elmwood, Conn. 06110.

## TAPE AND RECORDERS

THRIFTIEST "Live"—Operatic, Symphonic—Open Reels! P.O. Box 1101, Woodhaven, New York 11421.

GOLDEN AGE RADIO—your best source for radio tapes. Box 25215-T, Portland, Oregon 97225.

YESTERDAY'S RADIO PROGRAMS on Tape. Catalog \$1.00 refundable first order. Reel-Cassette. ADVENTURES, Box 4822-S, Inglewood, California 90302.

OPERA CLASSICAL MUSIC Open Reels. Rare mostly live free catalogue. K. Lohan Tapes, P.O. 298, Mastic Beach, N.Y. 11951.

TDK, BASF, Memorex, Maxell, cassettes, reels, 8-tracks. Lowest prices, new guaranteed. S&S Audio, P. O. Box 56039, Harwood Heights, Ill. 60656.

SCOTCH RECORDING TAPE, exclusively, all new, lowest prices. TAPE CENTER, Box 4305, Washington, D.C. 20012. 3600' FRESH Low Noise, High Output Ampex tape. 10-1/2" metal reel, 6 for \$35.00 plus \$3.50 UPS. Other tapes also on special, write for catalog. S.I.C., P.O. 88338, Atlanta, GA 30338.

RADIO'S GOLDEN DAYS on tape. Reel, Cassette, Cartridge catalog. Radio Memories, Box 2297, Newport News, VA 23602.

EVERYTHING ON OPEN REEL! Classical. Popular. Dolby. Quadraphonic. Latest releases. For "Reel News," send \$1.00. Barclay-Crocker, Room 857 S, 11 Broadway, New York 10004.

1930-1962 RADIO PROGRAMS. Tapes \$1.00 Hour! Established esteemed dealer. Informative 175 page catalog. \$1.25. AM Treasures, Box 192SR, Babylon, N.Y. 11702.

WE WILL BEAT any price sheet in America. Featuring TDK, Maxell, BASF, and Ampex. Tape World International, 220 Spring Street, Butler, PA 16001.

SONAR'S OPEN REEL TAPES. Duped one-to-one from master. All Formats. Highest quality anywhere! Send \$1.00 for catalog and mini stereo sample tape. Sonar Records, P.O. Box 455S, Kingsbridge Sta., Bronx, N.Y. 10463.

RADIO RERUNS best source for radio shows, remotes, chronologies, jazz, personalities. Box 724-SR, Redmond, WA 98052.

MAXELL, AMPEX, CAPITOL — Low Prices — excellent service. Write for complete tape & supplies catalog. Omega, Box 39253, Redford, MI 48239.

THRILLING Live Opera Tapes. Personal attention. Guaranteed! Incredible Variety. Enormous Free Catalogue. Live Opera, Box 3141, Steinway Station, L.I.C., N.Y. 11103.

TDK SUPER AVILYN C-90 CASSETTES \$3.19 Ea. 10 or more \$3.06 each. Shipping & Handling — add 10% under \$20.00 7% over \$20.00. Free Catalog. SAXITONE TAPE SALES, 1776 COLUMBIA RD., N.W., DEPT. S, WASHINGTON, D.C. 20009.

PRE-RECORDED Classical Cassettes. Complete inventory of quality imported and domestic selections, all Dolbyized. Fair prices. Latest catalogue available 50 cents. B&W Sound, 5521 La Cienega, L.A., CA 90056.

DON'T Buy another recording tape until you've checked our prices. M.L.R., P.O. Box 22635, San Francisco, CA 94122.

BLANK TAPE BONANZA. TDK: 10 SA-C90 \$30.85, 10 SA-C60 \$21.85. MAXELL: 12 UDC-90 \$35.31, 10 UD35-90 \$49.99, 12 UDXL-C90 (I or II) \$41.43. All prices include shipping. (PA add 6% sales tax). Give us a try! Tape World International, 220 Spring St., Butler, PA 16001.

FIVE EXCITING NEW TITLES FROM ADVENT. New Process CR/70 cassette recordings include New World Symphony—Orchestre de Paris; Brahms Piano Concerto—Gelber; more. Write for free catalog and dealer list. Advent Corporation, Dept. CSR, 195 Albany Street, Cambridge, MA 02139.

40,000 OLD RADIO SHOWS on Tape. Jazz/Big Band remotes, Country/Western, discographies, anthologies, chronologies. Send \$2 for huge catalog (refundable). McCoy's Recording, Box 1069S, Richland, Washington 99352.

OLD RADIO PROGRAMS. Sales, Rentals, Dolby. Catalog: \$1.00 deductible. Airwaves, 925FJ Eagle Heights, Madison, Wisconsin 53705.

BASF TAPE: We carry only BASF so our prices are the lowest! All tapes new and GUARANTEED. Enclose this ad with any order and we'll pay shipping (USA only). INTERGALACTIC ENTERPRISES, 1043 Kirts, Troy, Michigan 48084.

OLDTIME RADIO SHOW CASSETTES. Quality, Low Prices, Separations, Large Catalog, \$1.25 (refundable). Radio Classics, 706 South Clayton, Bloomington, Illinois 61701.

HISTORICAL OPERA DISC & TAPE — Magnificent quality, speedy service. Greatest live performances of past 50 years. Reel, cassette, disc. Free catalog. Historical Recording Enterprises, Box 12, Kew Gardens, N.Y. 11415.

## INSTRUCTION

LEARN Electronics Organ Servicing at home. All makes, including transistors. Experimental kit—trouble-shooting. Accredited NHSC. Free Booklet. Niles Bryant School, 3631 Stockton, Dept. A, Sacramento, Calif. 95820.

BROADCAST STATION? Operate your own FM, Cable, Carrier-Current from home, school, church or as money making business. Free details. "Broadcasting", Box 5516-RF, Walnut Creek, CA 94596.



## RECORDS

SHOW ALBUMS, Rare, Out-of-Print LP's. 52 pg. list. 50 cents. **ROBBER BRIDEGROOM 7"** Stereo 33-1/3, 4 songs — Jerry Orbach; Virginia Vestoff \$3.95. Broadway/Hollywood Recordings, Georgetown, Conn. 06829.

PROTECT your LP's—Poly sleeves for jackets 8 cents; Round Bottom Poly Inner sleeves 7 cents; Poly lined paper 15 cents; white jackets 35 cents. Postage \$1.50. Record House, Hillburn, N.Y. 10931.

COLLECTORS' Soundtracks. Mint. List 50 cents (refundable). Jemm's, P.O. Box 157, Glenview, Ill. 60025.

CASH for unwanted LP's and pre-recorded reel-to-reel tapes. TAPES, Hillburn PO, New York 10931.

HARD-TO-FIND Soundtracks, Shows, Nostalgia. Superb Imported, Domestic selections. Catalog \$1.00 (refundable). List Communications, P.O. Box 916-x, NYC 10023.

OLDIES oldies, 45rpm. Also current hits. Free Catalog. Corry's Record Shop, Box 166HC, Mason, Ohio 45040.

RARE RECORDS, 45's, 78's, 33's, Soundtracks, Original, Cast Personalities, all kinds, mostly mint, 5,000 record lists, \$2.00. Refundable. Dealers Welcomed. Gurley, Box A72, Princeton, N.C. 27569.

RECORD RATERS WANTED! Anyone qualifies. We ship you nationally released LP's to rate. We pay postage and handling. You pay nothing for LP's. All you pay is small membership fee. Applicants accepted "first come basis." Write: E.A.R.S., Inc., Dept. SR, Box 10245, 5221 W. Center Street, Milwaukee, WI 53210.

CLASSICAL RECORDINGS for collectors. Bi-monthly lists. Collections bought. ARS MUSICA, 13 Dante St., Larchmont, N.Y. 10538.

250,000 SOUNDTRACKS/OC, PERSONALITIES. FREE CATALOGUE! Rare Soundtrack/OC Valuebook, \$4. RTSR, 3700 Plaza, F211, Santa Ana, Calif. 92704.

COLLECTORS JEWEL! **ANDRE WATTS** performs historic concert *Ford's Theatre*, Washington, D.C. in *MacDowell Concerto* and narrates *Copland's Lincoln Portrait*. Two record, professionally recorded set available for \$50.00 tax deductible contribution to Reading Symphony Orchestra, 219 North Fifth, Reading, Pennsylvania 19601. Limited to 300 remittances.

JAPANESE JAZZ IMPORTS. Send for free catalogue self addressed stamped to Rob Records, 1540 Broadway, N.Y.C. 10036.

QUASI-RATIONAL PRODUCTS has everything in record protection; Liners, jackets for less — Discwasher, Maxwell, Watts, Nortronics, Jensen, etc. Free catalog. QUASI-RATIONAL PRODUCTS, P.O. Box 171, Prospect Heights, Illinois 60070.

45rpm OLDIES & NEWIES. Rock, POP, Country & Western, Latin, Imports, too. Low Prices. Euphoria Records, 9635 Muirkirk Rd., Laurel, MD 20811.

QUADRAPHONIC RECORDS AND TAPES—World's largest selection — all labels, over 1000 titles — at discount prices! For your free illustrated quad catalog, write: SOUND CONCEPTS, Box 654-A, Peoria, IL 61601.

PROTECT YOUR ALBUMS. White cardboard replacement jackets 35 cents. Plastic lined sleeves 15 cents. Postage \$1.25. Opera Boxes, 78 Sleeves. Free Catalog. CABCO 400-1, Box 8212, Columbus, Ohio 43201.

## TUBES

TV and Radio Tubes 36 cents. Free 48 page color catalog. Cornell, 4215-H University, San Diego, California 92105.

## MUSICAL INSTRUMENTS

UP TO 60% DISCOUNT. Name brand instruments Catalog. Freeport Music, 114 Q. Mahan St., W. Babylon, N.Y. 11704.

## WANTED

GOLD, silver, platinum, mercury wanted. Highest prices paid by refinery. Ores assayed. Free circular. Mercury Terminal, Norwood, MA 02062.

## HYPNOTISM

FREE Hypnotism, Self-Hypnosis, Sleep Learning Catalog! Drawer H400, Ruidoso, New Mexico 88345.

SLEEP LEARNING. Hypnotic Method. 92% effective. Details free. ASR Foundation, Box 23429 EG, Fort Lauderdale, Florida 33307.

AMAZING self-hypnosis record releases fantastic mental power. Instant results! Free trial. Write: Forum (AA6), 333 North Michigan, Chicago 60601.

## RUBBER STAMPS

RUBBER STAMPS, BUSINESS CARDS. Many new products. Catalog. Jackson's, Dept. K, Brownsville Rd., Mt. Vernon, Ill. 62864.

## FOR SALE

CB RADIOS — Police Scanners, Wholesale only!! Send letterhead for lowest prices anywhere. Four Wheeler, 10SR New Scotland, Albany, N.Y. 12208.

ONE PAIR JBL L45 Spkrs. Mint Cond. \$650. (904) 245-4244.

## REPAIRS AND SERVICES

RFI ELIMINATED easily, cheaply from CBer neighbors. No technical knowledge, legal implications, \$5. S.A.S.E. C.B. City, 600 E. Franklin, Monterey, CA 93940.

## PERSONALS

MAKE FRIENDS WORLDWIDE through international correspondence. Illustrated brochure free. Hermes-Verlag, Box 110660/Z, D-1000 Berlin 11, Germany.

## BUSINESS OPPORTUNITIES

I MADE \$40,000.00 Year by mailorder! Helped others make money! Free Proof. Torrey, Box 318-NN, Ypsilanti, Michigan 48197.

MAILORDER MILLIONAIRE helps beginners make \$500 weekly. Free report reveals secret plan! Executive (1K6), 333 North Michigan, Chicago 60601.

GET RICH with Secret Law that smashes debts and brings you \$500 to \$5 Million cash. Free report! Credit 4K6, 333 North Michigan, Chicago 60601.

FREE SECRET BOOK "2042 UNIQUE, Proven Enterprises." Fabulous "Little Knowns." Work Home! Haylings-B, Carlsbad, Calif. 92008

STEREO REPRESENTATIVES NEEDED!!! Sell 100 brands!! Lowest Possible Prices!! Krasco, 998 Orange Ave., West Haven, Conn. 06516.

CAMPUS REPRESENTATIVES — Double your profits! Contact Tokyo Audio, Ltd., Box 3241, Los Angeles, Calif. 90028.

NEW LUXURY Car without cost. Free Details! Codex-ZZ, Box 6073, Toledo, Ohio 43614

MAKE BIG MONEY in spare time selling: Tubes, Antennas, Speakers, Test Equipment, Lite Bulbs, Hi-Fi, etc. No investment. Free information: Allied Sales, Pimento, IN 47866. (812) 495-6555.

HI-FI ENTHUSIASTS WANTED!! Earn more than just spare money in your spare time. We need campus representatives to sell name brand stereo components at discount prices in your area. High commission, no investment required. Serious inquiries only, please. Contact: Alan Weisberg, K&L Sound Services Co., 75 No. Beacon St., Watertown, Mass. 02172. (617) 787-4073.

BIG MONEY!! Immediate, Guaranteed home income stuffing envelopes. FREE Supplies! Send 25 cents stamp. Profits, B725-SR6, Belen, N.M. 87002.

STEREO REPRESENTATIVES — Excellent earnings (no investment). Write: Mail Order Specialties, Box 12805, Kansas City 64124.

CASH WITH YOUR CAMERA! Earn \$5000-\$15,000 yearly selling to 4,000 clients. Sell photos fifteen or more times. Guaranteed. Details — 13 cents stamp. Pictureprofits, 26 Josephine Blvd., Suite SR677, Shoreham, N.Y. 11786.

HOW TO BORROW \$25,000 interest-free — indefinitely! Free Report: Executive-CD6, Box 368, Buford, Georgia 30518.

## MOVIE FILMS

16mm SOUND Features, Shorts, New, Used for Sale. Free Catalog. National Cinema, 333 W. 57th St., N.Y., N.Y. 10019.

## EDUCATIONAL OPPORTUNITIES

LEARN WHILE ASLEEP. Hypnotize! Astonishing details, strange catalog free! Autosuggestion, Box 24-ZD, Olympia, Washington 98597.

## PUBLICATIONS

COLLECTORS' CONTACT GUIDE \$4.00; Sound Search, \$6.00; Unauthorized Duplication of Sound Recordings, \$5.00; Recorded Sound Technical Guide, \$6.00. Write: Sound Search, 1506 W. Barker, Peoria, IL 61606.

**THE LISTENER'S REVIEW FINDER** SPRING 77

New quarterly indexes reviews and articles in over 15 magazines. Slips to undergrounds. RECORDING REVIEW INDEX of classical, jazz and misc. recording reviews. Code indicates reviewer's opinion of performance, sound and pressing. COMPONENT REVIEW INDEX of stereo component tests with reviewer's opinion code. ANNUAL INDEX for all reviews in fourth issue of each volume. OPERA CROSS-REFERENCE. PERFORMER CROSS-REFERENCE. ARTICLE INDEX by subject. DEMONSTRATION QUALITY RECORDING LIST. SPECIAL FEATURES. REVIEWS AND ARTICLES by our staff. CHARTER RATE \$12. PER YEAR (subscriptions for complete 4 issue volume only). P.O. BOX 15256, SR New Orleans, La. 70115

CLASSICAL REVIEWS — comprehensive comparisons, discographies, imported and rare releases. Special Introductory Rate, \$5.95. Subscribe now! American Record Guide, Box 812S, Melville, N.Y. 11746.

AUDIOGRAM — The Bi-Monthly newsletter that brings you Reviews, News, and our views of the Audio World. Free Information. Write: Audio Advisor, P.O. Box 17202, Washington, D.C. 20041.

## MISCELLANEOUS

WINEMAKERS. Free illustrated catalog of yeasts, equipment. Semplex, Box 12276Q, Minneapolis, Minn. 55412.

KAHLUA CAFE. Delicious recipe at a fraction of retail cost. \$2.00. Freeze, P.O. Box 7091, Riverside, Calif. 92513.

### CLASSIFIED ADVERTISING ORDER FORM

Please refer to heading on first page of this section for complete data concerning terms, frequency discounts, closing dates, etc.

|    |    |    |    |    |
|----|----|----|----|----|
| 1  | 2  | 3  | 4  | 5  |
| 6  | 7  | 8  | 9  | 10 |
| 11 | 12 | 13 | 14 | 15 |
| 16 | 17 | 18 | 19 | 20 |
| 21 | 22 | 23 | 24 | 25 |
| 26 | 27 | 28 | 29 | 30 |

**WORD COUNT:** 15 WORD MINIMUM. Include name and address. Name of city (Des Moines) or of state (New York) counts as one word each. Zip code numbers not counted. (Publisher reserves right to omit Zip Code if space does not permit.) Count each abbreviation, initial, single figure or group of figures or letters as a word. Symbols such as 35mm, COD, PO, AC, etc., count as one word. Hyphenated words count as two words. Telephone numbers count as one word.

\_\_\_\_ Words \$2.10 (Commercial Rate) \$1.25 (Reader Rate) \$3.15 (Expand-Ad Rate)

Payment of \$ \_\_\_\_\_ enclosed for \_\_\_\_\_ insertion(s).

PRINT NAME \_\_\_\_\_

ADDRESS \_\_\_\_\_

CITY \_\_\_\_\_

STATE \_\_\_\_\_

ZIP \_\_\_\_\_

SIGNATURE \_\_\_\_\_

SR-677

of her sensational success in Donizetti's *Lucrezia Borgia*. So it need not surprise us that this latest of her by now almost innumerable recordings is devoted to the "dramatic" repertoire. She appears to be ideally suited for the roles in question: her voice has grown darker, with a plush and well-supported mid-range, in the intervening years.

Overall, this is a very impressive recital. The dark beauty of Caballé's tones is further enhanced by meaningful expression and lovely phrasing. Lady Macbeth's "ascendivi a regnar" soars with a passionate commitment that befits a driven woman, not a *bel canto* diva. Her Santuzza smolders with an anguished passion, and the glottal attacks lend added effectiveness to her lower range. The high-lying Turandot aria soars with unusual tonal warmth, the cruelty softened by aristocratic phrasing. On the negative side, however, I must cite a few notes in the high register that are not firmly centered and a certain self-indulgence that forces languor on her conductors—most damagingly in *La Gioconda*. The orchestral frame, in general, is too submissive, but it does surround a glowing display of vocalism. G.J.

**FRENCH ORCHESTRAL FAVORITES.** **Ravel:** *Daphnis and Chloë Suite No. 2*. **Chabrier:** *España*. **Debussy:** *Prelude to the Afternoon of a Faun*. **Ibert:** *Escales*. Orchestre de Paris, Daniel Barenboim cond. COLUMBIA M-34500 \$6.98, ©MT-34500 \$7.98.

Performance: **Runs the gamut**  
Recording: **Excellent**

Four of the most popular and frequently heard works in the French orchestral repertoire are programmed together here, and the question immediately comes to mind as to whether Barenboim has brought anything to these oft-played favorites that is beyond the contributions of other conductors who have committed these scores to discs. The answer is, yes and no. Intoxicated, perhaps, by the ability of a great French orchestra to bring out the true bouquet of anything French it undertakes, he whips up a broadly paced and luxurious performance of the familiar second suite from *Daphnis and Chloë* which retains the fire of Ravel's score but neglects the glittering ice that Boulez, for example, knows so well how to replicate in sound. Chabrier's *España* needs a touch of elegance and restraint to disguise the essential vulgarity of its post-card Spain, but here it is flailed to a flashy frenzy. Yet Barenboim's *Afternoon of a Faun* is as drowsy and at the same time as full-blooded and sensuous as an exacting listener might wish, and Ibert's *Escales*, that musical cruise of the Mediterranean which can awaken a hunger for travel in the most tone-deaf stay-at-home, receives as loving and lavish a treatment as it ever has on disc. The collection is a mixed bag, then, but the performances grow better as they go along. P.K.

#### RECORDING OF SPECIAL MERIT

**MICHAEL McCRAW:** *Sonatas for Bassoon or Recorder and Continuo*. **Lavigne:** *Sonata in C Major for Recorder and Continuo*. **Boismortier:** *Rondeau in A Minor for Bassoon and Continuo*. **Loeillet:** *Sonata in G Major for Recorder and Continuo*. **Telemann:** *Sonata in F Minor for Bassoon and Continuo*. **Bertoli:** *Sonata Prima for Bassoon and Continuo*. **Handel:** *Sonata in F Major for Recorder and Continuo, Op. 1, No. 11*. Michael McCraw (re-

order, bassoon); Dennis Michno (harpichord); Julian Fifer (cello). CAMBRIDGE CRS 2826 \$6.98.

Performance: **Charming**  
Recording: **Good**

Michael McCraw is as enterprising as he is versatile. This record demonstrates his artistry as both bassoonist and recorder player as well as his musical background in turning up rare and interesting repertoire. His recorder playing is clean, in tune, and imbued with a bright, clear tone that brings joy and cheer to this charming music. His ornamentation is well thought out, and he has the ability to blend all manner of graces into the basic phrase. In his hands the bassoon is an instrument with all the suppleness and warmth of the cello. His approach is suave and graceful at all times.

The highlight of the record is the Bertoli (authorship dubious) *Sonata Prima* for Bassoon and Continuo. Taken from the first known collection of sonatas for the bassoon, it is full of the rich harmonies, curious turns of phrase, and dramatic contrasts so typical of the early Baroque Italian school. It is also a virtuoso piece comparable to the violin music of the period and is played as such.

Mr. McCraw is well supported by the fine harpsichord playing of Dennis Michno, whose sturdy realizations put him into equal partnership with Mr. McCraw. All of this is supported by the fine if unobtrusive cello playing of Julian Fifer. S.L.

#### RECORDING OF SPECIAL MERIT

**SHOWPIECES FOR ORCHESTRA, ALBUM 3.** **Chabrier:** *Joyeuse Marche; España*. **Weber (arr. Berlioz):** *Invitation to the Dance*. **Verdi:** *Aida: Ballet Music*. **Waldteufel:** *The Skaters, Waltz*. **Weinberger:** *Schwanda, the Bagpiper; Polka*. **Bizet:** *L'Arlésienne Suite; Farandole*. **Ponchielli:** *La Gioconda: Dance of the Hours*. **Tchaikovsky:** *Sleeping Beauty: Waltz*. Philharmonia Orchestra, Herbert von Karajan cond. ANGEL S-37250 \$6.98.

Performance: **Gorgeous**  
Recording: **Excellent**

This third in the series of albums from Angel called "Showpieces for Orchestra" is a more generous program than one usually encounters on a single disc, finding room as it does for two Chabrier works, all of Ponchielli's *Dance of the Hours*, the ballet music from Verdi's *Aida*, and half a dozen other familiar items which can be described with equal truth as outstanding favorites or worn-out war-horses. In any case, the motive for the manufacture of this particular series is patently commercial since there is, to say the least, no shortage of other recordings containing the same material. Yet Karajan is fairly successful in infusing these tired spirits with an energy that at times may sound less than spontaneous but is invariably gorgeous, especially the way the Philharmonia Orchestra plays and is recorded on this disc. The entire series of three albums, which opens with Suppé's *Light Cavalry Overture* in Album One and concludes in Album Three with the waltz from Tchaikovsky's *Sleeping Beauty*, can therefore be recommended in particular as a starter set for music lovers just beginning to accumulate a classical collection. P.K.

**COLIN TILNEY:** *Fantasias* (see **Best of the Month**, page 91)

## STEREO REVIEW ADVERTISERS' INDEX JUNE 1977

| READER SERVICE NO. | ADVERTISER                                | PAGE NUMBER  |
|--------------------|-------------------------------------------|--------------|
| 1                  | Acoustic Research                         | 109          |
| 2                  | ADC, Acoustrac                            | 113          |
| 3                  | ADC, BSR Division                         | 129          |
| 4                  | ADC, BSR Division                         | 12           |
| 5                  | Advent Corporation                        | 58, 59       |
| 6                  | AFS Systems                               | 97           |
| 6                  | Alwa                                      | 10, 11       |
|                    | Akai America, Ltd.                        | 29           |
| 7                  | Allison Acoustics                         | 57           |
| 8                  | Angel                                     | 128          |
| 9                  | Audio Discount Warehouse Sales            | 122          |
|                    | Audio Technica, U.S., Inc.                | 119          |
|                    | BASF Systems                              | 21           |
|                    | Bose Corporation                          | 69           |
| 10                 | British Industries, Co., BIC Venturi      | 2            |
| 11                 | Cambridge/Cybervox                        | 133          |
|                    | CBS Records                               | 149          |
|                    | Component Discounters                     | 138          |
| 12                 | Crown International                       | 125          |
| 13                 | Discount Music Club                       | 28           |
| 14                 | Discount Sound                            | 30           |
| 15                 | Discwasher, Inc.                          | 32, 33, 34   |
| 16                 | Discwasher, Inc.                          | 108          |
| 17                 | District Sound, Inc.                      | 30           |
|                    | Dixie Hi-Fi                               | 133          |
| 50                 | Dual                                      | 48, 49       |
| 18                 | Dynaco                                    | 26           |
| 19                 | Eastman Kodak                             | 115          |
| 21                 | Empire Scientific Corp.                   | 111          |
| 99                 | Empire Scientific Corp.                   | 13           |
| 20                 | Hi-Fi Buys                                | 138          |
| 22                 | Hitachi                                   | 51           |
| 23                 | Illinois Audio                            | 132          |
| 24                 | Infinity Systems, Inc.                    | 103          |
| 25                 | International Hi-Fi Distributors          | 137          |
|                    | JBL Sounds, Inc.                          | 40, 41, 123  |
|                    | Jensen Sound Laboratories                 | 105          |
| 26                 | JVC America                               | 14, 15       |
| 27                 | Kenwood Electronics                       | 16           |
| 28                 | Koss Electronics                          | Cover 4      |
|                    | Lux Audio of America, Ltd.                | 5            |
| 29                 | 3M Company                                | 88           |
|                    | Marantz, Inc.                             | 7            |
| 30                 | Maxell Corp. of America                   | 61           |
| 31                 | McIntosh Laboratories, Inc.               | 137          |
| 32                 | MGA                                       | 22, 23       |
| 33                 | Micro-Selki, division of Teac Corporation | 47           |
|                    | Midwest Hi-Fi                             | 132          |
| 35                 | MXR Innovations, Inc.                     | 124          |
| 36                 | Nakamichi Research (U.S.A.), Inc.         | 112, 113     |
| 37                 | Netronics Research & Development          | 120          |
| 38                 | Olympus Corporation of America            | 102          |
| 39                 | Onkyo                                     | 78, 79       |
| 40                 | Phase Linear Corp.                        | 144          |
| 41                 | Radio Shack                               | 63           |
|                    | RTR Industries                            | 39           |
| 42                 | S.A.E.                                    | 116          |
| 43                 | Sankyo Selki                              | 135          |
| 34                 | Sansui Electronics Corp.                  | 8, 9         |
| 100                | Scott, Inc., H.H.                         | 52           |
| 45                 | Sharp Electronics                         | 27           |
| 46                 | Sherwood Electronics                      | 117          |
| 47                 | Shure Brothers                            | 55           |
| 48                 | Sony Corporation of America               | 31           |
|                    | Sony Superscope                           | 150, Cover 3 |
| 49                 | Soundcraftsmen, Inc.                      | 145          |
|                    | Speakefab                                 | 120          |
| 51                 | Spectro-Acoustics, Inc.                   | 110          |
| 44                 | Stanton Magnetics                         | 25           |
| 52                 | Stereo Corp. of America                   | 143          |
| 53                 | Tannoy                                    | 107          |
| 54                 | TDK Electronics                           | 87           |
|                    | Teac Corporation                          | 101          |
| 55                 | Technical Sound Industries, Inc.          | 140          |
| 56                 | Technics by Panasonic                     | 121          |
| 57                 | Top Discount Audio                        | 122          |
| 58                 | Toshiba America, Inc.                     | 131          |
| 50                 | United Audio                              | 48, 49       |
| 59                 | U.S. Air National Guard                   | 43, 44, 45   |
| 60                 | U.S. Pioneer                              | Cover 2, 1   |
| 61                 | U.S. Pioneer                              | 98, 99       |
|                    | Yamaha International Corp.                | 70, 71       |
|                    | Classified Advertising                    | 146, 147     |

# The first Inaugural commemorative album in American history.

## Available in this deluxe limited edition, only through this ad.

On a windy, freezing cold night in January, the streets around The Kennedy Center in Washington, D.C. were lined in every direction with people from every part of the country, people of every political persuasion, people who wanted to be part of a very special event.

That same night, America and the world thrilled to a spectacle of unprecedented magnitude. Never before had so many giants of the entertainment world performed together for such an occasion:

The event, of course, was the Gala Concert for Jimmy Carter on the eve of his Inauguration. It was a beautiful night and was only the beginning of a very historic three-day period.

Now at the request of President Carter and the Inaugural Committee, the entire Inaugural celebration, from the first chord of the concert to the last float of the parade, has been captured in this beautifully crafted Columbia commemorative album.

### The Sounds and Sights.

The music, comedy and drama of the concert have been recorded onto two stereo LP discs, which are presented with the official Inaugural Gala Concert Program in a stunning hard-cover book.

Thirty-six pages of full-color photographs and text recreate the special "new spirit" that was so much a part of the concert, parade, balls, receptions, and of course, the Inauguration Ceremony itself.

President Carter's historical Inaugural Address and James Dickey's critically acclaimed poem "The Strength of Fields" (written especially for the occasion) are also reprinted in the book, to be reread and remembered for years.

This special deluxe album will be offered for a limited time only and will not be sold in any store. It is a truly unique collectors' item, something your family will always treasure.

All record company profits, and artist and publisher royalties, will be donated to the National Endowment for the Arts, a federally sponsored agency which supports the arts in colleges and communities throughout the United States.

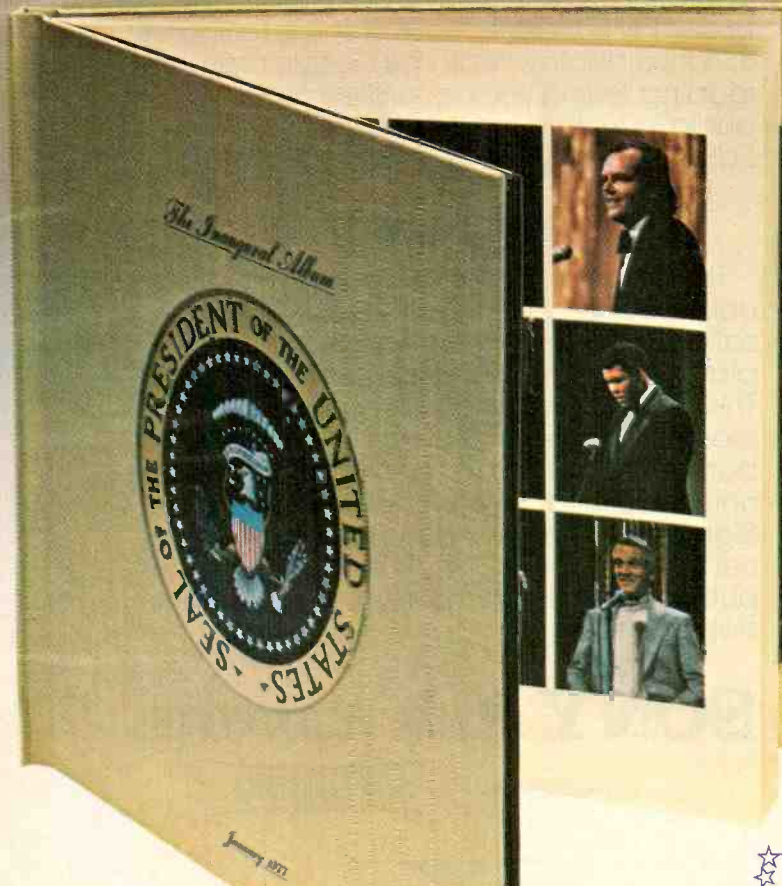

*Shirley MacLaine, Linda Ronstadt, Paul Simon, Loretta Lynn, Warren Beatty, Aretha Franklin, Redd Foxx, Freddie Prinze, Muhammad Ali, Jean Stapleton, Carroll O'Connor, Chevy Chase, Dan Aykroyd, Jack Nicholson, Mike Nichols, Elaine May, Joanne Woodward, Clamma Dale, Donnie Ray Albert, Leonard Bernstein, Frederica von Stade, The National Symphony Orchestra, Jack Albertson, Beverly Sills, Jimmy Carter, Paul Newman, Hank Aaron, The Alvin Ailey American Dance Theater, Bette Davis, James Dickey, John Wayne, and more!*

#### THE INAUGURAL ALBUM

P.O. Box 5859, Terre Haute, Indiana 47805

SR67

The Inaugural Album is a priceless family keepsake, and it makes an outstanding gift. To order the historic Inaugural commemorative album, enclose \$40 for each album ordered.

- I am enclosing a check or money order for \$\_\_\_\_\_
- Please charge my credit card # for \_\_\_\_\_ Inaugural Albums.
  - Master Charge  BankAmericard  American Express
  - Acct. # \_\_\_\_\_ Exp. Date \_\_\_\_\_
  - Master Charge: four numbers above name: # \_\_\_\_\_

Signature \_\_\_\_\_

Name \_\_\_\_\_

Address \_\_\_\_\_

City \_\_\_\_\_ State \_\_\_\_\_ Zip \_\_\_\_\_

# SONY 880-2

## THE WORLD'S BEST.

### DIRECT DRIVE SERVOCONTROL SYSTEM.

The name may be long — **Close-Loop Dual Capstan Tape Drive** — but the concept is simple: one capstan is just an extension of the motor shaft itself (the other connects through a belt-drive inertia fly-wheel). Gone are the intervening gears that can often impair optimum operating reliability as well as speed accuracy. The result — almost nonexistent wow and flutter — a mere 0.02% @ 15 ips.

### PHASE COMPENSATOR CIRCUIT.



Original Source\*

Source  
After Recording\*

Source Through  
Phase Compensator\*

Ideally, what you want on recorded tape is a "mirror image" of the original signal. No more. No less. Problem: the very nature of the recording process causes phase distortion. Solution: during playback, Sony's exclusive Phase Compensator Circuit compensates for phase distortion. Result: sound quality that's virtually identical to the original source. (REFER TO OSCILLOSCOPE READINGS.)

### SYMPHASE RECORDING.

Thanks to the durability of Sony's **Ferrite and Ferrite Heads** and incredible precision fabrication and alignment of the head gap, you can record any matrix 4-channel signal (like SQ\*\* or FM), play it back through a 4-channel decoder/amplifier, and retain the exact positioning of signal throughout the 360° 4-channel field. What started out in right front channel stays there. What began in left rear doesn't wander over to right rear. There's no phase shift whatsoever.

### PEAK READING VU METERS.

They're versatile. Accurate. And incredibly informative. **1.** You can set for standard VU operation to determine recording level. **2.** Set to display transient peaks only (up to +15 dB). **3.** A third display, Peak Hold, retains transient reading, letting you accurately measure audio input and adjusts accordingly with 2dB **Stepped Record Level Attenuators.**

### SYNCRO-TRAK.

This means you can lay down two individually recorded tracks in perfect synchronization with each other. Record head has playback-monitor function in record mode. This eliminates time lag that occurs when monitoring through playback head. Thus both tracks can be first generation, keeping noise levels at minimum. Flashing **Standby Signal** alerts you that the unrecorded channel is record-ready. And **Punch-In Record** puts you into record mode instantly, without stopping tape.

## SONY® Ask anyone.

Brought to you by **SUPERSCOPE.**

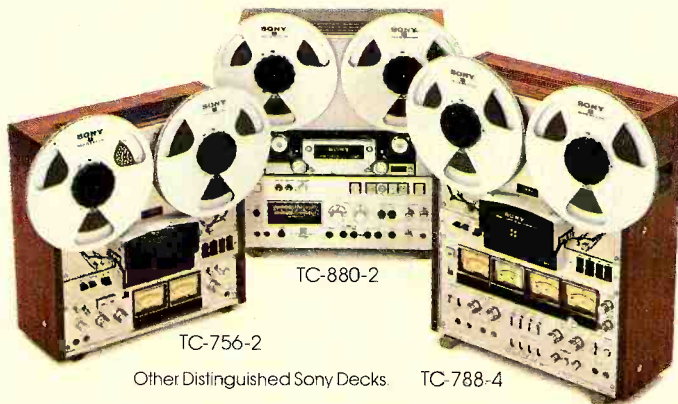

\*1000 Hz @ 0 dB, 15 ips. \*\*TM CBS, Inc. (Side panels of these units are constructed of plywood.

finished in genuine walnut veneer.) ©1976 Superscope, Inc., 20525 Nordhoff St., Chatsworth, CA 91311. Prices and models subject to change without notice. Consult the Yellow Pages for your nearest Superscope dealer.



You can be part of the music.



© 1977 Koss Corp.

Your workday is over. You've settled back into a recliner and a pair of Koss Technician™/VFR Stereophones in anticipation of a perfect, live symphony broadcast. Now with 132 finely tuned instruments and highly talented musicians, the conductor is ready to escort you into the cozy world of symphonic brilliance. As the last slight echoes of his baton taps disappear into silence, the violin

section fills your mind with a warm, glowing hum. The cellos, violas, and bass ease into the flow, adding a reverberating depth to the mood. And as the polished power of the brass begins to count the sensual woodwinds, you find the true beauty of your Koss Technicians. Because the VFR controls at the base of each earcup enable you to fine-tune the frequency response range to your idea of perfection.

Allowing you to shape the acoustic contour of the symphony to enrich the rolling lows of the timpani and bassoons, or add a chilling dimension to the high pitched violins and flutes.

So if you'd like to hear a performance that's at your command, visit your audio specialist and slip into the breathtaking Sound of Koss with Technician/VFR. Or, if you prefer, write us c/o Virginia

Lamm for a free, full color catalog of all our products. Either way, remember that with a pair of Koss Technicians, beauty is definitely at the fingertips of the beholder. Koss Technician/VFR Stereophones



 **KOSS** stereophones  
from the people who invented Stereophones.

KOSS CORPORATION, 4129 N. Port Washington Ave., Milwaukee, Wisconsin 53212 • Koss International/London, Milan, Dublin, Paris, Frankfurt • Amsterdam • Koss Limited/Eurlington, Ontario

CIRCLE NO. 28 ON READER SERVICE CARD