

NOVEMBER 1978 • \$1.25

Stereo Review[®]

CAN JAZZ BE ELECTRIFIED? ALBERTSON TALKS TO HANCOCK

NEVILLE MARRINER: NEW CONDUCTOR FOR THE MINNESOTA ORCHESTRA

POP CROSSOVERS: IS COUNTRY MUSIC GOING TO THE DOGS?

• JULIAN HIRSCH TESTS TWENTY MEDIUM-PRICE AMPLIFIERS •

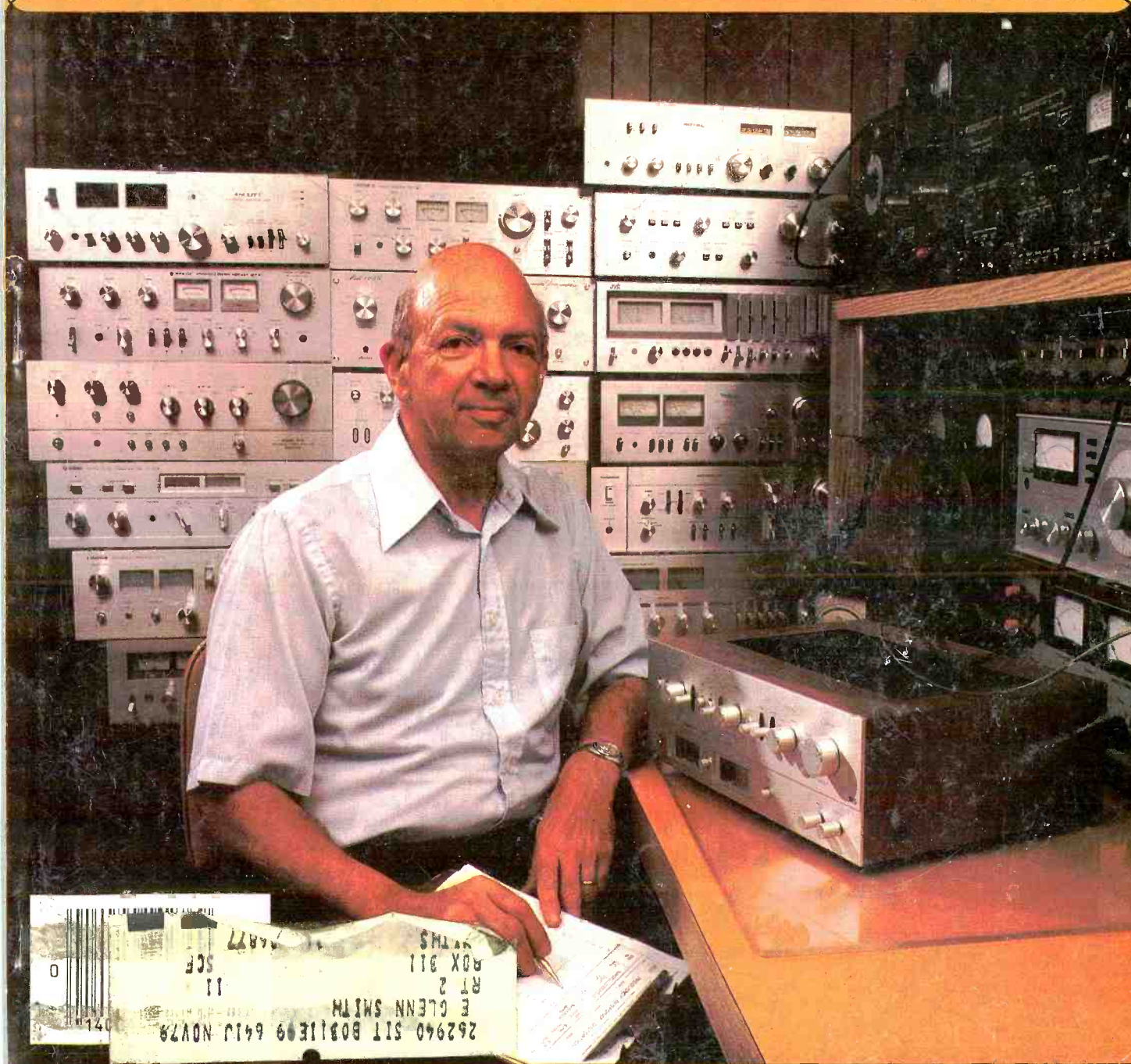

The big
difference
between this
cassette deck
and Pioneer's new
CFF1000
isn't sound.

262940 SIT B0811E99 641J NOV78
E GLENN SMITH
RT 2
BOX 311
MAY 11 1978



The Pioneer CT-F1000, \$600*

For years, Nakamichi has enjoyed a reputation for building the world's finest cassette deck.

Now Pioneer is introducing something Nakamichi won't enjoy at all: the Pioneer CT-F1000. A cassette deck that offers all the features and performance of Nakamichi's best cassette deck, at less than half the price.

PIONEER VS. NAKAMICHI: THE HEAD TO HEAD COMPETITION.

The \$1,650* Nakamichi 1000II and the \$600* Pioneer CT-F1000 are both honest three headed cassette decks that let you monitor right off the tape as you record.

Both have separate Dolby systems for the playback and recording heads. So when you're making a recording with the Dolby on, you can monitor it exactly the same way.

Both have two motors to insure accurate tape speed.

Both feature solenoid logic controls that let you go from fast forward to reverse, or from play to record without punching the stop button, and without jamming the tape.

And both are filled with convenient items like automatic memories for going back to a selected spot on a tape, multiplex filters for making cleaner FM recordings, separate bias and equalization switches for getting the most out of different kinds of tape, and even a pitch control adjustment that lets you match the pitch of a cassette to the tuning of your guitar or piano.

A \$1,000 GAP IN PRICE; NO GAP IN SOUND.

When we built the CT-F1000, however, we did more than match the Nakamichi's renowned features. We also matched its renowned performance.

Both machines boast totally inaudible total harmonic distortion levels of less than 1.5%.

Both have all but conquered the problem of wow and flutter. (An identical 0.05% for each machine.)

Both offer similarly impressive signal to noise ratios: 64 decibels Pioneer, 65 decibels Nakamichi. (At these levels

It's value.

we dare you to hear any noise at all, let alone any difference.)

And finally, where the CT-F1000 delivers a frequency response of 30 to 17,000 hertz, the Nakamichi deck goes from 35 to

20,000 hertz. (We offer a little more at the bottom; they offer a little more at the top. Either way, the specifications are close enough to be called virtually identical.)

A FEW PIONEER ADVANTAGES THAT AREN'T MONETARY.

To prevent you from making distorted tapes, the CT-F1000 has a peak limiter that the Nakamichi machine lacks.

Our tape heads are made out of a special single crystal ferrite material that's been proven to last longer than the Nakamichi's permalloy variety.

And our Dolby system can be calibrated by hand while the Nakamichi 1000II requires a screwdriver.

Admittedly, the Nakamichi 1000II does feature a fancy azimuth control for aligning your heads before every recording session. But we've developed a more accurate way to mount the heads in the first place. So you can spend your time recording, instead of aligning.

A FEW CONCESSIONS TO NAKAMICHI.

Obviously, at almost \$1,000 more, the Nakamichi 1000II must offer some advantages over the CT-F1000.

And we'd be remiss if we didn't point out that their VU meters extend slightly higher than ours.

And that they have extra input for premixed program sources.

And although their signal to noise ratio is hardly different than ours, the Nakamichi 1000II does feature an extra Nakamichi-invented noise reduction system.

Considering the slimness of these advantages, the choice is clear-cut:

You can buy a Nakamichi 1000II and get an incredibly expensive cassette deck.

Or you can buy a CT-F1000. And get one that's simply incredible.

PIONEER
We bring it back alive.



The Nakamichi 1000II: \$1,650*

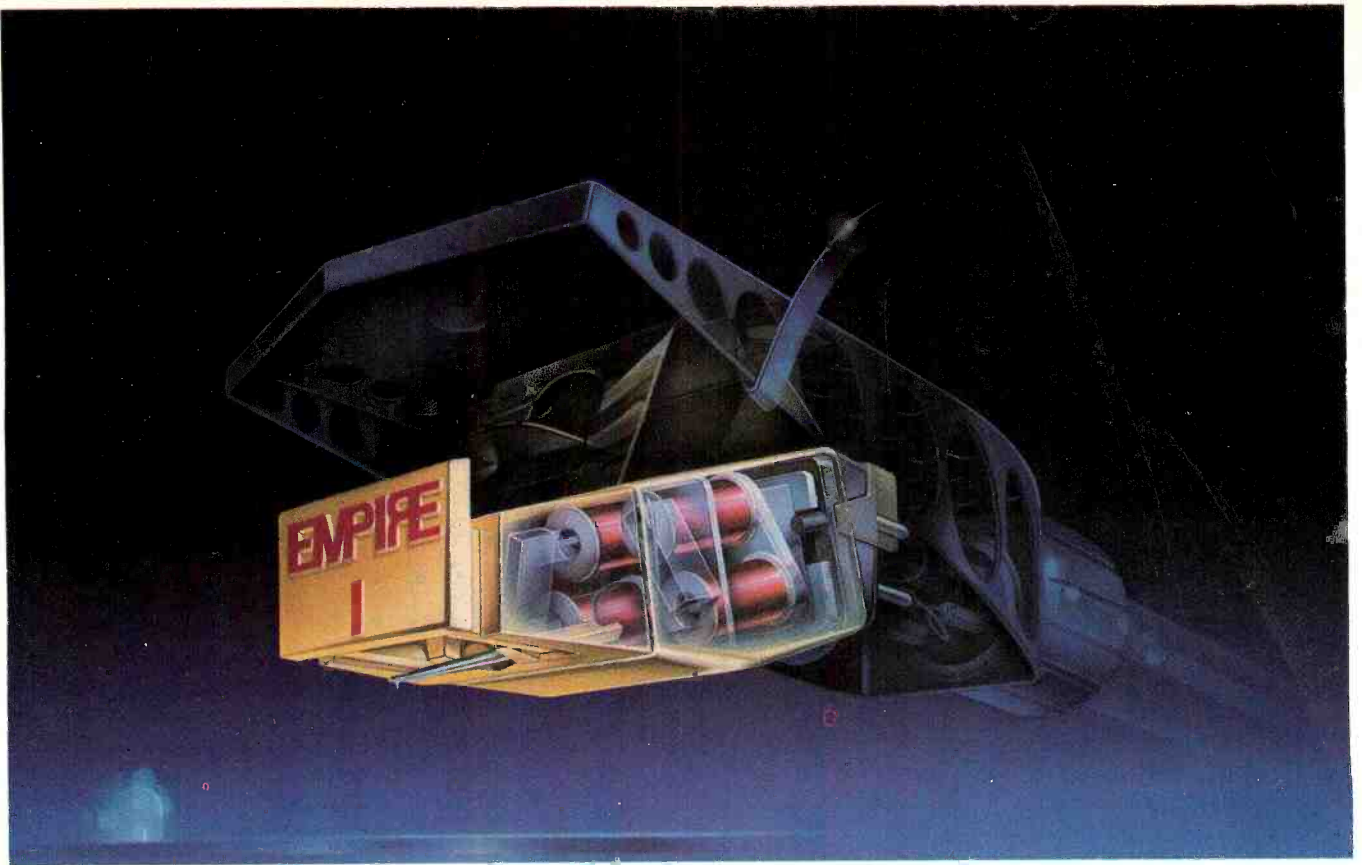

No matter what system you own there's an Empire Phono Cartridge designed to attain optimum performance.

Detail, brilliance, depth.

This is the promise of each Empire Phono Cartridge and although there are many Empire models, each designed to meet specific turntable performance characteristics, every Empire cartridge contains the following features:

Features	Details	Benefits
Unique Fixed Unidirectional Three-Magnet Structure	Every Empire cartridge uses 3 high energy ferrite magnets in the cartridge body to provide a high level of unidirectional flux.	Higher and more linear output signal, immunity to bi-directional magnetic distortion, and improved hum and microphonic rejection.
Molded Four-Pole Magnetic Assembly	Every Empire cartridge employs a four-pole magnetic assembly that is precisely aligned and locked in place by a high pressure injection molding process... providing a uniform and orthogonal magnetic field.	Improved crosstalk and reduced distortion that is insensitive to tracking force.
Tubular moving Iron Design	By using a tubular high magnetic saturation iron armature we obtain an optimum ratio of output level to effective tip mass.	Improved tracking ability and widened frequency response.
Four Coil Hum Bucking Assembly Plus Electromagnetic Shielding	Using custom designed computer controlled machines, a precision drawn copper wire (thinner than human hair and longer than a football field) is wound onto a symmetrical 4 bobbin structure. By using 2 coils per channel a symmetrical electrical circuit is formed.	Improved rejection of hum and stray noise fields.
Aluminum Alloy Cantilever	The Empire computer designed tubular cantilever provides optimum coupling of the diamond tip to the moving magnetic system resulting in minimum effective stylus tip mass.	Superb low level tracking, reduced tracking distortion... plus enhanced wideband separation characteristics.
Precision Ground Oriented Diamond Tips	Empire diamonds are precision ground, polished and inspected in house, using sophisticated television cameras and powerful microscopes to ensure accurate angular orientation.	Reduced tracing phase distortion, together with reduced wear of both the record and the diamond tip.

For the full story on Empire cartridges we suggest you "test-listen" to one at your local Empire dealer, and for information on our full line of cartridges, write for our brochure "How to Get the Most Out of Your Records": **Empire Scientific Corp.**, Garden City, N.Y. 11530

EMPIRE

FORMERLY HI FI/STEREO REVIEW

Stereo Review®

NOVEMBER 1978 • VOLUME 41 • NUMBER 5

The Equipment

NEW PRODUCTS	
<i>Roundup of the latest audio equipment and accessories</i>	22
AUDIO QUESTIONS AND ANSWERS	
<i>Power Response, "Professional" Gear, Extension Speakers, Equalization</i>	LARRY KLEIN 34
AUDIO BASICS	
<i>Addressing the Public</i>	RALPH HODGES 38
TAPE TALK	
<i>Double Dolby, Head Lubricants, Tape Squeal, Understanding EQ</i>	CRAIG STARK 44
AUDIO NEWS	
<i>An Audiophile Rhine Journey</i>	RALPH HODGES 53
TECHNICAL TALK	
<i>Testing Loudspeakers—Part 4</i>	JULIAN D. HIRSCH 54
EQUIPMENT TEST REPORTS	
<i>Twenty Medium-price Amplifiers</i>	JULIAN D. HIRSCH 55

The Music

NEVILLE MARRINER	
<i>An interview with the new conductor of the Minnesota Orchestra</i>	CLAIR W. VAN AUDSALL 92
IS COUNTRY GOING TO THE DOGS?	
<i>In some musical quarters, "cross" and "over" are two very dirty words</i>	NOEL COPPAGE 98
HERBIE HANCOCK	
<i>A little dialogue on art and commerce, jazz and funk</i>	CHRIS ALBERTSON 106
BEST RECORDINGS OF THE MONTH	
Orchestral: <i>Mozart's Piano Concerto No. 25 and "Eine Kleine Nachtmusik"</i>	
Piano: <i>Ashkenazy's Chopin, Jacobs' Debussy</i> Country Rock: <i>The Dirt Band Returns</i>	
Vocal: <i>Debby Boone's "Midstream"</i> Broadway: <i>The Best Little Whorehouse in Texas</i>	113
CLASSICAL DISCS AND TAPES	118
<i>Barenboim's Schubert</i>	ERIC SALZMAN 119
<i>Bernstein Collected</i>	JAMES GOODFRIEND 138
<i>Callas Ransomed from the Pirates</i>	GEORGE JELLINEK 144
CLASSICAL ROTOGRAVURE	WILLIAM LIVINGSTONE 146
POPULAR DISCS AND TAPES	148
<i>Mathis & Williams, Inc.</i>	PHYL GARLAND 149
<i>Genya Ravan: a Long Way from Lodz</i>	CHRIS ALBERTSON 154
<i>Irene Kral</i>	PETER REILLY 158
<i>Odd Couple: Cassidy & Ladd</i>	PETER REILLY 164
<i>Requiem for The Who</i>	STEVE SIMELS 172
<i>"Runaways," Son of "Hair"</i>	PAUL KRESH 178
<i>"Ain't Misbehavin'"</i>	JOEL VANCE 180
<i>Keith Jarrett: Running Out of Superlatives</i>	CHRIS ALBERTSON 182

The Regulars

BULLETIN	5
EDITORIALLY SPEAKING	WILLIAM ANDERSON 8
LETTERS TO THE EDITOR	12
INSTALLATION OF THE MONTH	RICHARD SARBIN 80
GOING ON RECORD	JAMES GOODFRIEND 84
THE POP BEAT	PAULETTE WEISS 88
ADVERTISERS' INDEX	187

COVER: Design by Borys Patchowsky; photo by Bruce Pendleton.

COPYRIGHT © 1978 BY ZIFF-DAVIS PUBLISHING COMPANY. All rights reserved. Stereo Review, November 1978, Volume 41, Number 5. Published monthly by Ziff-Davis Publishing Company; Editorial and Executive Offices at One Park Avenue, New York, N.Y. 10016, Telephone: 212-725-3500. Philip B. Korsant, President; Furman Hebb, Executive Vice President; Selwyn Taubman, Treasurer; Philip Sine, Secretary. Also publishers of Boating, Car and Driver, Cycle, Flying, Popular Electronics, Popular Photography, Psychology Today, Skiing, Stereo Directory, and Tape Recorder Annual. One-year subscription rate for U.S. and possessions, \$9.98; Canada, \$10.98. All other countries, one-year subscription rate \$14.98, cash orders only, payable in U.S. currency. Second-class postage paid at New York, N.Y. and at additional mailing offices. Authorized as second-class mail by the Post Office Department, Ottawa, Canada, and for payment of postage in cash. SUBSCRIPTION SERVICE: Forms 3579 and all subscription correspondence should be addressed to Stereo Review, Circulation Department, P.O. Box 2771, Boulder, Colorado 80323. Please allow at least eight weeks for change of address. Include your old address as well as new—enclosing if possible an address label from a recent issue. Material in this publication may not be reproduced in any form without permission. Requests for permission should be directed to Jerry Schneider, Rights and Permissions, Ziff-Davis Publishing Co., One Park Avenue, New York, N.Y. 10016.

This Device Gives You No Static

Zerostat—Now only \$20.

True electrostatic neutralization without
cartridges to replace, cords to plug in
or radioactivity.

Better function at a lower price.

ZEROSTAT

ZEROSTAT
ZEROSTAT
ZEROSTAT
ZEROSTAT
ZEROSTAT
ZEROSTAT
ZEROSTAT





Stereo Review BULLETIN

• THE DIGITAL REVOLUTION in recording is, it would appear, already well under way. Digital Sound Products Inc. is a new company formed to produce "the highest-quality digital recordings possible with the present state of the art," and a crew is already at work in Watford Town Hall in England producing four recordings with the London Symphony under the baton of Morton Gould (his own Latin American Symphonette is among them). Also scheduled: an organ-recital disc to be recorded at All Saints Church in Tooting.

• THE FAD FOR PICTURE DISCS AND COLOR DISCS shows no signs of tapering off. The picture disc of the Beatles' "Sgt. Pepper" album, issued in a limited edition of only 150,000 units, is already selling for ten dollars above its \$15.98 list price at New York's King Karol. Other hot collectibles include the Stones' Miss You disco single in shocking pink (for which Atlantic Records issued a button bearing the legend "I Have a Big Pink Twelve Inch") and Bruce Springsteen's "Darkness on the Edge of Town" with the Boss' face pressed right under the grooves.

• VIDEO HARDWARE: The Electronic Industries Association has announced U.S. sales of 185,830 home video tape recorders in the first 34 weeks of 1978. According to Jack K. Sauter, marketing vice president for RCA consumer electronics, "Surveys now show a potential market base for video-cassette recorders of 7 per cent of U.S. households." Expecting the market to increase substantially in the second half of 1978, RCA expanded its line of SelectaVision products and is now offering its first color TV cameras for home use at prices of \$850 and \$1,275.

• VIDEO SOFTWARE: Since the record companies were asleep at the switch when the home video revolution began, there is still very little made-for-the-medium prerecorded program material, and movies form the bulk of what is available on video cassettes. Reel Images Inc. offers a wide variety of fairly recent films, horror films, nostalgic favorites, and musicals (Elvis, the Beatles, Toscanini). For a catalog send \$1 to Reel Images Inc., Department R.P. 125, 456 Monroe Turnpike, Monroe, Conn. 06468. More than 150 feature films rated G to X are available from the International Video Movie Club. There is a \$25 membership fee, and prices are \$39.95 for family films and \$49.95 for "adult" films (Hanky Panky, Naughty Co-Eds, Congressional Playgirls). Write Veronica Smalec, Entertainment Video Releasing, Inc., One East 57th Street, New York, N.Y. 10022.

• MUSICAL TELECASTS OF SPECIAL INTEREST on the Public Broadcasting Service this month include Verdi's Macbeth on November 1. Produced by the BBC and WNET for Exxon's Great Performances series, the opera will be sung in Italian by Norman Bailey, Patricia Johnson, Nicolai Ghiaurov, and Neil Shicoff. On November 15, Great Performances will present Britain's Royal Ballet in Sir Frederick Ashton's A Month in the Country, based on Turgenev's drama and danced to music by Chopin. Smetana's The Bartered Bride will be presented in Texaco's Live from the Met series on November 21. It will be sung in English by Teresa Stratas, Nicolai Gedda, Jon Vickers and Martti Talvela. Load video tape; check local listings.

November 1978



Stereo Review BULLETIN

● 3M'S FIRST FOUR DIGITAL AUDIO MASTERING SYSTEMS will be delivered this year to A&M Records, Record Plant, Sound 80, and Warner Brothers Records. The digital system is the result of almost six years of research and development by 3M and a two-year joint project with the BBC. Claims for the system include virtually noise-free and distortion-free masters, a S/N ratio of better than 90 dB, and a uniform frequency response to 20,000 Hz. It consists of a 32-track pre-mix recorder and a two- or four-track mastering recorder. When a prototype was unveiled last November in New York, 3M indicated that the system would sell for "under \$150,000," but in May the company announced that it would be available, at least at first, through a rental arrangement so that 3M could better share responsibility for the introduction of the new digital technology.

● THE CHICAGO SYMPHONY claims the most extensive radio-broadcast series of any American orchestra. Sponsored by Standard Oil (Indiana), concerts of the 1978-1979 season will be carried by more than 300 stations in the United States and Canada. For time and station write Jess Brodnax, WFMT, 500 North Michigan Avenue, Chicago, Ill. 60711.

● AUTO STEREO of all kinds has achieved the wide-spread use foretold by the most optimistic prophets a few years ago. According to an independent market study, this year for the first time sales of equipment for presently owned cars surpassed those for new ones, although new-vehicle stereo sales have continued to rise rapidly. The boom is expected to continue through 1983, when total sales are expected to be over 13.5 million installations per year.

● RECENT ALBUMS CERTIFIED PLATINUM BY THE RIAA include Boston's "Don't Look Back" (Epic), Carly Simon's "Boys in the Trees" (Elektra), Abba's "The Album" (Atlantic), Teddy Pendergrass' "Life Is a Song Worth Singing" (CBS Philadelphia/International), Joe Walsh's "But Seriously, Folks" (Asylum), Meat Loaf's "Bat Out of Hell" (Epic/Cleveland International), the Commodores' "Natural High" (Motown), and Barbra Streisand's "Songbird" (Columbia). Platinum certification means sales of one million copies. When Meat Loaf explained to sportscaster Phil Rizzuto that after platinum comes double platinum, Rizzuto asked, "What does double platinum mean?" Mr. Loaf answered, "More money."

● THE SURVIVING ORIGINAL MEMBERS OF THE ALLMAN BROTHERS BAND will regroup for an album and a tour, probably by the beginning of next year. The reunion rumors, which had been rife in Southern rock circles, were confirmed when the band played a surprise set at Capricorn Records' annual Barbecue late in August, assisted by newer members Chuck Leavall and Lamar Williams, neither of whom is expected to participate further.

● PERFORMANCES OF THE SAN FRANCISCO OPERA, broadcast live in nine Western cities on Friday nights from September 15 through November 24, will be re-broadcast by National Public Radio in other cities throughout the country with a one-month delay. Check your local NPR station for dates and time.

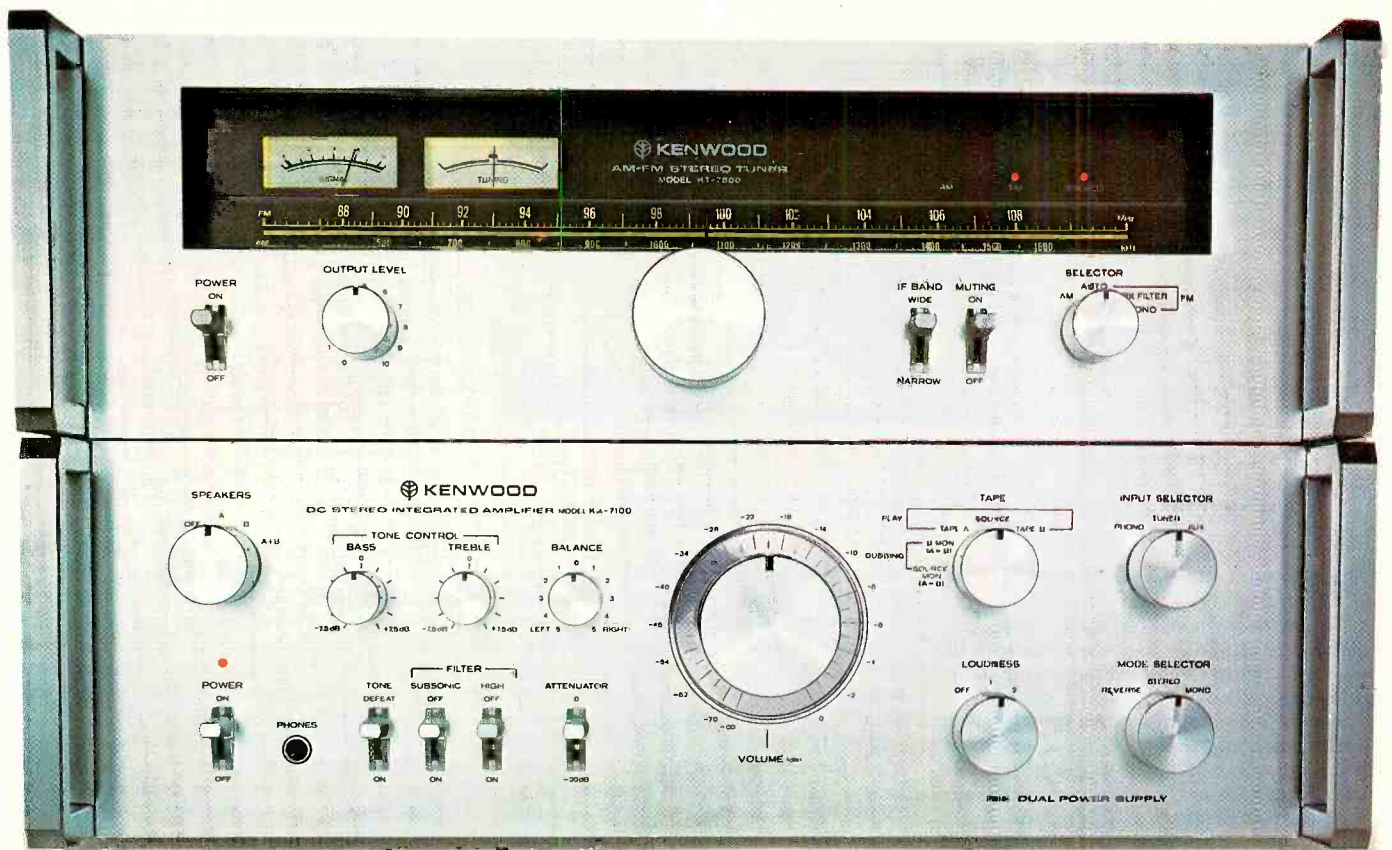

The 1980 Kenwoods.

No. We're not kidding. By 1980, the kind of performance these new Kenwoods deliver will be considered commonplace. Here's a summary:

1. The KA-7100 is an integrated DC amplifier with dual power supplies delivering 60 watts per channel, minimum RMS at 8 ohms from 20-20k Hz, with no more than 0.02% total harmonic distortion. Not only is that the lowest THD of *any* integrated amp, the KA-7100 is the lowest priced DC integrated amp on the market. (\$315*)

2. The KT-7500 marks the next plateau for FM tuners. For optimum reception under any condition it has two independent IF bands: the narrow band virtually eliminating interference when stations are close together, the wide band for lower distortion and maximizing stereo separation. In addition, we've developed new circuitry which eliminates the high

frequency beat distortion (that is, swishing noises) thought to be inherent in stereo FM broadcast. Even we're impressed that it costs only \$310*.

This combination of separate amp and tuner not only gives you performance unheard of in other separate components, it gives you performance that will remain elusive in receivers for quite a while.

The Kenwood KA-7100 and KT-7500. Solid evidence that the breakthroughs occurred ahead of schedule, and available to you now for a truly remarkable price. \$625* for the pair.

*Nationally advertised value. Actual prices are established by Kenwood dealers. Handles optional.

 **KENWOOD**

For the Kenwood Dealer nearest you, see your Yellow Pages, or write Kenwood, P.O. Box 6213, Carson, CA 90749.

Editorially Speaking

By William Anderson



LOOK WHAT THEY'VE DONE TO OUR SONG

ALPHONSE KARR was a nineteenth-century French novelist, critic, editor, and wit. Like practically everybody else, you have perhaps been finding useful applications for one of his more memorable aphorisms—*plus ça change, plus c'est la même chose*—ever since you first ran across it. An aphorism need not be *universally* true to be useful, of course, and what works very well in the general case quite often fails in the particular one. I was a little startled nonetheless to discover Karr's Rule broken not once but twice in this issue of *STEREO REVIEW*: it would appear, at least as far as country music and jazz are concerned, that the more things change, the more they do *not* remain the same.

It cannot have escaped the notice of very many observers of the pop scene that country-music stars have lately become more and more visible in the entertainment firmament. Quite aside from the ubiquitous award shows

(does *everybody* have one?), they now appear with astonishing regularity as guests and performers on TV talk shows, as the subjects of "specials," and a few have even had their own series (Mack Davis and Glen Campbell may have been elbowed off the tube by the doctor, cop, and jiggy shows, but *Hee Haw* will likely go on forever). Even more surprising is the appearance of such as Waylon Jennings, Willie Nelson, and (speaking of jiggy!) Dolly Parton on the covers of news magazines. That we seem not at all surprised to find them there says something about our current attitude toward country music (can you imagine such c-&-w old-timers as Jimmie Rodgers, Hank Williams, or Patsy Cline in the same spot?). What it says, principally, is that country music has changed, that an already huge generic market has broadened to include many of those whose ideas of a good musical time range all the way from Lawrence Welk

to Tony Orlando. What it does *not* say is that country music has *become* either of these—by and large it is still identifiably "country," country sanitized and urbanized, country with (to borrow Noel Coppage's apt phrase) indoor plumbing.

However crazy the artists, their record companies, and their new public may be about all this, "crossover" is, to many fans of "pure" country, merely another word for "sellout," a crass surrender to a new generation of carpetbaggers, a backsliding from the communion of the faithful (they don't call the Grand Ole Opry the Mother Church of Country Music for nothing).

You might think from all the hullabaloo and outrage that what is at stake is an ancient tradition hallowed by a stately passage down the echoing corridors of time, but not so: country music as a genre was "invented" in the middle to late Twenties by Jimmie Rodgers (the "father of country music" died in 1933). That makes it just about the same age as jazz, also largely "invented" in the Twenties—and also undergoing, just now, another attack of growing pains. I say *another* attack because country and jazz have both changed a great deal over their fifty-year spans; the distance between, say, Dixieland and bop is at least as great as that between the Carter Family and Buck Owens. Jazz purists are nonetheless upset about their music these days in the same way country purists are about theirs: the "new" jazz, whether of the funk, jazz-rock, or (horrors!) disco variety, is seen as an instance of Gresham's Law at work in the aesthetic arena, the weaker, simpler art threatening to drive the stronger, more complex one out of circulation. Not, I think, to worry. All pure, difficult art can always use new friends, but lasting conversions are not made overnight. A generation raised on Rick Wakeman and Bob Dylan is not going to discover Bill Evans and George Jones by itself. The latter two are strong waters, and even the most athletic of palates will need a little practice with crossover Ripple to prepare for them.

Stereo Review

PUBLISHER

EDGAR W. HOPPER

EDITOR

WILLIAM ANDERSON

MANAGING EDITOR

WILLIAM LIVINGSTONE

EDITORIAL COORDINATOR

LOUISE GOOCH BOUNDAS

ART DIRECTOR

BORYS PATCHOWSKY

TECHNICAL DIRECTOR

LARRY KLEIN

TECHNICAL EDITOR

RALPH HODGES

MUSIC EDITOR

JAMES GOODFRIEND

POPULAR MUSIC EDITOR

PAULETTE WEISS

SPECIAL PROJECTS EDITOR

STEVE SIMELS

ASSISTANT MUSIC EDITOR

VIVIENNE WINTERRY GOODMAN

PRODUCTION EDITOR

JOHN HARRISON

ASSISTANT EDITOR, RESEARCH

RICHARD SARBIN

COPY EDITOR

DAVID STEIN

EDITORIAL ASSISTANT

BARBARA AIKEN

CONTRIBUTING EDITORS

CHRIS ALBERTSON

NOEL COPPAGE

RICHARD FREED

PHYL GARLAND

ROBERT N. GREENE

DAVID HALL

ROY HEMMING

JULIAN D. HIRSCH

GEORGE JELLINEK

IGOR KIPNIS

IRVING KOLODIN

PAUL KRESH

STODDARD LINCOLN

J MARKS-HIGHWATER

RICK MITZ

LINCOLN PERRY

PETER REILLY

CHARLES RODRIGUES

ERIC SALZMAN

CRAIG STARK

JOEL VANCE

LONDON EDITOR

HENRY PLEASANTS

ADVERTISING DIRECTOR

JAMES J. SULLIVAN

ADVERTISING SERVICE MANAGER

LINDA BLUM

EXECUTIVE ASSISTANT

PEGI McENEANEY

Editorial and Executive Offices

Ziff-Davis Publishing Company
One Park Avenue, New York, New York 10016
212 725-3500

National Advertising Manager: Richard J. Halpern
Eastern Advertising Representative: Charles L. P. Watson

Midwestern Office: The Pattis Group

4761 West Touhy Ave., Lincolnwood, Illinois 60646
312 679-1100
Arnold S. Hoffman

Western Office

9025 Wilshire Boulevard
Beverly Hills, California 90211
213 273-8050; 272-1161
Western Advertising Manager: Linda Bartlett

Japan: James Yagi

Oji Palace Aoyama, 6-25, Minami Aoyama
6-Chome, Minato-ku, Tokyo, Japan
Telephone: 407-1930/6821, 582-2851

Circulation Office

P.O. Box 2771, Boulder, Colorado 80323

EDITORIAL CONTRIBUTIONS must be accompanied by return postage and will be handled with reasonable care; however, publisher assumes no responsibility for the return or safety of art work, photography, or manuscripts.

Member Audit Bureau of Circulations



ZIFF-DAVIS PUBLISHING COMPANY

Philip B. Korsant, President
Furman Hebb, Executive Vice President
John R. Emery, Sr. Vice President, Finance
Phillip T. Heffernan, Sr. Vice President
Edward D. Muhlfeld, Sr. Vice President
Philip Sine, Sr. Vice President, Secretary
Lawrence Spom, Sr. Vice President, Circulation and Marketing
Arthur W. Butzow, Vice President, Production
George E. Morrissey, Vice President
Sydney H. Rogers, Vice President
Sidney Holtz, Vice President
Albert S. Traina, Vice President
Paul H. Chook, Vice President
Edgar W. Hopper, Vice President
Robert N. Bavler, Jr., Vice President
Selwyn Taubman, Treasurer
W. Bradford Briggs, Vice Chairman

ZIFF CORPORATION

William Ziff, Chairman
I. Martin Pompadur, President
Hershel B. Sarbin, Executive Vice President



The Pile Driver: It's just no match for the Heil Driver.

Since the turn of the century, "Pile Driver" speakers have laboriously "pushed" the sound out. This can result in a blurring and clipping of notes.

The revolutionary new Heil Driver in Lafayette's Criterion Series 3000 loudspeakers "shoots" the sound out.

There's no blurring or clipping. Every note is crisp and clearly defined.

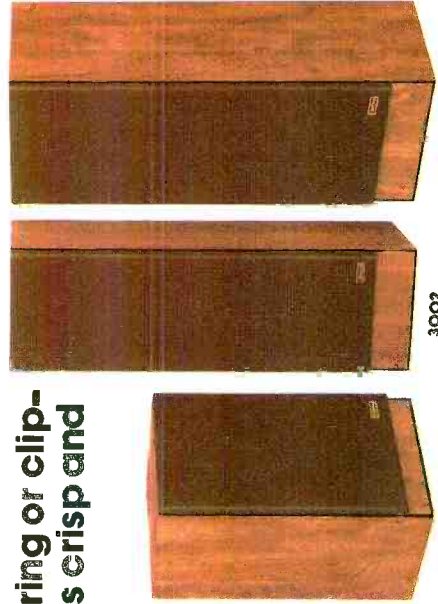

Ever since "talking machines" first started talking, speakers have produced sound by pushing the sound waves out of the speaker with a diaphragm. Sometimes referred to as a "driver." Or "pile driver."

This system has definite disadvantages. To reproduce sound faithfully, the driver has to have very rapid rise time (acceleration) and decay time (deceleration). But the mass of the driver is so great, it fights against its own immense inertia. So sound gets blurred. Parts of notes get clipped short.

The only solution is to reduce the mass of the driver so it can react more quickly. And that's exactly what Dr. Oscar Heil has done.

The Heil Air Motion Transformer* is the heart of Lafayette's new Criterion Series 3000 speakers. The Heil Driver is simplicity itself: It has just one moving part. Rather than "push" the air out, it "shoots" it out.

The faster a driver reacts, the higher the fidelity. The Heil Driver reacts incredibly swiftly. It actually transfers sound energy to the air more than 5 times the speed of its own motion! There is no blurring or clipping of notes. No ragged top ends. No rounding off of the initial "attack." Every note is clear.

THE CRITERION 3001 incorporates a 10 in. heavy duty woofer in a ported book shelf cabinet. It delivers a deep, solid bass and high efficiency.

THE CRITERION 3002 is a small tower design which couples the 10 in. woofer acoustically to a 10 in. passive radiator. It delivers a deeper, tighter bass.

THE CRITERION 3003 is a larger tower design featuring a 12 in. heavy duty woofer coupled acoustically to a 12 in. passive radiator. It has an even fuller, deeper bass and greater power capacity.

All 3 are equipped, with a variable high frequency Brilliance Control to tailor treble response to the acoustics of any room.

We predict that your reaction to the Criterion Series 3000 speakers featuring the remarkable Heil Driver will be the same as ours.

In a word: "Heil-Heiljahl!"

FREE 1979 CATALOG. Lafayette's catalog is all new for 1979! 172 illustrated pages — half in full color. Features our complete line — everything Lafayette makes or sells. Write Lafayette Dept. 11118, 1 Jericho Turnpike, Syosset, N.Y. 11791.

Lafayette

we let you hear what you've been missing.

CIRCLE NO. 47 ON READER SERVICE CARD

* Trademark of ESS Inc.

B-I-C INTRODUCES NEW TURNTABLES.



Four years ago, B-I-C invented the belt-driven record changer. In two years, it was the most popular turntable in America.

Success achieved so quickly is not easy to repeat. But in all modesty, we're about to do it again.

Consider:

1. Nine totally new B-I-C turntables. One is a single play manual, four are single play fully automatics and four are record changers.

2. V.I.A. It stands for Variable

Isolation Adjustment, the first turntable suspension that can be user-adjusted to dampen acoustic feedback and room vibration frequencies in nearly every listening environment. It's a B-I-C exclusive and all the new B-I-C turntables have it.

3. Triple-isolated chassis. On all B-I-C models, platter and tone arm are mounted on a sub-chassis, isolated between base and top plate by optimized isomer shock mounts.

Coupled with V.I.A., this system intercepts more extraneous vibration frequencies than any we know of.

4. The controlled-mass straight tone arm was computer designed for low mass, strength, and minimal tracking error. Sapphire bearings reduce friction to insignificance.

5. Stroboscopic variable pitch control is standard on the five lower-priced models.

6. Micro-processor digital drive is the most accurate drive system to be had

9 REMARKABLE



at any price. A digital computer continuously monitors platter speed and corrects variations by means of an AC servo system. Pitch can be varied by 3% up or down and locked in. It's standard on the four top B-I-C models as well as . . . a vacuum fluorescent digital display that reads out measured platter speed to .03% accuracy and updates itself every two seconds, and . . . a digital stop watch for timing selections to tape. This is another

micro-processor display function.

7. A carbon fibre tone arm is standard on two B-I-C models, optional on four others.

8. A micro-processor non-contacting velocity trip system initiates end-of-record cycle without moving parts. Standard on B-I-C's two top models, it's part of a two-motor drive system.

9. \$99.95 to \$319.95. Anyone will find a B-I-C turntable with the right features at the right price.

There's more to tell, but only our catalogue has room. We'll happily send you a free copy.

Seven of B-I-C's new turntables are the world's best for the money. Two are the world's best, period.

Before you even consider another turntable, see your B-I-C dealer or write: B-I-C AVIATION, Westbury, New York 11590.



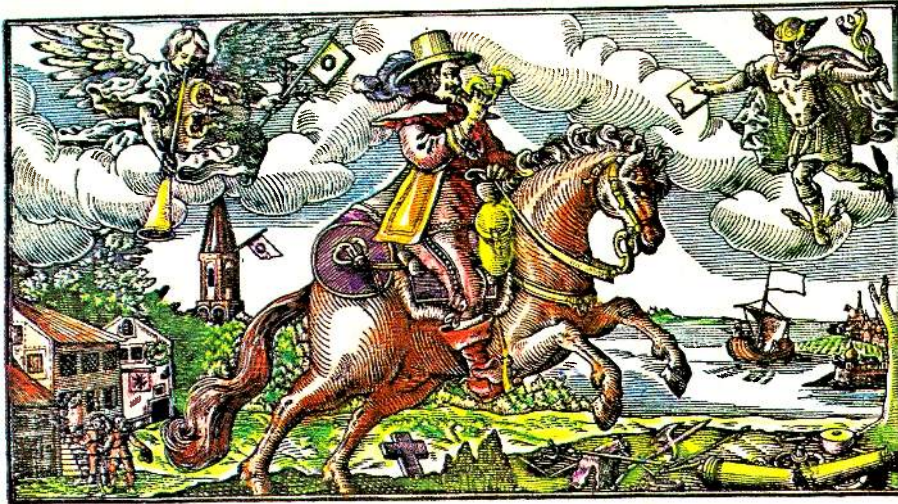

LETTERS TO THE EDITOR

Antennas

● I enjoyed John McVeigh's article on antennas in the September issue. As an apartment dweller, I have experimented with a number of indoor antennas, and by trial and error I discovered an inexpensive but effective hookup that combines two suggestions. I bought some inexpensive "rabbit ears" with a filter control and connected the master TV antenna to the bolts that held the rabbit ears. Then I connected the original leads from the rabbit ears to my tuner. This setup yields a large selection of stations, and the filter control affects the quality and strength of the signal. A dissatisfied audiophile can always reconnect the rabbit ears.

MALCOLM FRAZER
Laurel, Md.

John McVeigh replies: In some situations, connecting an apartment building's master TV antenna to rabbit ears for FM reception will cause multipath distortion. FM signals can be attenuated more safely by inserting a tunable FM trap (such as the Jerrold Electronics Model RFT-300) in the transmission line.

● The suggestion about use of a signal splitter in the article on antennas has increased my enjoyment not only of FM but also of VHF TV. My mind must have been sleepy before I read the article, for I had a splitter in the house but never connected it.

ROBERT GOLDSTEIN
Corona, N.Y.

Rodrigues on Bruckner

● Why don't you give Charles Rodrigues more work to do? That review of his on Bruckner in the September issue said it all.

OTHMAR HERBST
Chicago, Ill.

Buddy Holly

● I would like to thank STEREO REVIEW and Steve Simels for the excellent review of the *Buddy Holly Story* soundtrack album in the September issue. Immediately after reading

the article, I went out and bought "Twenty Golden Greats" by Buddy Holly and the Crickets. Now I can hardly wait to see the movie. Yes, Buddy Holly lives! Keep up the good work, Steve.

JACK C. OWENS
Gadsden, Ala.

Video Software

● The question of the shortage of video software raised in the "Editorially Speaking" in September seems to me not as difficult to solve as William Anderson makes out. The important thing is to get started, and I have a couple of musical suggestions.

1. Since common sense indicates that what should be done first is that which has the longest potential shelf life, what better than the classical warhorses already stabled in the record catalog? They could be harnessed not to shots of hundred-man symphony orchestras sawing away, but to travelogs. Why doesn't RCA (or somebody) work through its master tapes and bring out a Musical Travelog Series—a lot of sound-spectacular Sibelius to accompany a tour of Finland, Smetana's *Má Vlast* for Czechoslovakia, Villa-Lobos for the Amazon Basin, maybe even Ferde Grofé's *Grand Canyon Suite* or Copland's *Appalachian Spring* with appropriate travel footage? Films could be secured from the tourist departments of the countries concerned, from private individuals, or from the National Geographic Society.

2. Who owns the rights to *Fantasia*? The film should be reset to the relevant music in brand-new, state-of-the-art recordings. It would make the video-demonstration cassette (or disc) of all time, a selling tool beyond the wildest imaginings of the industry.

It perhaps goes without saying that the audio on all these would be designed to play through quality hi-fi installations.

HERB KAUFMAN
New York, N.Y.

Zubin Mehta

● Re Kolodin on Mehta, September 1978: I have observed Zubin Mehta on and off the po-

dium and believe him to be an extraordinary artist with far more personal dimension than one finds in the majority of gifted specialists. His periodic gaffes or excursions into untraditional areas are little more than the exercise of the artist's mandate—that occasional "Why not?" New York is fortunate to have him in his present stage of development. The mutual challenge will be mutually beneficial, I'm sure. As for Los Angeles, the loss was totally eclipsed by Giulini's arrival.

I. R. STERN
Northridge, Calif.

RFI

● You mean they got all the way through those Congressional hearings on radio-frequency interference ("Audio News," September) without once having to hear about the rescue by radio hams of Nicaraguan earthquake victims, foundering ships, and downed planes every other millenium? The questions that should be asked are really few and, it seems to me, easily answered if the special-interest lobbyists will only stand aside: (1) How many *practicing* hams (not just licenseholders) are there in the country? (2) How many Citizen's Band good-buddy hobbyists? (3) How many hi-fi installations? (4) Is there any record of (3) ever interfering with the activities of (1) and (2)?

J. BAKER
Chapel Hill, N.C.

Ry Cooder

● With "Jazz" (September "Best of the Month"), Ry Cooder has achieved what must be his ultimate ambition: to become a sideman on his own album.

STEPHEN HOFFMAN
Lead, S.D.

The \$600 Album

● I was startled to note in the September issue Paul Kresh's remark that copies of the 1954 release of Menotti's *The Saint of Bleeker Street* had been selling for something like \$600 on the rare-record market before the set was reissued by RCA. Because I possess a copy of that initial set, you can imagine my surprise on learning that the album was monetarily so valuable. I have about 1,400 LP's, of which perhaps more than half have been deleted from the catalogs (I've been collecting since the first LP's were released in the late Forties), and I'm sure other collectors can also point to deletions among their records. There must be other deletions besides the Menotti that command high prices from buyers. It wasn't long ago, for example, that movie soundtracks on LP were selling for brisk prices, but whether that interest remains cannot be determined by those of us who live outside the rare-record-buyers' market area. Maybe STEREO REVIEW could survey the rare-record scene?

BERNARD A. DUPONT
Putnam, Conn.

Paul Kresh, also struck by the \$600 figure, is already at work on a feature about the in-

(Continued on Page 14)

Unboxed Sound

Introducing minimum diffraction loudspeakers™ by Avid.

In the quest for accuracy, cabinet loudspeakers, regardless of price, still generally suffer from a common failure—they still sound like loudspeakers, or more precisely their sound obviously comes from a box.

Your brain hears the box.

Without going too deeply into psycho-acoustics, cabinet speakers tell us their sound is emanating from a box because the brain has been conditioned to recognize the characteristics... size, shape, etc.... of any sound source.

What creates the boxy effect? Diffracted or reradiated sound waves, those that bounce off the sharp edges of the speaker and grille assembly, are the clues interpreted by the brain as "box-like."

No diffraction, no box.

The problem is graphically illustrated in the drawings. By eliminating sharp cabinet edges and grille panel obstructions, you reduce diffraction effects... which means you eliminate the boxiness of the sound. And that's exactly what we've done with our new line of Avid Minimum Diffraction Loudspeakers™

To open the box, we closed the cover.

The solution was deceptively simple.

By engineering the drivers, cabinet enclosure and, importantly, the grille assembly to create a totally integrated acoustic system, we eliminated cabinet diffraction and the boxy sound quality inherent in typical cabinet loudspeakers.

Our new tweeter and midrange drivers have specially engineered coupling devices (we call them Optimum Dispersion Couplers™) which transmit sound waves with minimum diffraction.

"Solid front" grille panels perfectly mate with each coupler eliminating grille panel diffraction. And, the grille panels have rounded edges creating a smooth, gradual transition from the grille to the cabinet, significantly reducing cabinet edge diffraction—a major cause of boxy sound.

These three simple, but audibly significant, features, coupled with Avid's critically acclaimed accuracy, assure you a new level of performance and sense of reality.

Of course there's a lot more to the Avid story—like our new drivers and Q-Span testing. Write us for literature and a full description. We invite your comparison.



Unwanted cabinet/grille diffraction effects (B) give listener clue as to the size/shape of sound source—in this case a box. First arrival signals (A) locate source, while brain uses delayed room reflections (C) to identify listening environment.

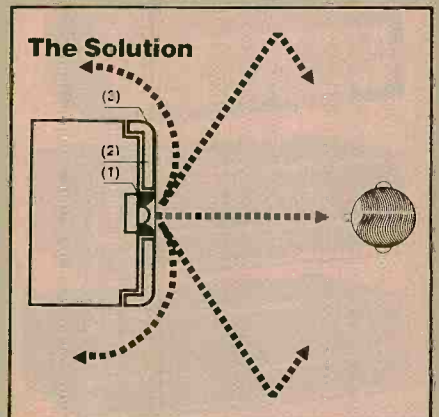
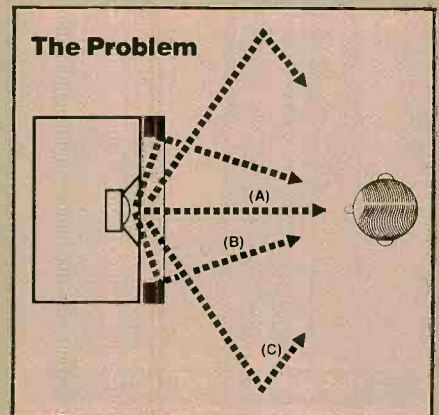

The careful integration of special engineered Optimum Dispersion Couplers™ (1), and solid front grille panels (2) with rolled edge design (3), significantly reduces the unwanted cabinet diffraction effects—a principal contributor to "boxy" sound. These design principals are incorporated in all Avid Minimum Diffraction Loudspeakers™

AVID.
10 Tripps Lane
East Providence
R.I. 02914

defatigable collector, the lengths he will go to, and the prices he will pay to get what he wants.

Disco vs. "Live"

● William Anderson's "Does Disco Cause Cancer?" editorial gives his seal of approval to what he calls "the Next Big Something—disco." He argues that the labels "fad," "mindless noise," and "nothing but a numbingly repetitious beat" applied to disco by "dispossessed rockers" might apply equally to dance manias of the past: "the waltz, the Charleston, jitterbugging, even the twist." Be that as it may, I have been a professional mu-

sician for thirty-five years (I was a member of the Tommy/Jimmy Dorsey Orchestra of 1957, among many other musical experiences), and I cannot remember a single dance craze of the past that was not initiated by and did not evolve to the accompanying sounds of live music performed by live musicians.

If we continue to condone and encourage developments in music that reduce opportunities for musicians to play and develop their skills, the next logical step might be records and tapes turned out by some kind of futuristic *Star Wars* group consisting of musical computer-robots programmed to give the public "what they want." Without the musicians who make the music, which in turn creates the reason for the equipment reports, inter-

views, and reviews in the magazine, how long would STEREO REVIEW be around?

BUD SAVARISE
Ashtabula, Ohio

The Editor replies: Without musicians to make them, how long would records be around? Even a computer has to be programmed by someone. Mr. Savarise underestimates the public's appetite for novelty. If punk rock can make it (both live and recorded), then anything can. The only thing the public tires of is "the same old thing," and one can easily imagine that that might lead to unemployment for those musicians unable to change their styles. I would hazard a guess that there are as many people (as a percentage of the total population) making their living as performing musicians as there ever were—but they're not playing waltzes, palm-court serenades, or big-band or small-combo jazz!

● William Anderson concludes his August editorial concerning the disco craze by stating that he "... cannot see that this new dance mania is anything but a healthy return to healthy concerns: a rediscovery of one's physical self, and that of one's partner, in the pure, liberating joy of rhythmic movement." That may very well be, but Mr. Anderson's view is shortsighted. The live musician is becoming a rare specimen these days, and disco can only make this situation much worse. The trend in our society has been toward technology and further away from the natural element, but I still prefer the live musician who can capture his/her audience without the help of a sixteen-track mixer and some unionized DJ. Meanwhile, I'll take care of my "physical self" in the gymnasium.

MARK WAGNER
Bethlehem, Pa.

Is the gym co-ed?

Mireille Mathieu

● Recently a great many viewers in the States were treated to "From Paris with Love: An Evening of French Television," which was broadcast nationally on the PBS network. It painfully reminded me how much some of us have longed for one of the singers on that show to make a return to the States, to those who have ever remained her fans. Her name is Mireille Mathieu, the same who in 1967 (at the age of nineteen; I assume she is now thirty) took America by storm [and won a STEREO REVIEW "Record of the Year" award]. But Atlantic (shame on you, Atlantic!) discontinued her American releases, most of them Barclay tapes. Today one rarely hears from her, except via imports (Polydor from Canada and Ariola from Germany). Now I understand that she has a new contract with Philips. I sincerely hope that her TV appearance, brief though it was, will move Phonogram [which distributes Philips in the U.S.] or Peters International to make her LP's available here. Other interested readers might implore them to give Mlle. Mathieu another chance (Phonogram is at 1 IBM Plaza, Chicago, Ill. 60611; Peters is at 619 West 54th Street, New York, N.Y. 10019).

PHILIP DAVID MORGAN
Saint James, N.Y.

(Continued on page 18)

Soundcraftsmen

EQUALIZERS... PRE-AMP EQUALIZERS... CLASS "H" AMPLIFIERS...

the Great Equalizers...



State-of-the-art in EQ—we're still the only high quality full-line equalizer manufacturer—all U.S. made. From \$249.

the Perfect Pre-Amps

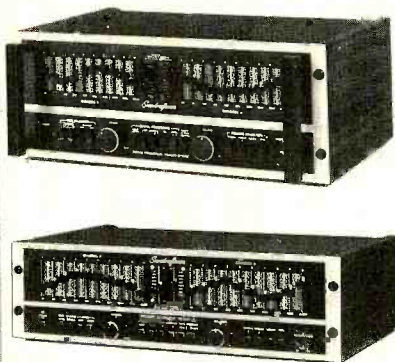

Two Preamp Equalizers. Features available include: Tape Eq/Signal Processing/Moving Coil Inputs/Tape Dubbing. From \$549.

and the NEW CLASS "H" 250 watt NON-LIMITED Amplifiers...

The new Class "H" Analog logic Vari-Portional® circuit with Auto-Crowbar protection circuit, input level controls, adjustable range meters, main and remote speaker selection, clipping indicators, Vari-Portional® indicators and speaker protection. 250 watts RMS minimum p/c 20-20KHZ @ 8 ohms, less than 0.1% THD. T.I.M. better than 0.02%. Slew rate better than 50V per microsecond. 3 models. From \$649.

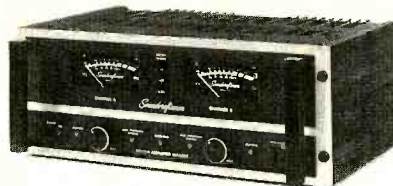

FREE BROCHURE

Includes TEST REPORTS, complete specifications, Class "H" amplifier ENGINEERING REPORT, EQ COMPARISON CHART, and the "WHY'S & HOW'S" of equalization—an easy-to-understand explanation of the relationship of acoustics to your environment. Also contains many unique IDEAS on "How the Soundcraftsmen Equalizer can measurably enhance your listening pleasures," "How typical room problems can be eliminated by Equalization," and a 10-POINT "DO-IT-YOURSELF" EQ evaluation checklist so you can FIND OUT FOR YOURSELF WHAT EQ CAN DO FOR YOU!

U.S.: 1721 Newport Circle, Santa Ana, CA 92705 • CANADA: Ontario.

CIRCLE NO. 76 ON READER SERVICE CARD

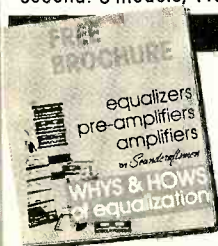

Ohm's Law 8:

Make loudspeakers with great pride, and they will get great reviews.

Ohm defies the laws of modern loudspeaker production.

We don't mass-produce our speakers in huge quantities. Most of the elements that go into Ohm loudspeakers are so intricate, they must be made by hand.



The result is pride-of-craftsmanship you can hear.

Audio critics have heard it. As you're about to read...

Complete Buyer's Guide to Stereo/Hifi:

"The Ohm C2 is a high efficiency speaker with ruler-flat response to 37 Hz., high power-handling capability, very smooth

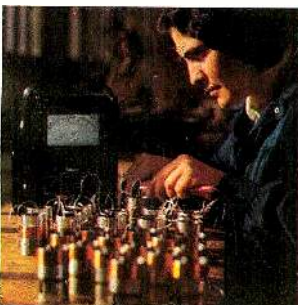

treble response, and excellent dispersion. Considering the size of the box, performance, and the price, the Ohm C2 must be reckoned with as one of the better speaker values available...Ohm speakers are very well made, and we recommend this model highly."

Stereo Review:

"Our standard live-room integrated frequency response measurement of the Ohm F produced one of the flattest extended curves we have ever seen from a loudspeaker...It should be apparent from the foregoing that we include the Ohm F among



those few speakers we have tested that achieves state-of-the-art performance." (Copyright 1973 by the Ziff-Davis Publishing Company. Reprinted from *Stereo Review*, October, 1973, by permission. All rights reserved.)

Canadian Stereo Guide:

"The Ohm E is just an ordinary speaker to look at.



But when you fire it up, it's something else again. Sound quality within the limits of its capability was well defined and well controlled, with no indication of mushiness even at the outer fringes of the spectrum. The Ohm E speaker system has an excellent dispersion pattern over its entire operating frequency range..."

Complete Buyer's Guide to Stereo/Hifi:

"The Ohm H manages to get prodigious bass response out of a small box without sacrificing efficiency. The high end is handled by conventional drivers and is everything one might ask from a speaker. Dispersion is excellent, and the overall sound quality is exemplary."

Stereo Review:

"In the simulated live-vs.-recorded test, the Ohm L proved to be a highly accurate reproducer of music...Its highs were strong, and even in our well damped listening room the

crispness imparted to vocal sibilants and instrumental sounds such as wire brushes and triangles could be plainly heard... The upper mid-range and high frequencies were virtually perfect." (Copyright 1977 by the Ziff-Davis Publishing Company. Reprinted from *Stereo Review*, June, 1977, by permission. All rights reserved.)

Complete Buyer's Guide to Stereo/Hifi:

"The Ohm F is an extraordinary loudspeaker. The coherent sound produced by this speaker is clear, full, and undistorted. It may well be the finest speaker on the market, and is certainly without a doubt among the top few."



For 13 complete reviews, and full specifications, please write us at: Ohm Acoustics Corp., 241 Taaffe Place, Brooklyn, N.Y. 11205.



We make loudspeakers correctly.

The world's finest all have one

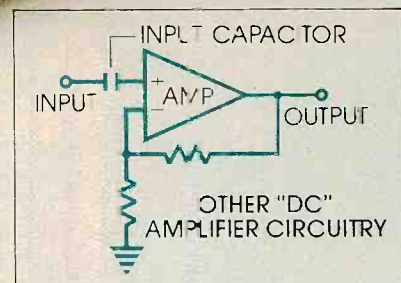

Sansui's unique DC

Sound quality is what your audio system is all about. So your new receiver or amplifier should, above all, offer you audibly better music reproduction than what you have now or might buy at a comparable price. That's why Sansui created its unique DC amplifier circuitry, which lets you actually hear and appreciate the difference.

Sansui's DC amplifier section (patent pending) is used in all Sansui DC integrated amplifiers and DC receivers, including the AU-717 and G-5000. Either way, your music reproduction will be cleaner, richer and more true-to-life than you have ever heard before.

LOWEST POSSIBLE DISTORTION

Sansui receivers and amplifiers have long been recognized for their distortion-free sound reproduction, virtually eliminating harmonic and intermodulation distortion. Now, Sansui's new DC circuitry enables us to conquer even subtler imperfections, such as transient intermodulation distortion (TIM), caused by time delays or "phase shifts."

FASTEST RESPONSE

Sansui's DC amplifier section is designed without input, output, or negative feedback loop capacitors to eliminate low frequency phase distortion. And our exclusive dual compensation circuitry gives the high-speed, high-frequency response to achieve most accurate reproduction of the most demanding musical transients.

The speed/response capabilities of an amplifier are measured by its rise time which, for both the G-5000 and AU-717, is a mere 1.4 microseconds, corresponding to a frequency response that extends from zero Hz (DC) to 200,000Hz.

Slew rate tells you how large a transient burst an amplifier can handle. The G-5000 is rated to swing a signal level by 56 volts per millionth of a second, and the AU-717 is just a trifle faster: 60V/ μ sec.

The result of Sansui's unique DC design is audibly cleaner sound.

HUMAN ENGINEERING

In developing the most sophisticated ampli-

receivers and amps thing in common:

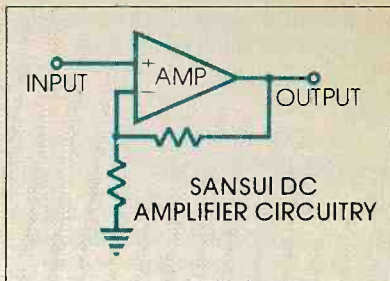

amplifier circuitry.

ation circuitry in the world, Sansui has not neglected the features that make components fun to run — for we believe that your audio components should provide not only superb music reproduction, but also great creative versatility. Both the AU- and the G-series feature a full complement of controls, logically arranged to make them a positive pleasure to operate.

THE G-5000 DC RECEIVER

Sansui's popularly priced G-5000 uses the same DC amplifier power design as Sansui's other, more costly models. It also incorporates our special new protective circuit that safeguards both your speakers and the G-5000 against mishap. Output is a usefully-powerful 45 watts per channel, min RMS, both channels driven into 8 ohms, from 20 to 20,000Hz, with no more than 0.03% total harmonic distortion.

THE AU-717 DC INTEGRATED AMPLIFIER

If your choice is for separates rather than a receiver, Sansui suggests the rack-mountable

AU-717 DC integrated amplifier. Our AU-717 has been acclaimed by the experts for its rare clarity of sound and for its superb versatility. Its DC power amplifier configuration means super-wide frequency response, with improved transient reproduction from the lowest lows to the highest highs. And the multitude of precise controls will meet your most sophisticated listening and recording needs. At 85 watts per channel, min RMS, both channels driven into 8 ohms, from 10 to 20,000Hz, with no more than 0.015% total harmonic distortion, the AU-717 is an unbeatable value for every music lover.

To hear the dramatically crisp and lifelike difference the AU-717 and G-5000 make, visit your franchised Sansui dealer today.

SANSUI ELECTRONICS CORP.

Lyndhurst, New Jersey 07071 • Gardena, Ca. 90247
SANSUI ELECTRIC CO., LTD., Tokyo, Japan
SANSUI AUDIO EUROPE S.A., Antwerp, Belgium
In Canada: Electronic Distributors



Airing Patti Smith

● Patti Smith has once again, through her interview with Steve Simels in the August issue, raised my consciousness. She's a great musician, artist, performer, etc. But she's a little bit off the mark concerning the radio airplay she's not getting. I work at an FM rocker (Top 40). Like many other such, we're playing *Because the Night*. We're not playing it because of Springsteen or anyone else. It's getting played simply because it's a strong song—hell, it's a masterpiece! Now if Patti is upset because the rest of the "Easter" album isn't getting played, she can blame herself. When Patti Smith starts handing out radio-station licenses, then we'll play the rest of "Easter."

Everyone here has listened to it at least fifty times, because it is probably the best album so far this year. But what goes out over the air is heard by a lot of people, people who may be offended by profanity.

Patti, I'll make you a deal. You pay the fine, get back the listeners who are offended, make sure the station doesn't get thrown off the air by the FCC, and I'll play your whole album on my show. Or better yet—help us get rid of some of the restrictions put on us by the government. Then we'll work on the people who are against profanity anywhere. No matter how far radio has progressed, we're still controlled by the public.

DOUG DAY
Two Rivers, Wis.

Critics

● The August review of Richie Furay's "Dance a Little Light" by a certain S.S. was truly despicable. This S.S. is a known rock-'n'-roll Nazi. Anybody or any group that does not fit into his preferred category of highly decadent and overly amplified musical storm troopers is automatically boring to S.S. I know that he is too hip to appreciate the music of those old flower children who were among the first to fuse folk with rock like the Springfield/Byrds boys. STEREO REVIEW should prevent this S.S. from reviewing any more albums of this genre (stick to the Stones, Steve; I hope you like their new disco hit). And people should ignore record critics who have a narrow span of musical taste.

JON SALCEDO
Lansing, Mich.

● Is Noel Coppage tone deaf or what? It would seem so after his insulting review of Todd Rundgren's "Hermit of Mink Hollow" in the August issue. Todd is both a fine producer and a multi-talented musician who; after many criticized and unprofitable years, has released a fine sequel to his classic "Something/Anything?" album. Mr. Coppage should turn his stereo up; blown ear drums might improve his taste in music. "One-man bland" indeed!

LAURENCE TOREH
Plymouth, Conn.

● I have absolutely nothing whatsoever to say about STEREO REVIEW's music critics.

RICHARD SAFRAN
Durham, N.C.

Free details on a different kind of record club

offering... BACH, BEETHOVEN, BRAHMS,
CHICAGO, JOHN DENVER, EARTH-WIND & FIRE,
C.W. McCALL, FREDDY FENDER, LINDA RONSTADT,
GROVER WASHINGTON JR., DONALD BYRD
and every other composer and artist in print

You can now own every record or tape that you may ever want... at tremendous savings and with no continuing purchase obligations. You can get valuable free dividend certificates, you can get quick service and all the 100% iron-clad guarantees you want.

Now you can stop price increases that leave you with less music for your record and tape budget. You can guarantee yourself more music for less money through membership in Discount Music Club.

Look at these benefits:

TREMENDOUS SAVINGS on every record and tape in print—no "agree-to-purchase" obligations of any kind.

DISCOUNTS OF 43% TO 73% off mfg. suggested list... special catalog features hundreds of titles and artists.

ALL LABELS AVAILABLE including most imports through special custom ordering service. If we don't stock it we'll get it for you.

SCHWANN CATALOG lists thousands of titles; classical, pop, jazz, ballet, opera, musical shows, folk, rock, vocal, instrumental, country.

DISCOUNT DIVIDEND CERTIFICATES. Dividend Gifts—Every shipment carries a dividend gift or dividend certificate. Certificates redeemable immediately for extra discounts.

NEWSLETTERS. Happenings in the world of music; concerts, critiques, new releases... special super-sale discounts of up to 73%.

DISCOUNT ACCESSORY GUIDE. Diamond needles, cloths, tape cleaners, etc. Discount Music Club is your complete one stop music and accessory buying service.

QUICK SERVICE. Same day shipping on many orders... rarely later than the next several days. Partial shipments always made in the event of unforeseen delay... all at no extra cost to you.

100% IRON-CLAD GUARANTEES on all products and services. Everything is guaranteed factory fresh and free of defects or damages of any sort. Your total satisfaction is unconditionally guaranteed.

Discount Music Club is a no-obligation membership club that guarantees tremendous discounts on all stereo records and tapes and lets you buy what you want...when you want...or not at all if you choose.

These are just a few of the money-saving reasons to write for free details. You can't lose so why not fill out and mail the coupon for immediate information.

	Discount Music Club Department 9-1178 650 Main St., New Rochelle, N.Y. 10801
NAME _____	
ADDRESS _____	
CITY _____	
STATE _____	ZIP _____

CIRCLE NO. 24 ON READER SERVICE CARD

Overlooked Chopin

● In his September review of Nathaniel Rosen's album of Chopin's cello music, Richard Freed says that the Introduction and Polonaise Brillante, Op. 3, had not been available at all for some time. However, our recording of this piece with Joel Krosnick and Cameron Grant has been on the market for the past five years—and still is. The number is Orion ORS 7291. For some reason, the Schwann catalog does not list this item. However, ORS 7291 is listed by Phonolog and other serious record catalogs.

GIVEON CORNFIELD
President, Orion Master Recordings, Inc.
Malibu, Calif.

Corrections

● On page 94 of the September issue it was erroneously reported that the new Theta preamplifier is distributed by Polk Audio. In fact, the distributor of the preamplifier is its manufacturer, Theta Electronics Corporation, 6831 Anaheim Road, Long Beach, Calif. 90815. We regret the error.

● The August feature review of "Edith Piaf at Carnegie Hall" from Peters International failed to indicate that both the two-record set and the cassette recording are in monophonic sound. They are available by mail order from Peters International at 619 West 54th Street, New York, N.Y. 10019, and the correct code number for the cassette is JCC 2014/5 (not 2015/5).

New Scott amps are loaded with extras.

DC Amplification.
Improves reliability, expands frequency response, and reduces TH and IM distortion.

Twin logarithmic Op Amp meters.
Visually monitor the peak average power amplifier output of each channel in both watts and dBW.

Attenuated volume control calibrated in dB.
Makes precise volume level selection and exact duplication of previous volume settings.

Bi-modal electro-sensor relay protection.
Protects amplifier as well as speakers from all conceivable malfunctions.

Complete tape monitoring and two-way copy capability.
Listen, record, monitor or copy from Tape I, Tape II, Tuner Aux, or two phono inputs in any combination.

Capacitance and impedance adjustments.
Main air accurate frequency response by adjusting for various phono cartridge requirements.

Two independent phono equalizer pre-amps.
Use both phono inputs at the same time; listen to one while recording the other, or vice versa. Impossible with other comparably priced amps.

Mid-range control.
In addition to the treble and bass controls, you can adjust the mid frequencies to add extra presence and richness.

Front Panel Accessory Switch.
Control accessory equipment with the flick of a switch.



At no extra cost.

When you consider separates, you want all the extras you can get for your money. And no one gives you more than Scott.

Just take our new 480A integrated amplifier. 85 watts per channel min. RMS, at 8 ohms from 20-20,000 Hz with no more than 0.03% THD.

It's the only amplifier in its price class that gives you two independent phono preamps. Now you can record one phono while listening to the other. Or vice versa.

All our amps boast dozens of other advantages you simply can't find in comparably priced units. Our state-of-the-art circuitry gives you plenty of power with very low distortion. And our features and functions give you full flexibility in producing the sound you like best.

When you move up to separates, move up to Scott. Where all the extras don't cost extra.



New Scott 460A Integrated Amplifier
70 watts per channel min. RMS, at 8 ohms from 20-20,000 Hz with no more than 0.04% THD



New Scott 440A Integrated Amplifier
55 watts per channel min. RMS, at 8 ohms from 20-20,000 Hz with no more than 0.05% THD



New Scott 420A Integrated Amplifier
40 watts per channel min. RMS, at 8 ohms from 20-20,000 Hz with no more than 0.08% THD

*Shown with optional rack mount handles

Scott's unique, gold warranty card. Individualized with your warranty, model and serial numbers, and expiration date. Scott's fully transferable, three-year parts and labor-limited warranty is your assurance of lasting pleasure.

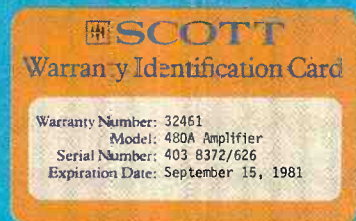

For specifications on our complete line of audio components, contact your nearest Scott dealer, or write H.H. Scott, Inc. Corporate Headquarters, 20-H Commerce Way, Woburn, MA 01801. In Canada: Paco Electronics, Ltd., Quebec, Canada

SCOTT
The Name to listen to.
Makers of high quality high fidelity equipment since 1947.

Introducing home stereo

The Jensen R430 Receiver.

Just one of six all-new car stereo receivers from Jensen.

Individual Bass & Treble Controls.

Volume.

Unique Cassette Door/Tuner Dial.

Accepts entire cassette firmly into unit; large, easy-to-read tuner scale.

Automatic Tape Alarm.

Reminds you to remove cassette to prevent damage to pinch roller and capstan (a major cause of wow and flutter). Program lights flash, speakers beep when ignition is turned off.

Power Amplifier.

Separate power amp installs in trunk. Provides up to 60 watts of Total System Power.

Bi-Amplification.

Divides and sends correct frequencies and power levels to respective drivers through four separate amps (2 for highs and 2 for lows).

Cassette Fast Forward/Rewind.

Loudness.

Recaptures all the bass that can disappear at low volume levels.



The Jensen Car

At long last... Jensen introduces the Stereo Receiver for your car. Indash.

Monitor-quality FM broadcasts with superior sensitivity and pin-point selectivity... from an FM multiplex section designed to the same exacting specifications as your favorite home receiver.

At the very heart of Jensen's Stereo Receiver can be found four independent, direct-coupled amplifier sections—two for each channel—delivering ample amounts of clean power over an incredibly wide dynamic range.

Several models even boast the electronic sophistication of bi-amplification. This advanced circuitry programs each of the receiver amplifiers to individually drive high

and low frequencies of each stereo channel—minimizing distortion and increasing peak power levels. For an impact, detail and transparency you never thought your car speakers capable of.

And just listen to the revelation of wide range signals stored in your favorite tapes... and encoded FM stereo broadcasts... through the

receivers for your car.



Fader.
Adjusts sound level between front and back speakers.

Balance.
Adjusts sound level between right and left speakers.

Tuning.

Tuner.
Separate Tuner On/Off retains pre-set volume level, eliminates radio blast when tape is removed.

Local/Distance.
"Local" mode offers interference-free local FM reception; "Distance" mode maximizes sensitivity for better long distance reception.

Dolby® Noise Reduction.
Processes out tape hiss on Dolby-encoded tapes; improves dynamic range of Dolby-encoded FM broadcasts.

Muting.
Eliminates inter-station noise when changing stations.

FM/AM.
Feather-touch electronic switching.

Stereo Receivers.

uncanny quiet background of a Dolby® Noise Reduction System.

Feather-touch electronic switching puts the Jensen Receiver through its sophisticated paces: Loudness, switchable Interstation

Muting, Tuner On/Off, Dolby, and Local/Distant reception. Independent bass and treble controls offer complete tone curve flexibility. And a unique tape alarm even reminds

you to eject an engaged tape when the ignition is turned off.

These are some of the features that have created a distinct new category: Car Stereo Receiver. Three models with Cassette and three with Eight-Track. All worthy of the Jensen name.

Anything less just wouldn't do. Not from the design laboratories

that invented the loudspeaker. And the Triaxial®. And now the Jensen Receiver

For a free color catalog write

JENSEN
SOUND LABORATORIES

Division of Pemcor, Inc.
4136 N. United Parkway
Schiller Park, Illinois 60176

*"Dolby" and "Dolby System" are Trademarks of Dolby Laboratories, Inc.
*Triax and Triaxial are registered Trademarks identifying the 3-way car speakers of Jensen Sound Laboratories, Division of Pemcor, Inc.

CIRCLE NO. 43 ON READER SERVICE CARD

New Products latest audio equipment and accessories

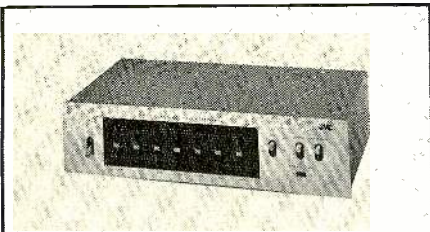

JVC Equalizer Switches into Tape Circuit

□ The JVC Model SEA-20G S.E.A. Graphic Equalizer is a seven-band unit with a special provision for switching the equalizer section into the tape-recorder circuits for equalization of the program before recording, thus permitting equalization of tape recordings. The controls cover seven different frequencies with centers ranging from 60 to 15,000 Hz; each control is adjustable over a range of ± 12 dB. A switch is included to defeat the device, and a tape-monitor switch is also provided. Frequency response is 20 to 50,000 Hz (+0, -1.5 dB) with distortion of 0.06 per cent at 3 volts output. Signal-to-noise ratio is 70 dB. The unit measures 15 $\frac{3}{8}$ x 10 $\frac{1}{2}$ x 4 inches and weighs 7 $\frac{1}{2}$ pounds. Price: \$169.95.

Circle 120 on reader service card



New Speaker System From Britain

□ The English loudspeaker manufacturer Mordaunt-Short Ltd. has arranged U.S. distribution of its Signifer three-way speaker system. This is an air-suspension design employing a 12-inch woofer, 5-inch mid-range, and 1-inch dome tweeter. Crossover frequen-

cies are 500 and 4,000 Hz. Nominal frequency range is 20 to 20,000 Hz with a specific frequency response of 38 to 20,000 Hz ± 2 dB. Sensitivity is 4.5 watts for a 96-dB sound-pressure level at 1 meter in anechoic conditions using pink noise, and harmonic distortion at this level is less than 1 per cent. Fundamental resonance is 38 Hz, and the system will accept amplifier powers ranging from 25 to 250 watts per channel. The Signifer measures 31 $\frac{1}{8}$ x 15 $\frac{1}{8}$ x 12 $\frac{1}{4}$ inches; an optional stand with casters raises the system 9 inches from the floor. Price: \$1,400 per pair (\$1,480 with stands).

Circle 121 on reader service card



High-end Cassette Deck from Eumig

□ Among the features of the new Eumig CCD Metropolitan cassette deck is its unusual speed-control system. Instead of a flywheel, the capstan-drive system has a lightweight disc on which have been photo-etched some 2,500 precisely spaced radii. The disc is fixed to the capstan, and when rotating it creates approximately 15,000 pulses per second to be detected by an optical sensor. The generated pulse rate is compared with a fixed reference to create an error voltage which is applied through a servo system to the capstan motor. This arrangement results in a wow and flutter rating of 0.05 per cent (weighted rms).

Replacing conventional recording-level meters on the CCD is a double lineup of LED's, in various colors, that light up in sequence to indicate recording level. The CCD is a three-head machine with logic-controlled solenoid transport switching. A remote-control unit duplicating all transport functions is included. Mixing and level controls employ voltage-controlled amplifiers, so that no audio signals pass through the controls themselves. Frequency response is 30 to 16,000 Hz ± 3 dB with ferric-oxide tape, improving to 20 to 20,000 Hz ± 3 dB with ferrichrome or CrO₂ tape. Signal-to-noise ratio (A weighted) for ferrichrome is 72 dB with Dolby noise reduction and 64 dB without. Dimensions are approximately 17 x 5 $\frac{1}{2}$ x 12 inches and weight is 16 pounds. Price: \$1,300.

Circle 122 on reader service card

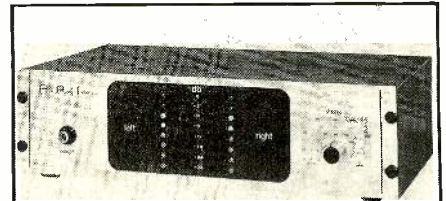

Peak-power Indicator From Lectrotech

□ Lectrotech, an electronic test-equipment manufacturer, has entered the consumer market with the PPI-400 Peak Power Indicator. The device monitors peak audio power as it appears across the speaker terminals of any power amplifier, receiver, or musical-instrument amplifier. A selector switch matches the 0-dB indication level of the PPI-400 to the maximum power level of the amplifier being monitored, and calibration can be made for any continuous power output between 2 and 1,200 watts per channel. Speaker impedances from 2 to 35 ohms can be accommodated. LED's are used as level indicators. Input impedance is 20,000 ohms minimum, and accuracy is within ± 0.25 dB; frequency response is 20 to above 20,000 Hz. The PPI-400 weighs 3 $\frac{1}{2}$ pounds and measures 14 x 3 $\frac{3}{4}$ x 8 inches. Price: \$129.95. An optional walnut case (LWC-1) is available at \$24.95.

Circle 123 on reader service card



Old Phonographs Revisited

□ For those interested in the oldest audio equipment as well as the newest, the *Antique Phonograph Monthly* provides articles, illustrations, and advertisements relevant to the collecting of phonographs made between 1880 and 1930. From the same source comes a series of full-color facsimiles of old phonograph catalogs and similar publications that hark back to a gentler era and may be of interest even to non-hobbyists. The publisher is Allen Koenigsberg, 650 Ocean Avenue, Brooklyn, N.Y. 11226. Send a stamped, self-addressed envelope for further information.

(Continued on page 24)



You know us best for our reputation in audio. In fact, it's audiophiles like you who have made TDK SA the best-selling High Bias cassette in America today. But here's something you may not know: the same Super Avilyn engineering principle that revolutionized audio cassettes is in TDK's equally revolutionary new Super Avilyn video cassettes.

No wonder that TDK Super Avilyn is the first 4-hour capability video cassette to be quality approved by the people who know: video cassette recorder engineers. And even less wonder that Super Avilyn makes possible an image so stunning, you will feel as though you are sitting in the broadcast studio.

What's more, TDK's strict quality control works to give you low wear on delicate video heads, virtually non-existent oxide shedding, and no problems with tape stretching, even with repeated playback.

That's because TDK Super Avilyn video cassettes are an actual component of the system, not just an accessory. Our tape is housed in a precision, jam-resistant mechanism, for years of consistent high quality video reproduction. And TDK Super Avilyn VHS video cassettes are compatible with all VHS machines, both those with short-play (2-hour) capability and those with short and long-play (4-hour) options.

TDK Super Avilyn VHS video cassettes: model VA-T60, for one and two-hour recording; model VA-T120, for two and four hour recording. If you like things to look as good as you like them to sound, take a look.

TDK Electronics Corp., Garden City, NY 11530. In Canada: Superior Electronics Ind., Ltd.

TDK
The Machine for your Machine. ©
CIRCLE NO. 83 ON READER SERVICE CARD

**What TDK
did for your ears,
it now does
for your eyes.**

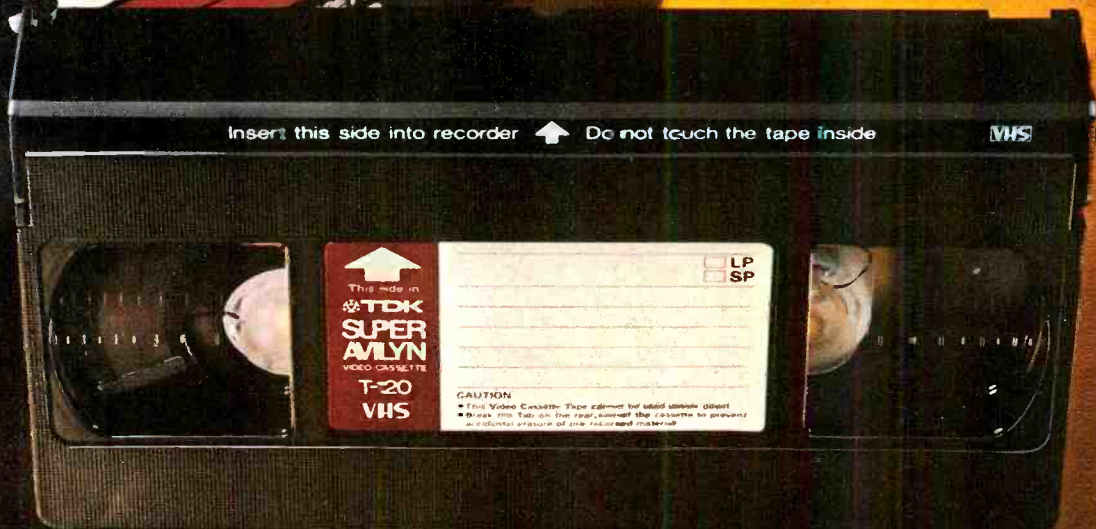

SONUS SERIES II.

THE BEST
KEEPS GETTING
BETTER.

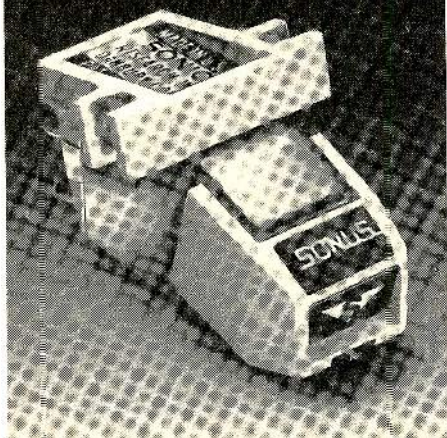

The original Sonus cartridge established a new standard in high definition phonograph reproduction. Yet we believe there is even further room for improvement in this often-overlooked area of high fidelity. So we have taken the original Sonus cartridges and refined their designs, taking full advantage of the latest in materials and techniques. Sonus Series II cartridges are the result of these new design developments.

The new Sonus Gold consists of three models with identical bodies and stylus assemblies, differing only in the form of their diamond tips. The new Sonus Silver comes in two stylus types, and shares all the qualities of their more costly counterparts, yet still can offer a dramatic improvement in sound reproduction overall. Both series employ a transducer system characterized by reproduction of exceptional accuracy, clarity and definition. For full details and a recommendation of which model is correct for your particular system, we suggest a visit to the Sonus dealer nearest you, or write us.

SONIC RESEARCH, INC., Sugar Hollow Rd.
Danbury, Conn. 06810

SONUS

High Definition Phono Cartridges

New Products

latest audio equipment and accessories

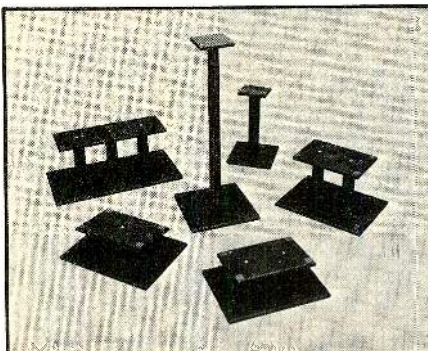

"The Stand"
For Speakers

□ Mastercraft Wood Products is marketing, under the general designation "The Stand," a variety of different speaker bases to fit mini speakers, conventional models, and some esoteric designs. These stands are available in standard and de luxe versions, both featuring oil-finish uprights and either black matte-finish (standard models) or oil-finish wood-veneer bases (de luxe models). They also include non-slip, non-scratch speaker mounts as well as provision for speaker-wire concealment. Many of the stands are available in kit form; prices range from \$36 to \$75.

Circle 124 on reader service card

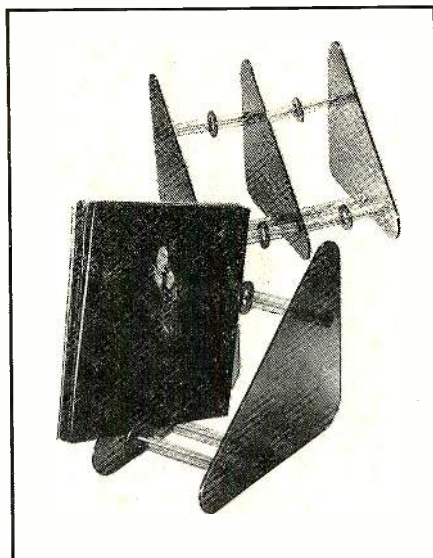

Plastic Racks for
Disc, Tape Storage

□ GTR Products has a new line of record and tape racks with walls of smoky plastic and horizontal support members of clear acrylic. Stackable, these racks are available in

appropriate sizes for discs, cassettes, or eight-track cartridges. The record racks (shown) can be had in units holding fifty or one hundred records, and the eight-track modules are made for either sixteen or thirty-two tapes. The cassette rack holds twenty cased cassettes. Sliding rings on the support members of the disc rack can be used to hold the records in a partly filled module in place. The smaller record rack measures 13¼ x 11½ x 7½ inches, and the smaller eight-track unit is 11½ x 7½ x 5¾ inches. Along with the cassette rack (14½ x 5¾ x 5¾ inches), these sell for \$9.95 each; the larger modules are priced at \$19.95 each.

Circle 125 on reader service card

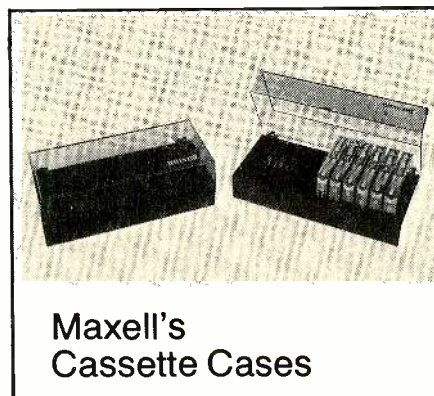

Maxell's
Cassette Cases

□ Maxell has added to its accessories line a plastic cassette-storage container that will accommodate twelve cassettes complete with their insert cards and outer boxes. The containers have hinged lids and measure approximately 3½ x 5 x 10½ inches. Price: \$5.95.

Circle 126 on reader service card



Nikko's Latest
Power Amplifier

□ The Alpha III power amplifier from Nikko, rated at 80 watts per channel into 8 ohms from 20 to 20,000 Hz, features a direct-coupled output stage with MOSFET transistors. Total harmonic distortion is 0.006 per cent, intermodulation distortion is no more than 0.01 per cent, and the signal-to-noise ratio is 115

(Continued on page 26)

THE INSIDE STORY ON THE PERFECT COUPLES.

INTEGRATED AMPLIFIERS

AM-2800: Power output meters w/100 or 3 watt Scale Selector. Low and High/Low Loudness Control, High & Low Frequency Filters w/Alternate Levels, Audio Mute (-15 dB or -30 dB), Bass, Midrange and Treble Controls. 2 phono inputs, 2 tape inputs. **Power Bandwidth (IHF):** 7 Hz to 40 kHz/8 ohms. **Residual Noise:** less than 0.5 mV at 8 ohms.

AM-2600: Power output meters w/80 or 3 watt Scale Selector. Low and High/Low Loudness Controls, High & Low Frequency Filters w/Alternate Levels, Audio Mute (-15 dB or -30 dB), 2 tape inputs, 2 phono inputs. **Power Bandwidth (IHF):** 7 Hz to 40 kHz/8 ohms. **Residual Noise:** less than 0.5 mV at 8 ohms.

AM-2400: Bass and Treble Controls w/Two Step Turnover Controls, Audio Mute Control, High & Low Frequency Filters, 2 tape inputs. **Power Bandwidth (IHF):** 7 Hz to 40 kHz/8 ohms. **Residual Noise:** less than 0.5 mV at 8 ohms.

AM-2200: 20 watts per Channel Continuous Output Power, min. RMS at 8 ohms from 20-20,000 Hz with no more than 0.5% T.H.D. High & Low Filters, Loudness Control, 2 tape inputs, detent volume control and tape monitor. **Power Bandwidth (IHF):** 10 Hz to 45 kHz/8 ohms. **Residual Noise:** less than 0.8 mV at 8 ohms.

All Units: S/N (IHF): Phono—better than 75 dB, Aux—better than 95 dB.

STEREO AM/FM TUNERS

AT-2600: PLL MPX Circuitry, High Blend Switch, Signal Strength/Deviation and FM Tuning Meters, Output Level Control and Automatic Frequency Controls, Variable FM Muting. **Sensitivity (IHF):** 1.7 μ V; **Capture Ratio:** 1.0 dB; **Stereo Separation:** more than 45 dB (1 kHz).

AT-2400: PLL MPX Circuitry, FM Mute Switch, High Blend Switch, Separate Signal Strength and Tuning Meters, Output Level Control and Automatic Frequency Controls. **Sensitivity (IHF):** 1.8 μ V; **Capture Ratio:** 1.0 dB; **Stereo Separation:** more than 42 dB (1 kHz).

AT-2200: PLL, FM Mute Switch, Separate Signal Strength and Tuning Meters, Output Level Control. **Sensitivity (IHF):** 1.9 μ V; **Capture Ratio:** 1.3 dB; **Stereo Separation:** more than 40 dB (1 kHz).

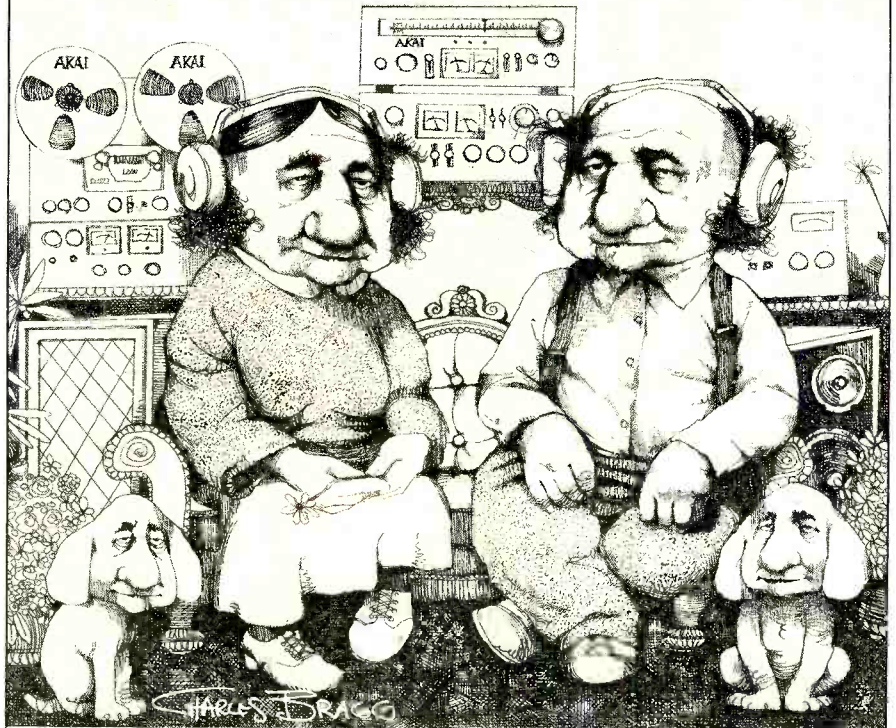

AKAI INTRODUCES THE PERFECT COUPLES.

Choosing a tuner and integrated amplifier is a lot like choosing a mate. You look for things like compatibility, performance, appearance and, of course, fidelity.

Now AKAI makes matching component separates foolproof with a whole new line of amps and tuners. Paired on the grounds of total compatibility. And priced to be affordable.

Take the AT-2600 and the big AM-2800 amp, with a solid 80 watts, RMS per channel, 8 ohms, 20-20,000 Hz at .08% Total Harmonic Distortion.

Or the AM-2600 amp at 60 watts, RMS per channel, 8 ohms, 20-20,000 Hz at .1% Total Harmonic Distortion. And

pair it with the AT-2600 tuner.

Or the AM-2400 amp at 40 watts, RMS per channel, 8 ohms, 20-20,000 Hz at .15% Total Harmonic Distortion. And the AT-2400 tuner.

No matter which perfect AKAI couple you choose, you get specs and features not found on all-in-one receivers in the same price category. Improvements you can hear.

Hear them today at your AKAI dealer. And live in perfect harmony.

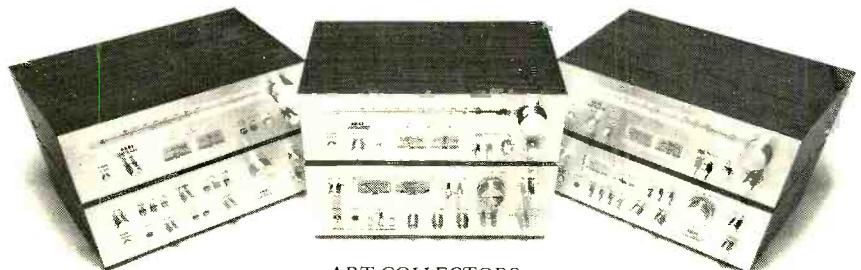

ART COLLECTORS:

For an 18" x 24" reproduction of this Charles Bragg etching suitable for framing, send \$2 to AKAI, Dept. SR, P.O. Box 6010, Compton, CA 90224. ATTN: Couples.

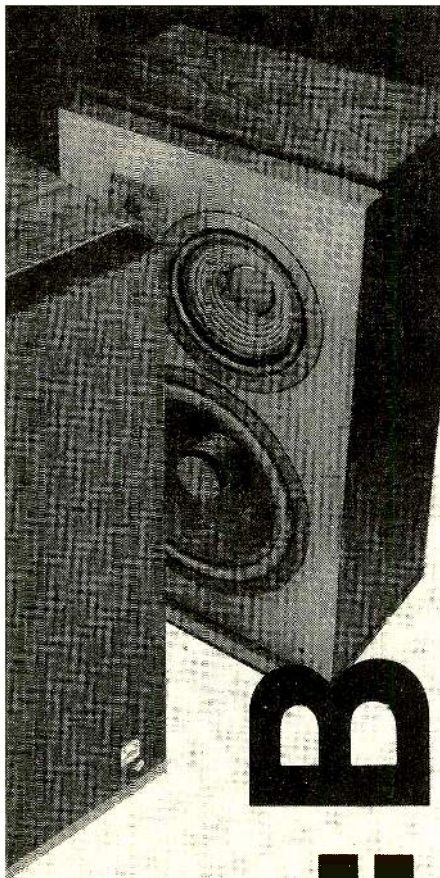

It sounds like music

An incredibly solid 30 Hz low end gives you bass response not found in any other speaker of this size. This is clean bass. It isn't phony. There is no "hump" around 80 Hz to give the impression of bass when there really isn't any. What's on your source material is what you're going to hear—accurately.

There is no sacrifice at the high end either. Both front and rear-firing tweeters give you the uniform total acoustic power output that takes you into a "live-music" environment.

When you buy your next pair of speakers, do yourself a favor—audition the Interface:B's. If your criteria is musical accuracy, the Interface:B's are what you'll buy.



Electro-Voice®

a **gulton** company

600 Cecil Street
Buchanan, Michigan 49107

Interface:B™

New Products

latest audio equipment and accessories

dB. Damping factor is 80, referred to a load impedance of 8 ohms. Twin front-panel LED displays indicate the power output of each channel in watts and decibels. Internal protection circuits are provided. The standard brushed-aluminum front panel is slotted for installation in standard 19-inch racks. An optional matte black front panel is available at slight additional cost. Dimensions are 19 x 5½ x 12¾ inches and weight is just under 30 pounds. Price: \$479.95.

Circle 127 on reader service card

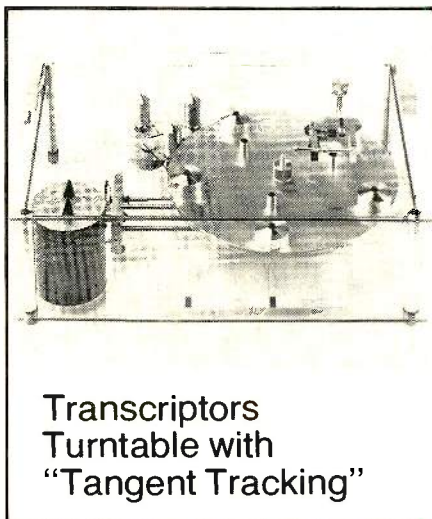

Transcriptors Turntable with "Tangent Tracking"

□ The new Transcriptors Microtracer turntable-and-arm combination is now available in the U.S. Bearing a strong family resemblance to its stainless-steel-and-glass predecessor, the Transcriptors Skeleton, the Microtracer is a unique straight-line-tracking design in which the platter moves horizontally beneath the tone arm while the arm itself remains relatively motionless. The arm is fixed to the turntable's lid on a jeweled, fluid-damped pivot; any change of the arm's angle from a precisely tangential condition breaks an infrared light beam, activating a d.c. servo motor that advances the platter along two stainless-steel rails on three aluminum wheels with Teflon-bushed bearings. The arm's effective length is 1¾ inches. Transcriptors claims that, because of the arm's very low effective mass, tracking forces as low as 0.2 gram can be used.

In play, the disc rests on nine support points over the 12-inch aluminum platter, which is rotated by a belt drive through step-down pulleys that provide speeds of 33⅓ and 45 rpm. Two ganged synchronous motors are employed, floated on an isolating suspension. Wow is less than 0.05 per cent and flutter is not measurable. Controls include a power switch, cueing, and a cueing index that positions the platter. The Microtracer is supplied with an Ortofon VMS-20ED Mk II cartridge but can be adjusted to suit any high-compliance cartridge. The unit measures 21¼

x 14¾ x 6¾ inches with the lid closed, 15¾ inches high with the lid open. Weight is approximately 37¼ pounds. Construction is of glass, aluminum, and stainless steel. Price: \$690. The Microtracer is imported by R. Allen Waech Associates, P.O. Box 10357SR, Milwaukee, Wis. 53210.



Low-cost Tuner From Kenwood

□ Kenwood has introduced the KT-5500, a budget-price AM/FM stereo tuner. It incorporates both signal-strength and center-channel meters as well as FM interstation-noise muting. Sensitivity is 1.9 microvolts with 50-dB quieting sensitivity of 4 microvolts for mono and 45 microvolts for stereo. Image-rejection ratio is 50 dB, selectivity measures 60 dB, and capture ratio is 1 dB. Stereo separation is better than 45 dB in the mid-range and better than 35 dB from 50 to 15,000 Hz. The KT-5500 measures 15 x 5½ x 11½ and weighs 10 pounds. Price: \$155.

Circle 128 on reader service card



Medium-price Open-reel Decks From Akai

□ For stereophiles preferring the open-reel tape format, Akai has brought out two new decks. The GX-4000D (shown) is a quarter-track stereo machine with a four-pole induction motor and Akai's GX glass and crystal ferrite heads for recording and playback.

(Continued on page 28)



The British are coming with a Boatload Bargain!

The ADC Accutrac® 4000/LRC.

The Accutrac 4000 astounded the world with its computerized track selection. And now, it's

astounding the world with its special Boatload Bargain! Because your stereo dealer ordered the

Accutrac 4000/LRC in such quantities, we had to bring in a boatload. So get in line for the incredible

Accutrac 4000/LRC with computerized track selection. It lets you hear the tracks on a record in any order you like, as often as you like, even skip the tracks you don't like! It's as easy as touching the buttons.



A BSR Company

ADC PROFESSIONAL PRODUCTS
A division of
BSR Consumer Products Group
Route 303, Blauvelt, NY 10913

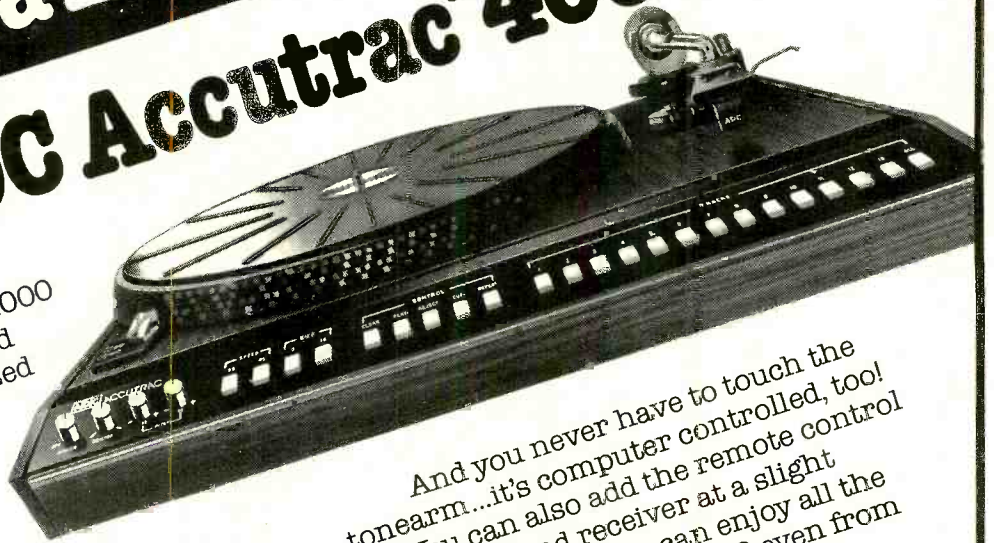

And you never have to touch the tonearm...it's computer controlled, too! You can also add the remote control transmitter and receiver at a slight additional cost. So you can enjoy all the features of the Accutrac 4000 even from across the room.

See the ADC Accutrac 4000/LRC at your dealer now. Your dreamboat turntable has just come in.

Only \$299⁹⁵

Price shown in this ad is approximate. Selling price is determined by the individual dealer. ®Accutrac is a registered trademark of Accutrac Ltd.

ALLISON: FOUR

“Within its frequency range the Allison: Four produced one of the flattest, smoothest frequency responses we have ever measured from a loud speaker. . . . The sound of this diminutive speaker is nothing less than astonishing.”

Hirsch-Houck Laboratories — Equipment Test Reports
STEREO REVIEW June 1978, Copyright Ziff-Davis Publ. Co.
*Higher in the West and South.

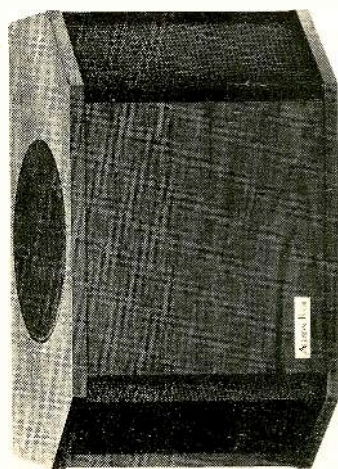

\$195*

CIRCLE NO. 4 ON READER SERVICE CARD

ALLISON ACOUSTICS 7 Tech Circle, Natick, Massachusetts 01760

New Products latest audio equipment and accessories

Front-panel pushbuttons control tape-type and speed selection (7½ and 3¾ ips), sound-on-sound, and tape monitor. Transport switching is mechanical by means of two rotating bar knobs. There is a pause control, separate record-level controls for microphone and line sources, and an output-level control for the front-panel headphone jack. Wow and flutter are less than 0.08 per cent rms, and distortion is less than 1 per cent for a 0-dB recording level at 1,000 Hz. Signal-to-noise ratio is better than 57 dB at 7½ ips, and frequency response is 30 to 24,000 Hz ±3 dB. The GX-4000D measures approximately 17½ x 12½ x 9 inches. Price: \$395. The GX-4000DB is the same unit with Dolby circuitry added to improve the signal-to-noise ratio by up to 10 dB above 5,000 Hz. Price: \$475.

Circle 129 on reader service card

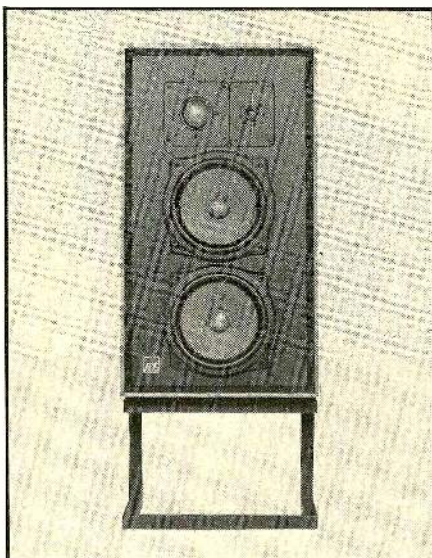

ADS Upgrades Its High-end Speaker Systems

□ ADS has redesigned its L710, L810, and L910 loudspeaker systems. The new units retain the original model numbers but with the additional designation “Series II.” Two changes common to all three systems are replacement of the 1-inch tweeter with a ¾-inch soft-dome design (for wider dispersion and smoother response in its 4,000- to 30,000-Hz operating range) and a newly designed 2-inch soft-dome mid-range driver.

The middle unit in this new line is the Model L810 Series II, which employs a pair of 8-inch long-excursion woofers mounted in separate sealed chambers in addition to the previously mentioned mid- and high-frequency drivers. These woofers have a free-air resonance of 20 Hz and operate from 20 to 550

Hz. Frequency response of the system is 35 to 23,000 Hz ±3 dB, and impedance is 6 ohms nominal, 4 ohms minimum. The recommended amplifier-power range for the L810/II is 20 to 200 watts, and it produces a sound-pressure level of 93 dB at a distance of 1 meter with a 1-watt input. Weight of the system is 46½ pounds and it measures 25½ x 14½ x 11¾ inches. Cabinet finish is natural walnut with a removable black grille. Price: \$359.95.

Circle 130 on reader service card

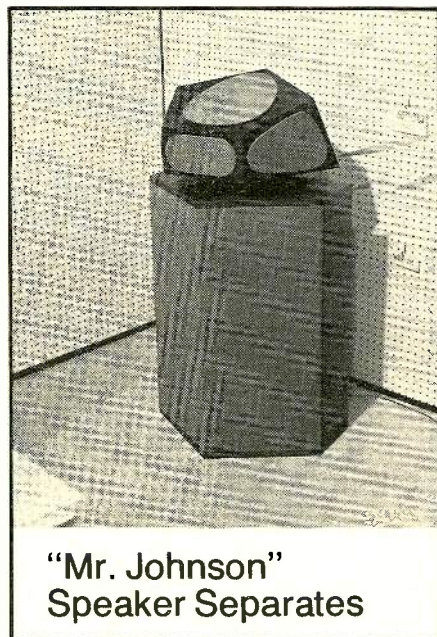

“Mr. Johnson” Speaker Separates

□ Speakers and Associated Sound, Inc., a new company, has announced a line of speakers under the “Mr. Johnson” name. Prominent among them is the Pentagon, a mid- and high-frequency system in the shape of a truncated five-sided prism. It incorporates ten drivers—five tweeters and five 5-inch full-range units—with sound being dispersed in an essentially omni-directional pattern. The system is intended to be added to existing loudspeakers or used with Mr. Johnson subwoofers. One of the latter, the W-HS, resembles a hassock and has a pair of 10-inch floor-facing woofers. The other, the W-DR (shown above with the Pentagon), is a direct radiator with four 8-inch woofers angled out in pairs.

The Pentagon has a frequency range of 75 to 20,000 Hz and a power-handling capacity of 200 watts (400 watts peak) at frequencies above 300 Hz. Nominal impedance is 8 ohms. It measures 22 x 13¾ x 20½, weighs 30 pounds, and is priced at \$265. The W-HS covers the range from 30 to 2,000 Hz, is rated at 50 watts per channel into 8 ohms, and weighs 65 pounds. It measures 26 x 21 x 19 inches and sells for \$275. The W-DR covers the same range as the W-HS and has a power-handling

(Continued on page 30)

You know what Technics quartz-locked direct drive does for records. Now listen to what it does for cassettes.

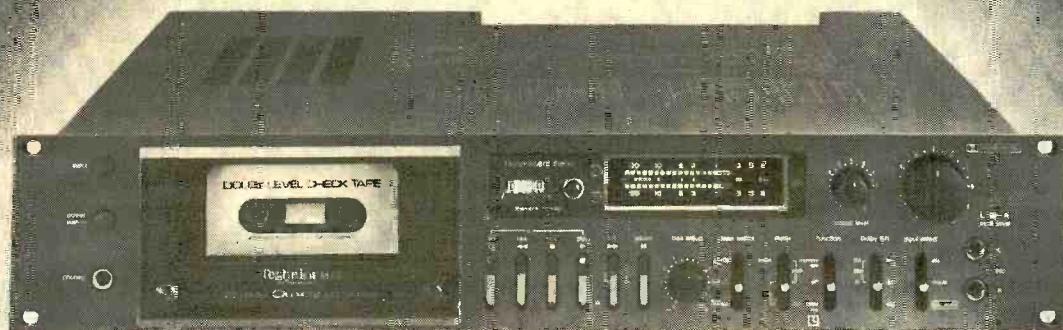

Accuracy good enough for even the most demanding professional, that's what Technics quartz-locked direct-drive turntables are all about. And that's why radio stations use them and discos abuse them.

Now you can record your records as accurately as a Technics turntable plays them. With the RS-M85, our new quartz-locked direct-drive cassette deck. Not only does it have the kind of transport accuracy that's hard to beat, it has that kind of price, too. The reason for all this accuracy: The performance of Technics direct drive combined with the precision of our quartz oscillator.

The RS-M85's servo-controlled system compares the motor rotation with the unwavering frequency of the quartz oscillator and instantly applies corrective torque if any speed deviations are detected.

To complement that accuracy, Technics RS-M85 has a Sendust head with a high-end frequency response of 18,000 Hz, low distortion and excellent dynamic range.

Since there's nothing ordinary about the RS-M85's

performance, there's nothing ordinary about its meters. The RS-M85 features Fluorescent Bar-Graph meters. They're completely electronic and therefore highly accurate. Response time is a mere 5 μ S. There's also a peak-check mode plus two selectable brightness levels.

To all this sophistication, the RS-M85 adds all this: A separate, coreless DC motor for reel drive. Dolby NR* Full IC logic control in all modes. A low-noise, high-linearity amplifier section. And a 3-position bias/EQ selector with bias fine adjustment.

Also available is Technics RP-070. An optional full function infrared wireless remote control.

Technics RS-M85. Compare specifications. Compare prices.

FREQ. RESF (CrO₂): 20-18,000 Hz. WOW AND FLUTTER: 0.035% WRMS. S/N RATIO (DOLBY): 69 dB. SPEED DEVIATION: No more than 0.3%.

Technics RS-M85. A rare combination of audio technology. A new standard of audio excellence.

*Dolby is a trademark of Dolby Laboratories, Inc.

Technics

Professional Series

CIRCLE NO 38 ON READER SERVICE CARD

A tape offer that sounds as good as the tape.



Buy 3 and get one free.

A lot of tape companies can make you an offer that sounds like this.

But not tape that sounds like this.

Because our new Maxell UD cassette should be considered among the world's finest recording tape.

You see, Maxell cassettes are built to higher standards than necessary. They're designed to give you recordings free of noise, dropouts and trouble.

So buy three Maxell UD 90's, and get a UD 60. Free.

If you think our offer sounds great, wait till you hear our tape.



*Available at participating Maxell dealers. Offer expires December 22, 1978.

CIRCLE NO. 53 ON READER SERVICE CARD

New Products

latest audio equipment and accessories

capacity of 100 watts and an impedance of 8 ohms. It weighs 55 pounds, measures 18 x 31 x 13½ inches, and is priced at \$325.

Circle 131 on reader service card



New Denon Tone Arm And MC Cartridge

□ Denon has added a third moving-coil cartridge, the DL-103d (shown) to the already available DL-103 and DL-103s. The new unit is basically similar but has a lighter moving system, greater compliance, and overall lower mass. It has a frequency response of 20 to 65,000 Hz, with separation better than 28 dB (at 1 kHz). Compliance is rated at 12×10^{-6} cm/dyne (100 Hz), recommended stylus pressure is 1.5 grams, and mass is 7.5 grams. The DL-103d retails for \$267.

Another new Denon unit is the DA-307 tone arm, in which the tone-arm tube is decoupled from the counterweight with a rubber damping material, the purpose being to eliminate resonance peaks caused by interaction between cartridge and tone arm. Also featured are gold-plated connections, a noncontacting magnetic antiskating device, and a lightweight, magnesium-alloy die-cast headshell. Price: \$255. Denon has also announced that its DL-103 cartridge is now available with a matching transformer. The combination package, called the DL-103/T, sells for \$200.

Circle 132 on reader service card



□ *Best Buys in Sight and Sound Equipment* is a new periodical which indexes descriptions, test reports, and evaluations of home-entertainment products. The publication covers audio and video as well as photographic and optical equipment, listing published reports on products in these areas which appear in a number of magazines. A total of thirty-two periodicals (STEREO REVIEW, *Popular Electronics*, *Popular Photography*, and *Consumer*

Reports among them) are currently indexed, along with several annuals; the publishers plan to expand the number of magazines covered in the future.

Best Buys was originally part of *Consumers Index*, appearing as the sight and sound section of that magazine for five years before being published separately. It is now published quarterly in February, May, August, and November by Pierian Press. A one-year subscription is \$9.80, and single copies are \$3. Order from "Best Buy" Guides, P.O. Box 1808, Ann Arbor, Mich. 48106.

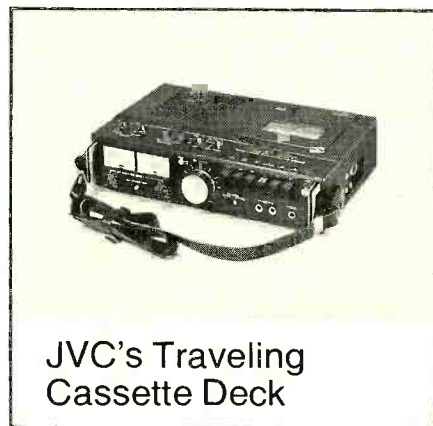

JVC's Traveling Cassette Deck

□ The JVC KD-1636 II cassette deck is a portable stereo unit that can either be used in the field or connected to a hi-fi system in the home. It has a monitor speaker built in and can be operated on long-life "D" cells for up to 12 hours, with 8- to 16-volt d.c. power sources, or 120-volt a.c. The deck incorporates JVC's Super ANRS noise-reduction system, a Sen-Alloy record-playback head, and a novel three-color LED peak indicator that changes from white to green to red as the level increases. Also included are separate bias and equalization switches and a headphone amplifier with its own volume control. Frequency response (CrO₂ tape) is 30 to 16,000 Hz ± 3 dB, with a signal-to-noise ratio of 57 dB (improved by up to 10 dB above 5,000 Hz with ANRS on). Wow and flutter are 0.08 per cent (weighted rms), and channel separation is 35 dB at 1,000 Hz. The KD-1636 II measures 14¾ x 4 x 9¾ inches and weighs just under 10½ pounds. A shoulder strap is provided. Price: approximately \$360.

Circle 133 on reader service card.

NOTICE: All product descriptions and specifications quoted in these columns are based on materials supplied by the manufacturer.

Recent fluctuations in the value of the dollar will have an effect on the price of merchandise imported into this country. Please be aware that the prices quoted in this issue may be subject to change.

The Eumig CCD. Opto-electronically engineered for absolute recording excellence.

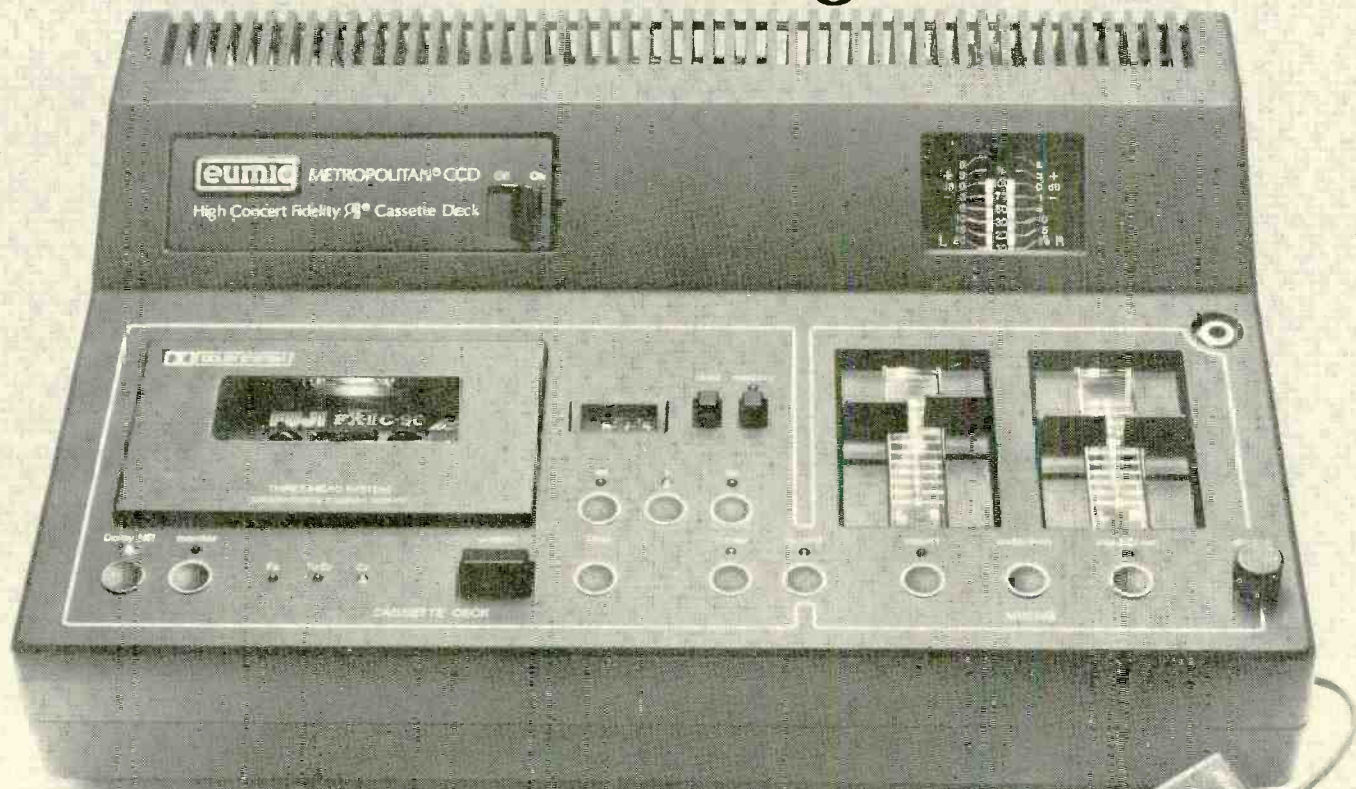

Eumig, one of the world's leaders in electro-mechanical research and development, has introduced a revolutionary new technology to cassette recording. It's the OPTO-ELECTRONIC SERVO CAPSTAN DRIVE SYSTEM incorporated in the unique Eumig CCD. This technology offers so many advantages that the Eumig CCD will out-perform every other cassette transport.

Ultra-Precision: The unique Eumig photo disc

Other decks use old-fashioned belts and flywheels to control the capstan. In the Eumig design these are replaced by a light-weight disc, photo-etched with 2500 radii, spaced precisely 1/50mm apart. When rotated, these radii create 15,000 pulses per second for instantaneous optically-sensed speed corrections. Wow and flutter is a mere 0.05% WRMS, and speed accuracy is $\pm 1\%$.



The Eumig photo disc weighs about 1/70th as much as a typical flywheel. When combined with an almost inertia-free, coreless drive motor, the CCD offers a startup time of less than 0.04 seconds, which means you never hear the wowing sound after a pause in recording. And the CCD boasts the fastest rewind time in the world—an astonishingly low 40 sec. (C-60).

Rugged reliability

The Opto-Electronic Servo System is only one among many dramatic advantages of the Eumig CCD. It offers three precision heads of our own design, mounted in a die-cast aluminum carrier made at our own facilities (as are virtually all parts of the CCD), for greatest precision. The Eumig CCD is engineered

with circuit boards rather than wires, for utmost reliability.

Advanced technology features

The comprehensive features of the CCD reflect Eumig's innovative technological approach. Two parallel LED displays allow simultaneous monitoring of both channel levels. Full solid-state/MOS logic is operated by feather-touch controls with logic-programmed LED indicators, and the flexible two-input mixing facilities use strictly DC controlled circuitry.

Perfect recording every time

Perfect performance is guaranteed with every type of tape because the Eumig CCD offers virtually flat frequency response to 20,000Hz (chrome); Dolby calibration adjustment for different tape sensitivities; and an azimuth adjustment to optimize high frequency performance with each and every tape.

The Eumig CCD, probably the finest deck in the world, is now available for \$1300, including full-function remote control, at select audio outlets throughout the country. Write to us for the name of the dealer nearest you. Then listen and compare. We believe you'll agree—it's incomparable.

Eumig (USA) Inc., Lake Success Business Park, 225 Community Drive,
Great Neck, New York 11020, (516) 466-6533
CIRCLE NO. 30 ON READER SERVICE CARD



Are Your Speakers Still Driving A Rattle Trap?

We've eliminated one of the greatest sources of speaker distortion. The conventional paper cone.

We replaced it with an aluminum honeycomb core. Then we coated it with a glass fiber reinforced skin. And the result was music to our ears. For the first time, we had sound reproduction free of unwanted vibration.

The greatest single improvement of this design is in the *quality* of bass response. It not only extends it, but makes it more powerful by freeing it from spurious vibrations.

This improvement is only possible because of the incredible combination of both *lightness* and *rigidity* of the

honeycomb material. With it, we've achieved a level of performance that no conventional paper cone can match.

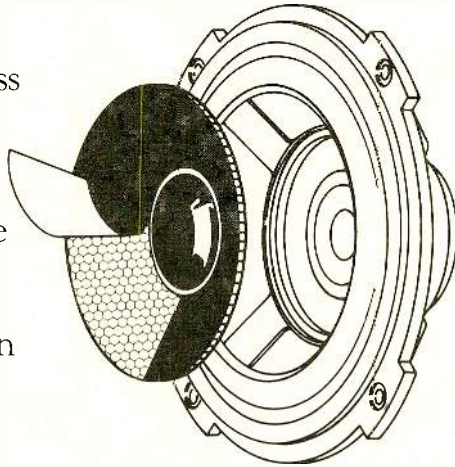

At that point, it would have been easy to quit. The sound sounded perfect to a lot of people. But not to us. So, we coupled our new cone with our patented FN iron ring. And there went 20 dB of magnetic distortion.

Next we went to work on the cabinet. We eliminated

the negative effect of sound diffraction at and around the speaker frames by mounting them flush, with the baffle surface flat to the edge of the cabinet. Finally, we had the sound just where we wanted it.

Then, we surrounded our speakers with hand-rubbed walnut and a black, semi-transparent grille. So, their look is now every bit as impressive as the sound they produce.

Our new Honeycomb Speaker Line is thought to be the most perfect way to reproduce perfect sound.

It ought to be. We've been driving toward perfection for a long time.

 **MITSUBISHI**
AUDIO SYSTEMS

Mitsubishi's Honeycomb Speakers. MS-10 10" 2-Way Bookshelf. MS-20 12" 2-Way Bookshelf. MS-30 12" 3-Way Bookshelf.
For more information write Melco Sales, Inc., Dept. SR. 3030 East Victoria Street, Compton, California 90221.

CIRCLE NO. 56 ON READER SERVICE CARD



Needle in the hi-fi haystack

Even we were astounded at how difficult it is to find an adequate other-brand replacement stylus for a Shure cartridge. We recently purchased 241 random styli that were not manufactured by Shure, but were being sold as replacements for our cartridges. Only ONE of these 241 styli could pass the same basic production line performance tests that ALL genuine Shure styli must pass. But don't simply accept what we say here. Send for the documented test results we've compiled for you in data booklet # AL548. Insist on a genuine Shure stylus so that your cartridge will retain its original performance capability—and at the same time protect your records.

Shure Brothers Inc.
222 Hartrey Ave., Evanston, IL 60204
In Canada: A. C. Simmonds & Sons Limited

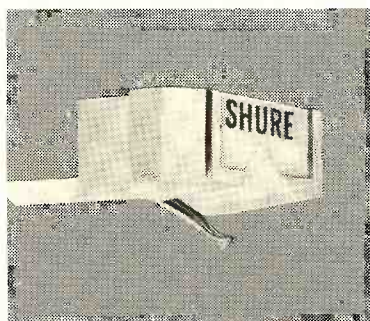

Manufacturers of high fidelity components, microphones, sound systems and related circuitry.

CIRCLE NO. 71 ON READER SERVICE CARD

Audio Q. and A.

By Larry Klein

Technical Director Klein checking the action of the slide-rule tuning mechanism of a wall-mounted B & O receiver on display at the Museum of Modern Art.



Power Response

Q. I've heard the term "power response" applied to speakers, and it seems to relate to a speaker's frequency response rather than its power-handling ability. Can you explain this specification?

GEORGE WATSON
Tuscaloosa, Ala.

A. When I first encountered the power-response concept about fifteen years ago, it immediately cleared up some puzzling questions I'd had involving frequency response measurements. For years manufacturers had been providing me with anechoic-chamber measurements that showed their speakers to be reasonably flat to perhaps 15,000 Hz ("cycles per second" in those days). When I listened to the same speakers at home, in many cases I found that the level of the high frequencies was audibly far below that of the mid frequencies. The discrepancies arose simply because the frequency-response curve supplied to me was produced by a chart recorder fed by a microphone placed *on-axis* (directly in front of the speaker system). And although the high-frequency sound-pressure level put out by the speaker remained fairly constant *on-axis*, the high-frequency energy reaching areas off to the sides of the system diminished rapidly as the frequency of the test signal was increased. In other words, the *total* energy (or power response) produced by the speaker fell off considerably at high frequencies even though the *on-axis* measuring microphone revealed no such loss. Of course, a microphone placed anywhere else but directly in front of the system would have registered the same loss of highs that I heard.

When a speaker with narrow high-frequency dispersion such as I've just described is installed in a normal room, it causes a variety of effects depending on the specific acoustic circumstances. In general, if the room has enough hard surfaces to be fairly reflective and the listener is distant enough from the speakers, the sound will become somewhat homogenized and the "beaming" of the tweeters will not be quite as evident, although the overall high-frequency response will still be down. However, in a normally "soft" room, a listener will hear excessive highs when he is directly in front of the speakers

and inadequate highs when he is off at an angle. (Boosting the treble in such cases will only aggravate the on-axis shrillness.)

Some manufacturers use a reverberant chamber to test a speaker's power response. The irregularly shaped chamber with highly reflective interior-wall treatment homogenizes any sounds generated within it and adds the on- and off-axis frequency responses together to provide a *total* power response. A highly directional speaker will almost always show a high-end deficiency when measured in such a test chamber.

"Professional" Gear

Q. Exactly what does the term "professional" mean when applied to hi-fi components, particularly tape recorders?

A. AMEL
Roseburg, Ore.

A. By definition, the term "professional" is not really applicable to hi-fi components meant for home (thus, "amateur") use. I am afraid, therefore, that it usually doesn't mean very much except as a way of implying high quality. In regard to tape recorders, the true professional open-reel machines are designed with such special features as the ability to handle 10½-inch reels, real VU meters (that is, they will match the 0-VU levels and ballistics of those used in recording studios), very fast (and smooth) servo-controlled winding and rewinding, balanced-line outputs and inputs, various editing functions, front-panel bias and equalization adjustments, and others that are usually lacking in audiophile decks. For turntables, "professional" means having a high torque, the ability to "back cue" (so a DJ can locate the exact beginning of a selection), and the ability to come up to speed very rapidly (so a tightly cued selection won't start with a "wow"). However, aside from such special features for professional use, the basic difference between professional studio gear and home audio equipment is in ruggedness—and hence reliability. The professional pays a premium price for equipment that is specifically designed not to break down in the middle of a broadcast or a live taping session. (For an audiophile a breakdown is an inconvenience; for a professional it can be a disaster.)

(Continued on page 36)

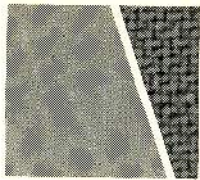

**fact:
calling this a "brush"**

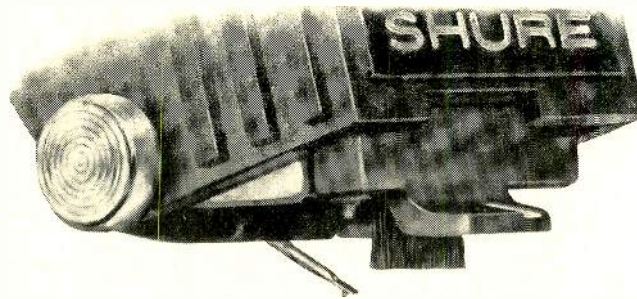

is like calling this a "radio"

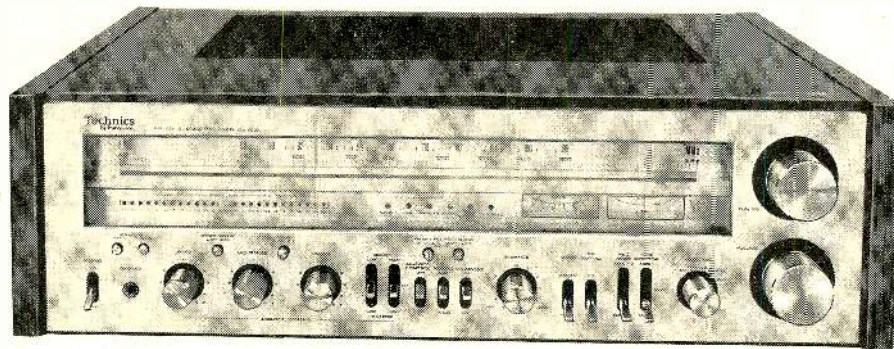

we call it a Dynamic Stabilizer

...critics call it a major innovation

True, the device on the front of a V15 Type IV cartridge bears a superficial resemblance to a cleaning brush.

In reality, it is a complex, exquisitely engineered subassembly which performs several complex functions that measurably enhance the quality of record reproduction!

Each one of its 10,000 conductive carbon fibers is positively grounded to discharge ever-present static electricity from the surface of your records. This eliminates static clicks and pops, as well as the tracking distortion produced by the varying electrostatic attraction between the record surface and the tone arm.

What's more, the Dynamic Stabilizer incorporates Shure-developed viscous damping that results in a uniquely efficient suspension system which maintains precise cartridge-to-record distance and uniform tracking

force—even on severely warped records. The stabilizer also acts as a shock absorber to cushion the stylus in case you accidentally drop the tone arm onto the record.

Finally, the tiny carbon fibers are so fine that 10 of them can fit *inside* a single groove to sweep free minute dust particles.

This integrated approach to pure sound reproduction extends throughout the design of the V15 Type IV. It sets a new standard of high trackability at ultra-low tracking forces—even on records that are warped, dusty, and charged with static.

If faithful reproduction of *all* your recordings is of paramount importance to you, we invite you to audition the V15 Type IV with the Dynamic Stabilizer. Or, write for the complete story (ask for AL569).

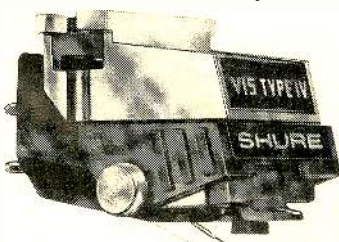

V15 Type IV...the stabilized cartridge



Shure Brothers Inc., 222 Hartrey Ave., Evanston, IL 60204, In Canada: A. C. Simmonds & Sons Limited
Manufacturers of high fidelity components, microphones, sound systems and related circuitry.

CIRCLE NO. 72 ON READER SERVICE CARD

TDK's new one-second, no-headache demagnetizer.



You don't need time or technical expertise to operate TDK's exclusive instant head demagnetizer. Just pop it into your deck and push "Play" to restore musical performance lost through inevitable head magnetization. Other demagnetizers can be less effective, take more time, or actually magnetize your heads and are more difficult to use. Because our HD-01's miniature battery powers sophisticated circuitry built into a standard cassette shell, it solves all of these problems. You will hear the performance improvement in your home, portable or auto system. TDK Electronics Corp., Garden City, NY 11530.

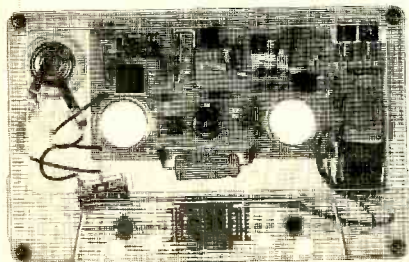

TDK
The Machine for your Machine.®

Audio Q. and A. . . .

ter, costly in terms of musicians' time, "dead air," or a ruined tape.)

Incidentally, in a few areas the specifications of a piece of professional gear may actually be inferior to those of a high-quality home unit. But whatever specs the professional unit has, it is designed to maintain them for years while running perhaps 10 to 12 hours a day.

Extension-speaker Switch

Q. I have a high-power stereo system with a 200-watt-per-channel power amplifier. Since I would like to have speakers (low-efficiency types) operating on my porch and in my living room and den, although not necessarily simultaneously, I asked a friend who is familiar with the technical end of hi-fi to design a switching system for me. He bought what he called a multipole selector switch and wired my three sets of speakers to it in such a way that only one pair could be used at a time (since two pairs of the speakers had 4-ohm impedances and he felt that my amplifier might have difficulty driving both sets at once). Everything worked fine for a while, but then the switch became intermittent so that the speakers would not always play when they were selected. We changed the switch and again things worked fine for a while and then the same trouble recurred. He is at a loss to explain the difficulty, and, of course, so am I. Do you have any suggestions?

DAVID DEVLIN
Boston, Mass.

A. Your problem sounds similar to one I ran into several years ago when trying to design a relay-operated A-B-C-D speaker-switching setup. Your switch probably failed because its contacts are not designed to handle the electrical currents put out by high-power audio amplifiers. Consider that with 4-ohm speakers being driven to, say, 150 watts on peaks (a not improbable figure), more than 6 amperes of current are flowing through the

switch contacts. A light-duty switch intended for input-selector use will simply not stand up under that kind of current flow for long.

Although there are some multipole rotary switches available that will take heavy currents, they are expensive and may be difficult to find. I would therefore suggest that you use conventional double-pole, double-throw "standard-duty" switches of at least a 10-amp rating. If wired as shown in the sketch below, switch A will select either main or extension speakers, and switch B will select either pair of extensions.

Equalized Speakers

Q. It seems to me that there's an increasing number of speaker systems that employ active equalizers as part of their design. How do such speakers compare in performance with conventional systems?

HERMAN FRIEBERG
Detroit, Mich.

A. In most human endeavors there are likely to be several alternative paths leading to the same general goal. Some approaches will get you there easier, quicker, cheaper, or more reliably than others—but human beings being what they are, there will usually be disagreement as to which paths will and which won't. And if, in addition, there's no agreement as to the desired goal, there can never be a consensus as to the best way of achieving it.

As far as I can tell, there are legitimate theoretical arguments both for and against designing speakers with equalization. And these arguments, if presented in full, would provide more than enough material to fill this column several times over. My own view, based on listening experience and our test reports, is that it is possible to achieve excellent results either way. The matter then comes down to the standard and legitimate questions of size, price, amplifier power requirements, and sound quality of the speaker system—all of which are factors that can and should be considered separately from the pros and cons of using electronic equalization.

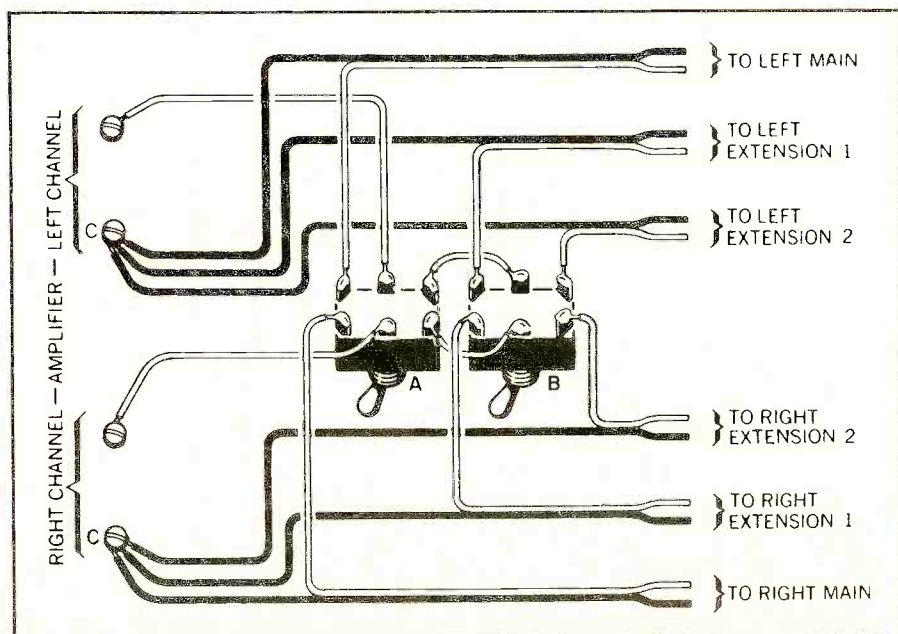

real to reel...



sounds best on ReVox B77

Real to reel means live performance recording, and that's where the ReVox B77 dramatically demonstrates its superiority over other tape recorders. Only the B77 has the wide dynamic range and generous record headroom you need to capture without compromise the full detail and dimension of live music.

Only the B77 delivers the "ruler-flat" frequency response you get from Willi Studer's legendary head design. Only the B77 combines the convenience of push-button digital logic control of tape motion, professional VU meters with built-in peak level indicators, and a self-contained tape cutter/splicer.

If you're thinking of upgrading your real to reel performance, try the ReVox B77. It's available in half or quarter track, 3 $\frac{3}{4}$ -7 $\frac{1}{2}$ or 7 $\frac{1}{2}$ -15 IPS. For complete information and list of demonstrating dealers, circle reader service number or contact us at the address shown below.

REVOX

Studer Revox America, Inc., 1819 Broadway, Nashville, Tennessee 37203 / (615) 329-9576 ■ In Canada: Studer Revox Canada, Ltd.

CIRCLE NO. 81 ON READER SERVICE CARD

CHAMBER OF MUSICAL HORRORS.

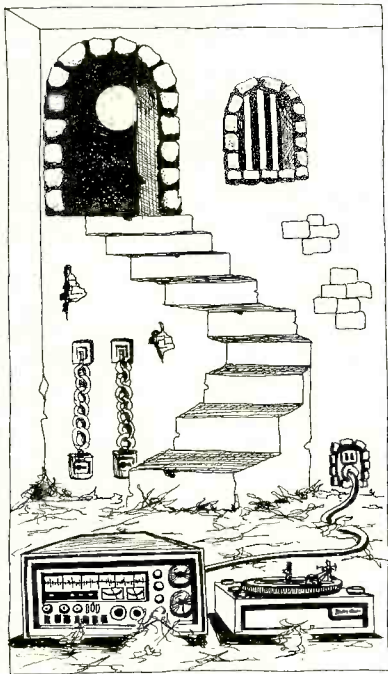

Music is tormented when confined in a room. Bad acoustics cause the misery. Walls and furniture scatter harmony. Weaken sounds. And make others scream. As the musical balance stretches out of shape.

Well. Now, there's an end to the agony. Our model 210 stereo graphic equalizer. Whipping room acoustics into line. Adjusting and correcting every octave. And setting the tonal balance free.

Unshackle your music. Equalize your room. And see what a pleasant place it becomes.

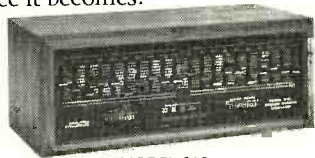

MODEL 210
STEREO GRAPHIC EQUALIZER

SPECTRO ACOUSTICS

DEPARTMENT QNO

P.O. BOX 369
RICHLAND, WA 99352
TELEPHONE — (509) 375-9608

CANADA:
TC ELECTRONICS
QUEBEC, CANADA

INTERNATIONAL:
FIMC
30 GREENHILL RD.
WESTWOOD, MASS. 02090

AN AMERICAN MANUFACTURER
OF HIGH FIDELITY COMPONENTS

CIRCLE NO. 79 ON READER SERVICE CARD

Audio Basics

By Ralph
Hodges



ADDRESSING THE PUBLIC

To the average audiophile, the term "professional" applied to audio equipment seems to have a well-nigh irresistible appeal—though not always, it would appear, for the right reasons. After all, the motor-vehicle equivalent of a "professional" studio-monitor loudspeaker system is a truck, and although a certain segment of the driving public has discovered that trucks can be fun, they are not the right form of transportation for everyone. Furthermore, there are trucks and then there are *trucks*. Many a present-day studio monitor system is something like a customized van with an eye-blinding paint job, the whole designed to appeal more to some client's taste for visual drama than his concern for aural fidelity.

But there are professional sound systems that are the figurative equivalent of a large tractor-trailer in their intended function of getting a heavy-duty job done as efficiently and unobtrusively as possible. The best of them—sound-reinforcement systems built, often with an astonishing sophistication, for large-auditorium or critical out-of-door applications such as music concerts—tend to be painstakingly designed from a high-fidelity standpoint, because their usefulness rests on their ability to "disappear" sonically and persuade the listener that they are playing no active role in whatever is being heard. To call such a prodigy of sonic engineering a mere "public-address system," as we used to, seems almost insulting.

One such system, neither particularly large nor small by current standards, is a "portable" affair created through the joint efforts of the acousticians of KMK Associates, Ltd. and Rosner Custom Sound Inc. to serve the summer productions of the Metropolitan Opera and the New York Philharmonic as they tour various parks in the greater New York area. It is "portable" in the sense that it can be transported from park to park on two 28-foot tractor-driven trailers (three more even larger trucks are required for the dismantlable concert shell that forms a stage housing for the performers). When erected, the sound system consists of two 40-foot-high towers flanking the concert shell, each containing a 20-foot-high speaker system.

The speaker arrays within each tower consist of eight 15-inch woofers in horn-loaded

cabinets, six powerful mid-range compression drivers fitted with several types of horns, and twelve compression tweeters capable of astonishing outputs. The drivers are all of relatively high efficiency, so that the use of a monstrous amplifier for each driver is not necessary. The triamplified system provides 80 watts for each woofer, 40 watts for each mid-range driver, and 20 watts for each tweeter. Added up, that amounts to 1,120 watts per tower, or a grand total of 2,240 watts. (That, by the way, is by no means a large amount of power for such applications these days.)

To this sound system is entrusted the job of getting an operatic or symphonic performance heard in a noisy urban environment by as many as 150,000 people without their being overly conscious that they are hearing a sound system rather than the on-stage performers. Surprisingly, even the prodigious sound output of a large symphony orchestra such as the New York Philharmonic, which typically numbers around 110 players for big nineteenth-century works, falls off to virtual inaudibility in an open field as soon as you walk a few paces away. The concert shell concentrates and "throws" the sound somewhat more effectively, so that the unamplified orchestra is judged to have satisfactory loud-

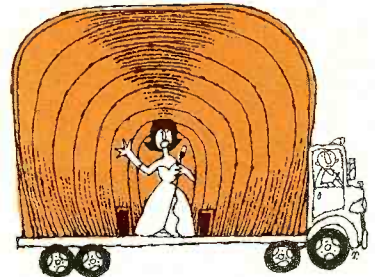

ness at a distance of as much as 50 feet. But in Central Park the orchestra is called upon to project about a quarter mile to reach all of its typically vast audience, and the area of effective sound coverage must spread at least 500 feet to either side as it emerges from its origin at the concert shell. This amounts to an appalling amount of space to be filled with substantial sound levels. The big loudspeaker and

(Continued on page 40)

FIDELITY TURNS INTO REALITY.

With The ADS 10 Digital Time Delay System.

If you are a typical reader of this magazine, you already own a good stereo system and your next component will be a time delay ambience-reproduction system.

The best two-channel stereo sound is still a limited illusion, a sonic painting on the wall between the stereo speakers. You don't have to open your eyes to know that you are hearing a reproduction rather than the real thing. Stereo provides a picture-window view of the recording locale, but as long as the sound is only projected at listeners from in front, stereo cannot produce the feeling of **being there** in the same acoustic space with the musicians. Better recordings and finer stereo components can improve the quality of the picture-window view but they cannot make the breakthrough to a convincing sense of "reality" in the hearing the sound in **three** dimensions, can only be achieved by re-creating the enveloping "ambient" sound field which surrounds the listener in any real acoustic space. Critics and reviewers have agreed that there is nothing you can add to a decent stereo system for \$1000 which will improve its performance as much as a good time delay ambience system can.

The ambience system you will want to own is the ADS 10 — the most sophisticated and the only complete time delay system now offered to the public. The ADS 10 is a fully optimized, fully integrated, third generation digital system containing everything you need to add to your existing stereo (ambience circuitry, amplifier, and speakers) — free of the limitations and compromises of earlier time delay units, with no money wasted on redundant parts or unused capacity. The ADS 10 speakers work at maximum efficiency for this application.

Building the amplifiers into the same chassis as the time delay circuitry, sharing the same power supply and cabinet, allows us to offer a full 100 watt per channel amp

at the price of a far smaller separate amplifier. This also simplifies installation in your home by eliminating another piece of gear requiring additional shelf space and interconnecting cables.

As for the ADS 10's time-delay and ambience-producing circuitry, we invite you to compare it with others. We believe you will find it to be the best-sounding, most natural and musical, most flexible and most logically designed ambience system available.

The ADS 10 has more flexibility of control than any other system, but it is simple to operate. Design of the controls has been human engineered so that you can easily select the size of the hall (from an intimate club to a cathedral), the depth of the stage, the location of your "seat" and the reverberant qualities of the hall itself. An irritating problem of earlier time delay systems — the unnatural sound of the ambience-enhanced human voice, as in "dry" recordings, for example — is resolved in the ADS 10 by a special circuit. Provision is made for adding ambience to the front channels for "dry" recordings, as well as to your own tape recordings. An ambience-enhanced headphone outlet provides the most natural, most musical headphone listening you've ever known.

Visit your ADS dealer. Bring your favorite records with you and listen to them through the ADS 10. Experience the difference between fidelity and reality. Change the hall. Deepen the stage. Move your "seat." Check the features and the performance of the ADS 10 against any other time delay system.

You'll discover the ADS 10 Acoustic Dimension Synthesizer is the system for which you've been waiting.

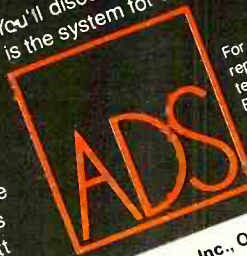

For a comprehensive explanation of ambience reproduction and the ADS 10 Time Delay System, request your free copy of the ADS 10 Brochure. For full information on the scientific basis, design, installation, features and functions of the ADS 10, we invite you to order the ADS 10 Owner's Manual at \$5.00 per copy.

ADS, Analog & Digital Systems, Inc., One Progress Way, Wilmington, MA 01887

Please send me a copy of the ADS 10 Owner's Manual. \$5.00 is enclosed.

Please send me a copy of the ADS 10 Brochure.

Name _____ Address _____ Zip _____

IOC 78 FP SR11

Q • How close can hi-fi get to an authentic musical experience?

A • Slip on new Audio-Technica Stereophones and hear for yourself.

If you want to find out how good the new Audio-Technica Stereophones really are, don't just compare them with other headphones. Put them up against the very finest *speaker* systems. But don't just listen to the equipment. Listen to the *music*. And be ready for a surprise!

Judged on the basis of flatness of response, freedom from distortion, transient response, sensitivity, and independence from room acoustics, these new dynamic and electret condenser models are perceptibly better sounding than speaker systems costing hundreds of dollars more.

And if you think that great performance can only come from heavy, bulky stereophones, get ready for another surprise. Our heaviest model is less than 7½ ozs. and our lightest is an incredible 4¾ ounces light. Comfort that lasts an entire opera if you wish.

For all the facts, send for our catalog. But for the revealing truth about stereophone performance, listen and compare at your nearby Audio-Technica showroom. It will be a great *musical* experience.



Model ATH-7
Our finest Electret Condenser with LED peak level indicators
\$149.95



Model ATH-1
The moving coil dynamic stereo-
phone that weighs just 4¾ oz.
\$29.95

 **audio-technica**
INNOVATION □ PRECISION □ INTEGRITY

amplifier arrays already described are certainly not excessive; in fact, they would be quite inadequate were they not designed according to "professional" criteria.

First of all, the loudspeaker arrays are highly directional. They project sound in a controlled beam rather than omnidirectionally. This makes sense when you consider that listeners who have managed to get close to the stage enclosure—and therefore close to the towers—would be all but deafened by a sound level intended to be heard a quarter mile away. So the loudspeaker arrays have been cleverly designed to aim a swath of sound that begins to hit ground level at full intensity about 50 feet out, just where the sound from the unamplified orchestra is beginning to fade rapidly. This also gets the available sound energy to where it's needed, rather than wasting it in other directions.

Next, the *quality* of the sound coming from the loudspeakers must be considered. In some respects the task of achieving uniform frequency response is more easily dealt with in an open-air setting than in a closed auditorium, because there are no wall and ceiling reflections (and consequent resonances) to fight. Within most of its coverage area this system has been successfully equalized to be within about 1 dB of its prescribed frequency-response characteristic, which is superb by any standard of high fidelity. But, because of the absence of rear and side reflecting surfaces, the sound will lack the normal hall reverberation that so enhances the enjoyment of large classical works.

To add something of a concert-hall acoustic, a reverb unit is inserted into the signal path. Then, to prevent catastrophic acoustic feedback from breaking out (after all, some of the output from the huge loudspeaker arrays will reach the eight or so on-stage microphones and drive them crazy), there is a filter set that will remove, as required, ½-octave segments of the signal going to the speakers. Such narrow "notch-outs" cannot be heard, but they enable the sound system to operate at a much higher level without breaking into a regenerative howl.

DURING several visits to Central Park this past summer I came to know the sound-reinforcement system and its capabilities fairly well. It is not, of course, perfect, but it can give you a sense of a live performance at a distance at which the performers themselves look no bigger than pedestrians viewed from the top of a New York skyscraper. The quality of sound that reaches a remote listener depends on many variables, and not all are under the control of the sound-system specialists. At such distances even the slightest breath of wind can carry the sound away (a result of gradient effects), but for the professionals who install such arrays this is merely another quantifiable design factor. The fact that the twelve tweeters in each tower operate only from 9,500 Hz up will give some idea of the pains taken to keep quality high.

To those who write asking about careers in audio, I'd like to suggest that the design and installation of such systems is a fascinating and rewarding business. You can't take the results home with you, but you are serving the cause of good music and good sound reproduction in a very direct fashion, and the field is an expanding one. As soon as enough people hear what these specially designed systems can do, every city will want one.

Motorola introduces the complete sound system for your car.



The TC887AX In-Dash Cassette with AM/FM Stereo, the EQB 3000 Graphic Equalizer, plus 3-way and 2-way speakers.

This new system from Motorola® gives you 30 watts of output and a sound that can sound as good as many home stereo systems.

The TC887AX has cassette features like automatic reverse for continuous play of the cassette without removal and reinsertion, locking fast forward to advance the tape quickly and quietly, locking rewind to rewind the tape and repeat a program, and direction indicator lights. Plus push-button tuning, a local/distance switch, balance control for adjusting right and left channels, a fader control for adjusting the front to rear sound level.

The Motorola EQB 3000 Graphic Equalizer has been designed specifically for the varying automotive environment. It compensates adequately for car

acoustic levels, speaker placement and ambient road noise. With five frequency bands from 60 Hz to 10,000 Hz, and a fader, it enables you to tailor the sound to your preference.

The Pow-R-Handler™ Professional Series 3-way speakers have 20 oz. one piece magnets and one inch aluminum voice coil for superior heat dissipation. The 2-ways are co-axial speakers with 10 oz. one piece magnets.

And this is just one of the many systems you can create with Motorola components. Listen to them at a dealer near you. And start getting sound in your car that can be as good as the sound you get at home.



MOTOROLA

Auto Sound Systems

CIRCLE NO. 57 ON READER SERVICE CARD

To find the dealer nearest you, write: Market Relations Manager, Motorola, Inc., Automotive Products Division, 1299 East Algonquin Road, Schaumburg, Illinois 60196. Motorola is a registered trademark of Motorola Inc.

We sound better because we listen better.

The new Harman Kardon receivers have power, features, excellent specifications.

But so do many other receivers.

What makes us better is the way we sound. More musical, with air between the instruments. Spacious, with extraordinary articulation that allows each instrument to register deep into your musical consciousness.

Why does Harman Kardon sound better?

It starts with ultra-wideband frequency response and remarkably low TIM (transient intermodulation distortion) and SID (slewing induced distortion). But these are merely minimum design parameters for Harman Kardon engineers.

Of course, it is possible for our engineers to build adequate receivers where others build them — in the laboratory. But that's not where you build exceptional ones. You make them in the listening room.

But not just when the receiver design has been

completed. Listening at every stage of development is critical.

The fact is that transistors with the same specifications, but from different manufacturers, vary in ways that affect the texture of music. That's why Harman Kardon engineers actually listened for the *musical character* of every component — singly and in combination — that went into the audio chain of all our new receivers. Every transistor. Every capacitor. Every resistor.

They listened for the subtle differences in component parts that make the immeasurable difference in the final product — changing, refining, in effect tuning the instrument until a receiver emerged that sounded exactly the way they wanted it to sound.

In short, it's not just great specifications that make the difference — it's listening to those things that others tend to take for granted.

Listen to the difference yourself. Visit your Harman Kardon dealer today.



Pictured: hk670 receiver 60/60 watts
Not shown: hk340 20/20 watts, hk450 30/30 watts,
hk560 40/40 watts

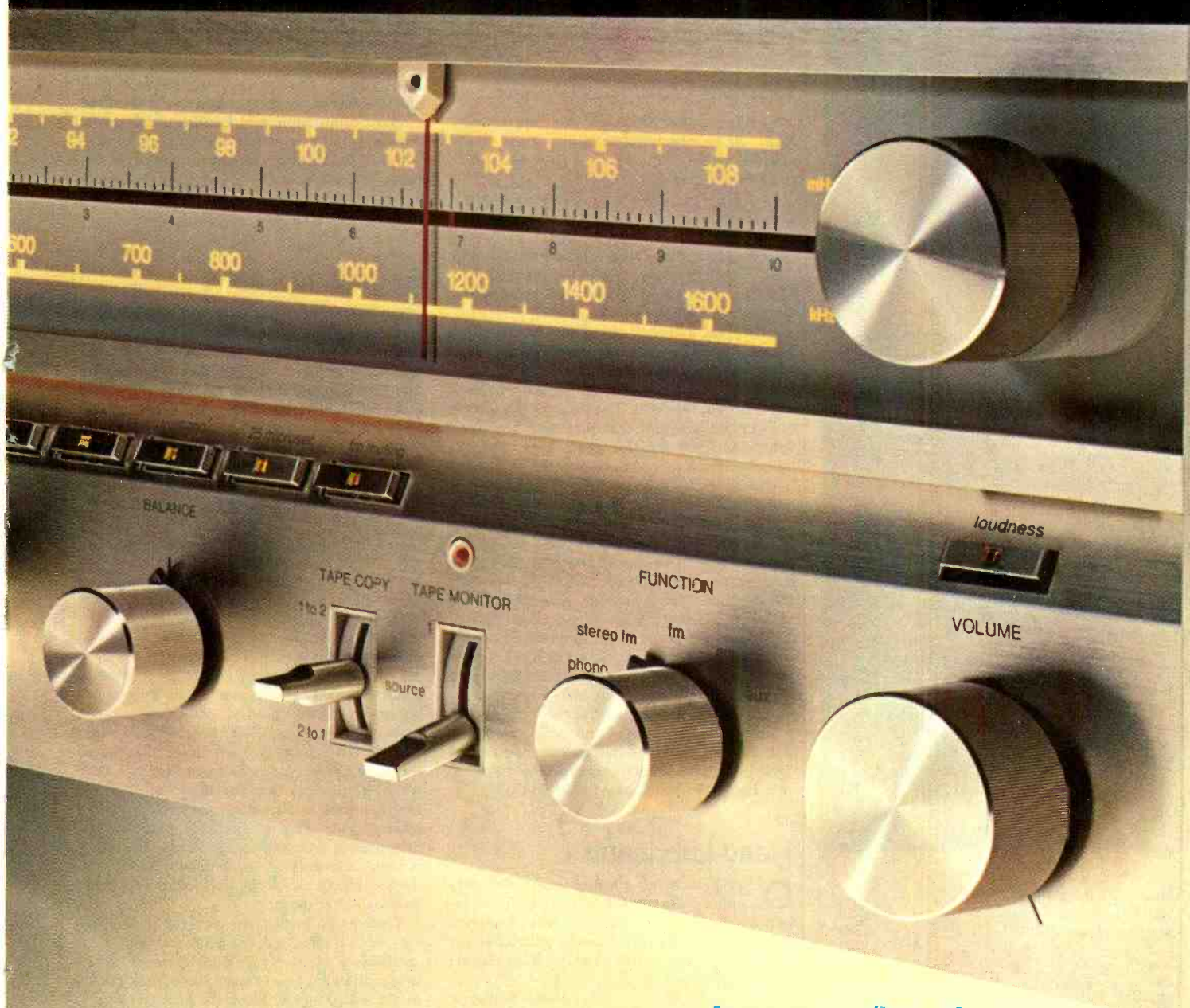

harman/kardon
Hear all the music.

55 Ames Court
Plainview NY 11803

CIRCLE NO. 35 ON READER SERVICE CARD

McIntosh

"A Technological Masterpiece..."



McIntosh C 32

"More Than a Preamplifier"

McIntosh has received peerless acclaim from prominent product testing laboratories and outstanding international recognition! You can learn why the "more than a preamplifier" C 32 has been selected for these unique honors.

Send us your name and address and we'll send you the complete product reviews and data on all McIntosh products, copies of the international awards, and a North American FM directory. You will understand why McIntosh product research and development always has the appearance and technological look to the future.

Keep up to date.
Send now - - -

McIntosh Laboratory Inc.
Box 96 East Side Station
Binghamton, NY 13904

Name _____

Address _____

City _____ State _____ Zip _____

If you are in a hurry for your catalog please send the coupon to McIntosh. For non-rush service send the Reader Service Card to the magazine.

CIRCLE NO. 54 ON READER SERVICE CARD

Tape Talk

By Craig Stark



Double Dolby Explained

Q. What is the "Double Dolby" system now being promoted in some of the newer cassette decks? Is it different from the standard Dolby system?

GENE BRADBURY
Greenville, R.I.

A. Happily, there's no mystery or advertising hype here, nor is there any departure from the standard Dolby-B system that has been in use for some years.

The great majority of cassette decks use a single, combination record/playback tape head and a single pair of Dolby-B noise-reduction circuits—one for the left channel, the other for the right. The same Dolby circuit is switched between "encode" and "decode" functions, just as the same tape head is switched from record to playback.

But an increasing number of today's cassette decks are designed with separate record and playback heads. This allows the user to listen not only to the signal being fed to the tape but also to an almost instantaneous playback of the signal just recorded on the tape. During this "simultaneous" record-playback operation, if there were only a single pair of Dolby circuits in the deck, they would be tied up in the *encoding* (recording) process. An instantaneous, comparative playback of such a tape would differ markedly in its sonic character from the input signal, for the "playback" would be of an encoded, not a decoded, signal. The solution is to incorporate *two* sets of Dolby circuits, one to record, the other to play back. Thus the name "Double Dolby."

Head Lubricants

Q. I've been using a head cleaner that contains a silicone lubricant, but I have begun to wonder if the silicone, while reducing friction, will build up a harmful residue on my tapes. Is it better to use a regular head cleaner without silicone?

JOHN SCHMIDT
Astoria, N.Y.

A. Whether the residual lubricant from such cleaners does any good I'll have to leave to your experience, though my instincts are against the use of such a product. Quality

tapes already contain such lubricants as their manufacturers deem appropriate, given their binder formulation and coating techniques. Anything more is at best superfluous, and at worst—though the amount involved is minute—it could conceivably migrate to the rubber pinch-roller, for example, where it would obviously do no good.

Squealing Tapes

Q. Some years ago (beginning in 1959) I bought a number of prerecorded tapes, and now when I play them back they squeak terribly. I've tried running them through on fast-forward and rewind to make sure they don't stick, but the squealing problem still shows up on several different decks. The local audio shops just tell me that open-reel is out. Can you suggest anything?

RONALD CUMMING
Colorado Springs, Colo.

A. Tapes as old as those you describe were almost invariably recorded on a cellulose-acetate base material. Acetate-base tapes used a plasticizer to give them flexibility, and unfortunately time, plus repeated temperature/humidity cycling with seasonal changes, tends to dry out the plasticizer, leaving the tapes rather stiff and likely to squeal. Back in the days when such tapes were popular (today, both open-reel and cassette tapes invariably use a polyester base material that doesn't have a fugitive plasticizer), some of the accessory companies manufactured little wick-like devices that one could place along the tape path to dispense a metered dose of a lubricant designed to take the place of the evaporated plasticizer. However, the commercial demand for such products has evidently shrunk below the point where it is economic to offer them.

There is no permanent cure for your problem, but an idea I got from 3M may get you a squeal-free play or two from these dried-out tapes, allowing you to copy them onto a more modern tape stock. Place the affected tape in a metal movie-film can of the appropriate diameter (obtainable at any photo shop), along with a moistened piece of blotting paper. Be sure the tape is wound onto its reel at moderate tension (that is, in a played rather

(Continued on page 48)

The A-800: A TEAC with features you can't live without at a price you can live with.

The TEAC A-800 gives you one of the best, most affordable combinations of precision, muscle and good looks around. It's a three head, two motor, dual capstan, solenoid-operated cassette deck that lists for less than \$800.*

The A-800 transport has a computer heritage... heavy, rock-steady, reliable. The closed-loop dual capstan system isolates the tape between the capstans to provide optimum tape-to-head contact. Result: better frequency response, fewer dropouts. An



tape between the capstans to

ultra-stable motor drives the capstans while all transport functions are operated through feather-touch solenoid switching both on the deck and with the optional RC-90 Remote Control.

The A-800 uses a combined record/playback head in which both elements are incorporated into a single housing. What's more, the playback head is a unique "Delta" design which incorporates both magnetic and non-magnetic ferrite materials which assures minimum feedthrough from the record head and eliminates low

frequency contour effects.

In addition to its built-in Dolby, the A-800 also accepts an optional dbx® Type II for wider dynamic range and up to 80 dB S/N. This optional dbx interface—a TEAC exclusive—lets you improve the overall signal-to-noise performance by up to 30 dB. It's got to be heard to be believed!



TEAC®

First. Because they last.

TEAC Corporation of America
7733 Telegraph Road
Montebello, California 90640

CIRCLE NO. 86 ON READER SERVICE CARD

©dbx is a trademark of dbx, Inc.

*Manufacturer's suggested retail price.



Wow & Flutter: 0.05%
Frequency Response: 30-18,000 Hz
± 3 dB (CrO₂/FeO)

MODEL A-800

IN/OUT

TAPE COUNTER

RECORD

REC MUTE

PAUSE

HOW MUCH OF THE MUSIC DO YOU WANT TO HEAR?

Today's professional musicians are putting more into their music than ever before. A whole new generation of recording equipment allows them to pack a tape or fill a record's grooves with musical

shadings and textures and subtleties that simply went unrecorded a few years ago.

JBL is part of that process.

In fact, according to a recent national survey by



Billboard Magazine, JBL is the most widely used
loudspeaker in professional recording studios.

There's a reason:

JBL delivers all the music, all the time. And it does it
with flawless accuracy and attention to detail that
professionals can't afford to be without.

If you want to get all the music out of your records
and tapes, get the loudspeaker the pros used to put
it there: JBL.

You don't have to be a professional to own JBL
loudspeakers. The same sound is available in a wide variety
of home systems, priced from \$175 to \$4,800.

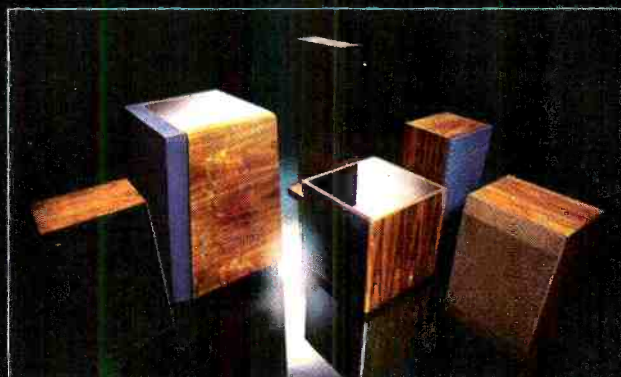

JBL

GET IT ALL.



Great specifications
won't impress your ears...
Great sound will!



Speaker Shown:
Apollo 8853

According to the 1978 Stereo Review Stereo Directory and Buyers Guide, there are at least 111 manufacturers of high fidelity speaker systems. All of whom would have you believe that they have perfected "The Listening Experience". Most of them will try to tell you how their speakers sound by their specification claims.

Frankly, that is impossible. You have to listen to a speaker to adequately judge its quality.

At AAL we utilize the finest domestic and international raw drivers. Superb craftsmanship is performed by union workers. Computer aided design yields optimum performance. All of this adds up to great sound... Which is what speakers are all about.

Listen to us!

American Acoustic Labs
629 West Cermak Rd.
Chicago, Illinois 60616

AAL 
SPEAKER SYSTEMS

Tape Talk . . .

than a fast-wound condition). Seal the film can with cellophane tape so it's airtight, and allow perhaps a day for the tape to absorb the moisture from the blotting paper. This will probably restore enough suppleness to get you through a run or two with no more than an inaudible amount of squealing, if that.

As for your local dealers and their advice, I should like to suggest, respectfully, that they get their heads examined.

Understanding EQ

Q. *Could you explain the difference between 120- and 70-microsecond equalization and tell me the relative advantages and disadvantages of each?*

LARRY THORPE
Columbia, Mo.

A. To understand the differences between these equalization characteristics fully, you must see how they fit into the overall playback-equalization scheme. Equalization in general is a deliberate modification of the frequency response of a component—in this case, the playback section of a cassette tape deck. The reason for this modification is to compensate for departures from flat frequency response that are predictably introduced by the component itself. By offsetting the known gains or losses at different frequencies inherent in the component, you "equalize" its ultimate output across the whole of the audio spectrum.

Ignoring minor aberrations at the frequency extremes, we find that the output from a normal tape playback head presented with equal recorded signals rises directly with frequency. Double the frequency and you double the playback output from the tape head. This is known technically as a "6-dB-per-octave slope," and unless you want to combine inaudible bass with an impossibly prominent treble, the playback section of your recorder must include a compensating (equalizing) 6-dB-per-octave slope in the opposite direction.

The complication that brings the 120- and 70-microsecond characteristics into the equalization picture is the fact that there are treble losses involved in recording very high frequencies (especially at slow tape speeds) that

exceed any practical amount of compensatory treble boost that could be supplied during the recording process itself. Thus, the higher frequencies recorded on the tape show a definite treble droop. The solution to this is to stop the basic bass-boost/treble-cut slope of the playback equalizer at a carefully chosen treble frequency, for when we stop cutting the treble electronically, the treble-boosting character of the tape head reasserts itself, making up for the treble droop on the recorded tape.

For regular ferric-oxide cassettes, the "carefully chosen" frequency is 1,326.3 Hz, "120 microseconds" in engineering jargon. Since chromium dioxide (and the CrO₂-equivalent ferric tapes) have an inherently stronger high end to begin with, they need less assistance from the playback head, so their boost commences at 2,273.6 Hz, or "70 microseconds." (Engineers prefer to speak of "microseconds" instead of frequencies when discussing equalizers because the number of microseconds directly indicates the proper resistor and capacitor characteristics needed to produce the desired turnover frequency.)

So far as advantages and disadvantages are concerned, you can get a good idea by examining the two curves in the accompanying graph which shows the relative treble boost produced by a playback head when used with the 120-microsecond (standard) and 70-microsecond (CrO₂) equalization. Throughout much of the treble range the 120-microsecond curve is about 4.5 dB higher than the 70-microsecond curve. This means that while each characteristic produces flat frequency response when used with the type of tape appropriate to it, any residual tape hiss picked up by the head will be boosted by an additional 4.5 dB when using 120-microsecond equalization. All else being equal, CrO₂-type tapes should give you less audible tape noise. Further, as a check of recorder specifications will show, the rated frequency response in most cases extends a couple of kilohertz higher when you use tapes designed for the 70-microsecond equalization. On the other hand, at low frequencies CrO₂ tapes have tended to have a lower maximum output level than good ferric formulations. Where the music you want to tape is characterized both by a very heavy "sock-it-to-you" bass and by a lack of very quiet passages (where hiss would show up)—hard rock is the example that comes to mind—using a good grade of ferric oxide with 120-microsecond equalization might give slightly better results.

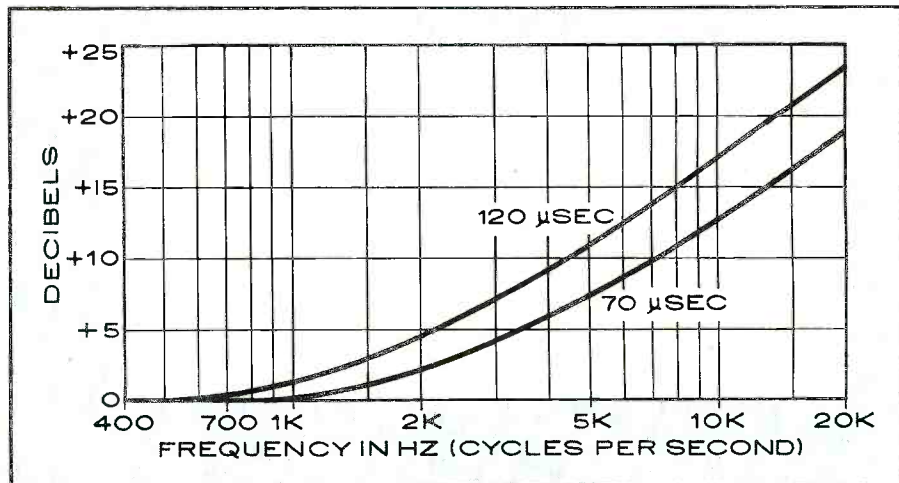

The evolution of the revolution.

The new Bose 901[®] Series IV Direct/Reflecting[®] speaker.

When Bose introduced the original 901[®] speaker, high-fidelity critics around the world hailed its revolutionary approach to sound reproduction.

"Bose has, in a single giant step, produced one of the finest speaker systems ever made."
(USA)

"The orchestra is there in front and the atmosphere of the concert hall all around."
(Belgium)

"Bose contains more technical innovations than any other speaker of the past 20 years."
(Austria)

"...sets new standards for loud-speaker music reproduction."
(France)

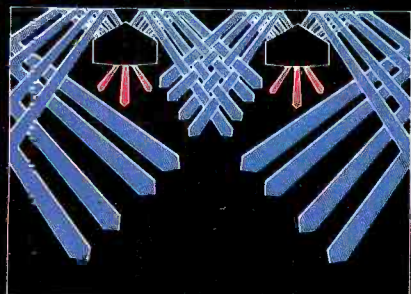

Now the 901[®] has evolved. Again introducing the Bose 901 Series IV Direct/Reflecting[®] speaker system. With new equalizer controls that consider your room as part of the speaker design. And a new answer to the problem of choosing an amplifier.

It is a known fact that moving a speaker just a few feet in a room will alter its performance. And that the variances in a speaker's performance from one living room to the next can be vast. This is a problem all speakers have regardless of design. Except one.

A new approach to the study of listening room acoustics and an ambitious survey of many actual listening rooms has resulted in new equalizer controls for the Bose 901 IV. These controls allow you to simultaneously adjust several bands of frequencies in a precise manner to match the per-

formance of the 901 IV to your room. In a way that cannot be duplicated even with an expensive graphic equalizer.

As a result, the 901 Series IV speakers perform as well in the living room as in the demonstration room.

Were our engineers to design a speaker specifically for your living room, you would not get better sound than you do when you properly adjust the equalizer controls on the Bose 901 Series IV.

And the 901 IV provides a simple answer to the problem of choosing the power rating of your amplifier or receiver. Choose any amplifier you wish. The 901 IV provides surprisingly loud sound with as little as 10 watts per channel. Yet it is durable enough for us to remove all power limitations on the 901 IV. There is no power limit. Period.*

With these new improvements, the Bose 901 IV gives you a flexibility no other speaker can. You can place the 901 IV in almost any room and get the life-like, spacious sound for which the 901 IV

Direct/Reflecting[®] speaker is famous. And you can match it to virtually any amplifier.

We think that once you hear the new Bose 901 IV Direct/Reflecting[®] speaker, you'll agree. The revolution has evolved.

BOSE

*There is a power limit in commercial applications. For information, contact Bose Customer Service.

B·I·C introduces four speaker systems good enough to match our remarkable new turntables and cassette decks.



We've combined linearity with efficiency in a way to maximize both...and bring you the most accurate and satisfying music at prices less than you'd expect.

Why linearity?

Because it makes for sound reproduction accuracy.

Why efficiency?

Because it provides a wide dynamic range.

When you combine the two, you have life-like sound that will satisfy even the most discriminating listener.

How did we do it?

The patented Venturi enclosure, which actually launched the high-efficiency era in speakers, has been significantly improved. The duct has been lengthened, retuned and acoustically damped. The result is a highly efficient, clean and tight response over an extended bass range.

We improved the crossover network configuration through computer calculation, with circuitry and component values meticulously selected to avoid time

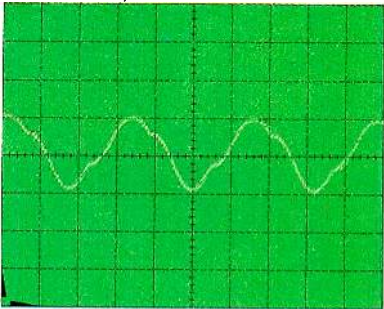

These oscilloscope photos show how the Venturi-coupled path multiplies and "cleans" the bass output. Above, a 25 Hz waveform taken directly in front of the woofer cone. Below, the same input measured at the Venturi duct is many times greater, and sinusoidal (nondistorted).

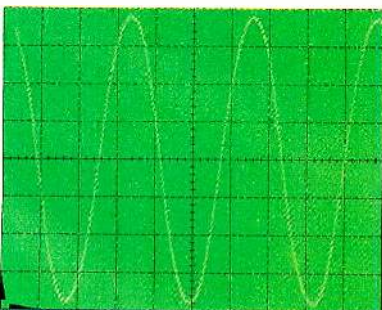

The new Venturi II design (right) both acts as an acoustic transformer, to multiply bass energy, and as a low pass filter to enhance the quality of the deep bass signal. Damping material (pink) acts to improve transient response. The response curve (below) shows how accuracy is maintained from treble peaks down through organ pedal notes.

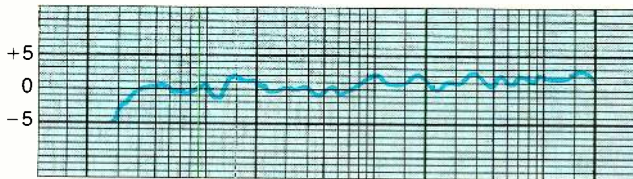

and phase distortion.

We have chosen components for their ability to withstand peak voltages and heavy current conditions.

We created our "transonic" grille to avoid edge reflections and diffraction.

We provided total protection to the speaker system by having a separate fuse for each driver in every speaker in the new B·I·C series.

We have done all of this, and a lot more, to attain what we believe the market needs:

Speaker systems good enough to complement the new B·I·C turntable line and the new B·I·C two-speed cassette deck — both of which received critical acclaim upon their introduction. (Of course, any of our equipment can be combined with other people's high-fidelity components to the advantage of those components.)

We concentrated on getting these new B·I·C loudspeakers to be standouts among the 200 or so speaker brands now being offered. Not standouts by words. Not stand-

outs because of unusual shapes or esoteric materials, which don't necessarily contribute to performance quality. But standouts because they combine design and componentry in such a manner as to maximize both linearity and efficiency — and therefore reproduce sound that the most discerning listener would want to hear.

We know that these are only claims, and even though it's B·I·C making them — B·I·C has been in the business for longer than just about any other company offering high-fidelity products — you must judge for yourself. The ultimate truth of a speaker is

in the listening, not in what is written about it.

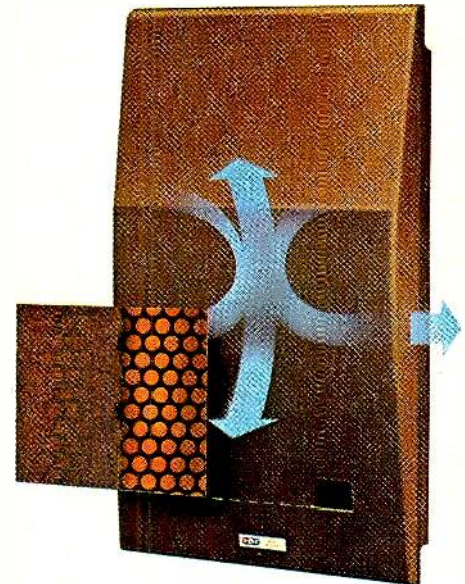

The new "transonic" grille is acoustically transparent and allows sound to radiate in all directions. Molded design eliminates grille frame, thus avoiding unwanted deflection of widely dispersed sound.

So please A-B the new B·I·C speakers against your other favorites. We are sure that you will be quite pleasantly surprised at both the sound and the price.

B·I·C SPEAKER SYSTEMS

B·I·C is a trademark of B·I·C | Avnet, Westbury, N.Y. 11590. In Canada: C.W. Pointon, Toronto.

CIRCLE NO. 7 ON READER SERVICE CARD (FOR EARLIEST RESPONSE WRITE DIRECT)

IMPORTED CANADIAN WHISKY • A BLEND • 80 PROOF • CALVERT DIST. CO., N.Y.C.

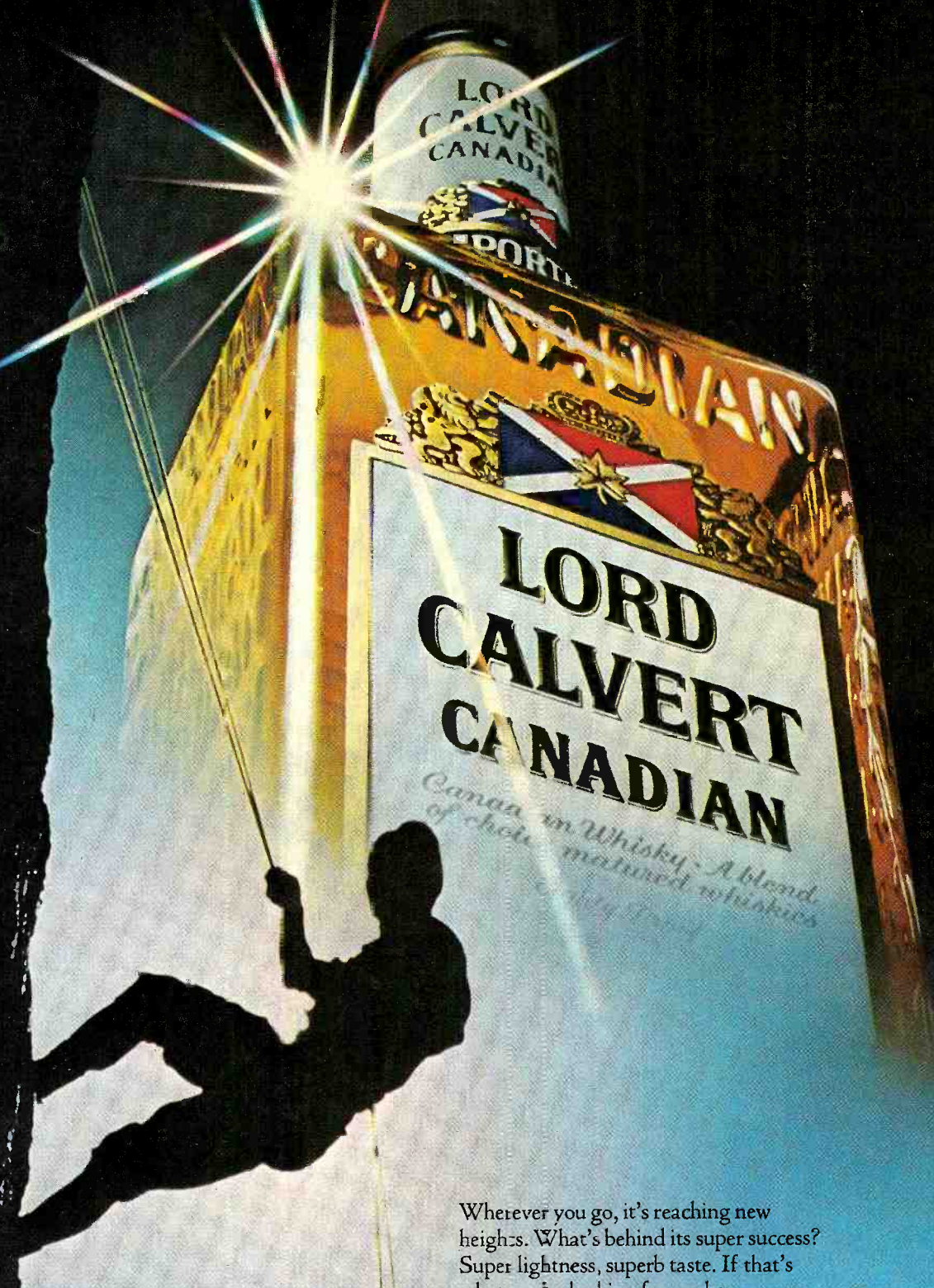

Wherever you go, it's reaching new heights. What's behind its super success? Super lightness, superb taste. If that's what you're looking for, make the ascent to Lord Calvert Canadian.

Follow the Canadian Superstar.

AN AUDIOPHILE RHINE JOURNEY

I THINK I remember now. It was at a Chicago ballroom late (too late) at night, with Lionel Hampton thundering away and Hitachi's National Marketing Manager Jerry Henricks shouting at me about the upcoming high-fidelity show in Düsseldorf, Germany, and something about a press exhibition of Japanese audio components (Hitachi's?) in a German castle on the Rhine. One gets used to hearing almost anything at such affairs, but there are fantasies even a magazine editor won't swallow. Still, I must have said something assentive, affirmative, or what have you. Why else would high August find me in front of the Cologne/Bonn air terminal, looking for a lift into town to become Hitachi's three-day guest at its audio "mini-convention"?

My God, this place is expensive! Five minutes watching the meter in the taxi and I am terrified and want to get out. The hotel room in Bonn works out to something like \$100 a night. As quickly as possible I locate host Henricks and stick close to his wallet for the duration.

Fortunately, the Hitachi schedule is not as hectic as I'd expected. In fact, the first day is free time except for cocktails and a sit-down dinner in the hotel, where we get a chance to meet fellow press people. Aside from a couple of American colleagues, they are European and largely unknown to me even by reputation, except for Walter Rios from *Off Duty*. The Swiss press corps astonishes everyone by eating an entire soup-to-nuts dinner—and then ordering a second round of exactly the same thing!

NEXT day takes us to Castle Drachenburg, a nineteenth-century architectural oddity surrounded by a game preserve overlooking the Rhine. Why we are here is still not apparent, but we are told that a Hitachi exec has a thing for castles on the Rhine (don't we all?). Coordinators of the exhibition bustle hither and yon, pumping hands and passing out cards. A carload of bouncy, multilingual Tokyo debs is let loose on us; they pour drinks, change clothes about five times in the course of the day, dance like dervishes when the band begins, and, alas, get securely locked up at the end of the evening. A film screening in the castle cellar reminds us that Hitachi makes, besides audio equipment, huge industrial turbines, experimental nuclear-fusion reactors, bullet trains, and a quite decent beer.

We then tour the rooms of the castle, each of which is devoted to a different product category in the Hitachi high-fidelity line. The highlights are the marriage of class-G circuitry and MOSFET output transistors in a big power amplifier, a PCM processor that sounds at least as good as everyone else's, and a new three-head cassette deck that in just over twenty seconds *automatically* sets bias and equalization for any tape used. The machine first adjusts bias for maximum output from the tape at 5,000 Hz (an arbitrary criterion for bias, the Hitachi spokesman ad-

mits, but one that seems to work out well in practice for most tapes). Then four tuned oscillators are brought into play for a response check, the results of which govern the equalization adjustment. Looks like a great product—if Hitachi can get its underlying concept across to the non-technical consumer. There is also an elaborate synthesizer that will faithfully play any musical composition, no matter how wretched; that one stores in its memory by pushing buttons, thereby making performers out of those lacking even a trace of keyboard technique. Dinner is German-prepared Japanese food. I fear the Germans have not yet got the hang of it, but the beer (draft König-Pilsener) is ambrosial.

It's north the next day to Düsseldorf and the big show, which is a true high-fidelity event substantially larger than the IHF's recent Atlanta show, to the point of occupying a number of large halls in the exhibition complex. Aside from some bewildering loudspeaker designs and some unfamiliar brand names appearing on the otherwise familiar panels of Japanese-made receivers, there is not a whole

type, but it is attractive nonetheless, with plenty of sex appeal). Ironically, 3M has not yet begun to promote Metafine in Germany, so the Luxman booth is the only place one sees even a mention of metal tape. Speakers with meters and other level indicators seem to appeal to the Germans, and they are everywhere. Roy Allison is here conducting an all-English presentation, which seems a dubious idea, but he pronounces himself pleased with the results nonetheless. Oskar Heil is also here for ESS, appearing more animated than I have ever seen him. Perhaps he is glad to get back to the German language.

THE Düsseldorf show is in competition with Berlin's Funkausstellung in the same sense that the new IHF shows are in competition with the CES, except that the timing conflicts do not exist, the shows being held in alternate years. If there must be an ultimate winner, it looks like Düsseldorf to me, at least insofar as high fidelity is concerned. The exhibits of hi-fi manufacturers are much bigger and more opulent here, and there is no risk of their being overshadowed by a Grundig blockbuster that sets up a multi-media production occupying a whole hall and grabbing all the attention. Last year in Berlin I heard that high fidelity was a "fringe" market in Germany. This year I hear that high fidelity's growth in Germany has been phenomenal of late, and everyone's going crazy with enthusiasm.

Next day some confusion in our flight times leaves a few hours to see the cathedral at Cologne, which looks better from the outside than the inside. A beer at the airport takes my



lot I haven't seen before. Exceptions are a large four-channel (!) receiver with SQ and discrete facilities, made by Telefunken in West Germany, and a new Luxman cassette deck that is announced as being pure-metal-tape ready (chances are this is an early proto-

last Deutschmark (if you believe the Löwenbräu from Miller is the same as that brewed in Munich, you'll believe anything), and Luft-hansa's Red Baron carries us off. *Wiedersehen*—when and if I can afford it.

—Ralph Hodges

Technical Talk

By Julian D. Hirsch

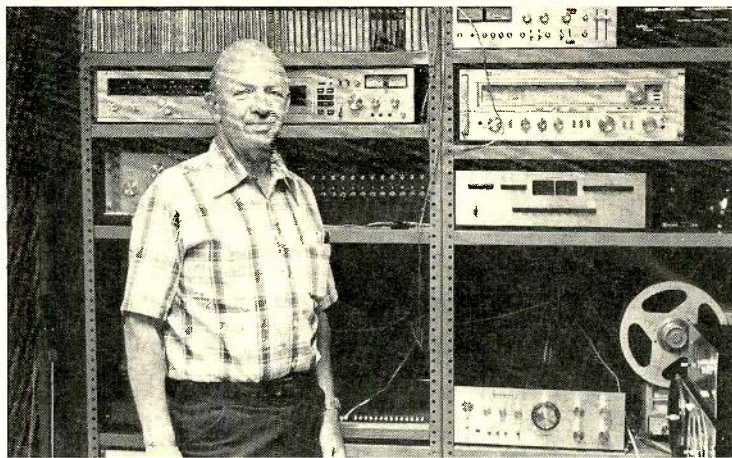

• Testing Loudspeakers—Part 4 •

In the past three issues I've been describing in some detail how Hirsch-Houck Laboratories quantitatively tests loudspeakers as well as spelling out our philosophy of testing. Briefly, I do not believe that measurements will ever be able to describe the sound of a loudspeaker totally, since (if for no other reason) there is no common language linking human perception to the world of acoustic measurements. A critical listener can learn to correlate—at least to some degree—the shape of a response curve with the audible sound produced. But even with my background of hundreds of speaker tests, I would hesitate to predict the *precise* sound of a speaker solely from an examination of its measured frequency response. However, from the sound of a speaker, I can fairly well predict the shape of its response curve as it would be measured in my laboratory.

In the final analysis, then, it all comes down to critical listening. Unlike some "experts," I am extremely reluctant to claim that my taste in the nuances of reproduced sound is the ultimate, or that a speaker I prefer is necessarily worlds above another one that may not appeal to me as strongly.

If we could somehow determine the *accuracy* of a speaker (as opposed to how *pleasing* its sound might be, since that is a purely subjective judgment), we would have a powerful handle on the problem of speaker evaluation. In the early days of hi-fi, there were a number of side-by-side comparisons between a live music source and the reproduced sound of the same performers; these were made on the reasonable assumption that facsimile reproduction of musical sounds was an indication of accurate reproduction. I recall attending such comparisons in Philadelphia's Orchestra Hall and New York's Carnegie Hall in which home audio components were given the task of duplicating the sound of solo performers, various groups, and the full Philadelphia Orchestra. None of the facsimiles were perfect, but the comparisons were still most impressive as indicators of the capabilities of those early components. At around that time, a group of fellow enthusiasts and I did much the same thing with the pipe organ in St. Mark's Church at Mt. Kisco, New York. We came, I think, a bit closer to success than the

earlier efforts, but the match between the live and the reproduced sound was still not quite perfect.

Later, Edgar Villchur used a live-vs.-recorded technique, often with startling success, to demonstrate the ability of his AR speakers to match the sound of such small, live sources as guitar soloists and chamber groups. Nearly two decades ago, listeners found that the AR speakers often provided a perfect imitation of the live source.

Does that mean that they were indeed "perfect" speakers? With all due respect, not quite. If they were, a lot of speaker designers have since been wasting their time trying to improve on perfection. Success in imitating a live source in a given environment depends as much on special recording and playback techniques as on the speakers themselves (assuming they are of reasonably good quality), and it really doesn't provide an adequate answer to the question of how the speaker will sound in the home when reproducing music recorded elsewhere.

Still, Villchur found this technique (using random noise instead of music) to be useful in testing the accuracy of the newly developed dome tweeters for his AR-3 system and later (with music) in testing the entire system. The appeal of the idea was strong, and we decided to apply it to our own speaker tests. With the assistance of Acoustic Research, a special test tape and reference speaker were prepared for us.

In order to compare a live source with a reproduction of the same material, it is necessary to have the original performers available for the comparison. This is inconvenient, to say the least, if you want to use live musicians. Therefore, the "original" performance we used is a tape recording of a number of brief musical selections. This monophonic recording is on track 1 of a 15-ips, half-track tape. The *sound* of this track as played through a good quality speaker (in our case, a modified AR-5) served as the reference "live" program for our tests.

The next step was to rerecord the "live" program on track 2 of the half-track tape so that it could later be played back alternately with the "original" sound on track 1. This recording had to be made anechoically so as not to impose an additional acoustic environment on the playback environment. Thus, we rerecorded the sound of the reference speaker—our "live" source—in an anechoic chamber, with the microphone very carefully positioned to insure that the signal recorded on track 2 was truly representative of the output of the reference speaker being fed by track 1.

When we used this in our listening room, the reference speaker was set up as close as possible to the speaker under test and was driven from track 1 of the tape. Its sound was, by definition, the "live" program. Track 2 of the tape, the special high-quality anechoic recording of the same sound, was used to drive the test speaker. After careful level matching, we would switch back and forth between the speakers and listen for any differences.

If the speaker under test were perfectly *accurate* over the frequency range covered by the test, its sound would be exactly like that of the reference speaker. If it were less than perfect in its accuracy, as it usually was, we

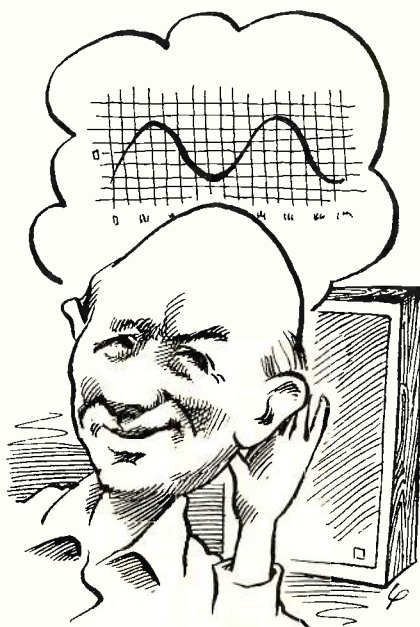

would be able to hear *some* change of tonal color when making the switch, and usually we could identify at least the approximate part of the frequency range that was responsible for the difference.

We have tested literally hundreds of speakers with this technique, but we recently decided to discontinue it. This does *not* mean that our results in the past were invalid. Our decision is based on a recognition of the advances in speaker design in the ten years or so that we have used this system and of some of the inherent limitations of the technique.

To reproduce the sound of the reference speaker perfectly, the speaker under test must not only have a perfectly flat frequency response, but its dispersion characteristics must be very similar to those of the reference speaker. Omnidirectional speakers and those using a substantial amount of reflected sound to achieve their effects can never sound like the original in this test, because their output is modified by the room acoustics in a different way than the forward-radiating sound from the "live" reference source.

A growing proportion of new speakers have very wide dispersion, often involving some use of reflected energy, and they are therefore

not easily tested with our simulated live-vs.-recorded system. In addition, the forward-facing, conventional speakers are beginning to sound more and more like each other, and so nearly like the reference that it is difficult to evaluate the differences. (Some of the major differences between speakers are in their bass responses, but our test is cut off at 200 Hz because of limitations in the anechoic chamber used to record the original tape.)

One possible solution would have been to expand the test greatly, using *three* reference speakers (one forward-facing, one radiating uniformly into a hemisphere, and one omnidirectional) and three tapes to go with them. This would have enabled us to match the directional properties of the "live" program to those of the test speaker and perhaps to obtain a closer sound match. The tapes would have had to be made in a very large chamber (or outdoors) to avoid the low-frequency limitations of the former system. All of this would have been quite expensive, time-consuming, and cumbersome. One other factor: space does not permit our going into detail, but there *are* some valid criticisms to be made against the entire simulated live-vs.-recorded test procedure.

Our other choice was just to drop this test entirely, and that is what we did. Modern speakers are so good that a test such as this would have to be greatly refined in order to reveal their inaccuracies clearly. We feel that we are able to do this better through the extended frequency-response measurements made possible by our new equipment, including a B&K microphone that is calibrated precisely from 4 Hz to 40 kHz ± 0.5 dB.

AT present, our subjective speaker tests consist merely of listening to and comparing the speakers just as anyone else would. We use an Advent comparator that lets the amplifier gain be trimmed to compensate for differences in speaker sensitivity, so that when we switch between speakers the apparent volume level does not change. Although this sort of comparison evaluates speakers only in one particular room, the same can be said for *any* listening test. Ultimately, each user must judge sound quality for himself, and *any* reviewer's comments on such matters should be taken as guidance, not gospel. That is the way it is, and despite better test methods, I suspect that is the way it is going to be for a long time to come.

Equipment Test Reports

By Hirsch-Houck Laboratories

TWENTY MEDIUM-PRICE AMPLIFIERS

Akai AM-2400	64	Philips AH 384	68
Harman Kardon A-401 ...	64	Pioneer SA-7500 II	70
Hitachi HA-330	64	Realistic SA-2001	70
JVC JA-S44	66	Rotel RA-713	70
Kenwood KA-5700	66	Sanyo DCA 611	72
Lafayette LA-40	66	Scott 440A	72
Marantz 1090	68	Sony TA-F5A	74
Nikko NA-850	66	Technics SU-7700	72
Onkyo A-5	68	Toshiba SB-420	74
Optonica SM-1515	68	Yamaha CA-410 II	74

ALL of us have had our perceptions of what things cost and how much they are worth radically changed by the distorting lens of inflation. This is as true of the audio field as it is of any other, and music lovers of modest means particularly may very well find themselves put off when confronted by the all-but-astronomical price tags on some of the newest, most sophisticated components. Just how much of the brimming cornucopia of sonic delights is within easy economic reach of those of us with not-so-brimming pocketbooks these days? What caliber of performance can reasonably be expected at the prices an ordinary buyer is prepared to pay?

To help answer these questions and others like them, Hirsch-Houck Labs decided to test a representative group of integrated amplifiers priced in the \$200 to \$300 range. Examination of the published specifications of amplifiers in this range, and experience with a few of them we had already tested, suggested that they might offer the optimum combination of performance and value.

Even while we were collecting the amplifiers we had decided to test,
(Continued on page 62)

See why TDK

It's the little things you can't see
that make a big difference in the way it sounds.

At first glance different brands of tape look pretty much alike. But if you look closely, you'll find there are many subtle differences. And it is these differences that make one tape stand out above all others.

Now you might not spend a lot of time looking closely at tape. But we have to—that's our business. At TDK we're committed to constantly improving our products. For years, our SA cassette has been the High bias reference standard for almost all quality cassette deck manufacturers. Yet we've incorporated improvement after improvement into SA's tape and mechanism since its introduction as the first non-chrome High bias cassette in 1975. These advances mean better quality sound for you. TDK makes this possible, by continuous attention to the little things you can't see.

The Particles

The lifeblood of recording tape is microscopic magnetic particles that can be arranged in patterns to store and reproduce sound. At best, they are as small as possible, uniform in size and shape; they are long and narrow (the greater the ratio of length to width, the better); and they are tightly, uniformly packed together, with no gaps or clumps.

Over 40 years of experience in magnetic ferrite technology and 25 years in developing and manufacturing recording tape, bring the TDK SA and AD cassette particle formulations as close to these ideals as current technology will allow.

The TDK SA particle is a cobalt gamma ferric oxide compound made highly stable by our proprietary cobalt-ion adsorption process. The SA particle possesses one of the greatest length/width ratios of any particle used in audio cassette recording: an amazing 11:1. These little wonders are truly "state-of-the-art," and mean higher maximum output level (MOL), higher signal-to-noise and lower noise.

The particle in TDK AD is *pure* gamma ferric oxide; it has been developed specifically for use in Normal bias decks—in the home, car, in portables. With a length/width ratio of 10:1, the AD particle can deliver what most conventional cassettes lack: an extended, hot high end, to capture all the elusive highs in music, from classical crescendo to raging rock and roll. It is the logical successor to the world's first high fidelity cassette tape particle, TDK SD, introduced in 1968.

clumps nor gaps of oxide build-up. So we suspend our particles in a unique new binding, and we're fanatic about the way we do it. TDK engineers and craftsmen wear surgically clean robes and caps, and we vacuum the air to eliminate

Tape layers: coating (top); backing.

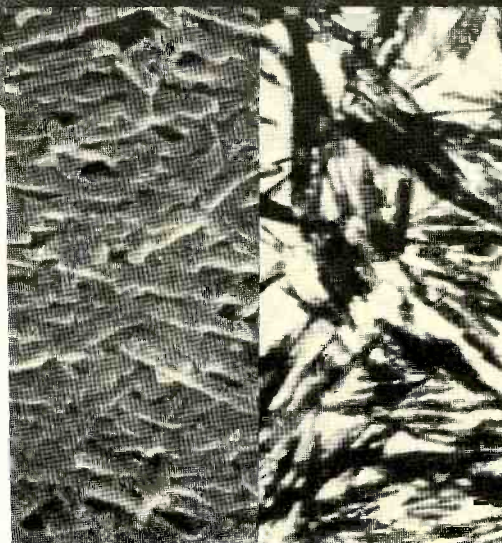
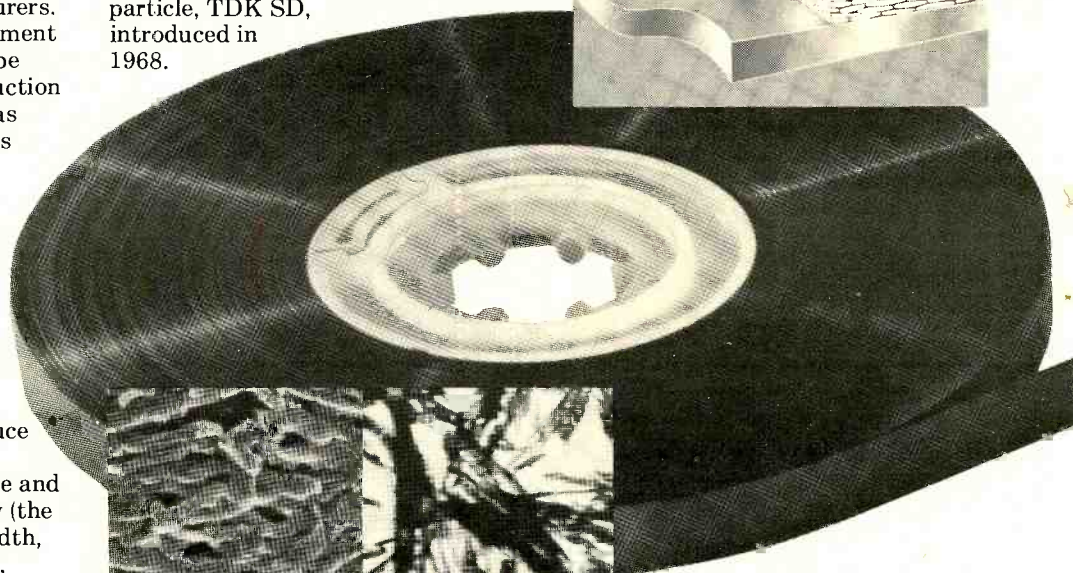
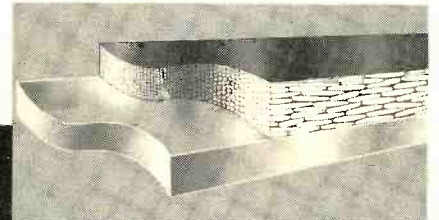

TDK SA tape surface (left) enlarged 30,000 times. TDK Super Avilyn particles (right) enlarged 20,000 times.

contaminating foreign matter and disruptive static charges. The high packing density that results means that the tape is prepared to handle high input level musical peaks gracefully, and without distortion.

The Base Film

We coat our oxides on broad rolls of supremely flexible, but nearly stretch-proof polyester film, to make sure TDK cassettes don't tangle or introduce wow and flutter.

The Polishing

After each roll is coated, it goes through a polishing process called "calendering." Any oxide is removed,

The Coating

To best attach the particles to the film used for backing, it's necessary to coat that film evenly, with neither

sounds better.

and the surface is smoothed to reduce tape head wear and oxide shedding. Reduced friction across the tape heads means lower noise.

The Edge

If you look closely at the edges of TDK's tape, you'll find that they are uniformly straight and parallel to a tolerance of one micron. That's because we slit our tape by pulling it across an array of precisely-positioned, surgically-sharp knives. That means the tape movement is unimpeded; and mis-tracking that could result in garbled stereo is eliminated.

The Hub/Clamp Assembly

TDK has met a major challenge which has always faced cassette manufacturers:

anchoring the tape to the hub without causing mechanical problems. We use a unique double clamp system we pioneered. It practically eliminates wow and flutter, distortion, drop-outs and other problems related to poor winding. Some manufacturers use plastic pins jammed into notches on the edge of the hub. This system can lead to uneven winding, which causes the edges to feather, the tape to bulk unevenly, and occasionally, to snap at the anchor.

The Cleaning

Like most leader tape, ours is designed to protect the recording surface from stress, and to provide a firm anchor to the hub. Unlike most leader tape, TDK's cleans your recorder heads as it passes by.

The Splice

Our splices are firm, with leader and tape lined up exactly. Our splicing tape is specially designed not to bleed adhesive into the cassette mechanism, which could gum up the works.

© 1978 TDK Electronics Corp.

The Inspection

Before any of our tape is loaded into cassette shells, it must pass a series of inspections to

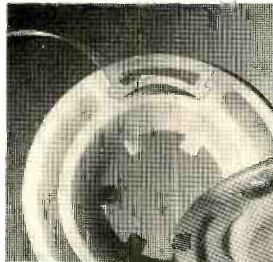

The TDK double clamp system.

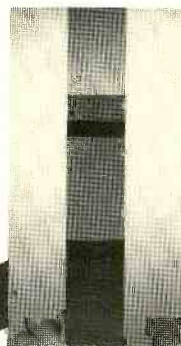

The TDK high tolerance tape/leader splice.

see if it matches up to our own rigorous standards. If it doesn't pass, it's discarded. We never compromise on quality.

The Music and the Machine

We go to more trouble than most companies do, when we manufacture our cassettes. We see to all the little details, so you can hear more of your music. Our super precision cassette mechanism delivers the tape to your heads precisely, without introducing friction, wow and flutter and other problems in the process. And we back that mechanism, and the tape within it, with high fidelity's original full lifetime warranty*, a measure of the value we have placed in our cassettes, for over 10 years.

So next time you buy cassettes, look closely at TDK, and think of all the little things you can't see that make our cassettes just that much better. TDK Electronics Corp., Garden City, NY 11530. In Canada: Superior Electronics Ind., Ltd.

*In the unlikely event that any TDK audio cassette ever fails to perform due to a defect in materials or workmanship, simply return it to your local dealer or to TDK for a free replacement.

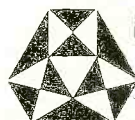

TDK®

The machine for your machine.®

TWENTY MEDIUM-PRICE AMPLIFIERS

Manufacturer and Model No.	Rated Power, watts, into 8 ohms @ % Distortion, 20-20,000 Hz	Price	Measured THD, %, at Rated Power			Frequency Response, dB, re 1 kHz Output		Clipping Headroom		Dynamic Headroom	
			20 Hz	1 kHz	20 kHz	Aux	Phono	dB	watts	dB	watts
Harman Kardon A-401	20 @ 0.5	\$200	0.063	0.056	0.16	±0.0	+1.2, -0.0	1.07	25.6	1.80	30.2
Yamaha CA-410 II	35 @ 0.05	235	0.03	0.01	0.016	+0.2, -0.1	+0.3, -0.7	1.76	52.5	2.06	56.2
Hitachi HA-330	40 @ 0.3	200	0.08	0.025	0.06	+0.2, -0.6	+0.3, -0.6	1.76	60.0	2.56	72.2
Lafayette LA-40	40 @ 0.3	220	0.063	0.038	0.032	+0, -0.3	+0.4, -0.3	2.52	71.4	2.81	76.5
Philips AH 384	40 @ 0.2	250	0.056	0.025	0.032	+0.2, -0.4	±0.1	1.10	51.5	1.48	56.2
Optonica SM-1515	40 @ 0.19	240	0.03	0.022	0.08	+0.4, -0	+1.4, -0	0.97	50.0	1.48	56.2
Akai AM-2400	40 @ 0.15	200	0.036	0.018	0.10	+0.2, -0.1	+0.9, -0	2.00	63.3	2.30	68.0
Kenwood KA-5700	40 @ 0.04	200	0.036	0.01	0.006	+0, -0.7	+0, -0.8	1.31	54.1	2.17	65.9
Toshiba SB-420	42 @ 0.3	230	0.056	0.016	0.063	+0, -0.5	±0.3	1.18	55.1	1.26	56.2
Marantz 1090	45 @ 0.1	240	0.063	0.036	0.05	+0, -0.3	+0.4, -0	1.75	67.3	2.05	72.2
Onkyo A-5	45 @ 0.1	250	0.04	0.01	0.016	+0.1, -0.3	±0.0	1.17	58.9	1.52	63.9
Pioneer SA-7500 II	45 @ 0.1	250	0.02	0.025	0.067	+0, -0.2	+0.8, -0.7	1.05	57.3	1.52	63.9
Rotel RA-713	45 @ 0.1	280	0.05	0.056	0.04	+0.2, -0.1	+0.6, -0.8	0.71	53.1	0.96	56.2
JVC JA-S44	45 @ 0.02	289	0.045	0.006	0.006	+0.0, -0.1	+1.1, -0.8	1.48	63.3	1.52	63.9
Technics SU-7700	50 @ 0.08	280	0.045	0.007	0.036	+0, -0.2	±0.1	1.21	66.1	1.60	72.2
Scott 440A	55 @ 0.05	330	0.025	0.014	0.04	+0.1, -0.4	+0, -1.0	1.38	75.7	2.13	87.8
Realistic SA-2001	60 @ 0.2	280	0.10	0.07	0.07	+0, -0.6	+0, -1.6	0.83	72.7	0.83	72.7
Nikko NA-850	60 @ 0.08	270	0.038	0.018	0.05	±0.1	+1.2, -0.0	0.90	73.8	1.30	80.9
Sanyo DCA 611	60 @ 0.08	250	0.032	0.016	0.08	+0, -1.7	+0, -2.2	1.22	79.4	1.54	85.5
Sony TA-F5A	70 @ 0.04	350	0.1 see text	0.01	0.056	±0.0	±0.0	0.13	72.0	0.13	72.0

INTERPRETING THE SPECIFICATIONS: The following comments are presented to help the reader interpret the tabulated test data.

• **Rated Power into 8 ohms:** simply the manufacturer's published rating for the amplifier. It is used as a basis for determining some measured ratings, such as the Clipping and Dynamic Headroom figures.

• **Measured THD at Rated Power:** total harmonic distortion (THD) measured with a spectrum analyzer at input frequencies of 20, 1,000, and 20,000 Hz. Both channels of the amplifier were driven to deliver their rated power to 8-ohm loads. The amplifier was pre-conditioned and heated by being operated for one hour at one-third of rated power, in accordance with FTC regulations. (It should be noted that virtually every distortion figure we obtained was entirely negligible from a listening standpoint.)

• **Frequency Response:** the variation in output

as the frequency of a constant-level input signal was varied from 20 to 20,000 Hz. It is expressed in decibels (dB) referred to the output at 1,000 Hz. The phono response is also corrected for the ideal RIAA equalization response.

• **Clipping Headroom:** the output of the amplifier at 1,000 Hz, with both channels driven to the clipping point into 8-ohm loads. It is expressed both in watts and in decibels relative to the manufacturer's rated power output. It is a measure of the conservatism with which the amplifier is rated by its manufacturer. For example, an amplifier rated at 50 watts that can deliver just 50 watts (no reserve margin) has 0 dB clipping headroom, but if it can actually deliver 60 watts at 1,000 Hz, its clipping headroom is 0.8 dB. For purposes of comparing the true power capabilities of these amplifiers, the Clipping

Headroom figures are more meaningful than the published power ratings.

• **Dynamic Headroom:** an indication of the regulation of the amplifier's power supply (the amount by which its voltages change under the varying load imposed by changes in signal level). There are different schools of thought in regard to regulation. Some (such as Sony, as exemplified by their TA-F5A amplifier) prefer a highly regulated power supply, which gives a very small Dynamic Headroom measurement. Others believe that a Dynamic Headroom of 2 or 3 dB helps to reproduce musical peaks without exacting an undue cost in power supply.

• **Input Sensitivity:** the input, in millivolts, that is needed to produce a reference output of 1 watt at maximum amplifier gain settings. It permits a comparison of how much signal voltage the

(Arranged in ascending order of rated power output)

Input Sensitivity, mV, for 1-watt Output		Maximum Phono Input, mV, at 1 and 20 kHz	S/N re 1 watt, dBa		Phono-input Impedance, kilohms and picofarads	Inputs		Filters		Meters	AC Outlets (S) Switched, (U) Unswitched	Dimensions, in.			Weight, lbs.
Aux	Phono		Aux	Phono		Hi	Lo	Hi	Lo			W	H	D	
28	0.58	130, 42	78.2	76.3	53, 120	2	1	No	Yes	No	1-S, 1-U	13 × 5¼ × 10¾	13.5		
30	0.56	140, 84	86.0	80.0	50, 200	2	1	Yes	No	Yes	2-S, 1-U	17½ × 5½ × 13½	17.2		
17.5	0.26	150, 89	72.8	71.0	44, 170	2	1	No	Yes	Yes	1-S, 2-U	15¾ × 5¾ × 13	17.2		
18	0.27	155, 90	71.0	72.8	45, 175	3	1	No	Yes	Yes	1-S, 2-U	15¾ × 5¾ × 13	17.3		
30	0.30	120	83.0	75.8	50, 110	2	2	Yes	Yes	Yes	1-S, 1-U	19 × 5½ × 14	25		
19.5	0.40	235	78.9	76.8	48, 500	2	1	Yes	Yes	Yes	1-S, 1-U	16 × 5¾ × 10	19.2		
21	0.40	160, 113	75.7	74.6	100, 120	2	1	Yes	Yes	No	1-S, 1-U	17¼ × 5¾ × 13	20		
25	0.41	233, 188	82.2	78.5	50, 70	2	1	No	Yes	Yes	2-S, 1-U	15 × 5½ × 11¾	16.8		
21.5	0.31	420, 262	77.7	75.4	53, 50	2	2	Yes	Yes	No	2-S, 1-U	17¾ × 5¾ × 14¾	25.3		
28.3	0.28	125, 66	84.4	79.8	52, 75	2	2	Yes	No	No	2-S, 2-U	16¾ × 5¾ × 11¾	20.9		
24.8	0.40	180, 162	80.7	77.0	49, 200	1	2	No	Yes	No	1-S, 2-U	17½ × 6¼ × 15	25.8		
22	0.30	205	83.6	76.0	49, 150	2	1	No	Yes	No	2-S, 2-U	15 × 5½ × 12½	20.1		
22	0.38	135, 100	71.8	66.8	50, 500	2	1	Yes	Yes	Yes	2-S	17 × 5¾ × 12	24.2		
21.3	0.30	230, 168	77.7	76.4	50, 175	2	1	No	Yes	Yes	2-S, 1-U	16½ × 6 × 12¾	22		
23	0.38	170, 53	80.0	77.0	50, 500	2	1	Yes	Yes	Yes	1-S, 1-U	17¼ × 5¾ × 13½	23.8		
18	0.25	225, 178	76.0	76.0	46, 300	2	1	Yes	No	Yes	1-S, 1-U	17 × 5¼ × 11¾	23.5		
25	0.15, 0.30, 0.68	210	75.3	73.8	50, 600	2	2	Yes	Yes	Yes	1-S, 1-U	16¾ × 5¾ × 12¾	23.0		
20	0.25	250, 157	81.4	78.9	49, 190	2	1	Yes	Yes	Yes	1-S, 1-U	15¼ × 5¾ × 12¼	19.8		
22	0.28	145, 100	77.8	73.5	42, 50	2	2	Yes	Yes	Yes	2-S, 1-U	16½ × 5¾ × 13¾	22		
19.5	0.265	260, 113	91.0	84.4	50, 175	2	1	Yes	Yes	Yes	2-S, 1-U	17½ × 5¾ × 14¾	18.1		

amplifiers actually require for the same listening volume.

• **Maximum Phono Input:** the phono overload level, which we have been measuring for many years. However, there is an important difference, in that this measurement is made at 20,000 Hz as well as at 1,000 Hz (formerly we used only the 1,000-Hz frequency). An ideal RIAA-equalized preamplifier requires a 19.6 dB greater input at 20,000 Hz than at 1,000 Hz for the same output (a voltage ratio of 9.55). If its high-frequency amplitude capability is limited for any reason, the 20,000 Hz waveform will become distorted before the input signal has reached 9.55 times the 1,000-Hz clipping level. The high-frequency waveform does not clip, as a rule, but becomes gradually distorted. We use the 1 per cent second-harmonic distortion condition (-40 dB) as a criterion of overload. The corresponding signal input, divided by 9.55 to obtain the equivalent

1,000-Hz input level, is shown as the second figure in the column (in a few cases, it is larger than the 1,000-Hz overload input, which is then used as the rating).

Although a preamplifier will rarely be driven to overload at these high frequencies, it *can* happen. This is believed to be one of the factors affecting the sound of a phono system, a cause of the differences sometimes heard between amplifiers.

• **Signal-to-Noise Ratio (S/N):** a measurement of the output of the amplifier across its speaker terminals with no input signal. The gain is set to the IHF standard value (0.5 volt at the high level input, or 5 millivolts at a phono input, for a 1-watt output at 1,000 Hz). The input is loaded with a 1,000-ohm resistor. The output noise is processed by an A-weighting filter (which reduces the effect of low-frequency noise and hum on the measurement, since they are much less audible than the higher-frequency hiss components).

The resulting voltage is expressed in decibels relative to 1 watt output, which is 2.83 volts across 8 ohms.

• **Phono Input Impedance:** the "resistance" is actually the input impedance measured at 1,000 Hz. A resistance is connected in series with the signal circuit going into the phono input and adjusted until the amplifier's output, as viewed on a spectrum analyzer, is reduced by half. At this point, the external resistance is equal to the amplifier's phono input impedance.

The capacitance is measured with a special capacitance meter (the Berkshire CCM) that plugs into the phono input. This measurement is made with the amplifier turned off; it is conceivable that the effective capacitance can be changed when the input circuit is active, but this effect is not readily measurable. In any event, the values obtained give a clue to any possible incompatibility between an amplifier and a specific phono cartridge.

What do you get when you put

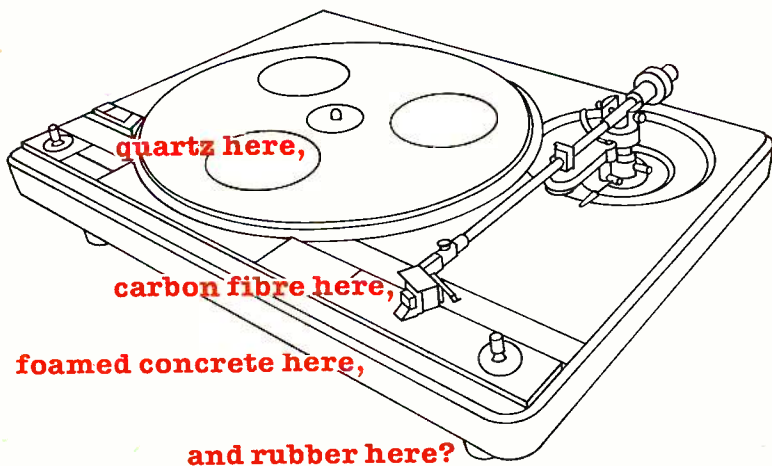

ADC THE FIRST LOW-MASS, TURNTABLE.

ADC is in the business of building breakthroughs.

First, we brought you the innovation of the low mass cartridge. Then the remarkable computerized Accutrac® turntables. Next, the State-of-the-Art Low Mass tonearms.

And now, our engineers have combined the latest advancements of tonearm technology and turntable construction to reduce mass and resonance to new lows.

Result: new benchmarks of high performance.

Finally, the integration of a carbon fibre design tonearm. The famous LMF Carbon Fibre tonearm was the model for the tonearm found on the ADC 1700DD.

In fact, until now you had to make a separate investment in an ADC tonearm to achieve this level of performance.

A level of performance never before available on an integrated turntable.

The mass is lowered by the development of a tapered profile. It is statically balanced with a lead-filled decoupled counterweight, and the headshell is molded carbon fibre, long known for its low mass to high tensile strength ratio.

Furthermore, the headshell is connected to the arm with gold plated computer terminal pins. And the main bearing cradle is made of sintered aluminum. The pivot system utilizes micron polished instrument bearings which are hand picked and matched perfectly to both the inner and outer races, for virtually frictionless movement.

The viscous cueing is a gentle 4mm/sec., and the tempered spring anti-skate adjustment is infinitely variable to 3.5 grams.

The design, the materials and the details interact to provide incomparable performance for a tonearm on an integrated turntable system.

In fact, the tonearm alone is worth the price of an ADC 1700DD.

Finally, resonance conquered. The technical know-how that conquered the problems of the tonearm mass, also conquered the problems of turntable resonance.

The ADC 1700DD reduces resonance to levels so negligible they are virtually nonexistent.

The achievement lies in the innovative construction formula for the turntable base that incorporates the latest advancements from European engineers.

The base is constructed with two dissimilar materials that are resonance-cancelling. First, the outer frame of the base is molded, and then a composition of foamed concrete is injected to absorb and neutralize resonance and feedback.

LOW RESONANCE

Beyond even this foamed concrete anti-resonance breakthrough, the base is isolated by energy absorbing, resonance-tuned, rubber suspension feet.

This is as close as technology has ever come to defying the physical laws of resonance.

The motor in the ADC 1700DD is also present standard of excellence: Direct Drive Quartz Phase-Locked Loop. The quartz is used in the reference oscillator of the motor.

An electronic phase comparator constantly monitors any variance in the speed, making instantaneous corrections. Even when out of the Quartz-Locked mode, the optical scanning system keeps drift at below 0.2%.

In fact, to check the speed at a glance, we've engineered the 1700DD with a pulsed LED strobe display for your convenience.

Low-mass. Low-resonance. High performance.

What is the result of all these breakthroughs? Pure pleasure.

The pleasure of enjoying your favorite music with less distortion and coloration than you may have ever experienced before. Now you can truly appreciate the integrity of the original recording.

Our engineers have reduced record wear and music distortion to a point where rumble is -70dB Din B, and Wow and flutter less than .03% WRMS.

In the history of audio technology, significant breakthroughs have been made over the past four years with the development of Quartz Lock Direct Drive, carbon fibre tonearms, foamed concrete anti-resonance construction. And now, ADC is the first to bring them all together in the 1700DD. We invite you to a demonstration of this and the other remarkable ADC turntables at your nearest franchised ADC dealer.

Or, if you'd like, write for further information to: ADC Professional Products, a division of BSR Consumer Products Group, Route 303, Blauvelt, N.Y. 10913.

Low-mass. Low-resonance. We think you'll be highly interested.

Distributed in Canada by BSR (Canada) Ltd., Rexdale, Ont.
*Accutrac is a registered trademark of Accutrac Ltd.



AMPLIFIERS

prices continued to rise, and some of them ended up beyond the \$300 limit. However, since these were among the amplifiers we would have included had we made such a survey only a couple of months earlier, we saw no reason to exclude them because of inflation's depredations. And, since similar economic conditions may be expected to prevail for some time, some of the prices quoted in the chart on pages 58-59 may have changed by the time you read this.

We assembled a group of twenty different amplifiers from as many manufacturers. They ranged in rated power output from 20 all the way to 70 watts with distortions from 0.5 to 0.02 per cent. Aside from these differences in electrical performance and the fact that a few models had unique or distinctive operating features, there was great overall similarity between the amplifiers. There was, in fact, a clearly visible "average" amplifier in this test sampling: a rated output of about 45 watts with 0.15 per cent distortion.

GIVEN the limitations of both testing (and use) time and publishing space, plus the large number of units involved, it was not practical to use all our normal test procedures. We chose to measure key characteristics only, following the new IHF Standard IHF-A-202, 1978, in almost every applicable detail. As a result, many of our test results do not correlate with the manufacturers' published ratings and specifications; our comparisons among the amplifiers are completely valid, however. The only manufacturer's rating of which we took any cog-

nizance was the FCC-mandated continuous power output and distortion, between 20 and 20,000 Hz, into 8-ohm loads. (The figures in the chart may not match those of the manufacturers in regard to distortion at 20 Hz because the bottom limit of our test generator's distortion is about 0.03 per cent.) This rating is basic to the clipping headroom and the dynamic headroom tests in the IHF standard. We did not attempt to measure tone-control or filter responses, since these will be set by the user as his ear dictates (the manufacturer's ratings for the filters are given in the text relating to each amplifier).

In the tabular presentation of our test data, we have departed slightly from the IHF standard by giving the clipping and dynamic headroom ratings both in decibels (as called for by the standard) and in actual watts output. The wattage figures may serve as a "bridge" between the former rating

system and the new one for those who have not yet adjusted to the IHF's "dB" ratings.

WE limited our listening to connecting each amplifier, in turn, to a tuner and speakers, checking the generation and "feel" of its controls at the same time. Each amplifier was auditioned in this way for at least one hour. We did not ear-check the phono input, since the variables introduced by phono cartridges would result in too many random sonic elements. The phono-input impedance column in the chart provides some guidance to the input's potential interaction with various cartridges. If a cartridge reacts well or badly to high or low capacitance, then it will not deliver optimum performance with some of the amplifiers. (Incidentally, capacitance can easily be added externally to low-capacitance inputs; it cannot be reduced, however.)

General Comparison

Most of the amplifiers in the test group are supplied in black (or dark-grey) metal cabinets. The Yamaha and JVC cabinets, however, are finished in light grey. The Optonica and Sony amplifiers have wooden side panels, and the units from Akai, Realistic, and Technics come in wooden cabinets covered with walnut-finish vinyl. The front panels and knobs are typically finished in satin aluminum, varying in color from silver to gold.

Thirteen of the amplifiers have twin output meters on their front panels. They are calibrated with varying degrees of accuracy to read in watts delivered to an 8-ohm load, and most have roughly logarithmic scales that can indicate power levels of a fraction of a watt. A couple have switched ranges, and one (Nikko) has continuously adjustable meter sensitivity.

All twenty amplifiers have a front-panel headphone jack (the Harman Kardon A-401 has *two*). All can drive at least two pairs of speakers, selected by front-panel controls (the Lafayette has three sets of speaker outputs). Most use insulated spring-loaded speaker connectors—just insert the stripped end of the speaker wire into the hole in the connector. Some—Hitachi, JVC, Kenwood, Onkyo, Optonica, Realistic, and Technics—use more conventional binding-post terminals.

The amplifiers from Marantz, Onkyo, Realistic, Rotel, and Toshiba have separate preamplifier outputs and main (power) amplifier inputs, joined by jumpers or a switch, so that signal-processing accessories can be connected to the system without using one of the tape-recording input/

(Continued on page 64)



The most powerful argument for our new receiver is not just power.



True, it's tempting to be swept up by our power.

150 watts per channel minimum RMS at 8 ohms, from 20Hz to 20kHz, with no more than 0.07% Total Harmonic Distortion, is nothing to sneeze at.

But raw power means nothing. What's important is how that power is delivered. In the case of the STR-V7, it's brought to you by Sony in a very classy package.

You get a combination of features and controls that are impressive on their own—but almost unheard of in a single machine.

To start with, we've built in a Dolby system, for decoding Dolbyized FM broadcasts.

The advantages of our tuner,

though, need no decoding. They include a normal and narrow FM IF bandwidth selector. It makes life simple for people in areas where their signals are crowded together elbow to elbow.

In our preamp section, the V7 comes equipped with a special phono EQ circuitry. Thanks to Sony's high IQ, it allows for direct connection of a low-output, moving-coil cartridge phono source. Without calling for an external step-up transformer or pre-preamp.

When you're gifted with as much power as the V7, you need a way to keep track of it. This receiver keeps tabs with two power-output meters, monitoring the power being fed to the speakers. So overload can't result from oversight.

And all that power comes from our direct coupled DC power amp. And our power is stable, thanks to a high-efficiency, high regulation toroidal-coil transformer.

There's a lot more to the STR-V7 than power. This receiver takes the best that contemporary technology has to offer, and offers it in a single machine.

Other manufacturers may have the power to bring you power. But only Sony has the power to bring you more than just power.

SONY AUDIO

© 1978 Sony Industries, a division of Sony Corp. of America, 9 West 57, N.Y., N.Y. 10019. Sony is a trademark of Sony Corp.

CIRCLE NO. 75 ON READER SERVICE CARD

AMPLIFIERS...

output circuits. Almost all the amplifiers can control two tape decks (the Harman Kardon has only one set of tape-recorder terminals). Most of them have front-panel switches for dubbing from either tape deck to the other (Philips and Kenwood can go only from recorder 1 to recorder 2). The Toshiba unit has a front-panel microphone jack with a separate level control that mixes the microphone signal with the regular program. Only the Sony lacks a loudness-compensation feature, and the Realistic and Yamaha amplifiers have separate level-setting controls that permit their loudness compensation to be used with full effectiveness (several others have "audio muting" switches that can be used to reduce the gain so as to operate the volume control in a more suitable portion of its range, but that is of course only a partial solution to the problem).

In recent years, many amplifier controls have been designed with mechanical detents that give an effect that can range from a positive switchlike setting to a slightly "ratchety" feeling as the knob is turned. The tone controls of eighteen amplifiers (all except Harman Kardon and Philips) have definite detented settings (Philips uses a detent at the center only). Most of the volume controls are also detented, if only to the extent of giving them the "ratchety" feeling mentioned. In the text for each of the amplifiers, its special features will be mentioned and described. Listing is in order of increasing rated power into 8 ohms, then decreasing distortion and alphabetically.



Akai AM-2400

● The power and distortion ratings of the Akai AM-2400 place it very close to the mean of the twenty amplifiers tested. Its power ratings are conservative, as evidenced by the relatively large clipping and dynamic headroom measurements.

The AM-2400 is one of the few amplifiers in this price group to have switchable tone-control turnover frequencies. Pushbuttons next to the tone controls change the bass turnover frequency from 400 to 200 Hz and the treble turnover from 2,500 to 5,000 Hz, as well as bypassing the tone-control circuits entirely if desired. The -3-dB response frequencies of the filters are given as 30 and 10,000 Hz (the slopes are not specified, and can be assumed to be 6 dB per octave).

Although the AM-2400, like the other amplifiers, has a specified nominal 50,000-ohm phono-input impedance, our measurements showed it to be 100,000 ohms, which produced a rise of 2.4 dB at 20,000 Hz when its phono response was checked through test phono-cartridge coils.

Circle 134 on reader service card

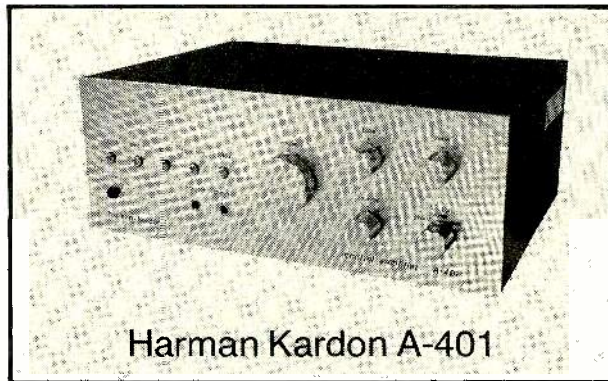

Harman Kardon A-401

● The A-401 enjoys the distinction of being the lowest in price, smallest, lightest, and lowest in power of the amplifiers tested. In fact, one might reasonably conclude that only its price accounts for its arbitrary inclusion in a group of amplifiers to which it has so little resemblance.

However, our tests show that the A-401 is rated quite conservatively, and under normal listening conditions its distortion is a small fraction of its rated 0.5 per cent. It is a smooth-handling, good-sounding amplifier with a minimum of "frills," and it should appeal to many people who are less impressed by meters and flashing lights than by good sound at a reasonable price. Although we had no difficulty driving low-efficiency speakers to a comfortable level with the A-401, this amplifier should be at its best with moderately efficient speakers.

Circle 135 on reader service card

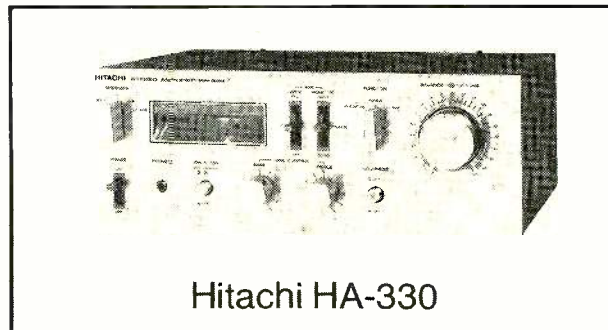

Hitachi HA-330

● Like most of the amplifiers, the Hitachi HA-330 is rated very conservatively. This "40-watt" amplifier can deliver 60 watts at the clipping point and more than 70 watts for short bursts (its dynamic headroom of 2.56 dB was one of the highest of the group). The distortion rating of 0.3 per cent was never approached in our tests; with both channels driven at full power, and fully heated by the preconditioning period, the amplifier's total harmonic distortion was comfortably under 0.1 per cent at all frequencies in the audio range, and only 0.025 per cent in the mid-range area.

The low filter is a true infrasonic rumble filter, with a 12-dB-per-octave slope below 20 Hz, and it is meant to be left on at all times in normal use. The meter scales, calibrated from 0.1 to 100 watts, are accurate within 20 per cent at most power-output levels.

Circle 136 on reader service card

(Continued on page 66)

The new Yamaha Separate.

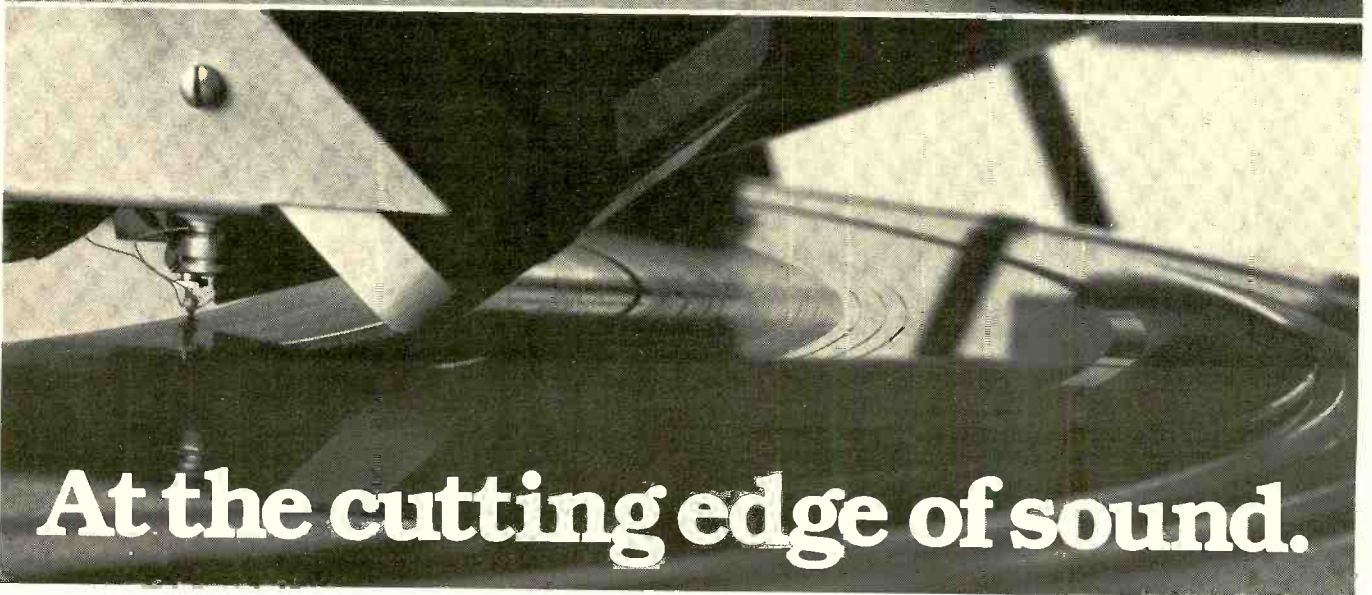
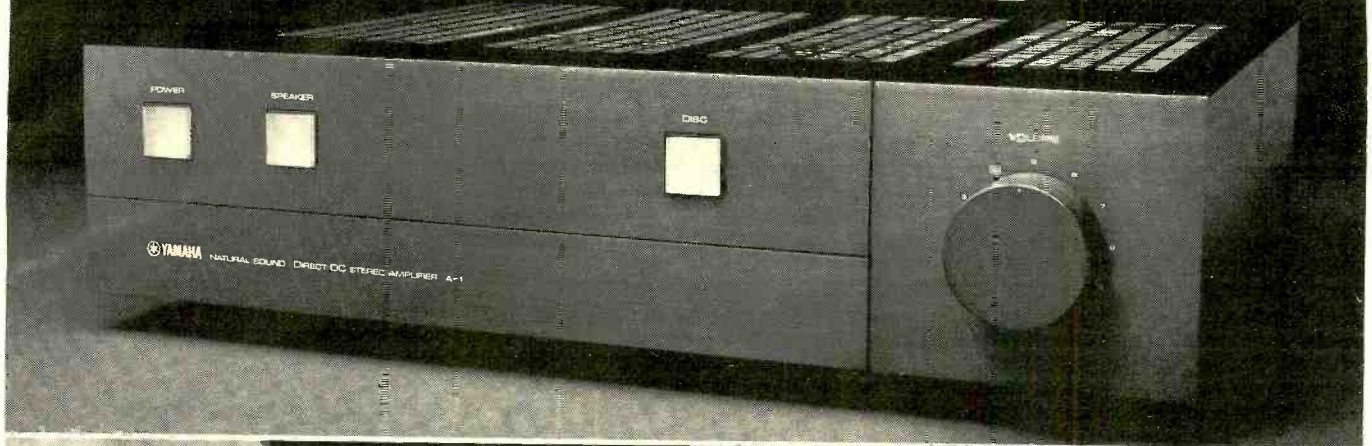

At the cutting edge of sound.

At the very edge of audio technology is exactly where the new Yamaha A-1 Amplification System stands.

Our engineers got there by cutting out excess circuitry and components through innovative configurations that reduced the very number and possibilities for noise and distortion to occur. It's as close as you can get to the proverbial straight wire with gain.

For a key example, note the computer-grade DISC switch on the right front panel. Engage it and you virtually direct-couple the phono cartridge to the output power amp. When disengaged, the tone control circuit is inserted between the DC phono equalizer and the DC amplifier. Sleekly positioned behind the bottom front panel, these precision tone controls can be used to enhance any signal source.

There's even a built-in MC Head Amp so

you can enjoy the transparent highs and extended frequency response of a moving coil phono cartridge.

In short, precision sound has never been achieved so cleanly and simply in look and function. So go for the cutting edge. Listen to the new A-1 Amplification System and its companion, the new T-1 Tuner, at your Audio Specialty Dealer.

For his name, check the Yellow Pages, or write Yamaha.

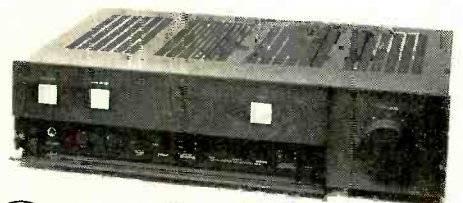
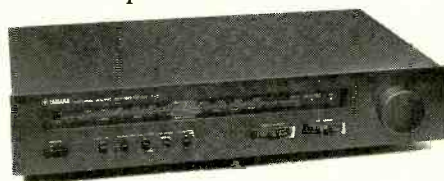

Audio Division, P.O. Box 6600, Buena Park, CA 90622

AMPLIFIERS...

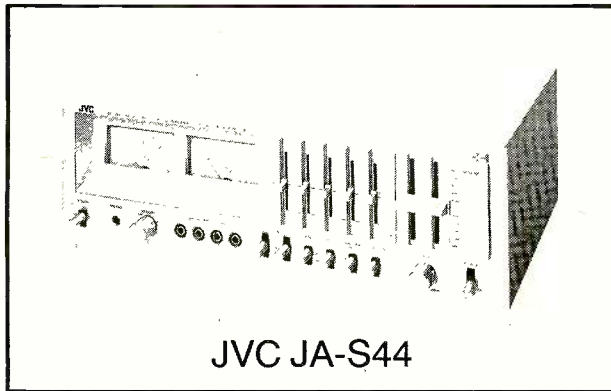

JVC JA-S44

● This amplifier is distinctively styled to match JVC's other audio components. It has a five-band (SEA) equalizer, operated by vertical sliders that have ± 12 -dB ranges centered at 40, 250, 1,000, 5,000, and 15,000 Hz. This is far more versatile than any two- or three-band tone-control system, and the entire equalizer can be bypassed by a front-panel button.

The volume control is also a vertical slider. The low filter has a 6-dB-per-octave slope below 18 Hz. The TAPE 2 input and output jacks are on the front panel, which is convenient for patching an extra tape deck temporarily into a system that normally uses one tape deck. It is, of course, less desirable if *two* decks are customarily used, since the front jacks are not duplicated in the rear of the amplifier.

The JA-S44 has the lowest distortion rating of any of the amplifiers tested. Within the limitations of our test equipment, we confirmed that it easily surpasses its ratings (the 20-Hz THD measurement was limited by residual distortion in our signal source). Like most of the amplifier meters, those of the JVC were accurate within about 10 to 20 per cent at most readings (they are also larger and more legible than most of the others).

Circle 137 on reader service card



Kenwood KA-5700

● Kenwood's KA-5700 has the lowest distortion rating (0.04 per cent) of any of the "40-watt" amplifiers we tested. As it happened, a number of the other amplifiers whose manufacturers gave them much higher distortion ratings nevertheless produced very similar readings in our tests. However, the benefits of Kenwood's low-distortion circuitry are demonstrated by a distortion of only 0.006 per cent at rated power and 20,000 Hz. This was matched

only by the JVC amplifier, with most of the others having at least ten times as much distortion at that frequency.

The low 70-pF input capacitance of the KA-5700 places it in a subclass with the Toshiba, Marantz, and Sanyo amplifiers, all of which have less than 100 pF of phono-loading capacitance. Kenwood's low filter has a 6-dB-per-octave slope, with its -3 -dB response at 18 Hz. This amplifier is the smallest and lightest of the group (although the Pioneer is almost the same size) except for the Harman Kardon, which is in a class by itself. Like most of the other amplifiers' meters, Kenwood's have typical errors of 10 to 20 per cent over their calibrated range of 0.03 to 60 watts.

Circle 138 on reader service card

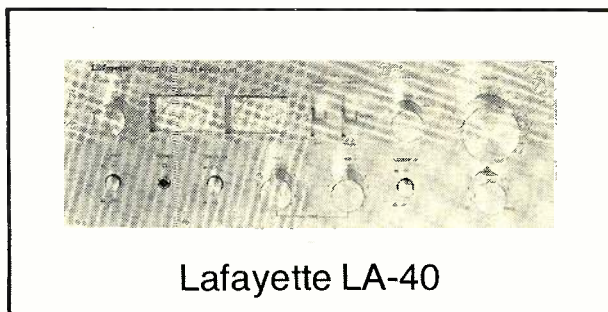

Lafayette LA-40

● The Lafayette LA-40 is another amplifier whose actual performance far surpasses its ratings. It has the greatest clipping and dynamic headroom of the twenty amplifiers tested, being able to deliver almost twice its rated power (76.5 watts) for a short burst, and a full 71.4 watts of continuous output at 1,000 Hz.

Its low-cut filter is a useful infrasonic filter, cutting off below 20 Hz with a 12-dB-per-octave slope. The meters, calibrated from 0.1 to 100 watts, are accurate within 20 per cent at most points. We noted that the meter illumination dims perceptibly when the continuous power output exceeds about 10 watts per channel.

Circle 139 on reader service card

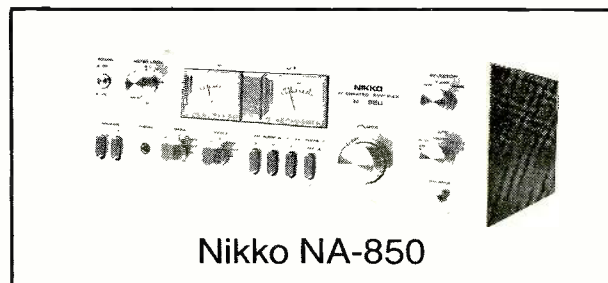

Nikko NA-850

● The Nikko NA-850 has all the conventional features found on the other amplifiers, with the addition of continuously adjustable meter sensitivity. The meters have scales calibrated from -20 to $+3$ dB, much like those of a cassette recorder. There are also two power scales from 0.6 to 60 watts and from 0.01 to 1.5 watts, with the upper limit corresponding to the 0-dB marking. When the meter sensitivity control is set fully counterclockwise, the 0-dB mark corresponds to 60 watts; at the clockwise limit, 0 dB is 1.5 watts. Calibrations on the front panel permit the

(Continued on page 68)

This new tuner, amplifier and turntable are all by LUX.

We'll leave the speakers up to you.

The tuner and integrated amplifier are from LUX's new Studio Standard Series, our newest and most modestly priced line of separates. Their features and performance, however, are anything but modest.

The T-4 tuner, for example, has LUX's exclusive Accutouch tuning system. The knob physically locks at every stat on that exceeds the tuning threshold—from 5 to 300 μ V. LUX's closed-loop tuning circuit is precisely referenced to the station's carrier frequency for lowest-distortion reception. And the i.f. bandwidth is adjustable—wide (normal) or narrow—to accommodate

date station density throughout the FM band.

The L-5 integrated amplifier has a DC direct-coupled power amplifier section with frequency response extending from 5 Hz to 100 kHz, +0, -1 dB. Bass and treble tone controls have switchable turnover frequencies, plus total tone defeat. Subsonic filter in addition to low and high-cut filters. And when tape decks are not in use, a special switch totally disconnects them from the amplifier, preventing loading which causes preamp distortion.

The PC-272 is LUX's lowest-priced turntable. Its servo-controlled

direct-drive brushless DC motor is totally free of the cogging (pulsing) that plagues many other direct-drive motors. And the straight, statically-balanced tonearm has a nested tube construction and internal damping that deal very effectively with resonance. Another feature: the vertical pivots extend through the arm, minimizing lateral play.

Altogether, these three components will deliver a clean, virtually distortion-free signal to your speakers. We'll leave that final decision to you and your LUX dealer—whose taste is as high in speakers as in electronics and turntables.

LUX Audio of America, Ltd.

160 Dupont Street, Plainview, New York 11603 • In Canada: White Electronics Development Corp., Ontario

Luxman T-4 AM/FM stereo tuner. Adjustable sensitivity, 10.3 dBf (1.8 μ V); 50-dB quieting sensitivity, 14.7 dBf (2.8 μ V); S/N: 75 dB. Alternate-channel selectivity, 85 dB (narrow), 40 dB (wide). THD (at 1 kHz) 0.08% (wide). (Luxman T-2: AM/FM stereo tuner similar to T-4, less Accutouch and CLL.)

Luxman L-5 integrated amplifier. 60 watts per channel minimum continuous power into 8 ohms, 20-20,000 Hz, with no more than 0.03% total harmonic or intermodulation distortion. Damping factor: 80 at 1 kHz (8 ohms). Phono signal-to-noise ratio better than 52 dB (IHF-A re 10 mV input) (Luxman L-3, similar, but 35 watts per channel, 20 Hz-20 kHz, 0.04% THD.)

Luxman PD-272. 12" die-cast aluminum platter with high density mat, 3.96 lbs. Detachable hinged cover, adjustable isolating feet. Separate pitch control ($\pm 4\%$), each speed. Rumble: better than 70 dB (DIN B); wow and flutter: better than 0.03% (WRMS).

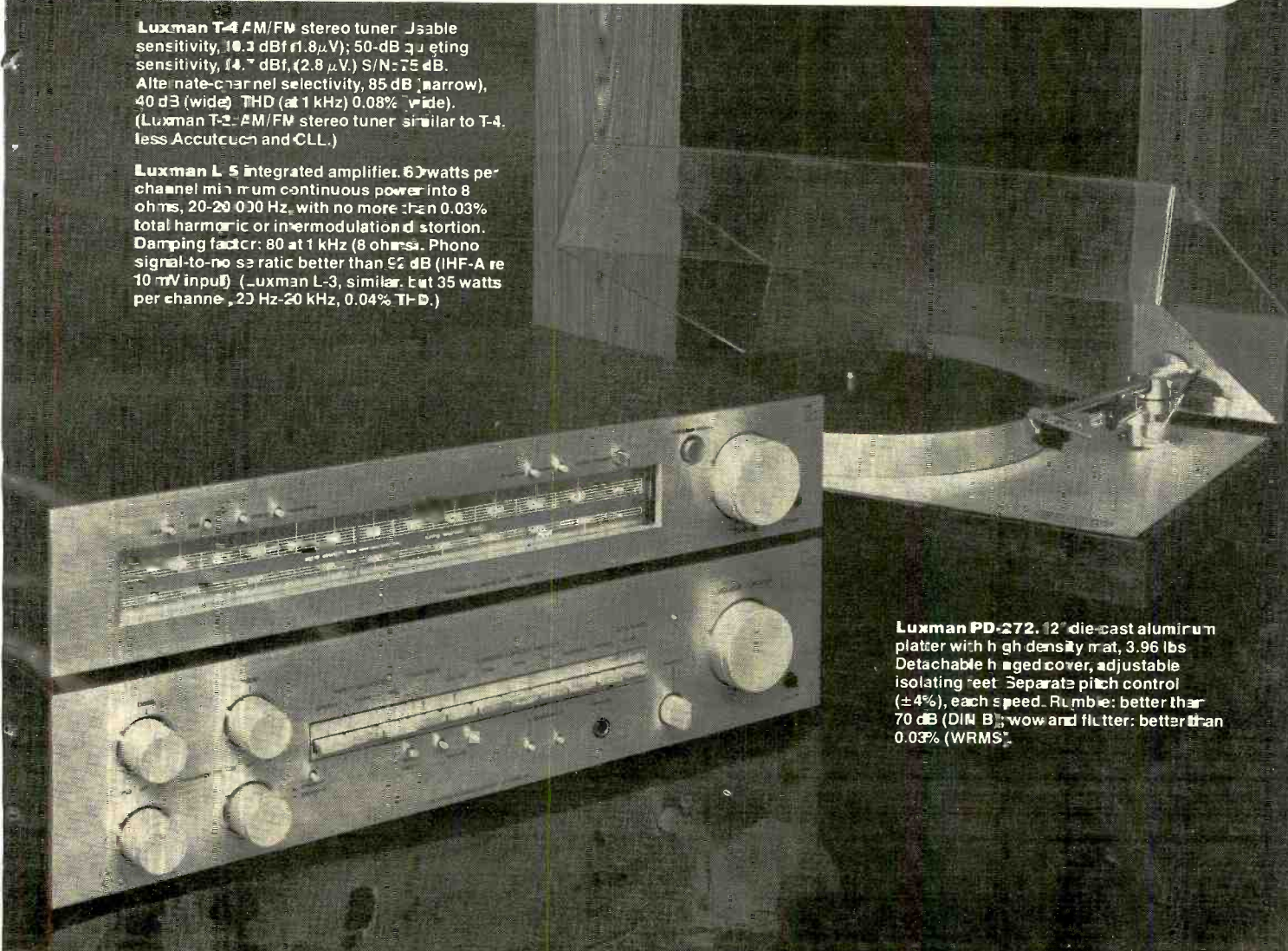

AMPLIFIERS...

0-dB reading to be set to correspond to almost any intermediate power-output level.

The low- and high-cut filters have rated cutoff frequencies of 15 and 10,000 Hz, with the slopes unspecified (and therefore presumed to be 6 dB per octave). The meter calibration errors are 30 to 50 per cent at most intermediate readings and several hundred per cent at the lowest readings, though near the top of the scale the error was only about 10 per cent. The relay protection system of the Nikko NA-850 is very effective, cutting the amplifier off instantly when it is overdriven.

Circle 140 on reader service card

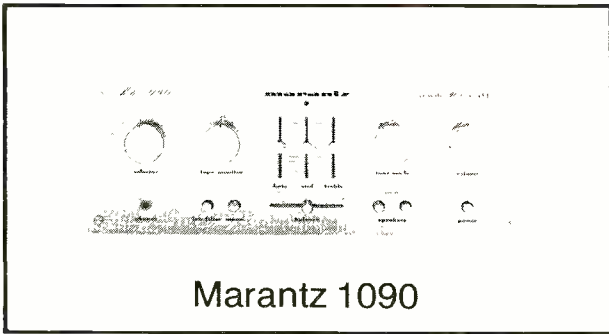

Marantz 1090

● The Marantz 1090 shares a number of control features, as well as its styling, with other Marantz products. It has three-band tone controls (bass, mid-range, and treble) using vertical sliders, plus a knob that can bypass the tone controls or activate the loudness compensation.

In addition to its 8-ohm power rating, the Marantz 1090 is rated to deliver 57 watts per channel to 4-ohm loads, from 20 to 20,000 Hz, with less than 0.1 per cent THD. The phono-overload limit, which is a good 125 millivolts at 1,000 Hz, decreases to the equivalent of only 66 millivolts when measured at 20,000 Hz.

Circle 141 on reader service card



Onkyo A-5

● Onkyo's Model A-5 is one of the heaviest and largest amplifiers in this price class. Its massiveness, which is quite genuine, is accentuated by the large volume-control knob. The bar knobs used for the other functions are both easy to turn and easy to read. The low filter cuts off below 10 Hz at a 6-dB-per-octave rate. The Onkyo A-5 is also

rated to deliver 50 watts per channel to 4-ohm loads, between 20 and 20,000 Hz, with no more than 0.1 per cent THD.

Circle 142 on reader service card

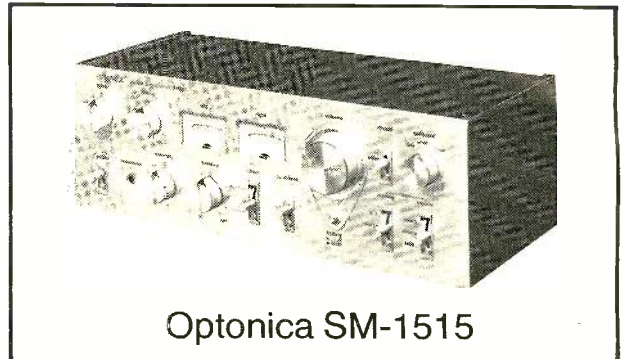

Optonica SM-1515

● Optonica's SM-1515, though very similar in most of its features to the other amplifiers, has distinctive and functional styling that sets it apart. Many amplifier controls lack clear index marks and panel markings that identify their settings and functions at a glance. Optonica uses gracefully tapered metal pointer knobs whose shape not only simplifies their operation but leaves no doubt about their positions even when viewed at a distance.

This is one of the two amplifiers in the group (the Scott 440A being the other) whose phono response at 20,000 Hz is not affected measurably by the presence of a high-inductance phono-cartridge winding in the signal path. In the SM-1515, this response is combined with a rather high phono-overload limit which is fully maintained throughout the audio spectrum (the 1,000-Hz overload is actually slightly lower than the figures obtained at 20 and 20,000 Hz). Our measurements suggest that the overall high-frequency and transient performance of the SM-1515 phono preamplifier is closer to the ideal than that of most of the other amplifiers in the group; however, it did have a relatively high phono-input capacitance—500 pF.

The output meters, calibrated from 0.01 to 70 watts, are somewhat less accurate than most, with errors of 40 to 50 per cent near the upper end of the meter range. The high and low filters, with 6-dB-per-octave slopes, had their -3-dB response frequencies at 7,000 and 30 Hz.

Circle 143 on reader service card

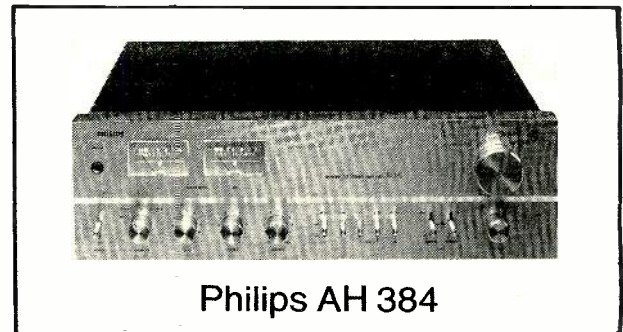

Philips AH 384

● The Philips AH 384 is the largest and heaviest of the amplifiers tested, although it is only about average in its
(Continued on page 70)

Empire introduces a revolutionary cleaning method that peels off every trace of dust, dirt and oil from deep down in your record's grooves.

A gentle sponge applicator spreads Disco Film over every inch of your record's surface.

It penetrates, surrounds and adheres to all the accumulated debris that can wear down diamonds and vinyl alike.

Once it dries into a flexible film you just peel it off.

Hold it up to the light and you can actually see all the gunk that was hiding in your record's grooves.

Play the record and you'll immediately hear how much better it sounds without the "clicks" and "pops" dirt can cause.

Disco Film cleans so thoroughly that your records will be cleaner than when you first bought them. And it is safe to use. The water soluble contents of Disco Film will not irritate records or skin in any way.

So don't put off better sound any longer. Peel off record dirt now with Disco Film.

Another record care product from the company that cares about your records, Audio Groome by Empire.

You get results in four easy steps:



1. Remove the cap from the Disco Film container and place your record on top of it. It is designed to support your records without allowing the grooves to touch any surface that would dirty them. One finger on the label holds the record in place.

Empire's new Disco-Film cleans your records like new. And here are the pictures to prove it.

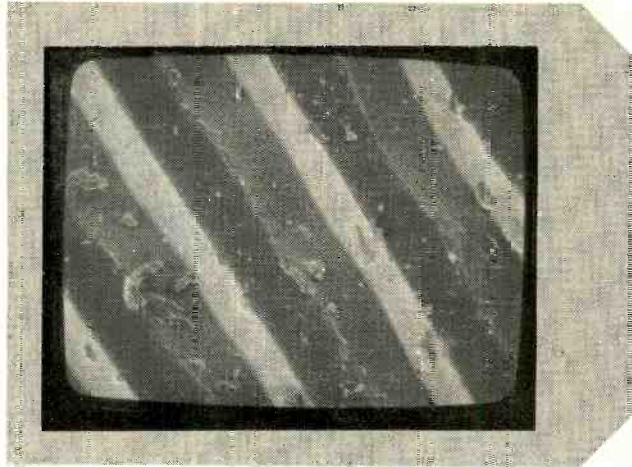

Before

500X magnification of a dirty record groove.

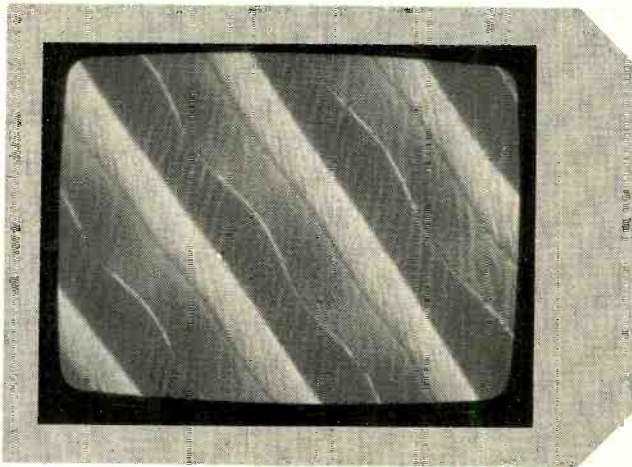

After

500X magnification of the same record groove after using Disco Film.

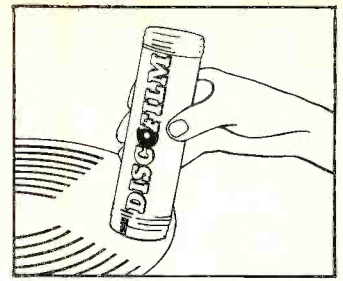

2. Squeeze out a generous portion onto the record and use the sponge applicator to gently work it into the grooves. Start from just outside the record's label and spread the gel towards the edge until the playing surface is covered. Flip it over and repeat the process.

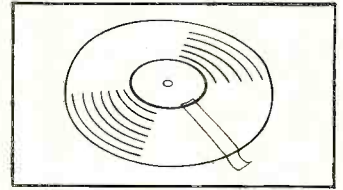

3. When completely dry, about 45-60 minutes depending on its thickness, place a strip of cellophane tape from the record's label to beyond the record's edge.

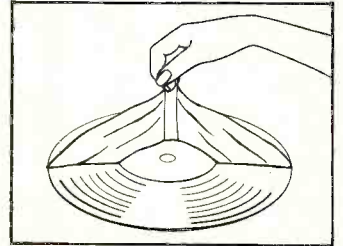

4. Using your fingernail, pry the outer edge of the film to help start its peeling. Then pull the tape slowly towards the center of the record until you have removed all of the Disco Film (any excess film can be removed with an additional piece of tape).

Write for your free brochure on all the fine record care products by Audio Groome.

EMPIRE

Empire Scientific Corp., Dept. AG, Garden City, N.Y. 11530



AMPLIFIERS...

power rating (the same chassis and panel are used on some higher-power Philips amplifiers). Two different distortion ratings are listed for this amplifier: a Philips brochure gives it as 0.05 per cent and the instruction booklet gives 0.2 per cent. We assumed the latter figure to be correct, although the amplifier also met the more stringent ratings.

The filters of the AH 384 have 6-dB-per-octave slopes, with nominal cutoff frequencies of 70 and 10,000 Hz. The meters are calibrated in decibels from -20 to +5 dB, but nowhere is the 0-dB reference given. According to our measurements, it is about 13 watts output into 8 ohms.

The Philips AH 384 is notable for being one of the few amplifiers in this group (with Optonica, Pioneer, and Realistic) whose phono preamplifier maintains its full overload rating from 20 to 20,000 Hz. In other words, when the overload signal level at 20 or 20,000 Hz is converted to the equivalent input at 1,000 Hz (according to the RIAA equalization response), the result is approximately the same as the actual measured value at 1,000 Hz. (The 20-kHz overload level given in the table [maximum phono input column] is also converted to the 1-kHz equivalent.)

Circle 144 on reader service card



Realistic SA-2001

At the top of the new Radio Shack amplifier lineup is the Realistic SA-2001. It carries a substantial power rating of 60 watts per channel at 0.2 per cent THD, and our tests indicate that its power-supply regulation is extremely stiff. As a result, its clipping and dynamic headroom ratings are identical at 0.83 dB, corresponding to a power output of about 73 watts.

The SA-2001 has a very complete array of control features, including switchable tone-control-turnover frequencies (125 or 400 Hz for the bass and 3,000 or 7,000 Hz for the treble). It also has three different phono-input sensitivities, selected by a switch in the rear of the amplifier. The phono-overload limit at 1,000 Hz was actually lower than the values at 20 or 20,000 Hz, which is quite unusual. In the least-sensitive switch position, the SA-2001 can handle phono inputs of as much as 440 millivolts, anywhere in the audio range, without distortion, placing this amplifier squarely at the head of the group in this respect. Even in the middle switch position, which gives a phono sensitivity roughly similar to that of the other amplifiers, its dynamic range is among the best in the group. However, the phono-input capacitance of this amplifier is among the highest in the group, and it varies

with the sensitivity setting. We recommend using the highest sensitivity, which gives a 500-pF capacitance—still on the high side, but no more so than that of several other amplifiers. The phono-overload limit is about 110 millivolts in this condition, which is perfectly acceptable.

The panel, knobs, and other controls of the Realistic SA-2001 are finished in a frosty satin aluminum, quite different from the bright finish used on most amplifiers. The two level meters are at the bottom of the panel; they are calibrated from 0.1 to 10 watts and from 1 to 100 watts, with the range selected by a pushbutton. Typical meter error is about 20 per cent.

Circle 145 on reader service card



Pioneer SA-7500 II

The very compact Pioneer SA-7500 II ranks near the top of its power group in almost every respect, including S/N, distortion, and phono-overload rating. Unlike the case with most of these amplifiers, the phono rating is established in the Pioneer by the 1,000-Hz overload limit of 205 millivolts. At 20,000 Hz, the equivalent overload input is about the same.

The SA-7500 II has a low-cut filter that cuts off at 15 Hz with a 6-dB-per-octave slope. Like several of the amplifiers in its power class, it is also rated for 4-ohm operation, delivering 50 watts with 0.1 per cent THD from 20 to 20,000 Hz.

Circle 146 on reader service card



Rotel RA-713

Although the Rotel RA-713 is rated similarly to several other amplifiers in this group (45 watts at 0.1 per cent THD), it has appreciably lower clipping and dynamic headroom ratings than most of the others. This does not in any way diminish its performance within its rated lim-

(Continued on page 72)

The Realistic SCT-30 tells it like it is:

Why 3 heads are better than 2. Why 2 capstans are better than 1. Why double Dolby* is better than single.

3 Heads.

Two independent record and play heads eliminate the compromises of one combined r/p head, and the head assembly is integrated to eliminate azimuth error. The result: cleaner sound. The third head lets you monitor

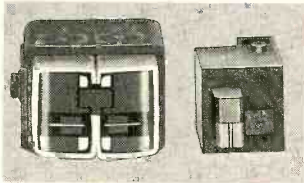

your recording an instant after it's made, without interrupting the program. SCT-30 has 3 heads!



2 Capstans.

Dual capstans (instead of the usual 1) reduce wow and flutter to an inaudible 0.06% WRMS or less, and extend the audio frequency response. SCT-30 has dual capstans!

Double Dolby.

You know the single Dolby system cuts noise and adds dynamic range. But let's examine double Dolby. You get Dolby on both record and monitor so you know exactly what your tape will sound like.

You get a decoder for recording superb Dolby FM stereo. And you get simultaneous listening enjoyment of the decoded broadcast on receivers with tape monitoring. The Realistic SCT-30 has double Dolby! About \$380.



P.S. - Supertape® Gold.

To go with 3 heads, 2 capstans and double Dolby, you need a cassette tape that will enhance — not degrade — performance. That's why we design and manufac-

ture Supertape Gold in our own Fort Worth factory. Like SCT-30, it's a playmate you can believe in at a price you can afford.

Why Realistic®?

Because Radio Shack has delivered quality audio at sensible prices since 1921, its Realistic tape and recorder line can point to over 5,000,000 customers as living proof of these claims. Add after-sale service that isn't lip service. Add in-house engineering and manufacturing of much of the Realistic line. And add the convenience of neighborhood shopping where you get "sound talk" from a specialist. That's Realistic!

*TM Dolby Laboratories, Inc.



Radio Shack®
The nationwide supermarket of sound™.

Radio Shack is a Division of Tandy Corporation, Fort Worth, TX 76102. Over 7000 locations in nine countries.

AMPLIFIERS...

its, but means only that its actual clipping power output and short-term peak output are somewhat less than those of its direct competitors. This is apparently the result of very stiff power-supply regulation (the supply voltages of the RA-713 do not change very much with varying signal levels).

The S/N measurements of the RA-713 are not as impressive as those of some others, but in use it is as quiet as any of the amplifiers. This is easily explained: the program source, in almost every case, will have more noise in it than will be added by *any* of the amplifiers in this group. The phono capacitance of 500 pF is relatively high, and the RA-713 should be used with a phono cartridge whose response is not degraded by a high load capacitance.

The filters of the RA-713 have 12-dB-per-octave slopes with cutoff frequencies of 20 and 20,000 Hz. Unlike most such filters, they are apparently designed not to remove audible hiss or rumble, but to remove noise *outside* the audible frequency range that could cause intermodulation or other overload effects. The meters, calibrated from 0.05 to 50 watts, have an error of 10 to 20 per cent of their readings over that range.

Circle 147 on reader service card

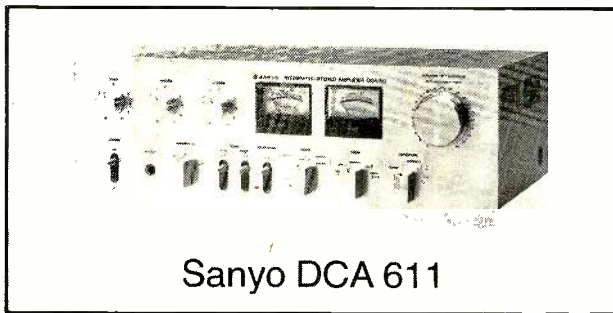

Sanyo DCA 611

● This new amplifier from Sanyo has easy-to-use bar knobs for most of its switching functions. It also has low and high filters with unspecified characteristics. The mode switch provides for normal and reverse stereo as well as mono from either input through both outputs. This was once a common feature in stereo amplifiers and receivers, but only the Sanyo among the present group has it. There is a triple tone-control system with a separate mid-range control. In addition to the two sets of tape-recording and monitoring terminals, there is a stereo jack on the front panel marked RECORD OUT 2. This carries the selected program to a third tape deck plugged into the jack (this is for recording only; there is no monitoring provision).

The meters on the DCA 611 have the usual 10 to 20 per cent error at most readings. However, this holds true only in the middle frequency range, such as at the 1,000 Hz we use for most test measurements. At lower or higher frequencies, the meter response falls off markedly, to the point where a full-power 20-Hz signal produces only a moderate pointer deflection. The scales are calibrated from 0.02 to 60 watts.

Circle 148 on reader service card

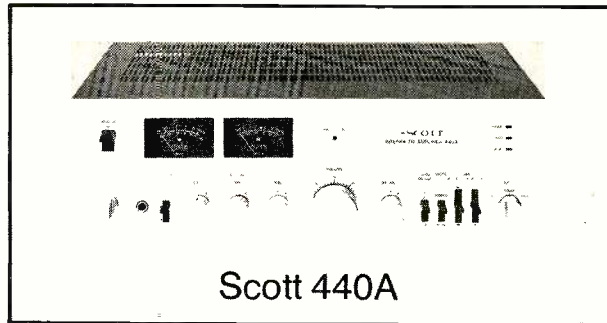

Scott 440A

● The Scott 440A is part of a new amplifier line from that company. Its styling is somewhat less "European" than their models of the recent past, yet it differs distinctly from that of most other Japanese-made amplifiers (like almost all of the amplifiers in this group, the Scott 440A is made in Japan). The dynamic headroom of 2.13 dB, slightly higher than the average of the group, enables the 55-watt rated Scott to deliver musical peaks of almost 88 watts before clipping. Although the 20,000-Hz phono overload limit of the 440A is somewhat lower than its 1,000-Hz overload level, it meets the amplifier's rated overload specification.

The markings for the input-selector knob are highly legible (as, indeed, are all the other panel markings of the amplifier), and they are augmented by colored lights above the knob that show which input source has been selected. The 440A has a three-band tone-control system with a mid-range control as well as the usual bass and treble controls. Its high-cut filter has a 6-dB-per-octave slope and cuts off at 8,000 Hz. The meter calibrations are exceptionally accurate at low readings, with an error of only 10 per cent from 0.001 to 1 watt, but the error increases to nearly 40 per cent at the 10-watt mark. There is one more calibration point, at 100 watts, but the amplifier will not reach that level. The meters, therefore, are useful and accurate indicators at normal listening levels (in the milliwatt and low watt range) but are of little value when the amplifier's limits are approached.

Circle 149 on reader service card

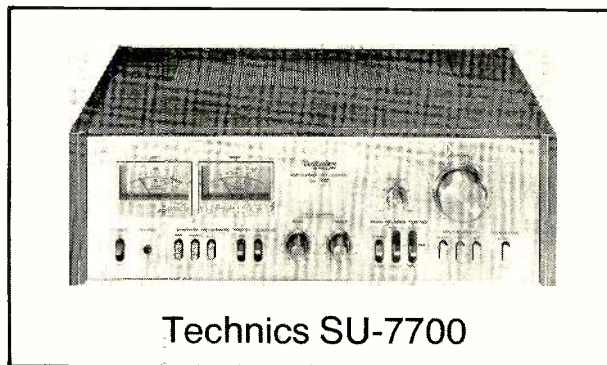

Technics SU-7700

● The Technics SU-7700 is one of the few amplifiers in its price range to come with a walnut-finish wooden cabinet. It makes effective use of pushbuttons, lever switches, and knobs to provide an excellent combination of operating "feel" and legibility in its operating controls.

Although the 1,000-Hz phono-overload input of 170 millivolts easily surpasses the amplifier's 150-millivolt

(Continued on page 74)



Enormously Efficient.

The computer-optimized Wharfedale E's. Beautifully designed and crafted. For the sophisticated connoisseur of sound.

Unusually efficient (94dB/W,m), the E's are clean and easy-to-listen-to. Response is wide and flat 50-18,000Hz, ± 3 dB for the E-70), with exceptional bass response. Distortion is inordinate y—and in a d b y—low.

That's why audio experts acclaim the E's. And why audiophiles adore them.

The Wharfedale E-70's and E-50's come in matched, hand-finished walnut-veneer pairs. Audition them at your Wharfedale dealer today. We know you'll be enormously impressed.



WHARFEDALE®



RANK HIFI Inc., 20 Bushes Lane, Elmwood Park, New Jersey 07407 (201) 791-7888

CIRCLE NO. 63 ON READER SERVICE CARD

AMPLIFIERS...

rating, its 20,000-Hz overload (referred to the equivalent 1,000-Hz level) is only 53 millivolts. This is one of the lowest phono-limit measurements in the group (only the Harman Kardon, at 42 millivolts, is lower). Whether or not it is significant, it at least suggests a relative lack of high-frequency transient response in the phono-preamplifier section. The phono-input capacitance of 500 pF is also relatively high.

On the other hand, the frequency response of the SU-7700, checked through either the high-level or phono inputs, is about as flat as our instruments can measure. The low filter has a 12-dB-per-octave slope beginning at 30 Hz, but the high filter cuts off above 8,000 Hz with a 6-dB-per-octave slope. The meters of the SU-7700 are somewhat more accurate than the others, reading within 10 per cent of the true power output into 8-ohm loads over almost their full range of 0.03 to 60 watts. This range is covered in two segments, with a pushbutton to change the meter sensitivity by a factor of ten.

Circle 150 on reader service card

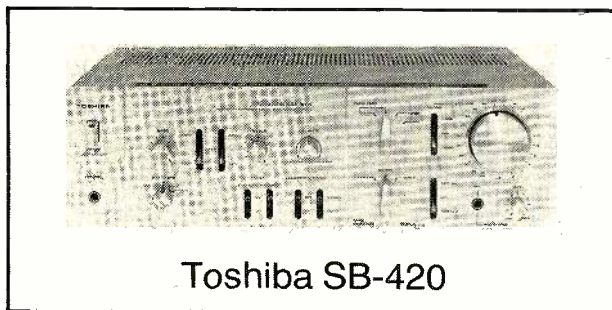

● The Toshiba SB-420 is one of the larger amplifiers of the group, and some of its performance measurements and control features also set it apart from the others. For example, it is one of the "flattest" in its overall frequency response, through either the high-level or the phono inputs. It also has the highest IHF-rated phono-overload rating of any of the amplifiers having comparable input sensitivity.

The filters of the SB-420 have 6-dB-per-octave slopes, with their -3-dB frequencies being 20 and 8,000 Hz. This is one of the few amplifiers to have selectable tone-control turnover frequencies (400 or 200 Hz for the bass, and 2,500 or 5,000 Hz for the treble) plus a tone-bypass feature. The front-panel controls are highly legible and have a good tactile response owing to the use of long-handled lever switches and bar knobs where appropriate.

The Toshiba amplifier has a three-position "muting" switch that reduces the audio gain by 10 or 20 dB. A by-product of this feature is the ability to operate the volume control at a higher than normal setting; this makes the loudness compensation more pleasing in many cases. The SB-420 also has a microphone input with a separate mixing gain-control knob. Unlike those of most amplifiers with microphone mixing facilities, the microphone signals from the SB-420 can be recorded on a tape deck by using a separate pair of MIC MIX recording outputs (these signals do not appear at the normal tape outputs). The Toshiba is also one of the few amplifiers to carry a FTC

power rating for 4-ohm loads: 50 watts per channel from 20 to 20,000 Hz with less than 0.3 per cent THD.

Circle 151 on reader service card

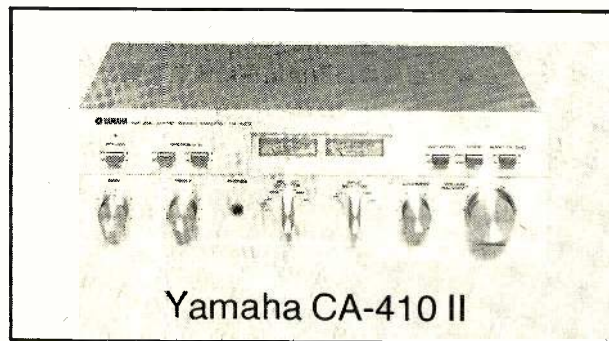

● Yamaha was the first manufacturer we know of to establish a policy of carrying the same level of basic performance through all price levels in the product line. The low-price (and relatively low-power) CA-410 II is an excellent illustration of this policy. Although it is rated at a modest 35 watts, it can deliver more than 50 watts to 8-ohm loads under most conditions. It also has a 4-ohm rating of 40 watts with 0.1 per cent distortion.

The Yamaha CA-410 II has separate controls for selecting the tape-recording and listening-signal sources, plus one of the few really effective loudness compensators we have seen. These features are also found on Yamaha's more expensive amplifiers and receivers. The level meters are calibrated from 0.01 to 50 watts and are accurate within 10 to 20 per cent at most readings. The high-cut filter cuts off at 8,000 Hz with a slope of 6 dB per octave.

The 1,200 picofarad (pF) phono-input capacitance of the CA-410 II is the highest we measured among these amplifiers. This amplifier should be used with phono cartridges whose performance is not seriously affected by a high load capacitance.

Circle 152 on reader service card

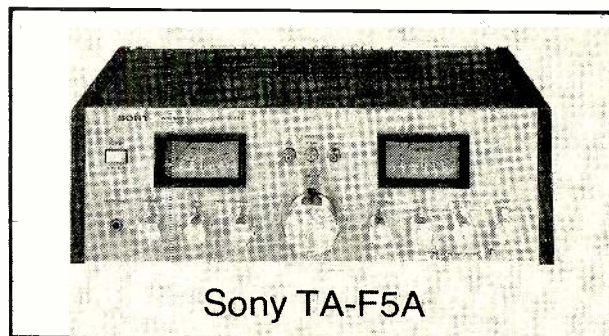

● This amplifier, like the Harman Kardon A-401, has little in common with many of the amplifiers in the test group. Its 70-watt power rating is substantially higher than the others, and its price is somewhat higher. However, it is of special interest because of its switching-type pulse power supply, which dispenses with the usual large, 60-Hz power transformer and bulky filter capacitors. Instead, the 120-volt a.c. input is rectified directly and used to power an oscillator that generates a high-power square-

(Continued on page 76)



Sankyo WIDE RECEIVERS



A wide receiver: he's a professional. Exciting to watch, dependable, powerful and tough, too. And he can deliver the kind of performance that will set the crowds cheering.

Well, the Sankyo line of Wide Receiver Stereos are all that... and more!

These new models have the quality features professionals specify. They're built with power

to spare. Built tough to give years of trouble-free dependability. Built with the exciting chrome or black front you're looking for.

And they can deliver the kind of audio performance that will make them an all-star in your record book.

Sankyo Wide Receivers... put them on your team and become a winner!



Sankyo

Sankyo Seiki (America) Inc.

149 Fifth Avenue, New York, N.Y. 10010 • (212) 260-0200

West Coast Office: 991 Francisco Street, Torrance, Calif. 90502 • (213) 321-0320

AMPLIFIERS...

wave signal at about 20,000 Hz. This is stepped up by a relatively small ferrite-core transformer and rectified to produce the amplifier's d.c. operating voltages. Only small filter capacitors are required at this high operating frequency. A regulating system maintains the amplifier's operating voltages constant within 1 per cent over a wide range of input-voltage and load changes.

The Sony TA-F5A has generally conventional, though refined, amplifier circuits. Its filters have 6-dB-per-octave slopes with cutoff frequencies of 15 and 9,000 Hz. The amplifier is no larger than many of the 40- or 45-watt amplifiers tested, and its 18-pound weight places it among the lightest of the group. This is a tangible benefit of the pulse-type power supply.

The extremely tight regulation of the power supply gives the TA-F5A its unique property: a clipping and dynamic headroom of only 0.13 dB. Since the power-supply voltages do not change with signal level, the amplifier delivers the same power output on a continuous basis as it does on short bursts. This gives rise to the strange situation that many of the so-called "55-watt" or "60-watt" amplifiers can actually deliver more momentary power under real listening conditions than this 70-watt amplifier.

We had difficulty measuring the full-power distortion at 20 Hz, which requires a 200-second scan time on our spectrum analyzer. After a number of attempts, we concluded that the distortion was changing appreciably dur-

ing the measurement interval, making the results questionable. Most of our readings were in the range of 0.1 per cent. At higher frequencies, where shorter analysis times could be used, the measured distortion was much lower.

On the "plus" side of the ledger, the Sony TA-F5A has a perfectly "flat" frequency response. There was not even 0.1 dB of output variation through either the high-level or the phono input over the 20- to 20,000-Hz range. The S/N of this amplifier is also far better than that of the others (and they are all very good). The noise level was too low to measure through the high-level inputs (it was better than 91 dB below 1 watt), and it was barely measurable through the phono input.

The power supply is very well shielded, and no trace of the switching frequency or its harmonics could be detected in the outputs down to more than 90 dB below rated power. The meters are quite accurate at low readings (0.01 to 0.1 watt) but the error increases to 20 or 30 per cent as the maximum reading is approached (the scale is calibrated to 100 watts).

The input selectors are light-touch pushbuttons with lights in their centers to show which source has been selected. The other controls are conventional knobs with a flat portion to provide a clear tactile and visual indication of the control setting. The volume-control knob is quite large, and it has a comfortable detent action. The power-transistor heat sinks extend from the rear of the amplifier, and four "feet" in the corners of the rear panel permit the amplifier to be stood on its back.

Circle 153 on reader service card

Commentary

When we undertook this project, we did not really expect to find any great differences among such similar products in such a highly competitive market. In general, the twenty amplifiers we tested do all that is claimed for them—and more. Overall, their refinement of performance and operation is most impressive. It would be difficult to single out any of the units as being markedly superior to their competitors. One might have its lowest distortion at 1,000 Hz while another would be lower at 20,000 Hz, and a third at 20 Hz. Similarly, there are minor differences in response flatness, S/N, and other characteristics, most of which are not likely to be audible under normal conditions.

We did, however, find some real differences among these amplifiers, principally in their phono-preamplifier sections. For most amplifiers, the phono-overload level is specified by the manufacturer (when it is specified at all) at a frequency of 1,000 Hz. Our measurements at that frequency suggest that none of these amplifiers could be overloaded by any present-day phono cartridge playing any commercial recording—in the mid-range. However, the new IHF amplifier

standard calls for phono-overload measurements to be made at other frequencies in the audio range as well, and converted to an equivalent 1,000-Hz level. In most cases, we found that the phono preamplifiers fell well short of matching their mid-

range performance when the phono overload was measured at 20,000 Hz. At that frequency, waveforms will "round" rather than "clip," and we used the spectrum analyzer to determine the level at which the distortion
(Continued on page 78)

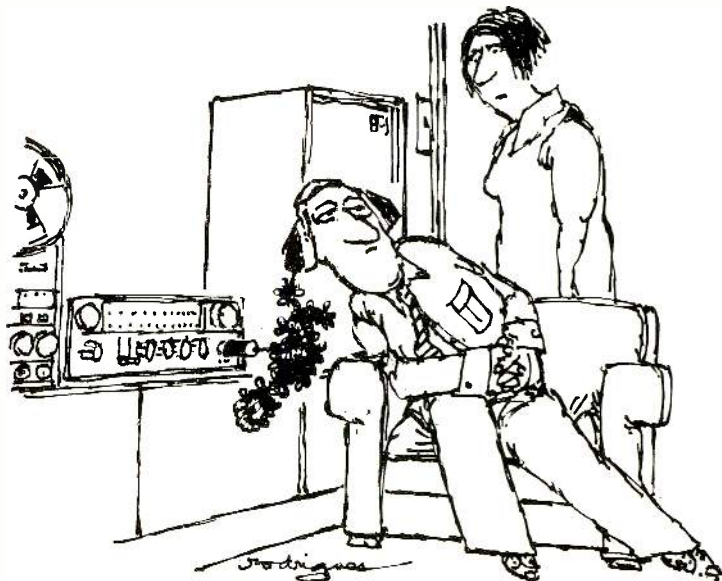

A \$150 cassette?

That's what our FX-I audiotape has been called, because of the *audible* improvement it makes. Especially on medium-priced decks and automobile cassette players.

People say it's almost unbelievable. Richer, fuller bass. Cleaner, more extended highs. Greater detail than they've ever heard before. (Or even thought their system could provide!)

It's all due to FX-I's Pure-Ferrix formulation: a unique low-noise gamma ferric oxide. With increased output at frequency extremes, to compensate for roll-offs in tape-deck response. And to help good equipment sound even better.

To hear how much better your deck can sound, make your next recording on Fuji FX-I. Our little cassette can make a big difference.

FUJI

Magnetic Tape Division of Fuji Photo Film U.S.A., Inc.
350 Fifth Avenue, New York, New York 10001

CIRCLE NO. 33 ON READER SERVICE CARD

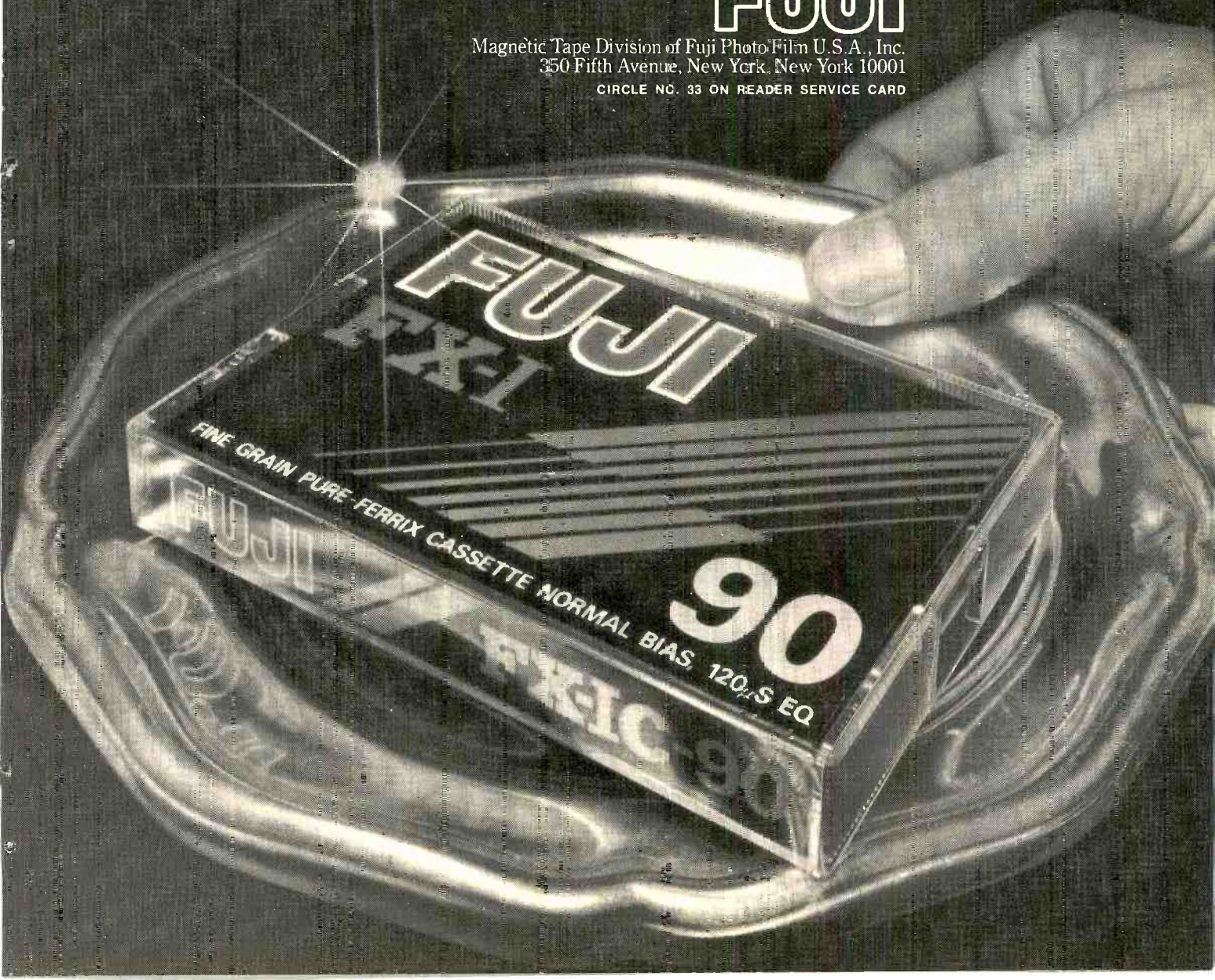

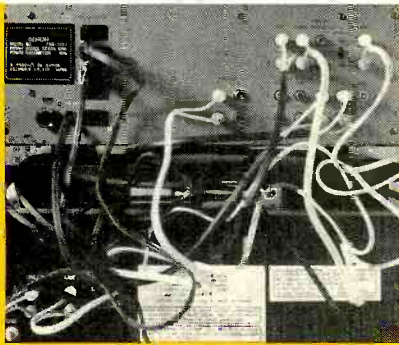

YOUR RACK'S TANGLE HAS A CURE:

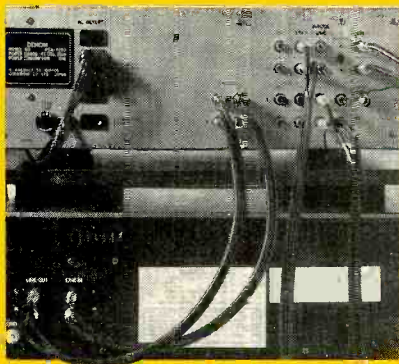

NEW HALF-METER GOLD-ENS™

- No hanging patch cords from stacked components.
- Reduces RF interference and hum.
- Superior quality Gold-ens have multi-strand hot and shielded leads.
- Molded nylon covers over individually soldered connections.

 **discwasher®**, inc.
1407 N. Providence Rd.
Columbia, Missouri 65201

AMPLIFIERS

rose to 1 per cent (-40 dB). This level is completely unambiguous when the signal is monitored on the analyzer screen. Since the 20,000-Hz response of an RIAA-equalized amplifier is 19.6 dB below its 1,000-Hz response, we divided the measured overload voltage by 9.55 (the equivalent voltage ratio) to obtain the IHF rating.

Somewhat to our surprise, only four of the twenty amplifiers did as well at 20,000 Hz as at 1,000 Hz. Often the decrease in level was moderate (20 to 30 per cent), but in some cases it was only a small fraction of the 1,000-Hz reading. It is certainly conceivable that *some* combinations of record and cartridge could overload *some* of these amplifiers at the highest frequencies. One thing seems certain, however: a phono preamplifier that does not exhibit this effect is less likely to be overloaded than one which does.

Even more disturbing (and surprising) was the range of input-capacitance values we measured on these amplifiers. Four of them were under 100 pF (one as low as 50 pF), but five of them had a capacitance of 500 pF or greater (one as high as 1,200 pF). It

NEW TEST METHODS

• Hirsch-Houck Laboratories is now using the Institute of High Fidelity's new *Standard Methods of Measurement for Audio Amplifiers* (IHF-A-202 1978). For convenience in making comparisons with previously tested products, we will correlate the new measurement results, when appropriate, with measurements made using our previous techniques. Copies of the new standard are available for \$7 from the Institute of High Fidelity, Dept. AS, 489 Fifth Avenue, New York, N.Y. 10017.

is a little difficult to understand how these amplifiers perform as well as they do with some cartridges, since most record players will add another 100 to 200 pF to the circuit. A few cartridges operate well with a 500-pF load, but 700 to 1,400 does seem excessive!

A possible justification for these high input-capacitance values is their potential benefit in reducing RFI (radio-frequency interference). We can think of no other reason why a manufacturer would place such a large capacitance in the phono input, given its possible deleterious effect on cartridge performance.

Summary

Our tests show very little significant difference between most of these amplifiers. The true power-output capabilities of the units can be seen in the clipping headroom and dynamic headroom columns of the table of test data. In spite of the apparently great spread of power outputs, in respect to clipping headroom it should be noted that the most powerful amplifier (the Sanyo DCA 611) delivers only 2 dB more output than the lowest-power amplifier (the Optonica SM-1515). (We exclude the Harman Kardon A-401 from this comparison since it is really in a different category.)

Probably the most reasonable way to make a choice from among these amplifiers would be on the basis of their features, styling, and price. For someone who enjoys modifying the frequency response of a system, one of the units with a mid-range tone control (or, better yet, the JVC with its five-band equalizer) would be worth considering. If you rarely use tone controls, this is of no importance. A few amplifiers have two phono inputs (marked Lo in the table) or three high-level inputs (Hi) compared

with the typical single phono input and two high-level inputs. If added input flexibility is important, your choice is easier.

Although meters are a very prominent feature of many of these amplifiers, do not be unduly influenced by their presence or absence. They are of little real value in indicating the *true* power output of an amplifier or even in showing when overload is occurring or is imminent. They can be considered a cosmetic feature, like the styling of the panel and the knobs.

When it comes to appearance, tastes differ widely, and we make no recommendations in this respect. To us, there was nothing compellingly attractive (or repulsive!) about the appearance of any of the amplifiers.

The consumer whose plight we were concerned with in the opening paragraph of this article is really most fortunate. Just about any of these amplifiers will provide superb performance, free of noise and distortion, with all the system flexibility many will ever need—and all in a compact, attractive, reliable, and inexpensive package. □

FOR THE PRICE OF A WATCH, OWN THIS GENIUS OF A CHRONOGRAPH.

Now there's a chronograph whose design dramatically outdistances all others. That's not big, bulky and mechanical like some. Or costly, finicky and undependable like others. And unlike the red LED's with their push-to-light displays and quick-to-die batteries—this one uses a power conserving liquid crystal display instead.

It's the Realtime Quartz Chronograph. A timepiece that masterfully joins the genius of micro-circuitry, ruggedness and styling. And it's available to you by mail through the Sharper Image, for only \$69.

So much data. Squeezed so thin.

Slimmer than 7mm, only 2.9 ounces, the Realtime chronograph is everything you could ask for in a watch, or a stopwatch.

In watch mode, it continually displays the hour and the minute, and every second flashes by. In large, crisp, liquid crystal digits. (Without you pressing buttons.) Its Union Carbide batteries last a year or more and can be easily changed by your local jeweler. Separate batteries for night light and time give you extra dependability.

Accuracy is calibrated to within 55 seconds a year.

Press the side button to command the month, date, and day of week. Easy to read, even in bright sunlight. It's American made chip is programmed to adjust for the end of the month, with resetting needed only once every four years.

They're off!

Stopwatch is activated with a command from the righthand face button (no interruption of watch operation).

Now you're ready to time any event to 1/100 of a second with uncanny precision, thanks to a quartz crystal whose vibrations split every second into 32,768 parts. The Realtime is more accurate than the finest mechanical chronograph ever made.

Record lap times. Cumulative times. Flick to watch mode anytime without interrupting the count. Or freeze the numbers at any moment. Take time out. You may even time beyond 60 minutes with Realtime's automatic start-over.

Built to take it.

The Realtime Quartz Chronograph runs in the rain. Goes swimming. Climbs mountains. It's carefully crafted of 100% solid stainless steel throughout—case, bracelet, clasp, buttons. The face crystal is hard rock glass (unlike the easily scratched plastic ones on most chronographs). It's shock-resistant, and invulnerable to perspiration, dust and the weather.

Realtime is in fact water resistant to 3 Atmospheres of pressure, and can be safely immersed in water to 80 feet.

What more do you get for \$69?

Assurance.

Your Realtime will never need maintenance as the solid state components have no moving parts. In the unlikely event that it needs repair, there are prompt service-by-mail facilities right here in the U.S. There's a 1 year factory warranty on parts and labor.

Buy without obligation.

We want you to be satisfied with your Realtime Quartz Chronograph.

After you receive it, wear it. Put it through the paces. Compare it with any chronograph that comes along. If for any reason whatsoever it's not the timepiece you expected, return it within two weeks. You're guaranteed a full and courteous refund, with no questions asked.

To order, send check for \$69 plus \$1.50 delivery (add \$4.14 sales tax in Calif.). Credit card holders may order with our toll free number below.

ORDER TOLL FREE (800) 824-7888. Ask for Operator 25R.
IN CALIFORNIA CALL (800) 852-7777.

THE SHARPER IMAGE

260 California Street, San Francisco, CA 94111.
Alaska and Hawaii (800) 824-7919.



5.26 13

2.10 FR

0.00 00

26.59 89

59.53 01



Installation of the Month

By Richard Sarbin

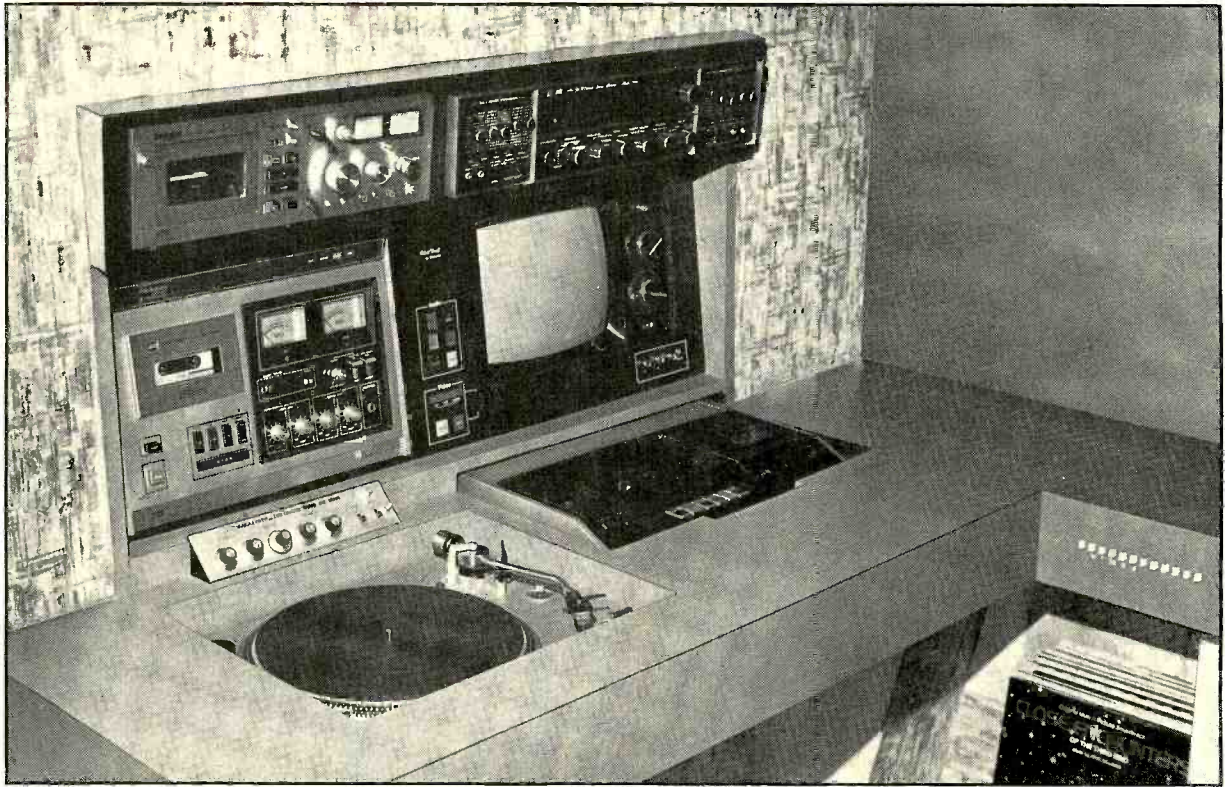

WITH considerable thought yet minimal expenditure, Don Camryn of Niagara Falls, New York, has designed and constructed a housing that successfully combines video and audio equipment to create a convenient home-entertainment complex. The compact installation, in an efficient utilization of available space, projects through the living-room wall into a large walk-in closet that provides the necessary rear access to the components and their connections.

The installation has three sections, all built from 1-inch-thick, Formica-covered flakeboard. The sturdy, L-shaped base section has a desk-height countertop with cutouts into which are set an RCA SelectaVision videocassette recorder (right) and a Technics SL-1300 Mark II turntable equipped with an Audio-Technica Signet TK5E cartridge (left). In a niche just above the turntable is a Realistic stereo mike mixer which Mr. Camryn uses primarily as a phono/tape mixer. The series of white buttons mounted on the apron of the short arm of the L (at right in photo) are Jer-

old electronic channel selectors; these make it unnecessary to use the mechanical selector on the video deck. A comfortable swivel chair (not shown) facing the console puts the operator within easy reach of all controls and monitoring devices.

The two upper sections of the console are angled slightly for greater visibility of the components. Within the four compartments are (clockwise from top left) a Technics RS-676US cassette deck, a JVC 5444 four-channel receiver, an RCA 12-inch black-and-white TV monitor, and a flush-mounted Technics RS-276US cassette deck. The components are set into black, satin-finish Formica panels that handsomely complement the chrome finishes and internal lighting of the equipment. Both audio and video program sources are selected by means of eight color-coded, illuminated pushbuttons at the left of the RCA monitor. The control center also includes a home-built digital readout for video-channel selection and a timer module that permits recording TV programs while the opera-

tor is away from home or occupied elsewhere.

The system feeds front-channel audio signals to a pair of Bose 901 Series II loudspeakers while a pair of homemade ceiling-mounted speakers provide rear-channel sound. TV programs are projected through an Advent VideoBeam Model 750 onto a large screen; the audio portion is fed into both speaker pairs, thus creating a type of "surround" sonics that makes disaster films and live shows all the more dramatic. Camryn also uses his system to make tapes of sound effects and mixes of conversation and music that serve as background for skits that he stages for friends.

A DOCTOR of chiropractic, Camryn admits that he frequently tears himself away from his video and audio tape equipment and listens more conventionally to LP records—mostly traditional and big-band jazz, country-and-western, and original movie soundtracks. And, thanks to the recent purchase of a Pioneer KP-800 FM/cassette car stereo, he is as entertained while on the road as he is at home.

Now Oldsmobile Starfire comes with standard sporty features you'd pay extra for in many other cars.

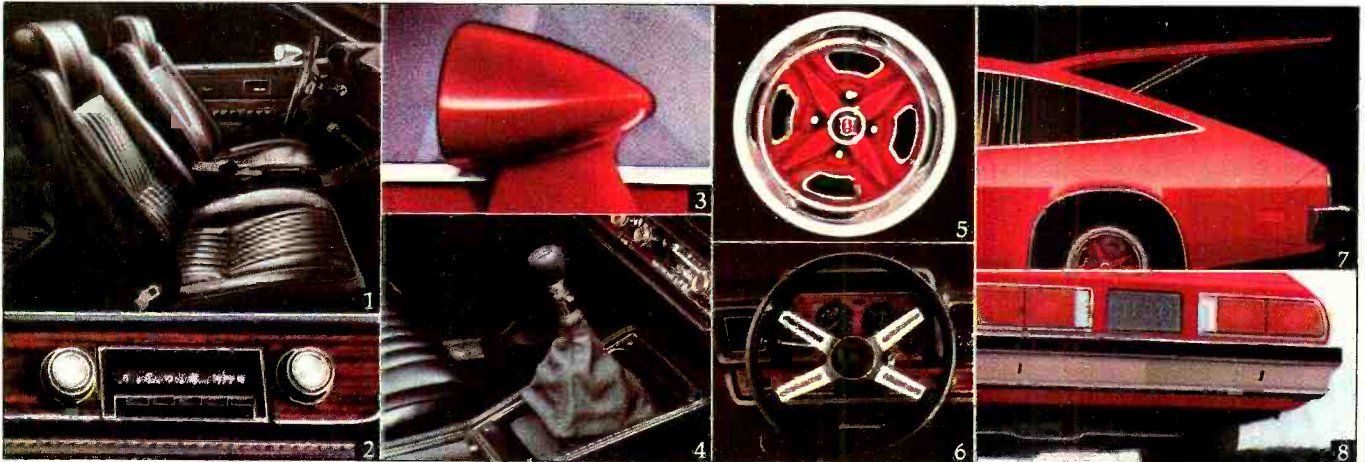

1. Bucket seats/2. AM radio/3. Sport mirrors/4. Console & 4-speed shifter/5. Sport wheels/6. Sport steering wheel/7. Hatchback/8. Rear stabilizer bar.



The 1979 Starfire. It gives you all the good stuff you see as standard equipment. And it's engineered to be an exciting road car as well — moving down a road with precision and authority is what a Starfire is all about.

But with all those road-wise qualities, all those standard features, you might think a Starfire is priced

out of reach. Not so, as you can see:

\$4095⁰⁰

That's the manufacturer's suggested retail price, including dealer prep. Taxes, license, destination charges and other equipment additional.

So if you're looking for a sporty road car that's a lot of value for the money, here it is.

Test-drive a Starfire today... and discover that great Olds feeling!

Oldsmobile

Starfire

Have one built for you.



TWICE THE SPEED! TWICE THE PERFORMANCE!



B-I-C INTRODUCES THE TWO SPEED CASSETTE DECK

1 7/8 ips for compatibility: 3 3/4 ips for extraordinary performance.

Recording engineers recognize that the way to obtain more professional results is to increase the speed at which tape is moved past the heads.

Until now, all conventional cassette decks have recorded and played back at 1 7/8 inches per second only. The new B-I-C tape decks do this... superbly. When used at 1 7/8 ips, they exceed virtually every existing performance spec. At 3 3/4 ips, they establish new standards.

This faster tape speed results in dramatic improvements in frequency response, dynamic range, signal-to-noise, and wow and flutter. It also provides much quicker rewind and fast forward times, automatically at either speed.

As an example, consider the model T-3's 3 3/4 ips specs.

Performance unheard of in any other cassette deck. Guaranteed frequency response of at least 25-22,000 hz \pm 3 dB. Wow and flutter less than .035% WRMS. Total harmonic distortion below 1.5%. Signal-to-noise ratio better than 67 dB (A-weighted).

To achieve these new performance standards we used a fresh approach to the electronics. The result—a group of new circuitry concepts which we have named "Broadband Electronics." These circuitry concepts lower residual noise and distortion. They enhance frequency response and stereo imaging. And—most important, these improvements are audible at either speed on all B-I-C tape decks.

The result is sound that is cleaner and more detailed than you have ever heard from cassette tape.

There are three B-I-C cassette decks, from the "no frills" Model T-1 at under \$300, to the 3-head, dual capstan T-3... all at prices you'd expect to pay for an ordinary one speed machine.

For a free 24-page brochure, see your B-I-C dealer or write B-I-C/Avnet, Westbury, N.Y. 11590.

**Twice the speed.
Twice the versatility.
Twice the performance.**

**THE NEW B-I-C
TWO-SPEED
CASSETTE DECK.**





The perfect pair.

The new Koss CM/530 bookshelf speakers with the perfect mirror-image sound.

Here is truly a remarkable achievement in loudspeaker design and performance. The Koss CM/530 bookshelf loudspeaker sets an entirely new standard in extended bandwidth response, high efficiency, low distortion and perfect mirror-image for speakers in its size and price range and within today's technological capabilities.

By designing a left and a right channel configuration for the passive radiator, the woofer and the tweeter, Koss engineers created a perfectly matched set of bookshelf speakers that can be placed horizontally or vertically without losing perfect right

to left or left to right imaging, an incredible degree of dispersion and the beautiful Sound of Koss.

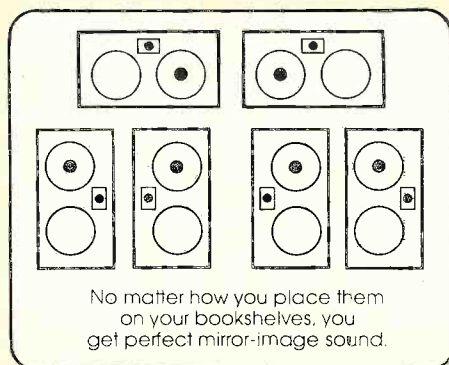

Once you've heard the CM/530 you'll be amazed at its breathtaking depth and clarity and incredible low distortion properties. By utilizing an 8-inch passive radiator to radiate the sound energy over the lower two octaves, Koss engineers were able to use an 8-inch woofer to reproduce the critical sounds in the midrange up to 3,000 Hz. Thus the CM/530 is able to reproduce a maximal flat frequency response from an f_3 (3 dB down point) of 36 Hz on upward. In addition, the CM/530's 1-inch dome tweeter produces an exceptionally flat energy output and unusually low distortion

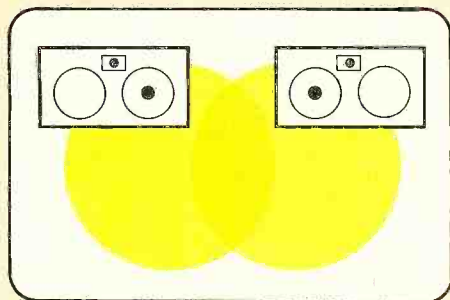

that gives your music a liveliness and transparency not found in competitive speakers.

But what really puts the CM/530 speakers in a class by themselves is their perfect mirror-image sound. By creating a right and left channel configuration, the sound from the left and right speakers comes to the listener with the same musical balance.

So, no matter whether you're sitting in your favorite easy chair or walking around your room, you'll always hear a perfectly balanced, full-bandwidth sound.

The Koss CM/530's also offer an unmatched increase in dynamic range over competitive bookshelf speakers. Due to the CM/530's higher efficiency and lower distortion, you can hear the higher sound pressure levels without clipping and also hear the lowest bass with a dramatic clarity as well. And to help you shape the extra sound you'll hear, there's a 3-position Tweeter Level Control switch on each speaker that allows you to alter the tweeter



frequency spectrum from a flat response to ± 3 dB.

Ask your Audio Dealer to give you a live demonstration of a matched pair of CM/530 bookshelf speakers. You'll be amazed at their perfect mirror-image sound. And while you're at it, try the perfect answer to private listening: Koss Stereophones. But by all means write, c/o Virginia Lamm for our full-color speaker and stereo-

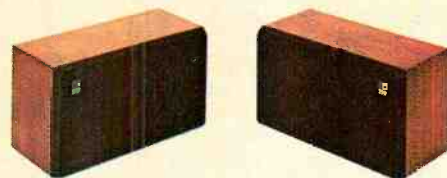

phone catalogs. The Sound of Koss will do great things for your records and tapes... and your image.

KOSS® CM/530 BOOKSHELF SPEAKERS

hearing is believing™

The Pop Beat

By Paulette Weiss



WHATEVER HAPPENED TO . . . ?

HAVE you found yourself wondering about Lena Zavaroni lately as you worked your way through your morning Wheaties? Are you curious to know the whereabouts of the Shirelles? Of Bill Haley and the Comets? Tiny Tim? If so, you're ready to play the *Whatever Happened To* game, the idea of which is to track down someone once famous who has faded from public view. Unearthing a particularly obscure figure will get you extra points, as will discovering an especially incongruous (or decidedly poetic) fate. It can be played alone or with any number of friends before, during, or after breakfast.

I've been playing a pop-music version of this game off and on since midsummer, when several things drove me into remembrance of things past. The first was seeing Emitt Rhodes' name on a new recording. Emitt was never what you'd call one of your superstars. As a matter of fact, in some rock circles back in the late Sixties and early Seventies he was dismissed as a "wimp." Too great a resemblance to Paul McCartney in both voice and face (coupled with poor record-company support) probably contributed to his fast fade. But he was visible for a while, and I liked him. He had a flair for attractive, sprightly melodies and a voice as pleasant as McCartney's, if a bit more nasal. Furthermore, he was as cute as a newt. Performers with less talent than Rhodes have made the Big Time, but Emitt simply disappeared, and until recently I had assumed that, as likely as not, he had wound up working in a dry-cleaning plant in Scranton. But then this record appeared—"Thistles" (Elektra 6E-132)—that credited Rhodes as producer. It was comforting to learn that he hadn't entirely given up his music career but had simply traded the spotlight for a behind-the-scenes role.

The news of Jackie Wilson's fate, on the other hand, was extremely discomfiting. Wilson was a big r-&-b star in the Fifties and Sixties. His voice, as smooth and rich as sable, had an extraordinary range, and in live performance his acrobatics—splits, spins, and kicks—made Elvis' hip-shaking seem almost effete. Wilson's career flourished until the mid-Sixties, when he was obscured by the British Invasion. He came to the forefront again in 1966 with the hit song *Whispers* and in 1967 with *Higher and Higher* (most recently

revived by Dolly Parton). But by the Seventies the star glow was gone for good, and Wilson was reduced to the status of a nostalgia act performing in Dick Clark's oldies revue.

An article by Bill Pollak in the *Village Voice* revealed to me the unpleasant side of this nostalgia game, providing a very sad answer to the question "Whatever happened to Jackie Wilson?" In October 1975, Wilson suffered brain damage after a heart attack felled him on stage in a New Jersey club. He has spent the years since in hospitals and nursing homes, unable to walk or talk and deeply in debt. The financial and legal ugliness that dogs this forgotten man is appalling. As Pollak's article indicates, using the title of Wilson's earliest smash, it looks like *Lonely Teardrops* for him from now on.



LENA: *Where is she now?*

Many performers' careers are similar to Wilson's, but without the tragic ending. Having fallen behind in the Big Pop Swim, some artists stay afloat in the smaller pond of the nostalgia circuit. Another of the things that started me looking backward this summer was a feature article in the *New York Times Magazine*. Titled *Vaudeville Strikes Back*, the article disclosed the present whereabouts of entertainers whose names alone summon up visions of used-to-be: the Shirelles, the Drifters, Danny and the Juniors, Tiny Tim, and

Eddie Fisher. Yes, they still swoon out in Du-buque when Eddie Fisher, now fifty, sings *Oh My Papa*. And twenty years later, with only one of the group's four original members replaced, Danny and the Juniors still knock them dead with *At the Hop* and *Rock and Roll Is Here to Stay*. The Shirelles, now a little too mature to be called a "girl group"; the Drifters, with only one original member left; and Tiny Tim, now fatter but still unctuous and scraggly haired—and still carrying that little ukulele in a greasy shopping bag—all travel in one bus and perform in Roy Radin's *Vaudeville '78*.

Like Richard Nader's famous rock-and-roll revival shows, Radin's really *reeks* of the past. Some of the coiffures may be blow-dried now, and there are more wrinkles and plumper figures, but the sound is still the same, and the crowds seem to like it. Like it? They *scream* for it!

Rick Nelson's unfortunate experience with the nostalgia circuit has been chronicled in his song *Garden Party*. In a Nader extravaganza at Madison Square Garden, instead of playing his Fifties' hits, Nelson performed new material—good new material. The crowd would have none of it and booed him off the stage. They had come to hear *Ricky Nelson*, not this stranger with the modern hair and modern sound.

FOR some time now pop audiences have been curious about what a lot of them missed: the bump-and-grind beginnings of rock. We know practically everything about Elvis by now, we've learned quite a bit about Buddy Holly from his biographical film, and from *American Hot Wax* we've picked up the half-facts of Alan Freed's "martyrdom." But whatever happened to Bill Haley and the Comets, whose *Rock Around the Clock* fueled the thundering lift-off of rock-'n'-roll?

A fellow journalist recently made me a gift of rare information from an interview he's just done with Haley, who lives in obscurity in Mexico City nine months of the year. He used to do some rock revivals, but he hasn't performed for several years now. A band claiming to be the Comets is still touring, but Haley insists that no one in it belonged to the original group. He's considering going on the road again and has hinted at talk-show appearances and a book on the Fifties, complete with early Elvis anecdotes no one has heard before.

A few performers, such as Paul Anka and Diana Ross, have managed the transition from a youthful career to a suitable adult one right before our eyes, but it isn't easy. We're hard on our stars, particularly in pop music. We don't like to see them age, yet they can't stay exactly the same. When our jesters amuse us, we reward them generously, but when they begin to bore us, like a capricious monarch we banish them to obscurity.

To help those who are interested in playing the *Whatever Happened To* game, here's a list of the routes pop artists travel when they drop out of sight:

- (1) Die, go mad, become chronically ill.
- (2) Retreat into an ordinary or a spiritual life.
- (3) Get a behind-the-scenes job.
- (4) Join the nostalgia circuit.
- (5) Enter an entirely new profession.

By the way, if you discover whatever happened to Lena Zavaroni, please let me know. It's beginning to bug me.



LEE FITS AMERICA

EasyLee. The feeling's as good as the look. Lee Rider jeans and jackets are 100% cotton with Lee Set[®], the SanforSet[®] process that starts denims softer, keeps 'em fitting smoother. The blue fades true, the size range is terrific. Check it now. The Lee Company, 640 5th Ave., New York 10019. (212) 765-5215.



SANFOR SET



A company of VF corporation

CIRCLE NO. 48 ON READER SERVICE CARD

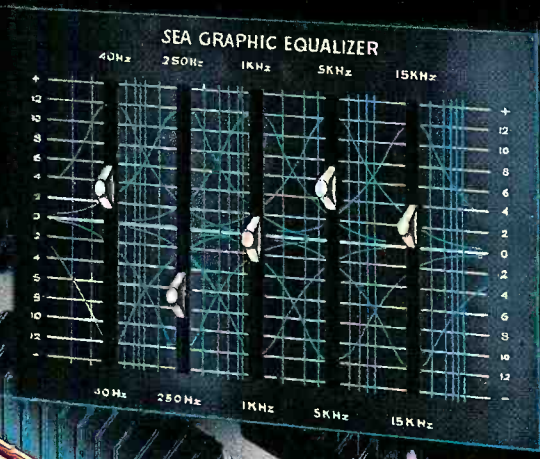

JVC

- FM
- AM
- PHONO
- AUX

FM MUTE OFF

TUNING

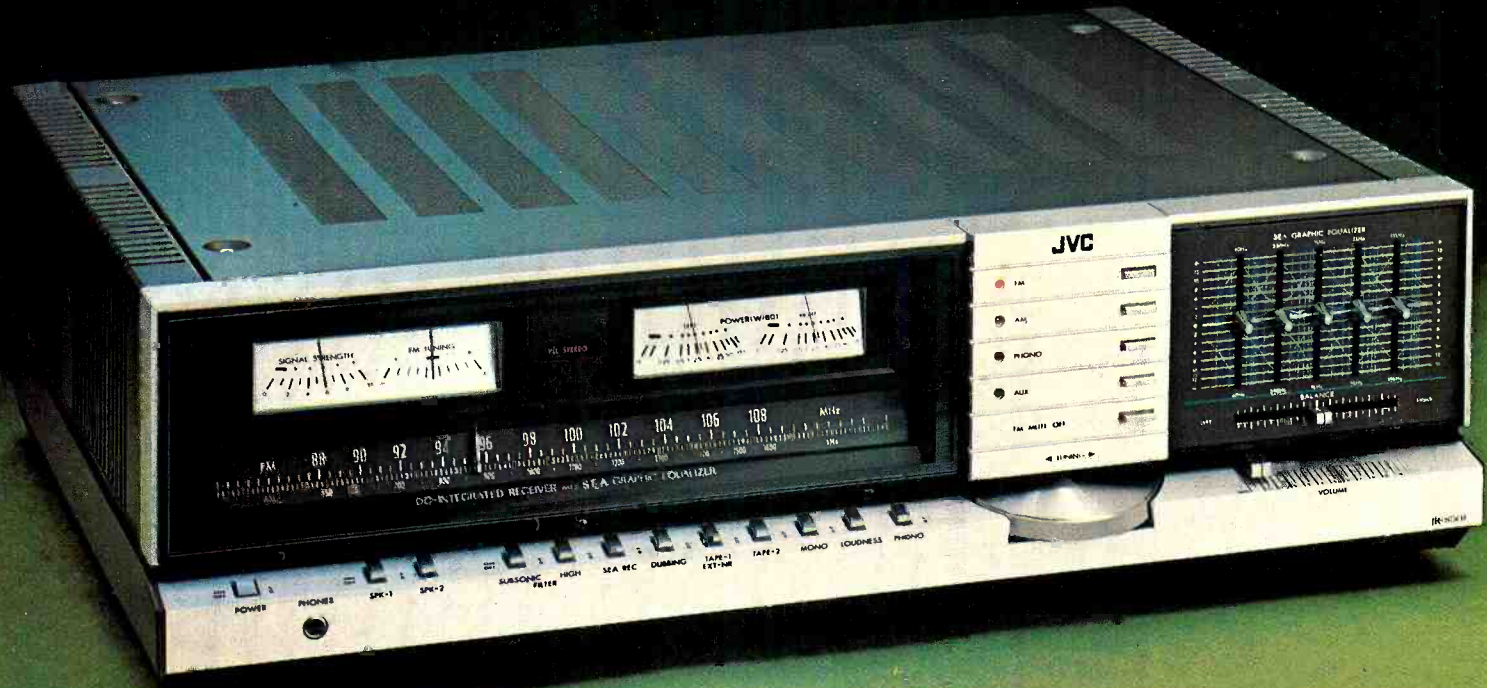
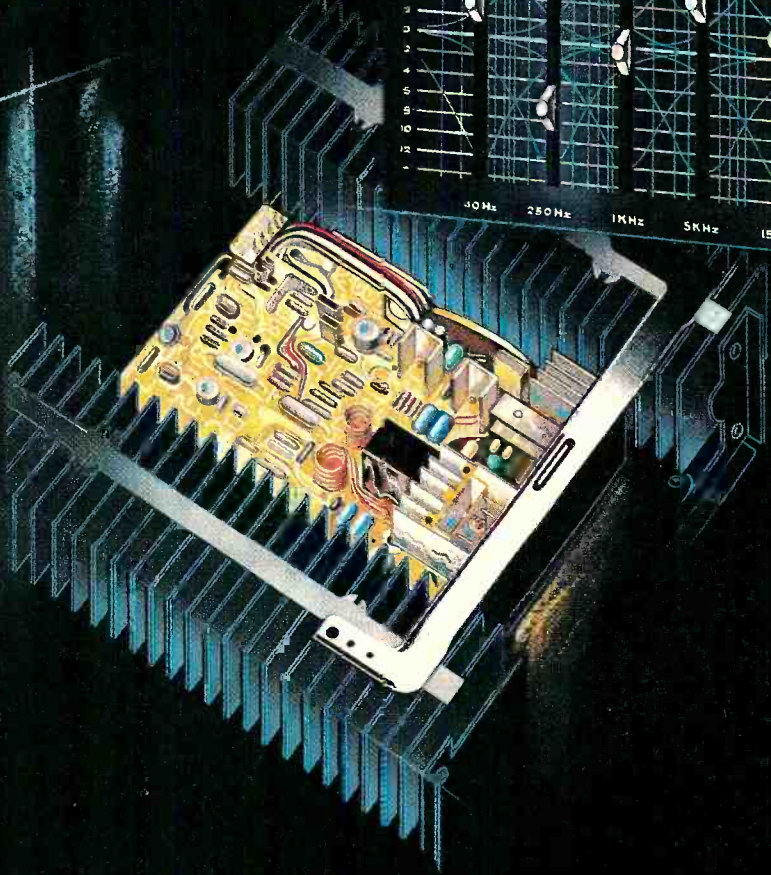

THE JVC RECEIVER.

Every bit as revolutionary as they look, and then some.

In our case, looks are never deceiving. Because all our new DC integrated stereo receivers combine unprecedentedly revolutionary styling with electronic design features that reflect JVC's more than 50 years' experience in audio development and innovation.

DC POWER AMPLIFIER DESIGN

Usually found only in costlier separates, JVC offers DC amplifier circuitry in *all* four of our new receivers. By eliminating distortion-causing capacitors in our interconnecting circuit sections, JVC designers have created an amplifier that offers virtually distortion-free performance (0.03% THD) not only over the entire audio spectrum, but above and below it. As a result, all the sounds you hear are clearer, cleaner and crisper. Moreover, our DC design improves square wave performance and eliminates phase-shift—both factors being of paramount importance in distortion-free music reproduction. In addition, Triple Power Protection circuits and dual power meters give you safety and full indication of receiver operation. There are four new JVC DC integrated receivers, offering your choice of 120, 85, 60 and 35 watts/channel* respectively.

S.E.A.—ALL THE WAY

JVC was the first receiver manufacturer to offer a built-in S.E.A. Graphic Equalizer in a quality receiver, and we continue this tradition by incorporating this convenient feature in our entire new receiver line. Far superior to even triple tone controls, this JVC exclusive gives you complete control over the entire musical spectrum. You can attenuate or accentuate any of five separate bands, covering the entire audible range of music. And as an added feature, we've incorporated a special button

so that the S.E.A. equalizer circuit can also be switched to your tape deck, so you record exactly what you hear.

PUSHBUTTON SOURCE SELECTORS

Unlike conventional receivers, ours incorporate an advanced pushbutton source selection panel. Color-keyed LEDs indicate the program source, and a full-function horizontal pushbutton panel provides total control over all receiver operations. Professional-type slider controls set volume and balance.

SUPERIOR TUNER SECTION

High sensitivity and tuning precision are featured in all four new JVC receivers. Multi-gang FM tuning capacitors, PLL MPX demodulators and other circuit refinements provide optimum frequency response and stereo separation for FM, with maximum sensitivity for AM reception—a feature often neglected in receiver designs. A thumb-control tuning wheel and accurate metering make station location and fine-tuning easy.

Other features include Mode/Loudness/Subsonic Filter switches and provision for connecting two sets of speakers.

Features, styling, innovation and performance: the four main things to look for in a DC integrated stereo receiver. And you'll find them all in a JVC. JVC America Company, Division of US JVC Corp., Maspeth, N.Y. 11378. In Canada, JVC Electronics of Canada, Ltd., Ont.

JVC

CIRCLE NO. 44 ON READER SERVICE CARD

JR-S501 (featured at left), Below: JR-S401 (top), JR-S201 (bottom left) & JR-S301 (bottom right).



* @ 8 Ohms, both channels driven from 20Hz-20 KHz, with no more than 0.03% THD.



NEVILLE MARRINER

A virtuoso conductor continues to accept new musical challenges

By Clair W. Van Ausdall

NEVILLE MARRINER, perhaps the most recorded conductor in history and already one of the foremost English conductors of our day, has been named the new music director of the Minnesota Orchestra beginning in September 1979. Not even this prestigious appointment, however, diminishes his well-known candor and irreverent wit, the target of which is often himself and his own musical image.

"Conductors?" he mused recently, when reminded that he began his musical career as a violinist. "Originally I tried to avoid them, but when I joined a symphony orchestra there was no way of doing that. You didn't necessarily have to *look* at them, but you could not get around the fact that they were actually *there*. I had no idea, I must say, that I would become one of them . . . one of those offensive people who stand up in front and impose their will on the other musicians."

Only a conductor with Marriner's world-wide reputation for striking just the right balance between scholarship and spontaneity in his music-making could joke so affectionately about his profession. Actually, up to now his reputation and his name have been better known in the United States than his face. He is probably the only front-rank conductor today whose fame was built by his recordings and the prizes and awards they garnered. What is even more remarkable, the conductor's baton was thrust into his hand almost by accident. Had it not been for the late Pierre Monteux's enthusiastic prodding, Marriner might have remained the violinist he started out to be.

He was born in 1924 in Lincoln, England. His first violin lessons were given him by his father, who had bought a book for that purpose. Then local teachers took over his musical education. Eventually, having won a series of scholarships, he entered London's Royal College of Music.

World War II interrupted his studies.

After demobilization he studied violin in Paris with the great René Benedetti, returned to England to teach at Eton (where he discovered to his chagrin that "public schools are not cradles of the arts"), then accepted a professorship at the Royal College of Music (the offer of which, he said, made him feel "like an old man"), and finally decided to remain in London as a free-lance violinist. He joined a string quartet, then a string trio, then a chamber orchestra. He played in a miscellany of excellent ensembles. It was, however, his work with Thurston Dart, in a group called the Jacobean Ensemble, that caused the greatest musical stir.

"... It was, I should think, the worst orchestra in London by far, absolutely the worst."

Dart had earlier made his living as a mathematician, but his heart was in music, and he was then already a recognized authority on the performance of Baroque music. For Bach and Handel he advocated brisk tempos, unsentimentalized ornamentation, and immaculate articulation—this in a day when overblown romantic interpretations were the standard even for the relatively few performances there were.

In Marriner, Dart found a ready disciple. A few years after the two had met they established an ensemble to put Dart's performance theories into practice. Very soon the group engaged the affections of an unsuspectedly large and demonstrative audience in con-

certs, on records, and in broadcasts. The rediscovery of Baroque music and its true beauty was at hand, and Dart and Marriner were among those leading the way.

Their performances on record have never been surpassed for stylistic clarity and vigor. Today Marriner gratefully acknowledges the influence Dart had on him: "Stylistically I owe him such a lot. When you played with him, whatever you did seemed right and authentic. He gave us courage."

In 1956, at the age of thirty-two, Marriner joined the London Symphony Orchestra, which in those days had—it was generally agreed—lost some of its historical luster. "It was, I should think," says Marriner with his usual candor, "the worst orchestra in London by far, absolutely the worst. They were casting around for new people. Quite a number of leading players joined at that time, though at first we were no help at all; hardly a concert went by without some frightful sort of mess. But we learned quickly, and suddenly we became the *top* orchestra in London. It was very exhilarating to see the group dragging itself up by the bootlaces."

Marriner took the position of principal second violin. "Very quickly," he says, "I discovered that it was hard, physically hard. There were some great moments, admittedly, but I realized that I didn't want to spend the rest of my life fiddling away like that."

The next year brought him deliverance. A group of London's finest string players who, Marriner says, were social as well as musical friends, decided to form a chamber ensemble. They needed a place to rehearse, and one of the city's historic churches, St. Martin-in-the-Fields, extended the hospitality of its undercroft (a crypt or basement). In return, the group played an introductory season of concerts there. The name they eventually gave themselves—the Academy of St. Martin-in-

MARRINER...

the-Fields—perpetuated the link with the church. Why “Academy”? “Well,” says Marriner, “we really had no wish to be an ‘orchestra’ or even a ‘chamber ensemble’—that phrase always seems to put people off in droves. The vicar of the church finally thought of ‘academy’ in the sense of a club or society, and we stuck it in.”

In its earliest days the Academy had no specific conductor. They followed seventeenth and eighteenth century practice: Marriner was concertmaster and “led” the group from his chair. In retrospect, however, he seems to have been destined both by background and ability to conduct the Academy. His profound interest and skill in ensemble playing reminds one of Bruno Walter’s philosophy—“In order to be a good conductor one must above all know how to perform chamber music well.” And the Marriner “ability” was obvious to, among others, Pierre Monteux, then conductor of the London Symphony Orchestra and an early admirer of Marriner and the Academy. Once, joking with Marriner about using a baton, he asked, “Why don’t you stand on your feet and conduct like a man?” That friendly riposte, coupled with the Academy’s increasingly complex repertoire, led to Marriner’s assuming the conductorship. Monteux’s influence continued to be felt, and after the Academy had got off to its successful start, Marriner studied with him, both in London and in the United States.

Marriner always stresses the high quality and independence of the original Academy members. He likes to recount a recording-session incident that took place in the early days of the Academy’s history. “It was probably the first time I had actually stood up and conducted. The music started, and then it stopped after about two bars, and on the tape you can hear a sort of muttered conversation in the background. Then it starts again and breaks down, and then it starts again and it goes on for about six bars and breaks down, and then the oboe player, Roger Lord, is heard to say, ‘Nev, if you’re going to stand up and conduct, can you stand somewhere where we can see you . . . or else somewhere where we can’t.’ I think this has always been the Academy’s attitude: either you’ve got to stand up or you’ve got to get out of the way and let them get on with it themselves.”

Marriner’s association with the Academy has produced an astonishing number of fine recordings. The first ones were subsidized by Louise Dyer, an Australian sheep-farmer and philanthropist, who founded a music-publishing house and a small phonograph-record label, L’Oiseau-Lyre, to issue such unusual and high-quality performances as theirs. “We used to say that whenever Louise made a record, she had to kill another sheep,” Marriner says. “But if it hadn’t been for her I wouldn’t be where I am today.” It was also Mrs. Dyer who insisted they keep the mellifluous name, Academy of St. Martin-in-the-Fields, though concerts are now held in the church very infre-



“A whole concert of those composers who sound like ice-cream makers—Manfredini, Albinoni, Tartini. . . .”

quently and recording sessions not at all because of the traffic noises in Trafalgar Square where it is located.

So impressive was Marriner’s achievement with the Academy, which rapidly grew into the world’s best-known and most highly respected chamber ensemble, that in 1969 the Los Angeles Chamber Orchestra, just being organized, invited him to become their conductor. Marriner, to whom the invitation came “out of a clear sky,” was delighted. For the first time he had been asked to accept a permanent post as a conductor rather than as a violinist. “It was wonderful. All I had to pack was a baton.”

The Los Angeles invitation pleased him on another count, he admits. The two people he most wanted to meet in all the world at that time were Jascha Heifetz and Goldie Hawn. He must have made his wish known in print, because both of them attended the first concert of the Los Angeles Chamber Orchestra and his dream was realized.

Critics praised him right from the start, for example Martin Bernheimer of the Los Angeles *Times*, who wrote: “Mr. Marriner has welded his forces into a stylish musical unity. They seem to play for the love of it. There is no mistaking their zest and scrupulous attention to detail.” In no time their concerts were being sold out.

Marriner is amazed by the playing of his new American instrumentalists. “They’re so virtuosic! They can play anything. And they maintain an intensely emotional temperature, different from English players. Their sound really fizzes!”

Since then, Marriner’s American reputation has grown rapidly. Today he is in great demand, a demand fostered by reviews like one in the New York *Times* following his performance with the New York Philharmonic, which was headlined “Neville Marriner Is a Virtuoso Conductor” and which went on to praise his precise beat, his lack of mannerisms, his musicality—“none of the meaningless arm-pumping that so often passes for conducting.”

Re-engagements fill his calendar: the New York Philharmonic, the Boston Symphony, the orchestras of Washington, D.C., Los Angeles, San Francisco, Tokyo, Vancouver, London (the BBC Symphony and the New Philharmonia), Bonn, Paris, Helsinki, Hamburg, Berlin, Vienna, Buffalo. And soon there will be first-time appearances in Stockholm, Australia, Amsterdam, and Cleveland.

Following closely on his three-year association with London’s South Bank Summer Festival, he assumes in 1979 the musical directorship of the Meadow Brook Music Festival at Oakland University in Rochester, Michigan, the summer home of the Detroit Symphony. Also in September of 1979 his directorship of the Minnesota Orchestra begins, and in 1981 he takes on principal conductorship of the Stuttgart Radio Symphony in Germany as well. One of the attractions of the latter post is the orchestra’s tradition of allowing an average of six rehearsals per concert rather than the more usual three or four. He also intends to maintain his very close relationship with the Orchestre National de Paris, with which he has a kind of “permanent guest conductor” status. (Continued on page 96)

Pickering's all NEW OA-3A Open Audio Stereo Headphones...

With Special Adapter for use with
Portable Radios, TV Sets and Tape Recorders.



LIGHT IN WEIGHT!
SUPER IN SOUND!
and it's made in the U.S.A.



Open Audio means you can enjoy the sound yet be part of what's going on around you. Just plug the special adapter into the earphone jack of any Mono Cassette Recorder, Portable Radio or TV Set and enjoy perfect sound everywhere you go.

- SOUND PERFECTION. You have to listen to believe.
- REVOLUTIONARY. So light. So comfortable to use.
- OPEN AUDIO. Enjoy the sound. Yet, be part of what's going on around you.
- PREDICTION. The OA-3A will be your favorite "component".

Hear them at your nearest Pickering dealer or
for further information write to:

 **PICKERING**

"for those who can hear the difference"

Pickering & Co., Inc.,
Dept. SR 101 Sunnyside Blvd.,
Plainview, New York 11803

CIRCLE NO. 41 ON READER SERVICE CARD

MARRINER...

Opera is a new enthusiasm. Marriner was invited to conduct his first when he was fifty, but he refused it on the half-humorous ground that he was too old. "You should start training for opera conducting when you're fifteen and willing to sweep out the theater if necessary, just to *be* there." But when the offer was repeated and enhanced, he agreed. Singers, he finds, are not as tireless in rehearsal as instrumentalists, and the melding of so many disparate elements presents challenges, but "when it all actually works, it's irresistible." In 1979 he conducts a *Mariage of Figaro* at Aix-en-Provence. The only thing that prevents him from

roque and the Classical period. Is this his favorite music? "If it means excluding everything else, by no means," he says. "People have been known to die of an overdose of Vivaldi. A whole concert of those composers who sound like ice-cream makers—Manfredini, Albinoni, Tartini—it's like being in a sewing-machine factory after a while." Mozart stands high on his list of favorites, of course, because the Academy is the perfect size for Mozart symphonies, but he does Beethoven, Mendelssohn, Bizet, Respighi, and Bartók with equal verve and stylistic distinction. "You don't need *opinions* to make a recording," he says. "What you need are *convictions*."

Though Marriner's accelerating professional schedule means that he must live all over the hemisphere, he looks forward to the time he can spend with his wife Molly and their two children. In addition to an apartment in London,

choir loft: he likes horse racing so much, for example, that he even carries a special credit card which allows him to bet on his favorites no matter where he is conducting or rehearsing. Known for the delicacy of his musical phrasing and his attention to detail, he nevertheless is attracted to a great deal of Romantic and contemporary music and the voluptuous sound of a large orchestra. "I like luxurious textures," is the way he puts it. He looks forward to his work with the Minnesota Orchestra. For him it will not be forsaking the Baroque boundaries within which he has established himself as a conductor par excellence of the chamber repertoire. Rather, it is a return to the symphonic days of his London Symphony Orchestra tenure and to all the repertoire he first learned there under a succession of great conductors. "Besides," he says jokingly, "they say you haven't really grown up, musically, un-

MARRINER ON RECORD

The conductor's own favorites

- VIVALDI: *The Four Seasons*. ARGO ZRG 654.
- CORELLI: *Concerti Grossi*. ARGO ZRG 773/5 three discs.
- STRAUSS: *Metamorphosen*. ARGO ZRG 604.
- ROSSINI: *Overtures*. PHILIPS 6500 878.
- HOLST: *The Planets*. PHILIPS 9500 425.
- BACH: *Mass in B Minor*. PHILIPS 7679 002.

Neville Marriner
rehearsing the Academy
of St. Martin-in-the-Fields



doing more is time. "For an opera you need about six weeks continuously, and I don't think I have even two weeks together between now and about 1981."

Already one of the most recorded conductors in history, with a list of more than two hundred albums behind him, he has just signed a new contract with Philips that will add another twenty records a year for the next ten years to his discography, not to mention the additional albums he is contractually allowed to make for other labels. Some he will record with the Academy, choosing from the repertoire with which he has up to now been so closely identified—music of the Ba-

they have two cottages, one in Dorset, the other in Lyme Regis, famed as the locale for both Jane Austen's *Persuasion* and, more recently, John Fowles' *The French Lieutenant's Woman*. He gardens when he can. The trouble with having to be in, say, Helsinki in April of 1981, as he will be, is that this is when the daffodils should be coming up in his flower beds.

Someone has said he looks like an English choirboy, and the quick, clear speaking voice, with which he is articulate on a wide range of subjects, has about it a kind of schoolroom innocence. On the other hand, certain of Marriner's interests are far removed from the world of the schoolroom or

til you go through the baptism of fire of being music director of an American orchestra. So here I go."

MARRINER looks at his packed schedule with a certain regret and a certain satisfaction. On the one hand he hates to be so busy that he has to miss the birthday celebration of his son or daughter, making instead "a rather feeble telephone call" from halfway around the world. On the other, he likes to know that he is going to be hard at work, apparently forever. "After all those years of opening my day-book and seeing acres of Nothing," he says with a smile, "it's nice to open it now and see acres of Everything!" □

AN ANT IN TROUBLE SCREAMS FOR HELP

BASF'S NEW PROFESSIONAL II CASSETTE CAN PROVE IT

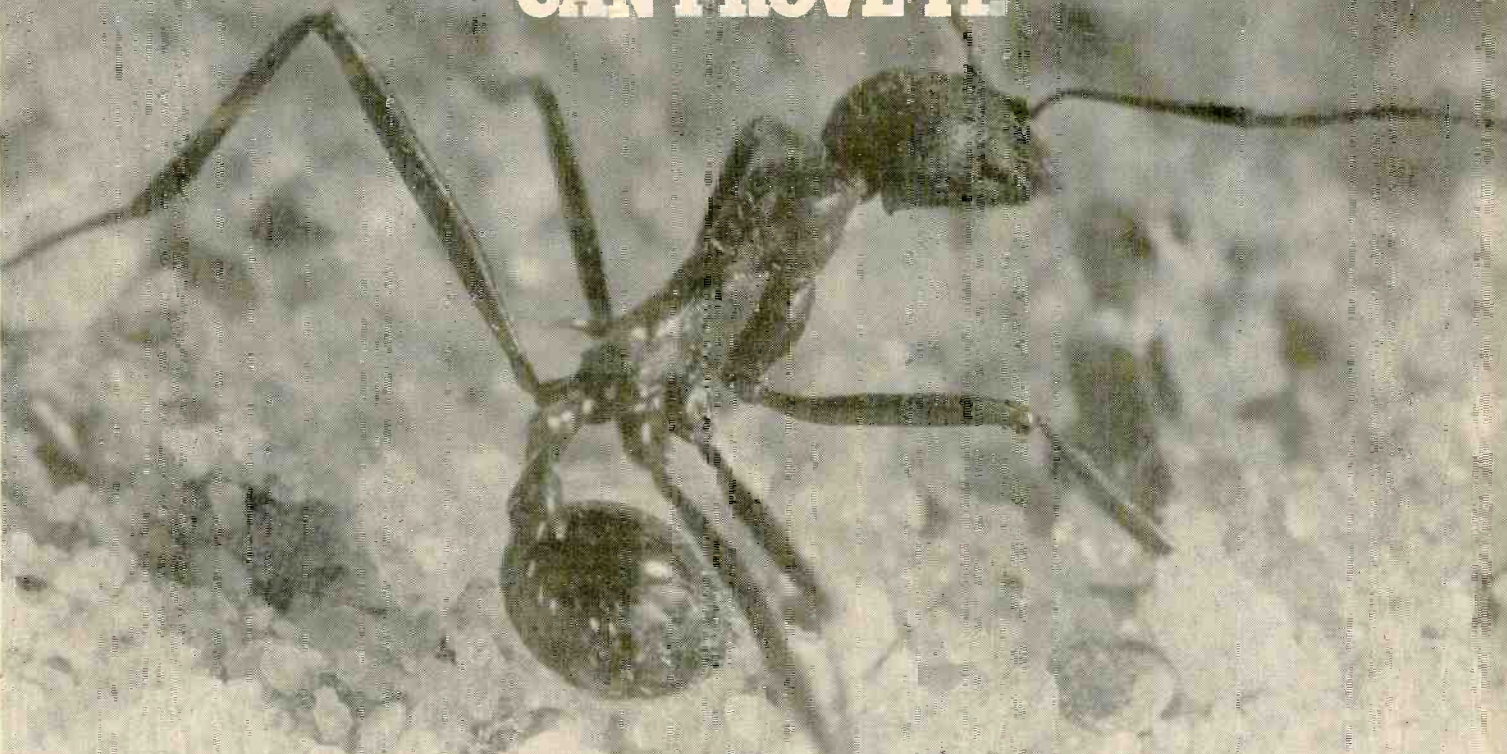

THE PEOPLE WHO INVENTED MAGNETIC RECORDING TAPE HAVE INVENTED A COATING FORMULA SO SENSITIVE IT CAN RECORD THE SOUNDS OF A TERRIFIED ANT.

OTHER WORLDS

Using an anechoic chamber, the finest sound equipment available, and the most sensitive tape ever made, we were able to record the sound of a desert ant in distress... a sound something like a fire alarm.

It's a startling demonstration of the sensitivity of our new second generation chrome formulation. Its brand-new, patented, coating process gives it more headroom, greater dynamic range, and a better signal-to-noise ratio. In other words, it gives it superb sensitivity.

And since Professional II is a pure chromium dioxide tape, and not a "chrome substitute", you not only get better sound performance, test results prove you get substantially less headwear.

PROFESSIONAL SERIES CASSETTES

In the Professional Series, Professional II is just one of three superb new BASF formulations.

Professional I is our new ferric formulation with unsurpassed maximum output. And Professional III is our new ferrochrome formulation. It gives excellent results in all

recorders, from car cassettes with only a ferric setting to more expensive recorders with Chrome and Ferrochrome settings.

If you would like to discover the sounds of an ant running, an ant in distress, an eye lash blinking, a butterfly in flight, and a number of other never-before-recorded sounds, send just \$3.50 to BASF OTHER WORLDS, Box 18367, Boston, Mass. 02118.

We will send you a \$4.99 Professional II C-90 cassette with the sounds of other worlds. Half of the cassette will be blank so that you can use it to discover other worlds in music. This offer will be available while supplies last. Please allow four weeks for delivery.



BASF

Sensitive Sound

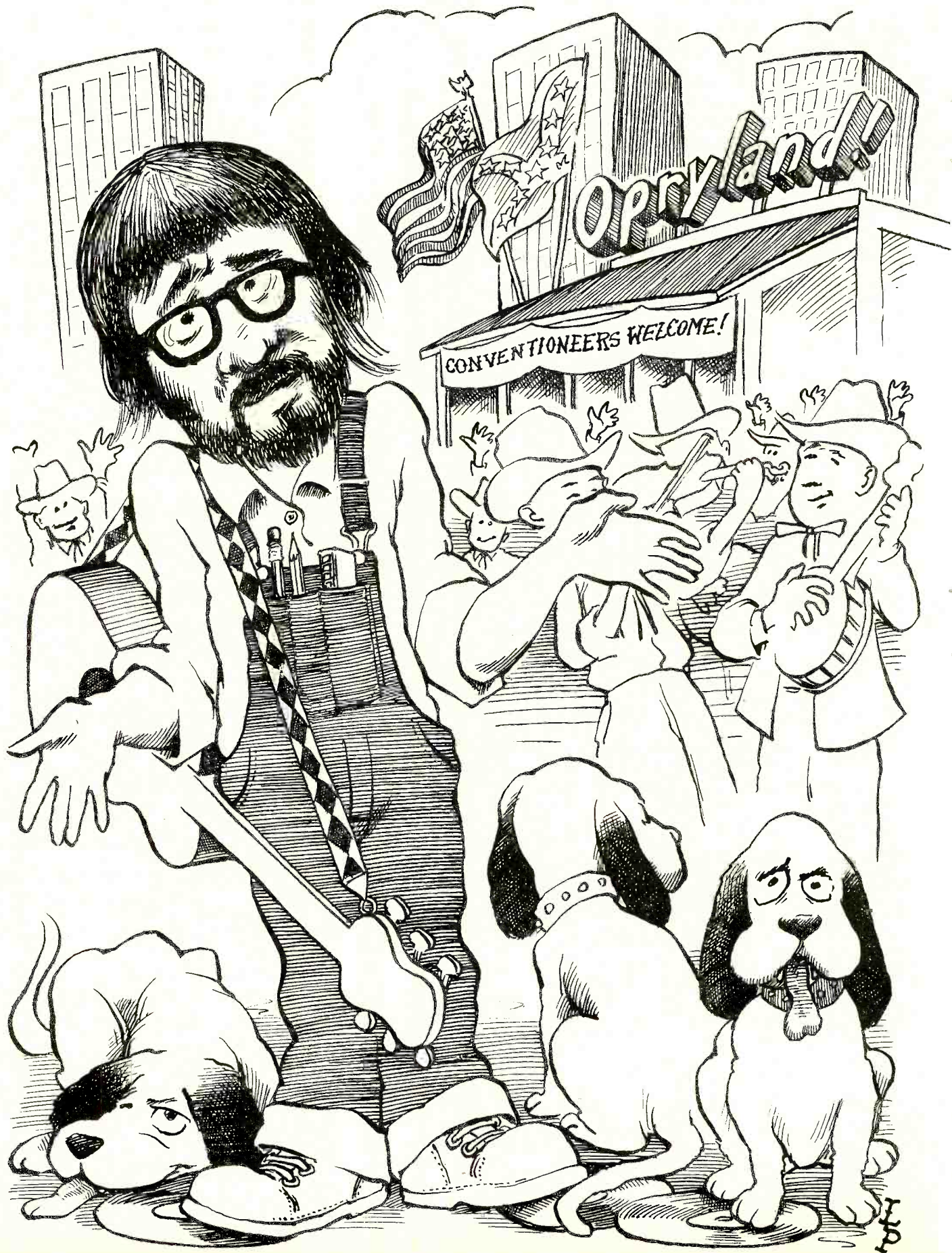

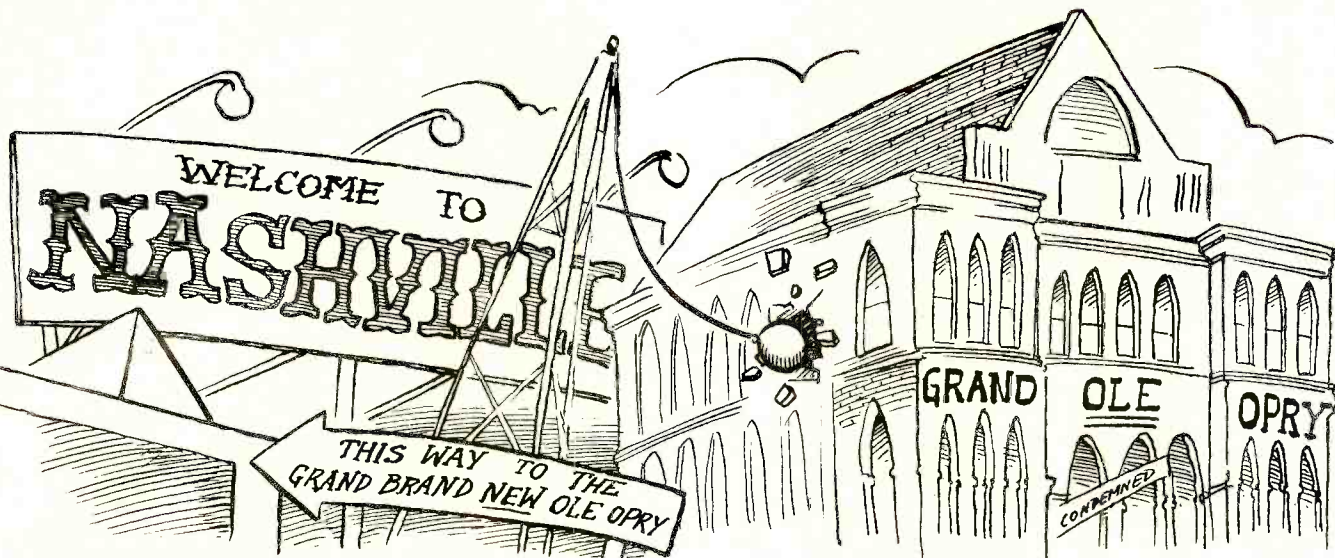

Noel Coppage reports from Nashville:

IS COUNTRY GOING TO THE DOGS?

Things have reached the point where, in some musical quarters, "cross" and "over" are two brand-new dirty words

DEAR BILL:

You sent me to Nashville—remember?—to see if I could find out what was going on down there where they define, sometimes by default, what country music is and will be. You sent me to Nashville, where they may right now be in the process of determining whether there is to be any country music as a separate, staunch entity as opposed to another vague styling of pop. This was after we had both watched a couple of country-music shows on national television in which everyone concerned went Hollywood, as Brother Dave Gardner would have put it, with the gusto of a hound dog, shows dotted with the pseudo-urbanes like Eddy Arnold (who, methinks, doth protest too much the smell of mule manure), shows awash in the strings of conserva-

tive orchestration to the point where you really had to do some fanciful listening to catch a single country twang. You sent me to Nashville, where Tootsie, friend-in-need and stalwart proprietress of Tootsie's Orchid Lounge across from the Grand Ole Opry ghost church, the Ryman Auditorium, is dead of cancer. To Nashville, where if you ask certain people for directions, they'll say, "You go down to the next crossover—uh, I mean, crosswalk. . . ." The point I want to drive home here, Bill, is you sent me to Nashville—you didn't send me to Georgia to be driven by Bert Lance's house in Calhoun and to wind up playing harmonica in a band fronted by Josh Graves in a bluegrass festival. The truth is, Bill, I may have let participatory journalism get a little out of hand. But I did get a new slant on how people

view labels, country and others, and—to borrow one of Josh's soft one-liners—they tell me I had a good time.

Oh, and I did get to Nashville a couple of times. Found it largely confusing. I went to a portion of the Fan Fair and was overwhelmed by the flurry of new names and new faces on the stage, slightly depressed by the vaguely Eagles-like slickness in so many of their styles, and made a trifle apprehensive by the realization that the age gap between the performers and the audience is widening. I talked with some people behind the scenes at some of the record companies and was told that young performers whose goal is pop stardom now see country as a good place to start. That figures, of course; it is one of the incidental, unintended influences of the success of Waylon and Willie

NASHVILLE

"... we are seeing our first batch of country music performers who were raised on television."



Columbia
JANIE FRICKE



Elektra
VERN GOSDIN



MCA
CONWAY TWITTY

and the boys from Austin, with their tons of hip young followers who normally listen to rock. It also jibed with my glancing observations at the Fan Fair, where young hippie types like Don Schlitz (who wrote *The Gambler*, which got considerable air play as recorded by himself and as recorded by Bobby Bare) came out one after another and did the singer-songwriter thing—which songwriter Sonny Throckmorton (soon to be *singer-songwriter* Sonny Throckmorton; he's working on an album), who wrote *Middle Age Crazy* for Jerry Lee Lewis, thinks is about to come into its own in country music.

He may be right; they were having writers' nights at the Exit/In, with some pretty mediocre singing and some rather far-out lyrics going (as they now say in Nashville) down. A guy named Zilch Fletcher, for example, did such stuff as a sing-along *Boogers in Your Nose* and a philosophical tune called *Love After Death*. And then the underground community, what there is of it in Nashville, was celebrating, in a modest way, one Paul Craft, who wrote *Drop Kick Me Jesus* for Bobby Bare, *Keep Me from Blowing Away*, recorded by Linda Ronstadt, *Midnight Flyer* for the Eagles, and (I suppose for himself—he *does* sing) *Linda Lovelace Come Sit on My Face*. So I tried not to get caught up in sorting out the new names—distracted though I was by some of them: how does Ottilie Yawn grab you? I jotted down mental notes on a few whose singing and/or writing impressed me, such as Janie Fricke, whose high, wild, black-sounding voice cuts through everything. But then she's not exactly a new name (it's hard to generalize down in Nashville just now, Bill, in case I'm not leaving enough drift); she's been a background singer in a lot of recordings, including those by Vern Gosdin that have shot out the top of the country charts lately. Speaking of Vern Gosdin and of label-integrity and of how hard it is to generalize, he's another of those unknown veterans who suddenly blossomed inside the hard-core country market but remains relatively unknown outside of it.

YET, I did get the feeling, for what it's worth, that not only are we seeing the country-as-stepping-stone-to-popstardom situation develop, not only are we seeing the singer-songwriter phenomenon happen in country as it once did in pop, but we are also seeing our first batch of country-music performers who were raised on television. People whose roots lie at least partly in *Howdy Doody* and the *Mickey Mouse Club*. People who grew up with a medium-influenced view of a sort of homoge-

nized America, a *pop* America, if you will. That's what the tube projects, relentlessly, and you can hear it in the music of several of these newcomers, country boys and girls with pop-America roots.

But, as I say, it's hard to generalize. There's Conway Twitty, who ironically started out as a rock star, giving *Music City News* a blast on keeping country "pure": "I have fans every night come up and say, 'Thank God you're not going pop on us.'" Conway says the so-called country radio stations are playing these schmaltzy crossover attempts so much and hard country so little that the fans are turning them off. "And lately the record companies are just as guilty as the radio stations," he says. "They keep shovin' stuff at the radio stations they want to cross over, and there's going to be a lot of people get hurt over it . . . already some record companies are in trouble over it."

And there's Vernon Oxford, singer-songwriter of *The Redneck National Anthem*, among other ditties, who gets almost no air play because he is too country for the country stations—but who has the largest fan club of anybody in country music and who has had a couple of tunes high on the charts *without* air play.

BUT I was going to tell you about the new slant I got on how people view what is country and what is otherwise when I was on the other side of the footlights. I went along on this Georgia tour for the ride—I really did—thinking maybe I could put Nashville in better perspective by taking a look at Atlanta, once the unquestioned princess of cities in the Southeast. But of course what I really wanted to do was play on the same stage with Josh, a legend on the dobro (actually he now plays a similar kind of resophonic guitar made by Jones) and a legend in bluegrass, being the third-most-important member of Flatt and Scruggs for fifteen years, then a key man in Flatt's Nashville Grass, then a key man in the Earl Scruggs Revue before going out on his own about five years ago.

I had been sitting around learning things from Charlie McCoy records for a chance like this, which came at an all-night jam session after Josh was softened up by having played three sets and drunk a few beers. So I wound up being treated like a musician—which is different from being treated like a writer—the next night at a large honky tonk called Country Green in the Atlanta suburbs and the following few days at this bluegrass festival in Western Georgia. (The drive by Bert Lance's place
(Continued on page 102)

*(A Smaller, Less Expensive Version of
The New Advent Loudspeaker.)*

The Advent/1.

For the past several years, the most popular and most imitated speaker in this country has been the Advent Loudspeaker, which, including its newly redesigned format, is approaching the 750,000 mark in sales. Also on the best-seller list has been the Smaller Advent Loudspeaker, a system carefully designed to have the same frequency range and much the same overall performance for less money in a smaller cabinet.

The Advent/1 is a new two-way acoustic-suspension speaker system that replaces the Smaller Advent. It is a redefinition of just how close we can come to the performance of our flagship speaker in a smaller, less expensive system.

The Advent/1 is one very short step down in performance from the New Advent Loudspeaker. It uses the same low-frequency and high-frequency drivers, and the only performance difference worth quantifying is that it has 2½ dB less output at 32 Hz. Its overall sound is as close to the New Advent's as one speaker can come to another. Its power-handling capabilities are the same, and its efficiency is high enough to allow it to be well driven by low-power amplifiers and receivers.

We feel that the performance-per-dollar (and per-cubic-foot) of the Advent/1 is unsurpassed by anything we or anyone else can offer in a speaker.

Its price* is \$100 to \$129 (depending on cabinet finish and how far we have shipped it).

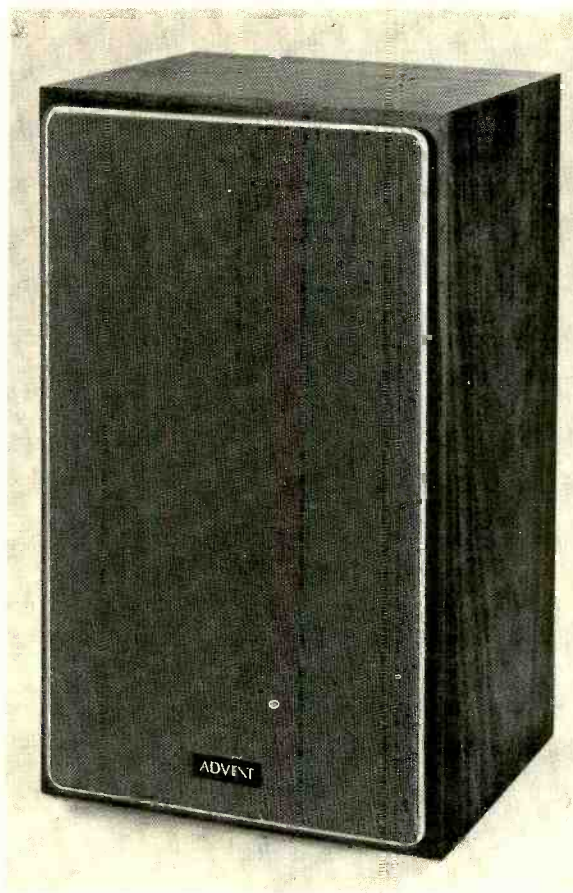

If you would like full information on the Advent/1, please send us the coupon.
Thank you.

SR-11/78

To: Advent Corporation,
195 Albany Street,
Cambridge, Massachusetts 02139

Please send information on the Advent/1
and a list of your dealers.

Name _____

Address _____

City _____

State _____ Zip _____

*Suggested prices, subject to change without notice.

Advent Corporation, 195 Albany Street, Cambridge, Massachusetts 02139.

NASHVILLE

"We must have done *Luckenbach, Texas*, by popular request, ten times."



Elektra

EDDIE RABBITT



CHARLIE RICH



Management Three

KENNY ROGERS

came before that, on the way down; Josh has friends everywhere, and one named Tom, who lives in Calhoun, took us by Bert's on the way to the VFW for a beer. "You won't hear many people in Calhoun say nothin' bad about Bert Lance," Tom told us.)

Since it's bluegrass that Josh is a legend in, and since this was by no stretch of the imagination a bluegrass band we'd assembled in a most impromptu way, I'd say I played better at the Country Green but learned more at the bluegrass festival—more about the labels people put on music, anyway. We had an electric guitar, an electric bass, Josh's dobro, and my harp. The guitar and bass were from the Joey Davis Band, which plays progressive country, Austin music, in the persons of Joey Davis himself, a singer, songwriter, guitarist, and philosopher ("You can pick your nose and you can pick your friends, but you can't wipe your friends on the couch"), and John, a hot, former rock, bassist with an unpronounceable last name who consents to being called Slappy.

We were apprehensive, to put it mildly, about how these non-bluegrass instruments would go over at a bluegrass festival, but we soon realized things there were a lot looser than we'd dared hope, that the change of style, change of pace, was welcome. We must have done *Luckenbach, Texas*, by popular request, ten times. Now *that* taught me something about the so-called hard country audience's resilience with regard to labels—and it contrasted nicely with the first thing I learned on this subject, which is that hard-core bluegrass fans consider bluegrass one thing and country quite another. I mean I didn't exactly *learn* this—I already knew it intellectually—I had it *driven home*, you might say, emotionally, and it's always better to feel the truth of something than to merely deduce it.

I gathered from talking to some of the pickers in the bluegrass bands that there is some debate raging among the younger of those about how progressive an approach to try on their audiences. Some of the younger ones clearly feel hemmed in by the rigid structure of bluegrass; some expressed a desire to do "more country stuff," and in the after-hours jam sessions at such an affair, they do it—but they also express a shyness about doing it before a bluegrass audience. And yet, there we were. Well, for one thing, there was Josh, who had the equipment and reputation and name to lead an audience into something "different" (Josh's latest album, as this is written, is mostly blues) where maybe a local band could

not lead the same audience; and, for another thing, we came out with non-bluegrass instruments in the first place, tilting expectations out of whack.

And so, on a larger scale, it may go with the larger labels of country and pop. I still don't believe I know many things *for sure*, Bill; I still have faith in only a few platitudes: power corrupts, evil is really ignorance, and beware of extremes. But it's hard to know, until you've sampled a few batches of it, whether something is extreme or not. Eddie Rabbitt's soft pop-like stylings of such songs as *You Don't Love Me Anymore*—is *that* sort of thing extreme? Is Vernon Oxford's redneckism extreme? Is the average country-music radio station's blandness extreme? (I gave a listen to WSIX-FM every time I was driving around Nashville; it plays what it calls "the cream of country," and you know how soft cream is—I kept hoping they'd play a certain jazz singer's "country" records so I could conjure with the idea of Charlie Rich, the non-dairy creamer . . . but they were too busy playing Kenny Rogers' latest sure-fire crossover.)

You also sent me to Nashville the city, Bill, and that's an even larger and more confusing subject. I picked up, on the one hand, a free tabloid called *Take One*, "The Alternative Magazine for Middle Tennessee," which now and then looks down a semi-hip nose at the red-neck music industry. A chap named Robert Kent, on the inside, was making a tongue-in-cheek proposal that Nashville forget about building a new football stadium, forget about renovating downtown Church Street one more time, forget about building a gospel music hall of fame (about which more in a minute), and concentrate instead on building a *wrestling* hall of fame. "Legends, handsome young men, peroxide blond demi-gods, and over-zealous elderly women are among the many elements composing the electricity generated by both country music and wrestling," he says. He says wrestling dates back to Greece and the first Olympics, and Nashville does, after all, call itself the Athens of the South.

NASHVILLE also calls itself, according to the ultra-establishment *Nashville!* magazine, a city in a "favorable marketing position." From reading around in that kind of view of Nashville, one learns that, according to a University of Nebraska survey that may or may not be dated, Nashville comes out number one among the ten top Southern cities in industry-attracting criteria (poor Atlanta, its antebellum look replaced by new plastic sky-

(Continued on page 104)

the (w)hole story

For years, SAE has been producing "state-of-the-art" separate components that offer value, quality and performance. That experience has now been applied to a line of integrated amplifiers. But what's the hole for? The answer is, ultimate performance!

Unlike others, our integrations are identical to our separates with the same designs and component parts already proven in SAE preamps and amps. But that's not all - in each of our integrations the preamp and amp section is entirely separated (even the power supply!). The preamp section, which is identical to our 2900 (or 3000, depending on the model) has its inputs and outputs near the front (hence the need for the hole), while the amp section (2200 or 3100) is at the rear. The only common parts are the chassis and the power switch. This unusual "U" shape design provides isolation of low and high level circuits, while retaining easy access to inputs and outputs (now only 3.5" behind the front panel).

These new units are so unique we don't consider them integrations. Instead, we call them preamp/amps. They meet all the goals of an ideal integration; (1) Convenience of an integration design; (2) Excellent value due to reduced packaging costs; 3) The performance of separate components.

No matter which of SAE's preamp/amps you choose - the 2922 with parametric EQ and 100 watts* per channel, 3022 with tone controls and 100 watts* per channel or the 3031 with tone controls and 50 watts* per channel, you are assured of SAE performance, quality and value. The preamp/amps are truly integrated separates. And that's the whole story.

*Per FTC Rating @ 8 ohms

For Complete Information Write:

SAE

Scientific Audio Electronics, Inc.
P.O. Box 60271 Terminal Annex, Los Angeles, CA 90060

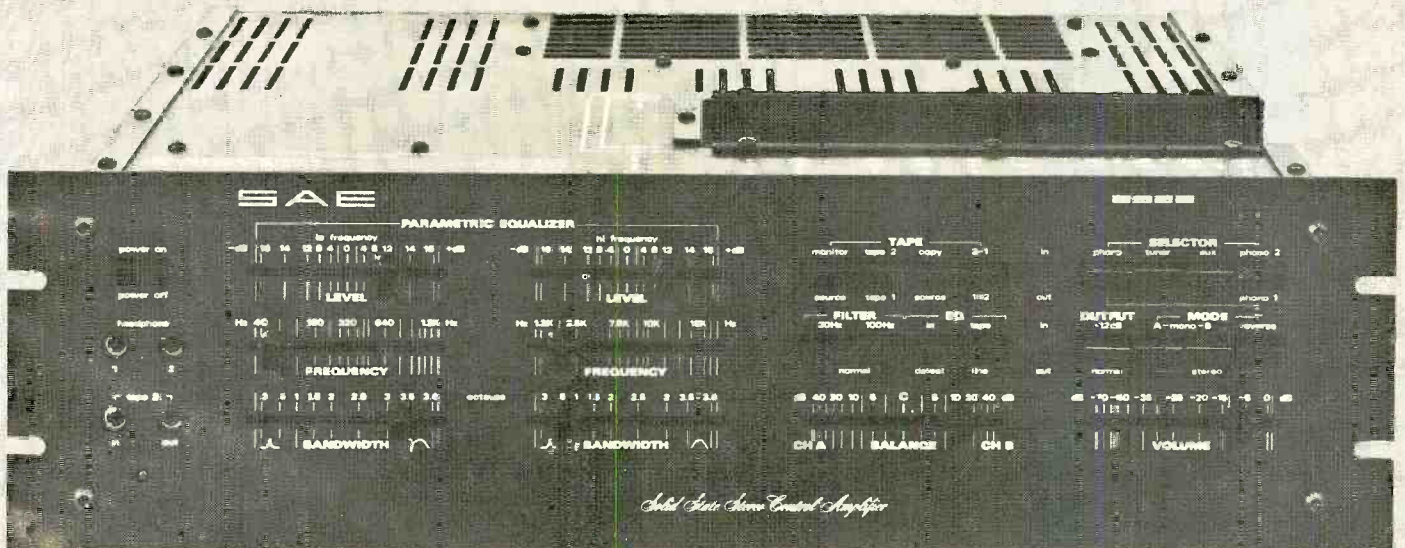

2922 Pre-amp/Amp

NASHVILLE

"... some people in Nashville think gospel is going to be The Next Big Thing."



Columbia
WILLIE NELSON



Capitol
ERNIE FORD



ABC/Dot
ROY CLARK

scrapers, its tax and crime rates edging into the "unfavorable" range, ranks dead last—even if its people do, on a per capita basis, put more money into the bank than any other Southern city's people). One also learns that the movers and shakers in Nashville are looking to jack up the convention trade. Dolly Carlisle writes in *Nashville!*: "For all practical purposes, the travel market here is saturated. According to a recent survey of the nation's tour brokers, Nashville is already listed among the top ten most popular destinations in the U.S. What could possibly magnify this existing situation?"

THE music-related tourism, especially if one counts the amusement park, Opryland, as part of it, accounts for most of that travel saturation. Maybe music-related interests can't magnify it, but some figure they can add to it with a proposal to build a gospel music hall of fame across from the Country Music Hall of Fame (which has finally got around to putting Willie Nelson's star on its walkway). That's right, Bill, some people in Nashville think gospel is going to be The Next Big Thing.

I think they mean on a long-term basis, and I know they mean a broad definition of gospel—producers say there's now very little difference in the way gospel and country or rock albums are produced; Willie Nelson hit it right on the button with his honky-tonk instrumentation on all those Baptist hymns in "The Troublemaker." The producer who has produced the most (white) gospel albums, believe it or not, is named Chris Christian. It used to be that practically all the white-gospel album sales were "trunk sales," sales out of the trunk of the performers' vehicle during the performance. Very inefficient. Black gospel, which is the only kind of music one company, Nashboro Records, deals in, has been selling its records through distributors for a long time. And Nashboro's president, Bud Howell, has been quoted as saying, "Black gospel alone outsells pure country music." I'm not sure what he means by pure, but I assume he means the Vernon Oxford kind, the not-a-snowball-in-hell's-chance-of-crossing-over kind.

Anyway, the Gospel Music Association, formed in 1969, has set a national goal to raise \$1.5 million to build this particular hall of fame, and Tennessee Ernie Ford (speaking of pseudo-urbanes), who has sold more records in the big, loose gospel category than anyone else has, has been named honorary national chairman of the fund drive.

So what does it all mean, this favorable market positioning, this emer-

gence of the singer-songwriter, this softening-and-hardening attitude about crossovers, this plethora of youngsters playing music for their elders, this banking on the Lord to help those who help themselves? Damned if I know, Bill. I expect Nashville to go on like it is for a while, which is to say gradually changing. One of these days, the entire audience as well as all the performers will have roots in the pop America of the tube. The melting-pot theory is alive and kicking in Nashville, and if you think television didn't have a lot to do with that, you're in disagreement with a number of "artists" clamoring to get on it. They have seen *Hee Haw* and it works. In true country-music style, they know their audience, and they know their audience watches the tube. "There's been a lot of them that've done it without a record," Bob Luman, who hasn't exactly done it yet, told *Music City News*. "They've had a lot of talent and were exposed in the right places . . . Roy Clark, for instance. He never had a number one record until he started doing television. . . . You've got to have it. It really is controlled in New York and L.A. Television is the name of the game, and that's where I'm heading."

MEANWHILE, you can still hear Moe Bandy on the radio, singing about bulldogging steers or whatever, and you can still catch an occasional outrageously country country song, like the lament of the would-be star's wife, "I'm tired of playing second fiddle to an old guitar," or (speaking of television) Tammy Wynette's *I'd Like to See Jesus on the Midnight Special*. This matter of how "country" country music is is a matter of degree. It takes time to move something as big as the Nashville music scene a whole degree, but it is moving. If it moves too quickly, the hard-country reaction will set in, but I think that would be a short-term phenomenon, like the current wave of Elvis imitators scouring the nation. This yen for television exposure has Nashville wired into New York and Los Angeles, which doesn't conflict with the lust for more convention trade or any other big thing the "other" Nashville wants, so I think things are going to get more and more corporate-looking down there.

It's a brave new world, Bill, but fortunately nobody in Nashville seems either smart enough or crazy enough to plunge us into it all at once.

As ever,

Noel Coppage

WHEN TOSHIBA BUILDS A CASSETTE DECK, SUPERIOR SPECS ARE NOT ENOUGH.

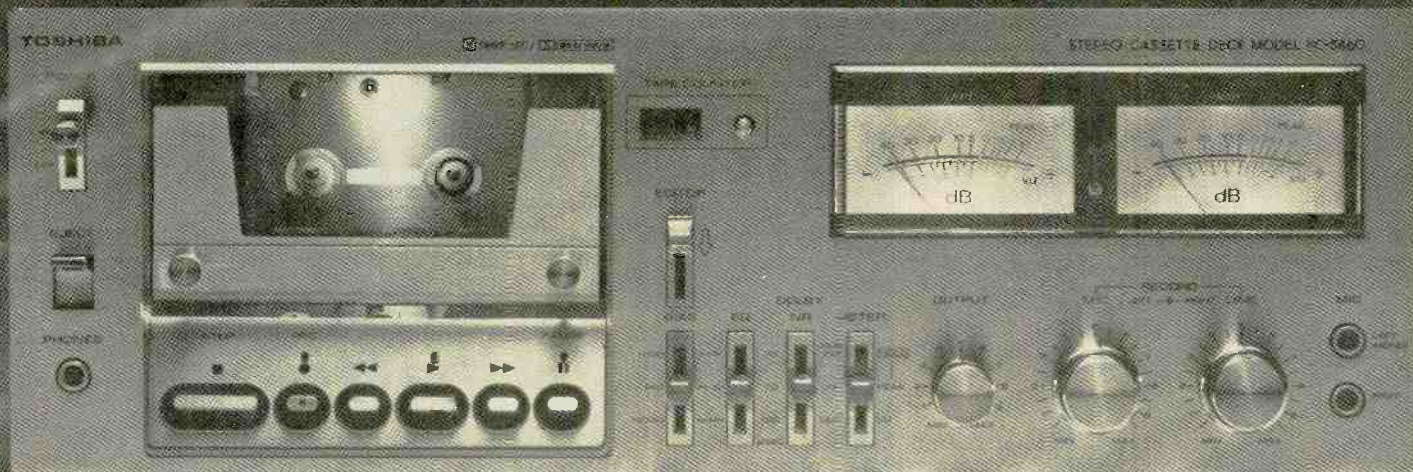

The Toshiba 5460 cassette deck. With an All-Sendust recording head, Dolby* FM and Direct Access feather-touch controls.

When you buy any of Toshiba's cassette decks, you can take excellent sound for granted.

Our 5460, for example, has inaudible wow and flutter: just 0.05% wrms. A high signal-to-noise ratio: 69 dB (± 3 dB, Dolby on, CrO₂). And wide frequency response: 20-18,000 Hz (FeCr).

But Toshiba goes beyond specs, to professional features for continued superior performance.

Consider the 5460's All-Sendust recording head. It stands up to wear much better than hardened permalloy. And it's not susceptible to the "chipping" that can occur with ferrite heads.

Then, get your hands on

our Direct Access feather-touch controls. The merest touch allows you to switch from one function to another. Without pressing the stop button or jamming the tape.

And the Toshiba 5460's front-loading cassette compartment has an oil-damped soft-eject mechanism, for smooth and convenient operation.

Of course, almost every cassette deck has Dolby these days. But few have Dolby FM as well. Toshiba does, with a switchable MPX filter circuit. So you can feed Dolby FM broadcasts through the 5460 to get cleaner sound. Whether or not you're recording.

The 5460 tape transport is DC servomotor-controlled.

And you'll appreciate

the three-function meter plus LED peak indicator. And our new edit/fade control.

Naturally, the 5460 has all the standards as well. Like three-position bias and equalization switches. Mike/line mixing. And circuitry to accommodate an accessory timer.

Look at and listen to the Toshiba 5460 and the full line of Toshiba cassette decks at better audio dealers.

As you'd expect from Toshiba, their sound and features are very impressive. And even their prices will be music to your ears.

TOSHIBA
Again, the first.

Toshiba America, Inc., 280 Park Ave., New York, NY 10017

HERBIE HANCOCK

A little dialogue on
the subjects of art
and commerce, jazz
and funk, acoustic
and synthetic,
critics and audiences
from the standpoints
of thirty-one years
as a performing
musician—and thirty-
one as a listener

By Chris Albertson

*Herbie Hancock
at the Vocoder*



It is served as a main course by a New York City radio station professing to have an all-jazz policy, advertised and promoted as jazz by companies who record it, placed on the jazz charts of the major music-trade publications, and even reviewed under the jazz heading in this magazine, but to me so-called fusion jazz, funk jazz, crossover music, or whatever the hysters are calling it this month is not jazz at all. It contains jazz elements, as do rock and disco music, but would we call a boogie performance by Horowitz classical music? Should we categorize Stanley Clarke's "Modern Man," Donald Byrd's "Caricatures," or Herbie Hancock's "Sunlight" as jazz albums merely because these men began their careers as jazz players?

Regular readers of STEREO REVIEW may have noted that I tend to be severe in my criticism of funk-pop albums by jazz musicians. That is not because I am an incorrigible purist who feels jazz is the only way to go, but rather because I feel cheated when I hear artists of extraordinary ability deliberately bringing their music down to a simplistic level.

Some of the outstanding jazz musicians who have defected to the land of funk-pop appear to realize that, by doing so, they have betrayed the fans and critics who helped them attain their initial recognition in the music business. And their feelings of guilt may be compounded by the fact that they continue to be categorized as jazz musicians and regularly have to face interviewers like me who take a dim view of their current output. This puts them on the defensive and often produces some astonishing rationales: "Although I enjoyed the music of, say, 'Sextant,' I would see many people leave the club with a heavier weight on their shoulders than when they came in," says Herbie Hancock in a quote from a recent Columbia Records publicity release. "I was, in effect, just creating another problem for them."

I was not aware that undiluted jazz had ever been seen as posing some kind of mental hazard, but the writer of this promotional piece took it from there: "And so Herbie Hancock began a new search. He had to thread his way through the tremendous body of craft that he had accumulated. He listened to the music that the rest of the world was listening to and began to recognize the part of himself, his musical self, that was reacting to Sly Stone and James Brown. He was not alone in this search, people everywhere were thinking about thinking less and being more."

All that sounds to me a little like ask-

ing Alexander Solzhenitsyn to write greeting-card verse, Michelangelo Antonioni to direct soap operas, and Julia Child to endorse Burger King. However, curious to find out why a musician who had spent a good part of his life perfecting his craft would lower his established high level of artistry to the one settled for on such albums as "Man-Child" and "Secrets," I arranged to interview Herbie Hancock. "I'll act as referee," said Columbia's jazz-promotion man, Peter Keepnews, only half in jest, but no mediator was needed. Hancock, aware of my views, seemed as anxious to discuss his current direction with me as I was to find out why he had taken it, and I suppose he interviewed me as much as I interviewed him. He was in New York to promote his latest album, "Sunlight,"

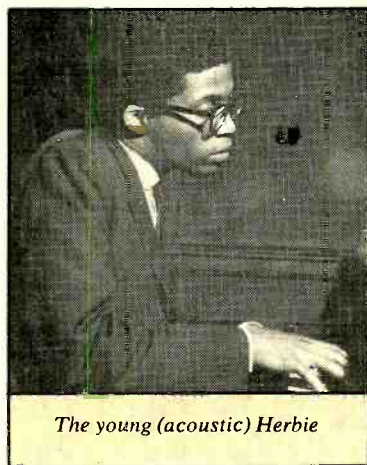

The young (acoustic) Herbie

and by the bed in his hotel room was his latest toy, a complex electronic gadget called the Vocoder VSM 201, which has enabled him to make his singing debut. More about that later. Hancock fired off the first question:

I want to ask you why you don't like me doing this thing.

Because I admire you as a jazz artist, and I consider your funk music a degradation of the high level you have achieved in the past.

But are you sure you know the reasons I'm doing this music?

No, but that's one reason I'm here.

Great, because I hate to see people assume that I'm doing something for this reason, or that reason, because those are the only reasons they can come up with. Anyway, what I'm looking for in my life is the freedom to do the music that I want to do when I want to do it; not just for my own personal pleasure, because I can do that at

home, but if I'm playing music for other people—on records, live, or on TV—then I must consider if it will be of value to the people listening to it. But I want the freedom to be able to choose that myself, which I think I have a right to, and it doesn't help me to have that kind of freedom if I get reviews that say "he should be doing this, and not that." I don't mind a reviewer saying "I personally would prefer him to play this and that," but if he says "he *should* be doing this and that," then I think the reviewer is kind of stepping out of his bounds.

How should your funk albums be reviewed? Isn't it perhaps a mistake to regard them from a jazz viewpoint?

That's a very big mistake. They should be judged on their own merits. If I were a reviewer, I would first ask myself how I could create the most value with my review, for the artist and for the people who are going to hear the music; when you discourage the artist, or the public, you actually create anti-value, but in order to encourage an artist you don't want to write something that is not true, so you look for the good points. Then, if you feel the performance contains elements that should be improved upon, or eliminated, you write that. If a person used to the jazz sounds of the Thirties were to review a record by, say, Cecil Taylor, which doesn't have any specific meter or pulse, he would have a hard time judging it by his own standards.

How should a reviewer approach "Sunlight"?

Well, people ask me, "What's on 'Sunlight' that hasn't been on your other albums?" Because I don't just want to repeat what I've done before, you know. Okay, the vocals are there, and, if you want my opinion, I like the vocals, I like the phrasing. It's in tune, but you can't give me credit for that, because the pitch is taken from the synthesizer, and that's got to play the tune. The phrasing is what I would have heard a singer use to the music, so I play it on the synthesizer, but I use my own voice. The musical content has a form that is very comfortable for improvising, and when I say "comfortable" I don't mean that it's not a challenge. Take the first song, *I Thought It Was You*: it's a sort of a disco thing, you can hear the disco thing with the beat, but the chord movement is basically simple. There are three symmetrical chord centers—it just turned out that way—and the chords move quickly through a few different keys. This was originally meant to be an instrumental album, so I played a piano solo

HERBIE HANCOCK

"... my challenge is to keep it simple and still make it sound fresh. That's hard to do."

on top of these chord progressions, one of the best solos I ever played—I could hear the influence of Keith Jarrett, from a melodic standpoint—but that was before I got the Vocoder, the device that allows me to sing, so we added the vocal, and the piano solo ended up in the background.

How was "Sunlight" a challenge?

As far as improvising is concerned, a musician makes his own challenge. Look what Coltrane did with *Impressions*—that's two chords—or *Chasin' the Trane*—that was just one chord, and there's nothing simpler than one chord. That's simpler than the three-chord rock-and-roll songs people talk about. My challenge in this song, and in a lot of songs I've been doing since the "Headhunters" album, has been to play within the framework of the music as it is, and one of the characteristics is a certain type of simplicity that is more important in this music than it was in the music I played in the Sixties.

You keep referring to "this kind of music." What is this kind of music?

Well, that's hard to describe. It has elements of jazz, funk, and popular music in it. You know, the big tradition of popular music from Frank Sinatra—that whole thing. I think those are basically the elements.

Will "Sunlight" and the second V.S.O.P. album be equally valid ten years from now?

It's hard to say, but suppose they weren't, suppose . . . oh, I think I know what you are leading up to, you suspect that the V.S.O.P. might be more valid.

Yes, isn't "Sunlight" a more trendy sort of album?

I wouldn't use the word "trendy," because that has the connotation of being less valid. I don't make the assumption that something which is valid for two hundred years is any more valid than something that only proved valid for five years.

Don't the two albums serve different functions?

That depends on what you feel the function should be.

Do you think "Sunlight" is an album people can and will dance to?

Yes, I think they can dance to it.

But not so the V.S.O.P. album?

No.

So that does make them different. As far as that is concerned, yes.

Isn't dance music more ephemeral than jazz?

Oh, I see what you mean. I'm not sure of that, though.

Are you saying that "Sunlight" will age as well as the V.S.O.P. album? Won't it sound more old-fashioned ten years from now?

Perhaps you're right, that could be very true. Are you trying to explain "trendy" the way you were meaning it?

Yes.

I think of something trendy as being a fad, and that has a negative connotation—not because it's short-lived, but because there's insincerity involved.

You mean a fad is usually a hype of some sort.

Yeah, yeah. That it's not the creation of value, real value, except in a business sense. It only benefits the person collecting the money. I've never done any music that's like that. I have never done any music just for the purpose of putting money in my pocket. I've been very fortunate because I've never had to do that. I've been able to survive playing the music that I want to play, and not just something that will put money in my pocket. That happens to be a by-product. I know a lot of people have a difficult time; they play the music they want to, but it's not feeding them. That's unfortunate.

In other words, you really enjoy playing funk music as much as you have enjoyed playing anything else.

Oh yeah, it's a rough challenge. It's really hard, a big challenge to me. It would, in certain ways, be easier for me to get more involved, to treat the music in a more complex way, because I'm used to doing that when playing jazz of the Sixties. It opens up a lot more room for exploration, but my challenge is to keep it simple and still make it sound fresh. That's hard to do. It's the same in your field. Let's say you're an intellectual and that you have a large vocabulary which you use in writing for an esoteric publication. Then you decide—you decide, nobody tells you—that what you have expressed so far has been specifically aimed at a certain group, and you decide for yourself that you would like to express it for some other people, too. So you don't utilize that huge vocabulary, you find a less complicated way of expressing yourself. It's a challenge, and that's exactly what I'm doing.

(Continued on page 110)

THE HERBIE HANCOCK GROUP: left to right, Kenneth Nash, Wah Wah Watson, Paul Jackson, Herbie Hancock, Jones Levi, and Benny Maupin.



MIDNIGHT DREAM COMPONENTS

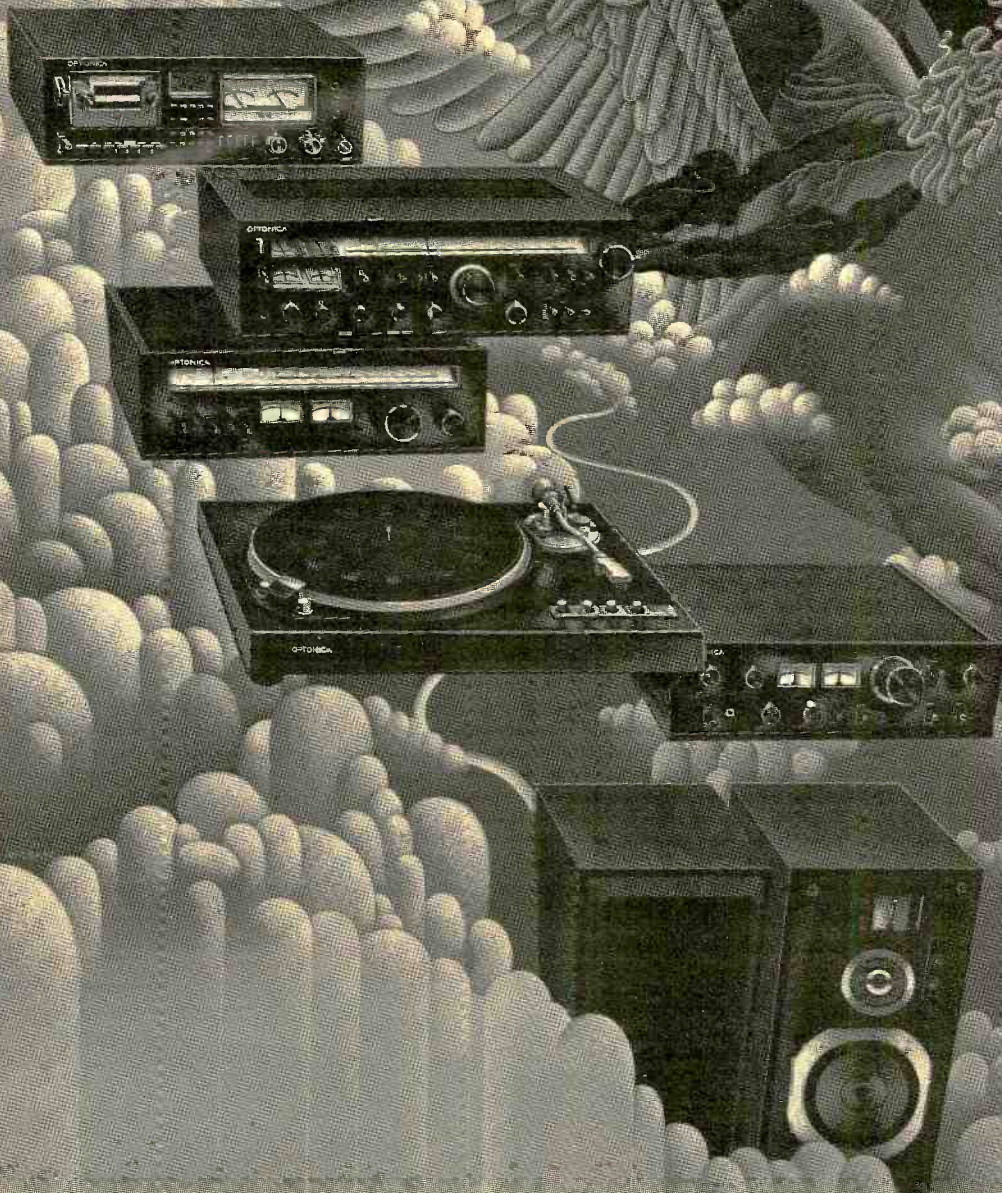

Hear your dream music on the dream system: black Optonica[®] components in the dark.

Fly up through soft and smoky clouds into a dream of midnight music, where smart black machines pour out high fidelity fantasies.

A passing cloud carries the gleaming ebony dream deck: the Optonica RT-6505.

At least a dozen of its switches control an endless range of recording and playback functions, governed by a small (and very intelligent) computer.

Now here's your new amplifier, equally black,

with softly glowing output meters that allow you to monitor output power (in watts or dB) for purity of sound and safety of speaker systems.

Next is the new ST-3205 tuner, with precise aircheck calibration for accurately pre-set recording levels.

A receiver sails by: the SA-5605, with Opto-Lock tuning, Delta Power, midrange tone adjustment and tuner cutout for disc-to-tape transfers.

A favorite record spins on the new Optonica RP-7505 turntable: direct-drive, full automatic, with unique metal/resin base that eliminates resonance problems.

Now your speaker systems: Optonica CP-5151's. If the highs you hear seem especially pure, it's because of a tiny metal ribbon tweeter that's about as heavy as the wing of a medium-sized butterfly.

It all comes together to create the kind of astonish-

ingly beautiful sound you might very well hear in tonight's midnight dream.

But why wait until dark? Visit an Optonica dealer and listen to the Optonica dream system, black as midnight, in the bright light of day.

OPTONICA

THE OPTIMUM.

10 Keystone Place, Paramus, N.J. 07652

HERBIE HANCOCK

"Chick said, 'Hey, man, why don't you sing it?' I said, 'Are you kidding? My voice goes out of tune. I can't sing!'"

Now, if you don't like the publication, if it's not to your taste, but you take on the job anyway, then you are being insincere.

What you are really saying is that you like the kind of music you are playing these days, the funk music, and that the wider audience and larger income are incidental.

Yeah, the larger income is incidental, but the wider audience has some consideration, not the major consideration. The major consideration is that I like it.

Reading the instrumentation listed for your new album, "Sunlight," I was reminded of a box of cookies.

Really? How so?

Well, there were the natural ingredients, soprano saxophone, bass, guitar, and so on, and—under your name—there were the chemicals: "E Mu Polyphonic Synthesizer, Oberheim Polyphonic Synthesizer, Yamaha CP-30, Hohner D6 Clavinet, Rhodes Electric Piano, ARP 2600, Mini Moog, ARP String Ensemble, Yamaha Polyphonic Synthesizer, Sequential Circuits Prophetia Synthesizer, Sennheiser Vocoder VSM 201."

Oh, [laughs] I see what you mean. I had never thought of it that way. I have the impression that you don't like electronic instruments.

I'm not against them per se, but that highly individual tone that marked the playing of Coleman Hawkins, Ben Webster, or John Coltrane—don't you think that playing a saxophone through a synthesizer robs the performance of an important human quality?

That's your feeling?

Yes.

I don't feel that way, and I have been listening to music for a long time. I started playing piano when I was seven, so I've got thirty-one years of experience as a player. So that is your opinion, and that doesn't make it the truth.

Certainly not, even with thirty-one years' experience as a listener. But let's get back to your album and those vocals. Why vocals?

I never before had vocals on any of my records, and within the past couple of years I started thinking why not have some vocals—why not? I had actually been looking for a vocalist for this album, and I don't know that much about vocalists, I never paid much attention to them, or to vocals—I don't know words to songs or anything. Anyway, every time I thought of the few vocalists I knew, their sound was either too jazz, funk, or church oriented, and I wanted something that had *all* those elements in it. Then I came across the Vocoder. It interested me—I tried it and liked the way it sounded, so that's why I put in the vocals.

Did you ever try singing without the Vocoder?

Oh, no! I know what my voice sounds like, so I didn't even try. I played the title song, *Sunlight*, for Chick [Corea] when we were on tour, and I sang for him the words I had written. He said "Hey, man, why don't you sing it?" I said, "Are you kidding? My voice goes out of tune, I can't sing!" He told me he knew my voice went out of tune, but that one can sometimes forgive such things when a composer sings his own songs. Anyway, I didn't even consider it, but then the Vocoder came along—it can make a singer out of anyone—and I really like the way it came out. The other experiment I tried was utilizing acoustic in-

struments in combination with the synthesizers so that the synthesizers expanded or fattened the sound. Instead of three or four trumpets and four trombones, I used two trumpets and two trombones, and I fattened the sound with the synthesizer. With the string sounds I used three violins and two cellos, and made them sound bigger with the synthesizer. It all worked very well. Also, a lot of the flute sounds are actually the synthesizers—I can't tell the difference. It sounds to me like real flutes.

If all that sounds terrible, so to me does the album. Perhaps Oberheim, Yamaha, Rhodes, or Sennheiser will some day come up with a plug-in Herbie Hancock. I hope they do it soon so that the real, live Hancock, after five years of funk, can return, full-time, to the instrument and music he plays best. In the meantime, we can look forward to a couple of promising albums—one on Columbia, the other on Polydor—featuring Hancock and Chick Corea playing duets on acoustic pianos. Because they have reached a wider audience with their funk music, Hancock and Corea now sell—according to a Columbia Records spokesman—a guaranteed minimum of 100,000 copies per album, *regardless of the content*. So perhaps a larger income is not the only "by-product." All that funk and nonsense we stodgy old critics so abhor has the effect of selling jazz records *too* to people who as yet don't know the difference but may, in time, get to know; I'll go along with that. □

CHICK COREA AND HERBIE HANCOCK: four hands on acoustic keys.

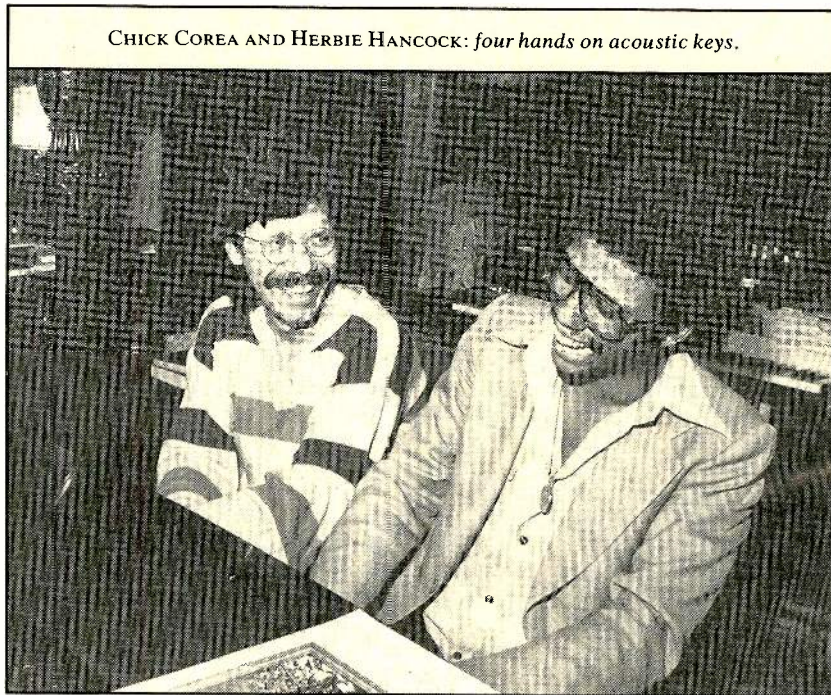

CBS Records

Before Sound Guard[®], you only played a record in mint condition once.



Magnification shows the record vinyl wearing away.

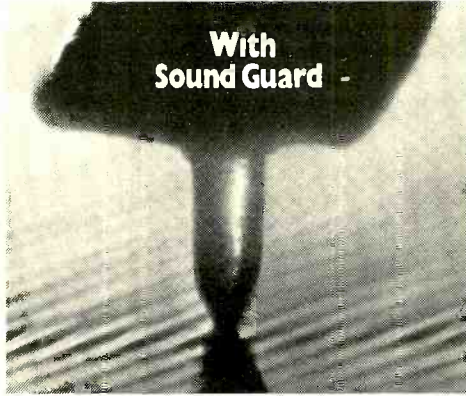

Same magnification shows no record wear.

You can see how the picture has changed.

Independent tests* show that records treated regularly with Sound Guard preservative keep the same full amplitude at all frequencies, the same absence of surface noise and harmonic distortion as records played just once in mint condition.

With its patented dry-lubricant film, Sound Guard

preservative maintains sound fidelity by reducing record wear. And with its built-in, permanent anti-static property, it resists dust accumulation.

And now, two new Sound Guard products:

1. Sound Guard[™] record cleaner, developed from extensive research into record cleaning problems and

methods, removes all common record contaminants—from dust particles to oily fingerprints.

And whether your records need a light cleaning to remove surface dust or a thorough cleaning to remove deep-seated contaminants, Sound Guard record cleaner does both.

2. Sound Guard[™]

Total Record Care System puts Sound Guard record preservative and Sound Guard record cleaner in one package—for the best possible total care for all of your records.

Available in audio and record outlets.

*Tests available on request.



Sound Guard[®] keeps your good sounds sounding good.



Sound Guard preservative—Sound Guard cleaner—Sound Guard Total Record Care System
Sound Guard is Ball Corporation's registered trademark. Copyright © Ball Corporation, 1977. Muncie, IN 47302

The best tape decks in the world are only as good as this tape.

While there's a lot of controversy over who makes the world's best tape deck, there's very little over who makes the world's best tape. Maxell.

Because Maxell gives you the

widest frequency response, the highest signal-to-noise ratio and the lowest distortion of any tape you can buy. In fact, people who own the finest high-performance tape equipment use our

tape more than any other brand.

So why buy one of the world's finest tape decks and get less than the world's best sound.

When you can use Maxell and get everything you paid for.



Maxell Corporation of America, 60 Oxford Drive, Moonachie, N.J. 07074.



CIRCLE NO 52 ON READER SERVICE CARD

STEREO REVIEW'S SELECTION OF RECORDINGS OF SPECIAL MERIT BEST OF THE MONTH



Conductor-soloist Bernstein: Enormous Authority in Mozart's C Major Concerto

FROM the beginning of his career, Leonard Bernstein has recorded as pianist as well as conductor—in solo works, song accompaniments, chamber music, and concertos—but his keyboard activity has not been very frequent. His best-selling recording as pianist is undoubtedly the *Rhapsody in Blue*, but the most rewarding are those of concertos by Mozart and Ravel; it is more than likely that Bernstein is more

successful in the dual role of soloist and conductor in Mozart concertos than any other musician who has undertaken it, and one only wishes he were more active in this particular area. His pre-stereo pairing of the Concertos No. 15, in B-flat (K. 450), and No. 17, in G Major (K. 453), for Columbia has not been available for some time, and since its retirement there has been only the remake (a splendid one) of K. 450 with the Vienna Philharmonic on London (CS-6499). Now Bernstein has recorded another Mozart concerto, the later and greater No. 25, in C Major (K. 503), this time with the Israel Philharmonic, again for Columbia, and it is one of the very finest things this extraordinary musician has given us in any category of his vast discography—

perhaps one of the finest things in the Mozart discography, too.

The concerto numbered K. 503 is one of Mozart's grandest—grand in the sense of having substance and dimension rather than being merely virtuosic (although none of his concertos is *merely* virtuosic)—and it receives a very grand-scale performance from Bernstein—at once expansive and alive with tension, serious and witty, expressive and subtle, delicate and dramatic. The symphonic stature of the work is of course realized to the full, and the solo part is played with a sense of rightness in terms of phrasing, style, and total integration of its parts that is simply beyond praise. Few of the keyboard stars who have “specialized” in Mozart have displayed such exquisite

touch or regard for appropriate color as Bernstein, with enormous authority and utterly without self-consciousness, does here.

Columbia does not bother to identify the cadenza Bernstein plays in the first movement: it is his own, and a remarkable one it is. There are no florid gestures, and no trivial ones either. The cadenza begins with a repeated emphasis of the four-note figure which, as Peter Eliot Stone points out in his annotation, so resembles the opening of Beethoven's Fifth Symphony, and this is reiterated several times before there is even a hint of the remainder of Mozart's theme. Then, by way of stressing the seriousness of the work, Bernstein takes us back, as it were, through its opening statement, to a reminiscence of the opening of the previous Mozart concerto—the C Minor, K. 491. This is as striking as it is unexpected, but it doesn't jar; it simply commands our attention, and it all works marvelously well—a cadenza, one might say, designed for the concerto itself rather than for the soloist.

Since the first movement alone in this imposing performance runs to seventeen minutes, there is no question of accommodating the entire concerto on a single side. The very generous filler on side two is a similarly distinguished performance of the Serenade in G, *Eine Kleine Nachtmusik*, played by the strings of the New York Philharmonic. How long this may have been in the can I don't know; it doesn't sound brand-new, but the sound is quite handsome enough and the performance is surely a winner. There is nothing at all cutesy or

condescending in Bernstein's approach, which, like the music itself, is straightforwardly early-Romantic, affectionate without excess, and a model of tastefulness and clarity.

—Richard Freed

MOZART: Piano Concerto No. 25, in C Major (K. 503). Leonard Bernstein (piano): Israel Philharmonic Orchestra; Leonard Bernstein cond. **Serenade No. 13, in G Major, ("Eine Kleine Nachtmusik," K. 525).** New York Philharmonic, Leonard Bernstein cond. COLUMBIA M 34574 \$7.98.

The Dirt Band: After Years of Trying, It Looks Like They've Finally Got It

LISTENING to the Nitty Gritty Dirt Band through the years has been something like popping my head into the kitchen now and then to ask "Is it soup yet?" They kept tinkering with their own, basically acoustic slant on a Sound . . . and never, it seemed to me, quite got it without help from special guest stars such as Doc Watson, Mother Maybelle Carter, and Roy Acuff, who helped make such a rousing success of the band's "Will the Circle Be Unbroken" back in 1972.

After their Russian tour last year, I

suppose I assumed they'd disband, but, lo and behold, they're not only still with us but have made some high-quality additions, turning out a rich yet light-riddled little album called (to show they're not as nitty or as gritty as they once were) "The Dirt Band."

Reed man and violinist Al Garth, who has been involved in some electrifying moments on various other people's albums, is a member of the group now, and he shows that yes, he can work with Jimmie Fadden's harp style (which is getting cleaner now that Merel Bregante is playing drums so Fadden doesn't have to). The additions (of Garth, especially) give the fills and improvisatory moments a much richer sound, but an even more important factor may be the way Jeff Hanna steps forward and fronts the band. He seems to be singing and playing the guitar with a new assurance, and his delivery is smooth and clean. Hanna is the focal point the band has been needing, and his control extends even to the production of this disc.

The other encouraging thing about the new album is the quality of the tunes, many of them Dirt Band originals and all of them pleasant, and their placement in the album gives it a balanced feel. I think it may be soup now.

—Noel Coppage

THE DIRT BAND. The Dirt Band (vocals and instrumentals); instrumental accompaniment. *In for the Night; Wild Nights; For a Little While; Lights; Escaping Reality; Whoa Babe; White Russia; Can't Stop Loving Me Now; On the Loose; Angel.* UNITED ARTISTS UA-LA854-H \$7.98, ® UA-EA854-H \$7.98, © UA-CA854-H \$7.98.

THE DIRT BAND (from left to right): Jeff Hanna, Jimmie Fadden, Al Garth, Merel Bregante, Richard Hathaway, John McEuen. It's soup now.



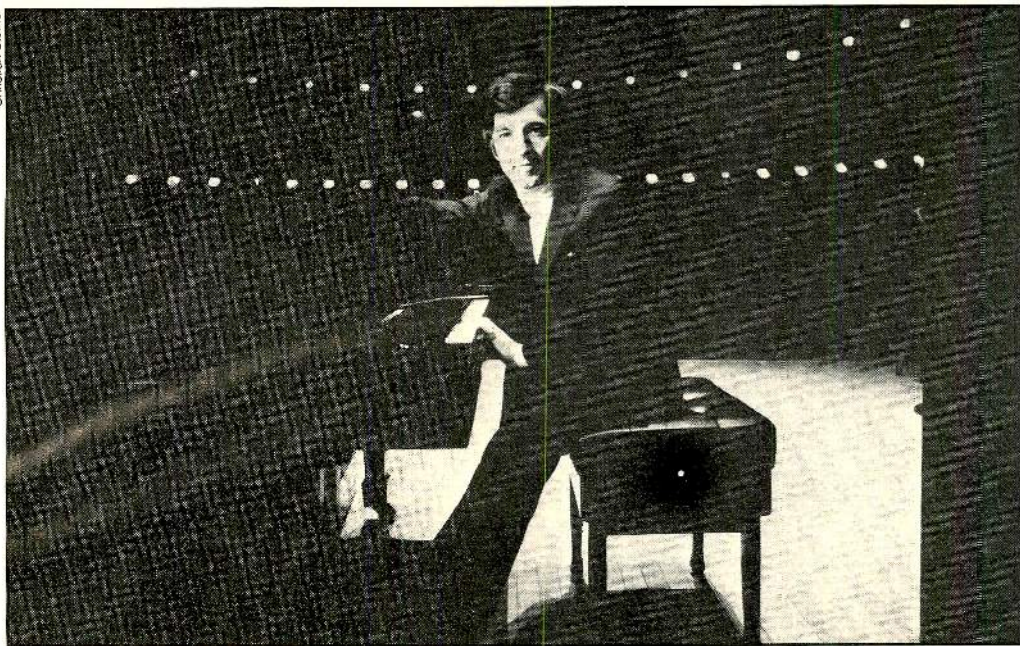

VLADIMIR ASHKENAZY:
Stunning eloquence,
pianistic splendor,
intellectual control—
and some of London's
clearest, most full-bodied
piano sound.

Vladimir Ashkenazy Gives Us Some of The Greatest Chopin Performances on Record

LONDON has just released Volume Three of Vladimir Ashkenazy's ongoing traversal of the solo keyboard repertoire of Chopin. I have not heard the first two volumes in the series, but if the quality of performance and recording of the third are representative, there seems to be little doubt that they can stand up to the very best of their kind—past, present, or future.

Ashkenazy's way with the first movement of the B Minor Sonata is disciplined and solidly virile, and in the marvelously nimble scherzo he achieves a truly gossamer sonic texture. But it is to the wonderful slow movement that Ashkenazy brings the full arsenal of his interpretive powers: Chopin's elegiac song is communicated with absolutely stunning eloquence. Finally, the amalgam of fierceness, pianistic splendor, and intellectual control forged in the fiery presto for me puts this reading unquestionably among the handful of really great recorded performances of this music.

On side two, Ashkenazy's handling of the almost miraculously ornamented variations of the *Berceuse* is only the highest of many high points reached in this group of mighty "small" pieces. The mazurka sequence—in an elegiac vein working toward elemental

dance—is superbly effective, as is the contrast achieved in the two nocturnes, the first emotion-laden, the second ethereally serene. Needless to say, the London recording staff has contributed its very best clear, full-bodied piano sound.
—David Hall

CHOPIN: *Piano Sonata No. 3, in B Minor, Op. 58. Berceuse in D-flat Major, Op. 57. Mazurkas, Op. 59: No. 1, in A Minor; No. 2, in A-flat Major; No. 3, in F-sharp Minor. Nocturnes, Op. 55: No. 1, in F Minor; No. 2, in E-flat Major.* Vladimir Ashkenazy (piano). LONDON CS 7030 \$7.98, © 5-7030 \$7.98.

Debbie Boone: the Most Interesting New Straight-On, Girl-type Girl Who Really Sings

PATTI SMITH, that Seventies, American street version of Ivy Compton-Burnett, recently allowed in these pages as how she's been learning a lot from Debbie Boone of late. Seems Patti's decided to bone up on Debbie's TV performances of *You Light Up My Life* so as to be as "totally focused" and to have as much "concentrated commitment" to a song as Debbie has.

Well, so much for Living Legends and how they get that way, and on to the delightful spontaneity of Debbie

Boone herself in her new Warner Bros. release, "Midstream." In it, Debbie solidifies her position as the most interesting new straight-on, MOR, girl-type girl who really *sings* since the days when Rosemary Clooney had the nation by its ear with her recording of *Hey, There*. That same pop generation also had dear l'il Sparkle Plenty herself, Doris Day, a born-to-win type if ever there was one. (Day has now, of course, faded away through soft-focus to no focus at all, but have you *heard* Clooney's latest recordings?) In this generation, Olivia Newton-John is to Debbie Boone what Day was to Clooney—foam rubber and icewater as opposed to flesh and blood

Side one here was produced by Brooks Arthur and side two by Joe Brooks, the man responsible for *You Light Up My Life*—and, the whispers went, the Svengali behind the success of that particular hit. Forget it. Boone sounds just as good, just as able to hit emotional magnetic north easily, truthfully, and exactly whether the material be Neil Sedaka's *What Became of My World* or the sophisticated ironies of Peter Allen and Carole Bayer Sager's *I'd Rather Leave While I'm in Love*. In fact, her best track from a commercial standpoint is probably *God Knows*, by Frannie Golde, Allee Willis, and Peter Noone, produced by Brooks Arthur.

On side two she sings five Joe Brooks songs, the best being *It Was Such a Good Day*, and also *When You're Loved* by Richard and Robert Sherman from (hold on!) *The Magic of Lassie*. That's one she could have passed along to Dad or one of her sis-



Warner Bros.

DEBBY BOONE: *character and feeling*

ters, but she does the best she can with it. And the best of what Debby Boone can do with *any* song is considerable. Even if at the moment she's being promoted—and regarded in some quarters—as a new brand of American Dream Shampoo, there's a lot of real character and feeling in her singing, and, most important, the beginnings of a unique vocal style. —Peter Reilly

DEBBY BOONE: *Midstream*. Debby Boone (vocals); orchestra and vocal accompaniment. *God Knows; What Becomes of My World; Another Goodbye; Don't You Love Me Anymore; Oh, No, Not My Baby; I'd Rather Leave While I'm in Love; When You're Loved; California; When It's Over; Come Share My Love; It Was Such a Good Day; If Ever I See You Again.* WARNER BROS. BSK 3130 \$7.98, © M8-3130 \$7.98, © M5-3130 \$7.98.

Debussy Preludes by Paul Jacobs: At Once Sensual and Intellectual, Personal and Virtuoso

PAUL JACOBS: *color and clarity*



Nonesuch Records

PAUL JACOBS, long known for his contemporary music performances and, in recent years, well established as the pianist of the New York Philharmonic, has recently been making a wider name for himself through the medium of recordings. His very successful set of the complete Debussy Etudes for Nonesuch has now been followed by the complete Preludes.

These works, much closer to the popular, "impressionist" Debussy than the Etudes, are usually tackled by pianists whose primary affinities lie with the nineteenth century—in other words, Debussy understood as the spiritual heir of Chopin and Liszt. Surprisingly, Jacobs does not entirely discard that tradition, for these interpretations are both personal *and* virtuosic. But he has obviously made a deep study of these works and, in the scholarly modern manner, even tracked down Debussy's own corrections and changes and incorporated them.

His feeling for the music is as sensual as it is intellectual; the playing is immensely elegant, quirky, full of sound and fantasy, and, though a bit lacking in longer line, always enthralling. The piano sound itself—Jacobs' playing is complemented by the fact that his instrument is a superbly recorded Bösen-

dorfer—is an extraordinary combination of color and clarity. A splendid dynamic range, crisp articulation, and telling nuances of interpretation are the key elements here, and harmonic balance is always artistically achieved as well—no muddy blurring anywhere. In short, these are performances with character, of an almost pre-Raphaelite sensitivity, in gorgeous sound.

—Eric Salzman

DEBUSSY: Preludes for Piano, Books 1 and 2. Paul Jacobs (piano). NONESUCH HB-73031 two discs \$3.96.

Carol Hall and the Original Broadway Cast Offer the Best Little Whorehouse on Records

EVEN before the show moved uptown to Manhattan's 46th Street Theatre from its off-Broadway opening, everybody in New York seemed to be urging everybody else to go see *The Best Little Whorehouse in Texas*. This cheerful musical spoof takes place at a venerable roadside establishment called the Chicken Ranch—because some customer once tried to pay for services with a chicken. As in the 1890's, when the Ranch opened, watermelons are served to the clients and a ceiling fan turns in every room, but now a jukebox instead of a piano plays in the parlor and the once-standard charge of three old-fashioned American dollars has gone up to about what a ticket costs for a show on Broadway. What with Tommy Tune's knockout choreography, Carol Hall's witty, hummable songs, and the gamey talk and high spirits that flow right up to the unexpectedly downbeat end, the premises (run by Carlin Glynn as the chic madam, Miss Mona) provide the setting for an evening of solid entertainment.

The original-cast recording retains much of the show's infectious character. The countrified score (country music was never quite as knowing as this, I think) comes right up and offers you a friendly lick on the nose from the opening number, in which the girls promise to treat every customer "real nice—and you come back now, hear?" This amiability lasts right through to the triumph of the local bluenoses at the end, when a vigilante group called the Watch Dogs closes down the Chicken

Ranch, and it's going to be a dreary Christmas for girls of good will.

Just hearing Delores Hall as the black maid at the Ranch sing *Twenty-four Hours of Lovin'* is worth the price of the album. Then there's Glynn, cheerfully explaining the services her girls offer and the strict house rules they work under in *A Li'l Ole Bitty Pissant Country Place*. And Jay Garner as the equivocating governor of the

pimps," and "no one messes with my girls." It's a classy establishment where even the clean-cut members of a winning college football team can safely spend their Thanksgiving holiday; their entrance is marked by a wildly macho number called *The Aggie Song*. In sum, everything about *The Best Little Whorehouse* is so sassy and agreeable that one wishes the record would go on even longer than it does—a feel-



Delores Hall sings *Twenty-four Hours of Lovin'* as the ghost of Marshal McCloud hovers in the background

Lone Star State—who thinks the Arabs and Jews should settle their differences in the Middle East in a Christian manner—avoiding reporters' questions in a wily number called *The Sidestep*. Henderson Forsythe as the open-minded sheriff doesn't get a chance to steal the record the way he does the show, but at least we have *Good Old Girl* as a token of his hilarious presence. At the Chicken Ranch, as Miss Mona explains, "nothin' dirty" goes on, there are "no

ing not prompted nowadays by too many musical-"comedy" albums.

—Paul Kresh

THE BEST LITTLE WHOREHOUSE IN TEXAS (Carol Hall). Original-cast recording. Clint Allmon, Pamela Blair, Lisa Brown, Gerry Burkhardt, Jay Bursky, Tom Cashin, Henderson Forsythe, Carlin Glynn, Delores Hall, and others (vocals). Rio Grande Band, Craig Chambers cond. MCA MCA-3049 \$6.98, © MCAT-3049 \$7.98, © MCAC-3049 \$7.98.



CLASSICAL DISCS AND TAPES

Reviewed by RICHARD FREED • DAVID HALL • GEORGE JELLINEK • PAUL KRESH
STODDARD LINCOLN • ERIC SALZMAN

BARTÓK: Roumanian Folk Dances (see SAINT-SAËNS)

BECKER: The Abongo (see COWELL)

RECORDING OF SPECIAL MERIT

BERLIOZ: Harold in Italy, Op. 16. Josef Suk (viola); Czech Philharmonic Orchestra, Dietrich Fischer-Dieskau cond. SUPRAPHON □ 410 2005 \$7.98 (from Qualiton Records, Ltd., 65-37 Austin Street, Rego Park, N.Y. 11374).

Performance: **Spectacular**
Recording: **Ditto**

This extraordinary record puts Supraphon right up there with the major European companies and establishes Dietrich Fischer-Dieskau as a genuine conducting personality. And then there is the viola playing of Josef Suk, who plays Berlioz's music with a wonderfully robust tone and a strong personality. Fischer-Dieskau inspires heroic feats of orchestral brilliance from the excellent Czech musicians. There is a bardic feeling throughout, and the Romantic qualities of melancholy, ecstasy, turmoil, and melodic vision are set off in vivid relief. The approach is narrative and dramatic, with a finale that is thrilling in its controlled impetuosity. The Pilgrim's March is fast by the usual measure, and the oboes and horns have the old-fashioned German tone now to be heard mostly in Eastern Euro-

pean orchestras, but these are not necessarily drawbacks at all. In fact, like Suk's tone quality, they add character. The recording is impressive enough in two channels; in four-channel SQ playback it is spectacular. E.S.

BOITO: Sinfonia in A Minor (see PUCCINI)

BRAHMS: Four Serious Songs, Op. 121 (see MOUSSORGSKY)

RECORDING OF SPECIAL MERIT

BRAHMS: Quintet for Piano and Strings in F Minor, Op. 34. Sviatoslav Richter (piano); Borodin Quartet. WESTMINSTER GOLD Ⓜ WG-8356 \$3.98.

Performance: **Treasurable**
Recording: **Not bad now**

This classic performance of the Brahms Piano Quintet, recorded in Moscow by Melodiya in 1959, has circulated here on various labels from time to time, and each reappearance has been frustrating because the inadequacy of the sound made it impossible to enjoy the performance to the full. Westminster/ABC's Lanky Linstrot has worked wonders in this latest remastering, and the strings are in the picture now. The sound is still hardly exemplary, even by 1959 standards, but as refurbished here it is more than adequate to enable any listener to revel in the sweep and grandeur of this treasurable performance, so alive with tension and conviction and the sort of give-and-take that builds a chamber-music performance into an Event. R.F.

RECORDING OF SPECIAL MERIT

BRAHMS: Serenade No. 1, in D Major, Op. 11. Symphony of the Air, Leopold Stokowski cond. VARÈSE SARABANDE VC 81050 \$7.98.

Performance: **Exuberant**
Recording: **Very good**

The curiously named Varèse Sarabande company, formed by three young men in Los Angeles who are serious about sound and interested in "non-basic" repertoire, has brought

us some interesting music from Japan (on superb JVC pressings) and some reissues from both the Remington and American Decca catalogs. Nothing from the last source was more eminently worthy of resurrection than this superb realization of Brahms' first work for orchestra. Stokowski had a fine feeling for the work—his version is at once more animated and more warmhearted than either of the two more recent recordings—and the Symphony of the Air in this 1961 performance sounds very much like the NBC Symphony it had been a half-dozen years earlier. The sound, quite good to begin with, has been opened out to a richer, fuller bloom (if still a little fiery in the string climaxes) in Dub Taylor's remastering. Martin Bookspan's annotation is preserved from the original issue, and the pressing itself is unusually clean. In all, downright irresistible. R.F.

BRAHMS: Three Duets, Op. 20; Four Duets, Op. 61; Five Duets, Op. 66; Wiegenlied, Op. 49, No. 4. HANDEL: *Beato in Ver Chi Può.* Renée Grant-Williams (soprano); Dorothy Barnhouse (mezzo-soprano); Alden Gilchrist (piano). 1750 ARCH S-1761 \$6.98.

Performance: **Good**
Recording: **Good**

Writing for vocal ensembles (duets and quartets) with piano accompaniment was a Brahms specialty, perhaps a natural outgrowth of his activity as a choral director. This thoughtfully assembled collection offers the three sets of duets for soprano and alto—all rarely heard material. (The four duets for alto and baritone, Op. 28, have been recorded by Dame Janet Baker and Dietrich Fischer-Dieskau, Angel S-36712.) The early Op. 20 still shows the composer under the Schumann-Mendelssohn influence; in the two later groups we find more characteristically Brahmsian harmonies and a heightened skill in developing the two voices independently rather than on parallel lines. Brahms' interest in German folk poetry and song was also an important influence in this phase of his output, as manifested in *Die Schwestern* (Op. 61) and *Jägerlied* and *Hüt du Dich* (Op. 66).

Explanation of symbols:

- Ⓜ = reel-to-reel stereo tape
- Ⓢ = eight-track stereo cartridge
- Ⓒ = stereo cassette
- = quadrasonic disc
- Ⓡ = reel-to-reel quadrasonic tape
- Ⓟ = eight-track quadrasonic tape

Monophonic recordings are indicated by the symbol Ⓜ

The first listing is the one reviewed; other formats, if available, follow it.

Judith Blegen and Frederica von Stade have recorded five of the twelve duets here (Columbia M-33307), and they sing with more vocal gloss and virtuosity. But Renée Grant-Williams and Dorothy Barnhouse, both seasoned artists active in opera and recitals on the West Coast, sing charmingly, clearly, and what is most essential, with pure intonation throughout. They also show considerable skill in the Handel duet, which calls for sustained phrasing and intertwining bel canto lines.

G.J.

BRITTEN: *Peter Grimes, Op. 33: Four Sea Interludes; Passacaglia.* **VAUGHAN WILLIAMS:** *Fantasia on a Theme by Thomas Tallis.* Philadelphia Orchestra, Eugene Ormandy cond. RCA ARL1-2744 \$7.98, © ARK1-2744 \$7.98.

Performance: **Sure-handed**
Recording: **Lush**

Eugene Ormandy and his orchestra deliver sure-handed renditions of Britten's marvelously atmospheric and emotional music from Peter Grimes, and RCA's recorded sound is gorgeous. Likewise, Vaughan Williams' glorious Tallis Fantasia could have been made to order for the Philadelphia strings, and they make the most of it. The quiet antiphonal sections come across most effectively (despite some traffic rumble in the background). But in the Britten the Philadelphians miss the sense of urgency achieved by André Previn and the London Symphony in their equally impressive-sounding Angel recording. And in the Vaughan Williams they face stiff competition from the formidable Sir Adrian Boult's Angel recording, which is encoded for four-channel playback.

D.H.

CHAUSSON: *Poème de l'Amour et de la Mer, Op. 19.* **DUPARC:** *Phidylé; La Vie Antérieure; Le Manoir de Rosemonde; Au Pays Où Se Fait la Guerre; L'Invitation au Voyage.* Janet Baker (mezzo-soprano); London Symphony Orchestra, André Previn cond. ANGEL □ S-37401 \$7.98.

Performance: **Very good, but . . .**
Recording: **Very good**

As always, Dame Janet Baker shows nothing less than total commitment in her performances of these too-seldom-heard works, and there are more than a few moments of exquisite beauty on this well-recorded disc, with especially effective interaction between singer and conductor. And yet, for all the dramatic conviction, for all the vocal and orchestral opulence, I had a nagging sense of something missing. In the Duparc songs I tended to explain this away in terms of the orchestra's being a less idiomatic participant than the piano originally specified for accompaniment, but a comparison of this performance of the Chausson work with the one by Victoria de los Angeles (Angel S-36897, with Jean-Pierre Jacquillat conducting) suggested that Baker herself is the "less idiomatic participant"—that she is simply not as much at home in this material as she is in the songs of Schubert and Brahms, and that she may be less than comfortable singing in French (though I did not have that impression with her earlier recordings of two of these same Duparc songs with Gerald Moore). There is no other collection of these Duparc songs now available, with either piano or orchestral accompaniment, that is as attractive as this new one, despite its short-

comings, but for the Chausson the choice would have to be De los Angeles. R.F.

CHOPIN: *Piano Sonata No. 3, in B Minor, Op. 58; Berceuse in D-flat Major, Op. 57; Mazurkas, Op. 59, Nos. 1, 2, and 3; Nocturnes, Op. 55, Nos. 1 and 2* (see Best of the Month, page 115)

CHOPIN: *Scherzos: No. 1, in B Minor, Op. 20; No. 2, in B-flat Minor, Op. 31; No. 3, in C-sharp Minor, Op. 39; No. 4, in E Major, Op. 54. Impromptus: No. 1, in A-flat Major, Op. 29; No. 2, in F-sharp Major, Op. 36; No. 3, in G-flat Major, Op. 51. Fantaisie-Impromptu in C-sharp Minor, Op. 66.* Roberto Szidon (piano). DEUTSCHE GRAMMOPHON 2536 378 \$8.98, © 3336 378 \$8.98.

Performance: **Glittry**
Recording: **On the bright side**

It is clear from the ferocious opening bars of the B Minor Scherzo that Roberto Szidon can do anything he wants to on the piano—and that he is determined to prove it, even to the

point of out-Horowitzing Horowitz. The results are certainly spectacular on first hearing, but the excessive contrasts in all departments, including certain aspects of tempo, pall on ear and mind alike after a while. It is the famous C-sharp Minor Scherzo that suffers most from this approach, with the end sections being too fast and the central chorale pulled about like so much taffy.

Matters improve in the relatively serene E Major Scherzo and the four impromptus, which, by their very nature, compel a measure of restraint and demand close attention to lyrical content and texture. On the whole, however, Szidon's Chopin is nervously exaggerated, and the impact is accentuated by either a very brightly voiced instrument or an excessive mid-range pre-emphasis in the tape-to-disc transfer. The piano's lower range comes through excellently, though. D.H.

RECORDING OF SPECIAL MERIT

CHOPIN: *Twenty-four Preludes, Op. 28.* Ivan Moravec (piano). SUPRAPHON 1 11 2139 \$7.98



G. Neuvacelle/Polydor

Barenboim's Schubert

DANIEL BARENBOIM is a multifaceted musician, and I am certainly an advocate of multifacetedness. Nevertheless, despite his growing fame as a conductor, it was as a brilliant young pianist that he started his career, and it is as a brilliant, and still youthful, pianist that he appears before us on a new Deutsche Grammophon recording of Schubert piano music.

Barenboim plays the *Moments Musicaux* with a wonderful delicacy and a spirit that evokes a poetic world at once precise and fantastic. It is a rare thing to catch the simplicity of this music and to maintain it on such a fine edge without the least touch of fussiness, condescension, or artificiality. The album's second side comprises lesser-known music, but it is hardly of less interest in terms of either content or interpretation. The Allegretto in C Minor is an "album piece," an occasional work written for a friend's music album. It is late Schubert of the utmost sim-

plicity—and of major importance. The *Valses Nobles*, a dozen out of some three hundred Schubert waltzes, contain some of the most wonderful dance music ever written. And the two early scherzos that complete the album are also quite dancy—No. 1 in particular—though they seem to have been connected with sonata projects. Barenboim's playing of them has, in any case, plenty of dance lilt. But it is in the poetry of the *Moments Musicaux*—poised between Classicism and the freshest early Romanticism—that his sensitive, articulated pianism is at its best. The sound of the recording is clear throughout, but it is not quite as beautiful as the playing deserves.

—Eric Saltzman

SCHUBERT: *Six Moments Musicaux, Op. 94 (D. 780); Allegretto in C Minor (D. 915); Two Scherzos (D. 593); Twelve Valses Nobles, Op. 77 (D. 969).* Daniel Barenboim (piano). DEUTSCHE GRAMMOPHON 2530 996 \$8.98.

(from Qualiton Records, Ltd., 65-37 Austin Street, Rego Park, N.Y. 11374).

Performance: **Poetic**
Recording: **Good**

It is good to have new Moravec recordings coming fairly regularly now from Supraphon. The Mozart, Schumann, and Franck concert-ed works have been most welcome, and if this disc excites any less enthusiasm it is only because Moravec's earlier recording of the Preludes (Connoisseur Society CS-1366) left little need for a remake. Naturally, an artist of Moravec's sensitivity adds depth to his interpretations over the years, and one may feel an even higher level of poetry is reached now in such a piece as the D-flat Major Prelude (No. 15); one may feel also that the drama tends to be too understated in the final D Minor, whose *appassionato* marking, however, is well realized in terms of inner tension if not the sort of grand flourish one is accustomed to. Degrees of difference between this and the earlier Moravec presentation, though, are slight where encountered, and the Supraphon sound, though no better than Connoisseur's, is very good in its own right. No separating bands between pieces, but the surfaces are very quiet. **R.F.**

RECORDING OF SPECIAL MERIT

COWELL: *Quartet Romantic*. **RIEGGER:** *Wind Quintet*. **R. C. SEEGER:** *Three Songs*. Beverly Morgan (mezzo-soprano, in Seeger only); members of Speculum Musicae, Paul Dunkel cond. **BECKER:** *The Abongo*. New

Jersey Percussion Ensemble at William Paterson College, Raymond DesRoches cond. NEW WORLD NW 285 \$8.98.

Performance: **All good**
Recording: **Special**

Henry Cowell's *Quartet Romantic* (for two flutes, violin, and viola) was written between 1915 and 1917, but don't let the title and dates fool you; this is very much a work of the modern age. It was, in fact, so far ahead of its time that a realization of the score has only recently become possible. As in one or two of his other works of the time, Cowell here pursued an idea about the interrelation of harmony and rhythm—that both are based on mathematical ratios—which has lately reappeared in the works of Stockhausen. The quartet is consequently so complex—each part is completely independent rhythmically, yet they must all fit together—that Cowell himself considered it unplayable. But, thanks to prerecorded "click tracks" heard through headphones, the superb young performers of Speculum Musicae have been able to put together a performance that is not merely competent but actually attractive and musical. As a result, the work emerges as one of the major pioneering efforts by one of our major, but still neglected, creative figures.

At least two of the other works on this album might also be called "pioneering." John J. Becker, today hardly more than a name in the reference books, was another of Cowell's generation of American eccentrics and innovators. *The Abongo*, written in 1933, is an early all-percussion piece intended to refer to

African tradition. It is neo-primitive, intriguing, heavy-footed, and nothing if not persistent. Ruth Crawford Seeger was one of the most notable figures of this period of ferment. Together with her husband, Charles Seeger, she made the transition from avant-gardism to folk music (her stepson Pete and her own children, Mike and Peggy, were, of course, pioneer folkies). The impressive settings of three Carl Sandburg poems recorded here date from her avant-garde period and their expressive content is extraordinary.

Wallingford Riegger's *Wind Quintet* is a bit closer to the main run of modern music. It is well written and has lots of dynamic vigor. Like everything else on this album, it is performed with great *elan*, and, as usual, New World Records has provided a sheaf of notes, texts, and references. **E.S.**

DEBUSSY: *Preludes for Piano, Books 1 and 2* (see *Best of the Month*, page 116)

DEBUSSY: *String Quartet in G Minor, Op. 10*. **RAVEL:** *String Quartet in F Major*. Orford Quartet. LONDON STS-15440 \$3.98.

Performance: **Brisk Debussy, supple Ravel**
Recording: **Close-up**

This appears to be the recording debut—in terms of U.S. release, at least—of the Toronto-based Orford Quartet (a group of youngish performers, to judge from the cover photograph and the liner information that they won first prize at the Stockholm International Competition as recently as 1974). They play

The New TCD 340 A With The Exclusive ACTILINEAR Recording System

Tape recorders can no longer be looked upon as independent units in today's extremely sophisticated sound systems, but rather as components within a total system with performance capability as advanced as all other components of that system.

Drawing upon its unequalled 30 year tradition in magnetic recording technology, Tandberg has met this challenge by developing a completely new concept known as ACTILINEAR Recording (Patent pending).

In conventional recording systems, the summation of record & bias currents in the recording head is done through passive components, leading to inherent compromise solutions. The new ACTILINEAR System is free of these compromises, as the passive components have been replaced with an active Transconductance amplifier developed by Tandberg. Just a couple of its benefits are: up to 20 dB more headroom over any recording system currently available, and the ability to handle the new high coercivity tapes.

In fact, Tandberg's new ACTILINEAR Recording System, when used in conjunction with the soon-to-be-available metal particle tapes now under intense development in the U.S., Japan and Ger-

many, offers performance parameters approaching those of experimental Pulse Code Modulation (PCM) technology, yet is fully compatible for playback on all existing tape recorders. It is literally a recording system for the future, with no obsolescence factor, as it can be used with any tape, available now or in years to come.

Tandberg engineers have mated this advanced recording system with the finest cassette deck transport available today, making their new TCD 340 A a worthy successor to the world-famous TCD 330 cassette deck. When used with the better brands of recording tape currently available, the TCD 340 A's ACTILINEAR Recording System permits an extremely linear frequency response, a significant increase in headroom, as well as a reduction of high frequency IM distortion and the cancellation of Slew Rate limitations.

And when metal particle cassette tapes become available, the TCD 340 A can be adjusted to take full advantage of their increased signal capacity. At that time, Tandberg will also offer the ultimate cassette deck—the remarkable TCD 340 AM, complete with front panel switching for the new metal particle tape.

Both these remarkable cassette decks

excel in more than just their circuitry. Like their famous predecessor, the TCD 340 series offers three separate heads (not a "2-in-1 sandwich" head compromise) for professional recording & monitoring, as well as Tandberg's renowned three-motor, dual capstan closed loop transport, coupled with complete logic-controlled solenoid operation. Plus exclusive features such as adjustable azimuth & built-in 10 kHz tone generator, allowing the user to select the perfect alignment for each cassette, as well as to spot dropouts and inferior quality tape. And the TCD 340 A boasts a 70 dB signal-to-noise ratio, plus very low 0.12% WRM wow & flutter!

And there's more: Automatic take-up of tape loops when the cassette is inserted. Frequency-equalized, peak-reading meters. Servo-controlled high speed winding. Plus vertical or horizontal operation, optional remote control & rack mounting.

Tandberg's TCD 330 was the deck that delivered cassette performance exceeded only by the finest reel-to-reel machines. Now, the 340 series with ACTILINEAR Recording narrows the gap even more.

For your nearest dealer, write: Tandberg of America, Inc., Labriola Court, Armonk, N.Y. 10504. Available in Canada.

TANDBERG

with great assurance, suggesting they have been together long enough to develop a truly unified style as well as a good understanding of the material. Their polished Debussy and Ravel performances would make anyone happy enough in the recital room, but on records, with so many similar pairings to choose from, one may be very selective. In particular, the Quartetto Italiano (Philips 835 361LY) and the Parrenin Quartet (Connoisseur Society CS-2103), both with long associations with these works (including previous recordings), dig in a little deeper and bring out a bit more of the music's essence. The Orford's Debussy seems rather on the brisk side, as if, in such moments as the climax of the slow movement, the musicians were inhibited by the fear of being overexpressive; they are more expansive and more persuasive in the Ravel. Both sides are well recorded, though with an extremely close-up focus that occasionally tends to exaggerate certain effects (the pizzicati in the second movement of the Ravel sound gargantuan). A good buy at the price, but the Parrenin and Quartetto Italiano versions are worth the difference. **R.F.**

DOHNÁNYI: Quintet in C Minor for Piano and Strings, Op. 1; Serenade in C Major for Violin, Viola, and Cello, Op. 10. New London Quintet. HNH 4072 \$7.98.

Performance: **Adequate to good**
Recording: **Very good**

DOHNÁNYI: Rhapsody in C Major, Op. 11, No. 3; Passacaglia, Op. 6; Variations on a Hungarian Folk Song, Op. 29; Three Singular

Pieces, Op. 44. Howard Shelley (piano). HNH 4055 \$7.98.

Performance: **Low-key**
Recording: **Very good**

Ernst von Dohnányi died in 1960 at the age of eighty-two; his centenary passed last year without notice. He may not have been among the most original of composers, but he was a consummate musician: his own works are invariably well crafted, tuneful, appealingly colored, and well proportioned, and other aspects of his musicianship might well be preserved in the form of a reissue of his famous recording, as both soloist and conductor, of Mozart's Piano Concerto in G Major (K. 453) with the Budapest Philharmonic. It was good to have the lovable orchestral Suite in F-sharp Minor put into circulation again two years ago (Milton Katims conducting, Turnabout TV-S 34623), and it is a nice surprise to be offered these additional chamber and solo pieces now. It is downright astounding that so attractive a work as the Serenade for String Trio is only now receiving its first stereo recording, and I wish I could be more enthusiastic about this performance by New London Quintet members Norman Freeman (violin), Kenneth Essex (viola), and Peter Willison (cello). It strikes me as no more than adequate—actually rather spiritless in spots—and certainly not in the same league as the classic Heifetz/Primrose/Feuermann version (still available on RCA ® LVT-1017) or the more sumptuously recorded Pougnet/Riddle/Pini (also mono, but good enough for us to hope Westminster might reissue it). But the Piano Quintet, a lesser but extremely amiable work which hasn't been around for years, fares better: with pianist Frank Wibaut and violinist Rolf Wilson added to the performing personnel the group comes to life and gives a charming performance.

Dohnányi's piano music used to circulate a bit more than it does now, especially the rhapsodies. I can't pretend to find anything very striking in any of the pieces played by Howard Shelley, but they are all attractive enough and certainly well made, and there is enough contrast to add up to a good program. The *Three Singular Pieces* (*Burletta, Nocturne—Cats on the Roof, Perpetuum Mobile*), composed in Florida as late as 1951, are intriguing, whimsical little pieces that are sure to be new to most listeners. Shelley's playing is assured, if somewhat understated. It has a certain air of intimacy about it which does not seem the least bit contrived, but rather suggests that he is playing music he knows and loves well for his own pleasure, and for ours too, if we happen to be listening. **R.F.**

DUPARC: Five Songs (see CHAUSSON)

RECORDING OF SPECIAL MERIT

DVOŘÁK: Piano Trio No. 3, in F Minor, Op. 65. Suk Trio. DENON/PCM OX-7122-ND \$14 (from selected audio dealers).

Performance: **Outstanding**
Recording: **Outstanding**

This is not the much admired recording that has circulated for the last ten or twelve years

Tandberg Presents the Next Generation

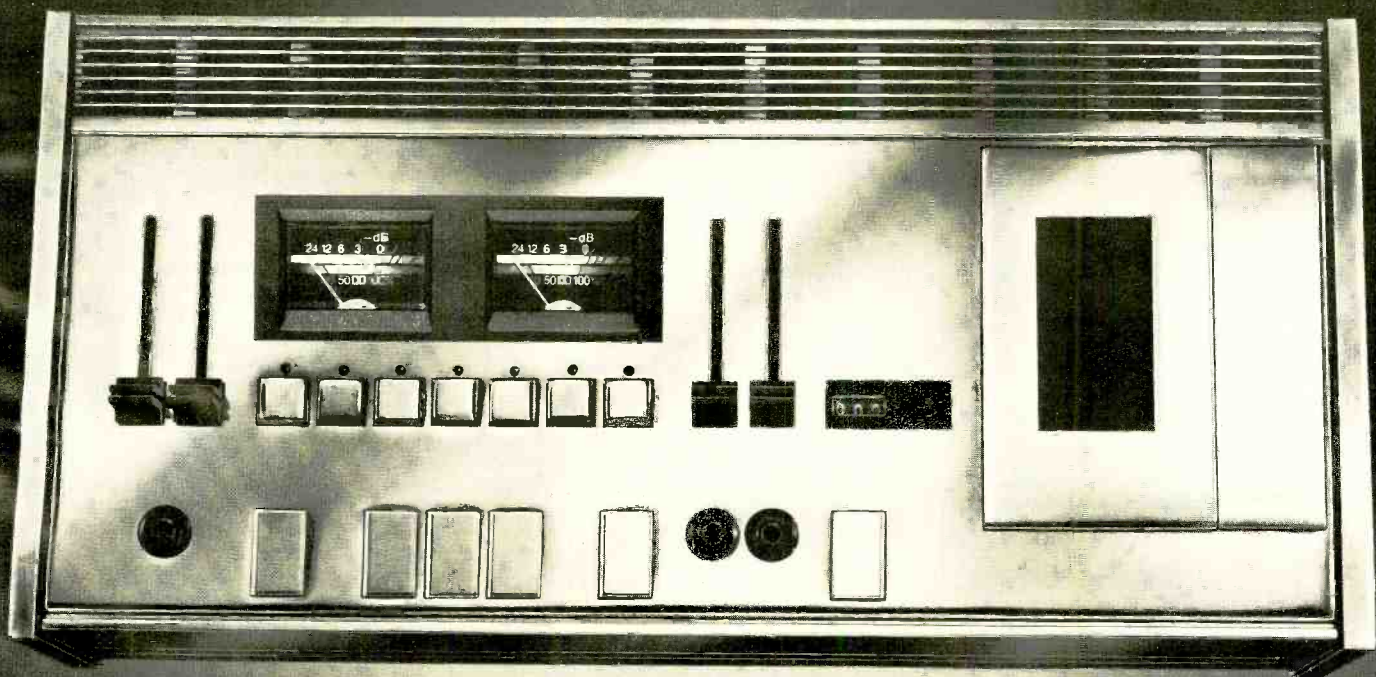



CALLAS

The Legend on Angel Records.

- Bellini: Norma.** (3 LPs) SCL-3615; Hlts. S-35666
Bellini: I Puritani. (3 LPs) CL-3502
Bizet: Carmen. (3 LPs) SCLX-3650; Hlts. S-36312
- Donizetti: Lucia di Lammermoor.** (2 LPs) SBL-3601; Hlts. S-35831
Leoncavallo: I Pagliacci & Mascagni:
Cavalleria rusticana. (3 LPs) CL-3528
Puccini: La Bohème. (2 LPs) BL-3560
Puccini: Madama Butterfly. (3 LPs) CL-3523
Puccini: Tosca. (2 LPs) BL-3508
Puccini: Tosca. (2 LPs) SBL-3650; Hlts. S-36326
- Rossini: Il Barbiere di Siviglia.** (3 LPs) SCL-3559; Hlts. S-35936
Verdi: Aida. (3 LPs) CL-3525
Verdi: Rigoletto. (2 LPs) BL-3537
Verdi: Il Trovatore. (3 LPs) 5sL-3554
Arias I Love, Album 1 S-36929
Arias I Love, Album 2 S-36930
Art of Callas, Vol. 1 (2 LPs) SB-3696
Art of Callas, Vol. 2—Puccini Heroines. 35195
Art of Callas, Vol. 3—Lyric & Coloratura Arias 35233
By Request (Attila, Il Pirata, more). S-36852
- Callas/The Legend—The Unreleased Recordings (Sonnambula '55; Trovatore & Masked Ball '64; Corsaro '69).** S-37557
Callas & Di Stefano at La Scala, Vol. 1 (Rigoletto, Tosca, Masked Ball). S-36940
Callas & Di Stefano at La Scala, Vol. 2 (Trovatore, Tosca, more). S-36966
Callas in Paris (Manon, more). S-36147
Great Arias from French Opera (Mignon, Le Cid, Carmen, more). S-35882
Great Sopranos of Our Time. S-36135
La Divina-Maria Callas (with 20 page commemorative booklet). (2 LPs) SB-3841
Mad Scenes (Anna Bolena, Hamlet, and Il Pirata). S-35764
Verdi Heroines (from Macbeth, Nabucco, Don Carlo and Ernani). S-35763
- AND ON SERAPHIM.**
Bellini: Norma. (3 LPs) IC-6037
Bellini: La Sonnambula (3 LPs) IB-6108
Donizetti: Lucia di Lammermoor. (2 LPs) IB-6032
Ponchielli: La Gioconda. (3 LPs) SIC-6031
Puccini: Manon Lescaut. (3 LPs) IC-6089
Rossini: Il Turco in Italia. (2 LPs) IB-6095
Verdi: La Forza del Destino. (3 LPs) IC-6088
Verdi: Un Ballo in Maschera. (3 LPs) IC-6087



CIRCLE NO. 5 ON READER SERVICE CARD

on Supraphon SUAST-50817, but a new one, made just a year and a half ago as a co-production of the Czechoslovak company and Nippon Columbia, in a series in which each firm records the same session with its own personnel and equipment. Supraphon is issuing these recordings in SQ quadruphony, the Japanese in two-channel stereo using Denon's PCM (pulse-code modulation) digital process, which, to my ear, yields results virtually unparalleled in dynamic range, freedom from distortion, and overall realism. The Suk Trio has been remaking much of its discography for this series—the Schubert B-flat Trio, the Beethoven *Archduke*, the Tchaikovsky A Minor, and the complete cycle of Dvořák trios of which the present disc represents the second of three installments (the Opp. 21 and 26 trios are on Denon OX-7114-ND). The new performance is every bit as splendid as the earlier one—charged with passionate conviction and the affection born of lifelong intimacy with the material (the heart that isn't melted by the soaring sweetness of Josef Suk's violin in the slow movement must have stopped beating long ago)—and it is easily the best-sounding recording of this work yet offered to the public. The price is steep, and the annotative insert is in Japanese only (except for the blurbs on the performers and the PCM process), but the impeccable pressing is as impressive as the performance and the recording. *R.F.*

FALLA: Spanish Dance No. 1 (see SAINT-SAËNS)

FRESCOBALDI: Toccata Decima; Cento Partite sopra Passacagli; Canzona Terza; Toccata Nona; Capriccio sopra la Bassa Fiamenga; Toccata Nona; Canzon Terza detta La Crivelli; Partite No. 14 sopra L'Aria della Romanesca. Bob van Asperen (harpsichord). TELEFUNKEN 6.42174 AW \$8.98.

Performance: **Frescobaldi with soul**
 Recording: **Very good**

Frescobaldi is one of those music-history biggies whose work has not survived very well in performance. His importance is uncontested. He was organist at St. Peter's, Rome, in the early seventeenth century, and people flocked there to hear the music—something, alas, that has not occurred much since. Like his contemporary Bernini, Frescobaldi was a seminal figure for Baroque art. His personal, intense, fantasy music comes out of the late Renaissance (the style known in art history as "mannerism") and looks forward to J. S. Bach. But whereas the music of Bach and the high Baroque is tightly structured, Frescobaldi's is decidedly rhapsodic. His canvases were large and within them he worked with a lot of freedom, a big range, and very spontaneous feelings. The rules were not yet fixed, the forms had not jelled into standard patterns, and the harmonies and tonalities are open and often rather daring. It is a performer's style, not far removed from improvisation, and the great fame of this music in its own day was in large part due to the composer's own performing wizardry. Nothing dies more quickly than a performing style undocumented except by ancient scores; the written notes simply do not tell enough of the story. And so Frescobaldi was long ago laid to rest in the honorable limbo of the library shelf.

Modern attempts to revive Frescobaldi's music necessarily involve a great deal of personal vision and daring. Bob van Asperen is a

Dutch harpsichordist with enough soul to put into these works to give them life. His are rhapsodic interpretations with character and a fine sense of the drama of early Baroque art. I suspect that the best solution to the puzzle of Frescobaldi—a better balance between strictness and freedom—has yet to be found, but until then Van Asperen's performances certainly shed a great deal of light on a fascinating dark corner of European music. *E.S.*

GEMINIANI: Concerti Grossi, Op. 3, Nos. 1-6. Jaap Schröder (violin); Academy of Ancient Music, Christopher Hogwood cond. L'OISEAU-LYRE DSLO 526 \$7.98.

Performance: **Shallow**
 Recording: **Thin**

Almost more than any other concerti grossi, Geminiani's Op. 3 brings to mind Quantz's admonition to observe "a majestic ritornello" which should be "more serious than jocular." When I put on the Academy of Ancient Music's recording of these wonderful pieces, my first reaction was to rush to my turntable to turn the speed down from 45 to 33 rpm. But it was already set at 33. The musicians achieve such an effect not only by excessively fast tempos but also through exaggerated double dotting and an all-pervading détaché. They play old instruments and provide a swelling and dying on every possible note. This is obviously an "authentic" performance. The funny thing is that, as the record went on, I got used to it. The musicians, after all, play in tune, and the ensemble is fine. They are certainly consistent in everything they do and create an integrity of their own. Even so, there is a heavy air of dutifulness about this performance that is disturbing. *S.L.*

GERSHWIN/WILD: Grand Fantasy on Airs from "Porgy and Bess"; Seven Virtuoso Etudes on Popular Songs. Earl Wild (piano). QUINTESSENCE PMC-7060 \$3.98.

Performance: **Dazzling, but overdone**
 Recording: **Very good**

With his diamond-sharp tone and supple fingerwork, pianist Earl Wild is surely one of our national treasures. When it comes to Gershwin, I would rather hear Wild at the piano in the Concerto in F or *Rhapsody in Blue* than anybody else (with the possible exception of Jesús María Sanromá in his prime). Wild not only chooses the right tempos, keeps the action briskly moving, and makes his instrument speak in a kind of musical New Yorkese, but he adds a touch of grandeur that transcends the music's street-level origins and sets it glittering in penthouse white tie and tails. I looked forward, therefore, with exceptional eagerness to hearing his Grand Fantasy on Airs from *Porgy and Bess*, but it is a bit of a letdown. Wild has done all sorts of clever things in his transcription—a *fugetta* to introduce *I Got Plenty of Nothin'*, juxtapositions of orchestral and vocal excerpts to create an elaborate pianistic tapestry—but therein lies the trouble. The resulting musical picture is simply too ingenious, too gussied up, too highly colored, too decorated with rills, trills, and folderol. The same kind of treatment mars the Seven Virtuoso Etudes on Popular Songs, all of which were set quite satisfactorily for piano by Gershwin himself. The playing, however, is dazzling. *P.K.*

(Continued on page 124)

To beat the other turntables, we gave our arm a little extra muscle.

The new Sanyo TP1030 may look like other direct drive turntables.

But it plays like no other you can buy. Because of a great arm. With a little muscle of its own.

The arm. The TP1030's low mass tonearm says "precision" from its rugged, light-alloy headshell to the micrometer-adjustable stylus force gauge. We counter-balanced it laterally, as well as vertically. The counterweight is heavier, and located closer to the pivot to reduce rotational inertia. The arm, with its anti-skating mechanism, rides in a bearing assembly that's virtually frictionless to provide superior tracking response.

The muscle. Most automatic turntables use a complicated linkage of gears, cams, and levers that "steal" power from the platter in order to operate the tonearm mechanism. While this arrangement works, it's far from ideal. So we gave the TP1030 a separate little DC motor and precision geartrain just to operate the tonearm. No linkages to add friction or mass to the tonearm assembly. No slurring of sound when you reject a record as the shock load of the arm mechanism hits the drive

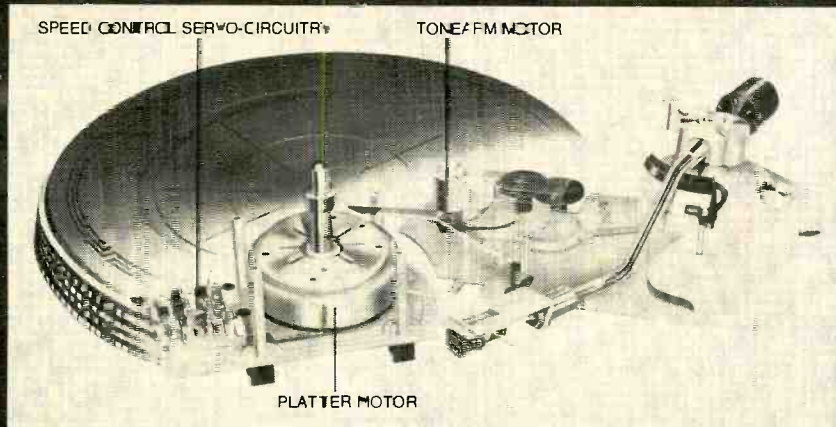

motor. Instead the tonearm is picked up, positioned, and set down more gently than you've ever seen.

The rest. The TP1030's platter motor is special, too. It's an C-control led, direct drive servomotor that turns in incredible 0.03% wow & flutter and -70dB rumble specs. And, of course,

the TP1030 offers electronic speed change with a built-in strobe and independently adjustable pitch on 33 and 45 rpm. Plus programmable operation that lets you choose automatic play of a single record, or automatic continuous repeat. Add deluxe touches like complete LED status indication, a built-in stylus examination mirror, a base of real wood, and dust cover, and you might think this sophisticated turntable is out of your reach.

The price. Surprise! The cost of this superb high fidelity component is just \$170*... which makes it the real value winner in deluxe turntables today.

See the TP1030 and also what's new in Sanyo receivers and cassette tape decks at a nearby Sanyo audio component dealer.

© 1978 Sanyo Electric Inc., 1200 W. Artesia Blvd., Compton, Calif. 90220

SANYO
That's life.



GRIEG: *Five Songs; Den Bergtekne, Op. 32* (see R. STRAUSS)

HANDEL: *Beato in Ver Chi Può* (see BRAHMS)

KREISLER: *Recitativo and Scherzo Capriccio, Op. 6* (see SAINT-SAËNS)

LIGETI: *Double Concerto for Flute, Oboe, and Orchestra; San Francisco Polyphony*. Gunnilla von Bahr (flute); Torleif Lännerholm (oboe); Swedish Radio Orchestra, Elgar Howarth cond. *String Quartet No. 1* ("Metamorphoses Nocturnes"). Voces Intimae Quartet. *Continuum*. Eva Nordwall (harpsichord). BIS LP-53 \$8.98 (from Qualiton Records, Ltd., 65-37 Austin Street, Rego Park, N.Y. 11374).

Performance: **Composer-supervised**
Recording: **Good to excellent**

György Ligeti was born in Hungary in 1923, left his native country in 1956, and has since established himself as one of the leading European avant-gardists. His post-1956 style is characterized by a technique of composing in sound densities and colors, a music of changing sound clusters that is represented here by the short but busy *Continuum* for harpsichord. Since the early 1970's, he has widened his scope quite a bit to include contrasting elements—more in the manner of (so to speak) "real" music. Examples are the *Double Concerto* of 1971-1972 and *San Francisco Polyphony* (1973-1974), a work that hovers between the ultimate order of the tone cluster and random disorder in a manner that is very expressionistic in effect. It is curious, but one senses something like real passion lurking just beneath the strange and alienating surface of this music. It is effective stuff, although, like much cluster and pulse music of recent vintage, it has little depth and does not wear well.

The early *String Quartet No. 1* was written before Ligeti's emigration in a very Hungari-

an, post-Bartókian style that suggests his later interests but in a very different context. It is a strong, somewhat inconsistent piece of considerable inspiration and power.

The two orchestral recordings were made live during concert performances (and include some lukewarm, utterly unnecessary applause). The others are quite good studio jobs. E.S.

LISZT: *Prometheus; Les Préludes; Festklänge*. London Philharmonic Orchestra, Georg Solti cond. LONDON CS 7084 \$7.98, © CS5 7084 \$7.95.

Performance: **Brilliant**
Recording: **Full-bodied, but...**

Only the lack of what I consider to be effective stereo depth illusion, especially in *Les Préludes*, keeps me from putting this disc into the "Special Merit" category, for Sir Georg Solti elicits from his players the kind of crackling performances that these Liszt symphonic poems need to become convincing to twentieth-century ears. *Prometheus* combines splendidly defiant gestures, intensely lyric elements, and an effective bit of *fugato*, but I must say that I find *Festklänge* rather empty of substance and overly long. *Les Préludes*, when accorded a reading on the order of the legendary Mengelberg's—which this one closely approaches—can still stir the blood.

London's recording here boasts a superbly full-bodied low register; the bass drum in the closing pages of *Les Préludes* is especially telling, as are the high-register cymbals. What is lacking, however, is the sense of lateral space and depth that can do so much to open up the middle-register textures of Liszt's scoring. The Solti/Orchestre de Paris recording of Liszt's *Tasso, Mephisto Waltz*, and *From the Cradle to the Grave* is outstanding in this respect. Here I get the feeling of many microphones closely placed, so that the sound emerging from the speakers seems to be from

the conductor's rather than the audience's perspective. However, *chacun à son gout*.

In any event the performances are just splendid, and I hope that Solti will complete his disc traversal of the Liszt tone poems. It's doubtful that his recorded performances of them will be surpassed in our time. D.H.

RECORDING OF SPECIAL MERIT

MAHLER: *Symphony No. 4, in G Major*. Frederica von Stade (mezzo-soprano); Vienna Philharmonic, Claudio Abbado cond. DEUTSCHE GRAMMOPHON 2530 966 \$8.98, © 3300 966 \$8.98.

Performance: **Moving**
Recording: **Outstanding**

Vienna was, of course, the last place to appreciate the genius of Gustav Mahler. True, in the early days there were such Viennese Mahler disciples as Bruno Walter, but the Viennese always preferred Bruckner and even minor native sons to their difficult Herr Generalmusikdirektor. In a sense, it was Leonard Bernstein who finally brought Mahler to a full measure of acceptance in his native city, and it is fitting that Abbado, who started out as something of a Bernstein protégé, should continue the good work. Although this is not as extravagant as a Bernstein reading, it is a performance of great dynamic and expressive range. The Fourth is Mahler's most joyous work—and, in some ways, his most "Viennese" (that is, his most Schubertian). The Viennese musicians are on home ground, and the sound is consistently wonderful without ever being lost in a welter of details. Abbado has captured the long lines with a sureness, delicacy, and glow of feeling that is most moving, and Frederica von Stade adds just the right note of vocal simplicity to the folk-song finale. The ease and appeal of a performance like this suggest a whole new level of popularity—and not just in Vienna—for a composer once considered difficult and/or esoteric. E.S.

MENDELSSOHN: *Symphonies: No. 1, in C Minor, Op. 11; No. 2, in B-flat Major, Op. 52* ("Hymn of Praise"); *No. 3, in A Minor, Op. 56* ("Scotch"); *No. 4, in A Major, Op. 90* ("Italian"); *No. 5, in D Minor, Op. 107* ("Reformation"). Celestina Casapietra, Adele Stolte (sopranos); Peter Schreier (tenor); Leipzig Radio Chorus; Leipzig Gewandhaus Orchestra, Kurt Masur cond. VANGUARD/CARDINAL VCS 10133/6 four discs \$15.98.

Performance: **Carefully detailed**
Recording: **Good to excellent**

Kurt Masur, leading the orchestra with which Mendelssohn himself was so closely associated, goes to great pains here to minimize the pompous aspects of such occasional music as the *Reformation* Symphony and the *Hymn of Praise* symphony-cantata (composed for the Gutenberg quadricentennial festival in Leipzig) and to make the most of the textural delicacy of Mendelssohn's instrumentation and clarity of line. Indeed, the comparatively modest body of violin tone heard in the familiar *Italian* and *Scotch* Symphonies suggests that Masur was seeking to approximate the sonority and balance of the orchestra as it must have been in Mendelssohn's day. Certainly the Gewandhaus Orchestra winds have a chance to display their very considerable

(Continued on page 128)

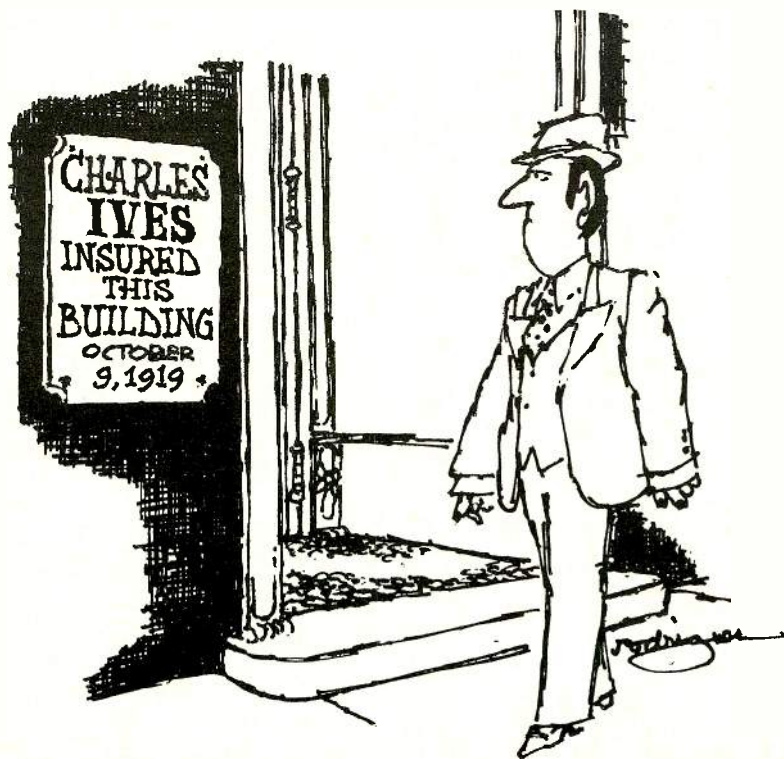

NOW THERE ARE THREE TRIAXIALS® FROM THE PEOPLE WHO INVENTED THE 3-WAY SPEAKER.

The 6" x 9" Jensen Triax®... the first ever.

This is the speaker that revolutionized car stereo sound. It features a separate woofer for the low tones, a tweeter for the highs, and a midrange for the middle tones... just like the better home stereo speakers.

The 5¼" Triax for front seat 3-way sound.

Another Jensen innovation. The 5¼" woofer mounts low in the front door for distortion-free bass. While a separate unit mounts high on the door, delivering sharp, clear high and middle tones from an individual tweeter and midrange.

A new 4" x 10" Triaxial for newer midsize cars.

It's specially designed to bring

3-way high fidelity to the narrower rear decks of the new midsize cars.

And a whole line of other quality speakers.

Jensen also offers a full line of coaxial 2-way speakers, dual cone speakers and surface mount speakers. All with the quality and great sound Jensen is famous for. And with a size and price to fit every car and wallet.



® "Triax" and "Triaxial" are registered trademarks identifying the 3-way car stereo speakers of Jensen Sound Laboratories, Division of Pemcor, Inc.

JENSEN

SOUND LABORATORIES

Division of Pemcor, Inc.
Schiller Park, Illinois 60176

CIRCLE NO. 8 ON READER SERVICE CARD

Specifications:

SPECIFICATIONS	NOMINAL	LIMIT
AMPLIFIER SECTION:		
Power output	—	53 Watt
THD at rated power %	—	0.5%
Power bandwidth at 8 OHMS	—	20–20,000 Hz
Frequency response RIAA deviation phono	30–20,000 Hz ± 0.5 dB	30–20,000 Hz ± 1 dB
Signal to noise ratio at 2.5 MV (dB)	85 dB	70 dB
Phono overload	240 MV	180 MV
FM TUNER SECTION:		
Usable sensitivity Mono UV at 300 OHMS	1.9	2.5
Usable sensitivity Stereo UV at 300 OHMS	3	5
50 dB quieting sensitivity Mono UV at 300 OHMS	3	5
THD Mono & THD Stereo	0.2% & 0.25%	0.3% & 0.5%
Frequency response Hz	12–15,000 Hz	35–12,000 Hz
Capture ratio (dB)	.75	2
Alternate channel selectivity (dB)	65	50
Image rejection (dB)	50	45
Stereo separation at one kHz (dB)	48	35

Features:

Two-Step High and Low Filters
Two-Step Base and Treble
Midrange Control
Tape Dubbing Monitor
Left and Right Channel Meters
Internal Circuit Protection System

Separate Defeat Switches for Base, Midrange and Treble
A JCPenney Warranty unsurpassed by any Hi-Fi manufacturer*

Price: \$449⁹⁵

*Within 5 years of purchase of speakers or 3 years of purchase of single or multiple play turntable, receiver, tuner, amplifier or tape deck of this Modular Component System we will, at our option, repair or replace these items if defective in material or workmanship. Just return it to the nearest JCPenney facility.

CIRCLE NO. 62 ON READER SERVICE CARD

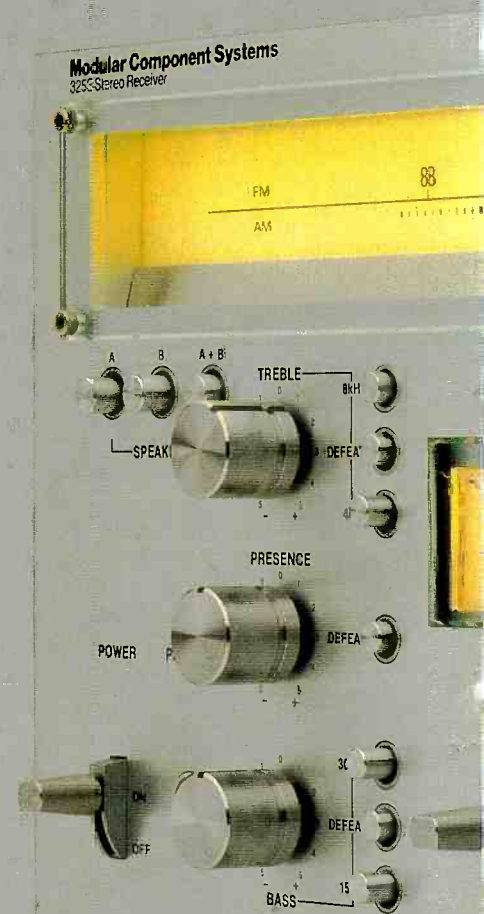

The incredible MCS Series 53 watt receiver.



Sold and serviced only at JCPenney



Sonic Exuberance and Musical History in a Digital Disc!



TELARC DIGITAL No. 5038 \$14.95

The place: Severance Hall in Cleveland, Ohio, highly respected for its superb acoustics. The date: April 4 and 5, 1978. Fifty nine musicians, including the entire reed, brass, and percussion sections of the Cleveland Orchestra, gathered to participate in a unique and significant first symphonic ensemble recording using a sophisticated new method of digital recording.

The music, by Bach, Handel, and Holst, was symphonic band music at its most exciting. The Cleveland Symphonic Winds were conducted by the leading figure in wind music today, Frederick Fennell. His early recordings on Mercury with the Eastman Symphonic Wind Ensemble helped launch the hi-fi era, and are still treasured by collectors. But the consummate artistry of the Cleveland Symphonic Winds under Fennell's direction in this session must be heard to be believed.

From the gleaming sound of the piccolo to the solid impact of the concert bass drum... from *pianissimo* to *triple forte*... this recording is a major milestone for both music and recording. The reaction by the musicians themselves, on hearing the playback, was best summed up by Frederick Fennell himself (as quoted in *High Fidelity*): "I'm glad to have lived long enough to have recorded that kind of sound!"



No matter what type of system you own, this record will sound impressive, both sonically and musically. And the better the system the better the sound... and the more complete the musical experience. A new era in digital recording is waiting for you today at your Audio-Technica dealer or wherever the very finest records are sold.

audio-technica
INNOVATION □ PRECISION □ INTEGRITY
AUDIO-TECHNICA U.S., INC., Dept. 118F,
33 Shiloh Avenue, Fairlawn, Ohio 44313

agility and finesse, most notably in the development sections of the *Italian* Symphony's end movements.

The First Symphony, a product of the fifteen-year-old Mendelssohn, is a real charmer with echoes of Weber, Schubert, and Mozart. It is good to hear the *Reformation* divested of some of its Teutonic pomp, yet there is no loss of festive atmosphere at the end. The *Hymn of Praise* has its fine moments, mostly in some of the brilliant writing of the opening orchestral section and in its slow movement, and some not so fine ones in the more obviously ceremonial choral episodes. Masur brings out what is best in the music, commanding splendid singing from the Leipzig Radio Chorus and having in soloists Celestina Casapietra and Peter Schreier musicians of star quality. Both bring the utmost dramatic tension and sustained lyrical line to their solo and duet assignments. But, despite the finesse that Masur and his players bring to the two most popular of the symphonies, I must confess a preference for the grander scale of Herbert von Karajan's *Scotch* and Leonard Bernstein's *Italian*. The sound of the Eurodisc taping is somewhat variable, effective in the First Symphony and the *Hymn of Praise* but just a mite anemic elsewhere. Nevertheless, at the low price this Vanguard set represents excellent value. *D.H.*

MERCADANTE: Sinfonia on Themes of Rossini's Stabat Mater (see PUCCHINI)

MOUSSORGSKY: Songs and Dances of Death. BRAHMS: Four Serious Songs, Op. 121. Erik Saedén (baritone); Hans Pålsson (piano). BIS LP-70 \$8.98.

Performance: **Good**
Recording: **Good**

Death is the protagonist in these gloomy cycles: an imminent menace in the Moussorgsky songs, the unavoidable certainty and liberating force in the Brahms cycle. Listening to the two will not cheer you up, but the pairing is logical. Some years ago, George London recorded both cycles (now on Columbia Special Products AMS 6734). His was a more sonorous and generally more solemn rendition than Erik Saedén's more inward one. Saedén, a distinguished member of the Stockholm Opera for more than a quarter of a century, is a seasoned interpreter. His vocal resources are modest nowadays, and here he favors a light tone and wisely graduated dynamics. He meets the challenges of the music skillfully, with only occasional hints of effort, though some of the climaxes (Moussorgsky's *Warrior* and the fourth Brahms song in particular) clearly call for more passion as well as a greater volume of sound. The interpretations are nonetheless artistic, but competition is extremely stiff in the Moussorgsky, where Christoff and Vishnevskaya (with orchestra) and Arkhipova (with piano) lead the field. In the Brahms songs, the recording by Alexander Kipnis (Seraphim 60076) continues to be the touchstone. Fischer-Dieskau's version (his third) is not available on a single disc, but there is an admirable alternative by Maureen Forrester on London STS-15113. *G.J.*

MOZART: Betulia Liberata (K. 118). Claes H. Ahnsjö (tenor), Ozia; Birgit Finnilä (contralto), Giuditta; Kari Lövaas (soprano), Amital; Siegfried Vogel (bass), Achior; Kate Gambierucci (soprano), Cabri; Ursula Reinhardt-

Kiss (soprano), Carmi; Berlin Radio Chorus; Berlin Chamber Orchestra, Vittorio Negri cond. PHILIPS 6703 087 three discs \$26.94.

Performance: **Lethargic**
Recording: **Good**

One by one we are getting recordings of all of Mozart's early dramatic and nearly dramatic works. *Betulia Liberata* must be classified as "nearly" . . . and not so near at that. Like the recently recorded *Mitridate*, it is a fruit of Mozart's Italian tour of 1770-1771. The text is a version of the story of Judith and Holofernes written by the famous Metastasio as a dramatic oratorio. Unfortunately, Metastasio displays almost no interest in either Judith or Holofernes (*he* does not even appear) and concentrates instead on theological disputes and the conversion of a certain Achior, Prince of the Ammonites. This material must have struck the average eighteenth-century sophisticate about the same way it strikes us today. At any rate, the other composers of the day, who generally loved Metastasio, avoided *Betulia Liberata* like the plague, and Mozart's version seems not to have been performed at all until modern times.

Nevertheless, at the age of fifteen Mozart was no mean vocal composer, and this score has its beauties. The most striking number is the finale for alto and chorus based on plain-song. Whenever a dramatic excuse presents itself—Achior's description of Holofernes, Carmi's description of the Assyrian terror, the aria Judith sings as she goes out to seduce and assassinate Holofernes—Mozart is fully equal to the task. But there is nothing truly lyric or reflective in the text—only sappy religious meditations, and even Mozart could not rise to these occasions.

Nor do the performers here. The cast includes some excellent singers who have specialized in early Mozart, and Negri is well known as a Mozart conductor; nevertheless, the performance never takes off. *E.S.*

RECORDING OF SPECIAL MERIT

MOZART: Mass in C Minor (K. 427). Valerie Masterson, Christiane Baumann (sopranos); Martin Kletmann (tenor); Michel Brodard (bass); Symphonic Chorus and Orchestra of the Gulbenkian Foundation of Lisbon, Michel Corboz cond. ERATO STU 71100 \$9.98 (from Euroclass Record Distributors, Ltd., 155 Avenue of the Americas, New York, N.Y. 10013).

Performance: **Excellent**
Recording: **Clear, attractive**

Mozart's great C Minor Mass is supposed to have been written on the occasion of his marriage to Constanza Weber, but for some reason it was never completed. Even so, it stands as one of the monuments of the Classical period. Calouste Gulbenkian was an Armenian oil billionaire who lived in England but endowed a foundation in Lisbon that supports a variety of musical activities of international scope and quality—as evidenced by this excellent recording and performance. This is a strong, dynamic reading with an energetic forward motion that never flags. The solo singing is notably strong—one of the sopranos, presumably Valerie Masterson (there is no way to tell for sure), is particularly impressive—and the recording is clear and vivid. *E.S.*

(Continued on page 130)

IT TAKES IMAGINATION TO CHANGE THE WAY AMERICA DRIVES.



INTRODUCING THE 1979 PLYMOUTH HORIZON.

**HORIZON...THE EFFICIENCY-SIZED
CAR THAT HAS CAUGHT AMERICA'S
IMAGINATION.**

We were ready when you were. With a new kind of American automobile designed to handle today's driving. Plymouth Horizon... the first American-made car its size with



front-wheel drive. It gives you a whole new sense of comfort and confidence.

**THE STABILITY
OF FRONT-WHEEL DRIVE.**

Horizon's front-wheel drive works wonders for you with outstanding

traction and handling in all kinds of weather. Whether it's snow or rain or wind. And Horizon handles turnpikes with remarkable stability. It literally pulls you down the highway, through turns and up hills.

ROOM YOU WOULDN'T IMAGINE.

Another benefit of front-wheel drive is that it virtually eliminates the large transmission tunnel you find in most cars. That means there's more room for people. Four big adults can ride in complete comfort.

You get a lot of other standard features, too. Like rack and pinion steering, front disc brakes, and whitewall radial tires. And you can have the option of automatic transmission, stereo, roof rack and an assortment of sporty trims.

And, as if all that were not enough, you get 38 miles to the gallon highway and 25 city.*

Plymouth Horizon. A whole new driving experience. A new sense of confidence. A new feeling of comfort. Check it out at your Chrysler-Plymouth dealer.

*EPA estimates based on manual transmission. Your mileage may vary depending on your driving habits, your car's condition and optional equipment. California mileage lower.

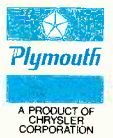
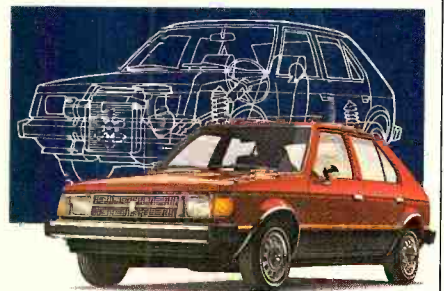

THAT'S IMAGINATION. THAT'S PLYMOUTH.

CIRCLE NO. 23 ON READER SERVICE CARD

MOZART: Piano Concerto No. 25, in C Major; Serenade No. 13, in G Major (see Best of the Month, page 113)

PAINE: Mass in D. Carmen Balthrop (soprano); Joy Blackett (contralto); Vinson Cole (tenor); John Cheek (bass); St. Louis Symphony Chorus and Orchestra, Gunther Schuller cond. NEW WORLD NW 262/3 two discs \$15.96.

Performance: **Dedicated**
Recording: **Reasonably good**

Viewed in historical perspective (which the elaborate notes accompanying this ambitious production facilitate doing), the Mass in D by John Knowles Paine (1838-1906) seems a considerable achievement, an almost-masterpiece, if you will, not of "American music" but of music composed by an American. The Mass was begun in 1859, when Paine, then in his early twenties, was still studying in Germany, and it was completed in the U.S. during the Civil War. Its more somber pages almost compel one to think of it as a "Mass in Time of War." It is a young man's music, and it is far fresher in quality and harmonic resource than what Paine wrote in later years after he had achieved eminence as the founder of Harvard's music department.

Paine set the entire text of the Roman Catholic Mass—a strange choice for one reared in a New England Protestant environment—and scored it for the Classical forces of solo quartet, chorus, symphony orchestra, and organ. In terms of coloration, these forces are employed with genuine imagination, especially

the woodwinds and organ. There are plenty of derivative elements—the overuse of persistent rhythmic figures suggests Schumann, the bass aria "Et in sanctum spiritum" and the "Et vitam venturi" fugue recall Handel and Haydn, respectively—but there are plenty of original passages that would do credit to any composer at any time, of any nationality. Examples are the opening Kyrie, a somber and powerful sonata movement with highly effective use of *fugato*; the beautiful contralto solo in the "Qui tollis" section of the Gloria; and the majestic introduction to the concluding fugue of the Gloria.

I confess to finding the opening of the Credo rather stuffily Victorian, but the intense lyricism of the "Et incarnatus est" soprano solo could melt the stoniest heart. A most effective dramatic touch is the major resolution on "sepultus est" at the end of the Crucifixus, which is otherwise of a stygian gloom. There is some splendid neo-Renaissance lyrical polyphony in the Confiteor, which is a *cappella*, and in the organ-accompanied Sanctus. The hushed "Dona nobis pacem" that concludes the Mass is very moving. One could perhaps complain about some excessive string/wind doubling here and there, but remember when the work was composed: Brahms' German Requiem had yet to be heard and Verdi's Requiem was still some years off; Haydn, possibly Beethoven, certainly Mendelssohn and Spohr, Bach learned in the organ loft—these were Paine's chief models. When the Mass was heard for the first time in the U.S.—in 1868, a year after Paine conducted the world première in Ber-

lin—the New England and Boston conservatories of music had just been founded, and the Harvard department was still two years in the future. So for an American composer to carry off a long, elaborate choral-orchestral work of this scope was indeed no mean feat.

Conductor Gunther Schuller, the splendid team of vocal soloists, the excellently trained St. Louis Symphony Chorus, and the very able St. Louis Symphony Orchestra all deserve the very highest praise for a truly dedicated performance. I only wish that the recording had been better. The New World disc isn't bad; it just isn't as good as it could have been. The soloists and chorus fare better than the orchestra, and the balances are fine in every respect. But the orchestra sounds somewhat muffled: the big climaxes never really open up, and there is never the sense of a sizable orchestral body (though the pickup of individual sections, the winds especially, is beautifully handled). I suspect too many microphones, too close up. Nonetheless, the album documents an early landmark in the high-art music of America. *D.H.*

RECORDING OF SPECIAL MERIT

PROKOFIEV: Sonata No. 7, in B-flat Major, Op. 83; Sonata No. 9, in C Major, Op. 103. Tedd Joselson (piano). RCA ARL1-2753 \$7.98, © ARK1-2753 \$7.98.

Performance: **Gently elegant**
Recording: **Sounds good**

One by one, Prokofiev's piano sonatas are getting out. The Ninth, his last completed pi-



The truth is clearly seen in every Scotch® Master™ Cassette, thanks to our see-through cassette shell. You can see the unique roller guides that reduce friction by moving the tape evenly across the head. And the two radially creased

shims that insure a smoother wind, improved mechanical reliability and reduced wow and flutter. Even the recorder head penetration.

The sexy, see-through Master Cassette shell. It's kind of like getting the naked truth.

3M
CORPORATION

ano composition (there is an incomplete Sonata No. 10), is one of those late-period works that searches out the utmost simplicity and directness of expression. Successfully too, I think: the music is beautiful and moving.

One way to get an unfamiliar sonata recorded is to pair it with a familiar one. In Prokofiev's case that has to be No. 7, certainly one of the most popular piano sonatas of the twentieth century. Tedd Joselson, who is recording *all* the Prokofiev sonatas, plays this music with restraint and elegance. The neo-Classicism of No. 9 is right up his alley. But No. 7, usually treated as a thud-and-blunder item, is also really quite appealing in this gentler, suaver treatment. The re-evaluation of Prokofiev as a neo-Classicalist is quite to the point, and the recording sounds good. *E.S.*

PUCCHINI: *Preludio Sinfonico; Capriccio Sinfonico. Edgar: Preludio.* **MERCADANTE:** *Sinfonia on Themes of Rossini's Stabat Mater.* **VERDI:** *La Battaglia di Legnano: Overture.* **BOITO:** *Sinfonia in A Minor.* Monte Carlo Opera Orchestra, Claudio Scimone cond. ERATO STU 71040 \$8.98 (from Euroclass Distributors, Ltd., 155 Avenue of the Americas, New York, N.Y. 10013).

Performance: **Good**
Recording: **Good**

Here is an endlessly fascinating disc—for me at least—with not a single piece of significant or distinctive music among its contents. Best of the lot, not surprisingly, is the Verdi overture, in the composer's characteristic vein for that revolutionary period (1849). Mer-

cadante's *Sinfonia*, a potpourri of choice melodies from Rossini's *Stabat Mater*, represents an intrepid attempt to find suitable orchestral guises for stubbornly vocal music that resists such efforts. Boito's *Sinfonia* is also an operatic overture, and it displays intimate knowledge of Verdi's *Luisa Miller*. It is full of catchy melodies that make you hum along without the benefit of previous acquaintance—but it was written by a sixteen-year-old who was still far from the probingly original spirit he was to become. Most intriguing are the Puccini excerpts. The *Edgar* Preludio was intended for a Madrid performance conducted by Mancinelli, and it is not published as part of the complete score. Its opening sounds like a sketch for the Roman dawn in *Tosca*'s final act. The other two are from Puccini's student years. The lyrical *Preludio Sinfonia*, with its luscious scoring, foreshadows *Edgar*. The *Capriccio* is a bit disjointed, but it will electrify listeners by springing on them the familiar opening measures of *La Bohème* with subsequent orchestral elaborations.

Claudio Scimone conducts affectionately and zestfully, and the orchestra matches the competence but incomplete refinement of the material. Don't look for substance here; look for fun, and you won't be disappointed. *G.J.*

RAVEL: *String Quartet in F Major* (see DE-BUSSY)

REIGGER: *Wind Quintet* (see COWELL)

ROOT: *The Haymakers, Part 2.* Erma Rose (piano); North Texas State University Grand

Chorus, Frank McKinley cond. NEW WORLD NW 234 \$8.98.

Performance: **Energetic**
Recording: **Good**

Primitive American art of the visual variety fetches fabulous prices these days, but few people are yet aware of an equivalent musical art. With the revival of early American music in full swing, however, it is not surprising that someone has rediscovered George F. Root. Root, born in Massachusetts in 1820, was the successor to a long line of New England singing teachers and composer-educators that stretched from the seventeenth century to William Billings in the eighteenth and Lowell Mason in the nineteenth. Root considered himself as much an educator as a composer, and his own works were all written for very practical purposes. In 1856, Lowell Mason's son commissioned a secular cantata from Root for the Mason Brothers publishing house. The subject chosen was haymaking, and Root—who had been brought up on a farm—wrote both words and music. *The Haymakers*, subtitled "An Operatic Cantata," was performed in 1860, apparently with rudimentary staging. It had a great success and was frequently performed in the next few years, but the Civil War put an end to such fripperies and afterwards European opera definitely triumphed in the U.S. over the awkward native attempts.

Is it possible to describe Root's masterpiece without seeming to damn it with faint praise? It is naïve in outlook and execution, primitive harmonically and contrapuntally,

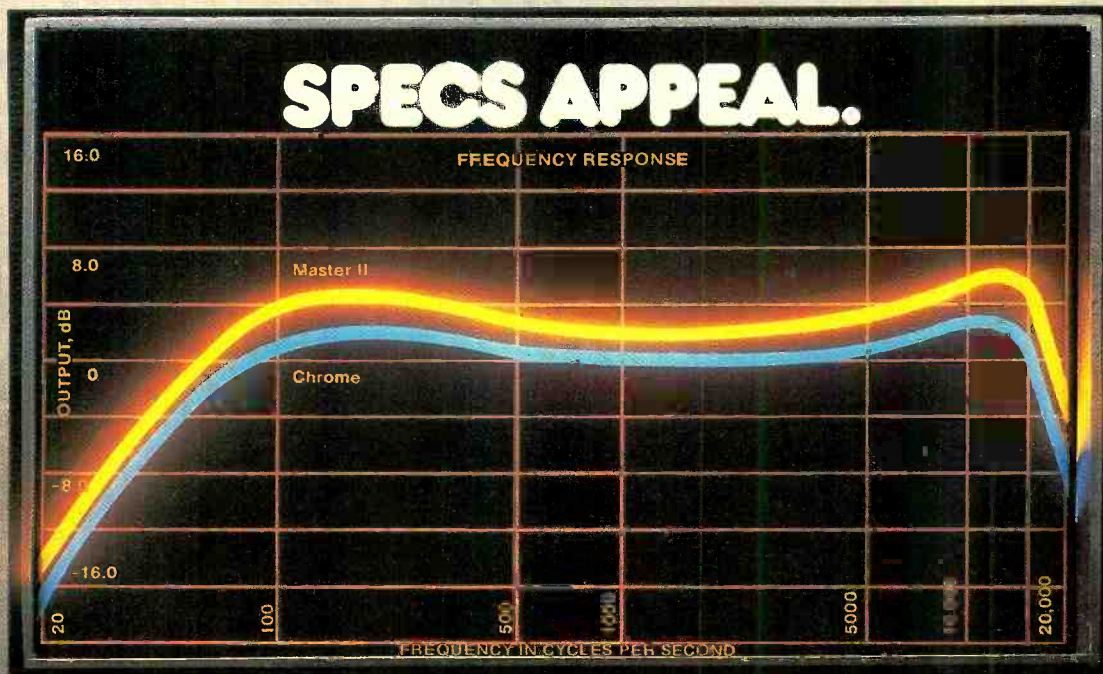

Master I Cassette is for normal bias recording. It features an excellent dynamic range, low distortion, uniform high frequency sensitivity and output that's 10 dB higher than standard tapes.

Master II Cassette is for chrome bias recording (70 microsecond equalization). It features a special coating that gives it a 3 dB better signal-to-noise ratio at low and high frequencies



than chrome cassettes.

Master III Cassette is for ferric-chrome bias recording. It offers a 3 dB output improvement at low frequencies and 2 dB output improvement at high frequencies over chromium dioxide.

SCOTCH® RECORDING TAPE. THE TRUTH COMES OUT.

Only good music. Music without distortion. If your turntable is a BSR Quanta® turntable. You see, with the introduction of the Quanta models 600, 700 and 800, BSR has created a turntable base with virtually no resonance.

NO MORE BAD VIBRATIONS.

Other turntables reduce resonance. BSR virtually eliminates resonance with concrete and foam. Low-frequency absorbing foamed concrete inside high-frequency absorbing foam.

Not one little vibration thanks to the isolation of the resonance-tuned suspension feet. No acoustical feedback. Just beautiful sound. And that's only the beginning.

On every BSR Quanta turntable is an S-shaped statically balanced tonearm. Viscous damped cueing for perfectly smooth arm movement. And on the Quanta 800 is the most accurate Quartz Phase-Locked Loop direct drive motor in existence. The quartz generated pulsed LED strobe display provides visual monitoring of the speed.

BSR Quanta turntables. Non-resonating. Not bad.

BSR

QUANTA®

**THE NON-RESONATING
TURNTABLES.**



BSR Consumer Products Group, Inc. 303, Blauvelt, NY 10913 • Distributed in Canada by BSR (Canada) Ltd., Ont. • Quanta is a registered trademark of BSR (USA) Ltd.

CIRCLE NO. 17 ON READER SERVICE CARD

and not especially distinguished melodically. And yet it is a work of the greatest charm. Not the least part of that charm is its completely winning sincerity. And, most important, Root knew the voice and how to make it work for him. His choral writing is more than charming; it is, with the simplest of means, really ingenious. From the opening "Good morning" to the traditional echo chorus, the haying, the storm, the laughing brook, and "Harvest Home," Root sketches everything with simplicity, a beguiling cleverness, and *joie de vivre*. The naïveté is, of course, no problem at all, but simply part of the charm.

This recording is not of the entire work but only of Part 2, with a couple of interpolations from earlier sections. The choral singing is first-class; the soloists are not particularly impressive but are perhaps closer to the spirit than most operatic or concert stars would have been. As usual, New World Records has provided a full text and generous notes. The recording should spark not only listener interest but also a revival of the work as a natural for schools and choral societies—the very kinds of musical organizations for which *The Haymakers* was written. E.S.

SAINT-SAËNS: Symphony No. 3, in C Minor ("Organ"). Leonard Raver (organ); New York Philharmonic, Leonard Bernstein cond. COLUMBIA M 34573 \$7.98, Ⓜ MT 34573 \$7.98, Ⓞ MA 34573 \$7.98.

Performance: **Splendid**
Recording: **Excellent**

Camille Saint-Saëns; the Renaissance man of mid-nineteenth century music who dabbled in science, wrote essays, and drew caricatures when he wasn't composing or writing caustic letters to French newspapers, actually wrote five symphonies, though only three are numbered. They have all been recorded, but it is the mammoth Third, or *Organ* Symphony, that the public has taken to its heart. Saint-Saëns, whose music often makes up in spectacularity what it lacks in profundity, wanted his symphony to "benefit by the progress of modern instrumentation"—and benefit it did. No other piece of the period has quite the same orchestral opulence. The composer himself had been an organist for twenty-four years and knew how to exploit the rich resources of that instrument. When the first theme of the first movement emerges again in the finale in throbbing organ tones with full orchestral accompaniment, it's a heady experience indeed. Perhaps that is why there are now fifteen recorded performances of the symphony listed in Schwann. If, by chance, there isn't a Saint-Saëns Third already in your collection, this mighty new one under Bernstein rivals any on discs to date and could be your number-one candidate. The New York Philharmonic is in excellent fettle, and Leonard Raver coaxes immense, magnificent chords from the great organ of the Methuen Memorial Music Hall. There may not be a scrap of real feeling behind the entire enterprise, and for all I know the organ passages could have been recorded separately and dubbed in later or the whole thing put together with splicing tape, but it *sounds* wonderful!

P.K.

SAINT-SAËNS: Violin Sonata No. 1, in D Minor, Op. 75; Violin Sonata No. 2, in E-flat Major, Op. 102. Robert Murray (violin); Jane Ab-
(Continued on page 134)



Wow & Flutter:
Signal-to-noise Ratio: (3% THD, Wtd.):
Frequency Response: \pm 3dB (Hi-Energy Tape):

0.05% (7½ ips)
65dB
30-24k (7½ ips)

The A-6600 isn't the only auto-reverse deck. It's only the best.

Or to put it another way, the A-6600 is one-of-a-kind. Period.

Sure, there are other decks that reverse automatically. But the A-6600's three-motor transport system was developed *specifically* for bi-directional play; two capstans pull the tape, one for each direction. Naturally, there's a heavy-duty servo-controlled DC capstan motor to provide smooth, precise tape movement. And just like a professional mixer, there are master gain controls for both mic and line inputs, *plus* separate left and right channel input level controls.

When you're taping from the radio or records, the "Auto-Space" feature

is an extra feature you'll love. When you stop the deck between selections, you can automatically add approximately 3 to 10 seconds of quiet space, so you're all cued up for the next selection.

You can monitor tape or source signals either pre or post output level, setting, and you don't have to reverse the deck to hear if there's music on the other tracks.

Clearly, the A-6600 is not just a "convenience" machine for people who don't want to get up to flop reels. It's a professional-quality computer-designed tape recording and play back deck, which happens to also play both ways automatically. Truly, one-of-a kind.



TEAC

First. Because they last.

TEAC Corporation of America • 7733 Telegraph Road • Montebello, CA 90640

CIRCLE NO. 87 ON READER SERVICE CARD

Why now, more than ever, we can ask, "Is it live, or is it Memorex?"



Quite simply, new MRX₃ is the best cassette Memorex has ever made. Better even than our own MF_X Oxide cassette. Here's exactly why: MRX₃ is made with a new, high-energy ferric oxide particle to give you the following improvements in sound reproduction.

1) Brighter highs, richer lows.

Higher output at saturation, specifically a 3.0 dB improvement over MRX₂ Oxide at high frequency maximum output level and a 3.0 dB boost at low frequencies.

2) Less distortion.

4.0 dB less distortion than MRX₂ Oxide

3) Wide dynamic range for broad recording flexibility, the most important indication of tape quality

Boosted M₀L and low noise level give you an excellent signal-to-noise ratio and 2.5 dB improvement in dynamic range over MRX₂ Oxide.

In short, new MRX₃ Oxide offers sound reproduction so true that now, more than ever, we can ask, "Is it live, or is it Memorex?"



MEMOREX

Recording Tape.
Is it live, or is it Memorex?

bott (piano). MUSICAL HERITAGE SOCIETY MHS 3785 \$4.95 (plus 95¢ shipping charge, from Musical Heritage Society, 14 Park Road, Tinton Falls, N.J. 07724).

Performance: **Engaging**
Recording: **Good**

SAINT-SAËNS: Violin Sonata No. 1, in D Minor, Op. 75. SZYMANOWSKI: Notturmo e Tarantella. BARTÓK: Rounanian Folk Dances. KREISLER: Recitativo and Scherzo Capriccio, Op. 6. FALLA (arr. Kreisler): La Vida Breve: Spanish Dance No. 1. Leopold La Fosse (violin); John Simms (piano). ORION ORS 77277 \$7.98.

Performance: **High-powered**
Recording: **Good**

If Saint-Saëns' First Violin Sonata is not exactly overexposed (Heifetz thought enough of it to record it twice, but it does not turn up much otherwise, either on records or in the recital room), the Second is virtually unexposed: this new MHS release would appear to be the first recording of Op. 102 to be issued in this country. It is an arresting work, and both it and the more familiar Op. 75 are given engaging, sympathetic performances by Robert Murray and Jane Abbott.

Leopold La Fosse and John Simms strike more sparks in their performance of the D Minor Sonata, and the Orion recording has a bit more presence than the MHS. La Fosse's tone is invariably handsome, and his high-powered approach is particularly appropriate to the shorter pieces on side two; Szymanowski's eerie *Notturmo e Tarantella* and the well-known Bartók sequence come off especially well, and there is plenty of flair in the Kreisler pieces. Sven Hansell's notes, concise but really informative, call for commendation too. Between these two records, though, I would probably choose the MHS, simply because it offers the only opportunity to hear the E-flat Sonata, while all the music La Fosse performs with such fire may be had elsewhere from such violinists as Heifetz, Wilkomirska, and Perlman.

R.F.

RECORDING OF SPECIAL MERIT

SCHUBERT: Octet in F Major, Op. 166 (D. 803). Academy of St. Martin-in-the-Fields Chamber Ensemble. PHILIPS 9500 400 \$8.98.

Performance: **Utterly Schubertian**
Recording: **Exceptional**

This lovable masterwork has been very fortunate in its recordings, and this newest version is definitely one of the very finest. It is surely the finest yet in terms of sound quality: the Philips engineers have achieved ideal balance among the instruments and have captured the most natural-sounding image of each of them. Aside from the sonic advantage, it becomes one of the most delicious of frustrations to try to sort out significant differences between this extremely beautiful performance and the no less beautiful ones recorded by the Melos Ensemble (Angel S-36529) and the New Vienna Octet (London STS-15436). Timothy Pay, the clarinetist in the Philips performance, may be less well known than the Melos Ensemble's Gervase de Peyer, but his playing is just as distinguished here, and the contribution of his horn-playing associate Timothy Brown, set off so effectively in the fine recording, has that burnished-gold quality one wants in this

(Continued on page 137)

©1978, Memorex Corporation, Santa Clara, California 95052, U.S.A.

If you'd like to hear an hour or more of uninterrupted music, don't let a few old myths stop you.

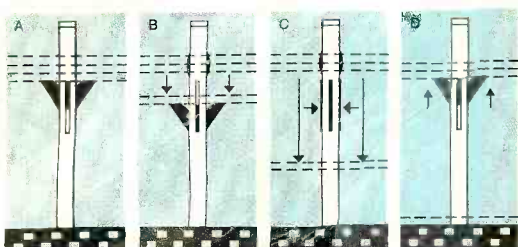

Dual's exclusive elevator-action. **A)** Records are supported entirely by platform. **B)** Bottom record is lowered away from stack above which is held in place by soft neoprene pads. **C)** Platform retracts, gently releasing record to platter. **D)** Platform rises to engage stack.

No need to worry about record grooves touching when stacked. Records are made with raised edges and centers which place an air cushion between the playing surfaces.

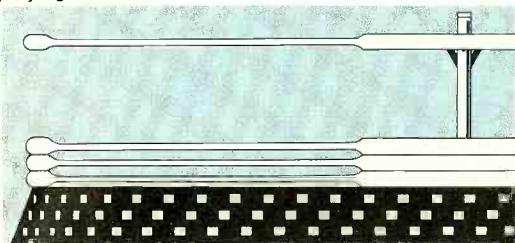

Records stacked on Dual's multiple-play spindle are handled with extraordinary care. Before the bottom record is released to the platter, it is gently lowered away from those above. Nothing is ever forced. This is Dual's famous "elevator-action" system. And since all records are made with raised edges and centers, an air cushion keeps the grooved surfaces from ever touching.

In the single-play mode, the short spindle rotates with the platter. This patented design permits more precise centering of the record, an important touch in achieving extremely low wow and flutter specifications. Another touch of Dual precision is the vertical tracking angle control; there's an optimum setting for single play and multiple play.

But one very important thing hasn't changed. Dual reliability. Backed by a two-year limited warranty, today's Duals are made to last just as long as the 1009 and its successors (the 1019 and 1219) which are often found to be worth more in trade than their original purchase price.

So if you'd like many years of uninterrupted pleasure from your next turntable, select one of our multiple-play models. (They start at less than \$180 for the CS1237.)

Unless, of course, you prefer old myths to future legends.

Myths die hard. Those about all multiple-play turntables compromising performance are no exception, despite the achievement of the legendary Dual 1009.

Before then, serious music lovers were understandably reluctant to entrust their records to the heavy-tracking, vinyl-chewing automatic tonearms of the day.

We therefore felt the need to prepare for the 1009's introduction by asking cartridge manufacturers and independent test labs to put it through the most demanding tests they could devise.

The manufacturers reported that the 1009 tracked flawlessly with their "professional-type" cartridges. The test labs found the 1009 matched the best of the manuals in rumble, wow and flutter—and they quickly adopted it as one of their reference-standard turntables.

Since then, of course, Dual has added refinement after refinement. The tonearms of *all* current Dual turntables are mounted in four-point gyroscopic gimbals, widely acknowledged as the finest suspension system available.

During play, Dual automatic tonearms are completely free-floating. They are engaged by the cycling mechanism only when being moved to or from the record.



For the life of your records



United Audio, 120 So. Columbus Ave., Mt. Vernon, NY 10553

CIRCLE NO. 50 ON READER SERVICE CARD



THE SPARKOMATIC SOUND.

IF YOU'RE A TRAVELIN' MAN WHO THINKS CAR SPEAKERS SHOULD LOOK TOUGH BUT ACT SENSITIVE.

Car speakers have never looked as exciting. Or sounded as extraordinary.

Because these Sparkomatic "component" look 3-way speakers are a totally new outlook for 6X9 rear deck audio. And because they reproduce high fidelity like you were sitting center aisle instead of center lane.

With these Sparkomatic car speakers you get the most technologically advanced auto sound you can own. They're magnificently responsive across the full frequency range with minimum distortion, optimum dispersion, and can easily handle 50 watt power peaks.

Beneath the acoustically transparent heavy gauge wire

mesh grilles are foam-edge air suspension woofers with 20 ounce magnets, foam-edge air suspension midrange speakers with 3 ounce ceramic magnets and dome horn tweeters.

So, if you're a travelin' man who likes to travel in style, these speakers are tailored just for you.

Visit a Sparkomatic dealer for a beautiful eyeful and a magnificent earful.

SPARKOMATIC[®]
For the Travelin' Man[™]

Car Sound/CB Equipment/Auto Clocks/Shifters/Creepers

For our free complete Car Sound Catalog write: "For The Travelin' Man", Dept. SR, Sparkomatic Corporation, Milford, PA 18337.
CIRCLE NO. 78 ON READER SERVICE CARD

work especially. The degree of integration is all one would expect from this source, and the pervasive, utterly Schubertian bloom is beyond even such expectations.

The most conspicuous difference between this performance and the other two cited here has nothing to do with the level of the playing or the sound: both of the other teams play all the repeats in the variations of the fourth movement, while the Academy of St. Martin-in-the-Fields Chamber Ensemble (this group is going to have to find a less cumbersome handle!) does not. Personally, I feel no impatience when the repeats are taken and no sense of deprivation when they are not, but this may be a factor to be considered by those who feel more strongly about it one way or the other.

R.F.

SCHUBERT: *String Quartet No. 9, in G Minor; Introduction and Variations on "Ihr Blümlein Alle" for Flute and Piano, Op. 160; Octet in F Major, Op. 166; Der Hirt auf dem Felsen, Op. 119* (see *Going on Record*, page 84)

SCHUMANN: *Quartet for Piano and Strings in E-flat Major, Op. 47; Märchenerzählungen, Op. 132; Spanisches Liebeslieder, Op. 138* (see *Going on Record*, page 84)

RECORDING OF SPECIAL MERIT

SCHUMANN: *Songs. Myrthen Liederkreis, Op. 25; Lieder und Gesänge, Op. 27; Drei Gedichte, Op. 30; Drei Gesänge, Op. 31; Aus dem Liederbuch eines Malers, Op. 36; Aus Rückerts Liebesfrühling, Op. 37; Liederkreis, Op. 39; Fünf Lieder, Op. 40; Romanzen und Balladen, Op. 45. Dietrich Fischer-Dieskau (baritone); Christoph Eschenbach (piano). DEUTSCHE GRAMMOPHON 2709 074 three discs \$26.94.*

Performance: **Masterly, but uneven**
Recording: **Very good**

Robert Schumann wrote 138 songs in the year 1840 alone, and this latest product of Dietrich Fischer-Dieskau's tireless and encyclopedic activity contains nearly half of them. Few of these are new to the baritone's repertoire: a number of them are on previous Deutsche Grammophon releases 139 109 and 139 236, with Jörg Demus as accompanist, while the *Liederkreis*, Op. 39, with Gerald Moore, is on Angel S-36266. To complicate matters even further, the eighteen songs from *Myrthen* contained in the present volume are already in the catalog on DG 2530 543, a single disc. Sorry to be so statistical, but we are dealing here not with a "recording artist" but rather with a one-man industry.

Among the songs new to me in this set are several great discoveries: *Flügel! Flügel! um zu Fliegen* (Op. 37) is major Schumann, soaring and powerful. Of the five settings of Hans Christian Andersen's grim and disturbing poems (Op. 40), *Der Soldat* and *Der Spielmann* are standouts. The six settings of Robert Reinick (Op. 36) are a more mixed lot, but two (*Ständchen* and *Nicht Schöneres*) cannot miss with their Schubertian charm.

Fischer-Dieskau is never less than a major artist, conveying understanding, tenderness, and compassion as perhaps no one else can. Listen to his *Die Lotosblume* and *Was Will die Einsame Träne* (Op. 25), *Die Rote Hanne* (Op. 31), and all five songs of Op. 27, and you will experience interpretive mastery on the highest level. Even when certain aspects of



"No, not that! Anything but the stereo!"

that mastery are open to challenge, we bow to the intellect and seriousness of purpose behind it. But interpretive maturity and wisdom cannot always compensate for failing vocal resources. A comparison between this *Liederkreis*, Op. 39, and the earlier (1965) Angel version clearly confirms the superiority of the latter. Today his voice is simply not as responsive to his interpretive faculties as it once was, his top notes are effortful, and the needed musical solutions are replaced by overinterpretation: unnecessary *parlando* effects, fussy mannerisms, exaggerated dynamic contrasts in which ravishing pianissimos are often followed by harsh and blustering fortés.

A few scattered instances of rhythmic imprecision aside, Christoph Eschenbach provides sensitive and virtuosic collaboration in which he is aided by sonorous piano reproduction. This is an important release, a real find for those who want to build a lieder library. But do not replace the Fischer-Dieskau of the 1960's with later vintages. Vocally, those were the years!

G.J.

R. C. SEEGER: *Three Songs* (see COWELL)

SMETANA: *The Two Widows.* Nada Šormová (soprano), Karolina; Marcela Machotková (soprano), Anežka; Jiří Zahradníček (tenor), Ladislav; Jaroslav Horáček (bass), Muňal; Zdeněk Švehla (tenor), Toník; Daniela Šounová (soprano), Lidunka. Prague National Theater Chorus and Orchestra, František Jílek cond. SUPRAPHON 112 2041/3 three discs \$23.94 (from Qualiton Records, Ltd., 65-37 Austin Street, Rego Park, N.Y. 11374).

Performance: **Zestful**
Recording: **Good average**

The Two Widows (1874) was the fifth of Bedřich Smetana's eight operas, and it signaled

the composer's return, after the serious historical works *Dalibor* (1867) and *Libuše* (1872), to the lighthearted genre he had so triumphantly mastered in *The Bartered Bride* (1866). Unlike the ebullient peasants of *The Bartered Bride*, though, the main characters of *The Two Widows* are well-to-do, fairly sophisticated people who converse in an intelligent and occasionally witty manner. This is more of a drawing-room comedy than a comic opera; it is entertaining and may produce an occasional smile, but there is really nothing to laugh about.

The story is slight. There are two cousins, both young widows: Karolina, full of *joie de vivre*, takes life as it comes, while Anežka regards widowhood as a permanent state—or so it seems. Eventually a determined and resourceful suitor, Ladislav, convinces Anežka to follow the dictates of her heart. There are effective arias for all the principals and skillful ensembles when the dramatic situation requires. At certain junctures the music evokes the brisk and bouncy Slavic spirit of *The Bartered Bride*, and it has plenty of sparkle in the finely wrought orchestral setting.

I am not familiar with the singers on this recording, but they are evidently thoroughly conversant with the opera (which, according to the detailed and multilingual annotations, has been a repertoire staple in Prague since 1923, with only spotty success before then). Tenor Jiří Zahradníček has an agreeable tone and makes a charming Ladislav. The two widows are well contrasted: Nada Šormová has a touch of acid in her tones and a considerable amount of vibrato, but she creates a very lively Karolina, while Marcela Machotková, with subtler and better controlled resources, makes a suitably demure Anežka.

G.J.

(Continued on page 140)

TAKING upon itself a share in the responsibility for celebrating the sixtieth birthday (August 25, 1978) of America's first great conductor-composer, Deutsche Grammophon has issued a new set of recordings of Leonard Bernstein's three symphonies plus his *Chichester Psalms*. The performances are all conducted by the composer, and the very international nature of the cast (Israel Philharmonic, Vienna Choir Boys, Montserrat Caballé, Christa Ludwig, Lukas Foss) is explainable by noting that all the recordings were made in conjunction with the Berlin Festival of 1977. That they represent Bernstein's ideal of performance would be a fair assumption. That

er of musical comedies. One wonders why. Obviously, it is not from any lack of talent on his part, nor any lack of craft; something far less tangible is involved, something in the very personality of the man. There are, I think, two powerful and opposing forces at work in this music, forces which relate to Bernstein's personality and to his general view of music, and to our perception of his music as well. They are dramatically verbalized in Jack Gottlieb's notes to this new recording of the Symphony No. 1. The first is Gottlieb's bald opening statement: "The three symphonies of Leonard Bernstein are concerned with the loss and retrieval of faith by

out feeling that here is a real talent. As for the programmatic meaning, the intention, as Bernstein wrote in 1944, was "not one of literalness but of emotional quality," and the sung text, from the *Lamentations*, is in Hebrew. If the symphony is "concerned" with the loss and retrieval of faith, it is not unduly apparent to the listener, who is therefore free to occupy himself with the music.

That concern is a great deal more apparent in the Second Symphony; at least it is if one reads Auden's poem, *The Age of Anxiety*, on which the work is based, or Bernstein's notes about unconsciously written details that programmatically relate to the poem. And yet, as one listens to this startlingly inventive and virile work, which uses much of the substance of popular music without ever descending to the level of a pop composition, the literal importance of the program fades into the distance. The music (in retrospect, it sounds curiously Hindemithian but with better basic ideas) is quite strong enough to sustain itself without the text. Interestingly, the original "program" called for dropping out the piano solo in the finale, but in the revised version of 1965 (which is the one recorded here) purely musical values took over from the poetic ones, and the piano now participates, even to the extent of enjoying a brief cadenza before the end. Again, the writer of music triumphs over the purveyor of philosophic concerns.

It is with the *Kaddish* Symphony that things begin to turn the other way (the later *Mass* is another, farther step in the same direction). One cannot separate music from philosophic speculation in the *Kaddish* because the scoring includes a narrator and his text is in the vernacular. And what a text it is! Written by Bernstein himself, it is a kind of verbal, religious strip-tease, embarrassing and unfortunate *not* for its concerns and its blasphemies (they are, after all, the concerns and the blasphemies of many of us) but for the theatrical airing of them in language that is lacking in both subtlety and poetry. Something there is in Bernstein—as there was in Carl Orff too—that seems to demand that the most intimate matters be presented in the loudest, most public way.

And what of the music of the *Kaddish*? Much of it—when one can pay attention to it—seems very beautiful. The text of the Hebrew-Aramaic *Kaddish* (which is the prayer for the dead that never mentions the word or the concept of death) is among the most "settable" of texts, and Bernstein sets it three times, the second of which (featuring here the incredibly beautiful singing of Montserrat Caballé) is particularly affecting. (The third setting involves a theme all too close to one in Aaron Copland's *Appalachian Spring*, which brings up another problem: not that of appropriation or even of eclecticism, but one that simply involves the very specific and *different* associations of that sort of tune for American audiences.) But the problem overall in *Kaddish* is that one all too often cannot hear the music for the words. It is again interesting that the principal difference between this revised version and the original is again in the direction of music: the original is cut down. Would Bernstein ever allow it to be cut completely and let the music stand on its own,

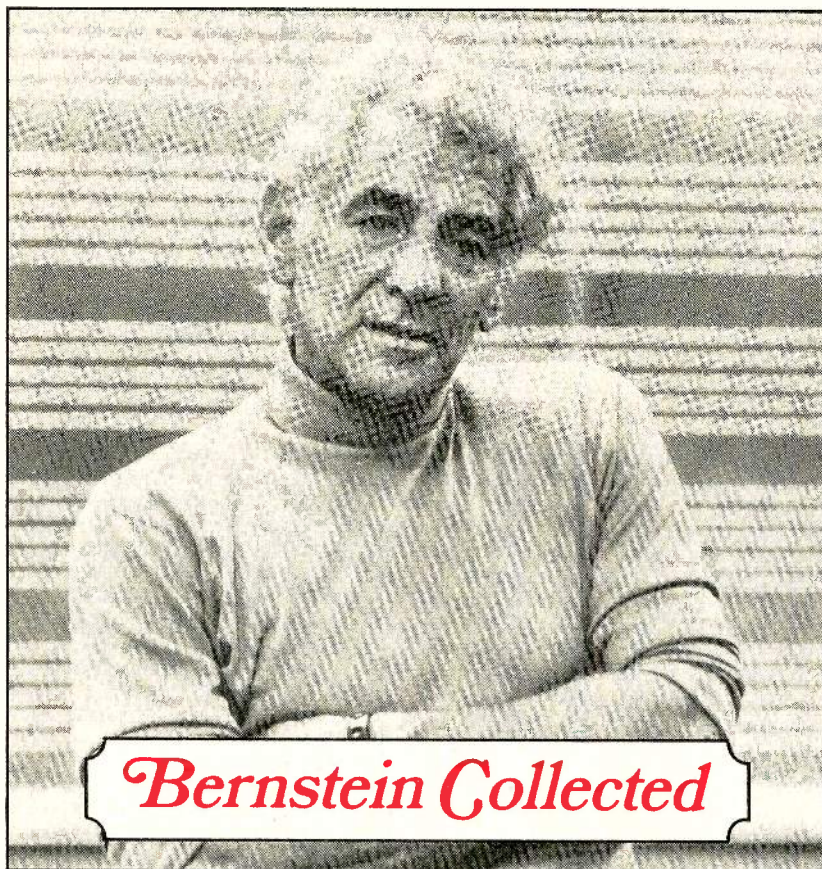

Bernstein Collected

they are performances and recordings of the highest quality is amply evident. Purely as documentation, the set is a considerable achievement, and all those concerned can be proud of their contributions to the whole.

But primary attention must go to a consideration of the works themselves, for it is in the very nature of a project such as this that some sort of re-evaluation of the composer and his music should result. Earlier recordings of all four works exist, but this is the first recording of the revised version of the Symphony No. 3, and the set as a whole represents Bernstein's current view of his own music.

It would be fair to say that the symphonies have not all enjoyed a huge success, critically or publicly, at least not one commensurate with Bernstein's enormous renown as a conductor nor even with his success as a compos-

man, not so much in God as in himself." The second is Bernstein's statement: "Although everything I write seems to have literary or dramatic underpinning, it is, after all, music that I am writing." The forces represented by each of these two thoughts are more or less present in virtually all of Bernstein's concert music, and the more I listen to any of it, the more I become convinced that Bernstein is most successful when he is writing music and least successful when he is writing about the loss and retrieval of faith.

Jeremiah, his first symphony, was composed at a time when people still thought in terms of "the great American symphony." *Jeremiah* is not "the great American symphony" (nor is Roy Harris' Third, nor any of the others), and it is, so far as I can tell, not a masterpiece. But one cannot listen to it today, as one could not listen to it then (1944), with-

suggesting the religious concerns and doubts rather than making them explicit?

Problems of this sort do not beset the *Chichester Psalms*, which are settings of the original Hebrew. The work is generally less self-conscious, less theatrical, more musical than others of Bernstein's recent concert works, and, if it did not have Bernstein's name on it, it could be easily accepted as a worthy if somewhat dry contribution to the sacred-music repertoire. But, knowing its source, one is conscious of the absence, seemingly the avoidance, of the sort of glorious, long-limbed melody that Bernstein can write and has written in such works as *Candide*. There is a straining for seriousness, for austerity, for profundity that one wishes he would forgo. I for one would be deliriously happy to hear such melodies as those for *Make Our Garden Grow*, *Oh Happy We*, or *Somewhere* in symphonic or choral context any time Leonard Bernstein wanted to put them there.

A FEW specifics of these performances must be mentioned. Caballé's singing, as previously indicated, is glorious, her cantillation style completely convincing, and her breath control, well... breathtaking. Christa Ludwig is also in superb form and mightily affecting in *Jeremiah*. The Vienna Choir Boys and the Jeunesse Choir are unfailingly musical, but Hebrew is not one of the languages they're accustomed to and in fast passages their diction is such that one is hard-pressed to distinguish a word. Lukas Foss of course plays the very devil out of the piano part in *The Age of Anxiety*, though his performance, and the orchestra's, is a mite less frenetic (in the frenetic passages) than in the old original recording with the New York Philharmonic. Apart from that interpretive cavil, there is no fault to be found with the Israel Philharmonic's playing. They sound like a major international orchestra, which, at this time, they must be. Of Michael Wager's contribution as narrator, I find it so difficult to divorce what he is saying from how he is saying it that I cannot pass judgment. The recordings are all of excellent quality; the records are available separately or boxed together. In all, then, this is a major tribute to a major musical figure and intriguing composer. I urge even doubters to hear it out, but I urge them also to attend more to the music than to what it is "about."

—James Goodfriend

BERNSTEIN: *Symphony No. 1 ("Jeremiah")*; *Chichester Psalms*. Christa Ludwig (mezzo-soprano, in *Symphony*); soloist from Vienna Boys Choir (in *Psalms*); Vienna Jeunesse Choir (in *Psalms*); Israel Philharmonic Orchestra, Leonard Bernstein cond. DEUTSCHE GRAMMOPHON 2530 968 \$8.98.

BERNSTEIN: *Symphony No. 2 ("The Age of Anxiety")*. Lukas Foss (piano); Israel Philharmonic Orchestra, Leonard Bernstein cond. DEUTSCHE GRAMMOPHON 2530 969 \$8.98.

BERNSTEIN: *Symphony No. 3 ("Kaddish")*. Montserrat Caballé (soprano); Michael Wager (speaker); Vienna Choir Boys; Vienna Jeunesse Choir; Israel Philharmonic Orchestra, Leonard Bernstein cond. DEUTSCHE GRAMMOPHON 2530 970 \$8.98.

The Ditton 44 by Celestion An hermetically sealed three-way system employing a 1" dome super tweeter functioning from the 5 kHz crossover point to well beyond audibility, a 6" cone midrange that functions down to 500 Hz and a 12" bass transducer that is operational down to 30 Hz. Overall frequency response is 30 Hz to 40 kHz. Available in walnut or teak finish. 30" h x 14½" w x 10" d.



We're not certain
you'll prefer the Ditton 44
over other \$300 speaker systems.
Just reasonably confident.

We not only know how to make speakers; we know how difficult it is to evaluate them. Especially at dealers, because speakers that you love in the showroom have a habit of sounding different at home.

At Celestion, we make all our own drivers and crossover networks (as we've been doing in England for more than fifty years). So we are reasonably confident of the outcome whenever and wherever our speakers are auditioned and compared with others.

That's why, when we entered the U.S. market in mid-1977, each of our models was introduced together with a select list of competitive systems we considered good values. And also worth your consideration.

Of course, not everyone who made the comparisons chose ours, but enough did to make us feel we were doing the right thing. There are obviously many music lovers who prefer a traditionally-made speaker that produces untraditionally clean, uncolored sound that is as close to the original as we know how to make it.

We don't know how pleased you will be with other speakers when you get home. But from what Celestion owners tell us, ours continue to be satisfying to live with long after the honeymoon is over.

Celestion
Loudspeakers for the perfectionist



Celestion Industries, Inc., Kuniholm Drive, Holliston, MA 01746
In Canada: ROCELCO Inc., Downsview M3J2J7

STRAUSS: *Der Krämerspiegel, Op. 66.*
GRIEG: *Ragnhild; Ragna; By a River; A Swan; My Thoughts Are Like a Mighty Mountain; Den Bergtekte, Op. 32.* Knut Skram (baritone); Eva Knardahl (piano); Göteborg Chamber Orchestra, Thomas Schuback cond. B1s LP-49 \$8.98 (from Qualiton Records, Ltd., 65-37 Austin Street, Rego Park, N.Y. 11374).

Performance: **Good**
 Recording: **Very good**

Here is a disc of rarities uniting lyrical Grieg and satirical Strauss. The five Grieg songs and his pastoral cantata *Den Bergtekte* (rough translation: *The Mountain-Enthralled*) receive affectionate and idiomatic perfor-

mances. The singing is competent rather than rapturous, but, since Grieg songs (except for *A Swan*) are hard to find on records, the program is commendable.

Der Krämerspiegel (rough translation: *A Mirror for Shopkeepers*) is a strange cycle of a dozen songs dating from the period (1903) when Strauss was involved in a feud with the German music publishers. In these settings of cleverly malicious poems by Alfred Kerr, he takes on the whole bunch of them, naming names (Breitkopf, Lienau, Bote und Bock, etc.), punning, and indulging in quotations from *Der Rosenkavalier*, *Death and Transfiguration*, and *Till Eulenspiegel*. There are moments of wit and moments of inspiration, and the music ends with a very pretty piano

postlude, but the cycle goes on too long for its own good. (Of course, no publisher was willing to accept it in the composer's lifetime. Boosey and Hawkes of London, unnamed in the text, finally published it in 1959.) The versatile baritone Knut Skram gives a committed performance, which is well accompanied and recorded in bright and spacious sound. *G.J.*

STRAVINSKY: *Oedipus Rex.* Sir Peter Pears (tenor), Oedipus; Kerstin Meyer (contralto), Jocasta; Benjamin Luxon (baritone), Messenger; Donald McIntyre (bass), Creon; Stafford Dean (bass), Tiresias; Ryland Davies (tenor), Shepherd; Alex McCowan, Narrator. John Alldis Choir; London Philharmonic Orchestra, Sir Georg Solti cond. LONDON OSA-1168 \$7.98.

Performance: **Occasionally overstated**
 Recording: **Good**

I found it uncomfortable to listen to this performance from the very outset because of the narration, which begins as if we are going to hear *Peter and the Wolf*, then refers to the work itself as an "opera-ahatorio" in which Oedipus contends with unsleeping "day-ties," etc. Musically, Sir Georg Solti's framing of the work seems more efficient than moving, while both Kerstin Meyer and Benjamin Luxon seem at odds with Stravinsky's notion of the "lofty dignity" imposed by his use of a Latin text; both singers have a tendency to overdramatize rather than understate. The latter, of course, is what Sir Peter Pears does, as eloquently and effectively as he did in the earlier of Stravinsky's own recordings of the work some twenty-five years ago. That version, recently reissued as *Odyssey* (Y-33789), is still far and away the most successful performance of *Oedipus Rex* yet recorded, and no matter that Jean Cocteau spoke his narration in French; the various English versions are so stuffy, lackluster, or just plain silly-sounding that the French is far preferable. Besides, Cocteau's narration is so vivid that one is mesmerized even if one doesn't understand all the words. Among stereo versions, Bernstein's (Columbia M 33999) is the most effective, with the Boston Symphony Orchestra playing more crisply than the London Philharmonic does for Solti, all the singers on a uniform level of excellence, and more presence in the sound. *R.F.*

SZYMANOWSKI: *Notturmo e Tarantella* (see SAINT-SAËNS)

VAUGHAN WILLIAMS: *Fantasia on a Theme by Thomas Tallis* (see BRITTEN)

VERDI: *La Battaglia di Legnano: Overture* (see PUCCINI)

WAGNER: *Opera Arias* (see Collections—Dietrich Fischer-Dieskau)

COLLECTIONS

RECORDING OF SPECIAL MERIT

BORIS CHRISTOFF: *Music from the Slavonic Orthodox Liturgy.* Chesnokov: *Evening Sacrifice.* Zinoviev: *We Hymn Thee.* Kochetov: *Blessed Is the Man.* Hristov: *Praise Ye the Name of God; Nunc Dimittis.* Dinev: *The Judicious Villain.* Stroumski: *The Great Glorification.* Lyubimov: *Blessed Is the Man.* Bort-
 (Continued on page 142)

800-638-6666

ONE CALL CAN DO IT. ONE CALL ON OUR TOLL-FREE NUMBER CAN GET YOU THE BEST PRICE ON ALL TYPES OF HOME AND CAR STEREO. THIS FALL, DISCOUNT SOUND IS OUT TO WIN YOU OVER WITH THE LOWEST PRICES AND THE FASTEST SERVICE!

PIONEER
 SX-780

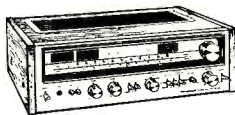

45 watts RMS per channel, 0.05% THD



Pure power DC receiver \$308



Belt drive changer with Shure V-15III \$190

PIONEER
 CT-F9191

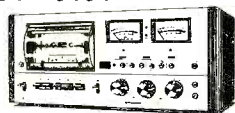

One of Pioneer's most popular units. \$269



4 speaker system, 12" woofer



45 watts RMS per channel, 0.04% THD

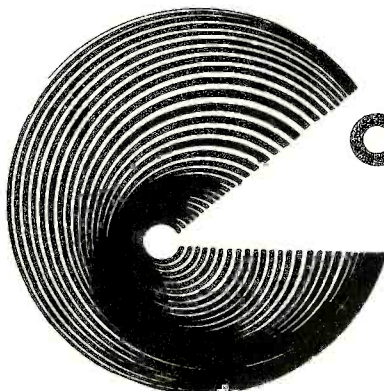

discount sound

5618 RANDOLPH RD., ROCKVILLE, MD. 20852 All orders shipped immediately • Phone orders accepted • Use your BankAmericard or Master Charge • Call or write for price quotes on all the top audio brands • Write for free catalog • All merchandise in factory sealed cartons with full manufacturer's warranty.

800-638-6666 301-881-8890

Receive the many benefits offered to you with a Musical Heritage Society membership, and . . .

SELECT 3 RECORDS OR CASSETTES FREE

with any
future purchase
you elect
to make.

CHOOSE FROM
ARTISTS SUCH AS

ANDRÉ · DE LARROCHA · OISTRAKH · RAMPAL · GILELS · ROSTROPOVICH AND MANY, MANY MORE

Just a sampling of the great artists available from our Master Catalogue of nearly 3000 recordings!

Centuries of Great Music at Your Fingertips

The Society's recordings span all periods of music . . . Medieval, Gothic, Renaissance, Baroque, Rococo, Classical, Romantic and Modern. We offer you a vast selection (nearly 3000 recordings) of works **available nowhere else!**

Among the exciting performances awaiting your listening pleasure are classical masterpieces by immortal composers — Mozart, Beethoven, the Bachs, Mendelssohn, Tchaikovsky, Handel and many, many more. Also available to members are works by composers who have become noteworthy due almost entirely to the Society's efforts — Pachelbel, Telemann, Fasch, Gilles. . . .

Every Recording Available at Enormous Savings!

Your membership in the Musical Heritage Society offers you more **immediately-available** recordings than any other single source!

This huge volume and our direct service (no middleman) entitle you to **substantial savings** on every record or cassette you purchase. Members' prices are only \$3.75 for each 33 $\frac{1}{3}$ RPM disc and \$4.95 for each Dolbyized cassette.



DE LARROCHA



ROSTROPOVICH

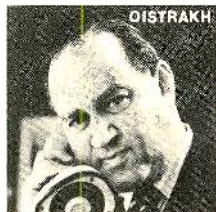

OISTRAKH



RAMPAL

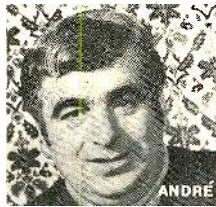

ANDRÉ



GILELS

Reproduction standards are among the finest available. That's just one reason why so many of these recordings merit international awards. Another reason is sheer artistic excellence. You can build a library of these superior recordings — as a member of the Musical Heritage Society!

Join the Society Now! Your Free No-Obligation Membership Includes . . .

- A free one-year subscription to **Musical Heritage Review** magazine. Issued 18 times each year, this definitive publication contains the Society's latest releases along with over 1200 pages annually of news, reviews and colorful editorial coverage of great music from all periods.
- **Huge savings** on every record (\$3.75) and cassette (\$4.95).
- **Immediate availability** from the largest selection of its kind.
- **No waiting.** Your order is shipped direct from our vast inventory.
- **Convenient ordering** with our Open Credit Account.
- **Discount purchasing** of the finest reproduction equipment and accessories.
- **Full 30-day Guarantee** on every record or cassette purchased.
- A free copy of the giant Master Catalogue with any purchase.

Enjoy the Finest Quality and Award-Winning Performances

Nowhere else will you find a collection of such vast proportions or exacting quality of performance or manufacture. More than 200 of the Society's recordings have won the GRAND PRIX DU DISQUE and other international awards of excellence. Society recordings are selected by experts and supported by critics worldwide.

MEMBERSHIP APPLICATION

Receive 3 Records or Cassettes of Your Choice **FREE** With Any Purchase! Apply Now for Your Society Membership.

To become a member of the Musical Heritage Society, please return this completed application to us. Your membership credit account will be immediately established and . . .

■ A certificate entitling you to **THREE RECORDS OR CASSETTES OF YOUR CHOICE ABSOLUTELY FREE** will be sent to you along with a Sample Catalogue. Use it with your initial purchase, or save it until you've seen our Master Catalogue of nearly 3000 great recordings.

■ The first issue of your *Musical Heritage Review* subscription will be mailed to you. It will contain several selections from the Master Catalogue along with many brand new Society releases.

■ Two, sometimes three musical selections will be scheduled for you to audition — without obligation — from each issue of the *Review*. To accept these audition selections, do nothing. They will automatically be shipped to you to audition free. But if you'd prefer an alternate selection, or none at all, just return the **RESPONSE FORM** included in each issue of the *Review*.

OFFER STRICTLY LIMITED TO NEW SOCIETY MEMBERSHIP APPLICATIONS WITHIN THE UNITED STATES. ONLY ONE APPLICATION PER HOUSEHOLD WILL BE CONSIDERED AND ALL APPLICATIONS ARE SUBJECT TO REVIEW BEFORE MEMBERSHIP IS GRANTED.

Mail this application to:

Musical Heritage Society Dept. STR 001
Musical Heritage Society Building
14 Park Road
Tinton Falls, New Jersey 07724

YES. I would like to become a member of the Musical Heritage Society.

NAME PLEASE PRINT CAREFULLY

ADDRESS

CITY STATE ZIP CODE

YOUR SIGNATURE

Enjoy the Many Society Benefits with No Purchase Obligation—Ever!

nyanski: *Grant, O Lord.* Boris Christoff (bass); Choir of the Alexander Nevsky Cathedral, Sofia, Angel Konstantinov cond. ANGEL S-37479 \$7.98.

Performance: **Outstanding**
Recording: **Excellent**

For several years Boris Christoff has been absent from the recording scene. It is a joy to have him back, and this magnificent disc, which marks the basso's first return to his native Bulgaria in thirty years, shows him at the top of his form. His mighty voice with its characteristic grainy timbre peals with undiminished power, steady as a rock, smoothly produced, fearlessly rising up to a firm F. He commands a rich palette of colors and a dynamic scale ranging from thundering sounds to a subtle mezza voce. This is the old Christoff, now fifty-nine, surrounded by an outstanding chorus and captured in splendidly resonant sound. It's enough to convert a vocal connoisseur to Slavonic Orthodoxy. *G.J.*

DIETRICH FISCHER-DIESKAU: *Wagnerian Aria Recital. Der Fliegende Holländer: Die Frist ist um. Parsifal: Nein! Lasst ihn unenthüllt!; Ja, Wehe! Wehe! Die Walküre: Wotan's Farewell.* Dietrich Fischer-Dieskau (baritone); Bavarian Radio Chorus and Symphony Orchestra, Rafael Kubelik cond. ANGEL □ S-37487 \$7.98.

Performance: **Individual**
Recording: **Good**

Dietrich Fischer-Dieskau is a versatile and altogether exceptional artist, but he is not,

and never was, a Wagnerian *Heldenbariton*. His high-placed, lightweight voice commands neither the power nor the dark sonority required for such roles as Hans Sachs, Wotan, and Telramund. But it can stand up to the more lyrical challenges of Wolfram and Amfortas with reasonable expectations of success, and, in fact, Fischer-Dieskau has performed these roles with distinction.

On records, however, he has not allowed natural limitations to deter him from interpreting the Dutchman, Telramund, and Hans Sachs, and now he has even gotten around to Wotan's imposing Farewell, the closing scene of *Die Walküre*. The results of these endeavors have always been a mixture of revelations and frustrations, and so they are in the present sequence of Wagnerian scenes. Wotan emerges here as an unusually tender father, but his awesome power is barely suggested. To the monologues of Amfortas, the artist brings rare eloquence and a profoundly moving expression of grief that make the vocal limitations seem unimportant. As for the Dutchman, there is plenty of brooding and mystery, but little of the character's ferocity. Declamatory overstress simply cannot make up for what nature denied this artist after so generously blessing him with heart, intellect, and interpretive mastery.

With all this said, however, I can still recommend this disc for the display it offers of exceptional lyric singing and textual illumination. We must face the fact that the German *Heldenbariton*, the proud race of Van Rooy, Schorr, Berglund, and Schöffler, seems to have vanished like the Nordic gods. Among

their contemporary impersonators Dietrich Fischer-Dieskau stands very high, and we should be thankful for that.

Rafael Kubelik was probably inhibited on this occasion by a desire not to overpower his soloist. The orchestral framework is, accordingly, effective but somewhat lacking in spaciousness and grandeur. *G.J.*

LEONTYNE PRICE: *Prima Donna—Volume 4. Mozart: Idomeneo: D'Oreste, d'Ajace. Berlioz: The Damnation of Faust: D'amour l'ardente flamme. Wagner: Tannhäuser: Dich, teure Halle. Verdi: Macbeth: La luce languie. J. Strauss Jr.: Die Fledermaus: Czardas. Mascagni: Cavalleria Rusticana: Voi lo sapete (with Elizabeth Bainbridge, mezzo-soprano). Dvořák: Rusalka: Song to the Moon. Cilèa: Adriana Lecouvreur: Poveri fiori. Korngold: Die Tote Stadt: Marietta's Lied. Puccini: Turandot: In questa reggia (with Daniele Biondi, tenor). Menotti: Amelia Goes to the Ball: While I waste these precious hours.* Leontyne Price (soprano); New Philharmonia Orchestra, Nello Santi cond. RCA ARL1-2529 \$7.98, © ARS1-2529 \$7.98, © ARK1-2529 \$7.98.

Performance: **Good to very good**
Recording: **Good**

As in the previous volumes of the Leontyne Price "Prima Donna" series that RCA has been releasing over the past dozen years, the arias here follow a historical-chronological sequence that makes sense in a certain way, yet proves disconcerting when listeners gripped by Lady Macbeth's ominous soliloquy are suddenly heartened by Rosalind's *Czardas*.

fact: the Shure/SME Series III is the state of the art in tone arms.

new!

Breakthroughs & Improvements.

The Series III is the culmination of research and development extending over more than seven years. It embodies a number of significant breakthroughs as well as evolutionary improvements over its distinguished Shure/SME predecessor.

Notable among these is an exotic nitrogen-hardened titanium tubing arm (with wall thickness only twice the diameter of the average human hair) providing a previously unattainable strength-to-weight ratio. The arm has a soft core annular cross-section with an internal fibrous lining which results in an efficient, natural damping of the vibration fed into the arm by the cartridge.

Cartridge Carrier.

The Series III "cartridge carrier," a combination tone arm and shell in one piece, is removable and interchangeable for multi-cartridge use. Coupling is close to the fulcrum so the carrying arm makes a minimum contribution to the Series III total effective mass (only 5.05 grams measured at 9 inch radius!).

Fluid Damper.

A built-in highly efficient F.D. 200 Fluid Damper gently but effectively resists spurious or potentially damaging stylus forces in both planes, yet does not interfere with normal arm motion.

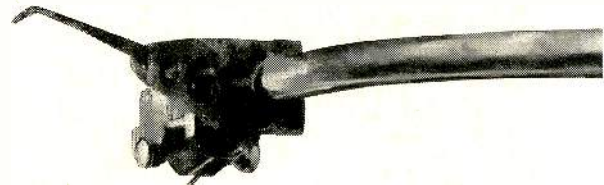

"The best pickup arm in the world."

Incomparable High Fidelity Performance!



THE SME SERIES III PRECISION PICKUP ARM WITH THE NEW SHURE V15 TYPE IV CARTRIDGE

The combination of the Shure V15 Type IV cartridge and the SME Series III tone arm transcends previous tone arm-cartridge system performance, and sets dramatic new standards in connoisseur-class high fidelity reproduction.

To the best of my knowledge, none of these operatic characters is in Miss Price's active repertoire, but that is hardly relevant. Superstars of her stature are not required to have large repertoires any more; a dozen or so roles suffice to please their world-wide audiences. Besides, Adriana Lecouvreur, Lady Macbeth, Marietta (*Die Tote Stadt*), and Ruskalka could be excellent Price roles. She does the respective arias very well here; in fact, her version of Marietta's Lied surpasses all other recent versions.

In general, Miss Price is in good voice. She has been conserving her resources wisely in recent years, accepting relatively few engagements and resisting the kind of overstress that jet planes impose on some of her not entirely unwilling colleagues. There are some lovely things on this record. The Berlioz aria may not lie perfectly in her range, but the opening lines are floated with a delicate legato and the melancholy mood is nicely sustained to the end. "*Dich, teure Halle*" is not rendered with the near-martial emphasis usually given it by German sopranos but with a more inward approach that is welcome for its rich-toned lyricism. Throughout the program, the intonation is consistently pure, the musicianship secure, and the artistic impulses and ringing top notes generally recall her best recorded efforts.

I have some reservations, however. The top range remains Miss Price's field of glory, but there are rough attacks and strident tones that previously were not there. They are particularly damaging to the murderously difficult *Idomeneo* aria, which is managed creditably but certainly not with ease. The same is true



Soprano Leontyne Price
autographing records at Sam Goody's

of the *Czardas* from *Die Fledermaus*, which calls for virtuosic abandon and gets studied competence instead. "*Voi lo sapete*," lying too low for comfort, is further weakened by a draggy tempo. Here and elsewhere a certain carelessness with the Italian texts is also noticeable. And "*In questa reggia*" must be marked a failure on all counts, even past its near-disaster opening.

The recorded sound varies but is generally

good; Nello Santi provides good routine accompaniments, veteran producer Richard Mohr affectionate if somewhat overwritten annotations. G.J.

TWENTIETH CENTURY ENGLISH MUSIC.
Britten: *Simple Symphony*. **Rawsthorne:** *Light Music for Strings*. **Chagrin:** *Five Aquarelles*. **Warlock:** *Capriol Suite*. Orchestra da Camera di Roma, Nicolas Flagello cond. PETERS INTERNATIONAL PLE 054 \$6.98.

Performance: **Lovely**
Recording: **Excellent**

These four lighthearted works are just the thing to pull from your collection when you need a little cheering up. Britten's *Simple Symphony* is a succinct and sunny work for strings, deservedly popular and almost as well played here by the Orchestra da Camera di Roma under Nicolas Flagello as with Britten himself conducting on the London label. Its "Boisterous Bourée," "Playful Pizzicato," "Sentimental Sarabande," and "Frolicsome Finale" are based on themes Britten chose from his own childhood compositions. Flagello also keeps the soufflé from falling in Alan Rawsthorne's lighter-than-air *Light Music for Strings* and in Francis Chagrin's Five Aquarelles, which are mood portraits of children ranging in temperament from dreamer to mischief maker. It is especially good to have the *Capriol Suite* by Peter Warlock available again, particularly in this immaculate rendition. Warlock killed himself at thirty-six during a bout of severe depression, but you'd never guess it from this sparkling suite. P.K.

...other features of the unique SHURE/SME Series III precision pickup arm:

- Unique balance system enables cartridges weighing 0 to 12 grams to be operated under conditions of minimum inertia.
- Interchangeable integral carrying arm replaces conventional tone arm and shell.
- Positive rack and pinion overhang adjustment.
- Main pillar hardened and ground.
- Low friction pivots, vertical axis: high precision fully protected ball races. Horizontal axis: knife edges. Less than .02 gram applied at the stylus will deflect the arm!
- Vertical and horizontal bearing axes intersect at stylus level for minimum warp-wow.
- Precise tracking force up to 2.5 grams can be applied without a tracking force gauge.

- Bias (antiskating) with fine adjustment.
- Longitudinal and lateral balance with fine adjustment.
- Ultra low-distortion geometry.
- Fluid-damped lowering and raising control.
- All electrical contacts heavily gold-plated.
- Superb camera finish throughout.
- 1978 Design Award from the British Design Council.

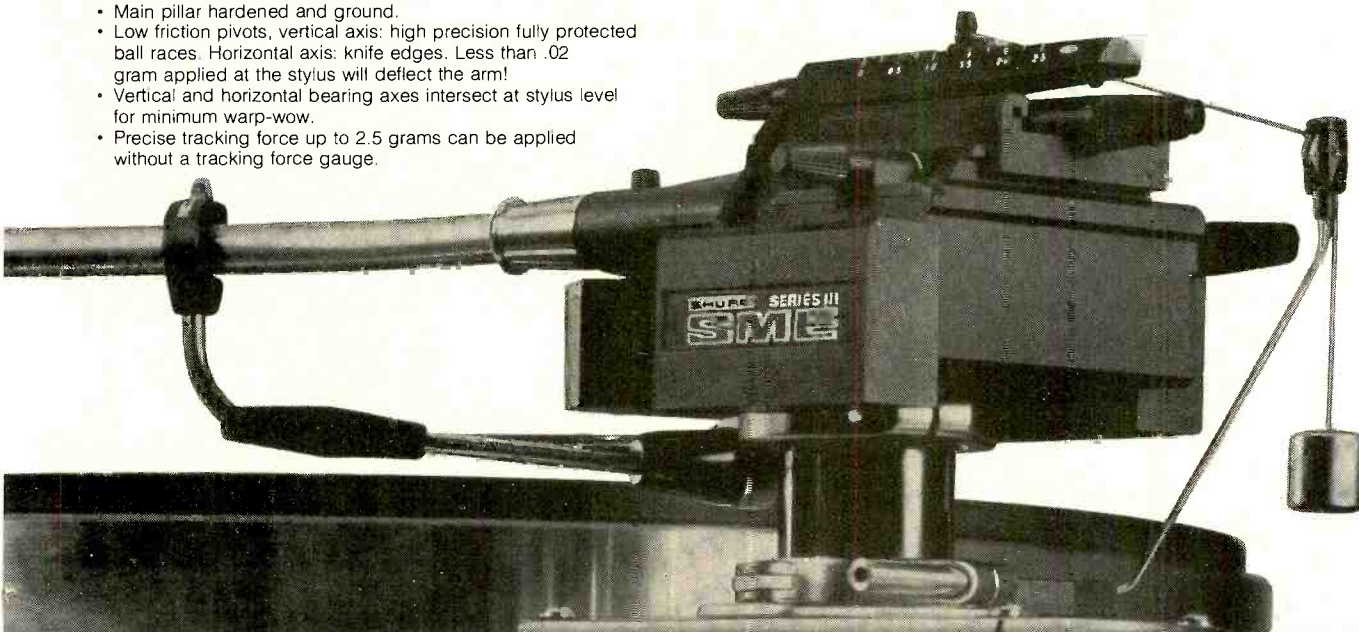

Send for complete brochure AL579:



Shure Brothers Inc., 222 Hartrey Ave., Evanston, IL 60204 In Canada: A. C. Simmonds & Sons Limited
Manufacturers of high fidelity components, microphones, sound systems and related circuitry.

Audio Discount
WAREHOUSE SALES
 DIRECT TO PUBLIC
 CALL THE
STEREO PHONE
1-800-631-2175
 TOLL FREE
 FOR ORDERS & PRICE QUOTES

**LARGEST SELECTION
 LOWEST PRICED ANYWHERE**

RECEIVERS TURNTABLES TUNERS
 SPEAKERS CHANGERS CARTRIDGES
 TAPE DECKS AMPLIFIERS HEADPHONES
 PRE-AMPS COMPACTS CAR AUDIOS

PIONEER



CTF-9191.....\$249
 CTF-7272.....\$199
 SX-1250.....\$469
 SX-950.....\$359
 SX-750.....\$249

TEAC

A-103 Stereo Cassette Deck with Dolby System \$165



PIONEER

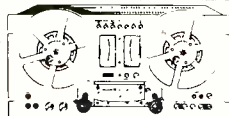

\$391

RT-707 3-MOTOR 4-HEAD AUTO-REVERSE STEREO TAPE DECK. 1/4 TR., 7/2", 3 3/4" LIST \$575.00

\$39⁹⁵



KOSS
 PRO/4 Triple A

TDK

CASE OF 10

SA/C90.....\$28
 SA/C60.....\$20
 AD C90.....\$24

**CALL TODAY
 TOLL FREE**

1-800-631-2175

MASTER CHARGE/BANKAMERICARD
 HONORED ON PHONE ORDERS

175 MONMOUTH RD.
 W. LONG BRANCH, N.J. 07764
 201-229-3300



CIRCLE NO. 6 ON READER SERVICE CARD

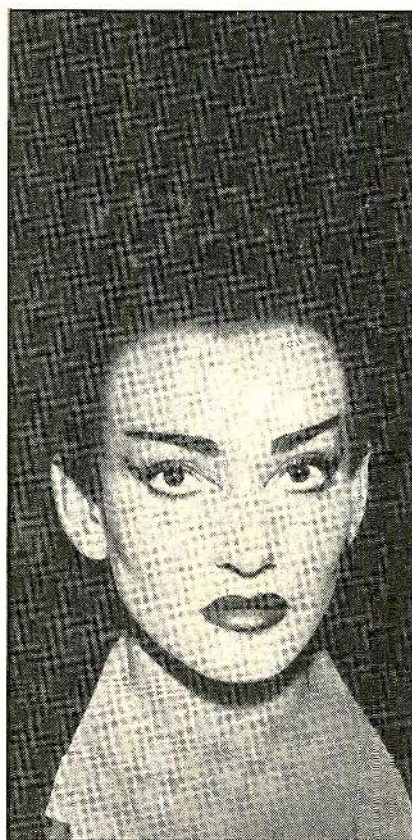

Man Ray Records

In Cherubini's *Medea*

Callas Ransomed from the Pirates

RECORDINGS of the late Maria Callas' stage performances in Italy, Mexico, New York, London, and other places have long been hot items in the flourishing worldwide "pirate" trade. A recent change in Italian law legitimized unauthorized concert recordings dating back twenty or more years, and a large number of them were released in Italy by Fonit/Cetra. Whether this also gives the go-ahead for worldwide distribution is for legal minds to ponder. The fact is that Turnabout has now issued in its historical series seven sets representing Callas in her vocal prime (1949-1955). Thus, for the first time, collectors are able to acquire them at attractive trade prices (\$4.98 per disc) instead of paying piratical ransoms.

The documentary appeal of these recordings is undeniable. Through them we witness the rise and early triumphs of a fascinating and controversial artist on her way toward becoming one of the most influential musical personalities of the century, establishing new standards and re-creating roles in operas that had been dormant for generations. Of the seven operas in the release, three (*Nabucco*, *Macbeth*, *I Vespri Siciliani*) never received complete studio treatments with Callas, and there are no commercial recordings of Callas with conductors Vittorio Gui, Erich Kleiber, and Leonard Bernstein. Then too, of course, everything here has the unvarnished spontaneity of a stage performance.

But along with these enormous pluses I must also point to the minuses. Clandestinely and amateurishly made, these recordings are far below today's commercial audio standards and, with one exception, fall far short of most studio productions from the 1949-1955 period. Under no circumstances can they be considered true representations of the operas in question; they are rather *documentations of the art of Callas and the conductors and singers involved*. With this in mind I feel no need to call attention to individual technical shortcomings. Let me just say that they are encyclopedic in range, involving distortion, poor balances, brusque editing, surface noise, and a general technical inadequacy.

DISTORTIONS in the powerful choral passages are particularly damaging to *Nabucco* (Naples, 1949), the earliest recording and, in fact, the first available representation of the young soprano, who is surrounded by such veterans as baritone Gino Bechi and bass Luciano Neroni. Despite their seniority, Callas dominates all her scenes by the sheer force of her magnetism and splendid vocal security. Boldness is the key element in her singing; she sails into her music with a demonic intensity that befits the character she portrays and fearlessly zeroes in on the climactic high notes (several C's and a brilliant E-flat). The entire performance is dynamically paced by Gui, the trumpety high baritone of Gino Bechi comes through effectively, Neroni is not always steady but consistently powerful and authoritative, and the rest of the cast is competent or better.

There is no trace in these recordings of the vocally precarious later Callas. She is in outstanding form in *I Vespri Siciliani* (Florence, 1951), despite a momentary lapse in the Bolero, and the indifferent recorded sound cannot

conceal the vast interpretive range she brought to the dramatically complex role of Elena. Her meaningful ways with recitatives, already amply evident in *Nabucco*, are further documented here. This opera had enjoyed more success in Germany than it did in Italy in the preceding decades, which in part explains the welcome presence of Erich Kleiber. Boris Christoff's *Procida* is magnificent and Enzo Mascherini's *Monforte* is acceptable, but I cannot say as much for Giorgio Kokolios-Bardi's *Arrigo*.

In *Macbeth* (Milan, 1952), Callas already appears as an established star of La Scala. This was her first portrayal of Lady Macbeth, but the mastery she would disclose in her commercial recording of that lady's three scenes seven years later (Angel 35763) is already in evidence. Only the Sleepwalking Scene appears less dramatically illuminating by comparison, but then her account of it on the Angel disc is the ultimate. The other vocal contributions are on a generally high level. Mascherini is not sufficiently responsive to Callas in their great *sotto-voce* scene after Duncan's murder, but he has his impressive moments; Italo Tajo is a thoughtful, distinguished Banquo, Gino Penno a sturdy Macduff, and Dario Caselli excels in the small role of the Doctor. And Victor de Sabata's leadership is of the kind that deserves more impressive sonics.

Il Trovatore (Milan, 1953) suffers somewhat from the uneven conducting of the usually reliable Antonino Votto: he is rigidly mechanical at times, particularly in the "*Miserere*," yet flexible enough to allow the veteran Ebe Stignani to virtually chew up the scenery in an overwhelming "*Condotta el'era in cepi*." Callas sings her first-act aria with an effortless flow of instrumental legato, her "*D'amor sull'ali rosee*" with plaintiveness, consummate phrasing, and accurate *fiorture*. Her final scene is extraordinarily moving. Ebe Stignani rekindles old memories with her flaming Azucena, and another veteran, Carlo Tagliabue, is a fading but still authoritative Luna; but Gino Penno presents a bullish, unpoetic Manrico, and he transposes "*Di quella pira*" down a tone and a half!

Because his role is less crucial in *Medea* (Milan, 1953), Penno does less damage there, but then the whole show is Callas. Her characterization of unbridled evil is familiar from the later commercial recording, but she is in far better voice here. The volcanic impression she makes is aided by Bernstein, who, by maintaining inexorable momentum, avoids the danger of turning this opera into a series of stately episodes. The supporting roles are in good hands.

Bernstein is again the conductor for *La Sonnambula* (Milan, 1955), and a very good one aside from a tendency to whip up the finales with an un-Bellinian frenzy. The lyric moments, however, are eloquent, and Callas and Cesare Valletti (a tenor whose affinity for bel canto matches the soprano's) makes us realize that librettist Felice Romani was a poet. Callas is superb in all the grand vocal moments, but the concluding "*Ah, non giunge*" is less ornately (and therefore more successfully) achieved in the Angel recording under Votto which followed two years later.

Finally, we have the legendary *Lucia di Lammermoor* (Berlin, 1955) with Herbert von Karajan conducting a choice Italian cast. Here, for the first time, the sound is a near match for that of studio recordings of the period, though there are several miking inconsistencies. Karajan combines total control with a flexibility that borders on permissiveness. Savoring the excellence of his cast, he supports them with a caressing touch and cajoles them into giving their best. If it is the Callas kind of *Lucia* that you prefer—vulnerable but no weakling, suffering but without excessive languor—she is even better here than in her two Angel recordings poetic, dramatically moving, vocally (a few instances of tonal harshness aside) refulgent. Giuseppe di Stefano is also in prime estate here: one might wish for tones more sensitively modulated, but his ardor and the sheer beauty of the sound are irresistible. Nicola Zaccaria is an outstanding Raimondo, and Rolando Panerai, with that admirably sharp and biting diction of his, is a memorable Ashton.

THE sets come in utilitarian but handsome boxes. There are no texts, only brief but informative notes by Richard Freed. Whether this initial adventure will be followed by future ones will, I suppose, depend on many factors. But I know that admirers of Maria Callas will welcome the release of these treasures from bondage. —George Jellinek

VERDI: *Nabucco*. Maria Callas, Gino Bechi, Luciano Neroni, Gino Sinimberghi, Amalia Peni; others. Chorus and Orchestra of the Teatro San Carlo, Naples, Vittorio Gui cond. TURNABOUT THS 65137/39 three discs \$14.94.

VERDI: *I Vespri Siciliani*. Maria Callas, Boris Christoff, Giorgio Kokolios-Bardi, Enzo Mascherini, Italo Tajo, Gino Penno; others. La Scala Orchestra and Chorus, Victor de Sabata cond. TURNABOUT THS 65134/36 three discs \$14.94.

VERDI: *Macbeth*. Maria Callas, Enzo Mascherini, Italo Tajo, Gino Penno; others. La Scala Orchestra and Chorus, Victor de Sabata cond. TURNABOUT THS 65131/33 three discs \$14.94.

VERDI: *Il Trovatore*. Maria Callas, Gino Penno, Ebe Stignani, Carlo Tagliabue, Giuseppe Modesti; others. La Scala Orchestra and Chorus, Antonino Votto cond. TURNABOUT THS 65140/41 two discs \$9.96.

CHERUBINI: *Medea*. Maria Callas, Gino Penno, Fedora Barbieri, Maria Luisa Nache, Giuseppe Modesti; others. La Scala Orchestra and Chorus, Leonard Bernstein cond. TURNABOUT THS 65157/59 three discs \$14.94.

BELLINI: *La Sonnambula*. Maria Callas, Cesare Valletti, Giuseppe Modesti, Eugenia Ratti; others. La Scala Orchestra and Chorus, Leonard Bernstein cond. TURNABOUT THS 65151/53 three discs \$14.94.

DONIZETTI: *Lucia di Lammermoor*. Maria Callas, Giuseppe di Stefano, Rolando Panerai, Nicola Zaccaria; others. La Scala Orchestra and Chorus, Herbert von Karajan cond. TURNABOUT THS 65144/45 two discs \$9.96.

"...making music — the nation's second biggest entertainment industry after television."*

Consider:

A one year study program in MULTITRACK RECORDING TECHNOLOGY

OR

The 4 year BS Degree MUSIC TECHNOLOGY program in co-operation with NYU.

Winter '78/'79 Quarter begins Wed. 12/6/78

Spring '79 Quarter begins Thurs. 3/8/78

*Forbes Magazine — July 10, 1978

Licensed — NY State Dept. of Ed.



For information phone or write:

Institute of audio research
64 University Place
New York, NY 10003
(212) 677-7580

CIRCLE NO. 38 ON READER SERVICE CARD

Order Toll Free!
Except N.Y., Alas., Hawaii

SCA 800-221-0974

FOR ORDERS ONLY!
Mon-Thurs 9AM-9PM, Fri-Sat 9AM-5PM, N.Y. Time

STEREO HOT-LINE



CHECK US OUT!

- ✓ Our prices are the lowest.
- ✓ Discounts on over 60 major brands.
- ✓ Reliability: one of the oldest audio mail-order houses in the U.S.A.
- ✓ Rated #1: by a leading trade publication.
- ✓ Large inventory: we buy in volume getting the best deals from the manufacturers you get the best deal from us.

GIVE US THE OPPORTUNITY TO BEAT THE BEST DEAL YOU'VE BEEN ABLE TO FIND.

— QUOTES AND INFORMATION —
(212) 253-8888, 9AM-5PM, MON.-SAT., N.Y. TIME

Write or Call us now for the lowest price quotes and a Free price flyer.

STEREO CORPORATION OF AMERICA

SR-1629 Flatbush Ave.
Brooklyn, New York 11210

CIRCLE NO. 80 ON READER SERVICE CARD



Michael J. Hirtlian

□ Composer **RICHARD RODGERS**, recipient of this year's STEREO REVIEW award for outstanding contributions to the quality of American musical life, gives as well as receives and has endowed many awards himself. This year he gave one million dollars to the American Academy and Institute of Arts and Letters to establish the Richard Rodgers Production Award. The income from the gift will be used

for an annual award to make possible an introductory New York production of a musical play by a composer, librettist, and lyricist not already established in the theater. With his wife, Rodgers is shown (center) presenting the check to Academy president Jacques Barzun. Mrs. Rodgers said that the gift is "a vote of confidence in musical theater and in New York City as its fountainhead."

CLASSICAL ROTO

By William Livingstone

□ Following his golden-jubilee concert at Avery Fisher Hall, pianist **CLAUDIO ARRAU** received his seventy-fifth birthday gift, the traditional inscribed tray, from Henry Steinway of Steinway and Sons. According to tradition in Holland, a man achieves wisdom when he reaches fifty and sees the patriarch Abraham. This derives from the Bible verse John 8:57 ("You are not yet fifty years old. How can you

have seen Abraham?"). Taking no chances on wisdom, the Dutch make sure that a man of fifty sees Abraham by treating him to a cake decorated with a likeness of the patriarch. On his fiftieth birthday, conductor **COLIN DAVIS** received this five-foot Abraham cake from Bob Bourma (left) and Ernst van der Vossen from the Dutch headquarters of Phonogram International, for which he records.



Phonogram



□ The Oklahoma Symphony Orchestra received a donation of \$5,000 from **LEONARD BERNSTEIN**. Keith Drake (right, above), chairman of the orchestra's fund-raising drive, accepts the check from Mr. Bernstein, who is president of Norman Laboratories, a loudspeaker manufacturer in Norman, Okla. Meanwhile, another **LEONARD BERNSTEIN** (below) was made an honorary member of the National Symphony Orchestra by its director, cellist-conductor Mstislav Rostropovich, as part of the composer-conductor's sixtieth-birthday celebrations at Wolf Trap. For more news of the latter Bernstein, see Best of the Month (page 113) and review (page 138).



PBS



Ken Kephardt/Lincoln Center

□ A star of the opera house, concert stage, recording studio, and TV talk show, soprano **JUDITH BLEGEN** sang at the opening concert of this summer's Mostly Mozart Festival at Lincoln Center conducted by Pinchas Zukerman. She is shown here holding Mozart dolls from the Center's gift shop and modeling the shop's best-selling item, the Mostly Mozart T-shirt. This fall Miss Blegen recorded her Mozart festival selections—*Exsultate Jubilate* and *L'Amerò Sarò Costante*—plus a couple of concert arias for Columbia. Zukerman again conducts and provides violin obbligato. The album is scheduled for January release.



RCA

□ On tour in Los Angeles, pianist **VLA-DIMIR HOROWITZ** took time out between concerts to autograph albums at Tower Records for more than 3,000 admirers. Here he displays a certificate of commendation presented to him by L.A.'s Mayor Tom Bradley for fifty years of memorable service to the performing arts in the U.S. Two October releases in RCA's Horowitz Collection series bring its total to seven albums. On the new ones he plays Chopin, Prokofiev, and Barber.

□ Soprano **RENATA SCOTTO** got the fall season off to a big start with the release of four new recordings in September and October: Verdi's *Nabucco* (Angel) and *Otello* (RCA), plus Puccini's *Madama Butterfly* and an album of operatic duets with Placido Domingo (both Columbia). In addition to opening the Met's television season as Desdemona in *Otello* on PBS in September, Miss Scotto has also been a frequent guest on TV talk shows. When she appeared on Dick Cavett's show on PBS, Cavett sang a few notes for her and asked whether his voice had operatic potential. "Not for opera," said Miss Scotto. "For Gilbert and Sullivan maybe—if you come to me for a one-hour singing lesson every day for three years."



C. Brownie Harris/WNET

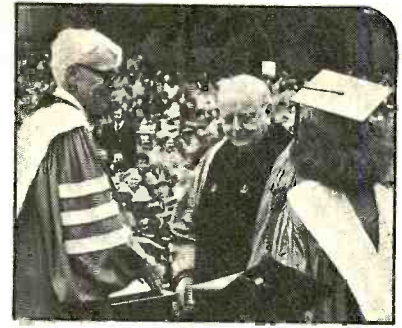

□ This year's recipients of honorary degrees of Doctor of Music include composer **VIRGIL THOMSON** (at Columbia University in New York City) and tenor **LUCIANO PAVAROTTI** (at Duquesne University in Pittsburgh). Thomson is shown with Columbia's president William J. McGill (left), and Pavarotti is flanked by Rev. Henry J. McNulty (left) and Rev. Edward L. Murray, Duquesne's president and vice president, respectively. Dr. Thomson, who will be eighty-two on November 25, has been similarly honored by Roosevelt U., Fairfield U., Missouri U., and N.Y.U., but it was a first for Dr. Pavarotti, a mere forty-three on October 12 this year. The tenor's fall schedule includes the Luciano Pavarotti Tennis Tournament benefiting the San Francisco Opera, where he is singing Cavaradossi in *Tosca*.

□ The American Society of Composers, Authors and Publishers is proud of the number of its members who have won Pulitzer Prizes in music. At an ASCAP luncheon in New York in honor of this year's winner, composer **MICHAEL COLGRASS**, guests included (l. to r.) ASCAP president Stanley Adams, Colgrass, composer Richard Wernick (winner in 1977), publisher

Warren MacKenzie, and Pulitzer-Prize-winning ASCAP composers Ned Rorem (1976) and Jacob Druckman (1972). Does the Pulitzer Prize still have much effect on a composer's career? "Absolutely," says last year's winner Wernick. "It cinched my academic promotion, got me more performances, and—more important—got me more commissions."



ASCAP



□ The winner of this year's Avery Fisher Prize is the young cellist **YO-YO MA**, who was born in Paris of Chinese parents. This was the first time the prize had been awarded to a single recipient. Winner Ma is shown here at Lincoln Center with Avery Fisher in the hall of the same name.



Christian Steiner/Angel Records

□ What are Bubbles and the Jock doing in Central Park? Well, after recording Verdi's *Rigoletto* for Angel this summer in London, soprano **BEVERLY SILLS** and baritone **SHERRILL MILNES** returned to New York in September and took a ride in the park before beginning further Angel sessions for an album of operetta duets. (Miss Sills' Victor Herbert album issued in 1975 is among the top ten best sellers in the history of the Angel label). Chatting about a title for the new operetta disc, due this month, Miss Sills jokingly suggested "Sills and Milnes Together Again."





POPULAR DISCS AND TAPES

Reviewed by CHRIS ALBERTSON • NOEL COPPAGE • PHYL GARLAND • PAUL KRESH
PETER REILLY • STEVE SIMELS • JOEL VANCE

JESSE BARISH. Jesse Barish (vocals, guitar, piano, flute); instrumental accompaniment. *Count On Me; Feeling for a Song; Power of Love; Love That's Right; You; Grand Illusion*; and four others. RCA AFL1-2555 \$7.98, © AFS1-2555 \$7.98, © AFK1-2555 \$7.98.

Performance: **Lovesick**
Recording: **Good**

Jesse Barish's *Count On Me* was one of the better-sounding songs on the last Jefferson Starship album, and it is clearly the best-sounding song on the first Jesse Barish album. I don't know what I expected, but the rest is mostly a letdown. Barish takes Marty Balin's thing for sickly sweet, convoluted phrases even further than Marty takes it, and a melody really has to have some charm to carry that kind of lyric. Some of the melodies here are nice, but detached; they're having no part of these lyrics. Can't say I blame them. N.C.

THE BEACH BOYS: M.I.U. Album. The Beach Boys (vocals and instrumentals); other musicians. *She's Got Rhythm; Come Go with Me; Peggy Sue; Kona Coast*; and eight others. BROTHER/REPRISE MSK 2268 \$7.98, © M8 2268 \$7.98, © M5 2268 \$7.98.

Performance: **Beside the point**
Recording: **Variable**

One of the things that annoys me somewhat about the public pronouncements of most

folks with a vested interest in the New Wave (funny how appropriate that term sounds in a review of the Beach Boys) is the odd selectivity of their prejudices. For example, Tom Robinson thinks that the Stones should break up but worships the water Bob Dylan walks on, while Johnny Rotten grovels before Neil Young's guitar case. Let's have some *consistency*, dammit. If everybody from the Sixties is burnt out and irrelevant, then there should be *no exceptions*.

What has that got to do with the Beach Boys' new album? Not a heck of a lot, actually, although Greg Shaw, who heretofore has supported the Boys through thick and thin despite being one of the New Wave's leading exponents, announced recently that it may be time to admit that they've lost it, at least on the basis of this record. I know what he means, but I think it's a premature judgment. "M.I.U." is pretty dire, a collection of outtakes from earlier efforts and half-baked bits of Brian Wilson childishness, but it exists, after all, for no other reason than to extricate the Boys from their contract with Warner Brothers, with whom their relationship over the years has been stormy at best. If their debut album for their new label, however, turns out to be as piffle-ridden as this one, then we should start to worry. In the meantime, as lugubrious (you won't believe *Peggy Sue*) and cringe-making (ditto for *My Diane*) as most of "M.I.U." is, you have to admire anybody who titles a song *Match Point of Our Love*. Do you suppose that was meant as a Cream parody, or as an indication that Brian harbors a secret passion for Chrissie Evert? S.S.

BLONDIE: Parallel Lines. Blondie (vocals and instrumentals). *Hanging On the Telephone; One Way or Another; Picture This; Fade Away and Radiate; Pretty Baby; 11:59*; and six others. CHRYSALIS CHR 1192 \$7.98, © 8CH 1192 \$7.98, © CCH 1192 \$7.98.

Performance: **Arch**
Recording: **Fine**

It would take a real curmudgeon to actively dislike the music on this album, but by the

same token I can't say that I'm exactly enthusiastic about it either. Blondie, I'm afraid, is one of those groups that is a lot more fun on paper than in the actual execution, at least so far. The band itself plays rather well, but the songwriting . . . well, if your music is a pastiche of Sixties Phil Spector and surf stuff, while your lyrics are oh-so-Seventies-coy, the end result can't help but be kind of queasily self-conscious, cute but basically false. And Debbie Harry's gum-chewing pose isn't all that convincing, really; I was *there*, Jack, and the bad girls in my high school would have eaten her for breakfast.

Still, like I said, it's so obviously frivolous that it seems almost unfair to come down too hard on these kids; they're just having fun. It's worth noting, however, that the only time they really rock out is on a marvelous old Buddy Holly tune, *I'm Gonna Love You Too*, in which the cuteness is appropriate for a change, bubblegum being eternal. Which only proves that while Debbie and Co. are undoubtedly too smart for their own good, even they can't write really dumb songs Like They Used To. S.S.

COLIN BLUNSTONE: Never Even Thought. Colin Blunstone (vocals); vocal and instrumental accompaniment. *I'll Never Forget You; Who's That Knocking on My Door; Never Even Thought; Do Magnolia Do; Touch and Go; Lovelight*; and three others. ROCKET BXL1-2903 \$7.98, © BXS1-2903 \$7.98, © BXX1-2903 \$7.98.

Performance: **Good**
Recording: **Fine**

Colin Blunstone was lead vocalist for the Zombies (*She's Not There, Time of the Season, Tell Her No*) during the Sixties and subsequently had some solo hits, but it's been a while since he's made a new record. This album shows him to have become a more flexible singer with the passage of time—the breathy, laconic, almost effete style of the Zombies days has given way to a tougher and more adventurous attack. The material is middle-of-the-road pop, only slightly above average, the standouts being *Who's That Knock-*

Explanation of symbols:

- Ⓜ = reel-to-reel stereo tape
- Ⓢ = eight-track stereo cartridge
- Ⓒ = stereo cassette
- Ⓚ = quadrasonic disc
- Ⓡ = reel-to-reel quadrasonic tape
- Ⓟ = eight-track quadrasonic tape

Monophonic recordings are indicated by the symbol Ⓜ

The first listing is the one reviewed; other formats, if available, follow it.

ing on *My Door*, a light, bouncy, jazzy item; *Never Even Thought*, the production number of the disc, written by Murray Head (who sang the role of Judas in the first recorded version of *Jesus Christ, Superstar* and appeared in the well received film *Sunday Bloody Sunday*); and the charming and sassy *Do Magnolia Do* with its traces of Nashville pop. I do wish the songs were better, but I can't fault the production or the sound, for both of which Bill Schnee is responsible; they are first-rate. J.V.

DEBBY BOONE: *Midstream* (see Best of the Month, page 115)

ELKIE BROOKS: *Shooting Star*. Elkie Brooks (vocals); vocal and instrumental accompaniment. *Only Love Can Break Your Heart*; *Since You Went Away*; *Stay with Me*; *Putting My Heart on the Line*; *Shooting Star*; and five others. A&M SP-4695 \$7.98.

Performance: **Needs direction**

Recording: **Good**

I liked Elkie Brooks' last album, "Two Days Away," which was produced by those legendary pros Jerry Leiber and Mike Stoller. In it she took on updated arrangements of such Leiber/Stoller classics as *Love Potion #9* and *Saved* and made them shine. Alas, this time out there's a different producer and a harum-scarum choice of material. Brooks is a good singer—at times a very good singer—but she is very dependent on technique and short on interpretation unless carefully directed. I look forward to hearing Elkie Brooks again, but next time I hope she'll have a better program and a producer who knows how to bring out the best in her. J.V.

CAPTAIN AND TENNILLE: *Dream*. Daryl Dragon (keyboards); Toni Tennille (vocals); vocal and instrumental accompaniment. *I'm on My Way*; *Dixie Hummingbird*; *If There Were Time*; *Back to the Island*; *Good Enough*; *Dream*; and five others. A&M SP-4707 \$7.98, © AAM 4707 \$7.98.

Performance: **Where's the music?**

Recording: **Smooth**

An older, conjugal version of the peanut-butter Donny and Marie Osmond, the Captain (Daryl Dragon) and (Toni) Tennille ooze through the grooves of their new album like some kind of "inventive" cheese party dip in which it's a challenge to taste the cheese. (You know, dips like avocado-rum, curry-cashew, or orange-garlic, which sort of wander around your palate looking for a place to land.) It's the same with the Darling Duo's approach to their material here. Their slowly-slowly version of the old Johnny Mercer *Dreams*, for instance, and their thickly pasty run-through of the Greenfield/Sedaka *You Never Done It Like That* go down easily enough at first, but almost immediately afterward one's ear begins to feel a bit queasy. Daryl still rumbles away at the keyboards, creating effects that sound as if he might be a Mighty Wurlitzer closet case, and Toni retains her enameled vocal smile no matter what she's singing. Presumably their fans will continue to gobble it all up, but I'll stick with plain old honest Cheddar, thank you. P.R.

NATALIE COLE: *Natalie...Live*. Natalie Cole (vocals); Natalie Cole Rhythm Section; vocal accompaniment; orchestra. *Insepara-*



Columbia

Mathis & Williams, Inc.

WHETHER first came up with the idea of pairing Johnny Mathis and Deniece Williams had a flash of true inspiration, because on the basis of what each had done previously, they were not exactly a likely combination. Mathis has stayed at the top for the past twenty years by adhering stolidly to the middle of the road, periodically releasing albums of standards, show tunes, film themes, and other people's hits—predictably pleasant but hardly exciting. He has not been identified with the soulstream except for his 1973 album "I'm Coming Home" (Columbia KC 32435), which was produced by Thom Bell and eagerly endorsed by a younger audience. He seemed then to be moving in a fresh direction, but he quickly relapsed into the slightly arthritic mode that had made him a favorite with the supper-club set. Still, "I'm Coming Home" showed that Johnny Mathis was far more versatile than his total recorded output might have suggested. (One of my favorites remains his very first album, "Johnny Mathis: A New Sound in Popular Song," on which he was showcased as a jazz singer with arrangements by Gil Evans, John Lewis, Teo Macero, Bob Prince, and Manny Albam. Originally released in the late Fifties, it has happily been reissued on Columbia Special Products P 13089.)

Deniece Williams is apparently the perfect cure for Mathis' stiffness, as was obvious from their first collaboration on his previous album, "You Light Up My Life" (Columbia JC 35459). Though the album as a whole presented a somewhat freer-wheeling Mathis than we had become used to, he and Williams struck a special spark on the two tracks they did together. The genuinely talented new sing-

er prodded the relaxed old pro, challenging him to dig into the rhythmic possibilities of the songs with a more emphatic approach. Mathis responded admirably, and "That's What Friends Are For," which has the two singing together throughout, was a natural next step.

THE key to their collaboration is that both Mathis and Williams are able craftsmen. Mathis can evidently sing just about anything he wants to, and well, and Williams is no slouch either. She bites into the songs with her high, almost metallic-sounding voice, the perfect complement to Mathis' suede-finish tones. There are so many delights to be found on "Friends" that it is hard to single out special tracks, though Johnny "gets down" on Ashford and Simpson's *You're All I Need to Get By* in a manner that might surprise those who've considered him a bit straight for their tastes. Additional standouts are *Heaven Must Have Sent You*, *I Just Can't Get Over You*, and *Just the Way You Are*. There's no dross on this album, no lackluster moments. S'wonderful all the way. —Phyl Garland

JOHNNY MATHIS AND DENIECE WILLIAMS: *That's What Friends Are For*. Johnny Mathis, Deniece Williams (vocals); vocal and instrumental accompaniment. *You're All I Need to Get By*; *Until You Come Back to Me*; *You're a Special Part of My Life*; *Ready or Not*; *Me for You*; *You for Me*; *Heaven Must Have Sent You*; *Just the Way You Are*; *That's What Friends Are For*; *I Just Can't Get Over You*; *Touching Me with Love*. COLUMBIA JC 35435 \$7.98, © JCA 35435 \$7.98, © JCT 35435 \$7.98.

"Mathis can sing just about anything he wants to . . ."

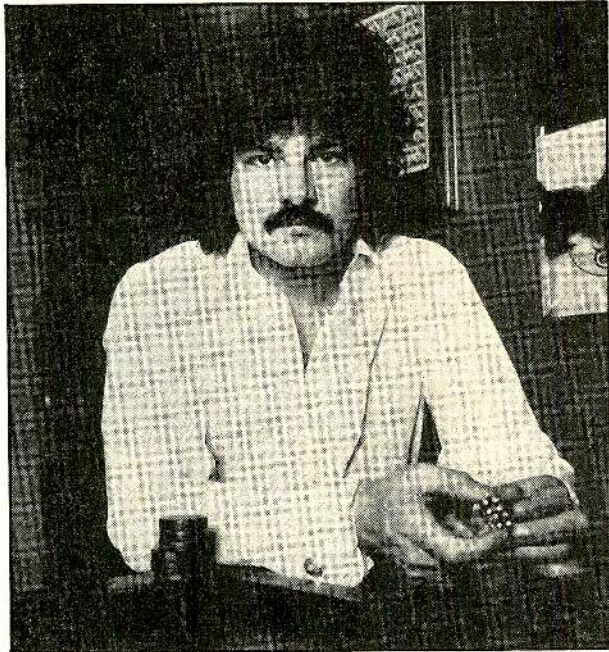

Portrait: Recorral

BURTON CUMMINGS:
one of the best
singers in rock

ble; Mr. Melody; Party Lights; Cry Baby; Be Thankful; Our Love; I'm Catching Hell; and nine others. CAPITOL SKBL-11709 two discs \$11.98, © 8X2B-11709 \$11.98, © 4X2B-11709 \$11.98.

Performance: **Disappointing**
Recording: **Good**

Natalie Cole's latest album is a severe disappointment. In this collage put together from appearances at the Latin Casino in New Jersey and the Universal Amphitheatre in California, she's a belter and a screamer and more than a bit of a drag. She hits everything full voice, with an arm-waving attack on lyrics that may be terrific in person but on record sounds like she's a witness to a three-car collision being interviewed on the six-o'clock evening news. Whatever happened to the charming, seductive, direct young singer she was only a few albums ago? The screaming fans and their roars of approval are of no help at all, either to Ms. Cole or to the at-home listener. Please, Natalie, no more like this. P.R.

RECORDING OF SPECIAL MERIT

BURTON CUMMINGS: *Dream of a Child.* Burton Cummings (vocals, piano); Ian Gardner (bass); Rick Schlosser (drums); Jeff Baxter (guitar); other musicians. *Break It to Them Gently; Hold On, I'm Comin'; I Will Play a Rhapsody; Wait by the Water; When a Man Loves a Woman; Shiny Stockings;* and six others. PORTRAIT JR 35481 \$7.98, © JRA 35481 \$7.98, © JRT 35481 \$7.98.

Performance: **Classy**
Recording: **Very good**

Burton Cummings is simply one of the best rock singers around, and here's more proof that most of the Guess Who sounds that really mattered came from him. On "Dream of a Child" he takes on an assortment of old and new songs, in old and new styles, and leads a band that has a heavy-hitting sound, like his vocals. There's every kind of thing here, from Bobby Darin's *Wait by the Water (Lillian)* at the urbane end to *Takes a Fool to Love a Fool* (by old Burton himself) at the country end,

and there's some jazzy stuff and a lot of rock in between. Cummings' voice is a fine amalgam of power and nuance, the ultimate equipment for singing your so-called progressive rock. He's as believable when happy (*It All Comes Together*) as he is when troubled (*Break It to Them Gently*), which is rare in someone who comes, as so many of our rock stars have, from such a fey age, such a feckless age. Of course, he's not perfect as a songwriter, but here he gets most of the bad writing out of his system in one place (*Roll with the Punches*), takes some help from other writers, and leads a tight, potent band. And then he does what he does best: he sings. N.C.

THE DIRT BAND (see Best of the Month, page 114)

RECORDING OF SPECIAL MERIT

DAVE EDMUNDS: *Tracks on Wax 4.* Dave Edmunds (vocals, guitars); Nick Lowe (vocals, bass); other musicians. *Trouble Boys; Never Been in Love; Not a Woman, Not a Child; Television; What Looks Best on You; Readers Wives;* and five others. SWANSONG SS 8505 \$7.98.

Performance: **Exhilarating intelligence**
Recording: **Excellent**

I loved Dave Edmunds as Rock Revival Purist, but Dave Edmunds as the other half of a demented late-Seventies Everly Brothers routine with Nick Lowe is even better, and as a consequence his new album is easily the best he's done. Certainly it's the funniest. Consider the following, from Lowe's *Television*: "Don't care if it's good or bad/Stare at it till it drives me mad/As long as it's on, I'm glad." Or a wonderful Gram Parsons-inspired c-&-w sendup that contains the immortal line, "What looks best on you/Is me." You have to love stuff like that.

Beyond the obvious yucks, however, are Edmunds' usual virtues: flawless production (listen to the instrumental layering on the Buddy Hollyish *Deborah*) and enormous vocal and instrumental authority. Moreover, with Lowe aboard as a major writing partner,

we get a collection of uniformly knockout ditties that work not just as genre pieces but as songs. None of them are particularly revolutionary, mind you, but here at last is an identifiable Edmunds voice. Call it Rockabilly Whimsey, call it Arthur, call it anything you like, but I defy even the most jaded to resist the charms of the sweeter songs or the deft rhythmic punch of the rockers. If there's any justice, "Tracks on Wax 4" will broaden Dave Edmunds' cult following to a size commensurate with his talent. Funny, touching, exhilarating stuff. S.S.

RECORDING OF SPECIAL MERIT

STEVE GIBBONS BAND: *Down in the Bunker.* Steve Gibbons Band (vocals and instrumentals). *Down in the Bunker; When You Get Out; Any Way Up; Big J.C.; No Spitting on the Bus; Mary Ain't Comin' Home;* and five others. POLYDOR PD-1-6154 \$7.98, © 8T1-6154 \$7.98, © CT1-6154 \$7.98.

Performance: **Excellent**
Recording: **Very good**

After more than half a decade in which the lyrics of rock songs have been plunging toward the nadir, surely we are about due for the return of the literate lyric. And this album indicates that our British brothers may again, as they did in the 1960's, give us back our own music. The Steve Gibbons Band appears to be something of a cult group, but its material is literate and often very funny. *Eddie Vortex* is a dig at flash-and-trash nostalgia rockers; *Mary Ain't Comin' Home* describes a biracial affair; and *No Spitting on the Bus*, in which a driver cautions his passengers that their fevered ideologies and tortured psyches must not lead them to damage public property, hilariously contrasts the outrageous with the mundane.

The Steve Gibbons Band doesn't play rock so much as jokes. Their material makes them, in effect, a show band; like all show bands they are meticulous in their execution and tailor their arrangements to the intent of the songs—all of which were written by Gibbons and all of which are well worth hearing. J.V.

BENNY GOLSON: *I'm Always Dancin' to the Music.* Benny Golson (saxophone); vocals and instrumentals. *Blues March (I'm Marchin'); Love Is the Key; Georgia on My Mind; Don't Ask My Neighbors; High on Sunshine;* and two others. COLUMBIA JC 35359 \$7.98, © JCA 35359 \$7.98, © JCT 35359 \$7.98.

Performance: **Easy on ears and feet**
Recording: **Very good**

Benny Golson must be a very smart fellow, particularly when it comes to applying the "If you can't beat 'em, join 'em" strategy for musical survival. He successfully made the shift from straight jazz to commercial television music years ago, and now he has expertly fused some of his old jazz favorites into an accessible music tailored for dancing. Emphasis is on the beat here, though the tempo is frequently held at a very relaxing level, ideal for those of us too out-of-shape to keep up with the hectic disco pace. The old standards, such as Golson's own *Blues March* and *Georgia on My Mind*, are very attractive in their new attire, while less elderly numbers such as *Don't Ask My Neighbors* seem to blend right in. The level of musicianship is good through-

(Continued on page 152)



The Swiss Racing Watch, by AGON. \$29.50

THE SWISS RACER.

Now you can own the same ultralight accurate Swiss racing watch that has toured Europe. It was developed by Agon, the race engineering division of Economic Swiss Time (E.S.T.). This impact-resistant, high-stress watch can withstand racing temperatures and conditions. As a result of the introduction of Noryl miracle plastic, a space program by-product, the case and band have been reduced in weight to only one ounce. You'll notice the lightness results in ease of handling and comfort, in addition to an improved strength-to-weight ratio.

Noryl is a non-conductor of heat, and is unaffected by chemicals, perspiration, or abrasion.

You'll have command of the time with a large, high-visibility dial — excellent even for twilight or darkness readings. The built-in calendar automatically keeps track of the date. The quick-change feature makes it easy to set the date, as you shift through the numbers in rapid sequence.

The Swiss Mechanical Movement was chosen for its consistent reliability. There are no batteries to wear out or fail. An oversized winding stem allows for easy operation, even with driving gloves. The heavy-duty unbreakable mainspring ensures you will receive years of rugged use.

Your investment is protected by the E.S.T. 12 month parts and labor warranty. Economic Swiss Time provides a full service-by-mail facility right here in the U.S. Service should never be needed,

but it's nice to know it's as close as your mailbox.

Order your Swiss Racer today without obligation. Give it a complete test run. If it's not what you expected, return it within 2 weeks. You're guaranteed a full and courteous refund. That's The Sharper Image satisfaction guarantee.

ORDER NOW TOLL-FREE

Credit card holders will get fastest delivery by calling the toll-free number below. Or send check for \$29.50 plus \$1.50 delivery (add \$1.77 sales tax in CA). But order now as supply is limited.

Ask for Operator 25M
(800) 824-7888
In California (800) 852-7777

THE SHARPER IMAGE

260 California Street
San Francisco, California 94111

out, particularly the vocal work and Golson's saxophone solos. The result is an album well suited for both the feet and the ears. P.G.

SAMMY HAGAR: *All Night Long*. Sammy Hagar (vocals, guitar); instrumental accompaniment. *Red; Rock 'n' Roll Weekend; Make It Last/Reckless*; and four others. CAPITOL SMAS-11812 \$7.98, © 8XW-11812 \$7.98, © 4XW-11812 \$7.98.

Performance: **Whoop-de-do**
Recording: **Good**

My nine-year-old friend Nicole has this way of saying "Whoop-de-do" that strikes me as just about the last word in satiric summing-up of the latest encounter she's had with much ado about nothing, and I wish you could hear her inflection so you'd know precisely how I feel about this album. Sammy Hagar belongs right up there, or down there, as the case may be, with Ted Nugent and Eddie Money. I suppose teenyboppers *require* a certain amount of this sort of thing, and I suppose it would be unsporting of me to point out that they could listen to the *real* Led Zeppelin. Even so, I think the live-album format makes Sammy a little harder to take than necessary; this one has some of the usual live-album excesses and is marked by a nearly incredible lack of variety. But there's much ado all right, enough ado for anybody. N.C.

RECORDING OF SPECIAL MERIT

MERLE HAGGARD: *I'm Always on a Mountain When I Fall*. Merle Haggard (vocals,

fiddle); instrumental accompaniment. *It's Been a Great Afternoon; Love Me When You Can; The Dream; The Immigrant*; and six others. MCA MCA-2375 \$6.98, © MCAT-2375 \$7.98, © MCAC-2375 \$7.98.

Performance: **Very good**
Recording: **Good**

This is the third straight good, strong album from Merle Haggard, with a lot of stuff in it that will keep him the truckers' favorite, a little Austin-like "progressivism" that might please several people, and an exercise in populism for those of us who want *that* out of Haggard in *The Immigrant*, which starts out "American ranchin' consists of a mansion/Where illegal immigrants do much of the labor by hand." And it just gets wryer and more ironic and angrier. Haggard is, I believe, plying his trade about as honestly as any "successful" person can these days, and although this album has a few dry spots (all written by someone else), it has a certain spirit about it too. Hag, when he's good, is *good*. N.C.

RECORDING OF SPECIAL MERIT

JOHN HAMMOND: *Footwork*. John Hammond (guitars, harmonica); Roosevelt Sykes (piano). *Preaching Blues; Crossroads Blues; Forty-four Rifle Blues; Ask Me Nice*; and six others. VANGUARD VSD 79400 \$7.98.

Performance: **Excellent**
Recording: **Very good**

John Hammond is about as good as white blues singers get or are likely to get. His style

is (as any classic country-blues style must be) based on the recordings of black artists from the Twenties and Thirties, and he consciously sings black, which is, after all, the only way to sing country blues. And, even more important, he is a good actor. Superior acting is what made Crosby and Presley great singers, and it continues to make Sinatra a great singer even though his voice is no longer the instrument it once was. Hammond follows the same precepts. When he sings *Preaching Blues, Crossroads Blues, and Come On in My Kitchen*, all by the tormented Robert Johnson, Hammond acts a believable character in a situation of pain and loneliness. This, combined with his fluent country-blues guitar, makes for a performance in which at times he almost seems to *be* Johnson. Likewise with Blind Willie McTell's *Broke Down Engine*: Hammond appropriates the elements of McTell's style in order to be closer to him. Two blues by Roosevelt "The Honeydripper" Sykes, pianist and longtime expatriate in France, are more relaxed, possibly because Sykes himself is there on piano. Bo Diddley's great *Who Do You Love* roars and churns, a reminder that Hammond was one of the very few serious folk musicians to sing Diddley and Chuck Berry selections in the early Sixties, when to do so was considered heresy by doctrinaire folkies. Good singing, good acting, and a good album. J.V.

RECORDING OF SPECIAL MERIT

MICHAEL JOHNSON: *The Michael Johnson Album*. Michael Johnson (vocals, guitar); vo-

BEFORE YOU THROW OUT A GOOD TURNTABLE OR SPEAKER SYSTEM, CONNECT WITH A GREAT AMPLIFIER. THE PHASE 400 SERIES TWO.

Some speakers sound fine, until you hit a low passage. Then they turn to mud, or rumble at you like a cheap turntable. Chances are, that muddy, distorted sound is in fact, the result of an inadequate amplifier stretched to its limits. Clipping! To improve your sound, you need plenty of reserve power. The Phase 400 Series Two delivers the tremendous power reserve you need for sonic accuracy over the audible frequency spectrum. To accurately reproduce low frequencies without clipping, your speakers require up to 10 times the minimum power requirement of the mid-range frequencies. With the Phase 400 Series Two, when you listen to the 1812 Overture,

you hear the blast of the cannon with awesome clarity. Even the deepest notes are clearly distinguishable. **ACCURACY YOU CAN HEAR.** To improve accuracy, the new 400 Series Two utilizes an advanced BI-FET input stage. This integrated circuit keeps the output virtually identical to the input. Distortion and noise are reduced to virtually inaudible levels. Beautiful music in, beautiful music out. **ACCURACY YOU CAN SEE.** You might have some questions about the 400's instantaneous LED output meters. Conventional-style VU meters are slow in comparison because they have to move the mass of the needle. The LED's move at lightning speed, accurately monitoring the output voltage, with scales for 8 and 4-ohm impedances. For accuracy, the meter contains 32 graduations, plus 4 fixed flashers to alert you to clipping. You have a visual safeguard, in addition to the Electronic Energy Limiters to prevent damage from overloads. See your Phase dealer about the Phase 400 Series Two. We think you'll recognize accuracy when you hear it. And when you see it.



Phase Linear[®]
THE POWERFUL DIFFERENCE

cal and instrumental accompaniment. *Sailing Without a Sail*; *Foolish*; *Ridin' in the Sky*; *25 Words or Less*; *Gypsy Woman*; and five others. EMI/AMERICA SW-17002 \$7.98, © 8XW-17002 \$7.98, © 4XW-17002 \$7.98.

Performance: **Quietly excellent**
Recording: **Very good**

Here's a really happy surprise. Michael Johnson plays superb guitar and sings with a kind of lazy, forthright intimacy that involves the listener immediately. How very good he is on guitar can be heard in *Gypsy Woman*, in which he uses the instrument as another voice, commenting on his own singing. How good he is vocally (and in familiar, demanding material) can be heard in his version of *Almost Like Being in Love*: he takes Frederick Loewe's melodic Viennese breeze across and through the Scottish heather of Alan Jay Lerner's lyrics and comes up with something uniquely his own. *Bluer Than Blue* has already been a chart hit for him, and it's easy to hear why—he has class and charm in any song. You may not be sandbagged by the quiet excellence of Johnson's work, but I'll bet you won't stop listening to him over the whole ten bands of this album. P.R.

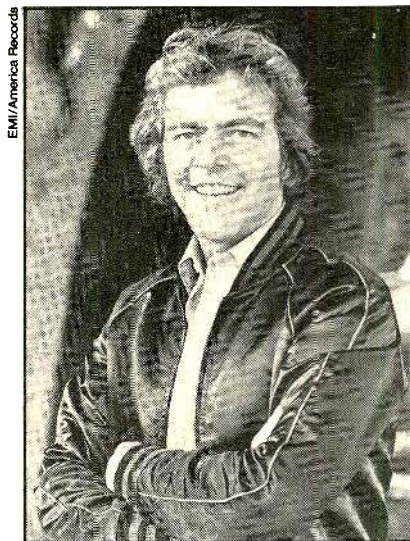

EMI/American Records

MICHAEL JOHNSON
Consistent, quiet excellence

others. ATLANTIC SD 19182 \$6.98, © TP 19182 \$7.98, © CS 19182 \$7.98.

Performance: **Tempting**
Recording: **Satisfactory**

I've never been able to understand why Margie Joseph hasn't made it bigger than she has, for the bulk of her work is a full cut above most of what comes thundering through the airwaves these days. She has achieved a rare balance of spirit and restraint that enables her

to build pyramids of intensity without letting a song run away with her. As for her voice, she possesses as fine a natural instrument as many a superstar, and she manipulates it with the keen sensitivity of a true artisan. The crux of the problem might be that she sounds just a bit too much like Aretha Franklin, specifically in terms of vocal timbre and phrasing. But careful listening reveals different shadings in style, and it is notable that Ms. Joseph always avoids the sort of hyperdramatic overkill that is the Soul Queen's hallmark.

"Feeling My Way" is quite possibly her best album. It is highlighted by exceptionally inviting songs, all written by Johnny Bristol, who also served as producer. He has brought to this effort a distinct gift for melody and a finely tuned rhythmic sense. Some peaks of delight here are *I Feel His Love Getting Stronger*, *You Turned Me On to Love*, and *Picture of a Clown*. Highly recommended. P.G.

GREG KIHN BAND: *Next of Kihn*. Greg Kihn (guitar, vocals); instrumental accompaniment. *Cold Hard Cash*; *Chinatown*; *Everybody Else*; *Understander*; *Secret Meetings*; and three others. BESERKLEY JBZ-0056 \$7.98, © PZA 8380-0056(H) \$7.98, © PZT 5380-0056(H) \$7.98.

Performance: **Straight but solid**
Recording: **Good mix**

Greg Kihn's band follows a lot of conventions—you can hear echoes of Springsteen and Elvis Costello and Bob Seger and other (Continued on page 156)

RECORDING OF SPECIAL MERIT

MARGIE JOSEPH: *Feeling My Way*. Margie Joseph (vocals); vocal and instrumental accompaniment. *I Feel His Love Getting Stronger*; *Come On Back to Me Lover*; *You Turned Me On to Love*; *He Came into My Life*; *Picture of a Clown*; *Love Takes Tears*; and four

Don't make a decision on speakers until you've heard all sides.

There are literally hundreds of high fidelity speakers to choose from. But before you make a purchase decision, you should listen to our speakers. And the reasoning behind them.

We pioneered the concept of omnidirectional sound radiation. That means we arrange multiple drivers so that they radiate sound in virtually all directions.

This results in a number of benefits.

First of all, high frequency sound waves travel in a beam along a fairly direct axis. So with conventional directional speakers, you have to be sitting on or very near this axis to really get the full impact of the highs. But with an omni-directional speaker, the sound is much more uniform throughout the entire listening area.

Secondly, in a concert hall environment, the listener hears a high ratio of indirect or reverberant sound to direct sound. Since omni-directional speakers radiate sound in many

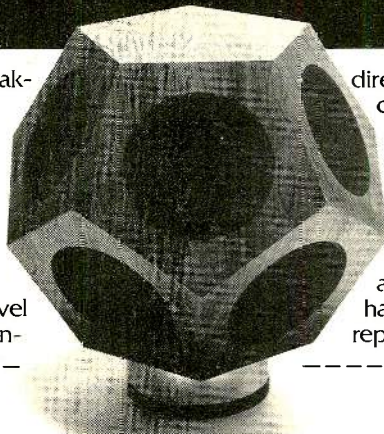

directions, they can more closely duplicate this concert hall ratio of indirect to direct sound.

Naturally, we think that the easiest way to appreciate the difference is to listen to our speakers for yourself. However, we'd like to warn you that our speakers are designed to impart as little coloration as possible. So don't expect "bigger than life" sounds with artificially sweetened highs or especially enhanced lows. Our speakers are designed to reproduce just what's been recorded. Nothing more and nothing less. We think that makes them nicer to live with in the long run.

So before you choose any speaker, listen to ours. And we think we'll win you over to our sides.

DAI
DESIGN ACOUSTICS
Speakers with an all-around better sound.

Please send me more information on your omni-directional speakers.

Name

Address

City State Zip

send to:
Design Acoustics, Inc.
2426 Amster St., Torrance, CA 90565

SR11

"I HAVE to become a superstar. My mother really expects this," Genya Ravan told me almost eight years ago. Well, she hasn't quite reached that status yet, but she's come a long way from Lodz, the Lower East Side, and London, three important stops on her route. It all began in Lodz, an industrial city in the heart of Poland, where she was born Genya Zelkovicv "in the mid-Thirties." In 1947 the Zelkovicv family moved to the U.S. and settled on New York's Lower East Side, a traditionally rough neighborhood that has been an ethnic melting pot since the 1890's. There Mr. Zelkovicv opened a candy store, and Genya grew up in a world of street gangs who

Washington, and doubly a compliment because it came from Detroit, whose "Motown Sound" was about to make a significant impact on the entire pop-music industry. A black sound was, to use the predictive vernacular, where it was about to be at: Goldie was right on target.

By 1965, the Motown Sound was everywhere, matched in popularity only by that of the British rock groups who had begun invading the American market with a style that was their own but, by admission, had its origin in black blues. Having left her Escorts, Goldie formed an all-girl group called Goldie and the Gingerbreads.

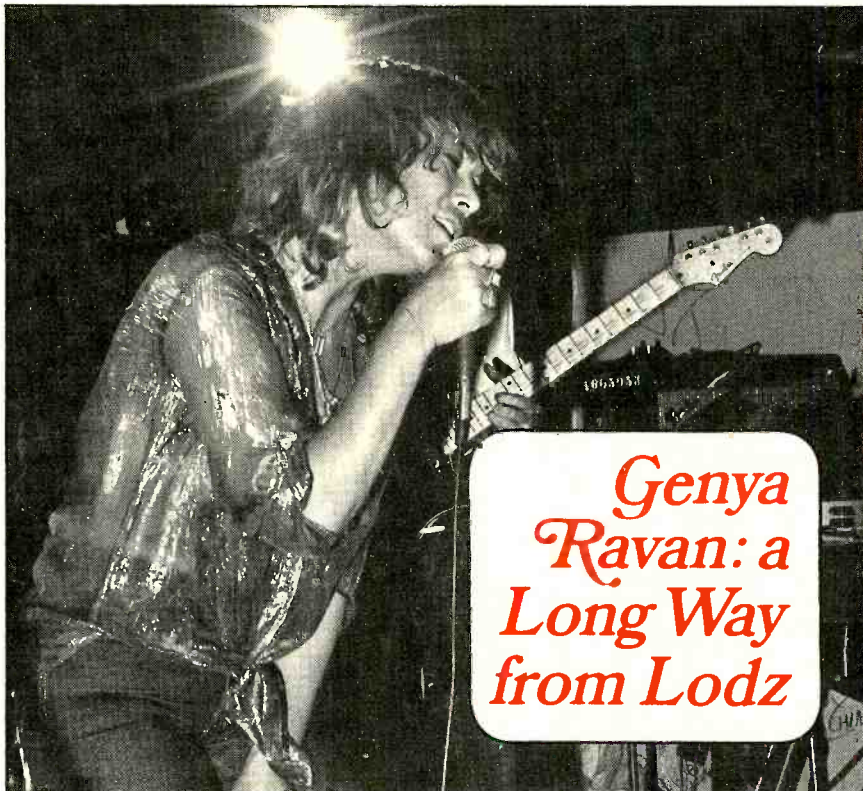

Genya Ravan: a Long Way from Lodz

moved, leather-jacketed, through the streets to the sounds of transistor rock-'n'-roll. She joined one of the gangs, the Furies, and recalls having to hide her leather jacket from her unsuspecting parents, who now called her Goldie because someone had told them that the name Genya might be considered downright un-American.

So it was Goldie Zelkovicv who, in 1962, jumped onto the stage at Brooklyn's Lollipop Lounge and sang with Richard Perry's group, the Escorts, and it was Goldie Zelkovicv who reaped from that impromptu performance her first professional job. She recorded four sides for Coral as the Escorts' lead singer, and one of them, *Somewhere*, hit the charts in Detroit.

"The Detroit disc jockeys," she recalls, "thought using the name Zelkovicv was some kind of joke, and they couldn't believe their eyes when they saw me at record hops—they had thought I was black." That was a compliment, for Goldie had great admiration for black singers, particularly Jeanette "Baby"

"This was when Eric Burdon and the Animals were hitting it big with *House of the Rising Sun*," she recalls, "and we were appearing at the Wagon Wheel, on 45th Street, when their manager walked in. 'Bloody hell, a girl's band,' he said, and he was so impressed that he suggested we go to England."

It turned out to be a good move for Goldie and the Gingerbreads. They toured with the Animals, the Yardbirds, and the Rolling Stones, they were given their first TV exposure by the Beatles, and they became a favorite entertainment at parties thrown by the day's jet set. They recorded for British Decca and scored a hit with their first release, *Can't You Hear My Heart Beat*, produced by Eric Burdon.

"We were semi-big, and very cooking," says Genya. "No original tunes, because that wasn't the thing. I was doing *Shout*, and things like that. Atlantic released some of our things over here, but they didn't catch on. My organist, Margo Lewis, was a bitch; this chick

was just great. Jimmy Smith heard her and flipped out. My drummer looked like Sophia Loren, a very pretty chick, and I still haven't found a cat that can be as funky as this chick was with her foot. My guitarist, too, was incredible, playing rhythmic patterns I hadn't heard from any cat. I had the group for five years, and it wasn't easy—you know, just before you go on a show you don't want to hear about somebody's period pains."

After a couple of years in Europe, Goldie and the Gingerbreads returned to the U.S., where the group eventually broke up. "We had reached a dead end. Breakups are often like rehearsals, a real drag. It happens with a lot of groups; you reach a point where you're not growing any more, you're not learning, you're not absorbing. But, believe me, we were very tight. I loved them. I don't love them any more, but I loved them then. It ended very badly. It ended like chicks; it didn't end with wishes of 'good luck,' nothing like that. I'm sure they don't want to see me, and I don't want to see them."

While Goldie and the Gingerbreads were still together, Goldie met a drummer by the name of Les DeMerle, who introduced her to jazz. "Actually, I had been turned on to jazz by King Pleasure. I loved the things he did, but Les took me down to hear Thad Jones and Mel Lewis, and all of a sudden I was meeting a lot of jazz people. It was a whole new world I hadn't known about. All I knew from was *Shake It Up Baby*, but jazz had a feeling, and I wanted it." It was during the brief period with DeMerle's jazz quintet that Goldie changed her name back to Genya and adopted the surname Ravan. "Whoever heard of a jazz singer named Goldie Zelkovicv? It just didn't sound right; besides, I was working with charts for the first time, and I had such talented jazz people as Frank Foster and Garnett Brown writing charts for me. Frank Foster and I really dug working together. We used different musicians, and I learned that with charts you could change musicians."

GENYA RAVAN's jazz experience, though artistically rewarding, was brief. By 1969 she was back in the pop world, stirring up excitement in clubs, on TV, and in such rock palaces as the Fillmores East and West, backed by a powerful band called Ten Wheel Drive. Genya and Ten Wheel Drive recorded three albums for Polydor, all of which made the company's best-seller list, but by 1971 personality conflicts had begun to threaten the band, and when Clive Davis—then president of Columbia Records—made a bid for Genya, she made the move without hesitation.

Eager to find a replacement for Janis Joplin, who had just died, Davis—or so the story goes—paid Polydor \$100,000 to get Genya out of her contract. If Genya's mother's expectation was to come true, this was surely the event that would do it; Clive Davis was enjoying a reputation as the recording industry's number one star-maker, he was credited with the superstardom of Janis Joplin, Sly Stone, Donovan, Blood, Sweat & Tears, Chicago, and, to some extent, Miles Davis. Since Genya already had developed an impressive following, the switch to Columbia, with its well-oiled distribution and promotion machinery, might just take her over the top. Sad to say, it

did not. In fact, it took her in the opposite direction.

After an expenditure rumored to have approached \$200,000 (including the payment to Polydor), Columbia released one album ("Genya Ravan," C 31001), a mixture of rock and jazz-oriented material produced by Michael Zager and Aram Scheffrin of Ten Wheel Drive and containing guest performances by Michael Olatunji, Arnie Lawrence, and James Moody. It was easily her best album, but sales were poor by Columbia's standards, and Clive Davis inexplicably dropped Genya from the label's roster. "It had a devastating effect on me," she recalls. "I mean, spending all that money and then dropping me just like that. I just had to go away and get my head together."

DURING the next few years, Genya recorded an album for Dunhill (it was called "They Love Me"—she hates it), spent some time in California, and then returned to New York to become a record producer. She produced Cryer and Ford's "You Know My Music" and Rosie's "Better Late Than Never" for RCA, the Dead Boys' "Young, Loud and Snotty" for Sire, and demos by Jimmy Miller, the Shirts, and the Miamis. But she really wanted to produce her own album, and that opportunity finally came earlier this year.

"Urban Desire"—promoted, and heavily so, as a "decidedly decadent" album—brings back the leather-clad Goldie of the Lower East Side, a gutsy rock-and-roller whose songs dig deep into a world of motorcycles, hard loving, and street survival. It's raw rock with a slight polish (no joke intended) that—in conjunction with the frank lyrics—brings the Sixties into the Seventies. Her Columbia album proved Genya capable of affecting the clarity and smoothness of Annie Ross, but here her voice is as down-to-earth as a pair of well-worn sneakers. No one will assume she is black, but the influence clearly remains, showing most prominently on *Back in My Arms Again*, the 1965 Supremes hit, which is also the album's initial single.

Because of the direction Genya seemed to be taking in 1972, "Urban Desire" came as something of a shock when I first heard it, but she is obviously more comfortable in this idiom, and the album sounds better each time I play it. There is a lot of good material, one of my personal favorites being *Aye Co'lorado*, Genya's own song about her first affair with a Puerto Rican, which features a guest appearance by Lou Reed, and *Darling, I Need You*, a 1975 song by John Cale, co-founder with Reed of the Velvet Underground.

It's good to see the return of Genya Ravan, and to find that she has lost none of the energy and spunk one used to associate with her. Will she ever pay a visit to Lodz? "I'd love to," she told me. "Hey, man, that's root city!"

—Chris Albertson

GENYA RAVAN: *Urban Desire*. Genya Ravan (vocals, percussion, harmonica); the Genya Ravan Band. *Jerry's Pigeons*; *The Knight Ain't Long Enough*; *Do It Just for Me*; *Shot in the Heart*; *Aye Co'lorado*; *Back in My Arms Again*; *Cornered*; *The Sweetest One*; *Darling, I Need You*; *Messin' Around*; *Shadowboxing*. 20TH CENTURY-FOX T-562 \$7.98.

B-I-C's FM ANTENNA GETS A GREAT RECEPTION.

In the fall of 1977, B-I-C introduced the Beam Box FM 10, the first electronically directable FM antenna. It sits conveniently near your receiver and requires no special installation. By simply adjusting its knobs you maximize the FM signal you want and minimize signals you don't want. At \$89.95, we thought it was quite a breakthrough. So have a lot of other people.

"I spent literally hundreds of dollars for FM antenna installations before I found the Beam Box. It really works. In fact, it works great." J.L.B., Alexandria, Virginia

"The Beam Box is the greatest thing that has happened to my FM tuner. In several different locations I tried dipoles, rabbit ears, cable TV hook-ups, and stationary outdoor antennas with sad results. So sad, I never taped FM music. Upon incorporation of the B-I-C Beam Box in my system I detected an improvement that was unbelievable, specifically in cleanness of signal, stereo separation and station lock-on. Additionally I was able to pick up more stations. I am now making perfect FM recordings." A.G.M.D, Hill AFB, Utah

"Since buying and installing the Beam Box, my reception problems have been completely eliminated. I receive stations in Connecticut and Long Island with absolute fidelity, which I think is pretty outstanding since I live in New Jersey. I am finally confident that my 'prestige' tuner is performing as it was designed to." J.P., Edgewater, N.J.

"Great invention! Perfect reception. No multipath. This is a great advance. Works beautifully in a New York apartment." T.W., New York City

Now B-I-C introduces the new FM 8 at only \$49.95. It's a bit less fancy and therefore less expensive than the original Beam Box FM 10. Performance is virtually the same.

If you're unhappy with your FM reception and can't improve it with your present FM antenna, The Beam Box may be your answer.

B I CTM

**THE
BEAM
BOX**TM

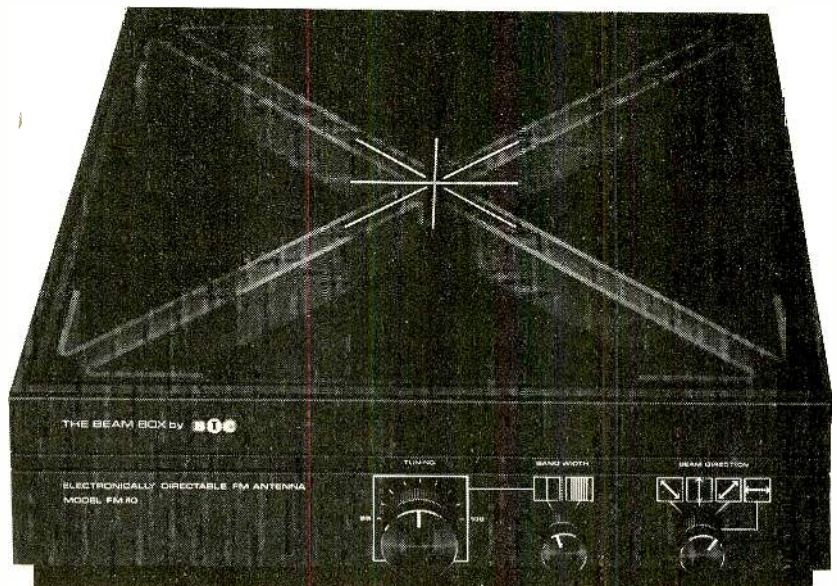

CIRCLE NO. 14 ON READER SERVICE CARD

ers—but once in a while listening to this album you get the feeling that out of formula could come originality (sort of like the old *Dr. Kildare* series on the tube, which eventually got to be fairly good). Kihn's group here does some solid work, anyway, and there're a lot of catchy tunes that are easy to pick up on. The group has the roughness of folk artistry about it, and a sort of lurking vitality. This album doesn't knock me out, but it does get me interested.

N.C.

RECORDING OF SPECIAL MERIT

LORI LIEBERMAN: *Letting Go*. Lori Lieberman (vocals); vocal and instrumental accompaniment. *Let Me Down Easy; Letting Go;*

You're the One; Boston; Jingle; What I Would Do; and three others. MILLENNIUM MNLP 8005 \$6.98.

Performance: **Wry and observant**
Recording: **Very good**

"Letting Go" is filled with sensitive, often deeply felt, but always unself-pitying work by Lori Lieberman. She's best in her own material (she wrote six out of the nine songs here). That's partly because the music lies easily within her limited range—she has a narrow but extremely expressive contralto—and partly because she delivers the wry lyrics of such songs as *Boston, Late Last Night, and Letting Go* with a deft, low-key punch that leaves just the right aftershock. All of her material seems



Millennium Records

LORI LIEBERMAN
A pocketful of wry

to reflect the same observant awareness, and the chunks of experience that she passes along to us have the tart tang of truth about them.

Best here is Lieberman's own *Jingle*, apparently drawn from her experience of going out to audition for a Burger King jingle at an advertising agency. She gives it the works: "I sang it from my gut, I would have sung it kneeling/Have it your way!" The presiding trend setter doesn't much care for it. "Well, I sank in my chair and he walked around me annoyed/And my pride just melted all over his corduroy..." On the way out he asks her if he can send her some songs *he's* written, since she's already done a couple of albums... "Have it your way," she replies. She spends the rest of her day trying to dodge feeling lousy by hitting Doubleday's and some of the other Fifth Avenue stores. The song ends as she's back on the bus, with the driver singing out of tune as passengers get on and off. *Jingle* is the kind of offbeat material that not too many composer/performers attempt. Since Lori Lieberman seems to have a pocketful of wry, perhaps she might consider a whole album of this kind of truth-telling satire. P.R.

KENNY NOLAN: *A Song Between Us*. Kenny Nolan (vocals); instrumental accompaniment. *A Song Between Us; I'd Love You to Love Me Back; Connect the Dots; But Love Me; Your Love;* and five others. POLYDOR PDI-6151 \$7.98.

Performance: **Sweet**
Recording: **Very good**

Kenny Nolan is another one of those all-around types who write their own words and music, do their own arrangements, and have their own production unit. He began by writing hit songs for others but recently started singing his material himself. It doesn't work out too well. The sentiments in most of his songs are awfully sweet to begin with, and his high voice and rather cloying singing style tend to compound the problem. Still, after prolonged exposure to Nolan's preciousness, you may start telling yourself, in his words, to "... take one beautiful day at a time/Why rush into tomorrow?" Such clichés may be all his lyrics have to offer, but some of the songs

(Continued on page 159)

Choose your car stereo as carefully as you choose your home system.

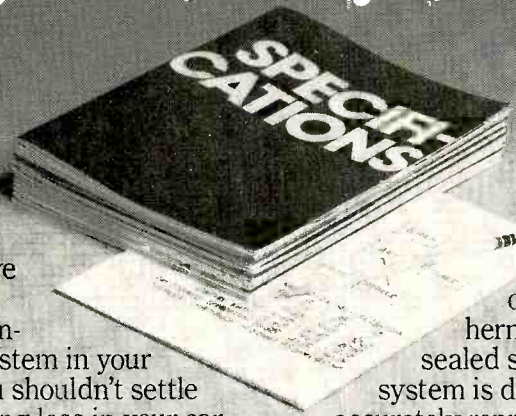

If you have a quality stereo component system in your home, you shouldn't settle for anything less in your car.

The Compo car stereo from Fujitsu Ten is a true separates system, not just a booster. Choose between two different power amplifiers for 40 or 80 RMS watts of power. The auto-reverse cassette deck with Dolby* has a special playback head for great frequency response. The AM/FM/MPX tuner features motor-driven automatic search, along with FET front end and PLL/IC for stable reception. Even a six-function remote control amplifier.

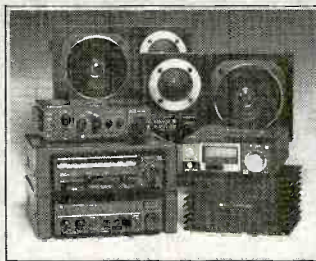

And our 2-way hermetically-sealed speaker system is designed to accurately reproduce every note under difficult acoustic conditions.

We suggest you compare Compo spec for spec against the competition the same way you'd compare an amplifier or tuner for your home system. You'll discover how 25 years of making car stereos leads to making the best.

Write for additional information on Compo and our complete car stereo and speaker line, plus the dealer nearest you.

Compo:™ The best separates on wheels.

*Dolby is the trademark of Dolby Laboratories, Inc.

TEN FUJITSU TEN CORP. OF AMERICA
1135 East Janis Street, Carson, CA 90746.

CIRCLE NO. 32 ON READER SERVICE CARD

In California, recording studio time can go for as much as \$165 an hour.

In New York, it's higher. (What isn't?)

In light of these costs, it's obvious that "paying your dues in the studio" can be a prohibitively expensive proposition.

Unless you own a Pioneer RT-2044.

By every standard, the RT-2044 is a professional four track studio machine.

It features a synchronous monitor function for sound-on-sound, and sound-with-sound recording. So you can make live overdubs, or sound tracks accompanying yourself on instruments.

It has three permalloy tape heads to give you the kind of frequency response and signal-to-noise ratio you'd normally only get in the studio.

It comes with three motors to insure perfect tape speed at 7½ or 15 ips, with either 7" or 10½" reels.

And it has all the other features you'd expect in a professional tape deck, like jam-proof logic controls, a frequency generator that lets you calibrate the tape to avoid making distorted recordings, a special cue-lock for easier editing, and even continuously variable bias settings that let you get the most out of your tape.

All told, the only thing the RT-2044 won't do that a recording studio will is give you an hourly bill. Because it costs \$1,650* just once.

Which is not on a hundred's less than many similarly endowed "professional" tape decks, but it's nowhere near what you'd spend in the studio learning how to sound truly "professional."

Feel free to try out the RT-2044, or the two track RT-2022, at any participating Pioneer dealer.

But don't spend too long playing with them.

Our dealers may start charging for studio time.

FOR THE PRICE OF A FEW HOURS IN A RECORDING STUDIO, YOU CAN OWN ONE.

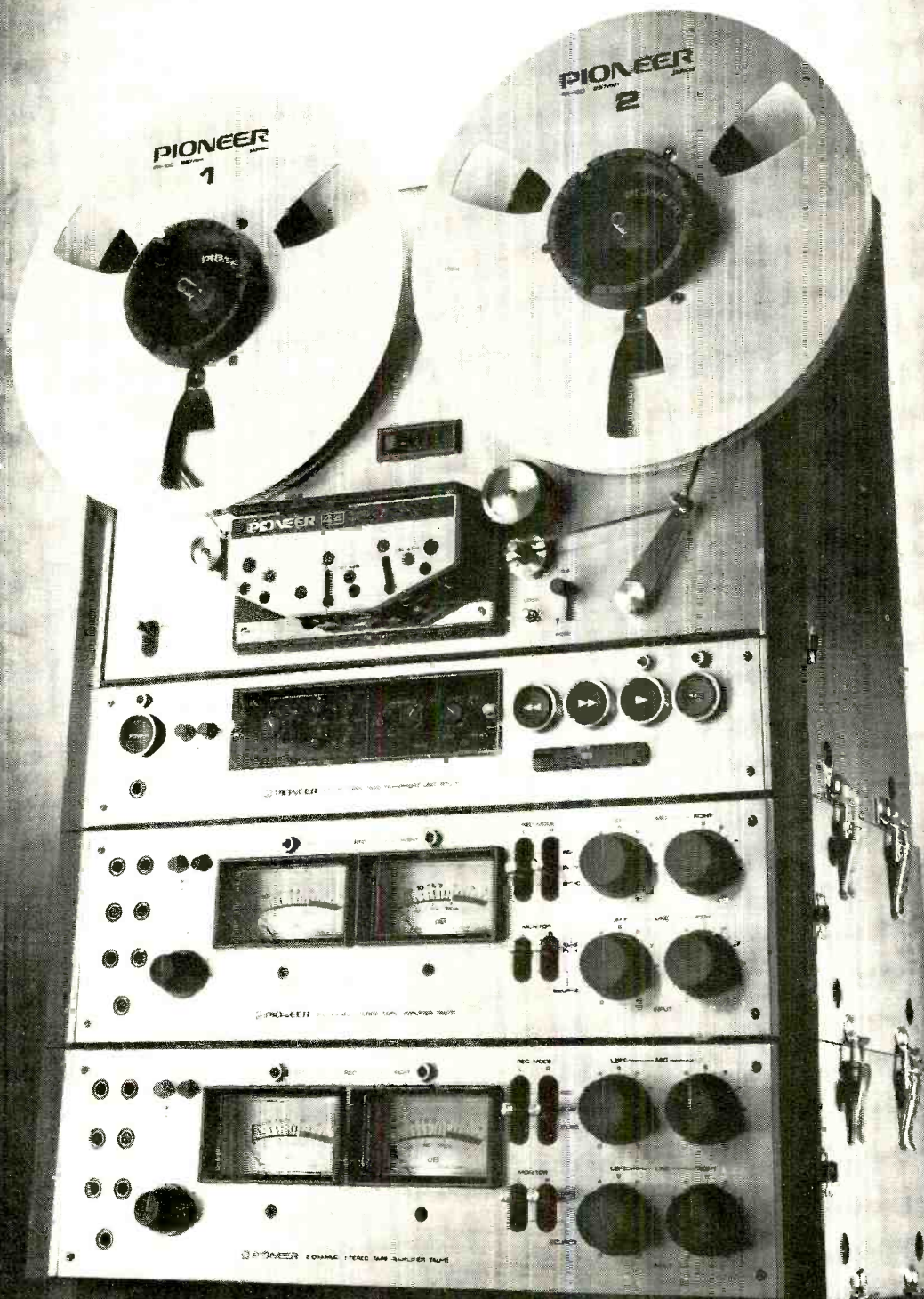

PIONEER © 1978 U.S. Pioneer Electronics Corp.
We bring it back alive. 85 Oxford Drive, Moonachie, N.J. 07074.

*Manufacturer's suggested price. The actual price will be set by the dealer.

CIRCLE NO. 90 ON READER SERVICE CARD



Irene Kral

“I SEE great danger in the confusions of our age, which so often has [mis]understood the call of art as the call to art; thus the artistic activity of [our] time, [instead of] positively affecting life, has called more and more of the young away from life.” It might be Bob Dylan talking about the strumming horde that followed in his wake. Instead, it is the equally influential (for his time and place, which was the Germany of the Weimar Republic) and equally popular poet Rainer Maria Rilke speaking in 1922 about his own followers who hoped to find in his poetry a Way of Life and the Ultimate Answer.

Popular music in 1978 is still trying to shake loose—at least the “serious” and/or “meaningful” segment of it—from the shadow of Dylan’s work. In the meantime there is still an enormous cottage industry at work churning out carefully primitive ballads that offer opinions on everything but real life itself. It is generally meticulously folksy, to the point where enunciation of the final “g” in any word ending in “ing” would immediately label you as one of *them*, “them” being the fakes, the phonies, and the sell-outs, the despicably successful Professionals who don’t know what’s Really Important.

Co-existing, but hardly thriving, in the commercial market are such truly fine artists as Irene Kral. If you want to hear supremely professional performances that are about real life and real feelings, then listen to her latest Choice album “Gentle Rain.” She is witness to the actual world around her, and she shares with her audience, by means of inflection, phrasing, and a lovely cloudless voice, a wealth of life experience. When she delivers the slight, mournful vignette that is Luiz Bonfá and Matt Dubey’s title song, *Gentle Rain*, it is as classically pure and humanly radiant as a Renoir painting. The Duke Ellington/Billy

Strayhorn *Something to Live For* gets the kind of performance from Kral that it has been waiting for since it was written, and her medley of Berlin’s *Remember* and *All Alone* combined with Coward’s *Someday I’ll Find You* and *I’ll See You Again*, which finishes off the album in the highest possible style and stylishness, is the kind of singing it would be a privilege to hear in any time.

But, unfortunately—at least as far as sales are concerned—the time happens to be *now*. And now is the time of the huge entertainment complexes that have audience tastes so cataloged, so programmed, so demographed, and so just plain figured out that the chance of this record’s getting much beyond the window at Doubleday’s or on the turntables of a few connoisseurs is about as likely as Tony Orlando’s turning up as our representative at the SALT talks. The kingdom from whence Ms. Kral comes—ruled over by the Dowager Empress Mabel Mercer and blessed with a court that probably includes every good American singer performing today—has always been terra incognita as far as the record biz has been concerned. And it seems likely to stay

It doesn’t take as much living up to as you might think . . .

that way, no matter how many raves appear in the media, no matter how many warmly appreciative liner notes (such as those written here by Rex Reed) are affixed to Kral’s al-

bums or how much her fans talk her up among their own friends.

The cause is twofold: the degraded musical culture that we live in, and the relentless pandering to it by the people in charge of the record business. The pesky stuff surrounds us like a sea of damp Kleenex. If something is built or manufactured or artistically conceived to last, if it is a work of possibly enduring value, it seems to be immediately judged stodgy, pretentious, almost surely boring, and, at the extreme, probably dangerous (that group of over-thirty nihilists must never be trusted again!). No, much better to take what the market analysts tell us we want. That way we can look down on it and enjoy it at the same time. We’ve grown so used to certain commercial additives being injected into our entertainment that we no longer care (or dare) to commit ourselves to our own taste and judgment. It is we, the Tweedledees, who have told the Tweedledums of Market Research that they can’t go too far wrong if they include those surefire ingredients that make things easier for us. The makers of a Disney family picture are as fully aware that they must include certain types of scenes in their products as are the makers of X-rated porn features. In any supermarket you’ll see the customers pass blithely by the fresh-produce counter on their way to the frozen foods. It’s easier. (What does it matter that the picture on the broccoli-with-hollandaise-sauce box bears little resemblance to the rubbery seaweed with library paste that’s inside? Or that the newest “serious-meaningful” pop singer is shown on his album cover holding a guitar that he hasn’t learned to tune, let alone play, yet?) The recordmakers try to figure us out with as much care as a con man eyeing a newly rich widow—and most of the time they fleece us with our squealing consent.

So, it’s up to you. You can go out and get the new Irene Kral album, safe in the knowledge that you’ve bought something as fine and as lasting as an Hermès wallet or a Rolls-Royce car. It doesn’t take as much living up to as you might think, and it won’t give you an inferiority complex because you don’t get every nuance immediately. What it will do is introduce you to a particular kind of excellence that you might have missed so far. And it might convince you that excellence is really the easiest thing of all to absorb, that Ultimate Answers are probably achieved only on the Ultimate Day, and that reality, as expressed by an artist like Irene Kral, is a series of small, deeply felt, daily wonders that add up to something rather grand.

(Shortly after this appreciation of Irene Kral’s work was completed, the news of her death reached me. Mixed in with the sadness of the event itself was a great deal of personal joy that she had recorded as much as she had—and all of it of superb quality—before her untimely passing.) —Peter Reilly

IRENE KRAL: *Gentle Rain*. Irene Kral (vocals); Alan Broadbent (piano). *The Gentle Rain; The Underdog; You Are There; Something to Live For; If You Could See Me Now; What’s New; Medley—Remember/Someday I’ll Find You/I’ll See You Again/All Alone*. CHOICE CRS 1020 \$6.98.

here, *Connect the Dots* for instance, are actually rather pretty. P.K.

TONY ORLANDO. Tony Orlando (vocals); vocal and instrumental accompaniment. *Save the Last Dance for Me*; *That Is Rock & Roll*; *A Lover's Question*; *Let the Good Times Roll*; *Since I Met You Baby*; and five others. ELEKTRA 6E-149 \$7.98, © ET-8149 \$7.98, © TC-5149 \$7.98.

Performance: **Plodding**
Recording: **Good**

Despite some ambitious arrangements and a helping hand from the dynamic Etta James, Tony Orlando's "comeback" album is a disappointment. The opening cut is a bow to disco fever called *Don't Let Go* that pits an impressive array of solo instruments against swinging strings and a solid beat. Orlando's head-on style would seem to be much more suited to the one-two, one-two bounce of *I Count the Tears* and *Save the Last Dance for Me*, but his plodding, totally undistinguished delivery reduces them to the old *Tie a Yellow Ribbon* mold. The rest of the album aims for updated rock-and-roll. The classic *Let the Good Times Roll*, to which Ms. James contributes lots of energy, and *Ya Ya* are the only cuts on the whole album with any pizzazz. But even here Orlando doesn't bring much personality to the music—he just sings, and with a voice that seems to have deteriorated during his latest brief retirement. Whatever happened to Dawn?

—Edward Buxbaum

JOHNNY OTIS: *The Original Johnny Otis Show.* Johnny Otis (vocals, drums, vibraphone); Little Esther, Mel Walker, Redd Lyte, Jimmy Rushing, the Robins, Marilyn Scott (vocals); instrumental accompaniment. *Harlem Nocturne*; *My Baby's Business*; *Round the Clock*; *Preston Love's Mansion*; *Beer Bottle Boogie*; *Uneasy Blues*; *All Nite Long*; *Wedding Boogie*; and twenty-four others. SAVOY SJL 2230 two discs \$7.98.

Performance: **Gems among the paste**
Recording: **Good restoration**

Savoy Records was a small, independent, California label specializing in black music in the late Forties and early Fifties. Johnny Otis—who is white, by the way—was on hand as artist, songwriter, talent scout, arranger, and occasional vocalist. He grew up in the Thirties idolizing the big swing bands, but by the late Forties when the big-band era was dead he made a precipitate and lucky switch to rhythm-and-blues, turning out several hits. His last big single was *Willie and the Hand Jive* on Capitol Records in the Fifties.

The Savoy catalog was purchased by Arista Records, and various double-disc reissues from the Savoy vaults have appeared from time to time. The thirty-two selections in this Otis package range from brilliant to so-so. The first four cuts, made when Otis was leading a neo-swing orchestra with access to the Count Basie arrangement book and Basie's vocalist Jimmy Rushing, are very exciting—especially *Preston Love's Mansion*, in which trombonist Henry Coker takes a solo that the fellows who made it into the history books wouldn't be ashamed of. Otis' talent discoveries included Mel Walker, a cautious but engaging vocalist whose duets with Little Esther resulted in big hits of the time, and the mysterious Marilyn Scott from the Carolinas,

Fine tune your living room.

Drapes muffle lows.

Rugs soak up lows.

Wood floors bounce highs.

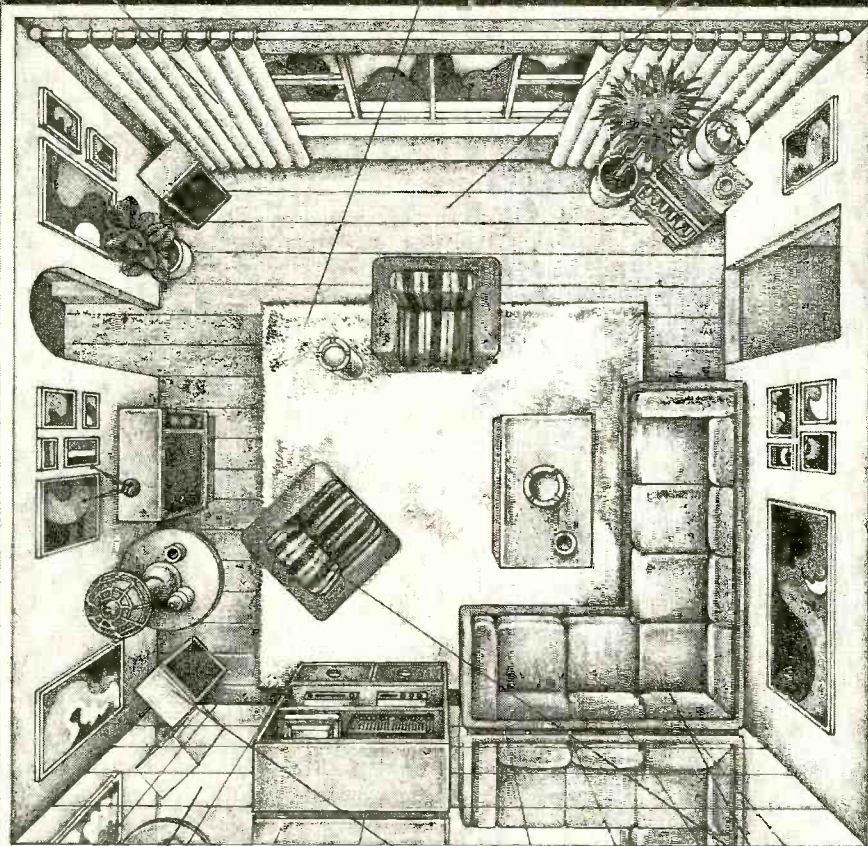

Mirrors reflect highs.

Poorly placed speakers, poor sound.

Upholstery soaks up lows.

Your stereo probably doesn't have the sound you thought you bought. Because you first heard it in a sound room. Unfortunately, most stereos are set up in rooms designed for living. Not listening.

That's why you need a Sound Shaper® One or Two. The frequency equalizers that re-shape music to fit your ears. And your living room.

Sound Shaper One has ten frequency controls, five for each stereo channel. And beautiful styling. But if your system is more sophisticated, you'll want Sound Shaper Two Mk1 with twenty-four frequency controls (twelve for each stereo channel). Plus, internal switching and monitoring. So highlight the vocal. Suppress the bass. Wipe out the flute entirely. And if you want the professional touch, get the new SLM-2 Sound Level Meter. With it, sound levels can be read directly on the Sound Shaper Two, so no longer will you have to run back and forth between the listening area and the equalizer.

Without redesigning your living room, turn it into a listening room.

Sound Shaper® One and Two

ADC PROFESSIONAL PRODUCTS
A Division of BSR Consumer Products Group
Route 303, Blauvelt, N.Y. 10913
A BSR COMPANY



Distributed in Canada by BSR (Canada) Ltd., Rexdale, Ont. • Sound Shaper is a registered trademark of Audio Dynamics Corporation.

LOW PRICES & RELIABILITY

DISCOUNT HI-FI STEREO COMPONENTS

- RECEIVERS • SPEAKERS • TURNTABLES
- CARTRIDGES • TAPE RECORDERS

Technics

SU8600
STEREO
INTEGRATED
AMPLIFIER

73 Watts Minimum RMS per channel at 8 ohms from 20-20,000 Hz with no more than 0.08% total harmonic distortion.

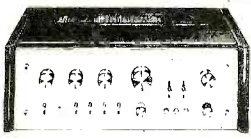

Sansui

SANSUI-AU717
STEREO

INTEGRATED AMPLIFIER 85 w/ch RMS into 8 ohms over 20-20,000 Hz with 0.025% total harmonic distortion



Get our low prices on these and hundreds of other components listed in our new FREE catalog



SEND FOR
CATALOG
TODAY!

District Sound Inc.

2316 RHODE ISLAND AVENUE, N.E.
Washington, D.C. 20018
(202)832-1900

CIRCLE NO. 27 ON READER SERVICE CARD

J&R BLANK TAPES & ACCESSORIES AT WHOLESALE PRICES!

BLANK TAPES

CASSETTE TAPES

Ampex Grand Master I C-90	\$2.14	TDK D C-90	\$1.20
Ampex Grand Master II C-90	\$2.78	TDK D C-90	\$1.68
BASF Studio C-90	\$2.69	TDK D C-120	\$2.10
BASF Professional II or III C-90	\$2.99	TDK D C-180	\$2.99
Maxell UD C-90	\$2.99	TDK AD C-90	\$1.79
Maxell UD C-60	\$1.93	TDK AD C-90	\$2.52
Maxell UD C-90	\$2.84	TDK SA C-90	\$2.22
Maxell UD XL I or II C-60	\$2.47	TDK SA C-90	\$3.16
Maxell UD XL I or II C-90	\$3.47		
Scotch low noise C-90 / 3 pk.	\$4.99 for 3 (10%)		
Scotch Master I C-90	\$2.84	Maxell UD 35-90 1800 ft.	\$5.49
Scotch Master II or III C-90	\$3.29	Maxell UD 35-180 3600 ft.	\$6.62
Sony Ferrichrome C-90	\$3.58	Maxell UD XL 35-90B 1800 ft.	\$6.62
		Maxell UD XL 35-180 3600 ft.	\$14.70
		Scotch 212 1800 ft.	\$4.35
		Scotch 207 1800 ft.	\$5.19
		TDK L-1800 1800 ft.	\$5.22

Minimum Order 12 Tapes - 100% Guaranteed.

CARTRIDGES

AT-20 SLA	\$119.00	VIS TYPE IV	\$89.90
AT-15 SA	\$82.50	SVI TYPE III	\$53.50
AT-14 SA	\$46.50	M95ED	\$26.50
AT-12 SA	\$34.90	M91ED	\$21.00
AT-10	\$12.00	MH (QUAD)	\$36.50
		M70EJ	\$9.90
881S	72.50	XLV/45000 (QUAD)	\$66.00
881EE S	55.00	XSV/3000	\$45.95
881EEE	42.50	XV15/750E	\$30.00
680EE	13.00	XV15/625E	\$20.98
500EE	14.40	XV15/400E	\$17.95

HEADPHONES

SE-205	\$19.95	PRO 4 AAA	\$37.05
SE-605	\$46.70	PRO 4 AAA	\$45.00
SE-A	\$33.50	HV/1	\$26.97
SE-B	\$39.95	HV/1LC	\$35.97
SE-700	\$59.95	PHASE/2+2	\$93.00
		TECHNICIAN/VFR	\$48.00
		K/6A	\$14.97
HD-400	\$24.99		
HD-414	\$35.97		
HD-424	\$59.95		

HOW TO ORDER: For shipment within 48 hours, send money order or certified check. Two weeks delay on personal checks. Please add \$3.50 per order for shipping & handling. (\$5.50 for orders outside U.S.). N.Y.S. residents add tax. No C.O.D.'s. All merchandise 100% guaranteed, brand new & factory fresh.



33 Park Row, Dept. SR, N.Y.C. 10038 (212) 732-8600

WRITE FOR FREE CATALOG

CIRCLE NO. 40 ON READER SERVICE CARD

whom Otis found and lost after recording the exciting *Beer Bottle Boogie* and *Uneasy Blues*. Walker, Little Esther, and "Preacher" Lee Graves have great fun with *Wedding Boogie*. Otis' fondness for and first loyalty to the swing music of his youth is evident not only in his use of brass but also in his vocal on *All Nite Long*, an adaption of Fats Waller's recording of *The Joint Is Jumpin'*. In the spoken coda, after the cops have come to break up the party, Otis uses the Waller line, "Don't give your right name."

Now, having mentioned some of the delights of this collection, I must also report that, considering the number of the selections, they are few and far between. Pete Welding, who wrote the detailed liner notes (in which Otis is quoted at length), accepts Otis' own contention that he found artistic satisfaction in his r-&-b success beyond what he might have found as a swing-band leader. That may be so, but there is a dulling monotony to most of these recordings. They were commercial ditties knocked out fast and cheap to take advantage of a newly discovered audience, and they sound it. Worse, they sound dated. But there are some fine moments nonetheless. J.V.

DOLLY PARTON: Heartbreaker. Dolly Parton (vocals); instrumental accompaniment. *I Really Got the Feeling; It's Too Late to Love Me Now; With You Gone; Baby I'm Burnin'*; and six others. RCA AFL1-2797 \$7.98, © AFS1-2797 \$7.98, © AFK1-2797 \$7.98.

Performance: **Image change complete?**
Recording: **Very good**

I said to a friend, "The best thing about this may be that Dolly Parton doesn't wear one of those two-sizes-too-small jump suits in the cover photo," and the friend said, "Does that make it a collector's item?" Maybe. I don't think the *content* would, although it is perfectly clear that Dolly can cut the mustard among pop singers—and she is definitely among pop singers with this album. It's almost a throwback to the girl-singer-and-orchestra shtick of the Fifties, but of course it sounds up to date (just as the Seventies, another throwback to the Fifties, sound up to date). Anyway, there's very little of Dolly Parton, Country Singer (or even Former Country Singer), to be heard here. There's a lot of the Dolly Parton who told some TV talk-show host, "I want to be a superstar, it's as simple as that," and a lot of the Dolly Parton who is interviewed in *Playboy* and *Playgirl*, a lot of the woman-of-the-world Dolly Parton. And she's not bad, of course, as woman-of-the-world singers go; the lighthearted quality of her voice goes well in this new environment, and she has that distinctive sound and such an easy time with the subtleties of pitch. I doubt if any other singer could show you as good a time with these particular tunes. But then comes the inevitable "So what?" It's awfully hard to find any poignancy if you stop speculating about Dolly's changing her image and just listen to the record. Some singer-songwriters aren't important enough to be *obligated* to be poignant, but Dolly Parton is. Obligated, that is, to the minority who listen rather than absorb. This album seems to me to serve the majority well enough, being up-beat, cute, and facile, but it gives its obligation to the minority only a lick and a promise. N.C.

(Continued on page 163)

FANTASTIC ELECTRONICS THE UNBEATABLES

(212) 435 0362

Call or write for unbeatable quotes on more than 70 top brand names from New York's finest audio dealer. Try us now.

TEAC A-103 cassette deck 159.95	ALTEC Lansing SPEAKER Model 3 99.95	AKAI cassette deck CS 707 D. 174.95
PIONEER SX-680 30 w per ch. 01 THD 194.95 cassette deck CTF 9191. 269.95	NEW CATALOG Master Charge and Visa Accepted	Reel To Reel GX 270D 469.95 30 day lowest price guarantee (incl. mtg. price change)

FANTASTIC ELECTRONICS
4820 13th Ave.
BROOKLYN, N.Y. 11219

CIRCLE NO. 31 ON READER SERVICE CARD

Hi-Fi Buys

ON PIONEER Technics
KENWOOD **Sansui**
AND OTHER FAMOUS BRANDS

KENWOOD KR-4070 AM/FM RECEIVER 40 watts RMS, at 8 ohms, no more than .05% THD.	PIONEER HPM-100
Technics SL-230 Automatic single-disc FC servo belt-drive turntable.	SANSUI AU-717 85 watts per channel with no more than 0.025% total harmonic distortion.
PIONEER RT-707 OPEN REEL, AUTO REVERSE PLAYBACK TAPE DECK	

CALL TOLL FREE
800-638-0935
MON.-FRI. 9-8, SAT. 9-4

Orders shipped within 48 hrs. • Phone and COD orders accepted • Use Visa, Master Charge, or NAC • Call or write for quotes • Catalog available upon request • All equipment factory sealed with full warranty.

Master Charge **Hi-Fi Buys** **VISA**
1362 HOLTEN LANE
LANGLEY PARK, MD. 20783
(301) 434-5330

CIRCLE NO. 36 ON READER SERVICE CARD

8 IMPORTANT REASONS WHY MORE PEOPLE BUY TOP QUALITY EQUIPMENT FROM INTERNATIONAL HI-FI THAN ANY OTHER MAIL ORDER COMPANY

MORE THAN 80,000 CUSTOMERS NATIONWIDE

1. Guaranteed lowest price . . . you pay same price many dealers pay.
2. No-risk, no-deposit . . . phone orders shipped C.O.D. or Credit Card.
3. Same day shipping when ordered by 1 p.m.
4. Seven audio advisors provide professional help for the inexperienced buyer.
5. Fully insured shipments plus full manufacturers' warranty.
6. Exclusive "no lemon" guarantee.
7. Fully staffed customer service department.
8. Over 70 top name brands . . . equipment most mail order and discount dealers can't supply.



CALL NOW
(301) 488-9600
 Mon.-Fri. 9-9, Sat. 9-4

Write for: • Brochure with prices and lines
 • Tips on buying by mail



International Hi-Fi Distributors
 Moravia Center
 Industrial Park, Dept. 11S
 Baltimore, Maryland 21206

CIRCLE NO. 39 ON READER SERVICE CARD

SOUND machine

EVERYTHING IN SOUND EQUIPMENT
 2836 Kennedy Boulevard • Jersey City, New Jersey 07304
 New Jersey 201/963-6300 New York 212/349-7070



We've Got The

LOWEST PRICES!

All it takes is a Phone Call to Prove It!
CALL TOLL FREE

800-526-6070

FREE PRICE QUOTES & INFORMATION

We carry everything in stereo, audio, color & black & white TV's, C.B.'s, scanners, radar detectors, computer games, phone answering equipment, calculators, tapes, accessories, etc.

• SONY • PANASONIC • G.E. • ZENITH • RCA
 • SHARP • SUPERSCOPE • SANYO • TECHNICS

CIRCLE NO. 77 ON READER SERVICE CARD

CAROLE BAYER SAGER: . . . *Too*. Carole Bayer Sager (vocals); Marvin Hamlisch (piano); Bruce Roberts, Melissa Manchester (piano, vocals); Russ Kunkel, Jim Gordon (drums); Lee Ritenour, Steve Lukather (guitars); Alice Cooper (vocals); other musicians. *Peace in My Heart; You're Interesting; Shadows; One Star Shining; It Doesn't Add Up*; and five others. ELEKTRA 6E-151 \$6.98, © ET8-151 \$7.98, © TC5-151 \$7.98.

Performance: **Tepid**
 Recording: **Good**

It would be nice if I could be nicer about this album. Carole Bayer Sager has collaborated as a lyricist with just about everyone in the music business at one time or another, and she's written some really good things. *You're Interesting*, a song that she's done with Peter Allen and has included here, is one of them. But her wavery, tentative delivery makes the almost four minutes she takes to sing it seem interminable. She pulls in Marvin Hamlisch on piano to accompany her in a flashy Don Costa arrangement of *To Make You Smile Again*, but the result is as tepid as English beer. Sager has the contacts, prestige, and power to make recordings like this indefinitely, but it seems rather pointless. P.R.

RECORDING OF SPECIAL MERIT

THE SHIRTS. The Shirts (vocals and instrumentals). *Reduced to a Whisper; Tell Me Your Plans; Empty Ever After; Teenage Crutch; 10th Floor Clown; The Story Goes*; and five others. CAPITOL SW-11791 \$7.98, © 8XW-11791 \$7.98, © 4XW-11791 \$7.98.

Performance: **Nifty**
 Recording: **Fine**

As far as I'm concerned, the Shirts were far and away the stars of the "Live at CBGB's" album; they were the least doctrinaire participants (they couldn't care less about punk ideology), they had interesting ideas about songwriting, and though as instrumentalists they were obviously influenced by decidedly non-New Wave sources (Steve Howe of Yes, for example), they had as much energy and drive as any of the hard-core punkers. They were also blessed with a lead singer, the utterly adorable Annie Golden, who had great moves and a powerful (if occasionally out of control) voice that was difficult to reconcile with the fact that she appeared to weigh about thirty pounds.

It's taken a long time for the Shirts to land a record deal compared with the unseemly haste with which many of their colleagues were hustled into the studio, a sad situation that they attribute in part to a Manhattanite prejudice against their native borough of Brooklyn (they may be right). But, if anything, the wait probably did them some good, giving them time to tighten up a bit, and I am happy to report that their debut album is unusually promising. Oh sure, this is still a young band with some growing to do; a lot of their songs, especially such ballads as *Tell Me Your Plans*, try to cram too many deliberately clever time and chord changes into too small a musical frame. But even those, miraculously, don't lose the furious momentum and rock-and-roll kick that make the Shirts so endearing on stage. When they learn to relax a bit, they should really be something. In the meantime, the band already takes an intelligent

(Continued on page 165)

YES, KITS! Your Way To

The World's Finest Speakers

FRIED B/2 \$300 a pair SEMI-KIT
 (If Factory Assembled, \$500.)

MINI-MONITOR (satellites below) are psycho-acoustically engineered for astounding bass response. The low-coloration Bextrene bass/mid unit is combined with *Fried's* new high power dome tweeter for outstanding depth and detail. Power handling: 25-100 W.

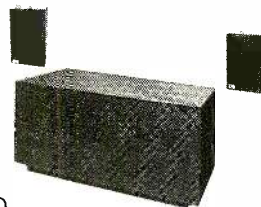

FRIED H/2 MONITOR SYSTEM \$800 SEMI-KIT
 (If Factory Assembled, \$1900.)

The H/2 combines the B/2 mini's with the new *Fried* dual channel transmission line sub-woofer for the ultimate no compromise system. The two new 10" high force factor Bextrene woofers produce 108 dB at 40 Hz and are flat to 20 Hz. Power handling: 25-100 W.

FREE CATALOG

JansZen Electrostats, Dalesford Bextrene
 Others from \$150 a Pair.

SoniKit

SR1-1173 65th Street, Oakland, Ca. 94608.

CIRCLE NO. 74 ON READER SERVICE CARD



QUALITY SOUND DIRECT

ALL the quality, mid and high end HI-FI, and VIDEO equipment you want at low direct prices you would not believe in an ad. . . . So send for our fall catalog with the coupon below, or call for immediate action!

SAVE NOW! . . .

Please Print

send me your Fall catalog NOW!

Name

Street

Town

State, Zip

QSD • Box 185, Villanova, Pa. 19085
 (215) 544-2277



Odd Couple: Cassidy & Ladd

LYRICIST Alan Jay Lerner, who ought to know whereof he speaks, recently wrote: "We live in a disposable age where what is new today is junk tomorrow. In popular music, what is junk tomorrow is also junk today." What he means, I'm sure, is not that the age itself is disposable, but that its culture is. Anyway, I could have danced all night with joy when I read those words and the plain common sense they represent. Most particularly because I'd just been confronted with two new releases, Shaun Cassidy's "Under Wraps" and "Cheryl Ladd," by the TV starlet of that name, that bear the same relation to music that frozen pizza does to food. Both albums are junk—expensive, carefully packaged, and unabrasive to the ear—and, like frozen pizza, they contain nothing to nourish the soul.

Shaun Cassidy's popularity has little to do with the way he sings. He is a teenage sex symbol following in the footsteps of such as Bobby Sherman and his half-brother David Cassidy, and the promotion of him is as intense, as calculated, and as cynical ("Milk him dry now; who knows who these crazy kids are gonna latch onto next . . .") as it would be for a new hair-spray. And Shaun Cassidy's records have little to do with music. They are simply easy tokens of his charismatic presence to throw around teenybopper households. I'm sure he could sell just as many records by sitting in front of a microphone and telling his fans what he did that day, how many cheeseburgers he ate, how many records he listened to, and what kind of girl he most likes to date. But the commercial system has dubbed him a "singer," and therefore he makes records.

And those records *sell*—do they ever! And, because few people have Alan Jay Lerner's courage or common sense, and because some of us in the media have, sheep-like, ever since the invention of the Demographic Youth Bulge in the Sixties, avoided telling it as we hear it for fear of being labeled part of the

gross, untrustworthy, over-thirty Establishment, records such as "Under Wraps" not only get made but reviewed. They're reviewed respectfully, because of the sales they represent, in the trade journals; exalted as "popular phenomena" by the hip weeklies desperately afraid of offending the Kids lest they take it out on advertising revenue; and treated everywhere else with a patronizing, sentimental fondness, dating back to the days of *Gidget Goes to an Orgy*, that seems based on a conviction that everything teenagers do is somehow "cute." Well, to hell with all that. Shaun Cassidy can't sing, he can barely manage to mouth the simplest lyric, and he comes across in this album more as a case of permanently arrested musical development than as in any way "cute."

CHERYL LADD, on the other hand, is so *darned* cute that one's first impulse is to squeeze her like a tube of toothpaste or French anchovy glop. Her reality quotient is, in truth, on just about that level. She's the girl who replaced Farrah Fawcett-Majors on the

Bunny doing "impressions" of soul singers from Bessie Smith through Janis Joplin. It will come as something of a surprise to her fans, I'm sure, that on these tracks she has a folk/street/black accent that would do credit to Muddy Waters. It is, like Bob Dylan's transfiguration into an Okie from Milwaukee the minute he hit a recording studio, one of those show-biz marvels that sometimes gives one a little tinge of suspicion about a performer's sincerity. Ms. Ladd's album may or may not sell (her audience is perhaps a little cooler in responding to her allure than Cassidy's prisoners of love are in succumbing to his), but, along with those of her "singing" TV cohorts, it doesn't really deserve review because nothing in it tries for excellence on any level.

THE sadness I feel about the unadulterated hype these albums represent is twofold: one, that the public sits still for this kind of thing; and, two, that as a reviewer I've been lazily content to take a sort of madness-of-the-crowd, that's-show-biz attitude toward it. Mr. Lerner's brave words have helped me to see the light, and I promise that in future I won't hesitate to tell you when a new piece of junk hits the pile. —Peter Reilly

Nothing in it tries
for excellence on
any level . . .

SHAUN CASSIDY: *Under Wraps*. Shaun Cassidy (vocals); orchestra. *Hard Love*; *Taxi Dancer*; *Lie to Me*; *One More Night of Your Love*; *It's Like Heaven*; *Our Night*; *She's Right*; *Midnight Sun*; *Right Before Your Skies*. WARNER BROS. BSK 3222 \$6.98, © M8 3222 \$7.97, © M5 3222 \$7.97.

CHERYL LADD. Cheryl Ladd (vocals); orchestra. *Think It Over*; *Walking in the Rain*; *Skinnydippin'*; *I Know I'll Never Love This Way Again*; *Lady Gray*; *Good Good Lovin'*; *You Turn Me Around*; *I'll Come Runnin'*; *Here Is a Song*; *The Rose Nobody Knows*. CAPITOL SW-11808 \$6.98, © 8XW-11808 \$7.98, © 4XW-11808 \$7.98.

world's most inane TV show, and she's not wasting any time carving out a piece of pop notoriety for herself. Her new record, junk incarnate and enshrined, seems to be just one of the several fronts she's moving on right now. She claims to have spent part of her early professional career as a singer. Just where that might have been boggles the mind, since on this recording she sounds like a Playboy

middle course between the complexity (sterility?) of the art rockers and the passion (misplaced aggression?) of the punks. Believable, assured, unselfconscious, the Shirts are, in other words, something like the best of both worlds. Long may they drip dry. S.S.

CANDI STATON: *House of Love*. Candi Staton (vocals); vocal and instrumental accompaniment. *Victim; Yesterday Evening; I Wonder Will I Ever Get Over It; I'm Gonna Make You Love Me*; and three others. WARNER BROS. BSK 3207 \$6.98, © M8 3207 \$7.98, © M5 3207 \$7.98.

Performance: **Engaging**
Recording: **Very good**

In the past, Candi Staton did not make a strong impression on me. Though her records were well done for the most part, she seemed to be one of the numerous competent but unspectacular soul singers scuttling about in the wake of the real heavies. But her new album offers a great deal to solidify her previously nebulous image. Much of the material here is lightly rocking, traditional r-&-b reminiscent of the engaging fare that gushed out, like black gold, from Memphis a decade ago. Indeed, there are moments on *Victim, So Blue*, and *I Wonder Will I Ever Get Over It* when she sounds a bit like a female Al Green, but without his affectations. This hint of the past lends a nostalgic touch to her rendition of the evergreen *I'm Gonna Make You Love Me*, while *Yesterday Evening* is more contemporary in tone, with a better than average melodic line and imagination apparent in the lyrics and arrangement.

The most exciting goody tucked into this surprisingly good set is the final track, a deeply emotional, unadulterated gospel reading of the Thomas Dorsey classic *Take My Hand, Precious Lord*. Here Staton sets aside all the flashy embellishments of show biz and simply lets her roots hang out to a piano accompaniment that rings true to the styles of the black church. It is ample evidence that she is a singer as capable of interpreting the moods of Sunday morning as of Saturday night. Should she ever decide to reverse the migration from gospel to pop that has marked the careers of so many artists of her genre, she might well set in motion a tidal wave of response. P.G.

JESSE WINCHESTER: *A Touch on the Rainy Side*. Jesse Winchester (vocals, guitar, keyboards); instrumental accompaniment. *A Touch on the Rainy Side; A Showman's Life; Sassy; Candida; High Ball; Holly*; and four others. BEARVILLE BRK 6984 \$7.98, © M8 6984 \$7.97, © M5 6984 \$7.97.

Performance: **Overproduced**
Recording: **Very good**

Jesse Winchester wasn't a one-issue folk artist when he was a draft exile in Montreal and not allowed to tour the States (as he has since done) or to record in Nashville (as he did in this case), but his music then had an edge on it that's clearly missing here. He's still capable of being elegantly and eloquently laconic, and he can still write a mighty pretty little melody, but his older albums seem to have a much greater sense of purpose and responsibility behind them than this one does. This one seems to aspire to be another of those airy, pleasant, undistinguished albums so common to the late Seventies. Jesse Winchester, finally able to use those sharp Nashville studio

(The Advent
Model 300 Stereo Receiver)

The Alternative.



Among today's stereo receivers, there is one—the Advent Model 300—that is clearly different. No flashing lights, gold inlays, or massive handles. Just sound quality comparable, within its power capabilities, with the best—including a phono preamp rated better than an \$1,800 separate preamp by a supercritical audio publication. This, together with excellent FM reception, comes for \$279.95* in a com-

pact, unobtrusive package that fits almost anywhere.

For full information, please send in this ad.

Name _____

Address _____

City _____

State _____ Zip _____

*Suggested price, subject to change without notice.

Advent Corporation

195 Albany Street, Cambridge, Massachusetts 02139

SR-11/78



CALENDAR OF CLASSICAL COMPOSERS

BACK by popular demand and updated from its original (1966) printing, Music Editor James Goodfriend's *Calendar of Classical Composers* is a listing of the most important composers from the year 1400 to the present, grouped according to the stylistic periods—Renaissance, Baroque, Classic, Romantic, etc.—in which they worked. This 12 x 24-inch aid, guide, and complement to your music listening is printed in color on heavy, non-reflecting stock suitable, as they say, for framing. A key to the calendar, consisting of capsule accounts of the principal stylistic characteristics of each musical period, is included. The whole will be sent rolled in a mailing tube to prevent creases; we pay postage. All you do is send 25¢ to:

Calendar of Classical Composers
Stereo Review, 1 Park Avenue, New York, N.Y. 10016



PIONEER

PIONEER ELECTRONICS

SX-1980	\$788.00
SX-1280	583.00
SX-1080	457.00
SX-980	372.00
SX-880	288.00
SX-780	228.00
SX-680	193.00
SX-580	165.00
SA-9500 II	302.00
SA-8500 II	230.00
SA-7500 II	165.00
TX-9500 II	265.00
TX-8500 II	196.00

PIONEER TURNTABLES

PL-630	\$252.00
PL-610	221.00
PL-560	180.00
PL-540	146.50
PL-518	114.00
PL-516	105.00
PL-514	89.00

PIONEER CASSETTE DECKS

CT-F1000	\$391.00
CT-F9191	314.00
CT-F900	312.00
CT-F700	245.00
CT-F6262	200.00
CT-F500	126.00

PIONEER LOUDSPEAKERS

HPM-150	\$330.00
HPM-100	172.00
HPM-60	129.00
HPM-40 PACKED PRS.	172. PR

OTHER BARGAINS

SANSUI 221	\$ 95.00
TEAC A-103	165.00
MARANTZ 2325	450.00
SHURE V15 III	63.00
DUAL 1245 W/BASE & COVER	162.00
SONY TCK-4	180.00
MARANTZ 7 MK II	94.00
KOSS PRO-4AAA	39.00

- These and forty more major component brands.
- Prices quoted are w/o freight.
- Write or phone your needs — all quotes answered same day.
- All units factory sealed
- Full manufacturer warranty.
- Shipped fully insured.

send for free catalog

name _____

address _____

city _____

state _____ zip _____

illinois audio

12 East Delaware Place, Chicago 60611

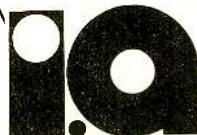

Phone flow!
(312) 664-0020

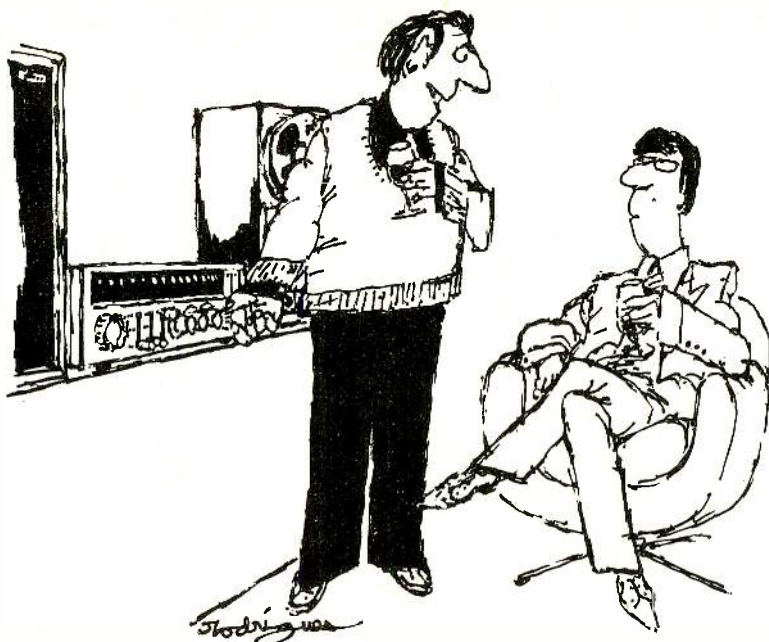

"I had it fitted with a special filter so it plays only the Top 40."

musicians in one of their favorite settings, the old-house informality of Quadrafonic Studios, could have done a lot of things more interesting than this too-smooth, semi-cushy, almost-orchestrated collection of so-what observations. I don't object to the smoothness and mellowness of his *singing*, though, and the melodies *are* pretty, even for a time that's been concentrating on prettying up the melodies. But the lyrics are mostly background music, and I don't think writing those is how Jesse Winchester ought to spend his time—or that listening to them encased in big, gas-guzzler arrangements is how I ought to spend mine.

JOHNNY WINTER: *White, Hot & Blue.* Johnny Winter (vocals, guitar); Edgar Winter (piano); Bobby Torello (drums); I. P. Sweat (bass); Pat Ramsey (harmonica); Pat Rush (guitar). *Walkin' by Myself; Slidin' In; Diving Duck; One Step at a Time; Nickel Blues*; and four others. **BLUE SKY JZ 35475 \$7.98, © JZA 35475 \$7.98, © JZT 35475 \$7.98.**

Performance: **Carried away**
Recording: **Good**

Johnny Winter's recent association with master bluesman Muddy Waters has prompted him to go back and play hardnosed blues, raise hell, and have fun the way he did before he was hailed as a major rock star a decade ago. Winter's enthusiasm for the freedom of blues playing as opposed to the orthodox trappings of rock is evident on this new album, and, while he may not be the guitarist the media claimed he was in 1968, he is a capable and experienced musician.

But enthusiasm is sometimes a problem with these performances. Winter gets so carried away with the energy and excitement of stomp-and-holler blues that he winds up playing standard guitar solos and indiscriminately growling his way through the vocals. Part of the greatness of blues as a musical form is its potential for subtlety, and Winters almost misses that entirely—except for a fine, restrained reading of Jimmy Reed's *Honest I*

Do, the best cut on the disc. The most disorganized cut is Winter's own *Nickel Blues*, in which neither he nor brother Edgar on piano appear to be listening to each other (boy, they *really* must have been loose on this one). But there's a great funny line in the lyrics: "Guess I'll pack my bags, throw a nickel in the air/If it comes down tails, I'm gonna get mine outta here."

LORNA WRIGHT: *Circle of Love.* Lorna Wright (vocals); vocal and instrumental accompaniment. *Night Music; Love Is Forever; Get a Little Crazy; Magic in Your Eyes; You Have Me; You Can't Find Yesterday*; and five others. **ROCKET BXL1-2902 \$7.98, © BXS1-2902 \$7.98, © BKK1-2902 \$7.98.**

Performance: **Promising**
Recording: **Good**

Lorna Wright is the sister of Gary Wright (originally of Spooky Tooth) and has had studio and stage experience as a back-up singer. She makes her debut here as a solo artist with a convincing voice, a solid delivery, lots of energy, and too many songs—mostly written by herself—that don't do her much good. This is an album in search of a hit single, by an artist in a hurry to establish her own identity. Ms. Wright shouldn't be so anxious. She has the talent to go where she wants to, but it will probably take her two or three albums with a more careful choice of songs before she gets there.

COLLECTIONS

RECORDING OF SPECIAL MERIT

THE FESTIVAL TAPES. John Hartford (vocals, guitar, fiddle); Bryan Bowers (autoharp); New Grass Revival (vocals and instrumentals); Byron Berline and Sundance (vocals and instrumentals); Tim Goodman (vocals, guitar); Peter Rowan (vocals, mandola); other musicians. *Blackberry Blossom; Love You Like a Man; Waugh Paugh; Goin' Back to Old* (Continued on page 168)

Stereo Review's

'HOW TO' REPRINT SERIES

Whether you are about to buy your first high-fidelity component or your fifteenth, you need to have all the facts you can get your hands on if you want to insure your complete satisfaction. Yes, the audio field is a complicated one, but *Stereo Review* has been running a kind of monthly seminar on the subject for almost two decades now, furnishing the kind of basic buying, installation, and operating guidance you can get nowhere

else. Today, over 450,000 readers use it monthly as the first, best textbook in their on-going audio educations. If you have come a little late to class, here's your chance to catch up. Any questions you may have about *How to Buy*, *How to Set Up*, *How to Use*, or *How to Understand* audio equipment are probably answered in one or more of the reprints listed below.

✓ DENOTES NEW REPRINTS AVAILABLE FOR THE FIRST TIME.

1. ROOM ACOUSTICS (How to Correct Your Room Acoustics)
2. GUIDELINES TO SPEAKER SHOPPING
3. RECORD DEFECTS (Their Causes & Cures)
4. LOUDSPEAKER POWER NEEDS (How Much Power Do You Need for Your Speakers)
- * 5. HOW IMPORTANT IS AUDIO-COMPONENT COMPATIBILITY?
6. GUIDE TO UPGRADING YOUR COMPONENTS
7. HOW TO SELECT A MICROPHONE
8. HOW TO CHOOSE AN AMPLIFIER
9. HI-FI TROUBLESHOOTING CHARTS
10. SPEAKER MYTHS (How to Avoid Bad Choices)
12. HOW TO SELECT AN FM TUNER
13. HI-FI DEMONSTRATION DISCS
- * 14. AUDIO EQUALIZERS (Understanding and Choosing Equalizers)
15. CLEAN UP AND TUNE UP YOUR AUDIO SYSTEM
17. USING FM INTERSTATION HISS TO TEST RECORDERS AND SPEAKERS
18. HOW TO BUY A RECEIVER
19. HOW TO BUY A PHONO CARTRIDGE
20. THE PROFESSIONAL APPROACH TO TAPE RECORDING
- * 21. HOW TO ELIMINATE RADIO-FREQUENCY INTERFERENCE
- ✓* 22. NOISE REDUCERS
- ✓ 23. UNDERSTANDING RECORD PLAYERS
- ✓ 24. HOW TO BUY HI FI (A Beginners Guide To Hi Fi)
- ✓ 25. HOW TO BUY A CASSETTE DECK

*Reprints marked with Asterisk \$1.50. All others, \$1.00. Minimum order \$3.00.

STEREO REVIEW REPRINTS, Dept. D1180
 P.O. Box 278, Pratt Station
 Brooklyn, New York 11205
 Please send the reprints listed below:

\$1.00 EACH

Reprint #	Quan.	Reprint #	Quan.

\$1.50 EACH

Reprint #	Quan.	Reprint #	Quan.

NUMBER OF REPRINTS ORDERED:

@ \$1.00 _____ @ \$1.50 _____

TOTAL ENCLOSED
 (MINIMUM ORDER \$3) _____ †

† Residents of CA, CO, DC, FL, IL, MI, MO, NY STATE, TX, AND VT add applicable sales tax. Outside U.S.A. add \$1.00 per order.

Print Name _____

Address _____

City _____

State _____ Zip _____

INSTANT SHELVING

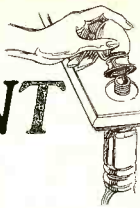

You assemble Kirsch Shelving in minutes with just a twist of the wrist. Ring-Lock® construction assures stability.

Modular design lets you start small and add on as your needs grow.

Available in Kirsch kits or components in a choice of stain-resistant, vinyl-laminated finishes.

For shelving brochure and dealers near you, write Kirsch Co., Dept. DR 1178, Sturgis, Mich. 49091.

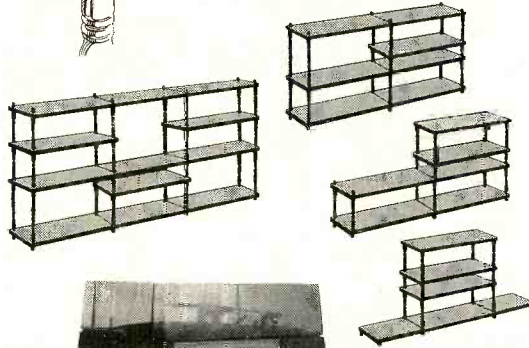

Kirsch

THE GREAT SPACEMAKER

©Registered TM, Kirsch Company

CIRCLE NO. 45 ON READER SERVICE CARD

Hand Music

The **Beomaster 2400 receiver**. Music at your fingertips from anywhere in your listening room. Cordless remote control makes music so convenient, so accessible, that it's woven naturally into your life. Our portfolio of literature explains this sophisticated receiver in detail. Write to us for it.



Bang & Olufsen

Bang & Olufsen of America, Inc. • 515 Busse Rd. • Elk Grove Village, IL 60007 • Dept. 12

CIRCLE NO. 11 ON READER SERVICE CARD

Kentucky; *Fiddler's Dream*; and four others. FLYING FISH FF-068 \$7.98.

Performance: **Rocky Mountain highs**
Recording: **Excellent remote**

Telluride, Colorado, at whose fourth Bluegrass and Country Festival this album was taped, has got to have one of the most spectacular settings of any village anywhere. Peaks of the San Juan range, two miles high, surround it on three sides. Playing in such a setting, I should think, would both inspire and humble a picker, for what he's doing is going out and nestling beside one of nature's real beauts, one of nature's greatest hits, you might say. And these pickers *do* seem inspired, or something, for they put some life into this live recording. Peter Rowan's *Land of the Navajo*, a haunting song that uses bluegrass instrumentation to make an unbluegrass sound, is my favorite, but there are several contenders, starting with John Hartford's *Nobody Eats at Linebaugh's Anymore* (it's about poor old Broadway in Nashville now that the Grand Ole Opry has moved to the outskirts of town). Byron Berline does some outstanding fiddling in three different songs, and the "bluegrass and country" ranges from the new-frontiers/semi-electric bluegrass of Berline's band *Sundance* to the almost-jugband stuff by Dan Sadowsky and Washboard Chaz. This festival was held in June 1977, and, judging from this disc, I'd say the quality of music in that month was worthy of a place where Mother Nature once patted her foot. N.C.

SIX PAK, VOLUME 1. Willie Nelson: *Some Other Time*; *Face of a Fighter*. Ray Wylie Hubbard: *Up Against the Wall Redneck Mother*; *Radio Song*. Cooder Browne: *Swinging with the Armadillo*; *Lonesome Rider*. Don Bowman: *Willon and Waylee*; *Power Tool Song*. Steve Fromholz: *Heroes*; *Fool's Gold*. Geezinslaw Brothers: *Another Pretty Country Song*; *Who's a Fool*. LONE STAR L-4600 \$7.98, © LC8-4600 \$7.98, © LCR4-4600 \$7.98.

Performance: **A little flat**
Recording: **Variable**

Seems an inauspicious way to revive Willie Nelson's Lone Star label, this little hodgepodge of regional and heretofore dormant talent (first I've heard of the Geezinslaw Brothers or Don Bowman in years), but that's the thing about undertaking to make Austin, Texas, a recording center. You have to start with the fact that Jerry Jeff Walker and Asleep at the Wheel and other local biggies (including Willie Nelson himself, represented here with two trebly-sounding minor songs recorded in, for Crissakes, 1961) are already signed up with other labels out of Nashville and New York and such places. Still, this isn't bad if you take it as a little novelty kind of thing. Bowman, who usually isn't as funny as he thinks he is, comes up with some actual satire in *Willon and Waylee* ("If I could get Willie . . . if I could get Waylon . . . to sing along with me," which, of course, he does), and Cooder Browne's modified Texas swing goes very nicely in there. I remember the Geezinslaws as being a lot funnier than this, though, and I reckon I'll stick with Bobby Bare's version of Ray Wylie Hubbard's *Up Against the Wall Redneck Mother*. But it's a start, and people, including musicians, are attracted to Willie, so I expect Lone Star to develop a little more kick as it ages. N.C.

STEREO REVIEW

DISCO



CROWN HEIGHTS AFFAIR: *Dream World*. Crown Heights Affair (vocals and instrumentals). *Galaxy of Love*; *I Love You*; *Say a Prayer for Two*; *Dream World*; *Things Are Going to Get Better*; and two others. DE-LITE DSR-9506 \$7.98, ® DC8-9506 \$7.98, © DCR4-9506 \$7.98.

Performance: **Loud but lean**
Recording: **Very good**

If raw energy were all that counted, this group of singing instrumentalists would walk away with a ton of trophies, so dense is the cloud of dust they stir up with their whumping and thumping. Unfortunately, little happens behind all that furor. The songs are based on trite little phrases that are repeated ad infinitum, vocally and instrumentally. Maybe too much of the effort went into the production of the disc; the first track, *Galaxy of Love*, is so cluttered with special electronic effects that it might better have launched a bona fide rocket than the tin can with an outside fuse the album turns out to be. The screaming horns and plodding rhythm section deserve special dishonor. Rather than a dream world, Crown Heights Affair has created an overamplified nightmare. P.G.

CISSY HOUSTON: *Think It Over*. Cissy Houston (vocals); vocal and instrumental accompaniment. *Think It Over*; *Love Don't Hurt People*; *Somebody Should Have Told Me*; *After You*; *I Just Want to Be with You*; and four others. PRIVATE STOCK PS 7015 \$7.98.

Performance: **Struggling to overcome**
Recording: **Satisfactory**

Cissy Houston has spent so many of the best years of her life supporting other artists as a background singer at recording sessions that she must by this time be due a Vinyl Heart for distinguished service. It is easy to understand why others have wanted to employ her talents. As a former lead gospel singer, she has the power and thrust to lift off almost any song from ground zero, forcing it to soar. Then, too, there is her throaty voice, a fine, rich instrument that can move into the higher registers without exhibiting any traces of strain. She endows whatever she sings—no matter how trite—with conviction and emotion. She is, in short, a first-rate musician.

In view of what Houston has to offer, it is lamentable that this new solo album is laced with third- and fourth-rate material. Admittedly, the disco numbers that make up two-thirds of this set are catchy in a pedestrian sort of way, but the singer is so much better than what she sings here. Most of the time she is done in by a leaden monotonous beat, and there are only spotty traces of her extraordinary abilities. Only *After You* and *I Just Want to Be with You* are fully representative of

Q • Where should you start in your search for better sound?

A • At the beginning. With a new Audio-Technica Dual Magnet™ stereo phono cartridge.

Our AT12XE, for instance. Tracking smoothly at 1 to 1-3/4 grams, depending on your record player. Delivers smooth, peak-free response from 15 Hz to 28,000 Hz (better than most speakers available). With a minimum 24 dB of honest stereo separation at important mid frequencies, and 18 dB minimum separation even at the standard high-frequency 10 kHz test point. At just \$65 suggested list price, it's an outstanding value in these days of inflated prices.

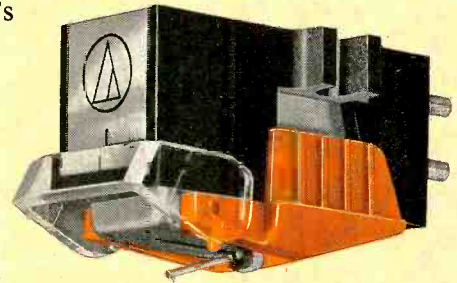

Audio-Technica cartridges have been widely-acclaimed for their great sound, and for good reason. Our unique, patented* Dual Magnet construction provides a separate magnetic system for each stereo channel. A concept that insures excellent stereo separation, while lowering magnetic mass. And the AT12XE features a tiny 0.3 x 0.7-mil nude-mounted elliptical diamond stylus on a thin-wall cantilever to further reduce moving mass where it counts. Each cartridge is individually assembled and tested to meet or exceed our rigid performance standards. As a result, the AT12XE is one of the great bargains of modern technology ...and a significant head start toward more beautiful sound.

Listen carefully at your Audio-Technica dealer's today.

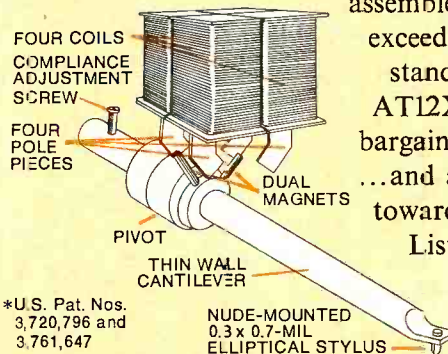

*U.S. Pat. Nos. 3,720,796 and 3,761,647



audio-technica
INNOVATION □ PRECISION □ INTEGRITY

AUDIO-TECHNICA U.S., INC., Dept. 118F, 33 Shawnee Avenue, Fairlawn, Ohio 44313
In Canada: Superior Electronics, Inc.

CIRCLE NO. 42 ON READER SERVICE CARD



The New 1978 Basic Repertoire

STEREO REVIEW again presents the annual revision of the Basic Repertoire. In pamphlet form, it includes 1978 disc and tape recommendations for 173 standard musical works. For your copy, send 50¢ in coin, plus a stamped, self-addressed No. 10 envelope (9½ x 4¾ in.), to Esther Maldonado. STEREO REVIEW, 1 Park Avenue, New York, N.Y. 10016.

BACK ISSUES AVAILABLE...



If you've missed any of the previously published issues of Stereo Review Magazine a wide selection is still available. Copies may be ordered for issues published during the past 36 months. In the event a particular issue ordered is out of print your payment will be returned promptly.

Place your order by mailing \$2.00 for each copy (\$2.50 outside U.S.A.) to Stereo Review, P.O. Box 278, Pratt Station, Brooklyn, 11205.

Please be sure to enclose payment and identify the specific issues you wish to receive.

what she has to offer; they are *almost* good enough to compensate for all the other disappointing moments. Perhaps next time around the *real* Cissy Houston will be permitted to stand up for the whole record. P.G.

RECORDING OF SPECIAL MERIT

PAUL JABARA: *Keeping Time*. Paul Jabara (vocals); vocal and instrumental accompaniment. *Didn't the Time Go Fast; Saturday Matinee; Dancin'; Last Dance*; and four others. CASABLANCA NBLP 7102 \$7.98, ® NBL8 7102 \$7.98, © NBL5 7102 \$7.98.

Performance: **Super**
Recording: **Topnotch**

Fresh from his featured role in the disco-oriented film *Thank God, It's Friday*, Paul Jabara delivers one impressive performance after another on his second LP. He teams his high-steppin' version of Carol King's *Take Good Care of My Baby* in a medley with his own *What's a Girl to Do*, sung solo with infectious glee by Pattie Brooks. A new Jabara song, *Dancin' (Lifts Your Spirits Higher)*, is among the best of the "shake it, make it, take it" songs about disco fever. Jabara's own version of his TGIF monster hit *Last Dance* has about one-tenth the horsepower of Donna Summer's rendition, but it is very well sung indeed. In addition, I nominate the long orchestral introduction to *Something's Missing* for the Disco Hall of Fame. Bravo, arranger-conductor Bob Esty! No one could possibly sit still through this, and the electronic flashes and jagged pieces of horn music that punctuate it are original and exciting. The song that finally follows is a good romantic ballad, but it's nowhere near as inspired as that intro. —Edward Buxbaum

LUV YOU MADLY ORCHESTRA. Luv You Madly Orchestra (instrumentals and vocals). *Moon Maiden; Soda Fountain Rag; Hippo Hop; Fleurette Africaine; Rocket Rock*; and four others. SALSOL SA 8507 \$7.98, © S8 8507 \$7.98, © SC 8507 \$7.98.

Performance: **Disco Duke**
Recording: **Good**

"Love you madly" was Duke Ellington's favorite phrase, but I doubt that he would have used it in connection with this enigmatic al-

bum of Ellington compositions butchered in disco style. Kermit Moore arranged and conducted this mess, but concept and production are credited to Duke's nephew, Stephen James, who, along with Moore, also wrote the album's two original compositions, proving in a most graphic way that creativity and taste do not necessarily run in the family.

An opening eight-minute medley begins with science-fiction-movie effects that modulate into Duke's six-tone musical phrase, *In the Beginning God*, disco-beats its way through atrocious snatches of such popular Ellingtonia as *Satin Doll, Caravan, Take the "A" Train, I Let a Song Go Out of My Heart*, and *Mood Indigo*, and fizzles out with a confusion of computer sounds, screaming women, cowbells, and a gong, all of which is somehow supposed to be a rendition of Duke's beautiful 1962 composition *Melancholia*. The ladies return, sighing, oohing, and aahing through *Moon Maiden* and three other lesser-known Ellington compositions drenched in disco clichés. Duke's first composition, *Soda Fountain Rag* (1916), gets a corny Saturday morning TV cartoon treatment, and Billy Strayhorn's *Lotus Blossom*, which ends the album, has been reduced to something that has both the technical sound and the style of bridge music from a Forties radio production. The two new selections are easily forgotten, but I should mention that one of them, *Hippo Hop*, seems to have been mastered at a fraction of the speed of the original recording; playing it at 45 rpm makes the strings sound less like the Portsmouth Sinfonia, but the real advantage is that it shortens what is a painful experience at any speed.

The producer's mother, Ruth Ellington (Duke's sister), wrote the album notes—a brief history of each selection—and I suppose this whole thing was done as an attempt by the Ellington estate to invade the lucrative disco market. Ellington was not the purist some of his followers are, and he would probably have welcomed the thought of translating his music into today's disco language, but this desecration will please neither Duke devotees nor disco dancers, who, believe it or not, have standards too. C.A.

MUSIQUE: *Keep On Jumpin'*. Musique (vocals); instrumental accompaniment. *Keep On Jumpin'; Summer Love; In the Bush; Summer*



THE SYLVERS:
disco music with
class as well as flash

Casablanca Records

Love Theme. PRELUDE PRL 12158 \$7.98. © PRL8 12158 \$7.98. © PRL9 12158 \$7.98.

Performance **Formula disco**
Recording: **Imbalanced**

At first glance, this album has lots of promise. It contains only four cuts, suggesting that Musique would like to give us dancing folk plenty of time to work up a disco sweat. Unfortunately, the engineering focuses so lopsidedly on the four girls' voices and on the percussive beat that the strings (and there are a lot of them) are never given a chance to vary the dance mood. The music gets monotonous, and adjusting your equalizer doesn't help.

The title cut, of the "everybody-jumpin'-till-you-see-the-sun-in-the-sky" variety, just goes on and on. *Summer Love* is much better, although it is another disco cliché, this time a pitch to the beach scene. The instrumental reprise on side two, oddly enough, is dancier. *In the Bush* has caught on in the raunchier discos, but it too needs remixing. There's a lot of music buried in the tracks—electric guitars, strings, and I think I heard a keyboard or two—that would make this album more fun to dance to if it were brought forward.

—Edward Buxbaum

RECORDING OF SPECIAL MERIT

SUPERMAX. Supermax (vocals and instrumentals). *Dance, Dance, Dance; Don't Stop the Music; I Am What I Am; Lovemachine;* and four others. VOYAGE V444 \$6.98.

Performance: **Heavy!**
Recording: **Superb**

The Germans have done it again. This Frankfurt product is the debut of both a new group and a new label, and it's one of the heaviest dance, dance, dance discs of the year. In fact, the first song is called *Dance, Dance, Dance* (not to be confused with several others of the same title) and it gets going with a syncopated, percussive rhythm augmented by sexy electronics. Sexy the album stays with *Push, Push (Sexy Chocolate Girl)*, which I thought was the most sensuous disco song I'd ever heard until I swayed through six minutes of *Don't Stop the Music* two cuts later on the same side (listen to this one even if you don't dance—I'm sure you'll think of something else to do while it's on). Other high spots here are the soaring finale to *Watch Out South Africa, Here We Come* and composer-arranger Kurt Horenstein's vocal work on the soulful *I Am What I Am* (again, not to be confused with the very different song of the same title by the Village People).

The sound throughout is clear as a bell and state-of-the-art deep, as we've come to expect from German engineers. There's an awful lot going on musically, yet everything is up front and perfectly balanced despite the density. Wow!
—Edward Buxbaum

RECORDING OF SPECIAL MERIT

THE SYLVERS: Forever Yours. The Sylvers (vocals); instrumental accompaniment. *Don't Stop, Get Off; Love Changes; Forever Yours; Come On Down to My House;* and six others. CASABLANCA NBLP 7103 \$6.98.

Performance **Bounce to every ounce**
Recording: **Very good**

Like the Jacksons, the Sylvers have grown up, though they have apparently retained

TOLL FREE 800-356-9514

KENWOOD



DC Stereo Integrated Amplifier
KA-7100

Dual



Direct Drive Single Play Semi-Automatic
DUAL 604

TEAC



Front Load Cassette Deck
A-105

- Home and Car Stereo
- Over 60 Brands Stocked and Discounted
- Write for Free Price Sheet
- All Equipment in Factory Sealed Cartons
- MASTER CHARGE and VISA Accepted by Phone

WDS

ISCONSIN DISCOUNT
STEREO

For The Lowest Prices
Call Toll Free

800-356-9514
608-271-6889

2517 whalen lane madison, wisconsin 53713

CIRCLE NO. 92 ON READER SERVICE CARD

TOP

DISCOUNT AUDIO

1150 N. Powis Rd.
West Chicago, IL 60185

YOUR NATIONAL HEADQUARTERS FOR NAME BRAND ELECTRONICS BY MAIL

MULTI-MILLION
\$\$\$
INVENTORY

FULL
MANUFACTURER
GUARANTEE
APPLIES
TO ALL SALES!

ALL ORDERS
Shipped In
Factory-Sealed
Cartons—
Most Within
24 Hours!

RECEIVERS • SPEAKERS • COMPACTS

AUTOMOTIVE • AMPLIFIERS • TUNERS

TOP DISCOUNT
AUDIO

1150 N. Powis Rd.
West Chicago, IL 60185
(312) 293-1825

We Honor VISA and
MASTERCHARGE
By Phone or Mail

Send catalog

MR. _____
MS. _____
(First) (Initial) (Last) (Date)

(Number and Street)

(City) (State) (Zip code)

Call or Write for the LOWEST PRICES Anywhere!

SR-11

TAPE DECKS • CHANGERS • CARTRIDGES • HEADPHONES



MCA Records

The late Keith Moon

Requiem for The Who

WE might as well face up to it: any Who album that contains three John Entwistle songs, *none of which are funny*, is in trouble right from the start. "Who Are You" baffles me. If there was ever a time when the Who could have been expected to come roaring back with the kind of raw energy and sly wit that has been seeping out of their music since the dawn of the Seventies, it is right now, when the New Wavers are breathing heavily down their necks.

Not that they have anything to prove, mind you. Paul Weller of the Jam said it best recently when he remarked that all the punk bands that claim never to have listened to the Who are simply not telling the truth. And I certainly don't mean to imply that the relatively reflective tone of both "Quadrophenia" and "The Who by Numbers" is an indication of creeping senility. In fact, both those albums have more than their share of real rock magic; you just have to listen a little harder to catch it.

No, it's just that Townshend's duet album with Ronnie Lane earlier this year was so bloody marvelous, and the interviews Pete has given lately (especially the two-parter in *Trouser Press*) suggested that he was as in touch as ever with the fans, the state of rock, and how what has been going on around him affects his own elder-statesman position. So while it was obvious that the new album would be, as usual, a meditation on the Who's relationship with rock, the very last thing I would have expected was that the product itself would be so . . . well, for want of a better word, Winwoody (as in *Sometimes I Feel So Uninspired*).

To be blunt about it, "Who Are You" is the very first Who album that I have ever found to be dismissable. Indeed, it's the only one I've ever had to push myself to listen to more than a couple of times. It's tuneless, for starters,

and at the very least I expect Pete to knock out a good melody or two, even now when he appears to have turned over an unprecedented amount of the songwriting responsibility to Entwistle. Of course, there's nothing dishonorable about losing one's muse temporarily; every creative person hits a dry stretch now and then. But somehow I can't help feeling that there is some more fundamental problem behind the lapses of "Who Are You."

Perhaps the title should be taken literally, as a question of identity. Perhaps Pete really is out of touch, not in the sense of not reading the papers or keeping up with the younger bands, but of being caught in a Yeatsian funk: the center cannot hold, and mere punk is loosed upon the world. In the album's one moderately compelling song he wails that "music must change," and he clearly means it; but what's never resolved is whether he means it the way the punk bands do—Death to the Dinosaurs—or the way the Sixties progressives believed that every new record had to be some kind of adventurous staking out of new musical turf (the pipe dream that rock was limitless).

Maybe Pete's frustrations are not with growing old, after all, but with rock itself. Chasing the Lost Chord well into disillusionment, he seems as let down by rock as Jimmy, the hero of "Quadrophenia," was let down by being a Mod. And if the central focus of one's life begins to dissolve, the resulting depression could easily explain producing an album as basically empty as this one. How else can you account for *New Song*, the first track, in which we are explicitly told that it is just the same old stuff, but now dished out without a shred of conviction?

I should mention, I suppose, at least in passing, that as an ensemble the Who still plays immensely better than just about anybody else and that the integration of Entwistle's one-man horn section with Pete's synthesizer work is, in the abstract, quite breathtaking. But the surface sheen of the material here cannot disguise the fact that there is next to nothing below that surface, and because of that the Who now seems to me like a band without a future. Believe me, I don't like having to say that, but until I figure out whether "Who Are You" has some deliberately world-weary melancholy undercurrent that I haven't connected with yet, that's the inescapable conclusion.

THE above was written before news came that the Who's Keith Moon, the most gifted and original rock drummer of the last twenty years, had died. Since replacing him would be like replacing one of the Marx Brothers—all but impossible—his death would seem to signal the end of the group as well. Anyone who doesn't own all their earlier albums is the poorer for it; "Who Are You" notwithstanding, they were the greatest rock band ever.

—Steve Simels

THE WHO: Who Are You. The Who (vocals and instrumentals); Rod Argent (keyboards); other musicians. *New Song; Had Enough; 905; Sister Disco; Music Must Change; Trick of the Light; Guitar and Pen; Love Is Coming Down; Who Are You.* MCA MCA-3050 \$7.98, © MCAT-3050 \$7.98, © MCAC-3050 \$7.98.

more of the youthful exuberance and spontaneous feeling that made them favorites among bubblegummers of all ages. Perhaps they were spared by just narrowly missing the sort of overblown superstardom that might have spoiled them. Their voices are more mature now, somewhat deeper, but the spirit and tastefully blended ensemble singing are as exciting as ever. This is disco music with class as well as flash, and the intention is clearly set forth in such songs as *Play This One Last Record* and *Come Dance with Me*. The opener, *Don't Stop, Get Off*, bounds out at a whoopingly lively pace that is maintained throughout, though a couple of semi-softies are slipped in for good measure. This is a funfest that also hits the mark musically. P.G.

RECOMMENDED DISCO HITS

- **ASHFORD & SIMPSON: *Is It Still Good to Ya.*** WARNER BROS. BSK 3219 \$7.97, ® M8-3219 \$7.97, © M5-3219 \$7.97.
- **ROY AYERS: *You Send Me.*** POLYDOR PD1-6159 \$7.98, ® 8T1-6159(A) \$7.98, © CT1-6159(A) \$7.98.
- **KONGAS: *Anikana-O.*** SALSOU SA8512 \$7.98, ® S8-8512 \$7.98, © SC-8512 \$7.98.
- **METROPOLIS: *The Greatest Show on Earth.*** SALSOU SA8511 \$7.98, ® S8-8511 \$7.98, © SC-8511 \$7.98.
- **VIVIAN REED: *The Other Side.*** UNITED ARTISTS UA-LA911-H \$7.98.
- **ROSE ROYCE: *Strikes Again.*** WARNER BROS./WHITFIELD WHK 3227 \$7.98, ® M8-3227 \$7.98, © M5-3227 \$7.98.
- **MICHAL URBANIAK: *Ecstasy.*** TK/MARLIN 2221 \$7.98.

(List compiled by John Harrison.)

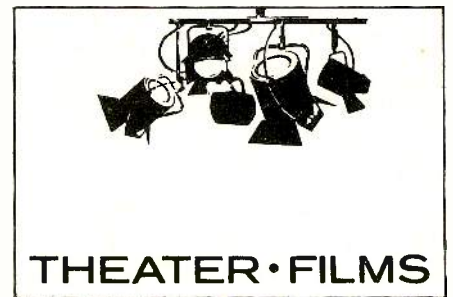

THE BEST LITTLE WHOREHOUSE IN TEXAS (see *Best of the Month*, page 117)

ULYSSES: THE GREEK SUITE (Michael Rapp). David Arias (narrator); Ted Neeley, Yvonne Iversen (vocals); vocal and instrumental accompaniment. 20TH-CENTURY FOX 2T-1101 two discs \$9.98.

Performance: **Trying**
Recording: **Excellent**

The rock idiom that served so well for such pop "operas" as *Tommy* and *Jesus Christ, Superstar*, is not flexible enough for as many purposes as its practitioners seem to think.

(Continued on page 174)

STEREO DISCOUNTERS offer an instant, no-cost, direct line to the most incredible prices on the largest selection of highest quality, name-brand hi-fi equipment and accessories available anywhere.

Expertly qualified audio specialists are now manning seven new toll free lines, going directly into our main warehouse, containing over \$4,000,000 of the latest hi-fi items.

Don't miss out, call us today and find out why our number is number one! Ask for our FREE, 48 page discount catalog or drop us a line — Stereo Discounters, Dept. SR 1178, 6730 Santa Barbara Court, Baltimore, Md. 21227.

Just a tiny sample of the thousands of items we have in stock . . .

"THE NUMBER ONE NUMBER IN DIRECT-BUY HI-FI."

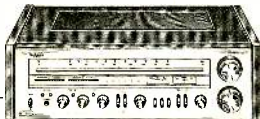

Technics
by Panasonic
RECEIVERS

Technics SA-400 AM/FM 90 Watt RMS

45 watts per channel. RMS at 8 ohms from 20Hz-20,000Hz. 0.04% Total Harmonic Distortion.

\$224

Technics SA700-100 watts per channel. RMS at 8 ohms from 20Hz-20,000Hz. 0.04% Total Harmonic Distortion. **\$388**

Pioneer SX780-45 watts per channel. RMS at 8 ohms from 20Hz-20,000Hz. 0.05% Total Harmonic Distortion. **\$243**

Pioneer SX 980-80 watts per channel. RMS at 8 ohms from 20Hz-20,000Hz. 0.05% Total Harmonic Distortion. **\$409**

Kenwood KR2090-16 watts per channel. RMS at 8 ohms from 20Hz-20,000Hz. 0.03% Total Harmonic Distortion. **\$146**

Kenwood KR4070-40 watts per channel. RMS at 8 ohms from 20Hz to 20,000Hz. 0.01% Total Harmonic Distortion. **\$212**

Sansui G5000-DC receiver 45 watts per channel. RMS at 8 ohms from 20Hz-20,000Hz. 0.03% Total Harmonic Distortion. **\$282**

Sansui G-7000-DC receiver 85 watts per channel. RMS at 8 ohms from 20Hz-20,000Hz. 0.25% Total Harmonic Distortion. **\$425**

Sony STR-V3 NEW 85 watt per channel. RMS at 8 ohms from 20Hz-20,000Hz. 0.1% Total Harmonic Distortion. **\$199**

Sony STR-V5 NEW 85 watts per channel. RMS at 8 ohms from 20Hz-20,000Hz. 0.07% Total Harmonic Distortion. **\$340**



Technics
by Panasonic

TURNTABLES

TECHNICS SL-3200

Semi-Auto Direct-Drive with pitch control, strobe, base and dust cover **\$99**

TECHNICS SL-220 Semi-Auto Belt-Drive **\$87**

TECHNICS SL-1401 Quartz-Lock Semi-Auto **\$182**

PIONEER PL-514 Semi-Auto Belt-Drive **\$89**

PIONEER PL-518 Semi-Auto Direct-Drive **\$129**

DUAL CS-1242 Multi-Play Auto with base and cover **\$140**

DUAL CS-604 Electronic Direct-Drive with base and cover **\$168**

SONY PS-T3 Fully Auto Direct-Drive **\$126**

SONY PS-X5 Fully Auto Quartz-Lock Direct Drive **\$160**

KENWOOD KD-3070 Direct-Drive Semi-Auto **\$134**



Technics
by Panasonic
AMPS/TUNERS

Technics SU7100

60 watts per channel. RMS at 8 ohms. 20-20kHz. 0.02% Total Harmonic Distortion.

\$98

Technics SU8600 Integrated Amp **\$215**

Kenwood KA-7100 Integrated Amp **\$213**

Kenwood KA-9100 Integrated Amp **\$370**

Sansui AU-517 Integrated DC Amp **\$296**

Sansui AU-717 Integrated DC Amp **\$354**

Pioneer SA-8500II Integrated Amp **\$266**

Technics ST8600 AM/FM Stereo Tuner **\$201**

Kenwood KT7500 AM/FM Stereo Tuner **\$209**



PIONEER
SPEAKERS

PIONEER HPM-100

4-way with 12" carbon-fiber bass driver **\$182**

PIONEER HPM-60 4-way with 10" carbon fiber bass driver **\$137**

SANSUI SP-2500X 3-way with 12" bass driver **\$120**

SANSUI SP-7500X 4-way with 16" bass driver **\$154**

TECHNICS SBX-50 Linear-phase 3-way tube-vented system **\$144**

TECHNICS SBX-10 Linear-phase 2-way tube-vented speaker system **\$57**

KENWOOD LS-500 3-way with 12" woofer **\$74**

ALTEC SEVEN 3-way with 12" woofer **\$166**

CALL FOR PRICES ON CERWIN VEGA, KOSS, TECHNICS PRO, ELECTRO-VOICE AND MARANTZ!!



TEAC
TAPE DECKS

Teac A-2300SX

3-motor, 3-Head open Reel Deck

\$398

Teac A2300SR Auto Reverse, 3-motor Reel Deck **\$448**

Akai GX-230D Auto Reverse, 3-motor Reel Deck **\$445**

Pioneer RT701 3-motor, 3-Head Direct-Drive Reel **\$364**

Pioneer CT-F500 Front-Load Dolby cassette **\$127**

Pioneer CT-F1000 3-Head Front-Load Dolby cassette **\$395**

Kenwood KX-1030 3-Head Front-Load Dolby cassette **\$292**

Akai CS-707D Front-Load Memory Dolby cassette **\$175**

Teac A-106 Front-Load Memory Dolby cassette **\$166**

Sansui SC-5100 Front-Load Dolby FM cassette **\$440**

SUPER BUYS

Pioneer KP-8005

Super Tuner AM/FM In-Dash Cassette Car Stereo **\$148**

Audio-Vox CAS-600 SuperPower 40 watt RMS In-dash AM/FM cassette car stereo **\$158**

Jensen C-9945 Triaxial 6" x 9" 20-oz. 3-way car speakers **\$55/pr.**

Shure V15 IV Super Track stereo cartridge **\$79**

Empire 2000E III cartridge 1/2-1 1/2 gram **\$15**

Koss PRO 4AAA Professional Stereophones **\$29**

Sony KV-1922 Trinitron 19" Diag. Color TV **\$475**



PIONEER

Maxell UDC-90 Ultra-Low-Noise 90 min cassette 10 for **\$30.50**

TDKSAC-90 Super avilyn 90-min. cassette 10 for **\$30.00**

Maxell UD35-90 open reel 1800 x 7" Tape 10 for **\$58.00**

High-Energy C-90 Premium Cassette Tape 10 for **\$34.00**

Call **STEREO DISCOUNTERS** Now! — Toll Free — Master Charge and Visa Welcome

1-800-638-3920

You can hear it working.

QUIETONE

Now, a record treatment that's effective for weeks! No need to treat or brush records each time they are played. A quick spray of QUIETONE, the environmentally safe aerosol that neutralizes static charges, provides carefully measured stylus lubrication and removes surface deposits with a specially developed solvent totally safe for records.

Most clicks and pops disappear. Annoying record hiss is reduced. Styli and record surface alike are protected by the lubrication property of QUIETONE.

And QUIETONE is extremely economical. Selling for less than \$8.00, a single aerosol will treat up to 100 sides. QUIETONE is dry to the touch, yet protection remains and static charges stay neutralized.

QUIETONE — the second generation in record care. Sold with a money back guarantee, available at leading stereo and record shops.



AudioKare
a division of
HAMMOND INDUSTRIES INC.
155 Michael Drive, Syosset, NY 11791 (516) 364-1900

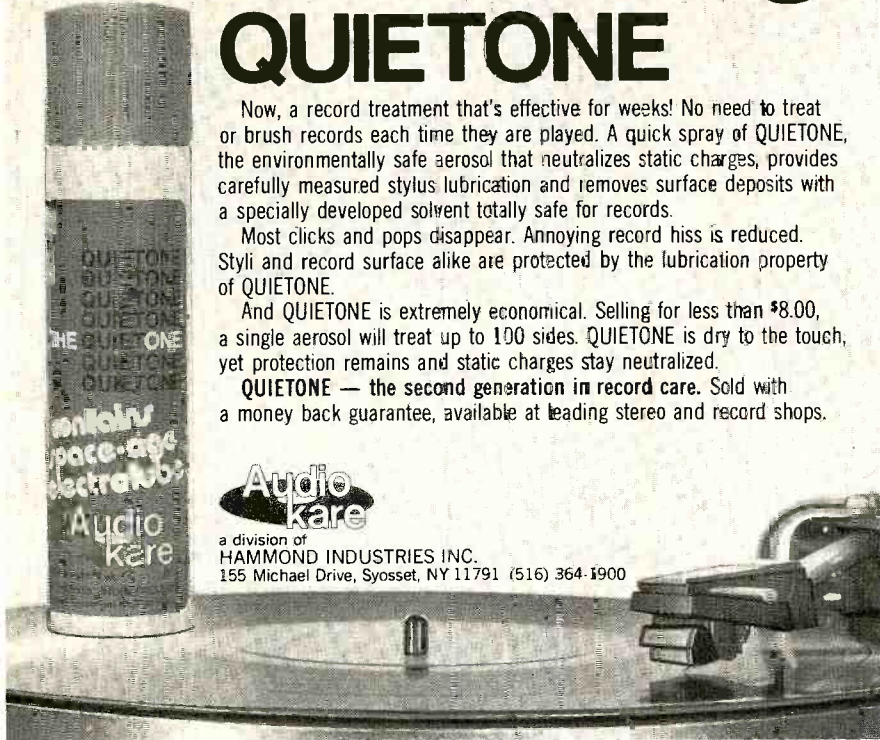

CIRCLE NO. 34 ON READER SERVICE CARD

SO WHERE'S THE GUITAR PLAYER?



He vanishes right in the middle of a riff. Eliminated by a low definition cartridge. But ADC could have saved him. The XLM Mk III features the famous ADC tapered cantilever, which when combined with our tiny .004" x .006" rectangular nude diamond results in 50% less mass. That's less than our previous lowest mass cartridge the highly acclaimed XLM Mk II. And because of its ultra linear frequency response, 10Hz to 20kHz ± 1dB, every instrument sounds alive and natural, all at an increased tracking force of 3/4 to 1 1/2 grams. So be good to guitar players and other musicians. Invest in something that understands them, and protects them. An ADC cartridge.



Audio Dynamics Corp., Pickett District Rd., New Milford, CT 06776 • Distributed in Canada by BSR (Canada) Ltd., Rexdale, Ont.
Please circle our reader service number and we'll send you a free record care gift.

CIRCLE NO. 15 ON READER SERVICE CARD

This long-winded, painfully pretentious, and numbingly simplistic version of *The Odyssey* may succeed in bringing Homer's saga to a wider public, but the voyage is slow going. Twentieth-Century Fox must think it's got hold of something in Michael Rapp's *The Greek Suite*; the album and the accompanying text are lavish, and no expense seems to have been spared to make it a sumptuous item on the vocal and instrumental levels as well, with singers and narrators in there trying every minute. But what we really have here is simply the last word in schlock. Poor Penelope (Yvonne Iversen) moans away for her missing husband in an interminable rock aria that, for this listener at least, is not going to replace Mary Magdalene's *I Don't Know How to Love Him* in any hurry. "Motherland, he's just a man/And he's been gone so long," this witless wife intones, and it's about as moving as a stalled car. All the sound effects of storms, one-eyed giants, six-headed monsters, and simpering Circes cannot for a single minute bring this score up to the level of its subject. Steal as the composer will from the style of Hadjidakis, Michael Rapp's Aegean is less a sea than a musical desert. P.K.

THE WAR OF THE WORLDS (Jeff Wayne-Gary Osborne). Richard Burton (narrator); Julie Covington, David Essex, Philip Lynott, Jo Partridge, Justin Hayward, Chris Thompson (vocals); instrumental accompaniment. COLUMBIA PC2 35290 two discs \$13.96.

Performance: **Numbing**
Recording: **Superb**

Orson Welles' 1938 radio adaptation of *The War of the Worlds* frightened half of New Jersey (the "invasion site") out of their homes and sent the rest of the country into a panic. You can get a fairly good recording of the broadcast on a two-disc Murray Hill set (S44217), and a satisfactory abridged reading by Patrick Waddington of the original H.G. Wells novel is available from Listening Library (1 Park Avenue, Old Greenwich, Conn. 06870). I cannot similarly recommend this new musical version, despite the imposing presence of Richard Burton as narrator and the most lavish packaging I've seen from Columbia Records in ages (including a booklet with full-color illustrations of the story). Jeff Wayne and Co. are supposed to have spent more than two years preparing the album, and I feel as if it took every bit as long to play through the four slow-going sides.

Burton is expertly calm and imperturbable reading snatches of Wells' rather musty prose, and one wonders whether the producers ever told him what his contribution would be used for. His narration is surrounded by incessant music, composed by Wayne, that seems undecided whether to be hard rock or sci-fi film score; it never gets very far in any direction, except maybe in getting on one's nerves. There are silly songs about the Black Smoke, the Red Weed, and the Flashing Heat Rays released by the invading Martians, who only sing "Ulla, Ulla" as the band plays on. There is some strong singing among the human characters, portrayed by a whole assortment of pop/rock notables, but long instrumental interludes keep bringing what action there is to a standstill. This particular interplanetary mission should have been aborted.

P.K.

(Continued on page 178)

Magazines At Discount

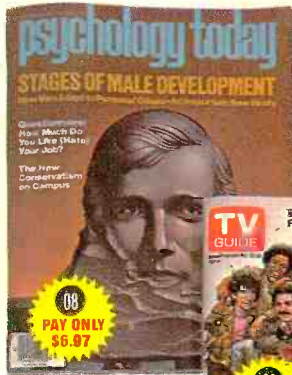

Reg. Rate: 12 Issues/\$12



Lowest Available Sub Rate
32 Issues



Newsstand Rate
25 issues/\$25

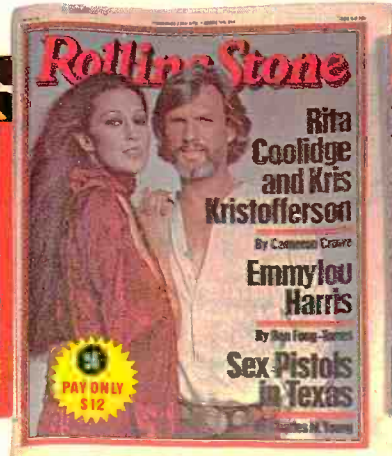

Reg. Rate: 26 issues/\$18



Newsstand Rate: 12 issues/\$25

You SAVE up to 50%

Here's your chance for a real bargain bonanza on your favorite magazines. You may select as many as five of these titles at the special introductory rates shown—up to 50% off! To order, indicate the magazines you want by inserting their code numbers in the boxes on the attached order card. Or write to: MAGAZINES AT DISCOUNT.

A Division of Ziff-Davis Publishing Co., P.O. Box 601, Broomall, Pennsylvania 19008

CHOOSE YOUR FAVORITES AT DISCOUNT PRICES!

<p>24 ISSUES APARTMENT LIFE YOU PAY ONLY \$7.97 Reg. Rate: 24 iss./\$14.97</p>	<p>18 ISSUES Field & Stream YOU PAY ONLY \$5.97 Reg. Rate: 18 iss./\$11.93</p>	<p>12 ISSUES PLAYBOY YOU PAY ONLY \$14.00 Newsstand Rate: 12 iss./\$25.00</p>	<p>7 ISSUES SKIING YOU PAY ONLY \$5.99 Reg. Rate: 7 iss./\$8.98</p>
<p>4 ISSUES BACK YOU PAY ONLY \$5.95 Reg. Rate: 4 iss./\$8.00</p>	<p>12 ISSUES FOUR WHEELER YOU PAY ONLY \$4.50 Reg. Rate: 12 iss./\$9.00</p>	<p>12 ISSUES PHOTOGRAPHY YOU PAY ONLY \$6.99 Reg. Rate: 12 iss./\$13.98</p>	<p>26 ISSUES Sports Illustrated YOU PAY ONLY \$12.77 Reg. Rate: 26 iss./\$32.90</p>
<p>12 ISSUES Better Homes and Gardens YOU PAY ONLY \$8.00 Newsstand Rate: 12 iss./\$11.40</p>	<p>12 ISSUES HOUSE BEAUTIFUL YOU PAY ONLY \$9.00 Reg. Rate: 12 iss./\$10.00</p>	<p>12 ISSUES psychology today YOU PAY ONLY \$6.97 Reg. Rate: 12 iss./\$12.00</p>	<p>12 ISSUES Stereo Review YOU PAY ONLY \$4.99 Reg. Rate: 12 iss./\$9.98</p>
<p>51 ISSUES Business Week YOU PAY ONLY \$26.00 Newsstand Rate: 51 iss./\$63.75 Reg. Rate: 51 iss./\$63.75</p>	<p>18 ISSUES Mechanix Illustrated YOU PAY ONLY \$5.96 Reg. Rate: 18 iss./\$11.90</p>	<p>12 ISSUES Prevention YOU PAY ONLY \$6.99 Reg. Rate: 12 iss./\$9.00</p>	<p>25 ISSUES TIME YOU PAY ONLY \$14.97 Newsstand Rate: 25 iss./\$25.00</p>
<p>6 ISSUES CAR CLASSICS YOU PAY ONLY \$4.50 Newsstand Rate: 6 iss./\$9.00</p>	<p>12 ISSUES Ms. YOU PAY ONLY \$5.97 Reg. Rate: 12 iss./\$10.00</p>	<p>18 ISSUES REDBOOK YOU PAY ONLY \$11.93 Newsstand Rate: 18 iss./\$22.50</p>	<p>32 ISSUES TV GUIDE YOU PAY ONLY \$9.53 Lowest Available Sub Rate</p>
<p>12 ISSUES CAR DRIVER YOU PAY ONLY \$5.99 Reg. Rate: 12 iss./\$11.98</p>	<p>23 ISSUES Newsweek YOU PAY ONLY \$12.99 Newsstand Rate: 23 iss./\$23.00</p>	<p>26 ISSUES Rolling Stone YOU PAY ONLY \$12.00 Reg. Rate: 26 iss./\$18.00</p>	<p>52 ISSUES TV GUIDE YOU PAY ONLY \$15.50 Lowest Available Sub Rate</p>
<p>12 ISSUES Cycle YOU PAY ONLY \$5.99 Reg. Rate: 12 iss./\$11.98</p>	<p>18 ISSUES NewTimes YOU PAY ONLY \$8.97 Newsstand Rate: 18 iss./\$18.00</p>	<p>9 ISSUES RUNNER YOU PAY ONLY \$6.97 Reg. Rate: 9 iss./\$13.50</p>	<p>15 ISSUES us YOU PAY ONLY \$8.97 Lowest Available Sub Rate</p>
<p>16 ISSUES ESQUIRE YOU PAY ONLY \$10.00 Newsstand Rate: 16 iss./\$20.00</p>	<p>12 ISSUES Outdoor Life YOU PAY ONLY \$3.97 Reg. Rate: 12 iss./\$7.94</p>	<p>12 ISSUES science digest YOU PAY ONLY \$7.97 Newsstand Rate: 12 iss./\$9.00</p>	<p>12 ISSUES Working Woman YOU PAY ONLY \$7.50 Newsstand Rate: 12 iss./\$15.00</p>

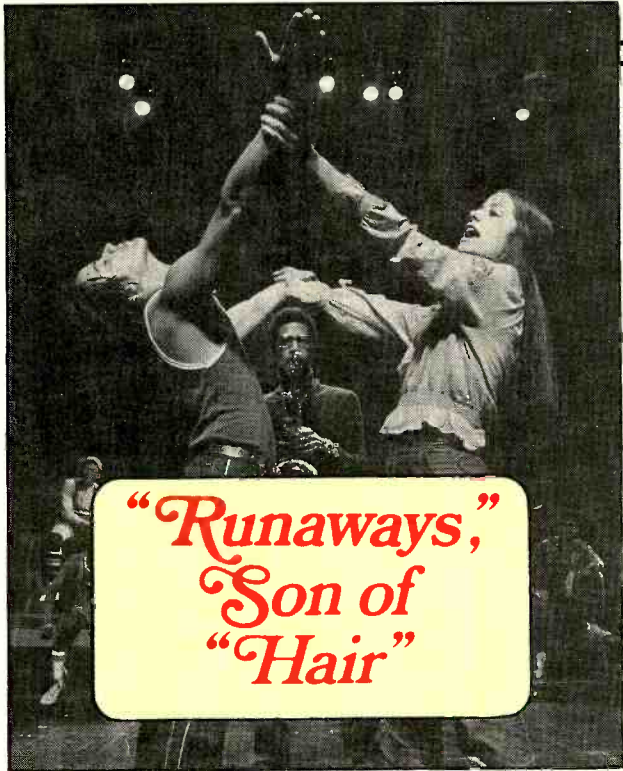

*“Runaways,”
Son of
“Hair”*

RUNAWAYS, like so many other Broadway musicals of late, moved uptown after making its mark off-Broadway at Joseph Papp's Public Theater, the first production of which—way back in 1966—was *Hair*. With its tribe of talented youngsters rounded up (in part from the streets) by writer/composer/director Elizabeth Swados, *Runaways* is a kind of descendant of *Hair*, more solemn in its sermonizing but almost as exuberant on the musical level. The show is set in an abandoned playground where the adolescent cast members, real or imagined refugees from unhappy homes, sing and dance with a fierce energy—and take time out to berate the audience as if it were made up of the parents whose mistreatment led them to run away. Although the songs have astonishing verve and are played, sung, and danced to an uptempo beat that varies from rock to reggae, in the theater the show can become depressing, since, between numbers, much of the blame for the performers' plight seems to be directed squarely at the audience. One would think, therefore, that the record of *Runaways* would be even more effective than the stage production, because the listener would be spared the extramusical propaganda.

It doesn't quite work out that way. Ms. Swados manages to get in a few licks at the listener's conscience in her liner notes, and the preaching quality is retained in the song *To the Dead of Family Wars*—although there's a kind of escape clause in it: we're told that it isn't all *our* fault that kids run away, since it started with Adam and Eve (sounds like a cop-out to me). Then, too, the sizzling

vitality of the show doesn't quite come through in the album; the sound is fine, but the hard edges seem to have been smoothed away in the recording studio. It's still affecting, however, to hear Venustra K. Robinson sing about the teenagers controlled by Times Square pimps in *Minnesota Strip*; *The Revenge Song* is a powerful ragtime number in which the kids tell how they dream of getting back at their neglectful parents; and Karen Evans egging on a team of would-be looters in *Enterprise* sounds scary indeed. Also memorable is the samba-like *No Lullabies for Luis*, in which Ray Contreras, as a young man on the needle, sings ironically about becoming “the first Puerto Rican junkie on the moon.”

RUNAWAYS' debt to the past is acknowledged in the self-conscious *Where Are Those People Who Did “Hair”?* It never quite reaches *Hair*'s level, but there are more than a few poignant moments in the seventeen numbers performed here (out of forty-one in the show). And there are enough infectiously joyous moments to leave you paradoxically feeling pretty good about life when the musical lecture's over.

—Paul Kresh

RUNAWAYS (Elizabeth Swados). Original-cast recording. Trini Alvarado, Ray Contreras, Karen Evans, Jossie de Guzman, Bruce Hlibok, Diane Lane, and others (vocals); Judith Fleisher (piano); Patience Higgins (flute, saxophone); David Sawyer (drums); Elizabeth Swados (guitar); other musicians. COLUMBIA JS 35410 \$8.98, © JSA 35410 \$8.98, © JST 35410 \$8.98.

JAZZ



KEN McINTYRE: *Introducing the Vibrations.* Ken McIntyre (flute, oboe, bassoon, bass clarinet, alto saxophone); Terumasa Hino (trumpet, flugelhorn); Richie Harper (piano); Alonzo Gardner (bass); Andrei Strobert (drums); Andy Vega (percussion). *Miss Priss*; *Shortie*; *Clear Eyes*; and three others. INNER CITY IC 2065 \$7.98.

Performance: **Interesting**
Recording: **Good**

This album was recorded two years ago; like Ken McIntyre's last U.S. release, it was made for the Danish Steeplechase label. McIntyre, now forty-seven, was active in the avant-garde jazz movement of the Sixties and has devoted much of his time in recent years to teaching. His music—original, but not avant-garde—often reflects jazz and folk traditions, and his playing reveals technical skill and versatility not often possessed by members of the avant-garde.

With this release, McIntyre introduced a new sextet called the Vibrations and added Japanese trumpeter Terumasa Hino, who makes a significant contribution to the proceedings, sounding infinitely better than he has on his own recordings. The compositions, all by McIntyre, were written between 1956 and 1962 but are heard here in new arrangements. *Theme*, *Shortie*, and *Clear Eyes* are taken at unusually slow tempos, the sort of snail's pace at which New Orleans clarinetist George Lewis used to carry *The Old Rugged Cross*, and they work very well. *Clear Eyes*, arranged for Terumasa's trumpet and McIntyre's oboe, is stunning. That Ken McIntyre has to record for a European label is a sad reflection of the attitude most American record companies have toward jazz. At least Inner City is bringing some of our valuable exports back home where they belong. C.A.

RECORDING OF SPECIAL MERIT

DAVE McKENNA: *McKenna.* Dave McKenna (piano). *Avalon*; *I Say I'm Sorry*; *How High the Moon*; *Darn That Dream*; *Tangerine*; and five others. CHIAROSCURO CR 202 \$7.98.

Performance: **Beautiful**
Recording: **Good**

Dave McKenna knows a good tune when he hears it, and he can make it even better when he plays it. In this set of ten solo performances he puts both hands to work on familiar material, dresses it up with imagination and good taste, and leaves us with a most enjoyable listening experience. McKenna is not an innovative pianist, and ears tuned in to Cecil Taylor or McCoy Tyner will certainly find his playing conservative, but he is a fine keeper of the flame. C.A.

“the hard edges seem to have been smoothed away”

(Continued on page 182)

Nikko. Accuracy Unlike Any Stereotype.

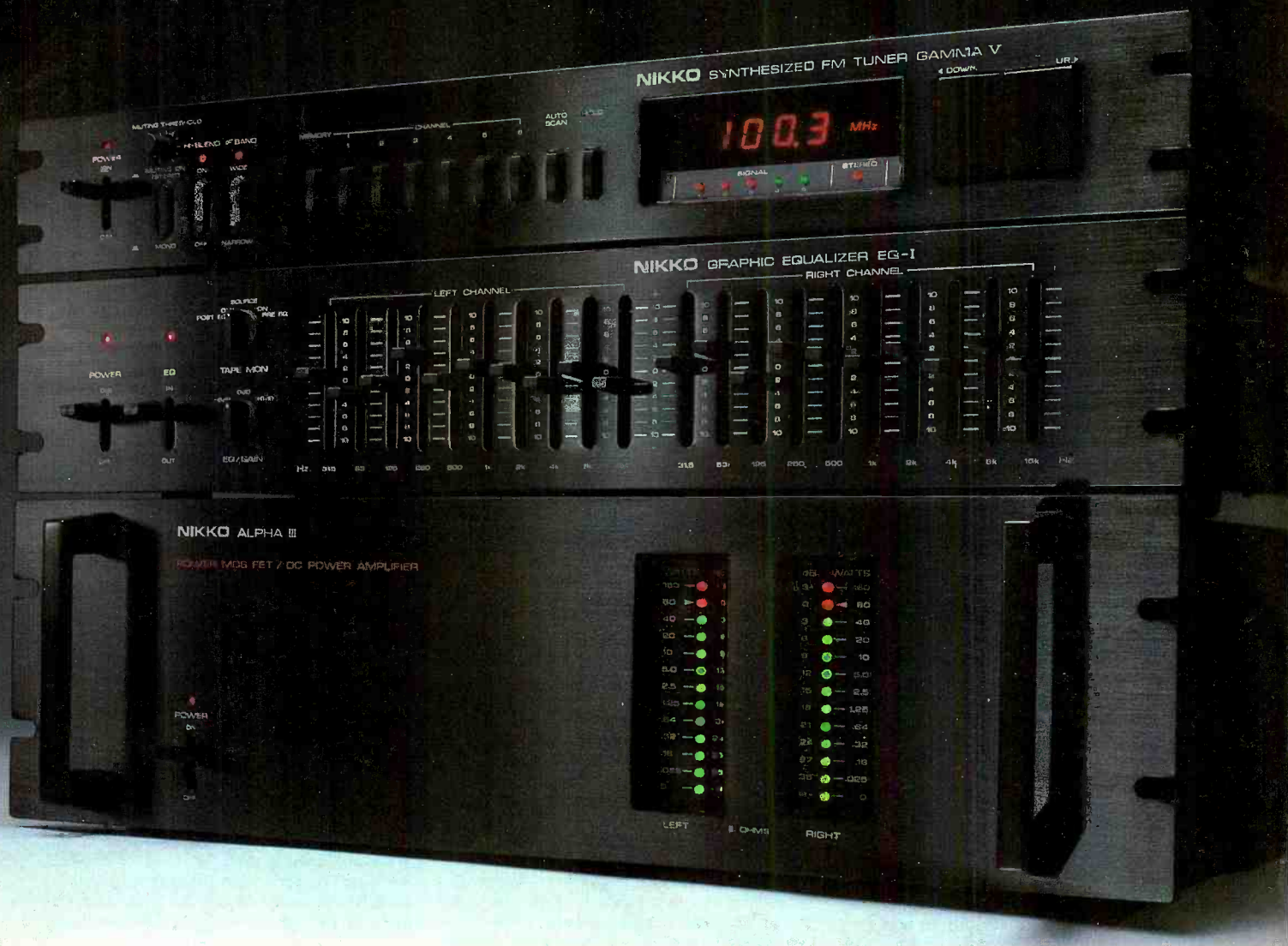

Hearing the seed of sound is what high technology is all about. Many stereotypes will predictably claim they've reached it . . . but only Nikko Audio actually delivers that pinnacle of purity through three new components in our professional series.

Gamma V Synthesized FM Digital Tuner

Six of your favorite stations can be exactly tuned into the memory bank for instant recall. With phase-lock-loop, twin-staged synthesized manual or automatic tuning circuitry throughout the entire FM band, you can be assured your stations will never fade away as the LED readout brightly shows the locked-in MHz numbers. Accuracy on the button.

Alpha III Power MOS-FET DC Amplifier

Accentuated accuracy. DC powered MOS-FET circuitry assures ultra wide frequency response at rated output, while the continuous DC operation from input to output stages guarantees absolute stability and extremely low distortion.

The LED window monitors the pulse of power in each channel. Plus, the THD is the lowest in the industry at anywhere near the price range —

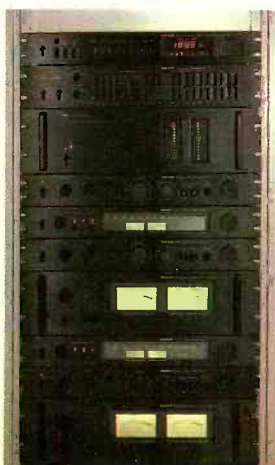

0.008% (80 watts per channel, both channels driven into 8 ohms, 0 to 20kHz).

EQ 1 Graphic Equalizer

For the discerning ear, you can shape the acoustics of your room into those of a recording studio with Nikko's EQ 1. At 10 bands per channel providing ± 12 dB boost or cut and ± 6 dB gain control, you will be in master control of all your live-sounding performances.

All three components can be professionally stacked into Nikko's new 19" rack mount cabinet. But hearing is believing.

Call our toll-free number for the name of your nearest Nikko dealer at (800) 423-2994 and find out why Nikko's reputation for accuracy is forever sound.

Nikko Audio

For those who take their stereo seriously

Nikko Electric Corp. of America
 16270 Raymer St., Van Nuys, Calif. 91406 (213) 988-0105
 218 Sherwood Ave., Farmingdale, N. Y. 11735 (516) 293-2906
 In Canada: Superior Electronics, Inc. ©Nikko Audio 1978



Bill Evans

Armelia McQueen, Nell Carter, Charlaine Woodard

"Ain't Misbehavin'"

SOMETIMES marvel at the current Fats Waller revival. Since September 1977 two biographies have been published (one by his son Maurice Waller [Schirmer], the other by me [Contemporary Books]) and *Ain't Misbehavin'*, a musical revue based on compositions Waller either wrote or made famous, opened on Broadway last May, was greeted ecstatically by the public and critics alike, and is sold out for months ahead.

Why should Thomas Wright "Fats" Waller become popular again all of a sudden? He died in 1943 at the peak of his career as composer, pianist, and entertainer. His many recordings have been kept in print, but until very recently they were ordinary catalog items selling slowly but steadily to jazz fans and to those fortunate folk who heard or saw Waller while he lived. He played "stride" piano, a muscular but sensitive New York style often confused with ragtime and boogie-woogie, a style few but fanatics and connoisseurs would recognize. He composed wonderful melodies, but they would be considered archaic in today's disco market. He was uproariously funny—his wisecracks and fractured *bons mots* were part of his appeal—but in this era of hostile and scatological humor they would seem tame, even timid.

To enjoy Waller is easy and to appreciate him is a pleasure, but this easy pleasure requires much good will on the part of the listener. Do the jaded and rapacious audiences of today possess such good will or can they be made to discover it? On the evidence of the smash success of *Ain't Misbehavin'*, they most certainly can. Thanks to director Richard Maltby Jr. and his effervescent cast, the revue is not only a triumph of conception, staging, and performance, but a vindication of Waller's spirit. He was a very loving and lovable man, and the show proves that his musical invitation to friendship is impervious to time. So score one for civilization.

The original-cast recording is also a triumph, not only for the cast but for producer Thomas Z. Shepard, who has successfully translated the verve, sass, and *joie de vivre* of the stage performance onto disc. This is a notable achievement, since recording studios and sessions are rather clinical, and actors used to bouncing off live audiences may freeze in front of the microphone or sing with less *oomph* than they do at curtain time. But having both seen the show and heard the recording, I can testify that there is very little aural or emotional difference between what goes on at the Longacre Theatre and what goes on in this LP's grooves. Andre De-Shields' saucy arrogance is there, as is Armelia McQueen's regal buffoonery, Charlaine Woodard's zany energy, Ken Page's rowdy sense of fun (he is the Waller lookalike in the show), and the delightfully salacious, hard-boiled stance of Nell Carter, who sings with the attack and timbre of the late Dinah Washington (whom Waller discovered in a Chicago club in 1942 and encouraged in her career).

If all that isn't enough, there is a surfeit of delight in the selection of songs that Waller composed or performed during his career (from 1922 to 1943). In several cases, director Maltby and associate director Murray Horwitz have written lyrics to Waller tunes that fit them perfectly, so great is their understanding of their subject and his times. While it is true that *Ain't Misbehavin'* is, as a whole, a single prolonged great moment, there are exquisite and hilarious peaks within that moment. One of them is *The Jitterbug Waltz*, set in a dance palace with the last couples swaying slowly as the band winds down. The lyrics are new, but they conjure up Waller's cosmopolitan tenderness, his knowledge of and love for the people of Harlem in its vanished Golden Age.

Two more are *The Ladies Who Sing with the Band* and *When the Nylons Bloom Again*, both from *Early to Bed*, a 1943 Broadway mu-

sical for which Waller composed the score and George Marion Jr., a Hollywood screenwriter, wrote the witty and bitter lyrics. Armelia McQueen has a field day singing the latter tune as a hilarious satire on grande-dame pop divas; she sounds somewhere between Grace Moore and Kate Smith. (When, oh when, is someone going to record the complete score of *Early to Bed*, Waller's last triumph and the likely prototype of others had he not died that same year? Are you listening, William Bolcom and Joan Morris?)

Mesdemoiselles Carter, McQueen, and Woodard have a raunchy romp with *Cash for Your Trash*, a World War II song that the government urged Waller to write and promote as part of the campaign to save scrap

Fats himself, lookin' good



metal, rubber, twine, and discards to be converted into war material, with Uncle Sam offering cash rewards for tireless scavengers. Waller and his manager, the late Ed Kirkeby, cheerfully produced the ditty, and official Washington was happy until someone down there found out what "trash" meant in Harlem slang, upon which the tune abruptly lost its G.I. certification. Waller had a healthy attitude toward sex—he found it at once natural and hilarious—and it is a delight, in these times, to have a historical example of American citizens making suckers out of the government instead of the other way around.

NELL CARTER and Armelia McQueen have richly deserved showcase solos on *Mean to Me* and *Squeeze Me*, respectively, but it is Charlene Woodard who—even with her gift for superbly berserk physical and vocal comedy—has the best voice in this remarkable cast, and she displays it stunningly on *Keepin' Out of Mischief Now*, a Waller melody with lyrics by his principal lyricist Andy Razaf. The song is a rhapsodic embrace of fidelity to a lover by a girl who has been around, and Woodard's interpretation is not only thrilling vocally but has the theatrical sensitivity of a fine actress simply becoming the character she portrays. When she sings, you feel that the man she's singing to is a very, very lucky fellow.

Black and Blue, again by Waller and Razaf—and movingly sung by the company—is a quietly desperate and dignified statement of the agony of being a black American in 1929, when the song was written. It serves now as an anthem of times that are, to this country's honor and relief, largely past. The song is a heart-stopping moment in a show that is all heart.

Along with the Waller classics *Ain't Misbehavin'* and *Honeysuckle Rose* there are twenty-one more gems, all delivered with marvelous pizzazz and class. Until you have a chance to see the show, this original-cast recording is a happy way to jump on the Waller bandwagon. As Fats himself might have said: "Oh, man, this is really ready!" —Joel Vance

AIN'T MISBEHAVIN' (Fats Waller-Luther Henderson). Original-cast recording. Nell Carter, Andre DeShields, Armelia McQueen, Ken Page, Charlene Woodard (vocals); instrumental accompaniment; Luther Henderson arr. and cond. *Ain't Misbehavin'*; *Lookin' Good but Feelin' Bad*; *Tain't Nobody's Business If I Do*; *Honeysuckle Rose*; *Squeeze Me*; *Handful of Keys*; *I've Got a Feeling I'm Falling*; *How Ya Baby*; *The Jitterbug Waltz*; *The Ladies Who Sing with the Band*; *Yacht Club Swing*; *When the Nylons Bloom Again*; *Cash for Your Trash*; *Off-time*; *The Joint Is Jumpin'*; *Spreadin' Rhythm Around*; *Lounging at the Waldorf*; *The Viper's Drag/The Reefer Song*; *Mean to Me*; *Your Feet's Too Big*; *That Ain't Right*; *Keepin' Out of Mischief Now*; *Find Out What They Like*; *Fat and Greasy*; *Black and Blue*; *Medley—I'm Gonna Sit Right Down and Write Myself a Letter/Two Sleepy People/I've Got My Fingers Crossed/I Can't Give You Anything but Love/It's a Sin to Tell a Lie/Honeysuckle Rose* (reprise). RCA CBL2-2965 two discs \$9.98, © CBS2-2965 \$10.95, © CBK2-2965 \$10.95.



HIGH PERFORMANCE

WHISTLER

SPEED RADAR DETECTORS

The First Choice Of-
DISCRIMINATING
DRIVERS

Whistler, Inc.
410 Great Rd. Box 37
Littleton, MA. 01460
617/486-3579

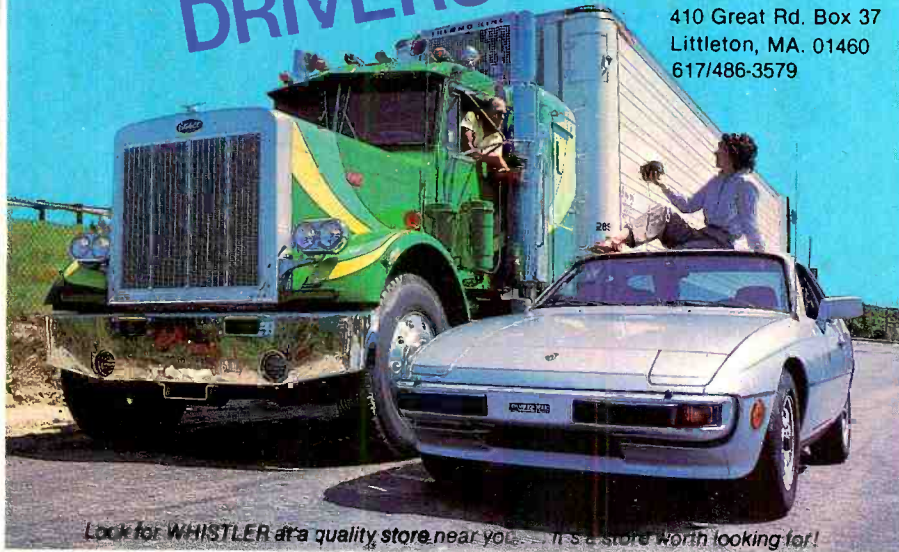

Look for WHISTLER at a quality store near you. It's a store worth looking for!

CIRCLE NO. 91 ON READER SERVICE CARD

The history of a people. The music of a man.

Ramsey Lewis draws deeply on his solid roots in jazz, rock, classical, and Latin music to emerge triumphant with an enduring musical milestone: his new album, "Legacy."

On one side Ramsey realizes his lifelong desire to play with a full symphony orchestra in "Legacy." It's a composition by James Mack which Ramsey premiered with the Kansas City Philharmonic in January, 1978. "Legacy," which utilizes a classical framework, leaves ample room for the patented Lewis piano to stretch out and search for new spaces while revisiting the best from the past.

And on the other side, Ramsey steams ahead with the kind of witty, sophisticated funk that's made him one of America's favorite piano-men.

RAMSEY LEWIS
LEGACY

including:
All The Way Live/Don't Look Back
Moog n' On/I Love To Please You



Ramsey Lewis
shares his "Legacy."

On Columbia Records and Tapes.

"Columbia," are trademarks of CBS Inc. © 1978 CBS Inc.

Headliners East. Agent: Rand Stoll (212) 371-2500

CIRCLE NO. 20 ON READER SERVICE CARD

tasy; *I Had It*; and three others. JAZZOLGY J-56 \$6.98.

Performance: **Disappointing**
Recording: **Poor remote**

Soprano Summit, headed by reed players Bob Wilber and Kenny Davern and featuring that wonderful keeper of the flame Marty Grosz, is fast building up a sizable collection of albums. We have heard them on the World Jazz, Concord Jazz, and Chiaroscuro labels, all to their great advantage, but this set on Jazzology does not do Soprano Summit justice. The performances were recorded during two sets at the 1976 Big Horn Jazz Festival in Mundelein, Illinois, and it sounds as if it had been taped off an inferior public-address system; the spoken introductions appear to have been delivered into a bucket, the music sounds muffled, and there is a low-frequency hum throughout. Fortunately, all but two of the selections, *I Had It* but *It's All Gone Now* and *A Porter's Love Song*, are in better albums by the group, so this is an offer you can afford to refuse unless you *must* have absolutely everything Soprano Summit has done. C.A.



Keith Jarrett, Jon Christensen, Jan Garbarek, Palle Danielsson

Jarrett: Out of Superlatives

NEVER cease to be amazed by the beauty Keith Jarrett so consistently creates, as both a composer and pianist. His is truly one of the most fertile and imaginative musical minds in America today, and there are no signs of stagnation. In my five years on STEREO REVIEW's jazz desk, I have reviewed ten Jarrett records, and I have had reservations about only one of them—the organ album, "Hymns/Spheres" (ECM-2-1086). Which leads me to make a little confession: I have run out of superlatives. Therefore, to avoid repeating myself, let me simply say that "My Song," his latest, is yet another out-

standing album of Jarrett compositions and performances; that he is supported with characteristic sympathy by Norwegian saxophonist Jan Garbarek and two other Scandinavians, bassist Palle Danielsson and drummer Jon Christensen; that side one is almost twenty-five minutes of lyrical, brooding music while the remaining twenty-four minutes (no skimping on time here) are livelier (even fiery as we pass through *Mandala*, the second track); and, finally, that although it presents a facet of Jarrett's music we have heard before, "My Song" belongs on your shelves along with all the other Jarrett albums. What? You don't have any other Jarrett albums? Where have you been the last five years?

—Chris Albertson

KEITH JARRETT: *My Song*. Keith Jarrett (piano, percussion); Jan Garbarek (soprano and tenor saxophones); Palle Danielsson (bass); Jon Christensen (drums). *Questar; My Song; Tabarka; Country; Mandala; The Journey Home*. ECM ECM-1-1115 \$7.98, © M8E-1115 \$7.98, © M5E-1115 \$7.98.

MIKE NOCK: *Magic Mansions*. Mike Nock (acoustic and Fender pianos, synthesizers); Charlie Mariano (soprano saxophone); Ron McClure (acoustic and electric bass); Al Foster (drums); Nacho Mena (percussion); Lyn Williamson (vocals). *Twister; Hybris; Black-out; Everglad*; and three others. LAURIE LES-6001 \$7.98 (from Laurie Records, 20 F. Robert Pitt Drive, Monsey, N.Y. 10952).

Performance: **Moderate fusion**
Recording: **Very good**

New Zealander Mike Nock came to this country in 1961, formed the early fusion group the Fourth Way with violinist Michael White in 1968, and slipped quietly from California to the New York music scene three years ago. Since arriving in the U.S., he has appeared and recorded with such artists as Coleman Hawkins, Art Blakey, Yusef Lateef, John Handy, Tal Farlow, and John Klemmer, but he has yet to establish his name with the public. The Fourth Way made three albums (for Capitol and its subsidiary Harvest) before disbanding in 1970, and "Almanac" (Improvising Artists 37.38.51), an excellent album re-

leased last year, was actually recorded in 1967, so "Magic Mansions" is Nock's first recording as a leader in eight years. It appears on the Laurie label (which I hadn't seen since the late Fifties when it gave us two excellent albums by the late Bernard Peiffer) and bodes well for Nock's future.

Nock began performing on the synthesizer ten years ago, and he uses it here, but not excessively. He is at his best on acoustic piano, though, and I would like to see him devote an entire album to that instrument so that his interesting style could be better displayed. Saxophonist Charlie Mariano, a former Charlie Parker disciple turned fusioner, here joins Nock on the soprano saxophone and proves that he still has an affinity for jazz, especially on *Hybris*, which is the kind of wonderful stuff I can't help wishing this whole album had been made of. C.A.

SOPRANO SUMMIT: *Live at the Big Horn Jazzfest*. Bob Wilber, Kenny Davern (reeds); Marty Grosz (banjo, guitar, vocals); Milt Hinton (bass); Fred Stoll (drums). *Swing Parade; Song of Songs; Ole Miss; Black and Tan Fan-*

RECORDING OF SPECIAL MERIT

MEL TORMÉ AND BUDDY RICH: *Together Again—for the First Time*. Mel Tormé (vocals); Buddy Rich (drums); orchestra. *Lady Be Good; When I Found You; Bluesette; Here's That Rainy Day*; and three others. CENTURY CRDD-1100 \$13.95 (from selected audio stores).

Performance: **Just grand**
Recording: **Spectacular**

This direct-to-disc recording by popular-jazz superstars Mel Tormé and Buddy Rich is spectacular listening in every way. Tormé sounds better than ever as he swings through such standards as *Lady Be Good, Bluesette, You Are the Sunshine of My Life*, and—his best, most incisive track—*Blues in the Night*. Rich and his drums are part of our national heritage by now, and he continues to demonstrate why. The director of recording for this was Keith Grant, and he's captured a sound so close to optimum live listening conditions that even my plants turned toward the speakers. "Together Again" is an album that's more than worth your time, the extra money it costs, and your undivided attention. Bravo to everyone involved! P.R.

RECORDING OF SPECIAL MERIT

MIKE WOFFORD: *Afterthoughts*. Mike Wofford (piano). *Struttin' with Some Barbecue; Oblivion; Monk's Mood/Off Minor; Cabin in the Sky/Nina Never Knew; I'll See You Again/Our Waltz*; and five others. DISCOVERY DS-784 \$7.98 (from Discovery Records, P.O. Box 48081, Los Angeles, Calif. 90048).

Performance: **Superb**
Recording: **Very good**

Pianist Mike Wofford turned forty this year. Though he began recording as a leader a little over ten years ago, this is only his fifth album. When you hear it (and you should), you will probably wonder why it isn't his tenth. It is equally perplexing that Wofford's name is barely known even in jazz circles. Is there no justice?

(Continued on page 184)

Select what you want in a record cleaner.

Convenience in use and storage.

You shouldn't need a separate shelf, elaborate motions or an act of Congress to clean your records. A comfortable, hand-held instrument that works best on a rotating turntable is ideal.

Effectiveness against micro-dust.

Tiny, invisible dust particles hide in delicate record grooves and can be ground into the vinyl. Only a slanted (directional) fiber using special ultra-small fiber tips can scoop up, rather than rearrange, this micro-dust contamination.

Effectiveness against chemical contamination.

Fingerprints and vapor-borne oils will deposit into channels of a record groove. Such contamination hides from adhesive rollers and all dry cleaning systems. Only a special fluid plus micro-fibers can safely remove such audible, impacted deposits.

Total removal of contamination/fluid.

Capillary action—the lifting of fluid by small fiber surface tension—is totally effective. You want to get contamination off the record, along with any fluid traces.

Lasting construction.

You want quality. A record cleaner can last a lifetime. A plastic wonder can crack into oblivion—or you can purchase the hand-rubbed elegance of milled walnut befitting the rest of your audio system.

Ultimate economy.

The value of a truly fine record cleaner is justified by the cost of replacing your record collection. Fifteen dollars is a small investment in long-term protection.

All of the above.

DISCWASHER, the Superior Record Cleaner.

See the finer audio dealers for a demonstration.



discwasher, inc. 1407 N. Providence Rd., Columbia, MO 65201

Not Only Does It Come Alive, It Jumps Out at You!

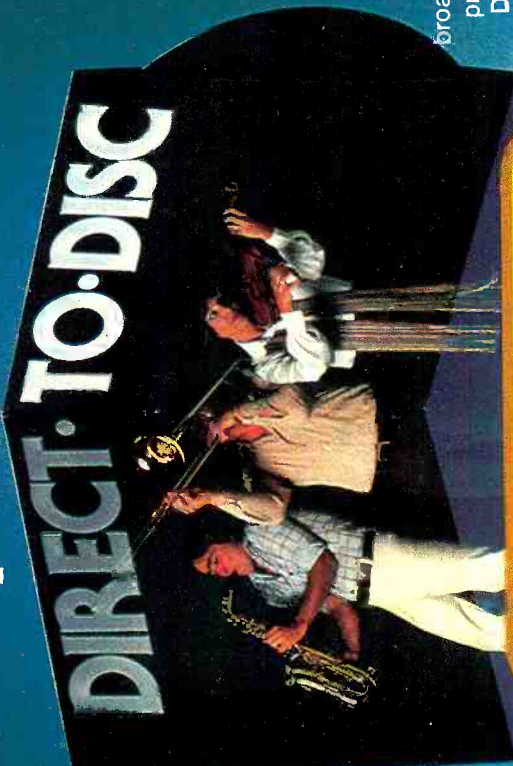

It jumps out at you because it's recorded "direct-to-disc" on Century Records. You'll hear it for the first time, the way it was played the first time. The closest thing to hearing an artist's live performance.

Century Records is the leader in the direct-to-disc recording industry with the

broadest line of artists and largest catalogue of product available. Soon to be released will be Denise McCann, Benny Goodman and Chick Donald, Walter & Woodrow.

Available at all better hi-fidelity and record shops everywhere.

6550 Sunset Blvd., Hollywood, CA 90028 (213) 464-3250 TELEX 67-7239
Available in Canada through **GRAY** Acoustics Ltd.

"Afterthoughts" is Wofford's second album for Discovery and, I believe, the first to feature him unaccompanied throughout. Recorded earlier this year, it contains a marvelously varied program of jazz and pop standards, ranging from ballads by Noël Coward, George Gershwin, and Michel Legrand to tunes by Bud Powell, Thelonious Monk, and Lil Armstrong. Wofford plays them all with immense feeling and the kind of musical imagination he exhibited on his Joplin album ("Scott Joplin: Interpretations '76"—Flying Dutchman BDL1-1376). He has a relaxed style, and he plays with a lyricism that is rarely found today among pianists his age. There are no bravura performances here; superb musicianship and taste prevail. C.A.

COLLECTION

MONTREUX SUMMIT, VOLUME 2. Woody Shaw, Maynard Ferguson (trumpets); Hubert Laws, Tys van Leer, Bobbi Humphrey (flutes); Stan Getz, Dexter Gordon, Benny Golson (tenor saxophones); George Duke, Bob James (keyboards); Eric Gale, Steve Khan (guitars); other musicians. *Be Cool; Rites of Darkness; The Moontrane; Red Top;* and three others. COLUMBIA JG 35090 two discs \$9.98, Ⓞ JGA 35090 \$9.98, Ⓞ JGT 35090 \$9.98.

Performance: **Low yield**
Recording: **Good remote**

Mon Dieu, another Montreux! Columbia assembled an army of current jazz and fusion favorites for a concert at the 1977 Montreux Jazz Festival, and the result is mostly a study in excessiveness. Like Volume 1 (reviewed here last April), this follow-up album is an odd mélange of substantial jazz and the kind of simplistic fusion-funk fare that often passes for jazz.

From a jazz point of view, only two of the seven tracks in this album make the grade: *The Moontrane*, a composition by trumpeter Woody Shaw, and *Red Top*, a tune written by Lionel Hampton and probably best remembered as an instrumental by saxophonist Gene Ammons (on EmArcy) and as a 1952 vocal version of Ammons' solo by King Pleasure and Betty Carter (on Prestige). Here both tunes have been arranged by trombonist Slide Hampton, whose charts never cease to impress me, and they are played by the more dedicated jazz players in this monstrous assemblage. *Two Part Invention*, featuring Bob James on acoustic piano and Hubert Laws on flute, is neither jazz nor rock-fusion music, but rather a classically oriented piece that displays the technical prowess of both players; it's somewhat out of context here, but it shows a side of Bob James that is more rewarding, artistically, than the one exemplified by *Night Crawler*, a blander-than-water tune that takes up all of side four and dares to put the pathetic playing of Bobbi Humphrey side by side with the fine flute of Hubert Laws. *Night Crawler* is less than sixteen minutes in length, which is skimpy as album sides go, but it seems endless. Tys van Leer's arrangement and adaptation of *Kanon for Flutes* (composer's name withheld) has a pleasant, classical open and close between which is sandwiched some dreadful funk à la mode, and Steve Khan's *Rites of Darkness* isn't worth the electricity it took to perform it. All told, Columbia has sacrificed quality for quantity with this bumper of a concert. C.A.

STEREO REVIEW MARKET PLACE

REGULAR CLASSIFIED: COMMERCIAL RATES: For firms or individuals offering commercial products or services, \$2.50 per word. Minimum order \$37.50. **EXPAND-AD® CLASSIFIED RATE:** \$3.75 per word. Minimum \$56.25. Frequency discount: 5% for 6 months; 10% for 12 months paid in advance. **PERSONAL RATE:** For individuals with a personal item to buy or sell, \$1.50 per word. No minimum! **DISPLAY CLASSIFIED:** 1" by one col., \$310.00. 2" by one col., \$620.00. Col. width 2-1/4". Advertiser to supply film positives. Please write or phone for frequency rates. **COLOR:** Color avail. for all classified ad styles at earned rate plus additional 25%. Color choice Publisher's option & subject to availability. Publisher reserves right to run ad in black if color not available on classified pages. In such cases color charge will be refunded or credited. **GENERAL INFORMATION:** Ad copy must be typewritten or clearly printed. Payment must accompany copy except when ads are to be billed on credit cards — American Express, Diners Club, Master Charge, VISA — or when ads are placed by accredited advertising agencies. First word in all ads set in caps. All copy subject to publisher's approval. All advertisers using P.O. Boxes in their addresses MUST supply publisher with permanent address and telephone number before ad can be run. Ads are not acknowledged. They will appear in the first issue to go to press after closing date. Closing Date: 5th of the 2nd month preceding cover date (for example, March issue closes January 5th). Send order and remittance to: Classified Advertising, **STEREO REVIEW**, One Park Avenue, New York, New York 10016. For inquiries contact: Gladys Mathieu at (212) 725-3926.

EQUIPMENT

WRITE for quotation on any Hi-Fi components: Sound Reproduction Inc., 460 Central Avenue, East Orange, N.J. 07018. 201-673-0600.

WRITE FOR DISCOUNT PRICES on your choice of components. District Sound, Inc., 2316 R.I. Ave., Wash., D.C. 20018. (202) 832-1900.

STEREO TV

The TE-200 TELEADAPTER EASYLY CONNECTS TO ANY TV & STEREO SYSTEM Using our coupling and matrix circuit, teleadapter takes a low impedance output from the television and delivers two HIGH IMPEDANCE CHANNELS OF SIMULATED STEREO to drive any amplifier. Frequency response is maintained so you can hear the tinkle of bells or booming bass sounds as it happens on TV. With service warranty and hookup instructions \$219.95 ppd. Guaranteed to make your TV 100% more enjoyable.

TE-300 UHF-VHF TV Hi-Fi Audio Tuner for the best TV sound - Solid state - mono and simulated stereo outputs - use with any amplifier. Andodized front panel - simulated walnut case. Dare to be 100% entertained. \$199.95 ppd. SEND CHECK, M.O., MASTERCARD or BANKAMERICARD NO and Expiration date TO: RHOADES NATIONAL CORP. DEPT. A BOX 817 HENDERSONVILLE, TENNESSEE 37075 (615) 824-1735.

NAME _____
ADDRESS _____
CITY _____ STATE _____ ZIP _____

SEND COMPLETE CATALOG

DIAMOND NEEDLES and STEREO CARTRIDGES at DISCOUNT PRICES for SHURE, PICKERING, STANTON, EMPIRE, GRADO and ADC. Send for free catalog. LYLE CARTRIDGES, Dept. S., Box 69, Kensington Station, Brooklyn, New York 11218. For Fast Service call Toll Free 800-221-0906.

SAVE UP TO 69% on over 100 top brand audio components from Carston Studios, New England's Audio Supermarket, one of the oldest mail order firms (Est. 1952) and certainly one of the most reliable. All orders shipped from stocked warehouse. Send for price quote and price list. Carston Studios, Old Brookfield Rd., Danbury, Conn. 06810.

PROFESSIONAL HI-FI COURSE—Instructors include Len Feldman, Julian Hirsch, Larry Klein and Larry Zide. Home study course also available. Send \$2.00 for full color AUDIO PRIMER and full information on joining Society Audio Consultants (SAC), 49 E 34th St., Dept. SR, New York, New York 10016.

PERFECTIONISTS PREFER DYNAKITS. Before Purchase You Owe Yourself Our Quote. Mainline III, 971 Fronheiser, Johnston, PA 15902.

SPEAKER INFORMATION KIT

Get 70 pages of speaker facts, specs, construction tips plus info on our raw speakers, crossovers and a line of 9 quality hi-fi speaker system kits. We'll send you our **full-color catalog**; plus **How to Hook Up Your System**, an exhaustive step-by-step treatise on hi-fi system installation; and our **Speaker Operating Manual**, chock full of facts on how to get the most from any speaker system, for only \$1.00. Even if you don't buy from us we want you to have the facts. That's how we got to be the world's largest manufacturer of speaker kits.

Send to:
Speakerlab, Dept. SR-W
735 N. Northlake
Seattle, WA 98103

SANSUI and PICKERING! BELOW mail order prices! Send to: GSH Super Savings, P.O. Box 86, Eden, N.C. 27288. Phone No. (919) 627-1919.

BARCLAY STEREO COMPONENTS for those who appreciate fine music: Audio Research, Crown, RTR, IMF, EMT, Dennon, Luxman, KEF, Nakamichi, Magnaplanar. Request free catalog — 233 East Lancaster Avenue, Wynnewood, PA 19096. (215) 667-3048.

LOWEST PRICES on stereo-esoteric COMPONENTS & tapes!!! Over 150 brands. Audio Unlimited, 431 Reynolds Circle #12B, San Jose, CA 95127. (408) 289-8875.

NEEDLE IN A HAYSTACK specializes in stereo styli and cartridges, accessories, special albums. All major brands and many hard-to-find replacements available. Free catalog. Dept. S, P.O. Box 17436, Washington, D.C. 20041.

FUJI maxell
Scotch TDK
PICKERING

Sound Guard
EMPIRE ADC
SHURE

BLANK TAPES • CARTRIDGES & RECORD CARE PRODUCTS AT WHOLESALE PRICES

Call TOLL FREE or write for LOW PRICES
IN CALIFORNIA
800/472-1783 **800/854-7769**

Approved by phone

McK's TAPE TOWN
111 S. COLLEGE AVE, PO BOX 5000
CLAREMONT CA 91711

A SINGER'S DREAM!



REMOVES VOCAL FROM MOST STEREO DISCS
The Thompson Vocal Eliminator can actually remove most or all of a solo vocalist from a standard stereo record and yet leave the background music virtually untouched! Not an equalizer! We can prove it works over the phone. Write for a brochure and demo record below. COST: \$195.00

ECHO Ambiance

We do it BETTER for LESS
Whether your interest is in using ambiance for a concert hall effect or as an echo chamber for studio recording use, we manufacture a broad line of sophisticated analog delay Echo and Reverberation devices at prices which only direct sales make possible. Prices range from \$159 to \$495.
Write for a brochure and demo record. Include \$1 to cover costs (refundable with order.)
Write to: **LT Sound**, Dept SR, P.O. Box 1061, Decatur, GA 30031 (404) 284-5155

STEREO COMPONENT Video Tape Equipment

**AKAI • B-I-C • Harman Kardon
Phase Linear • ALTEC • Kenwood •
TEAC • Marantz • Sony • Technics •
Sanyo • JVC • Pioneer • Dual •
RCA** Photographic Equipment Too!

**TO ORDER CALL TOLL FREE
(800) 421-8537**



Henny's
CAMERA • HI-FI • VIDEO
516 W. 8th St. Downtown L.A., Ca. 90014 Tel. 488-0341

DISKO MIX-MASTER IV outstanding performance, professional specs. Two phono inputs: tape, MIC inpts plus cueing. Literature available. Berkshire Audio, P.O. Box 35, Great Neck, NY 11021.

BARCLAY RECORDING & ELECTRONICS — Send \$2.00 for equipment catalog and component evaluation manual. 233 East Lancaster Avenue, Wynnewood, PA 19096. (215) 649-4915 or 649-2965.

BUILD YOUR OWN SPEAKERS



SAVE 50 TO 75%

Send for FREE 40 page Catalog/Manual Speaker Kits • Components • Crossovers
ACUSTA CRAFT
Dept. SR P.O. Box 12030
Shawnee Mission, Ks. 66212

Get QUALITY HI-FI with PROFESSIONAL ADVICE call the Pros at Audio Concepts

Franchised Dealers For:

JBL, AR, TECHNICS PRO, GREAT AMERICAN SOUND, MICRO-SEIKI, BOSE, DAHLQUIST, AVID, ADS/NAKAMICHI, MAXELL, DISCWASHER, MXR, YAMAHA, ONKYO, OPTONICA, SATIN ADC, ACUPHASE, PHASE LINEAR, TANDBERG, AKG, DBX, WIN LABS, SONUS, MICRO ACOUSTICS, HARMAN KARDON, AUDIO PULSE, VISONIK, STAX, DENNON, HAFFLER, G.A.S., OTHERS.

Free freight on most items.

Call us TOLL FREE. It's worth it!!!
(800) 423-4170

AUDIO CONCEPTS

1127 W. Huntington Dr., Arcadia, CA 91006
(213) 445-3663

WRITE, CALL, for price on components, video machines, car stereo over 300 video movies. H.S. Stereo, P.O. Box 273, Oakhurst, N.J. 07755. 201-493-3400.

TERRIFIC DISCOUNTS! Most brands — components, televisions, furniture! Quotations only: Allegheny COSR, Box 1029, Johnstown, PA 15907.

AT LAST! The ultimate cabinet design for housing stereo components—the Custom Sound Modular Equipment Cabinet. Neany two years in development featuring: Flexible modular design expandable to suit any size installation; accommodates any size components including the largest; totally enclosed design with locks prevents dust buildup, tampering, or theft, bottom casters for mobility and rear door for easy rear access; high grade furniture design and construction; very attractively priced. Before you invest in a rack, call or write for our free illustrated information. CSS, 8460 Marsh, Algonac, Michigan 48001. (313) 794-5400.

Unexplained buzz, pops, hash?

- Power line surges and hash could be the culprit! Line Cord Surge Suppressor/Hash Filter curbs damaging surges & disruptive hash. Protects valuable equipment. Strips away annoying hash from tools, appliances.
- Send SASE for free interference cures. At your dealer or order direct.



S/F-KW-3
\$22.50

ELECTRONIC SPECIALISTS, INC., DEPT. SR
171 SOUTH MAIN ST. NATICK, MASS. 01760

QS/QS? The Best in Quadraphonic Sound... fantastically priced add-on decoders! Free information. PHOTOLUM CORP., 118 East 28 Street, New York, NY 10016.

DYNAKITS — LOW PRICES, fast service. DEW Audio (formerly Underground HiFi), #4 Pinewood, Hampstead, N.H. 03841. (603) 329-5403.

ENJOY DOLBY broadcasts and recordings. Switchable or simultaneous encode/decode Outboard Dolby KITS. SFO INTEGEX, Box 747, Havertown, PA 19083.

TECHNICS, JBL, Craig, JVC at discount prices. Send for catalog. Sound Bargains, P.O. Box 3247, Martinsville, VA 24112.

AUDIOPHILE'S HIGH FIDELITY COMPONENTS. Over 100 Domestic and Foreign Brands, including analog and digital time-delay systems. Low prices! Efficient, personalized service. Buy with confidence! Audio America, Box 445 S, Lexington Park, Maryland 20653. (301) 862-3088. 5-9PM Week-days, 9AM-9PM Saturday and Sundays.

DIGITAL! Thrilling Telarc Soundstream recording: Frederick Fennell, Cleveland Symphonic Winds. Bach, Handel, Holst as never before. \$14.95 plus \$1.00 P&H. MasterCard, Visa. Write for free catalog Direct-to-Disc and other audiophile recordings on RCA-Japan, Sonic Arts, Toshiba-EMI, Umbrella labels, as well as quality audio accessories. Interstate 80 Marketing, P.O. Box 5367, Akron, OH 44313.

WHY PAY SHIPPING COSTS? We ship free and sell for Less! Stereo Equipment catalog/Quote. Corathers, Box 4060, Pasadena, CA 91106.

BRITISH AND EUROPEAN Equipment Direct to you. Most quality makes of equipment available at advantageous prices. Price list and price quotes send international reply coupon. For specific brochures send \$2.00 bills. Audio T, Dept. C, 190 West End Lane, London N.W. 6, phone #01-794-7848. Visitors welcome.

REK-O-KUT drive belts. Specify model. \$9.95 delivered. QRK Electronic Products, 1568 N. Sierra Vista, Fresno, CA 93703.

LOWEST PRICES. Huge Selection! Write for your prices, Stellar Sound, 6260 Melody Lane, Dallas, TX 75231.

The Comfortable Alternative to Headphones

YEAPLE Stereopillow™

Model 900—reviewed in High Fidelity, \$79.95 Stereo Review
Model 400—New compact version \$34.95



FREE reviews and dealer list from: Yeaple Corp., Dept. SR, 1255 University Ave., Rochester, NY 14607

HORNS-WOOFERS-MIDS-TWEETERS at tremendous OEM savings. Altec, Electro-Voice, Pioneer, Peerless, Phillips, Polydax and many others. Dozens of hard to find items used in major manufacturers most expensive systems. Huge selection of crossover network components, automobile systems, and musical instrument loudspeakers. Send for FREE catalog. SRC Audio Sales Div., Dept. SR, 328 Towerwood Dr., Dallas, TX 75234.

Reduce acoustic feedback!

ISOMATE™ mounts for turntables

10 db more power without distortion, howling, or mistaking from structure-borne sound. Block speaker vibration, shock, from your turntable/stylus. 4 Isolators in walnut feature hi-damping, 8 Hz resonance, designer styling. Satisfaction guaranteed.

only 16.95

ENID Corp. Box 194-19 Riverside, Ct. 06878

Lambda Series II by SpeakerKit, Ltd.

Woofers with butyl surrounds. Transmission lines. Open dome midrange and tweeters. Infra-woofers and ultra-tweeters. Accurate sound at a reasonable price. Send 25¢ for Series II catalog and manual.

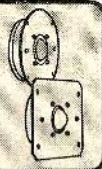

SpeakerKit Box 125, Menomonie, WI 54751

TAPE AND RECORDERS

GOLDEN AGE RADIO—Your best source for radio tapes. Free catalog. Box 25215-TA, Portland, Oregon 97225.

OPERA CLASSICAL MUSIC Open Reels. Rare mostly live free catalog. K. Lohan Tapes, P.O. 298, Mastic Beach, N.Y. 11951.

TDK, BASF, Memorex, Maxell, cassettes, reels, 8-tracks. Lowest prices, new guaranteed. S&S Audio, P.O. Box 56039, Harwood Heights, Ill. 60656.

SCOTCH RECORDING TAPE, exclusively, all new, lowest prices. TAPE CENTER, Box 4305, Washington, D.C. 20012.

RADIO'S GOLDEN DAYS on tape. Reel, Cassette, Cartridge catalog. Radio Memories, Box 2297, Newport News, VA 23602.

EVERYTHING ON OPEN REEL! Stereo. Quadraphonic. Catalogue \$1.00. Barclay-Crocker, Room 1470S, 11 Broadway, New York 10004.

1930-1962 **RADIO PROGRAMS.** Beats Television!! Tapes, \$1.00 Hour! Established esteemed dealer. Informative 200 page catalog, \$1.25. AM Treasures, Box 192SR, Babylon, N.Y. 11702.

RADIO SHOWS, remotes, chronologies, jazz, personalities. Large Catalog \$2.00 (Refundable). Box 82-SR, Redmond, WA 98052.

HISTORICAL OPERA DISC & TAPE — Magnificent quality, speedy service. Greatest live performances of past 50 years. Reel, cassette, disc. Free catalog. Historical Recording Enterprises, Box 12, Kew Gardens, N.Y. 11415.

LIVE OPERA TAPES (REELS) — CASSETTES. Unbelievable treasure since 1926. Over 4,000 selections. Free DELUXE Catalog: Mr. Tape, Box 138, Murray Hill Station, N.Y. 10016.

BASF TAPE: Largest Discounts, Fastest Service. All tapes guaranteed. INTERGALACTIC ENTERPRISES, 1043 Kirts, Troy, Michigan 48084.

YESTERDAY'S RADIO ON TAPE. Reels-Cassettes. Quality Sound. Reliable Service. Catalog \$1.00 refundable with first order. ADVENTURES, Box 4822-S, Inglewood, California 90302.

LIVE OPERA TAPES, CASSETTES. Incredible selection. Magnificent free catalogue. LIVE OPERA, Box 3141, Steinway Station, L.I.C., N.Y. 11103.

PARANOID ABOUT SPECS? Prove or disprove playback performance cassette or record player with surprising new technique developed by Emory Cook. Test cassette or record, instructions \$3.95 (Connecticut residents add tax). COOK LABORATORIES, INC. 375 Ely Avenue, Norwalk, CT 06854.

SAVE up to 60% BY MAIL on: SCOTCH, TDK, BASF, MAXELL, MEMOREX, CAPITOL MUSIC TAPE, CERTRON (over 180 different reel & cassette tapes to choose from); top brand recorders; America's largest collection of taping accessories, too. Same day service. **FREE catalog.**

America's Recording Tape Specialists
SAXITONE TAPE SALES
1776 b Columbia Rd., Washington, D.C. 20009
(202) 462-0800

BLANK TAPE SALE
MAXELL RECORDING PRODUCTS. Lowest prices on complete line of Maxell's quality products. Write or call for prices.
TDK: SA-C60 \$2.07 Ampex: Grandmaster-C60 .. \$2.29
TDK: SA-C90 2.99 Ampex: Grandmaster-C90 .. 2.75
TDK: AD-C90 2.49 BASF: Studio or CR02-C90 .. 2.49
Scotch: Master-C90 2.79 BASF: Prof. I-C90 2.79
Scotch: Master II or III-C90 .. 3.24 BASF: Prof. II or III-C90 .. 2.95
Minimum order 12 pieces. All tapes can be assorted. PA add sales tax. Shipping \$2.50 per order. Or write for complete catalog. (412) 283-8621.
Tape World, 220 Spring St., Butler, PA 16001

CLASSICAL CASSETTES FREE Catalog. Stereo-Dolby ... Quality Guaranteed ... Discounted ... Credit Cards Accepted. EKR Classics, GPO Box 19775J, New York, NY 10001.

BARGAINS! TAPES: blank, prerecorded. Records. Closeout prices! Catalog \$1.00 (refundable). Tower, Box 12, Lewes, Del. 19958.

OPEN REEL TAPES. Top quality. 100% money-back guarantee. Major labels. Classical, Pop, Rock, Quad-Direct Disk, Video. Bankcards accepted. Catalog/order information, \$1. No other fees, obligations. Reel Society, P.O. Box 9337R, N. Hollywood, CA 91609.

TAPE Cassette Sale!

	TDK		
CASSETTES			
TDK-DC-45	1.09	TDK-SAC-90	1.99
TDK-DC-60	1.29	TDK-SAC-90	2.99
TDK-DC-90	1.69	TDK-ADC-90	1.79
TDK-DC-180	2.99	TDK-ADC-90	2.89
8-TRACK			
TDK-45 D 8tk	1.59	TDK-45 AD 8tk	2.29
TDK-90 D 8tk	1.99	TDK-90 AD 8tk	2.99

LIFETIME PRODUCT GUARANTEE! **ORDER NOW!**
Minimum order 10 tapes
Orders shipped within 1-3 days. Please add \$2.00 for shipping and handling per order. N.Y.S. Res. add sales tax. NO C.O.D.'s. **FREE CATALOG!**

CONSUMERS CO.
P.O. Box 550 Dept. HF-10
Mt. Vernon, N.Y. 10551 Phone: (914) 864-2909

CASSETTE SAVINGS BREAKTHROUGH!!! Proven best or your-money-back. No minimum. Free same-day shipping. Sample \$1.00 — Facts free. Larksong, Box 468-C11, Point Arena, CA 95468.

OLD RADIO PROGRAMS. Sales, rentals, Dolby. Catalog: \$1.00 deductible. AIRWAVES, 211-SR E. Porter, Kirksville, MO 63501.

SAVE! ORDER MINIMUM 20 cassettes — cut any advertised price 10¢ — enclose that advertisement, Name Publication. 100% guaranteed. Add \$2.50 shipping. Tapeking, 864 East 7 Street, Brooklyn, N.Y. 11230.

OLD TIME RADIO — original broadcasts on quality tapes. Free catalog. Carl R. Froelich, Route One, New Freedom, Pennsylvania 17349.

TDK, MAXELL SCOTCH, BASF, Reels, Cassettes, 8-Tracks. Guaranteed! Y-H, 2007 Wilshire, SR-530, Los Angeles, CA 90057.

RECORDS

SHOW ALBUMS, Rare, Out-of-Print LP's. 64 pg. list. \$1.00. Bakers Wife cast LP \$9.95. Broadway/Hollywood Recordings, Georgetown, Conn. 06829.

PROTECT your LP's—Poly sleeves for jackets 9 cents; Round Bottom Inner Sleeves 8 cents; Square Bottom 6 cents; Poly lined paper 15 cents; white jackets 35 cents. Postage \$1.50. Record House, Hillburn, N.Y. 10931.

COLLECTORS' Soundtracks. Mint. List 50 cents (refundable). Jemm's, P.O. Box 157, Glenview, Ill. 60025.

OLDIES oldies, 45rpm. Also current hits. Free Catalog. Cor-ny's Record Shop, Box 166HK, Mason, Ohio 45040.

CLASSICAL RECORDINGS for collectors. Send \$1.00 for Bi-monthly lists. Collections bought, ARS MUSICA, 13 Dante St., Larchmont, N.Y. 10538.

PROTECT YOUR ALBUMS. White cardboard replacement jackets 35 cents. Plastic lined sleeves 15 cents. Postage \$1.25. Opera Boxes, 78 Sleeves. Free Catalog. CABCO 400-1, Box 8212, Columbus, Ohio 43201.

THOUSANDS of like new LP's and prerecorded tapes catalogue \$1.50. Records, Hillburn, New York 10931.

FREE CATALOG LP's \$2.50 to \$4.00 factory sealed. Modern Design, 1731 N.E. 51st St., Pompano Beach, FL 33064.

NOTICE: Record Raters Wanted

(No experience required) Each month you will receive nationally released albums to rate. **There is no extra charge for the LP's you receive** — all you pay is a small membership fee which covers all costs of the LP's including postage and handling. In return for your opinion you will build a substantial album collection — first come basis. For application write:

E.A.R.S. INC.
Box 10245 Dept. SR
5521 Center St., Milwaukee, WI 53210
"Guaranteed" © 1975 E.A.R.S., Inc.

FILM — STAGE SOUNDTRACKS! Monthly Listings! Many rarities. Over 1,000 listings! AJLSR, Box 557342, Miami, Fla. 33155.

RARE ORIGINAL RECORDS, all kinds, mostly mint. 5000 list \$2.00, refundable. Carl, Box 828, Princeton, NC 27569.

JAPANESE STYLE LINERS and everything else in record and tape protection. Free catalog. Quasi-Rational Products, Box 171, Prospect Heights, IL 60070.

DAYBREAK EXPRESS RECORDS Jazz imports from Europe and Japan. CBS-Sony, Trio-Whynot-Eastwind. Free Catalogue. Write: P.O. Box 582, Cathedral St. Station, New York, N.Y. 10025.

HAVING TROUBLE finding direct-to-disc and SOTA recordings? We have them all. Send for free catalogue. Knot So Cheap Records, 7505 Big Bend, Dept. SR10, Webster Groves, Mo. 63119.

DIRECT-TO-DISC recordings all labels. Send \$2.00 for descriptive catalog — Free Newsletter. Disconnection, P.O. Box 10705, Tampa, FL 33679.

RARE OFFER! Join Major Label's own record club WITHOUT any purchase obligation. New releases and reissues of legendary performances — great theatrical and movies personalities. Write for latest catalogue: DRG Records, 200 West 57th St., New York, NY 10019. (212) 582-3040.

DIRECT-TO-DISC, SUPER-DISC and **FILM MUSIC** recordings. Comprehensive, free catalog. COSMIC CHORDS, P.O. Box 4873, Boulder, Colo. 80302.

SEARCHING? LP's! DISContinued Records, 216 North Rose, Burbank, California 91505.

TUBES

TV and Radio Tubes 36 cents. Free 48 page color catalogue. Cornell, 4215-H University, San Diego, California 92105.

MUSICAL INSTRUMENTS

UP TO 60% DISCOUNT. Name brand instruments Catalog. Freepost Music, 114 Q. Mahan St., W. Babylon, N.Y. 11704.

INSTRUCTION

BROADCAST STATION: Start your own. Home, school, church, business operation. Get free equipment, records. Details free. "Broadcasting", Box 5516-R11, Walnut Creek, CA 94596.

WANTED

GOLD, silver, platinum, mercury, tantalum wanted. Highest prices paid by refinery. Ores assayed. Free circular. Mercury Terminal, Norwood, MA 02062.

POEMS, SONGS WANTED. Songs recorded — published. Radio released. Broadway Music Productions, Box 7438-CM, Sarasota, FL 33578.

HYPNOTISM

FREE Hypnotism, Self-Hypnosis, Sleep Learning Catalog! Drawer H400, Ruidoso, New Mexico 88345.

RUBBER STAMPS

RUBBER ADDRESS STAMPS, BUSINESS CARDS. Free Catalog — Fast Service. Jackson's, Brownsville Road-E-101, Mt. Vernon, Ill. 62864.

BUSINESS OPPORTUNITIES

I MADE \$40,000.00 Year by mail order! Helped others make money! Free Proof. Torrey, Box 318-NN, Ypsilanti, Michigan 48197.

STEREO REPRESENTATIVES NEEDED!!! Lowest Possible Prices!! Over 100 Brands!!! Krasco-Rep, 998 Orange Ave., West Haven, Conn. 06516.

NEW LUXURY Car without cost. Free Details! Codex-ZZ, Box 6073, Toledo, Ohio 43614.

MAKE BIG MONEY in spare time selling: Tubes, Antennas, Speakers, Test Equipment, Lite Bulbs, Hi-Fi, etc. No investment. Free information: Allied Sales, Pimento, IN 47866. (812) 495-6555.

MILLIONS IN MAIL! Free Secrets. Transworld-17, Box 6226, Toledo, Ohio 43614.

AUDIOPHILES WANTED!! Put your knowledge to use, earn an excellent spare time income. We need campus Dealers to sell name brand stereo equipment at substantial discounts in your area. No investment necessary. For information and application please write: ABCO, Dept SR, 1201 East Main Street, Meriden, Conn. 06450. Call (203) 238-7979.

GET RICH!! Secret law erases debt. Free report exposes millionaire's secrets. Blueprints, No. DD11, 453 W 256, NYC 10471.

\$650 WEEKLY for beginners!! Free report: Mailorder Consultants MDD11, 453 W. 256, Bronx, NY 10471.

REPRESENTATIVES increase your profits! Make \$\$\$
DEUTSCHE Radiowerke offers high quality IMPORTED Headphones, SPEAKERS, Microphones. 6311 Yucca Street, Hollywood, California 90028.

COLLEGE DEALERS — WRITE for details on college program. Fast shipments, low prices, excellent profit. Sound Reproduction, 460 Central Ave., East Orange, N.J. 07018.

\$3000.00 MONTHLY. Start immediately. Stuff envelopes at home. Information, send self-addressed stamped envelope. Village, Box 508-ZDH, West Covina, CA 91793.

\$500.00 Weekly possible mailing circulars! Free information. Wayne, Box 644, Ottawa, Kansas 66067.

\$1200.00 MONTHLY Correcting Pupils' Lessons!!! Start immediately. Free Report. Send self-addressed, stamped envelope. Home, Box 9201-SJXH, San Diego, CA 92109.

YOU CAN MAKE \$700.00 a month/spare time, stuffing envelopes! Free Proof. Write, Hagler, 500 W. University Parkway, Baltimore, MD 21210.

GOVERNMENT SURPLUS

JEEPS—\$59.30! — CARS—\$33.50! —450,000 ITEMS! — GOVERNMENT SURPLUS — Most COMPREHENSIVE DIRECTORY AVAILABLE tells how, where to buy — **YOUR AREA — \$2.00 — MONEYBACK GUARANTEE —** Government Information Services, Department EC-3, Box 99249, San Francisco, California 94109 (433 California).

MOVIE FILMS

16mm SOUND Features, Shorts, New, Used for Sale. Free Catalog. National Cinema, 333 W. 57th St., N.Y., N.Y. 10019.

CLUBS

TONY BENNETT Fan Club. To join send SAE envelope. Alpert, Box 893, Welch WV 24801.

PLANNING TO MOVE?

Let us know 8 weeks in advance so that you won't miss a single issue of **STEREO REVIEW**.

Attach old label where indicated and print new address in space provided. Also include your mailing label whenever you write concerning your subscription. It helps us serve you promptly.

Write to: P.O. Box 2771, Boulder, CO 80322, giving the following information:

Change address only Extend my subscription

ENTER NEW SUBSCRIPTION

1 year \$9.98 Payment enclosed (1 extra BONUS issue) delivery.
 Allow 30-60 days for delivery. Bill me later

NEW ADDRESS HERE **0422**

Name _____ please print

Address _____ Apt. _____

City _____

State _____ Zip _____

Additional postage on foreign orders: add \$1 a year for Canada, \$5 a year for all other countries outside the U.S. and its possessions. Cash only on foreign orders, payable in U.S. currency.

AFFIX OLD LABEL

If you have no label handy, print OLD address here.

Name _____ please print

Address _____

City _____

State _____ Zip _____

MAGAZINES & BOOKS

WORLD'S most outspoken publication. Natural health, healing, organic gardening. Free copy. Provoker Press, St. Catharines-164, Ontario L2R 7C9. U.S. Inquiries.

JUST PUBLISHED: The Soundtrack Record Collector's Guide. All you will ever need to know about Soundtrack, Original Cast and Personality Records. \$6.95. Dored Company, 1508 West Broadway, Minneapolis, Minn. 55411.

ELECTRONICS

ELECTRONICS BARGAINS, Closeouts, Surplus! Parts, stereo, industrial, educational. Amazing values! Fascinating items unavailable in stores or catalogs anywhere. Unusual FREE catalog. ETCO-014, Box 762, Plattsburgh, NY 12901.

EDUCATIONAL OPPORTUNITIES

LEARN WHILE ASLEEP. Hypnotize! Astonishing details, strange catalog free! Autosuggestion, Box 24-ZD, Olympia, Washington, 98507.

SERVICES

WRITING, RESEARCH, EDITING. All disciplines. Original! Professional Team. Confidential. Reasonable. Superior library facilities. Writers Unlimited, Box 4391, Washington, D.C. 20012. (202) 723-1715. Mastercharge — VISA accepted.

PERSONALS

MAKE FRIENDS WORLDWIDE through international correspondence. Illustrated brochure free. Hermes-Verlag, Box 110660/Z, D-1000 Berlin 11, Germany.

MISCELLANEOUS

FINALLY a simple way to organize Records & Tapes. Free Information. Musicfile, Dept. SR11, P.O. Box 32111, San Jose, CA 95152.

STEREO REVIEW ADVERTISERS' INDEX

READER SERVICE NO.	ADVERTISER	PAGE NUMBER
3	A.A.L. Speakers	48
	ADS	39
	Advent Corporation	101, 165
	Akai America, Ltd.	25
4	Alison Acoustics	28
5	Angel/EMI Records	122
6	Audio Discount Warehouse Sales	144
15	Audio Dynamics—Cartridge	174
42	Audio-Technica U.S., Inc.	169
	Audio-Technica U.S., Inc.	40, 128
9	Avid Corporation	13
10	Ball Corporation	111
11	Bang & Olufsen of America	168
	BASF	97
	Bose Corporation	49
7	British Industries Co., BIC Venturi	50, 51
12	British Industries Co., BIC	10, 11
13	British Industries Co., BIC	82, 83
14	British Industries Co., BIC	155
16	BSR (USA), Ltd.—Equalizer	159
17	BSR (USA), Ltd.—Quanta	132
18	BSR (USA), Ltd.—Acoutrac	27
19	BSR (USA), Ltd.—Turntable	60, 61
20	CBS Records	181
22	Celestion Industries, Inc.	139
94	Century Records	184
23	Chrysler Corporation—Plymouth	129
	Design Acoustics	153
24	Discount Music Club	18
25	Discount Sound	140
	Discwasher	4, 78, 183
27	District Sound, Inc.	160
28	Dover Corporation/Mt. Snow	179
50	Dual	135
29	Electro-Voice, Inc.	26
21	Empire Scientific Corp.	2
99	Empire Scientific Corp.	69
30	Eumig (USA), Inc.	31
31	Fantagist Photo Electronics	160
32	Fujitsu	156
33	Fuji Photo Film, USA	77
34	Hammond Industries	174
35	Harman Kardon, Inc.	42, 43
36	Hi-Fi Buys	85
26	Hitachi	160
37	Illinois Audio	166
38	Institute of Audio Research	145
39	International Hi-Fi Dist.	163
40	J & R Music World	160
	JBL	46, 47
8	Jensen Sound Laboratories	125
43	Jensen Sound Laboratories	20, 21
44	JVC America	90, 91
	Kenwood Electronics	7
45	Kirsch	168
46	Koss Corporation	86, 87
2	Koss Corporation	2
47	Lafayette Radio Electronics	9
48	Lee	89
	Lord Calvert Canadian	52
	Lux Audio of America, Ltd.	67
51	3M Company	130, 131
	Maranon, Inc.	188, Cover 3
52	Maxell Corp. of America	112
53	Maxell Corp. of America	30
54	Mcintosh Laboratory, Inc.	44
55	Memorex Corporation	134
56	Mitsubishi	32, 33
57	Motorola, Inc.	41
58	Musical Heritage Society	141
	Nikko Electronics of America	179
59	Ohm Acoustics Corp.	15
60	Oldsmobile	81
62	J. C. Penney	126, 127
	Phase Linear	152
41	Pickering & Company	95
	OSD (Quality Sound Direct)	71
	Radio Shack	71
63	Rank Organization	73
64	S.A.E.	103
65	Sankyo Seiki (America)	75
66	Sansul Electronics Corp.	16, 17
67	Sanyo	123
68	H. H. Scott, Inc.	19
69	Sharp Electronics	109
	Sharper Image	79, 151
70	Sherbourne Corporation/Killington	173
71	Shure Brothers	34
72	Shure Brothers	35
73	Shure Brothers	142, 143
	Sonic Research, Inc.	24
74	Sonikit	163
75	Sony Corporation of America	63
76	Soundcraftsmen	14
77	Sound Machine	163
78	Sparkomatic	136
79	Spectro Acoustics, Inc.	38
80	Stereo Corporation of America	145
	Stereo Discounters	173
81	Studer/Revox America	37
82	Tandberg of America, Inc.	120, 121
83	TDK Electronics	23
84	TDK Electronics	56, 57
85	TDK Electronics	45
86	Teac Corporation	36
87	Teac Corporation	133
88	Technics by Panasonic	29
89	Top Discount Audio	171
93	Toshiba America, Inc.	105
50	United Audio	135
90	U.S. Pioneer	157
1	U.S. Pioneer	Cover 2, 1
91	Whistler	181
92	Wisconsin Discount Stereo	171
	Yamaha International Corp.	65

TRY THE MARANTZ P. WILL NEVER KNOW OUR

By using a simple test you can prove to yourself that Marantz loudspeakers deliver the same brilliant sound separation over the widest possible listening area:

Here's the test:

Have your Marantz dealer place any pair of Marantz floor standing loudspeakers in a normal listening position. Now, listen as your selection of dynamic music is played through the Marantz loudspeakers. Notice the three dimensional quality of the sound. Now close your eyes and have two people slowly turn the Marantz loudspeakers until they're actually *facing each other*.

Did the sound change?

In almost every case we've found the listener cannot hear a change in the sound . . . because there isn't any! Even with the loudspeakers facing each other. Incredible!

But if you try the same test with most conventional loudspeakers you'll notice a striking difference. The sound literally falls apart. You'll hear a loss of overtones—sparkle and brilliance—all the qualities that make music open and spacious disappear.

WHY MARANTZ PASSED THE TEST WHILE OTHERS FAIL.

In a nutshell: Constant Radiated Power (CRP)—180 degrees dispersion regardless of frequency. To achieve CRP we consider both the frequency response and dispersion characteristics of each individual transducer in the system; woofer, midrange and tweeter. The result is a unique design approach incorporating three important performance parameters:

1. We know that dispersion is determined by the diameter of the radiating surface—the speaker cone—and the frequency being reproduced. So we pick the precise frequency at which each individual driver radiates 180 degrees and use this as the crossover point.

But many manufacturers often crossover at a frequency where, for example, the woofer's dispersion has already started to beam. Why? They may be trying to save money by using cheaper transducers and crossover networks. Or, perhaps they consider CRP to be unimportant. But you won't!

2. Our transducers are positioned on the baffle to ensure the best possible dispersion.

Other manufacturers may position their driver for eye-appeal, but that's not good enough for Marantz.

3. To control transition between our drivers, we use the most sophisticated, best thought-out crossover networks ever developed.

As you can see from the illustration below (Fig. A), wherever you are in the room you hear the same ideal stereo separation and 180 degrees dispersion pattern. Notice how the other speaker

"beams" certain frequencies in a narrow corridor (Fig. B). Unless you sit directly in front of those speakers, you lose part of the music.

TRANSDUCERS YOU'D EXPECT FROM A WINNER.

Wide sound dispersion alone doesn't guarantee sonic accuracy. You also

Tone burst test demonstrates superior low stored energy characteristics of Marantz loudspeakers.

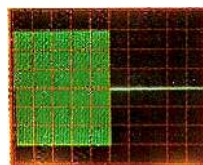

Original signal. Note instant start/instant stop of trace.

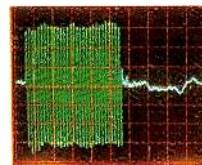

Marantz loudspeaker. Note close similarity to original signal.

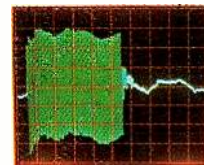

Competitor. Note overhang caused by inability of cone to stop vibrating.

need transducers that exhibit low distortion and low stored energy.

Stored energy is the continued vibration of a loudspeaker's radiating element after the driving force has stopped. It can exist in any loudspeaker; woofer, midrange or tweeter, and is heard as a smearing or running together of the individual instruments.

To assure Low Stored Energy, Marantz uses extremely rigid cones and domes tightly coupled to the voice coil to create a homogeneous rigid structure. Accurate control of this structure is then assured by an extremely powerful magnetic motor assembly. The result is that Marantz transducers move as a unit in a smooth, piston-like motion without the slightest hint of cone break-up or flexing—even under the most rapid acceleration and deceleration! You hear precise, sharp instrument definition—the truest musical sound possible—wherever you are in the room!

Your Marantz dealer has the full line of Marantz speaker systems. If you truly want the best—and are willing to spend a little more to get it—then go for it. Go for Marantz.



25th Anniversary **marantz**®

DO NOT TEST YOUR EARS LOUDSPEAKERS MOVED.

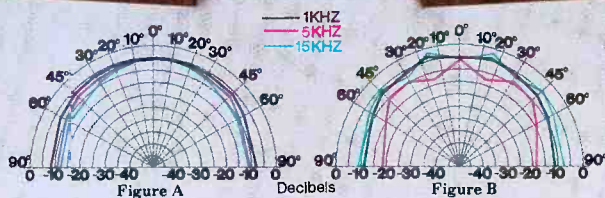

The Marantz speaker disperses all the frequencies 180 degrees.

Conventional speakers tend to narrow certain frequencies.

In actual test, speakers should be placed the same distance apart as you are away from them.



“ About the only thing I have that's better than a Koss Pro/4 Triple A are some extremely expensive electrostatics. ”

David Driskell
Audio Salesman
Los Angeles, California

“ I think the Pro/4 Triple A sounds really similar to an electrostatic headphone, very crisp, very good in the midrange and the highs, yet very dynamic and full in the bass. ”

There are few stereophones of any kind that can match the full-bandwidth sound of the new Pro/4 Triple A. That's because the Triple A's oversized voice coil and extra large diaphragm reproduce recorded material with a life-like intensity and minimal distortion never before available with dynamic stereophones.

“ If there's any clipping, it's in your amp. ”

With a frequency response from 10Hz to 22KHz, a highly efficient element and a perfect seal for low bass response to below audibility, the new Triple A lets every note blossom to its fullest



harmonic growth. You'll hear so much more of your favorite music you'll think you're listening to a whole new record.

“ The pneumatic ear-cushions do three things; they're a lot more comfortable, they eliminate listening fatigue, and they develop a deep, clean bass response. ”

What more can we say except that the unique dual suspension headband makes the Triple A one of

the most perfectly fitting, perfectly comfortable stereophones you'll ever slip on.

“ I talk a lot about the private listening experience. Especially with couples where she wants to watch a TV program and he wants to listen to Bach. They can be together and still do their own thing. ”

One of the beautiful things about the Sound of Koss stereophones is that

you can listen to your favorite music at any volume without disturbing anyone else. And that's beautiful.

“ The workmanship of the Triple A is beautiful. Even the inside which most of my customers never see is very machined, very precision made. ”

Why not stop by your audio dealer and take a good, long look at the new Koss Pro/4 Triple A. And while you're there listen to the Koss CM line of loudspeakers. They're in a class by themselves, too. Or write c/o Virginia Lamm for our free full-color catalogue. Better yet, listen to a live demonstration of the Sound of Koss with your own favorite record or tape. We think you'll agree with David, that when it comes to the Pro/4 Triple A, and other Koss stereophones and speakers: hearing is believing.

© 1978 Koss Corp.

KOSS stereophones/loudspeakers
hearing is believing™

KOSS CORPORATION, 4129 N. Port Washington Ave., Milwaukee, Wisconsin 53212 International Headquarters Milwaukee/facilities Canada · France · Germany · Ireland · Japan

CIRCLE NO. 2 ON READER SERVICE CARD