

Stereo Review

LISTENING TESTS: THE AUDIBILITY OF DISTORTION
REPORT FROM JAPAN • HOOKED ON COUNTRY
LAB TESTS: LINN AMP/PREAMP, AIWA TAPE DECK MORE



MR DAVID S BUCHANAN
8900 YELLOW WOOD PL
LOUISVILLE KY
01#KS
437492 BCH 8900Y091 741J JAN90
#BCH8900Y091 #
#2598*****S-DIGIT 40222



9/79/6



There's only
one disc here
the new
Sony AV Laser
won't play.

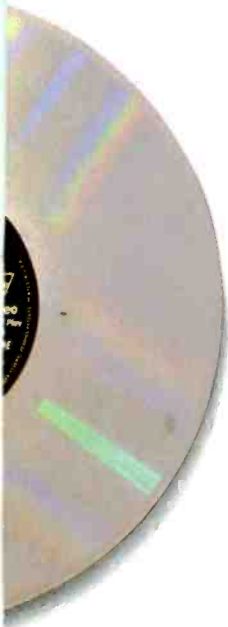

When your family is done flipping the old Frisbee,[®] there's something else they'll flip over. The new Sony AV Laser.[™] Its ability to play multiple size discs presents your family with an extravaganza of entertainment possibilities. Movies, CD concerts, rock videos, educational discs—you name it, and your family has found the perfect home for it in the new Sony AV Laser player.

The 12" Laserdisc. Putting a whole new spin on movies and shows.

Great movies are sailing your way on the 12" laserdisc. And not just a few. A whole sky full of 'em. Spaghetti westerns. Romances. Comedies. War flicks. Horror movies. And you'll have more fun watching them than ever before. Thanks to a razor sharp picture with up to 425 lines of resolution. Plus digital audio sound.

And choosing a movie is almost as much fun as watching one. Because there are over 2700 titles available. Most of which you can get for under \$40. Plus new releases that are even more affordable. In fact, they'll usually cost even less than the same movies on videocassette.



But you'll be seeing more than movies. View the world's greatest paintings,

operas and concerts from your easy chair. Or enjoy educational shows that let you and the kids visit wild animals in their natural habitat without leaving the comfort of your own.

The 8" Laserdisc. A big entertainer in a smaller size.

Naturally the 8" disc doesn't run quite as long as the 12" disc, but it's packed with all the quality you appreciated in the larger one. The 8" will also turn your head with up to 425 lines of razor sharp resolution. And again, digital audio sound. All of which makes family entertainment more entertaining than ever.

The CDV. It's 5" of fun for everyone.

Even mom and dad may want to get in on the excitement spun out by these CDVs. They offer a generous helping of CD music followed by a rock video that'll amaze any age. Dazzling light shows and all kinds of fantastic video effects will really get your place jumping.

The CD. The ears have it.

CDs have proved to be the most dramatic audio advance in decades. With this in mind, we made sure our AV Laser wouldn't just revolve around video discs, but compact discs as well. When you play one on



the AV Laser, you'll enjoy all the sound quality you'd find on one of our best CD players. Thanks to such brilliant features as 4X oversampling, 16 bit filters, and dual D/A converters.

The CD-3.[™] The latest hit for the latest hits.

Remember how much fun you had listening to 45s as a kid. Now your kids can have the same kind of fun with the new CD-3s. Each disc is only 3", but it's packed with 20 minutes of today's hottest music. Another big hit is sure to be the modest price.

So considering all the varied entertainment that's available to you, it only makes sense to have a Sony AV Laser. And to find out just how entertaining it can be, call 201-930-7669.

Of course, once you own one, if there's something you like, you can just play it.

And if it won't play, just toss it.



SONY.
THE ONE AND ONLY.

Catch a couple of free movies, CDs, and a Frisbee.

Right now, when you buy a Sony AV Laser, we'll send you free two big movie hits on 12" laserdisc. "Moonstruck" from MGM/UA. And "Beetlejuice" from Warner Home Video. Plus a free Frisbee. When you buy a Sony AV Laser player (which combines a great video system

with a superior CD player) we'll also offer you 5 CDs for the price of one. For more details, see your participating Sony dealer. This offer is good only from September 1, 1988 through January 31, 1989. So catch it while you can.

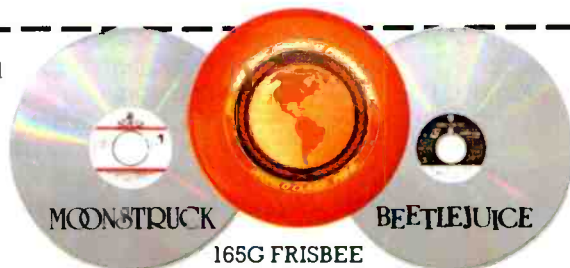

CIRCLE NO. 106 ON READER SERVICE CARD



How to install a 100-Watt* MOS FET Receiver, a Dolby HX Pro Cassette Deck, and an anti-resonant Compact Disc Player in every room.

Imagine controlling and enjoying a music system throughout your house. In the bedroom as you get dressed. In the family room as you relax. In the living room as you entertain. Better yet, imagine all of this music reproduced with consummate fidelity.

That's the idea behind the Kyocera Full-System Remote Control network. With additional speakers and Kyocera's tiny infrared remote sensors, you can enjoy your music — and control your system — in any room!

Just as important, the Kyocera network is the first remote system with audiophile credentials. You have your choice of critically acclaimed MOS FET Receivers,

sophisticated three-motor Cassette Decks, plus a new generation of CD Players with the Fine Ceramics anti-resonant construction Kyocera originated.

So you don't have to settle for an audiophile system that plays in only one room. Kyocera has the one audiophile system that plays in all of them.



Built right from the ground up.

Kyocera International, Inc., 100 Randolph Road, CN 6700, Somerset, NJ 08873-1284 (201) 560-0060
Kyocera Canada, Inc., 7470 Bath Road, Mississauga, Ont. L4T 1L2, Canada (416) 671-4300

*100 Watts/ch., continuous RMS, both ch. driven, 8 Ohms, 20 Hz-20 kHz, 0.02% THD

CIRCLE NO. 176 ON READER SERVICE CARD

Stereo Review

BULLETIN.....	5	TECHNICAL TALK.....	42
LETTERS.....	8	POPULAR MUSIC.....	109
NEW PRODUCTS.....	15	CLASSICAL MUSIC.....	127
RODRIGUES CONTEST.....	27	RECORD MAKERS.....	142
AUDIO Q&A.....	34	THE HIGH END.....	144

EQUIPMENT

CAR STEREO	30
The Eclipse ESD-230 compact disc player in the lab and on the road <i>by Julian Hirsch and Ken C. Pohlmann</i>	
HIRSCH-HOUCK LABS EQUIPMENT TEST REPORTS	51
Adcom GCD-575 Compact Disc Player, page 51	
Thiel CS1.2 Speaker, page 53	
Linn LK1 Preamplifier and LK280 Power Amplifier, page 56	
Aiwa AD-F780 Cassette Deck, page 65	
LISTENING TESTS: THE AUDIBILITY OF DISTORTION	72
Audio components are boasting lower and lower distortion, but how much does it matter? <i>by Ian G. Masters</i>	
TURNTABLES AND CARTRIDGES	79
The vinyl record is still very much with us, and the equipment for playing it is better than ever <i>by Ian G. Masters</i>	
SYSTEMS	84
Building on the repeat theme <i>by Rebecca Day</i>	
JAPAN AUDIO FAIR 1988	95
Style and substance at the world's largest annual audio show <i>by Bryan Harrell</i>	

MUSIC

HOOKED ON COUNTRY	86
It all started with a story on Pee Wee King . . . <i>by Alanna Nash</i>	
BEST RECORDINGS OF THE MONTH	101
Siouxsie and the Banshees, Jessye Norman recital, Richard Thompson, Beethoven Symphonies Nos. 4 and 5	

*Cover: The Linn LK280 power amplifier with one channel pulled out to show its modular construction; see page 56.
Design by Sue Llewellyn, photo by Robert Lorenz.*

STEREO BUYER POLL, SEE PAGE 133
Please fill in if you bought equipment in the past thirty days.
READER SERVICE INFORMATION CARD, FACING PAGE 133
Circle the items you want to know about.

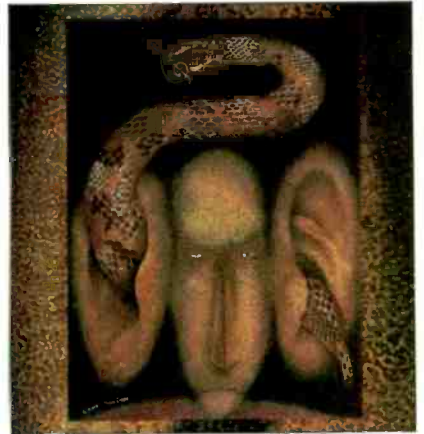

PAGE 72



PAGE 85



COPYRIGHT © 1988 BY DIAMANDIS COMMUNICATIONS INC. All rights reserved. Stereo Review, January 1989, Volume 54, Number 1. Stereo Review (ISSN 0039-1220) is published monthly by Diamandis Communications Inc. at 1515 Broadway, New York, NY 10036; telephone (212) 719-6000. Also publishers of Car Stereo Review, Stereo Buyers' Guide, Compact Disc Buyers' Guide, and Video Buyers' Guide. One-year subscription rate for the United States and its possessions, \$13.94; Canada, \$18.94; all other countries, \$21.94, cash orders only, payable in U.S. currency. Second-class postage paid at New York, NY 10001, and at additional mailing offices. Printed in the U.S.A. Authorized as second-class mail by the Post Office Department, Ottawa, Canada, and for payment of postage in cash. POSTMASTER/SUBSCRIPTION SERVICE: Please send change-of-address forms and all subscription correspondence to Stereo Review, P.O. Box 55627, Boulder, CO 80322-5627. Please allow at least eight weeks for the change of address to become effective. Include both your old and your new address, enclosing, if possible, an address label from a recent issue. If you have a subscription problem, write to the above address or call (800) 525-0643; in Colorado, call (303) 447-9330. PERMISSIONS: Material in this publication may not be reproduced in any form without permission. Requests for permission should be directed to: The Editor, Stereo Review, Diamandis Communications Inc., 1515 Broadway, New York, NY 10036. EDITORIAL CONTRIBUTIONS must be accompanied by return postage and will be handled with reasonable care, but the publisher assumes no responsibility for return or safety of unsolicited art, photos, or manuscripts.



Jensen shatters.

The sound of Jensen car speakers won't just blow you away. It will blow you to smithereens. It's sound that splinters. Sound that explodes. With enough power to turn your car into an earthquake of rock and roll.

AMERICAN CLASSIC® JTX-340
6" x 9" TRIAXIAL® SPEAKERS. 150
watts peak/60 watts continuous power.
Dynamic cone tweeters. Long throw
woofers. Bass optimized design.



CLASSIC BLUES JCX-220 6" x 9" COAXIAL
SPEAKERS. 130 watts peak/55 watts continuous
power. Dynamic cone tweeters. Long
working woofers. Hot new cosmetics.

JXL 653 6½" TRIAXIAL® SPEAKERS.
135 watts peak/65 watts continuous
power. Polycarbonate dynamic cone
tweeters. Long throw woofers.

All speakers made in U.S.A.

JENSEN
The most thrilling sound on wheels.



© 1989 International Jensen Inc. Jensen, American Classic and Triaxial are the registered trademarks of International Jensen Inc.

CIRCLE NO. 174 ON READER SERVICE CARD



by *Christie Barter*
and *Rebecca Day*

GRUNDIG IS BACK

The German manufacturer Grundig, best known in the U.S. for its short-wave radios and entertainment consoles in the late Fifties and early Sixties, is making a return to this country. Its Fine Arts line of audio components includes the A-903 amplifier (\$899), CCT-903 double cassette deck (\$999), T-903 tuner (\$499), and CD-9000 compact disc player (\$1,099). The video line starts at \$849 for a digital hi-fi VCR and includes 27-, 31-, and 35-inch TV's. Grundig will market the new products through specialty audio/video dealers.

NARAS A&R AWARDS

STEREO REVIEW Contributing Editor David Hall was honored recently by the New York Chapter of the National Academy of Recording Arts & Sciences. A veteran producer and former music director of Mercury Records, Hall received one of the chapter's four A&R/Producers Awards for 1988. The other honorees were George Avakian, a pioneer record producer in the jazz field; Nesuhi Ertegun, co-founder of Atlantic Records; and Kenneth Gamble and Leon Huff, architects of the "Philadelphia sound."

TECH NOTES

Denon America has discontinued production of its 60-minute high-bias and metal cassettes, claiming that the 75-minute cassette has made the 1-hour length unnecessary. The company has introduced 75- and 100-minute cassettes in its HD6 and HD7 high-bias formulations. A promotion package for Denon's HD8 metal-particle cassettes offers five 100-minute tapes and a CD-3 sampler of Denon jazz recordings for a suggested list price of \$24.95. . . . *ID Annual Design Review* chose the Soundstream System-1 and accompanying R-1 remote control (featured on the cover of our November issue) as a Main

Selection for 1988. . . Kenwood has introduced a Super VHS hi-fi VCR with strobe, slow motion, picture memory, twenty-one day/eight-event programmable timer with on-screen display, and MTS decoder for \$1,199. . . The dbx company has reduced prices from 24 to 40 percent on selected products, including the CX1 audio/video surround-sound processor (now \$1,500), BX1 configurable power amplifier (\$2,800), and TX1 AM/FM tuner (\$500). The company says the price drops were made possible by manufacturing efficiencies resulting from the consolidation of production facilities on the West Coast. . . Philips Consumer Electronics is raising prices for most Magnavox, Philco, and Sylvania audio products by 2 to 4 percent as of January 1, and there may be another increase of 1 to 2 percent in the second half of the year. Philips attributes the increases to rising costs of materials, basic components, and shipping.

AM STEREO PUSH

Representative Matthew J. Rinaldo of New Jersey, the senior Republican on the House Telecommunications Subcommittee, has proposed a measure that would require the FCC to adopt a single standard for stereo AM radio by April 1989. The bill is co-sponsored by Representative Don Ritter (R-Pa.). Attributing the decline of AM radio to low-quality broadcasts, Rinaldo said, "If AM stations are to regain their full ability to compete in the radio market, they must have the ability to produce sound comparable to FM stations."

MUSIC NOTES

Bon Jovi and the Soviet rock group Gorky Park were the first to sign on for an all-star benefit album being produced by the Make a Difference Foundation, dedicated to fighting drug and alcohol abuse. . . Conductor Daniel Barenboim and singer Barbara have been decorated by France's President François Mitterrand with the Legion of Honor. . . Dion,

Otis Redding, the Rolling Stones, the Temptations, and Stevie Wonder will be elected to the Rock-and-Roll Hall of Fame in ceremonies at the Waldorf-Astoria Hotel in New York on January 18. Producer-writer-arranger Phil Spector will also be honored.

"WORSE" THAN DAT?

The Recording Industry Association of America (RIAA), which has threatened a lawsuit against the first manufacturer to bring digital audio tape recorders to the U.S., has joined forces with the International Federation of Phonogram & Videogram Producers (IFPI) in a war on the recordable compact disc. The IFPI has issued a policy statement charging that recordable CD's represent an even greater threat to copyright owners than DAT does. The IFPI maintains that mass production of record-once discs (CD-R) could begin as early as this year.

JUKEBOX CENTENNIAL

This year marks the hundredth anniversary of the jukebox, and RCA Records is incorporating an anniversary logo on all 7-inch 45-rpm singles it produces during 1989. The world's first jukebox, according to RCA, was installed in the Palais Royale Saloon in San Francisco on November 23, 1889. Called a Nickel-in-the-Slot, it was a modification of Edison's first phonograph, which he had invented a few years earlier.

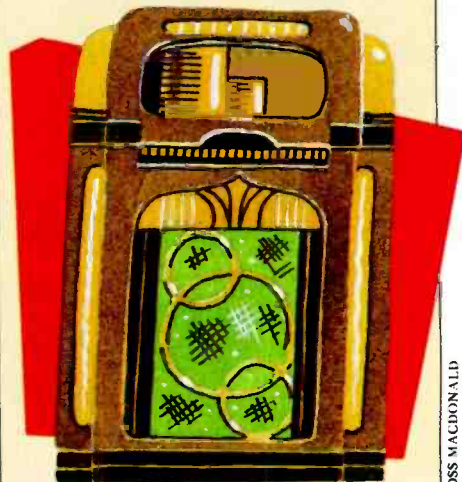

ROSS MACDONALD

The Monitor Series



Monitor 10B

"The best high performance speaker value on the market today." Off The Record

“Polk’s Remarkable Monitors Redefine Incredible Sound/Affordable Price”

“At their price, they’re simply a steal” Audiogram Magazine

Monitor 10B — \$349.95 ea.

Considered one of the worlds’ best sounding loudspeakers and, in the words of Audiogram magazine, “At the price they are simply a steal.” The Polk 10B utilizes dual trilaminate polymer drivers coupled to a built-in subwoofer for accurate bass response and superior dynamic range. A 1” dome tweeter perfectly complements the other drivers to insure outstanding reproduction of every type of music.

Monitor 7C — \$274.95 ea.

Basically a smaller, less expensive version of the Monitor 10B. By offering superlative performance whether mounted on a shelf or a speaker stand, the 7C is a highly versatile addition to any audio system. How good does it sound? Audio Alternative magazine said, “It is amazing.”

Monitor 5B — \$214.95 ea.

Similar in design and performance to the Monitor 7C, however it utilizes an 8” subwoofer (rather than 10”) and is more compact. The 5B represents one of the best values of the entire Monitor Series.

Monitor 5Jr. + — \$169.95 ea.

Called the best sounding speaker of its price in the world regardless of size. It achieves life-like three-dimensional imaging which 10 years ago was not available in any bookshelf speaker at any price.

Monitor 4.5 — \$122.45 ea.

Shares most of the high technology components and rewarding musical performance of the larger Polk speakers at a surprisingly low price. A critically tuned bass duct insures high efficiency and great bass performance despite its convenient compact design.

Monitor 4A — \$99.95 ea.

Identical to the 4.5 in a smaller cabinet. Audio critic Lawrence Johnson called it, “an all around star of great magnitude.” The 4A’s affordable price means that no matter how small your budget, you can afford the incredible sound of Polk!

Matthew Polk’s Vision: Superior Sound for Everyone

Polk Audio is an American company that was founded in 1972 by three Johns Hopkins University graduates who were fanatical audiophiles with a common vision. They believed that it was possible to make speakers that performed as well as the most exotic and expensive systems at a fraction of the price. Starting with only \$200, they began by designing and manufacturing the Monitor Series loudspeakers. The Monitor Series combined the advantages of American high technology and durability with European styling and refinement. Over the years an unending stream of rave reviews, industry awards, and thousands of enthusiastic Polk customers have established the Monitor Series as the choice for those looking for both incredible sound and an affordable price. There is no better value in audio equipment today than a Polk Monitor series loudspeaker.

Uncompromising Standards at Every Price

A limited budget does not mean a limited ability to appreciate fantastic sounding music. That’s why we put our best engineering efforts and only the finest materials into every Polk product regardless of price.

Every Polk Monitor Series speaker uses the same trilaminate polymer cone technology as the flagship SDA-SRS 1.2. Every Polk Monitor utilizes a 1” polymer dome tweeter, and most use exactly the same tweeter found in the SRS 1.2. All Polk Monitors employ costly multi-component crossover networks and ¾” thick high density, non-resonant cabinets. Pick up a Polk Monitor 4A, then pick up a comparably priced but larger speaker from a different manufacturer. You’ll notice that the Polk is heavier, more solidly built, and sports a superior fit and finish. Now compare the sound. We are sure you’ll agree with Musician magazine, which said Polk Monitors are: “Vastly superior to the competition.”



Matthew Polk with his incredible sounding/affordably priced Monitor Series loudspeakers. Front row (L to R) Monitor 5Jr. +, Monitor 4A, Monitor 4.5 Back row (L to R) Monitor 10B, Monitor 7C, Monitor 5B

The Thrilling Sound of Polk Monitors

Polk Monitors achieve open, boxless, three-dimensional imaging surpassed only by the SDA’s. Their silky smooth frequency response assures natural, non-fatiguing, easy to listen to sound, while their fast transient response results in music that is reproduced with life-like clarity and detail. In addition, dynamic bass performance, ultra-wide dispersion, high efficiency and high power handling are all hallmarks of Monitor Series performance.

There is a Polk Monitor Perfect for You

Each time you advance through the six Monitor Series models, you’ll immediately hear a remarkable improvement in efficiency, bass response, and output volume. They are designed so that a smaller Polk played in a small room will sound nearly identical to a larger Polk played in a large room. A larger Polk in a small room will, of course, play that much louder with even better bass. No matter what price range fits your budget, there is a spectacular Polk Monitor Series speaker waiting to fulfill your sonic dreams.

Stereo Review

LOUISE BOUNDAS

Editor in Chief

MICHAEL SMOLEN

Executive Editor

SUF LLEWELLYN

Art Director

WILLIAM WOLFE

Technical Editor

CHRISTIE BARTER

Music Editor

DAVID STEIN

Managing Editor

REBECCA DAY

WILLIAM GOLDMAN

ROBERT ANKOSKO

Senior Editors

LOREN FALLS

Associate Art Director

LAURA KELLY

Associate Editor

CATHERINE FLEMING

Assistant Art Director

BARBARA AIKEN, ROCCO MATTERA

Editorial Assistants

WILLIAM LIVINGSTONE

Editor at Large

Contributing Editors: Robert Ackart, Chris Albertson, Richard Freed, Phyl Garland, David Hall, Ron Givens, Bryan Harrell (Tokyo), Roy Hemming, Julian Hirsch, Ralph Hodges, Stoddard Lincoln, Ian Masters, Louis Meredith, Alanna Nash, Mark Peel, Henry Pleasants (London), Ken Pohlmann, Parke Puterbaugh, Charles Rodrigues, Eric Salzman, Steve Simels, Craig Stark, David Patrick Stearns

Production Director: Karen Rosen
Production Manager: Barbara Ross

WINSTON A. JOHNSON

Vice President and Publisher

ADVERTISING

Advertising Director: Nick Matarazzo

National Manager: Charles L. P. Watson

(212) 719-6038

Consultant: Richard J. Halpern

(212) 719-6025

Account Executive: Sharon Dube

(212) 719-6037

Assistant to the Publisher: Nadine L. Goody

Classified Advertising: (800) 445-6066

Midwestern Managers: Arnold S. Hoffman,

Jeffrey M. Plaster, (312) 679-1100

Western Managers: Robert Meth,

Paula Borgida, (213) 739-5130

Tokyo Office: Iwai Trading Co., Ltd.

603 Ginza Sky Heights Building, 18-13,

Ginza 7-Chome, Chuo-Ku, Tokyo, Japan 104

Japan Representative: J. S. Yagi, (03) 545-3908



STEREO REVIEW is published by Diamandis Communications Inc., a wholly owned subsidiary of Hachette Publications, Inc.

President & CEO: Peter G. Diamandis

Executive Vice President: Robert F. Spillane

Senior Vice President, Finance, & CFO: Arthur Sukel

Senior Vice President, Manufacturing & Distribution:

Murray Romer

Senior Vice President, Operations & Administration:

Robert J. Granata

Vice President, Controller: David Pecker

Vice President, General Counsel: Catherine Flickinger

Vice President, Circulation, Leon Rosenfield;

Vice President, Communications, Phyllis Crawley;

Vice President, Marketing, Anthony F. Incalcaterra;

Vice President, Research, Bruce Gershfield;

Senior Vice President, Sales, James A. Frahm

LETTERS

Price Isn't Everything

I protest Craig Stark's characterization of the a/d/s/ C2/3 cassette deck as "overpriced by a factor of two" in his November article, "Cassette Decks: The New Generation." In his myopic concentration on "features," he ignores the importance of viewing the a/d/s/ C2/3 in the context of the company's Atelier line, a matched set of components integrated in terms of visual harmony as well as performance and operating ease. If the price for long-term satisfaction of all the senses—audible, visual, and tactile—is paying more in terms of "absolute value" for some of the components that make up the system, the buyer is rewarded by a "total experience" that transcends the value of the components considered by themselves.

Place the typical cassette deck next to the typical amplifier, tuner, and CD player, and you end up with a visual cacophony of irregularly sized components with strident front panels filled with flashing lights and controls that lack any consistent component-to-component interface. The a/d/s/ Atelier system, however, offers a *comfortable* way to enjoy music, an understated elegance that I still find pleasurable after almost five years of owning an a/d/s/ C2 cassette deck. The system itself provides almost as much pleasure as the music it delivers.

I suggest that it's worth it to take home long-term excellence instead of faddish features and irregularly sized, overly complicated components. At the very least, potential buyers should be made aware that there's more to life than elapsed-time indicators.

ROGER C. PARKER
Dover, NH

Unsatisfactory CD Reissues

The minute I blasted the Police's *Roxanne* through my new CD player eighteen months ago, I became reinfatuated with music. Now, 130 CD's later, I sometimes wish I hadn't.

So many CD reissues from the late 1960's and early 1970's just sound horrible. There is a two-second crackle one minute and seven seconds into Cream's *Badge* in both "Strange Brew" and "Crossroads." That probably can't be corrected, but the very loud hiss should have been. "Led Zeppelin II" has a tremendous amount of hiss and several pops. Most annoying, however, is the muddled bass line; every song would sound so much better if the bass line had punch. Journey's "Infinity" wins my Find That Engineer and Kill Him Award: The levels are set much too high. The organ at the beginning of the

Stones' *Time Is on My Side* (in "Hot Rocks") sounds quite odd also.

This list barely scratches the surface. Why don't all record companies spend a few extra dollars to make old recordings sound better?

GEORGE ELIADES
Nashua, NH

Separates

Thomas R. Gillett's article on "Separates" in November was quite good except for one thing: His current-water analogy on page 80 is all wet. Voltage, or electromotive *force*, is like the pressure pushing water through a garden hose. Current is more like the water itself. Good amplifiers maintain a fairly constant voltage while delivering large amounts of water, I mean current.

BRAD MILLER
West Hartford, CT

Surround Headphones

In November "Audio Q&A," Ian G. Masters told a reader that he was not aware of any surround-sound headphones on the market today. JVC currently produces a headphone designed for use with surround-sound processors, the HA-SU7, and it is available from any authorized JVC dealer.

MATTHEW HEERE
Buckhannon, WV

Compact Disc Blues

The type of music I listen to is primarily rhythm-and-blues. I keep hearing that the analog disc is on the way out, yet each time a new r-&-b recording is released, I rarely see the CD version in stores. Of the scant few CD's I have come across in this category, a good percentage were simply rereleases of old recordings. This puts purchasing a CD player out of the question for me now.

Is it that the record companies are not producing r-&-b CD's as they should? Or are record dealers just not stocking them? Either way, at just about every record store I've been to, vinyl seems to be as popular as ever.

GLEN C. BARTHOLOMEW
Brooklyn, NY

Not according to the Recording Industry Association of America, which says that in the first half of 1988, 70.4 million CD's were sold in the U.S., but only 43.5 million LP's.

Weighty Polks

The November test report on the Polk Audio SDA-SRS 2.3 speaker states that it weighs about 100 pounds. They seemed heavier than that when I set

The McIntosh XRT 22 Loudspeaker System delivers

The McIntosh XRT 22 is the purest expression of the loudspeakers scientist's endeavors. It is the one *right combination* of component parts that has eluded the diligent searcher for the loudspeaker bridge to the dominion of reproduced musical reality. The high-frequency radiator column is an illustration of the *right combination*. The 23 tweeter elements can reproduce 300 watts sine wave input power at 20 kHz, with the lowest measured intermodulation distortion. Because each tweeter mechanism handles a small quantity of the total power, extremely low quantities of distortion are developed. The total column radiates the energy in a half cylindrical time co-ordinated sound field. The low distortion, transparency of sound, coherence of sound images, definition of musical instruments, and musical balance is simply a revelation that you must experience.

Extra Realism
Extra Depth
Extra Spaciousness
Extra Smoothness



**Handcrafted with pride in the United States
by dedicated, highly trained craftspeople.**

CIRCLE NO. 29 ON READER SERVICE CARD
For information on the McIntosh XRT 22 SPEAKERS and
other McIntosh products write:
McINTOSH LABORATORY INC.
P.O. Box 96 EAST SIDE STATION, DEPT. SR 127
BINGHAMTON, NY 13904-0096

mine up, and the owner's manual lists the weight as 155 pounds each.

CHARLEY WHITE
Norfolk, VA

You're right, of course, and we're sorry.

Car Speaker Phase

In November "Letters," David Se-cord, Jr., proposes wiring speakers in a car's door panels out of phase since

these speakers face each other. Unless I misunderstand his advice, this is a *very poor suggestion*. At low frequencies, the cones of both speakers will move toward or away from the listener together when they are wired in phase. There will *not* be a loss of bass because of phase cancellation for a seated listener.

Try it yourself. Place your home loudspeakers facing each other and sit between them. Now try wiring them in reverse phase. This will cause a per-

ceived *reduction* of bass and will make imaging extremely vague.

Again, the speakers in a car's door panels are *not* out of phase.

RALPH GONZALEZ
Wilmington, DE

Left-Handed Components

The photo on page 22 in November with the "New Products" item on Custom Woodwork & Design is clearly backwards, since I have yet to see a left-handed turntable or left-handed audio/video components. Or did Sota design a turntable specifically for Beatles lovers to play *Revolution No. 9*?

SALANAI S. HORSFALL
Honolulu, HI

We haven't seen any either. The photo was reversed.

Cataloging a Collection

I have been a hi-fi buff for at least forty of my sixty-one years. I am writing to share some thoughts about Dr. Joseph Lee's project of cataloging his music collection on a computer ("Systems," November). Over the years I have recorded some 150 10½-inch tapes and have decided to catalog the contents on my IBM. I made a number of false starts before I found the right data-base program. I now use dBase III+, which is ideal for my purposes.

I will ultimately catalog between 7,000 and 10,000 songs by tape number, tape-recorder number, stereo or mono, starting position (per tape counter), title, performer, type of music, and recording quality. The program lets me look quickly at the entire collection according to any of these categories I have selected. I simply push a button and, *voilà*, it's there.

W. S. HUBBARD
Westport, CT

Monkeying with Mingus

In his notes for the Columbia CD "The Shoes of the Fisherman's Wife," STEREO REVIEW Contributing Editor Chris Albertson correctly quotes Charles Mingus as saying that "Let My Children Hear Music" is "the best album I ever made." The problem is that Columbia has taken two Mingus albums, "Mingus Dynasty" and "Let My Children Hear Music," culled selected tracks from each, and merged them into a contrived third album, "The Shoes of the Fisherman's Wife."

Now Columbia is doing a similar thing with Thelonious Monk by issuing a CD called "Monk the Composer" (of course Monk was a composer, one of the more prolific American composers), a conglomeration of studio and live tracks. What Columbia is doing to the music of Monk and Mingus is akin to a

MOVE AROUND WITH PLUG-IN SOUND!



The only wireless speaker system that puts stereo in every room.

Experience the latest in wireless space-age technology with Recoton's WIRELESS 100. Enjoy crisp, clean sound everywhere — minus the static!

Easy to install, just plug the WIRELESS 100's exclusive transmitter into your main

stereo system or portable CD player and nearby AC outlet. Plug the companion speakers into any AC outlet — in your bedroom, kitchen, den, patio, basement — anywhere. Extra Recoton W101 companion speakers may be added to work from your main WIRELESS 100 system.

So don't restrict your stereo listening area. Set yourself free and move around with plug-in sound with Recoton's WIRELESS 100 stereo speaker system.



Winner of a Design and Engineering Award at the 1987 Consumer Electronics Show.

© 1988 Recoton Corp.



46-23 CRANE STREET, LONG ISLAND CITY, NY 11101

1-800-RECOTON

CIRCLE NO. 96 ON READER SERVICE CARD



REAL PEOPLE.
REAL TASTE.



Winston

AMERICA'S BEST.

© 1988 R. J. REYNOLDS TOBACCO CO.

16 mg. "tar", 1.2 mg. nicotine av. per cigarette by FTC method.

SURGEON GENERAL'S WARNING: Quitting Smoking
Now Greatly Reduces Serious Risks to Your Health.

museum curator's slicing a quadrant from one Picasso and pasting in a quadrant from another Picasso.

Both Monk and Mingus saw their albums as integral works long before such pop acts as the Beatles "invented" concept albums. If "Let My Children Hear Music" is Mingus's best album, why can't we have it intact as the artist intended? Columbia is messing with the music of dead artists and depriving the public of some of their most profound

work. Columbia has done a superb job in reissuing the work of other American composers, removing the canned applause from the Ellington "Jazz Party" CD, for example. I hope they will rectify the wrong they are doing in the cases of Mingus and Monk.

LAURENCE M. SVIRCHEV
Vancouver, British Columbia

Chris Albertson replies: In general, I agree with Mr. Svirchev, but it is better

to have shoes that don't quite fit than no shoes at all.

High-Definition Television

I have been hearing distressing information regarding the latest technology being considered for high-definition television (HDTV). First, all reports thus far have indicated that the technology is based on out-of-date broadcasting systems that are inferior to what is available today. Second, the word is that three or four different versions will be available, creating another VHS-vs.-Beta controversy, which will certainly leave someone a loser. Finally, the wide-screen TV sets already available in Japan have not been designed with a wide enough aspect ratio to allow for full-screen reproduction of the standard Cinemascope picture. So here will be another hardware/software format that still won't give us the full picture, which is very important to those of us who enjoy movies.

What information do you have on this subject, and who can we write to that can make a difference?

SAM KENT
Boulder, CO

Technical Editor William Wolfe replies: There are many different HDTV technologies, based on various designs and offering different aspect ratios, currently in development worldwide. It is still too early to tell which one (or ones) will prevail in the U.S.—or even which is the most attractive from a consumer perspective. One major issue is compatibility between the proposed broadcasting methods and standard television sets; fortunately, the FCC has ruled that it will consider only those HDTV designs that are compatible with the current NTSC system. As for letter writing, you can start with the presidents of every major video hardware manufacturer in the world. You might also express your concerns to the National Association of Broadcasters. Write to Walter W. Wurfel, Senior Vice President, Public Affairs and Communications, National Association of Broadcasters, 1771 N St., N.W., Washington, DC 20036.

First Things First

The first two things I do when my copy of STEREO REVIEW arrives are 1) tear out the annoying reader reply cards that increasingly clutter up magazines these days, and 2) look for the Rodrigues cartoons to cheer me up. The "state of the art" and "long-throw woofer" cartoons published last summer were among his best yet. Applause and thank you to Charles Rodrigues for entertaining us with our excesses and inconsistencies.

JACK VINCENT
Oakland, CA

Designing For Great Sound!



Paul Barton has centered his life on the real sound of music. As a symphony violinist, recording studio founder and Canada's foremost loudspeaker designer, the accurate reproduction of music is simply his highest priority.

PSB speakers are Paul Barton's signature. Therefore they must meet the high standards defined in the PSB design criteria.

Performance: accuracy, neutrality, powerful bass, freedom from resonance.

Appearance: fine craftsmanship in graceful cabinets that occupy minimum floor space.

Value: knowing through experience the balance required to achieve the best sound your dollar can buy.

Reliability: good quality standards, high power handling systems.

The latest PSB designs have been developed as a result of extensive studies in advanced materials and technologies including cast tube injection molding and mineral-filled polypropylenes. From the flagship model STRATUS to the newly introduced CURVE and MKII series, PSB speakers continue to be designed for one purpose and one purpose only...the real sound of music.

For your own copy of "Choosing and Using Loudspeakers" and the name of the PSB dealer nearest you, call or write.

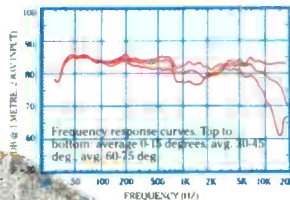

psb
SPEAKERS

111100 35 S.W. 7th Street, Suite 100, University Ave., Norwood, MA 02062 (617) 282-1450
In Canada contact: 1500 Lakeshore Rd., Toronto, ON, M8Z 1R6 (416) 597-0381
© Copyright 1987 PSB Speakers, Inc. All Rights Reserved.

Investing in sound? Here's how to make it pay off.



Great buys—at a great buy: SAVE UP TO 58%!

Stereo Review is written for people who want to make smart buying decisions. We'll help you find the right stereo equipment—the *first* time you buy—and show you how to use it the right way. Because *sound information* is the key to getting an audio system that gives you what you really want.

We test over 70 stereo products in all price ranges each year. *Stereo Review's* product evaluations tell you how the components sound... identify unique features... compare models to others in the same price bracket. We warn you about design quirks, distortion, potential problems. We make the components suffer—so you don't have to.

You'll appreciate our straightforward explanations of audio technology. Telling you how to get more out of your equipment. Announcing important breakthroughs. Clueing you in on professional maintenance tips. The kind of inexpensive know-how that can make a million-dollar difference in how your system sounds.

Even if you already have the perfect system, you'll value *Stereo Review's* record reviews. An average of 30 a month, in all categories of music. They'll insure that your system's power isn't wasted on inferior recordings.

Use this coupon to subscribe to *Stereo Review* at UP TO 58% OFF! It's one of the best sound investments you'll ever make!

Stereo Review

P.O. Box 55627
Boulder, CO 80322-5627

YES! I want superior stereo sound.
Please enter my subscription to *Stereo Review* for the term checked below:

- One year (12 issues) \$13.94
 Two years (24 issues) \$24.94
 Three years (36 issues) \$34.94

CHECK ONE: Payment enclosed. Bill me later.

Mr. _____
Mrs. _____
Ms. _____
(please print full name) 8H59

Address _____

City _____

State _____ Zip _____

Annual newsstand cost is \$27.70. The full one-year subscription price is \$13.94.

Foreign postage: Add \$5 a year for Canada, \$8 a year (payment in U.S. currency; must accompany order) for other countries outside U.S. and possessions. Please allow 30 to 60 days for delivery of first issue.



Invitation to a free concert. You bring the music.

You are cordially invited to attend the next best thing to a live concert by your favorite recording artists: an audition of your favorite recordings on some of the most technologically advanced speakers in the world.

At your Infinity dealer.

Ahead is a listening experience that will take you by surprise. Music you never knew was there before. Subtle inner voices and dynamic impact that lesser speakers simply aren't capable of delivering. And the uncanny sense

of the performers' presence that is Infinity's sonic signature.

So before you buy any loudspeakers, drop by your Infinity dealer with your favorite tape, CD or LP in hand and ask for an ear-opening demonstration of any Infinity speakers.

Then sit back and enjoy the music.



 **Infinity**[®]

We get you back to what it's all about. Music.

NEW PRODUCTS

Carver

The Carver CT-Seven combines a spatial-enhancing Sonic Holography preamplifier and an AM/FM tuner in one component. It is designed for "straight wire with gain" operation and is said to be capable of passing input signals perfectly without affecting musical nuances. The Asymmetrical Charge-Coupled FM Detector circuit is said to reduce multipath distortion. Included are eight FM and eight AM presets and two tape-monitor loops with bidirectional dubbing. Price: \$779. Carver Corp., Dept. SR, P.O. Box 1237, Lynnwood, WA 98046.

Circle 120 on reader service card



Revox

The Revox B160 FM tuner has thirty presets that can be divided into ten subgroups of stations with similar programming. It has switchable IF bandwidth and two levels of Hi-blend to improve reception of weak stations. The fluorescent display can show a pre-

set station's frequency, call letters, or a four-character label selected by the user. Frequency response is rated as 20 to 15,000 Hz ± 0.5 dB. Price: \$1,575. Studer Revox America, Dept. SR, 1425 Elm Hill Pike, Nashville, TN 37210.

Circle 121 on reader service card



TDK

TDK has reformulated its entire audio cassette line and added two high-performance normal-bias tapes, AR and AR-X. Available in 60-, 90-, and 100-minute lengths, the AR tape uses a particle said to have high magnetic efficiency. AR-X, which uses a new dual layer of fine Avilyn particles for high recording density, replaces AD-X tape and is available in 60- and 90-minute lengths. The upgraded Type II SD series—60 and 90 minutes and a new 45-minute length—is said to have improved sensitivity and maximum output level (MOL). The improved SA cassettes, also Type II, in new 46-, 76-, and 100-minute lengths, are claimed to have better remanence and coercivity and reduced audible modulation. In metal tapes, the new MA cassettes (60, 90, and 110 minutes) use an improved particle said to increase their MOL and reduce bias noise; they also feature a new antiresonance mechanism. Available in the same lengths, the new MA-X formulation is rated for an MOL 0.5 dB higher than MA tape in the low and high frequencies. TDK Electronics, Dept. SR, 12 Harbor Dr., Port Washington, NY 11050.

Circle 123 on reader service card



Luxman

Luxman's D-113D CD player has a digital-direct output for direct coupling by either optical fiber or coaxial cable to a digital-input amplifier. All digital-to-analog conversion and analog circuits have been eliminated from the player. Digital connection is said to eliminate the pickup of logic switching noise that can radiate from servo and digital switching circuits and to remove the

potential noise and distortion effects of analog connecting cords. Up to sixteen tracks can be programmed in any sequence and repeated as desired. A remote control is included, and there are jacks for connection with Luxman's multiroom remote-control systems. Price: \$550. Luxman, Dept. SR, 19145 Gramercy Place, Torrance, CA 90501.

Circle 122 on reader service card

NEW PRODUCTS

Celestion

The Celestion SL600Si two-way speaker system has a cabinet made using Aerolam, a rigid, honeycomb material said to help eliminate enclosure resonances. The 6½-inch cast woofer and 1¼-inch copper-dome tweeter have connections for biwiring or biamping. The second-order crossover is at 2,300 Hz. Frequency response is rated as -6 dB at 60 Hz and -3 dB at 75 Hz. Sensitivity is rated as 82 dB sound-pressure level with a 1-watt input, power handling as 35 to 120 watts. Nominal impedance is 8 ohms. The cabinet measures 7¾ inches wide, 9¼ inches deep, and 14½ inches high. Finish is dark-gray Velvetex. The matching spiked stand is 24 inches high. Price: \$1,999 a pair; stands, \$299 a pair. Celestion Industries, Dept. SR, 89 Doug Brown Way, Holliston, MA 01746.

Circle 124 on reader service card



Heath

Heath has introduced a line of stereo components designed by Harman Kardon. The ACW-2540 cassette deck (\$349), the ADW-2530 compact disc player (\$349), the floor-standing three-way ASW-1230 speakers (\$399 each), and the two-way ASW-1082 speakers (\$160 each) are sold assembled. Available in kit form are the 100-watt AA-2500 power amplifier (\$449, or \$499 assembled), with four dual-polarity

power supplies; the AJ-2520 AM/FM tuner (\$229, or \$249 assembled), with quartz-locked tuning system, sixteen presets, and three-segment signal-strength meter; and the AP-2510 preamplifier (\$349, or \$399 assembled), which has inputs for tape, CD, tuner, auxiliary, and two phono cartridges. Heath Company, Dept. SR, Hilltop Road, St. Joseph, MI 49085.

Circle 125 on reader service card



Nikko

Nikko's R-550 AM/FM receiver has an "automatic record out" function that can route any source to all four sets of recorder outputs, two audio and two video, and a "processor select" system to record and monitor two or more different sources simultaneously. Both the audio and video circuits provide for dubbing in either direction. The amplifier section is rated for 55 watts per channel into 8 ohms, 62 watts per chan-

nel into 4 ohms. Dynamic headroom into 8 ohms is rated as 1.45 dB. The tuner section has ten presets for each band. The FM ratings include alternate-channel selectivity of 75.8 dB, a capture ratio of 2 dB, a 50-dB quieting sensitivity of 37.2 dBf in stereo, and a stereo signal-to-noise ratio of 73 dB. Price: \$450. Nikko, Dept. SR, 5830 S. Triangle Dr., Commerce, CA 90040.

Circle 126 on reader service card

DENON

PCM AUDIO TECHNOLOGY / COMPACT DISC

WHAT MAKES ONE AUDIO BRAND SOUND BETTER.

CD PLAYERS have always been susceptible to errors in converting digital data to analog audio. In fact, academic researchers recently declared that error in converting the Most Significant Bit is a primary cause of audible problems. Every Denon Compact Disc Player since 1983 has corrected this problem with the Super Linear Converter.

Now, with the new "Delta" conversion circuit, Denon's DCD-3520 and DCD-1520 represent the closest approach yet to true 16-bit linearity. Denon's 20-bit 8x oversampling digital filter joined to a pair of true 20-bit Super Linear Converters quite simply elevate digital playback to a new level of musicality.

DCD-1520



But then, Denon built the world's first professional digital audio recorder back in 1972. And we've recorded digital master tapes of unsurpassed musical accuracy.

It's simply easier to make digital audio sound more like music when you know what music sounds like.

DENON

DESIGN INTEGRITY

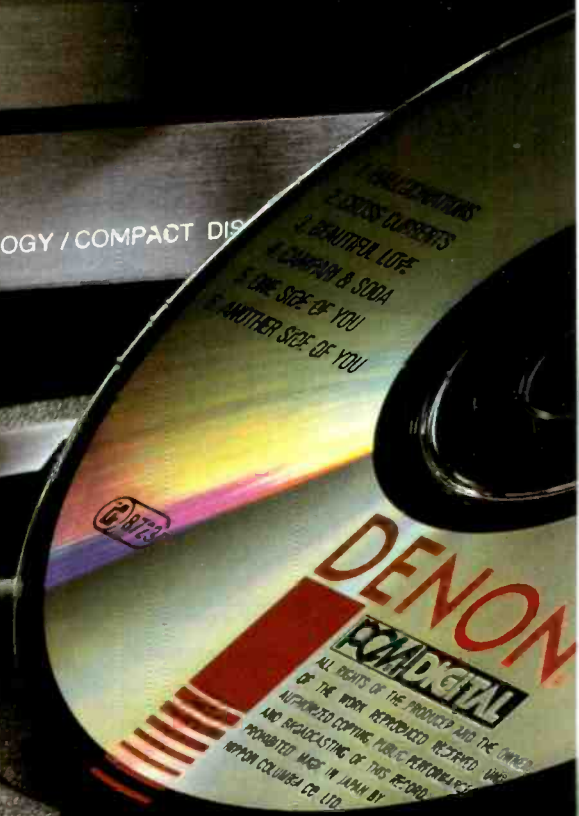

A Sound Investment

ANY 8 COMPACT DISCS FOR 1¢



Tracy Chapman.
(Elektra) 369892

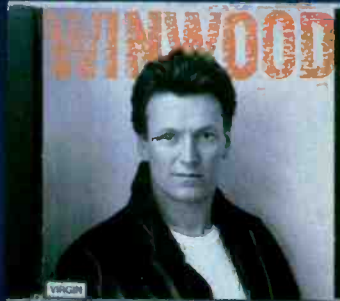

Steve Winwood—Roll With It.
(Virgin) 371211

plus shipping and handling with membership

Little Feat—Let It Roll
(Warner Bros.) 373720

Kronos Quartet
(Nonesuch) 373993

Mieczyslaw Horowitz—
Mozart/Chopin/Schumann
(Nonesuch) 373902

Wynton Marsalis—Portrait
of Wynton Marsalis
(CBS Master) 373555

Ozzy Osbourne—No Rest
For The Wicked
(Epic) 373308

Olivia Newton John—The
Rumour (MCA) 373035

Various Artists—Folkways/
A Tribute To Woody Guthrie
(Columbia) 372995

Sugar Cubes—Life's Too
Good (Elektra) 372896

Big Audio Dynamite—
Tighten Up, Vol. '88
(Columbia) 372672

Emanuel Ax—Chopin: 4
Scherzos, Mazurkas
(CBS Master) 372466

Gerald Schwarz, Cornet—
Bach: Brandenburg
Concertos/Suite In B Minor/
Ransom Wilson, Flute/L.A.
Chamber Orchestra
(Angel) 372367-392365

The Psychedelic Furs—All
of This and Nothing
(Columbia) 372136

Willie Nelson—What A
Wonderful World
(Columbia) 372128

Richard Marx (EMI) 369611

Luther Vandross—Any
Love (Epic) 373399

Bob James—The Scarlatti
Dialogues
(CBS Masterworks) 369835

John Williams—The
Baroque Album
(CBS Masterworks) 369769

Claude Bolling—Piano
Bolling's Greatest Hits
(CBS) 369751

Patti Smith Group—
Dream Of Life
(Arista) 370478

Michael Crawford—Songs
From Stage & Screen
(Columbia) 370411

Hank Williams, Jr.—Wild
Streak (Warner Bros./
Curb) 370320

Wynton Marsalis Quartet
—Live At Blues Alley
(Columbia) 370080-390088

Sergiu Comissiona—
Schumann: Symphony No.
1 In B Flat "Spring" Op. 38
& No. 1 In D Minor Op. 120
Houston Symphony
(Pro Arte) 369850

Schumann-Cello
Concerto.—Yo-Yo Ma;
Davis, Bavarian Radio Sym.
Orch.
(CBS Masterworks) 369843

Johnny Mathis—Once In A
While (Columbia) 368639

Georgia Satellites—Open
All Night (Elektra) 368480

**Joan Jett And The
Blackhearts**—Up Your
Alley
(CBS Associated/Blackheart)
368340

Basia—Time And Tides
(Epic) 368043

REO Speedwagon—
Greatest Hits (Epic) 367672

The Best of Eric Carmen
(Arista) 367599

Brahms—Double Concerto.
Isaac Stern, Yo-Yo Ma,
Abbado, Chicago Sym.
(CBS Master) 367250

Dwight Yoakam—Buenas
Noches From A Lonely
Room (Reprise) 372078

Talking Heads—Naked
(Fly/Sire) 369397

Michael Feinstein—
Remember: Michael
Feinstein Sings Irving Berlin
(Elektra) 369322

Prince—Love Sexy
(Paisley Park) 369124

**Ziggy Marley & The
Melody Makers**—
Conscious Party
(Virgin) 369512

Peter Cetera—One More
Story
(Full Moon/Warner Bros.)
368811

Europe—Out of This World
(Epic) 370403

George Benson—Twice
The Love
(Warner Bros.) 373258

Mendelssohn—Violin
Concerto; **Saint-Saens**:
Intr. & Rondo Capriccioso;
Massenet: Meditation.
Nadja Salerno-Sonnenberg
(Angel) 366872

Brian Wilson (Sire/Reprise)
366427

Midnight Oil—Diesel And
Dust (Columbia) 366153

Billy Ocean—Tear Down
These Walls
(Jive/Arista) 365825

Beethoven—Symphony
No. 9. Norrington, The
London Classical Players
(Angel) 365619

Keith Sweat—Make It Last
Forever (Elektra) 365544

George Harrison—Cloud
Nine (Dark Horse) 365494

Vladimir Feltsman—
American "Live" Debut
(CBS Master)
365254-395251

James Taylor—Never Die
Young (Columbia) 365189

Taylor Dayne—Tell It To My
Heart (Arista) 364711

Daryl Hall & John Oates—
ooh yeah! (Arista) 365775

Metallica—And Justice For
All (Elektra) 372805

Wynton Marsalis—
Baroque Music For
Trumpets.
(CBS Master) 364695

Foreigner—Inside
Information (Atlantic) 364018

Madonna—You Can Dance
(Sire) 362657

Linda Ronstadt—
Canclones De Mi Padre
(Asylum) 362640

Andres Segovia
Collection, Vol. 1 Music
By Bach
(MCA Classics) 362293

George Michael—Faith
(Columbia) 362228

Belinda Carlisle—Heaven
On Earth
(MCA) 362129

Michael Jackson—Bad
(Epic) 362079

Sting—... Nothing Like The
Sun (A&M) 361675

Introducing The Hardline
According To Terence
Trent D'Arby
(Columbia) 361618

Poison—Open Up And Say
... Ahh!
(Capitol/Enigma) 368688

Kenny G—Silhouette
(Arista) 371559

Guns N' Roses—Appetite
For Destruction
(Geffen) 359984

Various Artists—World's
Greatest Overtures Strauss/
Suppe/Brahms/Beethoven/
Wagner/Tchaikovsky
(Pro Arte) 361279

Yes—Big Generator
(ATCO) 361170

Claudio Abbado—
Tchaikovsky: Symphony
No. 6 Chicago Symphony
Orchestra
(CBS Master) 361022

Bruce Springsteen—
Tunnel Of Love
(Columbia) 360115

Billy Idol—Vital Idol
(Chrysalis) 360107

Debbie Gibson—Out Of
The Blue (Atlantic) 359927

Kiri Te Kanawa—Sings
Gershwin (Angel) 359745

Aerosmith—Permanent
Vacation (Geffen) 359075

"La Bamba", Orig.
Soundtrack
(Slash/Warner Bros.) 357939

10,000 Maniacs—In My
Tribe (Elektra) 361600



The Movies Go To The Opera
—Various Artists. (Angel
Studio) 372342



Robert Palmer—Heavy
Nova. (EMI) 370395

Eiton John—Reg Strikes
Back (MCA) 370536

INXS—Kick (Atlantic) 361519



Gold & Platinum Vol. IV
—Various Artists.
(Real Gone Music) 369413

Bob James—Ivory Coast
(Warner Bros.) 372789

UB40 (A&M) 372730

Brandford Marsalis—
Random Abstract
(Columbia) 371849

Grover Washington, Jr.—
Then and Now
(Columbia) 371476

Yehudi Menuhin—Handel:
Orchestral Suites Royal
Philharmonic Orch.
(MCA Classics/RPO) 371005

Spyro Gyra—Rites of
Summer (MCA) 370767

Randy Travis—Old 8 x 10
(Warner Bros.) 370643

Pat Benatar—Wide Awake
In Dreamland
(Chrysalis) 370528

Classics of the 50's, 60's and 70's

Grateful Dead—Europe 72
(Warner Bros.)
370064-390062

Bob Dylan—Blonde On
Blonde (Columbia) 369942

Jerry Lee Lewis—18
Original Sun Greatest Hits
(Rhino) 369108

The Turtles—20 Greatest
Hits (Rhino) 369090

Best of Ritchie Valens
(Rhino) 369082

Dion and The Belmonts—
Their Best (Laure) 369074

The Drifters—Golden Hits
(Atlantic) 365841

Traffic—John Barleycorn
Must Die (Island) 364935

Supertramp—Classics Vol.
9 (A&M) 364471

Jimi Hendrix—The Cry Of
Love (Reprise) 363556

Stevie Wonder—
Innervisions (Tamla) 362368

The Who—Who's Next
(MCA) 357277

Yes—Fragile
(Atlantic) 351957

Aretha Franklin—30
Greatest Hits (Atlantic)
350793-390799

Rolling Stones—Sticky
Fingers (Rolling Stones Rec.)
350645

Jethro Tull—Thick As A
Brick (Chrysalis) 367136

The Mamas & The Papas—
16 Of Their Greatest Hits
(MCA) 348623

Buddy Holly—From The
Orig. Master Tapes
(MCA) 348110

Best Of The Monkees—
Then And Now
(Arista) 346536



The Best of The Doors.
(Elektra) 357616-397612

Creedence Clearwater
Revival—20 Greatest Hits
(Fantasy) 308049

Lynyrd Skynyrd Band—
Gold & Platinum
(MCA) 307447-397448

Woodstock—Orig.
Soundtrack
(Atlantic) 291864-391862



**Beach Boys—Made In
The U.S.A.** (Capitol)
346445

Led Zeppelin—Houses Of
The Holy (Atlantic) 293597

Emerson, Lake & Palmer—
Brain Salad Surgery
(Atlantic) 291526

Led Zeppelin IV
(Atlantic) 291435

America—Greatest Hits
(Warner Bros.) 291385

James Taylor—Greatest
Hits (Warner Bros.) 291302

The Steve Miller Band—
Greatest Hits 1974-78
(Capitol) 290171

Linda Ronstadt—Greatest
Hits (Asylum) 286740

Meat Loaf—Bat Out Of Hell
(Epic) 279133

Billy Joel—The Stranger
(Columbia) 277491

Best Of The Band
(Capitol) 269365

Boston (Epic) 269209

Peter Dinklage—
Frankton Comes Alive!
(A&M) 262311-392316

Chicago IX—Greatest Hits
(Columbia) 260638

Bruce Springsteen—Born
To Run (Columbia) 257279

Cat Stevens—Greatest Hits
(A&M) 256560

Jim Croce—Photographs &
Memories: His Greatest
Hits (Sajal) 246868

Santana—Greatest Hits
(Columbia) 244459

Janis Joplin—Greatest
Hits (Columbia) 231670

Simon & Garfunkel—
Greatest Hits
(Columbia) 219477

Blood, Sweat & Tears—
Greatest Hits
(Columbia) 214650

Sly & The Family Stone—
Greatest Hits
(Epic) 196246

Bob Dylan—Greatest Hits
(Columbia) 138586



Huey Lewis & The News—
Small World. (Chrysalis) 371419

Cocktail—Original Soundtrack.
(Elektra) 373779

Luciano Pavarotti—Pavarotti In
Concert. (CBS Master) 373500



Van Halen—OU812.
(Warner Bros.) 369371



Bobby McFerrin—Simple
Pleasures. (EMI) 369306

- David Sanborn—Close Up
(Warner Bros.) 370304
- Tchaikovsky Waltzes—
Comissiona, Houston Sym.
(Pro Arte) 357871
- Beethoven—Piano Conc.
No. 5, Perahia; Haitink,
Concertgebouw Orch.
(CBS Masters.) 357657
- Grateful Dead—In The
Dark (Arista) 357087
- Heart—Bad Animals
(Capitol) 356667
- Best Of Earth, Wind &
Fire—Vol. I
(Columbia/Arc) 290916

- Sade—Stronger Than Pride
(Epic) 368027
- Gloria Estefan & Miami
Sound Machine—Let It
Loose (Epic) 356279
- Vladimir Horowitz, Piano
—Favorite Encores
(CBS Masterworks) 355164
- Fleetwood Mac—Tango In
The Night
(Warner Bros.) 354902
- U2—The Joshua Tree
(Island) 354449
- Suzanne Vega—Solitude
Standing (A&M) 356287

- Julio Iglesias—Non-Stop
(Columbia) 367094
- Pachelbel Canon—Other
Digital Delights, Davis,
Toronto Chamber Orch.
(Fantare) 348649
- The Police—Every Breath
You Take... The Singles
(A&M) 348318
- Huey Lewis And The
News—Forel
(Chrysalis) 347955
- Enoch Light & The Light
Brigade—The Big Bands
Of The Thirties
(Project 3) 341263

- Robert Plant—Now and
Zen (Es Paranza) 366716
- Best Of The Kinks—1977-
1986 (Arista) 345314
- Anita Baker—Rapture
(Elektra) 344622
- Copland—Rodeo, Billy The
Kid, Slatkin, St. Louis Sym.
(Angel) 344184
- Vivaldi—The 4 Seasons.
Copland, Members Of The
French Nat'l Orch.
(CBS Masters.) 343715
- Tchaikovsky—Eugene
Onegin, Seiji Ozawa, Berlin
Phil. (Angel) 343244
- Barbra Streisand—The
Broadway Album
(Columbia) 342097
- Andreas Vollenweider—
Down To The Moon
(CBS) 346643
- Barry Manilow—Greatest
Hits (Arista) 288670

- Carly Simon—Greatest
Hits Live (Arista) 365874
- The Cars—Greatest Hits
(Elektra) 339903
- Gershwin—Rhapsody In
Blue, etc. Tison Thomas,
L.A. Philharmonic
(CBS Master.) 339226
- Mozart—Symphony No. 40
In G Minor, Kubelik,
Bavarian Radio Sym.
(CBS Master.) 339044
- Sting—The Dream Of The
Blue Turtles (A&M) 336669
- Billy Joel—Greatest Hits
Vols. 1 & 2
(Columbia) 336396-396390
- Dire Straits—Brothers In
Arms (Warner Bros.) 336222
- Carpenters—Yesterday
Once More
(A&M) 334607-394601
- Whitney Houston
(Arista) 334391

- Whitney Houston—
Whitney (Arista) 356154
- Air Supply—Greatest Hits
(Arista) 321307
- Elton John—Greatest Hits
(MCA) 319541
- Michael Jackson—Thriller
(Epic) 318089
- Squeeze—Singles—45's
And Under (A&M) 317974
- Stevie Wonder—Orig.
Musiquarium I—Greatest
Hits (Tamla) 314997-394999
- Nell Diamond—12 Greatest
Hits, Vol. II (Columbia)
314443
- Best Of Blondie
(Chrysalis) 311811
- Boyz n the City—Hits!
(Columbia) 306571
- Linda Ronstadt—'Round
Midnight with Nelson
Riddle And His Orch.
(Asylum) 348987-398982

A sound investment, indeed! You can get EIGHT brand-new, high-quality Compact Discs for 1¢—that's a good deal! And that's exactly what you get as a new member of the CBS Compact Disc Club. Just fill in and mail the application—we'll send you 8 CDs and bill you 1¢, plus shipping and handling. You simply agree to buy six more CDs (at regular club prices) in the next three years—and you may then cancel your membership anytime after doing so.

How the Club works: About every four weeks (13 times a year) you'll receive the Club's music magazine, which describes the Selection of the Month... plus many exciting alternates; new hits and old favorites from every field of music. In addition, up to six times a year, you may receive offers of Special Selections, usually at a discount off regular Club prices, for a total of up to 19 buying opportunities.

If you wish to receive the Selection of the Month, you need do nothing—it will be shipped automatically. If you prefer an alternate selection, or none at all, fill in the response card always provided and mail it by the date specified. You will always have

at least 10 days in which to make your decision. If you ever receive any Selection without having 10 days to decide, you may return it at our expense.

The CDs you order during your membership will be billed at regular Club prices, which currently are \$12.98 to \$15.98—plus shipping and handling. (Multiple-unit sets may be somewhat higher.) After completing your enrollment agreement you may cancel membership at any time; if you decide to continue as a member, you'll be eligible for our money-saving bonus plan. It lets you buy one CD at half price for each CD you buy at regular Club prices.

10-Day Free Trial: We'll send details of the Club's operation with your introductory shipment. If you are not satisfied for any reason whatsoever, just return everything within 10 days and you will have no further obligation. So why not choose 8 CDs for 1¢ right now?

ADVANCE BONUS OFFER: As a special offer to new members, take one additional Compact Disc right now and pay only \$6.95. It's a chance to get a ninth selection at a super low price!

CBS COMPACT DISC CLUB, 1400 N. Fruitridge P.O. Box 1129, Terre Haute, Indiana 47811-1129 049/S89

Please accept my membership application under the terms outlined in this advertisement. Send me the 8 Compact Discs listed here and bill me 1¢ plus shipping and handling for all eight. I agree to buy six more selections at regular Club prices in the coming three years—and may cancel my membership at any time after doing so.

Send me these 8 CDs for 1¢

My main musical interest is (check one): (But I may always choose from any category)

Hard Rock Soft Rock Jazz

Robert Plant, Huey Lewis & The News, David Sanborn, Pat Benatar, Steve Winwood, Spyro Gyra

Pop/Easy Listening Classical

Neil Diamond, Barry Manilow, Vladimir Horowitz, Johnny Mathis, Ray Conniff, Yo-Yo Ma

Mr. _____
 Mrs. _____
 Miss _____
 Address _____ Apt. _____
 City _____
 State _____ Zip _____

Do you have a VCR? (04) Yes No
 Do you have a credit card? (03) Yes No MQ2/F6 MQ3/F7

ADVANCE BONUS OFFER: Also send me one more CD right now at the super low price of just \$6.95, which will be billed to me.

Note: we reserve the right to reject any application or cancel any membership. These offers are not available in APO, FPO, Alaska, Hawaii, Puerto Rico; write for details of alternative offer. Canadian residents serviced from Toronto. Applicable sales tax added to all orders. *Classical members serviced by the CBS Classical Club.

Selections with two numbers contain 2 CDs and count as 2—so write in both numbers. © 1989 CBS Records Inc. **CBS COMPACT DISC CLUB: Terre Haute, IN 47811**

NEW PRODUCTS

Nakamichi

The TA-2A remote-control receiver from Nakamichi uses Stasis amplifier circuitry, which does not require or use global feedback to reduce distortion. The amplifier section is said to have a uniform output impedance and to be able to drive "difficult" speakers. It is rated at 50 watts per channel from 20 to 20,000 Hz into 8 ohms with no more than 0.1 percent distortion. The AM/FM tuner section has ten presets and manual or auto-seek tuning. There are three high-level inputs (CD, tape, and video) and a phono preamp with built-in subsonic filter. Independent selectors permit listening to one program while recording another. Price: \$529. Nakamichi America, Dept. SR, 19701 S. Vermont Ave., Torrance, CA 90502.

Circle 127 on reader service card



Tandberg

The Tandberg TPR 3080 A is an FM-only stereo receiver with inputs for moving-magnet and moving-coil cartridges, a CD player, an onboard tuner, and two tape decks. The output stage of the amplifier uses high-current zero-negative-feedback circuitry with bipolar output transistors rated for 25 amperes. Continuous average power per channel into 8 ohms is given as 80 watts from 20 to 20,000 Hz with less than 0.09 percent distortion. Peak current capability is rated as 30 amperes. Separate record-output and program selectors allow listening to one source while recording another. Price: \$2,500; RC 3000 remote control, \$150. Tandberg of America, Dept. SR, 122 Dupont St., Plainview, NY 11803.

Circle 128 on reader service card

Bang & Olufsen

The Beogram 9000 is a tangential-tracking automatic turntable from Bang & Olufsen that's designed to match the Beocenter 9000 music system. The Beogram 9000 automatically senses a record's size and sets the appropriate playback speed. It uses B&O's Optimum Pivot Point tonearm-suspension technology, which is said to prevent virtually all internal and external vibrations from reaching the stylus tip and distorting the music. A three-point leaf-spring-and-pendulum suspension system further reduces vibration effects. Price: \$450. Bang & Olufsen of America, Dept. SR, 1150 Feehanville Dr., Mt. Prospect, IL 60056.

Circle 129 on reader service card





RZ-7000 Computerized Stereo A/V Receiver

CRAFTSMANSHIP

We put so much into our new RZ-7000 Computerized Stereo A/V Receiver, we thought it deserved a new, sleek look on the outside, too. It deserves more because it provides a better man/machine interface that makes every operation simpler and more logical. Like the station call/equalization memory system: not only can you preset stations and equalizations, you can give them four-character names for quick and easy recognition. You can even make an equalized setting part of the station preset.

And it deserves more because it has everything you need to incorporate audio and video components into a single versatile system.

Don't you think you deserve the RZ-7000?

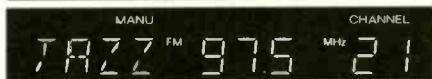

The RZ Series of receivers consists of the RZ-7000, RZ-5000, RZ-3000 and RZ-1000.



SANSUI ELECTRIC CO., LTD.
14-1, Izumi 2-Chome, Suginami-ku, TOKYO 168, Japan
Telex: J28310 SANSUITK

SANSUI ELECTRONICS CORP.
P.O. Box 625, Lyndhurst, NJ07071 (201) 460-9710
in Canada: VANTAGE ELECTRONICS CORP. Vancouver, Toronto

CIRCLE NO. 99 ON READER SERVICE CARD



Motorized main analog volume control. Digitally synthesized AM/FM stereo tuner with 19 presets. 7-band graphic equalizer with Acoustic Memory feature. Record out selector allows separate recording and listening. Video and audio dubbing capability. Cable FM/TV ready. Pre-out and main-in connections.

- Dolby is a registered trademark of Dolby Laboratories, Inc.
- 125 watts RMS per channel, at 8 Ohms, 20-20,000 Hz, 01% THD.



PHILIPS FR980. ADVANCED FEATURES FOR THE DISCERNING AUDIO AND VIDEOPHILE.

The engineers at Philips of the Netherlands steadfastly refuse to accept the commonly accepted. The result: The Philips FR980.

Arguably the most sophisticated A/V receiver available today.

Not only does the FR980 provide the world's most advanced technology, it also offers an extraordinary array of options to mix and match audio and video signals. The possibilities are virtually limitless.

Philips has designed and crafted an advanced receiver that keeps you abreast of emerging technologies like CD-V. Further, the FR980 incorporates three audiophile-quality listening modes to pamper you with impeccable sonic authenticity.

Beyond the experience of true Dolby® Surround Sound, the FR980 features two custom equalization

modes: Movie mode to make special audio effects come alive. And Music mode with a more gentle equalization to bring out the best in the newest music videos already encoded with Dolby Surround Sound.

With 125 watts* per channel to drive the main speakers, and 30 watts for both rear surround sound speakers, the FR980 recreates the true theatrical experience.

The world's most sophisticated A/V receiver demands the most sophisticated remote control: a full "learning" type user-programmable remote. It features an alphanumeric LCD screen, and system memory to handle more than 740 different functions from virtually any infrared controlled component, audio or video.

Audition the new FR980 at your Philips audio/video specialist. Call 1-800-223-7772 for the one nearest you.

WORLD-CLASS TECHNOLOGY. EUROPEAN EXCELLENCE.



PHILIPS

NEW PRODUCTS



Advent

Advent has upgraded its Baby bookshelf loudspeaker to the Baby II, which has a higher sensitivity rating (89 dB) and a new 1/2-inch ferrofluid-filled polycarbonate-dome tweeter said to provide greater dispersion and better imaging than the original model. The two-way speaker has a 6 1/2-inch long-throw woofer. Frequency response is given as 60 to 21,000 Hz, and power handling is 50 watts continuous, 150 watts peak. Total harmonic distortion is rated as less than 1.25 percent above 100 Hz with a 1-watt input. The cabinet has wood end caps with rounded corners. Dimensions are 16 1/2 x 11 x 6 1/4 inches. Advent, Dept. SR, 4138 N. United Pkwy., Schiller Park, IL 60176.

Circle 130 on reader service card

Fultron

Fultron's Model 15-0739 programmable car stereo equalizer/amplifier (shown here below a Fultron cassette receiver) is rated to provide 240 watts of peak power. It includes a spectrum analyzer with a peak-hold option as well as electronic volume and fader controls. A built-in microphone and pink-noise

generator can sense acoustical changes in a vehicle to adjust system response automatically. There are four memories for preset EQ curves. Price: \$219.95. Fultron by Arthur Fulmer, Dept. SR, 2nd and Gayoso Sts., P.O. Box 177, Memphis, TN 38101.

Circle 131 on reader service card



Axiom

The AX Sub Centre Channel speaker system from Axiom Audio includes both a subwoofer and a center-channel speaker for a surround-sound system. The two-way center-channel system, placed between the two 10-inch drivers of the subwoofer, has its own internal enclosure and a separate input. Both systems are magnetically shielded so that a television set or video monitor can be placed directly on top of the 33 x 16 x 15-inch cabinet or, as shown, on top of the matching optional video shelf. The built-in passive crossover for the subwoofer can be set for a crossover point of 120 or 250 Hz; there are also inputs for an external electronic crossover and for biamping.

Frequency response of the subwoofer is given as 29 to 120 or 250 Hz \pm 3 dB; the center-channel speaker is rated for 180 to 22,000 Hz \pm 2 dB. Power handling is rated as 1,000 watts maximum rms for the subwoofer, 350 watts for the center speaker. Price: \$1,449; video shelf, \$299. Axiom Audio, Dept. SR, Box 82, Highway 60, Dwight, Ontario POA 1H0, Canada.

Circle 132 on reader service card

Onkyo

The Onkyo RC-AV20 Unifier is a third-generation programmable remote control, replacing the original RC-AV1. It can control up to ten products, and each of its fifty-one keys is controlled by a master audio/video switch for dual-mode operation, enabling it to learn up to 102 command codes. Colored symbols (white for audio, blue for video) facilitate identification of functions. Price: \$99.95. Onkyo U.S.A. Corp., Dept. SR, 200 Williams Dr., Ramsey, NJ 07449.



More For My Money

I'd always thought you needed big speakers to get good sound. So every couple of years, some department store would have a sale and I would buy the biggest speakers I could find for the money. Then I moved across the country to take a new job. I left my old speakers behind. I was sure they wouldn't fit in my new apartment and I was ready for new ones anyway.

After the move, I went shopping for new speakers at a specialty hi-fi store near my apartment. I told the salesman to show me something under \$500. He took me into a room full of all kinds and sizes of speakers.

The first speakers he demonstrated were fantastic. The bass was big and tight. The stereo image was beautiful. Surely it was the biggest pair in the room.

"I don't have the room for those big speakers," I said. "And besides, I'm sure I can't afford them."

He stopped the demonstration to show me a KLIPSCH[®] kg², a compact and elegant model. "Yeah, this is more my size," I said, "let's hear a pair of these."

"You just did," he said.

I bought those kg²s. I paid a lot less than I had planned. And, believe me, I got a lot more for my money.

For your nearest KLIPSCH dealer, look in the Yellow Pages or call toll free, 1-800-223-3527.

 **klipsch**[®]
A LEGEND IN SOUND[™]

P.O. BOX 688 • HOPE, ARKANSAS USA 71801

CIRCLE NO. 2 ON READER SERVICE CARD

WE'RE NOT RESTING ON OUR REELS.

©1988 TEAC CORPORATION OF AMERICA, 7733 TELEGRAPH ROAD, MONTEBELLO, CA 910640

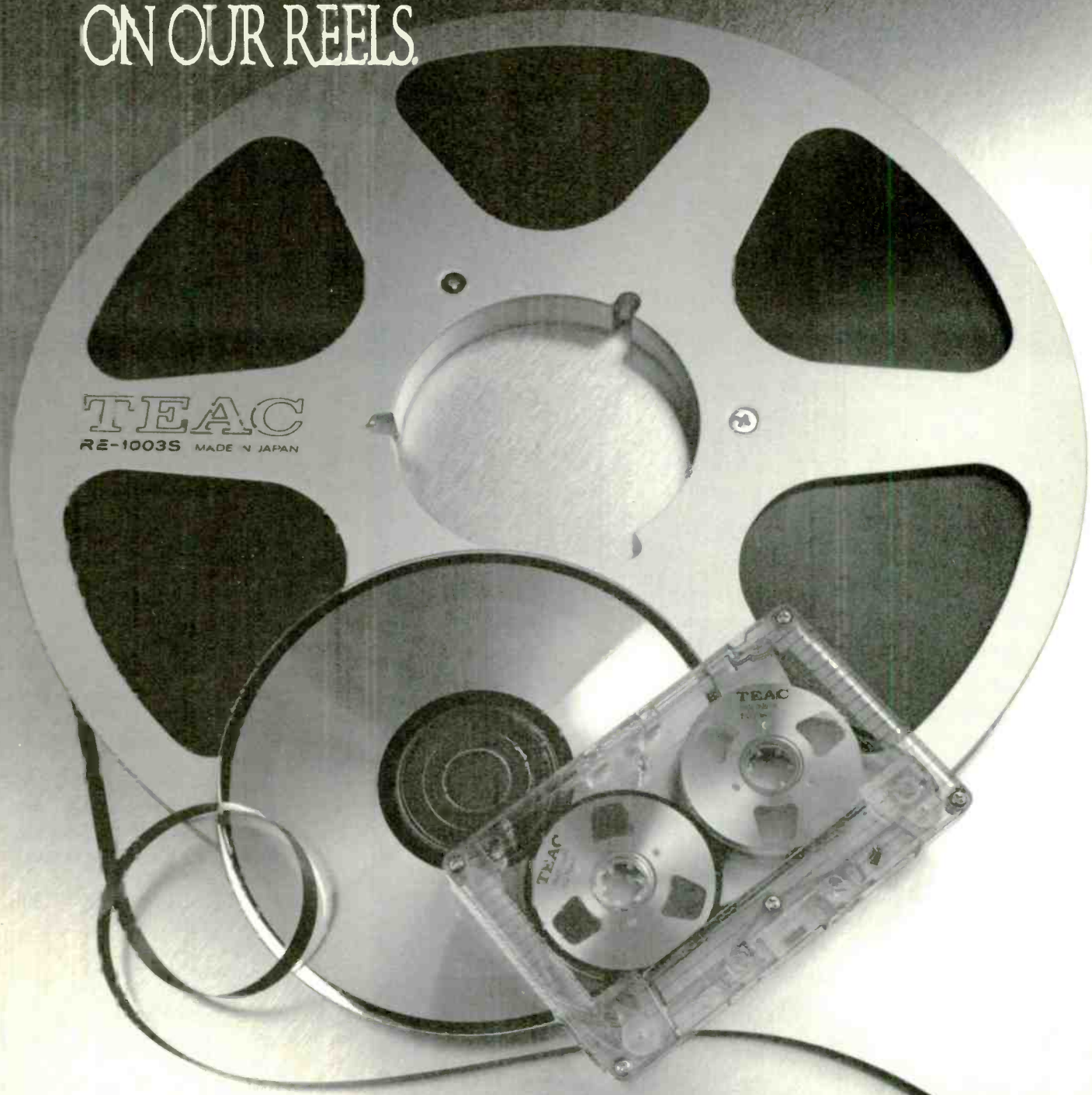

We've built such a reputation for making precision open reel tape recorders, some people think that's all we do. The fact is, we make a full line of audio components. From compact disc players to speakers, receivers to video cassette recorders, equalizers, and audio/video controllers. And of course, a full line of cassette decks and open reel recorders.

One thing, however, will never change. Our uncompromising commitment to building components that last. Every aspect of design, engineering, and manufacturing is driven by this singular goal. To assure every Teac we make is built to provide years of flawless performance.

Performance after performance.

TEAC

CIRCLE NO. 180 ON READER SERVICE CARD

The First Thing We Do Is Build Them To Last.

Announcing the Fifth Annual

RODRIGUES CARTOON CAPTION CONTEST

THE Fifth Annual Rodrigues Cartoon Caption Contest, now officially open, may bring you fame and fortune. Once again the editors of STEREO REVIEW have commissioned artist Charles Rodrigues to supply a drawing, and we invite the readers to submit amusing captions for it.

The person who sends in the one we think is funniest will receive the original drawing shown below, a cash prize of \$100, and the glory of seeing his or her name published in this magazine along with the winning caption when the results of the contest are announced.

Anyone may enter, and there is no limit to the number of times you may enter, but each caption submitted must be on a separate sheet of paper that also contains the clearly legible name and address of the person who enters it in the contest. Entries with more than one caption per page will be disqualified. All entries must be received by STEREO REVIEW no later than March 1, 1989.

The distinguished panel of judges will include members of the editorial staff of STEREO REVIEW and Rodrigues himself as well as Thomas Briggie, Michael Binyon, Bruce

Barstow, and Matt Mirapaul, winners of the previous contests. Entries will be judged on the basis of originality, appropriateness, and humor. The decision of the judges will be final.

You've missed your chance to work with Rembrandt, Picasso, and Andy Warhol, but you may still know the thrill of collaborating with Rodrigues, contributor to STEREO REVIEW since Volume I, Number 1 (February 1958). So far all the winners of this contest have been men who earn their living as systems programmers or doing other work that involves computers. You may be the first winner representing a different profession. Last year Matt Mirapaul proved that to win you don't have to have a surname that begins with "B."

The winning caption (and a selection of runners up) will be published in the June or July issue. Every year we plan to announce the winner in June, but the judges laugh so hard at the entries that it slows them down to July. Cudgel your brains, sharpen your wits, and let us know what you think is going on in this drawing.

The usual restrictions and disclaimers are printed below. Send entries to:

Rodrigues Cartoon
STEREO REVIEW
1515 Broadway
New York, NY 10036

No purchase is necessary. Anyone may enter except the staff of Stereo Review and its parent company (Diamandis Communications Inc.) and their immediate families. All entries become the property of Stereo Review, and none will be returned. If you wish to be notified of the results of the contest by mail, send a stamped self-addressed envelope to the above address.

In the unlikely event of duplicate entries, the one first received will be considered the winning entry. The names of the winner and perhaps a dozen runners-up will be published in Stereo Review and may appear in promotional literature for the magazine. Submitting an entry will be deemed consent for such use.

Stereo Review will arrange the delivery of the prize; any tax on it will be the responsibility of the winner. The judges have every intention of reaching a decision in time for the publication of the results in the June 1989 issue, but Stereo Review reserves the right to delay the announcement until July if the response is as overwhelming as last year's.





Quality Time. Your moments together are too precious to waste. That's why Pioneer created the PD-M700 6-disc CD player. Now you can enjoy up to six hours of digital music without interruption, at the touch of a single button.

Pioneer invented the 6-disc CD magazine system. This innovative format offers you multiple programming options, cataloging capability and is designed to work in both Pioneer home and car multi-CD players. Simply put, no other CD format offers you so many features and is so easy to use.

Pioneer offers a complete line of 6-disc CD players, all with Non-Repeating Random Play. Now you can spend less time changing your music and more time enjoying it.



PIONEER®

We Bring The Revolution Home.™

CIRCLE NO. 85 ON READER SERVICE CARD



ECLIPSE ESD-230 CD PLAYER

by Julian Hirsch and Ken C. Pohlmann

THE Eclipse ESD-230 is an add-on CD player to be used with an existing head unit and power amplifier. While it was designed to complement other Eclipse components, an adaptor is available so that the player can be used with other manufacturers' products.

The sleek front panel of the ESD-230 has flat pushbutton controls that feel excellent to the touch. There are controls for play/pause, repeat, search mode (by track or within a track), program play, program memory, eject, music scan, track/search up and down, and track number (1-9 and +10).

When a disc is inserted, the display lights up with the track number and elapsed time. Other indicators light up when special functions such as program play, repeat play, search, and music scan are being performed. The eject button pushes the disc half-way out of the slot and shuts the player off until another disc is loaded.

The manual that comes with the ESD-230 is fairly straightforward,

and a quick readthrough should allow even the most casual user to program and operate the CD player with little difficulty. Price: \$750. Eclipse, Dept. SR, 19281 Pacific Gateway Dr., Torrance, CA 90502.

Lab Tests

All measurements were made with an EIA standard load of 10,000 ohms and 1,000 picofarads across the front-channel line outputs. The CD player's output clipped at 1.5 volts with a 0-dB, 1,000-Hz test signal when the level control was set slightly below its maximum.

The frequency response of the player was excellent, varying only +0.45, -0 dB from 20 to 20,000 Hz. Distortion at 1,000 Hz was about 0.056 percent with a recorded level of 0 dB and 0.0075 percent referred to a -20-dB level. The A-weighted noise level at 0 dB was -85 dB, and the dynamic range was 94 dB. Channel separation was not as great as I have found in many home CD players, ranging from a maximum of 70 dB at 1,000 Hz to a minimum of 50 dB at 20,000 Hz.

The low-level linearity errors of the digital-to-analog (D/A) converter were average at any listenable level; typical measurements were +0.5 dB at -60 dB and +8 dB at -90 dB. The interchannel phase shift reached 42 degrees at 20,000 Hz. The player's impact resistance was excellent, a key factor in the automotive environment. *J.H.*

Road Tests

My installation of the Eclipse proceeded without a hitch, primarily because I piggy-backed onto an Eclipse system, using the EQZ-200 cassette tuner as the head unit. Otherwise you might need a wiring adaptor: The ESD-230 uses a DIN connector both for audio output and primary power input. It was a snap to plug it into the EQZ-200 head unit. An external DC-to-DC converter box is used only for a ground and a power back-up lead (connected to the car's clock lead, for example).

If you're not using an Eclipse head unit, or another manufacturer's unit with the same interconnection scheme, you should use an adaptor cable (Eclipse calls it a "wiring sub-assembly") that converts the DIN connector to a pair of audio phono plugs and a power pin connector via an in-line filter and fuse. Then it's an easy matter to connect the player to any system's wiring protocol. Without the adaptor, you're condemned to play "identify the DIN pins"—a frustrating job.

In my case, snapping the DIN connectors together and wiring the ground and back-up completed the electrical hook-up. After unscrewing a shipping bracket, I slipped the player into a DIN chassis mounted under the dash. In other words, installation was a piece of cake.

On the road, the ESD-230 proved to be simple and satisfactory to operate. The player turns itself on when a disc is fed into the power loading slot. The loader itself is quick to grab a disc and swallow it, and playback also begins quickly. Our test sample's loader was very noisy, however, making quite an acoustical racket when loading and unloading discs, and mechanical noise was even distinctly audible

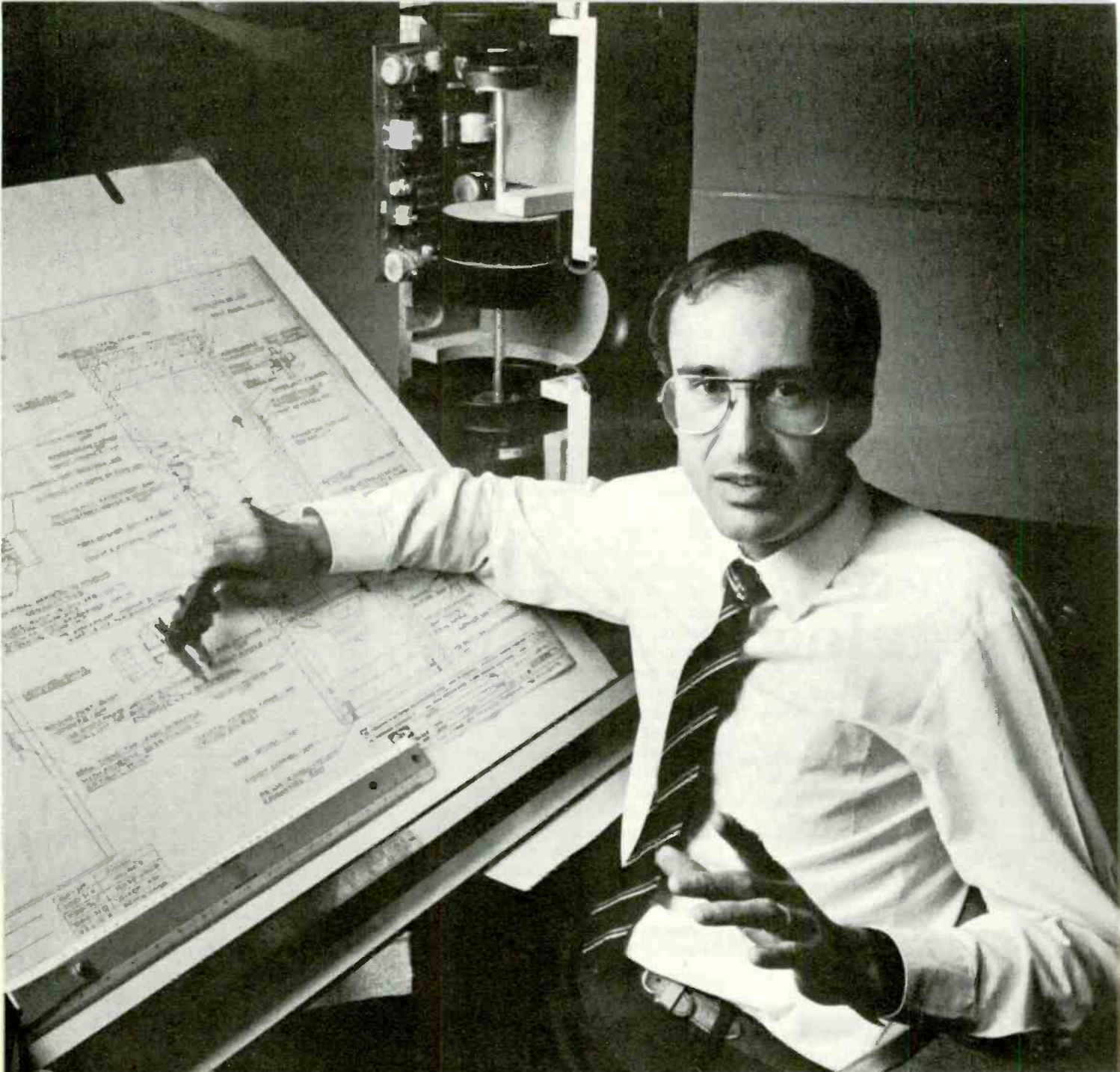

'We can't break the laws of physics, only bend them.'

— Mike Bough, KEF Chief Development Engineer

ONE STEP IN THE MAKING OF A KEF

'You can have deep bass (from a sealed box). You can have efficient bass (from a reflex enclosure). But the laws of physics say you can't have both. At KEF, we're as law-abiding as anyone. But nine years of KEF research have shown us a way around the dilemma.

'We use two separate chambers

for bass loading: one damps back radiation, while the other forms an efficient resonant cavity with a tuned port. This "coupled-cavity" is the first reasonably-sized enclosure to combine outstanding bass extension with high efficiency.

'They always say it can't be done. Until someone does it'

CIRCLE NO. 69 ON READER SERVICE CARD

KEF Electronics Ltd., Torrington, Middlesex, Kent ME15 6GP, England
 KEF Electronics of America, Inc., 1470 Sullyfield Circle, Chantilly, VA 22021 703/631-6610
 Anyth Sound Equipment Ltd., 593 Rue Du Parc Industriel, Longueuil, Quebec, Canada 514/679-5490

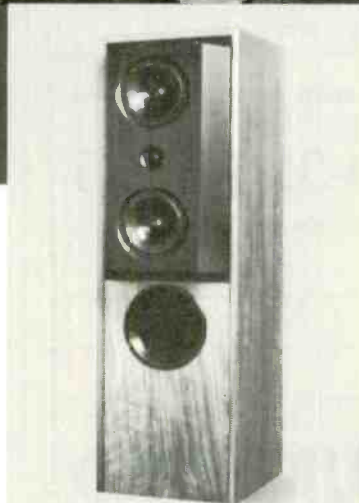

REFERENCE MODEL 104/2



The Speaker Engineers

CRUTCHFIELD

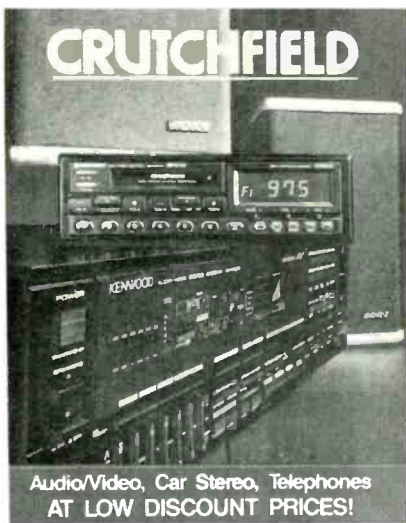

Audio/Video, Car Stereo, Telephones
AT LOW DISCOUNT PRICES!

You'll find the most helpful shopping information in the 116 page Crutchfield catalog.

FREE Stereo Catalog

Refer to the Crutchfield catalog before buying your next car stereo, home stereo, or video product:

- 116 pages of helpful articles, consumer tips, charts, and installation guides.
- Color photos, complete descriptions and technical specifications on hundreds of the finest brand name products.

You get more value shopping Crutchfield:

- Toll-free product advice, ordering, and customer service.
- 24 hour shipping.
- Absolute satisfaction guaranteed.
- Full 30-day return privileges.
- Discount prices on Sony, Pioneer, JVC, Jensen, Proton, Advent, Clarion, Akai, Kenwood, Canon, AR, Infinity, Bose, and many more!

Call or send this coupon now for your FREE Catalog

800-336-5566

Be sure to mention *Stereo Review* when calling

Name _____

Address _____ Apt. # _____

City _____ State _____ Zip _____

CRUTCHFIELD

1 Crutchfield Park, Dept. SR, Charlottesville, VA 22906

CAR STEREO

when a disc was playing. This kind of noise has no business in an advanced device like a CD player, and we hope the problem is limited to our review unit.

The eject button performed as advertised; the disc is unloaded so that it protrudes halfway from the slot. I liked this feature—it made it easy to grasp the disc by the edges, or even by the center hole, thus avoiding fingerprints on the data surface.

The front-panel controls were easy to see and easy to use. Functions are logically consolidated to reduce the number of controls. For example, the mode button switches the forward and reverse buttons between search and scan functions. I also liked the direct track-access buttons, aligned along the bottom of the panel for easy identification. Simply press the track number you want, and you're there; you don't even have to hit the play button. Programming was also easy. I have one small front-panel gripe—the displays are recessed, and in my below-dash installation that made them difficult to see.

In use, the player performed well. I was well satisfied with its fidelity and considered it to be more than adequate for most car installations. Its frequency response, distortion level, and noise floor were all acceptable. I listened to a variety of musical selections, including Kraftwerk's "The Man Machine" (Capi-

tol CDP-46039-2) and Tangerine Dream's "Optical Race" (Private Music 2042-2-P). I felt that the Eclipse fully reproduced all the nuances of these electronic scores, including the tape hiss in "The Man Machine" and the lack of it in "Optical Race." The compressed dynamic range of these recordings helped them to prevail over top-down wind and road noise; a switchable compression circuit would have been a desirable feature in this CD player for recordings with a wider dynamic range.

Mechanically, the performance was very good but not perfect. The manufacturer selected a Sony drive for the ESD-230. It was shock-mounted well and withstood virtually all road conditions, but it did skip under hard abuse, such as potholes. In short, while I would rate the ESD-230's roadworthiness as high, I have seen better players in this respect.

Minor gripes aside, this car CD player is competitive with those already on the market. Although it has a few weaknesses, none of them are anywhere close to fatal. Anyone in the market for a car CD player should consider the Eclipse ESD-230, particularly those who have already invested in Eclipse systems. Its plug-in compatibility makes it ideally suited for such installations. *K.P.*

Circle 139 on reader service card

FEATURES

- DIN-size chassis, DIN power/audio connector
- Four servomotors for focus system, tracking, spindle, and laser carriage
- Three-beam laser pickup
- Isolated, floating motor construction
- Direct track access by number
- Programming for up to nineteen tracks in any order
- Fast scan in both directions with audible sound
- Music scan (first 10 seconds of each track in a programmed sequence)
- Repeat for a single track
- Power loading and eject

LABORATORY MEASUREMENTS

Frequency response: 20 to 20,000 Hz +0.45, -0 dB

Channel separation: 70 dB at 1,000 Hz, 50 dB at 20,000 Hz

Noise (A-weighted, referred to 0-dB level): -85 dB

Phase shift at 20,000 Hz: 42 degrees

Dynamic range: 94 dB

Total harmonic distortion at 1,000 Hz: 0.056% referred to 0-dB level, 0.0075% referred to -20-dB level

Linearity error: +0.5 dB at -60 dB, +8 dB at -90 dB

Impact resistance: A
Speed error: +0.0155%

Beep, honk, toot.

You'll have to forgive Merit smokers for blowing their own horns a bit. They've found a way to continue to enjoy everything they love about smoking. The rich, rewarding taste. The genuine satisfaction. Yet, at the same time, they're getting even less tar than with other leading lights. Fact is, Merit tastes as good or better than cigarettes with up to 38% more tar. Enriched Flavor™ is the secret. Only Merit has it. Though with all those Merit smokers, it won't be a secret for long.

Enriched Flavor,™ low tar. A solution with Merit.



**SURGEON GENERAL'S WARNING: Quitting Smoking
Now Greatly Reduces Serious Risks to Your Health.**

© Philip Morris Inc. 1988

Kings: 8 mg "tar," 0.6 mg nicotine av. per cigarette by FTC method.

by Ian G. Masters



Multiple Outlets

Q *I am planning to finish an extra room to house my stereo equipment. Would there be any benefit in using a separate AC outlet for each component, or would it be acceptable to run everything from a single outlet?*

RON COLEMAN
Conyers, GA

A Assuming that the total power consumption of your audio components does not exceed the maximum capacity of the AC circuit, there is no real virtue in using several outlets, particularly as most of the outlets in a room are usually connected to the same fuse or breaker anyway. It's usually not a good idea to use a series of multiple-plug adapters to connect a large number of cords to a single outlet, both because this is aesthetically ugly and because it might pose a shock hazard in some circumstances. But several companies make "power strips" that provide four or six outlets fed from a single wall outlet, and the most convenient of these include a master power switch as well.

Depending on the nature of your particular equipment, the same thing may be achieved by using the AC outlets on the equipment itself. Again, make sure the total power consumption of your components is within the allowable range of the main power switch (usually on the receiver or preamplifier).

Up Against the Wall

Q *When I commented to a local dealer that a particular pair of small speakers had very little bass, he moved them closer to the wall, and the low-frequency output improved quite a bit. How does a wall act as a bass enhancer?*

MICHAEL HASS
Urbana, IL

A At low frequencies, most speakers are essentially omnidirectional devices: They radiate as much energy to the rear as to the front. If a speaker is placed away from a wall, the back wave takes some time to reach the wall, be reflected, and then travel to the listening position. During this time, the level of the rear radiation attenuates natural-



AUDIO Q&A

ly, as do all sounds over distance, and the reflecting wall absorbs some of the energy as well. In addition, depending on frequency, the reflected rear wave can interfere with the forward radiation when they finally come together, further attenuating level.

With the speaker placed directly against the wall, however, the rear wave is reflected almost instantly, radiating forward in phase with, and reinforcing, the front wave. The increase in bass level can be as much as 6 dB. The more surfaces the speaker contacts, the greater the effect—placing a speaker on the floor in the corner of the room can boost bass substantially. A few speakers are designed with such positioning in mind, but most are not.

Receiver as Tuner

Q My receiver has a tape input but no tape-monitor loop, which means that I am only able to use my graphic equalizer when listening to tapes, not with any other source. I am considering buying an integrated amplifier with a tape monitor so I can use the equalizer

to its fullest. If I do, is there any way that I can use my present receiver just as a tuner?

N. ADHIKARI
Pittsburgh, PA

A It's possible, but since receivers and integrated amplifiers of similar specifications and features don't differ greatly in price, the arrangement you suggest would seem to be unnecessarily complicated. But if you do want to set things up this way, here's how to go about it:

Since your receiver does not provide line-level outputs, your only choice is to take a feed from the amplifier outputs. There are two types of these, for speakers and for headphones. It would be a fairly simple matter to use an adaptor cord with a stereo phone plug on one end and a pair of RCA plugs on the other to connect the headphone output to a line-level input on your new amplifier, but you may not wish to have such a cable traipsing across the front of your equipment, and you may also have problems with overloading the inputs of your amplifier. A better solution is to

connect a pair of heavy-duty resistors to the receiver's speaker terminals and to connect this arrangement in parallel to the appropriate input of your amplifier, preferably through some sort of level control.

Whichever way you decide to go about it, take some care when you use the setup. For one thing, the input you choose should be one of the tape-monitor returns rather than a conventional auxiliary or tuner input, as these are often short-circuited when not selected, and such shorts can damage the output stages of the receiver very quickly. Also, the receiver's output will potentially be much higher than a normal line-level signal, so you must be careful not to overload the input circuits of your amplifier. Hook the two components together with both power switches off and the integrated amplifier's input set to any other source. Turn on the amplifier and set it to a comfortable listening level, using a tape or disc. Then, making sure the receiver's level control is all the way down, turn its power on and select the input it has been connected to. If the system makes awful buzzing or cracking

**JUST CRUISIN'
WITH MY
SHERWOOD.**

It's the same excitement I felt when I got my first set of wheels. Only this time it's not a new car.

It's a new Sherwood.

Awesome sounds. Power. Clarity.

Radical good looks.

Compared to my old car radio, the music really comes alive.

And the price didn't kill me, either.

So that's how it goes:

I turn on my Sherwood.

Then it returns the favor.



 **Sherwood**

LIVE PERFORMANCE SOUND™

3845 Artesia Blvd. Cerritos, CA 90701

© 1988 Inkel Corporation



YAMAHA
POWER

YAMAHA
POWER

www.yamaha.com

THE LOUDSPEAKER SYSTEM THAT HAS THE CRITICS PURRING.

"Awesome low end, extraordinarily smooth middles and highs, and remarkably good depth." —*J. Gordon Holt, Stereophile.*

"The audio equivalent of dinner at Le Francais."
—*Rich Warren, North Shore Magazine.*

"... the cutting edge of technology ... left people open mouthed as they left the listening room." —*Nancy Malitz, Gannett News Service.*

"... the latest industry incarnation of an 'ultimate' listening system."
—*Ron Scibilia, Audio Times.*

"It wasn't the size, the contents or even the price that turned heads, but the knockout sound." —*Larry Johnson, Ovation Magazine.*

Recently, at a carefully selected location in Milford, Pennsylvania, some of the most discerning ears in the business were invited to hear something they'd never heard before. The Altec Lansing Bias™* 550. The first speakers in the world with Pentamplified sound.

And as you can see, the response was overwhelming.

But then the Bias 550 is a system unlike any other. Discrete amplifiers for each of five bandwidths,

adjustable by remote control. Providing each speaker cabinet with 750 watts of perfectly sculptured sound.

The Bias 550 is the finest example yet of our commitment to total high fidelity. The flagship to a range of loudspeakers that have consistently pushed back the frontiers of audio reproduction. For more information and an Altec Lansing catalog, call 1-800-ALTEC 88.**

**ALTEC
LANSING**

Loudspeakers for the well trained ear.

OUR BEST HEADPHONE — EVER!

Nothing in our past listening experience prepared us for our first audition of the new DM-90 Digital-Monitor headphones. We were absolutely stunned. We then took the sample to our "golden ear" dealers, and they too were amazed!

The verdict: THE DM-90 AT \$99.95 IS EQUAL TO, OR BETTER THAN ANY OTHER DYNAMIC HEADPHONE ON THE MARKET, AT ANY PRICE!

Some headphones can be said to have extended deep bass, others smooth midrange, some, transparent highs and superior dynamic range. Our new DM-90 has all of this, and more. It is unquestionably our best headphone—ever!

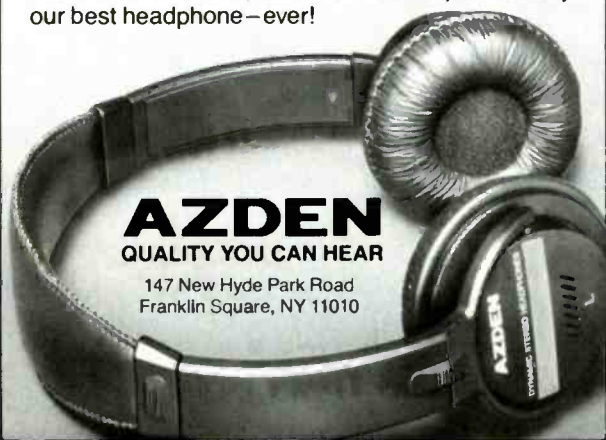

AZDEN
QUALITY YOU CAN HEAR

147 New Hyde Park Road
Franklin Square, NY 11010

Listen to the DM-90 at the following authorized dealers:

CALIFORNIA
Fry's Electronics, Fremont • Down to Earth Stereo, San Diego • Wong's, San Francisco • Fry's Electronics, Sunnyvale • Digital Ear, Tustin

COLORADO
Sound Shop, Colorado Spgs • Soundtrack, Denver • Sound Company, Grand Junction • Soundtronic, Pueblo

DISTRICT OF COLUMBIA
The Equalizer

FLORIDA
Sound Advice, All locations • BrandsMart, Miami • La Mirage, Miami

GEORGIA
Atlanta Stereo, Atlanta

IDAHO
Sound Pro, Boise • Inkley's, Idaho Falls • Mel Quale's, Twin Falls

ILLINOIS
Muscraff, All locations • Stereo Systems, Aurora, Joliet, Naperville

MASSACHUSETTS
Cameras Inc., Arlington

MICHIGAN
Adray's, Dearborn

MINNESOTA
Campus Audio, Minneapolis

MONTANA
Sound Pro, Bozeman • Thirsty Ear, Bozeman

NEW HAMPSHIRE
Guornos, Selem

NEW JERSEY
Wiz-Record Dept., All locations • Rand's Camera, Toms River • Samm Sound, W. Caldwell • Consumer Electronics, Maple Shade

NEW YORK
Wiz-Record Dept., All locations • P.C. Richard, All locations • Albany Appliance, Albany • Focus Electronics, Brooklyn • Brothers Camera, Manhattan • Jems Sound, Manhattan • SAS Sound City, Manhattan • 6th Avenue Electronics, Manhattan

NEW MEXICO
Tom Crier, Clovis

PENNSYLVANIA
Sound Advice, Doylestown • Studio One, Erie • Gola Electronics, Philadelphia • Sounds Good To Me, Sharon

UTAH
Inkley's, Logan, Ogden, Salt Lake City • Gadgets, Salt Lake City

WASHINGTON
Evergreen Audio, Bremerton • Stereo Shoppe, Tacoma

WYOMING
New Music Box, Laramie

CIRCLE NO. 164 ON READER SERVICE CARD

noises, shut the power off immediately and abandon the project.

If all is well, however, gradually ease the level control of the receiver up to a volume comparable to that of the first input selected. If that means the receiver's control is only turned up a very tiny bit, back off the control between the two units and try again. When everything is working, mark the correct setting for the receiver's level control; better still, wedge something under the knob to inhibit its rotation. Remember, the receiver's level control will continue to operate, so you should make sure it's at the correct position every time you use your system. The same is true of the receiver's tone controls, so these should be left flat.

All in all, more trouble than it's worth.

Three-Beam Lasers

Q In a compact disc player, does a three-beam laser pickup have any advantage over a single beam?

MARK BURGAN
Tyler, TX

A Not as far as the player's sound quality goes, but the laser beam has more to do than just read the digital audio information. A compact disc resembles a vinyl record in that its information is recorded in a spiral read by some form of a pickup—in this case a laser beam—but it differs in that there is no physical groove to guide that pickup. The mechanism that moves the beam across the surface of the disc must have some method of analyzing where it is and compensating for any mistracking before it becomes too great for the digital error-correction circuitry to deal with.

One way to accomplish this is to split the laser beam into three separate "spots" focused on the disc surface side by side. The middle one reads the audio bit stream, and the outer two ideally reflect off the blank space between tracks. If one of these outer spots starts picking up the audio information, it means that the main beam is not centered on the track, and an appropriate positional correction is made.

A large number—perhaps the majority—of high-quality players employ the three-beam system, but not all audio companies believe its complexity is necessary. At least one of them—Matsushita (Panasonic and Technics)—has abandoned the three-beam system in favor of a single, finely focused beam combined with a very fast-acting linear motor that can restore the laser to its proper position before it strays too far for the error-correction circuitry to do its work. □

DAHLQUIST

ASK ABOUT OUR **NEW**

M900 SERIES

516-234-5757

HIGH PERFORMANCE LOUDSPEAKERS



COMPROMISING WITH YOUR TAPE IS LIKE COMPROMISING WITH ANY OTHER COMPONENT IN YOUR SYSTEM.

Even the most advanced system is only as good as the tape you put into it. That's why Maxell has created XLII-S.

Its unique Epitaxial formula combines gammaferric oxide and cobalt ferrite for superior response at all frequency levels. The resulting superfine particles offer unprecedented clarity and brilliance. And make XLII-S the perfect tape for recording your most demanding sources.

So match your tape to the other components in your system and use only XLII-S from Maxell. Anything less is just kid stuff.



maxell
The Tape That Delivers
Higher Performance.

The ultimate in sound. The



Steve Winwood: Roll With It 154633

Liz Story: Speechless • Forgiveness, Speechless, Welcome Home, Back Porch, Vigil, Frog Park, more. RCA/Novus 100494

Decade/Best Of Steely Dan MCA 154135
Beethoven, Symphony No. 7: Coriolan & Prometheus Overtures • Royal Philharmonic/Previn. RCA DIGITAL 153621

Jethro Tull: Aqualung Chrysalis 124705

Whitney Houston: Whitney • I Wanna Dance With Somebody (Who Loves Me), Didn't We Almost Have It All, more. Arista 152854

Metallica: ...And Justice For All • One, Blackened, title song, To Live Is To Die, Shortest Straw, more. Elektra 200478

Talking Heads: Naked • (Nothing But) Flowers, Mr. Jones, Totally Nude, Blind, The Democratic Circus, The Facts Of Life, etc. Fly/Sire DIGITAL 153810

David Sanborn: Close-Up • Lush jazz sax effort! Slam, You Are Everything, J.T. Goodbye, Same Girl, etc. Warner Bros. 134408

Dwight Yoakam: Buenas Noches From A Lonely Room • Title Song, Streets Of Bakersfield (with Buck Owens), more. Reprise 100009

The Best Of The Band Capitol 134485

Classic Old & Gold, Vol. 1 • 20 hits! A Little Bit Of Soul, He's So Fine, A Teenager In Love, Sweet Talkin' Guy, etc. Laurie 134627

INXS: Kick • Need You Tonight, Devil Inside, New Sensation, title song, Never Tear Us Apart, The Loved One, Wild Life, etc. Atlantic DIGITAL 153606

The Glenn Miller Orchestra: In The Digital Mood • In The Mood, Chattanooga Choo Choo, more. GRP DIGITAL 143293

Tangerine Dream: Phaedra 100510

Steve Winwood: Chronicles • Higher Love, Valerie, While You See A Chance, My Love's Leavin', Talking Back To The Night, more. Island 134501

Pictures At An Exhibition, Night On The Bare Mountain, more • Montreal Symphony/Dutoit. London DIGITAL 125314

Whitesnake • Here I Go Again, Still Of The Night, Give Me All Your Love, Crying In The Rain, Bad Boys, more. Geffen 163629

ZZ Top: Afterburner Warner Bros. 164042

Carly Simon: Greatest Hits Live Anticipation, You're So Vain, Coming Around Again, Nobody Does It Better, etc. Arista 154537

Huey Lewis: Small World • Perfect World, Walking With The Kid, World To Me, Better Be True, Old Antone's, etc. Chrysalis 134347



Horowitz Plays Mozart 115436

Najee: Day By Day • Personality, title song, That's The Way Of The World, Tonight I'm Yours, Gina, Najee's Nasty Groove, etc. EMI-Manhattan 100001

Genesis: Invisible Touch • Land Of Confusion, title song, etc. Atlantic 153740

More Dirty Dancing • Do You Love Me, Love Man, Big Girls Don't Cry, Wipeout, Some Kind Of Wonderful, Cry To Me, more. RCA 130766

The Who's Greatest Hits MCA 164160

Tchaikovsky, 1812 Overture: Romeo & Juliet; Nutcracker Suite • Chicago Symphony/Solti. London DIGITAL 125179

James Galway: Greatest Hits RCA 173233

The Moody Blues: Sur La Mer • I Know You're Out There Somewhere, No More Lies, Here Comes The Weekend, Vintage Wine, etc. Polydor 124546

The Beach Boys: Endless Summer California Girls, Help Me Rhonda, Surfer Girl, more. Capitol 223559

Cinderella: Long Cold Winter • Gypsy Road, Don't Know What You Got (Till It's Gone), The Last Mile, etc. Mercury 114780



Bon Jovi: New Jersey 100516

Strauss, Also sprach Zarathustra Chicago Symphony Orchestra/Reiner. RCA 163627

Charlie Parker & Dizzy Gillespie: Bird & Diz • Leap Frog, My Melancholy Baby, Mohawk, etc. Verve 173413

Robert Palmer: Heavy Nova • Simply Irresistible, Disturbing Behavior, She Makes My Day, More Than Ever, Change His Ways, etc. EMI-Manhattan 100035

The Very Best Of The Everly Brothers Bye Bye Love, Crying In The Rain, Bird Dog, others. Warner Bros. 103826

Kenny G: Silhouette • We've Saved The Best For Last, title song, Tradewinds, Pastel, Against Doctor's Orders, Let Go, more. Arista 100603

D.J. Jazzy Jeff & The Fresh Prince: He's The D.J., I'm The Rapper • Parents Just Don't Understand, Nightmare On My Street, etc. Jive 264134

Raffi: Singable Songs For The Very Young Shoreline 144494

Elton John: Reg Strikes Back • A Word In Spanish, I Don't Wanna Go On With You Like That, Goodbye Marlon Brando, Town Of Plenty, etc. MCA DIGITAL 100602

Elton John: Greatest Hits, Vol. 1 MCA 163322

Vivaldi, The Four Seasons • English Concert/Pinnock. Archiv DIGITAL 115356

Joe Cocker: Classics Contains 13 Hits! A&M 104887

Bruce Hornsby And The Range: Scenes From The Southside • The Valley Road and Jacob's Ladder, plus others. RCA 180187

Crosby, Stills, Nash & Young: Greatest Hits (So Far) • Suite: Judy Blue Eyes, etc. Atlantic 130230

New Age Bach: The Goldberg Variations Joel Spiegelman plays the Kurzweil 250 Digital Keyboard. East-West 100488

John Cougar Mellencamp: The Lonesome Jubilee • Paper In Fire, Check It Out, Cherry Bomb, Rooty Toot Toot, etc. Mercury 134420

Elvis: 18 Number One Hits RCA 172190

Robert Cray: Don't Be Afraid Of The Dark Title song, Don't You Even Care, more. Mercury/Hightone 100471

Jimi Hendrix: Kiss The Sky • Purple Haze, All Along The Watchtower, Voodoo Child, Are You Experienced, etc. Reprise 161349

Parton/Ronstadt/Harris: Trio • To Know Him Is To Love Him, etc. 114804

Chicago 19 • I Don't Wanna Live Without Your Love, Heart In Pieces, etc. Reprise 154404

Peter Cetera: One More Story • One Good Woman, more. Warner Bros. 100463

Buckwheat Zydeco: Taking It Home Why Does Love Got To Be So Sad? (with Eric Clapton), Creole Country, more. Island 100597

The Sound Of Music/Orig. Soundtrack RCA 100046



Randy Travis: Old 8x10 100008

The Police: Every Breath You Take • The Singles • Don't Stand So Close To Me ('86), Roxanne, etc. A&M 173924

Sting: Nothing Like The Sun • We'll Be Together, They Dance Alone, Be Still My Beating Heart, more. A&M 273965

Mozart, Overtures • Academy of St. Martin/Marriner, Marriage Of Figaro, 8 more. Angel DIGITAL 134267

START NOW WITH 4 COMPACT DISCS!

Yes, pick any 4 compact discs shown here! You need buy just one selection at regular Club prices (usually \$14.98-\$15.98) . . . and take up to one full year to do it. Then you can choose another CD free as a bonus. That's 6 compact discs for the price of 1 and there's nothing more to buy . . . ever! (Shipping & handling added to each shipment.)

HOW THE CLUB OPERATES

You select from hundreds of exciting compact discs described in the Club's magazine and mailed to you approximately every 3 weeks (19 times a year). Each issue highlights a Featured Selection in your preferred music category, plus alternate selections. If you'd like the Featured Selection, do nothing. It will be sent to you automatically. If you'd prefer an alternate selection, or none at all, just return the

ultimate in savings...



GET 6 COMPACT DISCS FOR THE PRICE OF 1 WITH NOTHING MORE TO BUY...EVER!

Start with **4** COMPACT DISCS now!
pay just shipping & handling with Club membership.
 Buy just **1** smash hit in one year's time.
 Then get **1** bonus CD of your choice.
 Enjoy **6** CDs for the price of one.
Nothing more to buy...EVER!

Steve Miller: Born 2 B Blue • Ya Ya, Born To Be Blue, Just A Little Bit, Gold Bless The Child, Filthy McNasty, etc. Capitol 100591

Anthrax: State Of Euphoria • Be All, End All, Make Me Laugh, Out Of Sight, Out Of Mind, Schism, more. Mercury 100595

Johnny Cash: Classic Cash • Folsom Prison Blues, Ring Of Fire, I Walk The Line, Get Rhythm, Cry, Cry, Cry, more. Mercury 100595

Procol Harum: Classics • 12 great hits! A&M 134445

Special EFX: Double Feature • The Lady And The Sea, Passages, Golden Days, Mirrors, more. GRP DIGITAL 100016

Jazz CD Sampler • Over 67 minutes of jazz, with 15 classic performances by Ella, Armstrong, Basie, Getz, etc. PolyGram 173406

The Judds: Greatest Hits RCA 144578

Alman Brothers Band: Eat A Peach • Melissa, Blue Sky, Ain't Washin' Time No More, etc. Polydor 163353



Dirty Dancing/Soundtrack 182522

Scott Joplin, Piano Rags • Joshua Rifkin plays The Entertainer, Maple Leaf Rag, Gladiolus Rag, 14 more. Nonesuch 164055

Eric Clapton: Time Pieces (The Best Of) Layla, I Shot The Sheriff, After Midnight, Cocaine, etc. Polydor 123385

card enclosed with each issue of your magazine by the date specified on the card. You will have at least 10 days to decide, or you may return your Featured Selection at our expense. Cancel your membership at any time after completing your membership agreement, simply by writing to us.

FREE 10-DAY TRIAL

Listen to your 4 introductory selections for a full 10 days. If not satisfied, return them with no further obligation. You send no money now, so complete the coupon and mail it today.

SAVE 50%

INSTANT HALF-PRICE BONUS PLAN

Unlike other clubs, you get 50%-off Bonus Savings with every CD you buy at regular Club prices, effective with your first full-price purchase!



YOUR SAVINGS START HERE

Mail to: BMG Compact Disc Club
 P.O. Box 91412 • Indianapolis, IN 46219

YES, please accept my membership in the BMG Compact Disc Club and send me the four Compact Discs I've indicated here, billing me for just shipping and handling under the terms of this ad. I need buy just 1 CD at regular Club prices during the next year—after which I can choose a FREE bonus CD! That's 6 for the price of 1...with nothing more to buy ever! (Shipping & handling is added to each shipment.)

RUSH ME THESE 4 CDS (Indicate by number)

D	D	D	D
---	---	---	---

I am most interested in the musical category checked here—but I am always free to choose from any (check one only).

- EASY LISTENING** (Instrumental Vocal Moods) **COUNTRY**
 HARD ROCK **POP SOFT ROCK** **CLASSICAL**

MR _____
 MRS _____
 MISS _____ First Name Initial Last Name (PLEASE PRINT)
 Address _____
 City _____ State _____ Zip _____
 Telephone (_____) _____
 Area Code

Signature _____
 Limited to new members, continental USA only. Current CD Club members not eligible for this offer. One membership per family. We reserve the right to request additional information or reject any applications. Local taxes, if any, will be added.



by Julian Hirsch

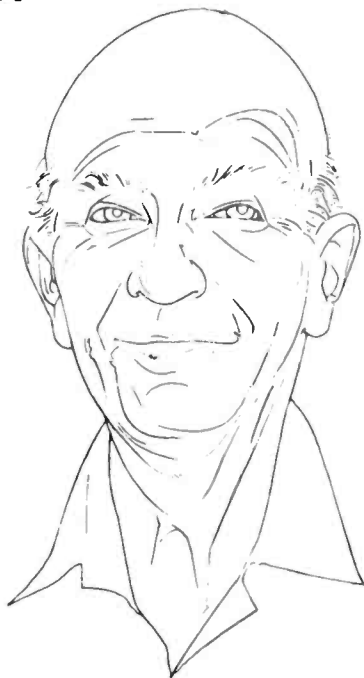

Subjective Evaluations

NOT long ago I had a very revealing and educational experience in the subjective evaluation of audio components. A small group of audio critics and editors was invited to audition two new speaker systems from a well-known manufacturer. These rather expensive speakers were not compared in an A/B fashion; in fact, they were in separate rooms, which were acoustically treated and completely isolated from the outside world and from each other.

The ancillary equipment used to derive the test signals and drive the speakers was of professional quality, well beyond the means of any but the most affluent audiophile. The source material consisted of CD's and digital tapes. No effort or expense was spared to provide the most favorable listening conditions for the speakers and the listeners. Instead of the usual speaker listening session, where a comparison is invited, the manufacturer's aim was to obtain a critical evaluation of each speaker from the listeners.

The two speakers were quite similar in their overall design, although the somewhat smaller (and far less expensive) system did not employ some of the exotic materials used in the drivers of the larger speaker. Usually when different models from the same manufacturer are compared, there is a distinct family kinship in respect to sound quality, with the expected trade-offs in bass and treble extension or smoothness. Frankly, that is pretty much what I expected to hear from these two speakers.

The speakers were auditioned separately, with about half the panel listening to each of them. The listeners used their own favorite CD's as well as recordings provided by the manufacturer. After about 30 minutes, the two groups of listeners changed places and the process was repeated. As it happened, I was in the first group to listen to the larger speaker. Its sound was truly excellent, with a spaciousness and sonic image that I have yet to hear in my own listening environment. I was very impressed, but in view of its price (several thousand dollars), I was not too surprised by what I heard.

When the time came to change places with the other group, we found that they were engaged in an energetic discussion among themselves and with the manufacturer's engineers, and they appeared to be not entirely happy (to put it mildly) with what they had heard. It seems that the sound was not particularly pleasing (let alone *good*) unless the speaker was raised from the floor or tilted back to aim the tweeter directly at the listeners' ears, apparently because of some irregularity in its vertical directivity pattern.

Since my group was not about to make a summary judgment of the smaller speaker without putting the system through its paces, we listened to it initially in its normal floor-standing location. It was indeed a hard-, unpleasant-sounding speaker, certainly not a reasonable value at its fairly substantial price (about half that of the other system). Following the suggestion of our predecessors, we tilted the system back a few degrees, and the change was striking. I would not have believed

it possible if I had not experienced it myself.

Instead of being overpoweringly harsh and unpleasant sounding, it became a slightly bass-shy, slightly brittle, but quite listenable speaker—merely from being tilted back perhaps 5 or 10 degrees. Although still no match for its deluxe sibling, it was at least worthy of sharing the same family name.

The most obvious physical difference between the two speakers other than size (although they were not grossly different in size, either) was the material from which their radiators were fabricated. The smaller one used merely exotic materials, but the materials of the other might be described as "super-exotic," at least in the sense that its construction was evidently much more costly than that of the smaller speaker system.

What is the point of this account? There are several. For one thing, the sound of a speaker heard in one environment can have little or nothing in common with how it sounds in another *almost* identical environment. I am considering the tilting of the speaker to be equivalent to a change of environment, since nothing was done to change the drivers or their enclosures. Another interesting fact is that *all* of the listeners agreed on what we had heard when we met afterward with the manufacturer's engineers to discuss our findings. There was essential unanimity concerning the excellence of the large speaker and the serious problems of the smaller one, as well as the approach that might be followed to correct them.

My own experience in this listening session was an eye (and ear) opener. I have listened to many hundreds of speakers over the years, in my own home and in the lab, and I have yet to find one whose sound could be changed from poor to good or vice versa simply by changing its position or orientation. As a rule, the effects of such moves are much more subtle than that, although I am sure that some people are more sensitive to them than I am. Personally, I find it refreshing that I can still experience a "first" in my audio activity after about forty years in the field. □

Axiom

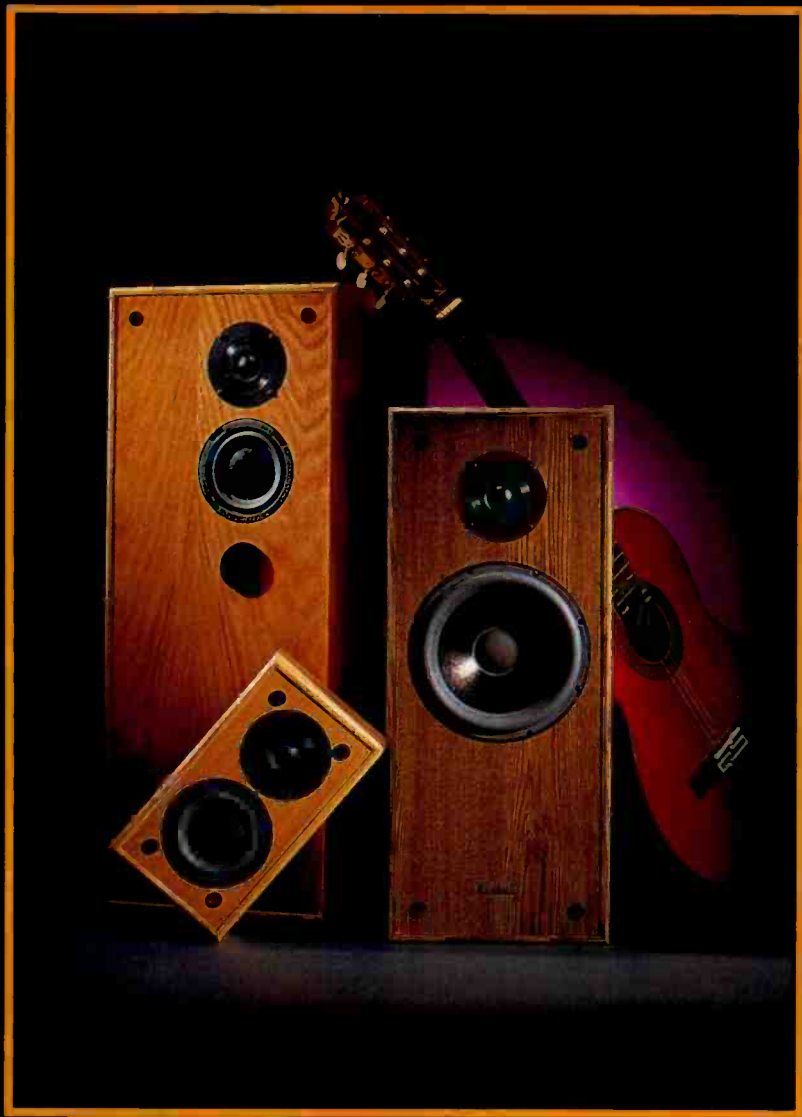

AXIOM — THE COMPANY

Dwight, Ontario is a small town near the western gate to the raw magnificence of famous Algonquin park. Dwight is also the design and manufacturing home of AXIOM loudspeakers

AXIOM is one of the few speaker companies that designs, manufactures and distributes it's own product using it's own facility and employing a dedicated team of highly motivated local people. We believe in concentrating our efforts towards one goal — The perfection of the AXIOM line of loudspeakers! At AXIOM we use a hands on approach to the quality and performance of each and every individual speaker. Every AXIOM employee has been expertly trained in the manufacture of high quality loudspeakers and takes pride in the results. Every AXIOM loudspeaker is rigorously tested on a state-of-the-art Hewlett Packard Spectrum Analyzer in an anechoic chamber to ensure that each one is an exact reproduction of the National Research Council designed prototype. This has resulted in one of the finest quality control systems in the Industry and reflects the depth of the company's confidence in the lifetime guarantee which comes with every AXIOM loudspeaker.

An axiom is something you can take for granted, a self-evident truth. The quality in an Axiom loudspeaker is something you can take for granted but this is only because we at AXIOM take nothing for granted.

LA COMPAGNIE AXIOM

Dwight est une petite ville ontarienne, à proximité de l'entrée ouest du magnifique parc Algonquin, où sont conçues et fabriquées les enceintes acoustiques AXIOM.

AXIOM est l'une des rares compagnies qui conçoit, fabrique et distribue ses propres produits, dans ses propres usines, avec son propre personnel — des spécialistes dévoués et motivés. Nous concentrons tous nos efforts sur un seul objectif: la perfection de la gamme AXIOM. Pour assurer la qualité et le rendement de toutes et chacune de ses enceintes acoustiques, AXIOM s'en charge directement, du début à la fin. Chaque artisan d'AXIOM a reçu une formation spécialisée et il est fier de son travail. Chaque enceinte acoustique est rigoureusement testée dans une chambre anéchoïde, avec un analyseur de spectre Hewlett Packard très perfectionné, afin d'être la reproduction exacte du prototype du Centre national de recherches. Résultat: l'un des meilleurs systèmes de contrôle de la qualité de toute l'industrie et une garantie à vie très complète qui accompagne chaque enceinte acoustique AXIOM.

Un axiome, rappelle le dictionnaire, c'est une «vérité indémontrable mais évidente par quiconque en comprend le sens». La qualité de chaque enceinte AXIOM est quelque chose d'évident, car pour les fabricants des enceintes AXIOM, rien n'est jamais indémontrable... ni évident.



NATIONAL RESEARCH COUNCIL

Ottawa is home to one of the finest research facilities in the world, namely the National Research Council. It is here with State-of-the-art equipment and rigorous testing methods that acoustician Dr. Floyd Toole has built an international reputation for his research into loudspeaker design and evaluation.

It has taken many years of research in both the laboratory and the listening environment to create a criteria of laboratory measurement that will consistently win the listening environment tests. This translates into laboratory research that has a direct effect on the sound reproduction that you will hear in your living room, not just a set of fancy measurements that have no meaning in the real world.

AXIOM designers have used these same research facilities and measurement criteria for many years and the design and development of every AXIOM model is the result of exhaustive research and 'The Pursuit of Excellence in Sound Reproduction'. The goal of our design team is a programme of ongoing research into every AXIOM model to create the perfect loudspeaker irrespective of its price. The result of this ongoing research is a line of loudspeakers with better sound performance than the competition at many times the price!



LE CONSEIL NATIONAL DE RECHERCHES D'OTTAWA

C'est à Ottawa que se trouve l'un des meilleurs centres de recherches du monde entier, notre Conseil national de recherches Canada. C'est là, avec des appareils extrêmement perfectionnés et des méthodes de contrôle rigoureuses, que l'acousticien Floyd Toole s'est valu une réputation mondiale pour ses recherches sur la conception et l'évaluation des enceintes.

Plusieurs années de recherche et des centaines de tests en laboratoire et en salle d'écoute ont permis de définir des critères de mesure en laboratoire qui correspondent vraiment aux tests d'écoute. Bilan: une recherche en laboratoire qui a un rapport direct avec la sonorité que vous entendez dans votre salon, et non pas des mesures fantaisistes qui ne veulent rien dire dans la réalité.

Les ingénieurs d'AXIOM utilisent les mêmes installations de recherche et les mêmes critères de mesure depuis plusieurs années. La conception et le développement de chaque modèle AXIOM est le fruit d'une recherche exhaustive, toujours dans un même et unique but: la poursuite de l'excellence en reproduction sonore. L'objectif de notre équipe de conception a toujours été et demeure toujours de respecter, pour chaque modèle AXIOM, un programme continu de recherche afin de créer une enceinte parfaite, peu importe son prix. Le résultat de cette recherche incessante: une gamme d'enceintes acoustiques d'un rendement sonore bien meilleur que celles de produits considérablement plus chers!



"The AXIOM AX 1.5 minimizes both cost and compromise." The cabinet is exceptionally well-braced, using our own unique dual-damping system which effectively eliminates standing waves. We mounted the port on the front so that the speaker can be placed against a wall for very linear response. The AX 1.5 along with all of the models in the AXIOM line incorporates our bevelled cabinet edge, an aid in eliminating diffraction and drastically improving imaging. The AX 1.5 is available in three versions. The regular AX 1.5 is available in black oak or dark oak vinyl veneer. The AX 1.5 Bookshelf is slightly shorter and available in black oak, dark oak, and white vinyl veneer. The AX 1.5 Reference Monitor incorporates a five way gold plated binding post and is available in black oak, dark oak, and natural oak real wood veneer.

The AXIOM AX 2 is our all-star player. It has low power requirements, high power handling capability, very linear response and excellent low frequency extension (deep bass). The AX 2 is available in either full size or Bookshelf size. It's a two-way design with an 8" bass driver and a special dome tweeter that delivers superior dispersion and imaging. It also features a rear-mounted port and a cabinet that's both dual-braced and dual-damped. The AX 2 Reference Monitor is hand crafted in three finishes of oak — black, dark, and natural. The AX 2 Reference Monitor is also designed with an optional bi-amp feature.

The AXIOM AX 3 is designed along the lines of the prestigious AX 5 Reference Monitor. The AX 3 incorporates the same dual cabinet design as the AX 5 Reference Monitor. The 8" sub-woofer in the AX 3 is positioned in the front of the enclosure. The AX 3 is designed to be placed up against the wall for optimum performance. The AX 3 Reference Monitor incorporates an optional bi-amp feature between the sub-woofer and internal satellite system.

The AXIOM AX 5 Reference Monitor combines the best features of both two-way and three-way speaker designs, with none of the problems often found in each. What we've created is essentially a two-way speaker with an additional driver, a sub-woofer, mounted at the rear of the enclosure. In fact, it's actually two speaker systems in one. There's a small enclosure inside the outer enclosure to house the 'satellite' system at the front which operates from 180 to 22,000 Hz. The cabinet housing the 10" sub-woofer at the rear is braced seven ways and is vented with a tuned port in the front of the enclosure. This configuration has four main advantages: elimination of Doppler distortion, ability to handle high power levels, extraordinary dispersion and imaging — and, of course, awesome bass response. The AX 5 Reference Monitor has won numerous awards and praise worldwide. The AX 5 Reference Monitor is exceptionally accurate. It's no wonder that the AX 5 Reference Monitor has been acclaimed as "THE BEST SPEAKER AVAILABLE AT ANY PRICE".

«L'enceinte AXIOM AX 1.5 réduit à la fois le coût et le compromis. Le cabinet est exceptionnellement bien armé, utilisant notre propre système unique de double amortissement qui élimine efficacement les ondes stationnaires. Nous avons monté le port sur le devant, de sorte que le haut-parleur peut être placé contre un mur pour une réponse très linéaire. L'AX 1.5, ainsi que tous les modèles de la gamme AXIOM, incorpore notre bordure de cabinet chanfreinée, un moyen d'éliminer la diffraction et d'améliorer considérablement l'imagerie. L'AX 1.5 est disponible en trois versions. Le modèle standard AX 1.5 est disponible en noyer foncé et blanc, et la AX 1.5 Reference Monitor est disponible en noyer foncé, noyer foncé et blanc, et la AX 1.5 Reference Monitor est disponible en noyer foncé, noyer foncé et blanc, et la AX 1.5 Reference Monitor est disponible en noyer foncé, noyer foncé et blanc.

L'enceinte AXIOM AX 2 est notre vedette. Elle a de faibles exigences en matière de puissance, une grande capacité de gestion de la puissance, une réponse très linéaire et une excellente extension de basse fréquence (basses profondes). Elle est disponible en format standard ou étagère. C'est un design à deux voies avec un haut-parleur de 8" et un tweeter spécial qui offre une dispersion et une imagerie supérieures. Elle dispose également d'un port arrière et d'un cabinet à la fois doublement armé et doublement amorti. L'AX 2 Reference Monitor est artisanal et est disponible en trois finitions de chêne — noir, foncé et naturel. L'AX 2 Reference Monitor est également conçu avec une option de bi-amplification.

L'AXIOM AX 3 est conçue dans l'esprit de la prestigieuse AX 5 Reference Monitor. L'AX 3 incorpore le même design à double cabinet que l'AX 5 Reference Monitor. Le sub-haut-parleur de 8" de l'AX 3 est positionné à l'avant de l'enceinte. L'AX 3 est conçue pour être placée contre un mur pour donner le meilleur rendement.

L'enceinte AXIOM AX 5 Reference Monitor combine les meilleures caractéristiques des conceptions à deux voies et à trois voies, sans aucun des problèmes souvent rencontrés dans l'une ou l'autre. Ce que nous avons créé est essentiellement un haut-parleur à deux voies avec un driver supplémentaire, un sub-haut-parleur, monté à l'arrière de l'enceinte. En fait, il s'agit de deux systèmes de haut-parleurs en un. Il y a une petite enceinte à l'intérieur de l'enceinte extérieure pour abriter le système 'satellite' à l'avant qui fonctionne de 180 à 22 000 Hz. Le cabinet qui abrite le sub-haut-parleur de 10" à l'arrière est armé sept fois et est ventilé avec un port accordé à l'avant de l'enceinte. Cette configuration a quatre avantages principaux : élimination de la distorsion Doppler, capacité de gestion de la puissance élevée, dispersion et imagerie extraordinaires — et, bien sûr, une réponse aux basses fréquences remarquable. L'AX 5 Reference Monitor a remporté de nombreux prix et éloges dans le monde entier. L'AX 5 Reference Monitor est exceptionnellement précise. Il n'est pas étonnant que l'AX 5 Reference Monitor ait été acclamé comme « LE MEILLEUR HIGHER-PERFORMANCE SPEAKER DISPONIBLE À UN PRIX QUELCONQUE ».

AX 5 REFERENCE MONITOR

AX 2 BOOKSHELF



AX 1.5 BOOKSHELF

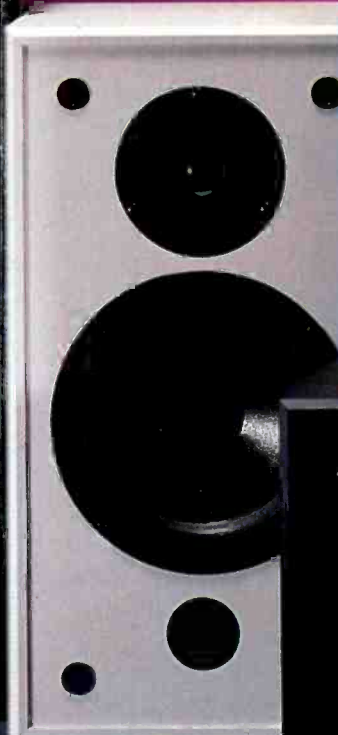

AX 1



« prix et les compromis ». Le coffret est remarquablement bien consolidé et fait appel à notre système exclusif de double amortissement qui élimine les brèves stationnaires. L'éventail est placé contre un mur et donne une réponse très linéaire. Tout comme les autres modèles de la gamme AXIOM, la AX 1.5 a des bords biseautés, ce qui contribue à stabiliser l'image. Ce modèle est disponible en trois versions: normale, à placage vinyle chêne noir ou chêne foncé; étagère, un peu plus courte, à placage vinyle chêne noir; et Monitor avec bornes cinq faces plaquées or, en placage bois véritable chêne noir, chêne foncé et chêne neutre.

La demande peu de puissance mais elle peut en prendre beaucoup, elle a une réponse très linéaire et une excellente extension dans les basses fréquences. Elle est disponible en deux versions: H.P. de basses de 8" et tweeter type dôme donnant une dispersion et une image supérieures. L'évent est monté à l'arrière, le renforcement et l'amortissement du Monitor est fabriquée à la main dans trois fins de chêne: noir, foncé et neutre. Elle est aussi disponible avec possibilité de bi-amplification en option.

La prestigieuse AX 5 Reference Monitor, dont elle partage le même boîtier double. Le sub-woofer de 8" de la AX 3 est monté à l'avant de l'enceinte. La AX 3 est conçue pour être utilisée avec un système satellite interne.

Elle offre les meilleures caractéristiques des modèles à deux et à trois voies, sans les problèmes fréquents de chacune de ces solutions. Il s'agit essentiellement d'une enceinte deux voies additionnée d'un troisième haut-parleur, un sub-woofer monté à l'arrière. En fait, ce sont deux systèmes en un. A l'intérieur avant du boîtier extérieur se trouve une petite enceinte qui loge le «satellite» et qui donne une réponse de 180 à 22 000 Hz. Le boîtier qui contient le sub-woofer de 10" à l'arrière, est renforcé à sept endroits et il est doté d'un évent accordé à l'avant du boîtier. Cette configuration a quatre grands avantages: élimination de la distorsion Doppler, très grande puissance admissible, dispersion et image extraordinaires et, bien sûr, graves vraiment graves. La AX 5 Reference Monitor a gagné de nombreux prix et s'est valu de nombreux éloges dans le monde entier. Elle est exceptionnellement fidèle. Pas surprenant que la AX 5 Reference Monitor ait été acclamée comme «LA MEILLEURE ENCEINTE A N'IMPORTE QUEL PRIX.»

AX 3 REFERENCE MONITOR

AX 2



AXIOM SUB-SATELLITE REFERENCE SYSTEM

We designed the AXIOM Sub-Satellite System with four distinct components that can be employed either together or separately.

The AX SUB uses two 10" aluminium cone drivers, one for each channel in a stereo configuration. Many years of research have gone into the development of this driver. The aluminium cone is perfectly rigid to eliminate cone break-up which reduces distortion dramatically and increases power handling substantially. They're housed in a specially shielded cabinet which allows the sub-woofer to be used in conjunction with the video shelf to make a television stand. The AX SUB is designed to be versatile and expandable. The AX SUB SATELLITE SYSTEM can be powered with one single amplifier or bi-amped utilizing either the internal passive x-over or an external electronic x-over. The internal passive x-over is switchable to either 120Hz or 250Hz.

The AX 1's use our small 4.5" dome woofer. This woofer has the advantage over conventional woofers in that it disperses accurately out to 70 degrees off axis. (A standard configuration woofer will only disperse accurately to approximately 45 degrees.) This wider dispersion will drastically improve the imaging and overall accuracy of the system since the reflected sound and the direct sound are now the same sound. The problem with poor dispersion is that it is like having one accurate speaker playing directly at you and another or series of other loudspeakers which are not very accurate playing beside, above and below you.

The AX SUB is excellent for surround sound application. The AX SUB is available either with or without a built in centre channel. The optimum surround sound system should incorporate an AX SUB CENTRE CHANNEL, a pair of AX 1's as front channel speakers, a pair of AX 1's as side channel speakers, and a pair of AX 2's, AX 3's or AX 5's as rear channel speakers.

Matching AX 1 stands are available for optimum listening height.

SYSTEME SOUS-SATELLITE AXIOM REFERENCE

Le système sous satellite AXIOM comprend quatre composants distincts, utilisables ensemble ou séparément.

Le AX SUB comprend deux H.P. de 10" de type cône, en aluminium, un pour chaque canal stéréo. Ce haut-parleur est le fruit de nombreuses années de recherche. Le cône en aluminium est parfaitement rigide, pour éliminer toute segmentation. Cela réduit considérablement la distorsion et augmente sensiblement la tenue en puissance. Les H.P. sont logés dans un coffret spécialement protégé qui permet au sub-woofer d'être utilisé, avec la tablette vidéo, comme base de télévision. Le AX SUB est conçu pour être polyvalent et expansible. Le SOUS-SATELLITE AX SUB peut être alimenté par un seul ampli ou par deux, avec le diviseur passif de fréquences interne ou un diviseur électronique externe. Le diviseur interne est commutable à 120 Hz ou à 250 Hz.

Le AX 1 comprend notre petit woofer de 4.5" type dôme. Ce woofer a, sur les H.P. de graves ordinaires, l'avantage d'avoir une très vaste dispersion, précise jusqu'à 70°. (Un haut-parleur de graves a, au mieux, une dispersion précise à 45° maximum.) Cette vaste dispersion améliore considérablement l'image et la précision de l'enceinte puisque le son direct et le son indirect ne sont pas le même son. Pour comprendre les problèmes d'une mauvaise dispersion, imaginez une enceinte fidèle directement devant vous et une série d'autres enceintes, moins fidèles, à côté, au-dessus ou en dessous.

Le AX SUB est excellent pour l'ambiophonie («surround»). Il est disponible avec ou sans canal central intégré. Un système ambiophonique optimal comprendrait un AX SUB comme CANAL CENTRAL, une paire de AX 1 à l'avant, une paire de AX 1 sur les côtés et une paire de AX 2, de AX 3 ou de AX 5 à l'arrière.

Des pieds harmonisés donnent au AX 1 la hauteur d'écoute optimale.



Axiom

EXACT ENGINEERING FOR EXACTING ENGINEERS LE CHOIX DES PROFESSIONNELS



THE AXIOM AX 5 REFERENCE LOUDSPEAKERS HAVE EARNED RECOGNITION BY SEVERAL ESTEEMED RECORDING STUDIOS THROUGHOUT NORTH AMERICA AS THE MOST ACCURATE LOUDSPEAKERS AVAILABLE, IRRESPECTIVE OF PRICE.

PICTURED HERE ARE THE AX 5 REFERENCE LOUDSPEAKERS IN THE SYNCLAVIER ROOM AT LE STUDIO, MORIN HEIGHTS IN QUEBEC, CANADA. LE STUDIO, FAMOUS FOR RECORDING ARTISTS SUCH AS DAVID BOWIE, THE POLICE, COREY HART AND CAT STEVENS, IS ONE OF THE MOST TECHNOLOGICALLY ADVANCED STUDIOS IN THE WORLD. WHEN PERFORMANCE AND ACCURACY ARE IMPORTANT, AXIOM IS THE CHOICE OF THE PROFESSIONALS, WE HOPE YOU MAKE IT YOURS.

LE HAUT-PARLEUR AXIOM AX5 RÉFÉRENCE A MÉRITÉ LA RECONNAISSANCE DE PLUSIEURS STUDIOS D'ENREGISTREMENT ESTIMÉS À TRAVERS L'AMÉRIQUE DU NORD COMME LES PLUS PRÉCIS PRÉSENTEMENT DISPONIBLES (INDÉPENDAMMENT DU PRIX).

PHOTOGRAPHIÉS ICI, LES HAUT-PARLEURS AX5 RÉFÉRENCE DANS LA CHAMBRE SYNCLAVIER DU STUDIO DE MORIN-HEIGHTS AU QUÉBEC, CANADA.

LE STUDIO, RENOMMÉ POUR SES ENREGISTREMENTS D'ARTISTES TEL QUE: DAVID BOWIE, THE POLICE, COREY HART ET CAT STEVENS EST L'UN DES PLUS RÉPUTÉ AU MONDE... UN «LEADER». LORSQUE LA PERFORMANCE ET L'EXACTITUDE SONT IMPORTANTES, AXIOM EST LE CHOIX DES PROFESSIONNELS. NOUS ESPÉRONS QUE VOUS EN FEREZ LE VÔTRE.



TWEETER DESIGN

The tweeters used in the AXIOM family of loudspeakers are carefully designed to meet a variety of criteria. One of the criteria which is important to discuss here is dispersion. You hear much talk of horn loaded designs which will increase the efficiency of the tweeter, but since the tweeter is not the limiting factor in the efficiency of most loudspeakers the only advantage to a horn loaded design is to increase power handling. Unfortunately there are serious drawbacks to horn loaded tweeters which will effect the sound quality of the loudspeaker. A horn loaded design must recess the dome into the front plate in order to create the horn. This recessing of the dome drastically impairs the off axis performance of the tweeter and thus has a detrimental effect on the imaging and overall accuracy of the loudspeaker. Fig.1 shows the response of our tweeter at 0, 30, and 60 degrees, as you can see the off axis performance is almost identical to the on axis performance. Fig. 2 shows the exact same tweeter with only a slightly thicker front plate measured at 0, 30, and 60 degrees, as you can see the tweeter in fig. 2 shows a major deterioration of off axis performance. The more recessed the dome the worse the off axis performance becomes.

CHOIX DES TWEETERS

Les tweeters qui entrent dans la fabrication des enceintes acoustiques AXIOM sont choisis avec soin, selon divers critères, dont un auquel il vaut la peine de s'arrêter: la dispersion. Vous avez sûrement entendu dire qu'un pavillon de charge augmente l'efficacité du tweeter. Mais comme ce n'est pas le tweeter qui limite l'efficacité de la plupart des enceintes acoustiques, son seul avantage est d'accroître la tenue en puissance. Il a par contre plusieurs inconvénients. Il oblige à placer le dôme en retrait, dans la plaque avant. Or, ce recul du dôme entrave le rendement hors-axe du tweeter et a donc un effet désastreux sur l'image et la fidélité globale des enceintes. Le fig. 1 montre la réponse de notre tweeter à 0°, 30° et 60°. Comme vous le voyez, le rendement hors-axe est presque identique au rendement en axe. Le fig. 2 montre le même tweeter, mais avec une plaque avant à peine plus épaisse, toujours à 0°, 30° et 60°. On constate une grande détérioration du rendement hors-axe. Plus on recule le dôme, pire est le rendement hors-axe.

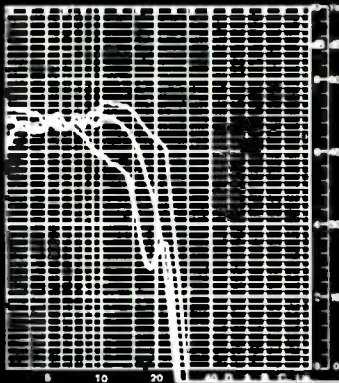

Fig. 1

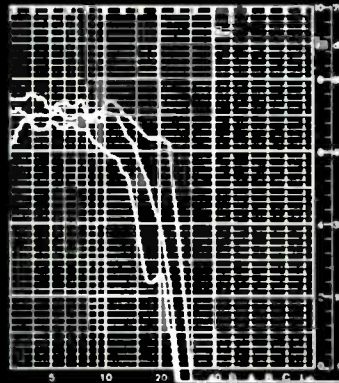

Fig. 2



SPECIFICATIONS/FICHE TECHNIQUE

MODEL/MODELE	FREQUENCY RESPONSE/ RÉPONSE EN FREQUENCE	SENSITIVITY/ SENSIBILITE	MINIMUM IMPEDANCE/ IMPEDANCE MINIMALE	RECOMMENDED MIN. AMP POWER/ PUISSANCE MIN. REC. DE L'AMPLI	RECOMMENDED MAX. AMP POWER/ PUISSANCE MAX. REC. DE L'AMPLI	DIMENSIONS (H x W x D) (H x L x P)
AX 1.5	45 - 22K Hz + 2db	89db ANECHOIC	6 OHMS	15 WATTS	100 WATTS	19.5" (495.3 mm) x 8.375" (212.73 mm) x 7.625" (193.68 mm)
AX 1.5 BOOKSHELF	50 - 22K Hz + 2db	89db ANECHOIC	6 OHMS	15 WATTS	100 WATTS	15.25" (387.1 mm) x 8.375" (212.73 mm) x 7.625" (193.68 mm)
AX 2	40 - 22K Hz + 2db	89db ANECHOIC	6 OHMS	15 WATTS	250 WATTS	24" (609.6 mm) x 10" (254 mm) x 9" (228.6 mm)
AX 2 BOOKSHELF	43 - 22K Hz + 2db	89db ANECHOIC	6 OHMS	15 WATTS	250 WATTS	19.5" (495.3 mm) x 10" (254 mm) x 9" (228.6 mm)
AX 3	36 - 22K Hz + 2db	88db ANECHOIC	4 OHMS	30 WATTS	300 WATTS	30" (762 mm) x 10" (254 mm) x 9" (228.6 mm)

FINISHES: Dark Oak and Black Oak Vinyl Veneer FINIS: Placage vinyle chêne foncé et chêne noir. The AX 1.5 Bookshelf is also available in white. La AX 1.5 "Bookshelf" est aussi disponible en blanc.

AX 1.5 REFERENCE	45 - 22K Hz + 2db	89db ANECHOIC	6 OHMS	15 WATTS	100 WATTS	19.5" (495.3 mm) x 8.375" (212.73 mm) x 7.625" (193.68 mm)
AX 2 REFERENCE	40 - 22K Hz + 2db	89db ANECHOIC	6 OHMS	15 WATTS	250 WATTS	24" (609.6 mm) x 10" (254 mm) x 9" (228.6 mm)
AX 3 REFERENCE	36 - 22K Hz + 2db	88db ANECHOIC	4 OHMS	30 WATTS	300 WATTS	30" (762 mm) x 10" (254 mm) x 9" (228.6 mm)
AX 5 REFERENCE	32 - 22K Hz + 2db	87db ANECHOIC	4 OHMS	40 WATTS	350 WATTS	30" (762 mm) x 12" (304.8 mm) x 11.25" (285.75 mm)
AX 1 REFERENCE	70 - 22K Hz + 2db	87db ANECHOIC	4 OHMS	30 WATTS	100 WATTS	11.5" (292.1 mm) x 6.5" (165.1 mm) x 5.75" (146.05 mm)
AX SUB REFERENCE	29-250/125 Hz + 3db	87db ANECHOIC	4 OHMS	40 WATTS	1000 WATTS	15" (381 mm) x 33" (838.2 mm) x 15.75" (400.05 mm)

*The combined recommended maximum amplifier power of the AX 1 REFERENCE & AX SUB REFERENCE is 350 watts.
Tenue en puissance combinée recommandée du AX 1 REFERENCE et du AX SUB REFERENCE: 350 watts.

FINISHES: Natural, Dark, and Black Oak FINIS: Chêne neutre, foncé et noir.

AXIOM
Hwy. #60, Dwight, Ontario
Canada P0A 1H0 (705) 635-2222

TEST REPORTS



ADCOM GCD-575 CD PLAYER

Julian Hirsch, Hirsch-Houck Laboratories

ADCOM'S GCD-575 CD player combines simple, easy-to-operate controls with several advanced circuit-design features that set it apart from other players. Despite its considerable operating versatility, it presents a neat, uncluttered appearance with a semi-gloss black finish (it is also available in white), small round pushbuttons, and exceptionally legible white markings.

The GCD-575 uses dual digital-to-analog (D/A) converters, quadruple oversampling, and low-group-delay digital and analog filters. Its analog audio section is direct-coupled and has a low, 100-ohm output impedance, which permits the player to be used with almost any

type of amplifier or preamplifier with minimal signal degradation even when there are long connecting cables.

In addition to its two analog audio outputs, the GCD-575 has a coaxial digital output for use with an external D/A converter. One analog output provides a fixed level (nominally 2.5 volts), and the level from the other, up to a maximum of more than 4.5 volts, is controlled by a front-panel knob. Providing this combination of low impedance and high output level actually requires a small built-in power amplifier, in contrast to the low-level amplifier output stage of a typical CD player, and Adcom has designed a high-quality Class A amplifier for that

purpose. The variable output can drive a system power amplifier directly, eliminating the preamplifier, or it can be used for headphone listening through the front-panel jack. A multiwound power transformer and three separate regulated power supplies operate the audio, digital, and display circuits and isolate them from each other.

The GCD-575 has all of the conventional CD player operating controls, including track skipping and fast search (with sound) in either direction and a repeat function for the entire disc or a selected portion. An Intro feature plays the first few seconds of each track before proceeding to the next one (the play time can be set from 1 to 60 seconds using the player's remote control), and Auto Space introduces 4 seconds of silence between tracks. The memory button is used for programming a sequence of up to twenty-four tracks in any order.

JOOK LEUNG

TEST REPORTS

Two unique features of the GCD-575 are its polarity switch and its Analog Frequency/Phase Contour (AFPC) circuit. Normally, in accord with CD recording standards, the polarity of the player's output signal is positive. Pressing the POLARITY button simply inverts the signal's polarity (and the small red LED in the button changes from red to green). It has been claimed that the sound from some recordings can be improved by a polarity reversal, and this control makes it easy for the user to decide for himself. The AFPC feature is a proprietary Adcom circuit that is designed to make overly bright CD's sound more like good analog discs. Activating it lights a red LED in the AFPC control button.

The display window contains a twenty-selection Music Calendar that shows the numbers of the unplayed tracks on a disc. Initially, the total number of tracks and total playing time are displayed. During play, the current track number and its elapsed playing time are shown. The TIME button toggles between

elapsed time in the track, elapsed time on the disc, remaining time in the track, and remaining time on the disc. Illuminated words appear as required to identify the status of the player's other functions.

The GCD-575 comes with a wireless remote control that duplicates almost all of its front-panel controls and provides a ten-key numerical keypad for direct track access. The player can also be operated from an external timer. The memory system is unusual in that pauses can be placed in the program wherever desired (play must be pressed to resume the programmed sequence). Also unusual is that the player can be programmed with the disc drawer open, allowing reference to the disc label when making selections.

The Adcom GCD-575 measures 17 inches wide, 11¼ inches deep, and 3½ inches high. It weighs 12 pounds. It comes with a high-quality 4-foot interconnect cable with gold-plated plugs. Price: \$600 (\$650 in white). Adcom, Dept. SR, 11 Elkins Rd., East Brunswick, NJ 08816.

Lab Tests

The output of the Adcom GCD-575 was 2.65 volts from the fixed-level jacks and a maximum of 5.8 volts from the variable jacks. The channel imbalance was a barely detectable 0.02 dB. The frequency response was flat within +0.05, -0.025 dB from 10 to 20,000 Hz. With the AFPC circuit active, the portion of the frequency range below 1,000 Hz was boosted by about 1 dB, and the response rolled off above 1,000 Hz to -2.5 dB at 7,000 Hz and -3.2 dB at 20,000 Hz.

The interchannel phase shift was the lowest we have measured from a CD player, less than 0.2 degree overall from 5,000 to 20,000 Hz. The AFPC circuit had virtually no effect on phase shift, which differed from the normal measurements by a maximum of 0.4 degree in the 6,000- to 8,000-Hz range.

The channel separation measured 101 to 109 dB at 1,000 Hz, falling to 76 dB at 20,000 Hz. Harmonic distortion at a 0-dB level was nearly constant over most of the audio range, reading 0.0028 percent from 20 to 1,000 Hz and reaching a maximum of 0.011 percent at 12,000 Hz. The 1,000-Hz distortion was 0.0028 percent at 0 dB, 0.0022 percent at -30 dB, and less than 0.002 percent from -50 to -90 dB.

The low-level linearity of the GCD-575 was the best we have yet measured, with no measurable error (which means less than a fraction of a decibel) down to our -90-dB measurement limit. The A-weighted noise level was -109 dB referred to a 0-dB signal level, and the dynamic range was 95 dB. Power-line hum (60, 120, and 180 Hz) was between -115 and -130 dB.

Comments

Our measurements established that the Adcom GCD-575 is a superlative CD player, surpassing any other we have measured in respect to phase shift and linearity over the full recorded dynamic range and in general pushing the state of the art in digital-disc playback. The numbers speak for themselves, and even if it has not been clearly demonstrated that this degree of refinement has audible benefits, our mea-

FEATURES

- Three-beam laser pickup
- Quadruple-oversampling digital filters
- Linear 16-bit D/A converters
- Separate fixed- and variable-level direct-coupled analog outputs with gold-plated jacks
- Class A direct-coupled power amplifier for variable-level output; can be connected to system amplifier or headphone jack
- Low output impedance (100 ohms)
- Selectable circuit to "soften" hard-sounding CD's
- Coaxial digital output
- Polarity-reversal switch
- Reversible cast-metal feet with built-in iso-points
- Can play 3-inch CD's without an adaptor
- Programmable for up to twenty-four tracks in any order
- Repeat of whole disc or selected segment
- Music Calendar display for track numbers through No. 20
- Display of total tracks and time, current track number and elapsed or remaining time in current track or on disc
- Wireless remote control, including direct track access by number

LABORATORY MEASUREMENTS

Maximum output level: 2.65 volts (fixed), 5.3 volts (variable)

Total harmonic distortion at 1,000 Hz: 0.0028% at 0 dB, 0.0022% at -30 dB, 0.0016% at -70 dB

Signal-to-noise ratio (A-weighted): 109 dB

Channel separation: 105 dB at 1,000 Hz, 76 dB at 20,000 Hz

Dynamic range: 95 dB

Frequency response: 20 to 20,000 Hz +0, -0.25 dB

Maximum phase shift from 5,000 to 20,000 Hz: 0.2 degree at 5,000 Hz

Cueing time: 2 to 2.5 seconds

Cueing accuracy: A

Impact resistance: top, B; sides, B

Defect tracking: (Philips TS5A test disc): tracked maximum-level defects

TEST REPORTS

surements show that the GCD-575 was designed and built with an extraordinary attention to detail.

The player had no trouble in tracking the largest calibrated defects on our Philips test disc, and its slew time of 2 to 2.5 seconds, while not one of the shortest available, should be fast enough to suit most people. Frankly, in view of the near perfection of its disc-playing performance, we were a little surprised to find that it was not totally immune to physical shock: A moderate tap on its top was able to induce a dropout (although this effect was minimized if the player was on a very firm, rigid support). We doubt, however, that anyone would find this vulnerability to shock bothersome.

When we experimented with the polarity-inverting and frequency-contouring features, there were no surprises. Except for the change in the color of the LED indicator, we detected no change in any program when the output polarity was inverted. Of course, even the most "golden-eared" listener rarely, if ever, hears any differences between one polarity and the other. The AFPC circuit is another matter. When the program had appreciable high-frequency content, there was a definite softening effect when the contouring was used. When we played one of those hard-sounding discs that gave the CD a bad name in its early years, the circuit made a worthwhile improvement. With any reasonably good recording, however, the unmodified playback is likely to sound just as good (but not identical).

The quality of the Adcom GCD-575 was also apparent in the design of its operating controls. As with any equipment of equivalent complexity, its instruction manual should be studied carefully in order to appreciate its special qualities. But after that, one could hardly wish for a simpler or more versatile CD player. If the GCD-575 had been as impervious to our pounding on its cabinet as a couple of other players we have tested in the past, we would have been sorely tempted to call it "the best" in the field—and that's a verdict we rarely render.

Circle 140 on reader service card



JOOK LEUNG

THIEL CS1.2 SPEAKER SYSTEM

Julian Hirsch, Hirsch-Houck Laboratories

THIEL'S approach to speaker design emphasizes the importance of controlling time and phase response, as well as frequency response, in order to provide accurate reproduction of the spatial image and the tonal quality of a program. Its Coherent Source speaker systems demonstrate the validity of this conception of speaker performance.

The CS1.2 is the smallest member of the Thiel family of Coherent Source speakers. It is a two-way, floor-standing system consisting of a 6½-inch woofer in a vented enclosure and a 1-inch dome tweeter. Its basic design closely resembles that of larger Thiel systems, with the

woofer in the middle of a gently sloping front panel, the tweeter above it, and the woofer port at the bottom. To minimize diffraction of the sound waves, the edges of the molded-plastic panel are smoothly rounded, and the tweeter is recessed slightly into the panel. The slope of the panel is intended to place the drivers equidistant from a seated listener, thereby preserving the time coherence of the program.

For minimum crossover phase shift, Thiel uses a 6-dB-per-octave slope between the two drivers. The crossover network, which uses high-quality capacitors and air-core inductors, is surprisingly complex, having been designed to comple-

TEST REPORTS

ment the phase and amplitude characteristics of each driver to produce a true first-order response.

Despite the small diameter of its woofer, the CS1.2 is rated for a frequency response down to 50 Hz at the -3 -dB point. The woofer has a rigid, die-cast magnesium basket, and its long voice coil and large magnet give it the same bass capability as most 10-inch drivers. The tweeter dome is made of aluminum, with a resonance above the audible range, and its voice coil is cooled by ferrofluid.

The CS1.2 stands 36 inches high and $10\frac{1}{2}$ inches square, and it weighs 47 pounds. Heavy internal bracing and thick cabinet walls (1 inch at the sides and $1\frac{1}{2}$ inches for the front panel) minimize cabinet vibration, and the sloping front panel helps to reduce internal standing waves. The cabinet is teak-veneered on all sides (a black laminate is also available), and it has a black cloth grille. Pointed mounting feet are supplied to improve the speaker's contact with the floor (it is supported at three points for stability). The multiway binding-post connectors are under the cabinet. System specifications (measured with 10-foot spacing in an anechoic room) include a frequency response of 52 to 18,000 Hz ± 2 dB, sensitivity of 87 dB, impedance of 4 ohms, and recommended amplifier power of 40 to 150 watts.

Though placement is not critical, the Thiel CS1.2 speakers should be well away from all walls. Their wide dispersion permits (and encourages) spacing the speakers fairly far apart. Optimum phase and time alignment is said to be provided only for a seated listener more than 8 feet from the speakers. Price: \$1,090 a pair. Thiel, Dept. SR, 1042 Nandino Blvd., Lexington, KY 40511.

Lab Tests

We tried to follow the manufacturer's placement recommendations as closely as possible, although our listening tests indicated that the CS1.2's basic sound character was not affected to any great degree by reasonable variations.

The room response at 0 and 30 degrees off the axis with the microphone was virtually identical. This

characteristic is stressed in Thiel's brochures, and our experience totally confirmed the superb dispersion of the system. Also, there was no sign of the usual middle or upper-bass irregularity caused by room resonances; the smooth response extended to 70 Hz and below.

Combining close-miked response measurements of the woofer cone and port produced a very flat response curve, ± 1 dB from 70 to 1,100 Hz. This spliced easily to the room-response curve to form a composite frequency response of ± 2.5 dB from 46 to 20,000 Hz, slightly surpassing Thiel's rating. We noted with interest that our composite response curve closely resembled anechoic curves on the same speaker units that were supplied to us by Thiel. Our quasi-anechoic FFT measurements gave generally similar results, although we found a considerable variation with different microphone heights.

The speaker's horizontal dispersion in the FFT measurement was extraordinary. The response curves on-axis and at 45 degrees off-axis matched within 3 or 4 dB from 200 to 18,000 Hz, differing for the most part only by a small level shift. These results were obtained at the optimum microphone height and spacing; other positions introduced more conventional divergences between the curves at the higher frequencies. The group-delay variation was only about 0.2 millisecond overall from 300 to 20,000 Hz, confirming the system's excellent phase linearity.

The system's impedance was unusually constant with frequency, remaining between 3 and 6 ohms and averaging about 4 ohms from 20 to 20,000 Hz. Its sensitivity measured 87.5 dB sound-pressure level (SPL) at 1 meter with a pink-noise input of 2.83 volts. At an input level corresponding to a 90-dB SPL at 1 meter, bass distortion increased almost linearly from about 0.5 percent at 100 Hz to 5.3 percent at 50 Hz and 10 percent at 20 Hz.

Surprisingly, the CS1.2 was able to absorb large peak inputs in our pulse power tests, in which it was driven at frequencies of 100, 1,000, and 10,000 Hz with a one-cycle burst followed by 128 cycles off.

The impedance of the system was between 4 and 4.4 ohms at these frequencies. At 100 Hz, the woofer output began to sound slightly hard with an input of a couple of hundred watts, but it did not develop a solid rattle until we reached 410 watts. At the other frequencies, our amplifier clipped (at 1,400 to 1,600 watts output) before any significant distortion appeared in the speaker's output waveform.

Comments

The Thiel CS1.2 not only lived up to its manufacturer's claims but sounded every bit as good as it measured. Although it was most effective when placed as recommended, the exact listening position was not at all critical.

The most striking overall characteristic of the speaker's sound was its smoothness and lack of coloration. As usual, we listened to it for some time before making any measurements. Our test results were quite consistent with the system's subjective performance.

Several years ago we tested the larger Thiel CS2 and had the same reaction to its sound and measured performance. The similarity is no coincidence. Jim Thiel is one of those rare people who knows what music should sound like and—equally important—who knows how to design a speaker that translates his ideas into reality without doing violence to one's budget or aesthetic sensibilities.

The open, effortless quality and seamless sound stage of the CS1.2 made it very easy to listen to for extended periods. Even the bass (at least down to 50 Hz or so, which covers a large part of that range) was reproduced with clarity and believability. Of course, the CS1.2 cannot match a speaker whose bottom end extends to 30 or even 40 Hz, but the difference was obvious only when listening to organ, bass drum, or other sounds requiring extended low-bass response.

You might hope for this caliber of sound from a speaker selling for upwards of \$2,000, but it is not at all common in the price range of the Thiel CS1.2. Listen to it if possible—it is worth hearing even if you have no plans to buy a speaker. □

Plain Vanilla

Not only do we design and build it, we know how to put it together

...simple as plain vanilla.

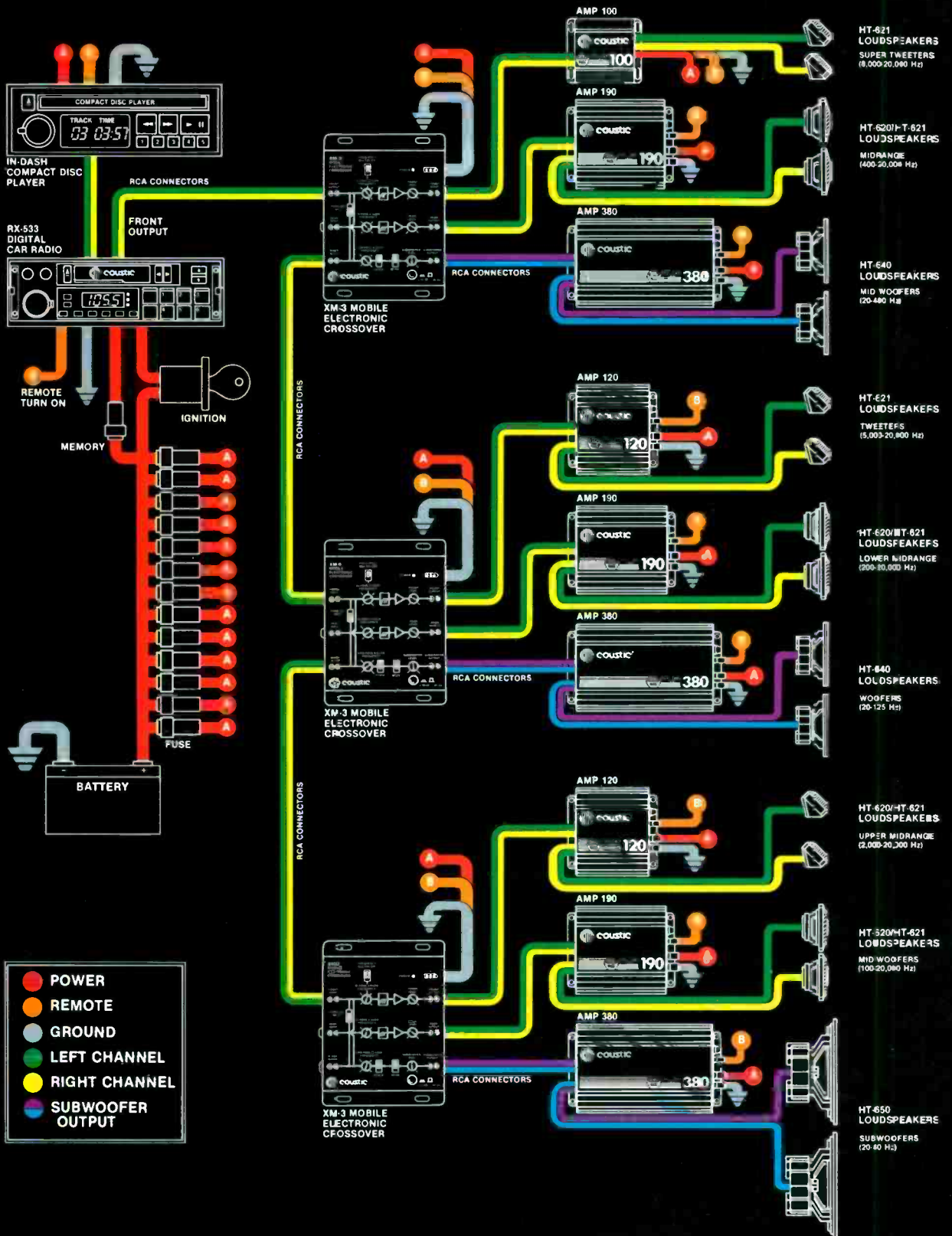

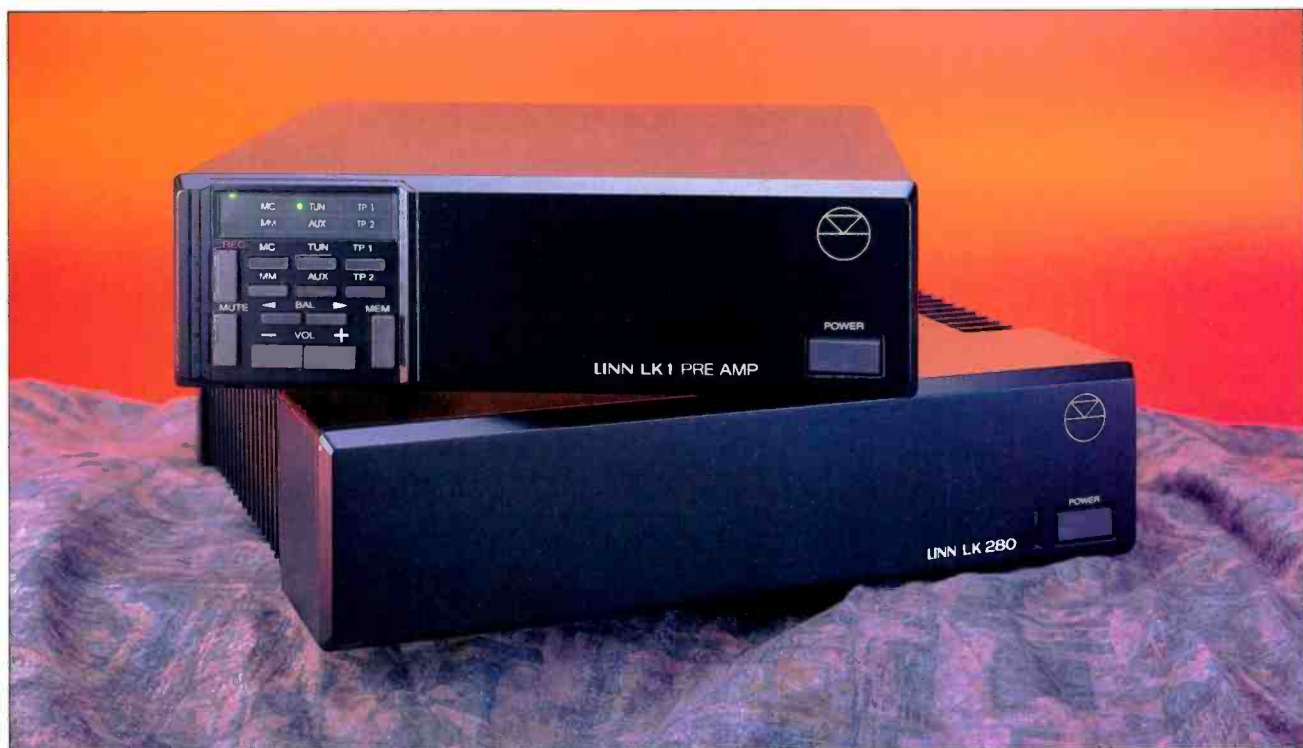

JOCK LEUNG

LINN LK1 PREAMPLIFIER AND LK280 POWER AMPLIFIER

Julian Hirsch, Hirsch-Houck Laboratories

LINN Products, headquartered in Glasgow, Scotland, is probably best known for its record-playing components, including turntables, tonearms, and cartridges, and—more recently—a line of high-quality loudspeakers. Less familiar to American audiophiles are Linn's electronic components, the LK1 preamplifier and the LK280 power amplifier (which has replaced the LK2). Like the other Linn components, they are constructed with exceptional care and attention to quality control, and they embody design features not often encountered in consumer audio products. Although the amplifier and preamplifier are physically and electrically independent, and each is electrically compatible with any standard audio component, connecting them to another company's electronic components would be difficult without special

cables. Therefore, we tested the combination as we would an integrated amplifier.

The black-finished LK1 and LK280 are substantially smaller than other preamplifiers and power amplifiers of similar output ratings. The LK1 measures 10¼ inches wide, 3 inches high, and 10½ inches deep, and it weighs 10 pounds. Except for the prominent power button, its front panel is unlike that of a typical preamplifier. A 2½-inch square section at its left end contains all the operating controls and a display that shows which input source is being heard and which is being recorded (the two functions are entirely separate). Two volume-control buttons raise and lower the listening level smoothly in 256 steps, which cannot be heard as discrete level changes, and two other buttons perform a similar function for the left/right channel balance.

The program-input buttons select from two high-level sources (tuner and auxiliary) and either a moving-magnet (MM) or moving-coil (MC) phono cartridge. The LK1 can also handle two tape decks, providing full monitoring and dubbing capabilities. A green light appears in the window next to the name of the source being heard, and a red light shows which source has been selected for recording. The control identification markings are large and exceptionally clear.

The rear apron of the Linn LK1 is as distinctive as its front panel. Except for the gold-plated RCA-type jacks for the phono inputs, all connectors are professional cannon-type XLR jacks. Each carries the signals for both channels and has a separate ground line that minimizes the possibility of hum or noise pickup from ground loops between the preamplifier and power amplifier. Markings above the jacks show the assignment of each pin. The input jacks are three-pin types; the five-pin tape-deck jacks carry both recording (output) and playback (input) signals. There are two identical preamplifier outputs, simplifying the LK1's use in a biamplified mu-

Deceptive Engineering

Obvious but **very** deceptive...

You'll probably notice our 50-watt RX-533 offers obvious features such as Digital AM/FM cassette/radio with Dolby® B & C noise reduction, 24-preset stations, preset scan, tape program search, separate bass & treble tone controls, etc., and of course, it's **removable!**

But you'll probably overlook the not-so-visible but specially engineered features such as FM optimizer II circuitry designed for superior FM reception and built-in Automatic Radio Monitor for filling the void with music while you are fidgeting with your tape. Special cassette features such as "Auto Azimuth Correction System" rotates the tape head 180 degrees whenever tape direction changes to keep perfect azimuth alignment, Keyoff Pinch Roller Release minimizes wear and tear of tape pinch roller and DC servo motor accurately controls tape movement thus minimizing wow and flutter.

Plus pre-amp outputs and CD/AUX input: capability designed for flexible system expansion, two-tone illuminated control panel guarantees easy viewing and identification and replaceable Lithium back-up battery helps protect and store information in the microprocessor.

Though not in plain view, these state-of-the-art engineering innovations are obviously what you have come to expect from a company with over 11 years of manufacturing experience.

Cooustic...a sound investment.



cooustic®

4260 Charter Street
Vernon, CA 90058-2596
(213) 582-2832



TEST REPORTS

sic system. Output cables fitted with high-quality XLR connectors are supplied, and accessory cables for input components and tape decks are available.

Internally, the LK1 is as unconventional as its exterior suggests. It uses modular construction, with one large board carrying all signal circuits and a separate board containing the digital control circuits. There are no mechanical switches or controls in the signal path, and solid-state analog switches are located at the points in the circuit where they are required. These switches are operated by a DC control voltage; the front-panel buttons (which actually operate membrane switches on the control board be-

hind them) never handle audio signals. Volume and balance adjustments are done through banks of precision fixed resistors switched by solid-state devices so as to provide stable gain settings without introducing noise or distortion.

A microprocessor on the LK1's digital board controls all the switching functions and also provides memory and remote-control capability. Using the control buttons, level and balance settings for *each* of the input sources can be memorized, to be called up each time that source is selected. The buttons can also instantly shift the balance to either side or to the center, mute the audio completely, recall the memorized settings, or lock out the

preamplifier controls to prevent undesired changes.

A compact optional wireless remote control duplicates all of the LK1's controls, though its lock-out function disables only the remote, leaving the front-panel controls fully operational. In addition to the red and green indicators in the preamplifier's window, a red light flashes whenever a signal is received from the controller. The controller also contains a number of additional, unmarked buttons intended for use with future Linn products.

The third module of the LK1 is its power supply, based on a shielded toroidal transformer. The supply delivers a lightly regulated ± 15 volts to noncritical circuits and to the individual regulators associated with every circuit block. A highly stable ± 11 -volt source serves as a reference for all of the local regulators, which enable each stage to be highly isolated from the others. The power supply also has a protection circuit that senses any sudden change in the output (or a loss of AC line input) and mutes the preamplifier. This muting action not only prevents undesirable line-voltage transients from reaching the power amplifier or speakers but completely eliminates any turn-on thumps from the preamplifier.

The Linn LK280 power amplifier, rated for 80 watts per channel into 8-ohm loads, or 160 watts into 4 ohms, is styled like the LK1, although its front panel has no controls other than a power button (with a barely visible green pilot light next to it). It also matches the LK1 in depth (10½ inches) and height (3 inches), although the heat-sink fins on its sides increase the total width to 12¾ inches. Naturally, its power supply is huskier and heavier than that of the preamplifier, giving the LK280 a total weight of 20 pounds, which *feels* surprisingly heavy in view of its compact dimensions.

The Linn LK280 is effectively a dual-mono amplifier, with only the power cord and primary transformer winding common to the two channels. The shielded power transformer occupies most of the interior volume; the two modular amplifier channels are mounted vertically

FEATURES

- LK1 Preamplifier**
- Dual-mono construction
- Inputs for tuner, auxiliary, MM or MC phono cartridge, two tape decks
- Outputs for two power amplifiers, two tape decks
- Line-level inputs and outputs via XLR connectors
- Gold-plated phono jacks for phono inputs
- Digital control system with pushbutton operation
- Independent selection of sources for listening and recording
- Dubbing from either tape deck to the other
- Memory for level and balance settings of each input source
- Volume adjustment in 256 steps using precision resistor network
- Protection system to silence output during any power-supply or line-voltage transient
- Front-panel control lock-out to prevent setting changes
- Optional wireless remote control (duplicates all front-panel controls)
- LK280 Power Amplifier**
- Dual-mono construction
- Inputs through XLR connectors
- Special firm-contact speaker jacks and plugs
- No current limiting
- Protection circuit to sense over-current operation and instantly shut off power supply of affected channel

LABORATORY MEASUREMENTS

All measurements through combined LK1 and LK280

Frequency response: 20 to 20,000 Hz $+0$, -2 dB

Slew factor: greater than 25

Output at clipping (1,000 Hz): 89 watts into 8 ohms, 174 watts into 4 ohms, 356 watts into 2 ohms

Clipping headroom (relative to rated output): 0.46 dB into 8 ohms, 0.36 dB into 4 ohms

Dynamic power output: 85.5 watts into 8 ohms, 166 watts into 4 ohms, 410 watts into 2 ohms

Dynamic headroom: 0.26 dB into 8 ohms, 0.16 dB into 4 ohms

Harmonic distortion (THD + noise at 1,000 Hz into 8 ohms): 0.2% at 1 watt, 0.07% at 10

watts, 0.03% at 80 watts (measured with 22-kHz bandwidth)

Maximum distortion (20 to 20,000 Hz into 8 ohms): 0.28% at 80 watts (20 and 20,000 Hz, measured with 80-kHz bandwidth)

A-weighted noise (referred to a 1-watt output): auxiliary -73 dB; phono (MM), -75.2 dB; phono (MC), -69.5 dB

Sensitivity (for a 1-watt output): auxiliary, 165 mV; phono (MM), 1.55 mV; phono (MC), 0.03 mV

Phono-input overload (MM): 20 Hz, 85 mV; 1,000 Hz, 64 mV; 20,000 Hz, 24 mV

Prism Effect

What has prism effect, a refractive phenomenon, to do with audio equipment?

Nothing, except that it is the simplest analogy to describe what our sophisticated XM-3* Mobile Electronic Crossover does to audio signals.

When an ordinary ray of white light passes through a prism, it is systematically separated into the primary colors of the spectrum—optically much more aesthetic than the original light.

Similarly, when an audio signal enters the XM-3, the original signal is then separated, via various controls, to the front and/or rear tweeters, mid-ranges and sub-woofers, creating distinctive bands of the audio frequency spectrum that are space and user-specific.

Specially engineered features such as Front and Rear Pre-Amp Inputs and Front and Rear Outputs as well as a constant Sub-Woofers Output, Asymmetrical Electronic Crossover which has two high-pass (32-400 Hz variable)

crossover points for the front and rear outputs and a low-pass (32-400 Hz variable) crossover point for the sub-woofer output, Woofer/Enclosure Equalization engineered for optimizing bass response, Phase Inverter allowing the sub-woofer output to be shifted 180 degrees out-of-phase to compensate for in-vehicle acoustical abnormalities and Frequency Multiplier Switch which, by multiplying crossover points for the front channel, transforms the XM-3 from a **BI-AMP SYSTEM** to a **TRI-AMP SYSTEM**, etc., all contributed to create the **PRISM EFFECT** and make the XM-3 the most versatile electronic crossover ever manufactured for automotive use.

Cooustic... a sound investment.



cooustic[®]

4260 Charter Street
Vernon, CA 90058-2596



TEST REPORTS

along the sides, close to their heat sinks. Each channel module has its own power supply (except for the common transformer) and is easily replaceable as a unit if service is required. The rear apron contains the two XLR input jacks and the corresponding speaker-output jacks. The speaker outputs, though conceptually similar to banana-plug jacks, are not usable with conventional banana plugs. The supplied plugs fit so tightly into the jacks that removing them by hand can sometimes be difficult.

The overall quality of construction and the materials used in the LK280 are similar to those of the LK1. According to Linn, the LK280 has no circuitry for sensing the output-device temperature, and its design eliminates any need for adjusting the quiescent current in the output stages. It also does not have any conventional current-limiting circuits, being protected against catastrophic failure by a line fuse and against all forms of overload or operating abuse by a unique sensing circuit that responds to any source of potential damage by instantly shutting down the affected channel. Typically, an excessive static current drain, or a larger transient drain lasting more than a few milliseconds, will trigger the shutdown. Power can be restored only by switching the amplifier off for at least 5 minutes and then turning it on again. Other than this instantaneous shutoff action, there is nothing in the amplifier to impede its delivery of power to the load.

The suggested list price of the Linn LK1 preamplifier is \$1,050; the LK280 power amplifier is \$1,495. Accessory prices: remote control for the LK1, \$110; tuner/auxiliary input cable with XLR connectors, \$35; tape-recorder input/output cable with XLR connectors, \$45. Linn Products, Ltd., Dept. SR, 8709 Castle Park Dr., Indianapolis, IN 46256.

Lab Tests

During the preconditioning period, the exterior of the LK280 became fairly warm, though not uncomfortable to the touch. Even in normal operation both it and the LK1 preamplifier were noticeably

warmer than most amplifiers. For most of our tests, the LK1's gain was set so that an input of 0.5 volt produced a 1-watt output from the LK280.

The amplifier's 1,000-Hz output (into 8 ohms) clipped at 89 watts per channel, for a clipping headroom of 0.46 dB, and with 4-ohm loads the output was 174 watts (headroom of 0.36 dB). When it was driving 2 ohms, the amplifier's protection system shut it off at 356 watts. The 8-ohm dynamic output was slightly less than the steady-state clipping power, although the measurement of a tone-burst signal is inherently less accurate than a steady-state measurement and the differences were minor. The 8-ohm dynamic power was 85.5 watts, increasing to 166 watts into 4 ohms and an impressive 410 watts into 2 ohms.

At 80 watts into 8 ohms, the total harmonic distortion (THD) plus noise at 1,000 Hz was about 0.15 percent from 50 to 3,000 Hz, increasing to 0.23 percent at 20,000 Hz. At lower power levels the distortion was slightly less, but it was typically between 0.1 and 0.2 percent over the range of 20 to 20,000 Hz. By limiting the measurement bandwidth to 22,000 Hz to exclude ultrasonic noise, we were able to make a 4-ohm measurement of 1,000-Hz distortion over the full power range. From 0.3 percent at 0.5 watt, it decreased linearly to 0.07 percent at 8 watts and 0.025 percent at about 175 watts, just before the waveform clipped.

The RIAA phono-equalization error (measured at a tape output of the preamplifier) was less than 0.5 dB from 50 to 20,000 Hz and reached -2.5 dB at 20 Hz. The MM phono-input termination was inexplicably different from the manufacturer's specification of 47,000 ohms and 69 picofarads; we measured it as 90,000 ohms in parallel with 88 picofarads. The phono-overload input was acceptable, with readings from 85 millivolts (mV) at 20 Hz to 64 mV at 1,000 Hz, but the 20,000-Hz overload point of only 24 mV was undeniably low. With cartridges of moderate output, most records would be unlikely to overload the phono stage, but the safety

margin is less than it should be in a preamplifier of this quality.

Comments

The Linn LK1 and LK280 represent an unusual blend of digital and analog technology. Although their audio functions are purely analog, the effectiveness of the LK1's digital circuits in controlling and protecting the amplifier was impressive. The LK1's pushbutton controls may seem a bit strange at first, but it takes only a few minutes to appreciate their logical design.

The considerable combined cost of the two Linn units is not difficult to justify, especially when you look inside and see their gemlike construction. In our case, a mishap on the test bench that could (and should) have destroyed both output stages did no more than shut off the amplifier totally—which gave us some bad moments until we turned it on the following day, and everything functioned normally! Heartened by that recovery, we fearlessly went ahead with 2-ohm clipping-power tests, which have been the nemesis of quite a few amplifiers—or their fuses, at least. The results show that the LK280 is a powerhouse far surpassing its modest 80-watt rating and would seem to justify Linn's claim that it can drive *any* speaker without risk of damaging it. We got the impression that the amplifier itself was quite bulletproof as well.

Apart from the skimpy phono-overload margin, we found only one respect in which the Linn preamplifier fell short of ideal performance. Its digital control circuits radiated enough radio-frequency "hash" to degrade the performance of an FM tuner placed near the preamplifier. This effect was exacerbated (and possibly caused) by the fact that the antenna of the tuner was within a couple of feet of the LK1; it would almost certainly not have been detected if a good external antenna had been used.

Even if these beautiful products are not quite perfect (what is?), they are among the most satisfying audio components we have seen in some time, and worth every cent of their price.

Circle 141 on reader service card

Double Scoop

When one is plainly not enough ...indulge!

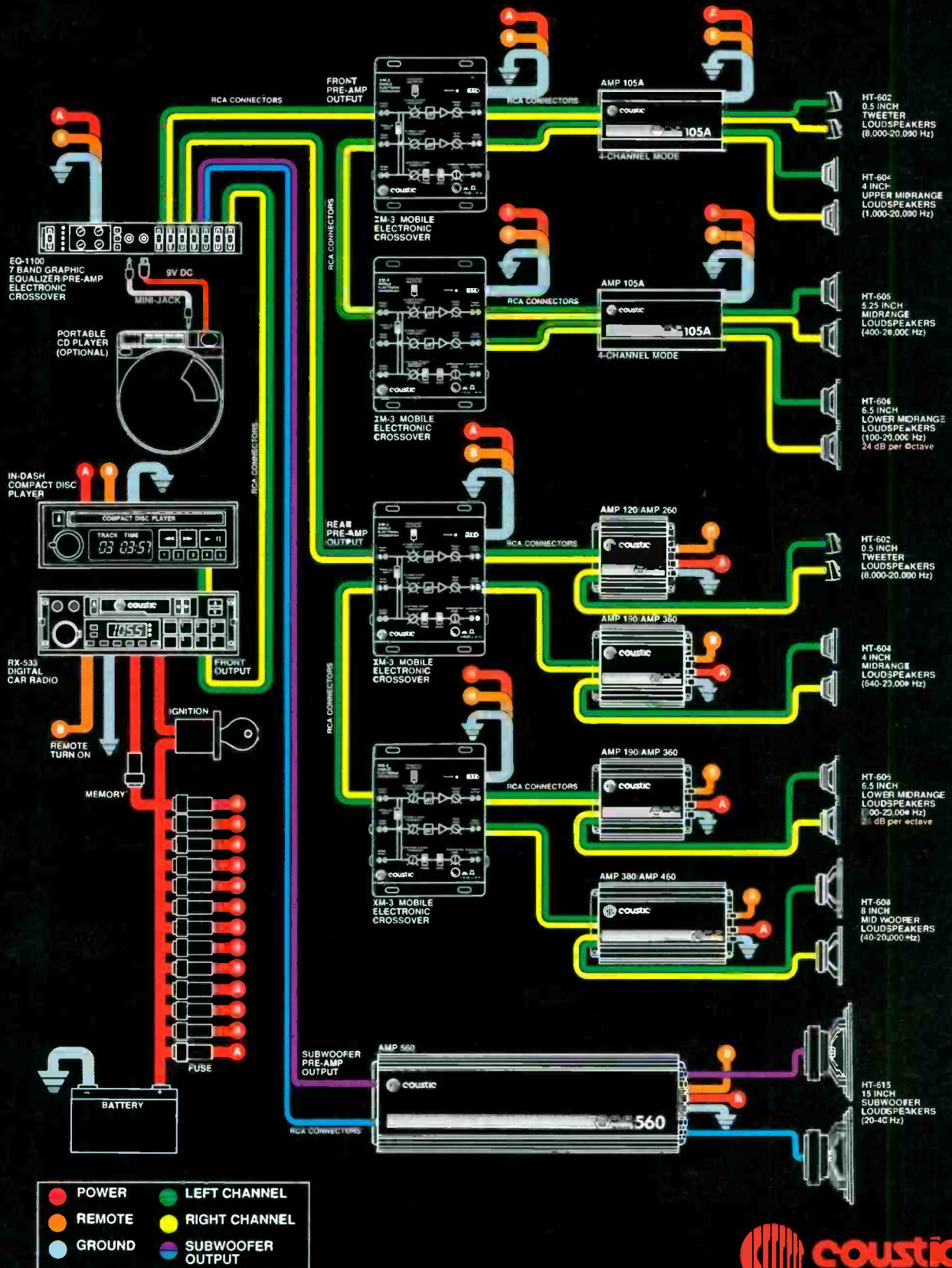

CIRCLE NO. 18 ON READER SERVICE CARD

cooustic
...a sound investment.

TURBOCHARGE YOUR CD PLAYER.

PIONEER STEREO AMPLIFIER A-91D

Pioneer Digital Stereo Amplifier
ULTIMATE FIDELITY STEREO COMPONENT BY PIONEER

VOLUME CONTROL
16 18 14

POWER

DIGITAL OPERATE

DIGITAL REC SELECTOR

OFF ADPT/DAT 1

SPEAKERS

BASS

TREBLE

L BALANCE R

DIGITAL-1 DIGITAL-2 DIGITAL-3

DAT1

TAPE-1

LINE-1

LINE-2

TUNER

CD

PHONO

ANALOGUE INPUT

SOURCE OFF

ANALOGUE REC SELECTOR

ADPT/DAT 2 ADPT/TAPE 2

DIGITAL ANALOGUE

ADAPTOR

MODE LOUDNESS

DIRECT

MC SUBST

ON

L R ON



56
66
80
∞





THE ELITE A-91D INTEGRATED AMPLIFIER.

Now that the compact disc has taken the world by storm, ordinary amplifiers are failing their driving test. Because ordinary amplifiers simply can't handle the dynamic range and purer signal that digital sound delivers.

Fortunately, the A-91D is far from ordinary. Because the A-91D is built with one thought in mind—to maximize the performance of digital sound.

With 170 watts per channel into 4 ohm speaker loads, and 120 watts into 8 ohms, the A-91D unleashes digital's full dynamic range. Extra-large capacitors and huge finned cast-iron enclosed transformers further contribute to the A-91D's high current capacity and stability into speaker loads as low as 2 ohms.

Along with all this power comes unprecedented purity. You can plug the latest CD players with optical outputs directly into the A-91D, and reap the rewards of independent digital conversion circuitry—with twin, glitch-free D/A converters, a digital filter with four-times oversampling, and an analog lowpass filter made from quality discrete parts. The A-91D also uses Pioneer's exclusive Non-Switching™ Type III amplifier circuit to totally eliminate switching

distortion. What's more, critical signal paths are kept extraordinarily short for less electronic interference and cleaner sound.

When it comes to digital sound, there's no such thing as good vibrations. That's why the A-91D uses a special anti-vibration honeycomb design in the chassis frame. In isolation barriers between electronic sections. Even in all five insulator feet. A large aluminum volume control knob with a specially balanced brass shaft also absorbs distortion-causing vibration, and printed circuit boards are mounted in rubber for the same reason.

The A-91D is not only ready for digital, it's ready for the future. With six digital inputs (2 optical), and three digital outputs (1 optical).

So if you want your digital sound to drive you to new heights, you need to drive your digital components with the Elite A-91D.

For more information, call 1-800-421-1404.

ELITE
BY PIONEER

©1987 Pioneer Electronics (USA) Inc., Long Beach, CA

CIRCLE NO. 31 ON READER SERVICE CARD

THE ELITE REGISTER

ALABAMA

Birmingham
Audition, Inc.
Florence
Ingram Audio

ALASKA

Anchorage
Magnum Electronics

ARIZONA

Phoenix
Integrated Systems
Jerry's Audio
Tucson
Jerry's Audio

ARKANSAS

Fayetteville
Amp Audio
Little Rock
Walloch Home Center
Pine Bluff
Stereo Junction

CALIFORNIA

Alamo
Laser Faire
Alhambra
Audio Video Center
Berkeley
The Sounding
Board, Inc.
Beverly Hills
Beverly Hills Audio
Concord
Sounding Board
Encino
Audio Video
Electronics
Glendale
Marconi Radio
Irvine
Sound Quest
Los Angeles
Royal Sound
Mill Valley
Videola
Mission Viejo
Videolaser
Monrovia
Video Place
Palo Alto
Western Audio
Imports
Riverside
Speakercraft
Sacramento
Paradyne
San Bernardino
Video Mart
San Diego
Convoy Audio Video
Stereo Design
San Francisco
Audio Excellence
Videola
Wong's Hi Fi
San Jose
Quement Electronics
Santa Monica
Jonas Miller Sound

Tustin
Digital Ear
Woodland Hills
Wilson Audio Video
Entertainment

COLORADO

Denver
Listen Up

CONNECTICUT

Danbury
Sounds Alive
East Hartford
Hi Fi Image
Greenwich
Aud Vid
Groton
Leiser Sound
Newington
Sound Playground
Norwich
Leiser Sound
Orange
Sounds Alive
Stamford
Sounds Alive
Waterbury
Zinno Music
Westport
Sounds Alive

FLORIDA

Altamonte Springs
Boss Audio & Video
Daytona
Electronics
Environment
Ft. Lauderdale
Sound Design &
Engineering
Melbourne
Audio Mart
Merritt Island
Audio Mart
Miami
Audio Coll
Audio Plus
Kalu
Overseas Electronics
Victors International
Pinellas Park
Cooper For Stereo
Royal Palm Beach
Family Video
Super Centers
Stuart
Sound & Vision

HAWAII

Honolulu
Sam Sung
Electronics, Inc.

IDAHO

Idaho Falls
Phase Four Stereo
Pocatello
Phase Four Stereo

ILLINOIS

Burbank
Digital TV

Chicago
Mills Recording
Belmont Electronics
Darien
K-B TV
Kankakee
Barrett's
Entertainment
Lansing
Unitek Electronics
Peoria
Northpoint Video,
Audio & Appliance
Quincy
First in Video
MusicWorld

INDIANA

Angola
King's Antenna
Crown Point
Crown Electronics
Fort Wayne
Lehman Electronics
Huntington
Lehman Electronics
Logansport
Todd's
Warsaw
Butterfly

IOWA

Cherokee
Wilson TV
Fort Dodge
Sound World
Orange City
The Movie Express

KANSAS

Mission
Accent Sound
Overland Park
ESP Industrial
Communications
Salina
Del's TV & Tape Center

KENTUCKY

London
Sounds Around Town
Louisville
Audio Video by Design

LOUISIANA

Baton Rouge
Art Colley's Audio
Specialties
Metairie
Alterman Audio
New Orleans
Alterman Audio

MARYLAND

Annapolis
H.A. Hi Tech

Gaithersburg
Audio Buys

MASSACHUSETTS

Auburn
Leiser Sound
Cambridge
Audio Video
Environments
Frammingham
Natural Sound
Littleton
Music Shack
Seekonk
Leiser Sound
Shrewsbury
Leiser Sound

MICHIGAN

Ferndale
Jam Hi Fi Sound
Specialists
Plymouth
Digital Entertainment

MINNESOTA

Edina
Laser Ware
Scholes Enterprises
Fairmont
Bill's Radio & TV
Minneapolis
Peterson
Entertainment Design
Richfield
Pro Line Audio
St. Paul
Robert Paul TV

MISSISSIPPI

Meridian
Hoopers Electronic
Supply

MISSOURI

Kirkville
Wright Tire &
Appliance
Kirkwood
Warner
Communications
Oakville
Quality Sight
and Sound

MONTANA

Great Falls
Rocky Mountain Hi Fi

NEW JERSEY

Cherry Hill
Soundworks
Cliffside Park
Entertainment
Environment

Hamilton Square
Rock Dreams
Millburn
Professional Audio
New Brunswick
Hi Fi Haven
Toms River
Rand's Camera & Hi Fi
Woodbridge
Woodbridge Stereo
Wyckoff
Conklin's Audio Video

NEW YORK

Astoria
Steinway Sounds
Hicksville
Designatron
Huntington Station
Audio Breakthrough
Manhasset
Audio Breakthrough
Merrick
Performance Audio
& Video
New York
Audio Breakthrough
Bryce Audio
Custom Media Design
East Side Stereo
Lyric Hi Fi
Sound by Singer
Rego Park
Watts That Sound/
Continental Sound
Rochester
Rowe Photo
Scarsdale
The Listening Room
Watertown
The Happy Ear
White Plains
Audio Design
Lyric Hi Fi

NORTH CAROLINA

Albemarle
Music Mart
Durham
Kerr's Audio Visions
Fayetteville
Rhudy's Camera
& Video
Hickory
Dacia Electronics
Lenoir
Crowells
Reidsville
Trent's Stereoland

NORTH DAKOTA

Minot
Einstein's Audio/Video
John Iverson Co.

OHIO

Beachwood
Nutec
Cincinnati
Audio Vision Plus
Cleveland
Northwood Home
Electronics
Dayton
Distinct Audio & Video
Mansfield
High Tech Video
Maple Heights
Eric Martins
South Euclid
Atlantis Home
Entertainment System
Westlake
New Images
Electronics

OKLAHOMA

Oklahoma City
Contemporary Sounds
of Oklahoma

OREGON

Astoria
Greenburg's Furniture
Salem
Salem Sound Center

PENNSYLVANIA

Berwyn
Soundex Electronics
Broomall
Hi Fi House
Lancaster
Video Gallery Plus
Natrona Heights
Butch's Sound Shack
Philadelphia
Music on the Square
Willow Grove
Soundex Electronics
York
The Electronics Place

RHODE ISLAND

N. Providence
Eastern Discount
Westerly
Leiser Sound, Inc.

SOUTH CAROLINA

Columbia
Laser Experience
Georgetown
Stereo Video Center
Hartsville
Haynes Electronics

SOUTH DAKOTA

Pierre
Team Electronics
Rapid City
Team Electronics

Sioux Falls
Dakota Sound
Yankton
Team Electronics

TENNESSEE

Knoxville
Hi Fi House
Memphis
New Wave Audio
and Video
Nashville
Hi Fi Buys

TEXAS

Dallas
Custom Video
Fort Worth
Marvin Electronics Co.
Houston
Audio Video Plus
Laredo
Jett Sales
Lubbock
American Audio Video

UTAH

Midvale
Inkley's

VERMONT

South Burlington
LaserWorld

VIRGINIA

Alexandria
Video Station
of Virginia
Franklin
Audio Showroom
Manassas
Audio Buys
Newport News
Sound Approach
Roanoke
Lee Hartman & Sons
Virginia Beach
Digital Sound
Winchester
Sound City

WASHINGTON

Redmond
Home Entertainment
by Design
Seattle
Definitive Audio

WISCONSIN

East Troy
Video Playground
Glendale
Sound Stage
Green Bay
Sound World
Hayward
M&M Video
LaCrosse
Team Electronics



CIRCLE NO. 31 ON READER SERVICE CARD



AIWA AD-F780 CASSETTE DECK

Craig Stark, Hirsch-Houck Laboratories

THE new Aiwa AD-F780 cassette deck is designed for the audiophile who wants a number of advanced features at a medium price point. In addition to the usual Dolby B and Dolby C noise-reduction systems, this three-head, dual-capstan deck incorporates both the Dolby HX Pro headroom-extension system and user-adjustable bias and tape-sensitivity adjustments. The headroom-extension system operates automatically to control the recorder's bias current. The effect is to prevent high-level high frequencies from overloading the tape, and it would be a fair estimate to say that at high recording levels Dolby HX Pro adds nearly half an octave of usable treble response—with no ill effects

that we have been able to discover.

The record and playback heads in the AD-F780 are separate, although, as is customary, they are contained within a single casing. Separate heads permit the user to make an immediate comparison between the original sound source and the taped result. The closed-loop, dual-capstan drive system is belt-coupled to a DC servomotor. A second DC motor is used to turn the take-up and supply reels.

The cassette-well door mechanism is unusual in that it contains a spring-loaded plate, called an Anti-Modulation Tape Stabilizer, that exerts some additional pressure to hold the cassette tightly in place. According to Aiwa, this reduces vibrations in the cassette shell. While

we had no way to test its effectiveness for this purpose, we did find that it eliminated all label visibility and slightly impeded access to the tape heads and capstans for cleaning. The rear illumination inside the cassette well made it possible to estimate the amount of tape on each reel, however, and we were happy to find that the AD-F780 automatically takes up any tape slack when a cassette is inserted.

Both the four-digit tape counter and the tape-level indicators use fluorescent displays. The counter registers tape-hub revolutions only; it does not show the elapsed or remaining time. The level indicators have twelve peak-reading segments per channel and are calibrated from -20 to +10 dB. As the numbers on the display are too small to be useful, the two-color presentation (blue below 0 dB, red above) is important in use.

The Aiwa AD-F780 provides front-panel, user-adjustable bias and sensitivity controls. As there are no built-in test tones or me-

TEST REPORTS

tering, however, these adjustments must be made by ear, using a source such as low-level FM interstation hiss. A color-coded guide for setting the bias for various brands of tape is

supplied on the top front edge of the deck.

The transport functions are actuated by light-touch solenoid controls. Slide switches are used to

select Dolby B, Dolby C, or no noise reduction, memory stop or repeat, and external-timer operation. Push-buttons are supplied for tape/monitor switching, record mute, and multiplex-filter defeat. Large concentric record-level knobs for the two channels allow adjustment for channel balance. No playback level control is provided either for the main outputs or for the headphone output.

The Aiwa AD-F780 measures 17 inches wide, 5 inches high (including its large mounting feet), and 12½ inches deep, and it weighs approximately 11¼ pounds. Price: \$450. Aiwa, Dept. SR, 35 Oxford Dr., Moonachie, NJ 07074.

FEATURES

- Separate record and playback heads
- Dolby HX Pro headroom extension
- Dual-capstan transport
- User-adjustable bias and sensitivity controls
- Dolby B and Dolby C noise reduction
- Four-digit fluorescent tape counter
- Twelve-segment-per-channel peak-level indicators
- Switchable FM-multiplex filter
- External-timer facility

LAB MEASUREMENTS

Fast-forward time (C-60): 64 seconds

Rewind time (C-60): 62 seconds

Speed error: +0.87%

Dolby tracking error: Dolby B, +0, -1 dB; Dolby C, +0, -2.5 dB

Wow-and-flutter: 0.037% wrms, 0.075% DIN peak-weighted

Line input for indicated 0 dB: 58 mv

Line output at indicated 0 dB: 0.62 volt

Meter indication at IEC-standard 0 dB: +1 dB

Tape: TDK AD (Type I, ferric) IEC 0-dB distortion: 0.67%

Meter indication at 3% third-harmonic distortion: +6 dB

Signal-to-noise ratios (in decibels):

	Unwtd.	A-wtd.	CCIR/ARM
NR off	51.5	59.5	57.0
Dolby B	60.2	69.4	67.6
Dolby C	63.1	76.2	77.0

Tape: TDK SA (Type II, chrome-equivalent) IEC 0-dB distortion: 0.90%

Meter indication at 3% third-harmonic distortion: +6 dB

Signal-to-noise ratios (in decibels):

	Unwtd.	A-wtd.	CCIR/ARM
NR off	52.2	60.1	57.4
Dolby B	59.7	69.6	67.9
Dolby C	62.7	76.9	77.4

Tape: TDK MA (Type IV, metal) IEC 0-dB distortion: 1.4%

Meter indication at 3% third-harmonic distortion: +3 dB

Signal-to-noise ratios (in decibels):

	Unwtd.	A-wtd.	CCIR/ARM
NR off	50.7	58.3	55.4
Dolby B	58.3	68.0	66.0
Dolby C	61.3	75.2	75.5

Lab Tests

Measured with our ferric and CrO₂ IEC-standard BASF test tapes, the playback frequency response of the AD-F780 was very flat. It deviated by less than ±1 dB from 31.5 to 12,500 Hz and dropped off smoothly above that to -2.5 dB at the 18,000-Hz upper limit of the test tapes.

For checking overall record-playback response we used "center-line" samples of TDK AD (ferric), TDK SA (high bias), and TDK MA (metal). We use the same tapes and standard levels consistently, so readers can compare test reports from different issues of STEREO REVIEW. As can be seen from the accompanying graphs, the low-frequency performance of the AD-F780 was excellent: There is less than a 2-dB drop all the way down to 20 Hz, and there are no low-frequency "head bumps" of consequence.

At the high-frequency end, response at the IEC-standard 0-dB level of 250 nwb/meter fell off to -6 dB at 12,000 Hz with the ferric and high-bias tapes. On machines without Dolby HX Pro this point would normally be reached at approximately 8,000 Hz. With HX Pro the metal tape reached 19,000 Hz before its response fell to half-strength (-6 dB) at this level. Switching in Dolby C, which uses less record treble pre-emphasis, extended 0-dB response to 18,000 Hz. At the -20-dB level normally used for measuring record-playback re-

AIWA AD-F780 CASSETTE DECK
RECORD-PLAYBACK RESPONSE

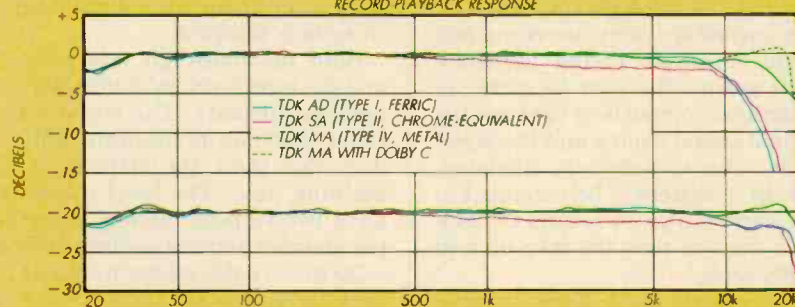

PLAYBACK-ONLY RESPONSE
(IEC-STANDARD BASF TEST TAPES)

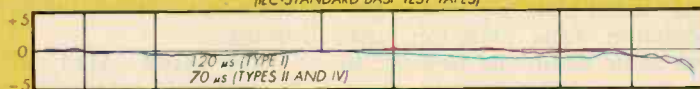

FREQUENCY IN HERTZ



“Why all Boston Acoustics

speakers sound alike. (More or less, that is.)”

Andy Petite, chief designer, Boston Acoustics.

“At Boston Acoustics, live music is our basic reference standard. And since we design each of our speakers to sound musically accurate, all of our systems have a remarkable sonic resemblance.

“Any full-range speaker system, whatever its size, should have good octave-to-octave tonal balance and wide dispersion. We provide these qualities in *all* of our speaker systems—from the A40 bookshelf to the T1000 tower. (From our long experience in listening to many competitive speaker lines, the same can be said of only a few.)

“In larger rooms and at higher listening levels, the differences—and the superiority—of our more expensive systems begin to emerge. They can play louder without strain, and reproduce deeper bass. *But this doesn't detract from the musicality, accuracy and tonal balance of our smaller speakers.*

“How much sound a speaker produces in your listening room also depends on the room's size, the music you listen to, and how loud you play it. Because all Boston Acoustic speaker systems—bookshelf, floor-standing and tower—meet all *our* standards, there's at least one that should meet *your* special requirements and conditions.*

“So when you visit a Boston Acoustics dealer, ask to hear a Boston speaker. *Any* Boston. We can't promise you perfection, but we *will* bring you as close to the music as the state of the art allows.”

*“It certainly helps that we design and build our own speakers—all with the same high quality materials. Further, we manufacture all our speakers to such tight tolerances that any two samples of a given model are virtually identical. And to insure this, we test each completed system—every single one—before it leaves the factory.

“Finally, sonic similarity is especially important with surround-sound systems. An all-Boston system assures the greatest sonic impact.”



The A40 Series II.

Our most popular bookshelf system.

“... attains an aura of spaciousness surpassed only by some of the far more expensive multi-directional speakers.” *The New York Times*.
Suggested retail: \$170 a pair.



Introducing the T930 Tower System.

Combines our finest midrange and tweeter with a new 10-inch long-throw woofer.
Suggested retail: \$800 a pair in walnut veneer, \$650 a pair in black woodgrain laminate.

BostonAcoustics

MAGNEPLANARS®...

Because
Music Doesn't
Come In Boxes.

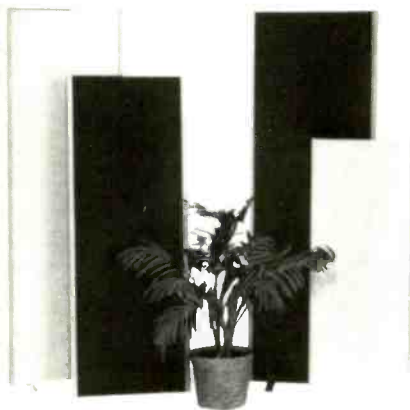

From the \$495 per pair SMGa to the \$1995 MG-IIIa, Magneplanar® speaker technology eliminates the box for a more open, natural sound. And because Magneplanars are bipolar — radiating sonic energy to the rear as well as forward — the three dimensional space the artists occupied while recording is recreated precisely in your home.

MAGNEPAN

1645 9th Street
White Bear Lake, MN 55110

sponse, the two conventional tapes were within +0.5, -2.5 dB out to 18,000 Hz, and the metal tape made it to 20,000 Hz. This is very good performance for any cassette deck and especially commendable for one in the price range of the Aiwa AD-F780.

The door mechanism of the Aiwa AD-F780 tape deck contains an unusual spring-loaded plate that holds the cassette tightly in place to reduce vibrations in the shell.

Our wow-and-flutter measurements of 0.075 percent (DIN peak-weighted) and 0.037 percent (wrms), though very close to Aiwa's specs, were not quite so impressive. Signal-to-noise ratios (S/N) were very good, however. The fact that the S/N's for metal tape were not significantly better than those for ferric was slightly disappointing, but not unexpected in a deck at this price.

Tape sensitivity and output levels were entirely normal, and Dolby tracking error was commendably low. High-speed winding times were slightly better than average. The

deck did run slightly fast (+0.87 percent), but since I do not have absolute pitch, I did not find the effect audible.

Comments

Although it is easy to operate in a couple of respects, the AD-F780's human engineering could stand improvement. The solenoids that control the transport functions clunk surprisingly loudly, especially when a tape is first loaded into the machine. The numbers on the tape-level indicators are impossibly small, as are the markings that identify the LED indicators for Dolby B, Dolby C, and tape type.

Sonically, on the other hand, we have few faults to find. With Dolby C, the signal-to-hiss ratio was good, and the sonic imaging was very good. Nor could we fault the clarity except in one respect. While we did not detect any wavering of pitch with musical sources (we did with pure test tones, where it is always audible), the relatively high wow-and-flutter of the AD-F780 did detract slightly from the open, transparent character of the sound. We did not judge this to be a serious audible defect, however, and especially in view of the price, we found the overall quality of the Aiwa AD-F780 to be very high indeed.

Circle 142 on reader service card

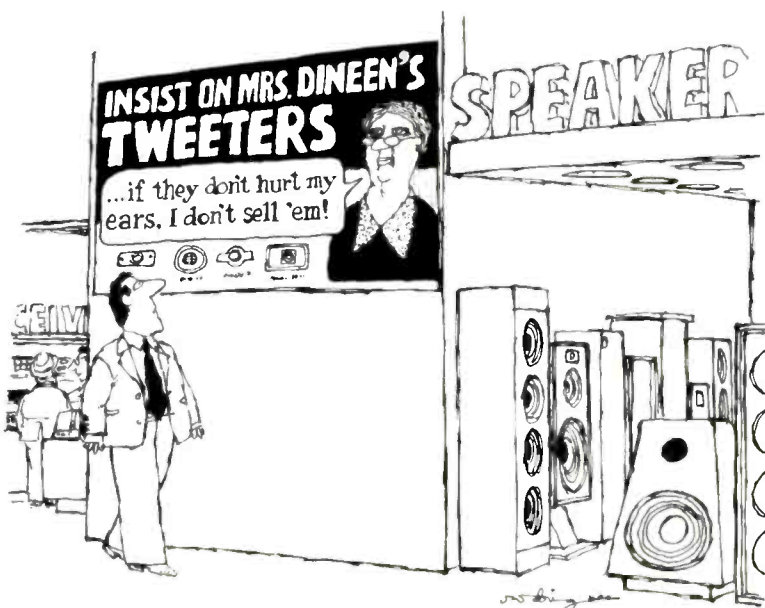

TWO VERY IMPORTANT FACTORS FOR AUDIO & VIDEO EQUIPMENT PERFORMANCE

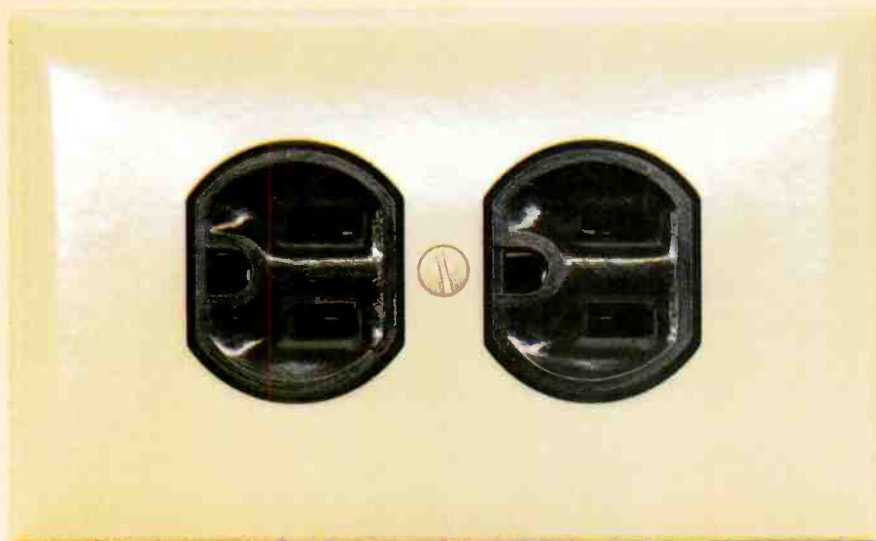

You know how important the top one is for performance, but you might not know that the other is just as vital. It's a ComponentGuard GuardCard, and it's the safest, easiest way to keep your home electronics in perfect working order—while protecting you from costly repairs.

ComponentGuard extended service plans pay for everything required to fix troublesome equipment, even in some cases, to guaranteeing the product's key performance specifications.

When servicing is needed, just show your GuardCard. Which makes ComponentGuard as problem free for you as it is for your equipment.

Remember, if it plugs into the wall, protect it with ComponentGuard.

CIRCLE NO. 56 ON READER SERVICE CARD

COMPONENTGUARD™

ComponentGuard coverage is sold at fine audio, video and electronics stores everywhere. Or, call 1-800-421-9820.

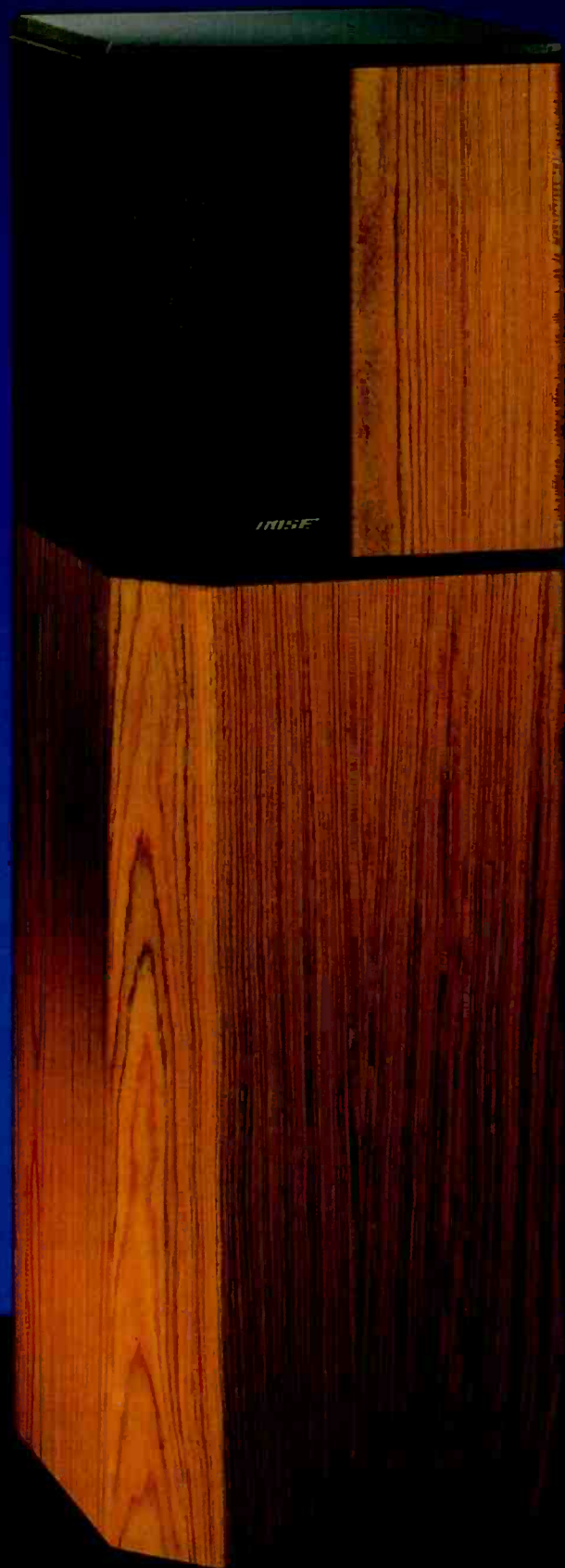

Introducing the most powerful expression of a new technology:

The Bose® 10.2™ Series II Direct/Reflecting® system with Acoustimass® speaker technology.

Inside and out, it's a speaker unlike any other.

The new Bose 10.2 Series II speaker successfully harnesses a series of audio technologies to take the listener one step closer toward the goal of all speakers: the realism of live music. The 10.2 Series II speaker combines the most powerful version of Acoustimass speaker design available for the home with the proven, critically-acclaimed benefits of a Bose Direct/Reflecting® system. The result: a musical listening system with *no* compromises—one that's at home in any environment.

Technology in harmony with home aesthetics.

Moreover, the 10.2 Series II system brings lifelike sound into the living environment without overwhelming it. Each speaker's genuine wood veneer, hand-crafted Acoustimass enclosure produces the bass necessary to make even the most demanding music come to life, yet requires just *one square foot* of floor space. The system's Stereo Targeting® arrays precisely shape and control sound, providing listeners—regardless of where they stand or sit—with full, balanced stereo sound from both speakers. Where the speakers look best is also where they *sound* best.

Greater musical realism with any sound source.

Like all Bose Direct/Reflecting® speakers, the 10.2 Series II system is designed to accurately reproduce much of the clarity and spaciousness of live music. This strict attention to sonic detail is carried through to the lowest notes, where Acoustimass speaker technology provides much of the realism and impact normally experienced *only* in the concert hall. The system's purer sound provides the dynamic range and high power capability required for optimum results with any audio or video system and software—especially digital.

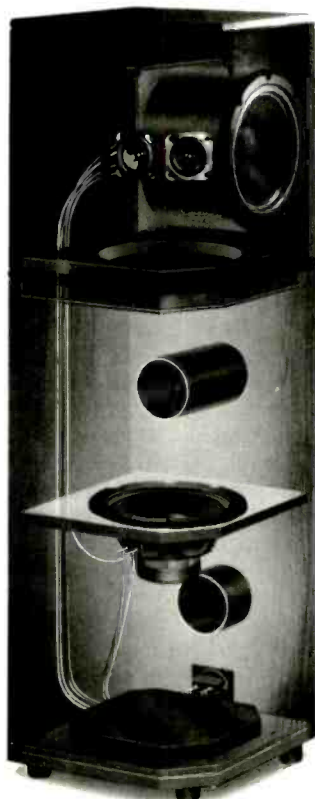

How an Acoustimass® speaker works.

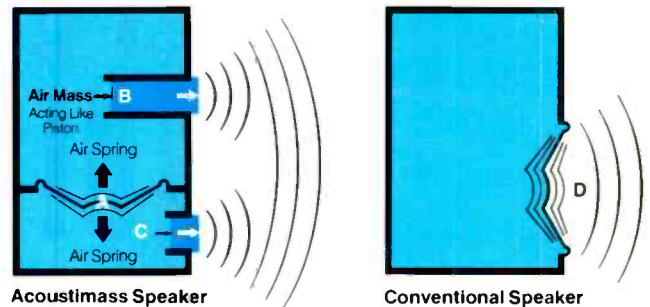

Acoustimass Speaker

Conventional Speaker

Improving speaker performance means first reducing distortion. The design of an Acoustimass® speaker *substantially* reduces distortion (see diagrams and graph). The benefits of this patented speaker technology are *purier sound* and an *increase in the dynamic range of bass performance*.

Left: An Acoustimass speaker *launches* sound into the room using two masses of air working like pistons (B&C, darker blue), rather than by a surface vibrating directly into the room. *The sound launched into the room by the Acoustimass speaker's air pistons is the purest sound that can be produced by present technology.*

Right: A vibrating cone radiating directly into the room (D) produces unfiltered sound.

Cone Excursion Comparison.

(lower excursion means lower distortion)

Graph: The distortion produced by any speaker rises dramatically with its cone motion, or *excursion*. At port-tuned frequencies, a typical Acoustimass speaker's cone has less than *1/16* the maximum excursion* of sealed and ported cones. Inside an Acoustimass speaker, the interaction of the air springs with the air masses in the ports produces a very high pressure at the surface of the cone. This greatly reduces the cone's excursion, and therefore reduces distortion. The air springs act with their respective masses to form low-pass filters, removing any small distortion components generated by the cone.

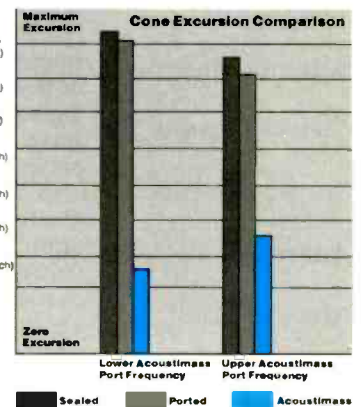

*based on cone travel measurements at 128 watts input.

Judge for yourself.

Ask your authorized Bose dealer to demonstrate the new Bose 10.2 system with Acoustimass speaker technology against any other speaker—and hear the difference for yourself. For more information, call Bose Corporation toll-free at 1-800-444-2673 between 9 a.m. and 5 p.m. EST.

BOSE®
Better sound through research.

THE AUDIBILITY OF DISTORTION

BY IAN G. MASTERS

The quest for ever-lower distortion specifications has occupied audio engineers for much of the past half century. But how much does it matter?

An audio signal travels a very tortuous path on its way from a Rubinstein arpeggio or Whitney Houston's steam-driven larynx to our living rooms. What a piano string or a voice—or, indeed, any source of sound—does is set up a series of compressions and rarefactions of air in its immediate surroundings. The pattern of these pressure differences over time is the “waveform” of the sound, and it can be as simple as a sine wave or as complicated as a symphony orchestra going full tilt.

In a live performance, these pressure differences radiate outward at a constant rate until they encounter an eardrum, which they then push and pull in perfect step with the original sound. The waveform at the ear is theoretically the same as that of the original sound, assuming there has been no interference along the way. When it comes to turning that sound into an audio signal and back again, things are much more complicated: A microphone converts the variations in air pressure to an analogous electrical signal, which may then be increased or decreased in magnitude, stored as an undulating groove on a vinyl record or a varying magnetic pattern on tape, or even used to modulate a high-frequency carrier and sent over the air. At the end of the chain, an electrodynamic device converts the varying electrical signal back to air-pressure differences, and these finally reach our eardrums. At every step along the way, the waveform of an ideal audio signal should be exactly the same as the original; any variation from the original, however caused, is called “distortion.”

Much of the effort of audio designers over the past half-century or so has been aimed at reducing the amount of such distortion that creeps into a high-fidelity signal. That they have done their work well is evident in any set of component specs, where distortion figures of hundredths or even thousandths of a percent are common. Still, no one has come up with an audio component that adds *nothing* of its own—distortion is present at every stage, and it is cumulative throughout the audio chain.

But how much does it matter? The quest for ever-lower distortion levels is of theoretical interest in itself, of course, and there will probably never be a time when designers will be entirely satisfied, but there is a point below which we can no longer *hear* distortion even though it may be measurable in the lab. What we don't know for sure, however, is the threshold below which a given sort of distortion is no longer audible. To try to find out, the editors of STEREO REVIEW commissioned David Clark of DLC Design to conduct a series of listening tests to determine just what distortions we can hear and what we can't hear. As listening subjects, Clark called on the worthy members of the Southeastern Michigan Woofer and Tweeter Marching Society (SMWTMS, pronounced “smootums”), one of the country's most active and enthusiastic audio clubs.

Types of Distortion

Virtually everything that affects an audio signal as it passes through the system is a

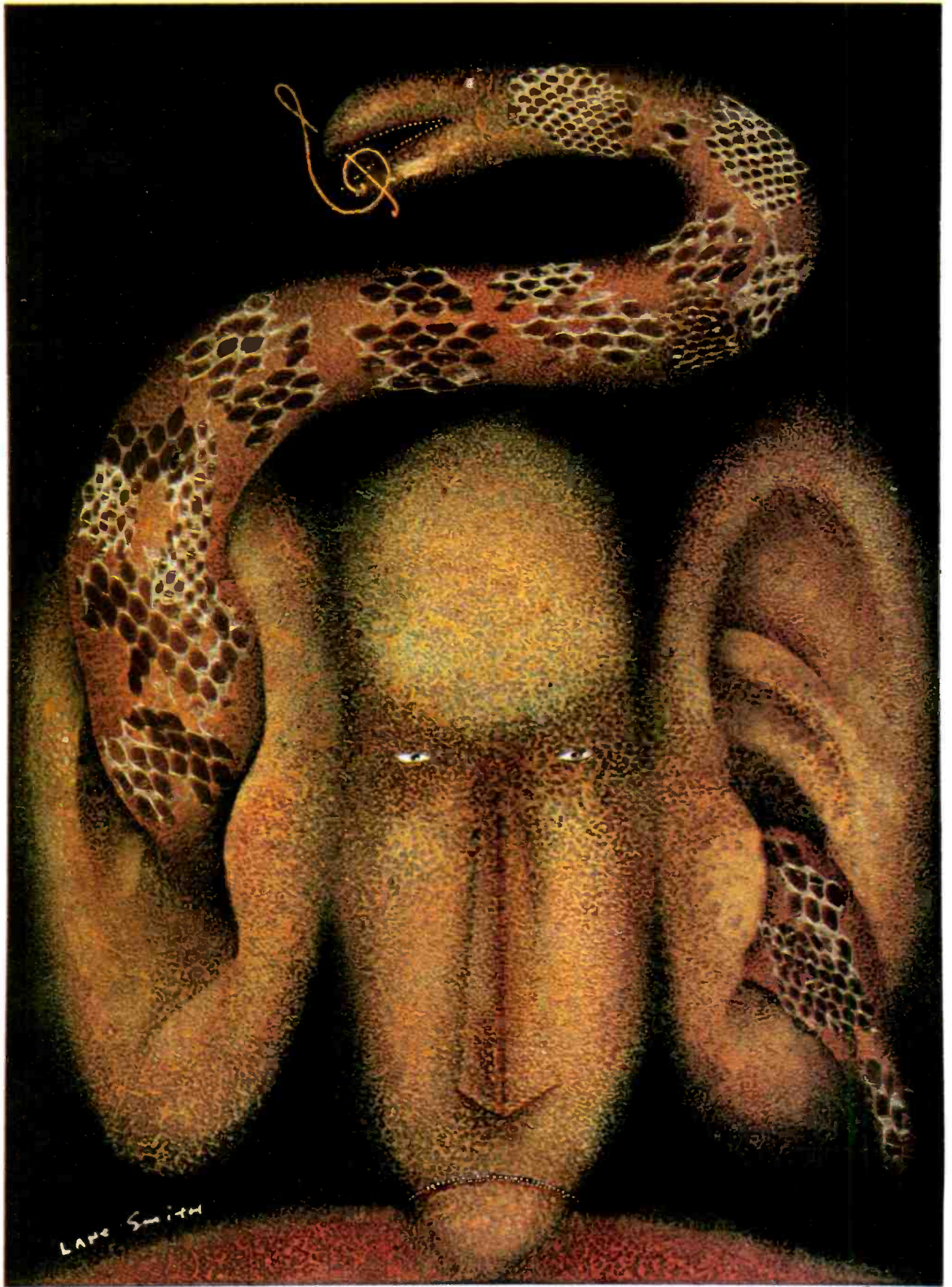

THE REFERENCE SYSTEM

All specifications are from the manufacturers' literature.

□ Yamaha CDX-1110U CD player

Frequency response: 2 to 20,000 Hz ± 0.3 dB
Distortion (THD + noise at 1,000 Hz): 0.002%
Dynamic range: 100 dB
Signal-to-noise ratio: 118 dB
Channel separation at 1,000 Hz: 100 dB
Output voltage: 2 volts rms

□ Conrad-Johnson MC-8 preamplifier

Gain: high-gain phono stage, 54 dB; low-gain phono stage, 35 dB; high-level, 27 dB
Maximum output: 10 volts, rated at 0.5 volt
Phase: high-gain phono, phase-inverting; low-gain phono, phase correct; low-level stage, phase correct
Phono overload: greater than 150 mV at 1 kHz
Frequency response: RIAA equalization, ± 0.25 dB from 20 to 20,000 Hz; band-pass, 5 Hz to more than 100 kHz
Total hum and noise (20 to 20,000 Hz): phono inputs, 76 dB; high-level, 86 dB

Distortion: total harmonic distortion, less than 0.1%; intermodulation distortion, less than 0.1%

Output impedance: less than 200 ohms

□ Conrad-Johnson MS 100 power amplifier

Power: 100 watts per channel (both channels driven) into 8 ohms from 20 to 20,000 Hz with no more than 1% total harmonic or intermodulation distortion
Sensitivity: 1.5 volts
Phase: Phase-correct (noninverting)
Frequency response: 20 to 20,000 Hz $+0, -0.25$ dB
Hum and noise: 90 dB up to full power output
Input impedance: 100 kilohms

□ Quad ESL 63 speakers

Impedance: 8 ohms nominal
Sensitivity: 87 dB sound-pressure level with 1 watt at 1 meter
Frequency response: 36 to 20,000 Hz ± 5 dB
Recommended power range: 100 to 190 watts per channel

form of distortion, although some things are known by more specialized names. There are two main categories of distortion: nonlinear and linear.

The nonlinear type is what usually carries the name distortion. It includes a variety of effects in which something is added to the audio waveform on its way through a component. Most familiar, perhaps, is *harmonic* distortion, where the equipment generates spurious signals that are harmonically related to the original signal. Since most music is rich in harmonics, this sort of distortion is often masked by the program material unless it is high enough in level to change the tonal character of the instruments themselves. Also contributing new sounds is *intermodulation* distortion (IM), which generates frequencies at the numerical sum and difference of the frequencies of two sounds in the program material. Because these added frequencies are unlikely to be harmonically related to the music, they are less likely to be masked. Other types of nonlinear distortion, or noise, abound, including the familiar hiss characteristic of analog tape and FM radio.

In linear distortion, nothing is added, but the relationships between different parts of the signal are altered in some fashion. The

most prevalent type of linear distortion is rarely called distortion: When an audio component deals with some frequencies more efficiently than others—that is, emphasizes them—we normally talk of *frequency-response irregularities* (or nonlinearities) rather than distortion. But it is a form of distortion nonetheless.

By the same token, some types of audio equipment tend to delay certain frequencies with respect to others. This effect is known as *phase shift* or *group delay*, and it is most often a physical attribute of speakers, although it has always been a measurable factor in the performance of filters, crossover networks, equalizers, and the like. Recently the phase-shifting potential of the analog filters contained in all compact disc players has received much attention, although the jury is still out on whether such phase shift in CD players is audible.

For the purposes of this investigation, Clark decided to use one type of nonlinear distortion, total harmonic distortion (or "grunge"), and

two forms of linear distortion, phase shifting at several levels of severity and a frequency-response peak in the sensitive midrange. For listening comparisons, a device was constructed that could add the three types of distortion, at various predetermined levels, to a signal that was otherwise undistorted (for all practical purposes).

The Test Setup

For the listening tests to be valid, it was absolutely necessary that the playback system being used contribute as little spurious information of its own as possible. Quad ESL 63 speakers were chosen for the auditions, partly because of their neutral character but mainly because they have little phase shift of their own. These were driven by a 100-watt-per-channel amplifier from Conrad Johnson's Motif series, the MS-100, controlled by a preamplifier from the same series, the MC-8. As a source, a Yamaha CDX-1110U compact disc player was selected. Its "floating" 18-bit linear digital-to-analog converter and eight-times oversampling place it at or near the forefront of CD technology. The tests were conducted in an IEC-standard listening room, one in which the major acoustic problems have been tamed.

The signal to be evaluated was

DESIGN OF THE TESTS

also very important, because some program material is better at concealing, or revealing, distortion than other material. In each of the three major sections of the test, a test signal was used, both because it would be easier to detect unmasked distortion and because it would educate the listeners as to what they should be listening for. In the case of harmonic distortion, a 220-Hz sine wave was chosen; for frequency response it was pink noise, and for phase shift a repeating pulse.

Similarly, for each type of distortion a short piece of music was selected that had proved itself to be revealing of the particular problem involved. The "optimal" selection for the THD test was *Song for Riya*, a solo-flute piece from Paul Horn's "Inside the Cathedral" (Kuckuck CD 075). For frequency response, Clark selected the *Sanctus* from Fauré's Requiem performed by the Atlanta Symphony and Chorus under Robert Shaw (Telarc CD-80135). And for phase shift, a short drum excerpt from the "Sheffield Track Record" (Sheffield CD 14/20) was used. In practice, only short bits of these selections were auditioned, rather than whole tracks, as only parts of them were suitable.

INALLY, in all three sections of the test a single "natural" selection was auditioned to represent the critical test passage that one might listen to or use to demonstrate an audio system: a jazz selection from "The Name Is Makowicz" (Sheffield CD-21) by Adam Makowicz. It was chosen specifically because it didn't show up any of the kinds of distortion particularly under investigation and would therefore suggest the levels of distortion that might be audible in normal listening.

Test Rounds

For each type of distortion, and for each program selection, twenty trials were performed. First, the "natural" jazz selection was played at a fairly gross level of distortion, and listeners could compare that with the undistorted version. This was repeated four more times, for a total of five trials. Then the comparison was repeated with the distort-

I WAS well prepared when STEREO REVIEW asked me to conduct listening tests to determine the threshold of audibility of distortion. In 1982, the ABX Company, of which I was a part owner, looked into this very topic, and luckily the distortion generators were still available to me. In addition, I had a very good idea just how much distortion would be audible to a critical listener.

Why run tests if we already knew the answers? First, I thought we could show the importance of the kind of program material in hearing distortion. Second, we could show the importance of listener training by starting with high distortion for practice and progressing to the lowest audible amount. Third, I hoped to show that with a good experiment design, the conclusions could be clear without resorting to statistics.

The first distortion we tested was "grunge," a waveform nonlinearity that can be measured with many standard techniques. The grunge-generating circuit is good to work with because the distortion is a constant percentage regardless of signal amplitude or frequency. We measured grunge as a percentage of total harmonic distortion (THD).

The other two distortions we tested, phase shift and response peaking, are linear distortions. All-pass phase shift is best viewed as a time distortion. With this type of distortion the frequency response is flat and free of nonlinearity, but low frequencies are delayed relative to the highs. At its maximum setting of 2,700 degrees shift, the circuit we used delays the lows by nearly 7 milliseconds, which is like having a speaker's woofer 7 feet behind the tweeter.

Ordinary frequency-response error is also linear. We used a peak in response produced by the 3-kHz slider of an octave-band graphic equalizer. The small amount of peaking we found to be audible shows how important it is to make sure that frequency responses match when you compare audio components.

Source material was chosen carefully. The "natural" music piece, used for all three distortions, was a highly regarded recording of a jazz combo featuring saxophone and piano, the kind of recording an audiophile might use to audition equipment in a showroom. The three "optimal" recordings were each selected to expose one of the three distortions: solo flute for grunge, snare and kick drum for phase shift, and choir for

frequency-response peak. Test signals are the ultimate exposers for the ear as well as for test instruments. A pure sine wave allowed hearing the grunge, a sharp pulse exposed the phase shift, and pink noise made the 3-kHz peak stand out.

The reproduction system had to be of the highest quality so it would add the least possible distortion of its own. We selected Quad ESL 63 electrostatic loudspeakers because of their extremely low phase shift, low harmonic distortion, very flat frequency response, good off-axis frequency response, and just plain great sound. Conrad-Johnson Design lent us a 100-watt-per-channel power amp and a preamp from its solid-state Motif series. A Yamaha CDX-1110U 18-bit, eight-times-oversampling CD player was fed to the preamp directly or through one of the three distortion circuits. An ABX CS-4 controller and RM-2 relay module routed the signal to the speakers, with switch points determined by the listeners.

My associate Mark Ziembra, who helped with the music selections, also assisted with the running of the tests. We prepared the test equipment, test forms, and refreshments for the listeners. It took longer than anticipated for them to become familiar with the sound system and the "natural" music selection, so we had to skip some of the more difficult phase-shift and response-peak tests.

Listener concentration and alertness drifted near the end. It is also certain that there was some group interaction that resulted in "herd instinct" responses. Nevertheless, the trials were double-blind, so "cheating" was impossible. Training listeners to hear phase-shift distortion proved to be more difficult than I had anticipated. As a result, we could not confirm the audibility of the full 2,700 degrees of shift available with the music selections.

The amounts of distortion that were required to reach audibility probably seem very high, but our results are consistent with other scientific studies. It is the people who rely on casual, uncontrolled comparisons who "hear" the tiniest bit of distortion. This does not mean that all systems with distortion below the thresholds we found sound the same. Noise, room reflections, speaker/listener locations, channel separation, interchannel phase shift, and speaker directional patterns are other factors that affect reproduced sound, but we did not test any of them in this particular investigation.

David L. Clark

DISTORTION LISTENING TESTS

HARMONIC DISTORTION ("GRUNGE")

	THD Level	Number of Correct Responses										Total Correct	Total Responses	% Correct	Probability Level	
		Listeners														
		A	B	C	D	E	F	G	H	I	J					K
"Natural" music (jazz band)	8%	4	2	3	5	4	3	5	4	5	5	5	45	55	82	0.001
	4%	3	3	3	4	2	3	4	2	4	4	4	36	55	65	0.015
	2%	3	2	2	4	3	3	2	4	2	2	4	31	55	56	0.209
	1%	2	3	1	1	3	2	3	2	3	2	2	24	55	44	0.861
"Optimal" music (solo flute)	8%	5	5	3	5	5	5	5	5	5	3	5	51	55	93	0.001
	4%	5	5	3	5	5	5	5	4	5	4	5	51	55	93	0.001
	2%	3	3	3	5	5	5	5	4	5	3	5	46	55	84	0.001
	1%	3	5	1	1	4	3	3	3	4	3	4	34	55	62	0.052
Test signal (sine wave)	8%	5	5	5	5	5	5	5	5	5	5	5	55	55	100	0.001
	4%	5	5	5	5	5	5	5	5	5	5	5	55	55	100	0.001
	2%	5	5	5	5	5	5	5	5	5	5	5	55	55	100	0.001
	1%	5	5	5	5	5	5	5	5	5	5	5	55	55	100	0.001
	0.4%	5	5	5	5	4	5	5	5	3	1	43	50	86	0.001	

FREQUENCY-RESPONSE PEAK

	Peak Level	Number of Correct Responses														Total Correct	Total Responses	% Correct	Probability Level
		Listeners																	
		A	B	C	D	E	F	G	H	I	J	K	L	M	N				
"Natural" music (jazz band)	+5 db	5	5	5	5	5	5	5	5	5	5	4	3	5	5	67	70	96	0.001
	+2 db	3	5	2	2	2	4	3	5	1	5	3	1	4	3	43	70	61	0.036
	+1 db											4	1	5	5	15	20	75	0.021
	+0.5 db											2	1	3	3	9	20	45	0.748
"Optimal" music (choral music)	+5 db	5	5	5	5	5	5	4	5	5	5	5	5	5	5	69	70	99	0.001
	+2 db	5	5	5	5	5	4	5	5	2	5	5	5	4	3	63	70	90	0.001
	+1 db	3	5	4	2	1	4	3	5	3	4	10	8	10	7	69	90	77	0.001
	+0.5 db											2	1	0	0	3	20	15	0.999
Test signal (pink noise)	+5 db	5	5	5	5	5	5	5	5	5	5	5	5	5	5	70	70	100	0.001
	+2 db	5	5	5	5	5	5	5	5	5	5	5	5	5	5	70	70	100	0.001
	+1 db	5	5	5	5	5	5	5	5	5	5	4	4	5	4	67	70	96	0.001
	+0.5 db	3	2	5	2	3	4	3	4	1	4	2	3	4	3	43	70	61	0.001

PHASE SHIFT

	Degree of Shift	Number of Correct Responses														Total Correct	Total Responses	% Correct	Probability Level
		Listeners																	
		A	B	C	D	E	F	G	H	I	J	K	L	M	N				
"Natural" music (jazz band)	2700°	4	2	4	3	3	2	4	4	2	5	2	2	3	3	43	70	61	0.036
	2150°											1	2	2	0	5	20	25	0.994
"Optimal" music (drums)	2700°	3	3	2	4	1	3	3	2	3	2	5	2	5	2	40	70	57	0.141
	2150°											5	3	1	2	11	20	55	0.412
	1620°											4	4	4	3	15	20	75	0.021
	1080°											4	2	1	4	11	20	55	0.412
Test signal (repeating pulse)	2700°	5	4	4	5	3	5	5	5	3	5	5	5	5	4	63	70	90	0.001
	2150°	5	4	4	5	3	5	5	3	5	3	5	1	5	3	56	70	80	0.001
	1620°	5	5	4	5	3	4	5	3	3	4	5	4	3	2	55	70	79	0.001
	1080°	4	3	3	4	3	5	4	5	4	3	4	4	1	4	51	70	73	0.001
	mono	1080°										5	3	5	5	18	20	90	0.001

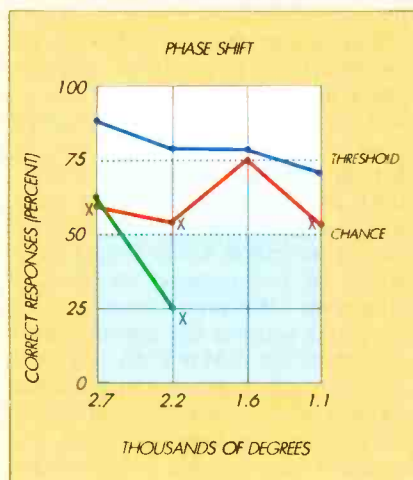
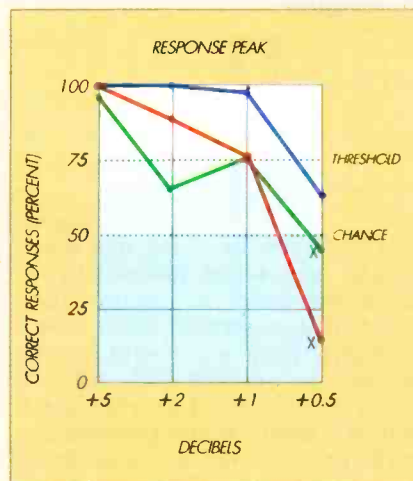
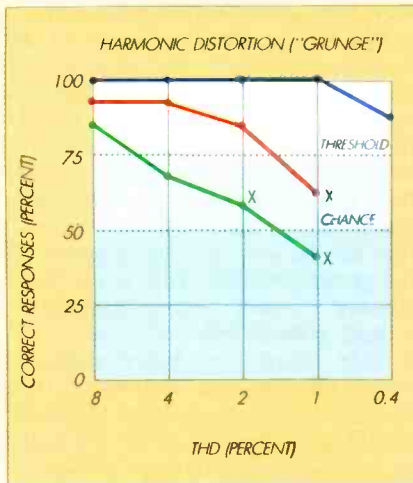

— "NATURAL" MUSIC
— "OPTIMAL" MUSIC
— TEST SIGNAL

The table on the facing page shows how the fifteen participants in the distortion listening sessions responded. The participants are identified by letter (A to K for those involved in the initial sessions, L to O for those who took part in the follow-up session). For each type of distortion, each musical selection, and each distortion level, all participating listeners made five attempts (except in one case where ten trials were performed) to distinguish the distorted signal from the clean signal in controlled, double-blind A/B comparisons. The numbers in the lettered columns of the table indicate the number of correct choices made by each listener in each test; where no number appears, that listener did not participate in that series of trials. To the right of the lettered columns are indicated the total number of correct choices made in each round, the total number of choices, and the percentage of the choices that were correct. In an A/B type test, choices in 50 percent of the trials are likely to be correct from pure guesswork. When choices in half of the remaining trials are correct (75 percent overall), psychologists say the audibility threshold has been reached. Higher percentages indicate a more strongly audible effect. It is, of course, possible that a listener could get a perfect score (100 percent) by guessing, but psychologists guard against this by also requiring a large number of trials, which lowers the probability that a high score is due to chance. A probability level of 0.05 (one chance in twenty) is commonly taken to indicate that further investigation is warranted. The graphs at left show the levels at which the various sorts of distortion were audible with the source material employed. At all the points marked by an "X," the data do not warrant the conclusion that any differences were audible. Where the correct responses totaled between 50 and 75 percent (light blue), the significance of the results is uncertain; below 50 percent (dark blue), correct choices were almost certainly the result of guesswork.

tion level reduced; four levels were used in all. The whole process was repeated using the "optimal" selection, and then with the test signal.

In the initial series, therefore, the intention was for some 180 trials to be performed, using ten listeners, for a total of 1,800 responses. In practice, however, several of the tests were curtailed when it became apparent that the listeners could not identify the distortion at fairly high levels. In the case of the "grunge" test, on the other hand, a fifth distortion level was added. Once the first results had been tabulated, a second series of tests was performed, with new subjects, to clarify some of the results of the first round. In all, 1,940 responses were recorded from fifteen different listeners.

All listening was double-blind, using the ABX comparator system. In any given trial, the listeners could choose either signal A (the distorted version), signal B (undistorted), or signal X (identical to either A or B, as selected randomly by the comparator device). On a score sheet, each subject would mark whether X sounded like A or B, and then he would pass on to the next trial and repeat the process. At the end of each test series, the comparator was programmed to read out the correct answer for each trial, and each listener's sheet was compared with that. For each test series, therefore, fifty responses were recorded in five trials by ten listeners. These were in some cases supplemented by the results of the second round of tests.

The purpose of this large amount of information was to determine whether the listeners *really* heard distortion at the various levels, or simply *thought* they did. If the number of correct answers in a given test was close to half of the total, for instance, it could be concluded that the subjects were merely guessing and were hearing no real differences—pure chance could be expected to yield a result of 50 percent in some instances. If the statistical probability level is less than 0.05 in one test, one could conclude with reasonable certainty that the subjects were hearing differences. Between these two limits (less than half correct and more than 75 percent correct) there is less certainty, but scores in the lower part of that range are insufficient to lead to a sure conclusion that the listeners were hearing distortions.

The Test Results

The first test was for total harmonic distortion (THD), or "grunge." Four levels of THD were used, beginning with 8 percent, then 4, 2, and 1 percent. Using the "natural" music selection, virtually all listeners could hear 8 percent THD, but their certainty began to drop almost immediately as the level decreased. Scores at 4 percent THD were almost two-thirds correct, indicating that at least some of the subjects could hear the distortion reliably. But at 1 percent the scores were very close to pure chance, suggesting that this was the minimum distortion level audible with this musical selection.

In tests with the "optimal" music selection, the grunge was much easier to hear, at least at the higher levels; the subjects showed virtual certainty down to 2 percent. But the 1-percent results, while slightly higher than with the "natural" music, still do not show that this level was audible. As expected, however, in the rounds with test signals the distortion was easily audible not only down to 1 percent but as low as 0.4 percent. An additional series of trials was performed at this lowest level, and the subjects' scores were 86 percent correct (as compared to 100 percent at the higher levels).

Similar results were evident when frequency-response irregularities were tested. For this, a broad peak, centered on 3,000 Hz, was added to the various program sources at +5, +2, +1, and +0.5 dB. As in the harmonic-distortion test, the "natural" music was auditioned first, followed by the "optimal" music and the test signal (pink noise).

A PECULIAR thing happened with the jazz selection. With the highest-level peak, the scores were 85 percent correct, indicating that the distortion was easily audible. The next level proved more difficult, however, and the scores were only a little better than chance. But when the peak was dropped to the +1-dB level, the audibility rose. Scores just below that level dropped back to worse than chance, however.

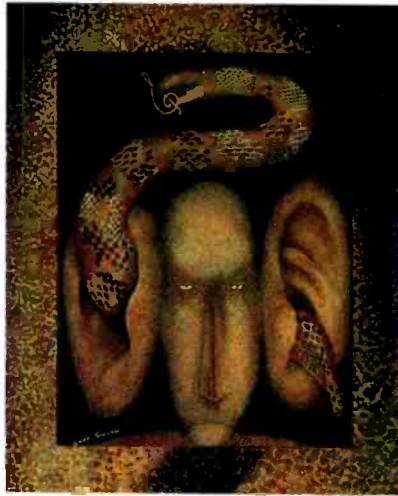

With the "optimal" music selection, things looked more normal. As low as +1 dB, scores were better than chance, dropping below the chance level only at the +0.5-dB level. With the pink-noise signal, the scores were slightly better than chance even at the lowest level.

Phase shift turned out to be the most difficult form of distortion to hear. Four amounts of phase shift were used. The greatest was some 2,700 degrees. The amount of phase shift was progressively reduced to 2,150, 1,620, and 1,080 degrees. None of these levels would ever be encountered in a normal audio component. Even so, and in spite of the gross amounts of shift applied, the order of the trials had to be altered in this case, with the repeating-pulse test signal being auditioned first, just so the subjects would know what to listen for. The whole process took some time, as the effects of even gross amounts of phase shift tended to be fairly subtle; indeed, one listener never did identify its sound.

Once educated, however, the majority of listeners had little difficulty hearing phase shift at all levels as long as the test signal was used. Only with the least amount of shift did responses drop to the 73-percent-correct level, but this amount was probably still audible. With the "optimal" music selection, which was not dissimilar to the test pulse but was masked to some extent by reverberation on the disc, the scores dropped, only reaching some certainty at 1,600 degrees; above and below this amount the scores were close to chance. With the "natural" music, even the greatest amount of phase shift was not audible.

Conclusions

Listening sessions of this sort are very difficult for the subjects, as they require a new set of aural skills, as well as specialized materials. The members of SMWTMS who volunteered to take part in this series of experiments found the process fatiguing, partly because they had to strain to hear anything and partly because they had to learn what to listen for as they went along. There does seem to be some evidence that sensitivity to some types of distortion can be learned. One listener in the group, who has had more than passing contact with phase shift, scored almost perfectly in some rounds where the other subjects were straining to hear anything. The chances that an average listener would be as familiar as this test subject with a particular type of distortion are remote, however, so there is little likelihood of his being bothered by the sorts of distortion in this investigation.

W HENEVER, the amount of distortion used in the tests was much greater than would normally be encountered from any audio equipment that a serious buyer might consider. Even so, it only became audible to our listeners—when it was audible at all—by using test signals and short musical passages specially chosen to reveal the particular type of distortion. When "normal" music was substituted, the audibility vanished at all but the highest distortion levels.

Such an exercise can hardly be considered definitive, of course. Other music, other types of distortion, other listeners, or other equipment might yield different results. But the carefully controlled conditions of this series of tests were designed to enable distortion to be audible at much lower levels than would be encountered in real-life situations. Without these conditions and without the learning process that the SMWTMS subjects went through, it is very improbable that any of us would be troubled by the amounts of distortion that are normally encountered in today's hi-fi reproduction. □

TURNABLES & CARTRIDGES

TECHNOLOGICALLY IMPROVED AND COMPETITIVELY PRICED, RECORD-PLAYING SYSTEMS ARE ALIVE AND WELL.



The CS 7000 semi-automatic turntable from Dual is one of the few remaining turntables that still offer a 78-rpm playing speed. It has heavy metal feet, a full-floating subchassis, and a resonance-damped die-cast aluminum platter. The list price is \$750.

BY IAN G. MASTERS

NO doubt about it, that iridescent little CD is seductive. There is wonder in those shifting bands of pink and blue representing many millions of information snippets ready to be transformed into flawless Mozart. But there comes a time when all of us prefer the familiar, and to audiophiles there is nothing more familiar than the vinyl LP. Whatever inroads digital recordings may have made, and may make in the future, the conventional record is still very much with us and is likely to be for a long time to come.

In this phase of the digital era, it's natural that our listen-

The Linn Sondek LP12 turntable has a 9-pound platter that's die-cast from zinc-aluminum alloy and is supported by Linn's single-point bearing. The entire assembly and tonearm board are mounted on a steel subchassis that is isolated from the motor, base plate, and external vibrations. Price is \$1,165.



Audio-Technica's AT160ML phono cartridge has a Vector-Aligned moving-magnet system, which uses two tiny magnets, each said to be located ideally to reproduce one stereo channel while ignoring signals from the other channel. Suggested list price is \$295.



The Revolver turntable from Music Hall (\$525 in black-ash veneer or \$575 in redwood) is a two-speed belt-drive system available with or without tonearm. Unusual features of the Revolver are a split-plinth configuration and a one-piece platter injection-molded from glass-filled polyphenylene.

Kenwood's KD-77FC is a fully automatic, direct-drive, linear-tracking turntable (\$249). Featuring seven-selection random-access programming and automatic disc-size and speed selection, the turntable can be controlled remotely with the Kenwood programmable RC-100. Its tonearm accepts any P-mount cartridge. Wow-and-flutter is rated as 0.025 percent.





Sumiko's Talisman Virtuoso DTi is a high-output moving-coil cartridge. Its double-trapezoid body, said to be extremely rigid, is designed to cancel internal resonances. The stylus/cantilever assembly combines the hardness of a diamond with the low moving mass of a titanium tube. Price is \$1,200.



The Ortofon X5-MC high-output moving-coil cartridge (\$300) is designed for direct connection to a moving-magnet phono input. Output is rated as 2 millivolts at 5 cm/s groove velocity. It has a nude diamond stylus. High output with low moving mass is said to be achieved through a focused magnetic field and 230 windings per pole piece.



ing patterns should tend to favor the compact disc, with its low noise and wide dynamics, and many owners of CD players have virtually abandoned the older medium—most have even paid a considerable premium to buy digital versions of their favorite recordings. But that can only go so far, as nobody is likely to replace an entire analog collection built up over the years, even if everything were available on CD. To do so would presuppose that the vinyl record has no merit whatever, and that's simply not the case.

AFTER all, the whole field of high fidelity was built around the vinyl disc, which at its best can produce staggeringly good sound. There is, of course, an anti-digital element that would have us believe the LP is inherently superior to the compact disc, but even if that viewpoint is discounted—as it has to be on any rational technical grounds—it's well to remember that the improvements wrought by the digital system are relatively small. A vinyl record in good shape, played on a high-quality turntable and cartridge, can produce first-class sound—often better sound, in fact, than a CD made from the same master tape if that tape was equalized specifically to compensate for vinyl's distinctive characteristics.

There's no need, therefore, to trash all that black vinyl, and your own musical history with it. And if your tastes run to the more esoteric items in the catalog, it's very unlikely that you will be able to abandon the LP in the near future. While the vinyl record has long since been surpassed by the cassette in terms of number of recordings sold, and even the newfangled CD outsells vinyl in terms of dollars, for selection the conventional record is still king, particularly when it comes to older or more unusual recordings. Even if you never buy another LP, chances are that you own a fair collection of LP's now and that you will want to play them from time to time—one estimate several years ago put the number of LP's in circulation around the world at some 50 billion, and they're not likely to be supplanted overnight.

With all those LP's out there, it's not surprising that audio manufacturers continue to offer a wide selec-



▲ *The EPI Thorens TD 520 is a semiautomatic single-play turntable (\$1,100 with tonearm). Belt-driven with an automatic tonearm lift, it has playing speeds of 33 $\frac{1}{3}$, 45, and 78 rpm.*

► *Shure's Ultra 500 (\$400) is a moving-magnet cartridge that has a Micro-Ridge stylus tip and Microwall beryllium stylus shank for better tracking. It includes a viscous-damped dynamic stabilizer and Shure's Side-Guard stylus-protection system.*



▼ *A belt-driven automatic turntable, the Pioneer PL-910 (\$400) has a DC servomotor that operates at 33 $\frac{1}{3}$ or 45 rpm, a statically balanced linear-tracking tonearm, and a moving-magnet cartridge.*



tion of equipment to play them. At last count, more than 100 turntables were available from three dozen or so companies, as well as almost three times as many models of phono cartridge. This equipment doesn't receive the same level of promotional support as CD gear, of course, but the audio companies have hardly abandoned the conventional record.

TURNTABLES themselves tend to fall into two broad categories: minimalist and automatic. Vinyl purists—many of whom have little use for digital audio—have always favored the manual turntable, and it's one of the ironies of high fidelity that the higher you go on the price scale, the less a turntable will do for you (but, apologists will point out, the better it will do it). Manual turntables are usually belt-driven, as this technique is said to isolate the platter from motor noise and surface-borne vibrations better than direct-drive designs, in which the platter is mounted directly on the shaft of the motor. On the negative side, belt-drive turntables tend to take longer to get up to speed, but if you don't require split-second cueing that probably doesn't matter.

Many manual turntables are supplied without tonearms, which allows the user to choose one that suits his specific requirements. This class of turntable tends to be fairly expensive. With the exception of one stripped-down Technics model that sells for \$130 (including tonearm), prices start at about \$450 for the Conrad-Johnson Sonographe SG-3 and range up to an Olympian \$30,000 for Grundig's Quintessence. This behemoth features two motors and a 47-pound platter, and it can accommodate up to three tonearms at a time. Not far behind are a couple of turntables from Japan's Micro-Seiki, which can cost from \$15,000 to \$20,000 depending on whether you choose a bronze or steel platter.

Most manual turntables, however, cost from \$1,000 to \$4,000, including the elegant Premiere from Oracle (\$2,350) and the Cosmos from Sota (\$3,500), a current audiophile favorite. Perhaps the best-known advocate of the minimalist turntable is Scotland's Linn Prod-

ucts, whose LP-12 (\$1,165 including tonearm) has been a staple for years. Linn now offers a somewhat less expensive model, the Axis, which goes for \$740.

Belt-driven turntables also dominate the low end of the turntable market, mainly because they are inexpensive to build. Virtually all models below the \$150 mark are belt-driven, although one of the Realistic tables from Radio Shack is an exception: The LAB-450 offers direct drive for only \$130. And nearly all turntables at this level of market include both tonearm and cartridge; while this is undoubtedly convenient, such models should really be considered starter components.

In sheer numbers, however, most turntables available today use direct-drive technology, which turns the platter with the motor at the precise record speed of 33 $\frac{1}{3}$ or 45 rpm. Most turntables in this range also offer some level of automatic performance, although the degree of automation varies widely. Some simply lift the arm at the end of a side and return it to its rest; others will perform the whole sequence of placing the stylus in the opening groove, playing the side, lifting the stylus at the end, and shutting off the unit. More elaborate automatic features include programmability: The Technics SL-J33 (\$270) allows the user to play up to eight selections in any order, an option we have become accustomed to with compact discs.

Io be able to offer any level of automation, all turntables in this range include a tonearm, although most allow buyers to choose their own cartridges. By and large, tonearms supplied with such models continue to be the familiar pivoted sort, although a small number of turntables have linear-tracking arms, which eliminate both skating problems and horizontal-tracking-angle errors. Models with linear tonearms range from the bargain Kenwood KD-47F at \$119 to the Revox B291 at \$1,500.

Increasingly, the supplied tonearms are designed to be used with P-mount cartridges, which have standard weights and dimensions and are simply plugged into the headshell with no further fuss. The conventional cartridge continues to

thrive, however, and these still outnumber their P-mount cousins. Except at the very high end, there is very little besides convenience to choose between P-mount and conventional cartridges; whatever requirements you have of a cartridge can be satisfied with either type.

Cartridges, like turntables, can be broken down into two broad categories: Cartridges are either moving-coil (MC) or moving-magnet (MM) transducers. The MM type goes under a variety of names, but it can be thought of generally as a fixed-coil device. Purists tend to prefer moving-coil cartridges and, like manual turntables, these inhabit the top end of the price scale. It is possible to spend as much as \$5,600 for an MC cartridge (the Kiseki Lapus Lazuli), although the majority of MC models range from about \$300 to \$1,000.

While many audiophiles swear by the sonic benefits of moving-coil cartridges, most have several disadvantages. The first is cost: Not only are MC cartridges themselves usually more expensive than their fixed-coil equivalents, but there is a hidden cost as well. The output of most MC models is much lower than that of other cartridges, so that you may need an additional device to step up the level. While numerous transformers and outboard preamplification devices are available, more and more amplifier manufacturers include built-in MC head amplifiers in their products that can take the output of a moving-coil cartridge directly. Still, the low level does make a moving-coil cartridge more susceptible to hum and other problems than models with "conventional" levels. For this reason, a number of manufacturers, such as Ortofon and Yamaha, have produced MC cartridges that produce output levels closer to those of fixed-coil models, thereby removing the necessity of extra amplification stages.

The majority of cartridges use fixed coils, however, under such names as "moving iron," "induced magnet," "flux bridger," and so forth. All produce the sort of output the standard magnetic phono input is designed to accept, and the best of them offer performance levels every bit as high as those of moving-coil cartridges, although not all audiophiles will admit this. Virtually all models designed for consumer use have an elliptical stylus, although there are some specialty shapes—such as Stanton's Stereohedron—

that are used for particular applications. While the majority of fixed-coil cartridges use standard mountings (as do virtually all moving-coil models), the P-mount system is gaining ground. Fortunately, it is possible to duplicate practically any level of quality in P-mount form, if that's what your tonearm calls for.

Separate tonearms have never been very numerous, but the gradual shift of audio toward digital media has not affected this class of equipment very much. This is doubtless because separate tonearms have been the preserve of the most committed high-end audiophiles, who are the least willing to abandon the vinyl record. At the moment, about thirty-five companies offer about seventy different tonearms, ranging from just over \$250 to \$4,750 for Goldmund's T3F arm. Clearly, the buyer considering a separate turntable/arm combination must be prepared to lay out considerable money, particularly as there is little point in buying a separate arm unless its quality is matched by the cartridge.

RECORD-PLAYING equipment, like all areas of audio components, includes some things that defy categorization. One such item is the ADC RC1 (\$110), which will engender no little nostalgia among readers who were around in the Sixties and early Seventies: It's a record changer that can handle up to four discs. Another is RCA's MTT230 linear-tracking turntable (\$249), the playing status of which can be displayed on a TV monitor when used as part of the company's Dimensia system. Perhaps the most exotic device ever to play a bit of vinyl, however, is the ever-forthcoming "optical" turntable from Finial Technology, which will use a laser to track a conventional LP, just as a CD player uses one to track a compact disc (no price or availability date set).

After more than a century of pre-dominance, Mr. Edison's physical recording device—as modified by Berliner, Blumlein, Goldmark, and others—has had to move over a bit as newer technologies have been brought to the marketplace. But the vinyl LP still has a strong future, as does the equipment we will still require to play it. □

SYSTEMS

Building on the repeat theme

by Rebecca Day

JOE BASILE quit his job as a Wall Street investment banker so he could sell hi-fi equipment at Perdue Radio Co. in West Caldwell, New Jersey. But that's not really surprising considering that Basile spent the year before working part time and the four years before that volunteering at the audio specialty store. Perdue holds a special place in Basile's heart; it's where he bought his first piece of McIntosh equipment. He was seventeen.

The years haven't tarnished Basile's enthusiasm for audio. At the ripe old age of twenty-three, he has only multiplied his components. Instead of one McIntosh MC7270 amplifier he has two: One powers the low-frequency drivers of his Apogee Acoustics Duetta ribbon

loudspeakers, and the other the middle and high frequencies. He also has two Nakamichi RX-505 cassette decks, one for playback and one for recording. His two Mitsubishi HS-U70 Super VHS VCR's operate on the same dubbing strategy.

Basile has only one McIntosh C-31V preamplifier, which serves as his audio/video control center. He also has a McIntosh MCD-7005 CD player and a McIntosh MR-7082 tuner. A Tandberg TD20ASE open-reel tape deck, a dbx Model 14/10 computerized equalizer, and a Sota Sapphire Series II turntable with a Dynavector Karat 19A cartridge round out the main audio portion of the system.

Basile's Yamaha AVC-50 audio/video integrated amplifier is





used exclusively for video enhancement and route selection in his surround-sound system. A Yamaha CDV-1000 videodisc player and a Mitsubishi CD-3503 Super VHS-capable video monitor provide the pictures. The surround sound comes from the Duettas in the front of the 16 x 21-foot room, two Canton Plus S satellite speakers mounted in the upper rear corners, a Canton Plus C subwoofer hidden behind the sofa

against the rear wall, and a Canton GL 260F speaker mounted on the wall above the TV screen for the mono center channel to localize dialogue and vocals. Two Bryston Model 2B 100-watt mono amplifiers feed the subwoofer, and each feeds one channel of the satellites. A third Bryston 2B powers the center front speaker. Signal processing is done by a Lexicon CP-1 Dolby Pro Logic Digital Audio Environment

Processor. Cabinetry is by Custom Woodwork and Design, wiring by Monster Cable. Basile says that he rarely uses the surround-sound system for straight audio listening.

Basile's system is far from finished. "I'm always looking for something different," he says. The McIntosh equipment is safe—for now. But "if they introduce a new amp, preamp, or CD player, that's an automatic; I'll buy it." Better make that two. □

HOOKED ON COUNTRY



BY ALANNA NASH



FOR me, it started not with John Travolta and the "urban cowboy" boom but with Pee Wee King. Not in the Fifties, when King was riding tall in his own saddle, but in 1974, when the Country Music Association saw fit to induct him into the Hall of Fame.

I had just gotten out of journalism school then, and was scouting around for stories to free-lance to national magazines. Pee Wee King not only lived in my home town of Louisville, but, coincidentally, my earliest memory of television was of King, circa 1953, squeezing a country polka out of his accordion. And so, after consulting the *Writer's Market* for some kind of periodical that might find Pee Wee as fascinating as I did, I fired off a letter to *Country Music Magazine*. They went for the idea, I slowpoked over to Pee Wee's, and the story appeared in the magazine. That, I thought, was that.

*I just learned how to yodel
I sure can play guitar
I love to sing them country songs
And I wanna be a star.
If I don't make it pretty soon
I don't know what I'll do
'Cause I just saw John Travolty
Now he's a cowboy, too.
—Skeeter Davis
Everybody Wants a Cowboy
© High Harmony Music*

*** Introduction and interviews excerpted from Alanna Nash's book *Behind Closed Doors: Talking with the Legends of Country Music*, © 1988 by Alandale Productions. Published by Alfred A. Knopf, New York (554 pages, 27 photos, \$14.95 paperback). ***

In no time, however, the magazine's English editor and Singapore-born art director were on the phone talking to me about going to Nashville to do a "sisters" story, or profiles of the sisters of Loretta Lynn, Dolly Parton, and Tanya Tucker, who hoped to follow in their siblings' footsteps.

What I knew about country music at that point would have filled a one-gallon cowboy hat (give or take a liter). But in comparison to the rest of the magazine, heck, I was at least from the right *country*, and to top it off, I was from Kentucky, home of the Renfro Valley Barn Dance and the birthplace of untold numbers of hillbilly stars. And so, with fourteen years of private classical violin lessons behind me, and feeling, as Knight-Ridder columnist Tom Hennessy would one day write, that "anyone who liked [country] music was poor, sad, uneducated, non-liberal, rural, drank whiskey to excess, and would probably wind up in a tar-paper asylum in

ILLUSTRATIONS BY MARK FALLS

the Ozarks," I made my first trip to Nashville in October 1975. There, in addition to Crystal Gayle, Stella Parton, and La Costa, I interviewed Marty Robbins, Minnie Pearl, and a rising young star named Emmylou Harris.

My aunt, Iona Fagan, an amateur geneologist, claims that we Nashes are descended from General Francis Nash, the founder of Fort Nashborough, later rechristened Nashville. Don't ask me to prove it—especially since both my parents are Tennesseans who moved to Kentucky "to get away from country music and everything it stands for." But it must be something in the genes: After that first trip, I was hooked.



The next twelve years would be the most dramatic and turbulent time in the history of the music—years that saw the "outlaw" phenomenon of Willie Nelson and Waylon Jennings, the pop-crossover stampee of Kenny Rogers, the Charlie Daniels and Alabama brands of Southern rock, the rise of the progressive traditionalists such as Emmylou Harris and Ricky Skaggs, the urban-rural sensibility of Rosanne Cash, the Las Vegas-tinged soul of Lee Greenwood, the New Traditionalists such as George Strait, Randy Travis, and Dwight Yoakam, the indestructibility of George Jones and stonehard honky-tonk, the filigreed harmonies of the Judds, and the rock roots of Steve Earle. During those years, I would interview almost every significant country performer of the last several decades for books, magazine articles, and network and syndicated radio shows.

"Country stars are symbolic ordinary figures," movie critic Pauline Kael wrote in her *New Yorker* review of Robert Altman's *Nashville*. So in almost every case, in addition to gleaning more information about a uniquely American form of music, I was interested in finding out why these particular artists chose to lead extraordinary lives—the incessant traveling in the back of a Silver Eagle, the estrangement from family and friends, the toll it takes on their health—in order to sing about the virtues of rural existence and the pain of heartbreak, or, in short, ordinary life.

What I was not fully prepared for

was the workings of the country mind, and, as such, the set of values that places country musicians on a different plane from their counterparts in pop or rock. For example:

□ George Jones, who once rode a lawn mower to a liquor store when Tammy Wynette, in an attempt to keep him sober, hid the keys to the cars.

□ Jeannie C. Riley, who turned to gospel music after *Harper Valley P.T.A.*, and whose dining room boasts a photo of herself and her daughter dressed and posed as Madonna and Child. An outtake from the session, I am told, shows the Madonna reaching for a cup of coffee.

□ David Allan Coe, the ex-convict turned country star, who sports a tattoo of a spider on his principal private part.

□ Barbara Mandrell, who charges a fee to view her honeymoon nightgown, on display at Mandrell Country Museum.

□ And Mr. and Mrs. Hank Williams, Sr., who remain colorful figures in death. At Audrey's funeral, for example, Bob Harrington, the "Bourbon Street Preacher," stood next to the open casket, singing *Hey, Good Lookin'* to the deceased. And a few years ago plans were under way to unearth Hank Sr. and rebury him in the toe of a mammoth cowboy boot. The top of the boot was to be a revolving restaurant with a panoramic view of Montgomery, Alabama.

Since country performers customarily create their music out of their own lives and experiences—and since country singers have traditionally come from working-class roots, allowing the auto mechanic of today to become the honky-tonk hero of tomorrow—it seemed obvious early on that these artists had a great deal to say about their art: how they came to write particular songs, what their triumphs and tragedies have been, and if they are happy in a life that seems so grand and unimaginable to almost everyone.

All in all, the dozen years that went into this book have been delightful ones for me. I have learned a lot. I have come to appreciate the depth and soul of a music easily dismissed by some as "corny" and shallow. And I have met some unforgettable people, many of whom will never be household names.

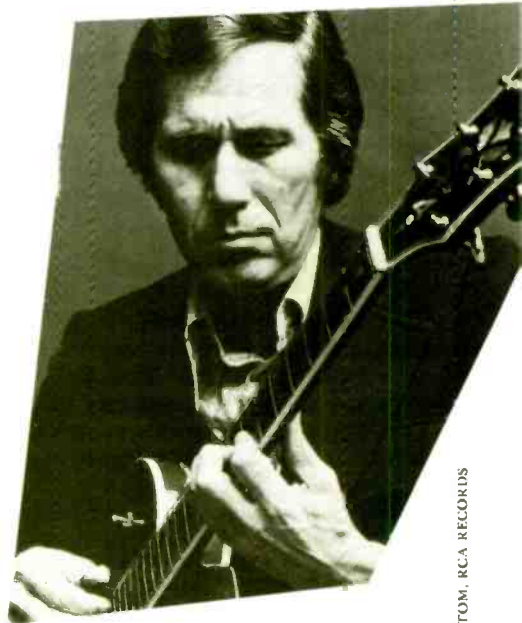

CHET ATKINS ON DOLLY PARTON

The first time I ever heard Dolly Parton was many years ago. She was nine or ten years old, and she came over and did a talent show that was on WSM [Nashville] on Friday night. They used young people on there, and an announcer up there, Grant Turner, liked her and brought me a tape on her and said, "She's sensational." And I listened to it

PHOTOS: TOP, ANNIE LIEBOVITZ/COLUMBIA; BOTTOM, RCA RECORDS

and I said, "Yeah, she's all right, but she's only nine or ten years old. She needs to go to school." I think I told him to talk to me about her later, or something like that. But she sounded entirely different than she does now, the best I remember. It was a little young voice, kinda low, not high like it is now, the best I remember. She must have been trying to sound more mature. Really, she sounded like a little man. I've gotta ask her about that sometime and see if she's had a sex-change operation since then. But in essence, I guess you could say I turned her down that time. I didn't the next time, of course. That's what's important. But one time we were rehearsing a TV show out at Opryland, and I was sitting there waiting for something to happen. She came walking across the stage with a pair of real tight pants on, and she walked up to me and said, "I saw you lookin' at my crotch." And it embarrassed the hell out of me, and I said, "Well, it was only a glance. Damn, I'm sorry!" And I really didn't realize I had done it. But she accused me, and I suppose I did. And I said, "Well, you do that, too, once in a while, don't you?" And she said, "Oh, sometimes," and she went giggling off. She loves to tease, Dolly does.

DOLLY PARTON ON IMAGE

I've looked the same since I was just a kid. In fact, that's always been one of the things people have always kidded me about. I started doin' my hair like this when I was in high school, when the style was first out, the teasin' and all, and then it got out of style. But I enjoyed it. I liked it that way. And then, when everything started changing, people got to sayin', "Well, you should change your hairstyle. That's out of style." And I thought, "Well, they noticed, so it may be a gimmick in addition to somethin' I enjoy. I'll just keep it this way to see who all will notice, and to stir up as much interest as I can." And the more interest I stirred up, the higher I put it, the more extreme I got. Then, later on in years, I started wearin' wigs, because I was so involved with my music that I couldn't sit under a hair dryer in a beauty shop. I never



Tammy Wynette

go to a beauty shop. But it's just handy to wear wigs, and it's become like a gimmick. But my sex image—what exactly does that mean? I've always worn tight clothes, I've always had big boobs. Well, I've always been well developed.

TAMMY WYNETTE ON SEX SYMBOLS

I've never ever thought of myself as a sex symbol, and never will. No way. I guess that goes back to my childhood. I played basketball, and Daddy would never let me wear the shorts. I always had to wear blue jeans with a jersey. I took the shorts home one day and begged and pleaded. I said, "Please let me wear the shorts. Everybody else does." I was the only one that dressed differently on the basketball court. Daddy took one look at those shorts, and they were cut square across the legs, and he said, "Flor, put some elastic in them legs, and she can wear 'em."

Lacy J. Dalton

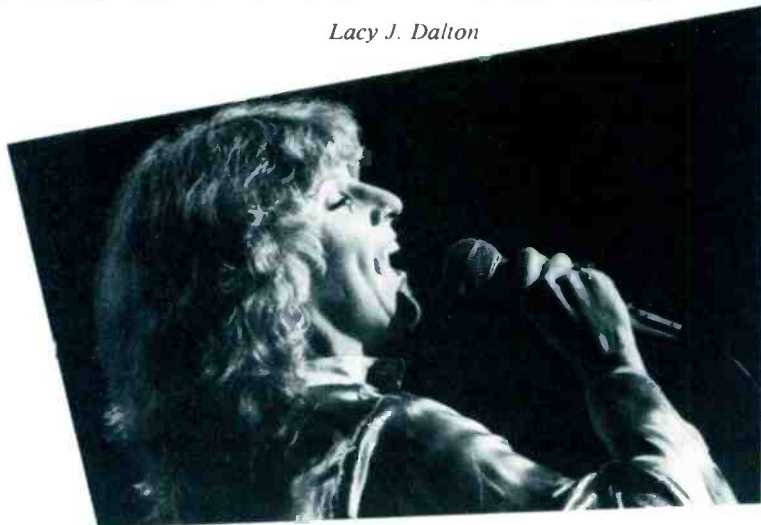

I was *still* the only one dressed different on the court!"

LACY J. DALTON ON IMAGE

I don't know about just being a honky-tonk performer. I don't even know if I like that. I'm uncomfortable when anyone tries to put a label or an image on me. Besides, there's a whole other side of me that isn't like that at all. I would like to see that emphasized a little more. There actually is a sensitive human being here with some intelligence, a person who doesn't want to throw her life away with drugs and alcohol. I think the last thing the young people of this world need is somebody else exhibiting wanton and ridiculous destruction of their body for the enjoyment of the masses. That's not where I'm at. I drink beer occasionally because it relaxes me, and it relaxes my throat. I may look like some kind of a drug addict, because

VANTAGE

ULTRA LIGHTS

SURGEON GENERAL'S WARNING: Smoking Causes Lung Cancer, Heart Disease, Emphysema, And May Complicate Pregnancy.

5 mg. "tar", 0.5 mg. nicotine av. per cigarette by FTC method.



*ULTRA TASTE PERFORMANCE
IN AN ULTRA LIGHT*



I wear blue jeans and I'm forty and I have strange-looking hair. But I don't take drugs at all. Ever. In fact, I very much disapprove of them. I think people think I'm very hard. Writers like to play up the idea that I'm an outlaw. Well, I'm not hard. And I'm not tough. I fall to pieces as easily as anybody. And I don't want to be thought of as the kind of person who's just hell-bent and whiskey-bound, and all that crap. I mean, I don't want to be another Hank Williams and die when I'm . . . well, I'm already older than he was. I'd just like this image—if I have an image—to be a little closer to the truth. I don't want people to think all I ever do is drink beer and ride motorcycles and get tattoos. That's just not how it is. What I always say to my manager is that I'm a middle-aged housewife who's having a fling. There's also that part of me, as well as the creative person. But the composite has never really arrived. Maybe I *am* a bad girl. Maybe I *am* just a hideous wreck of an old outlaw. But I don't feel like that. I feel a lot younger. And a lot more positive. On the other hand, there's definitely a side of me that's wild and crazy, but it's not evil, not satanic. I never even break the law anymore. I try real hard to be good.

MI INNIE PEARL
ON ELVIS

When we went to Hawaii with Elvis, I was not aware of the fact that he was so encapsulated in his fame. I had heard that he couldn't get out and do what he wanted to do, but I hadn't seen it. I didn't know what a prisoner he was, how hounded he was by the public. And we went first-class, of course, flying with him. But when we got to the Honolulu International Airport, there were something like three thousand screaming women trying to get to the airplane, with a number of policemen and security people trying to hold back the crowd.

Now, you realize this was just after he came back from the service, and he was making *Blue Hawaii* in Honolulu. I would say that he was at his [physical] peak at this point. Very handsome, very boyish, very charming, very nice—a delightful person. Well-mannered, no airs about him, very courteous.

The next day all the rest of us on the show were down on Waikiki beach, and we were all cavorting and kidding and having a big time down there. We got to talking about the fact that we wished Elvis could come down and be with us, and we turned and looked up at his penthouse, which was facing the ocean. And he was standing on the balcony of that penthouse, alone, looking down at us. And we hollered and waved at him, and he waved at us. He was just standing there, a solitary figure, lonely looking, looking down at us having such a good time. He literally was a prisoner because of the fans.

CONWAY TWITTY
ON ELVIS

He totally separated himself from reality. He created his own world. But it wasn't real, and nobody can exist in that for long. All the things around you fall apart. You can see it happen to a lot of people in our business—not just the music business, but in the movies. Those people box themselves into situations where there's nothing really real. They begin to believe all the things that are written about them, and things that people think about them. And there's no way you can measure up to that.

Conway Twitty



DAVID ALLAN COE
ON IMAGE

I will probably always be the Mysterious Rhinestone Cowboy. It might be hard for people to understand that in country music nobody except Porter Wagoner was wearin' rhinestone suits when David Allan Coe went to Nashville. They was all wearin' three-piece suits. When I went to Nashville I had long hair, I was wearin' earrings, I had a beard—I was everything that they are against. And I could sing better than any one of 'em.



David Allan Coe

ALABAMA
ON THE ROAD

Randy Owen: We was playin' near Gadsden, Alabama. And this club was like a VFW. And the guy who managed it was the bouncer, too. He had so many black eyes, and so many black-and-blue places on him where people had beat him up every Saturday night. He would approach the fella and say, "Okay, I'm gonna throw you out!" And the guy would go to work on him, and just beat the hell out of him. And he never threw *anybody* out! But anyway, we was playing, and the drummer had a stage that he sat on. We stood out in front of it, you know. And the drummer had a problem. He loved to sip the, you know, stuff, and he sipped it pretty heavy. So we looked back there, and he was real bad. Course, that's the reason why he's not playing with us now. But I

MARK TUCKER/COLUMBIA

DENNIS CARNEY/WARNER BROS

"You don't have to spend an arm and a leg to get some of our best thinking."

Peter Tribeman
President, NAD (USA)



The 7225PE's front panel contains all the controls and displays needed for effective day-to-day use.



The rear panel contains additional controls and connections, including the Soft Clipping switch, speaker impedance selector, gold-plated phono-in jacks, heavy-duty binding-post speaker terminals, and preamp-out/main-in jumpers for system expansion.

Lately you have been hearing a lot about our take-it-to-the-limit Monitor Series components. We ask you to consider now a new member of the NAD Classic Series: The 7225PE Receiver. It is compact, shockingly powerful, and entirely affordable.

Simply put, a "25 watt" receiver is not expected to perform and sound like the 7225PE. Experienced listeners, in blind tests against receivers rated at twice and three times the power, have been moved to such comments as: "More open," "more dynamic," "richer sound." It was not news to us.

To obtain a glimpse into the reasons for this, ask your dealer to take the 7225PE off the shelf. Pick it up yourself. You will realize at once that you are holding a *very* substantial component. As you would expect from NAD, every ounce is there to enhance listening and ease of use.

For example, NAD's renowned Power Envelope amplifier design uses a two-stage "smart" power supply that provides higher power for musical peaks. Up to 85 watts of clean dynamic power. And our Soft Clipping™ circuit (which is defeatable) prevents harsh distortion when the demands of the music exceed most other amplifiers' limits.

In short, the 7225PE is a prime example of NAD's "no-compromises" design philosophy. And, we think, a product destined to become a standard

in its class. The ultimate judgment, however, should be made by listening. We invite you to do so at one of our carefully selected dealers. You may be surprised at what you hear.

Call us at (617) 762-0202 for your nearest dealer, or send the coupon for detailed product literature, to: NAD(USA), Inc., 575 University Avenue, Norwood, Massachusetts 02062.



For the music, pure and simple.

Please send 7225PE Receiver information and dealer locations to:

Name _____
Address _____
City _____
State _____ Zip _____

looked, and the last thing I saw was his heels. He was goin' off the stage, backwards. And, you know, we lost the drummer for a while.

Teddy Gentry: It's definitely not an easy life, though. Like, not too long ago, we played twenty-nine straight days, seven days a week, without a night off. The bad thing about playing with a group is, when you're sick, you can't leave everybody else hanging, so you go ahead and play anyway. I've played sitting onstage with a flight jacket on to keep the chill factor down. You sit there and shake and shiver and have a high temperature, but you still go ahead and give it your best effort, because the other guys can't afford not to play, for one thing.

Alabama



N AOMI JUDD
BACK HOME

I don't go to beauty salons. But when I was home last week, I wanted to go to Jane's Beauty Parlor in Ashland, Kentucky, on Thirteenth Street, and get a manicure. Because all of a sudden I've got this gorgeous diamond ring from our manager. After all those years that I could only have stubs, workin' as a nurse . . . you know, you can't give somebody a bedpan with these [long] fingernails. . . . I'm sitting there in this little beauty shop, gettin' a manicure, flashin' this diamond ring, and it was *wonderful*. Wynonna's heard this story, so she's totally bored. Take your nap, dear. But I found out that these people are *so for* us. They are *with* us. This lady who happened to be in the beauty shop, her sister and I went to school together. And she called her sister on the phone and said, "Get down here right away! Naomi Judd's in the beauty parlor!"

Becky was cooking supper for her husband, who's a mechanic down at Fairchild's in Ashland. This poor man had just come in from work, and she's cookin' him supper. She left the pots on the stove and ran out the back door, and we sat for an hour and just hooted and hollered over how the teacher used to have to separate us because we were so disruptive, we laughed so much. And this girl looks exactly the same as she did twenty years ago. And here I'm sitting there, and she wants to know what Willie Nelson's really like, and did Conway Twitty really leave his wife for his secretary, and I'm talking a blue streak. You know, I'm as excited as a kid on Christmas morning, being able to share all this



Emmylou Harris

E MMYLOU HARRIS
ON COUNTRY

I listened to country music when I was growing up. I mean, I wasn't raised on a farm in Tennessee, you know, one of twelve children, or anything. I was from Alabama, but we traveled around all my life, because my father was in the Marine Corps. So I have no roots anywhere, but we lived all over the place—North Carolina, Virginia. And we made a lot of family trips from wherever we were stationed at the time to my mother's family in Birmingham. We'd always travel at night, and that's when you get WWVA [Wheeling, West Virginia] the best, so that's a sound from my childhood. But I really found a deep love and appreciation for country music. I don't know if it's because I'm originally from the South, and just latently found my roots, or what it is. But it's just a sound, and a feeling that's in the music. And you either hear it and appreciate it, or you don't. □

Wynonna and Naomi Judd



RCA RECORDS

MCCUIRE/WARNER BROS.

RCA RECORDS

The Ford JBL Audio System

Feel the beat. Music pulsing with power. Rich and resonant. Reproduced with life-like realism. In the new bi-amplified system developed in America by Ford, one of the largest manufacturers of car radios in the world, and JBL, the leader in professional recording studio loudspeakers.

Featuring an 85-watt subwoofer for deep, vibrant bass. Plus a separate 60-watt amplifier driving eight mid-range speakers and tweeters positioned for

optimum stereo imaging. And you can add the Ford Compact Disc player for extra listening pleasure.

The optional Ford JBL Audio System is also available in Mercury Cougar. Hear it for yourself. At your Ford or Lincoln-Mercury dealer.



AUDIO SYSTEMS

The sound of quality

NEW THUNDER FOR THE BIRD



Finally, a CD player that reproduces all of the music, not just bits and bytes of it.



Adcom's new GCD-575 Compact Disc Player has been worth waiting for. Now there's a CD player with analog audio circuits as advanced as its digital stages. Featuring a no-compromise Class "A" audio section, the GCD-575 is the first affordable CD player that delivers the long anticipated technical benefits of digital

sound. So visit your authorized Adcom dealer and listen to all of the music... not just bits and bytes of it.

ADCOM[®]
fine stereo components

11 Elkins Road, East Brunswick, NJ 08816 U.S.A. (201) 390-1130
Distributed in Canada by PRO ACOUSTICS INC. Pointe Claire, Quebec H9R 4X5

CIRCLE NO 60 ON READER SERVICE CARD

1988

JAPAN

AUDIO FAIR

B
Y
B
R
Y
A
N
H
A
R
R
E
L
L

THE world's largest annual audio fair was just a little less large this year, as the Japan Audio Fair moved from the usual Harumi Exposition Grounds on Tokyo Bay across town to the Sunshine City Convention Center in Ikebukuro. Sponsored by the Japan Audio Society, the fair attracted roughly a quarter of a million visitors, including industry and media people from around the world.

The fair site was spread throughout several floors of the modern Sunshine City complex, and in addition to exhibits by some fifty-two manufacturers, displays of consumer DAT and satellite broadcast reception equipment were featured. Overall, the fair presented a series of new images in the Japanese audio industry, highlighted by new cosmetic designs, particularly in rack systems. In substance—namely, technology—however, nothing much was very new except for the appearance of the wide variety of satellite receiving equipment.

Digital Audio

While DAT has yet to attain major popularity, there is an interesting new “bit war” emerging in CD players, with Sony's claim of 45-bit operation topping all others—for now. This year's new CD players emphasize design refinements over technological breakthroughs. Pioneer showed its new PD-2000 (¥95,000, or \$760, at 125 yen to the dollar) and PD-717 (¥62,000, or \$496), machines that are equipped

with twin digital-to-analog (D/A) converters, eight-times oversampling, and coaxial digital outputs. Teac's new separates, the DA-10 D/A converter and DU-10 CD player (no prices yet), were joined by the D1 and P1 of last year, which now have a companion DAT deck, the R1, that can be ordered for ¥500,000 (\$4,000). A&D's DP-9000 (¥158,000, or \$1,264) has a 3-kilogram top panel and a stiff honeycomb chassis.

Equipped with a “real” 20-bit system is Denon's DCD-3500, available in black (¥208,000, or \$1,664) or in a cosmetically tweaked gold version (¥228,000, or \$1,824). Onkyo's C-2001 (¥300,000, or \$2,400) has a fifth foot in the center to help support its “high carbon stiff chassis.” The Kenwood DP-9010 is a drive-only CD player, designed for use with D/A-converter-equipped amplifiers such as Kenwood's DA-1100EX at ¥138,000 (\$1,104). A “linear 20-bit” system is featured in the new Technics SL-P999 (¥69,800, or \$559), and Yamaha offers 22-bit operation in the new CDX-2020 (¥198,000, or \$1,584). The highest bidder in bits was Sony with a “45-bit” system, said to be used in its CDP-338ESD (¥89,800, or \$719) and other new CD players. What this means in terms of sound quality, however, has yet to be determined.

Though DAT hasn't become as popular as expected, several manufacturers have come out with new decks. The JVC XT-Z900 is claimed to have 18-bit D/A conversion, eight-times

REPORT FROM
TOKYO

oversampling, and digital mixing. Other new DAT decks to appear were the A&D D-9000 (¥200,000, or \$1,600) and the Technics SV-MD11, a cannon-connector version of the famous SV-MD1 portable DAT recorder.

Speakers

Despite strong success in all other areas of audio, Japanese speakers have garnered relatively little popularity outside Japan, apart from those supplied with rack systems. Even in Japan, foreign manufacturers hold a strong share of the market for speakers sold separately. Notable are Bose and JBL, whose speakers were displayed right alongside those of Japanese manufacturers at the fair, rather than at the much smaller Imported Audio Fair running concurrently across town in the Hotel Grand Palace. The prototype Bose 403W in white was a real eye-catcher.

The Japanese weren't without surprises, however. Yamaha unveiled its new AST-1 Active Servo Speaker System (¥135,000, or \$1,080), comprising two small bookshelf-size speakers and a special processing amplifier. Yamaha claims bass response down to 28 Hz from a speaker-cabinet volume of only 6 liters.

Visually exciting as always were the Sasaki speakers with their spherical crystal enclosures. In addition to the 3½-inch-driver CB-60M (¥43,800 per pair, or \$350), Sasaki offers the CB-300M (¥140,000 per pair, or \$1,120), which has 5¼-inch woofers and 10-millimeter (about 2/5 inch) polycarbonate-dome tweeters. The crystal enclosures of the CB-300M-B and CB-300M-O versions (¥220,000 per pair, or \$1,760) are specially treated to give off an eerie fluorescent glow in blue and orange, respectively.

Also eerie was the Technics display for its new SST-1 Sound Space Twin Load Horn, which made use of oddly costumed mannequins. I was particularly startled when one turned out to be a real person and started moving after a long stretch of stillness. The SST-1 system (¥200,000, or \$1,600) includes a pair of full-range horns, a power drive unit, and a stand. Designed for commercial placement, the horns are available in metallic black, red, or silver. Technics also showed its Audio Flat Panel (AFP) speakers. The huge SB-AFP1000 is

The world's most expensive set of headphones must be Sony's MDR-R10 at ¥360,000 (\$2,880). The drivers are enclosed in two-hundred-year-old zelkova wood, but the phones themselves feel surprisingly light.

Teac's Esoteric line of separates includes the new DA-10 digital-to-analog converter and matching DU-10 compact disc player.

The big Panasonic/Technics display featured a variety of products shown off by oddly costumed mannequins, some of them alive.

Technics also showed its compact professional WB-C10 cassette deck and matching WA-M50 four-channel power amplifier, designed for use in small restaurants and bars. The brand name for this line is Ramsa.





New at the show this year was a wide variety of reception equipment, like these dish antennas, for satellite broadcasts.



Denon showed its new digital audio tape deck, the DTR-X.



Crystal speakers by Sasaki Glass flank the company's new cassette player, which has a similarly unusual appearance.



Aiwa's new portable CD players include the tiny DX-DG8, which plays 3-inch CD's only.

priced at ¥2.5 million (\$16,400), assembly and placement optional, but the relatively modest SB-AFP10 version is yours for just ¥500,000 (\$4,000).

Also strong in speakers was Mitsubishi, which had the famously enormous D-80M superwoofer on display. The company will be happy to build one for your system for just ¥1.5 million (\$12,000).

Along with the new SSG-333ES "acoustically formed loudspeaker" (¥120,000 per pair, or \$960), Sony presented what must be the world's most expensive headphones, the MDR-R10 at ¥360,000 (\$2,880). Though they look heavy with their two big wooden driver enclosures (made of genuine two-hundred-year-old zelkova wood, by the way), the MDR-R10's are surprisingly light. The 2-inch biocellulose diaphragms are said to have ten times the rigidity of conventional cone paper. And wearing comfort is assured by the Greek sheepskin earpads and the pure silk covering the soft-silicon insulated cord, made of 99.9999% pure linear-crystal oxygen-free copper.

Cassette Decks

Several new decks featured heads with pure-copper Ohno-continuous-casting windings, including the Aiwa XK-009 (¥99,800, or \$799) and XK-007 (¥79,800, or \$639), the Onkyo K701 (¥69,800, or \$559), and the Pioneer T-616 (¥59,800, or \$479). The Aiwa and Pioneer decks also feature cassette stabilizers, which apply slight pressure on the cassette to damp out resonance, as do the A&D GX-Z9100 (¥108,000, or \$864) and GX-Z7100 (¥87,000, or \$699) and the JVC TD-V721 (¥87,000, or \$699).

It appears that remote control has now become standard on better cassette decks, with nearly unlimited control possibilities in more sophisticated machines: Yamaha's new KX-1000 (¥89,800, or \$719) and KX-R700 (¥69,800, or \$559) have thirty-nine-key wireless remotes. Teac has gone all out with a pair of new CD cassette receivers with a bold and attractive design approach. The Models a-1 (¥150,000, or \$1,200) and a-2 (¥130,000, or \$1,040) are the size of one large component but include an amplifier, tuner, double cassette deck, and CD player; a pair of matching speakers is available for ¥50,000 (\$400). Also attractive are the Technics



WB-C10 autoreverse cassette player and matching WA-M50 four-channel power amplifier, designed for use in small restaurants and drinking places.

Teac also proudly displayed its "super analog" open-reel tape decks: the X-2000R (¥239,000, or \$1,912) has amorphous-cobalt recording and playback heads, dual-capstan drive, and dbx Type 1 noise reduction. Also in Teac's current line is the ¥109,000 (\$875) X-300 three-motor, three-head deck.

Electronics

Built-in D/A converters (DAC's) are becoming popular in amplifiers—presumably it allows the magic D word to be prominently displayed on the product. The Technics SE-M100 Direct Digital Drive integrated amplifier (¥90,000, or \$720) places the DAC just before the current-amp drive stage. The handsome A&D DAA-9500 Digital Power Amplifier (¥800,000, or \$6,400) has a built-in DAC system and a remote control; the matching DAP-9500 Digital Control Amplifier features a book-sized "intelligent communication remote" panel that can also be used to operate other A&D and Mitsubishi components. A DAC is also built into the Onkyo Integra A-2001 integrated amp (¥280,000, or \$2,240). Its front panel proclaims: "The real phase technology is equipped as a necessary method to reproduce music precisery [sic]."

Yamaha's new Titanium Series components were on display, as was the new DSP-100 digital sound processor (¥89,800, or \$719). The Pioneer A-50DV integrated amplifier (¥67,000, or \$539) has twin left/right DAC's and is finished in titanium gray. Other new Pioneer offerings included the M-90a power amplifier (¥220,000, or \$1,760) and C-90a preamplifier (¥180,000, or \$1,440) as well as the Exclusive M5a Class A mono power amplifier at ¥500,000 (\$4,000) each. Sansui's AU-X111 MOS Vintage integrated amplifier (¥400,000, or \$3,200) is said to have sixteen MOSFET's in its "Diamond Power Stage."

The winner in the overkill department is a newcomer: Audio Devices of Tokyo, whose first line is a startling collection of white components with fancy (and real) gold trim that look like they could have been designed back in nineteenth-century France. While the technology

doesn't appear radically new, the construction approach is on a massive scale. Both the AD-E1 phono-equalizer amplifier (¥1.5 million, or \$12,000) and AD-C1 control amp (¥2.5 million, or \$16,400) weigh 27 kilograms (about 59½ pounds), and each AD-P1 mono power amplifier (¥1.5 million, or \$12,000) tips the scales at 32 kilograms (70½ pounds). The whole set's yours for a cool ¥7 million, or \$56,000.

Rack Systems

Appearance is what's new in rack systems. Most manufacturers are beginning to shun black, though only for slightly lighter shades of dark gray and titanium that are often hard to describe. Onkyo's full-size Liverpool components (17 inches wide) are finished in a rich, dark silver and have rather uncluttered front panels. Sansui's Bar 7 and Bar 9 systems are in titanium, and the Alpine AL-7 system (¥235,000, or \$1,880) had clean styling in dark matte gray. Three of Aiwa's new rack systems are also finished in dark gray, and they are the first systems of their kind equipped with the BBE Sound system developed originally for professional use by Barcus-Berry Electronics of the U.S.A.

The most striking design approach, however, turned out to be an old one. Kenwood's HD-7000 (¥323,000, or \$2,584) and HD-5000 (¥300,000, or \$2,400) systems have a very classic design in silver with beautiful wood side panels.

The Multiformat Trend

Laser-optical players that play both videodiscs and CD's are becoming quite commonplace, and for good reason. Most offer good value to the budding audio/videophile; there are clear advantages in a single unit's playing five different types of software—CD, CDV, CD-3, and both sizes of laserdiscs. Current suppliers of multiformat disc players include Aiwa, A&D, Denon, Pioneer, Sony, Teac, Technics, and Yamaha, with prices averaging around ¥135,000, or \$1,080. In addition, the Pioneer CLD-970 (¥188,000, or \$1,504) and CLD-770 (¥158,000, or \$1,264) can play both sides of a disc without its being manually turned over—sort of autoreverse in the disc format.

Car Audio

The Japanese market for car audio is growing along with the grow-

ing market for cars, which seem to be growing bigger every year. Sales of full-size Japanese cars are stronger than ever. Along with an increasing variety of car CD changers and players, the new thing this year is—and it had to happen—car A/V components. It may sound ridiculous to those who've never experienced the kind of traffic jams we often have here in Tokyo. The Alpine limited-edition car A/V series includes the Model 1401 VHF/UHF tuner with its own 15-watt-per-channel amplifier (¥36,000, or \$288), Model 1501 5-inch LCD color monitor (¥84,000, or \$672), Model 1701 A/V control unit (¥30,000, or \$240), Model 1711 TV diversity-tuning system (¥18,000, or \$144) and matching antennas (¥8,000, or \$64). The Technics G-1 A/V unit (¥208,000, or \$1,664) boasts a 3-inch LCD color monitor, and in the Pioneer Carrozzeria series are the GEX-M900TV AM/FM/TV tuner/CD changer controller and the TV-M-C6 6-inch LCD color monitor.

Even ordinary car audio systems are making greater use of color displays to show all sorts of information, some of it useful. The display on the Alpine Model 7360J (¥118,000, or \$944) looks like a small video game but becomes a spectrum analyzer. JVC offers the CS-D51 Dynamic Bass Boost system (¥59,800, or \$479), a trunk-mounted subwoofer system that looks like a little wood stove. A duct pipes deep bass into the car through the panel behind the rear seats.

Portables

Among portables, the compact new Aiwa DX-DG8 plays CD-3's only. Sony's new D-88 portable player is designed for CD-3's but will play 5-inch CD's if you don't mind them protruding from the player while they spin. Also interesting are Kenwood's three "laptop" systems based around the AM-M70 integrated amplifier (¥25,800, or \$206, separately), which has easy connections for a personal stereo as the program source.

Though this year's Japan Audio Fair held few surprises, there are indications that the industry here is becoming more creative in both external design and in new product executions. The Eighties have produced so many astonishing technological advances that it may take all of the next decade to assimilate them fully. □

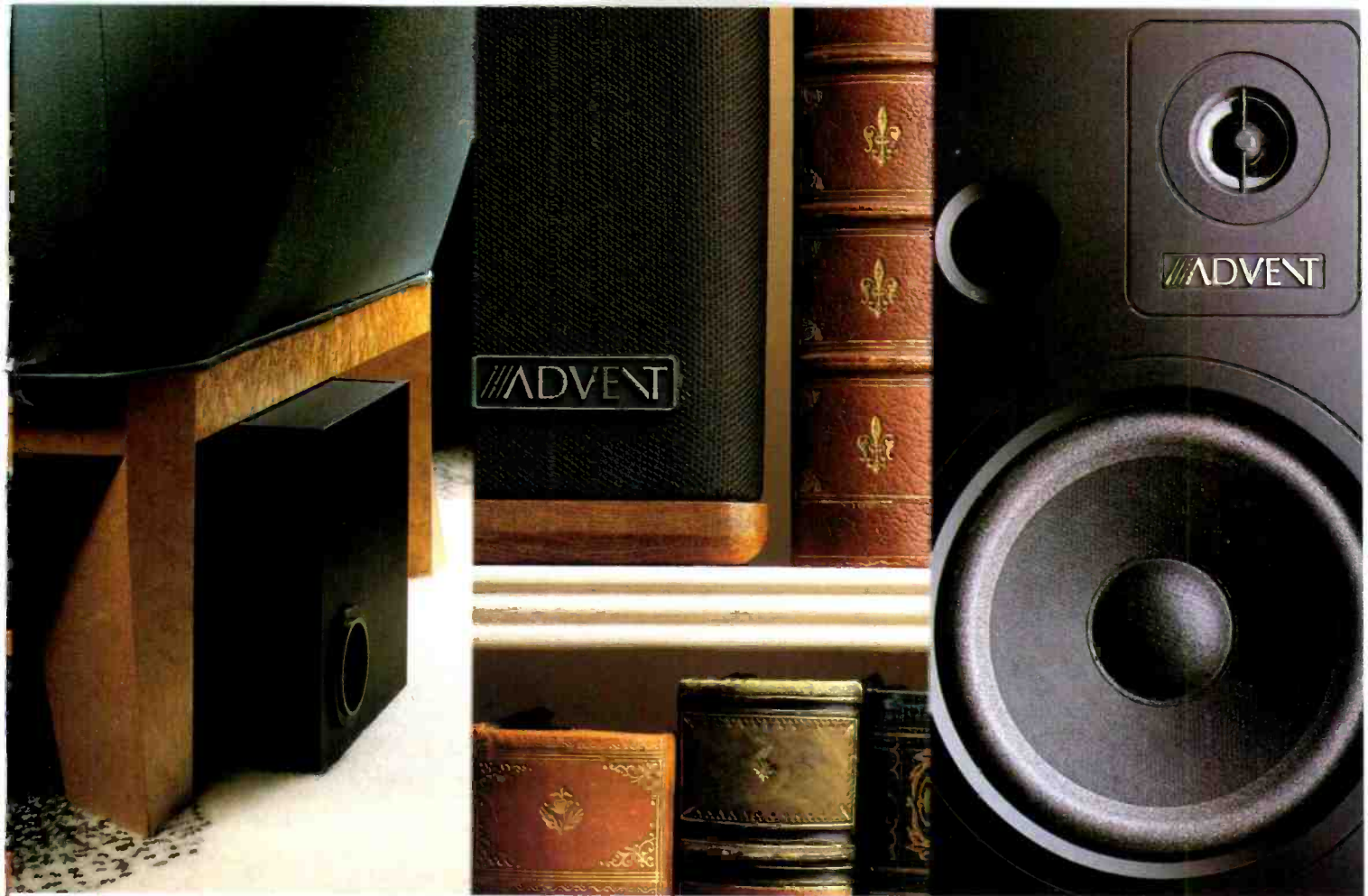

INTRODUCING SOUND AS IT WAS MEANT TO BE HEARD IN PLACES IT WASN'T.

For years, Baby Advent® bookshelf speakers proved that you don't need a lot of space to enjoy accurate sound. With our new Mini-Advents and Mini-Advent/Subwoofer System, you can get that sound in places you never dreamed of.

Mini-Advents are designed for people with little room for loudspeakers. Less than a foot tall, they fit on bookshelves. Tables. Even walls and ceilings, when using optional mounting brackets. Perfect for completing a surround sound system.

THEY'RE SMALL, BUT DEFINITELY NOT SHORT ON SOUND. Our 5¼" high excursion woofers and ½" polycarbonate dome tweeters supply Mini-Advents with 120 watts peak power—quite powerful for speakers this size. Tuned bass ports, too. So that Mini-Advents get every ounce of bass from such a small speaker cabinet.

FOR EVEN GREATER SOUND FROM SMALL SPEAKERS, THERE'S OUR SUBWOOFER SYSTEM. When connected to the Mini-Advents, our

subwoofer creates a 165 watt three-way speaker system by directing the high and midrange frequencies to the Mini-Advents while handling the bass frequencies itself.

The amazing thing is that our subwoofer can give your system extra bass and added power while remaining out of sight. Only seven inches tall and twelve inches wide, it fits neatly in any corner and sounds great behind couches or plants.

Like all our speakers, Mini-Advents are designed to look as good as they sound. Made with real pecan wood, they'll look terrific wherever you put them.

Now that you know all about these great-sounding loudspeakers that take up little space, take a little time and listen to a pair at your nearest Advent dealer.



DIGITAL
READY

///ADVENT®

Sound as it was meant to be heard.

© 1988 International Jensen Inc.
Advent® is a registered trademark of International Jensen Inc.

CIRCLE NO. 30 ON READER SERVICE CARD



Introducing the Delco/Bose Gold Series Music System.

By now you know that the Delco/Bose music system is the most widely reviewed, and highly acclaimed, automotive music system available. For those who can truly appreciate the quality of Cadillac and the experience of superb music, we invite you to audition the new *Delco/Bose Gold Series Music System*.

The first Delco/Bose music systems earned their acclaim because they represented a bold new approach to automotive musical reproduction, made possible by the most intensive research effort ever made in this field. The new Gold Series Music System builds upon this technological foundation by incorporating the results of six years of additional research and development.

BOSE
Better sound through research.



Every critical system component is completely new: amplifiers, equalization circuitry, speakers, digital sound source—even the wire that harnesses them together. In developing them, we made full use of the latest advances in electronic and acoustical technology, materials and design. The result: an automotive music system with even more clarity, power and accuracy—one capable of

bringing you even closer to the realism of live music while sitting inside your car.

We submit that you simply must experience this new music system to believe it. The Delco/Bose Gold Series is an available option in Sevilles, Eldorados, Fleetwoods and DeVilles at your Cadillac dealer.

Delco Electronics
Subsidiary of GM Hughes Electronics
It's who we are



Delco **BOSE**
GOLD SERIES



BEST RECORDINGS OF THE MONTH

Stereo Review's critics choose the outstanding current releases

SIOUXSIE AND THE BANSHEES: "PEEP SHOW"

THE tenth album by Siouxsie and the Banshees, "Peep Show," is a fascinating plunge into the subconscious. It is one of the rare instances in recent memory where the considerable ego that's involved in making music—the flashy, extroverted announcement of self that is the bottom-line motive of rock-and-roll—has been silenced to allow a different sort of voice to emerge. Dreamlike, hypnotic, and carnivalesque, "Peep Show" brims with nonlinear logic, compulsive rhythms, and icy,

crystalline textures. Not since the days of the Doors and the Velvet Underground has a band delved so deeply into the universal mind and released so much psychic energy on record.

The album opens with *Peek-a-Boo*, a fascinating collage of sound that incorporates a backward percussion track. Siouxsie Sioux's incantatory voice bounces from channel to channel as she describes a back-street peep show (hence the album's title) and mocks the voyeuristic impulse of those in attendance. A faint splash of reggae opens *The Killing Jar*, then the music dissolves into a trancelike drone in the style of Brian Eno or the Velvet Underground. *Scarecrow* has a Middle Eastern feel, and *Carousel* is a whirling, surrealistic hall of mirrors set to a calliope's mad melody. The first side rushes to a climax in *Burn-Up*, with cello and drums simulating a train's mounting momentum while Siouxsie breathlessly limns a scene of ecological holo-

caust running rampant across the earth.

Overall, the second side is more abstract and ethereal, culminating in an eloquent expression of love (*The Last Beat of My Heart*) and the barest utterance of hope amid the ruins (*Rhapsody*). Dispensing with formal modes of thought and composition, the ten songs in "Peep Show" consist of interlocking jigsaw-puzzle parts that have a logic all their own. In this utterly unconventional and thoroughly intoxicating album, an unlikely band of post-punk survivors has managed a transcendent feat: They are not playing music, the music is playing them.

Parke Puterbaugh

SIOUXSIE AND THE BANSHEES: *Peep Show*. Siouxsie and the Banshees (vocals and instrumentals). *Peek-a-Boo*; *The Killing Jar*; *Scarecrow*; *Carousel*; *Burn-Up*; *Ornaments of Gold*; *Turn to Stone*; *Rawhead and Bloodybones*; *The Last Beat of My Heart*; *Rhapsody*. GEF-FEN GHS 24205, © MSG 24205, © 2-24205 (43 min).

Siouxsie Sioux and Banshees Budgie (left) and Steve Severin



GLORIOUS LIVE RECITAL FROM JESSYE NORMAN

ALL of Jessye Norman's recordings have been distinguished, but the new Philips recording of her recital at the 1987 Hohenems Festival in Austria has a spontaneity, impulsiveness, risk, and exhilaration that could hardly be hoped for in a studio situation—in other words, it has a quality of *liveness*. One senses the stimulation Norman must have felt in singing directly to a live audience and feeling its response, as opposed to the dryish process of studio takes that can always be done over. In this case it would be virtually impossible to imagine any of the songs more effectively realized in terms of their poetic or dramatic content, and even harder to imagine any of them more beautifully or brilliantly sung—or more sympathetically and musically accompanied than they are here by Geoffrey Parsons.

And what songs they are! The first

JOHN STODDART/GEFFEN RECORDS

BEST RECORDINGS OF THE MONTH

of the two by Handel, *Dank sei dir, Herr*, is a suitable opening for a festival—which is what this recital proves to be. The half-dozen songs by Schumann and the eleven by Schubert gloriously traverse a broad emotional range. The unfeigned sincerity and simple dignity Norman brings to Schubert's overfamiliar *Ave Maria* make for an almost miraculous restorative, and the drama is given full and convincing rein in such songs as *Erlkönig*, *Der Tod und das Mädchen*, and *Meeresstille*. The four encore pieces are sheer joy: one of Brahms's shortest but most endearing songs, with words by Schumann's son Felix; a little-known Strauss setting of a Bierbaum poem whose title is translated, "We both feel like skipping"; and a pair of spirituals that simply blaze with fervor, joy, and the sense of what a wonderful hour the singer and her audience have shared.

One element of live recording I could do without is applause. In this case we get it *before* the performance as well as between each grouping of songs and after each of the encores. I suppose Philips wanted to

reinforce the sense of a live event, but when the applause is on separate tracks running as long as forty-two seconds, it seems a bit contrived. (Since it *is* on separate tracks, of course, you can easily program playback of the CD, or tape, to avoid it.) The recording itself is very good indeed, sensibly focused far enough back to give Norman's huge voice all the room it needs. And the only word for that voice is "glorious."
Richard Freed

JESSYE NORMAN: Song Recital. Handel: *Dank sei dir, Herr*. Rinaldo: *Armida, dispietata!*—*Lascia ch'io pianga*. Schumann: *Myrthen*, Op. 25: *Widmung*; *Du bist wie eine Blume*. *Liederkreis*, Op. 39: *Schöne Fremde*; *Auf einer Burg*; *Wehmut*; *Frühlingsnacht*. Schubert: *Der Musensohn*; *Auf dem See*; *Meeresstille*; *Ave Maria*; *An die Natur*; *Rastlose Liebe*; *Gretchen am Spinnrade*; *Die Liebe hat gelogen*; *Der Tod und das Mädchen*; *Erlkönig*. Brahms: *Meine Liebe ist grün*, Op. 63, No. 5. Strauss: *Wir beide wollen springen*. Anon.: *He's Got the Whole World in His Hand* (arr. M. Bonds); *Great Day* (arr. T. Kern). Jessye Norman (soprano); Geoffrey Parsons (piano). PHILIPS © 422 048-4, © 422 048-2 (65 min).

Jessye Norman: ablaze with fervor and joy



RICHARD THOMPSON'S "AMNESIA"

NO one could ever accuse Richard Thompson of being a wimp. He does not mince words or melodies. Opinions, recollections, emotions—all these come at you in great gusts. Oh, he can be tender, and sometimes even sentimental, but then he lays bare his heart, soul, brain, and guts. Maybe that's why this magnificent artist has never sold many records: His music is dangerously strong.

And "strong" is the word for his new album, "Amnesia." When Thompson is angry about something, his lyrics almost leave scars. In *Reckless Kind* a spurned man snipes, "They say you run with a pregnant crowd/Live your love scenes right out loud." In *Jerusalem on the Jukebox* he lashes out at greedy churchmen: "God has the sharpest suit and the cleanest chin." When he is sentimental, his songs ache with disappointment. *I Still Dream* sums up the awkward futility of a man who has lost love—and has come damnably close to regaining it—in this phrase: "Like a drowning man I clung to my defenses." In *Waltzing's for Dreamers* a heartbroken suitor takes to the dance floor with a woman he doesn't know, and the description of the dance is a catalog of sadness: "One step for aching/And two steps for breaking/Waltzing's for dreamers/And losers in love."

In addition to being a superb lyricist, Thompson is a masterly guitarist. His instrumental work here is typically dark and brooding. Emphasizing the lower range of his guitar, he shows an amazing range of emotions. He can produce sweet, well-rounded notes when he wants to, and he can play with fiery distortion. Then there are the sour, groaning, acidic passages that no one else plays. Thompson is fortunate enough to be eloquent—and precisely so—with his fingers as well as his words.

Maybe that will count for some-

HOLOGRAPHIC SOUND

image



CLOSE YOUR EYES...

Step beyond a fourth dimension where picture perfect sound is the only reality. Experience the ultimate live performance in your own living room.

Introducing HOLOGRAPHIC SOUND from IMAGE! Your doorway to great musical performances of past, present, and future has finally been opened. From the threshold of Sound Engineering Excellence, IMAGE captivates you with brilliant performances of listening pleasure.

— IMAGE — a product so special that simply owning it says you recognize the utmost in quality. The objective of the IMAGE Acoustical Engineers was to create a line of loudspeakers that would further the integrity of reproduced sound. Our **Commitment to Excellence** with constant improvement and innovation is the driving force behind IMAGE.

THE HOLOGRAPHIC "IMAGE"

Instead of taking a back seat to the live musical performance, HOLOGRAPHIC SOUND from IMAGE makes you feel like a participant. Music has been given a 4 - Dimensional depth and clarity that is unwavering both on and off-axis. True, vibrant sound 'appears' in your listening window right out of thin air. HOLOGRAPHIC SOUND from IMAGE - for musical coherence and accuracy the name says it all!

CIRCLE NO. 47 ON READER SERVICE CARD

135 Torbay Road, Markham, Ontario, Canada L3F 1G7 (416) 475-0050 Telex 06-986689 Fax (416) 475-8643

image

BEST RECORDINGS OF THE MONTH

HUGH BROWN/CAPITOL RECORDS



Richard Thompson: eloquent

thing with record buyers this time. "Amnesia" is one of the best records I've heard recently, and Richard Thompson, as always, deserves a wider audience. *Ron Givens*

RICHARD THOMPSON: *Amnesia*. Richard Thompson (vocals, guitar); instrumental accompaniment. *Turning of the Tide; Gypsy Love Songs; Reckless Kind; Jerusalem on the Jukebox; I Still Dream; Don't Tempt Me; Yankee, Go Home; Can't Win; Waltzing's for Dreamers; Pharoah*. CAPITOL C1-48845, © C4-48845, © C2-48845 (44 min).

SOLTI'S THOUGHTFUL BEETHOVEN

GEORG SOLTI'S new recording of the Beethoven Fifth Symphony (coupled with the Fourth) on London is, in its own way, just as gripping as Carlos Kleiber's ultradramatic 1975 version with the Vienna Philharmonic on Deutsche Grammophon. But along with the drama, Solti's performance with the Chicago Symphony offers a particularly thoughtful interpretation. This is a thinking man's Beethoven Fifth.

There is both heft and momentum in the statement of the famous "fate" theme at the opening, and the rest of the first movement comes off beautifully, with the episode for solo oboe conveying an extra degree of pathos. The slow movement is spacious and majestic, à la Furtwängler; balances are me-

ticulous, and the woodwinds acquit themselves nobly. The recitative-like element in the scherzo gets a subtle and effective rubato treatment, and the lead-in to the finale is handled in a most masterly fashion, too. Solti's pacing is moderate throughout the last movement, but not at the expense of dramatic effect. As a result, the two-measure crescendo into the recapitulation achieves its full impact instead of seeming a mad scramble. All in all, this is a Beethoven Fifth that searches out and delivers the musical essence of the work rather than mere theatrics.

Solti's approach to the lyrically expansive Fourth Symphony is warmly straightforward, if somewhat lacking in the magical aura imparted to the music by, say, a Walter, Monteux, or Beecham. The performance is especially noteworthy for the beautifully managed flare-up of horns at the close of the scherzo, and the whole of the finale is marked by exceptionally elegant woodwind work and well-sprung rhythms.

Not the least interesting aspect of this release is that the Fifth Symphony was recorded in Chicago's Medinah Temple and the Fourth in Orchestra Hall, thus affording a direct aural comparison of the city's two major recording locales. The results are fine in both cases, although the Orchestra Hall recording is marginally sharper in its acoustic focus. *David Hall*

BEETHOVEN: *Symphony No. 4, in B-flat Major, Op. 60; Symphony No. 5, in C Minor, Op. 67*. Chicago Symphony Orchestra, Georg Solti cond. LONDON ④ 421 580-1, © 421 580-4, © 421 580-2 (72 min).

Georg Solti: masterly



NOW ON CD Compact Discs of previously released LP's

POPULAR

- **ARE YOU FROM DIXIE?** RCA 8416-2-R. "Great country brother teams of the 1930's," including the Allen Brothers, Lone Star Cowboys, and Blue Sky Boys.
- **DUKE ELLINGTON:** *The Far East Suite*. RCA 7640-2-RB. One of the jazz classics, recorded in 1966.
- **DAVE MCKENNA:** *This Is the Moment*. PORTRAIT RK 44091. Reissue of the pianist's debut album of 1959.
- **GLENN MILLER:** *Major Glenn Miller and the Army Air Force Band*. BLUEBIRD/RCA 6360-2-RB. Wartime recordings dating from 1943-1944.
- **PETER PAN** (Leonard Bernstein-Alec Wilder). COLUMBIA CK 4312. Original 1950 Broadway cast, with Jean Arthur and Boris Karloff.
- **PETER PAN** (Mark Charlap-Carolyn Leigh-Jule Styne-Comden and Green). RCA 3762-2-RG. Original Broadway cast of 1954, with Mary Martin and Cyril Ritchard.
- **RAGGED BUT RIGHT**. RCA 8416-2-R. "Great country string bands of the 1930's," including the Prairie Ramblers and Mainer's Mountaineers.
- **ARTIE SHAW:** *Free for All*. PORTRAIT RK 44090. Recordings by the clarinetist and bandleader dating from 1937.

CLASSICAL

- **BACH:** *The Well-Tempered Clavier, Book II*. Landowska. RCA 7825-2-RC (three CD's). Recorded between 1951 and 1954. Book I was released earlier this year.
- **BIZET:** *Carmen*. Stevens, Peerce, Merrill, Albanese; Reiner. RCA 7981-2-RG (three CD's). A catalog classic, originally released in 1951.
- **MOZART:** *Two-Piano Concerto; Piano Sonata No. 16*. A. Schnabel, K. U. Schnabel; Boult, Sargent. ARABESQUE Z6590. *Piano Concertos Nos. 20 and 21; Piano Sonata No. 12*. A. Schnabel; Susskind, Sargent. Z6591. *Piano Concertos Nos. 24 and 27; Rondo in A Minor*. A. Schnabel; Susskind, Barbirolli. Z6592. *Piano Quintet in G Minor; Piano Sonata No. 8*. A. Schnabel, Pro Arte Quartet. Z6593. Recorded in London's Abbey Road studios between 1934 and 1949.
- **R. STRAUSS:** *Capriccio*. Janowitz, Fischer-Dieskau; Böhm. DEUTSCHE GRAMMOPHON 419 023-2 (two CD's). "Brilliant" (October 1972). *Daphne*. Gueden; Böhm. DG 423 579-2 (two CD's). "Inspired" (June 1965).

CHICAGO SYMPHONY ORCHESTRA

Tommy LiPuma
produces music for
Al Jarreau
and David Sanborn.

But who
produces music for
Tommy LiPuma?



What kind of car audio system could meet the standards of a man with 4 Grammys?

It should have cassette, CD and DAT players that produce studio-quality response, immune from vibration.

Its tuner should be so phenomenally sensitive that it can *double* the reach of other high-end systems.

And it should be a joy to use. With a touch-sensitive control screen that allows any adjustment—from volume to EQ—to be made with the brush of a fingertip.

Which is why, when he leaves the studio, Tommy LiPuma goes on the road with Eclipse.™

©Eclipse Mobile Sound Systems, 19281 Pacific Gateway Drive, Torrance, CA 90502, (213) 532-3062. In Canada: (416) 294-4833.

CIRCLE NO. 159 ON READER SERVICE CARD



ECLIPSE™
MOBILE SOUND SYSTEMS



SURGEON GENERAL'S WARNING: Smoking Causes Lung Cancer, Heart Disease, Emphysema, And May Complicate Pregnancy.

Kings Box: 11 mg "tar", 1.1 mg nicotine
100's Box: 10 mg "tar", 0.8 mg nicotine
av. per cigarette by FTC method.

Made especially
for menthol smokers
by Marlboro.



Great refreshment in the Slip-Top® box.

Until now, separates this good had to be inconvenient.

Since time immemorial, dedicated audio buffs have been forced to choose between all-out performance or all-out convenience.

Such a decision is no longer necessary.

Introducing seriously sophisticated separates that not only offer performance designed to bring tears to your eyes, but also uncompromising remote control capabilities, as well.

The heart of this remarkable new stack is the CX-1000U digital preamp.

You'll find audio and video switching with 10 audio and 4 video inputs. 5 audio and 2 video record outputs.

Even optical and coax digital audio inputs and outputs.

And Yamaha's Hi-Bit, 8 times oversampling digital filter moves unwanted digital noise so inaudibly far above your music, it can't possibly interfere.

While our Hi-Bit twin D/A converters ensure even the lowest level signals are reproduced with excellent linearity.

Anchoring the power portion of the trio is the new MX-1000U power amp.

Featuring specs nothing short of sensational, with a rather awesome 260 watts RMS per channel. (Both channels driven into 8 ohms, 20-20,000 Hz at no more than 0.003% THD.)

And dynamic power capable of delivering a phenomenal *1000 watts* per channel into *1 ohm*.

All made possible by Yamaha's exclusive Hyperbolic Conversion Amplification (HCA) circuitry that eliminates crossover and switching distortion and provides extremely high



Quite possibly the most potent remote to ever grace your coffee table.

dynamic power to drive the greatest possible range of speakers.

And as a versatile complement to the CX and MX-1000U, we proudly introduce our new TX-1000U tuner.

You'll find a 6-way multi-status memory to lock in 6 different parameters to give you optimum reception.

Plus 24 station presets. Even programmable station call letters. And more.

Drop by your Yamaha dealer for a demonstration today.

The experience may be a bit unnerving at first.

All that uncompromised power and performance. *Plus* the convenience of a full-function remote control.

But we have a feeling you'll get used to it.

YAMAHA®

*Discs and tapes reviewed by
Chris Albertson, Phyl Garland,
Ron Givens, Roy Hemming,
Alanna Nash, Parke
Puterbaugh, Steve Simels*

ANTHRAX: *State of Euphoria*. Anthrax (vocals and instrumentals). *Be All, End All; Out of Sight, Out of Mind; Make Me Laugh; Antisocial; Who Cares Wins*; and five others. MEGAFORCE/ISLAND 91004-1, © 91004-4, © 91004-2 (53 min).

Performance: *Fast-faster-fastest*
Recording: *Fair*

Anthrax is a speed-metal quintet from Noo Yawk who look like cartoon characters (imagine the Bowery Boys in surfer jams) and play like a runaway subway. The holocaustal center of their music is the blurry fusion of Dan Spitz's lead guitar with Charlie Benante's ram-paging drums. Beyond the high-speed thrills, however, "State of Euphoria" trots out well-worn clichés (*Misery Loves Company* and *Out of Sight, Out of Mind*) and toothless, subliterate attacks on obvious targets (televangelists, authority figures, money grubbers). On the plus side, Anthrax deplores racism (*Schism*), worries about the homeless (*Who Cares Wins*), and urges dour teen headbangers to think positive (*Be All, End All*). Meanwhile, the music erupts in jerky fits and spasms, the tempos routinely switched mid-song as if someone were randomly pressing buttons on a blender. Not for me. *P.P.*

CROSSING POINT: *Point of No Return*. Crossing Point (instrumentals); other musicians. *When the Smoke Clears; In Due Time; Quiet Dreaming; No Time Soon; Slow and Steady; Frayed Edges*; and four others (nine others on CD). OPTIMISM OP 5002. © OPC 5002, © OPCD 5002 (65 min).

Performance: *Light*
Recording: *Bright*

The second album from Crossing Point, a fusion quintet from New Jersey, is crammed with pleasant, if unexciting, music. The CD runs for over an hour—including more than twenty minutes from their first release as a bonus. The melodies are nice, and many of the solos are enjoyable, including those by

EXPLANATION OF SYMBOLS:

- = DIGITAL-MASTER LP
- Ⓢ = TAPE CASSETTE
- Ⓢ = COMPACT DISC (TIMINGS ARE TO NEAREST MINUTE)

KEITH RICHARDS SOLO

IF nothing else, "Talk Is Cheap," the first solo album by Rolling Stones guitarist Keith Richards, puts an end to the two-decades-old confusion about how he spells his last name, and the thanks of a grateful nation go to the man for finally clearing that up. As for the album itself, well, it's not as good as a vintage, late-Stones album like "Tattoo You," and it's not going to change anybody's life (no *Satisfaction* or *Tumbling Dice* in this lot). But it's far more listenable than Mick Jagger's recent solo efforts, and in its stubborn refusal to concede anything to late-Eighties music and record making it is either heroic or endearingly wrong-headed. I vote the former, with reservations.

From its sound alone, you would think the album had been recorded in 1968, or earlier, for all the technological sophistication of the studios where it was put together. What you hear (and my guess is that the illusion was painstakingly and artfully produced) sounds like a genuinely live band, with mostly pre-synthesizer instrumentation, bashing out Richards's songs as if they've just learned them. There are some rough edges, but there's also a cohesive feel that's really rare in commercial rock these days, and obviously it's Richards's doing. One of the things that's so impressive about the record is that he's gotten sophisticated players (drummer Steve Jordan, for example) to hit that basic Stones groove as if they'd been playing with him all their lives. As a band leader, Richards must be an inspiration.

As a songwriter, however, he's only half of one of rock's all-time great songwriting teams. If there's a serious problem with "Talk Is Cheap," it's because of the missing half. Say what you will about Mick Jagger—that his singing has become impossibly mannered over the last several years, that his refusal to act his age on stage is beginning to look like a case of arrested development—but he remains a superior lyricist. Without him, unfortunately, Richards too often seems to be singing about nothing in particular, as in the otherwise wonderfully Stoneshish rocker *How I Wish*. In fact, the only song where the lyrics seem to engage him on a gut level is *You Don't Move Me*, which is clearly addressed to Jagger and (its sinuously compelling music notwithstanding) is as spiteful and mean-spirited as John Lennon's *How Do You Sleep*.

That allowed, however, on balance this is a nifty record. Given Richards's roots-rock proclivities, the music is entertainingly all over the map, from rock-



ably to James Brown to Chuck Berry to Al Green. The band is brilliant throughout, especially NRBQ bassist Joey Spampinato, who has the old Chess Records feel down cold, and Richards's singing is surprisingly evocative, with only an occasional lapse into macho melodramatics. "Talk Is Cheap" is a convincing declaration of artistic independence from one of rock's most influential figures. *Steve Simels*

KEITH RICHARDS: *Talk Is Cheap*. Keith Richards (vocals, guitar); Waddy Wachtel (guitar); Steve Jordan (drums); Charley Drayton (bass); Ivan Neville (keyboards); other musicians. *Big Enough; Take It So Hard; Struggle; I Could Have Stood You Up; Make No Mistake; You Don't Move Me; How I Wish; Rockawhile; Whip It Up; Locked Away; It Means a Lot*. VIRGIN 90973-1, © 90973-4, © 90973-2 (47 min).



The Jeff Healey Band: Tom Stephen, Healey, and Joe Rockman

the leader of the band, reedman Richard Reiter, who plays fluid, restrained improvisations. The band's performances have a tendency to be peppy, but they never really reach a climax, and if they have a certain static quality, it's because of the metronomic nature of the rhythm section. *When the Smoke Clears* sounds like *Return to Forever*, but without the surge and flow of that band. *No Time Soon* is only middling funk. Much of "Point of No Return" starts in a nice place; it just never goes anywhere from there. R.G.

THE JEFF HEALEY BAND: *See the Light*. The Jeff Healey Band (vocals and instrumentals); vocal and instrumental accompaniment. *Confidence Man*; *River of No Return*; *Don't Let Your Chance Go By*; *Nice Problem to Have*; *Someday*; *Someway*; *Blue Jean Blues*; *Hideaway*; and five others. ARISTA AL-8553, © AC-8553, © ARCD-8553 (50 min).

Performance: *Incredible guitar*
Recording: *Okay*

From the start of this set—a driving blues called *Confidence Man*—you can tell that Jeff Healey has the goods. It features the kind of guitar work you expect from, say, Eric Clapton—bell-clear tone, effortless note-twisting, riveting solos. And it's just the first song in the first album by this twenty-one-year-old blind man from Toronto. In the rest of "See the Light," Healey burns his way through bluesy rock, bluesy hard rock, bluesy boogie, bluesy blues—and he simply rips. There are nearly two dozen solos here, and Healey runs through a virtual catalog of guitar technique. From the stinging filagree of *Nice*

Problem to Have to the melt-down bursts of *See the Light*, he shows imagination and power to spare.

As a vocalist, Healey has room to improve. Not that he's bad, really, so much as unseasoned. The songs are pretty good—some are by Healey, others by John Hiatt, ZZ Top, and Freddie King—but Healey's singing undercuts their effectiveness. When it comes to making a point, he's more articulate with his fingers. R.G.

JOHN HIATT: *Slow Turning*. John Hiatt (vocals, guitar); the Goners (vocals and instrumentals); Bernie Leadon (guitar, banjo); other musicians. *Drive South*; *Trudy and Dave*; *Tennessee Plates*; *Icy Blue Heart*; *Sometime Other Than Now*; *Georgia Rae*; *Ride Along*; and five others. A&M SP-5206, © CS-5206, © CD-5206 (50 min).

Performance: *Assured*
Recording: *Fine*

John Hiatt's last album, the justifiably acclaimed "Bring the Family," was recorded more or less live with a pickup band that happened to star such terrific players as Ry Cooder and Nick Lowe. This new one, however, was done with Hiatt's obviously simpatico road band and produced by Glyn Johns, a man who's gotten gorgeous sounds out of everybody from the Who to the Eagles. The result, while not as surprising and nakedly emotional as "Family," is a literate, funny, first-rate set of pop/soul/country tunes rendered with an off-hand insouciance that is immensely appealing. Picks to click: *Tennessee Plates*, the hilarious and wonderfully rocked-out saga of a small-time crook who lifts

a Cadillac from Graceland; *Is Anybody There*, a classic Memphis-style ballad that Elvis Presley should have lived to sing; *Trudy and Dave*, a catchy bit of neorockabilly about a couple who hold up a bank machine for laundry money; and *It'll Come to You*, an atmospheric slice of swamp funk that's also one of the wryest meditations on guilt you're likely to hear on the radio for the foreseeable future. S.S.

OZZY OSBOURNE: *No Rest for the Wicked*. Ozzy Osbourne (vocals); vocal and instrumental accompaniment. *Miracle Man*; *Devil's Daughter*; *Crazy Babies*; *Breaking All the Rules*; and four others. CBS ASSOCIATED OZ 44245, © OZT 44245, © ZK 44245 (38 min).

Performance: *Sludge*
Recording: *Mud*

Ozzy Osbourne and his ilk are having a field day now that the evangelists who've lambasted them for years have been revealed to be lechers, liars, and frauds. *Miracle Man*, which opens this album, puts a heavy-metal headlock on Jimmy Swaggert, complete with the taunting chorus, "Miracle man got busted." The problem, however, with this and everything else in the album is that it ought to be funnier or more incisive or more *something*. Someone like Alice Cooper would at least inject humor or horror-show chutzpah into the music. Instead, it's as dull as dog food.

Soundwise, "No Rest for the Wicked" is so compressed you'll think your speakers have asphalt baffling. Therefore it's hard to tell if Osbourne's new guitarist is an improvement over his several former ones. Lyrically, he rails against drinking in *Demon Alcohol* and declares himself ready to wage war with the *Devil's Daughter*. On the darker side, he revels in vacant vices on songs like *Tattooed Dancer* and *Bloodbath in Paradise*, the latter a chillingly glib account of the Manson murders that senselessly raises the specter of evil with the line, "Charlie and the family might get you." Though he alternately shuns and embraces his devilish image, the only real sorcery involved in Ozzy Osbourne's career has been the ability to repackage the same album in seven different covers. P.P.

FREDDY POWERS: *The Country Jazz Singer*. Freddy Powers (vocals, guitar); Clint Strong (guitar); Dean Reynolds (bass). *Texas and Oklahoma*; *I Don't Care Anymore*; *Texas Bar-b-Que*; *A Friend in California*; *Riding High*; *Little Hotel Room*; *I Always Get Lucky with You*; and seven others. INORBIT SP-1000 (\$10 postpaid from Freddy Powers Fan Club, P.O. Box 26064, Wauwatosa, WI 53226).

Performance: *Delightful*
Recording: *Very good*

Freddy Powers, known to the country-music audience as the co-writer of a

ARISTA RECORDS

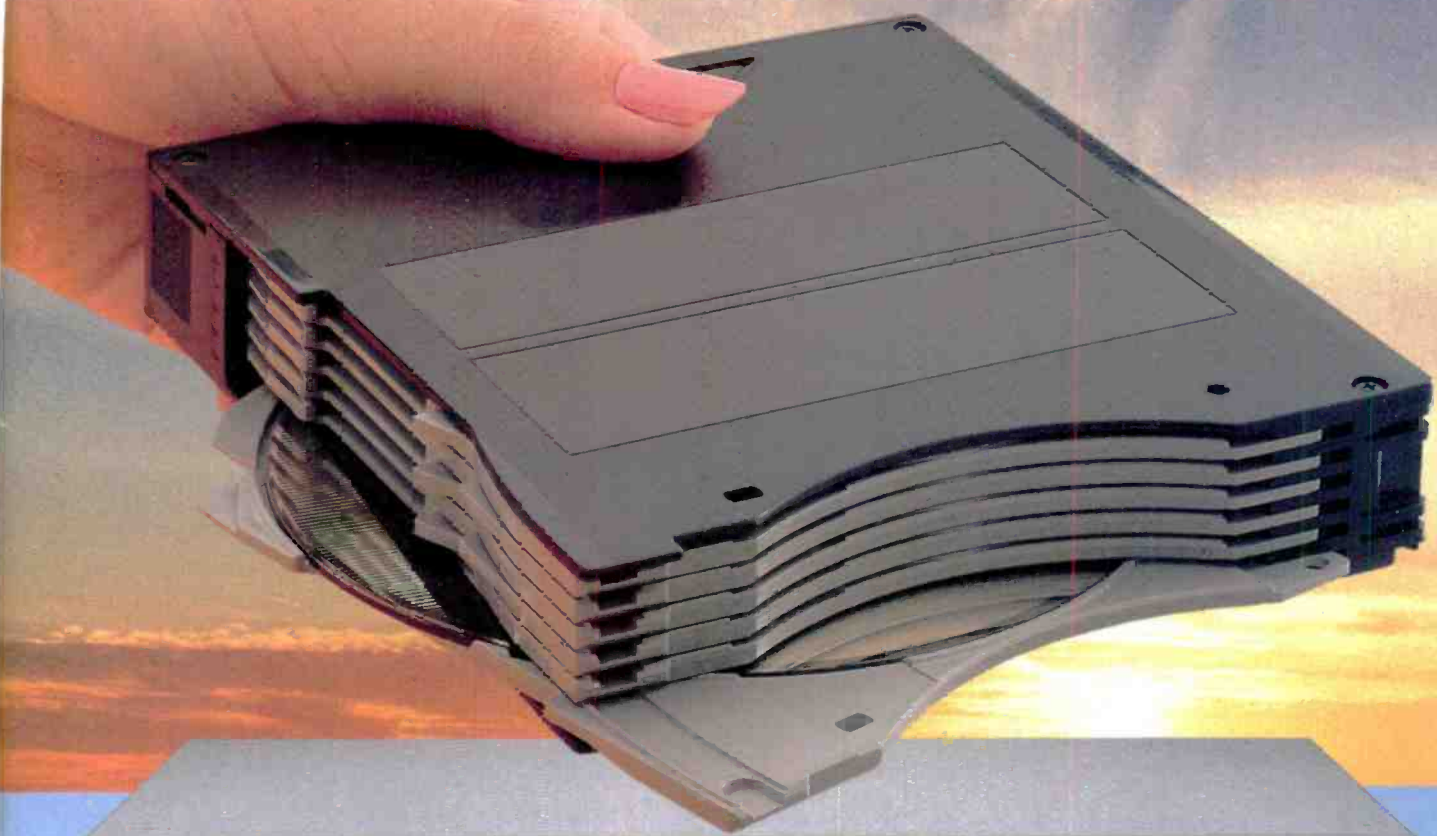

For the Changing Times

The New 6-Disc Realistic® CD Changer

Now there's a more convenient way to enjoy the best in sound—the new compact disc *changer* from Radio Shack. You can load up to six discs in its magazine, sit back, and enjoy hours of superb digital stereo. Or, program up to 32 selections from the six discs to play in any sequence. Either way, you can pause, replay, program and search, using the wireless infrared remote control.

The large LED display simplifies remote operation. Manual and automatic search make it easy to find selections.

This high-performance changer has a heavily cushioned deck mechanism and Tri-Spot laser pickup system for accurate tracking. Two-times oversampling provides superior sound. And Radio Shack stocks

extra magazines so you can protect all of your CDs and have them loaded in your preferred order, ready for play anytime.

Come in and try the Realistic CD-6000. It's affordably priced at only \$359.95—so you can enjoy the convenience of a changer for less than the price of some single-disc players. Sold only at Radio Shack. Low as \$13 per month*.



Radio Shack®

The Technology Store™

A DIVISION OF TANDY CORPORATION

Prices apply at participating Radio Shack stores and dealers. • Radio Shack ValuePlus® Revolving Credit. Actual payment may vary depending upon account balance.

PERREUX

CIRCLE NO. 54 ON READER SERVICE CARD

PERREUX *US & Canadian Distributors: Audio Products International Corp
135 Torbay Road, Markham, Ontario, Canada L3R 1G7*

myriad of Merle Haggard songs (*I Always Get Lucky with You, Natural High, Let's Chase Each Other Around the Room Tonight*), appears here in an impressive, if quiet, performance of upbeat jazz and country ballads. A dexterous musician and adroit lyricist, Powers dedicates his album to Django Reinhardt, Haggard, and Willie Nelson, among others, citing their influence on his music. Judging from this outing, however, it looks as if Powers may have been as much of an influence on Haggard as Haggard has been on him. Their current styles are that enmeshed.

Powers cannot approach the vocal mastery of his celebrated friend, however, and the timbre of his warm, but sometimes thin, voice owes more to Nelson—whose platinum album "Somewhere Over the Rainbow" Powers co-produced—than to Haggard. But this lovely LP is an eye-opener, revealing Powers as a remarkable country-jazz stylist and songwriter worthy of far larger exposure on his own. And his twenty-year-old lead guitarist, Clint Strong, will send you reeling. *A.N.*

SIOUXSIE AND THE BANSHEES: *Peep Show* (see Best of the Month, page 101)

THE SOUND OF MUSIC (Richard Rodgers—Oscar Hammerstein II). Frederica von Stade, Håkan Hagegård, Eileen Farrell, Barbara Daniels, Lewis Dahle von Schlanbusch; Cincinnati May Festival Chorus; Cincinnati Pops Orchestra, Erich Kunzel cond. TELARC © CD-80162 (70 min).

Performance: *Glowing*
Recording: *Impressive*

First it was the New York Philharmonic's exciting *Follies*. Now it's the Cincinnati Pops' turn to breathe fresh life into the score of a major Broadway musical—and, in the process, show that an American symphony orchestra, in combination with a well-chosen "cross-over" cast and first-rate musical direction, can be the natural vehicle for worthy CD remakes of works in this important genre. This is as complete a *Sound of Music* as has yet been recorded. It includes the two songs Richard Rodgers wrote for the film version after Oscar Hammerstein's death as well as all the Broadway material, even several interludes not in the original-cast album. Frederica von Stade is a wonderfully warm and vocally glowing Maria; she's out of her element only briefly in the yodeling sections of *Lonely Goatherd*. Eileen Farrell, in the best voice she's been in for some years, makes *Climb Every Mountain* genuinely thrilling. Håkan Hagegård and Barbara Daniels are also splendid, and conductor Erich Kunzel paces everything with the right mixture of bounce, bite, and romantic sentimentality. The sound engineering is alternately spacious and intimate (Continued on page 116)

RANDY NEWMAN'S BACK



RANDY NEWMAN has given us some wonderful music. Not just lyrics that capture and dissect people, places, and special points in time; not just melodies that hold and transport us with joy and grief, and the emotions in between, and sometimes all of them at once; but a magic combination of words and tunes that aspires to be musical literature, and nearly always succeeds.

Every Randy Newman album is important, but his new "Land of Dreams" is especially so. Like any good author, Newman speaks eloquently through his characters: the racists, overt and otherwise, of *Rednecks* in the "Good Old Boys" album, for example, or the cavalier God of *God's Song (That's Why I Love Mankind)* in "Sail Away." On occasion he's spoken in the first person, although it's hard to say how much these songs were really about himself. But in "Land of Dreams," for the first time, Newman has gotten very personal.

It's possible to see the first six songs (side one of the album and cassette) as an autobiographical sketch, starting with the New Orleans of Newman's infancy and ending with the awful maturity earned by a romantic betrayal. In the course of this sweet-and-sour suite, Newman touches upon desperately assimilating Jews in the 1940's South, the osmotic inculcation of racial attitudes, the cruelty of parents, and the joy, sorrow, and pity of love. And he does it with humor, irony, sadness, and anger.

Then there's the rest of "Land of Dreams," songs about an insensitive jerk's attitude toward the underprivileged, the sweet dreams of success of small-time rappers, a guy from Buffalo who returns from California with the true meaning of life, sweet patriotism, crass materialism, and the cruelty of a man to his wife and kids. The lyrics are

vivid, and they function on many levels: They tell a story, portray the attitude of a narrator, and insinuate the attitude of the composer, which often contradicts that of the narrator. Take *Roll with the Punches*, for example. Newman paints a bleak interior scene—the slum housing of a black child—in sardonic, childlike terms: "Mr. Rat's on the stairway/Mr. Junkie's lyin' in his own vomit on the floor." Then the loutish, fat-cat narrator coldly instructs this kid, "You gotta roll with the punches little black boy/That's what you got to do/You got to roll with the punches."

As always, Newman writes dramatic, often theatrical music. His melodies can be sweet and breezy, sentimental and foursquare, quiet and sinister. Some of the arrangements are melodramatic, but they all seem just right. The bombastic pounding in *Four Eyes* helps give the song's narrative a proper surreal quality, the ragtime piano of *New Orleans Wins the War* reinforces the song's sense of place, and the bouncy, chipper rendition of *It's Money That Matters* serves as ironic counterpoint to the song's lyrics.

It's been four years since Randy Newman's last solo effort. Illness and movie work have kept him otherwise occupied. If we're very lucky, it won't take him so long before his next one.

Ron Givens

RANDY NEWMAN: *Land of Dreams*. Randy Newman (vocals, keyboards); other musicians. *Dixie Flyer; New Orleans Wins the War; Four Eyes; Falling in Love; Something Special; Bad News from Home; Roll with the Punches; Masterman and Baby J; Red Bandana; Follow the Flag; It's Money That Matters; I Want You to Hurt Like I Do.* REPRISE 25773-1, © 25773-4, © 25773-2 (41 min).

"They Were Designed To Play Music This They Do Very Well, In At A Bargain Price... It's Hard To Ima

It has always been true that placement in the listening room has a profound effect on the sound of any loudspeaker, regardless of its inherent qualities. Cambridge SoundWorks has confronted this fact and created Ensemble,[™] a speaker system that can provide in your home, the superb sound once reserved for the best conventional speakers under laboratory conditions. And because we market it directly, Ensemble costs far less than previous all-out designs. Perhaps best of all, it virtually disappears in your listening room.



Henry Kloss, creator of the dominant speaker models of the '50s (Acoustic Research), '60s (KLH), and '70s (Advent), brings you Ensemble, a genuinely new kind of speaker system for the '90s, available factory direct from Cambridge SoundWorks.

The best sound comes in four small packages.

Ensemble consists of four speaker units. Two compact low-frequency speakers reproduce the deep bass, while two small satellite units reproduce the rest of the music. Separating the low bass on both channels from the rest of the range makes it possible to reproduce just the right energy in each part of the musical spectrum without turning your listening room into a stereo showroom. With clumsy conventional systems, you can either strive for that balance by letting loudspeakers dominate your room, or sacrifice it for less conspicuous speaker placement.

Your listening room works with Ensemble, not against it.

Room acoustics emphasize and de-emphasize various parts of the musical

Unlike satellite systems which use a single large subwoofer, Ensemble features separate compact bass units for each stereo channel. They fit more gracefully into your living environment, and help minimize the effects of the listening room's standing waves.

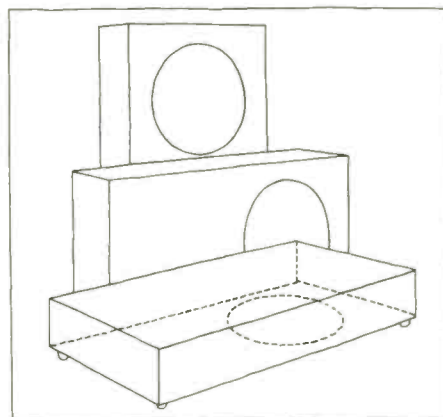

Because low frequencies are non-directional, Ensemble's bass units can be installed horizontally, vertically, facing upwards, or facing downwards.

range, depending upon where the speaker is placed in the room. If you put a conventional speaker where the room can help the low bass, it may hinder the upper ranges, or vice-versa.

Ensemble, on the other hand, *takes advantage* of your room's acoustics. You put the low-frequency units where they provide the best bass, whether or not that location is good for the high frequencies (and it usually

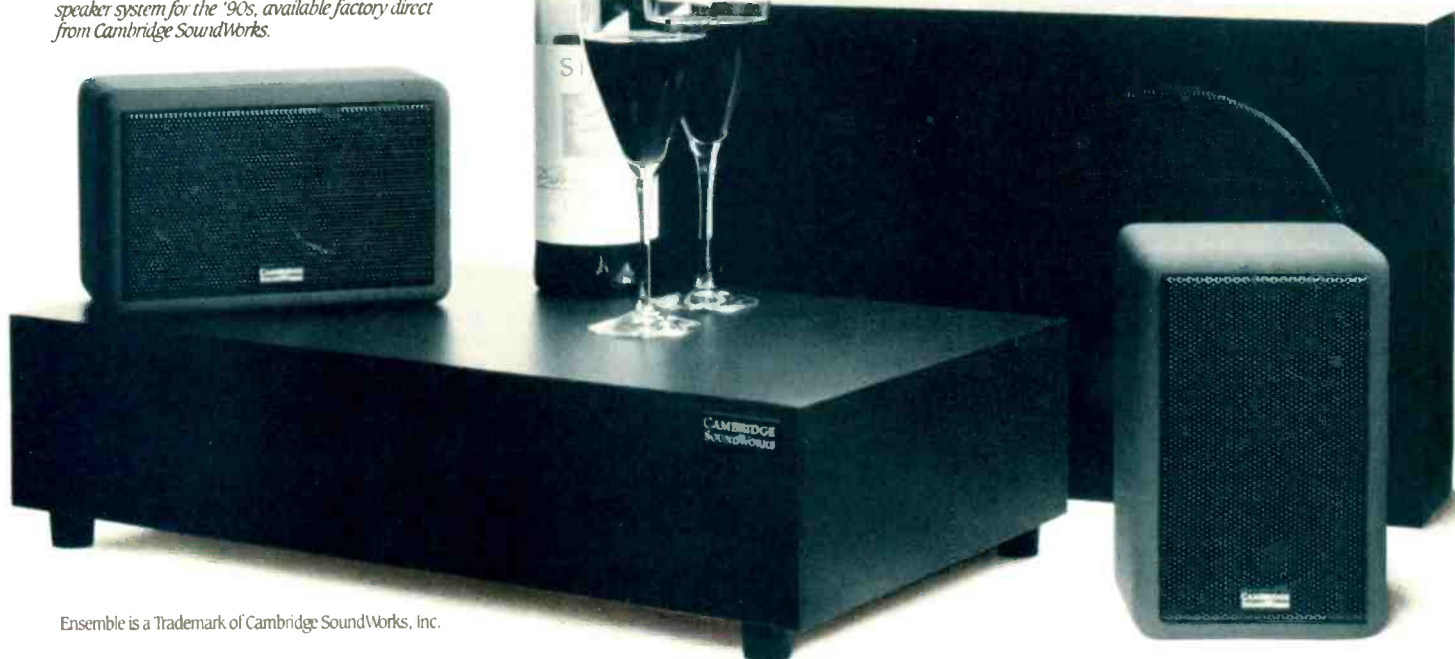

-And Make It Sound Like Music. A Most Unobtrusive Way, gine Going Wrong With Ensemble.”

Julian Hirsch
Stereo Review, Sept. '88

isn't for any speaker). Then you put the satellites where they provide a well-defined stereo "stage."

The ear can't tell where bass sounds come from, which is why Ensemble's bass units can be tucked out of the way—on the

in gunmetal gray Nextel, a suede-like finish highly resistant to scratching. We even gold-plate all connectors to prevent corrosion. But perhaps an even bigger difference between Ensemble and other speakers is how we sell it...

Call 1-800-AKA-HIFI*
(1-800-252-4434)

Our toll-free number will connect you to a Cambridge SoundWorks audio expert. He or she will answer all your questions from

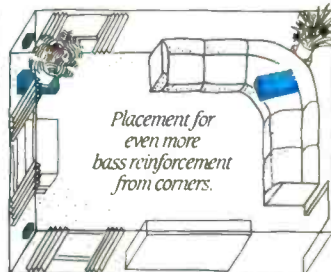
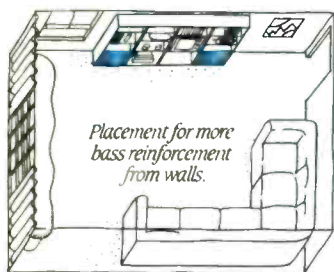

You can put Ensemble's low-frequency units exactly where they should go for superb bass. You can't do this with conventional speakers because you have to be concerned about the upper frequencies coming from the same enclosures as the low ones.

floor, atop bookshelves, or under furniture. The satellites can be hung directly on the wall, or placed unobtrusively on windowsills or shelves (among other possibilities). The result is extraordinary. There are no bulky speaker boxes to dominate your living space, yet Ensemble reproduces the satisfying deep bass that *no* mini speakers can.

Not all the differences between Ensemble and other speaker systems are as obvious as our two subwoofers.

Unlike three-piece satellite systems that may appear similar, Ensemble's four-piece design doesn't cut any corners. We use premium quality components for maximum power handling, individual crossovers that allow several wiring options and cabinets ruggedly constructed for proper acoustical performance. The low-frequency units use the classic acoustic suspension design, and are finished in black laminate. The satellites are finished

**The best showroom of all:
your living room.**

Choosing a loudspeaker after a brief listen at a dealer's showroom is like deciding on a car after one quick trip around the block. Therefore we make it possible to audition Ensemble right in your own home. In fact, Ensemble is sold *only* by Cambridge SoundWorks directly from the factory.

That only makes sense. You get to match Ensemble specifically to your listening room in a way no other system permits. You get to listen for hours without a salesman hovering nearby. And if after 30 days of all that you're not happy, you can return Ensemble for a full refund (we'll even reimburse the original UPS shipping charges in the continental U.S.).

What Henry Kloss tells his friends:

Every time I came out with a new speaker at AR, KLH, or Advent, my friends would ask me, "Henry, is it worth the extra money for me to trade up?" And every time I would answer, "No, what you've already got is still good enough."

But today, with the introduction of Ensemble, I tell them, "Perhaps now is the time to give your old speakers to the children."

shipping charges in the continental U.S.). You also get to save.

At only \$499—complete with all hardware, 100' of speaker cable, and free ongoing assistance—Ensemble

costs hundreds of dollars less than it would in a retail store.

why (or why not) to buy Ensemble to those you may have about related equipment. Your audio expert will take your order (you can use Visa, MasterCard or American Express), and arrange surface shipment via UPS (\$7 to \$25 anywhere in the continental U.S.). You should have Ensemble within one week. And your Cambridge SoundWorks audio expert will continue as your personal contact with us, to answer questions which might come up after you've begun to enjoy Ensemble at home. We think you'll like this new way of doing business.

*In Canada, call 1-800-525-4434. Audio experts are on duty Mon.-Fri., 9AM-10PM, Sat., Sun., 9AM-6PM Eastern Time.

CAMBRIDGE SOUNDWORKS

154 California St., Newton, Massachusetts 02158

- Send more information and test reports.
 - Send Ensemble risk-free for 30 days, for \$499.*
 - Send an Ensemble Gift Certificate for \$499.*
- I'm paying by Check MC Visa AmEx

Acct. Number _____ Exp. _____

Signature _____

Name _____

Address _____

City _____ State _____ Zip _____

Phone (Area Code) _____ Number _____

FOR IMMEDIATE SERVICE: 1-800-AKA-HIFI

MA residents add 5% sales tax

*Plus freight. Call and ask.

Suite 102J



Sweethearts Janis Gill (left) and Kristine Arnold

where it should be, and it will knock your socks off when the organ enters during the wedding processional and again in the finale. *R.H.*

SWEETHEARTS OF THE RODEO: One Time, One Night. Kristine Arnold (vocals); Janis Gill (vocals, guitar); vocal and instrumental accompaniment. *Satisfy You; Blue to the Bone; So Sad (To Watch Good Love Go Bad); Don't Look Down; You Never Talk Sweet; I Feel Fine;* and five others. COLUMBIA FC 40614, © FCT 40614, © CK 40614 (34 min).

Performance: *Half and half*
Recording: *Nice*

After a sterling debut album two years ago, Kristine Arnold and Janis Gill, a real-life sisters act known as Sweethearts of the Rodeo, have returned with a snappy encore of smart, New Country fare. Blending traditional country and traditional rock, with more than a smattering of the Everly Brothers' sound, the sisters come on strong with an infectious energy, an emotional intensity that has already been compared to that of Patsy Cline, and never-failing vocal perfection. Now Janis, who supplies vocal harmonies to her sister's leads, has

added songwriting to her résumé, co-writing three of the songs here (two with Don Schlitz, one with Gail Davies), including the kick-off tune, *Satisfy You*, a slight but uptempo bouncer that brings to mind *Midnight Girl/Sunset Town* from the duo's first album.

Not everything satisfies, though. Side two, especially, seems somewhat uninspired. The Sweethearts do nothing to improve on the Beatles' *I Feel Fine*, and the rest of the program is often more tame than tangy. The title tune, a watered-down version of a Los Lobos scorcher, is particularly disappointing. But the Everly Brothers influence is more pronounced than before—aside from performing Don and Phil's *So Sad (To Watch Good Love Go Bad)*, with guest vocalist Rodney Crowell, the Sweethearts resurrect that unmistakable keening on *You Never Talk Sweet*, *Blue to the Bone*, and *Gone Again*. In those numbers, at least, you're bound to go down like a felled steer.

Failings aside, Sweethearts of the Rodeo are showing themselves to be among the most durable, if not the most original, of the contemporary country newcomers. Credit producer Steve Buckingham for a sparkling production, for instrumental restraint, and for pre-

serving the sisters' natural blend. Country is lucky to have them all. *A.N.*

TAKE 6. Take 6 (vocals). *Gold Mine; Spread Love; If We Ever; A Quiet Place; Mary;* and five others. REPRISE 25670-1, © 25670-4, © 25670-2 (37 min).

Performance: *Awesome new talent*
Recording: *Excellent*

Imagine an *cappella* vocal group with the dazzling virtuosity of the Manhattan Transfer that specializes in performing traditional songs with religious themes in a sassy doo-wop singing style reminiscent of the Big Band era. Take 6, comprising six black male singers from Nashville, is such a group, and it is one of the most original vocal ensembles to emerge in ages. Its recording debut, "Take 6" on Reprise, displays inventive genius and flawless craftsmanship, drawing upon the rich traditions of gospel, rhythm-and-blues, and jazz and combining them with rare sophistication. There's extraordinary beauty in the way the group executes unexpected harmonic changes in spirituals like *Mary (O Mary, Don't You Weep)* and *Get Away Jordan*, transforming the latter into a challenging bop anthem. The more subdued tracks, like *A Quiet Place* and *He Never Sleeps*, are also surpassingly lovely.

Although Take 6 has been working as a group since 1980, it is just now attracting the attention of established artists like Stevie Wonder, Smokey Robinson, Johnny Mathis, and Joe Sample, who have all toured or recorded with the sextet. Thanks to this release, and to the group's performance at the World Series, Take 6 should be well on its way to the popular acclaim it so richly deserves. *P.G.*

RICHARD THOMPSON: Amnesia (see Best of the Month, page 102)

U2: Rattle and Hum. U2 (vocals and instrumentals); Bob Dylan (vocals); B. B. King (guitar, vocals); Brian Eno, Benmont Tench (keyboards); other musicians. *Helter Skelter; Van Diemen's Land; Desire; Hawkmoon 269; Angel of Harlem; Love Rescue Me; When Love Comes to Town; All Along the Watchtower; I Still Haven't Found What I'm Looking For;* and eight others. ISLAND 91003-1 two LP's, © 91003-4 one cassette, © 91003-2 one CD (73 min).

Performance: *Mondo overreach*
Recording: *Very good*

This soundtrack album, like the concert film it derives from, has "well meaning" written all over it. There are earnest *pronunciamentos* (lead singer Bono, introducing *Helter Skelter*, observes, "Here's a song Charles Manson stole from the Beatles. We're stealing it back"), performances with revered elders like Bob Dylan and B. B. King, the obligatory vague moralizing (covering a

(Continued on page 120)



INCOMPARABLE MUSICAL EXPERIENCE

No other speaker manufacturer has the musical experience of M&K.

We are the only manufacturer that is also a digital recording label—constantly referencing the sound of our speakers to live professional musicians in a digital recording environment. When you hear the emotion and excitement of live music from an M&K speaker system, it is a direct result of our ability to engineer and perfect our speakers *in our own recording studio*.

M&K Sound is at the cutting edge in both loudspeaker and recording technology. RealTime Records (and its associated label Perpetua Records) has been a vital part of our company since 1974. We helped pioneer both direct-to-disc and digital recording, and, in 1983, we were the first U.S. label to release digital Compact Discs.

Satellite Speakers

Since 1978, M&K Satellite and Powered Subwoofer speakers have excited music lovers with a lifelike detail and clarity of sound unmatched by conventional speakers. And the compact size of M&K Satellites fits easily into virtually any environment or decor.

Each M&K Satellite has the unique and uncanny ability to reproduce the sharp transients and presence of live musical



instruments. Close your eyes, and the speakers will seem to disappear. In their place, you'll hear instruments in a wide and deep three-dimensional space, reproduced with a precision that has astounded the most experienced audio reviewers. Above all, *the sound is live*.

Powered Subwoofers

Since 1974, music lovers worldwide have discovered deep bass by adding an M&K Subwoofer to their systems. Even without M&K Satellites, an M&K Powered Subwoofer, with its own internal amplifier, will make your music or video source come alive, adding much deeper bass response and a greater tactile sense of "punch" and "impact" to the sound.

When our engineers walk from the recording studio where musicians are performing, into the control room where M&K speakers are reproducing the music, the sound on both sides of the door is *alive*. That is the treat that awaits you from M&K speakers.

Systems from \$250 to \$2500 at select audio specialists nationwide. Call or write for speaker and CD literature.

M&K President and chief speaker designer Ken Kreisel, recording the English Chamber Orchestra at London's Abbey Road Studios, using M&K S-1B Satellites and V-1B Subwoofers.

MILLER & KREISEL SOUND CORPORATION

10391 Jefferson Blvd., Culver City, CA 90232 213/204-2854

CIRCLE NO. 48 ON READER SERVICE CARD



The Brains.

*Carver's new CT-Seven Remote Control
Preamplifier/Tuner with Asymmetrical
Charge Coupled FM Detection and
Sonic Holography.[®]*

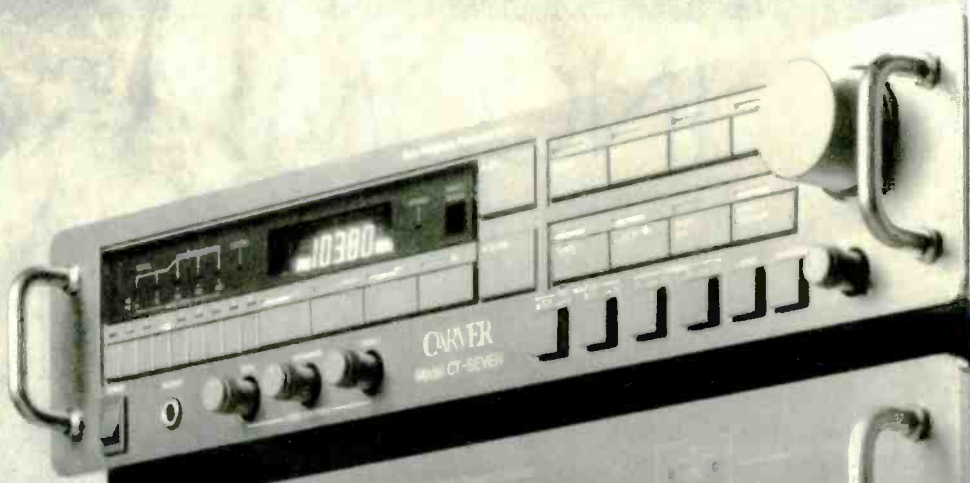

The Brawn.

*Your choice of four high power advanced
Magnetic Field amplifier designs.*

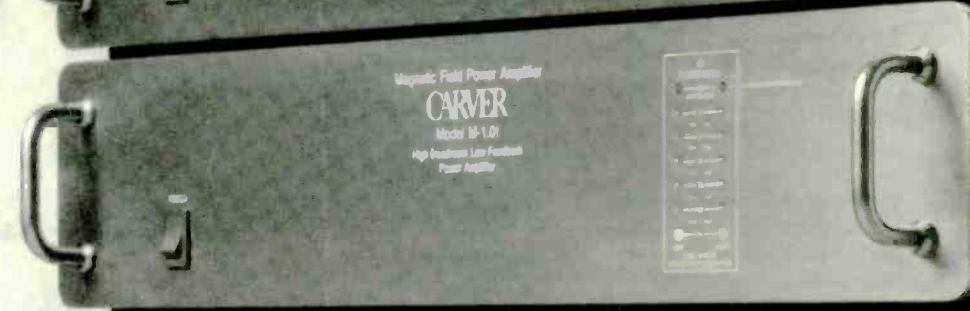

Powerful

Distributed in Canada by: **evolution
technology**

Power and finesse. They've always been important factors in a serious listening system. Now there's a new way to achieve both without overpowering your budget.

Our new CT-Seven preamplifier/tuner combines a Sonic Holography® preamplifier and Asymmetrical Charge-Coupled FM Detection tuner into one convenient component.

It makes beautiful music with our whole line of Magnetic Field Power amplifiers. Including the new M-4.0t with the same transfer function and power output as Bob Carver's \$17,500-pr. ultra-esoteric Silver Seven monoblock amplifiers.

The CT-Seven as an audiophile preamplifier: Like Carver's fine separate preamplifiers, the CT-Seven is designed as a "straight wire with gain," capable of perfectly passing input signals without adding or subtracting any musical nuances.

It includes a meticulously engineered, ultra-low noise phono stage that flawlessly duplicates the theoretical RIAA equalization curve.

The CT-Seven as a complete sound control center: From the comfort of your listening chair you can choose from six sound sources including dual tape monitors, CD input and video/auxiliary inputs (suitable for video sound or DAT). Unlike most remote volume adjustments which use distortion-inducing electronics, the CT-Seven employs a motorized volume control for smooth control and smoother sound quality. Also included are useful 3-band tone controls, mono switch, loudness equalization and a studio-quality headphone amplifier.



The CT-Seven as your passport to musical reality: The CT's Sonic Holography® Generator is capable of redefining your perception of music by recreating the sound stage and 3-dimensional spatial characteristics of a live performance. According to some of America's top reviewers, Sonic Holography® "... seems to open a curtain and reveal a deployment of musical forces extending behind, between and beyond the speakers. The effect strains credibility."

And you can create it from any stereo record, tape CD or even FM broadcast. With your existing speakers. At the touch of a remote button.

The CT-Seven as a high performance quartz synthesized FM tuner: You've simply never heard FM until you've heard it through the Carver Asymmetrical Charge-Coupled FM Detector circuit. Multipath distortion, interference and distant station noise are dramatically reduced. Weak stations emerge into dramatic clarity. Yet stereo separation, space, depth, and ambience were not only retained, but seemingly enhanced by the lack of background noise.

Choose 8 FM and 8 AM presets by remote control. Scan the broadcast band automatically or manually. With the CT-Seven's ACCD circuit on, you'll discover "new" stations which were previously unlistenable!

The CT-Seven's power partners: Only Carver gives you four high power amplifier choices from 140 watts to 375 watts per channel. Each is perfectly matched to the CT-Seven. And each uses Carver's cool-running Magnetic Field Technology which dispenses with bulky power supplies and power-wasting external heat sinks... yet which is so rugged it's used in the world's largest touring professional sound systems.

Choose from the new "modestly-powered" M-0.5t (140 watts per channel RMS 20-20kHz both channels driven into 8 ohms with less than 0.1% THD), the M-1.0t (200 watts/ch. per channel RMS 20-20kHz both channels driven into 8 ohms with less than 0.15% THD), M-500t (250 watts per channel RMS 20-20kHz both channels driven into 8 ohms with less than 0.15% THD), or the new M-4.0t (375 watts per channel RMS 20-20kHz both channels driven into 8 ohms with less than 0.5% THD).

Hear brains and brawn together at your Carver dealer. Switch the CT-Seven and the most expensive tuner in the room to hear Asymmetrical Charge-Coupled FM Detection work its magic. Put on your favorite CD, press the CT-Seven's Sonic Holography® remote button and feel the sound room "disappear." Turn up the volume to live performance levels and discover the impact of true dynamic headroom.

And then get ready for another pleasant experience when you discover what a super value the CT-Seven and Carver power amplifiers are.

CARVER

Musical

Accurate

P.O. Box 1237, Lynnwood, WA 98046

CIRCLE NO. 168 ON READER SERVICE CARD

JAZZ

Jimi Hendrix song, Bono adds, "All I've got is this red guitar, three chords, and . . . the truth!"), and even a gatefold photo of the band at one of the holiest shrines of rock-and-roll, the Sun Studios where Elvis Presley cut his first records.

Unfortunately, "Rattle and Hum" is also something of a mess, and not simply because such displays of high-mindedness are beginning to look a little pretentious (sorry guys, you're a successful arena-rock band, not Vatican II). The real problem with much of what's captured here is that the band is musically out of its depth. In the attempt to identify with the wretched of the earth, Bono and company try to appropriate certain blues and country styles whose essence eludes them. The result is either tedium (*Van Diemen's Land*) or unintentional parody (*Angel of Harlem*), and while these guys aren't the first Brits who've mangled American roots music (remember Elvis Costello's "Almost Blue"?), that doesn't make "Rattle and Hum" any less painful.

Of course, when it stays within the narrow confines of its own distinctive style, U2 remains an impressive, even moving band, as the live versions of some of its better-known songs included here clearly demonstrate. And to be fair,

the Beatles cover makes a certain kind of sense in theory, given the similarity between *Helter Skelter's* signature guitar line and the Edge's trademark chiming. Mostly, though, this album is an embarrassing dud by an outfit that has gotten so big it's forgotten how to play to its own strengths. S.S.

KIM WILDE: *Close.* Kim Wilde (vocals); instrumental accompaniment. *Hey Mister Heartache; You Came; Love in the Natural Way; Never Trust a Stranger; European Soul; Stone;* and four others. MCA MCA-42230. © MCAC-42230, © MCAD-42230 (43 min).

Performance: *Limited*
Recording: *Good*

As long as the rhythms remain locked into a discofied gallop, the melodies stay restrained, and the subject matter is simplistic, Kim Wilde is fine. That's the case with most of "Close." The tempos and tunes are programmed and so, at times, are the lyrics. Nearly every song deals with romance, yet they have a curious lack of passion. There's probably a good reason for this: On the two occasions that Wilde strays from the formula, she sounds stiff and awkward. Maybe she's programmed as well. R.G.

BENNY GOODMAN: *The Benny Goodman Yale Archives, Volume 1.* Benny Goodman (clarinet); other musicians. *Sweet Georgia Brown; Broadway; Slipped Disc; Blue Room; Diga Diga Doo; Lullaby in Rhythm;* and six others. MUSICMASTERS 20142S, © 40142A, © 60142Z (50 min).

Performance: *Good*
Recording: *Very good*

When Benny Goodman died in 1986, he left five truckloads of tapes, arrangements, and memorabilia to Yale University. Included were the twelve performances found on this Musicmasters release, the first in a planned series featuring previously unissued Goodman material. Made between 1955 and 1986, the twelve selections feature the Swing Era star in fine form, and the stellar cast of "sidemen" includes Zoot Sims, Joe Newman, Bill Harris, Flip Phillips, Teddy Wilson, and Red Norvo. With instrumental combinations ranging from a quintet to a full band, the album is a memorable, diversified Goodman (Continued on page 124)

Five years ago, the PS-10 got great reviews. It still earns them today, in a store near you.

In 1983, *Rolling Stone* said, "...the PS-10 loudspeakers by Design Acoustics could be the last pair you'll ever buy." *High Fidelity* commented, "The overall sound is smooth, clean, and detailed." *Ovation* noted that the PS-10, "...provided a very open and transparent sound with excellent and stable stereo imaging." And *Stereo Review* concluded that,

"...the PS-10s delivered a smooth, balanced sound... (enabling them) to fit almost anywhere both aesthetically and acoustically."

A MODERN-DAY CLASSIC

The PS-10 continues to earn thousands of new friends with its unique Point Source™ design. The PS-10 has the smallest possible front face, to eliminate diffraction and reflections that blur the stereo image from ordinary bookshelf speakers. Plus a down-firing 10" woofer that is always exactly coupled to the room, regardless of its location.

MEETS THE DIGITAL CHALLENGE

Over the years, the PS-10 has been constantly refined and improved. Today, it meets the challenge of digital recordings with impressive performance, yet easily fits the smallest room neatly and unobtrusively. Write for dealer list and literature today.

DCI DESIGN[®]
ACOUSTICS
An Audio-Technica Company
1225 Commerce Drive, Stow, OH 44224

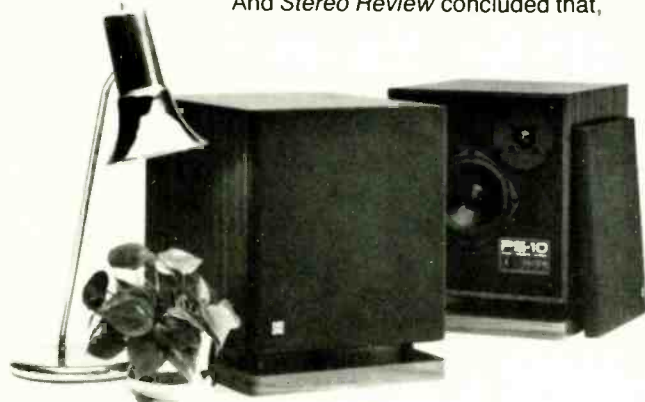

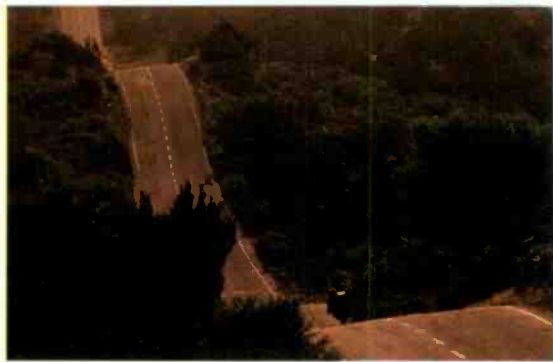

DISCOVER TODAY'S MOTORCYCLING.

Here are just a few of the 11 million Americans who ride motorcycles, and if it looks like they're having fun, it's because they are. If you've ever thought you'd like to be one of them, this is your invitation. For the Motorcycle RiderCourse nearest you, call toll free: 800-447-4700.

**DISCOVER
TODAY'S
MOTORCYCLING**



Cassette Decks



Teac V-285CHX Stereo Cassette Deck

• Dolby B & C noise reduction • Dolby HX Pro headroom extension system • Two tape head design • DC motor • Tape bias control • Black

Sale Price **\$99⁹⁵** Retail \$160

- Teac V-770**
3-heads with IC logic controls . . . \$269⁹⁵
- Teac V-970X**
3-head dbx stereo cassette deck . . . \$479⁹⁵
- Teac R-425**
Auto-reverse Dolby stereo cassette deck \$119⁹⁵
- Teac R-435X**
Auto-reverse Dolby dbx cassette deck \$149⁹⁵
- Teac R-616X**
Auto-reverse Dolby B/C & dbx cassette \$299⁹⁵
- Technics RS-829R**
Auto-reverse Dolby B/C cassette . . . \$199⁹⁵

Compact Disc Players



Technics SL-P150 High Resolution CD Player

• 4X (176.4 kHz) oversampling digital filter • 2 digital-to-analog converters • High speed transport • Preset edit • Track/disc/program repeat • 20 track memory

Sale Price **\$174⁹⁵** Retail \$240

- Sharp DX-650**
Our "Best Buy" programmable CD player \$117⁹⁵
- Teac PD-155**
2X Oversampling, 3-beam laser . . . \$149⁹⁵
- Teac PD-450**
Remote, 3-beam laser, CD player . . . \$174⁹⁵
- Technics SL-P230**
16-bit/4X oversampling, programmable \$199⁹⁵
- Technics SL-P250**
Remote control, 4X oversampling . . . \$219⁹⁵
- Technics SL-P350**
18-bit remote control CD player . . . \$259⁹⁵

Compact Disc Players



Teac AD-4 CD Player/Cassette Deck Combo

• Wireless remote control of both CD & cassette sections • 16-track random program dubbing & play • Dolby B & C • Auto reverse record/play • Synchro start dubbing

Sale Price **\$279⁹⁵** Retail \$599

- Teac AD-7**
CD player/Cassette deck combo . . . \$399⁹⁵
- Teac PD-500M**
6-disc remote control CD changer . . . \$259⁹⁵
- Technics SL-P600C**
6-disc oversampling CD changer . . . \$329⁹⁵
- Toshiba XR-9057**
6+1 disc CD changer . . . \$274⁹⁵
- Magnavox CD-8473**
785-track programmable, remote . . . \$229⁹⁵
- Akai CD-A305B**
Remote control, 3-beam laser . . . \$179⁹⁵

This Month's



39⁹⁹ 10 CD Set
Laserlight 15800



17⁹⁹ 5 CD Set
Laserlight 15900

Double Cassette Decks

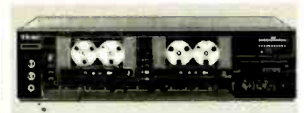

Teac W-99ORX Stereo Double Reverse Cassette Deck

• Dolby B/C and dbx • Cobalt amorphous tape heads • Record timer • 3-motor transport • Intro check • Random program dubbing system • Auto tape select • Wireless remote

Sale Price **\$499⁹⁵** Retail \$759

- Teac W-350**
Dolby B stereo double cassette deck \$99⁹⁵
- Teac W-370**
Dolby C stereo double cassette deck \$119⁹⁵
- Teac W-450R**
Auto-reverse Dolby B/C double cassette \$199⁹⁵
- Teac W-660R**
Double auto-rev, Dolby B/C . . . \$299⁹⁵
- Technics RS-T230**
Dolby B/C high speed double deck \$179⁹⁵
- Sherwood S-289RDR**
Double auto reverse cassette deck \$199⁹⁵

Stereo Receivers



Teac AG-35 AM/FM Stereo Receiver

• 35 watts RMS per channel • LED power level meters • Quartz PLL tuner • 16 station presets • Search • LCD frequency display • Black finish

Sale Price **\$139⁹⁵** Retail \$199

- Technics SA-130**
35 watts/channel analog receiver . . . \$89⁹⁵
- Technics SA-290**
50 watts/channel digital receiver . . . \$149⁹⁵
- Harman Kardon HK-7951**
70 watts/channel digital receiver . . . \$449⁹⁵
- Sherwood S-2730CP**
35 watts/channel A/V receiver . . . \$119⁹⁵
- Sherwood S-2750CP**
55 watts/channel A/V receiver . . . \$149⁹⁵
- Sherwood S-2770CP-II**
75 watts/channel A/V receiver . . . \$249⁹⁵

Stereo Speaker Specials



The Bose Acoustimass AM-5 Speaker System

• A new technology for the home • Clean sound & low distortion system contains • 4 2.5" wide range drivers • New Acoustimass bass system • Black satin finish

Sale Price **\$699⁹⁵** Retail \$799

- Bose "RoomMate"**
Powered mini speaker . . . pair \$299⁹⁵
- Bose 101**
Mini speaker system, black finish pair \$179⁹⁵
- Pinnacle PM5+**
Top rated 2-way mini speakers . . . pair \$129⁹⁵
- Koss M80+**
2-way mini speakers . . . pair \$139⁹⁵
- Technics SB-L36**
2-Way speaker, 10-inch woofer . . . pair \$99⁹⁵
- Technics SB-L56**
3-way speaker, bass-reflex design pair \$149⁹⁵

Equalizer Specials



ADC SS-325X Memory Equalizer/Real Time Analyzer

• Precision 12 band graphic equalizer • 5 memories for storing EQ curves • Fine resolution bass control • Real time analyzer includes microphone, and large display

Sale Price **\$269⁹⁵** Retail \$399

- Nikko EQ-30**
Pro 30-band mono equalizer . . . \$249⁹⁵
- Teac EQ-A5**
10-band graphic equalizer . . . \$69⁹⁵
- Teac EQ-A30**
10-band graphic EQ with spectrum . . . \$199⁹⁵
- ADC SS100SL**
10-band graphic EQ with display . . . \$99⁹⁵
- ADC SS300SL**
10-band graphic EQ with RTA . . . \$169⁹⁵
- ADC SS525X**
12-bands with Automatic EQ . . . \$369⁹⁵

Amplifiers/Tuners/Mixers

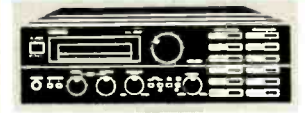

Nikko NA-2000 High Power Integrated Amplifier

• 100 watts RMS per channel • Recording output selector • 2-tape monitors • Bi-directional dubbing • Stereo-wide mode • MC cartridge input • DC amplifier section

Sale Price **\$199⁹⁵** Retail \$330

- Nikko A-130**
100 Watts per channel power amplifier \$249⁹⁵
- Nikko A-230**
120 Watts/channel pro power amplifier \$349⁹⁵
- SAE T-101**
Computer direct line AM/FM tuner \$249⁹⁵
- Atus AM-100**
2-phono, 2 aux stereo mixer . . . \$79⁹⁵
- Gemini MX-5200**
3-phono inputs 7-band EQ stereo mixer \$159⁹⁵
- Gemini MX-9200**
3-phono inputs 20-band EQ mixer . . . \$274⁹⁵

Turntable Specials



Technics SL-QD22 Quartz Direct Drive Turntable

• Auto return system features separate torque motor • P-Mount cartridge connector • Front panel controls • Quartz controlled accuracy • Black finish

Sale Price **\$119⁹⁵** Retail \$195

- Technics SL-BD20**
Semi-automatic belt-drive turntable . . . \$79⁹⁵
- Technics SL-DD22**
Semi-automatic direct-drive turntable \$109⁹⁵
- Akai AP-A305CB**
Semi-automatic belt-drive turntable . . . \$89⁹⁵
- ADC LT-1**
Linear tracking for great sound . . . \$79⁹⁵
- Sherwood ST-875**
Semi-automatic belt-drive . . . \$99⁹⁵
- Gemini DJQ-1300**
Manual direct drive turntable . . . \$169⁹⁵

Phono Cartridges



Shure V-15 Type V-MR Deluxe Micro Ridge Phono Cartridge

• Micro ridge stylus tip • Excellent trackability • Dynamic stabilizer • Side-guard stylus protection • Duo-point alignment gauge

Sale Price **\$129⁹⁵** Retail \$299

- Shure V15-IVMR**
Micro ridge stylus . . . \$69⁹⁵
- Shure V15-HRP**
P-mount cartridge, HyperRidge stylus . . . \$49⁹⁵
- Audio Technica AT231LP**
Universal mount, Linear stylus . . . \$39⁹⁵
- Audio Technica AT216EP**
Universal mount cartridge . . . \$29⁹⁵
- Stanton 680EL**
Top-of-the-line pro disc cartridge . . . \$54⁹⁵
- Stanton 1500AL**
P-mount disc cartridge . . . \$19⁹⁵



ORDER TOLL-FREE **1-800-221-8180** IN NEW YORK, ALASKA & CANADA CALL: 1-718-417-3737
 Mail Order Hours: Monday To Friday 8 AM to 8 PM, Saturday 9 AM to 6 PM, Sunday 10 AM to 4 PM
 Dealer & Institutional Inquiries Call Toll-Free 1-800-221-3191 — In New York 1-718-417-3747
 J&R Music World, Dept. SRO189, 23 Park Row, New York City, NY 10038



MUSIC WORLD

Super Specials

VHS Video Movie Specials



18⁹⁵ Each

FIVE EASY PIECES

Also Available:
 • Easy Rider
 • The Last Detail



18⁹⁵ Each

LA BAMBA

Also Available:
 • The Big Chill
 • Dr. Strangelove
 • Stand By Me
 • Silverado
 • Ghostbusters
 • The Karate Kid

Portable Stereo



Panasonic RX-SA79
 XBS Radio/Cassette Stereo-To-Go
 • XBS extra bass system • AM/FM stereo tuner
 • 3-band equalizer • Auto reverse Dolby B
 cassette • NiCad battery and charger • XBS
 lightweight headphones • Black

Sale Price **\$139⁹⁵** Retail \$169

Sony WM-F100III
 AM/FM cassette SuperWalkman . . . \$129⁹⁵

Sony WMA-F55
 AM/FM cassette with Mega bass system . . . \$59⁹⁵

Sony DT-4
 AM/FM stereo compact disc portable . . . \$249⁹⁵

JVC PC-V55
 AM/FM cassette, auto-rev, 5-band EQ . . . \$149⁹⁵

Panasonic RX-FW39
 AM/FM cassette w/XBS super woofer . . . \$169⁹⁵

Toshiba XR-9457
 Rechargeable AM/FM CD player . . . \$249⁹⁵

Audio Add-Ons



Terk FM-8500
 Electronic Indoor FM Antenna
 • Omnidirectional design improves reception
 • Adjustable gain control • Amplifies incoming
 signal by up to 24 times • AC operated • One-
 year warranty

Sale Price **\$34⁹⁵** Retail \$89

Terk FM-9500
 Deluxe electronic FM antenna . . . \$59⁹⁵

Terk FM-9650
 New disc shaped electronic FM antenna . . . \$79⁹⁵

dbx 224XDS
 Type II tape noise reduction . . . \$179⁹⁵

dbx 200XG
 Program route selector . . . \$79⁹⁵

Nikke CO-23
 2-way stereo crossover . . . \$299⁹⁵

Parsec LS-4
 Electronic FM antenna . . . \$54⁹⁵

Video Specials



Akai VS-33U
 4-Head Quick Start VHS Video Recorder
 • Exclusive quick start tape handling
 • DX4-head system with HQ circuitry • 107
 channel cable ready tuner with 62 presets
 • Wireless remote • 30 day/4 event timer

Sale Price **\$299⁹⁵** Retail \$449

Panasonic PV-4860
 4-head Hi-Fi video recorder . . . \$499⁹⁵

Panasonic PV-S4864 S-VHS
 4-head Hi-Fi video recorder . . . \$779⁹⁵

Panasonic PV-400
 VHS Camcorder, FREE PVMAO case . . . \$999⁹⁵

JVC HR-D750
 4-Head Hi-Fi video recorder . . . \$579⁹⁵

Samsung VR-2000
 VHS HQ remote control video recorder . . . \$219⁹⁵

Sony KV-27XRI0
 27-inch XBR TV/monitor, MTS stereo . . . \$999⁹⁵

Stereo Headphones



Beyerdynamic DT-990
 Audiophile Stereo Headphones
 • Open style headphones with an unbelievable
 frequency response of 5-35kHz • Unique
 moving coil assembly • Exceptional transient
 response

Sale Price **\$179⁹⁵** Retail \$220

Koss Pro450
 NEW high quality closed ear design . . . \$138⁹⁵

Sony MDR-V6
 Digital ready, perfect for portables . . . \$74⁹⁵

Koss JCK200
 Closed ear wireless headphones . . . \$118⁹⁵

Sony MDR-WIOL
 Extra lightweight stereo headphones . . . \$13⁹⁵

Koss Pro4AAA+
 Studio quality closed ear design . . . \$38⁹⁵

Sennheiser HD-430
 Digital ready open air design . . . \$89⁹⁵

Audio Accessories



Recoton W-100
 Wireless Stereo Speaker System
 • Eliminate the need for room-to-room wires
 • Enjoy true stereo anywhere you choose
 • Speakers plug into convenient wall AC
 outlets anywhere

Sale Price **\$199⁹⁵** Retail \$299/PR

Discwasher CD
 Compact disc cleaner with fluid . . . \$12.89

AudioSource LLC1
 CD Player lens cleaner . . . \$24⁹⁵

Discwasher DiscKit
 Record cleaning system w/Zerostat . . . \$31⁹⁵

Memorex CS-40
 Cordless headphone trans/receiver . . . \$69⁹⁵

Monster Cable 10/10
 High quality speaker cable, 10-foot/ear . . . \$24⁹⁵

Monster ACK/KIT
 Interlink 300 w/XP speaker cable . . . \$24⁹⁵

Home/Office



Brother WP-55
 Word Processor/Office System
 • High resolution monitor • 91 by 15 display • 15
 CPS daisywheel printer • 64K memory
 • 70,000 word Spell-Right • Block move
 copy

Sale Price **\$569⁹⁵** Retail \$899

Brother FAX60
 Fax with answering machine & phone . . . \$999⁹⁵

Smith Corona PWP-80
 Word processor w/LCD display . . . CALL

Brother AX-22
 Electronic typewriter with correction . . . \$144⁹⁵

Sharp Z70
 Compact personal copier . . . \$799⁹⁵

Code-A-Phone 3570
 Remote answering machine w/dialer . . . \$89⁹⁵

Sony IT-M500
 Phone, 54 dialer, speakerphone . . . \$88⁹⁵

Cassette Tape Specials



TDK SA-100
 Extended Length High Bias Cassettes
 • Now 100 minutes for extended length and
 compact disc recording • Super precision
 anti-resonance mechanism • Super high
 resolution

Sale Price **\$24⁹⁵** 10 Pack

TDK MIX
 Get 2 SA90 & 1 SA90 together... 3-pack . . . \$5⁹⁹

TDK SAX90
 Extended range high bias . . . Each \$2⁹⁹

Maxell MX90
 Metal bias cassette . . . Each \$2⁹⁹

Sony UX-Pro90
 Top rated high bias . . . Each \$2⁹⁹

Sony UX90
 Normal bias, great for portables . . . Each \$1⁶⁹

Fuji Metal90
 Metal bias cassette tape . . . \$2¹⁹

Radar Detectors



BEL Vector 3 or Whistler Spectrum II
 Radar Detectors

Your Choice **174⁹⁵**

Cobra RD-3160
 Shirt pocket size radar detector . . . \$139⁹⁵

Cobra RD-3170
 Voice synthesized warning system . . . \$168⁹⁵

Uniden RD-9XL
 Super small super hot radar detector . . . \$174⁹⁵

Clarion 8825RT
 AM/FM cassette car receiver . . . CALL

Sherwood XR-1604
 Auto-rev, Dolby B&C, 20 watts x 2 . . . \$269⁹⁵

Hifonics Thor
 125 watts X 2 car power amplifier . . . \$309⁹⁵

Musical Instruments



Yamaha DD-5
 Portable Digital Drum Set
 • 4 touch sensitive drum pads • 12 PCM
 percussion instrument sounds • 30 preset auto
 rhythms • Tempo control • Intro/Fill-in • Drum
 sticks included

Sale Price **\$99⁹⁵** Retail \$99

Yamaha PSS-130
 32-key mini keyboard, 8 preset sounds . . . \$39⁹⁵

Yamaha PSS-480
 49-key midi keyboard, 100 sounds . . . \$164⁹⁵

Casio PT-100
 32-key mini keyboard, 6-note polyphonic . . . \$44⁹⁵

Casio DH-100
 MIDI wind instrument, 6 preset tones . . . \$164⁹⁵

Casio DG-10
 Electronic guitar instrument . . . \$249⁹⁵

Casio CP-S101
 61-key full size, programmable . . . \$319⁹⁵



FREE CATALOGUE

For a FREE catalogue call toll-free
 800-426-6027, or Write:
 J&R Music World
 Department SRO189
 59-50 Queens-Midtown Expressway
 Maspeth, NY 11378.

Name _____
 Address _____
 City _____ State _____ Zip _____

SEND MONEY ORDER, CERTIFIED OR CASHIER'S CHECK, MASTERCARD, VISA, AMERICAN EXPRESS OR DISCOVER CARD (include Interbank No. expiration date and signature.) TO: **J&R MUSIC WORLD, DEPT. SRO189, 23 PARK ROW, NEW YORK CITY, NY 10038.** Personal and business checks must clear our Authorization Center before processing. Shipping, Handling & Insurance Charge is 5% of Total Order with a \$4.95 minimum. (Canadian Orders Add 15% Shipping, with a \$9.95 minimum charge.) For shipments by air, please double these charges. \$25 MINIMUM ORDER. DO NOT SEND CASH. Sorry, NO C.O.D.'s. NEW YORK RESIDENTS PLEASE ADD SALES TAX. WE ARE NOT RESPONSIBLE FOR TYPOGRAPHICAL ERRORS. ALL PICTURES SHOWN FOR VISUAL REPRESENTATION ONLY. ALL MERCHANDISE SHIPPED BRAND NEW, FACTORY FRESH, AND 100% GUARANTEED.



MAXINE SULLIVAN



IF ever a singer captured and sustained a sense of boundless, swinging joy, it was Maxine Sullivan, whose popularity during the big-band era was closely linked to a single hit, a Claude Thornhill version of the folk song *Loch Lomond*. A diminutive woman of great spirit, Sullivan had an oddly shaped career. She achieved popular success in the late Thirties and was widely known for her vocal work with the John Kirby band in the Forties, but she dropped out in the mid Fifties to work as a nurse. She returned formally as a singer in 1967, recording on small labels with minimal distribution and singing in small clubs. By the late Seventies she was singing with far more authority, mastery of cadence, and distinction of style than she ever had before.

Sullivan's mature gifts are wonderfully captured on a new compact disc, "Swingin' Sweet," that was recorded live in 1986 at the Fujitsu-Concord Jazz Festival in Tokyo. She is accompanied by the Scott Hamilton Quintet, and the forty-six minutes of music includes such favorites as *I Got a Right to Sing the Blues*, *Something to Remem-*

ber You By, *Georgia on My Mind*, and, of course, *Loch Lomond*.

While this disc can be enjoyed for the pure pleasure it provides, it has special significance as a document of Sullivan's last major public performance. She died in 1987 in the Bronx, where she was as well known as a community leader as she was as an artist. With this recording, she has left us something to remember her by at her best. *Phyl Garland*

MAXINE SULLIVAN, SCOTT HAMILTON QUINTET: *Swingin' Sweet*. Maxine Sullivan (vocals); Scott Hamilton (tenor saxophone); John Bunch (piano); Chris Flory (guitar); other musicians. *Sweet Georgia Brown; As Long as I Live; I Got a Right to Sing the Blues; Something to Remember You By; Wrap Your Troubles in Dreams (And Dream Your Troubles Away); Georgia on My Mind; You Were Meant for Me; A Hundred Years from Today; Just One of Those Things; I'm Crazy 'Bout My Baby (And My Baby's Crazy 'Bout Me); I Hadn't Anyone Till You; Cheatin' on Me; You're Driving Me Crazy; Loch Lomond.* CONCORD JAZZ © CCD-4351 (46 min).

weave that should delight anyone who likes jazz served straight up and swinging. The series promises to be a valuable one. *C.A.*

JOHN KLEMMER: *Nexus One (For Trane)*. John Klemmer (tenor saxophone); Bob Magnusson (bass); Carl Burnett (drums). *My One and Only Love; Impressions; Nexus; Mr. P.C.; Softly as in a Morning Sunrise.* RCA © 6577-2-RB (57 min).

Performance: *A bit self-indulgent*
Recording: *Good*

Tenor saxophonist John Klemmer seems to have suffered a musical identity crisis. His previous albums ranged from undisciplined utterances made in the name of the avant-garde to some frankly pop-ish items. Now, in "Nexus One," an album dedicated to John Coltrane, he strives to prove that there is something of substance in his playing, something a true jazz fan can embrace. Klemmer is accompanied here only by drums on three tracks, with a bass added for the other two. It's a little self-indulgent—one or two such solo tracks would have made the point—but it's an attractive set nonetheless. *C.A.*

COLLECTION

JAZZ FROM THE USSR. Oleg Lundstrem Orchestra: *Jive*. David Azarian Trio: *My Favorite Things*. Allegro Jazz Ensemble: *Song of Fading Flowers; A Trip with Pleasant Company*. Valery Mysovsky Trio: *Red Roses for a Blue Lady*. Leonid Chizhik: *Sentimental Elegy*. And five others. MELODIYA/MOBILE FIDELITY © MFCD 890 (63 min).

Performance: *Generally good*
Recording: *Very good*

Somehow we always seem amazed to hear that they're playing jazz in Russia, but what should surprise us is how good it sounds. In the past three or four decades, European jazz has reached a very high level of quality, in large measure thanks to the access the musicians have had to their American counterparts. Many U.S. musicians have taken up residence on the Continent, others flock there each year to play the festivals, and there is no shortage of jazz recordings. The Russians, on the other hand, have a hard time getting to know the real thing, but you wouldn't think so from hearing the sounds of tenor saxophonist Nikolai Panov with Oleg Lundstrem's big band, David Azarian's Bill-Evans-like reading of *My Favorite Things*, or Nikolai Levinovsky's Brazilian-sounding Allegro Jazz Ensemble in "Jazz from the USSR." Released by Mobile Fidelity Sound Lab in an arrangement with Russia's Melodiya label, the album contains a full hour of intriguing, sometimes excellent jazz by Soviet artists, not counting a brief rendering of *Sweet Sue* that sounds like a bad night at the Red Blazer. *C.A.*

SAVE MONEY, TIME AND FREIGHT ON FAMOUS BRAND STEREO EQUIPMENT

illinois audio

(800) 621-8042 / (312) 664-0020
12 E. DELAWARE PLACE • CHICAGO, IL 60611

LOUDSPEAKERS



TECHNICS SBL-36
Powerful Loudspeaker System
• Linear Phase 2-Way System • Large Diam. 10" Woofer • Anti-resonance cabinet • Attractive Woodgrain Finish
CALL FOR PRICE

E.P.I. CD55
3-Way Speaker System

• 12" Bass Driver • Wide Frequency Response • Constant Dispersion Design • Specially Designed High Efficiency Cabinet
List: \$250.00 ea.
SALE: \$99.00 ea.



TECHNICS SBK476
3-Way Speaker System

• 12" Woofer • Horn Super Tweeter • High Heat Resistance • Efficiency Bass Reflex Design • Heavy Duty Anti-Resonance Cabinet
CALL FOR PRICE



E.P.I. T/E320
Powerful 3-Way Speaker System

• 10" Bass Drive • Amazingly Accurate Frequency Response • Ultra-Wide Dispersion • Integrated Midrange/Treble
CALL FOR PRICE



PORTABLES

TOSHIBA RT4048
AM/FM Stereo Radio
Cassette Player

• Dolby B NR • Auto Reverse • 3 Band EQ • Built-In Stereo Tuner • Auto Shut-Off • Lightweight Headphones • Belt Clip Included
List: \$89.95
SALE: \$55.00



SONY WMF100III
Sony Super Walkman
AM/FM Stereo Cassette
Player • Xtra Small Size

• Auto Reverse • Quick Charger • Dolby B NR
List: \$199.95
SALE: \$125.00



SONY D-15
Discman Portable
CD Player

• Ultra Small & Light Wt. • 24-Track Random Music Sensor • 4-Repeat Modes • Unilinear Converter w/ Digital Filter
CALL FOR PRICE



AUTO



SONY ESS-93

6" x 9" 3-Way Car Speakers
• Hi-Power • Oval Shape • 80 Watts Max. Power Handling
List: \$109.95 Pair **SALE: \$66.00 Pair**



SHERWOOD GRD350
Car Stereo with Cassette Deck

• AM Stereo/FM Stereo Receiver • Full Logic Controlled • Dolby B/C NR • Auto Reverse • Built-In Amp. w/Balance & Fader • Local/Dist. Switch • Preset Scan • Clock • Security Cover
List: \$329.95 **SALE: \$182.00**

CASSETTE DECKS



TEAC V-285CHX
Stereo Cassette Deck

• Dolby B & C & HX PRO NR • Bias Fine Tuning • Full Auto Stop Mech. • Metal Tape Compatible • 3-Pos. Tape Select. • 3-Digit Tape Counter
List: \$149.95 **SALE: \$99.95**



TEAC R435X
Auto Reverse Cassette Deck

• Bi-Directional record and playback • Dolby B, C & dbx Noise Reduction • 3-position tape selector • Output level controls
List: \$265.00 **SALE: \$149.95**



TECHNICS RST-55R
Double Quick Reverse
Cassette Deck

• Auto Reverse on Both Tape Drives • 24 Hr. Contin. Playback • Hi-Spd. Editing • Synchro Start, Stop & Mute • dbx, Dolby B & C
CALL FOR PRICE



TEAC W990RX
Auto Reverse Double Cassette Deck

• Continuous Recording/Playback • 3-Motor IC Logic • Wireless Remote Control • Sync Reverse • 2-Speed Dubbing • Reverse Editing • Dolby B, C & dbx NR
CALL FOR PRICE

RECEIVERS



TECHNICS SA-180
Quartz Synthesizer
AM/FM Stereo Receiver

• 70 Watts (35x2) • 16 Memory Presets • Tape Mon. Switch • Bass & Treble Controls • Quartz Clock • Low Distortion
List: \$240.00 **SALE: \$127.00**



TECHNICS SAR-330
Quartz Synthesized
Remote Controlled Receiver

• AM / FM Stereo Receiver • 140 Watts (70x2) • Full Remote Control • 24 Presets • 7-Band EQ w/ Spectrum Analyzer • 4 Aud. Inputs plus 2 Aud. / Vid. Inputs • Station File
CALL FOR PRICE



JVC RX-777VS
Surround Sound Receiver

• AM / FM Stereo Digital Receiver • 160 Watts (80x2) • Dolby Surround Sound • Built-In Synthesizer-Tuner • 40 Memory Presets • 7-Band EQ • 2 PR. Speaker Connections
CALL FOR PRICE



JVC RX-999
Remote Controlled Receiver

• 200 Watts (100x2) • Digital Dolby Surround Sound • 3 Video Inputs • Programm. 7 band EQ • Dig. Synth. Tuner • 80 presets • Preset Scan
CALL FOR PRICE

CD PLAYERS



SHARP DX-650
Compact Disc Player

• 3-Beam Laser Pick-up • Programmable Memory • Cue/Review
List: \$249.95 **SALE: \$119.95**



TECHNICS SLP-520
Remote Controlled CD Player

• Double Oversampling Filter • Program up to 20 Selections • 2-Speed Search • High Resolution Laser Pick-Up • High Speed Transport • Preset Editing • Music Scan
List: \$550.00 **SALE: \$259.95**



SONY CDP-22
Compact CD Player

• Unilinear Converter w/Digital Filter • Env. Diff. Detection Sys. • 16-Track Random Music Sensor • Auto Music Sensor • 4 Repeat Modes w/Shuttle Play
List: \$250.00 **SALE: \$179.00**



TECHNICS SLP400C
Multi-Disc CD Changer

• Programmable 6-Disc Changer/Player • Remote Control • 36-Step Random Access Program • Quadruple Oversampling Digital Filter • High Resolution Laser Pick-Up
CALL FOR PRICE



JVC XLM600
CD Multi Changer

• 6-Disc Capability • Remote Control • Random Access Program. up to 32 steps from 7 discs • Repeat • Memory back-up • 3 Beam Laser Pick-up and digital filter
CALL FOR PRICE

TURNTABLES

TECHNICS SLBD22
Belt Drive Semi-Automatic Turntable

• TAP Cartridge Connect. Sys. • Highly Sens. Gimbal Suspension Tonearm • Anti-Vibr. Construction • Pitch Control • Illum. Stroboscope
CALL FOR PRICE

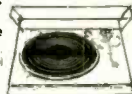

TECHNICS SLDD33
Phase Locked Direct Drive Automatic Turntable

• Highly Sensitive Gimbal Sus. Tonearm • TAP Mount Cart. Connector System • Front Panel Oper.
CALL FOR PRICE

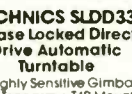

DUAL CS505-2
Belt Driven Semi-Automatic Turntable

• Ultra Low Mass Tonearm • Interchangeable 1/2" Mount Pick-Up Head • Fine Speed Adjustment • Anti-Resonance Mat • Two Scale Anti-Skate Device • Floating Chassis
List: \$299.00 **SALE: \$199.95**



HEADPHONES

KOSS PRO4X PLUS

Lightweight Design • Pro Choice • Digital Ready
List: \$90.00 **SALE: \$49.95**

SENNHEISER HD450

Open Air • Innovative Design • Sound Isolating
CALL FOR PRICE

SONY MDR CD6

Adjustable • Open Air • Digital Ready
List: \$119.95 **SALE: \$79.00**

AUDIO TAPE

TDK SD-90

Ultra Quiet Hi-bias tape
10 for **\$12.50**

SONY UX-PRO 90

High bias, perfect for live or digital recordings
10 for **\$24.89**

MAXELL UDSII90

Standard Hi-bias cassette
10 for **\$16.95**

MAXELL MX90

Metaxial 90 min. cassette
10 for **\$25.95**

CARTRIDGES

SURE V15-IVMR

Micro Ridge Standard Mount • Ultra Accurate Tracking • Dynamic Stabilizer
List: \$110.00 **SALE: \$69.95**

AT 122LP

Dual Magnet • Plug-In Connector • Linear Contact Diamond Stylus
List: \$125.00 **SALE: \$49.95**

SHURE V15MR

Ultra Accurate Tracking • Dynamic Stabilizer • Side-guard Protection
List: \$275.00 **SALE: \$129.95**

illinois audio

12 E. Delaware Pl., Chicago 60611

16 YEARS OF MEETING THE NATION'S STEREO NEEDS WITH THE ABSOLUTE BEST PRICES ON TOP NAME NATIONAL BRANDS
Call Mon. thru Sat. 10 to 5 (312) 664-0020 • 1 (800) 621-8042



Prices in this ad are for mail-order only. Freight charges not included in prices. All merchandise shipped brand new, factory fresh with full warranty. Not responsible for typographical errors.



NOTE: This is just a partial listing of our extensive inventory, please call for quotes on additional items or to request a free price list.

COMPETITIVE PRICING... CALL NOW FOR YOUR BEST DELIVERED PRICE!

SUPER VHS CAMCORDERS 8mm CAMCORDERS HI-FI STEREO CAMCORDERS



OLYMPUS VSX405 VX406



SONY CALL



PANASONIC 445 420



HITACHI RCA MINOLTA

- SUPER VHS 8:1 ZOOM w/FLYING ERASE HEAD INCLUDES ALL ACCESSORIES **\$1199 CALL \$1399**
- SAME AS ABOVE w/CHARACTER GEN **\$1199 CALL \$1399**
- SAME AS ABOVE w/DIGITAL **\$1199 CALL \$1399**

- 8mm 6:1 ZOOM 5 LUX INCLUDES ALL ACCESSORIES **\$799**
- VHS-C 6:1 ZOOM 7 LUX INCLUDES ALL ACCESSORIES **\$699**
- VHS FULL-SIZE TAPE 7 LUX 6:1 ZOOM TIME/DATE (w/HARD CASE) **\$799**
- SAME AS ABOVE w/FLYING ERASE HEAD **\$899**

TOSHIBA SKS80 **CALL**

We carry a complete inventory at very low prices:

- GE 9815 • GE 9825 • PANASONIC PV420 • HITACHI VM3100 • MINOLTA V1400S
- PVS350 PANA • VM27 QUASAR, \$1399 • PANASONIC PVS150, \$1299
- JVC GRC55U SVHS-C • PANASONIC PV110, \$1050 • VHS-C CAMCORDER 7 LUX 6x2, \$699
- JVC GR25U, \$899 • CANON E70, 8mm MINI • RICOH 620 • SONY CALL

SONY BATTERY PACK NP 77 - CALL



OLYMPUS VX801-VX802 - Call

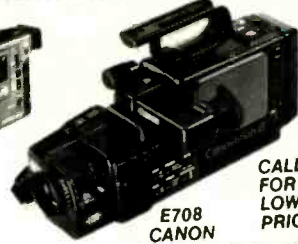

E708 CANON **CALL FOR LOWEST PRICE**



CANON 8mm DECK RECORDER PORT. PCM

VCR's - VHS & BETA

- dbx DBR1 Hi-Fi Dig. \$449
- QUASAR VHS485 4 Hd Hi-Fi MTS OSP \$395
- HRS 5000U **BEST BUY! \$375**
- AKAI VSM910
- JVC HRS8000U - NEW - IN STOCK \$449
- CANON VRHF 730 4HD Hi-Fi \$490
- MITSUBISHI HS423 Best S-VHS \$950
- SONY SLHF360
- SONY SL330
- TOSHIBA SV970

PHONES/ANSWERING MACHINES

- BELL PHONES, PANASONIC and CAR PHONES



SONY SPP-110

TV'S

- PIONEER 502-401
- SONY / TOSHIBA SVHS TV
- JVC AV2658
- SUPER 30" TV \$1199



26" REMOTE \$319

VIDEO CASSETTE PLAYERS \$169



Tote Vision CB-7000 VHS w/5" Color TV **\$399**



Tote Vision GS 3000H, AC-DC **\$199**

VHS w/19" QUASAR Color TV **\$525**

VHS w/13" Color TV **\$399**

SPECIAL EFFECT & CHARACTER GENERATORS

- ZENITH Source Selector/RCA 5 in-3 out... **\$98**
- ZENITH Character Generator **\$219**
- SANSUI Character Generator VCG99 **Call \$119**
- SUNPAK LIGHT **Call \$119**
- NEWMARK VAM2000 Digital Disolv **Call \$319**
- JVC JXW9 Special Effects **\$199**
- JVC Color Corrector **\$350**
- SANSUI VX99 **\$199**
- VAC301 **\$69**
- VAC312 **\$199**
- AZDEN or NADY Wireless Misc **Call**

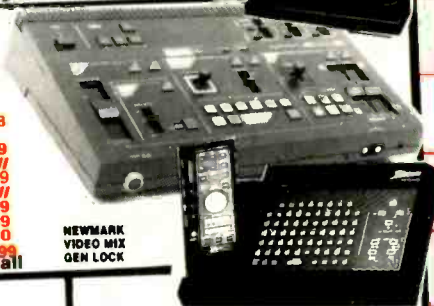

NEWARK VIDEO MIX GEN LOCK

AUDIO HI-FI RECEIVERS



NEW MODELS LASER DISC

- Pioneer • Magnavox
- LDW1 • CLD3030 • CDV474
- COMPACT DISC**
- Pioneer • Magnavox • JVC • Teac
- PDM700 • XLM600 • CDB473
- RECEIVERS**
- VSX9300 • RX999

FAX MACHINES SHARP

- UX80 Call
- UX140 Call
- OTHER MODELS Call

CAR STEREO

JVC-SONY **CALL**

FOR MORE INFO, Call: (201) 696-6531 **WE WILL MATCH OR BEAT ANY LEGITIMATE PRICE**

Call Toll-Free: **1 (800) 444-6300**
Orders: **1 (800) 247-4654**

We ship within 24 hours. All prices quoted included manufacturer's standard accessories & U.S. Warranty. All units are factory sealed. Shipping & handling extra. Not responsible for typographical errors S&H non-refundable.



Discs and tapes reviewed by Robert Ackart, Richard Freed, David Hall, Stoddard Lincoln, Eric Salzman, and David Patrick Stearns

BEETHOVEN: *Violin Concerto in D Major, Op. 61. Romances for Violin and Orchestra: No. 1, in G Major, Op. 40; No. 2, in F Major, Op. 50.* Frank Peter Zimmermann (violin); English Chamber Orchestra, Jeffrey Tate cond. ANGEL © CDC 49737-2 (62 min).

Performance: *Poised and cool*
Recording: *Very good*

Frank Peter Zimmermann turns out impeccably executed performances of both the concerto and the two gentle romances that together constitute the whole of Beethoven's contribution to the violin-and-orchestra repertoire. There is Classical poise in his playing of the concerto, but nothing approaching the tonal warmth and tensile phrasing achieved by his compatriot Anne-Sophie Mutter with Karajan and the Berlin Philharmonic. I'm inclined, however, to lay a good part of the blame for the communicative shortcomings of this recording on the conductor, Jeffrey Tate. A more highly strung treatment of the orchestral role might have stirred Zimmermann to something more than mere technical perfection. (He brings the intricate Kreisler cadenzas off superbly, by the way.) The recording itself is spacious and crystal clear. *D.H.*

BEETHOVEN: *Symphonies Nos. 4 and 5* (see Best of the Month, page 104)

BELLINI: *Opera Arias. I Puritani: Son vergin vezzosa; Ah! rendetemi la speme. I Capuleti e i Montecchi: Eccomi in lieta vesta. La sonnambula: Oh! se una volta sola. Beatrice di Tenda: Oh! mie fedeli!* June Anderson (soprano); Orchestre Philharmonique de Monte-Carlo, Nicola Rescigno cond. ANGEL © CDC-47561 (54 min).

Performance: *Stylish*
Recording: *Fine*

Of the five arias that make up this album, the selections from *I Capuleti* and *Beatrice* are not well known, but the other three are. June Anderson sings

EXPLANATION OF SYMBOLS:

- Ⓛ = DIGITAL-MASTER LP
- Ⓢ = TAPE CASSETTE
- Ⓢ = COMPACT DISC (TIMINGS ARE TO NEAREST MINUTE)

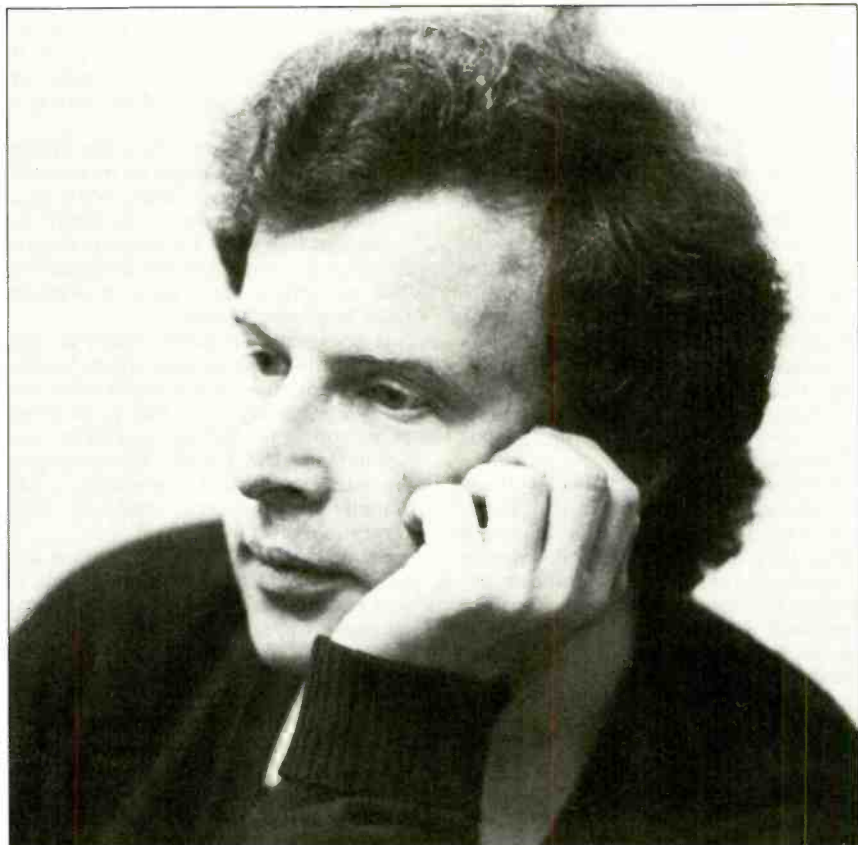

ANDRÁS SCHIFF'S MOZART

ADMIRABLE as András Schiff's recordings of the Mozart sonatas have been, his London disc of shorter works, recorded in the Mozartsaal of the Konzerthaus in Vienna, strikes me as being on a still higher level. The pieces are all fascinating and substantial, not excepting those whose titles might suggest otherwise, and Schiff is at all points as attuned to the substance as he is to the considerable charm of the music.

The set of Variations on *Ah, vous dirai-je, maman* is an inspired choice to open the sequence; we may well be reminded of Schiff's recording of the lovable concerted work his compatriot Dohnányi based on the same nursery tune. Schiff makes the uncluttered simplicity of the tune and what Mozart spun out of it a sort of keynote for his entire recital. The humor, the wit, and the undisguised warmth in the piece are all the more affecting for Schiff's unerring sense of subtle understatement, of letting such qualities arise from the notes without a gratuitous boost or nudge.

The Rondo in A Minor and the Adagio in B Minor, surely the best known of the eight pieces recorded here, benefit

from the same sense of Classical purity and restraint. The Minuet in D Major, the Gigue in G Major, and the Variations on *Unser dummer Pöbel meint* may be more familiar to some listeners from Tchaikovsky's orchestrations of them in his fourth orchestral suite (*Mozartiana*) than in their original form, but what gems they are!

There is as little to be accomplished in trying to evaluate Schiff's performances as there would be in evaluating the music itself. He is thoroughly inside this material, and all there is left for us to do is share the profound joys and wonders he finds in it. The sound itself could be a little smoother, but it is very realistic, and John Arthur's annotation is exemplary. *Richard Freed*

MOZART: *Variations on "Ah, vous dirai-je, maman" (K. 265); Andante for Mechanical Organ in F Major (K. 616); Rondo in A Minor (K. 511); Adagio for Glass Harmonica in C Major (K. 617a); Adagio in B Minor (K. 540); Minuet in D Major (K. 355); Gigue in G Major (K. 574); Variations on "Unser dummer Pöbel meint" (K. 455).* András Schiff (piano). LONDON © 421 369-2 (72 min).

VIVIANNE/AGNES BRUNEAU ASSOCIATES

BEETHOVEN'S NINE, TIMES TWO

THE modern art and cult of conducting was invented by Richard Wagner for the express purpose of performing the Beethoven symphonies. Wagner wanted to prove that the Beethoven symphonies were really forerunners of the Wagnerian music drama. His idea was to "play" the symphony orchestra the way Liszt played the piano.

The eighteenth-century orchestra was a kind of collaborative enterprise; what held it together was steady rhythmic pulsation. (The modern equivalent would be a jazz or rock ensemble.) The nineteenth-century orchestra became a giant instrument on which the composer and the conductor gave free rein to their personalities and fantasies. Rubato. Schmalz.

Beethoven? Right in between. Wagner wanted to make him a Romantic, and his example set the style for many generations to come. The Beethoven interpreters of those generations regarded him as the great test, and their approach was highly personal. Then a reaction set in. The era of the Classical Beethoven probably began with Toscanini, and it has spread everywhere. Nowadays even the Russians and the Russian-influenced Americans, even Leonard Bernstein, generally keep to the clean, Classical side of *Beethovenstrasse*.

Bernard Haitink and the Concertgebouw, in their new complete set of the nine symphonies for Philips, represent the modern view of Classical Beethoven in high estate. By contrast, Riccardo Muti, in his new EMI/Angel set, might be regarded as a postmodernist; he does not take us all the way back to the excesses of the Romantic past, but all his work is suffused with expressive color and warmth. Muti reminds us that Beethoven was the master of the dramatic narrative in music.

Take the Ninth. The great *Choral* Symphony was Wagner's—and just about everybody else's—favorite vehi-

cle. Hard to miss with that choral finale. But try the dark, tragic first movement. Haitink has demystified it. He plays it straight, as if it were by Haydn or maybe Bruckner. Calm, conservative, a bit stiff, no urgency.

Muti loves the mystery, the tragic drama. He hides as much as he reveals, and yet he is always clear. Muti is a phrase-maker, and he is not afraid to make a phrase work by speeding it up a fraction and then smoothing it down. The movement has a sense of urgency from beginning to end.

It goes like that pretty much all the way. Haitink is at his best in the Haydnish movements—pretty much all of the First Symphony and the even-numbered ones thereafter, especially the Second and the Fourth. Everything is reasonable, polished, measured, occasionally heavy-footed, and, by and large, unexceptionable.

Significantly, Muti's fast tempos are nearly always brisker than Haitink's, and his moderate and slow tempos are almost always slower. *Adagio* is truly *adagio*, and *con brio* is *con brio*. The contrasts are more vivid. Muti recorded the set over a period of three years; Haitink accomplished the same in a few months. As a result, the individual interpretations are more varied and clearly more thoughtful in Muti's set. He has already left his stamp on the sound of the Philadelphia Orchestra, much as Stokowski and Ormandy did in the past, and it is an appealingly warm sound. But his real virtues are in the areas of tempo and phrasing. Muti's Beethoven has a beautiful fetch. It breathes. It has what the Italians call *slancio*—impulse, impetuosity. His sentences are big lines and phrases, and he builds them up into elegant and dramatic musical stories. It works very well for Beethoven.

There are a lot of secondary advantages to the Muti set. He takes a number of repeats that Haitink omits—and the repeat is nearly always for the better. He



Haitink: the Classical Beethoven in high estate

incorporates a few details from recent musicological research. And he includes three bonus overtures, two of which, *The Consecration of the House* and the *Leonore* No. 3, must certainly rank with the Nine as major symphonic Beethoven. Haitink includes only the overture to *Egmont* with his Nine.

I like the EMI sound better, too. In some ways the Philips recording is closer and more up-front, but any advantages so gained are offset by the abnormally long reverberation delay, which doesn't sound real to my ears. In contrast, the Philadelphia sound is fat and mellow, but the reverb is short.

The CD format is particularly appropriate for that famous finale of the Ninth. For once the choral and solo vocal writing can be heard clearly. Muti's lesser-known group of quartet singers is, if anything, even better than Haitink's stars, and the Westminster Choir is as good as ever—in all its fullness and glory. Music like this really shows off the tremendous step forward represented by digital recording and the compact disc. Very effective in both sets.

Eric Salzman

BEETHOVEN: Symphonies Nos. 1-9; Egmont Overture, Op. 84. Lucia Popp (soprano); Carolyn Watkinson (contralto); Peter Schreier (tenor); Robert Holl (bass); Netherlands Radio Chorus; Concertgebouw Orchestra. Bernard Haitink cond. PHILIPS © 416 822-4 six cassettes, © 416 822-2 six CD's (360 min).

BEETHOVEN: Symphonies Nos. 1-9. Overtures: Fidelio, Op. 72b; The Consecration of the House, Op. 124; Leonore No. 3, Op. 72a. Cheryl Studer, (soprano); Delores Ziegler (mezzo-soprano); Peter Seiffert (tenor); James Morris (bass); Westminster Choir; Philadelphia Orchestra, Riccardo Muti cond. EMI/ANGEL © CDCF-49487 six CD's (392 min).

Muti: Beethoven as a master of dramatic narrative



each one with accuracy, flourish, and the style needed to bring these florid, often artificial, but always melodically beautiful airs to flesh-and-blood life. One high note is unexpectedly shrill, and once a vocal wobble is disconcertingly discernible, but otherwise her sensitive performance is equal to Bellini's musical and dramatic demands.

Anderson is an American singer who has until recently preferred to make her career in Europe rather than to shuttle about the globe. She has been heard in New York in a concert version of Rossini's *Semiramide* at Carnegie Hall and in Chicago with the Lyric Opera; both appearances were triumphs. Like Maria Callas, Anderson has chosen to concentrate on the bel canto repertoire and is well on the way to making it her own. If she lacks Callas's special interpretive incisiveness and intensity, she still creates, from her roulades and cadenzas, sympathetic, believable heroines. Under Nicola Rescigno's precise direction, the Monte Carlo orchestra plays very well indeed. Only one grumble: Could we not have had another selection or two to fill out the CD? *R.A.*

LISZT: *Mephisto Waltz No. 1; Tarentella; Rapsodie espagnole; Pensées des morts; St. Francis of Assisi Preaching to the Birds; Bénédiction de Dieu dans la solitude.* Stephen Hough (piano). VIRGIN ◉ 90700-1, ◉ 90700-4, ◉ 90700-2 (75 min).

Performance: *Virtuosic*
Recording: *Outstanding*

Stephen Hough, a Naumburg winner in 1983, has more than a couple of fistfuls of technique and seems to be enjoying himself thoroughly in these Liszt pieces. He plays the first three in the most unabashedly barnstorming manner, with great freedom and flair. As stunning as it all sounds, though—and the vividness of the recorded sound is at least as breathtaking as the playing—I sense as much self-consciousness as abandon in the excessive rubato and exaggerated dynamic contrast. The relatively (but *only* relatively) “straight” readings of the *Mephisto Waltz* from Bolet on London and Minoru Nojima on Reference Recordings provide deeper and more durable listening pleasure because they find more substance in the music. Hough also rather overpowers the *Rapsodie espagnole*, leaving little in the way of charm.

After all the barnstorming and glitter, though, it comes as a surprise to find him so much more convincing in the three longer pieces, all with religious connotations, that complete this recital. There is absolutely nothing superficial in these realizations. They shine with depth and poetry, calling attention not to Hough's considerable dexterity but to the uncontrived nobility of Liszt's conceptions. The fireworks in the showpieces are impressive (at least the first time around), and the sound quality



Stephen Hough: Liszt with flair

throughout is exceptional, but it is for these last three items that I especially recommend this record. *R.F.*

MOZART: *Mass in C Minor (K. 427, "The Great").* Sylvia McNair, Diana Montague (soprano); Anthony Rolfe Johnson (tenor); Cornelius Hauptmann (bass); Monteverdi Choir; English Baroque Soloists, John Eliot Gardiner cond. PHILIPS ◉ 420 210-4, ◉ 420 210-2 (53 min).

Performance: *Hair-raising*
Recording: *Too churchy*

Mozart's unfinished Mass in C Minor was his most imposing choral work before the Requiem. The music anticipates the more hellish moments of *Don Giovanni* (it was written four years before that operatic masterpiece), and conductor John Eliot Gardiner makes much of this connection in a genuinely thrilling performance. The “*Gratias*” doesn't resemble any conventional expression of gratitude; it seems inspired more by Gluck's *Furies* in *Orfeo*. Gardiner also gives a menacing relentlessness to the dotted rhythms of the “*Qui tollis*,” whose big, homophonic chords are sung with almost hypnotic effect by the Monteverdi Choir.

Gardiner's grandly conceived interpretation—with spacious tempos to match the spacious acoustic of the London recording venue—is highly theatrical, a sort of abstract opera. The conductor seems to have a firm sense of the music's subtext even in Mozart's more baffling settings, when he does just the opposite of what you'd expect him to. Gardiner's reading is characteristically scrupulous throughout, right down to the gentle pulse of “*Et incarnatus est.*”

What keeps this recording from being ideal is the engineering. At best, the res-

onant space in which the taping was done (perhaps a church, though it's unidentified in the booklet) lends an air of solemnity to this severe piece, but at worst it clouds the harmonies and hardens the tones of the vocal soloists. Soprano Sylvia McNair fares best in the “*Et incarnatus est*,” but it sounds as if she was recorded in a different room. Rarely has such a rewarding performance been so hard to listen to. *D.P.S.*

PUCCINI: *Manon Lescaut.* Kiri Te Kanawa (soprano), Manon; José Carreras (tenor), Des Grieux; Paolo Coni (baritone), Lescaut; Italo Tajo (bass), Geronte; William Matteuzzi (tenor), Edmondo; others. Chorus and Orchestra of the Teatro Comunale di Bologna, Riccardo Chailly cond. LONDON ◉ 412 426-1 two LP's, ◉ 412 426-4 two cassettes, ◉ 412 426-2 two CD's (116 min).

Performance: *Adequate*
Recording: *Good*

There are three recordings of *Manon Lescaut* currently available on CD, featuring sopranos Maria Callas, Montserrat Caballé, and Mirella Freni (perhaps today's best Manon) and tenors Plácido Domingo (twice recorded) and Giuseppe di Stefano. Why, one asks, when a wealth of operatic literature remains untouched, do we have yet another album of a standard and appealing but not *that* significant a work? The answer, presumably, has to do with contractual obligations, but it has little to do with what opera lovers may need or want.

You can fairly well predict what this performance will be like by reading the cast list, and repeated hearings have not materially altered my initial response. Kiri Te Kanawa's light, silvery, well-produced soprano has the right timbre for Manon, and she sings the role gracefully and sincerely, if without the engagement of a Callas or the vocal opulence of a Caballé. I had special hopes for José Carreras, whose newer recordings find him freer and less strained vocally than in the recent past; there has lately been a return to his genial lyric style. Des Grieux, however, is a weightier business than Rodolfo, for example, which the tenor recorded so movingly a short time ago. While he offers some lovely singing here in the lighter sections, “heavy” moments are often forced so that the sound is simply unpleasant. It is difficult to write negatively of Carreras, whose commitment, musicianship, and *natural* beauty of voice is always manifest. But why is he not used more in recordings where his special gifts, and even his present limitations, would be assets rather than liabilities?

Paolo Coni projects the gruff, good-humored amorality of Lescaut, William Matteuzzi brings the proper youthfulness to Edmondo without overstating it, and the veteran basso Italo Tajo charac-
(Continued on page 132)



Dear Stereo Review Reader:

"At Wisconsin Discount Stereo, We Care."

Most electronic discount mail order houses cut the price and cut out service completely—**NOT WDS**. We offer the best service of all the electronic discounters (in fact, better than most retailers).

Here at **WDS** we offer:

- ★ **\$40,000,000 Inventory**—Most orders shipped within 48 hours.
- ★ **Largest and Best Warranty Service Center**—over 100 people work in service alone.
- ★ **All items Factory Sealed**
- ★ **All products carry full Manufacturers Warranty**
- ★ **Buyer Protection Insurance Policy—No Charge**
For first 30 days of ownership, we'll repair any item with which you have a problem—within 48 hours, excluding Saturday and Sunday, in our shop—Guaranteed or we'll replace it with a brand new factory sealed unit.
- ★ **10-Day Return Policy.** Your request must be phoned in for prior authorization. All products must be in original factory packing, clean, unscratched, in perfect working condition. Returns subject to 10% restocking fee. Shipping & Handling are non-refundable.
- ★ **Guaranteed Lowest Delivered Price**
On most items, we guarantee a lower delivered price than any other factory authorized dealer. If you find a better price, call us and we'll beat it.
- ★ **Toll Free 800 # For All Your Needs:**
 - ☎ Product Information
 - ☎ Pricing
 - ☎ To Order (or, check on an order)
 - ☎ Repair Service
- ★ **Professional Sales Staff**—With an average of 9 years selling Audio/Video equipment
- ★ **All items shipped double boxed for extra protection**

We invite you to compare our **Service** and our **Price** and we're sure you'll agree—

WDS RATED #1!

**So, Remember... "AT WDS, WE CARE."
Give us a chance to prove it to you.**

Glenn Roskilly
General Manager
1-800-356-9514

WDS
Wisconsin Discount Stereo
9417 W. Badger Road
Madison, WI 53713
Some Items Limited Quantities.

HOURS
Mon-Thur 8-8
Fri-Sat 8-9
Sun 9-5
OR COD

Discount Hotline
1-800-356-9514
BUYER'S GUIDE AVAILABLE: Send \$3.95 for STEREO — \$3.95 for VIDEO — or \$7.00 FOR BOTH

WDS
Wisconsin Discount Stereo
9417 W. Badger Road
Madison, WI 53713
Some Items Limited Quantities.

HOURS
Mon-Thur 8-8
Fri-Sat 8-9
Sun 9-5
OR COD



RCA 4-HEAD **\$269**
We offer over 20 4-Head models under \$300—CALL!

VHS MTS HIFI **\$349**
On-screen programming with 6/21 day timer & 97 function remote

GE VG7785 **\$349**
SPECIAL PURCHASE
4-Head MTS HIFI with O.S.P.

4-HEAD MTS HIFI **\$389**
Over 30 4-Head MTS HIFI Models under \$400—CALL!

JVC HRD750 **\$648**
SPECIAL PURCHASE
4-Head MTS HIFI with O.S.P.

SUPER VHS 4-HEAD MTS HIFI **\$648**
SPECIAL BUYS!!
Two models to choose from

JVC HRS5000
Brand new Super VHS HIFI
4-Head MTS HIFI

JVC HRS8000 **\$389**
GUARANTEED LOW PRICE
Digital Super VHS HIFI
Rated BEST VCR model!

PANASONIC PV400 **CALL!**
CALL! SPECIAL PURCHASE
GE CG9806

ZENITH VM6300 **\$679**
GUARANTEED LOW PRICE
RCA Camcorder

JVC GR55 **CALL!**
GUARANTEED LOW PRICE
Sharp VL800

SONY CCD30 **CALL!**
GUARANTEED LOW PRICE
Sony Camcorders

PIONEER CLD1030 **\$169**
GUARANTEED LOW PRICE
Combination CD/Laser/Disc
Plays all size discs

AUDIOSOURCE SS-1 II **\$179**
Dolby Surround Sound with 30 Watts/CH and Bass

GE CG9825 SUPER VHS **CALL!**
GUARANTEED LOW PRICE
RCA CC130

PANASONIC PV420 **CALL!**
CALL SPECIAL
GE CG9810

TOSHIBA XRP9 **\$159**
Also includes remote, case, battery pack
BEST BUY!

SONY D4 DISCMAN **\$179**
SONY D14
SONY D160

SONY D15 DISCMAN **\$225**
GUARANTEED LOW PRICE
Toshiba XRP9437
Toshiba XRP9458

SONY CFD444 **\$188**
Sharp QTC990
Digital Sound Labs WXC80

SONY KV25XR10 **GUARANTEED LOW PRICE**
Best 27" Monitor/Receiver

JVC AV26S85 **GUARANTEED LOW PRICE**
Best 36" Monitor/Receiver

RECEIVER SPECIALS

JVC RX550 **\$259**
Remote Control 60 Watt/CH
Audio/Video Receiver

SHERWOOD S2770 II **\$239**
Remote Control 74 Watt/CH
Audio/Video Receiver

TECHNICS SAR930 **\$229**
Remote Control 50 Watt/CH
Audio/Video Receiver

JVC TDR611 **\$499**
TOP RATED PRE-AMP AND POWER AMP
+WAY BELOW NORMAL COST*

TEAC V670 **\$265**
3-Heads, 9 Motor with Dolby B + C + HX Pro

TEAC W990 RX **\$197**
Double Auto Reverse Deck with Dolby B + C + dbx

TEAC AD4 **\$275**
Combination CD/Cassette
Dolby B + C HOT BUY!

EPI T/E 280 II **\$108**
TOWER SPEAKER

EPI 12" 3-WAY SPEAKER **\$87 EA.**
3-WAY SPEAKER WAY BELOW NORMAL COST
FLOOR STANDING

SONY MDRV6 **\$67**
Stanton SR585
KOSS JCK9005

SONY WIRELESS REMOTE SPEAKERS **\$179 /SET**
WIRELESS REMOTE SPEAKERS

RECOTON WIRELESS REMOTE SPEAKERS **\$239**
SHERWOOD XR1604
Removable DIN Chassis
Car Stereo—Top of the Line!

EPI T/E 320 II **\$142**
TOWER SPEAKER

TECHNICS SLP350 **\$249**
4K over sampling with dual D/A converters

TEAC PD500 **\$279**
6-disc stacker with 16-bit D/A Converter and 32 program

TEAC AD7 **\$355**
Combination CD/Cassette
Dolby B + C + dbx HOT BUY!

VIDEO RECORDER SPECIALS

JVC HRD750 **\$648**
SPECIAL PURCHASE
4-Head MTS HIFI with O.S.P.

JVC HRS5000 **\$648**
Brand new Super VHS HIFI
4-Head MTS HIFI

JVC GR55 **CALL!**
GUARANTEED LOW PRICE
Sharp VL800

GE CG9825 SUPER VHS **CALL!**
GUARANTEED LOW PRICE
RCA CC130

SONY D15 DISCMAN **\$225**
GUARANTEED LOW PRICE
Toshiba XRP9437
Toshiba XRP9458

CASSETTE DECK SPECIALS

JVC RX550 **\$259**
Remote Control 60 Watt/CH
Audio/Video Receiver

SHERWOOD S2770 II **\$239**
Remote Control 74 Watt/CH
Audio/Video Receiver

TECHNICS SAR930 **\$229**
Remote Control 50 Watt/CH
Audio/Video Receiver

JVC TDR611 **\$499**
TOP RATED PRE-AMP AND POWER AMP
+WAY BELOW NORMAL COST*

TEAC V670 **\$265**
3-Heads, 9 Motor with Dolby B + C + HX Pro

TEAC W990 RX **\$197**
Double Auto Reverse Deck with Dolby B + C + dbx

TEAC AD4 **\$275**
Combination CD/Cassette
Dolby B + C HOT BUY!

EPI T/E 280 II **\$108**
TOWER SPEAKER

EPI 12" 3-WAY SPEAKER **\$87 EA.**
3-WAY SPEAKER WAY BELOW NORMAL COST
FLOOR STANDING

SONY MDRV6 **\$67**
Stanton SR585
KOSS JCK9005

SONY WIRELESS REMOTE SPEAKERS **\$179 /SET**
WIRELESS REMOTE SPEAKERS

RECOTON WIRELESS REMOTE SPEAKERS **\$239**
SHERWOOD XR1604
Removable DIN Chassis
Car Stereo—Top of the Line!

EPI T/E 320 II **\$142**
TOWER SPEAKER

TECHNICS SLP350 **\$249**
4K over sampling with dual D/A converters

TEAC PD500 **\$279**
6-disc stacker with 16-bit D/A Converter and 32 program

TEAC AD7 **\$355**
Combination CD/Cassette
Dolby B + C + dbx HOT BUY!

SHERWOOD CRD910 **\$159**
Auto reverse with CD inputs
Dolby B/C and High Power

TECHNICS SLP350 **\$249**
4K over sampling with dual D/A converters

TEAC PD500 **\$279**
6-disc stacker with 16-bit D/A Converter and 32 program

TEAC AD7 **\$355**
Combination CD/Cassette
Dolby B + C + dbx HOT BUY!

Why pay more?

- ✓ \$40 million inventory PLUS professional staff.
- ✓ Extended warranties available on most items.
- *RETURN POLICY: Returns accepted within 10 days (Must be called in for prior authorization). All products must have all original packing, clean unscratched. Returns subject to restocking fee. Shipping + Handling non-refundable.
- *GUARANTEED LOW PRICE—Compared to any other factory authorized dealer, delivered to your door with full warranty.

CAR STEREO SPECIALS

SHERWOOD CRD910 **\$159**
Auto reverse with CD inputs
Dolby B/C and High Power

TECHNICS SLP350 **\$249**
4K over sampling with dual D/A converters

TEAC PD500 **\$279**
6-disc stacker with 16-bit D/A Converter and 32 program

TEAC AD7 **\$355**
Combination CD/Cassette
Dolby B + C + dbx HOT BUY!

SHERWOOD CRD910 **\$159**
Auto reverse with CD inputs
Dolby B/C and High Power

TV SPECIALS

SONY KV25XR10 **GUARANTEED LOW PRICE**
Best 27" Monitor/Receiver

JVC AV26S85 **GUARANTEED LOW PRICE**
Best 36" Monitor/Receiver

DISTRIBUTOR PRICES

TOP BRANDS OF AUDIO & VIDEO

* NEW WEST COAST SERVICE

UP TILL **11 pm (EST)** [8 pm West Coast Time]

* NO-RISK, NO DEPOSIT

Telephone ordering. Nothing to pay till you receive merchandise

* SAME DAY SHIPPING

on orders called in before 1 P.M.

* 90 DAY LEMON-PROOF

exchange policy

* CALL OR WRITE

For Free CD or Equipment Catalog

OPEN 14 HOURS A DAY

DAILY 9 to 11 SAT. 10-5

(301) 488-9600



INTERNATIONAL
HI FI
DISTRIBUTORS
MORAVIA CENTER
INDUSTRIAL PARK
BALTIMORE, MD.
21206

CIRCLE NO. 4 ON READER SERVICE CARD

terizes Geronte with definition if little vocal sheen. The chorus and orchestra of the Teatro Comunale di Bologna provide ardent support under Riccardo Chailly's predictably taut and disciplined direction. R.A.

COLLECTIONS

ENSEMBLE ALCATRAZ: *Visions and Miracles. Cantigas de Santa Maria Nos. 34, 42, 103, 117, 333. Las Huelgas Codex: Fontis in rivulum; Ad honorem salvatoris. Alavanca de Mudanza, Suite (arr. Ensemble Alcatraz).* Anne Hodgkinson, Ellen McDonald (sopranos); Lawrence Ohran, Mitchell Sandler (baritones); Ensemble Alcatraz. NONESUCH ① 79180-1, ② 79180-4, ③ 79180-2 (69 min).

Performance: *Honest*
Recording: *Fine*

The San Francisco-based Ensemble Alcatraz derives its name (like that of the island in San Francisco Bay) from an early Iberian word for pelican. The bird was a religious symbol, and the name is very much in the spirit of this collection of mystical medieval music. Most of the selections are from the *Cantigas de Santa Maria*, songs in praise of the Blessed Virgin Mary collected in Spain during the thirteenth century. They tend to be fairly extroverted and earthy, using their melodic lines as vehicles to tell the stories of miraculous healings and other such happenings. What they lack in poetic specificity and melodic development they make up for in bracing primitivism. Most of the refrains are sung by a small unison chorus that answers the soloist, and the music itself has a sense of group celebration that borders on being tribal.

Two other selections are from the *Huelgas Codex*, a collection of pilgrim songs. More spare and affecting than the Marian songs, they're essentially rhapsodic prayers set to music, with vocal lines that are astonishingly eloquent in their range of expression. With these selections the album achieves its emotional high point.

The Ensemble Alcatraz, comprising a soprano, Susan Rode Morris, and four instrumentalists, approaches all the music in a natural and unaffected way. Morris does not have a particularly distinctive voice, but she knows how to tell stories through song, speech, and various stages of declamation in between. Her sound wears well during these long, multistanza songs. And although the group, augmented here by four additional singers, has an improvisatory spontaneity, it doesn't try to make the music sound any more strange and exotic than it is. Other medieval-music ensembles may be more entertaining, but Ensemble Alcatraz is perhaps more communicative. D.P.S.

JESSYE NORMAN: *Song Recital* (see Best of the Month, page 101)

Easy Listening!

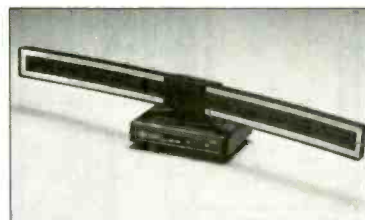

FM / Stereo Antenna

Get crisp, clean, undistorted sound without a costly, bulky outdoor antenna. Just attach the cable to your receiver, sit back and enjoy the finest quality FM/Stereo you've ever heard.

\$32⁵⁰

Model FM-9700

SCOPE ELECTRONICS TOLL FREE **800-648-2626**
260 Motor Pkwy., Hauppauge, NY 11788
In New York State: **800-852-1446 Ext. 242**
ASK FOR FREE CATALOG
Money orders, checks accepted. Please add \$4.50 per item shipping & handling. NYS residents add sales tax.

FREE

details
A DIFFERENT KIND OF RECORD CLUB

TREMENDOUS SAVINGS INCLUDING COMPACT DISCS...

on every record and tape in print—no "agree-to-purchase" obligation of any kind.

DISCOUNTS OF 20% TO 73% off mfg. suggested list... special catalog features hundreds of titles and artists.

MOST LABELS AVAILABLE including most imports through special custom ordering service—guarantees satisfaction

SCHWANN CATALOG lists thousands of titles.

DISCOUNT DIVIDEND COUPONS redeemable immediately for extra discounts.

NEWSLETTERS

informational news and happenings in the world of music... special super sale listings.

DISCOUNT NEEDLE GUIDE most mfg. replacements available.

QUICK SERVICE

same day shipping on many orders... rarely later than the next several days.

100% IRON-CLAD GUARANTEES

on all products and services—your total satisfaction is unconditionally guaranteed

Discount Music Club is a no-obligation membership club that guarantees tremendous discounts on all stereo records, tapes and CD's and let you buy what you want...when you want...or not at all if you choose. These are just a few of the money-saving reasons to write for free details. You can't lose so why not fill out and mail the coupon below for immediate information.

DISCOUNT MUSIC CLUB, INC. 009-0189
481 Main Street, New Rochelle, N.Y. 10801

Name _____
Address _____
City _____
State _____ Zip _____

CIRCLE NO. 71 ON READER SERVICE CARD

HIGHVOLTAGE

AUDIO AND VIDEO AT WHOLESALE PRICES!

RECEIVERS + AMPS

Pioneer VSX-9300SNew
Pioneer VSX-5300Call
Pioneer VSX-3300249
Pioneer VSA-910Call
Sony STR AV1000489
Sony STR AV900369
Sony STR AV290199
Nikko Alpha 650949
Nikko Alpha 450579
Technics SAR 530485
Technics SAR 430385
Technics SU AV55520
Technics SU AV44199
JVC RX 1001VCall
JVC RX 777399
JVC RX 333199
JVC SVA30175
SSI 4000 Pro LogicNew
SSI 360 II299

AZDEN HEADPHONES

DSR-90 Pro Digital75
DSR-50 Digital49

CASSETTE DECKS

Pioneer CT W900RNew
Pioneer CT W700RCall
Pioneer CT W300145
JVC TDW 999 BK325
JVC TDW 444 BK205
Technics RST 33R249

CD PLAYERS

Pioneer PD M700Call
Pioneer PD M600Lowest
Pioneer PD 7100Prices
Pioneer PD 4050135
JVC XLM 600369
JVC XLM 400295
JVC XLZ 444220
JVC XLV 222159
Sony CDP 370335
Sony CDP 350189
Magnavox CDB 650289
Magnavox CDB 473249
Technics SLP 770New
Technics SLP 550325
Technics SLP 350269

Kyocera's KD3030u
8mm Camcorder
•HIGH RESOLUTION
•HIGH SPEED SHUTTER
•POWER ZOOM
•HI FI AUDIO
•ONLY 2.4 lbs

Call For Price!

CAMCORDER SPECIALS

Panasonic PV S3501689
Panasonic PV 420989
RCA CPR 3001049
RCA CPR 250899
Sony CCD V9Call
Sony CCD F401099
Minolta V2000Call
Olympus VX 802999
JVC GRC 55U1289
JVC GRC 25U949

VCR SPECIALS

Panasonic PV S4864699
Panasonic PV 4860469
RCA VPT 695899
RCA VR 595New
RCA VR 475Call
JVC HRS 8000U995
JVC HRS 7000U799
Mitsubishi U-70New
Mitsubishi U-50Call
Quasar VH 5677Call
Quasar VH 5485439

PERSONAL STEREOS

Sony WMF-1001115
Sony WMF-7789
Sony WMF-4569
Sony D-15Call

CAR STEREO
We Carry a Full Line of Sony and Pioneer
Call Us For Your Best Price!

RADAR DETECTORS

Passport Equiv189
Unlden RD9139
Cobra RD-3170175

800-654-7787

HIGHVOLTAGE, 39 W. 32nd St., New York, NY 10001
VISA, MC and COD Accepted. All Products New, Factory Fresh and Subject to Availability. Customer Service Call 212-564-4410

CIRCLE NO. 66 ON READER SERVICE CARD

HELP US HELP YOU!

PARTICIPATE IN THE STEREO REVIEW BUYER POLL

Stereo Review wants to know more about our readers. How much equipment you buy (and how often), how much you spend on it, what sort of product features you like. That will help us create a better, more informative magazine, specially geared to your tastes and preferences.

To gather this important information, we've created the Stereo Review Buyer Poll. And we need your help to make it work.

If you've bought any equipment within the past 30 days, we'd like you to participate (see instructions below). We'll use the information you give us to keep manufacturers up to date on the buying habits of stereo enthusiasts—the most knowledgeable group of audio buyers in the country. And in the long run, that will mean better service for you.

HOW TO PARTICIPATE

You can participate in the Stereo Review Buyer Poll by sending in the Reader Service Card appearing next to this page. We've provided space for you to list any equipment purchased in the past 30 days. Any kind of audio/video equipment qualifies.

For example:

Home Audio Components

- Amplifier
- Receiver/Tuner
- Speakers
- Turntable
- Cassette Deck
- Equalizer
- CD player

Portable Stereo

- Portable Cassette Player
- Portable CD Player
- Headphones

Car Stereo

- Tuner
- Cassette Deck
- Speakers

Home Video

- VCR
- Camcorder
- Videodisc Player
- Stereo TV

Fill in the type of equipment, manufacturer, model number, and price you paid. Include all the equipment you bought this month. Then print your name and address and drop it in the mail (we pay the postage). It's that simple!

Free Information Service ★ ★ ★

Get free literature on stereo products featured in this issue. Simply fill out your name and address, circle the number on the card that corresponds to the key number at the bottom of the advertisements and mail this card today.

1 2 3 4 5 6 7 8 9 10 11 12 13 14 15 16 17 18 19 20 21 22 23 24 25 26 27 28 29 30 31 32
33 34 35 36 37 38 39 40 41 42 43 44 45 46 47 48 49 50 51 52 53 54 55 56 57 58 59 60 61 62 63 64
65 66 67 68 69 70 71 72 73 74 75 76 77 78 79 80 81 82 83 84 85 86 87 88 89 90 91 92 93 94 95 96
97 98 99 100 101 102 103 104 105 106 107 108 109 110 111 112 113 114 115 116 117 118 119 120 121 122 123 124 125 126 127 128
129 130 131 132 133 134 135 136 137 138 139 140 141 142 143 144 145 146 147 148 149 150 151 152 153 154 155 156 157 158 159 160

STEREO REVIEW BUYER POLL

1. In the past 30 days, have you purchased any audio or video equipment or accessories?
A. YES B. NO → Thank You

2. Which type(s) of equipment did you purchase in the past 30 days?
A. Home audio B. Portable stereo
C. Car stereo D. Video

3. In the space below, please write in the type (speakers, car CD player, stereo VCR, etc.), the make, the model number and the price paid for each item purchased in the past 30 days.

TYPE	MAKE	MODEL	PRICE PAID
CD player	Sony	KS-5933	\$379.00
Speakers	Boys	BS3-1A	\$4.50 PA
car radio/cassette deck	Shankar	KT 9372 (A)	\$1699.00

Indicate if you'd like to subscribe to STEREO REVIEW (you'll save 50% off our regular subscription rate!)
 Please send me 12 issues of STEREO REVIEW for \$5.99 and bill me. (Full year subscription price \$11.99)

PLEASE PRINT CLEARLY.

NAME: STEVEN NELSON
ADDRESS: 158 LORRAINE AVENUE
CITY: NEW ROCHELLE STATE: NEW YORK ZIP: 10554

(Zip code must be included to insure delivery)
Void after October 31, 1987

SR 0671

LOOK FOR THE BUYER POLL EVERY MONTH

The Stereo Review Buyer Poll will appear in every issue—just check the Table of Contents for that month's location. You can participate in any month in which you purchased audio/video equipment. Of course, even if you don't join our Poll, you can still send in the Reader Service card to get information about products advertised in that month's issue.

We hope you'll participate regularly in the Stereo Review Buyer Poll. Your answers are important to us—and you'll find the resulting benefits important to you.

Thanks for helping us out!

Stereo Review

THE MET'S NEW "WALKÜRE"

ANOTHER *Ring of the Niebelungen*? There have been so many "must-have" *Ring* cycles issued over the past few years, it's difficult not to approach the Metropolitan Opera's new recording of *Die Walküre*, the first installment in a full *Ring*, without wondering if even the presence of Jessye Norman, Hildegard Behrens, James Morris, and James Levine is enough to inspire yet another Wagnerian-sized investment of time and money. Maybe we can skip this one? Or at least wait and choose between it and the Bernard Haitink *Die Walküre* coming out on EMI/Angel in a couple of months?

Sorry, but the Met's *Walküre* is another mandatory purchase for Wagnerites, as well as an ideal set for those just starting a *Ring* collection. In several key instances the individual artists come across better here than they ever have previously on record, and that's no small compliment for such a phonogenic group. Even Jessye Norman's tendency to overinterpret the words is at a minimum, perhaps because she's too much on fire to linger too long over anything. Not only is she in peak vocal form, but she has never seemed more dramatically genuine.

Though Behrens isn't in her very best voice, you'd have to go back to Martha Mödl in the early 1950's to find another soprano so alert to Brünnhilde's psychology, and Behrens's voice is a much more compelling instrument than Mödl's. Morris offers the most elegantly vocalized Wotan on record, beautifully colored with his lean, black-mahogany voice, even if he rarely strays from the role's primary emotions and occasionally sounds less than sincere.

As Fricka, Christa Ludwig has been heard in more sumptuous voice, but she characterizes her role much more intensely than she did in Georg Solti's *Walküre* recording on London. Gary Lakes's Siegmund is truly a "wolf cub," as Hundung calls him—appropriately unvarnished, a tad crude, and certainly a match for Hundung. Next to Norman, though, his affinity for the words seems a bit limited.

Taken together, this cast upsets the widespread notion that great Wagnerian voices disappeared with Birgit Nilsson and Jon Vickers. The luxurious casting here—including Linda Kelm, a Brünnhilde in her own right, contributing some steely "hoyotoho"s in the minor role of Helmwig—is arguably as strong as that of the Clemens Kraus 1953 Bayreuth *Ring* on Rodolphe, which is considered to have been recorded during a golden age of Wagnerian voices.

The best news, though, is that James Levine fuses these individual perform-



Behrens (Brünnhilde) and Morris (Wotan)

ances into a gripping representation of the opera as a whole. The piece can seem like four great scenes connected by a lot of semi-arid orchestral wash, but Levine gives an emotionally vital purpose to his reading as he negotiates the peaks and valleys of *Die Walküre*'s landscape. Except for the Act II confrontation between Brünnhilde and Siegmund, which is curiously unmoving, Levine's approach is red-blooded, explosive (though never bombastic), and essentially Verdian. With that comes a hypersensitivity to the theatrical subtext of every moment. Those who like their Wagner more subtle and sensuous must look elsewhere.

The Metropolitan Opera Orchestra, as fine as it is, doesn't have the deeply textured strings of the great orchestras of the world. Nonetheless, it plays with the insight, specificity, and confidence that can only be forged over many rehearsals and performances.

Finally, as an outgrowth of a Met production, this set has the best of both worlds—the theatrical impact of a live recording but the clean, airy sound of a studio recording. Deutsche Grammophon's engineering team has rarely done better. *David Patrick Stearns*

WAGNER: *Die Walküre*. Gary Lakes (tenor), Siegmund; Kurt Moll (bass), Hundung; James Morris (bass), Wotan; Jessye Norman (soprano), Sieglinde; Hildegard Behrens (soprano), Brünnhilde; Christa Ludwig (mezzo-soprano), Fricka; others. Metropolitan Opera Orchestra, James Levine cond. DEUTSCHE GRAMMOPHON © 423 389-1 four LP's, © 423 389-4 three cassettes, © 423 389-2 four CD's (244 min).

STATEMENT OF OWNERSHIP, MANAGEMENT AND CIRCULATION (Required by 39 U.S.C. 3685)

1. Title of Publication: *Stereo Review*
a. Publication No. 504-850
2. Date of filing: September 26, 1988
3. Frequency of issue: Monthly
a. No. of issues published annually: 12
b. Annual subscription price: \$13.94
4. Location of known office of publication (*not printers*): 1515 Broadway, New York, NY 10036
5. Complete mailing address of the headquarters or general business offices of the publisher (*not printers*): 1515 Broadway, New York, New York 10036
6. Full names and complete mailing address of publisher, editor, and managing editor: Publisher, Winston A. Johnson, 1515 Broadway, New York, New York 10036. Editor, Louise Boundas, 1515 Broadway, New York, New York 10036. Managing Editor, David Stein, 1515 Broadway, New York, New York 10036
7. Owner: Hachette Publications Inc., 1515 Broadway, New York, New York 10036
8. Known bondholders, mortgagees, and other security holders owning or holding 1 percent or more of total amount of bonds, mortgages or other securities: None

10. Extent and Nature of Circulation:

	Average No. Copies Each Issue During Preceding 12 Months	Actual No. Copies of Single Issue Published Nearest to Filing Date
A. Total no. copies printed (<i>net press run</i>)	612,082	597,563
B. Paid and/or requested circulation		
1. Sales through dealers and carriers, street vendors and counter sales	54,548	52,470
2. Mail subscriptions	461,664	447,740
C. Total paid circulation (<i>sum of 10B1 and 10B2</i>)	516,212	500,210
D. Free distribution by mail, carrier or other means, samples, complimentary, and other free copies	12,206	12,074
E. Total distribution (<i>sum of C and D</i>)	528,418	512,284
F. Copies not distributed		
1. Office use, left over, unaccounted, spoiled after printing	2,112	1,999
2. Returns from news agents	81,552	83,280
G. Total (<i>sum of E, F1 and F2—should equal net press run shown in A</i>)	612,082	597,563

11. I certify that the statements made by me above are correct and complete.

LEON ROSENFELD,
Vice President/Circulation

STEREO REVIEW RETAIL MART

Where to buy Polk Speakers

AUTHORIZED HOME DEALERS

CANADA Call Evolution Technology, Toronto for nearest dealer 1-416-335-4422
AK Anchorage: Magnum Electronics • Fairbanks: Hoiffs
AL Birmingham: Audition • Dothan: International Audio • Huntsville: Sound Distributors • Mobile: Hi Fi Zone • Montgomery: The Record Shop • Tuscaloosa: Kincaid Stereo & TV
AR Ft. Smith: Stereo One • Little Rock: Leisure Electronics • Searcy: Softmar
AZ Flagstaff: Sound Pro • Phoenix/Mesa: Hi Fi Sales • Tucson: Audio Emporium • Yuma: Warehouse Stereo
CA Bakersfield: Casa Moore • Campbell: Sound Goods • Canoga Park: Shelley's • Chico: Sounds By Dave • Corona Del Mar: Pacific Coast Audio Video • Davis: World Electronics • Eureka: Eureka Audio Video • Lancaster: California Soundworks • Mountain View: Sound Goods • Napa: Futurvision • Orange: Absolute Audio • Perris: California Stereo • Redondo: Systems Design • Sacramento: Good Guys • San Diego: Sound Company • San Francisco & Suburbs: Good Guys Stereo Store • San Gabriel: Audio Concepts • San Jose: Good Guys • San Luis Obispo: Audio Ecstasy • Santa Barbara: Creative Stereo • Santa Cruz: Sound Wave • Santa Maria: Creative Stereo • Santa Monica: Shelley's Stereo • Sherman Oaks: Systems Design • Stockton: Gluskus • Thousand Oaks: Creative Stereo • Ukiah: Music Hut • Ukiah: Audio Haven • Ventura: Creative Stereo • Westville: Incredible Sounds • Westminster: Videotek Stereo
CO Boulder: Soundtrack • Colorado Springs: Sunshine Audio • Denver & Suburbs: Soundtrack • Pueblo: Sunshine Audio
CT Avon: Hi Fi Stereo House • Danbury: Carlson's • Fairfield: Audio Design • Greenwich: Al Franklin's • Hartford: Al Franklin's • New Haven: Audio Etc. • Newington: Hi Fi Stereo House • New London: Roberts • Norwalk: AudioTronics • Waterbury: Zimo Music
DE Wilmington: Bryn Mawr Stereo
FL Daytona Beach: Stereotypes • Ft. Myers: Stereo Garage • Ft. Lauderdale: Sound Advice • Ft. Pierce: Sound Shack • Ft. Walton Beach: Audio International • Gainesville: Electronics World • Jacksonville: Audio Tech • Key West: Audio International • Lakeland: Sound Factory • Merritt Island: Southern Audio • Miami: Electronic Equipment Co. • South Advice • Naples: Stereo Garage • Orlando: Audio Spectrum • Panama City: Walfound Stereo • Pensacola: Fidler Hi Fi • Sunrise: Sound Advice • St. Petersburg: Cooper for Stereo • Sound Video • Tallahassee: Stereo Store • Tampa: Sound Advice • W. Palm Beach: Electronic Connection • Sound Advice
GA Athens: Hi Fi Buys • Atlanta & Suburbs: Hi Fi Buys • Augusta: Stereo City • Brunswick: H&H Service Store • Columbus • Merit TV Macos • Georgia Music • Savannah: Audio Warehouse • Valdosta: Stereo Connection
HI Honolulu: Honolulu Audio Video
IA Davenport: Gregg's Music • Des Moines: Audio Labs • Dodge City: Sound World • Dubuque: Renner's Iowa City: Hawkeye Audio • Mason City: Sound World • Waterloo: Team
IL Boise: Stereo Shoppers • Sandpoint: Electracraft
IN Twin Falls: Audio Warehouse
IL Alton: Reliable Stereo • Aurora: Stereo Systems • Carbondale: Southern Stereo • Champaign: Good Vibes • Chicago & Suburbs: United Audio • Decatur: J.R. Lloyd's • DeKalb: Audio Plus • Highland Park: Columbia • Joliet: Stereo Systems • Kankakee: Barnett's Entertainment • Lansing: Audio Clinic • Naperville: Stereo Systems • Normal: Sundown One • Peoria: Team Electronics • Rockford: Columbia • Springfield: Sundown One • Spring Valley: Audio Labs • Vernon Hills: Alan's • Waukegan: Alan's
IN Bloomington: Campus Audio • Bluffton: Eley TV & Appliance • Evansville: Risley's • Ft. Wayne: Classic Stereo • Indianapolis: Ovation • Lafayette: Good Vibes • Marion: Classic Stereo • Michigan City: Audio Connection • Muncie: Classic Stereo • South Bend: Classic Stereo • Terre Haute: Stereo Crafters

KS Junction City: Audio Junction • Overland Park: Audio Electronics • Wichita: Audio Visions • Topeka: Nelson's
KY Bowling Green: Audio Center • Lexington: Ovation Audio • Louisville: Audio Video Buy Design • Owensboro, Paducah: Risley's • Pikeville: Mayo Inc.
LA Lafayette: Sound Electronics • Metairie & New Orleans: Alterman Audio • Opelousas: Sound Electronics
MA Boston: Waltham Camera & Stereo • Fitchburg: Fitchburg Music • N. Dartmouth: Sound II • Pittsfield: HBS Stereo • Worcester: O'Coins
ME Bangor: Sound Source • Camden: Harbor Audio • Portland: New England Music
MD Annapolis: Spaceways • Baltimore: Soundscape • College Park: Spaceways • Gaithersburg: Audio Buys
MI Ann Arbor: Absolute Sound, Hi Fi Buys • Birmingham: Almas Hi Fi • Dearborn: Almas Hi Fi • Farmington Hills: Almas Hi Fi • Flint: Stereo Center • Grand Rapids: Classic Stereo • Kalamazoo: Classic Stereo • Lansing Midland: Hi Fi Buys • Petoskey: Kurtz Music • Royal Oak: Absolute Sound • Court St. Listening Room • Traverse City: Kurtz Music
MN Duluth: Mel's TV & Audio • Mankato: Audio King • Minneapolis & Suburbs: Audio King • Rochester: Audio King • St. Paul: Audio King
MO Cape Girardeau: Stereo One • Columbia: Johnson Audio • Rolla: End of the Rainbow • St. Louis: Sound Central
MS • Hattisburg: McLeland TV • Jackson: Hooper's • Pascagoula: Empress
MT Billings: Hi Fi Stereo House & Sound Bozeman: Thirsty Ear • Great Falls: Rocky Mountain Hi Fi • Missoula: Aspen Sound
NC Boone: Holtons • Chapel Hill: Stereo Sound • Charlotte: Audio Video Systems • Conover • In City • Greensboro: Stereo Sound • Hendersonville: Pro Sound • Kinston: Stereo Concepts • Moorehead City: Anderson Audio • New Bern: Anderson Audio • Raleigh: Audio Buys Stereo
ND Bismarck: Pacific Sound • Fargo: Today Electronics
NE Kearney: Midwest Audio • Lincoln: Stereo West • Omaha: Stereo West • York: Midwest Audio
NH Concord: Audio of New England • Laconia: Lakeside Stereo • New London: North Star • Salem: Cuomo's
NJ East Brunswick: Atlantic Stereo • Maple Shade: Bryn Mawr Stereo • Montclair: Perdue Radio • Raritan: AC Audio • Ridgewood: Sound-ing Board • Shrewsbury: Monmouth Stereo • Toms River: Rands Camera • Wall Twp.: Monmouth Stereo • West Caldwell: Perdue Radio
NM Alamogordo: D&K Electronics • Albuquerque: West Coast Sound • Carlsbad: Beason's • Clovis: Towne Crier • Santa Fe: West Coast Sound • NV Las Vegas: Upper Ear
NY Albany: Clark Music • Batavia: Unicorn Audio • Buffalo: Speaker Shop • Corning: Chemung • Elmira: Chemung • Fredonia: Studio One • Siena Falls: Audio Genesis • Goshen: Longplayer's Stereo • Ithaca: Chemung • Jamestown: Studio One • Manhasset: Audio Breakthroughs • Massena: Hi Fi Shop • Newburgh: Audio Expressions • New Hartford: Adirondack Music • New York City: Audio Breakthroughs, Electronic Workshop • Rochester: JB Sound • Scarsdale: Listening Room • Syracuse: Clark Music • Vestal: Hart Electronics • Woodbury: Audio Breakthroughs

OH Akron: Audio Craft • Canton: Belton Audio • Cleveland & Suburbs: Audio Craft • Cincinnati: Stereo Lab • Columbus: Stereo Lab • Dayton: Stereo Showcase • Findlay: Audio Craft • Lima: Classic Stereo • Toledo: Audio Craft
OK Lawton: Hi Fi Shop • Oklahoma City: Audio Dimensions • Shawnee: Rave Sounds • Stillwater: Carlunes • Tulsa: Audio Advice
OR Beaverton: Stereo Superstores • Eugene: University Hi Fi • Grants Pass: Shekells • Medford: Shekells • Portland: Stereo Superstores
PA Allentown: Bryn Mawr Stereo • Blakely: Hart Electronics • Bryn Mawr: Bryn Mawr Stereo • Camp Hill: Bryn Mawr Stereo • Chambersburg: Sunrise Electronics • Erie: Studio One • Johnstown: Gary's Entertainment • Kingston: Hart Electronics • Lancaster: G'n T Stereo • Longhorne: Bryn Mawr • Montgomeryville: Bryn Mawr Stereo • Natrona Heights: Stereo Land • Philadelphia & Suburbs: Bryn Mawr Stereo • Pittsburgh: Audio Junction • Quakertown: Bryn Mawr Stereo • Reading: G'n T Stereo • Saltsburg: Stereo Shoppe • State College: Paul & Tony's Stereo • Stroudsburg: Main St. Audio Video • Westford: Audio Insight • Williamsport: Robert M. Sides
PUERTO RICO Rio Piedras: Precision Audio
RI N. Providence: Eastern Audio
SC Anderson: Music Machine • Charleston: Audio Warehouse • Columbia: Music Machine • Greenville: Mitchell's Stereo • Musc Machine • Greenwood: Stereo Shop • Spartanburg: Stereo Shop
SD Aberdeen: Engel Music • Rapid City: Team Electronics • Sioux Falls & Audio King
TN Chattanooga: R&R TV • Cookeville: Lindsey Ward • Jackson: New Wave Electronics • Kingsport: Audition • Knoxville: Lindsey Ward • McMinnville: Lindsey Ward • Memphis: New Wave Electronics • Nashville: Hi Fi Buys
TX Amarillo: Sound Systems Ltd. • Arlington: Sound Idea • Austin: Marcum Electronics • College Station: Audio Video • Corpus Christi: Tape Town • Dallas: Hillcrest Hi Fidelity • El Paso: Soundquest • Ft. Worth: Sound Idea • Houston: Sheffield Audio • Hurst: Sound Idea • Laredo: Metex International • Longview: Audio Techniques • Lubbock: Electronics Supercenter • San Antonio: Bill Case Sound • San Marcos: Discovery Audio Video • Sherman: Worldwide Stereo • Temple: Audio Tech • Texarkana: Sound Towne • Waco: Audio Tech
UT Logan: Stokes Brothers • Ogden: Stokes Brothers • Salt Lake City: Broadway Music • St. George: Boulevard Home Furnishings
VA Bristol: Audition • Charlottesville: Holdens Sound Machine • Falls Church/Manassas: Audio Buys • Richmond: Gary's Stereo • Roanoke: Holdens • Virginia Beach: Digital Sound
VT Brattleboro: Scientific Stereo • Essex Junction: Creative Sound • Rutland: Mountain Music
WA Bellingham: QC Stereo • Chelan: Music Store • Oak Harbor: QC Stereo Center • Richland: Tri Ear Stereo • Spokane: Electracraft (H&S)
WI Appleton: Sound World • Eau Claire: EME Audio Systems • Green Bay: Sound World • Lacrosse: Sound World • Madison: Happy Medium • Milwaukee: Audio Emporium • Wausau: Sound World
WV Barboursville, Beckley, Charleston: Pied Piper • Clarkburg: Audio Visual Concepts • Huntington: Pied Piper • Piedmont: Sound Gallery • Wheeling: Stereo Lab
WY Cheyenne: Electronics Unlimited

polkaudio
The Speaker Specialists®

RETAIL MART

AN EXCLUSIVE MEDIUM FOR ALL RETAILERS
OF AUDIO AND VIDEO EQUIPMENT

The STEREO REVIEW Retail Mart is an ideal forum to reach interested audio/video enthusiasts who are active buyers themselves, and who advise others on stereo and video purchases. The Retail Mart is an exclusive section designed to showcase your advertising in STEREO REVIEW, and since the manufacturers of many of the brands you sell consistently advertise in STEREO REVIEW, your impact is even greater!

CALL US TODAY TO PLACE YOUR AD
IN THE STEREO REVIEW RETAIL MART . . .
AND MAKE STEREO REVIEW READERS YOUR CUSTOMERS!
(800) 445-6066

The Sound Seller

For the Musical Difference

Authorized Dealer For:

Acoustat	NAD (in store only)
Audio Control	Belles
Nitty Gritty	CWD
M&K	dbx
Nakamichi	Fried
Oracel	Harman Kardon
Polk	3D
PROAC	Orkyo
Proton	Grado
STAX	Audioquest
Thorens	Celestion
Dahquist	DCM
Hafler	Niles
Monster Cable	Kinergetics
Citation	Duntech

1706 Main St.
Mannette, WI 54143
(715) 735-9002

Audio Unlimited

AUTHORIZED DEALER FOR:

- AR
- Altec
- Audio Control
- Audio Dynamics
- Audioquest
- B & K
- dbx
- Fried
- Grado
- Hafler
- JVC
- Monster Cable
- Pioneer Elite
- Proton
- Sony-Car
- Stax
- Superphon
- Thorens

503-963-5731
1203 Adams Ave.
La Grande, OR 97850

10:00-5:30 M-Thurs.
10:00-3:00 Fri.
Pacific Time



At SOUND STAGE you can talk to a knowledgeable salesperson who will advise you on the best audio or video equipment that meets your needs and budget. From our large selection you can compare performance specifications and prices.

ALL SOUND STAGE equipment includes:
• 30-day best price protection
• free 3-year warranty with parts & labor
• free delivery

PLEASE, NO MAIL ORDER

NAD	CARVER	DENON	BANG & OLUFSEN
CWD	M&K	ENERGY	DBX SOUNDFIELD
ADS	GRADO	ELITE	AUDIO CONTROL
DCM	PULSAR	SIGNET	MONSTER CABLE
NEC	KLOSS	LINGO BOX	
	AMBRIA	TALISMAN	

Call for store hours
(718) 961-9888

173 Broadway
NYC, NY 10007
(NW corner of
B'way & Cortlandt
Enter on Cortlandt
One light up.)
OR
18a-10 Horace Harding Expwy
Fresh Meadow, NY 11365 (Exit 25 L/E)



STEREO REVIEW RETAIL MART

Audio Den Ltd.

Authorized Sales and Service
Residential • Commercial
AUDIO AND VIDEO COMPONENTS
MEDIA ROOMS • SURROUND SOUND • ANTENNAS

- | | | | |
|-------------------------|-------------|----------------|--------------------------|
| • ADCOM (in store only) | • MOTIF | • NITTY GRITTY | • SHURE ULTRA |
| • A R TURNTABLES | • NAD | • ORTOFON | • SONOGRAPHE |
| • CALIFORNIA LABS | • NAKAMICHI | • PARADIGM | • SOTA |
| • CAMBER | • N E C | • PINNACLE | • SPECTRAL |
| • CONRAD JOHNSON | • MAGNEPAN | • ROGERS | • STAX |
| • C W D | • MERLIN | • SENNHEISER | • SYNTHESIS |
| • DUAL | | | • TERK |
| • GRADO | | | • THORENS |
| • HAFLER | | | • VELODYNE |
| • KLIPSCH | | | • V P I |
| • M I T CABLES | | | • WELL TEMPERED |
| • MONSTER CABLES | | | • YAMAHA (in store only) |

SMITH HAVEN PLAZA
2021 NESCONSET HWY (RT 347)
LAKE GROVE, N.Y. 11755
(516) 360-1990

THE FINEST IN HOME AUDIO, CAR STEREO & VIDEO EQUIPMENT

AUTHORIZED DEALER FOR

- | | |
|------------------|--------------------|
| • ADS | • MISSION |
| • AKG | • MONSTER CABLE |
| • ALTEC-LANSING | • ORION |
| • AUDIO CONTROL | • OLYMPUS |
| • AUDIO PRO | • POLK AUDIO (CAR) |
| • B & W | • PROTON |
| • dbx | • SAE |
| • DENON | • SANSUI |
| • GUL | • SURROUND SOUND |
| • HAFLER | • SNOOPER |
| • INFINITY (CAR) | • SONY |
| • JVC | • SOUND CRAFTSMEN |
| • KENWOOD | • TERK ANTENNAS |
| • KICKER | • CELESTION |
| • MINOLTA | • CERWIN VEGA |

Sound CITY
Meadtown Shopping Center
Route 23 South
Kilmeron, N.J. (201) **838-3444**

STEREO REVIEW CLASSIFIED

AUTHORIZED

HIGH-END LOUDSPEAKER systems, speaker kits and the widest selection of raw drivers from the world's finest manufacturers. For beginners and audiophiles. Free catalog. A&S SPEAKERS, 3170 23rd St., San Francisco, CA 94110. (415) 641-4573

CALL US LAST

WE WILL
BEAT ANY PRICE
PRINTED IN THIS MAGAZINE ON
AUDIO & CAR STEREO

The SOUND Approach

6067 Jericho Tpke., Commack, NY 11725
FAST DELIVERY (516) **499-7680**
FULL WARRANTY

CABLE TV CONVERTERS/DESCRAMBLERS Guaranteed lowest prices in U.S., Jerrold, Hamlin, Zenith—many others! Lowest dealer prices! Orders shipped within 24 hours! MasterCard—Visa—C.O.D. accepted. Free catalog—call (800) 345-8927 only! Pacific Cable Co., Inc., 7325 1/2 Reseda Blvd., 1345, Reseda, CA 91335. All other information, call (818) 716-5914.

ORDER TOLL-FREE 1(800) 222-3465. DISCOUNTS! AR * AUDIOQUEST * BOSE * B&K * GRADO * HARMAN KARDON * JBL * LAST * LIVEWIRE * MONSTER CABLE * NITTY GRITTY * SONY * STAX * STRAIGHTWIRE * PLUS MORE. HCM AUDIO, 1600 BX MANGROVE, CHICO, CA 95926. (916) 345-1341.

LOUDSPEAKER COMPONENTS—KITS, Eton, Dynaudio, Focal, Eclipse. Catalog \$1.00, Meniscus, 3275S Gladiola, Wyoming, Michigan 49509. (616) 534-9121.

WE SELL MORE HIGH PERFORMANCE SPEAKER KITS than anyone in the U.S. Free catalog: 1(800) 346-9183. AUDIO CONCEPTS INC.

**hifi
buys**

YOU CAN AFFORD SOMETHING BETTER AT HIFI BUYS

WE CARRY THE BEST STEREO & VIDEO AT THE BEST PRICE!

- | | | | |
|------------------|-----------------|--------------|-------------|
| • Advent | • KEF | • NEC | • Stax |
| • Bang & Olufsen | • Kenwood | • Panasonic | • Thorens |
| • Bazooka | • Kicker | • Pickering | • Toshiba |
| • Belles | • Magnavox | • Sennheiser | • Velodyne |
| • Carver | • Mitsubishi | • Sharp | • Yamaha |
| • Denon | • Monster Cable | • Signet | • AND MORE! |
| • Infinity | • Nakamichi | • Sony | |

14 ATLANTA LOCATIONS
(404) 436-1231

SINGERS! REMOVE VOCALS FROM RECORDS AND CDs!









SING WITH THE WORLD'S BEST BANDS!

An Unlimited supply of Backgrounds from standard stereo records! Record with your voice or perform live with the backgrounds. Used in Professional Performance yet connects easily to a home component stereo. This unique product is manufactured and sold Exclusively by LT Sound - Not sold through dealers. Call or write for a Free Brochure and Demo Record.

LT Sound, Dept. SR-3, 7980 LT Parkway
Lithonia, GA 30058 (404) 482-4724
Manufactured and Sold Exclusively by LT Sound
24 HOUR PHONE DEMO LINE: (404) 482-2485

PHILIPS, AUDAX, PEERLESS, FOCAL, AND DYNAUDIO LOUDSPEAKERS in stock with good prices and competent services. Crossover components also. MADISOUND SPEAKER COMPONENTS, 8608 University Green, Box 4283, Madison, WI 53711. (608) 831-3433.

AUTHORIZED

PICKERING	 ORTOFON X5-MC Std. Mount High Output M.C. 20-45k Hz response. FG II stylus tip. Highly detailed, transparent sound.	 ORTOFON OM-40 Std. Mount Moving Magnet 20-29k Hz response. VdM II stylus tip. Silky smooth sound with good channel separation.	 SHURE V15 V-MR Std. Mount Moving Magnet 20-28k Hz response. Micro-Ridge stylus tip. Budget reference cartridge with excellent trackability.	 AUDIO TECH. AT160ML Std. Mount Moving Magnet 5-35k Hz response. Microline stylus tip. Low distortion with reduced record & stylus wear.
	 AUDIO TECH. AT152MLP P-Mount Moving Magnet 5-35k Hz response. MicroLine stylus tip. Top rated P-Mnt cartridge.	 SHURE V15HR-P P-Mnt Moving Magnet 15-27k Hz response. Hyper-Ridge stylus tip. Lowest price V15 P-Mnt cartridge.	 PICKERING XV15 625 DJDP Std. Mount Pro D.J. Cartridge 20-20k Hz response. Includes extra stylus.	 DISC KIT \$19.95 w/purchase of any cartridge* *while supplies last

We are the original mail order phono cartridge and stylus replacement specialists. Since 1972 Lyle Cartridges has helped audiophiles locate replacement styl for their cartridges at reasonable prices and with excellent service. Our goal is to help those who still prefer to play analog recordings.

LYLE CARTRIDGES
Dept. B1, Box 188
Valley Stream, N.Y. 11582
Phones Open Mon-Sat 9 am-8 pm

CALL TOLL-FREE FOR FREE PRICE QUOTES AND VISA/MC ORDERS N.Y. STATE (516) 599-1112
(800) 221-0906

SEND SELF-ADDRESSED STAMPED ENVELOPE FOR OUR FREE CATALOG.

MONSTER CABLE **TIPTONES** LAST

SERIOUS AUDIOPHILES DESERVE SERIOUS SERVICE.

And that's what you'll get at Reference Audio Systems. We offer the best in high-end audio and the best in friendly service by our knowledgeable staff. From the latest CD player to a classic mega-watt amplifier, you'll like our surprisingly affordable prices and fast shipping.

MAGNAVOX · UBA · THORENS · NITTY GRITTY · CELESTION · HAUM · STAX · AUDIOPRO · SONANCE · ENER · GRADO · MAGNUM · DUAL · ORTOFON

SHURE **MONSTER CABLE** **GRADO**

We Are Proud To Offer
A LARGE SELECTION OF:
NEEDLES CARTRIDGES

TOLL FREE
(800) 342-9969
High Quality Turntables & Accessories in Stock

M&Y CO.
8344 Melrose Ave
Los Angeles, CA 90069

Featuring:

- ORTOFON
- SHURE
- GRADO
- DYNAVECTOR
- AUDIO TECHNICA
- PICKERING
- SIGNET
- NITTY GRITTY
- STANTON
- BEYERDYNAMIC
- AUDIOQUEST
- STAX
- CARNEQUE ONE
- THORENS
- AR
- MICRO SEIKI
- AND MANY MORE

SIGNET **ORTOFON** **BEYERDYNAMIC**

Reference Audio Systems

Call Us... (213) 719-1500

Member Better Business Bureau
18214 Dalton Ave, Dept. D, Gardena, CA 90248
Hours: M-F 9 to 6, Sat. 9 to 1 Pacific Time

High-end and hard-to-find audio components. Low, low prices! AUDIO AMERICA (Virginia). Call 1-703-745-2223.

GET LOW PRICES ON ALL types of audio equipment — including high-end and esoteric products not normally discounted. Now we can **SAVE YOU MONEY** on the equipment you really want. Extensive selection — no need to settle for second choice. Thousands of satisfied customers world-wide. All products feature USA manufacturer's warranty. Call us for price quotes or friendly, expert advice. Catalog \$1.00. **616-451-3868**. Audio Advisor, 225 Oakes, S.W., Grand Rapids, MI 49503. We accept VISA/MC/AMEX/DISCOVER.

DIRECT SIGHT AND SOUND, America's best kept audio and video secret, continues to please... Five years and over 40,000 customers later, we still offer the best in audio, video, and auto sound including esoterics at incredible prices! We sell and service only U.S. warranty merchandise! Our staff is not only knowledgeable, but helpful and courteous in choosing the right component for you. Become one of the **ELITE!** Call (404) 436-5611. Direct Sight and Sound, 3095 Bolling Way, Dept. S, Atlanta, GA 30305. MC / VISA / AMEX. COD with deposit.

CALL TOLL FREE! 1 (800) 826-0520. **KI-NERGETICS, ACOUSTAT, HAFLER, HARMAN KARDON, PROTON, AUDIO CONTROL, NITTY-GRITTY, M&K, STAX, PROAC, DAHLQUIST, CELESTION, BELLES, dbx, FRIED, ORACLE, THORENS, MONSTER, CWD, ONKYO, 3D, GRADO, DCM, CITATION, NILES, AUDIOQUEST, SOUND SELLER, 1706 MAIN, MARINETTE, WI 54143. (715) 735-9002.**

LOWEST PRICES
On over 150 brands
Car - Home - Video
For Specials List and Catalog only
800-233-8375

HIGH QUALITY BRANDS—Car, Home, Video including esoteric. Audio Unlimited, 1203D Adams Ave., LaGrande, Oregon 97850. (503) 963-5731.
EXPERIENCED, FRIENDLY ADVICE! AUDIRE, PS, CWD, STAX, SUPERPHON, THORENS, MIRAGE, GRADO, FRIED, MONSTER CABLE, QUAD, SPICA, STRAIGHTWIRE, more. Immediate, FREE Shipping! READ BROTHERS STEREO, 593-B King Street, Charleston, South Carolina 29403. (803) 723-7276.
LOW PRICES!! Yamaha, Denon, Carver, Adcom, Boston Acoustics, Luxman, Haller, A/D/S, B&K, KEF, Onkyo, Proton, Bose, Snell, DCM, M&K, P.S. Audio & many others!! SOUND ADVICE. (414) 727-0071.
Buying and selling used audio components! Call 1(703) 745-2223.

"STEREO WORLD" IS YOUR DISCOUNT MAILORDER SOURCE WITH SUPER DEALS ON AUDIO/VIDEO AND CAR STEREO LINES INCLUDING: TECHNICS, PANASONIC, JVC, SONY, PYLE, PIONEER, SHERWOOD, PHILIPS, CLARION, DENON, SOUND STREAM, PRECISION POWER AMPS, JENSEN, AND MANY OTHERS. CALL OR WRITE FOR YOUR FREE CATALOG. FREE UPS IN 48 STATES. 10AM-8PM MON-FRI; WEDNESDAY TIL 10PM. VISA/MC (MO/CK MUST CLEAR)/COD-EXTRA. P.O. BOX 596, MONROE, NY 10950. (914) 782-6044.

Stereo Review
MAIL ORDER MART
lets you turn up the volume where your customers are...
Want to beam your mail order message where the customers are? Sell surplus inventory? STEREO REVIEW's new Mail Order Mart was designed with your marketing needs in mind. And this flexible new medium is so budget-wise, you can't afford not to use it!
Call Toll Free
(800) 445-6066

SAVE 40% ON HIGH-END home speakers, subwoofers, amplifiers. FREE CATALOG! RTRD, 3021 Sangamon Ave., Springfield, IL 62702. (217) 529-8793.

FOR SALE
WE SELL SECOND HAND high quality audio-video with money back guarantee! Send your name and address for FREE monthly inventory. Ross Stereo, 2423 Morena Blvd. San Diego, CA 92110. (619) 275-3632.

ACOUSTICAL MAGIC IS FLEXIBLE BOROSILICATE CERAMIC COATING. A MODERN DAY SPACE AGE PRODUCT, ADAPTED TO AUDIO. DESIGNED ESPECIALLY FOR SPEAKER ENCLOSURES. GONE IS THE MUFFLED, BLURRED, SOUND OF CONE SPEAKERS. FOR FURTHER DETAILS CALL: 1 (800) 654-4761.

STEREO REVIEW CLASSIFIED

FOR INVENTORS

INVENTORS! Can you patent and profit from your idea? Call AMERICAN INVENTORS CORPORATION for free information. Over a decade of service. 1(800) 338-5656. In Massachusetts or Canada call (413) 568-3753.

INVENTORS! Call the INNOVATION CENTER in Washington D.C.—For FREE info call in U.S. & CANADA: 1 (800) 228-7700.

WANTED TO BUY

CASH PAID FOR CLASSICAL ALBUMS—RCA LIVING STEREO, MERCURY LIVING PRESENCE (stereo). Also audiophile albums: MOBILE FIDELITY, NAUTILUS, CBS MASTER-SOUNDS, JAPANESE, etc. CHAD KASSEM, PO Box 2043, Salina, KS 67402-2043, (913) 825-8609.

MOVIE FILM/VIDEO TAPE

CABLE TV CONVERTERS. Scientific Atlanta, Jerrold, Oak, Zenith, Hamlin. Many others. "New" VIDEO HOPPER "The Copy Killer". Visa, M/C and AmEx. 1(800) 826-7623. B&B Inc., P.O. Box 21-327, St. Paul, MN 55121.

CABLE TV CONVERTERS—FREE CATALOG—ARIZONA VIDEO, 3661 N. Campbell, #310-C, Tucson, Arizona 85719. (602) 323-3330.

RENTAL MOVIE STABILIZER. Connect between VCRs or to Monitor. Satisfaction guaranteed. \$59.95, \$4 handling. 1 (800) 338-8751.

SERVICES

Attention GENESIS Owners—Repairs & Upgrades are possible! Original Specification & Improved Parts by LRS. (603) 749-1904, (24 hrs.)

INSTRUCTION

FREE CATALOG. Institute of Audio/Video Engineering. 1831 Hyperion (SR), Hollywood, CA 90027. RECORDING SCHOOL. (800) 551-8877, (213) 666-2380. Approved for International Students. Member of NATTS.

MISCELLANEOUS

CONFISCATED CARS, trucks, boats, 4 wheelers, motorcycles, by FBI, IRS, DEA. Available in your area now. Call (805) 682-7555 EXT. C-1005.

EASY WORK! EXCELLENT PAY! Assemble products at home. Call for information. (504)-641-8003. Ext. 9542.

RETAIL MART

WE HAVE THE FINEST SHOWROOM in our area with the best selection of audio/video components available. We represent Adcom, Infinity, Thorens, Dual, Jamo, Yamaha, Canton, Luxman, Klipsch, SONY ES, and more. CONTINENTAL SOUND, 98-77 Queens Blvd., Forest Hills, NY 11375. (718) 459-7507.

ATTENTION CLASSIFIED ADVERTISERS

The CLASSIFIED MAGNET attracts prime prospects for your mail order products and services.

Reach the readers (proven buyers) of this and other DCI Magazine titles through low-cost Marketplace Classified advertising.

To place your ads, or for further information (including rates, ad styles, sizes, multititle discounts) call Lois Price Toll Free at: (800) 445-6066

STEREO REVIEW MAIL ORDER MART

FOCUS Electronics (718) 871-7600
 MON THURS 9-9
 FRIDAY 9-7
 SUNDAY 10-6
 NOV AND DEC MON THURS 9AM-9PM

MAGNAVOX PINNACLE PIONEER YAMAHA JVC AIWA DENON

COMPACT DISC PLAYERS

— MAGNAVOX —
 CDB 473 RMT VOLUME 199.95
 CDB 480 NEW LOW 289.95
 CDB 486 NEW STACKER LOW
 CDB 482 NEW LOW

— DENON —
 DCD 3300 STUD REF 1199.95
 DCD 1700 2K SUP LIN CON 429.95
 DCD 1400 REMOTE 329.95
 DCD 800 REMOTE 289.95
 DCD 610 REMOTE 269.95
 DCD 600 REMOTE 269.95

— YAMAHA —
 CDX 1110 TOPS 279.95
 CDX 510 NEW 279.95
 CDX 410 NEW 259.95

— PIONEER —
 PDW 700 TOP STACKER ALL PIONEER IN STOCK AT THE BEST PRICES IN THE COUNTRY
 PDW 600 NEW STRK 299.95
 PDW 500 NEW STRK 259.95
 PDW 400 NEW STRK 209.95
 PD 7100 NEW TOP SINGLE 350.95
 PD 5000 NEW RMT SINGL 219.95
 PD 3100 NEW SINGLE 149.95
 DLD1000 LASER DSCD 149.95

— JVC —
 JX11 600 6.1 STACKER 379.95
 JX11 400 NEW STRK 299.95
 JX11 300 6 DISC STRK 259.95
 JX12 555 NEW TOP SINGL 309.95
 JX12 444 NEW REMOTE 229.95
 JX11 222 NEW 179.95

— NAD —
 5240 CD PLAYER 279.95
 5220 CD PLAYER 279.95

— SONY —
 CDP C70 TOP REMOTE CAROUSEL 339.95
 CDP C60 RMT CONTROL 289.95

SUPER SPECIALS

PINNACLE PNB 4 FANTASTIC SOUND FROM A BOOKSHELF 5 SPEAKER GREAT FREQ RESPONSE TOP RATED ONLY 129.95 PR

YAMAHA MYS-1 MASTER VOLUME CONTROLLER SELECTOR 6 CH. WITH 3 INPUT SELECTORS AFTER SETTING VOLUMES ON SEPARATES WILL UNIFORMALLY ADJUST VOLUME ONLY 161.95

MAGNAVOX CDB 473 FEATURE LADEN COMPACT DISC PLAYER FITS 16 BIT DA CONVERTERS. QUAL OVER SAMPLING REMOTE WITH VOLUME CONTROL & MORE SPECIALLY PRICED 199.95

— D.A.T. —
 SONY DTC 500 1999.95
 CASIO DA1 1599.95

BLANK TAPES AVAILABLE CASSETTE DECKS

— YAMAHA —
 KR1200 3 HDS B C DBX 589.95
 KR 610 B C HX PRO 379.95
 KR 460 B C HX PRO 249.95
 KR 300 2 MOTOR DOL 219.95
 KRW 900 TOP DOUBLE CASS LOW
 KRW 500 DBL BC AIR 349.95

M 85 260W PC PWR AMP 849.95
 KR900 130W PC INTG AMP 509.95
 KR500 85W PC INTG AMP 279.95
 KR300 30W PC INTG AMP LOW
 T85 HI END TUNER 389.95
 AKC30 AVR CONTROLLER 369.95
 AVCS20 A V CONTROLLER 419.95
 SR 50 SURR. PROC. 259.95
 ED1000 GC W MIC 329.95
 DSP 3000 NEW DSP ONLY NEW

— MISSION —
 700 249.95 PR. 707 319.95
 737 459.95 PR. 770 699.95

HIFEND SPEAKERS

— DENON —
 DRM 44HX COMF 3 HOS 559.95
 DRM 30HX RMT 3HD HX PRO 439.95
 DRM 24HX NEW B C HX PRO LOW
 DRM 14HX HX PRO RMT 329.95
 DRM 12HX HX PRO DOL 289.95
 DRM 10HX DOL HX PRO 259.95
 DRM 07 DOLBY B C 189.95

— JVC —
 TDV 710 NEW 3 HEAD TOP SINGLE 499.95
 TDV 610 NEW AIR SINGL 319.95
 TDV 311 NEW AIR BC 189.95
 TDV 311 NEW DOL SINGL 169.95
 TDW 999 NEW TOP DBL 329.95
 TDW 777 NEW DBL AIR 269.95
 TDW 444 DOL AUTO REV 209.95
 TDW 272 DOL AIR BC 189.95

— PIONEER —
 CTW 900R NEW TOP DBL 179.95
 CTW 700R NEW DBL AIR ALL PIONEER IN STOCK AT THE BEST PRICES AROUND
 CTW 500 NEW DBL BC 269.95
 CTW 300 NEW DBL HX PC 269.95
 CTS 800 NEW 3 HD BC HX PRO BEST PRICES AROUND
 CTS 600 NEW BC HX PRO 219.95
 CTS 200 NEW SINGLE 159.95

— AIWA —
 ADW 909 TOP DOUBLE LOW
 CTW 800 AIR DBL HX PRO 329.95
 ADW 707 AIR DBL BC 259.95
 ADR 30 AIR SINGLE CASS 159.95

SEPARATES

— YAMAHA —
 DSP1 DIG SOUND PROC 759.95
 M 35 40W AMP FOR DSP1 239.95

— JBL —
 L627 219.95 PR. L827 299.95 PR.
 L207 399.95 PR. L6307 499.95 PR.
 L8307 539.95 PR. L1007 999.95 PR.

— B & K WAY PORTED 229.95 PR.
 2 2 BOOKSHELF 229.95 PR.

— ADVENT —
 MINI SUBWOOFER IN STOCK
 BABY II IN STOCK
 PRODR TOWER IN STOCK
 LEGACY IN STOCK
 MAESTRO IN STOCK

— PINNACLE —
 PN2 NEW 2MT EXD 99.95 PR.
 PN5 + TOP RATED SHF 129.95 PR.
 PN6 + LARGER 179.95 PR.
 PN8 LARGER BETTER 189.95 PR.
 PN MONITOR 200 TOPS 199.95 PR.

HEADPHONES

— DENON —
 DM90 BRAND NEW TOP OF THE LINE DIGITAL HEADPHONE THE DARLING OF THE SUMMER C'S SHOW 359.95
 INTRO SPECIAL 79.95
 DSR 50 DIG FULL SIZE 49.95
 DSR 48 DIGITAL LWLT 34.95
 DSR 38 DIGITAL FWH 24.95

DENON AUDIO TAPES

MINI 20
 HDB 100 439 EA. HDB 304 19 EA.
 HDB 60 939 EA. HD7 903 19 EA.
 HD7 60 2.69 EA.

DCA 3280 259.95 DCA 3150 159.95
 KSRX618 349.95 KSRX618 109.95
 KSRX418 269.95 KSRX418 109.95
 KSRX308 LOW KSRX208 LOW
 KSR18 139.95 KLC30 499.95
 KSA20 219.95 KSE75 169.95

— PIONEER "IN STOCK!" —
 — BOSTON ACOUSTICS —
 770011 PR 169.95 765 PR 229.95
 797 AWARD WIN 6X9 3 WAY 189.95 PR.
 CALL FOR PILE, ALMA, CLARION

— YAMAHA —
 YCR550 299.95 YCR450 219.95
 YCR350 199.95 YCR150 199.95

BOOMBOXES

— JVC —
 PCV 300 NEW DOUBLE CASS CD PLAYER AIR GRAPHIC EQUALIZER DETACH SPEAKERS ONLY 359.95
 PCV 2 SINGLE CASSETTE CD AIR DETACH SPKRS GR ONLY 329.95
 PC77 CASSETTE WITH DIG TUNE RANGE TOPS 199.95

— SONY —
 CFD 444 AMFM CASS WCD PLAYER DETACH SPKRS & GRAPHIC EQ LOW
 CFD 66 AMFM CASS CD LOW
 CFD 77 AMFM AIR CASS CD LOW

WHEN IN NEW YORK, VISIT US IN OUR NEWLY EXPANDED SOUND ROOM AT 4523 15th AVENUE!!

1-800-223-3411

FOR ORDERS ONLY ORDER NOW FOR HOLIDAY DELIVERY!

FOCUS ELECTRONICS-STORE: 4523 15th AVENUE, BROOKLYN, NY 11219 MAIL ORDER: 1225 39th STREET, BROOKLYN, NY 11218
 ORDERS ONLY 1800 223 3411 FOR INFORMATION OR NEW YORK STATE ORDERS PLEASE CALL 1 718 871 7600 FOR CUSTOMER SERVICE PLEASE CALL 1 718 871 5011 MONDAY THROUGH 10AM 4PM VISA MC AMEX AND DISC CASHY ACCEPTED SOME STATES CARRY AN EXCLUSIVE NATIONAL ONE YEAR PARTS AND LABOR WARRANTY THROUGH FOCUS ELECTRONICS OTHERS CARRY STANDARD MANUFACTURERS WARRANTY EXTENDED WARRANTY IS AVAILABLE SOME ALLOCATED PRODUCTS MAY TAKE 2-6 WEEKS OR MORE FOR DELIVERY PLEASE ASK AT TIME OF PURCHASE FOURTEEN DAY RETURN POLICY A RESTOCKING FEE MAY BE CHARGED FOR ITEMS RETURNED AFTER 90 DAY PERIOD ALL UNITS ARE SHIPPED NEW ITEMS THAT ARE ACCEPTED FOR RETURN MAY BE CHARGED A RESTOCKING FEE IF PACKAGING AND/OR ITEM IS NOT AS NEW WHEN RETURNED SHIPPING HANDLING AND INSURANCE ARE EXTRA AND NON REFUNDABLE NOT RESPONSIBLE FOR TYPOGRAPHICAL ERRORS PRICES AND AVAILABILITY SUBJECT TO CHANGE WITHOUT NOTICE APPLICABLE FREE GIFTS MUST BE REQUESTED AT TIME OF PURCHASE ALL PRICES IN THIS AD ARE FOR MAIL ORDER ONLY AND ARE IN U.S. DOLLARS AND ARE SUBJECT TO CHANGE WITHOUT NOTICE AND WITHOUT NOTICE APPLICABLE STOCK & PRICES SOME CHANGES ARE BEYOND OUR CONTROL WE'RE IN BUSINESS FOR 22 YEARS AND OUR MANY SATISFIED CUSTOMERS ARE OUR BEST ADVERTISEMENT.

FOCUS ELECTRONICS-STORE: 4523 15th AVENUE, BROOKLYN, NY 11219 MAIL ORDER: 1225 39th STREET, BROOKLYN, NY 11218
 ORDERS ONLY 1800 223 3411 FOR INFORMATION OR NEW YORK STATE ORDERS PLEASE CALL 1 718 871 7600 FOR CUSTOMER SERVICE PLEASE CALL 1 718 871 5011 MONDAY THROUGH 10AM 4PM VISA MC AMEX AND DISC CASHY ACCEPTED SOME STATES CARRY AN EXCLUSIVE NATIONAL ONE YEAR PARTS AND LABOR WARRANTY THROUGH FOCUS ELECTRONICS OTHERS CARRY STANDARD MANUFACTURERS WARRANTY EXTENDED WARRANTY IS AVAILABLE SOME ALLOCATED PRODUCTS MAY TAKE 2-6 WEEKS OR MORE FOR DELIVERY PLEASE ASK AT TIME OF PURCHASE FOURTEEN DAY RETURN POLICY A RESTOCKING FEE MAY BE CHARGED FOR ITEMS RETURNED AFTER 90 DAY PERIOD ALL UNITS ARE SHIPPED NEW ITEMS THAT ARE ACCEPTED FOR RETURN MAY BE CHARGED A RESTOCKING FEE IF PACKAGING AND/OR ITEM IS NOT AS NEW WHEN RETURNED SHIPPING HANDLING AND INSURANCE ARE EXTRA AND NON REFUNDABLE NOT RESPONSIBLE FOR TYPOGRAPHICAL ERRORS PRICES AND AVAILABILITY SUBJECT TO CHANGE WITHOUT NOTICE APPLICABLE FREE GIFTS MUST BE REQUESTED AT TIME OF PURCHASE ALL PRICES IN THIS AD ARE FOR MAIL ORDER ONLY AND ARE IN U.S. DOLLARS AND ARE SUBJECT TO CHANGE WITHOUT NOTICE AND WITHOUT NOTICE APPLICABLE STOCK & PRICES SOME CHANGES ARE BEYOND OUR CONTROL WE'RE IN BUSINESS FOR 22 YEARS AND OUR MANY SATISFIED CUSTOMERS ARE OUR BEST ADVERTISEMENT.

Stereo Review
MAIL ORDER MART
 lets you turn up the volume where your customers are...

Advertising to prime, heavy spending STEREO REVIEW customers is no longer a luxury! Now, with mail order marketer's needs in mind, STEREO REVIEW has launched a Mail Order Mart, a new ad program to enable you to heavy up where the customers are. To sell surplus inventory, for example.

In today's crowded, competitive market, you can't afford not to be heard by STEREO REVIEW subscribers who spent \$400 million on equipment in 1983 alone. And now, the economical new Mail Order Mart lets you tune in profits at surprisingly affordable rates.

To place your ad in Mail Order Mart,
(800) 445-6066

TIPS FOR MAIL ORDER PURCHASERS

It is impossible for us to verify all of the claims of advertisers. Therefore, the following information is provided for your protection:

1. Confirm price and merchandise information with the seller, including brand, model, color or finish, accessories and rebates included in the price.

2. Understand the seller's return and refund policy, including the allowable return period and who pays the postage for returned merchandise.

3. Understand the product's warranty. Is there a manufacturer's warranty, and if so, is it from a U.S. or foreign manufacturer? Does the seller itself offer a warranty? In either case, what is covered by warranty, how long is the warranty period, where will the product be serviced, what do you have to do, and will the product be repaired or replaced? You may want to receive a copy of the written warranty before placing your order.

4. Keep a copy of all transactions, including cancelled checks, receipts and correspondence. For phone orders, make a note of the order including merchandise ordered, price, order date, expected delivery date and salesperson's name.

5. If the merchandise is not shipped within the promised time or if no time was promised, 30 days of receipt of the order, you generally have the right to cancel the order and get a refund.

6. Merchandise substitution without your express prior consent is not allowed.

7. If you have a problem with your order or the merchandise, write a letter to the seller with all the pertinent information and keep a copy.

8. If you are unable to obtain satisfaction from the seller, contact the consumer protection agency in the seller's state or your local U.S. Postal Service.

STEREO REVIEW MAIL ORDER MART

CALL FOR PRICES ON MODELS NOT LISTED

6th AVENUE

TO ORDER BY PHONE CALL (212) 575-4792

STORE HOURS: MON-SAT: 10am-6pm, SUN: 11am-4pm EST

TO ORDER OUR NEW FALL CATALOG SEND US OR FREE WORDER!

ELECTRONICS CITY, INC. PROVIDING YOU WITH AN ALTERNATIVE!

XMAS SPECIAL - No Extra Charge for Second Day Air. WE SHIP C.O.D. NO DEPOSIT REQUIRED. EXTENDED SERVICE POLICIES AVAILABLE ON ALL PRODUCTS.

HI END SPEAKERS

CELESTION DL4II

\$297 - ENGLISH MONITOR HI-END - AFFORDABLE!

D. ACOUSTIC PS-10	389
D. ACOUSTIC PS-103	649
INFINITY KAPPA 6	CALL
INFINITY KAPPA 9	1850
KEF 104.2	1850
KEF 103.3	989
KEF C-95	989
KEF C-35	249
MISSION 700LE	279
POLK AUDIO SIR	239
POLK RTA-111	CALL
POLK SDA-SR51.2	399
SEATTLE SOUND 36	289
YAMAHA NS-10M	289

COMPACT DISK PLAYERS

DENON DCD 810

\$298 - 16 BIT OVERSAMPLING - DUAL D/A CONVERTER

ADS CD3	499	TECHNICS SLP550	299
CARVER DT1200M-II	499	SONY D-15	249
DENON DCD-910	CALL	YAMAHA CDX-1110	CALL
DENON DCD-1520	NEW	YAMAHA CDX-910	539
DENON DCD-810	319	YAMAHA CDX-S10	239
DENON DCD-610	239	CD CHANGERS	---
DBX DX-5	CALL	DENON DCM-555	439
MAGNAVOX CDB-471	149	JVC XLM-600	389
MAGNAVOX CDB-52	249	MAGNAVOX CDB58A	289
NAD 5240	359	NAD 5170	597
NAD 5300	699	PIONEER PDM-700	479
NAD 5100	516	PIONEER PDM-600	389
NAKAMICHI OMS7AII1299	PIONEER PDM-400	268	
NAKAMICHI OMS-5A	CALL	SONY CDP-C70	CALL
NAKAMICHI OMS-1A	259	WE CARRY A FULL LINE OF PORTABLE SONY, YOSHIDA, TECHNICS & CITIZEN CD PLAYERS	---
PIONEER PD-7100	379		
SONY CDP-950	CALL		
TEAC PDM400	229		

VCR'S & VIDEO PLAYERS

PANASONIC PV-4800

\$289 - 4 HEAD ON SCREEN PROGRAM CARD READY - LASER PLAYER

G&E V6-7785	529	RCA VP6695HF	899
JVC HRD-750U	499	TOSHIBA DX-900	769
JVC HRD-8000U	979	TOSHIBA SV-970	1099
PANASONIC PV4800	289	MITSUBISHI HS423UR	989
PANASONIC PV4860	449	---	---
PANASONIC PV5464A	669	PIONEER CLD-1030	599
NEC N666U	449	PIONEER CLD-3030	969
NEC DX5000U	769	SONY MDP-200	699
NEC DX 8000U	CALL	MAGNAVOX CDV-474	719

CASSETTE DECKS

NAKAMICHI CR-1A

\$289 - STATE OF ART DOLBY BSE 3 POSITION BISTO

AIWA ADF780	329	DRAGON	1766
AIWA ADFW909	469	NAKAMICHI CR-7A	1329
DENON DRM30HX	399	PIONEER CT-W90R	429
DENON DRM24HX	319	PROTON 740	319
DENON DRM10HR	459	TEAC W-990RX	CALL
DENON DRM44HX	489	YAMAHA KX-1200	549
LUXMAN R-106	489	YAMAHA KX-800	449
JVC TDV711	369	YAMAHA KX-400	249
MARANTZ SD-565	699	YAMAHA KXW-302	356
NAD 6300	499	SONY TCW900	499
NAD 6240	CALL	---	---
NAKAMICHI CR-1A	289	SONY DTC-100	1399
NAKAMICHI CR-2A	396	SONY DTC-500S	1649
NAKAMICHI CR-3A	639	ALPINE 5700	999

RECEIVERS

CARVER 6250

\$689 - 125 W/P/C - SONIC HOLOGRAPHY - REMOTE

AR-110	769	NAKAMICHI TA1A	NEW
CARVER 150	549	PIONEER VSX9300	619
CARVER AVR-100	949	PIONEER VSX7300	499
CARVER 6200	529	PROTON D-940	449
CARVER 6250	689	PROTON AV-300	CALL
DENON DRA-1025	CALL	SHERWOOD RWA430R	389
DENON DRA-625	419	SONY STRAV1000	499
DENON DRA-35V	239	AKAI AA-V-435	489
LUXMAN R-115	599	TECHNICS SAR530	449
NAD 7600	1189	YAMAHA RX-300	219
NAD 7240	379	YAMAHA RX-700	CALL
NAD 7100	CALL	YAMAHA RX-900	549
NAKAMICHI SR4A	CALL	YAMAHA RX-1100	679
NAKAMICHI SR2A	349	YAMAHA RX-500	269

CAMCORDERS

PANASONIC PV420

\$969 - FULL SIZE VHS - 7.1UP LOW LIGHT - 8X1 ZOOM - AUTO FOCUS

PANASONIC PVS350	1629	OLYMPUS VXS405	1789
PANASONIC PV400	869	MINOLTA CR8200	1149
PANASONIC PV460	1549	MINOLTA CR1400	989
PANASONIC PVS445	CALL	PENTAX PXC67	1149
PANASONIC AG-450	1749	PENTAX PXC67	1099
SONY CCDV9	1049	JVC GRC25V	929
SONY CCDV5	799	JVC GRC55V	1249
SONY CCD40	CALL	YASHICA 1700	1069
SONY CCD30	899	RCA CPR250	859
OLYMPUS VX802	969	NIKON B20	CALL
		CANON E708	1389
		CANON F1000	CALL

TURNTABLES & CARTRIDGES

DUAL CS-5000B

\$329 - 3 SPEED - BELT DRIVE - SIMI-AUTO

AR ES-1	549	---	---
DUAL CS-5000B	329	AZDEN YM-PS0VL	119
DUAL CS-505MKII	239	ORTOPON XTMC	89
DENON DP-23F	199	ORTOPON X3MC	149
DENON DP-35FB	226	ORTOPON X5MC	189
DENON DP-47F	336	GRADO SIGNATURE B	149
DENON DP-59F	466	SHURE V15 TYPE V-MR	149
THORENS TD-320	548	AUDIO TECHNICA LAB STANDARD	69
THORENS TD-280	249	---	---
TECHNICS SL1200MKII	339	---	---
BLQ TX-2	289	PARSEC ANTENNA MODEL L24	49
YAMAHA PF-800	469	SENNHEISER HEADPHONES	39
J.A. MICHELL SYNCRO REGA	CALL	---	---

SEPARATES

NAD 3300

\$478 - 60 W/P/C - DY NAKMIC PWR PARAMETER TONE CONTROLS

AR P-10	769	NAD 2600	596
ADCOM GFA-555	649	NAD 3300	478
ADCOM GFA-535	279	NAD 1700	1995
CARVER 4-0	639	NAKAMICHI CA-7A	669
CARVER TX-11A	549	PROTON D-1200	629
DENON PMA-920	489	YAMAHA MX-1000U	869
DENON PMA-520	289	YAMAHA AX-900	469
DENON TX-800	329	YAMAHA TX-500	229
LUXMAN LV-109	CALL	YAMAHA DSR-100	CALL

CAR STEREOS

NAKAMICHI RD-450

\$449 - CD PLAYER - CASSETTE DECK - AUTO REVERSE

ADS 320	429	KENWOOD KRC-757	386
ADS 300	275	NAKAMICHI RD-700	749
ADS PD-8	169	NAKAMICHI RD-450	449
ADS PM-15	539	NAKAMICHI PA-350	349
ALPINE 7280	339	POLK AUDIO MM-10A	129
ALPINE 7285	486	PROTON 214 CDII	369
ALPINE 7905	626	PROTON D-275	319
ALPINE 7907	696	SONY XR-7200	CALL
ALPINE 5925	696	SONY XR-7200	CALL
B. ACOUSTIC 797	149	SOUNDSTREAM TC301	259
B. ACOUSTIC 767	96	SOUNDSTREAM D100	499
CARVER M-240	269	SOUNDSTREAM D100	CALL
DENON DCR-5320	319	CLARION CQ825SR	259
DENON DCR-5220	269	PIONEER KEH650OR	289
INFINITY 8562K	86	JVC KS-RX618	329

3 SOUND ROOMS • CAMCORDER VIDEO ROOM • 7 DAY NO-QUESTIONS-ASKED DEFECTIVE EXCHANGE • 30 DAY HOME TRIAL SPEAKER AUDITION • DELIVERY & SET-UP AVAILABLE. 6th Ave. Electronics is conveniently located at 1030 & 1024 Ave. of the Americas, NY, NY 10018 (Between 38th and 39th Sts.)

RETAIL ONLY 212-391-2777

STORE HOURS: MON-SAT 10am-7pm, SUN 11am-6pm EST

We carry a full line of Acoustic Research, Audio Lab, Audio Quest, ADS, Advent, Bose, B&W, Celestion, Citation, DBX Soundfield & Electronics, Dual, Harman Kardon, Infinity, J.A. Michell, JBL, Kindel, Kenwood Car, Luxman, Magnavox, Marantz 94 series, Nakamichi NAD, Proton, Revalver, RM Labs, Sansui, Sony, Teac, Thorens, and Vintage. ALL PRODUCTS WARRANTED

ALL MAJOR CREDIT CARDS ACCEPTED.

Consumer Affairs license #805697. Ad represents small percentage of inventory. Price and availability subject to change. Checks accepted w/credit card authorization. Some sale items limited in availability & quantities. We ship C.O.D., no deposit required. Extended service policies avail. on all products. NOT RESPONSIBLE FOR TYPOGRAPHICAL ERRORS

CLASSIFIED ADVERTISERS:

You can reach millions of prime prospects for your mail order products or services through low-cost Marketplace Classified advertising in this or other titles of the

DCI CLASSIFIED MAGNET

To place an ad, or for further information including rates, ad styles, sizes and multi-title discounts, call Toll-Free:

(800) 445-6066

THIS MAGAZINE IS AVAILABLE IN MICROFORM DIRECT INQUIRIES TO:

MICRO PHOTO DIVISION

BELL & HOWELL

OLD MANFIELD ROAD
WOOSTER OH 44694
Contact Christine Ellis
Call toll free (800) 324-8881
in Ohio call (216) 264-0666 collect



by *Christie Barter*
& *Ron Givens*

Paul Shaffer has been one of the gassiest guys in the music business for a long, long time, so you'd expect him to have put out a record rack's worth of albums already. But, no-o-o-o-o. Even

Henry Mancini and London's Royal Philharmonic Pops Orchestra titled "Premier Pops." It's truly a one-man show: Mancini not only conducts and occasionally provides the piano obbligato, but the program consists entirely of music he has composed over the years for concerts, television, and

rock titles. Included are Michael Jackson's *Thriller*, Ritchie Valens's *La Bamba*, John Lennon's *Imagine*, Madonna's *Material Girl*, and the Eurythmics' *Sweet Dreams*. □

WE can all be thankful that saxophonist Michael Brecker's second solo album didn't take as long as his first. His new record on Impulse/MCA, "Don't Try This at Home," comes only a year after his album "Michael Brecker" dominated the jazz charts at No. 1 for twenty-one consecutive weeks. Before making the earlier album Brecker had had more than twenty years of experience in such groups as the jazz-rock band Dreams, the Brecker Brothers Band (his fusion combo with brother Randy on trumpet), and the more traditional Steps Ahead. All that on top of constant studio work with the likes of Bruce Springsteen, Michael Jackson, Frank Sinatra, and hundreds of others. "Don't Try This at Home" features Brecker's touring band and star soloists including Herbie Hancock, Don Grolnick, and Mark O'Connor. □



Brecker: on his own

works under the absolutely accurate title (for its day), "First Ladies of the Opera." Gathered for the first time together on the air were Leontyne Price, Birgit Nilsson, Joan Sutherland, and Renata Tebaldi. Each sings two arias. List price: \$39.95. □

DO you long for the guitar heroes of yesteryear? Well, a new record will take you back to the golden era of progressive rock. As part of its "No Speak" series of instrumental-only recordings, I.R.S. Records recently issued "Guitar Speak, Vol. 1." Each

ALAN SINGER/NBC PHOTO



Shaffer and band members: "Coast to Coast"

though he's got years of extremely hip experience—as bandleader for *Late Night with David Letterman*, as musician and actor on *Saturday Night Live*, and as a session player—Shaffer is only now making his solo debut. His new Capitol release, "Coast to Coast," features an all-star lineup of guest musicians performing material in the styles of several major cities. New York City, for example, is represented by *When the Radio Is On*, a tune described as "doo wop meets rap," with vocals by Dion, DJ Jazzy Jeff, and Shaffer. Other performers on the record include George Clinton and the P-Funk All-Stars, Eric Burdon of Animals fame, and Ashford and Simpson. □

films, all of it served up in his own arrangements.

The album's follow-up, as yet untitled but due for release early in the new year, makes an even stronger bid for crossover status: Mancini leads the RPO Pops in a program of a dozen top-selling

Mancini: one-man show



LA TE Christmas shoppers, buying for music lovers with long memories, should look for the new Video Artists International releases compiled from the popular all-live Bell Telephone Hour telecasts of the Fifties and Sixties. A special Christmas show was, in fact, one of the program's annual traditions, and two of the VAI tapes recall them vividly. "A Trip to Christmas" is hosted by Jane Wyatt and stars, among others, the Lennon Sisters, soprano Lisa della Casa, the Bil Baird Marionettes, and the New York City Ballet's Edward Villella partnering Violette Verdy. "An Old-Fashioned Christmas" features Jane Morgan, John Raitt, Florence Henderson, Rosemary Clooney, Earl Wrightson, and Howard Keel. These cassettes retail for \$19.95 each.

Another Telephone Hour special, first aired in 1967, offers an hour of vocal fire-



Tebaldi: First Lady

of the twelve newly recorded tracks showcases a well-known guitarist. Included are such greats as Robby Krieger (of the Doors), Leslie West (known primarily for his work in Mountain), Alvin Lee (who came to fame with Ten Years After), Steve Howe (lead guitarist for Yes and Asia), Phil Manzanera (of Roxy Music), and Rick Derringer (formerly of McCoys and the Edgar Winter Group). As the title of the record implies, this is the first in a series of "Guitar Speaks"

LYNN GOLDSMITH/MCA RECORDS

CHRISTIAN STEINER/LONDON RECORDS

DENON AMERICA



releases, which will include a live recording of a concert featuring many of these musicians that was taped in London in November. □

IN the late Fifties, rock-and-roll disc jockey and impresario Alan Freed gave the rambunctious new musical style a boost by promoting live stage shows in Brooklyn. The productions generally featured a laundry list of the biggest stars, each performing a few of their hits. Now, some thirty years later, record producer Richard Perry is trying to re-create that golden era on disc. His new Warner Bros. recording in progress has the immortal songs of that time sung by the stars of today. Among the tunes on the record are *For Your Precious Love*, a hit by Jerry Butler and the Impressions performed by Michael McDonald; *Fever*, a success for both Peggy Lee and Little Willie John, sung by Chaka Khan; *Mr. Lee*, a Bobettes hit done by the Pointer Sisters; and Fats Domino's *I'm Ready* as reworked by Elton John. □

WHERE there's a will (and, naturally, enough money) there's a way. Wall Street's Gilbert Kaplan, the founder and publisher of the internationally successful magazine *Institutional Investor*, has had a thing about Mahler's Second, or *Resurrection*, Symphony for over twenty years. He's traveled the globe to hear virtually every major performance of the work. He's studied the score and memorized its five movements. He's even sought out conductor Georg Solti for a few pointers on how to conduct the piece

Kaplan: Mahler investment



MCA CLASSICS



The Pointer Sisters: greatest hits of a golden era

himself. And in September 1982 he did just that at New York's Avery Fisher Hall.

Since then, armed with Mahler's autograph manuscript of the Second Symphony, which he picked up in Switzerland, Kaplan has intensified his study of the music and refined his skill at conducting it in numerous performances worldwide. And a couple of years ago MCA Classics invited him to record it. In the recording, recently made in Cardiff, England, Kaplan conducts the London Symphony Orchestra and Chorus, the BBC Welsh Chorus, and three other Welsh choirs. The soloists are soprano Benita Valente and contralto Maureen Forrester. And the recording is available now, in all three formats, at your local record store. □

WHEN Ray Charles recently celebrated his fifty-eighth birthday, the party was truly a fruitful occasion. Joining Charles for the festivities were the California Raisins, his co-stars in an animated TV commercial for the California Raisin Board. In addition to singing with the raisins, Charles has just portrayed God in an independently produced feature film called *Limit Up*. And, of course, there's his newest album, "Just Between Us," on Columbia Records. □

PIONEERS in performing the music of Beethoven on "original" or "authentic" instruments have included Anthony Newman and Ste-

phen Simon on Newport Classic, Steven Lubin and Christopher Hogwood on L'Oiseau-Lyre, and Roger Norrington on Angel. Now the Smithsonian Institution in Washington, which owns a famous collection of antique instruments, is getting in on the authentic-Beethoven act with a set of recordings, "Beethoven: The Early Years Through 'Eroica'."

Not sold in record stores, these recordings can be ordered from Smithsonian Collection of Recordings, P.O. Box 23345, Washington, DC 20026. The set is available on six LP's or five cassettes for \$54.95 or on six CD's for \$69.96. Add \$4.49 for postage and handling. □

GRACENOTES. As part of its new Masters series, Portrait Records is releasing a two-record set of Duke Ellington big-band sessions from 1938. . . . Donna Summer's new record on Geffen will be out in early 1989. . . . Novus/RCA has issued a record by pianist Marcus Roberts, the keyboardist for Wynton Marsalis. . . . Sinéad O'Connor could be heard on the soundtracks of one of the country's recent top-grossing films: Her (*I Want Your Hands on Me* ironically underpins Freddy Krueger's macabre moves in *Nightmare on Elm Street IV: The Dream Master*. O'Connor declined, however, to be represented

BMG MUSIC



Charles with Raisins: a fruitful birthday

The set includes the composer's first three symphonies played by the Smithsonian Chamber Orchestra conducted by Jaap Schröder, the six Opus 18 quartets played by the Smithsonian String Quartet, and the two Opus 5 sonatas for fortepiano and cello performed by James Weaver (fortepiano) and Kenneth Slowik (cello).

on the soundtrack album released by Chrysalis. . . . Jessye Norman has signed a new exclusive contract with Philips. . . . Placido Domingo joins Zubin Mehta and the New York Philharmonic for the annual PBS New Year's gala being carried live from Lincoln Center on Saturday evening, December 31. Happy New Year! □

LEVINE/SCHNEIDER

THE HIGH END

by Ralph Hodges

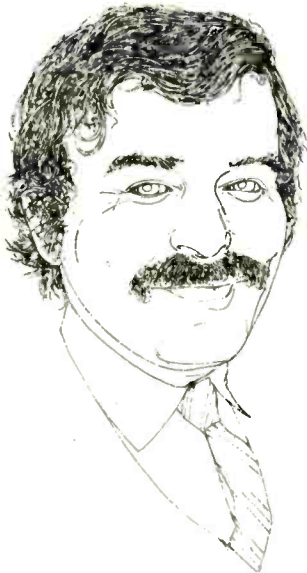

The (Record) Dust Settles

PRIOR to the full-scale introduction of the compact disc to this country, no hi-fi issue was more hotly debated than the design of phono cartridges. At the heart of the controversy was the question of whether the moving-magnet or moving-coil principle was superior, but there were many peripheral disputes that generated diverse ideas and occasional refurbished cartridge designs.

The turmoil died down considerably as audiophiles began to consider the promise of laser pickups, and now the debate is becoming a side show among audio-worshipping congregations that recognize the ascendancy of the CD and wonder whether it means salvation or damnation. So now is a logical time to ask what all the phono-cartridge fracas was about, if anything.

I was an early convert to the first moving-coil models to come out of Japan in significant numbers, and I have given considerable thought to why. My initial purchase was unappealingly heavy, and yet its shielding was not the best (what you could see of the body was made of wood), so that it hummed appallingly if given any chance. I had to pay Mark Levinson a considerable sum for a

black box to make it work with most preamps. Notwithstanding, I was charmed by the sound it yielded with many records, and particularly with massed strings, which so often border on the unbearably aggressive. Its far-from-flat frequency response surely played a part here, correcting for the equalization characteristics of certain records. But it was easy to persuade myself there was more to it: a sense of detail and coherence that made a violin ensemble almost countable.

This flawed cartridge, and a number of far superior ones that replaced it in my tonearm, became the focus of a vigorous dialogue with Shure Brothers, and particularly with Bernie Jakobs, who directed the company's phono-cartridge engineering. Bernie's patience in listening to claims of moving-coil superiority was unflagging; so was his determination to do the "right thing," and Shure never introduced a moving-coil design. I decided to call Bernie up to ask whether his views had changed at all.

"I still think," he assured me, "that the moving-coil phenomenon has to do with the inevitable uptilt in frequency response at the extreme top end and the increased tracking force that moving coils require. More tracking force means more groove-wall indentation, and that means a change in the groove configuration, even if only temporary. It is possible that some listeners, with some records, will actually prefer the sound of an altered groove. And it is certainly true that all cartridges sound discernibly different at different tracking forces. We, however, keep to the philosophy of minimum groove deformation, letting the record, as recorded, speak for itself."

I have read of cartridges whose generator geometries are deliberately skewed, increasing their sensitivity to vertical modulation and adding a perhaps-pleasing "phasiness." How prevalent is this practice?

"We've seen no examples, and certainly nothing that could be called deliberate," Jakobs told me. "A 90-degree included angle is definitely the norm for the transducer system. Here again, however, groove indentation is going to play

an important role in what the cartridge picks up, and things can go in many directions, depending on lateral versus vertical compliance, moving mass, and all the rest."

Independent investigations have suggested that the Decca series of cartridges, based on a unique design that directly senses vertical and lateral compliance and then matrixes them to derive the actual stereo channels, has an enhanced electrical sensitivity to the vertical. If so, I asked Jakobs, is this not evidence of deliberate manipulation?

"I am speculating here, but I suspect that the Decca's increased electrical sensitivity to vertical information is just compensation for its low vertical compliance. In other words, electrical parameters are being adjusted to suit mechanical ones. That is certainly one way of doing it, and it is a legitimate part of cartridge design."

I had hassled Bernie over the years on the subject of vertical tracking angle, insisting that small corrections in adjustment could be appropriate for virtually every record played. He was always stoically noncommittal. What about now?

"I am not surprised at what you've heard," he said. "I would attribute it to conceptual and evolutionary differences in the Westrex and Neumann cutter heads."

There followed a lengthy discussion of vertical cutting angle, stylus rake angle, and various effects on included groove angle that persuaded me that my thinking on these matters is not as subtle as I had thought. Jakobs concluded:

"Yes, I will agree that resetting the vertical angle for different records can be justified, especially when line-contact styli are involved. However, I believe that two basic adjustment positions, one for older records and another for newer ones, would be as effective as fine-tuning for every disc."

At last, a small concession from one of the maestros of cartridge engineering. Perhaps I am not really deaf or deluded. But, with CD's so dominant, is it too late? Not for the hundreds of LP's I have in storage, awaiting shelf space. Maybe I can score a few more points on Bernie before they stop making styli. □

Excellence Guaranteed.

LUXMAN
5 YEAR
WARRANTY



For over 60 years, Luxman home audio components have earned the highest accolades for their musical warmth and transparency. Now, Luxman is proud to announce that it is backing all new models with a 5-Year warranty, parts and labor included.

The Luxman stamp represents sonic excellence and the best full-line warranty in the industry.

For your authorized dealer, call:
1-800-4-LUXMAN

CIRCLE NO. 52 ON READER SERVICE CARD

Nothing comes remotely close.



Introducing "The System" by Proton.



You're looking at the perfect synthesis of advanced electronics, sophisticated design and uncompromising sound. It's "The System," Proton's incomparable new, integrated audio components with remote control.

There's a fully programmable compact disc player that lets you play up to 20 of your favorite selections—in any order—totally free of distortion or noise.

A digital tuner that locks in the precise station frequency for clean, undistorted listening. Powered by a component-quality amp with 22 watts per channel. An auto-reverse cassette deck with Dolby® B Noise Reduction that plays and records in both directions for continuous enjoyment.

And our AL-200, two-way acoustic suspension speaker system. Its 6.5 inch woofer and wide dispersion dome tweeter

deliver sound so breathtaking, you simply won't believe your ears.

Even the sleek, comfortable remote control is a work of art that's exceptionally easy to work. While you may find a system with similar components as "The System," that's where the similarity ends. Because when it comes to sound, nothing comes remotely close.

Call for your free Ultimate Systems Guide. Proton's Ultimate Systems Guide for Audio/Videophiles tells you all about the innovative technology and design in our renowned line. For your copy, and the name of the Proton retailer nearest you, call (800) 772-0172. In California, (800) 428-1006.

PROTON

CLEARLY THE BEST
737 W. Artesia Blvd., Compton, CA 90220