

# Stereo Review

JULY 1996 • US \$3.50 • CANADA \$4.50 • UK £2.20

## Jukeboxes

**FIVE 100-CD  
CHANGERS AND HOW  
THEY STACK UP**

**HOME THEATER**  
Practical Setups For  
Real-Life Rooms

**GET IT TOGETHER**  
A Guide To Wiring  
An A/V System

**LISTEN UP**  
How To Protect  
Your Hearing

**TEST REPORTS**  
Eosone Speaker,  
Optimus A/V  
Receiver, Cinepro  
Power Amp,  
and more



MAY '97

#BXBDHM\*\*\*\*\*5-DIGIT 40222  
#BCH11000098 1#430492  
11

\*DISC-75\*

A night scene of a prison. A chain-link fence topped with barbed wire runs across the foreground. A sign is attached to the fence. In the background, a building is illuminated with orange lights, and a person is visible on the roof. The sky is dark blue.

## **PREMIER TESTING SITE**

**Trespassers will be cooked,  
vibrated, humidified, dropped  
and reduced to the point of  
whimpering "Mommy" to  
our sound.**



*Premier is the car stereo that pain & kill.* If the sound gets aggressive at times, it's because our merciless testing hammers something called *stereocangs™* into the soul of each unit. Most of you have heard this condition referred to as *high-quality sound*. It answers to neither one.

After the headunits are shaken like they're out of their minds, operated in 95 percent humidity subjected to temperatures from -40 to 176 degrees and dropped from nail-biting heights, they're able to arm wrestle your car and win.

Our Premier® speakers wish they could be so lucky.

Their hell consists of acoustic analysis tests, strength tests, ultraviolet radiation tests, more extreme temperature tests and weatherability irradiation tests, which force them to belt out an obscene amount of volume for 150 head-kicking hours.

Whew! (Wipe sweat from forehead and flick.)

Special robotics and computer-aided design and manufacturing techniques were built by our own hands to ensure a nod from our furrw-browed engineers. Then to keep the obsessive-compulsive dedication to sound quality consistent, we chiseled Premier dealers from the same slab of concrete as the engineers.

Hopefully the headunits inherit some of our approach-and-get-racked attitude. But we felt the fools lurking. So Premier invented Detachable Face Security™ and then added a car alarm, built into the unit itself, that blasts its warning inside the car to terrorize the thieving rodents into scampering away without your beloved stereo.

These premises, these conditions, these posture-perfect engineers exist solely to safeguard the reliability and ultimate sound performance of your Premier system. But if you're able to create a more unlikely condition in your own car than our tests simulate (good luck), and the stereo starts to cower, our warranty will be idling for two long years, anxiously awaiting the chance to participate.

Its disappointment quickly silenced by an earful of soul-searching sound.

Call 1-800-746-6337 for the Premier dealer nearest you.



High Voltage output sends improved dynamic range input to amplifiers with less noise-floor and distortion.



Assembled with high-quality components by our hands, these amplifiers have a built-in crossover and come dressed in purple.



Depending on the speaker's frequency demands, RigLite™ Composite Cones contain the perfect tailor-blended mix of maximum-performance materials in order to be both rigid and light.



**PREMIER**



Bose®

Proudly

Introduces

The World's

Second Best

Music

System.



**The Lifestyle® 901® Music System**  
*Only Live Sounds Better.*

**Why Second Best?**

Listen to your favorite symphony in a world-class performance hall and you're listening to the ultimate music "system". Nothing sounds better.

In developing the advanced technologies behind the Lifestyle® 901 music system, we recognized how important the hall's acoustics were to the quality of sound. So our research began there.

At a live concert you hear unsurpassed clarity. Music comes to life when this clarity is combined with the spaciousness of sound reflecting off the walls, floor and ceiling. Instruments sing. And voices dance.

Our goal was to develop a complete, easy-to-use audio system that re-creates the clarity and spaciousness of a live concert more accurately than anyone ever had. Introducing the Lifestyle® 901 music system, engineered to sound second only to live.

Call for our booklet and to find out where you can hear the best audio system from the most respected name in sound.

**1.800.444.BOSE Ext. 757**



*Our research began in concert halls, to make sure the sound of the Lifestyle® 901 system was second only to live. Compare it to the largest, most expensive audio systems you can find.*

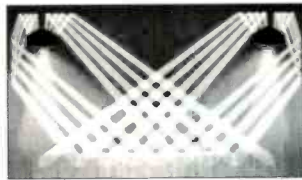

*Exclusive Bose Direct/Reflecting® speaker technology reflects sound off the walls of your room to re-create much of the concert hall spaciousness and emotional impact of a live performance.*



*Nine full-range Bose HVC drivers per speaker, rather than conventional woofers and tweeters, provide new standards for life-like clarity and bass that are unmatched by conventional systems.*



*Fully integrated system electronics ensure optimum performance. Includes a brushed aluminum music center with built-in AM/FM tuner and six-disc CD changer. Remote works through walls.*

© 1999 Kenwood Inc. Dolby and AC-3 are trademarks of Dolby Laboratories Licensing Corporation. THX is registered trademark of Lucasfilm Ltd.

WITH OUR NEW SYSTEM, YOU CAN BASICALLY  
CONTROL EVERYTHING IN YOUR HOUSE BUT YOUR KIDS.  
BUT DON'T THINK WE'RE NOT WORKING ON IT.



Welcome to Stage 3. A new line of Kenwood home products designed to simplify the way people interact with their technology. The Stage 3 Home Theater Controller (KC-Z1) features Dolby® Digital (AC-3) and THX® Cinema for surround sound. But the heart of Stage 3 is the portable TouchPanel. This intuitive graphic interface lets you do every-



thing from adjusting the volume to cueing up your Laser Disc from any room in the house. The TouchPanel puts the power over technology back where it belongs. In the hands of the people. For the nearest dealer, call 1-800-KENWOOD or check out our new web site at [www.kenwoodusa.com](http://www.kenwoodusa.com).

**KENWOOD**

HOME AUDIO, CAR AUDIO, COMMUNICATIONS.

CIRCLE NO. 22 ON READER SERVICE CARD



# Stereo Review

INCORPORATING HIGH FIDELITY

## July 1996

Keep the music playing with a CD jukebox like the five we compare in this issue: (from top) the two-piece JVC XL-MC302, the Technics SL-MC400, the Pioneer PD-F1004, the Kenwood DP-J2070, and the Sony CDP-CX153. See page 52 for details.

Photograph by Jook P. Leung

- LETTERS** ..... 8
- NEW PRODUCTS** ..... 15
- TIME DELAY** ..... 28
- AUDIO Q&A** ..... 32
- SIGNALS** ..... 36
- TECHNICAL TALK** ..... 38
- POPULAR MUSIC** ..... 78
- CLASSICAL MUSIC** ..... 87
- CENTER STAGE** ..... 104

### STEREO REVIEW ONLINE

Join us at our site on America Online and link up with thousands of other people who are interested in the same good stuff you read about in STEREO REVIEW. Browse our message boards and put in your 2¢ worth . . . or ask for opinions about equipment or a special CD. Enter our Libraries and find a test report from last year. Pose your questions to the experts in our live conferences. Somebody swiped the May issue before you could get to it? You can find lots of the information you missed on STEREO REVIEW ONLINE.

All you need is a computer, a modem, and America Online software. To sign up, call America Online at 1-800-603-8181 for a free startup kit. Our keyword is STEREO REVIEW. See you in cyberspace!



PRINTED IN THE U.S.A.

### 6 Bulletin

The DVD bandwagon rolls on, Roaring Twenties revisited, CD alert, and more

### 24 Technology Update

I Want My HDTV!  
BY MICHAEL FEAZEL

### 40 Equipment Test Reports

Optimus STAV-3470 audio/video receiver, page 40  
Cinepro 600X power amplifier, page 44  
MB Quart Domain 20 speaker, page 46  
Eosone RSS 702 three-piece speaker system, page 47

### 49 Rodrigues Cartoon Caption Contest

The winner!

### 50 User's Report

KEF 60S/80C/30B Home Theater Speaker System  
BY DAVID RANADA

### 52 Megachangers

Five 100-CD changers and how they play  
BY DANIEL KUMIN

### 60 Real-Life Home Theater

Experts plan surround-sound speaker systems for three problem rooms  
BY REBECCA DAY

### 67 Making the Connection

How to wire an A/V system without becoming unglued  
BY IAN G. MASTERS

### 71 What?

Tips on protecting your hearing  
BY TOM NOUSAINÉ

### 75 Best Recordings of the Month

Merle Haggard wakes up, a magical "Magic Flute," Cast continues the British Invasion, and Henryk Gorecki's *other* music

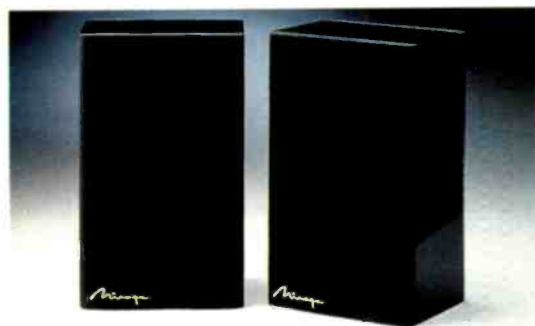

▲ Page 15

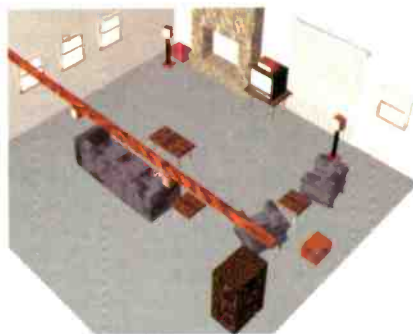

▲ Page 60



▲ Page 40



▼ Page 76

# BULLETIN

BY BOB ANKOSKO & WILLIAM LIVINGSTONE

## DVD ROLLS ON

Two more companies have jumped on the DVD bandwagon: Zenith plans to introduce a DVD player this fall, while JVC says it will wait until early next year to bring two players to market, about the same time it hopes to introduce Dolby Digital (AC-3) audio gear. So far, more than a dozen hardware manufacturers have lined up behind the new movie format. The first DVD players could hit store shelves as early as September.

## TEACHER, TEACHER

In conjunction with its sponsorship of four concerts by Wynton Marsalis, Harman International has begun a program to encourage music appreciation among 8- to 12-year-olds. The classes are being held at five schools in each city where Marsalis is playing, including concerts in Detroit on June 29 and San Francisco on July 11. Harman is donating a \$2,600 audio system and a 12-CD starter library to each school. Two of the ten school sessions held in the spring in Chicago and Washington, D.C., were led by Marsalis, trumpet in hand, and Dr. Sidney Harman, founder of Harman International.

## CD ALERT!

Do any of your CD packages have foam inserts? If so, get rid of the foam! Technical editor David Ranada has discovered instances where the foam used to protect discs during shipping has decayed and eaten into the label side of the discs. Although he has encountered the problem only with 12-year-old opera sets pressed in Europe, who knows what the foam will do to a disc 10 years from now. Better safe than sorry.

## MUSIC ON PBS TV

July is a big month for music on PBS. Evening at Pops

opens on Monday, July 1, with the Boston Pops joined by Patti Labelle, Edwin Hawkins, and the Boston Community Gospel Choir. Other events: In Performance at the White House with Linda Ronstadt and Aaron Neville, as well as the Dallas Symphony under Andrew Litton (both July 3), a Capitol Fourth with Erich Kunzel and the National Symphony (July 4), the Mostly Mozart Festival with Itzhak Perlman and Pinchas Zukerman (July 10), and the Lincoln Center Summer Festival '96 with John Eliot Gardiner and the Orchestre Révolutionnaire et Romantique (July 27).

## INSTALLER LOCATOR

Looking for an expert car stereo installer? The Consumer Electronics Manufacturers Association has set up a toll-free number you can call to locate installation specialists who have completed the association's Mobile Electronics Certification Program. The number is 1-800-767-6327.

## JVC JAZZ

Concerts and festivals in JVC's series of jazz events run through September. The JVC Jazz Festival, New York, is being held June 21-29, and the Newport Jazz Festival at Saratoga Springs, New York, takes place June 29 and 30. The actual Newport, Rhode Island, edition is planned for August 16-18. Similar events are set for Chicago, Concord (California), Los Angeles, Toronto, Dallas, and Atlanta, as well as London, Paris, Turin, Rome, and the Hague.

## A/V RESOURCES

Crutchfield, the mail-order catalog company, is offering the *Crutchfield Audio/Video Reference binder* for \$24.95 (\$4.95 with some purchases). It includes more than 200 adhesive-backed and color-coded CableLabels, illustrated hookup instructions for



## EDISON'S TREASURES FROM THE TWENTIES

By the time Black Friday had brought the Roaring Twenties to a grinding halt, the industrialist in Thomas Alva Edison had produced more than 3,000 musical recordings in a failed attempt to fortify the Edison Record Company. The original shellac test pressings were piled in a corner and forgotten for half a century until electrical engineers Craig Maier and Richard Carlson of New Jersey volunteered to help restore them. The colleagues set up a lab in Maier's basement and began the painstaking process of transferring the recordings to digital tape. Along the way they decided to release some of them on CD and devised a computer program, DCart, to remove hiss and clicks. "It allows us to take away that veil [of noise] so you can enjoy the performance," Maier says.

DCart was used on two of the three CD's in the Edison Laterals series, including *Hot Dance of the Roaring 20's* (\$17.98 plus shipping); a fourth disc is due out this fall. Maier and Carlson recently began selling a Windows version of the DCart program for \$49. Among its many features is a "vinyl mode" for rejuvenating worn-out LP's. For more information on the CD's and the DCart program, write to Diamond Cut Productions, P.O. Box 305, Hibernia, NJ 07842-0305.

a variety of audio and A/V scenarios, and a section on speaker placement and room acoustics. To order the binder, call 1-800-555-9507. ... Billed as "the most unique audio [vacuum] tube substitution manual published

since the 1960's," the 443-page *Gold Aero Tube Library, Volume 1: Tube Complement and Substitution Guide 1950-1995* is available as a binder from Cool Sounds Press for \$49.95 (plus shipping). Call 1-800-853-7166. □

ILLUSTRATION BY MIKE LEE



Species	*1452309
Die Hard With A Vengeance	*1462209
Top Gun (Remastered)	*1429406
Bladerunner (The Dir.'s Cut)	*1097906
The Omen	*1207901
Unforgiven (1992)	*1084003
The Professional	*1364801
Pink Floyd: The Wall	*1293802
Basic Instinct	*1033208
Backdraft	*0559005
Philadelphia	*1251404

# 3 Laser Discs \$1.00 EA

See Details Below.

Plus 1 More At Great Savings!



THE EMPIRE STRIKES BACK (THX) 1415801\*

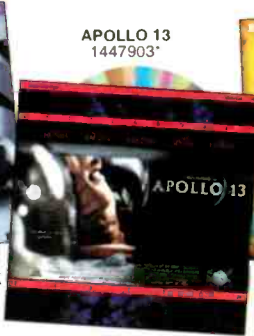

APOLLO 13 1447903\*



BRAVEHEART 1491604\*

The Wizard Of Oz	0001404
The Wild Bunch (Dir.'s Cut)	*1388008
All About Eve (Remastered)	1491000
The Invaders	1491406
Beyond Rangoon	*1489707
Nine Months	*1479906
Aliens (THX)	*1402601
Alien (THX)	*1402502
Total Recall	*1286103

## CLUB FAVORITES

A Nightmare On Elm Street	1460401*
Outbreak	1389501*
Predator	0364901*
Jurassic Park	1264001*
Rob Roy	1423201*
Batman Forever	1432509*
True Lies	1327105*
Forrest Gump	1333202*
Stargate	1334903*
Star Trek Generations	1382803*
Terminator 2: Judgment Day	0233205*
The Shawshank Redemption	1345503*



WATERWORLD 1472000\*

The Silence Of The Lambs	0805309
The Fugitive	*1197706
The Hunt For Red October	*0825000

## \* Letterbox

Return Of The Jedi (THX)	*1415900
Star Wars (THX)	*1416007
A Clockwork Orange	*1356005
Jaws	*0844605
Ghost	*0826008
Cliffhanger	*1149301
Bridge On The River Kwai (Restored)	*1143809
2001: A Space Odyssey	*0844308
Goodfellas	*0969808
Forget Paris	*1454909
Immortal Beloved	*1372309
Dolores Claiborne	*1451905
The Odd Couple	*1460807
First Knight	*1460104
Ferris Bueller's Day Off	*0427302
Bad Boys	*1451806
Clive Barker's Lord Of Illusions	*1471804
Casper (The Movie)	*1427905
Clear And Present Danger	*1326305

The Sound Of Music	*0003905
The Abyss	*0881102
Close Encounters Of The Third Kind (Special Edition)	*1273002
The Last Of The Mohicans (1992)	*1071406
Congo	*1453604
Jade	1483908
Living In Oblivion	*1484005
The Net	*1469907
Something To Talk About	*1478502
Moonlight And Valentino	*1498609
Johnny Mnemonic	*1452101
Never Say Never Again (Remastered)	*1443001
Clueless	*1462506
The Stars Fell On Henrietta	*1490903
An American Werewolf In London	*1453703
Bram Stoker's Dracula	*1102904
Interview With The Vampire	*1364405

## NEW RELEASES

The Indian In The Cupboard	1456201*
Assassins	1491109*
The French Connection	1491307*
Mute Witness	1460203*
Raising Arizona	1491802*
American Gigolo	0203000
Desperado	1485101*
Fair Game	1491505*
Party Girl	1487107
A Walk In The Clouds	1496504*
Cocoon	1469808*
The Usual Suspects	1479401*



ACE VENTURA 2: WHEN NATURE CALLS 1490309\*

Legends Of The Fall	*1371301
Virtuosity	*1483601
E.T.: The Extra-Terrestrial	*0681106
Under Siege 2: Dark Territory	*1483007
Hackers	*1482900

©1996 The Columbia House Company

Here's a great way to build a collection of your favorite movies - on laserdisc! Just write in the numbers of the 3 laserdiscs you want for \$1.00 each, plus shipping and handling. In exchange, you simply agree to buy four more laserdiscs in the next two years, at regular Club prices (currently as low as \$29.95, plus shipping/handling)-and you may cancel membership at any time after doing so. What's more, you can get still one more movie for the low price of \$19.95 and have less to buy later (see complete details in coupon).

Free Magazine sent every four weeks (up to 13 times a year) reviewing our Director's Selection - plus scores of alternate choices, including many lower-priced laserdiscs. And you may also receive Special Selection mailings up to four times a year. (That's up to 17 buying opportunities a year.)

Buy only what you want! If you want the Director's Selection, do nothing - it will be sent automatically. If you prefer an alternate selection, or none at all, just mail the response card always provided

by the date specified. And you'll always have 14 days to decide; if not, you may return the selection at our expense.

**Money-Saving Bonus Plan.** If you continue your membership after fulfilling your obligation, you'll be eligible for our generous bonus plan. It enables you to enjoy great savings on the movies you want - for as long as you decide to remain a member!

**10-Day Risk-Free Trial.** We'll send details of the Club's operation with your introductory package. If not satisfied, return everything within 10 days at our expense for a full refund and no further obligation.

For fastest service, use your credit card and call us toll-free 24 hours a day:

**1-800-538-2233** Dept. 6EJ

**COLUMBIA HOUSE** Entertainment America... One Person at a Time.®  
**LASERDISC CLUB**

## Columbia House Laserdisc Club

Dept. 6EJ, P.O. Box 1112, Terre Haute, Indiana 47811-1112

Yes, please enroll me under the terms outlined in this advertisement. As a member, I need to buy only 4 more selections, at regular Club prices, in the next 2 years.

Send me these 3 laserdiscs for \$1.00 each-plus \$1.75 each shipping and handling (total \$8.25).

### BUY YOUR FIRST SELECTION NOW-AND HAVE LESS TO BUY LATER!

Also, send me my first selection for \$19.95, plus \$1.75 shipping/handling, which I'm adding to my \$8.25 payment (total \$29.95). I then need to buy only 3 more (instead of 4) in the next 2 years.

### Please Check How Paying:

My check is enclosed  
 Charge my introductory laserdiscs and future Club purchases to:  
 MasterCard  Diners Club  AMEX  VISA  Discover

DHR/DHW  
DHS/DHX

Acct. No. \_\_\_\_\_ Exp. Date \_\_\_\_\_

Signature \_\_\_\_\_

Name \_\_\_\_\_

Address \_\_\_\_\_ Apt. \_\_\_\_\_

City \_\_\_\_\_ State \_\_\_\_\_

Zip \_\_\_\_\_ Phone No. (\_\_\_\_\_) \_\_\_\_\_

### Do any of the following apply to you? (41)

I own a Personal Computer (1)  I own a PC with a CD-ROM (2)  I plan to buy a PC with a CD-ROM (3)

Note: This offer applies to first-time Laserdisc Club members only. Limit one per household. Columbia House reserves the right to request additional information, reject any application or cancel any membership. Offer limited to the continental U.S. (excluding Alaska). Applicable sales tax added to all orders. 03-6/96

# Stereo Review

Vice President, Editor in Chief  
LOUISE BOUNDAS

Executive Editor  
BOB ANKOSKO

Art Director  
MINDY OSWALD

Technical Editor  
DAVID RANADA

Senior Editor  
ROB SABIN

Director, Hirsch-Houck Laboratories  
JULIAN HIRSCH

Managing Editor  
DAVID STEIN

Popular Music Editor  
STEVE SIMELS

Classical Music Editor  
ROBERT RIPPS

Associate Editor  
KEN RICHARDSON

Associate Art Director  
ANDREW THOMPSON

Assistant Editor  
JAE SEGARCA

Database Coordinator  
SANTIAGO PIZZINI

Editor at Large  
WILLIAM LIVINGSTONE

Contributors: Robert Ackart, Chris Alberson,  
Francis Davis, Rebecca Day, Richard Freed,  
Phyl Garland, Ron Givens, Corey Greenberg, David Hall,  
Bryan Harrell (Tokyo), Jamie James, George Jelinek,  
Daniel Kumin, Ian Masters, Brett Milano,  
Alanna Nash, Tom Noursaine, Henry Pleasants (London),  
Ken Pohlmann, Parke Puterbaugh,  
Charles Rodrigues, Eric Salzman, Craig Stark

Vice President, Group Publisher  
TONY CATALANO

## Consumer Electronics Group Advertising

VP/Associate Publisher  
Scott Constantine

Regional VP/Ad Director, East Coast:  
Charles L. P. Watson, (212) 767-6038

Regional Account Managers, East Coast:  
Christine B. Forhez, (212) 767-6025  
Penry Price, (212) 767-6077

Midwest Advertising Manager:  
Jerry Stoeckigt, (312) 923-4804

Regional VP/Ad Director, West Coast:  
Robert Meth, (213) 954-4831

Western Advertising Manager:  
Paula Mayeri, (213) 954-4830

Sales Assistant: Nikki Parker

National Record Label Sales Representatives:  
The Mitchell Advertising Group (MAG Inc.)  
Mitch Herskowitz, (212) 490-1715  
Steve Gross, (212) 490-1895

Assistant to the Publisher: Aline J. Pulley  
Promotion Coordinator: Adele Ferratoli-Kaltter  
Operations Manager: Sylvia Correa

Advertising Coordinator: Linda Neuweiler  
Sales Assistant: Yvonne Telesford  
Classified Advertising: (800) 445-6066

Production Manager: Vicki L. Feinmel  
Production Director: Patti Burns

Business Manager: Jonathan J. Bigham  
General Manager: Greg Roperti

HIRM  
Hachette  
Filipacchi  
Magazines

Stereo Review is published  
by Hachette Filipacchi Magazines, Inc.

Chairman: Daniel Filipacchi  
President, CEO, & COO: David J. Pecker  
Executive VP & Editorial Director: Jean-Louis Ginière  
President, Hachette Filipacchi New Media: Paul DeBenedictis  
Senior VP, Global Advertising: Paul DuCharme  
Senior VP, Director of Corporate Sales: Nicholas Matarazzo  
Senior VP, CFO, & Treasurer: John T. O'Connor  
VP, General Counsel: Catherine Flickinger  
VP, Manufacturing & Distribution: Anthony R. Romano  
VP, Circulation: David W. Leckey  
VP, Research & Marketing Services: Susan Smollens  
VP, Communications & Special Projects: Keith Estabrook  
VP, Magazine Development: Marcia Sachar  
VP, Dir. Creative Services, Corporate Sales: Lynn Chaiken  
Senior VP, Corporate Sales, Detroit: H. E. (Bud) Allen  
VP, Financial Operations: Margaret Carroll



# LETTERS

## Beach Bummers

Ken Pohlmann said that "to keep things fair" in his tests of six portable CD players ("Life's a Beach" in May), he evaluated the sound quality using a pair of \$150 Sennheiser headphones, and with those phones "they all pretty much sounded the same." That's not a fair test because most people are not going to go out and buy \$150 headphones for their \$200 CD players. A real test would have been to use the supplied headphones.

BILL LORENZ  
Groveland, MA

*Many people do buy better-quality headphones for portable CD and tape players, particularly since manufacturers tend to cut corners on supplied phones. The Sennheisers Ken Pohlmann used are not an unreasonable choice for someone buying one pair of phones for home and portable use. And testing these portables with their supplied headphones would only have resulted in a review of the colorations found in low-end headphones, revealing little or nothing about sonic flaws in the players. For that it was necessary to use a single pair of high-quality phones that put all the players on equal footing.*

I have gone through more cassette portables in the last ten years than I can count. Their headphones, like those of the CD players you reviewed, are made of cheap plastic that breaks all too easily. If an earpiece doesn't break off, one of the channels will become intermittent because of a broken connection. If you unplug the phones after each use, you'll break the solder that connects the circuit board to the mini jack.

The players themselves are no better. How many times are those lids going to open and close before breaking off, as has happened to me with numerous cassette portables? And how long are the digital displays on these CD portables going to last in the Texas heat before the chips fry?

None of them comes with a carrying case as a standard accessory, and none will still work if you drop it a few feet, which is how any equipment for use outdoors should be designed. As for features, I'm not asking for much: just a three-band equalizer, a pitch control for those nasty, carelessly mastered classic-rock CD's, and a good pair of headphones — or no headphones so I can make my own choice.

RAYMOND MORAN  
Austin, TX

## Tori Amos, Enigma

Concerning Parke Puterbaugh's May review of Tori Amos's "Boys for Pele," I would argue that her lyrics are enigmatic rather than "inscrutable." Her "free association" touches down in recurrent themes of social trials and human cruelty, often stemming from her difficult relations with her father and her religious upbringing. Sometimes the

feelings are clear, and sometimes they are confusing, as in "Boys for Pele."

Musicians often sacrifice grammar, pronunciation, and some semantics in the interest of musicality. Amos has a superior ability to focus her concerns amidst a whirlwind of thought and emotion, music and lyrics, giving us poetry. She makes beautiful music with some ugly themes.

JASON HAMMILL  
Trumansburg, NY

## Surround Insanity

I watch a lot of movies at home on video and recently upgraded to a VCR with hi-fi sound, which I play through a two-channel system. The enhancement of my viewing/listening pleasure is even greater than I had anticipated. So you'd think I would now be eager to upgrade further, to a full surround system. I am not, and Tom Noursaine explains why in "Surround Sanity" (April) when he lists the sonic episodes from films he used to evaluate surround-speaker arrangements. His list of noises incidental to action sequences or gimmicky musical effects confirmed my impression of the dozens of films I have seen in theaters with surround sound, that these effects rarely make a significant contribution to the dramatic impact of a film and are often distracting.

I am not eager to invest several hundred dollars to hear bathroom tiles shattering all around me, a jet plane pass through my body, or the slap-echo off the back of a concert hall. As for the center speaker, I find a phantom center channel completely satisfactory, well defined, and stable.

I can't believe I am the only person who feels that "surround sanity" means leaving it in the theaters. I hope that two-channel sound remains a consumer option for a good long time.

JOHN NIESSINK  
Portage, MI

## Hirschonomics

Julian Hirsch's "Technical Talk" in May reminded me of why I resubscribed to STEREO REVIEW after a couple of decades of doing without it. I'm still using the AR-4x speakers he praised thirty years ago (see "Time Delay" in the same issue), and he is still right on the mark today in his comments on "Audio's Ergonomic Challenge."

One thing he might have discussed is the disappearance of tuning knobs from home receivers. (At least I wasn't able to find any in my price range when I was shopping for a receiver a year or two ago.) Manual tuning with a rotary motion is much easier to control than with pushbuttons or bars and should be restored.

BRYAN RINGO  
Canton, NY

## Computer Speakers

I was surprised to read William Haupt's April letter bemoaning low-fi computer

# Heard any good movies lately?

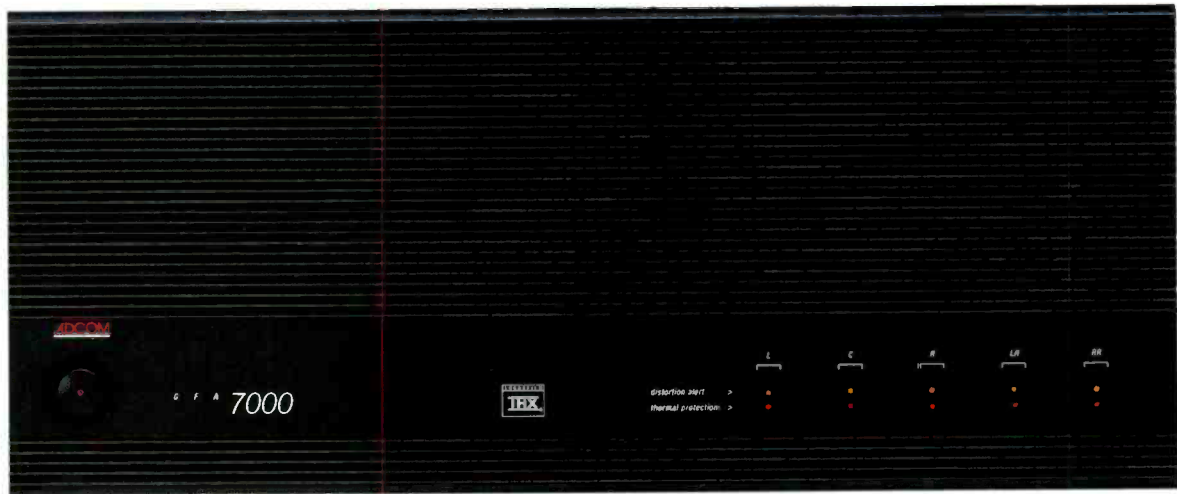

Adcom's 5-channel GFA-7000 amplifier is playing to rave reviews.

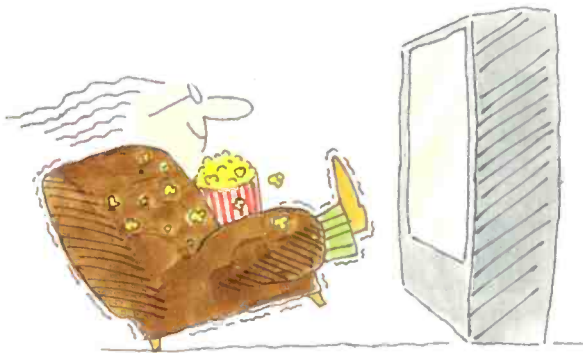

Today's movie soundtracks demand more than conventional home audio systems can deliver. That's why Adcom developed the Home THX® certified GFA-7000 power amplifier. With our GFA-7000, the movies you play at home will sound just the way the filmmakers intended. But that's not all. Adcom engineers went beyond the demanding requirements of THX® and created a home theater power amplifier that's caught the attention of the world's most critical audiophiles as well.

## The GFA-7000 is really five amplifiers in one.

The quantity and quality of power needed to faithfully reproduce the full range of frequencies and overall dynamic range of today's exciting soundtracks are highly demanding, especially considering that top home theater systems can utilize five separate full range speaker systems.

That's why Adcom's GFA-7000 has five separate amplifier modules, each rated at 130 watts into 8 ohms\*. To assure that no channel of information is compromised, each module must be capable of delivering all its power all the time, so each amplifier channel is given its own power supply and is mounted on its own circuit board. Even the toroidal power transformer has individual secondary windings for each amplifier module. With the GFA-7000, you'll never get stuck without enough power. It's like having true all-wheel drive.

## Movies or music, the GFA-7000 delivers a real performance.

The power amplifier is the heart of every high performance audio/video system. It is also the foundation on which Adcom has built its reputation for performance and value. You can be sure our GFA-7000 amplifier is an audiophile's amplifier, first and foremost. And because it exceeds THX® specifications and is ready for Dolby AC-3, it is sure to be the ticket to a movie buff's heart as well.

Listen to an award-winning movie or your favorite music on an Adcom GFA-7000. You'll hear what Adcom is always talking about. Two thumbs up for performance and value.

# ADCOM®

details you can hear

Distributed in Canada by Pro Acoustics, Inc. Montréal, Québec (514) 344-1226 • 11 Elkins Road, East Brunswick, NJ 08816 U.S.A. (908) 390-1130 © 1996 ADCOM  
THX® is a registered trademark of Lucasfilm Ltd. \*Power ratings are to FTC requirements. Continuous average power at any frequency between 20Hz and 20kHz with all channels driven at less than 0.05% THD.

CIRCLE NO. 1 ON READER SERVICE CARD

# "Selling Direct Allows Camb Speakers Hundreds Of Doll

Cambridge SoundWorks manufactures critically acclaimed speakers and music systems designed by Audio Hall of Fame member Henry Kloss (founder of AR, KLH and Advent). We sell them – along with components from Harman Kardon, Pioneer, Sony and others – factory-direct, so you can save hundreds of dollars. *Audio* magazine says we may have "the best value in the world." *Home Theater Technology* says our speakers "sound much better than other systems – at half the price."

## Ensemble\*

*Ensemble* is our best speaker system. We think it competes with audiophile tower speakers selling for over \$1,000 a pair. Yet its unique four-piece design literally disappears in your room.

*Ensemble* consists of two compact, two-way satellite speakers

*Our dual-subwoofer Ensemble outperforms expensive tower speakers because of its great room placement flexibility. \$599.99*

and two slim-line (4 1/2" thick) subwoofer cabinets enclosing 8" woofers.

Because the bass produced by the subwoofers is non-directional, you can put them in out-of-the-way places...even behind or under furniture. Then place the satellite speakers to create a realistic stereo image. *High Performance Review* describes *Ensemble* by saying "...stereo imaging is phenomenally sharp...the dynamics are stunning...some of the speakers I'm comparing it to cost \$1900 to \$2800." White or charcoal grey. **\$599.99**

## Ensemble II

*Ensemble II* is our best value high-performance speaker system. It uses the same satellites as *Ensemble*, but with a single subwoofer cabinet that holds two 6 1/2" woofers in an acoustic suspension enclosure.



*Ensemble II is our best value in a high-performance speaker system. Its satellite speakers are identical to Ensemble's. \$499.99*

Because 90% of the music is reproduced by the satellites, *Ensemble II* sounds much like *Ensemble*. *Stereo Review* says "Ensemble II can be compared only with much larger speakers at substantially higher prices." White or charcoal grey. **\$499.99**

## Ensemble III

*Ensemble III* was designed to bring big sound into smaller rooms. It has two small, two-way satellites and a subwoofer cabinet that encloses a single 6 1/2" woofer with two voice coils.

*Ensemble III* maintains the smooth, natural tonal balance of our more expensive systems, but without the same deep bass extension. *Stereo Review* says it "sounds first rate in every respect." **\$349.99**

*Ensemble III brings high-performance sound into even very small rooms. \$349.99*



## Ensemble IV

Our most compact and affordable subwoofer/satellite speaker system is *Ensemble IV*. It consists of two "cube" satellites containing wide-range 3" speaker drivers and a shoebox-sized subwoofer with a 5 3/4" woofer. It doesn't have the same deep bass extension as our more expensive speakers – but it sounds terrific.



*Ensemble IV is our most affordable subwoofer/satellite speaker system. \$249.99*

*Home Theater Technology* says "Ensemble IV produces a level of sound quality that is so much bigger and better than you'd expect from an inexpensive system that it's almost ridiculous." **\$249.99**

## The Outdoor

Our all-weather speaker is called *The Outdoor*. It has the natural, accurate, wide-range sound that Henry Kloss designs are known for. We don't know of any all-weather speaker that sounds better. Free-standing (shown), **\$299.99pr.** In-wall version, **\$349.99pr.**



## Center Channel Speakers

Cambridge SoundWorks manufactures two speakers specifically for use as center channel speakers in Dolby® Pro Logic® home theater systems. Both are magnetically shielded so they can be placed near a TV or computer

# Cambridge SoundWorks To Price Yours Below The Competition."

Inc. Magazine



Center Channel Plus



Center Channel

monitor. *Center Channel* is identical to an *Ensemble* satellite (but with magnetic shielding). **\$159.99.** *Center Channel Plus* uses an ultra-low, ultra-wide design that is ideal for placement above (or, with optional support stand, below) a TV monitor. It is, we believe, the finest center channel speaker available. **\$229.99**

## Surround Speakers

Cambridge SoundWorks makes two "dipole radiator" surround sound speakers. Dolby Laboratories recommends dipole radiator speakers for use as surround speakers. *The Surround* has high power handling capacity and is often selected for "high end" surround sound systems. **\$399.99 pr.** The smaller *The Surround II* is arguably the country's best value in a dipole radiator speaker. **\$249.99 pr.**



Powered Subwoofer

Slave Subwoofer

Powered Subwoofer II

in conjunction with the *Powered Subwoofer*. **\$299.99** The new *Powered Subwoofer II* uses a 120-watt amplifier with a custom designed 8" woofer. **\$399.99**



The Surround II

The Surround

## Powered Subwoofers

The *Powered Subwoofer* by Cambridge SoundWorks uses a heavy-duty 12" woofer housed in an acoustic suspension cabinet

## SoundWorks Amplified Speakers

*SoundWorks* is a compact, amplified, subwoofer/satellite speaker system. Never before has so much "big" sound come from



SoundWorks

something so small. Connect it to a portable CD/tape player, boombox, TV or computer – anything with an earphone jack – for beautiful, room-filling sound. *Audio* called it "really amazing...exceptionally good." *PC Computing* named *SoundWorks* "the best multimedia sound system costing over \$100." Available in black or computer-beige. **\$219.99**

## Factory-Direct Savings

Our speakers are available only directly from Cambridge SoundWorks, and through cost-efficient Best Buy stores.\* Order them, then listen in your own home. If you aren't satisfied, return them

within 30 days for a full refund.

\*Actual prices may vary by store.



To Order, For a Free Catalog, Or For The Nearest Store Location, Call **1-800-FOR-HIFI** (1-800-367-4434)



Critically Acclaimed. Factory-Direct.

311 Needham Street, Suite 102, Newton, MA 02164  
Tel: 1-800-367-4434 Fax: 617-332-9229  
Canada: 1-800-525-4434 www.hifi.com  
Outside U.S. or Canada: 617-332-5936

© 1996 Cambridge SoundWorks. ®Ensemble is a registered trademark of Cambridge SoundWorks, Inc. KLH is a trademark of KLH, Inc. AR and Advent are trademarks of International Jensen Inc. ®Dolby and ®Pro Logic are registered trademarks of Dolby Laboratories Licensing Corp. Cambridge SoundWorks is not affiliated with KLH, Advent or AR.



CIRCLE NO. 6 ON READER SERVICE CARD

**CAMBRIDGE  
SOUNDWORKS**  
BY HENRY KLOSS



# FREE Audio Catalog

At Cambridge SoundWorks we make unique, critically-acclaimed speakers and music systems designed by Henry Kloss (founder of AR, KLH & Advent). We sell them—and components from companies like Sony, Pioneer, Philips, Carver and others—factory direct, with no expensive middlemen. Call today and find out why *Audio* magazine said we may have "the best value in the world."

- Call toll-free for factory-direct savings.
- Save hundreds on components and systems from Cambridge SoundWorks, Sony, Pioneer, AIWA, Harman Kardon, Philips, Carver and more.
- Audio experts will answer your questions before and after you buy, 8AM-Midnight (ET), 365 days a year—even holidays.
- 30-Day Total Satisfaction Guarantee on all products.
- 7-Year Parts & Labor Speaker Warranty.

"Best Buy." *PC Magazine*



Add our award-winning \$219.99 SoundWorks system to your computer, radio, TV, or Walkman for room-filling sound and powerful bass.

\$219<sup>99</sup>

**1-800-FOR-HIFI**  
Critically-Acclaimed. Factory Direct.

**CAMBRIDGE  
SOUNDWORKS**

311 Needham Street, Suite 102, Newton, MA 02164  
Tel: 1-800-367-4434 Fax: 617-332-9229  
Canada: 1-800-525-4434 Outside U.S. or Canada: 617-332-5936  
World Wide Web Address: www.hifi.com  
©1996 Cambridge SoundWorks, Inc.

speakers! I can't believe a STEREO REVIEW reader would expect a computer speaker to sound good! These are toys! A much cheaper solution that works for me is to run a cable from the computer's line output to an auxiliary input on a good stereo system. Even if the system is located in a different room, the sound could come from a pair of remote speakers hooked to the stereo system, and you could adjust the volume through the computer's software controls. One caution: Physically disconnect the computer when it's not being used because it pumps a lot of noise into the line outputs. That's another reason to wonder about "hi-fi" multimedia PC's. If you check the specs on your computer's sound system, you'll find they're not even close to those of the cheapest CD player!

CARL VALLE  
Webster Groves, MO

## Recordable CD Is Where?

Ken Pohlmann did a great job in "Recordable CD Is Here!" in March, but the only noncomputer equipment he mentioned was the \$2,000 Pioneer Elite PDR-99 recorder. Are there others, and where do I purchase blank discs?

B. J. WILLIAMS  
Austin, TX

At present, only Pioneer is offering CD-R recorders for the consumer audio market, though several manufacturers produce professional models. Besides the Elite PDR-99 (reviewed here in January), Pioneer recently added the PDR-05, a non-Elite model that lacks the PDR-99's rosewood side panels and Legato Link S circuitry and sells for \$1,950. CD-R blanks with 60-minute capacity are available from Pioneer (RDD-60) and TDK (CD-RXG); cost is about \$20. You can find local retailers for these companies' products by calling 1-800-PIONEER or 1-800-TDK-TAPE, respectively.

## External Timers

I need an external timer and am having trouble finding one. Ian Masters indicated in an "Audio Q&A" reply a while back that several manufacturers still make them. Can you suggest some?

THEODORE R. POSTEL  
Chicago, IL

Radio Shack sells a fine digital clock/timer for \$24.99 (catalog No. 61-1060). We don't know about any others currently available.

## Speakers from a Van

As an audio engineer who also repairs speakers for a local audio retailer, I feel you should alert readers to an especially poor component included in February "New Products": Innovative Sound Systems' Acoustic Response Monitor 707. The woofers in these speakers blow at even nominal listening levels, and I've replaced a multitude of them. I was astonished when I saw the price given as \$749 a pair. This unit is worth no more than \$150 a pair, tops!

Furthermore, I know of no reputable dealers who sell this line. In our area they're

sold out of the backs of vans. Understand that I do not benefit from harming the reputation of this manufacturer. In fact, I make a good profit retrofitting these speakers.

SCOTT A. DIXON  
Sarasota, FL

I work at an independent audio shop in Indianapolis, and my experience with Acoustic Response speakers has not been good. They sell these speakers from the backs of vans here, usually pitching them at gas stations, stoplights, parks, and so on. From what I've seen, they don't compare with even a \$100 pair of speakers. The \$749 list price is absurd.

GERALD WILLIS  
Indianapolis, IN

February "New Products" shows a speaker from Innovative Sound Systems. I had a pair of these worth no more than a hundred bucks. I thought everything in your magazine was top quality, but these are second-rate. Do you audition the equipment you put in your magazine? PATRICK CALHOUN  
Indianapolis, IN

"New Products" covers a wide range of equipment, including some components from lesser-known manufacturers. While we make every effort to weed out unreliable companies and products, unless otherwise noted the only components shown in the magazine that you can be sure we've auditioned are the ones featured in our test reports and user's reports.

We referred these complaints to Conrad Viva, president of Professional Audio Concepts and its affiliate, Innovative Sound Systems, in Orange, California, who confirmed that Innovative distributes almost exclusively through a network of "independent people" and that the "suggested retail price" we were given for the Acoustic Response 707 may be different from the actual selling price. He called the published specifications for the speakers accurate, however, and said that "the product is reputable and we stand by it." Nonetheless, it's always a good idea to stick with established retailers or mail-order companies when purchasing new equipment.

## Corrections

The caption that accompanied the photo of the Marantz DP-870 processor in "Dolby Digital Surround" in May incorrectly stated that it provides Dolby Pro Logic decoding. This unit only does Dolby Digital (AC-3) decoding.

The address that we printed for Acoustic Research in May's "New Products" was an old one. The company's current address is Dept. SR, 9424 Eton Ave., Suite J, Chatsworth, CA 91311. □

We welcome your letters. Please address correspondence to Editor, *Stereo Review*, 1633 Broadway, New York, NY 10019. You should include your address and telephone number for verification. Letters may be edited for clarity and length.

“When we needed special equipment on opening day, I knew RadioShack had it...”

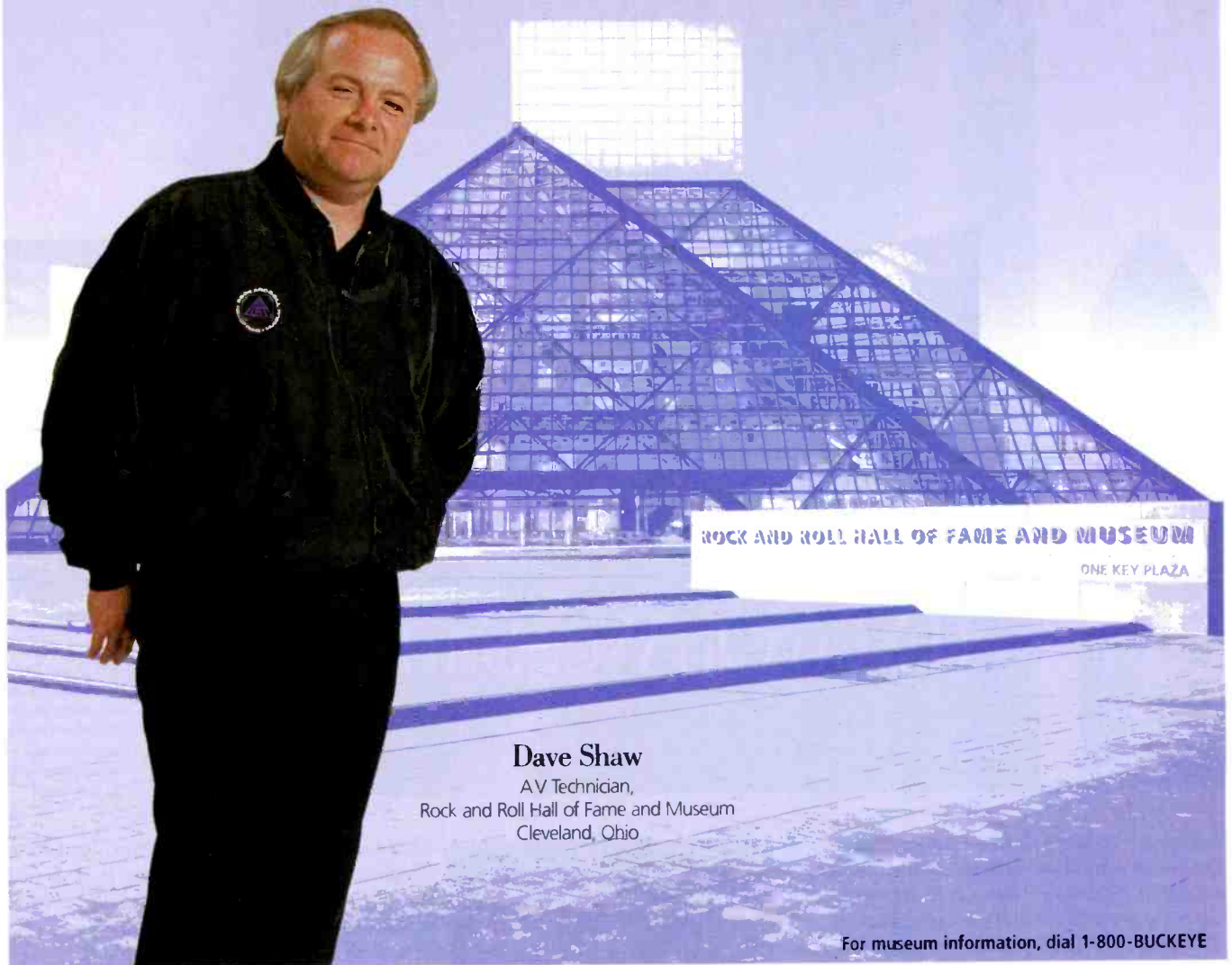

**Dave Shaw**

AV Technician,  
Rock and Roll Hall of Fame and Museum  
Cleveland, Ohio

For museum information, dial 1-800-BUCKEYE



**W**hen Dave Shaw gets in a jam at the Rock and Roll Hall of Fame and Museum, help is always nearby. “When 25,000 people showed up on opening day, we needed PA equipment outside. I ran up the hill to the Shack and soon we had amps, cords, XLR connectors and a wireless mic hooked up to direct crowds.” When you visit “The House That Rock Built™” in Cleveland, you’ll see and hear rock’s legendary performers and explore rock’s impact on modern culture. One way or another, RadioShack helps the

Museum keep rocking “...nearly every week,” says Dave. For the products, the parts and the people to help you put it all together, we’re in downtown Cleveland and over 6,600 other locations. For a store near you, call 1-800-THE-SHACK.



**RadioShack.**  
OFFICIAL CONSUMER  
ELECTRONICS PRODUCTS

# Corners Beautifully.

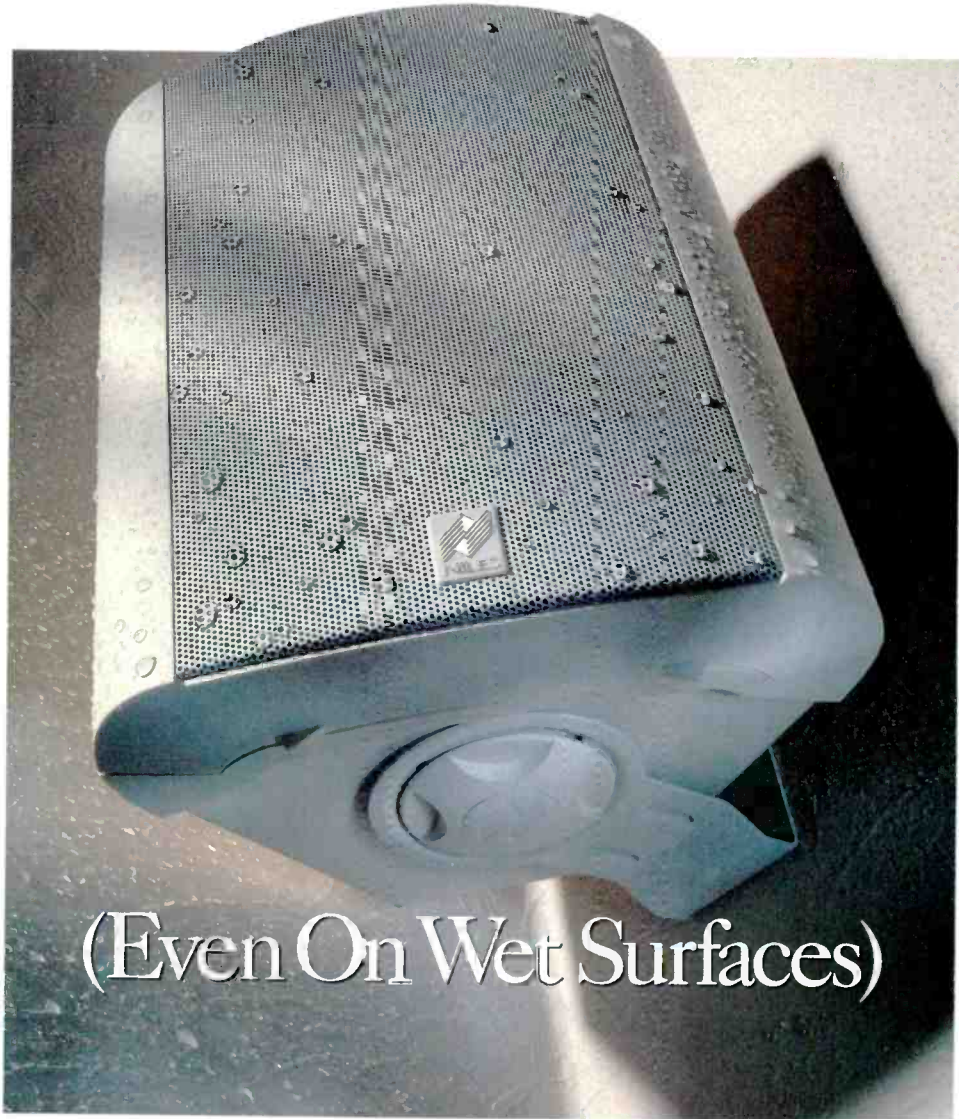

*Tapered to tuck neatly into corners and under eaves, the OS-10 comes with a clever pivoting bracket that provides endless mounting solutions.*



*Tough enough for marine applications and beach-front living. Exceeds military anti-corrosion specs (MIL-STD-883D).*



*ElastoDynamic™ Hybrid Dome Tweeter. Impervious to moisture. Niles' unique tweeter design offers extended frequency response with stunning detail and clarity.*

(Even On Wet Surfaces)

Niles' speaker engineers are driven to design the very best. The result is *unparalleled* performance—sonically, visually, and functionally. The Niles OS-10 Indoor/Outdoor Loudspeaker will exceed all of your expectations.

**Sonically.** The OS-10 handily outperforms many traditional bookshelf speakers. Much of its superb sonic character comes from its unique tweeter design. Constructed from a composite matrix of elastomers and natural fiber substrates, the ElastoDynamic™ tweeter yields extended frequency response with stunning detail and clarity. But to be a great speaker, you need great bass. Here the OS-10 shows its true horsepower thanks to its injection-molded, polypropylene woofer cone, supple butyl-rubber surround, and powerful magnet structure.



**Visually.** The OS-10's aerodynamic shape speaks for itself. But what may not be readily apparent speaks just as loudly. The OS-10's



tapered enclosure tucks neatly into corners or under eaves, complementing any decor, inside or out. Its clever pivoting bracket (standard equipment on the OS-10) gives you endless mounting solutions. Available in white or black, either finish is paintable for a truly custom look.

**Functionally.** We don't take the term "weather-proof" lightly. The OS-10 is designed to withstand extreme climates—from Minneapolis to Miami. Its rugged, non-resonant cabinet is totally sealed (insects or moisture can't creep in) and will not fade under the sun's rays. The grills and brackets are

aluminum; the connectors are gold-plated; all the hardware is brass or stainless steel—this speaker will not rust! And we guarantee it for two years.

For the name and number of your nearest authorized Niles dealer call 1-800-BUY-HIFI.

**NILES**  
BLENDING HIGH FIDELITY  
AND ARCHITECTURE

Niles Audio Corporation, Inc.  
P.O. Box 160818 Miami, FL 33116  
In Canada call Aralex Acoustics, Ltd. (604) 873-4475





# NEW PRODUCTS



## ▲ HARMAN KARDON

Harman Kardon's ADP-303 Dolby Digital (AC-3) surround processor features separate level controls for its six dedicated RCA-jack outputs as well as a master volume control, which lets it work with compatible A/V receivers (such as the company's AVR-80) or as a stand-alone device with one or more power amplifiers. It

has both RF-modulated and direct digital inputs, so it can accept both the AC-3 output of a current laserdisc player and future AC-3 signals from a DSS receiver, DVD player, or HDTV set. Price: \$799. Harman Kardon, Dept. SR, 80 Crossways Park West, Woodbury, NY 11797.

• Circle 120 on reader service card

## ▶ PINNACLE

The Classic Gold Tower from Pinnacle uses two 8-inch drivers, one crossing over at 150 Hz and the other at 2 kHz, in a three-way system with a 1-inch gold-colored aluminum-dome tweeter. Frequency response for the tripleported, 37 $\frac{1}{8}$ -inch-tall speaker is given as 27 Hz to 21 kHz  $\pm$ 3 dB, power handling as 150 watts, impedance as 8 ohms, and sensitivity as 95 dB. Biampable binding posts, brass decoupling feet, a black vinyl finish, and a seven-year warranty fill out the package. Price: \$900 a pair. Pinnacle, Dept. SR, 225 Executive Dr., Plainview, NY 11803.

• Circle 121 on reader service card



## ▲ CWD

CWD's Wildwood A/V furniture has interchangeable wood and acoustic-fabric doors in each 74-inch-tall side tower for flexible speaker placement. An adjustable bridge kit fits over the TV. The direct-view model (not shown)

has a TV stand with a covered center-speaker compartment. Finish is oak or birch. Price: \$2,400; for direct-view TV, \$2,850. CWD, Dept. SR, P.O. Box 8, North Reading, MA 01864.

• Circle 122 on reader service card

## ▼ MIRAGE

The bipolar Mirage MBS-2 surround speaker's convertible crossover can compensate for the artificially boosted bass and lower-midrange frequencies that wall-mounting often causes or leave response unaltered for use with stands. Each 12 $\frac{1}{8}$ -

inch-tall speaker, finished in black or white, has two 5 $\frac{1}{2}$ -inch polypropylene woofers and two 1-inch titanium-dome tweeters. Price: \$600 a pair. Mirage, Dept. SR, 3641 McNicoll Ave., Scarborough, Ontario M1X 1G5.

• Circle 123 on reader service card

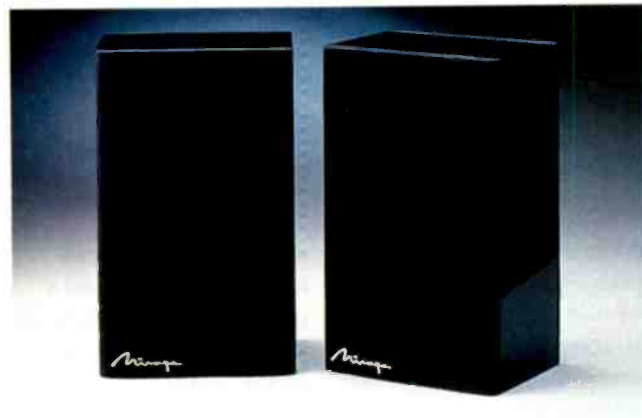

# NEW PRODUCTS



## ▲ DENON

Denon's DRM-650S cassette deck features Dolby S noise reduction as well as Dolby B and C and Dolby HX Pro headroom extension. A full-logic tape-transport mechanism and a two-motor nonslip drive system are said to help reduce the

deck's rated wow and flutter to 0.055 percent wrms. An automatic tape-tuning system adjusts sensitivity and bias for each tape used. Price: \$350. Denon Electronics, Dept. SR, 222 New Road, Parsippany, NJ 07054.

• Circle 124 on reader service card



## ◀ ALTEC LANSING

Along with its 6 x 9-inch carbon/mica woofer, the Altec CA96 triaxial car speaker has a 1/2-inch "mid-tweeter" and a 1/2-inch supertweeter, both soft Mylar domes. Acoustic lenses on each tweeter control dispersion. Price: 250 a pair. Altec Lansing, Dept. SR, Milford, PA 18337-0277.

• Circle 126 on reader service card



## ▲ ORION

Orion's NT100 and NT200 car power amps (\$1,100 and \$1,200) are rated for 50 and 100 watts per channel, respectively, into 4 ohms with less than 0.005 percent distortion. Both feature dual-

mono construction, separate MOSFET power supplies, and a choice of balanced or unbalanced inputs. Orion, Dept. SR, 118 W. Julie Dr., Tempe, AZ 85283.

• Circle 128 on reader service card

## ▼ PARADIGM

Paradigm's PS-1200 powered subwoofer uses a high-current 130-watt amplifier to juice a long-throw 12-inch polypropylene driver mounted in a ported bandpass enclosure. Features include auto on/off, speaker-level and line-level inputs, a high-pass output, a variable crossover,

and phase adjustment. Bandwidth for the 19 3/4 x 17 x 21-inch subwoofer, finished in black ash woodgrain vinyl, is given as 24 to 150 Hz. Price: \$619.

Paradigm, distributed by AudioStream, Dept. SR, MPO Box 2410, Niagara Falls, NY 14302.

• Circle 125 on reader service card

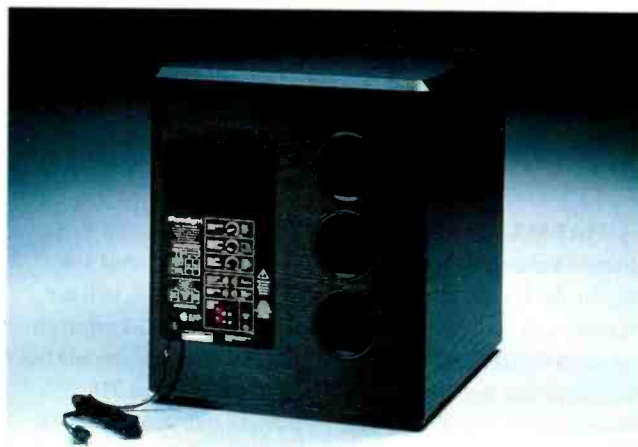

## ▼ RUARK

The 5 1/2-inch woofer in the Ruark Icon has a pentagonal cone that is said to dissipate voice-coil reflections for improved midrange clarity. The two-way, bass-reflex speaker also features a 1-inch, liquid-cooled fabric-dome tweeter and magnetic shielding. It stands

13 3/4 inches tall and is finished in black ash, cherry, or walnut veneer. Rated low-end limit is 58 Hz. Price: \$699 a pair.

Ruark, imported by Audio Influx, Dept. SR, P.O. Box 381, Highland Lakes, NJ 07422-0381.

• Circle 127 on reader service card



# "Polk's SRT System will give you a thrill a minute"

David Ranada, Stereo Review, January, 1996

The most influential audio journals of Europe and America agree, the Polk Audio Signature Reference Theater system is a stunning achievement.

"The sound was extremely clean and extremely powerful, I was scared... an amazing combination of flatness and low frequency extension we have never before measured in our listening room... the effects produced by SDA had to be heard to be believed... spectacular directional and spatial effects..."

David Ranada, Stereo Review, January, 1996

**"...better than real cinema."**

"... this is cinema shakeup, cinema shake-down, cinema turn-it-upside-down. You're not on the edge of your seat, you're forced back into it. The realism is intense... this is a system which can excel with music sources... breathy and clear... admirable speed and grace... totally absorbing"

What Hi-Fi?, Great Britain. February, 1996

For more information and the location of a Polk SRT dealer near you, call (800) 377 - 7655.



*The SRT system consists of 35 active drive units housed in seven enclosures (including two 300 watt powered subwoofers) and a Control Center with wireless remote.*

*Matthew Polk*  
Co-founder, Polk Audio

**WARNING: THIS SYSTEM IS CAPABLE OF EXTREME SOUND PRESSURE LEVELS. SRT SYSTEMS ARE SUPPLIED WITH A SOUND PRESSURE LEVEL METER TO HELP YOU DETERMINE SAFE LISTENING LEVELS.**

Dealer Locator Number

1-800-992-2520  
Ad code: 10014

**polk audio**  
The Speaker Specialists™

5601 Metro Drive, Baltimore, Maryland 21215 USA (410)358-3600.

"Polk Audio", "The Speaker Specialists" and "Dynamic Balance" are registered trademarks of Polk Investment Corporation used under license by Polk Audio Incorporated.

CIRCLE NO. 34 ON READER SERVICE CARD

# NEW PRODUCTS

## ▼ SONY

Said to be the world's smallest car changer, Sony's six-disc MDX-60 MiniDisc changer measures just under 7 x 3½ x 5 inches, small enough to slip into a glove box. It features a 1-bit D/A converter, a 10-second antishock memory, and an Ex-Change function that lets you replace other discs while one is playing. Price: \$1,000. Sony Electronics, Dept. SR., 1 Sony Drive, Park Ridge, NJ 07656.



## ▼ PROTON

Proton's 34-inch WT-3650, a wide-screen direct-view TV, is designed for use in a home theater. Its four picture formats include the traditional 4:3 aspect ratio, the same digitally enlarged to fill the screen, a 16:9 ratio for letter-boxed movies, and a 16:9 "zoom" mode to adjust letter-boxed images. It also has



## ▲ MTX

The MTX Blueprint 622RCM is a weatherproof speaker suitable for small bathrooms and other wall/ceiling installations where a stereo speaker pair isn't practical. It includes one 6½-inch dual-voice-coil polypropylene woofer and two ½-inch polycarbonate-dome tweeters, one for each channel. A mesh grille is supplied. Price: \$220 a pair. MTX, Dept. SR, 4545 E. Baseline Rd., Phoenix, AZ 85044.

• Circle 129 on reader service card

a PIP function using dual tuners and a multispeaker sound system with a Spatializer processor. The extensive rear- and front-panel connections can accommodate several composite- and S-video inputs. Price: \$5,000. Proton, Dept. SR, 13855 Struikman Rd., Cerritos, CA 90703.

• Circle 131 on reader service card



## ▲ COINCIDENT

Coincident's Troubador (\$1,495 a pair) is a 9¾-inch-tall, two-way speaker with a 6½-inch composite woofer, a concentric 1-inch silk-dome tweeter, and a cabinet designed without parallel walls to avoid internal standing waves. Matching stands (\$495 a pair) can be ordered as Troubass passive subwoofers (\$1,595 a

pair). Sensitivity is rated as 90 dB, power handling as 7 to 150 watts, and the low-frequency limit as 45 Hz. Wood veneer finishes include maple, rosewood, and satin or high-gloss black. Coincident Speaker Technology, Dept. SR, 51 Miriam Crescent, Richmond Hill, Ontario L4B 2P8.

• Circle 130 on reader service card



## ▲ AIWA

The Aiwa SC-C27 three-piece multimedia speaker system offers two contoured satellites, each driven by a 5-watt amplifier, and a bass module driven by its own 10-watt amp. Low-end performance is further enhanced by Super T-Bass circuitry. Volume and bass controls are mounted

atop the bass unit, and an auto on/off circuit simplifies operation. All three pieces are finished in a matte pebble gray, and they are magnetically shielded for use near a monitor. Price: \$175. Aiwa America, Dept. SR, 800 Corporate Drive, Mahwah, NJ 07430.

• Circle 132 on reader service card

# NEW BACARDI SPICE

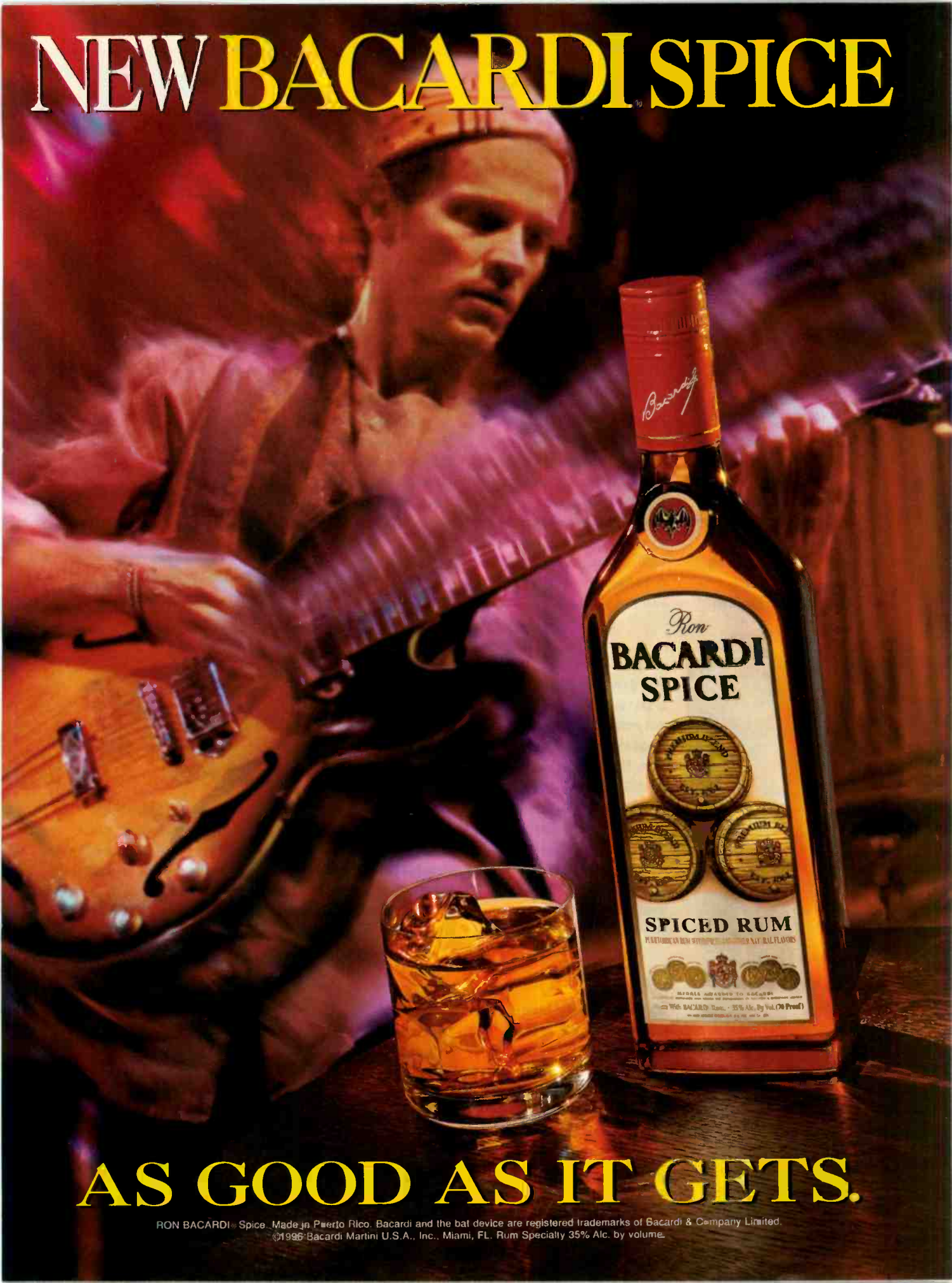

## AS GOOD AS IT GETS.

RON BACARDI® Spice. Made in Puerto Rico. Bacardi and the bat device are registered trademarks of Bacardi & Company Limited.  
©1996 Bacardi Martini U.S.A., Inc., Miami, FL. Rum Specialty 35% Alc. by volume.

# NEW PRODUCTS



## ▼ JVC

Rated at 100 watts x 4 (or 120 watts per channel in stereo), JVC's RX-818V receiver offers Dolby Pro Logic processing in the digital domain as well as two theater modes, four music modes, and a headphone mode that localizes sounds in front of the listener. A center-channel tone control helps in speaker

matching. There are five audio inputs (including phono), three video inputs, and a line-level subwoofer output. The multibrand remote control has a phosphorescent panel to simplify its use in dark rooms. Price: \$550. JVC, Dept. SR, 41 Slater Dr., Elmwood Park, NJ 07407.

• Circle 133 on reader service card



## ◀ DISC-SAVER

Disc-Saver's CD Restorer solution is said to have a natural abrasive that polishes CD scratches to eliminate sticking or audible pops. The DS-15 Deluxe CD Care Kit (\$22.95) comes with enough Restorer, Shield cleaner/protectant, and Pro-Wipes wipe cloths for 125 treatments. Disc-Saver/Pleasant Associates, Dept. SR, 100 Carl Dr., Unit 14, Manchester, NH 03103.

• Circle 135 on reader service card

## SOUND DYNAMICS ▶

The THC-2 from Sound Dynamics can be used either as a center speaker or as left and right mains if positioned vertically with the tweeters on the inside. The 21-inch-wide/tall matte-black speaker has dual vents in the front along with two 5¼-inch magnetically shielded, injection-molded woofers and a ¾-inch

multilaminate dome tweeter. Frequency response is given as 45 Hz to 22 kHz ±3 dB, sensitivity as 90 dB, maximum power-handling as 175 watts, and nominal impedance as 8 ohms. Sound Dynamics, Dept. SR, 3641 McNicoll Ave., Scarborough, Ontario, M1X 1G5.

• Circle 137 on reader service card

## MESSINA ▶

Messina's triangular MICS-50 surround speakers match the design of the front, center, and passive subwoofer models in its In Corner series. The 10 x 14 x 10-inch MICS-50 has a single 4-inch wide-dispersion driver and can be mounted on a wall or in a ceiling corner (using the supplied brackets and paintable wire concealers) or on a pair

of STD-74 stands as shown. Price: \$199 a pair; stands, \$159. Messina Electronic, Dept. SR, 900 Michèle-Bohec, Suite 106, Blainville, Quebec J7C 5E2.

• Circle 134 on reader service card



## ▲ SOUNDSTREAM

Soundstream's Reference404s car amplifier is rated to deliver 50 watts each to four channels into 4 ohms or 200 watts to two into 2-ohm or 1-ohm loads. It features a 1,280-watt Darlington power array with sixteen output devices

and a switch to select either high-current operation into ½ ohm or normal operation into 4 ohms. Price: \$499. Soundstream Technologies, Dept. SR, 120 Blue Ravine Rd., Folsom, CA 95630.

• Circle 136 on reader service card



# You can go with the innovators. Or be fooled by the imitators.



M-1si

*"The holy grail  
of home theater."*

- VIDEO MAGAZINE

Fortunately most people are discerning enough to know - and hear - the difference.

They're aware that many manufacturers are now trying to duplicate the unique design and outstanding performance of Mirage, the inventors of the original Bipolar loudspeaker. Yet they're equally aware that no one has even managed to come close.

Our flagship M-1si towers offer the perfect case in point. This fully symmetrical, three-way Bipolar speaker has earned the acclaim and awards of audiophiles around the world. Its dual 8" subwoofers in individual chambers generate amazingly accurate bass down to 20Hz while proprietary tweeter and midrange designs ensure minimal distortion and optimal dispersion.

Now Mirage is setting amazing new standards in Home Theater sound as well, with an awesome array of full-range speakers, center

*"Since there aren't  
any faults that  
we can hear,  
the standard in  
loudspeaker design  
may well be at  
hand... the bench-  
mark of modern  
engineering."*

- THE INNER EAR REPORT

channels, subwoofers and satellite surrounds. No matter where you are in the room, with Mirage Bipolar you're utterly immersed in the most spacious, three-dimensional music and sound effects imaginable.

So you can put off purchasing until the next millennium, in hopes that the imitators will eventually catch up. Or you can listen to Mirage and enjoy the future of Home Theater today.

FOR AN EXPERT DEMONSTRATION OR MORE INFORMATION ON OUR HOME THEATER SYSTEMS, VISIT THE EXCLUSIVE MIRAGE DEALER IN YOUR AREA.



3641 MCNICOLL AVENUE,  
SCARBOROUGH, ONTARIO  
CANADA M1X 1G5

(416)321-1800 FAX (416)321-1500

CIRCLE NO. 7 ON READER SERVICE CARD



**6 MILES**  
Pumping bass frequencies impede concentration during marital duties.

**3 MILES**  
Clear, pure sound disturbs small dogs and other household pests.

**1 MILE**  
Clapping-activated lights flicker to a groovy bass beat.





**THE EPICENTER**

Driver turns on Pioneer car stereo system featuring a 35W x 4-channel CD player with detachable face. Subsequent rush of sound induces tingling in pelvic region and desire to bang head on dashboard.

**1,000 FEET**  
Power chords cause bladder and bowel control to weaken.

**250 FEET**  
Screaming high frequencies pose severe threat to limited-edition ceramic frog collections.

**0-50 FEET**  
Old folks clutch ears and moan in agony. Anyone with pacemaker should evacuate area.



# TECHNOLOGY UPDATE

## I Want My HDTV

BY MICHAEL FEAZEL

**A**fter more than eight years of technological development and political haranguing, the Federal Communications Commission has finally proposed formal adoption of the Grand Alliance standard for high-definition television. That's the good news.

Unfortunately, there's some bad news, too. The bureaucratic and economic realities of this decision mean that most cities won't see their first full-fledged commercial HDTV broadcasts until the fall of 1997, and it will be several *more* years before a significant number of consumers actually buy an HDTV set.

Still, the good news is very good indeed. Tests of the Grand Alliance system conducted at the Advanced TV Test Center (ATTC) in Alexandria, Virginia, as well as field tests from a broadcast station in Charlotte, North Carolina, showed that both the video and the CD-quality audio received on HDTV sets was virtually identical to the high-definition source material. That could open the door to home-theater systems that are indistinguishable from the cinema experience. The picture quality exceeded the targets of the FCC advisory committee that set the goals for HDTV development some years back. Even rendition of high-motion video, which has long been a problem for HDTV prototypes, was near-perfect when the full capability of the system was brought to bear.

The Dolby Digital (AC-3) audio system selected for HDTV, which includes five full-range surround channels plus a subwoofer channel, also tested well. It performed even better than in 1993, when AC-3 first aced out the Philips MPEG-2 system to become the designated HDTV standard. With a new integrated coder in place, the quality of over-the-air audio broadcasts was indistinguishable from the source material for all but a minority of the expert listeners.

Despite its strengths, though, HDTV still has some niggling problems. For example, on HDTV prototypes the average time for a viewable picture to reappear after a channel change is 0.9 to 1.2 seconds. That doesn't sound like much, but channel surfers get impatient just dealing with the 0.25- to 0.33-second channel-switching time of cable-converter boxes. Officials of the Grand Alliance — which is made up of consumer-electronics manufacturers, research facilities, and others — promise that much of the delay will disappear in production receivers.

The other key problem for consumers involves current NTSC-standard TV sets. Under the FCC guidelines, HDTV channels have to be shoehorned into the same spectrum now being used for NTSC television *without interfering* with simultaneous NTSC broadcasts on adjacent channels. That would never have been possible until HDTV went digital, allowing stations to broadcast at a power level less than one-eighth of that of analog NTSC. Theoretically, any digital HDTV interference with NTSC broadcasts at such power levels should

be virtually unnoticeable, showing up only as light "snow" in the picture.

But the tests showed that HDTV is surprisingly likely to interfere with both the NTSC video and audio being broadcast on adjacent channels. The video problem, which appears as colored stripes in the NTSC picture, looks to be easily solved through more precise engineering. Solving the audio problem, however, which shows up as an annoying crackling sound and distortion in the NTSC stereo audio signal, may not be so simple. The best-case scenario calls for tailoring the HDTV signal in each community to eliminate the interference. In the worst case, HDTV broadcasters may be unable to use some adjacent channels, or they may have to operate at a lower power level, thereby reducing their signal's reach and the size of their potential audience.

Consequently, it's predicted that 100 to 150 commercial TV stations could receive a smaller HDTV signal-coverage area than they now have for NTSC, resulting in both a smaller audience and lower ad revenue. Another 650 stations will have roughly the same coverage area, and about 800 will have more.

Congress has emerged as an even bigger threat to broadcasters. Senate majority leader and Republican Presidential candidate Bob Dole (Kansas), among others, has suggested that broadcasters compete against cellular-phone operators and other interests for the spectrum the FCC originally promised to them for HDTV. It's been estimated that such auctions might generate \$40 billion in revenue. If so, the average TV station would have to pay more than \$25 million for the rights to an HDTV channel, not to mention the multimillion-dollar cost of converting its facilities for HDTV. Since the market value of the average TV station is probably less than that, such auctions would likely preclude many broadcasters from offering HDTV.

For now it appears that Congress will go along with the original FCC plan, which calls for waiting until after the old NTSC channels are turned off in ten or fifteen years before auctioning that spectrum. But even if Congress doesn't interfere, it will be more than a year before most broadcasters get their HDTV licenses. The FCC won't begin assigning channels until this fall, and the licensing process



The first HDTV sets, similar to this Zenith prototype, could carry a \$2,000 premium over comparably equipped NTSC models.

**MX-D8T** Home Theater  
Mini System



# Own Your Own Theater.

It's easier than you think. In fact, the MX-D8T Home Theater Mini System from JVC is so easy to set up, you can add great surround sound to your movies, videos and TV shows

in just minutes. Your living room never sounded so dramatic. And you don't have to mortgage the rest of the house to afford it.



Visit us on the World Wide Web at <http://www.jvc-america.com>

CIRCLE NO. 20 ON READER SERVICE CARD

**JVC**

# TECHNOLOGY UPDATE

could take months. Nonetheless, many broadcasters are gearing up for HDTV.

Both NBC and ABC have committed publicly to delivering their first HDTV signals to local TV stations in the fall of 1997, though that won't help local stations that haven't made the estimated \$1 million investment to pass through a network HDTV signal. But both networks own their own stations in several major markets, and those are likely to be among the first to add HDTV. CBS, which had been notably tardy in publicly committing to HDTV broadcasts, became an advocate after it was taken over by Westinghouse, even becoming a founding member of the Advanced TV Technology Center, which is intended to help stations make the HDTV transition.

HDTV will happen on a city-by-city basis. The first HDTV station will be in Washington, D.C., where a group of broadcasters will cooperate to establish the Model HDTV Station to show other stations how HDTV equipment and transmissions work. The station will be co-located with an NTSC station in Washington and should be on the air by the end of the year with an experimental license.

New York City's TV stations will be among the first commercial HDTV broadcasters. Nine stations that share TV antennas atop the World Trade Center have already ordered HDTV antennas. KPTV in Portland, Oregon, also has begun installing digital equipment in preparation for the switch to HDTV, and other Chris-Craft-owned stations will follow.

Another leader is Maryland Public TV (MPT), which operates several public stations throughout the state. MPT already has the parts in place to begin all-digital broadcasting as soon as the FCC grants its license, including digital cameras, sound equipment, special-effects boxes, switchers, transmitters, and antennas.

The decision among broadcasters to switch to HDTV has been made easier by some new features written into the digital standard that provide additional flexibility. Initially, broadcasters worried that the limited audience for HDTV and their advertisers' reluctance to pay a significant premium for HDTV ads would result in their huge investments in equipment yielding little new revenue. But the final Grand Alliance standard allows broadcasters

to parse the digital signal in an almost infinite number of ways and, most important, to use the parts of the 6-MHz channel that aren't needed for HDTV video and audio for almost anything else. This opens up new revenue sources and encourages broadcasters to go digital. In fact, the cognoscenti no longer refer to HDTV — it's now "digital advanced TV," or DATV.

**O**ne much-discussed option is to use the digital TV channel for several "super-NTSC" channels instead of one HDTV channel. The video and audio quality of even four advanced digital NTSC programs sharing a single TV channel is far superior to the best analog TV picture today, though it falls well short of HDTV. Still, many broadcasters will probably go this route, at least for the short term, in the belief that audiences would prefer a wider variety of programming with improved video and audio quality over a single top-quality HDTV program. The FCC, for its part, may allow broadcasters to transmit multichannel NTSC for a portion (and possibly most) of each day, but it will almost certainly mandate *some* HDTV transmission to help seed the new technology.

Even while broadcasting full-fledged HDTV, a standard 6-MHz channel can still carry a lot of other information. The amount varies widely depending on the type of programming being broadcast, but the Grand Alliance system allows it to be dynamically allocated, even in microsecond blocks. During a typical movie, for example, as much as half of the channel might be available for carrying stock-market data, video games, the full text of newspapers, or digital stereo radio channels.

The \$64,000 question that remains is how attractive HDTV or DATV will be to the public, especially given the high price tags expected for the first HDTV sets. One estimate, from former Zenith Chairman Jerry Pearlman, is that an HDTV set in 1997 will cost \$2,000 more than a comparably sized — and already pricey — full-featured big-screen TV set. Others rush to assure us that the differential will rapidly fade: Bruce Allan, Thomson Consumer Electronics vice president for technology and business, predicted that the HDTV premium will fall to

\$500 to \$750 within five years. By the tenth year, he said, the premium could be as little as \$250 to \$350, and possibly less for small-screen sets.

A number of observers question whether consumers will pay such large premiums, especially since most don't even bother to fine-tune their existing TV sets. "There's not enough focus on the consumer," said Mary Frost, an analyst for Price Waterhouse. "There needs to be some serious research on price points." Allan said Thomson is doing such research and that the results are very promising, though he won't provide details.

Set manufacturers are counting on the so-called "early adopters," including home-theater and stereo buffs and computer junkies, to prime the HDTV pump. Once the early adopters show off their HDTV home theaters to enough of their neighbors (and once they buy enough HDTV sets to allow volume production to drive prices down), the industry believes HDTV will take off on its own.

That's the hope, at least, and the companies that have invested hundreds of millions of dollars in developing HDTV/DATV remain relentlessly optimistic about its prospects. Pearlman, who steered Zenith into HDTV, predicted that an astounding 2 million HDTV sets would be sold in the first year, even at a \$2,000 premium. That would make it the most successful consumer-electronics product introduction in history, surpassing even digital satellite dishes, CD players, and VCR's. By 2004 as many as 20 percent of all TV's in regular use will be large-screen HDTV's, Pearlman estimated, adding that the TV-set bill for consumers could approach \$35 billion over the next ten to fifteen years.

**T**hat's no small change. But whether the world's most advanced TV standard, eight years and more in the making, can really metamorphose into the world's biggest consumer-electronics cash cow remains to be seen. Even if the pundits are right, it could take a lot longer than eight years to find out. □

*Michael Feazel, senior editor of the industry newsletter Television Digest and associate managing editor of Communications Daily, has been covering HDTV since 1988.*

# An offer we hope you can't resist!

We are offering the MMG with a 60 day satisfaction guarantee and up to 100% allowance if you upgrade to another pair of Magneplanars within one year.

Read what Bob O'Neill has to say about our new Maggies® in his article in **Bound for Sound**.

For information call 1-800-474-1646

## The Audio Curmudgeon

Bob O'Neill

Five-hundred bucks per pair is the price.

Magnepan is selling the MMG direct!

That's right! By mail!—or at least UPS.



For only five-hundred bucks with a 60 day "if you don't like 'em send 'em back guarantee." You also get a 100% trade-in allowance if you buy another, presumably larger, pair at your dealer within one year. What a deal!

These Mini-Mags are the smallest speakers that Magnepan makes — they even have the great quasi-ribbon tweeter/mid-range. Their size may be small but their sound is BIG.

In preparation for this review, I listened to a number of speakers in the price range. (And remember, with ordinary box speakers you have to figure another one or two hundred dollars for stands. The MMG's are, of course, floor standing and thus require no stinking stands.) I have yet to hear any other competitive speakers that sound as real, or as natural as the Mini-Mags. In order to grab your attention in a dealer show room, the box speakers have a boosted bass and exaggerated highs. Take one of these boxes home and see how long it takes you to tire of boomy one note bass and ear splitting treble.

Let's face it, there are few - very few - good \$500 speakers out there. Most of them will make Bonnie Raitt sound like Lyle Lovett, and they will not have the definition and imagery, breadth or depth of sound stage that a planar speaker can give you. On the MMG's, a Steinway will sound like a Steinway and not like that old spinet in your uncle's basement.

Buy these! They are one of the true bargains in audio. And then in three or four months when you've become as hooked on planar sound as I am, truck 'em on down to your Magneplanar dealer and trade 'em in (remember that 100% trade-in allowance) on some bigger and better Maggies.

Above article reprinted by permission  
**Bound for Sound**  
220 N Main St - Kewanee IL 61443

Magnepan reserves the right to modify the price, policies and design at any time.

# Magneplanar®

LOUDSPEAKERS



The MMG is a full-range dipole with planar magnetic and quasi ribbon drivers and the smallest speaker we have ever produced. We know from experience Magneplanar owners are loyal customers, and usually purchase another pair when they are ready to step up to something better. We also know the best place to become familiar with a speaker is in your home...at your leisure. As an introduction to the unique Magneplanar sound we have developed the MMG (Mini-Mag) at \$500 per pair. Available in natural or black solid oak trim with off-white, grey or black fabric. Offer available only in the United States and Canada.

**MAGNEPAN**

1645 Ninth Street - White Bear Lake MN 55110

**1-800-474-1646 for information**

CIRCLE NO. 23 ON READER SERVICE CARD

# TIME DELAY



## 30 YEARS AGO

In the July 1966 cover story, Hans Fantel and Larry Klein hosted a symposium, "The Engineers Have Their Say About Phono Cartridges," with a side discussion in which United Audio's Julian Gorski and AR's Edgar Villchur offered views on "Skating and Anti-Skating in Record Players." And Bennett Evans offered a buyer's guide to portable FM radios, with 28 models ranging in price from \$24.95 to \$249.95, some weighing more than 10 pounds.

Among new products were JBL's Carnival and Festival indoor/outdoor speaker



JBL in/outdoor speaker, 1966

systems (starting at \$105) and Benjamin's top-of-the-line automatic turntable/changer, the Miracord PW-50H (\$149.50). Hirsch-Houck Laboratories tested the Dynaco PAS-3X preamp kit (\$69.95), calling it "an outstanding preamplifier — it would be a bargain at twice its price." Meanwhile, reissues ruled in Best of the Month, as George Jellinek endorsed Madeleine Grey's performance of Canteloube and Ravel songs on Angel, and Nat Hentoff enthused over Billie Holiday's "The Golden Years/Volume II" on Columbia.

Like, dig, man: Discussing the score for *Doctor Zhivago* and composer Maurice Jarre, the critic Gene Lees wrote, "I must conclude that producer David Lean, who seems impressed by [Jarre], is a square."



## 20 YEARS AGO

In honor of the 1976 Bicentennial, the July fireworks included a fold-out "Calendar of American Music 1612-1976" and "The Revolution in

American Popular Music," which examined the life and work of Elvis Presley. And in a column pondering which rock act might be most appropriate for America's 200th birthday party, Steve Simels suggested that patriots urge Columbia to reissue Paul Revere and the Raiders' "Midnight Ride," noting that "it might be a good symbolic gesture to throw a shipment of Janis Ian records off a boat into Boston Harbor at the same time."

Shure engineer Scott Masticola took a sobering look at "Record Wear," asserting that science did not



Yeaple "Stereopillow," 1976

yet have the last word on the causes and prevention of record and stylus deterioration. New products included the Fons CQ 30 turntable, which could vary platter speed from 29 to 100 rpm, and the Yeaple "Stereopillow," a polyurethane decorator pillow with a built-in pair of 4-inch speakers. And Julian Hirsch's test report on Stax's SR-5 headphones concluded, "Aside from their sound, which is unexcelled, the most striking feature . . . is their comfort."

Those wacky reviewers: Noel Coppage became the only critic in rock history to dis "The Sun Sessions" of Elvis Presley ("My stars, what awful dreck"), and Chris Albertson described "Transformation" by ex-Springsteen

## The Rolling Stones, 1986



sideman David Sancious as sounding like "the Vienna Choir Boys goosed by as many fingers."

## 10 YEARS AGO

Japanese audio technology was the theme of the July 1986 issue. Tokyo correspondent Bryan Harrell examined the state of Japanese hi-fi, including a look at TDK's prototype DAT cassettes, and provided a glossary of Japanese audio terms (distortion: *hizumi*). "Made in the U.S.A." toured Japanese-owned A/V factories in this country, and "Systems" starred Nakamichi gear. Meanwhile, Julian Hirsch tested Advent's Legacy speaker system, which he said "does credit to the Advent name." And Richard Freed celebrated the Liszt centennial with a survey of recordings, urging readers not to miss Jorge Bolet's *Totentanz* on London.



Life in the service economy: "It pains me to say it," wrote Louis Meredith in a review of the latest album by the Rolling Stones, "but 'Dirty Work' sounds more like temp work."

— Steve Simels

# "The sweet spot, where sound and spatiality are most enjoyable, was very wide with the Vivid 3D."

John Sunier *Audio Magazine* April 96



## The Holy Grail of Audio

The audio holy grail is to make the speakers sound invisible and to eliminate the sweet spot. We feel we've achieved this goal with SRS technology and the Vivid 3D Theater.

## Enhance any System

The Vivid 3D Theater easily connects to an existing two speaker stereo system as well as surround sound technologies such as Dolby Pro Logic® and THX®.

"...the VHT-200's action with surround-encoded soundtracks and music did produce a surprisingly satisfactory sense of envelopment and front-to-side sonic continuity, if not front/surround directionality....The VHT-200 can produce, with less noise and distortion than many Dolby Pro Logic circuits we've tested, much of the excitement of surround-sound home theater with only two speakers. *Stereo Review, May 96 David Ranada*

"Using SRS with the "70mm" setting of a Fosgate/Harman Kardon Dolby Pro Logic processor achieved excellent surround effects from music and movies on laserdiscs and from telecasts." *Audio Magazine, April 96 John Sunier*

## Improve Multizone Sound

The Vivid 3D Theater actually eliminates several problems installers run into when connecting a multizone sound system. By placing the Vivid 3D theater between the audio feed and the distribution amplifier, SRS will provide improved sound coverage in all zones, even if the speaker position in these rooms is less than favorable. The Vivid 3D Theater also gives a new dimension of sound to in-wall and ceiling speakers, bringing them to life with a full, rich sound.

Stereo processing creates flat, two-dimensional sound, whereas SRS processing fills an entire room with lifelike, three-dimensional sound.

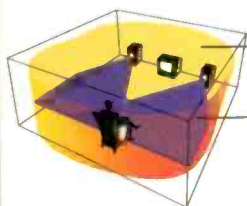

SRS 3D Sound

Stereo Sound

U.S. Dealer and international distributor inquires welcome

"The health club had very low ceilings and I wanted to avoid having to put in too many speakers, yet even coverage was needed. It turned out that the solution lay in signal processing, not acoustics. A NuReality SRS processor was used, and the effect was that the loudspeakers become essentially impossible to localize." *Sound and Communications, February 96 Rob Baum*

## Mono Recordings

Put multi-channel excitement back into any mono recording with the Vivid 3D Theater. Old movies come to life with SRS technology.

"The SRS mono mode is used when stereo is not available...and is very effective in adding ambience. One of the best I have ever heard done correctly." *High Performance Review, Winter 95/96 John Gatski*

## How it Works

You only have two ears, yet you hear in three dimensions. Patented SRS technology is based on a natural psychoacoustic phenomenon, known as Head Related Transfer Functions or HRTFs, that have been largely ignored by modern sound reproduction technologies. HRTFs allow your brain to localize sound because the spectral characteristics, or frequency response, of the sound varies. These "spatial cues" supplied primarily by the outer ear, or pinna, are transferred to the brain—enabling you to position sounds very accurately in three-dimensional space. SRS technology essentially mimics these diffractive effects of the pinna by extracting information from a recording that originally came from the sides and rear. This ambience information gives you a sense of acoustic space. SRS then uses HRTF-based corrections to cause the ear to perceive these sounds in their original spatial relationships. The result is that the sense of realism you perceive from reproduced sound is dramatically enhanced.

Rack mounts also available.



**NUREALITY®**

800-501-8086 or 714-442-1080

<http://www.nureality.com> [sales@NuReality.com](mailto:sales@NuReality.com)

In Canada Contact:

May Audio Marketing 514-651-5707

# Inside Definitive's Revolutionary BP2000

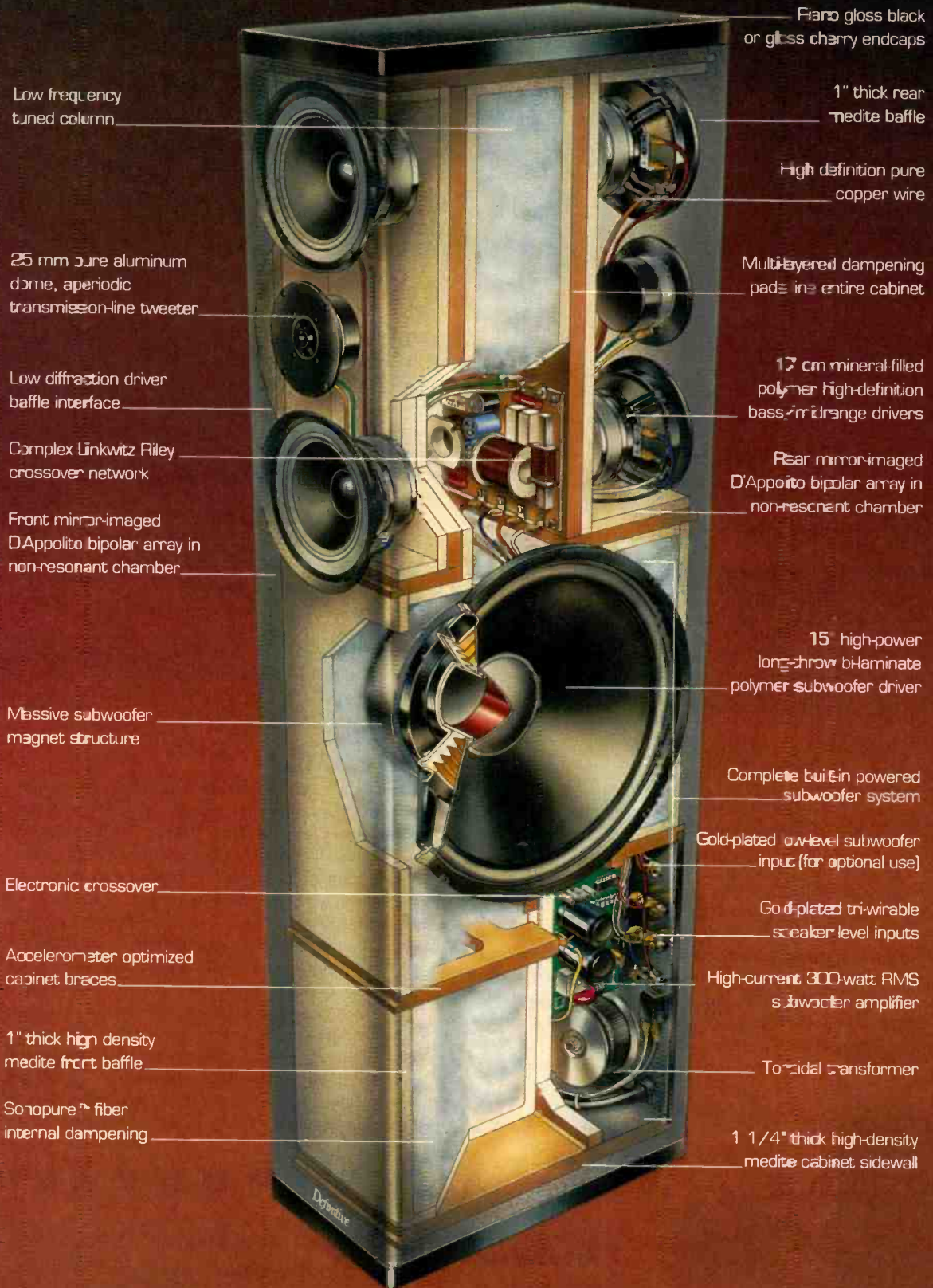

**"Definitive's new BP2000 absolutely kills most more-expensive speakers!"**

~Brent Butterworth, *Home Theater Technology*



# Definitive's New BP2000 Brings You the Ultimate Listening Experience!

*"The first speaker I have been able to audition in my own familiar surroundings that has given me that special thrill that usually costs ten or more times its price to obtain."*

—Julian Hirsch, *Stereo Review*

*"Frankly, if circumstances allowed, I would choose these speakers for myself."*

—Julian Hirsch, *Stereo Review*

## Speaker of the Decade

Now, with the BP2000, Definitive literally reinvents the loudspeaker. We have combined a six-driver dual D'Appolito bipolar array with a built-in (side-firing) 300-watt powered 15" subwoofer. (Yes, a complete powered subwoofer built into each speaker!) The result is extraordinary sonic performance beyond anything you've ever heard.

Both music and movies are reproduced with unequalled purity, transparency and lifelike realism. And the astounding high resolution imaging and awesome bass impact totally envelop you in sonic ecstasy. They are an amazing achievement!



*Definitive's complete AC-3 ready BP2000 Home Theater System is the perfect choice for ultimate music and movie performance.*

## The Ultimate Home Theater

In addition to being an audiophile's dream, the BP2000s are also the main speakers in Definitive's AC-3 ready Ultimate Home Theater System. This astonishing system is absolutely the finest sounding available. It recreates a "you are there" spatial reality that actually puts you into the soundspace of the original cinematic action.

The complete system combines the BP2000s (\$1499 ea.) with a C/L/R 2000 center (\$650 ea.) and BPX bipolar surrounds (from \$399 ea.). Of course, dual 15" powered subwoofers are already built into the sleek BP2000 towers. Truly the ultimate listening experience! Visit your Definitive dealer today.

**Definitive Technology®**  
*The Leader in High-Performance Loudspeakers™*

11105 Valley Hts. Dr. • Baltimore, MD 21117 • (410) 363-7148  
Visit us at <http://www.soundsite.com/definitive>.

CIRCLE NO. 15 ON READER SERVICE CARD

See our dealer list on page 32

## Authorized Dealers

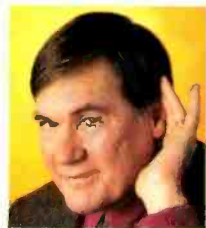

# AUDIO Q & A

IAN G. MASTERS

## Digital Phantom

**Q** I currently don't use a center channel in my Dolby Pro Logic setup because I find it distracting when the dialogue comes from the top or bottom of the TV screen. I would eventually like to move to Dolby Digital (AC-3), but I don't want to buy extra amplification and a center speaker unless there's no other choice. Does Dolby Digital have a phantom-center option similar to Dolby Pro Logic's?

KEN PLOURDE  
Upton, MA

**A** The few Dolby Digital decoders I've used so far have all allowed operation without a center-channel speaker; as with Pro Logic, the center-channel signal is distributed to the main left and right channels. Similarly, although all Dolby Digital decoders include a dedicated subwoofer output, you don't have to use one. The decoder can be configured to route the low-frequency material to the main channels if you choose.

As for your reaction to the use of a center channel in Pro Logic, there have certainly been times when I, too, have preferred to use the phantom mode, especially when the timbral match between the main and center speakers wasn't all it should have been. But the lack of a center speaker can be a noticeable drawback when there are other listeners in the room sitting off-axis. In that case, even a tonal mismatch or hearing dialogue from above or below the screen is preferable to the dialogue's being localized off-screen at one of the main speakers.

## Biwiring for Beginners

**Q** My new speakers can be hooked up in three different ways: with conventional single cables, biwiring, or biamplifying. I tried the first two and could hear no real difference. What are the benefits of the different hookups?

DARREN R. SCHACKMAN  
Galveston, TX

**A** Biwiring is running separate cables to the high- and low-frequency drivers of the speaker from the outputs of a single amplifier. Although some audiophiles ascribe significant sonic advantages to this approach, the main benefit seems to be the extra thickness of wire. Long runs of speaker cable require heavier (though not necessarily expensive) wire, and adding a second, parallel run has the same effect as substituting a thicker cable.

In a biamplified system, the high and low frequencies are separated by an outboard crossover placed before the power amplifier,

and the drivers for each portion of the spectrum are amplified separately. That's supposed to reduce intermodulation distortion in the individual amplifiers, and it usually allows you to maximize power to the bass drivers, where it is needed most. But good speaker designers go to great lengths to match their driver and crossover characteristics to create a smooth transition from low to high frequencies. Unless the electronic crossover in a biamplified system matches those characteristics exactly, you could end up with inferior response, whatever the other benefits may be.

## Combining for Mono

**Q** In the new house I am building, I have run wires through the walls for all the speakers in the main home-theater location and also a single wire to the kitchen and workshop. In each remote location, I'd like to have a single speaker with its own volume control for background music. The receiver doesn't have a mono switch. How do I derive a mono signal from the Speaker B terminals of my receiver?

KELLY MURLEY  
Walled Lake, MI

**A** Unfortunately, you don't. You could rig a kind of bridge at the input that would give you mono (by doing the same thing a mono switch would do, if one were provided), but there's no easy way to achieve an L + R mono signal after the amplifier stage. If you were simply to hook the two sets of speaker terminals together, you would risk damage to the output sections. Even if it did work, it would also reduce the signal in your primary listening room to mono.

## Subwoofers High and Low

**Q** I just bought two powered subwoofers, but I'm not sure how to hook them up to my A/V receiver. Each of them has both high- and low-level inputs. I'm not using the main low-level output jacks on the receiver at present, so I might use those to feed the subs' low-level inputs, but would I be better off feeding the receiver's high-level speaker outputs to the high-level inputs?

CHARLES COBBINA  
Oklahoma City, OK

**A** There's little to choose from between the two hookups. If you use the high-level (speaker-level) connectors, the signal is fed through a resistor inside the box to reduce it to line level before it is re-amplified. This connection may be more desirable than running an RCA cable from the main output

- AK: Alaska Audio; Juneau; Pyramid; Anchorage.
- AL: Cohen's Electronics; Montgomery; Kincaid's TV; Tuscaloosa; Ltkis Audio; Birmingham.
- AR: Custom Audio Video; Little Rock.
- AZ: Jerry's Audio Video; Phoenix; Tucson.
- CA: Access to Music; Lakeside; Acoustic A/V; S. Lake Tahoe; Audio Concepts; Long Beach; San Gabriel Bay Area Audio; San Jose; Boots Camera; Fresno; Christopher Hansen; West LA; Coast Satellite; Alascadero; Santa Maria; Creative Stereo; Santa Barbara; Ventura; David Rutledge Audio; Palm Desert; DB Audio; Berkeley; Digital Ear; Tustin; Larson's; Redding; Monterey Stereo; Monterey; Pacific Coast A/V; Newport Beach; Paradyme; Sacramento; Performance Audio; San Francisco; Sound Co.; Escondido; San Diego; Speaker Craft; Riverside; Systems Design; Fedondo Beach; Videotek; Westminster; Westchester TV; Bakersfield; Wilson Home Theater; Woodland Hills.
- CO: Listen Up; Denver; Boulder; Colorado Springs.
- CT: Al Franklin's; Greenwich; Carston's Audio Video; Danbury; Roberts Audio Video; New London.
- DC & Suburbs: Meyer; Imce.
- DE: Sound Studio; Newark; Wilmington.
- FL: Absolute Sound; Winter Park; Audio Advisors; West Palm Beach; Audio Center; Deerfield Beach; Audio Video Stereo; Tallahassee; The Audionoise; Vero Beach; Cooper for Stereo; Clearwater; Hoyt Stereo; Jacksonville; Palm Audio; Destin; Sansoung Sound; Tampa; Sound Concepts; Coral Gables; Sound Ideas; Gainesville; Sound Insight.
- GA: Pierce Stereo; Davina; Davina & Stuart A/V; Stuart; GA Audio Warehouse; Atlanta; Stereo Jct.; Macon; Laser Disc Enterprises; Atlanta; Marlin TV; Columbus; Stereo Connections; Valdosta; Stereo Festival; Atlanta.
- HI: Audio Center; Honolulu; Waipahu.
- IA: Audio King; Cedar Rapids; Des Moines; Archer Audio Video; Ft. Dodge; Audio Video Logic; Des Moines; Audio Visions; Sioux City; Camera Corner; Davenport; Hawkeye A/V; Iowa City; Waterloo.
- ID: Ultimate Electronics; Boise; Wise Buy; Idaho Falls.
- IL: United Audio Centers; Chicago & Suburbs; Camera Corner; Bloomington; Cars & Stereo; Rockford; Good Vibes; Champaign; Jon's Home Ctr.; Quincy; Sound Forum; Crystal Lake; Select Sound; Naperville; Sundown A/V; Springfield.
- IN: Classic Stereo; Ft. Wayne; Mishawaka; Good Vibes; Lafayette; Kings Great Buys; Evansville; Ovalion Audio; Clarksville; Indianapolis.
- KS: Accent Sound; Overland Park; Advance Audio; Wichita; Audio Junction; Junction City; Manhattan.
- KY: Ovalion Audio; Lexington; Louisville.
- LA: Allerman Audio; New Orleans; Metairie; LaRa Charles Music; Lake Charles; Sound Advice; Baton Rouge; Wright's Sound Gallery; Shreveport.
- MA: Cookin'; Chestnut Hill; Saugus; Goodwinds Audio; Boston; Shrewsbury; Nantucket; Salem; Haverhill; Pittsfield Radio; Pittsfield; MD: Meyer Emco; Beltsville; Rockville; Gaithersburg; Gramophone; Baltimore; Elkocit City; Soundscape; Baltimore.
- ME: Cookin'; Portland.
- MI: Pecar's; Detroit; Troy; Classical Jazz Holland; Classic Stereo; Kalamazoo; Grand Rapids; Stereo Center FRAV; Flint; Court St. Listening Room; Midland; Saginaw.
- MN: Audio King; Minneapolis & Suburbs; Rochester; St. Cloud; Audio Designs; Winona.
- MO: Independence A/V; Independence; Reference Audio; Sedalia; Sound Central; St. Louis.
- MS: Ideal Acoustics; Starkville; McLelland TV; Hattiesburg; Players A/V; Ridgeland.
- MT: Aspen Sound; Missoula; Avitel; Bozeman; Car & Home Stereo Ctr.; Billings; Rocky Mt. Hi Fi; Great Falls.
- NC: Audio Video Systems; Charlotte; Audio Visions; Wilmington; New Audio Video; Durham; Greensboro; Raleigh; Winston Salem; Audio Lab; Wilmington; Tri City Elect.; Conover.
- NF: Custom Electronics; Oranby; Lincoln.
- NH: Cookin'; Nashua; Manchester; Newton; Salem; S. Nashua.
- NJ: Hal's Stereo; Trenton; Monmouth Stereo; Shrewsbury; Sound Waves; Northfield; Woodbridge Stereo; West Caldwell; Woodbridge.
- NM: Ultimate Elect.; Albuquerque; Sound Ideas; Albuquerque.
- NV: Ultimate Elect.; Las Vegas; Upper Ear; Las Vegas.
- NY: Audio Breakthroughs; Manhattan; Audio Den; Lake Grove; Audio Expressions; Newburgh; Audio Junction; Watertown; Clark Music; Albany; Syracuse Stereo Exchange; Manhattan; Nanuet; Hart Elect.; Vestal; Innovative Audio; Brookly; Listening Rm; Scarsdale; Rowe Camera; Rochester; Sound Mill; Mt. Kisco; Speaker Shop; Amherst; Buffalo.
- OH: Audio Craft; Akron; Cleveland; Mayfield Hts.; Westlake; Audio Etc.; Dayton; Classic Stereo; Lima; Paragon Sound; Toledo; Threshold Audio; Heath.
- OK: Ultimate Electronics; Tulsa; K Labs Premium Audio; Tulsa; Photo World; Bartlesville.
- OR: Bradford's HiFi; Eugene; Chelsea A/V; Portland; Beaverton; Kelly's Home Ctr.; Salem; Larson's; Medford; Roseburg; Stereo Plant; Bend.
- PA: Audio Junction; Pittsburgh; Gary's Elect.; State College; INT Stereo; Lancaster; Hart Elect.; Blakely; Kingston; Hi Fi House; Abington; Bromall; Carmo Hill; Harrisburg; Listening Post; Pittsburgh; Palmer Audio; Allentown; Pro Audio; Bloomsburg; Stereo Shoppe; Selingsgrove; Williamsport; Stereoland; Natrona Heights; The StereoShop; Greensburg; Studio One; Erie.
- RI: Stereo Discount Ctr.; Providence.
- SC: A/V Design; Charleston; Custom Theater & Audio; Myrtle Beach; Upstairs Audio; Columbia.
- SD: Audio King; Sioux Falls; Sound Pro; Rapid City.
- TN: College HiFi; Chattanooga; Hi Fi Buys; Nashville; Now Audio Video; Knoxville; Modern Music; Memphis; Sound Room; Johnson City.
- TX: Home Entertainment; Dallas; Houston; Plano; Audio Tech; Temple; Waco; Audio Video; College Station; Brock A/V; Beaumont; Bunkley's Sound Systems; Abilene; Bjorn's; San Antonio; High Fidelity; Austin; Krystal Clear; Dallas; Marvin Electronics; Ft. Worth; Sound Quest; El Paso; Sound Systems; Amarillo; Sound Towne; Texarkana.
- UT: Alpine Elect.; Provo; Audio Works; Salt Lake City; Crazy Bob's; St. George; Stokes Bros.; Logan; Ultimate Elect.; Layton; Murray; Orem; Salt Lake City.
- VA: Meyer Emco; Fairfax; Falls Church; Tyson's Corner; Audio Connection; Virginia Beach; AudioTronics; Roanoke; Home Media Store; Richmond; Stereo Type; Charlottesville.
- VT: Audio Video Authority; S. Burlington.
- WA: Aspen Sound; Spokane; Deliniva Audio; Bellevue; Seattle; Evergreen Audio; Silverdale; Pacific Sight & Sound; Wenatchee; Tin Ear; Kennewick; W. VA: Sound Post; Princeton.
- WI: Audio Emporium; Milwaukee; Absolute Sound & Vision; Sheboygan; Hi-Fi Heaven; Appleton; Green Bay; Sound Video; Wausau.
- Puerto Rico: Precision Audio; Rio Piedras.
- Canada: A & B Sound; Calgary; Edmonton; Kelowna; Vancouver & Suburbs; Victoria; Advance Electronics; Winnipeg; Bay Bloor Radio; Toronto; Centre Audio Charist; Trois Rivières; CORA; Quebec City; Digital Dynamics; Clearbrook; Great West Audio; London; Kebecson; Montreal; Lipton's; New Market Ontario; Peak Audio; Halifax; Sound Room; Vancouver; Stereoland; Windsor; Treble Clef; Ottawa.
- Mexico: Contact Group; Veracruz; Mexico City.

# “All Definitive’s Bipolar Towers Deliver Astounding Sound for Music & Movie Perfection”

*You must hear the superiority of Definitive’s remarkably affordable BP6, 8, 10 & 20 and experience the miracle of bipolar technology!*

## “Truly Outstanding”

— Stereo Review

**A**bsolute sonic superiority and unexcelled value have made Definitive the leader in high-performance loudspeakers. It’s no wonder experts agree that Definitive’s critically acclaimed bipolar towers (priced from \$299 ea.) dramatically outperform the competition.

Our exquisitely styled, American-made, advanced technology bipolar (front and rear radiating) systems are the critics’ choice. They combine lush spacious sound-staging, lifelike depth-of-field, razor-sharp resolution and pinpoint 3-D imaging with powerful subwoofer-quality bass (to below 20 Hz), high efficiency and ultra-wide dynamic range. The result is superb music and movie reproduction so real that it has been called “an incredible sonic miracle.”



BP10 - \$550 ea.    BP20 - \$799 ea.    BP8 - \$399 ea.  
BP6 (not shown) - \$299 ea.

*The breathtaking performance of our award-winning bipolar speakers makes your music and movies really come alive.*

## “Music and Movie Sound was Stunning” — Video Magazine

Combine BP6s, 8s, 10s or 20s with our matching centers, bipolar surrounds and optional PowerField subwoofers for the most lifelike, spectacular “you are there” music and home theater available. All are completely Dolby AC-3 ready.

## Award after Award Confirms Definitive’s Sonic Superiority

- Stereo Review “Dream System”
  - Video Magazine Product-of-the-Year
  - AudioVideo Speaker-of-the-Year
  - CES Design & Engineering Awards
  - Sound & Vision Critic’s Choice
  - Inner Ear Report Editor’s Choice
- You owe it to yourself to hear these remarkable speakers today.

**Definitive Technology**  
The Leader In High-Performance Loudspeakers™

11105 Valley Hts. Dr. • Baltimore, MD 21117 • (410) 363-7148  
Visit us at <http://www.soundsite.com/definitive>.

CIRCLE NO. 15 ON READER SERVICE CARD  
See our dealer list on facing page

NEW FOR 1996

# Stereo Review

PRESENTS

## THE BASIC REPERTORY ON COMPACT DISC

A CRITICAL DISCOGRAPHY



**N**oted critic Richard Freed's revised and updated choices of the best current CD's of the most often performed music in the classical orchestral repertory. Hundreds of recordings of symphonic works from Bach to Wagner!

To receive your copy of this handy guide, send a self-addressed business-size (#10) envelope, stamped with 55¢ postage, and a check or money order for \$3 payable to Stereo Review (no cash, please), to The Basic Repertory, Stereo Review, 1633 Broadway, New York, NY 10019. Orders from outside the U.S.A. must be accompanied by a self-addressed envelope and \$4 (payable in US. funds).

jacks if the subwoofer is very far from your receiver, as the speaker-level signal is less likely to pick up hum and other interference. But either input will work fine.

### TV Output Level

**Q** My new television has MTS stereo sound and a pair of RCA jacks in the rear to access the set's variable audio output. By connecting these jacks to a high-level input on my preamplifier, I get very good TV sound through my audio system. But the set's specifications show an audio output of 5 watts per channel. Am I risking harm to the rest of my equipment the way I have it set up?

BRIAN CLEARMAN  
Fort Riley, KS

**A** I doubt it. The wattage rating probably refers to the power fed to the internal speakers, and possibly to external speakers if there are terminals for that on the set. The RCA outputs are undoubtedly at the much lower "line level" and thus perfectly safe to plug into the inputs of your preamplifier. If there were an overload problem, you'd immediately hear it as distortion.

### Audio for Overseas

**Q** I plan to purchase an audio system in the United States and eventually take it to Europe. What might be the problems in operating U.S. equipment in a country with 240 volts and 50 Hz as power standards? A step-down transformer might solve the voltage problem, but I'm concerned that the transformer or the difference in line frequency might introduce hum or other noise into the sound path. All the audio dealers I have asked have said there won't be a problem and I should just use a transformer. Are they right?

ARKADI CUERNIAK  
Tel Aviv, Israel

**A** Equipment specifically designed to work with a variety of voltages and frequencies does exist, of course, but I assume you don't necessarily want to be limited to those models. Speaking strictly of voltage, your audio dealers are basically correct: Stepping the European 240 volts down to North American 110 volts is no big deal. The one thing to remember is that things like power amplifiers need a lot of electricity and will require a heavy-duty transformer; the kind that lets you use your electric shaver just won't cut it. Other than that, a transformer is not likely to inject noise unless it's malfunctioning and radiating interference.

Line frequency is a different matter. Either your equipment will be tolerant of different frequencies, or it won't, and if it won't, there's not a lot you can do short of totally rebuilding it. At one time, motors in things like turntables and tape decks were tied to the line frequency and thus didn't cross oceans very well. That's rarely the case nowadays; motors are generally DC-driven and servo-controlled and thus frequency-independent. But power supplies in all sorts of equipment can be affected.

One job of the power supply is to filter

out the line frequency, which would otherwise be audible as an extremely loud hum. A component designed to be used on this continent may be able to handle only 60 Hz; as soon as you plug it into 50 Hz it will begin to make a horrible racket. Other equipment is designed to remove both 50- and 60-Hz noise. Most components designed in Japan fall into this category because they are often intended for sale in international markets and because both frequency standards are used in Japan. It's not always easy to find out if a component is 50/60-Hz compatible, but if the owner's manual goes into detail about the various national versions of a particular component, it will probably travel satisfactorily.

The other sort of incompatibility to be aware of has nothing to do with power. Different parts of the world have very different standards for things like the FM band, television broadcasts, and the like. A VCR, radio, camcorder, recorded videotape, or TV set bought in the U.S. may well turn out to be useless or limited when you reach your destination.

### Why Eight-Track Died

**Q** I recently came across an old eight-track tape deck. When I hooked it up to my system I found it played flawlessly. It seems to me that, had this format stuck around, technical improvements would have enabled it to compete on a sonic level with today's cassette decks. So why did it die?

GARO HAGOPIAN  
Wakefield, MA

**A** Back at its start in the mid-Sixties, the eight-track cartridge had a couple of advantages over the compact cassette. First, it had a slightly wider recorded track and thus slightly lower inherent noise. Second, it ran at twice the linear speed of the cassette, so it was capable of superior high-frequency response. But it was almost totally a North American format and was scorned by Europeans and Japanese alike — including the Japanese audio manufacturers, whose reluctance to lavish technical niceties on the eight-track helped make it an also-ran.

In all fairness, though, eight-track could be infuriating. Music was recorded on four separate stereo "programs" selected via a single pushbutton, and since the tape moved in a continuous one-way loop, the only way to find a particular spot was to hit fast-forward — there was no rewind function. That made the format unpopular among people who wanted to tape their favorite records.

In the end, eight-track was abandoned in the mid-Seventies by the record companies, who were unwilling to support more than one consumer tape format. By then, the cassette had become the international standard, and the eight-track just disappeared.

**If you have a question about audio, send it to Q&A, Stereo Review, 1633 Broadway, New York, NY 10019. Sorry, only questions chosen for publication can be answered.**

# Spatializer 3-D Stereo Surround Sound

# HEARING IS BELIEVING

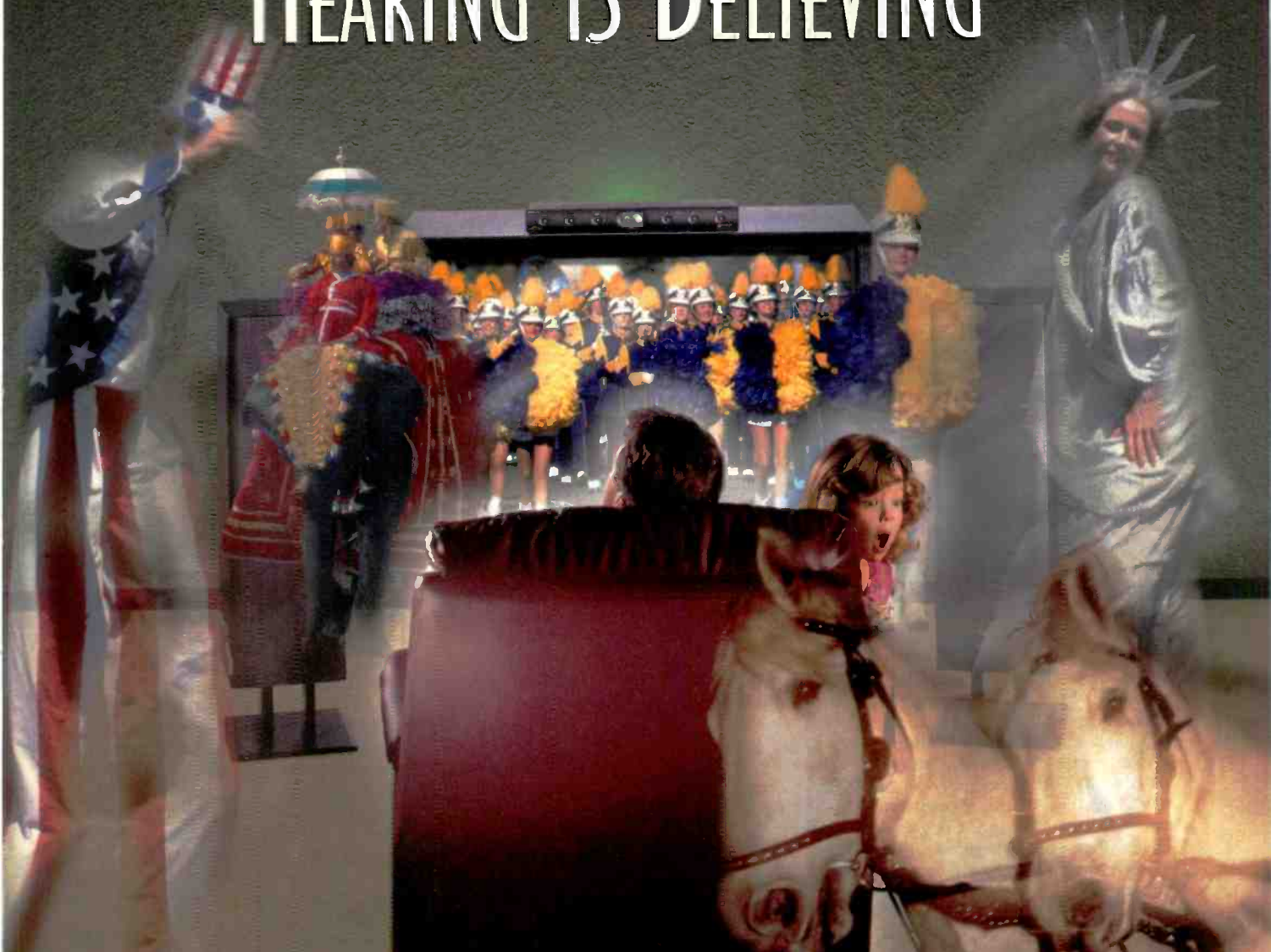

## Experience the richness and depth Spatializer® 3-D Stereo Surround can add to your stereo or multi-channel home theater system.

Utilizing Spatializer's patented 3-D stereo technology, originally created for use in the professional recording industry, the Spatializer HTMS•2510™ provides an audio experience that is nothing short of unbelievable. The same technology that enhanced the soundtracks for

Crimson Tide and The Lion King, along with recordings by artists such as Michael Jackson and Bonnie Raitt, is now available for you to enjoy in your home - without adding additional speakers or amplifiers. See your local Spatializer dealer today and experience Spatializer 3-D sound for yourself.

# SPATIALIZER®

## HTMS•2510™



The HTMS•2510™ utilizes Spatializer's revolutionary 3-D stereo technology to create a Virtual Speaker Array™ around the listener.

Call (800) 470-7281 for the location of the Spatializer dealer nearest you, to obtain a free Spatializer 3-D Stereo demo CD, or to order the HTMS•2510 directly from Spatializer. The Spatializer 3-D Stereo demo CD is available throughout the United States while supplies last.



INNOVATIONS  
IN SOUND ENGINEERING

Spatializer Audio Laboratories, Inc. • Sales and Marketing Office • 453 Ravendale Drive, Suite C • Mountain View, CA 94043 • (415) 428-0400 • Web site: <http://www.spatializer.com/> • E-Mail: [htms@spatializer.com](mailto:htms@spatializer.com)  
©1996 Desper Products, Inc. Spatializer® and HTMS•2510™ are trademarks of Desper Products, Inc. All other corporate and product names are trademarks of their respective owners.

CIRCLE NO. 43 ON READER SERVICE CARD



## SIGNALS

KEN C. POHLMANN

# Tom Holman's New Experiment

**T**he early part of this century was a time filled with optimism. People believed that technology, in transforming their lives, had achieved its ultimate purposes. Indeed, Charles Duell, director of the U.S. Patent Office, even proposed that Congress dissolve the Patent Office outright. Everything significant had already been patented, he argued, and future inventions would just be recombinations of existing ones.

Case in point: Many early-1900's futurists predicted that by the end of the twentieth century people would travel by air, that air travel would be economical, safe, and comfortable, and that it would surpass other forms of transportation. Basing their expectations on existing technology and logically extrapolating into the future, they predicted that travelers would ride in hot-air balloons attached to a vast network of rails linking cities across America, with horses pulling the balloons from place to place.

Today, as I write this column on my laptop computer aboard a Boeing 747 cruising at 600 miles per hour, 33,000 feet above the Atlantic Ocean, I am sincerely thankful the U.S. Congress rejected the idea of shutting down the Patent Office, thus encouraging invention of the airplane, the jet engine, computers, and everything else that lets a 747 take flight.

In all fairness to Mr. Duell and other dead-wrong futurists, however, it is tragically easy to misunderstand the nature of change. It is logical to survey existing conditions and extend those conditions linearly into the future. If we rely on horses for transportation, then it is logical to think that we will devise new ways to use horses for transportation. The problem is that change, particularly technological change, is illogical.

Given horse technology, there is no logic that can predict an engine that creates the mechanical equivalent of horsepower. The future is never a simple extension of the past. Entirely new ideas, technologies, and inventions routinely upset everything. Because it is difficult to predict revolution and impossible to schedule it, we can never completely know the future.

Still, people persist in modeling the fu-

ture on the past. Just look at the various proposals for a new super audio format employing the high-capacity disc, the DVD. Many companies and organizations are floating proposals, and, unfortunately, most of them envision a format that is equivalent to pulling around hot-air balloons with horses. That is, these proposals simply extrapolate from the CD format. Many call for a stereo format with a wordlength of 20 to 24 bits and a sampling frequency of 88.2 or 96 kHz.

On one hand, these proposals are perfectly logical, and implementing them would make for better sound quality than present-day CD's. But they are colossally inefficient and, in fact, offer minuscule real benefit. They demand a bit rate that is several times the existing rate, while ignoring the benefit of recent innovations such as perceptual coding. Moreover, the marginal improvement in sound quality will be discernible only to a few people

**Forcing 5.1 playback  
to serve as the basis for an  
audio-only format is  
a sign of creative laziness.**

with expensive playback systems. In short, these proposals are elitist and narrow-minded. I support the idea of encoding music signals with higher fidelity, but to stop there, and ignore other exciting possibilities, shows a lack of imagination.

One person who has never lacked imagination is Tomlinson Holman. He is credited with almost single-handedly pulling film sound into the modern era with the resurrection of multichannel audio for films (a technology that had been allowed to languish) and with the upgrading of film audio through the development of the THX standard for theatrical and home viewing (otherwise known as Tomlinson Holman's eXperiment). Holman was also an early advocate of multichannel audio for videodiscs and for the forthcoming DVD movie format; he first proposed 5.1 audio and coined the term.

Recently, at the International Alliance for Multichannel Music (IAMM) conference in Los Angeles, Holman and other audio notables (such as John Eargle and George Massenburg) met to discuss and debate the future of audio. Holman described this as a critical time in the history of recorded music — our decisions now will dictate the next half-century of audio playback. He reminded the audience that although two-channel sound still dominates music playback, the emergence of 5.1 sound has been rapid, particularly in home theater applications.

But 5.1 playback was developed specifically to provide the minimum number of channels needed to accompany a picture. Audio-only playback is an entirely different experience. For critical audio reproduction, a 5.1-channel system provides only a very coarse spatial representation. For more realistic playback, he suggested, more channels are needed. Relying on scientific studies of the psychoacoustics of localization, Holman noted that our response to spatial cues is extremely dependent on the absolute direction of the cue. Moreover, there is a limit to our ability to discriminate spatial information. Armed with this data, he argued that at least *ten* channels are needed for satisfactory audio playback. He described 5.1 playback as a limitation and called for careful consideration of more sophisticated multichannel architectures.

The point is this: Proponents of a new super audio format that merely extends the CD's wordlength and sampling frequency are misguided. Proponents who advocate a 5.1 system have imaginations that are almost as feeble. The 5.1 format was created for movie playback; forcing it to serve as the basis for a new audio-only format is simply a sign of creative laziness. The plain fact that a super audio format will be derived from DVD, a technology invented for movies, is no excuse to saddle it with 5.1's limitations.

So how many channels are enough? No one knows the answer. Holman has suggested a starting point, but, rightly, his statements raise more questions than answers. Nonetheless, the important issue is that we have a rare opportunity to make significant improvements in music reproduction. We can't rely on simple extrapolations of past technology. Instead, we must rethink all our basic assumptions and find the best path to substantially improve the next generation of audio playback.

Our future is not preordained. We are its architects, and it is our collective imagination, or lack of it, that will build future worlds. Only our vocal support of creative and exciting leaps of technology will make them happen. Next time someone pitches you a small-minded vision of the future, sniff carefully for hot air and horse manure. Then tell them that you'd prefer to travel by jet. □

# PRESENTING THE ADVENT B<sub>2</sub>R SERIES™



## BACH TO ROCK

*The Perfect Formula for Sound.*

EXPERIENCE THE ONE SPEAKER LINE THAT BRINGS OUT THE BEST IN ANY STYLE OF MUSIC...  
FROM A SOPHISTICATED CLASSICAL ORCHESTRA, TO HOME THEATER, TO A DOWN-AND-DIRTY ROCK CONCERT.

THE RESULT OF EXTENSIVE RESEARCH, THE NEW B<sub>2</sub>R SERIES IS THE PROVEN CONSUMER'S CHOICE FOR TASTEFUL CABINETRY AND ACCURATE SOUND REPRODUCTION. FOR "SOUND AS IT WAS MEANT TO BE HEARD," DISCOVER THE B<sub>2</sub>R SERIES... NOW PLAYING AT YOUR LOCAL ADVENT RETAILER.

PS-13

Advent's "Perfect Formula for Sound" appearing in a home near you.

For more information call, 800-477-3257

**ADVENT**

Advent is a registered trademark and B<sub>2</sub>R Series is a trademark of International Jensen Incorporated.

CIRCLE NO. 4 ON READER SERVICE CARD





## TECHNICAL TALK

JULIAN HIRSCH

# The Evolving Stereo Receiver

In the early years of high-fidelity music in the home, the middle to late 1940's, there were two major sources of good music for home enjoyment, the phonograph record and FM radio. Recorded music had been available for several decades on 78-rpm discs, of course, but the development of the 33 $\frac{1}{3}$ -rpm long-play record, or LP, after the Second World War represented a quantum leap in sound quality and convenience. The LP quickly became the mainstay of recorded home music, a position it held for more than thirty years. It had no serious competition, at least in the world of classical music, until the advent of the CD in the 1980's. The consumer versions of tape recorders in that period were definitely not of hi-fi caliber, and even if one invested in a better machine, the selection of prerecorded music on tape was somewhat limited compared with LP's, and the tapes were expensive.

FM radio had appeared shortly before the war on an experimental basis, but it did not become a commercial reality until the reassignment of broadcast frequencies after the war. The early FM broadcasts, at least in the northeastern states, actually had regular programs of live music, providing a sound quality that was not to be equaled until the digital revolution many years later. Even live "stereo" broadcasts were offered in the New York area (and possibly elsewhere) through cooperation between the broadcasters, with an FM station carrying one channel and an AM station carrying the other (stereo FM came along some years later). Many of us, myself included, used separate AM and FM radios to receive these broadcasts, although some manufacturers produced AM/FM tuners with completely separate circuits and controls in a single unit so that the two channels could be received through a single tuner.

For the audiophile, a term I believe originated in the mid-1940's, roughly concurrently with my own interest in audio, FM radio was a welcome change from the restricted bandwidth, high noise level, and high distortion of the AM band. Early FM tuners, such as those from Pilot and Meissner, were crude, insensitive, and far from offering the performance of

later tuners, but they were cheap and, compared with AM tuners, represented a major advance in sound quality.

Still, those first FM tuners, which used vacuum tubes, were subject to an ongoing frequency drift as they warmed up. The worst of them could drift endlessly, and even the better ones, despite their frequency-compensation circuits, required occasional retuning to maintain low noise and distortion levels. The obvious, and inexpensive, solution was automatic frequency control (AFC), which in effect locked the tuner to the received frequency and greatly reduced the drift problem.

Transistors, with their relatively cool operation, would seem to offer an obvious means of minimizing thermal frequency drift. Unfortunately, the germanium transistors that were used in the first solid-

**Many of us used separate AM and FM radios to get "stereo" broadcasts in the late 1940's.**

state tuners and receivers were notorious for their noise and thermal instability. A number of years elapsed before affordable silicon transistors (and, later, integrated circuits) became available, allowing even inexpensive tuners to have stable, drift-free operation.

Before receivers came to dominate the market, a good many high-quality (and high-priced) separate FM tuners were developed. Often the designer's goal was to achieve the highest sensitivity so as to provide low-noise reception of weak signals. Even today, however, the least expensive way to improve FM reception and range is to install a good FM antenna, high and in the clear, with a rotator if necessary. Unfortunately, in some circumstances this may not be feasible.

Along with parallel developments in power-amplifier technology, the development of affordable integrated circuits allowed much of the circuitry of a component tuner to be condensed into a single

chip, which could then be included with a preamplifier and power amp in a single component, the receiver. Little can be measured of a receiver's tuner section other than its overall performance, from antenna input to audio output, but that is essentially what we would normally wish to measure anyway. Considering the extensive miniaturization of receiver tuner sections, their performance has often been quite impressive.

The FM tuner sections of the A/V receivers we have tested lately, however, although perfectly adequate, are not at all outstanding compared with many of the separate tuners of the past, or even some of the earlier stereo receivers. I suspect that the peak value per dollar of receiver tuner sections was reached several years ago, before the A/V revolution got fully under way. Clearly, the modern A/V receiver is designed to function in a home where video plays a prominent role, or even a dominant one. The dynamic, spatial, and spectral properties of movie or video soundtracks, as reproduced in a home-theater system, take precedence over clear, low-noise reception of music from FM broadcasts.

That, in turn, suggests that the peak of serious consumer interest in FM reception in the home has passed. The 1996 *Stereo Buyer's Guide* lists only about forty separate tuners, many of them priced in the "high-end" category (the price range is an amazing \$60 to \$13,800!). Nevertheless, I am confident that a functioning FM tuner section, though perhaps not one of the caliber of those of a few years ago, will continue to be a part of every home music system for the foreseeable future.

What about the AM tuner? Whether as part of a component AM/FM tuner or a receiver, it has always been (and still is, to the best of my knowledge) a mere convenience, with no pretense of sonic quality. Almost without exception, these AM tuners have extremely limited bandwidth and sensitivity, although they can be perfectly satisfactory for talk radio.

As for the receiver itself, I believe that most of today's medium-price receivers, whether designed for conventional or A/V applications, represent a solid foundation for any home music system. Overall, they deliver a caliber of sonic performance and value per dollar that would have been inconceivable just a few years ago. Many of those priced at less than \$400 or \$500 would have been unimaginable for twice that price not long ago.

Most of these are fully capable of supplying four or five channels of power to a home theater. And their tuner sections, as far as I can tell from measurements, are generally as good as those in more advanced A/V receivers costing several times as much. At least this one section of the receiver seems to have evolved about as far as it's going to. □



*Remember your first stereo?*

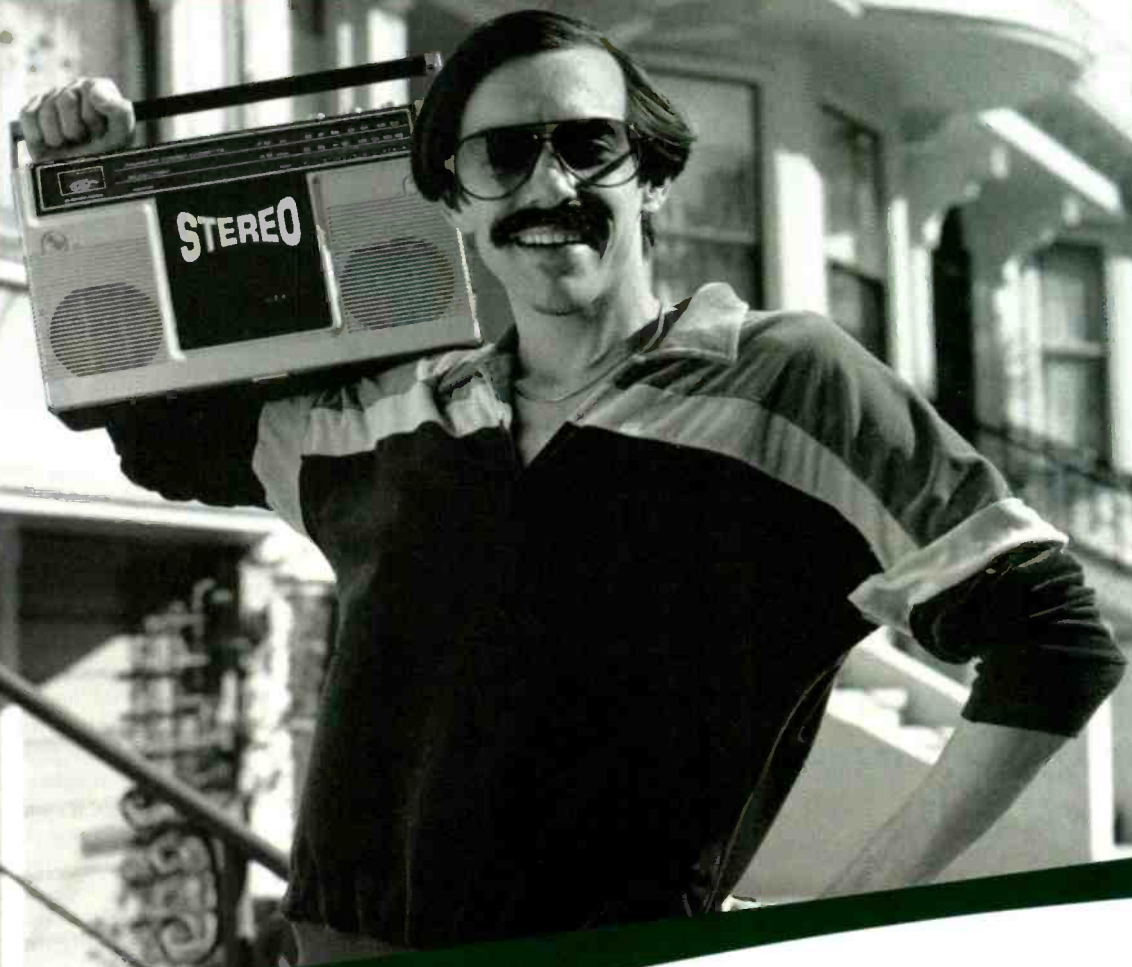

*It came wedged between styrofoam, and produced that most wondrous of effects — a left and right channel. Suddenly your favorite songs sounded like music, and not the intercom system on a WWII submarine. You've come a long way in your appreciation of audio since then. All the way to NHT. We create some of the industry's most celebrated products, including the Model 2.5. It features components and ideas from our acclaimed bookshelf speakers, together with a built-in subwoofer, producing the clarity and imaging of the finest 2-way designs with the dynamic range of much larger systems. We're able to design products such as this because, like you, we've never lost our love for sound.*



WE'RE INSIDE YOUR HEAD.

CIRCLE NO. 28 ON READER SERVICE CARD

FOR THE NHT DEALER NEAREST YOU: (U.S.) CALL 1-800-NHT-9993; (CANADA) ARTECH ELECTRONICS LTD., 514-631-6448. NHT WEB SITE: <http://www.nhthifi.com>



DOCK P. JELING

## Optimus STAV-3470 Audio/Video Receiver

DAVID RANADA • TECHNICAL EDITOR

**R**adio Shack lists three A/V receivers in its 1996 catalog. The top-of-the-line Optimus STAV-3470 is said to be capable of delivering 150 watts per channel in stereo operation and "110 watts *equal* power to front, center, and rear surround channels in Dolby Pro Logic mode" (emphasis as printed in the catalog).

Aside from those generous power specifications, the STAV-3470 is a typical midprice A/V receiver in terms of features, though some features are implemented with interesting twists. In manual station selection with the thirty-preset tuner, that twist is more of a twirl: The main tuning device is a small, finger-driven multi-jog dial set between the front panel's fluorescent display and the tone and balance control knobs. The dial is more intuitive and speedier in operation than ordinary tuner-scan buttons, though not as sexy as a flywheel tuning knob (now extremely rare).

Standard Dolby Pro Logic surround decoding is provided along with three ambience-enhancement modes. As the manual puts it, the Studio mode is supposed to provide "a subtly rever-

berated sound" with non-Dolby Surround-encoded signals. The Arena mode is for surround enhancement of "live performances," and Simulated Surround is supposed to produce a surround effect from monaural signals. The receiver has the standard set of Dolby Pro Logic adjustments — center-speaker mode, test tone, center and surround speaker levels, and surround delay time — but they can only be accessed with the remote control, and not all of them apply to all of the enhancement modes. The programmable remote is also the only way to activate the receiver's sleep timer. Both the remote and the front panel contain a general-reset button, cryptically labeled Return.

The rear-panel connections are thoroughly standard: one switched AC

convenience outlet, snap-clip connectors for two sets of main speakers, two surrounds, and the center speaker, line-level outputs for the center channel and a subwoofer, and push connectors for the supplied antennas. RCA-jack connections are provided for a turntable (moving-magnet cartridge), a CD player, one VCR, one audio recorder, one TV monitor (video output only), and a laserdisc player (A/V inputs only). For the video components, composite-video (RCA-jack) connectors are supplied. Finally, there are jacks for connecting to other Optimus components so that you can use the receiver's remote to control them.

On the test bench, the STAV-3470 was an average performer from its tuner section through to the Dolby Pro Logic decoding. One measurement did surprise us, however. The line-level subwoofer output proved to be a simple mono blend of the stereo channels, with no crossover filtering whatsoever. This is as it should be and rarely is, since such a simple mono mix allows a powered subwoofer's crossover to do its work correctly, without unpredictable complications from receiver-originated filtering. Unfortunately, there are no pre-out/main-in connections, which would have greatly simplified powered-subwoofer selection and setup.

In only one area did the STAV-3470's performance stand out as unusual: Its stereo output was a powerful 180 and 255 watts into 8- and 4-ohm loads, respectively. And its front-chan-

**DIMENSIONS:** 16 $\frac{5}{8}$  inches wide, 6 $\frac{1}{2}$  inches high, 11 $\frac{7}{8}$  inches deep

**WEIGHT:** 21 pounds

**PRICE:** \$499

**MANUFACTURER:** Optimus by Radio Shack, Dept. SR, 1400 One Tandy Center, Fort Worth, TX 76102; telephone, 817-390-3011

# TEST REPORTS

nel power output (driven one channel at a time into 8 ohms) was only 33 to 37 watts lower in Dolby Pro Logic mode, which represents a drop in maximum level of only 1 dB or so.

But despite the wording in the Radio Shack catalog, the manual's specification page, and the "4-Channel Equal Power Output" printed on the STAV-3740's front panel, we couldn't obtain surround-channel power outputs close to those of the front channels. In Dolby Pro Logic mode, for example, we measured a little over 41 watts per channel at clipping, about 5.3 dB below the maximum output of more than 140 watts from each of the front channels.

There's less of a discrepancy between the receiver's specifications and our test results than you might think, however. The key is the phrase "4-Channel" on the front panel. While there are indeed only four encoded channels in a Dolby Stereo signal, and four outputs from a Dolby Pro Logic decoder circuit, there are *five* speakers in a true home-theater system, three fronts and two surrounds. This receiver, along with quite a few others, ap-



parently has only four separate power-amplifier circuits, so it connects the two surround speakers in series. Half the power of the single surround amplifier is thus delivered to each surround speaker. Although such a setup would be unrepresentative of normal

use, if we had hung a single 8-ohm load across the surround outputs (as opposed to two 8-ohm loads in series), we would have measured an output of around 165 watts, to some extent justifying Radio Shack's claim.

All this is important only to those obsessed with data sheets and test results. Since the two surround speakers are driven by the same signal, their in-room output levels will combine to be between 3 and 6 dB louder than either speaker used alone (which is not even possible with the STAV-3740), thus making up the difference with the maximum front-channel levels. Of course, that assumes the surround speakers have the same sensitivity as the front speakers. A small difference in speaker sensitivity (a few decibels) can make a huge difference in the amplifier wattage required to reach a given sound level.

In any case, the STAV-3740 sounded as if it had lots of power available, and it cleanly drove our listening-room system, which included a powered subwoofer, to extremely loud levels with both music and soundtracks. Dolby Pro Logic decoding was very good

## MEASUREMENTS

### AMPLIFIER SECTION

All data for two-channel stereo operation.

#### OUTPUT AT CLIPPING (at 1 kHz)

8 ohms	180 watts
4 ohms	255 watts

#### CLIPPING HEADROOM (re 150-watt rating)

8 ohms	0.8 dB
--------	--------

#### DYNAMIC POWER

8 ohms	190 watts
4 ohms	312 watts

#### DYNAMIC HEADROOM (re 150-watt rating)

8 ohms	1 dB
--------	------

#### DISTORTION AT RATED POWER

	0.012%
--	--------

#### SENSITIVITY (for 1 watt output into 8 ohms)

CD	16.7 mV
phono	0.18 mV

#### NOISE (re 1 watt, A-wtd)

CD	-79.2 dB
phono	-74.3 dB

#### RIAA PHONO EQUALIZATION ERROR

20 Hz to 20 kHz	+0.36, -0 dB
-----------------	--------------

#### FREQUENCY RESPONSE (tone controls centered)

20 Hz to 20 kHz	+0 dB, -0.4 dB
-----------------	----------------

#### TONE-CONTROL RANGE

100 Hz	+8.8, -9.2 dB
10 kHz	+8.6, -8.7 dB

#### SUPER BASS EFFECT

	+11.1 dB at 60 Hz
--	-------------------

### DOLBY PRO LOGIC PERFORMANCE

#### FREQUENCY RESPONSE

left, right	20 Hz to 20 kHz +0, -0.5 dB
center	20 Hz to 20 kHz +0, -0.3 dB
surround	20 Hz to 6 kHz +0, -3 dB

#### OUTPUT AT CLIPPING (8-ohm loads)

left, center, right	143 to 147 watts
surround	41 watts

#### NOISE (re 1-watt output, A-wtd)

left, right	-71 dB
center	-73.4 dB
surround	-62.5 dB

#### DISTORTION (THD+N, 1 kHz, 1-watt output)

left, right	0.05%
center	0.2%
surround	0.24%

#### SURROUND-DECODER INPUT-OVERLOAD

MARGINS (at 1 kHz)	
left, right (re 2-volt input)	+1.5 dB
center (re 1.4-volt input)	+4.8 dB
surround (re 1.4-volt input)	+1.1 dB

#### SURROUND-CHANNEL NOISE-REDUCTION

CALIBRATION ERROR	
re Dolby spec (247.5 mV)	-2 dB
re THX spec (141.4 mV)	+3 dB

#### CHANNEL SEPARATION (100 Hz to 7 kHz)

left output, right driven	>31 dB
left output, center driven	>34 dB
left output, surround driven	>27 dB
center output, left driven	>27 dB
center output, surround driven	>36 dB
surround output, left driven	>42 dB
surround output, center driven	>46 dB

### TUNER SECTION

All data for FM only except frequency response.

#### SENSITIVITY (50-dB quieting)

mono	16 dBf
stereo	26 dBf

#### NOISE (at 65 dBf)

mono	-68 dB
stereo (mostly pilot leakage)	-33 dB

#### DISTORTION (THD+N at 65 dBf)

mono	0.8%
stereo (including pilot leakage)	1.6%

#### CAPTURE RATIO (at 65 dBf)

	1.5 dB
--	--------

#### AM REJECTION

	60 dB
--	-------

#### SELECTIVITY

alternate-channel	61 dB
adjacent-channel	14 dB

#### PILOT-CARRIER LEAKAGE

19-kHz	-35 dB
38-kHz	-35 dB

#### HUM

	-88 dB
--	--------

#### CHANNEL SEPARATION

100 Hz	48 dB
1 kHz	42 dB
10 kHz	40 dB

#### FREQUENCY RESPONSE

FM	30 Hz to 15 kHz +3, -0 dB
AM	150 Hz to 3.2 kHz +0, -6 dB

## TEST REPORTS

except for the slightly high surround-channel noise level, a common fault.

The best enhancement mode was Studio, which produces no reverberation but generates instead a single surround-channel artificial reflection 5 milliseconds after the original signal comes out of the front speakers. It was a subtle effect, even with the surround speakers turned way up, unlike many other receivers' enhancement modes, which seem oriented more to making an exaggerated showroom demonstration than to being useful with typical music. In addition to a single surround-channel reflection, the Arena and Simulated Surround modes mix a single reflection into the front channels (the delay time is determined by the receiver's surround delay setting). This colors the front-channel sound appreciably, making these modes less suitable for music enhancement although possibly useful with some video programs. There's also a slow treble rolloff above 5 kHz in these two modes. The front-panel Super Bass button produced a large equalizer-like boost at 60 Hz.

The STAV-3470 receiver operated with no major problems. There were some minor quirks, however. My experiences trying to test the tuner section lead me to recommend that you press the Return button the first time you turn on the unit and also every time you turn it on after it has been disconnected from AC power, just in case the internal computer has gotten confused by the disconnection. Another quirk: Although the front-panel volume knob is continuously variable, single presses of the remote's volume control produce volume changes that are too great, especially at the low end of the range. The volume steps provided for center and surround speaker-level balancing are also too large for really good surround-sound level matching. Finally, part of the reason this receiver can deliver so much power from a relatively small and lightweight package is that it contains a cooling fan that's always on. With classical music of wide dynamic range the fan proved distractingly noisy from 12 feet away during quiet passages at normal listening levels.

The Optimus STAV-3470 has no important flaws, however, and is a good all-around performer. If you think you can live with those minor operating annoyances, it deserves consideration along with similarly priced and powered A/V receivers. □

# "Astounding!"

**INTRODUCING...**

## PARADIGM® REFERENCE SPEAKER SYSTEMS

**A new high-end speaker division,  
dedicated to providing the highest  
standard of technological design  
excellence, and deliver absolutely  
breathtaking sonic performance!**

**W**ith years of design expertise and a state-of-the-art in-house R&D facility, Paradigm engineers and acousticians set out to build the world's finest speakers, regardless of cost! The result is Paradigm Reference...electrifying and eminently satisfying high-end speaker systems that bring you closer than ever to the live event!

And, while this stunning performance heightens the sheer enjoyment of music, it is equally important for the best in home theater sound, especially now with the arrival of digital AC-3.

We invite you to visit your nearest Authorized Paradigm Reference Dealer and experience this astonishing new reference standard in music and home theater sound for yourself!

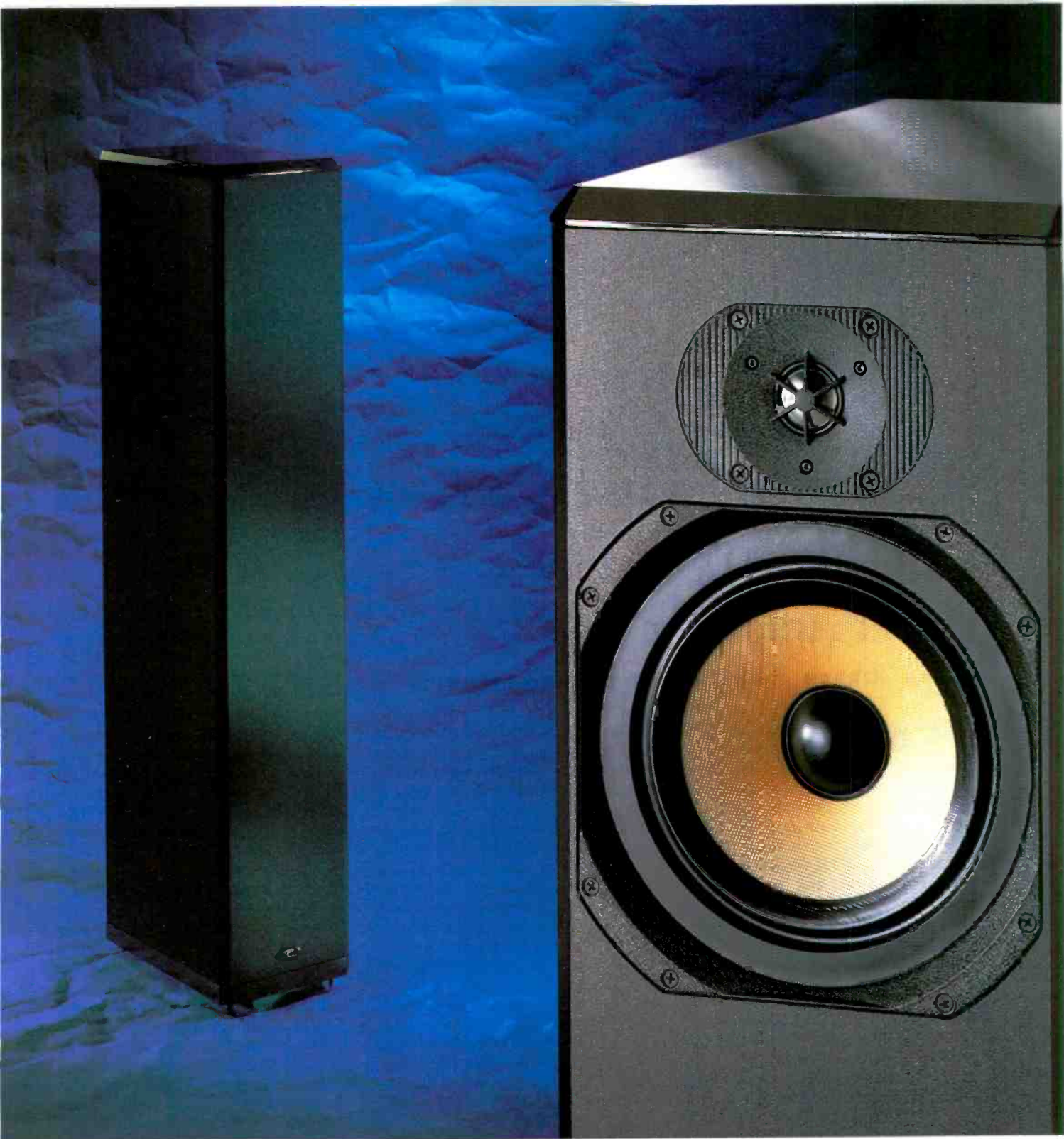

Studio/20



Studio/60



Studio/80



Studio/100



Esprii/BP  
Bipolar



Eclipse/BP  
Bipolar



LCR-450  
Left/Center/Right



CC-450  
Center Channel



ADP-450  
Surround

AC-3 is a trademark of Dolby Labs



**PARADIGM® REFERENCE**

THE ULTIMATE IN HIGH-END PERFORMANCE FOR MUSIC AND HOME THEATER™

For more information visit your nearest Authorized Paradigm Reference Dealer or write:  
AudioStream, c/o PO Box 2410, Niagara Falls, NY 14302 (905) 632-0180  
In Canada: Paradigm, 101 Hanlan Rd., Woodbridge, ON L4L 3P4 (905) 850-2889

CIRCLE NO. 35 ON READER SERVICE CARD



## Cinepro 600X Power Amplifier

**JULIAN HIRSCH • HIRSCH-HOUCK LABORATORIES**

**C**inepro Theater Products, although perhaps not a household name among audiophiles, is a manufacturer of amplifiers for movie theaters and other professional sound applications. Cinepro's 600X stereo power amplifier is a modified version of a THX-certified professional amplifier that has been in production since 1989, the company says. The first in a line of "prosumer" audio products Cinepro is planning to offer, the 600X carries a three-year parts-and-labor warranty and is said to have been improved cosmetically and electronically over its predecessor. It also has a substantially reduced price tag of \$699.

The 600X is rated for operation into loads of 8, 4, or 2 ohms with respective power ratings of 200, 300, and 400 watts per channel from 20 Hz to 20 kHz at less than 0.15 percent total harmonic distortion (THD). It can also be switched to a mono mode, with ratings of 600 watts into 8 ohms and 800 watts into 4 ohms.

The 600X's cabinet is very sturdy, featuring heavy-gauge steel panels (the front panel is 5/16 inch thick), and the power transformer, though uncased, is massive. A cooling fan on the left side panel comes on as needed to

maintain safe internal temperatures. It is fairly quiet and unlikely to be audible under any home listening conditions (during our high-power tests it operated only briefly).

The amplifier circuitry is on a single large printed board. Each channel uses six Motorola power transistors, and the low-level circuits are also completely discrete (no integrated circuits were visible on the amplifier board).

The 600X is relatively compact for its power capabilities. It has roughly the same dimensions as a moderate-size A/V receiver, though it is considerably heavier. The front panel contains a rocker-type power switch and six LED indicator lights (three per channel). Red lights show that the amplifier is turned on, green lights indicate the presence of a signal, and red "Sof-Clip" lights flicker on to warn that the signal is approaching the clip-

ping level, remaining lit when the amplifier reaches that point.

The Cinepro 600X has versatile input/output connections at opposite ends of its back panel (the space between them contains the output-transistor heat sink). The signal inputs are provided with both 1/4-inch phone jacks and professional-style balanced (XLR) sockets. The amplifier comes with four gold-plated phone-plug adaptors that allow the use of standard RCA plugs through the unbalanced inputs. The speaker outputs are two pairs of binding posts with standard 3/4-inch spacing, compatible with stripped wire, lugs, or dual banana plugs. An adjacent toggle switch selects stereo or mono operation.

Another small toggle switch near the input jacks offers the option of "lifting" the amplifier circuits off the (chassis) ground. One of its settings will usually result in a lower noise and hum level from the amplifier.

Our lab tests of the Cinepro 600X revealed its excellent performance and impressive power capabilities. Although we normally test very powerful amplifiers with caution, not to say trepidation, the Cinepro 600X withstood a considerable amount of (non-intentional) overdriving and clipping without mishap. We did blow the 10-ampere line fuse a couple of times in full-power testing of both channels, and our load resistors (able to handle up to 500 watts without damage) became perilously hot occasionally. Through all of this abuse (at least by home hi-fi standards) the amplifier performed perfectly, and it never be-

**DIMENSIONS:** 18 inches wide, 5 1/2 inches high, 12 1/2 inches deep (including heat sink)

**WEIGHT:** 32 pounds

**PRICE:** \$699

**MANUFACTURER:** Cinepro Theater Products, Dept. SR, 1030 Vicente, San Francisco, CA 94116; telephone, 1-800-395-1222.

came uncomfortably warm on its exterior surfaces (heat sinks excluded). The Sof-Clip LED's did light frequently, however.

As our test results eloquently confirm, this amplifier is a true professional in its performance and ruggedness. It can deliver about 500 watts per channel into 4-ohm loads, or 300 watts into 8 ohms, with negligible distortion. In fact, our distortion measurement of 0.021 percent at rated power was lower than Cinepro's spec. Furthermore, in spite of frequently being driven into hard clipping, it suffered no damage more serious than blowing the line fuse.

Notwithstanding its professional pedigree, the Cinepro 600X has all the qualities we expect to find in a top-notch consumer product, including very low noise and distortion, flat frequency response, lack of audible acoustic noise (the fan runs only when the amplifier is delivering enough power to deafen anyone close to the speakers), and attractive styling.

But is such an amplifier necessary, or even advisable, for listening to music at home? If an amplifier costs a few thousand dollars, as do most of those that come close to matching the performance of the 600X, I would normally say no unless you want the amp to drive certain high-end speakers that combine very low efficiency with a low impedance.

The Cinepro 600X, however, is an outstanding exception. Frankly, its price is almost too low to be real (I suspected a typo at first). Obviously, it would be risky to couple a powerhouse amp like this one with a small speaker, which could be destroyed in

an instant by a careless act, such as plugging a signal cable into the amplifier (or pulling one out) while it is connected to the speakers. But if it is installed and used with reasonable care, the 600X can be used safely with most speakers, and I have no doubt it would acquit itself admirably. I would

## MEASUREMENTS

<b>OUTPUT AT CLIPPING</b> (at 1 kHz)	
8 ohms .....	300 watts
4 ohms .....	500 watts
<b>CLIPPING HEADROOM</b> (re rated power)	
8 ohms .....	1.76 dB
4 ohms .....	1.6 dB
<b>DYNAMIC POWER</b>	
8 ohms .....	420 watts
4 ohms .....	528 watts
2 ohms .....	900 watts
<b>DYNAMIC HEADROOM</b>	
8 ohms .....	3.22 dB
4 ohms .....	2.45 dB
2 ohms .....	3.52 dB
<b>DISTORTION AT RATED POWER</b> 0.021%	
<b>SENSITIVITY</b>	
(for 1-watt output into 8 ohms) ... 120 mV	
<b>NOISE</b> (re 1 watt, A-wtd) ... -92 dB	
<b>FREQUENCY RESPONSE</b>	
20 Hz to 20 kHz +0, -0.09 dB	

suggest that you install fuses on your speaker cables, though.

Clearly, the Cinepro 600X amplifier was designed to drive theater sound systems — which is to say, with enormous sound levels a good part of the time. A well-equipped home system obviously can also benefit from the 600X's capabilities, especially when it is driving suitably rugged or inefficient speakers. □

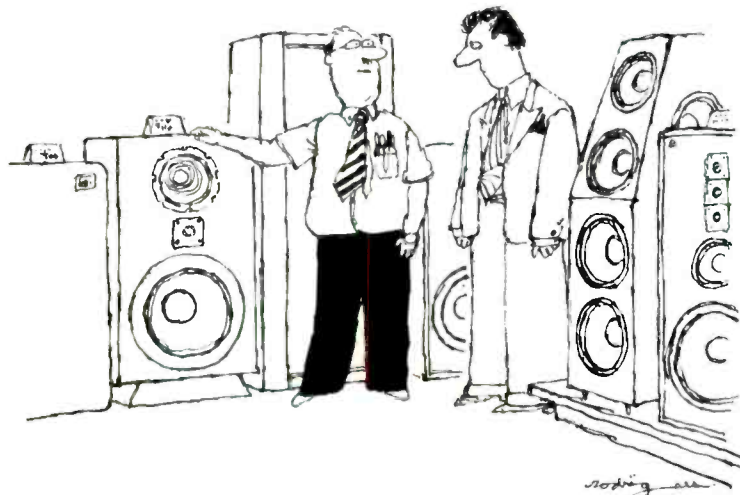

"This is our best-selling out-of-wall speaker."

**CRUTCHFIELD** \$3.00

**Sony DSS is Here!**

**SAVE!** on the perfect Stereo

Audio • Car Stereo • Video • Home Theater

PLUS MORE CAR STEREO

# FREE Stereo Catalog

Discover the fun, comfortable alternative to those dizzying, frustrating mega-stereo stores. Relax with your new Crutchfield catalog and find out why *Catalog Age* magazine calls Crutchfield the "King of Service."

## Information you can't find anywhere else

You'll love the detailed product descriptions, color photos, comparison charts and honest specs. All those technical terms are explained in the simple language that's helped make Crutchfield famous.



## You won't believe the selection

We're a full-service, factory-authorized dealer offering discount prices



Discounts on major brands, with loads of information to help you shop and compare!

on top name brands including **Sony, Kenwood, Pioneer, JVC, Polk, Bose, Advent, Infinity and Yamaha.**

## Fantastic service seven days a week

- Information and advice you just won't find anywhere else.
- FREE technical advice when you need it — days, nights, even on the weekend!
- Nobody ships faster!

Call for your **FREE** catalog

**1-800-955-9009**

24 hours a day, 7 days a week

**CRUTCHFIELD**

1 Crutchfield Park, Dept. SR, Charlottesville, VA 22906  
Check out our Web site at <http://www.crutchfield.com>

## TEST REPORTS



JOCK P. LEUNG

# MB Quart Domain 20 Speaker

**JULIAN HIRSCH • HIRSCH-HOUCK LABORATORIES**

**M**B Quart, the well-known German company, manufactures and distributes a broad line of home and car speakers for the U.S. audio market. One of its newest entries on the home audio side is the moderately priced Domain series, which comprises three bookshelf speakers, two floor-standing models, a center speaker, a powered subwoofer, and a wall-mounted surround speaker.

What sets the Domain line apart is that each speaker except the surround accepts a variety of grille/frame assemblies (or top panels in the case of the subwoofer). MB Quart offers ten high-grade vinyl-laminate finishes: white birch, driftwood, maple, oak, cherry, black ash, three types of burl, and piano black. A primed fiberboard frame is available for those who want to paint it themselves. The price of a Domain speaker includes the frame of your choice, but replacement frames are available separately if you want to change the look of the speaker. A clever idea.

The least expensive model in the series is the Domain 20, a 10½-inch-tall bookshelf speaker that arrived with an attractive cherry-finish frame, which adds a touch of elegance to its other-

wise featureless black exterior. The frame, held in place by four small dowels, is very easy to remove and put back in place. The rear panel contains only a pair of recessed multiway binding posts.

The two-way, vented system has one "5¼-inch" woofer (the actual cone diameter is about 4½ inches) and a ¾-inch titanium-dome tweeter. The port opening is on the front panel, to the right of the tweeter and just above the woofer. According to the manufacturer, the crossover slopes are 12 dB per octave for the tweeter and 18 dB per octave for the woofer, both at 4 kHz. Nominal impedance is 6 ohms, rated sensitivity is 87 dB sound-pressure level (SPL) at 1 meter with a 2.83-volt input, and the system is rated to handle up to 100 watts of input

**DIMENSIONS:** 10½ inches high, 7½ inches wide, 8¼ inches deep

**WEIGHT:** 9 pounds, 3 ounces

**FINISH:** Black enclosure with choice of grille/frame (see text)

**PRICE:** \$299 a pair

**MANUFACTURER:** MB Quart, Dept. SR, 25 Walpole Park S., Walpole, MA 02081; telephone, 508-668-8973

power. Frequency response is rated as 70 Hz to 22 kHz  $\pm 3$  dB.

For listening and most measurements, we placed the Domain 20 speakers on 26-inch stands, about 7 feet apart and 3 feet from the wall behind them. The room response, averaged for the left and right speakers and corrected for room absorption, was within  $\pm 5$  dB from 90 Hz to 20 kHz.

The dispersion of the ¾-inch tweeter was excellent over a  $\pm 45$ -degree angle off its forward axis. There was no significant change in response below 12 kHz, and it fell off only 5 dB at 15 kHz and 10 dB at 20 kHz.

A close-miked woofer-response measurement, combined with a separate measurement of the port output (corrected for their different diameters) yielded a smooth  $\pm 3$ -dB variation between 40 Hz and 1 kHz. Such low-frequency performance is not likely to be obtained in a normal room environment, however, where the speakers radiate into a large volume.

The measured sensitivity of the Domain 20 was 90 dB (higher than its rated 87 dB). The woofer distortion was between 0.5 and 0.8 percent from 140 Hz to 2 kHz at the standard measurement input level of 2.83 volts. It rose rapidly at lower frequencies, to 2 percent at 100 Hz, 5 percent at 60 Hz, and 10 percent at 47 Hz, still very creditable performance for a woofer with a 4½-inch cone.

System impedance dropped to 4 ohms between 200 and 300 Hz, with maximum readings of 15 ohms at 110 Hz and 1.8 kHz. Overall, the impedance characteristic was consistent with the speaker's 6-ohm rating.

Quasi-anechoic MLS frequency-response measurements, at microphone distances of 1, 2, and 3 meters, were excellent. This test is valid only above 300 Hz, and at the longer microphone distances it is most useful above 1 kHz. But all the measurements were consistent with each other from 1 to 20 kHz, and they confirmed the speaker's response range and the smoothness of the system output.

Except for a dip of about 3 dB centered between 4 and 5 kHz (apparently a crossover artifact), the speaker's on-axis response varied only  $\pm 1.5$  dB from about 500 Hz to 20 kHz. Such response would be considered noteworthy performance in a speaker of any size or price.

As suggested by the measured response, the Domain 20 delivered a balanced, effortless sound with most



of the program material we used. Most of the time there was no audible clue as to the physical dimensions of the speakers. In general, the neutrality of the sound — a striking absence of coloration — was the Domain 20's most obvious characteristic, whether reproducing music or voice. A "boxy" coloration on male voices, one of the most common weaknesses of loudspeakers, simply did not exist.

Although we did not use the Domain 20 in a home-theater installation, it is offered for that purpose and is claimed to be magnetically shielded (to avoid distortion of the video image if the speakers are placed on or near a TV or video monitor). We measured the external magnetic flux surrounding the speakers and found levels of 2 gauss or more at a distance of 6 inches from the speaker's front panel, 3 inches from the top, sides, or back panel, and 4 inches from the bottom of the cabinet. Although these flux levels are somewhat higher than those of other small A/V speakers we have tested, when we placed the Domain 20 on a TV monitor there was no visible effect on the picture with any orientation of the speaker cabinet.

The Domain 20 does not supersede natural laws in any way. Deep bass is not its forte, in spite of the potentially misleading close-miked measurement results. Its actual (useful) lower limit is in the range of 60 to 70 Hz. Of course, most music does not contain

**The Domain 20's most obvious characteristic was a striking absence of coloration, whether reproducing music or voice.**

much energy in the lowest octaves, and these speakers do such a great job of reproducing the rest of the spectrum that most people will not miss the bottom end.

If you must have deep bass and find the small size and fine sound quality of the Domain 20 to be otherwise suitable, a subwoofer is an ideal solution (the Domain line includes a powered sub, as noted earlier, although we did not test it). Pairing the Domain 20 with our reference subwoofer produced superb results. □

BOOK P. LEUNG



## Eosone RSS 702 Three-Piece Speaker System

**JULIAN HIRSCH • HIRSCH-HOUCK LABORATORIES**

**A**lthough the Eosone brand name is new to the high-fidelity audio market, its founder, Arnie Nudell, is well known as a co-founder of Infinity Systems, where he designed a number of outstanding loudspeaker systems over more than two decades. Subsequently, he co-founded Genesis Technologies, where he designed the 1.2-ton, \$90,000 Genesis I system, certainly a candidate for the "best home speaker system" ever made.

Eosone ("dawn of sound," derived from Eos, the Greek goddess of dawn, and *sonus*, Latin for sound) offers a line of much more affordable home speaker systems designed for both music and home-theater applications. Among them is a family of "subwoofer/satellite" systems consisting of a separate powered bass module and two, three, or five small satellite speakers.

The RSS 702 (\$850), which is the subject of this report, is intended for stereo music listening and consists of a powered bass module and two small satellites. The RSS 703 (\$1,000) adds a third satellite for center-channel fill, and the RSS 705 (\$1,300) is a full home-theater system with five identical satellites for front, surround, and center-channel duties. Since all of the

satellites are magnetically shielded, any of them can be used in the center-channel position (usually on top of the TV) without video degradation. The bass module is not shielded, but it is normally placed on the floor and should have no effect on picture quality.

The all-black, molded-plastic, fully sealed satellites are small and light, each with a front panel sloping backward at about 30 degrees. Behind the grille, which is not user-removable, are a 4-inch midrange cone driver and a 1/2-inch dome tweeter. A second identical dome tweeter is located on

### **DIMENSIONS**

Satellites: 4 1/2 inches wide, 5 1/2 inches deep, 7 inches high  
Bass module: 17 inches wide, 15 1/2 inches deep, 13 inches high

### **WEIGHT**

Satellites: 3 pounds, 3 ounces each  
Bass module: 33 pounds

### **FINISH**

Satellites: black molded plastic  
Bass module: black vinyl

**PRICE:** \$850

**MANUFACTURER:** Eosone International,  
Dept. SR, 2550 Britannia Blvd.,  
Suite F, San Diego, CA 92173; telephone,  
1-800-347-1876

## TEST REPORTS

the rear of the enclosure, directly behind the front tweeter, a feature Eosone calls Radiant Surround Field technology that is said to widen the sound field. The rated crossover frequency between the midrange driver and the tweeters is 4 kHz.

According to the manufacturer, the output of the rear tweeter is out of phase with the front tweeter and the midrange driver. This is said to minimize side-wall reflections and to improve the clarity of the sound.

The bass module is a roughly cubical black box whose single 10-inch cone driver operates in a vented enclosure. The port is on the front panel, close to the woofer, and behind the removable black grille. The bass module's overall frequency response is specified as 32 to 200 Hz, and its built-in amplifier is rated at 55 watts. The rear of the bass module has AC-power and signal connections, high-level for connection to a receiver's speaker output and low-level for a pre-amplifier or line output. There are knob-operated controls for adjusting the module's output level and crossover frequency.

The controls are continuously variable, with a volume range from maximum to fully off and a crossover range from 80 to 160 Hz (120 Hz is the center setting). A small slide control switches the bass module's phase between 0 and 180 degrees, permitting a degree of compensation for the time difference between its sound and that from the satellites. Although there is also a power switch for the bass module, it can be left powered continuously since it automatically shuts down after a few minutes if there's no input signal and powers up instantly when a signal is applied. All speaker connectors are insulated spring clips, which accept only stripped wire ends (12-foot connecting cables are supplied).

For room-response measurements and listening purposes, we placed the satellites on stands about 8 feet apart, 3 feet in front of a wall, and the bass module against the wall near the left satellite. We measured the room response of the satellites alone, averaging the signals from the left and right speakers and applying a correction for the known absorption characteristics of the room.

The smoothed and averaged response curve varied  $\pm 5$  dB from 100 Hz to 20 kHz and only  $\pm 3$  dB between 300 Hz and 10 kHz. It dropped off below 200 Hz at a rate of 12 dB per oc-

tave. A close-miked measurement near the satellite's midrange driver revealed a  $\pm 2.5$ -dB variation from 110 Hz to 3 kHz, falling off at 6 dB per octave from 2 to 4 kHz.

The satellite's polar response over a  $\pm 45$ -degree angle off its forward axis was excellent, with a variation of less than  $\pm 2$  dB from 100 Hz to 10 kHz and a falloff to  $-10$  dB at 20 kHz. A quasi-anechoic on-axis response measurement at distances from 1 to 3 meters confirmed the smoothness and flatness of the close-miked satellite response, with less than  $\pm 2$  dB variation from 300 Hz to 15 kHz. Impressive performance.

**T**he satellite's minimum impedance was about 6 ohms at 200 to 300 Hz. Its maximum readings were 25 ohms at 20 Hz, 22 ohms at 150 Hz, and 29 ohms at 2 kHz. Actually, the satellites' impedance is of little importance since the power delivered to them is much less than the power to the woofer, which comes from its own amplifier. In any case, the satellites operate at moderate levels despite the relatively low system sensitivity rating of 86 dB (which we confirmed by measurement).

We measured the bass module's response separately, using close microphone spacing to minimize room effects. The crossover frequency was set to its center (120-Hz) position, which I found to provide the best balance of sound. Combining the outputs from the cone and port produced a bass response flat within 1 dB overall from 50 to 100 Hz. It dropped off at 6 dB per octave below 50 Hz. The crossover-frequency adjustment varied both

the maximum output level and the frequency coverage of the bass module, which is of little consequence since in any case it should be set by ear for the most satisfactory overall balance.

We measured bass distortion using close microphone spacing at a 90-dB sound-pressure level (SPL) 1 meter from the module's cone. Readings ranged from 3 to 5 percent between 55 and 200 Hz, increasing at lower frequencies to 10 percent or more below 40 Hz.

We also verified the effectiveness of the satellites' magnetic shielding. A gaussmeter scan revealed less than 1 gauss (the meter's minimum reading) on any part of the exterior except in direct contact with the rear tweeter (which wouldn't be that close to the TV in any normal installation).

Listening tests confirmed the measurements in every respect. The bass module delivered a skin-tingling, room-shaking bass that blended unobtrusively with the output of the satellites. The overall effect was close to that produced by some larger and more expensive two-piece speaker systems. Although the Eosone three-piece system dips down to the 40-Hz region or slightly below, however, it cannot be expected to match the bottom-octave performance of speaker systems several times its size and weight (and price).

Still, all things considered, the RSS 702 ranks with the best three-piece designs in its frequency coverage, spatial properties, and overall sound quality. Be prepared to experiment with the bass module level and crossover adjustments — you will be pleasantly surprised! □



# CAMEL'S GROOVE

A NON-STOP, OVER  
IN THE PARTY CAPITAL  
AND EVERYTHING

NOVEMBER



SURGEON GENERAL'S WARNING: Smoking Causes Lung Cancer, Heart Disease, Emphysema, And May Complicate Pregnancy.

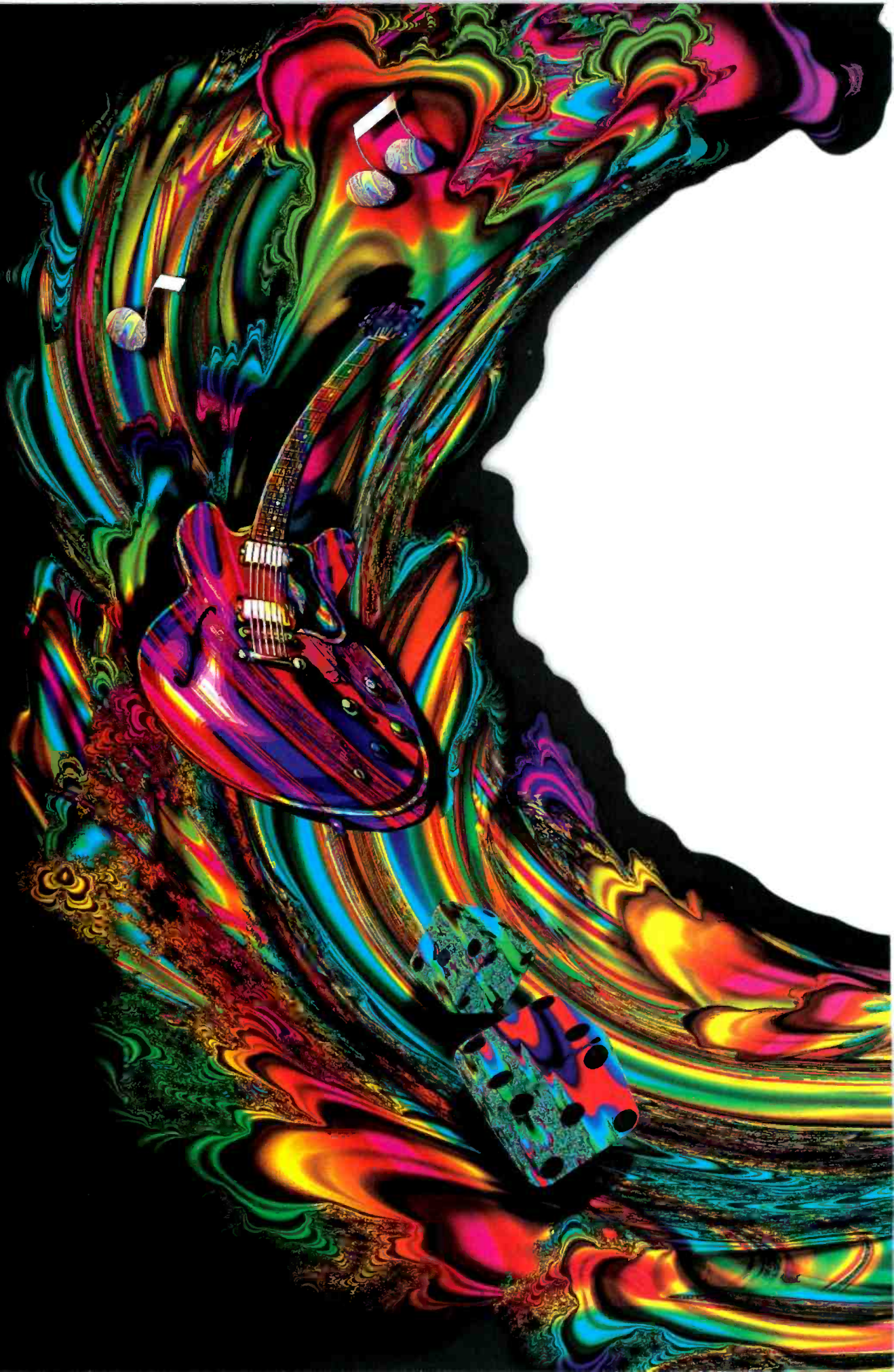

BIG VEGAS

# BLENDER

THE TOP WEEKEND  
OF THE UNIVERSE.  
S'S ON THE HOUSE!

ER 22-24

CAL



Big  
gro  
b

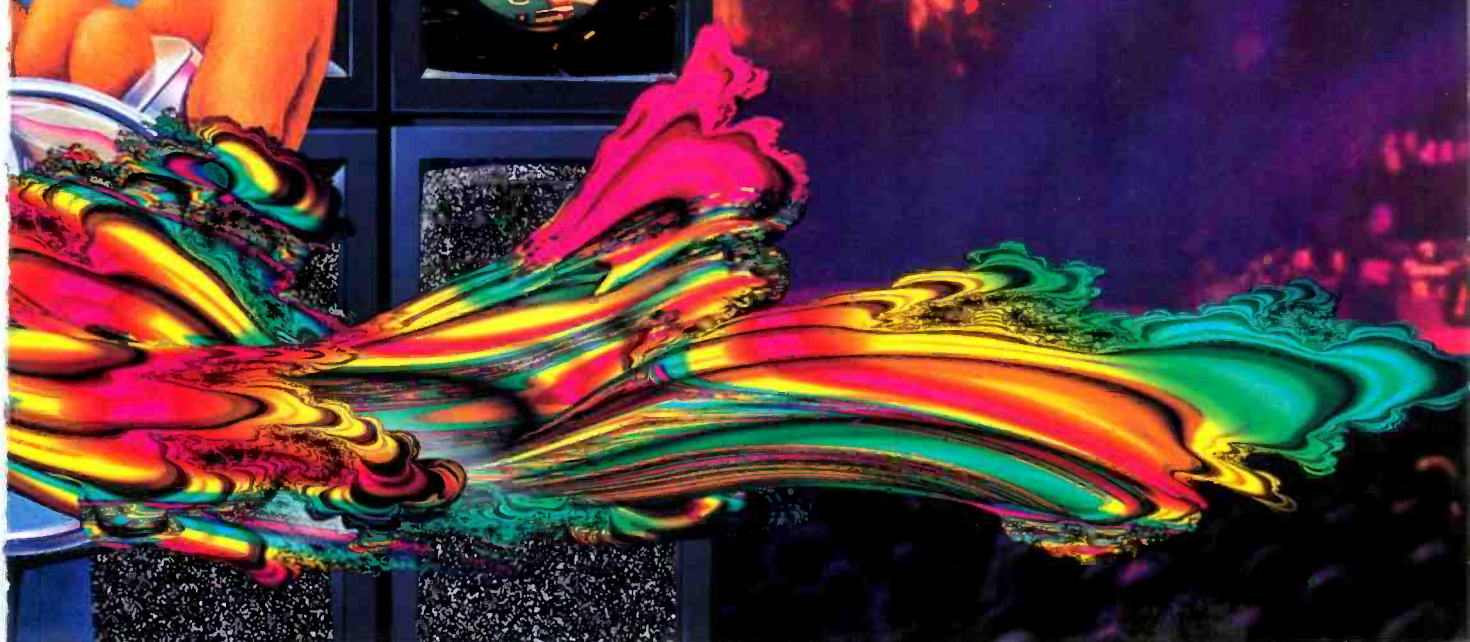
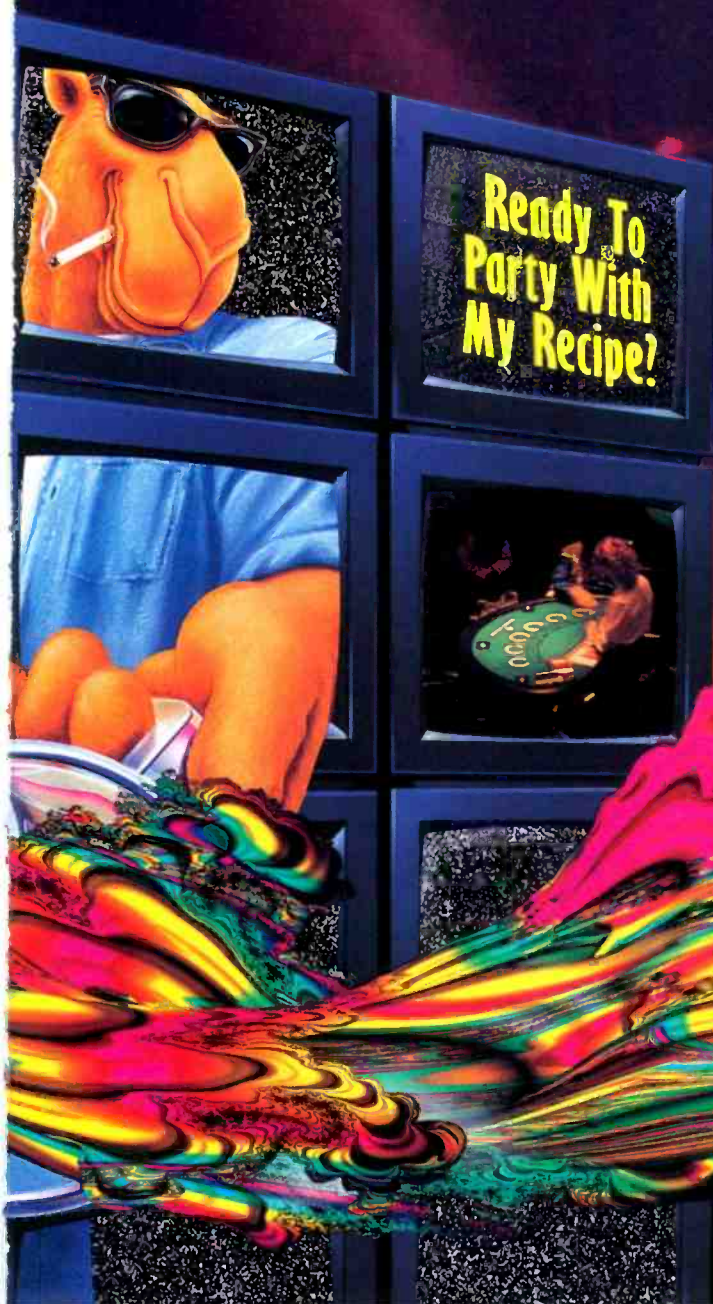

T U R N I T O N



W H I P I T U P

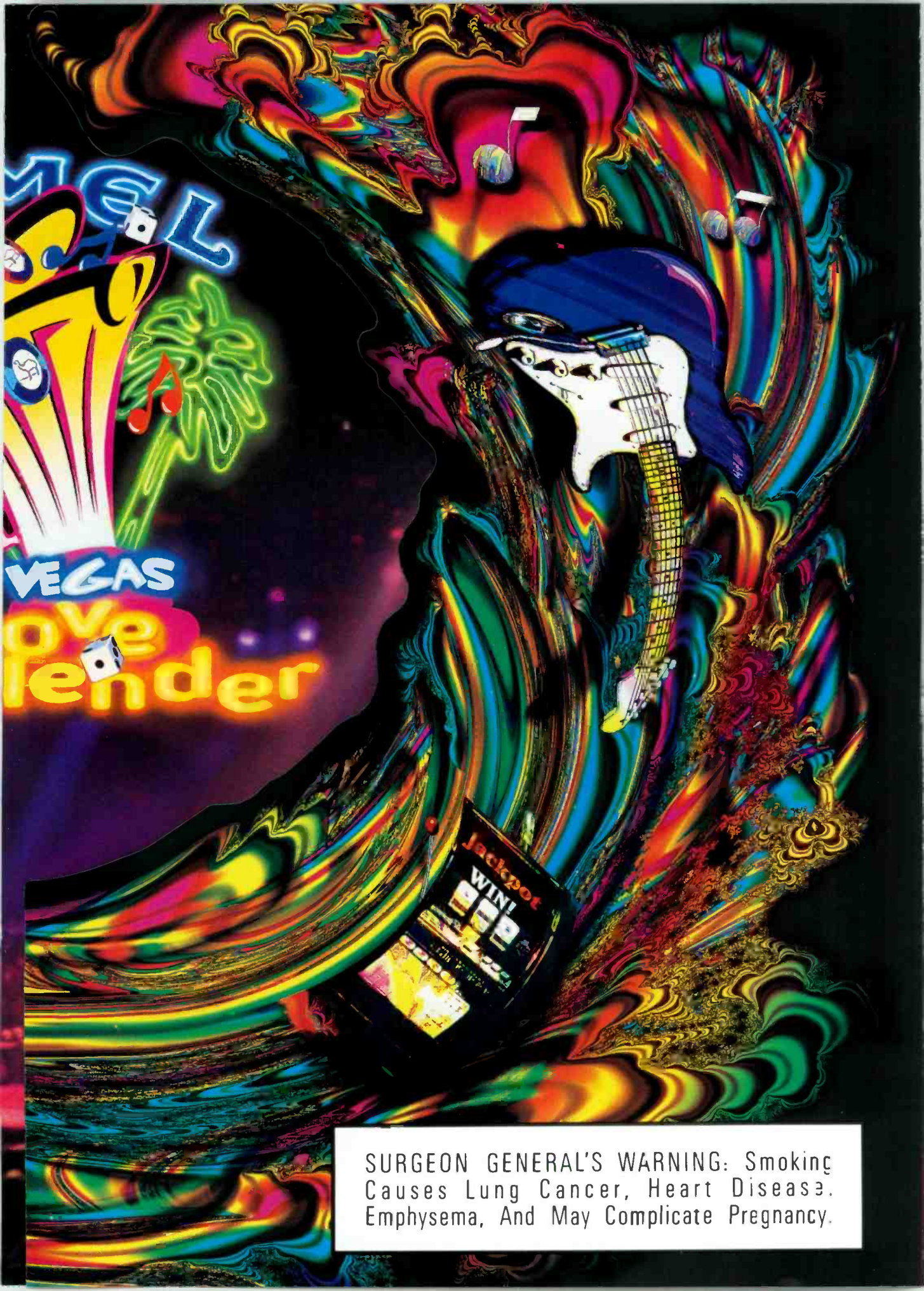

SURGEON GENERAL'S WARNING: Smoking Causes Lung Cancer, Heart Disease, Emphysema, And May Complicate Pregnancy.

# THIRSTING FOR SOMETHING WILD!

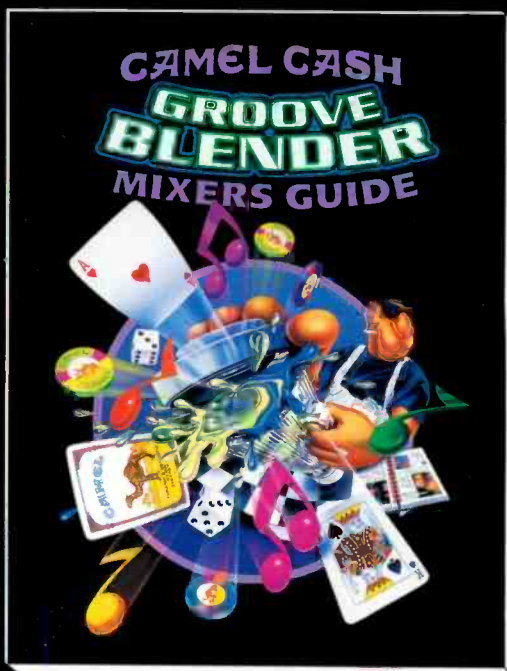

Get in the groove with the Camel Cash Groove Blender Mixers Guide, the official Groove Blender catalog. And whip up party-pounding items like \$25 Ticketmaster® gift certificates, exclusive CDs, subscriptions to the hottest magazines around and more. To get it, go to wherever you buy your smokes or call

## 1-800-CAMEL-CASH\*

1-800-226-3522

### \*MUST BE A SMOKER, 21 YEARS OF AGE OR OLDER TO ENTER

**NO PURCHASE NECESSARY.** Here's How To Enter:

1. On an official entry form only, hand print your name, home address, and home phone number. Entries missing name and address or on which the certification box has not been fully completed (including entrant's signature) will not be considered eligible.
2. Mail your entry to: Camel's Big Vegas Groove Blender, P.O. Box 5777, Norwood, MN 55583-5777. All entries must be mailed via U.S. Postal Service first class mail (no express, registered or certified mail accepted). Participants must pay postage when submitting entries. No reproductions of entry forms accepted. You may enter as many times as you like, but only one sweepstakes entry per outer envelope (mailed separately) is allowed. Additional information regarding the sweepstakes or entry forms may be obtained by calling 1-800-226-3522. Incomplete, illegible or mutilated entries are ineligible. Sponsor is not responsible for lost, late, damaged, postage-due, misdirected or slow delivered mail.
3. The Camel's Big Vegas Groove Blender is limited to legal residents of the 48 continental United States (Alaska and Hawaii excluded) who are 21 years of age or older and are smokers, except employees of R.J. Reynolds Tobacco Company, its affiliates, subsidiaries, advertising and promotion agencies and the immediate families of each. All federal, state and local laws and regulations apply. Offer void in MA, MI, VA and wherever prohibited by law. Prize delivery limited to United States only.
4. R.J. Reynolds Tobacco Company is the Sponsor of this promotion. All entries become the property of the Sponsor and will not be returned. Sponsor will not acknowledge receipt of or confirm eligibility or ineligibility of any entry(s). Sponsor will not return any ineligible entries.
5. All entries must be received by September 10, 1996. There will be 500 Prize Winners. Winners will be determined by a random drawing from all entries received. The drawing will be held on or about September 11th, 1996 by an independent judging organization whose decisions are final on all matters relating to this promotion. Odds of winning depend upon the number of eligible entries received but will not exceed 1 in 130,000. Provisional prize winners will be notified by mail. Provisional prize winners must execute and return an Affidavit of Eligibility/Release of Liability/Publicity/Prize Acceptance Form within 20 days of attempted delivery. Provisional prize winners are subject to age verification. Travel companions must sign and return a liability release and where legal, a publicity release prior to issuance of travel documents. Noncompliance within the 20 day time period or return of any provisional prize notification as undeliverable may result in disqualification and the selection of an alternate provisional prize winner. No substitution, transfer of prizes, or election of cash in lieu of prizes will be permitted except at sole discretion of Sponsor. All federal, state and local income and other taxes on prizes are solely the responsibility of the winners. In the event of prize unavailability, Sponsor reserves the right to substitute a prize of equal or greater value. Acceptance of prize offered constitutes permission to use winner's name, biographical information, and/or likeness for purposes of advertising and promotion without further compensation, unless prohibited by law. All prizes will be awarded and will be fulfilled in November, 1996.
6. PRIZES: The following prizes will be awarded: 500 Prizes of 2 round-trip airplane tickets to Las Vegas, hotel accommodations for November 22nd and 23rd, 1996, \$250 cash, attendance to Camel party, valued at approximately \$1,350.00 each. Total value of all prize values is approximately \$675,000. Travel must be completed by November 24th, 1996. Restrictions and blackout dates may apply. Accommodations are subject to availability and change without notice. Trip companions must be 21 years of age or older and must sign and return a liability/publicity release prior to travel. Taxes, tips, alcoholic beverages, ground transportation not specified herein and all others expenses not specified herein are solely the responsibility of winners. All airfare will be round-trip coach, unless otherwise specified herein, from airport nearest winner's home location. All hotel lodging is one-room double occupancy unless otherwise specified herein. The difference between any stated value and actual value will not be awarded to winners. In the event of cancellation by winner, the ability to reschedule will be allowed only at Sponsor's discretion.
7. Any game materials including without limitation the offer, rules and announcement of winners, containing production, printing or typographical errors, or obtained outside authorized, legitimate channels are automatically void; and the liability of Sponsor, if any, is limited to the replacement of such materials and recipient agrees to release Sponsor, its parent, the judging organization and their respective officers, directors, employees and agents from any and all losses, claims, or damages that may result.
8. By claiming a prize, winners agree that R.J. Reynolds Tobacco Company, its parent, and the judging organization and their respective officers, directors, employees and agents shall have no liability for any injuries, losses or damages of any kind (including death) resulting from acceptance, possession, participation in or use of any prize.
9. For advance copies of Affidavit of Eligibility/Release of Liability/Publicity/Prize Acceptance Form or the names of prize winners (available after 10/15/96), send a separate, self-addressed stamped envelope to Camel's Big Vegas Groove Blender, Winners List, P.O. Box 5526, Norwood, MN 55583-5526. Indicate "Affidavit" or "Winners List" as applicable on the outside of the envelope.

ALL PROMOTIONAL COSTS PAID BY MANUFACTURER.

© 1996 R.J. REYNOLDS TOBACCO CO. PTD IN USA

**SURGEON GENERAL'S WARNING: Smoking Causes Lung Cancer, Heart Disease, Emphysema, And May Complicate Pregnancy.**

**CAMEL LIGHTS**

11 mg. "tar", 0.8 mg. nicotine av.  
per cigarette by FTC method.



# THE TWELFTH ANNUAL RODRIGUES CARTOON CAPTION CONTEST WINNER

**C**ONGRATULATIONS to Mark L. Bowers, of Woburn, Massachusetts, the winner of this year's Rodrigues Cartoon Caption Contest, whose winning entry is printed under the drawing.

As we did in previous years, in our issue of January 1996 we published a drawing by our regular cartoonist, Charles Rodrigues, and invited readers to submit captions for it. The prize for the one the judges considered

to be the funniest is \$100 and the original drawing. The editors of STEREO REVIEW thank Mr. Bowers and the thousands of other readers from across North America, foreign lands, and ships at sea who submitted captions.

We also thank the previous winners, who served as judges: Thomas Briggie (Wadsworth, Ohio), Michael Binyon (Weaverly, California), Bruce Barstow (Philadel-

phia), Matthew Mirapaul (Evanston, Illinois), Marc Welenteychik (Richmond), Douglas Daughettee (Birmingham), Kelly Mills (Raleigh), Diane Sullivan (Grand Falls, New Brunswick), Ron Haynes (Nashville), and Douglas Alderman (Herndon, Virginia). Young Dr. Brian Hoffman, of New York City, the winner in 1993, could not leave his patients long enough to judge captions this year but will be back in 1997.

Predictably, there were many entries about trunk-mounting, flat frequency response, compact systems, MiniDisc technology, and working for peanuts, but none of them made the final cut. The association of the elephant with the Republican Party brought in many political captions, including some about Democratic donkeys that are unprintable.

As usual, the most frequently mentioned composition was Tchaikovsky's *1812 Overture*. Among musicians on our readers' minds were Paul Simon, Smashing Pumpkins, Madonna, and Luciano Pavarotti. Other famous people mentioned include Julian Hirsch, Oprah Winfrey, O. J. Simpson, Sabu, Newt Gingrich, and Hillary Clinton (go figure!).

An audiophile who has been reading STEREO REVIEW for more than twenty years, Mr. Bowers is the chief of the engineering department of an analytical-instrumentation company. He describes his musical tastes as wide-ranging and says he tends to listen to classical in the morning and rock at night.

If you like one of the runners-up below better than the winning entry, take comfort in the knowledge that you are a typical reader and have something in common with viewers of the Miss America Contest. We expect to announce next year's contest in the January issue. —William Livingstone

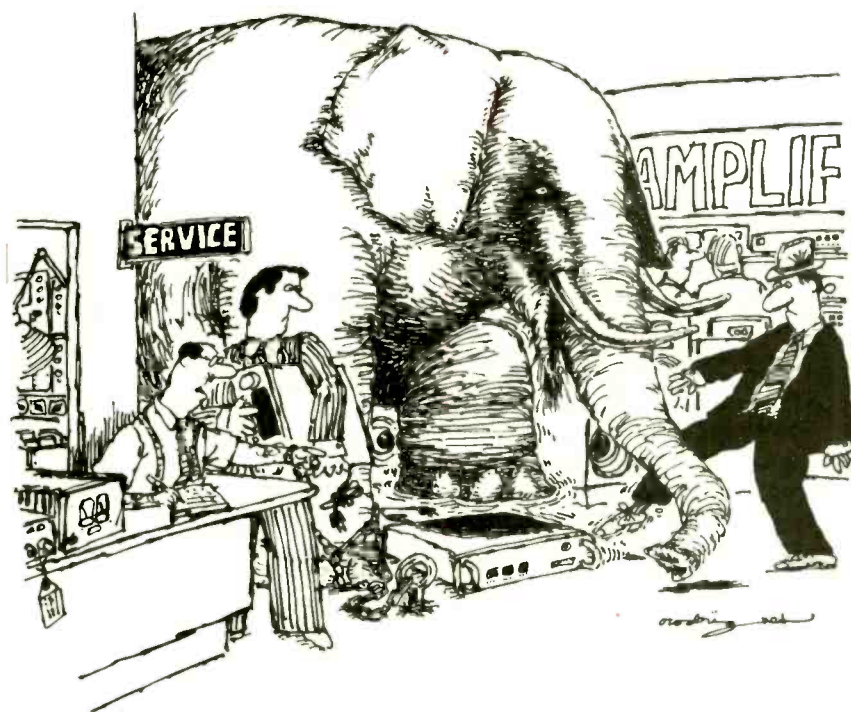

*"I explained to you quite clearly that we are not responsible for equipment left here after thirty days."*

## RUNNERS-UP

*"If the customer wants an ultra-compact high-end shelf system, the customer gets an ultra-compact high-end shelf system!"*  
— MICHAEL McHALE, Shenandoah, PA.

*"Well, what exactly did you think 'Jumbo Mark-Down Sale' meant?"*  
— NEIL GRANT, San Francisco, CA

*"Don't you Republicans think you've taken this Japan bashing a bit too far?"*  
— EDWARD LEIBS, Quincy, MA

*"Easy, Timba! Let's hear his story first."*  
— GERALD MOODY, Nashville, TN

*"That's just our packaging department. The real animals are in sales."*  
— MARC POCHÉ, San Jose, CA

*"Most amps start clipping just at the sight of Tiny. Yours checks out fine, sir."*  
— GLEN-ERIC NELSON, Vernon Hills, IL

*"Everyone's a do-it-yourselfer! Tell that wise-guy in the hat to butt out while Qualified Service Personnel disassemble his equipment!"*  
— BILL LASHER, Scotch Plains, NJ

*"That's why you should never buy the demo."* — ROBERT FROMMELT, Roselle, IL

*"I wish he'd get his own elephant and do this at home."*  
— BRUCE NELSON, San Mateo, CA

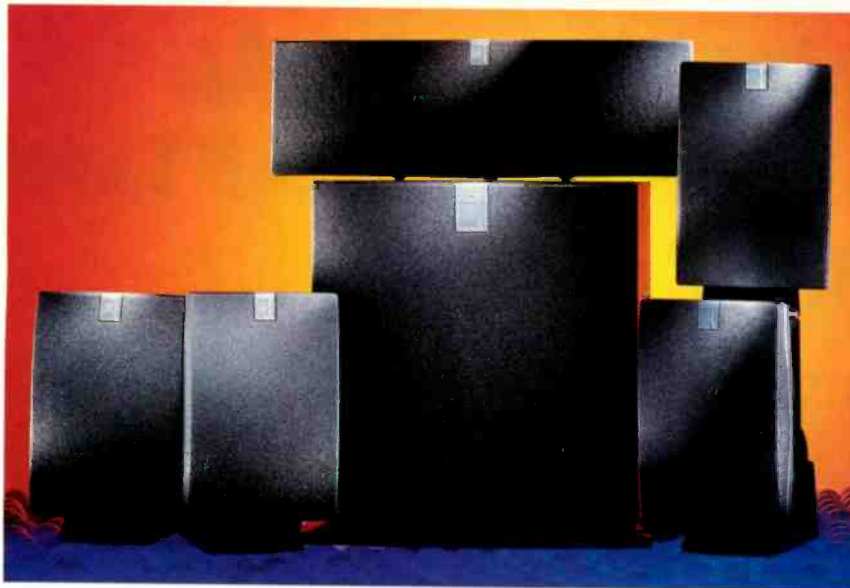

ROBERTO BROSIAN

## KEF 60S/80C/30B Home Theater Speaker System

DAVID RANADA • TECHNICAL EDITOR

**H**ome theater's popularity is finally prompting the major speaker manufacturers to give some thought to budget-price A/V speaker systems. KEF's entry is the 60S/80C/30B system, which lists for \$1,540. As is usual with most high-quality home-theater speaker systems, the speakers that make up this one are available separately, hence the somewhat awkward product designation.

No special surround speakers are provided with the system. Instead, two pairs of identical satellite speakers are used as surrounds as well as the front left/right mains. Each of these Model 60S satellites (\$320 a pair) contains a magnetically shielded version of KEF's proprietary Uni-Q combination woofer/tweeter mounted in a ported, molded-plastic enclosure. The woofer in the 60S is specified as a 5¼-inch coated-paper cone. Mounted coaxially (where the woofer's dustcap would normally go) is a ¾-inch fluid-cooled polymer-dome tweeter. KEF says that the profile of the woofer cone modifies the directivity factor (or "Q") of the tweeter so that both drivers have the same directivity in the crossover region. Nominal impedance of the 60S is 4 ohms; sensitivity is given as 89 dB

sound-pressure level (SPL) at 1 meter with a 2.8-volt input (equivalent to 2 watts into 4 ohms). Connections are via multiway binding posts spaced to accept dual banana plugs.

The 60S enclosure is mounted via a swiveling ball joint on a nonremovable metal base that lets the speaker tilt up or down (+30 or -5 degrees) and to rotate left or right (up to 45 degrees). This flexibility comes in handy if you mount the speaker on a wall or the ceiling (screw-mount holes in the base and a mounting template are provided for ceiling installation). The removable grille can be flipped over to orient the KEF logo correctly if you mount the speaker upside down. Speaker weight is 4 pounds.

Another Uni-Q dual-driver unit, apparently identical to that in the Model 60S, is used in the Model 80C center speaker (\$200). The 80C's ported, molded-plastic enclosure is horizontally oriented and considerably larger than the 60S's, measuring 6 x 17¾ x 6½ inches, weighing 4½ pounds, and having twice the internal volume (5 liters vs. 2.5 liters). Sensitivity and impedance ratings for the two models are identical, however. Intended for set-top placement approximately flush with the screen, the 80C has an ad-

justable rear foot that allows it to be used atop televisions with curved upper surfaces. When fully extended, the rear foot ends up about 1½ inches below the speaker's front feet. Connections are again via multiway binding posts, but the 80C's are too widely spaced to accept dual banana plugs.

The size of both the Uni-Q drivers and their enclosures precludes extended bass response from the 60S or the 80C. Indeed, KEF specifies the -3-dB points for these speakers as 100 and 80 Hz, respectively. Deep bass for the entire system is handled instead by the Model 30B powered subwoofer (\$700). It contains a single 12-inch paper-cone driver operating in a sealed (acoustic-suspension) enclosure measuring 14½ x 14¼ x 15½ inches and weighing 30 pounds. The internal amplifier, rated at 100 watts, is capable of driving the subwoofer to a specified maximum peak output on normal program material of 110 dB SPL.

The bass module's crossover has both speaker-level (spring-clip) and line-level (RCA-type) inputs and outputs. The line-level inputs have a full-output sensitivity of 250 millivolts, and the line-level outputs are high-pass-filtered starting at 150 Hz, with a 12-dB-per-octave rolloff below that frequency. This relatively high filter point is ideal for the 60S and 80C speakers as it will keep excessive levels of deep bass from overdriving them. On the other hand, the woofer's low-pass crossover point is continuously variable between 80 and 150 Hz, also with a rolloff of 12 dB per octave. This wide adjustment range makes the 30B suitable for use with satellites other than the KEF 60S.

Three slide switches are on the subwoofer's rear panel, located somewhat inconveniently beneath the line-level connections. The power switch has three positions (off/auto/on). The central (auto) position places the subwoofer in standby mode; it will automatically turn on within 3 seconds after an audio signal is sensed at any of the inputs and off after 3 to 5 minutes of silence. The second slide switch activates a standard phase-inversion function.

The last slide switch changes the subwoofer between Cinema and Music operation. It's not clear what this switch actually does. Two different frequency-response specifications are given in the manual, 40 to 150 Hz ±2 dB for Music, 50 to 80 Hz ±2 dB for Cinema, but all it says in explanation

is that "the position of this switch is dependent on musical taste, subwoofer placement, and room size." KEF recommends that you "adjust it to suit your own personal preference," a suggestion as vague as the few other speaker-balancing instructions in the manual. My personal preference was to leave it in the Music position, which seemed to suit both music and soundtracks just fine.

For our listening tests, I placed all three front satellites away from the walls on stands that put the Uni-Q drivers at seated-ear height. KEF's subwoofer manual states that the 30B is "designed to operate in free space away from side and rear walls," implying that good performance cannot be obtained with close-to-wall or corner placement. Don't believe it. I found it just as easy to get a maximally flat transition to the front satellite speakers with the 30B placed in our standard front-corner location as with other subwoofer modules. Corner placement has other advantages, including minimal physical obtrusiveness, improved sensitivity (which translates to greater potential bass dynamic range or lower distortion at the same in-room sound level), and extended response at the bottom of the range. As it is, KEF's specified 40-Hz low-frequency cutoff point in Music mode is both realistic and rather high; the 30B benefits from the reinforcement that corner placement can provide.

There was interaction between the subwoofer's volume and crossover-frequency controls, which complicated setting up with our microphone and spectrum analyzer. Specifically, the crossover-frequency knob raises the subwoofer output level as it raises the crossover frequency. Those who do subwoofer balancing by ear alone, which makes it virtually impossible to obtain the most accurate overall response, can remain blissfully ignorant of such interactions.

For most of our listening we used the high-pass-loopback line-level connections provided by the subwoofer. After adjustment for maximum flatness, the combined frequency response of the left/right front satellites and the subwoofer came out as 40 Hz to 16 kHz  $\pm 5.5$  dB. The speakers did not, however, sound as colored as that large deviation would imply. There are at least two reasons for this: First, for most of that range the response measured about as flat as we have ever found in our listening room,  $\pm 2.5$  dB

from 40 Hz to 2 kHz. And, second, above 2 kHz the response rolled off slowly and rather smoothly. In particular, there was virtually no trace of the upper-midrange dip and treble peak combination that we often find with lower-price speakers. There was also nary a trace of such a swayback response in our off-axis measurements, where the treble just rolled off more and more rapidly above 2 kHz as we moved from on-axis to far-off-axis measurements.

Surprisingly, mainly because the 80C center speaker appears to use the same drivers as the 60S satellites, the 80C had a noticeably different sound quality — and measured frequency response. Its on-axis response *did* have a  $-8$ -dB dip (relative to 1 kHz) at around 5 kHz, followed by a rise to  $-2$

**When played at levels just short of live music, the KEF system sounded appealingly neutral.**

dB at 10 kHz. This coloration prevented a left/center/right pan of pink noise from remaining unaltered in timbre as the sound passed through the center position.

It also prevented extraordinary performance on our critical front-channel surround-sound imaging tests. So while surround imaging was only average to good, *stereo* imaging, in which the center speaker plays no part, was distinctly tighter than we usually find. I attribute this to the coaxial mounting of the Uni-Q woofer and tweeter, which eliminates the disparity in sound-source heights between what would usually be vertically separated drivers.

With the 60S used as a surround speaker, its unusually good imaging ability actually proved detrimental to producing the desired envelopment effect. But the swivel-mount base comes in handy here by enabling you to aim the speakers away from the main listening position. I got very nice surround results with the 60S surrounds placed directly to the sides of the main listening position but aimed toward the back of the room.

Even with corner placement, the in-room subwoofer response rolled off below 40 Hz and virtually disappeared

altogether below 32 Hz. The high (150-Hz) crossover frequency to the satellites was further responsible for a smidgen of imaging at the subwoofer's position with some program material (for completely unlocalizable bass, the subwoofer-to-satellite crossover frequency should be below 100 Hz, preferably around 80 Hz). The 30B's distortion was, however, rather low, even at high volume levels, and the 32-Hz cutoff isn't really that important for bass reproduction except in pipe-organ music.

If you can possibly manage it, do use the line-level high-pass-loopback facilities provided with the subwoofer. While this is possible only with amplifiers or receivers that have pre-out/main-in terminals or certain types of external-processor connections, using these outputs to drive the front left/right speakers is the only easy way to prevent excessive levels of deep bass from reaching them. This connection scheme is shown in the 30S manual. Without the loopback, which happens if you use the speaker-level subwoofer connections (also illustrated in the manual), the system will begin to sound strained at lifelike volume levels as the 60S's start overloading. There are a few things to keep in mind if you use the loopback hookup in a surround system: 1) Set the center-speaker mode of your surround decoder to Normal. 2) Make sure any bass-directing circuitry — as in a Dolby Digital AC-3 setup — shunts all the bass through the main left/right outputs, with no output to the subwoofer jack. And 3) do not hook up the the amplifier/receiver's subwoofer output. KEF's manuals make no mention of these critical points.

**F**or the price, KEF has produced a very fine speaker system. When played at levels up to just short of live, which is plenty loud for most domestic situations, the sound was appealingly neutral and well balanced, with very good stereo imaging. The main speakers are also very appealing in terms of size and styling, while the entire system is seductively priced. For the beginner, or even for the advanced listener with price or space restrictions, the KEF 60S/80C/30B system can be highly recommended.

KEF, Dept. SR, 89 Doug Brown Way, Holliston, MA 01746; telephone, 508-429-3600.

# MEGACHANGERS

## FIVE 100-CD CHANGERS AND HOW THEY PLAY

by Daniel Kumin

REMEMBER THE RECORD CHANGER? Thirty years ago, *everybody* had one, and music lovers used them constantly. Nowadays multidisc CD changers fill much the same niche and enjoy similar ubiquity. But where the black-platter-swappers of yore typically maxed out at five or six LP's per load, CD changers have continued to swell in capacity since the first ones hit store shelves more than a decade ago, passing through 6-, 10-, 12-, 18-, 24-, and 50-disc variations. Today, a changer has to swallow at least 50 CD's to be considered "high-capacity," and 100-disc players are no longer restricted to commercial applications or conspicuous consumers.

To prove the point we rounded up five megachangers for a hands-on look at how they work. Presented here in no particular order, they offer different solutions to the problems of storing, cataloging, accessing, and playing 100 or more CD's, and each has settled into a different notch on the cost-benefit scale.

### Technics SL-MC400

**T**he Technics SL-MC400 is the density champ and price leader (\$300) of the five. It packs 110 discs, not "merely" 100, into a component that's about the size of a typical A/V receiver. The front panel flips down to reveal the disc-storage mechanism, which means the player can be placed in a component rack or stack of gear.



### COMPARISON TESTS

JVC  
XL-MC302

KENWOOD  
DP-J2070

PIONEER  
PD-F1004

SONY  
CDP-CX153

TECHNICS  
SL-MC400

The down side of the SL-MC400's compact capacity is that disc-loading is a bit finicky because its vertical slots are spaced barely  $\frac{1}{8}$  inch apart. Technics's rather clever solution is a manual-loading "sled" that slides along the rack, with a notch that reveals the selected slot number. You tip a CD into the sled and flip the whole business up to dump the disc into the rack; an ancillary lever is used to catapult a loaded disc out of its slot and back into the sled. Though the SL-MC400 is still not the easiest changer to load, its Rube Goldbergesque mechanism is much better than trying to load discs directly into those tiny slots. There's no interior light, though, so a well-lit component area is essential to read the slot numbers.

The SL-MC400 also features a "zero" slot for single-disc play. Since this slot does not participate in full-load programming functions, you can load it separately. Even better, you can swap up to 108 of the remaining 109 discs while one is playing. The changer's front-panel controls are mostly straightforward, and its display is quite legible. It shows elapsed time in the current track (and total time on the disc in stop mode) but not remaining disc or track time. Programmed

PHOTO BY JOCK P. LEUNG



## TECHNICS SL-MC400 110 DISCS



**DIMENSIONS:** 17 x 6 $\frac{1}{4}$  x 1 $\frac{1}{4}$  inches. **WEIGHT:** 15 $\frac{1}{2}$  pounds. **PRICE:** \$300. **MANUFACTURER:** Technics, Dept. SR, One Panasonic Way, Secaucus, NJ 07094; phone, 201-348-9090.

selections and grouping data are also confirmed in the display window.

Speaking of grouping, the SL-MC400 lets you catalog discs in five groups. The groups are initially labeled simply A through E, but they can also be assigned display names from a fixed palette of fourteen names such as Blues, Dance, New Age, and Classic. (What? No "Polka"?) Each group can comprise up to 110 discs, and a disc can be assigned to more than one group. Unlike the other changers evaluated here, the Technics makes no provision for user-assigned titles for either discs or groups. Setting up groups requires only a couple of keystrokes once the desired discs are selected. You can confirm a group's contents — by disc number — but only when the player is stopped.

The SL-MC400 permits one thirty-two-step playback sequence of entire discs or individual tracks to be programmed with the front-panel keys or the remote control (a step can be a whole disc or a track from any disc). A nice touch is that you can assemble the sequence gradually by adding any currently playing track (the program is retained in memory even when the power is off). There are two shuffle-play modes: One mixes up the tracks of a single disc, with no repeats, and the other reshuffles the changer's entire deck (all tracks from all discs) at the end of each track it plays — that means some tracks will be repeated before all the others have been played.

The back panel of the SL-MC400 has only a power cord and a pair of analog audio outputs. Construction is reasonably solid, though with an obvious eye to cost savings. Technics supplies a plastic CD-booklet binder complete with slot-number stickers. There

are only twenty-eight dual-folder pages, however, so you have to insert booklets back to back — a pain, and kinda chintzy.

Sonically, I had no beef with the SL-MC400. Its performance was on par with that of a good midprice single-disc player. Mechanically, it kicks up a racket when changing discs, but the noise is no worse than with most six- and ten-disc magazine changers. Despite the noise, it was quite agile when handling discs. When you power it up the pickup sled immediately scans up and down the rack, memorizing which slots are empty (this takes only 7 seconds). Consequently, if you hit the disc-skip button and there's an empty slot or two (or ninety-nine, for that matter), the sled proceeds without pausing. As a result, the SL-MC400's longest disc-to-disc change time was only 11 seconds. Changes between adjacent slots took 9 seconds, making this the fastest changer in the test group.

In ergonomic terms, the SL-MC400 is good but not great. For one thing, about a third of its front panel is wasted on two disc windows — nicely backlit when the panel is up but functionally useless. The space would have been better used for bigger displays and buttons and more room between keys. The controls are accessible and clearly labeled for the most part, but you'll probably need the manual to master most operations beyond simply playing a whole disc. The supplied remote control is compact and reasonably legible, though a bit crowded and with too many keys the same size.

**The Bottom Line:** While the Technics SL-MC400's feature set is basic, its disc-change speed and intelligence are well above average. If you're on a

budget and need big storage in little space, it will do the trick.

## Pioneer PD-F1004

The 100-disc PD-F1004 (\$765) from Pioneer is another horizontal-rack, front-loading CD changer. It's a bit tall at 7 $\frac{1}{2}$  inches, but it's conventionally sized and shaped otherwise. The elegant front panel has only a dozen pushbuttons. Attractively grouped and shaped, they handle all functions except programming. The amber display is equally simple and good-looking, but the tiny gold-on-black panel lettering is dead to read even under normal room lighting.

Loading discs into the PD-F1004 is accomplished by opening the entire front panel, revealing four 25-CD racks, each of which can be released and swung down at the press of a button. This modular design improves access to the disc slots, though inserting or removing discs is still tricky because the slots are tightly spaced. You do get the hang of it, but extracting a single disc from a full rack takes some fiddling: You have to pinch the edge of the disc between your fingernails and draw it out — hard for the ham-fisted.

On the plus side, dividing the storage area in four makes it easier to identify slot numbers and organize discs than with a full 100-disc mechanism. (Oddly, though, you can't program the PD-F1004 for playback one rack at a time.) There's no interior lighting, but the gold-on-gray lettering rates slightly above average in readability. A lighted telltale above each rack indicates the one in play by flashing slowly; any of the discs in the remaining three racks can be replaced. When you open the changer's front panel, the display switches to show the number of the rack in use.

Single-disc play is not an integral feature of the PD-F1004. You have to keep one slot open or swap a disc, which makes the process distinctly more laborious than with some of the other changers in this group.

The PD-F1004 has a fairly well-equipped rear panel. Joining the requisite analog outputs are a Toslink optical digital output, three jacks marked Control In, Control Out, and CD-Deck Synchro, for fully automated CD dubbing with a compatible Pioneer tape deck. The Control In and Out jacks are for daisy-chaining Pioneer's SR components (most models) so that they can all be operated by one remote. An

eight-pin Control-I/O port is for connecting the PD-F1004 to the optional PD-API CD controller (\$260), which allows you to link up to three PD-F1004's together. Finally, a video output delivers on-screen menus.

The remote that comes with the PD-F1004 is unusual: Four crescent-shaped cursor (arrow) keys surround a large Enter button, and there are eight small keys for play, stop, pause, disc and track-skip (one pair each), and power. A flip-up door reveals numeric keys for disc/track access and buttons for fast search and programming. The cursor keys navigate the TV screen displays, which (remarkably) are *required* if you want to use the changer's custom-filing and disc-naming features. Owners of audio-only systems are out of luck.

Pioneer's screen displays are a mixed blessing. Yes, you get titles of discs and custom groupings and an intuitive graphic disc-searching routine. But entering titles into the system is a laborious task. You have to call up the display, use the remote's cursor keys to get to an Input icon, select it, and then go back up to a pair of up/down arrows to select the slot number you wish to title. *Then* you must move the cursor around an alphabetic grid and select each letter using the Enter key. If you accidentally hit any of several other icons before you're done — all too easy to do — you have to start over. On the plus side, Pioneer permits twenty-character titles, which is well above average.

If you manage to stay on the job, you'll be able to search for discs by keying in the initial letters of their titles. Enter "B," for example, and the search screen, which shows only one title at a time, might show "Bach-CPE." If you're actually looking for "Berlioz" you might have to scroll through Bach-JS, Beaser, Beethoven, Bellini, Berg, and who knows what else before you get to it.

The PD-F1004's custom-filing system lets you organize discs into three user-defined groups of up to 100 CD's. Programming and disc-access operations performed while a custom group is selected are applied only to discs in that group. The procedure for creating a group is fairly straightforward, although it requires a mix of remote-control and on-screen commands.

In everyday life, the best disc reference would probably still be the standard-issue CD-booklet binder Pioneer provides, which is identical to the one

with the Technics changer. You'd think a \$765 changer would come with a classier notebook.

The PD-F1004's maximum disc-seeking time was about 15 seconds, while the change time between adjacent CD's was typically about 9 seconds. That's not too bad, but the changer doesn't "know" whether a disc slot is empty or full. To take an extreme example, if you loaded discs in the first and last slots only, played Disc 1, and then pressed Disc+, it would take the changer about 15 *minutes* to find and begin playing Disc 100. That's lame: Every megachanger should have enough disc-seeking intelligence to skip over empty slots.

Once loaded, programmed, and set up, however, the PD-F1004 worked very smoothly, and it was noticeably quieter than most of the others I evaluated. The on-screen graphical interface, despite its limitations, does provide a centralized control for A/V systems, and the player delivered first-rate sonics.

**The Bottom Line:** If you seek an elegant-looking changer for an audio/video system and intend to load it up and not swap discs very often, the Pioneer PD-F1004 should do nicely.

### Kenwood DP-J2070

**W**ith its 100-disc load, drop-down faceplate, and standard-size footprint, the Kenwood DP-J2070 (\$650) looks quite conventional. For the most part, it is — but Kenwood threw in a handful of innovations to make it stand out from the crowd.

The DP-J2070's front panel folds down to reveal the mechanism within. Unlike the other changers in this group, its entire face does not drop

down: A small panel at the right with the disc-skip, play/pause, and stop keys stays put. It also has the smallest disc window of the lot. A sliding indicator at the top of the panel shows relative disc position, while the display shows the actual disc number.

Inside, Kenwood divides the discs into two 50-CD racks with bright white numbering that scores well for legibility. When you hit a rack's release button it slides almost all the way out, making it fairly easy to load discs. The 1/8-inch disc spacing makes removal a challenge, though. The dual-rack system lets you swap discs from one rack while the other is in play, but there is no single-play provision. To play a stray disc, you have to keep a slot open or remove a disc. Kenwood's CD-booklet binder is a little nicer than the ones Technics and Pioneer provide.

The DP-J2070's front panel sports only basic transport controls and the power button — everything else is on the remote. The oversized dot-matrix display is legible and accommodates rather densely packed icons for various modes of operation. Much of the window is occupied by a twelve-character matrix for displaying disc names (there's no on-screen display for A/V systems).

Around back, the DP-J2070 has two sets of control jacks and a pair of analog audio outputs. The System Control jacks are for interconnecting an all-Kenwood system. The two Relay Control jacks (and a pair of audio mixing inputs) are for daisy-chaining up to three 2070-series 100-disc changers. The DP-J2070 even has a random-relay mode that shuffles tracks across two or three changers.

The remote control is workable but



**DIMENSIONS:** 16½ x 7½ x 15½ inches. **WEIGHT:** 24 pounds. **PRICE:** \$765. **MANUFACTURER:** Pioneer, Dept. SR, P.O. Box 1540, Long Beach, CA 90801, phone, 1-800-746-6337.

## KENWOOD DP-J2070 100 DISCS



**DIMENSIONS:** 17¼ x 7¼ x 16¼ inches. **WEIGHT:** 24 pounds. **PRICE:** \$650. **MANUFACTURER:** Kenwood, Dept. SR, P.O. Box 22745, Long Beach, CA 90801-5745; phone, 1-800-453-6966.

no paragon. Its forty-two small, black keys and its white-on-gray graphics are rough on the eyes. Though some keys are round and some oval, the shapes are too similar to distinguish reliably by feel. Worse, the main transport keys (play, stop, pause, skip) are smack in the middle of everything.

Nevertheless, the Kenwood DP-J2070 delivers a lot of functionality. You can program a thirty-two-track set from among all of the discs by following a simple remote-control procedure. The Best Selection Memory function provides another thirty-two-track/all-discs program register. You can also randomize track playback either from one CD or from all. But, like the Pioneer and JVC changers in this group, the Kenwood has no clue to how many discs are loaded, so it blindly scans through empty slots until it hits a disc, wasting precious time. Kenwood does throw in an Edit mode that automatically rearranges a single disc's tracks by tape length, a priceless perk for intensive dubbers.

The DP-J2070's disc-filing abilities are considerable. You can title each disc with up to twenty-four characters, but the front panel shows only twelve at a time: You have to press a key on the remote to see the rest. Text entry via the remote control is arduous, requiring multiple key strokes per character, though the routine is simplified by auto-scrolling up/down keys and the choice of upper- or lower-case alphanumeric characters.

But Kenwood had a stroke of genius: a front-panel mini-DIN jack that accepts a standard IBM-compatible computer keyboard, making text entry much, *much* faster. Keyboard entry is not foolproof — the changer failed to

respond to the shift key occasionally, and it didn't always record each character on the first try — but it is a dramatic improvement over the remote-control routine.

Once your discs are loaded and titled, you can search through them by name. You use the remote's search and up/down keys to isolate the title's first letter, then press Enter. Like the Pioneer changer, the Kenwood searches on only one letter, so you must scroll through all entries beginning with that character. Another option is to use the remote to scroll through all entered disc titles in slot-number sequence.

Kenwood also provides ten Music File Type categories, each of which can be assigned up to thirty-two discs. Seven labels are preprogrammed (Pop, Jazz, Classic, Rock, R&B, Country, and Easy), and three can be named by the user. For even more flexibility in programming, a disc can be assigned to multiple categories, and you can restrict the all-disc random-play mode to those in a single category.

Last, but not least, the DP-J2070 incorporates a defeatable "read-ahead" memory that can cut disc-change time by about two-thirds (to 3-4 seconds) during programmed play or multidisc random play — when the changer "knows" in advance a disc-change is coming. The 16-bit RAM permits the mechanism to begin changing discs 10 seconds *before* a track's end mark, giving the pickup a whopping head start. This is an impressive feature. Maximum disc-change time was 14 seconds.

Kenwood packed a lot of features and programming power into this changer for a reasonable price, and it didn't skimp much on the details.

Sound quality was on a par with the other players in the pack, and manufacturing fit and finish, though perhaps not the best of the lot, were fine.

**The Bottom Line:** Kenwood's DP-J2070 changer represents a fine value, and its keyboard-entry facility is a godsend if you want to catalog discs by title. This feature alone could justify the price of admission and go far to compensate for some ho-hum ergonomic qualities.

## Sony CDP-CX153

Sony pioneered the megachanger category several years ago with the introduction of the \$1,200 CDP-CX100. Like its forerunner, the \$600 CDP-CX153 has a jukebox-like vertical carousel, but instead of loading discs from the top, you insert them through a 5 x 7-inch drop-down hatch on the front panel. Thanks to the radial storage mechanism, disc slots are further apart than in straight-line changers, making it far easier to load and unload CD's. The tradeoff for this convenience is a portly player — almost 8 inches tall and more than 18 inches deep, counting knob and cable protrusions — that may not fit some racks or cabinets.

I found the CDP-CX153 to be the best-looking changer in the group. A simple blue dot-matrix display shows disc and time data, while sensibly grouped pushbuttons control virtually all functions from the front panel. Graphics are fairly readable but small (a bit annoying considering there's plenty of room for larger lettering).

Beyond the big disc-loading door and display, the faceplate is dominated by a large jog/shuttle dial with a centralized Enter key. This intuitive control is used to select disc numbers for loading, play, or programming, to scroll through characters for titling, and to run through lists of disc titles.

The CDP-CX153's rear panel is equipped with analog audio outputs, a Toslink optical digital output, and a power cord. There's also a pair of mini-jacks, marked Control-A, that permit up to three Sony megachangers to be daisy-chained, though you'll need the optional CTRL-300 controller (about \$300) to operate them.

I expected the Sony player to be the disc-changing champ since its bidirectional carousel never has to turn more than halfway around to change from any disc to any other. But that was not the case: Change times ranged from about 13 seconds to upwards of 16



seconds (once, in shuffle-play mode), which is below average. (The intervals might be longer than the songs in an all-Ramones set.) Equally irritating, the Sony changer was one of the noisiest, producing a ratcheting sound that was audible across the room.

Everyday use was mostly pleasant, however. Loading discs was easy: The jog wheel directs the carousel to the desired slot, while the display shows the slot number. Three internal lights glow amber to indicate the active slot, making in-the-dark loading a snap. Removing discs was also much easier than with the others. The price for this ease is that you can't exchange any discs while one is playing — hit the Eject key and the music grinds to a halt. On the plus side, the CDP-CX153 is smart. When it's powered up, the first thing it does is spin the carousel and note which slots are empty so that it doesn't waste time scanning them later.

Sony's remote-control layout is sensible and easier to master than some, in large part because it has fewer keys — far fewer than, say, the Kenwood (this is possible because you use the front-panel controls for titling). There are no remaining-time display modes, however. Feature-wise, the changer has all the usual repeat modes (track, disc, all) and random-play modes (one or all discs), and you can even combine repeat and random play for one disc or the full carousel. Thirty-two-step programming (a step being either a track or a disc) is also offered, and, unlike most of the other changers in this group, Sony's generously provides three program memories.

The CDP-CX153's Custom File mode lets you assign thirteen-character titles to each disc. Using the jog dial to enter titles streamlines the process, though not quite as much as Kenwood's keyboard option. Once you've titled all 100 discs, you can create up to eight groups (also nameable with up to thirteen characters) that can be selected individually for continuous or shuffle playback. Unlike most of the other megachangers in this group, the Sony lets you put each disc in only one group. In other words, your "Peaches & Herb" CD could belong to "70's Disco" or "Goopy Duos," but not both — kind of a drag.

This changer has the Delete Bank function found on some of Sony's other CD players, which I call the *Revolution #9* feature. For each disc you can specify a track or tracks to be

skipped every time it cues up, regardless of play mode (deletions can be temporarily overridden before play commences). Oddly, tracks above No. 32 cannot be deleted.

The Custom File system saves titles and custom data (deletions, group affiliation, etc.) for up to 200 discs in a memory bank that's linked to an individual CD's unique TOC-ID data, so even if you move a disc to another slot or swap discs, the CDP-CX153 will remember its title, group association, and deletion data — very cool indeed. The CD-booklet binder Sony provides is marginally better than average, but still pretty cheap.

**The Bottom Line:** If you want a full panoply of programming/library functions and can handle its linebacker-like size, uninspiring speed, and anvil-chorus digestive tract, the Sony CDP-CX153 is the one to get.

### JVC XL-MC302

Let's start with the important stuff: The CD-booklet binder that comes with JVC's \$870 XL-MC302 megachanger wins hands down, with by far the nicest cover and the best numbering stickers. (It still requires back-to-back inserts, though.) JVC's changer also takes the size competition handily. A two-piece affair, it includes a hideaway 100-disc storage module that's about 14 inches square and a controller/display component that doubles as a single-disc player. The idea is to combine the convenience and speed of a single-disc player with high-capacity storage. Neat.

Besides its single-disc tray, the XL-MC302C controller's front panel has a blue display with a twenty-track music calendar and all the usual CD transport and programming buttons. Aside from a pair of keys marked Disc Skip (+ and -) and a couple of others, you'd never suspect the true nature of this component. There are other clues around back. In addition to a pair of analog audio outputs, there are RCA jacks marked Control Line 1, Control Line 2, and Signal In. These color-coded jacks connect to corresponding ports on the XL-MC302M 100-disc module with a supplied triple-RCA cable. The controller's rear panel also has a power cord and a pair of Compu-Link-3 mini-jacks for use in an all-JVC system.

JVC's provisions for expanding capacity are clever. You can add one or two XL-MCMI 100-disc slave modules (\$550 each) to double or triple disc capacity. And since all programming and data-entry modes can handle up to 300 entries, the combo system behaves like a single 300-disc changer.

The XL-MC302M 100-disc module has no controls, only an open button for its large door. Electronic interlocks prevent opening it while it's playing, and a "secret" code (999) can be invoked for kid-proofing. Inside, two 50-disc columns flank a central pickup elevator. Discs are loaded onto thin, removable trays, spaced about six to the inch. Loading and (especially) unloading discs was decidedly easier, although slower, than in lateral-style changers. The downside is a bulky transport/storage mechanism and the



**DIMENSIONS:** 17 x 7 $\frac{1}{4}$  x 18 $\frac{1}{2}$  inches. **WEIGHT:** 20 pounds. **PRICE:** \$600. **MANUFACTURER:** Sony, Dept. SR, 1 Sony Dr., Park Ridge, NJ 07656; phone. 1-800-222-7669.

# MEASUREMENTS

	JVC XL-MC302	KENWOOD DP-J2070	PIONEER PD-F1004	SONY CDP-CX153	TECHNICS SL-MC400
<b>MAXIMUM OUTPUT</b>	2.02 volts	2.22 volts	2.10 volts	1.97 volts	2.05 volts
<b>FREQUENCY RESPONSE</b> (20 Hz to 20 kHz, de-emphasis off/on)	+0, -0.16 dB/ +0.07, -0.21 dB	+0.12, -0.97 dB/ +0.13, -1.0 dB	+0, -0.65 dB/ +0, -0.69 dB	+0.03, -0.03 dB/ +0.04, -0.03 dB	+0, -0.29 dB/ +0.36, -0.47 dB
<b>CHANNEL SEPARATION</b> (at 20 kHz)	89.1 dB	80.2 dB	89.6 dB	79.8 dB	72.8 dB
<b>NOISE LEVEL</b> (A-weighted, de-emphasis off/on)	-95.7/-99.3 dB	-93.9/-95.4 dB	-93.4/-94.8 dB	-94.2/-96.1 dB	-93.6/-92.7 dB
<b>DISTORTION</b> (at 0/-20 dBFS*)	0.0018/0.017%	0.0063/0.032%	0.0054/0.029%	0.0038/0.024%	0.0044/0.040%
<b>LINEARITY</b> (at -90 dBFS*)	-0.05 dB	-0.38 dB	-0.3 dB	-0.05 dB	-12.23 dB
<b>EXCESS NOISE</b> (with/without signal) 16 bits (EN16) 20 bits (EN20)	+0.14/+0.24 dB +6.8/+6.5 dB	+0.9/+0.9 dB +14.9/+15.3 dB	+3.0/+2.9 dB +19.7/+19.7 dB	+1.7/+1.7 dB +16.5 dB/+17.5 dB	+2.7/+2.4 dB +17.5/+17.7 dB
<b>PITCH ERROR</b> (in cents**)	0	+2.9	0	0	+1
<b>DEFECT TRACKING</b> (Pierre Verany test disc)	4 millimeters (single-play transport)	1.25 millimeters	2 millimeters	1.5 millimeters	2.5 millimeters
<b>CUEING TIME</b> Disc 1 to Disc 2 Disc 1 to most distant disc	13.5 seconds 18 seconds	3.5/9.4 seconds*** 14 seconds	8.7 seconds 15.5 seconds	12.8 seconds 16.6 seconds	9 seconds 11 seconds

\* decibels referred to digital full-scale    \*\* one-hundredths of a musical semitone    \*\*\*with/without "read-ahead" memory

## OUR EVOLVING TEST PROCEDURES

The revision of our CD-player test procedures that began with July's review of portable players continues. As in that article, we are publishing Excess Noise figures for 16- and quasi-20-bit performance of these five CD changers, but this time we have added measurements made with a signal applied in order to get some gauge of player distortion at lower signal levels. (Technically — very technically — that signal is a 251-Hz sine wave recorded at -60 dBFS with triangular probability-density-function dither in the EN16 test and noise-shaped dither in the EN20 test.) The EN measurement technique actually rejects this signal and looks instead for the amount of noise, plus any added distortion, that ends up in the EN measurement band.

Use the EN numbers as before: Look for the player with the lowest EN values in both the EN16 and EN20 tests as well as good linearity (less than 1 dB of error). Look first at the EN values with a signal. If there's a tie, only then look for the player with the lower values *without* a signal.

All of our other CD measurements have

also changed, principally by the use of inherently distortion-free "dithered" test tones. Most test discs in common use heretofore do not have such tones, and previous test procedures had been designed to work around or even to ignore that fact. The use of dithered test signals establishes theoretical limits for certain tests, such as distortion and noise level. You will no longer see in these pages measurement results that misleadingly surpass the inherent limits of the CD system.

We are dropping tests for dynamic range and quantization noise. The former parameter is better served by the EN measurements, with lower EN figures indicating a wider dynamic range. The rationale for the quantization-noise test disappears with the use of dithered test signals. Besides, our distortion, noise-level, and EN tests combined tell you all you need to know in this regard. We have added a pitch-error test, with results measured in cents. One cent is 1/100 of a musical semitone, a very small pitch change. In critical play-along-with-a-CD situations, you'll start to notice pitch discrepancies when the pitch error

is greater than around  $\pm 3$  cents. Our results are rounded to the nearest tenth of a cent.

There's a clear winner in this round of lab tests. The JVC XL-MC302 provided surprisingly superior performance in nearly every parameter. In particular, its EN figures were the best we have yet measured. JVC's proprietary PEM-DD digital-to-analog (D/A) converters are probably responsible, and they can be found in other JVC players as well.

There's also a lab-test loser: The linearity error at -90 dBFS of the Technics SL-MC400 was the worst we have measured in several years. Unlike the other players' errors, the SL-MC400's was clearly audible at normal volumes using a suitable test-tone signal. With any of the other players, the sine wave was very soft but still audible in a very quiet listening room — it disappeared with the SL-MC400. This is the third recent Technics/Panasonic CD player we have tested that has had significant linearity problems. Since earlier Technics players with MASH D/A converters performed well, we're puzzled.

—David Ranada

need to handle disc trays that could be lost or damaged.

The XL-MC302's remote control is also unconventional. Only basic transport and mode keys are exposed on the large handset; additional buttons, including a numeric keypad, are hidden behind a door. An LCD window shows most commands and figures promi-

nently in disc-titling. In fact, it shows most commands before they're actually sent to the controller, which takes some getting used to. For example, using the remote to play a disc is a three-step process: First you specify the disc using the numeric or +/- keys, then hit Transfer to send the command to the controller, and finally hit play to com-

mence operation. While this cuts down on accidental errors, it's cumbersome — and exacerbated by a hard-to-read LCD panel (it's not back-lit) — although basic commands like disc-skip, play, pause, and stop are sent to the controller without delay.

Unfortunately, no extra points can be awarded to the JVC changer for

disc-search smarts. Like the Kenwood and Pioneer models, it has no clue to which slots are empty, so issuing a next-disc (or "random-all") command with less than 100 discs on board risks long periods of blind searching. Otherwise, disc-to-disc speed was below average, ranging from 13.5 to 18 seconds. The JVC's mechanical noise was about on par with a typical magazine changer's.

The usual playback modes are available, including one-disc, continuous (from any point through Disc 100), repeat disc/program/track, and shuffle play by disc, load, or User File. You can also create one thirty-two-step sequence (tracks or discs) and store it in memory for instant recall.

The XL-MC302 provides ten User Files, each of which holds up to thirty-two discs. A disc can reside in multiple files, and file groupings can be addressed for all play modes, including random and repeat. JVC allows eight-character titles for each disc and each User File. Titles must be entered from the remote, using a rather serpentine procedure that requires multiple presses of nine alphabetic keys: The first key enters A, B, or C; the second key D, E, or F; and so on. It could take as many as twenty-nine key presses (by my count) to enter eight characters — pretty labor intensive!

Using the remote, you can search for discs by scrolling through all titles or only those in a particular User File. Unlike the other title-searching changers in our test group, the XL-MC302 lets you search by as many letters as you care to enter, which is helpful in separating the Mozarts from the Mötley Crües. It also has a delete mode that lets you specify tracks to be



**DIMENSIONS:** controller, 17½ x 4 x 11 inches; storage unit, 14½ x 14½ x 14½ inches. **WEIGHT:** controller, 7¾ pounds; storage unit, 30 pounds. **PRICE:** \$870. **MANUFACTURER:** JVC, Dept. SR, 41 Slater Dr., Elmwood Park, NJ 07407; phone, 1-800-252-5722.

skipped whenever a disc is played, even when the changer is in random-play or User File mode, but unlike the Sony changer, the JVC ties the delete memory to the slot, not the disc itself.

Last, but not least, this megachanger system sounded very fine indeed. The controller employs JVC's unusual 1-bit digital-to-analog (D/A) conversion system, which delivers outstanding sonic refinement and depth.

**The Bottom Line:** The JVC XL-MC302 has a lot to offer, with programming flexibility, hideaway storage for 100 CD's, the convenience of a single-disc player, and topnotch performance. At the same time, it's a bit challenging to operate. If its benefits are enough to outweigh its slightly clumsy user interface, you may find it a satisfying choice.

**THERE'S NO DENYING IT:** Today's megachangers deliver a ton of quality and features for your hard-earned money, which is just as it should be. The trick is to decide which of these changers provides the feature/performance/price combination that best serves your individual needs. □

## A SUBCODE IS A TERRIBLE THING TO WASTE

As demonstrated by these tests, the Achilles' heel of most megachangers is having to enter CD titles manually into the system. To be human is to err, and using a remote control to key in all those letters one by one is a huge drag — so huge that I suspect most folks never actually do it. Why isn't relevant information (album and song titles, etc.) "burned" into the CD's voluminous subcode data area? CD changers (and single-disc players, for that matter) would be able to display titles automatically and perform searches without extra work on the part of the hapless owner.

There's no technical reason why such

details could not be included in a CD's subcode. (In fact, the MiniDisc format already does so.) The answer, shrouded in the mists of history, is political: The constituents of the original CD-standards convocation could not agree on precisely how, or why, to deploy the subcode data. Consequently, no single standard was adopted, giving rise to such odd formats as CD+Graphics, CD+MIDI (!), and CD-Video, none of which ever caught on.

The moral: A single standard is where it's at. With the audio-only version of the forthcoming DVD format still to be finalized, let's hope the powers that be don't screw it up again! —D.K.

by Rebecca Day

# Real Home

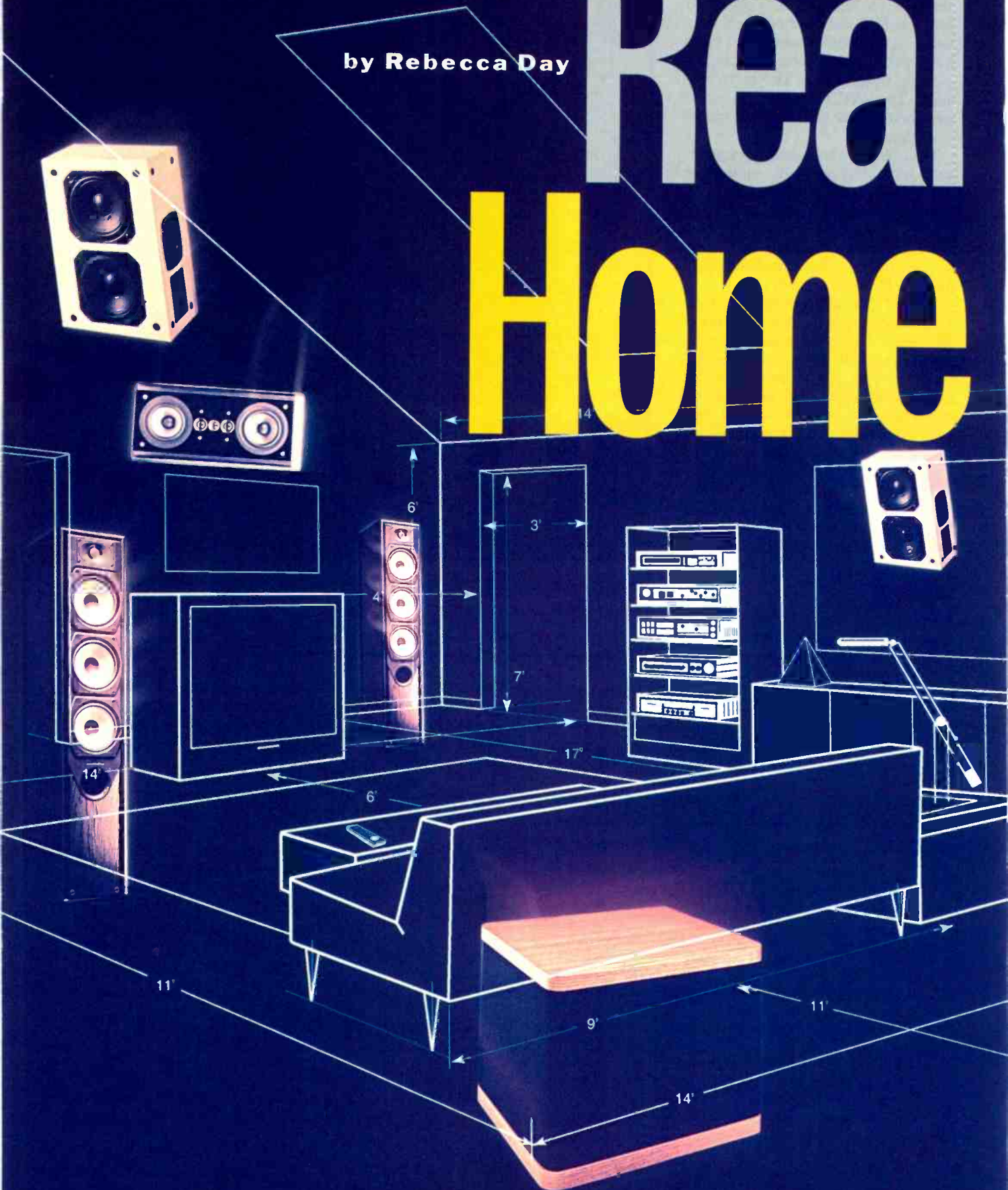

# Life

# Theater

**Expert installer/designers  
plan surround-sound speaker  
systems for problem rooms**

**O**ne of the biggest challenges in outfitting a family room or a living room for home theater is deciding where to put all those speakers. Beyond the main speaker pair, which is probably already accounted for, you have to find suitable locations for a center speaker, a pair of surround speakers, and at least one subwoofer. For most of us, that means having to work around fireplaces, bookshelves, doorways, windows, sofas and chairs, heating registers, odd alcoves, cathedral ceilings, you name it — all kinds of things that can stand in the way of an ideal speaker layout.

To find out how the pros work around such obstacles, we submitted sketches of three real-life problem rooms to a trio of well-known A/V installation specialists. One was assigned a great room with a vaulted ceiling, the second a New York City apartment, and the third a cozy family room. We then asked each of our experts to recommend speakers for the room in question and tell us where to put them to achieve the best possible results for both music and movie soundtracks. In the following pages, we present “before” and “after” sketches of each room along with the experts’ comments.

## **The Great Room**

Russ Herschelmann, owner of R. Herschelmann Designs in Ignacio, California, has

probably had more difficult rooms than this one to outfit in his career, but he can’t remember any. We asked him to suggest a surround-sound speaker layout for a highly reflective 20 x 25-foot great room with a vaulted post-and-beam ceiling that peaks at 12 feet. The room is chock full of windows, partly covered by vertical blinds, and has a sliding-glass door and a solid wood floor. One small area rug, a sofa, and two upholstered chairs are all that provide whatever sound absorption the room has.

On first glance, you might be tempted to leave the 35-inch TV in the corner to the left of the fireplace for good aesthetic balance. No go, says Herschelmann, who wants to put the listener on the couch in a sweet spot that will serve both music and soundtrack playback. Herschelmann’s first inclination was to install wall-to-wall carpeting, board up all the windows, and paint the walls and ceiling black to create the best theater environment. Fearing arrest by the interior-design police, he agreed to make do with this glass and wood cavern.

And he showed us how to make it work. An acoustically live room is a great venue for a Home THX speaker system, Herschelmann says. Lucasfilm’s THX standard specifies dipole surround speakers, which create a convincing ambient field in a reflective environment, and front left, center, and right speakers with limited vertical dispersion, which



**Before**

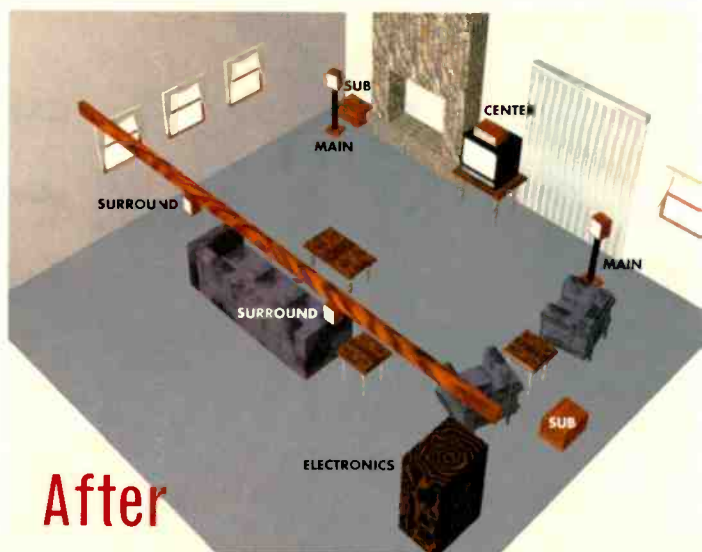

**After**

### Great Room: R. Herschelmann Designs, Ignacio, CA

tightens the front-channel image by minimizing reflections from the floor and ceiling.

For the front and surround speakers, Herschelmann suggests a THX-certified home-theater speaker grouping from Boston Acoustics, Kenwood, JBL, or Altec Lansing, all of which offer complete THX speaker packages (including subwoofers) in the \$3,000 range.

The first thing on Herschelmann's agenda is to convince the homeowner to move the TV out of the corner and over to the right side of the fireplace; the center speaker would then go on top of the set. Then he'd put the front left and right speakers on stands at ear level and place one on the left of the fireplace (where the TV used to be) and the other just to the right of the sliding-glass door on the other side of the room. He'd pull both speakers a few feet away from the wall and toe them in toward the prime listening spot on the couch.

**F**or optimal surround-sound coverage, Herschelmann recommends mounting the dipole surround speakers on the ceiling beam above the couch, roughly a foot to either side of it, so that they fire toward the front and back of the room. If the owner wanted to prepare for the digital future, he'd suggest using full-range surround speakers that can handle the

### Herschelmann's first inclination was to board up the windows and paint the walls and ceiling black.

requirements of the Dolby Digital (AC-3) 5.1-channel format.

Since the total room volume exceeds 5,000 cubic feet, Herschelmann recommends using *four* subwoofers to achieve a theater-like bass impact. Knowing that some folks would consider this excessive, he agreed to start with two subs but urges the owner to consider upgrading to four later on. His subwoofer of choice is the Boston Acoustics Model 595x, a passive sub that he says delivers more bang for the buck than many larger models. He'd use one mono amplifier to power both subwoofers, which would be situated asymmetrically to promote smooth response: one in the corner behind the left speaker, the other on the right wall behind the chair closer to the couch.

With all the speakers in place, Herschelmann stresses the importance of a dark room for the best picture — and sound — quality. To that end, he insists on covering the sliding-glass doors with drapes. "Movies are more involving in a room where the only source of light is the TV monitor," he says, noting that even the audio sys-

tem comes across better in the dark. "Your brain has a much easier time assimilating the real performance when there are no visual cues telling you where the room boundaries are — like the New York Philharmonic Orchestra sitting in your fireplace." To keep viewers' eyes focused on the big screen, Herschelmann suggests concealing the electronic equipment in a closed cabinet or putting it in a rack outside the field of view.

To enhance music-only listening, Herschelmann recommends using a parametric equalizer to bring the THX speakers' ultraflat frequency response more into line with the response of traditional high-end speakers, which tend to have a 3- to 6-dB dip around 3 kHz and a rising high-frequency response above 8 to 12 kHz.

Now that the TV is positioned directly across from the sofa for prime viewing, it also blocks the stationary part of the sliding-glass doors leading to the deck. While this is likely to offend some people's design sensibilities, Herschelmann believes it's a small price to pay for outstanding A/V performance.

### A City Apartment

Finding a place to put home-theater speakers and electronics can be quite a chore in an apartment. Space is tight, and something always seems to get in the way of the ideal system lay-

ROOM DIAGRAMS: THE CINEMA SOURCE

out. But working with the inflexible space of an apartment is nothing new for Mitchell Klein, president of Media Systems in Boston, which is home to a multitude of apartment dwellers.

In the case of the 12 x 20 x 9-foot space we assigned to Klein, there's a huge heating register precisely where you might be inclined to put a TV, for example. No problem, Klein says: Move the existing 27-inch TV out of the corner and position it facing the middle of the couch on the other side of the room. Then swing one of the comfy chairs over to the left of the couch to provide another seat with a good view of the screen.

**T**o bring music and movie soundtracks to life in this apartment, Klein recommends speakers from B&W's new 600 series because "they're great-sounding and price-competitive, and they outperform anything in their class." Few mainstream speakers are built with just music in mind these days, and the B&W's are no exception, although they're "built for music first," he says. "These speakers have typical B&W voicing, so they'll please critical listeners, but because they're so articulate and accurate — not bright or boomy — they're a natural for video, too. They cover the human voice range extraordinarily well."

## Working around an apartment's inflexible space is nothing new for Mitchell Klein of Media Systems.

For mains, Klein would choose a pair of 19<sup>3</sup>/<sub>8</sub>-inch-tall B&W DM602's (\$275 each) and put them on stands 2 to 3 feet to either side of the TV. This spacing is important to insure a solid soundstage and to prevent the TV picture from distorting, Klein says, noting that the DM602 is *not* magnetically shielded. To seal the front stage he would tap B&W's CC6 center speaker (\$350), which is shielded and voiced to match the DM602. "The CC6 will provide clear, faithful reproduction of all the essential on-screen audio information," he says. He'd put the 17<sup>3</sup>/<sub>4</sub>-inch-wide horizontally oriented speaker on top of the TV to anchor dialogue to the picture.

Klein recommends B&W's DS6 dipole speakers (\$300 each) for the surround-channel duties. Ideally, he would like to mount the 9<sup>3</sup>/<sub>4</sub> x 15 x 6-inch speakers on the walls to the sides of the main listening position, but the room layout makes that impossible: The couch backs up to a wall, and there is an open kitchen/dining area to the left. Instead, he would peg the DS6 surrounds high on the wall behind the couch, positioning one

about a foot away from the outside wall and the other above the bookcase to the left of the couch. This placement scheme should produce an enveloping sound field for listeners on the sofa and the chair, according to Klein.

The apartment theater would be complete with the addition of a B&W AS6 powered subwoofer (\$700), which packs a 100-watt amplifier and a crossover. While there's no question about the AS6's bass-producing abilities with music, Klein thinks it could probably use some reinforcement for explosive movie soundtracks. To get as much output as possible from the 20 x 15<sup>3</sup>/<sub>4</sub> x 17<sup>7</sup>/<sub>8</sub>-inch box, he would put it in the corner near the right front speaker.

Klein would like to see a second AS6 in the mix to give the system "more bang and oomph. It would be a nice upgrade for this person, but the neighbors won't like it nearly as much as he will."

### A Cozy Family Room

Where do you put six home-theater speakers in a 13 x 13-foot family room with two doorways, a closet, a wall unit, and an L-shaped couch? At first look, Bill Anderson, president of Genesis Audio & Video in Lake Forest, California, was inclined to design and build one of his own trademark A/V cabinets to accommodate the owner's 27-inch TV and electronic gear. When

## City Apartment: Media Systems, Boston, MA

Before



After

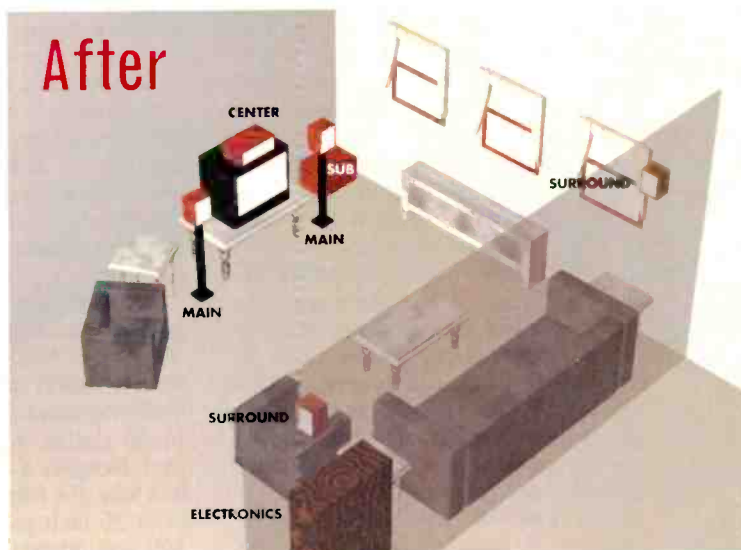

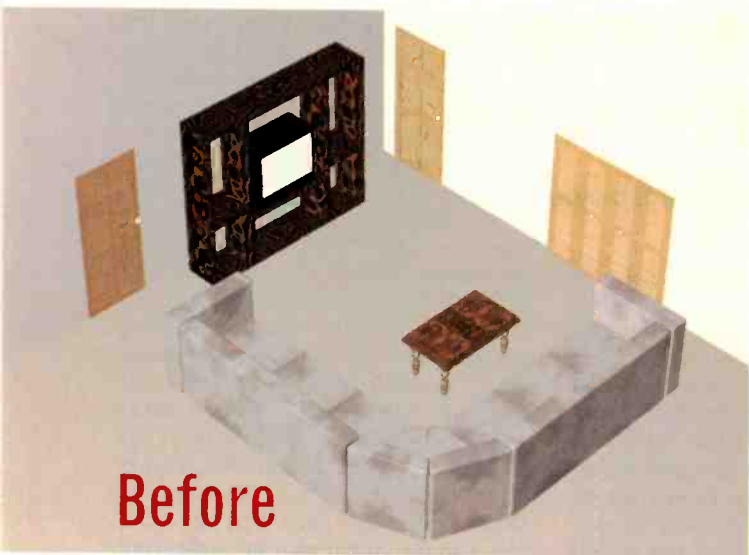

**Before**

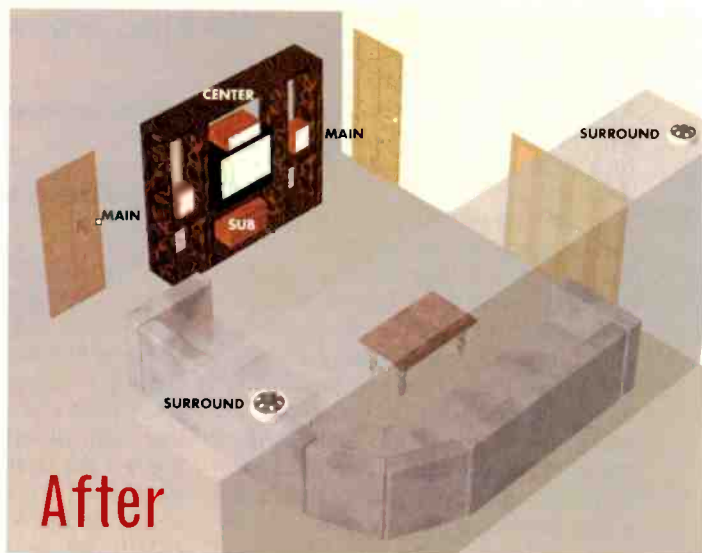

**After**

**Cozy Family Room: Genesis Audio & Video, Lake Forest, CA**

we reminded him that the owner is not about to give up (or move) the existing rosewood wall unit, he agreed to devise a surround-sound system that incorporates it.

The solution starts with a pair of the finest bookshelf speakers you can find — speakers that can deliver the performance of some floor-standing models but don't require as much space. Anderson's choice? Snell's 11-inch-tall Type M speakers (\$480 a pair), which he says will fit on any book-size shelf (although you may have to lay them on their sides). He recommends placing the speakers in the wall unit at ear level (say, 36 to 42 inches off the floor) and about 60 inches apart to avoid what's known as cognitive dissonance, the psychoacoustic conflict between visual and aural images.

**W**ithout actually being in the room to hear the main speakers, it's difficult to specify exact positioning, but Anderson thinks they may need to be toed in slightly to minimize any problems that might be caused by early reflections. If that doesn't do the trick, he suggests experimenting with acoustic treatments — like the fabric-covered SoundBoard panels from Acoustic Innovations — on the front wall. Minimizing early reflections is particularly important for

**Where do you put six speakers in a 13 x 13-foot room with a wall unit and an L-shaped couch?**

music listening. Anderson says, because they can cause unnatural reverberant effects in a square room.

To insure a solid tonal match across the front, Anderson opts for the 16½-inch-wide Snell MC CC-1 center speaker (\$500). Its woofer-tweeter-woofer configuration delivers wide horizontal dispersion, which helps to improve dialogue intelligibility for everyone in the room, he says. To keep the front image tight, the CC-1 should be situated no more than 20 inches (horizontally) away from the main speakers, either directly above or below the TV. If appearance is high on the owner's list of priorities, Anderson suggests laying the Type M's on their sides for a more balanced look across the front.

Velodyne got the call for low-frequency punch. Anderson says Velodyne's new VA-810X II powered subwoofer (\$699) is a good match for the Snells because it delivers audiophile sound quality with home-theater impact. Roughly a cube, about 15 inches to a side, the sub packs an 8-inch driver, a 10-inch passive radiator, and a 100-watt power amp. For hookup flex-

ibility, it accepts both speaker-level and line-level inputs and has an adjustable crossover that can be used to filter bass out of the signals going to the Type M speakers. Then it's a simple matter of adjusting the subwoofer's level control to suit listening preferences.

Although the subwoofer could be placed in a corner for increased output, Anderson would rather see it go inside the wall unit, if possible. "There's no optimum placement for a subwoofer in a 13 x 13 room," Anderson says, "so we would place the box in the first one-seventh of the room — possibly in the wall unit if it doesn't resonate — to minimize the effect of room modes produced by the square dimensions."

When it comes to the surround channel, Anderson usually calls for dipoles. But the layout of this room is less than ideal for a dipole speaker, so he recommends mounting a pair of Sonance S3R round in-wall speakers (\$380 a pair) in the rear corners of the ceiling. With a 6½-inch woofer and a pivoting coaxial tweeter, the S3R boasts a wide dispersion pattern, Anderson says, which makes it a good choice for use as a surround speaker. He suggests aiming the tweeters toward the side walls to diffuse the sound field further.

The price tag of this compact speaker grouping is just over \$2,000, and Anderson says it will definitely rock. □



# The magazine that knocks you on your ear



**FREE ISSUE!**

It used to be simple. You had a car. It came with a radio. You listened. Period. Now you've got options. So many options, it's easy to get blown away just trying to find components that fit together - and fit your budget too.

So what do you do when it's time to upgrade your car stereo? Tune in to CAR STEREO REVIEW! Whether you like your sounds big and bouncy or tight and well controlled...whether you own a Ferrari or a Hyundai, CAR STEREO REVIEW lets you drive away with a system that's custom built for the way you like to listen. You'll get head-to-head comparisons of CD players and changers, cassette decks, amplifiers, crossovers, speakers, equalizers, security systems, cellular phones, and more, in every price range. Plus, every issue brings you complete test reports.

User's evaluations. Reviews of the hottest, state-of-the-art equipment. A do-it-yourself course on installation. And there's a bonus: the most complete, up-to-date buyer's guide available anywhere in the world.

So, if you're ready to treat your ears to great sound at a price that's right for you, check out CAR STEREO REVIEW.

Send for your FREE ISSUE! It's easy - just fill out and mail the attached postage-paid card for your free sample issue. If you're delighted with CAR STEREO REVIEW, you'll receive 5 more issues (for a total of 6 issues - 1 year) and be billed for \$11.97. If not, simply write "cancel" on your bill and owe nothing. The free issue is yours to keep. Don't delay - make tracks for the best possible audio system by sending for your free issue of CAR STEREO REVIEW. Do it today!

If the attached card is missing please write:  
 Car Stereo Review,  
 P.O. Box 57316, Boulder, CO 80322-7316.  
 Canadian orders add \$7.00 per year (includes 7% GST);  
 foreign orders add \$7 per year; payment in U.S. funds must accompany order.  
 Please allow 30 to 60 days for delivery of first issue.

# Let Us Entertain You!



As a professional association of audio/video specialty stores, PARA sets the standards for high quality retail shopping. Member dealers share a dedication to the values of service and high performance products that bring the joys of music and movies into the lives of their customers.

## PARA Home Theater Specialists

- ▼ PARA stores will take the time to ask about what you already own and suggest home theater components that will integrate into your current system.
- ▼ PARA home entertainment professionals are educated to explain the newest technologies in clear, friendly language, helping you get the best value for your money.
- ▼ Let us help you choose the music or home theater system that's right for you.



Professional AudioVideo Retailers Association

**CALL TOLL FREE 1-888-FOR-PARA to find the PARA dealer nearest you!**

BY IAN G. MASTERS

# MAKING THE CONNECTION

**How to wire an  
A/V system without  
coming unglued**

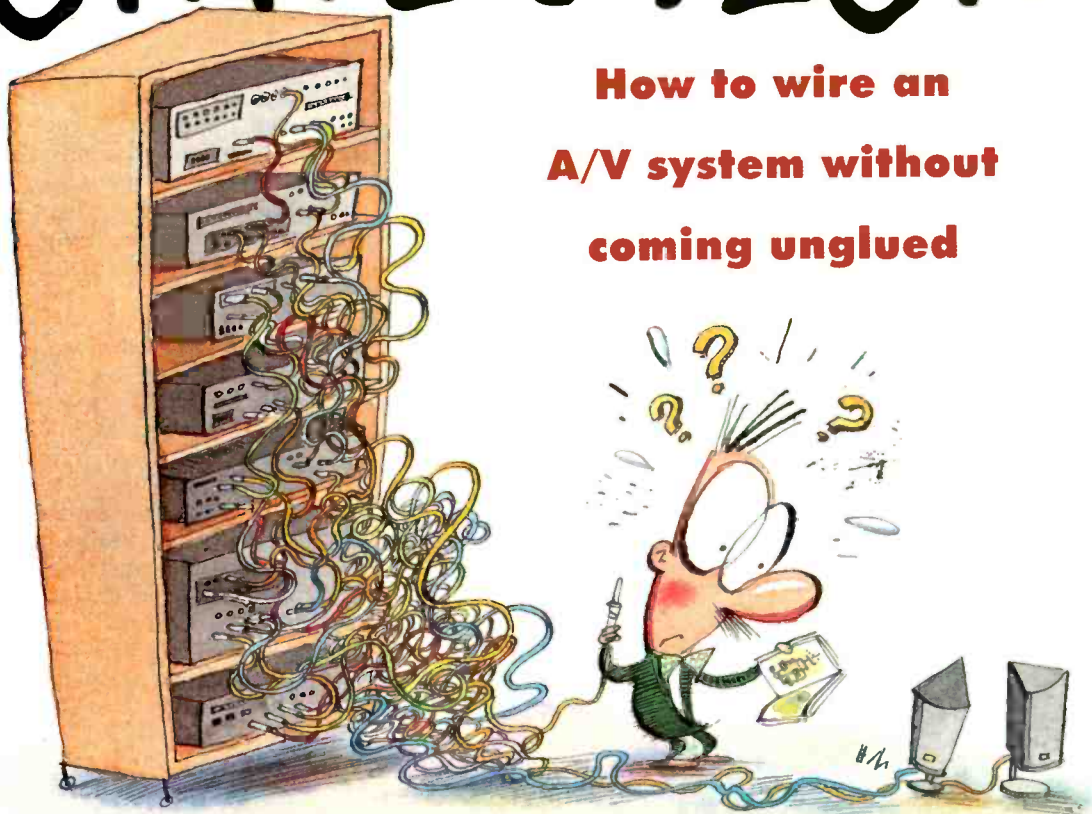

**M**y father was no dummy, but he didn't have a technical bone in his body. When I was a very small child, a special Saturday afternoon treat was listening to records, and to do that, the old man had to get the turntable out of a closet and attach it to the big radio in the living room. This involved uncoiling a cable from the back of the record player and plugging it into a jack on the radio, then flicking a switch to change from radio to record mode. My father had mastered this operation, but somehow it always seemed a bit of a challenge for him.

It's hard to imagine, then, what he

would make of even the most modest of today's audio/video systems. My fairly ordinary surround receiver, for example, sports just under forty RCA jacks, an assortment of S-video, RF, and integrated-remote connectors, and terminals for up to eight speakers. Snaking across the floor from the receiver are several cables that are plugged into the rear of a television monitor boasting twenty-eight RCA jacks of its own and a host of other connectors.

It's no wonder some people get confused when it comes to hooking up a system. True, the equipment manufacturers do try to be helpful, but the

wiring diagrams in most instruction manuals are often difficult to understand. My sainted father, if he'd attempted the task at all, would have just hooked things up to the best of his ability and lived with the consequences, even if the system failed to perform all the functions he wanted.

For those not so easily discouraged, however, wiring an A/V system is not an impossible task. The main trick is to break the system down into modules and deal with each one separately. For example, when you're concerned with making one tape deck copy to another, don't even *think* of what's going on at the speaker end. Using this ap-

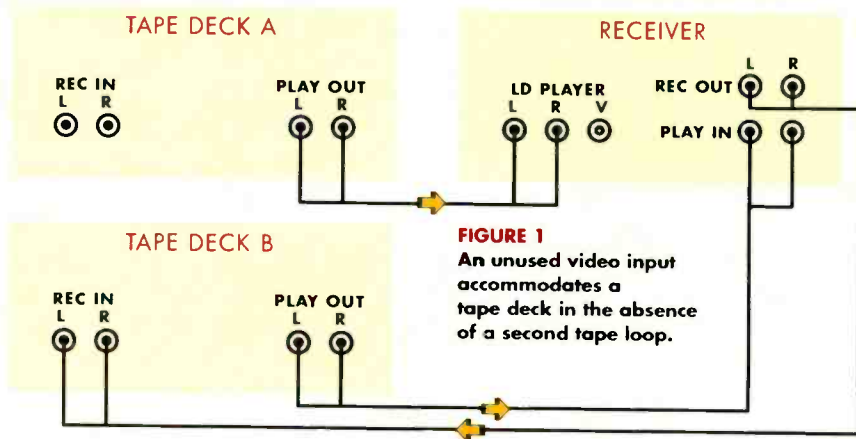

**FIGURE 1**  
An unused video input accommodates a tape deck in the absence of a second tape loop.

proach, each wiring operation can be analyzed logically and dealt with individually, making it less daunting. Sketching wiring diagrams before you begin might help as well. And it can also be useful to physically arrange the equipment in the same order as the signal path. If nothing else, it might result in a somewhat more controlled tangle of wires behind the equipment.

Below are examples of some common wiring situations and how to deal with them. Before you begin any wiring project, however, there are two basic rules to keep in mind. First, label both ends of every cable you connect with a piece of tape; you should note the component it plugs into and the exact label of the jack it connects to. Second, cables are important, so buy good, sturdy ones that make firm contact and will stand up to some use.

### Too Little of a Good Thing

Unlike the multijack wonder I described earlier, many A/V receivers accommodate too few external components. By the time the designers have added in the various video connections, they've had to scrap the extra line-level input or a second tape-monitor loop that would have come in handy for connecting another tape deck or a signal processor. Of course, there are external switch boxes to overcome such deficiencies, but in the case of the tape facilities, there's often a better way.

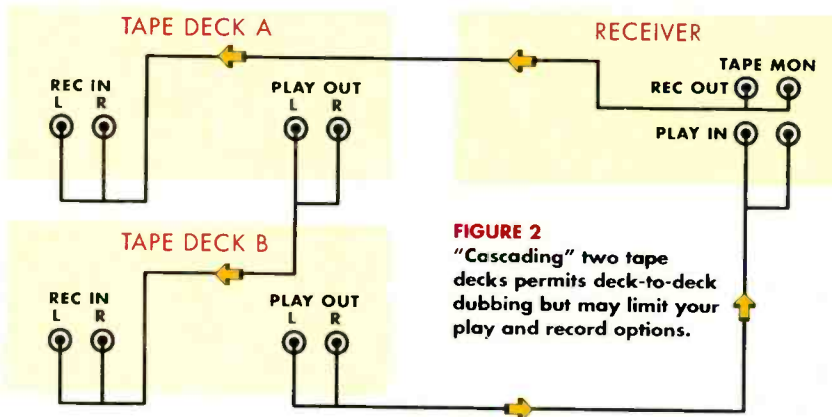

**FIGURE 2**  
"Cascading" two tape decks permits deck-to-deck dubbing but may limit your play and record options.

**M**ost people who have two tape decks in their systems use them to copy tapes, since the copies are often better than those made with a single two-well dubbing deck. The more elaborate receivers and preamps typically have internal wiring that lets you dub from one deck to another at the flick of a switch, but if you have only one tape loop, that's impossible.

One solution is to use one of the decks as a playback-only device and hook it up to an unused line-level input (Figure 1). Not everyone has multiple video sources, for instance, but lots of receivers accommodate more than one. So if you only have a VCR, there's nothing to stop you from connecting an audio tape deck to, say, the audio inputs intended for a videodisc player; just ignore the video input jack. And remember that you'll be selecting the videodisc player on the front-panel switch whenever you want to play something on that tape deck or

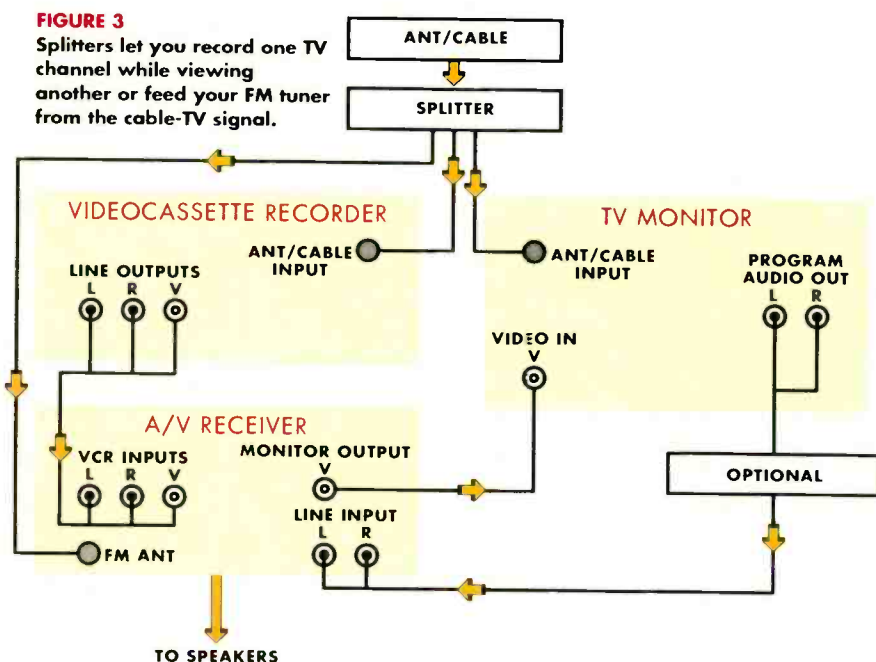

**FIGURE 3**  
Splitters let you record one TV channel while viewing another or feed your FM tuner from the cable-TV signal.

dub from it to your recording deck. An unused set of VCR connections can likewise be used to connect an audio recorder's outputs *and* inputs.

If all your line inputs are occupied, another option for deck-to-deck dubbing is to "cascade" the tape decks — in other words, connect them in series. Thus, the tape-out jacks on the receiver connect to the inputs of Deck A, its outputs feed to the inputs of Deck B, and its outputs in turn feed back to the receiver's tape-in connectors (Figure 2).

With typical audio decks, however, this arrangement has some limitations. To play a tape through your speakers, in most cases you'll have to use Deck B, unless Deck B has facilities for passing the Deck A output to the receiver without being placed in record mode. Likewise, only Deck A will be able to record from the receiver, and you'll likely have to plug headphones directly into Deck A to monitor recordings.

### RF Is Your Friend

Television sets didn't always have video inputs, and without them the only way you could feed a signal into a TV set was through its antenna terminals. For that reason, VCR's all contain radio-frequency (RF) modulators, which take a line-level video signal and simulate the kind of antenna signal the TV's tuner expects to see. Among other things, that allows a TV/VCR switch in the VCR to choose between the simulated signal and the real off-air or cable signal to be fed to the TV's own tuner.

Although feeding a line-level signal from a VCR to a TV monitor yields a better picture, because there is much less manipulation of the video information, there *are* times when it is useful to have the RF signal as an alternative. The classic situation is when you wish to tape one program on a VCR while watching another. Nowadays, the typical system may have the cable or antenna feeding the VCR's built-in tuner, where the viewing/recording channel is selected and the signal is decoded before it travels to the TV as a line-level signal.

But a TV set also has its own tuner, which similarly accepts a signal from the cable or antenna. Therefore, it's easy to insert an RF splitter before the antenna or cable connects to the VCR and then route a second, identical RF signal to the TV (Figure 3). Simply

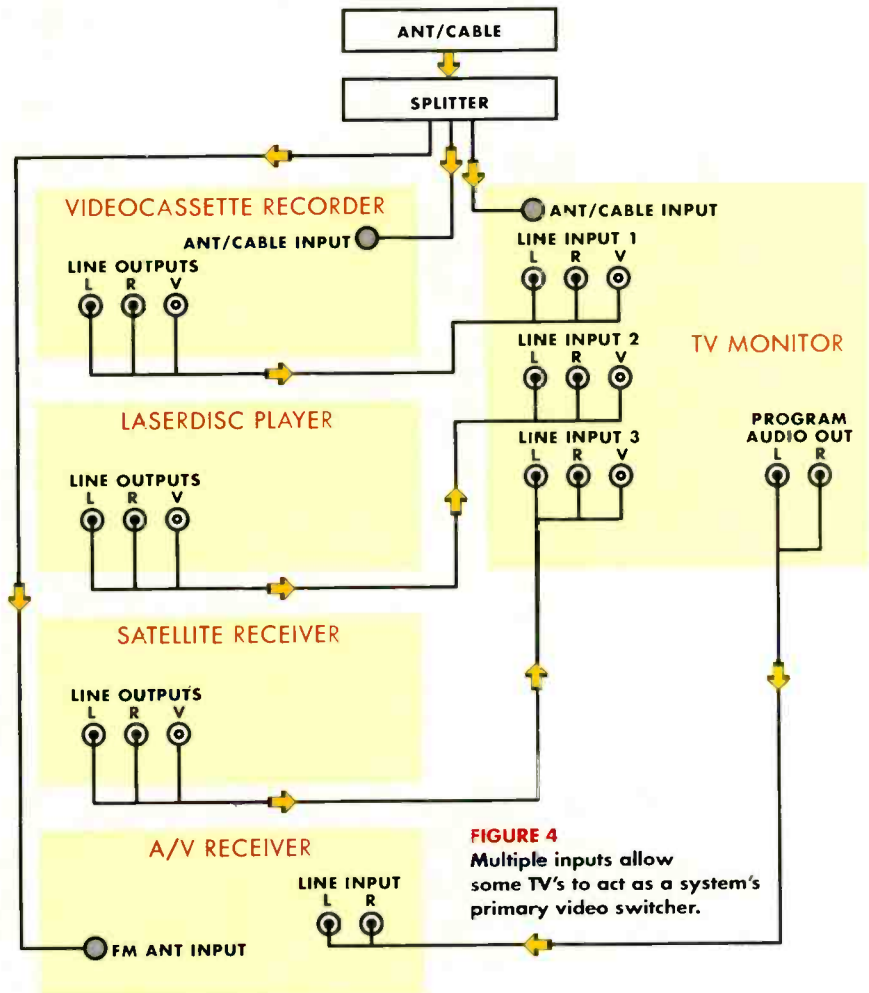

**FIGURE 4**  
Multiple inputs allow some TV's to act as a system's primary video switcher.

switching the TV from video to cable/antenna mode allows it to ignore what's happening back at the VCR and tune in whatever you want while the VCR continues recording the channel that's been selected on *its* tuner. (Of course, your TV should have a cable-ready tuner or a converter box if you expect to be able to view all of your cable channels while the VCR is recording something else.)

An extra fillip on this is to add a second splitter or to use a three-way splitter to feed your receiver's FM tuner as well (Figure 3). Most cable systems carry FM signals along with TV signals (some charge a premium), and since the FM band nestles in between Channels 6 and 7 of the TV band, your rooftop antenna will pick it up fine.

Depending on how far your television is from the rest of your equipment, it might also be practical to feed its line-level stereo output back to an unused line-level input on your A/V receiver, which would let you hear stereo or Dolby Surround sound from

**The trick to wiring an A/V system is to break it down into modules.**

**Fortunately,  
it's fairly easy  
to upgrade  
your receiver's  
amplifier  
output.**

your off-air program. Once again, this won't affect the recording VCR, as it doesn't care what happens after it in the equipment chain, so switching the receiver's audio selector to play the TV sound won't hurt your recording.

If you like hearing your TV sound through your audio system all the time, there are two additional options. One is to use the A/V receiver as the central switching point for all audio or video source components; most systems are set up this way. Here, the video signal goes from the VCR to the receiver and then on to the television, while the audio stops at the receiver and is routed to its surround-sound processor and then the speakers.

But you can often use the television itself as the traffic cop. Many better TV sets let you select among a number of video sources using the remote control. In this case, each source connects directly to the TV set, and the audio signal from these sources can be picked up at the TV's "program audio" output and fed to the surround-

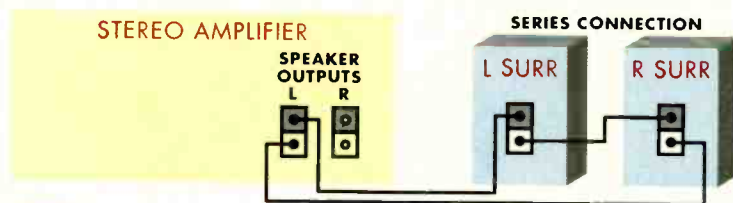

**FIGURE 5**  
Connecting surround speakers in series can prevent amplifier overload.

sound audio system (Figure 4). Here again, the audio signal that gets decoded and fed to the speakers is determined by what's on the screen; the VCR can be happily recording something else without being affected.

#### **More Power to You**

A full-blown home-theater setup can be a pretty complicated assemblage of equipment, and once you've got yours together and are familiar with its quirks, it's natural not to want to change it very often. But there is one area where many A/V users would like to see some improvement.

Early surround receivers usually had adequate power for the main speakers but were somewhat chintzy when it came to the other channels. It took some time for manufacturers to figure out that an A/V receiver's center-channel amplifier should be blessed with as much power as its front left and right amplifiers. That was an important part of the Home THX standard, and most non-THX equipment has now followed suit. With a standard Dolby Pro Logic

receiver, the surround-channel outputs should ideally have a power rating of no less than half that of the front-channel outputs, a characteristic of few A/V receivers even now. And with Dolby Digital (AC-3) coming on fast with its stereophonic surround channels, you should ideally have identical power ratings for all five primary speakers in a home-theater setup (subwoofers are another matter altogether).

Fortunately, if you are satisfied with your equipment otherwise, it's fairly easy to upgrade your receiver's amplifier output, at least for a Pro Logic system. (For Dolby Digital AC-3 you might be better off saving your money for new AC-3 components.) If you are fortunate enough to have a receiver with line-level outputs for the channels you wish to upgrade, then it's a straightforward matter: Simply buy an outboard amplifier with adequate power and feed it the appropriate signals. A normal two-channel stereo amp should work fine for center/surround upgrades, with one channel running the center speaker and the other feeding the surrounds wired in parallel (they get a mono signal anyway in a Dolby Pro Logic system, even though there are two of them). The only danger is that the combined impedance of the two paralleled surrounds might be so low as to stress the amplifier; in that case, you can wire them in series (Figure 5). That will keep the impedance up but may affect the sound quality.

If there are no line-level outputs on your present receiver, all is not lost. The most reliable solution is to buy a level/impedance-matching box that converts a high-level speaker signal into a low-level signal acceptable to any amplifier's RCA input. Carver makes just such a device, the Z-5 Power Expander (\$85), which simultaneously converts up to five speaker outputs from a surround-sound receiver and also provides a level control for each channel.

**T**oday's audio/video systems can be marvelous instruments of entertainment and enjoyment. They can also be a big source of frustration unless we take some pains to configure them to our needs. Some judicious routing of signals may be all that's necessary to wring every last ounce of pleasure from your equipment, so don't be afraid to jump into that jumble of wires and make your system work for you, instead of the other way around. □

by Tom Nousaine

# HEAR TODAY, GONE TOMORROW

*Dear Stereo Review,*

*I am writing this letter to relay an unfortunate incident in my personal world of hi-fi. I damaged my hearing — just in one ear, and the loss is barely noticeable. But it is probably irreversible. The same thing could easily happen to anyone while listening to music. Without good ears, what does it matter if you have the world's best audio system?*

*I am normally very careful about listening levels, for fear of messing up my ears. But I got carried away one day while testing a subwoofer I had built for a friend. When he came over to listen to it for the first time, I connected 200 real watts of power to it and cranked up Telarc's recording of the 1812 Overture. I was sitting a few feet from the woofer during the demonstration, adjusting the level and crossover. I was surprised at the gobs of power the thing could handle, so I showed him just what it could do. He said he was scared when the first cannon blasts went off, which was good. I was pleased that my friend was happy with his new subwoofer. It really was impressive — deep and extremely accurate.*

*Three or four days later, I noticed a very slight pain in my left ear that would not go away. A couple of days after that the world sounded a little dimmer in that ear.*

*Please understand that listening at dangerously high levels is all too easy to do. Without a reference of some sort, you don't realize how loud the music is. My father is almost deaf in one ear from flying in the Air Force. He always said, "When you are young and you can hear everything, you can't afford the stereo you want. But when you are old and have the money to spend on the killer system, you don't have the ears to hear it." I am 21 years old and already on the way to fulfilling that prophecy.*

*Be careful.*

JIM TIEMANN  
Dundee, IL

**D**o you take your hearing for granted? Do you blast your stereo until someone tells you to turn it down? Or go to rock concerts or drag races and never think about using ear-plugs? Or maybe you work in a loud environment and, rather than do something to reduce the noise, simply tolerate it. Jim Tiemann's story is a poignant reminder that our ears are our most prized audio possessions of all. And, as with any valuable component, we must take precautions to prevent damage, which in the case of our hearing is often irreparable.

Before we delve into what you can do to protect your hearing, let's review the mechanics of hearing loss. While Tiemann attributes his problem to a subwoofer demonstration, hearing loss is usually a high-frequency phenomenon. The human ear is most sensitive — and therefore most susceptible to injury — in the 2- to 3-kHz range. As you move above and below that range, the ear becomes increasingly less sensitive. At very high frequencies, sound is extremely directional, making it unlikely that your ears will be exposed to a potentially harmful direct beam of sound. And at very low frequencies, sound is "heard" mostly through bone conduction — that is, through the bones in your chest and face, not your ear canal.

Actually, most of us are subjected to very loud low-frequency energy all the time. Notice how the ground shakes when an eighteen-wheeler or a train approaches? That's real bass, but the lows won't hurt your ears. The high-

# Too Loud Is Bad. But TOO LOUD FOR TOO LONG Is Worse.

frequency transient energy accompanying the low stuff is what puts your hearing at risk. In Tiemann's case, the "cracks" of those impeccably recorded cannon shots, heard at extremely close range, are probably what hurt the inner mechanism of his ear.

**T**oo loud is bad. But too loud for too long is worse. Exposure to loud sound over a long period can cause a gradual loss in hearing acuity. So it should come as no surprise that factory workers, auto-racing enthusiasts, night-club employees, pilots, recording engineers, sound crews, and musicians are among those most at risk of developing hearing problems. Those of us who regularly attend music shows with huge sound systems or who use headphones for extended periods are also at risk.

While judging at a car stereo event last year I took periodic readings of the sound-pressure level (SPL) in the main staging area and found it to be a fairly steady 105 dB, a level that the Occupational Safety and Health Administration (OSHA) considers unsafe after only 1 hour of exposure (see the chart on this page for maximum safe-exposure times at various sound levels). Inside the cars, sound levels were often much higher. The event lasted all day long, and most of the contestants, judges, and spectators stayed until the last trophy was handed out. By that time, many of my fellow judges were experiencing a phenomenon known as threshold shift, a sense of dulled hearing that lingers after the offending sound stops. But because I had worn special earplugs throughout the event, my hearing was as sharp as ever. I could easily hear the shuffle of gravel under sandals 30 feet away.

The moral of this story: Car-stereo sound-offs and other "loud" sporting events can produce ear-shattering sound levels. If your ears are ringing or seem clogged (or both), or you wake up with a headache the next morning, it was simply *too loud*. One or two such high-SPL encounters may

not damage your hearing permanently, but repeated exposure will begin an irreversible decline, even though the effects may not be noticeable for years to come.

So how do you protect those golden ears from being ravaged by excessive sound levels? Well, when it comes to listening at home, the solution is a no-brainer: Keep the volume down. It's okay to crank it up a bit, but don't go nuts. As far as night clubs, rock concerts, and other high-volume encounters go, the only realistic option — short of staying home or standing out in the parking lot — is to use a hearing-protection device like earplugs. Think of earplugs as condoms for your ears. If you engage in potentially dangerous auditory behavior, take measures to protect yourself.

While the earmuff headsets worn by airline-terminal workers, Indy pit crews, and target shooters do a great job of blocking out loud sound, they're not going to do much good at a Van Halen concert. You'll look like a geek, and the music — well, let's just say

you'll be lucky if you can tell the verse from the chorus. Fortunately, there are plenty of inexpensive (and unobtrusive) earplugs to choose from, including models designed specifically for listening to music.

The least expensive type of earplug is the simple foam insert, available in many hardware stores and pharmacies for less than a buck a pair. You roll it between your fingers to compress it and insert it into your ear canal. When the foam expands in your ear, it blocks (actually attenuates) the sound. The E-A-R Noise Filter earplugs from Cabot Safety Corp. (1-800-327-3431), for example, provide 29 dB of attenuation. They're perfect for mowing the lawn and are nearly invisible in use (especially the flesh-tone models), which means they're suitable for a night on the town.

A slightly more expensive option is the E-A-R Ultrafit triple-flange earplug, available in hardware stores for about \$3 a pair. These premolded rubber plugs work almost as well as the foamies, providing 21 dB of attenuation, but they do have little Frankenstein-monster handles that protrude from your ears.

While both foam and rubber plugs are good at keeping loud noise out, they can be a little uncomfortable and are not the best option for music listening. First off, most of the attenuation they provide is at high frequencies, which makes music and speech sound muffled. Second, because they completely block the ear canal (when properly plugged in), they fundamentally change the balance of sound you hear. As a result, your breathing sounds abnormally loud, your voice sounds deeper in pitch and hollow in timbre, and your footsteps sound as though a T-Rex is sneaking up on you. In other words, you sound like Darth Vader to yourself. The worst part of this "occlusion effect" is that people tend to loosen the plugs to overcome it — which defeats the purpose of wearing them in the first place. Without a good seal, they can't do their job.

## Safe Sound

SOUND-PRESSURE LEVEL (dBA)	MAXIMUM DURATION PER DAY
90	8 hours
92	6 hours
95	4 hours
97	3 hours
100	2 hours
102	1½ hours
105	1 hour
110	½ hour
115	¼ hour or less

SOURCE: OSHA





30-40 dB  
FAINT

50-70 dB  
MODERATE

80-100 dB  
VERY LOUD

110-130 dB  
EXTREMELY LOUD

140-170 dB  
PAINFUL



WHISPER

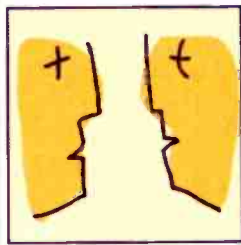

CONVERSATION

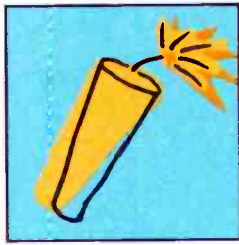

FIRECRACKERS



ROCK CONCERT

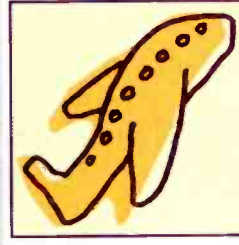

JET AIRPLANE

ILLUSTRATION BY DISMAL DOWNY

Fortunately for music lovers, there are special earplugs that alleviate these side effects. Available in music stores for about \$15 a pair, Cabot's E-A-R Hi-Fi Earplug provides 12 dB of protection with only slight attenuation at higher frequencies, thanks to the use of a specially tuned resonator and acoustic resistor. Like the less expensive Ultrafit plug, it has a triple-flange rubber tip and a small handle that sticks out of your ear. No big deal, except that when Bonnie Raitt leans over to whisper in your ear during one of her breaks, she might get a handle up her nose.

At the high end of the hearing-protection market are the ER-15 and ER-25 Musician's Earplugs from Etymotic Research. Initially designed to protect classical musicians from hearing loss, the ER-15 provides 15 dB of flat attenuation over the entire frequency spectrum through a speaker-cone-like diaphragm. Its sibling, the ER-25, offers 25 dB of attenuation for those who need maximum protection. Both are made using special molds that must be custom fitted to your ear canals, and they are therefore available only through audiologists. Cost is about \$140 a pair, which includes fitting.

Aside from their excellent attenuation characteristics, Musician's Earplugs are also nearly invisible and extremely comfortable — so comfortable, in fact, that it's easy to "lose" them in your ears! They aren't cheap, but they're a worthwhile investment for audio professionals and enthusiasts who don't want to put their hearing at risk but at the same time don't want to miss any of the music. I can't recommend them highly enough.

**W**hile carefully protecting your ears from extreme sound levels is a prudent thing to do, there is little you can do about another major cause of hearing loss: aging. Most of us experience a gradual decline in hearing acuity as we grow older — especially men. But that doesn't mean seniors can't enjoy music. Most hearing loss is a threshold phenomenon: We lose the ability to hear soft sounds, but above a certain level our hearing may still be close to normal. It's when the effects of noise-induced hearing loss are combined with age-related losses that you find serious impairment, as in people who have difficulty understanding conversation.

A shocking example of advanced hearing damage from prolonged exposure to loud music was revealed at a recent Audio Engineering Society convention. George Martin, the Beatles' legendary producer, followed an impassioned speech about his career by receiving questions from the audience through a *sign-language interpreter*. Numerous other tales of woe have emerged from the world of rock music. Perhaps most notably, the Who's guitarist, Pete Townshend, has made no secret that he suffers from a severe case of tinnitus, a constant ringing in the ears. What could be worse than losing the ability to hear what you love most — music?

That's why whenever I go to a concert and see a stack of amplifiers and speakers on stage, I immediately pop in my earplugs. I *know* the concert's going to be too loud, so why should I take the chance? I can enjoy the show without having to worry about my hearing, *and* I increase the odds that I'll be able to enjoy similar shows for years to come. So the next time you come in contact with loud sound, music or otherwise, do yourself a favor and use some kind of protection. Practice safe sound. □

ORIGINAL MASTER RECORDING™

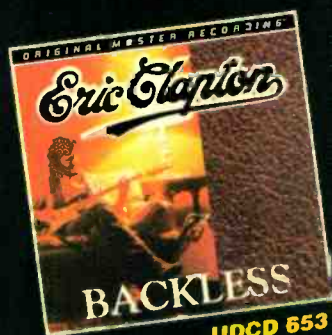

ULTRADISC II™  
The GAIN System



# NATURE'S ENCORE

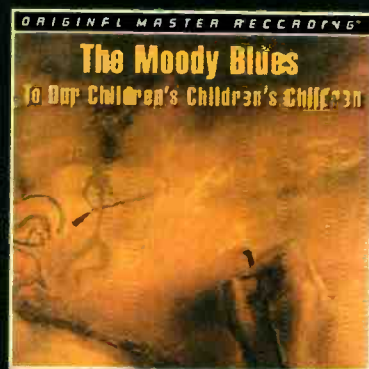

NEW RELEASE UDCD 671



NEW RELEASE UDCD 674



NEW RELEASE UDCD 673

## BETTER SOUNDING MUSIC. UPGRADE TO ULTRADISC II™.

Your favorite artists sound surprisingly better on Ultradisc II™. Why? Because Mobile Fidelity's mastering technology is a cut above—and you can hear the difference. As the creators of the 24k gold audiophile CD, we have developed major advances such as The GAIN System™, a proprietary mastering system that uses the highest grade of digital technology available. Starting with the original master tapes, we are able to capture every last nuance of the original recording. What does this mean? You'll hear music like you've never heard it before!

### Ultradisc II™ The Original 24K Gold Audiophile Compact Disc.

To receive a color catalog or The GAIN System™ technical paper, call 800-423-5359.

Find these great titles and more in the Audiophile Sections at



(Selected Stores)



105 Morris Street • Sebastopol, CA 95472  
WWW.JRL ADDRESS: <http://www.mofi.com/>  
In Canada call 800-267-1216 (Music Retailers)  
or 570-465-4434 (Hi-Fi Retailers)

CIRCLE NO. 26 ON READER SERVICE CARD



# BEST OF THE MONTH

**STEREO REVIEW'S  
CRITICS CHOOSE THE OUTSTANDING  
CURRENT RELEASES**



## Merle Haggard Wakes Up

**M**erle Haggard has somnambulated through so many albums in the last decade and a half that some of us had lost hope he'd ever make meaningful music again. In "1996," however, he has suddenly come alive, and the result is not only one of his most satisfying records in ages but also one of his most inventive. For example, in *Sin City Blues* he takes a story about burning out on the sleaze of New Orleans and gives it a western-swing format punctuated by Bourbon Street horns. And in *Beer Can Hill*, with guests Dwight Yoakam and Buck Owens, he marries the traditional Bakersfield sound to a Cajun attitude and beat, and even adds a saxophone! What's more, in the

hands of the players here — top studio pickers peppered with members of Haggard's legendary road band, the Strangers — the eclecticism doesn't just work, it cooks breakfast, lunch, and dinner.

Occasionally, the Hag relies on the tried and true. *Five Days a Week* is *Working Man's Blues* revisited, and *Kids Get Lonesome Too*, which could be a song of consolation to a child or a sweetheart/wife, sounds at first like a sweet toss-off, but both songs actually pick up resonance with repeated plays. There are real epiphanies here, too. *If Anyone Ought to Know*, for instance, which trods the loner path Haggard has walked his entire career, turns out to be a mini-masterpiece masquerading as an album cut.

Just as Dolly Parton has never tried to hide the aggressive, masculine side of her personality in song, Haggard has drawn on the more feminine aspects of his sensitivity without shame. In "1996" he taps into that in *No Time to Cry*, a cover of Iris DeMent's heartbreaking song of dealing with her father's death. And those who revere Clint Black should compare his version of *Untanglin' My Mind* (which he and Haggard wrote together) with Merle's version here. The difference is the dividing line between a master and an interpreter — and you don't have to guess which is which.

All in all, "1996" is a remarkable comeback. For Haggard, pushing 60, it's either the last hurrah or the beginning of a helluva September romp. *Alanna Nash*

### **MERLE HAGGARD: 1996.**

*Sin City Blues; No Time to Cry; Beer Can Hill; Truck Driver's Blues; Too Many Highways; Five Days a Week; Kids Get Lonesome Too; If Anyone Ought to Know; Untanglin' My Mind; Winds of Change.* CURB 77796 (32 min).

## A Magical "Magic Flute"

**W**illiam Christie's latest opera recording, Mozart's *The Magic Flute* on Erato, is a popular, brainy, quicksilver ensemble performance that is full of sentiment and takes "historical performance" out of the hothouse and into the opera house, and into the real world.

Christie not only brings "historical performance" into the classical-music mainstream, but he also bridges the gap between instrumental music and opera — and, for that matter, between opera and popular musical theater. Since opera was at dead center of the Baroque and of the Classical style as well, and since Mozart's *Singspiel* operas were an early form of musical comedy, this is not just a nice little side issue but, in more ways than one, the very heart of the matter.

*The Magic Flute* is a perfect case in point. The American conductor is best known for his revival of French Baroque opera and, secondarily, for his performances of Handel and Purcell. Mozart, who stood between the old and the new music, represents a major step in a new direction for Christie and the singers and instrumentalists of his Les Arts Florissants ensemble.

This magical *Magic Flute* comes from the Aix-en-Provence Festival in France. Musically, it is characterized by a certain ease and freedom in performance style, a close cooperation between singers and instrumentalists, the use of ornamentation (most notably a rather startling Act I ca-

# BEST OF THE MONTH

denza for the Three Ladies), and a surprising amount of musico-dramatic sentiment. A theater-seasoned performance, it is kept fresh by allowing a certain level of individual expression within a strongly defined frame — a way of working that Mozart would have recognized and appreciated.

Dramatic, however, does not necessarily mean melodramatic. And Christie's idea of theatrical Mozart is light-fingered, almost dancey at times, and always close to its popular roots (an approach that has a lot of historical and musical authority behind it).

Because Les Arts Florissants uses gut-stringed instruments and woodwinds made of wood, the young, fresh, and flexible voices in the cast sit perfectly on their orchestral accompaniments. Because a light, vibrato-free vocal sound is used throughout, the fioratura and ornamentation are all easy to control and command.

In the conventional sense, this is opera without stars, but, of course, Christie himself is the star. And soprano Rosa Mannion, the exquisite Pamina and a Christie regular, is fast becoming a true early-opera diva. Anton Scharinger, a first-class baritone singer/actor, is the highly amusing and extremely musical Papageno. Hans Peter Blochwitz, the



BERNARD/ERATO

Soprano Natalie Dessay as the Queen of the Night

Tamino, has a light, engaging tenor reminiscent of some of the great German operetta tenors. Their highly focused voices have something in common with the traditional theater singing of pre-microphone days, and the results are pleasing and apropos.

One of the remarkable achievements of this production is that the dialogue, nearly always the weakest element in today's standard multinational productions, holds its own. Although some nonsinging actors are used, the principals speak for themselves, so there is real continuity between

the sung and spoken scenes. One of the compensations of a cast without stars is the high ensemble level, always a specialty of Les Arts Florissants and the Christie method.

The eighteenth-century musical-comedy approach suits the work very well, but it is not without its pitfalls. Most of the time, everything whirls ahead in the most natural and easy-going manner, but once in a while the singers seem hard pressed to keep up. The coloratura ornamentation of the Queen of the Night (soprano Natalie Dessay) and the verbal patter of the Three Boys suffer the most from the brisk tempos. These are the kind of blemishes that you would expect if you heard the opera in the theater. Al-

though the recording was made at the studios of Radio France in Paris, it has the quality and, on occasion, the shortcomings of a superb live performance. That may be its greatest claim to authenticity.

*Eric Salzmann*

## MOZART: The Magic Flute.

Rosa Mannion (Pamina), Natalie Dessay (Queen of the Night), Hans Peter Blochwitz (Tamino), Anton Scharinger (Papageno), Reinhard Hagen (Sarastro), others: Les Arts Florissants, William Christie cond. ERATO 12705 (two CD's, 150 min).

## Cast: The British Invasion, Continued



NORMAN WATSON/ROGGRAM

Cast: yet another fab four

It's not often that a band disappears from the face of the earth after a debut as promising as the self-titled 1991 album by the La's, the English combo rightly praised for its blend of wry cynicism and pop effervescence. The good news is that one of the La's has formed a new band, Cast, and made a follow-up, "All Change," that's worthy of the old band.

The surprise is that the frontman is not Lee Mavericks, the La's' singer/guitarist/main writer (who is still MIA). Instead, Cast is headed by John Power, who played bass in the La's but here emerges as a songwriter and lead singer of considerable mettle. Though Power recaptures the La's' tunefulness and smarts, he does not try to recreate their sound. He sings less like Mavericks than like early-Seventies David Bowie (*Four Walls* seems so much like a "Hunky Dory" outtake that it fooled a Bowieophile I played it for). And while the La's favored two-minute songs

and a stripped-down, near-acoustic production, Cast goes for a large-scale sound that's drenched in late-Sixties psychedelia (courtesy of producer John Leckie of Stone Roses/XTC fame). In fact, the kick-off to the first track, *Alright* — a big stack of electric leads and Pete Townshend acoustic strums — is pure power-chord heaven.

There are other neat sonic tricks here, including a quasi-Eastern, Jimmy Page-era Yardbirds tone on some of the guitar leads (check the extended solo that closes *Two of a Kind*). Power's songs have a solid foundation — seldom deep but always intelligent, convincingly optimistic, and consistently catchy. Despite a pointless hidden track at disc's end, Cast's "All Change" stands as the second bright debut of Power's career.

*Brett Milano*

## CAST: All Change.

*Alright: Promised Land; Sandstorm; Mankind; Tell It Like It Is; Four Walls; Finetime: Back of My Mind; Walkaway; Reflections: History; Two of a Kind.* POLYDOR 529 312 (65 min).

## Beyond Gorecki's Symphony No. 3

**T**he Dutch-based Schönberg Ensemble under its music director, Reinbert de Leeuw, has given us an unsettling and eerily beautiful new CD that couples two works by Henryk Gorecki, the Polish master whose 1976 *Symphony of Sorrowful Songs* (Symphony No. 3) became an international bestseller in its Nonesuch recording. The Philips disc includes his *Lerchenmusik*, which dates from the mid-1980's, and *Kleines Requiem für eine Polka*, completed in 1993.

Although a literal translation of *Lerchenmusik* is "lark music," it has no avian connotation but refers to Lerchenborg Castle in Denmark, the site of a music festival whose patron, Louise Lerche-Lerchenborg, commissioned the work. The scoring is the same as for Brahms's Clarinet Trio (clarinet, cello, and piano), but what a difference in the musical content! Music of suspended animation is succeeded by outbursts that suggest the proverbial fire alarm in the night. Here and there I sensed echoes of Bartok and Messiaen, as well as Gregorian chant, especially in the second of the three movements. The most intensely expressive music comes in the last movement, where the opening of the Beethoven Fourth Piano Concerto seems to be lurking in the background and eventually manifests itself to singularly moving effect.

No less masterly is the more elaborate-

ly scored *Kleines Requiem für eine Polka*, which calls for a piano and thirteen other instruments. The opening slow movement hints of the *Dies Irae*. The sonorities and textures suggest bits and pieces of Arvo Pärt and Charles Ives. Things turn violent in the second movement, with horn fanfares and alarm bells. A lyrical episode is succeeded in due course by the "polka," which could have come out of Kurt Weill's *Mahagonny*. The *Adagio cantabile* finale is a poignant affair marked by a haunting horn solo that reminded me of

the concluding pages of the Ives Third Symphony.

De Leeuw, as conductor and piano soloist, presides over 67 minutes of wonderful musicmaking, and Philips has come up with a lovely church acoustic to contain and project the sound. This is deeply moving music — to be lived with and remembered.

David Hall

### GOECKI: *Kleines Requiem für eine Polka*; *Lerchenmusik*.

Harmen de Boer (clarinet); Larissa Groeneveld (cello); Reinbert de Leeuw (piano); Schönberg Ensemble, Reinbert de Leeuw cond. PHILIPS 442 533 (67 min).

JAAP DE JONG/PHILIPS CLASSICS



Reinbert de Leeuw: wonderful musicmaking

## NOW ON CD

### POPULAR

#### ENNIO MORRICONE: *Drammi Gotici* (Gothic Dramas).

DRG 32916. Music from a 1977 Italian TV horror series, and far bleaker than Morricone's more familiar work for the spaghetti westerns starring Clint Eastwood.

#### PATRICE RUSHEN: *Straight from the Heart*.

RHINO/ELEKTRA 73508. The 1982 album by the multi-instrumentalist and singer, featuring *Forget Me Not*.

#### THE SEARCHERS: *Take Me for What I'm Worth; It's the Searchers*.

MOBILE FIDELITY 667. The British Invasion band's first two albums on one disc, in their original U.K. configurations.

#### LESLIE WEST: *Mountain*.

COLUMBIA/LEGACY 66439. The guitarist's 1969 solo album, which also functioned as the debut



of his band of the same name with bassist Felix Pappalardi. Songs include early versions of Mountain tracks *Blood of the Sun* and *Long Red*.

### CLASSICAL

#### HANDEL: *Water Music; Concerti Grossi, Op. 6, Nos. 4 and 5*.

Concentus Musicus Wien, Nikolaus Harnoncourt cond. TELDEC 97987. "Harnoncourt and the Concentus Musicus Wien [set] a new standard and style in the performance of early orchestral music — pure in sound, vivacious, even passionate . . ." (March 1979).

#### HAYDN: "Paris" Symphonies.

Philharmonia Hungarica, Antal Dorati cond. LONDON 448 194 (two CD's for the price of one). "... dazzling technical prowess and seemingly limitless expressive sympathy" (February 1973).

#### SHOSTAKOVICH: *Symphony No. 5; The Age of Gold, Polka; Suite from "Michurin."*

USSR Symphony, Maxim Shostakovich cond. RCA VICTOR/MELODIYA 32041. "The orchestra is just a bit less polished but possibly more expressive in this music than some of its Western counterparts . . ." (October 1972).

#### VAUGHAN WILLIAMS: *Tallis Fantasia; "Greensleeves" Fantasia; Flos Campi; Five Variants of "Dives and Lazarus."*

Utah Symphony, Maurice Abravanel cond. VANGUARD SVC-43. "... affectionate and well-recorded performances" (August 1968).



# POPULAR MUSIC

NEW RECORDINGS REVIEWED BY CHRIS ALBERTSON, FRANCIS DAVIS,  
PHYL GARLAND, RON GIVENS, BRETT MILANO,  
ALANNA NASH, PARKE PUTERBAUGH, KEN RICHARDSON, & STEVE SIMELS

## ROSANNE CASH: 10 Song Demo.

CAPITOL 32390 (36 min).

Performance: Stripped down  
Recording: Ditto

The story goes that when Rosanne Cash and her husband, John Leventhal, submitted the rough recordings of her new album, Capitol liked them enough to release them exactly as they were. And so we have "10 Song Demo," an intimate package of confessional pop-rock songs recorded with the help of only three additional musicians. Sometimes, as in the opening *Price of Temptation*, where a stark piano fills in behind the voice, the accompaniment is given to only one instrument. The result is both a startlingly clean sound and a wonderful showcase for some breathtaking electric guitar solos, particularly in *Bells and Roses*.



Yet Cash's introspective and sometimes neurotic lyrics still hold center stage. Despite a new husband and a change of venue (she has now lived in New York for the last few years), she doesn't seem any happier for it. The album's opening lines — "Standing on the edge tonight / Don't know if I'll fall or fly" — set a mood that barely changes. As before, Cash balances staunch feminism (in *If I Were a Man*, she declares she'd "change the way the whole world thinks," and elsewhere again refers to God as "she") with sexual desire and vulnerability. In *Take My Body*, for example, she invites her partner to let it "be fuel for all your fantasies . . . while you're at it, let's

make it a national shrine." Then she says, perhaps tongue-in-cheek, that she doesn't have very much use for her body anymore anyway, even if "every curve is a path to my soul."

"10 Song Demo" bears some resemblance to Cash's gloomy 1990 album, "Interiors," but whereas that work was moody and atmospheric, the new album is a walk through an even more private chamber of Cash's troubled heart. Newcomers may find this rough sledding; tempos are almost unyieldingly slow and brooding, and anxiety and torpidness hang over the album like a shroud. It's as if Cash didn't sit down to actually write songs, but rather to dump out her psyche and fashion music around what fell out. How much you appreciate that depends on your devotion going in. *A.N.*

## STEVE EARLE: I Feel Alright.

WARNER BROS. 46201 (39 min).

Performance: More than alright  
Recording: Surprising

The news that Steve Earle feels alright, in itself reason to celebrate. After a stack of studio albums that helped reshape country music (and a glorious mess of a live disc), he did a David Crosby at the turn of the decade, nearly becoming a heroin casualty before heading to jail. Following "Train a Comin'," a low-key acoustic disc of songs from his backlog, "I Feel Alright" is Earle's real comeback album, so it's no surprise that it's being hailed as a masterpiece.

It's not a masterpiece, but it's still a proud addition to his catalog. The biggest left curve is the production, a low-tech, high-separation, half-acoustic sound that was cribbed either from mid-Sixties AM radio or from Tom Petty's last album. Lyrically, Earle pulls few punches: The title track and *You're Still Standin' There* both celebrate his survival while flipping the finger at friends who didn't stick around. *CCKMP* ("Cocaine cannot kill my pain") ranks as one of the frankest, least judgmental songs

about heroin addiction since Lou Reed abandoned the topic. *Valentine's Day*, one of Earle's few flat-out love songs, comes the closest to falling into sentiment, but his war-torn voice keeps it from going down too smooth.

So what's missing? Just the high-volume bravado of Earle's best album. "Copperhead Road," a disc that defied stereotype by proving that redneck rock could be done with as much intelligence as attitude. That sound turns up only once here, in *The Unrepentant*, an energizing outlaw ballad that sides with the bad guys. When Earle unites the bluster of old with the newfound depth of "I Feel Alright," then we can start talking masterpiece. *B.M.*

## BEN FOLDS FIVE.

PASSENGER/CAROLINE 9501 (46 min).

Performance: Ebony, ivory, Green Day  
Recording: Powerful

Imagine, if you will, a pianist who plays with the ferocity of Jerry Lee Lewis, the finesse of Elton John, and the brainy pop cunning of Todd Rundgren. Such an animal is Ben Folds, leader of the Ben Folds Five (actually a trio). Their eponymous debut is a white-knuckle ride up and down the keyboard — an unplugged one, that is, with nary a synth or any other gadget in sight. (There's no guitar either, although Robert Sledge's bass occasionally makes a fuzz-toned crawl in that direction, tonally and texturally filling in the sound.) Yet this group is more than just a piano-based Green Day: if they're punks, they're the kind who made it to class even if they did stay up all night practicing. Skeptics should proceed immediately to *Philosophy*, a statement of principle that rises to an instrumental boil as Folds quotes Gershwin before grinding to a halt in a cloud of dust and splintered keys.

Folds and company affectionately tweak the alternative world in *Underground* ("Hand me my nose ring / Show me the mosh pit"), a kind of Broadway show tune that percolates jauntily while psychoanalyzing the movement's misfit underpinnings.

## Marti Jones: Who's that girl?

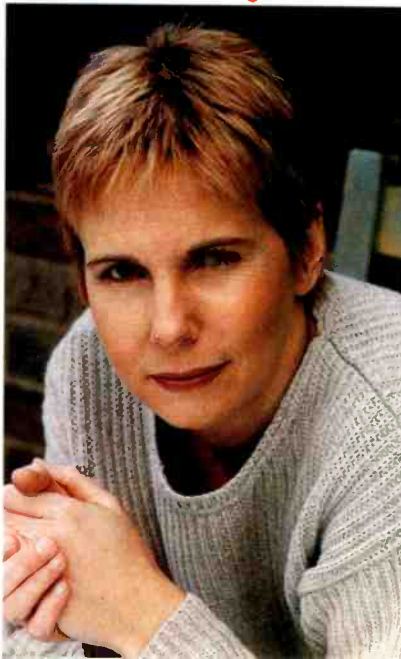

ANN CROCK/SUGAR HILL



JOHN FAUS/PASSENGER

**Ben Folds Five: world's biggest trio?**

Contempt for the smug and self-satisfied is dished out in *Sports & Wine*, a song you should play at the first opportunity for that certain obnoxious someone in your life. A split-second segue leads into yet another character study. *Uncle Walter*, about a bag of wind from another generation: "And he sees the children smoking pot / He knows that in a moment they'll be shooting up heroin / Teardrops in his armchair / A 50-minute lecture / Tobacco juice rolling down his chin." These irreverent musings are breathlessly yelped as the band frolics in its own alternative universe, where the tunes are usually uptempo, the playing is virtuosic, and the spirit is animated. Do not miss this record: It's the freshest thing I've heard in years. *P.P.*

**MARTI JONES: Live at Spirit Square.**  
SUGAR HILL 5502 (71 min).

**Performance: Definitive overview**  
**Recording: Excellent**

The new Marti Jones album is actually six years old, but after a hiatus triggered by motherhood and music-biz disenchantment, anything from this siren-voiced singer is welcome. Recorded in concert in Charlotte, North Carolina, in front of what amounted to a hometown crowd, "Live at Spirit Square" was originally conceived as a promo-only CD to help fan the flames for Jones's then-current album, "Any Kind of Lie." Instead, it languished in the vault, and now it serves as a career overview and a reminder of just how much Jones has been missed in this decade.

At the time of the recording, she had a simpatico ensemble, including bassist/producer/husband Don Dixon and guitarist Jamie Hoover (of the amazing Spongtones). The arrangements here are artfully uncluttered and classy, building on a rhythmic framework provided by Dixon, percussionist Jim Brock, and drummer Toni Wilhelm. Refreshingly, there is no stooping to the adolescent mindset (wrongly assumed to be the only target audience for rock that matters). A brace of Dixon/Jones originals, many from "Any Kind of Lie," are fleshed out with covers of Elvis Costello, John Hiatt, and others that demonstrate Jones's ability to claim a song as her own.

Peerless vocals, flawless playing, songs

that convey elevated sentiments, pure pop for now-and-then people — all that and more can be found on "Live at Spirit Square." *P.P.*

**BILL KIRCHEN: Have Love, Will Travel.**  
BLACK TOP 1130 (44 min).

**Performance: Head-turning**  
**Recording: Good**

Bill Kirchen is the man responsible for the high-powered guitar licks in Commander Cody and His Lost Planet Airmen's *Hot Rod Lincoln*. If you liked that, you'll be entranced by "Have Love, Will Travel" — a rip-roarin', impeccably played composite of rock, western swing, blues, rockabilly, twang, doo-wop, and R&B sealed with the personal stamp of a very funny if nerdy-bright guy. Whether he's pondering "Which Came First" — the heartache or the sad song — or steering home two oddball trucker's songs (*Womb to the Tomb*, a "dieselbilly" ghost saga, and *Nitro Express*, about trying to commandeer a runaway load), Kirchen is that rarest of breeds: a first-rate, serious axeman and a dyed-in-the-wool musical prankster. Chances are, you'll thank him for it. *A.N.*

**MARIA MCKEE: Life Is Sweet.**

GEFFEN 24819 (51 min).

**Performance: Stand back**  
**Recording: Very good**

"Life Is Sweet" is the breakthrough album for Maria McKee, a dizzying, soul-baring work that catches you up in the G-force of her insistent, confessional candor. McKee confronts and exorcises her demons in a suite of songs that unfurl with a bruising but liberating intensity. Make no mistake: This is her album. She wrote or co-wrote all the songs. She plays all but a handful of guitar parts and sings as if her sanity hangs in the balance. This isn't just some grungehead's fashionable and generalized disenchantment with the way the world works; McKee fearlessly deconstructs her own life with strokes both boldly hacked and finely etched.

Her agitation finds expression in restless songs that modulate uneasily and lash out when a Pandora's box of repressed memories is opened. Listen to the sudden surge in volume and intensity that turns *I'm Not Listening* from painful remembrance to primal scream. Like Marianne Faithfull or Yoko Ono, McKee strips back layers to expose the hidden kernel of pure, unadulterated feeling. The little-girl voice of *Everybody* bears a child's hopeful wish — "Everybody, everybody gets to be somebody sometime / Maybe tomorrow" — while the music paints a bright, pop-hued rainbow around her. The ghosts of family members and childhood traumas haunt songs like *Smarter* and *Human*, which describe cycles of compulsive and codependent behavior while rising to emotional and musical crescendos that are like a bloodletting.

"Life Is Sweet" is not an easy album to listen to: it couldn't have been an easy one to make. All the same, it is a brave and thrilling one, suffused with the will to rise above and rebuild a scarred life. *P.P.*

**THE MOOG COOKBOOK.**

RESTLESS 72914 (45 min).

**Performance: Necessary**  
**Recording: Whiz-bang**

Somebody had to do this sooner or later: alternative rock's greatest hits rendered in the style of those tacky, instrumental Moog albums that were briefly the rage in the Seventies. In fact, this sort of thing has been done before: Devo used to release easy-listening versions of its own songs, and Seattle musician Sarah DeBell scored a recent cult hit with the CD "Grunge Lite." But neither of those projects had the delicious nastiness of "The Moog Cookbook," which takes ten sacred-cow songs down a few pegs.

Soundgarden's *Black Hole Sun*, for instance, becomes an unholy cross of generic bossa nova and the theme to the old *Dating Game* TV show, while the deep brooding of Tom Petty's *Free Fallin'* gets trashed via robot vocals and some Rick Wakemanesque keyboard flourishes. Even less mercy is shown R.E.M.'s *The One I Love* and Green Day's *Basket Case*, both of which come out sounding like space-age bachelor-pad music gone horribly wrong. The most deserving target, Lenny Kravitz's *Are You*

**THE DISCONTENT OF OUR WINTERS**

Talk about our over-litigious society: Now comes word that Johnny and Edgar Winter, America's best-loved albino twin-brother rock stars, are suing DC Comics. Seems the Winters took exception to two suspiciously familiar-looking bad guys featured in



**EDGAR WINTER**



**JOHNNY WINTER**



**EDGAR AUTUMN**



**JOHNNY AUTUMN**

DC's recent *Jonah Hex* mini-series, who (1) are albino twin brothers named Johnny and Edgar Autumn, (2) are half-human/half-worm, and (3) apparently have sex with barnyard animals. Hey, dudes, where's your sense of humor? *S.S.*

# POPULAR MUSIC

*Gonna Go My Way?*, gets a polka treatment that's only slightly more ridiculous than the original.

"The Moog Cookbook" makes more sense when you realize that one of its perpetrators is Roger Manning, former frontman of Jellyfish, a band that made two good albums of ornate pop in a Queen/Wings vein before grunge came along and rendered such music hopelessly unhip. Many of the songs here are the very ones that knocked Jellyfish off the radio and the charts, so consider this Manning's way of getting even. *B.M.*

## LINDA RONSTADT:

**Dedicated to the One I Love.**

ELEKTRA 61916 (47 min).

**Performance: Spreading fairy dust**

**Recording: Better than needed**

Is this some kind of a joke? Linda Ronstadt beaming down a collection of rock, pop, and other classics (such as *Be My Baby*, *In My Room*, *We Will Rock You*, the Brahms "Lullaby," and Snow White's *Good Night*) while fronting what sounds like a choir of angels? And singing them all in a breathy, airy whisper? Imagine music for a David Lynch kiddie movie — synthesizers weaving cotton-candy instrumental beds, a feather to everybody's lips, the audio level nearly quiet as a tomb. Quick, somebody wave the magic wand! The fairy princess has flipped her wig! *A.N.*

## STEELEYE SPAN: Time.

SHANACHIE 79099 (59 min).

**Performance: Fresh**

**Recording: Full-bodied**

## MADDY PRIOR AND THE CARNIVAL BAND: Hang Up Sorrow and Care.

PARK 31 (57 min).

**Performance: Merrie**

**Recording: Intimate**

Speaking of "Time," Steeleye Span has been delving into traditional British folk music for 27 years now, and the band's latest album shows none of its strengths diminished. Whether setting age-old stories to new tunes (such as *The Prickly Bush*, a tale previously adapted by Led Zeppelin as *Gallows Pole*) or writing original material (*You Will Burn*, a chilling account of a witch hunt), Steeleye can still span the centuries with both reverence and a modern kick. Longtime guitarist Bob Johnson and violinist Peter Knight are present, and the album marks the return of original singer Gay Woods, whose huskier voice blends and contrasts nicely with the purity of the band's other founding vocalist and one constant member, Maddy Prior.

Those yearning for more Maddy are directed to "Hang Up Sorrow and Care," her fourth outing with the Carnival Band, here in a joyous program of songs dating back as far as 1597. Ballads and dances to the heart and the bottle are expertly played in a trad setting that features such instruments as lute, recorder, hoboy, curtal, kazoo, and "ye great dooble bass." Add to that Prior's chiming vocals in lines like "Oh! that I had but a fine Man / A sweet Man / A dainty Man / And a spicy one," and you under-

stand why this album is subtitled "A Cure for All Melancholy." (Available from Park Records, P.O. Box 391887, Cambridge, MA 02139.) *K.R.*

## TINY TIM

**WITH BRAVE COMBO: Girl.**

ROUNDER 9050 (44 min).

**Performance: A little too campy**

**Recording: Fine**

Okay, stop snickering. Yes, this is that Tiny Tim — the *Tip-Toe Thru' the Tulips with Me* guy who got married in front of Johnny Carson and several other attendants from coast to coast back in 1969. But this isn't the same guy who became the butt of innumerable jokes through his fey courting, wooing, and wedding of the enchanting Miss Vicki. At least, it's not *exactly* the same guy.

Yes, we get some unreconstructed campiness here, particularly in the remakes of the Beatles' *Girl* and Led Zeppelin's *Stairway to Heaven*. The point of those numbers seems to be the contrast between Tim's "unhip" vocal stylings and the "hip" material, and sometimes the stuff works. Even better, though, are the tunes where Tim gets to strut his old-fashioned, Tin Pan Alley sensibilities — not to mention his natural, non-falsetto vocal range — without post-modern compromises.

That's the difference, by the way, between Tim and Brave Combo: He never looks before he leaps into absurdity, whereas the band members always make it clear they are more sophisticated than any of their material. When Tim puts all of his



Rudy Vallee heart into a song like *That Old Feeling*, there's a charm that goes well beyond the gimlet-eyed irony of the backing vocals. And his crooning in *Stardust*, with staccato vibrato, has a sweetness that is undercut by the gimmicky synth accents of the band.

Of course, Tim can be unabashedly corny to the point of embarrassment, but there is something wonderful about his old-timey performances. Maybe he's a relic, a throwback to a time when Jolson was king, but Tiny Tim is never as affecting as when he's left to his own devices. *R.G.*

## DON WALSER: Texas Top Hand.

WATERMELON 1048 (41 min).

**Performance: A big Texas howdy**

**Recording: Good**

Sixty-one-year-old Don Walser, who began his full-time country music career only after retiring from the National Guard, is the genuine article, a honky-tonk king one newspaper wit dubbed "the missing

link between Buddy Holly and the Butthole Surfers." On his second album, "Texas Top Hand," he weds his expressive tenor to big-band accompaniment (assembled by producer Ray Benson) and tackles a variety of material, from his own tunes to numbers by Hank Williams, Faron Young, Bob Nolan, and Merle Travis. Walser has Grade A taste, and he can sell a song as well as anyone going — but no one can moan *Weary Blues*



from *Waiting* with the bone-numbing dread of ole Hank, and the world doesn't need yet another recording of *Divorce Me C.O.D.*, even if Benson's pickers do dress it to the nines. What the world does need is more original songs like *Signposts of Life*, *You Walk By*, and *Texas Top Hand*. A guy like Don Walser should come across exactly as what he is: a yodeling iconoclast of the highest order. *A.N.*

## PETER WOLF: Long Line.

REPRISE 46199 (47 min).

**Performance: Comeback time**

**Recording: Live-sounding**

If you're looking for a nonstop party album in the old J. Geils Band vein, this isn't it. Instead, "Long Line" is a gutsy comeback for Geils frontman Peter Wolf after six years without a record deal and after an apparent heartbreak or two. The opening title song finds Wolf announcing that "I been tossed around and twisted up, I'm on the outside looking in," and it sets the tone — both for its semi-acoustic setting and for its grizzled-survivor theme.

The music is usually closer to Van Morrison's neighborhood than to the Geils Band's. The token rocker *Sky High* proves that Wolf can still sing in his familiar style, but it's the slower numbers here that bring out his best efforts: check the whispered final verse of the countryish *Wasted Time* or the late-night ballad treatment of *Two Loves*. An uncluttered live-band sound is used nearly throughout, and the one departure — *Riverside Drive*, a hip-hop number with some jazz overtones — is just weird enough to work.

Co-written with various collaborators, Wolf's new tunes show sides of his personality that didn't come out before — more vulnerable in the ballads, flat-out romantic in *Seventh Heaven*. With the songwriting help of ex-girlfriend Aimee Mann, he also gets good and cynical on a pair of deceptively sweet-sounding pop tunes. But even in the album's heavier moments — notably *Romeo Is Dead*, an R&B number full of foreboding — Wolf still throws in the occasional "ooh, yeah!" to let you know it's still the same guy. *B.M.*



# POPULAR MUSIC



## JAZZ

**ALLAN CHASE QUARTET:**  
**Dark Clouds with Silver Linings.**  
ACCURATE 5013 (61 min).  
**Performance:** Airy and unfettered  
**Recording:** Excellent

Pianoless quartets might not be the novelty they once were, but here's a reminder that the format offers the dual advantages of unfettered blowing opportunities for the horns and a light and airy texture for the listener — all by virtue of suppressing harmony in favor of melody and rhythm. In addition to interacting nicely with trumpeter Ron Horton, bassist Tony Scherr, and drummer Matt Wilson, Allan Chase — a member of the too modestly named Your Neighborhood Saxophone Quartet — has chosen a refreshing program of tunes, beginning with a title track from Sun Ra (an uncharacteristically straightforward, faintly sentimental ballad) and ending with an original that bounces cagily along like something by Thelonious Monk. In between are a number of surprising standards (including a veering and abstract *Poinciana*) and two items by Bud Powell. With its hypnotic ostinato, Powell's *Comin' Up* elic-

its the friskiest improvisations from Chase and Horton. Everything here, though, is topnotch. *F.D.*

**JEANNIE AND JIMMY CHEATHAM AND THE SWEET BABY BLUES BAND: Gud Nuz Bluz.**

CONCORD 4690 (57 min).  
**Performance:** Irresistible  
**Recording:** Good

“**G**ud Nuz Bluz” is the Sweet Baby Blues Band's eighth album in 11 years. Co-led by bass trombonist Jimmy Cheatham and his pianist/singer wife, Jeannie, the group may seem anachronistic at first earful, but the appeal of its happy blend of Kansas City-style romps and blues easily spans generation gaps.

As on the Cheathams' past albums, “Gud Nuz Bluz” features a guest musician and ends with everybody in and around the band being recruited for the vocal chorus. The guest here is Plas Johnson, a solid sax player probably best known for his whimsical tenor work on Henry Mancini's *Pink Panther* film score. Jimmy Cheatham's tight and often richly textured arrangements reflect his vast listening and writing experience, and Jeannie's sometimes sobbing, sometimes growling vocals fit them to a tee. In keeping with the modus operandi, several of the tunes were penned by Jeannie. This time, my favorite Cheatham opus is *A Few Good Men* — a call to arms, as it were. This is music for any time zone. *C.A.*

**BENNY GOLSON: I Remember Miles.**  
EVIDENCE 22141 (64 min).  
**Performance:** sMiles  
**Recording:** Excellent

**T**enor saxophonist Benny Golson made this mark some 36 years ago when he and Art Farmer co-led the Jazztet, a group that also featured bassist Addison Farmer and trombonist Curtis Fuller. The latter is also on hand for “I Remember Miles,” a memorable tribute to the enigmatic musician, recorded in 1992. Eddie Henderson's muted trumpet lends a Miles-ish flavoring, while a solid rhythmic foundation is laid down by pianist Mulgrew Miller, drummer Tony Reedus, and bassist Ray Drummond. But it is Golson who shines brightest here. Most leaders tend to hog the solo spots, but not Golson — and when he does step forward, he communicates with characteristic grace, authority, and good taste. *C.A.*

**CHARLIE HADEN/QUARTET WEST:**  
**Now Is the Hour.**  
VERVE 529 827 (60 min).  
**Performance:** Lustrous  
**Recording:** Excellent

**B**assist Charlie Haden and Quartet West — featuring tenor saxophonist Ernie Watts, pianist Alan Broadbent, and drummer Larance Marable — continue their investigation of American postwar optimism and romantic discontent, with a French string section taking the place of phantasmagoric vocals this time. Moody but hardly

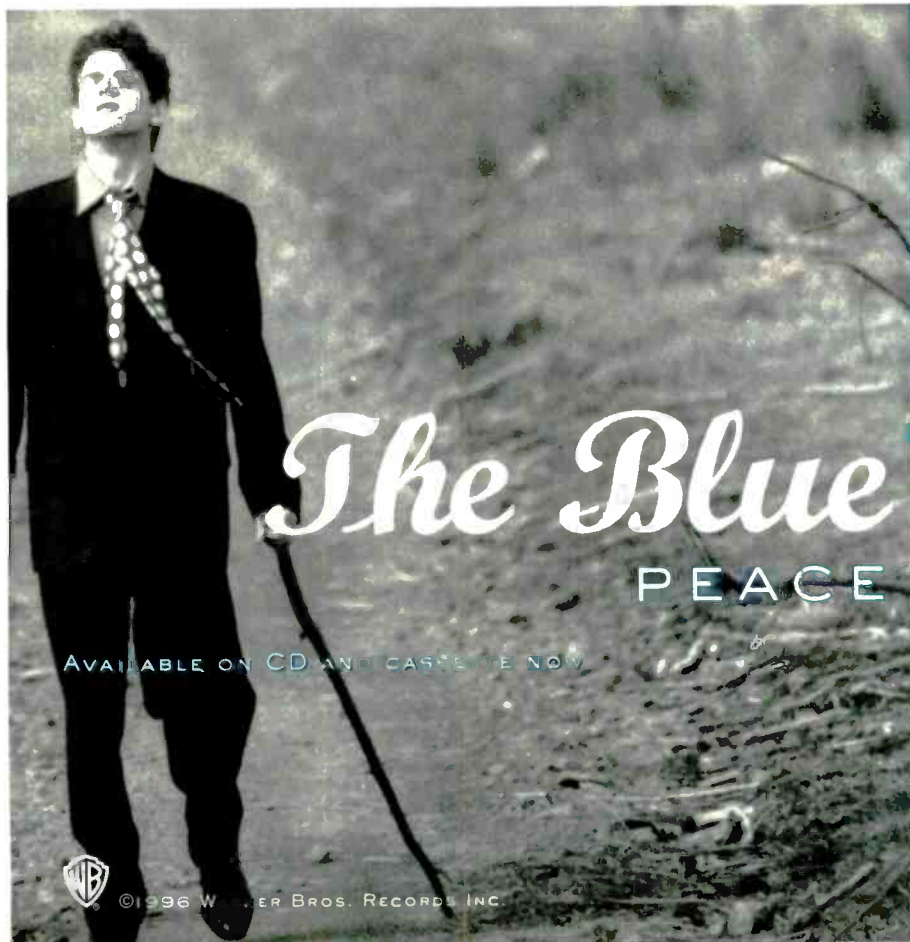

# The Blue Nile

## PEACE AT LAST

AVAILABLE ON CD AND CASSETTE NOW



©1996 WARNER BROS. RECORDS INC.

AN ASTUTE CRITIC FROM THIS VERY PUBLICATION ONCE SAID OF THE BLUE NILE: “I HAD NEVER HEARD SUCH PURE, DESPERATE FEELING ON A RECORD BEFORE.”



# MUSIC WORLD®

**Super Specials!**  
CALL TO ORDER  
OTHER MOVIE TITLES

### Laser Discs



**Braveheart**  
PIONEER  
\$44.99 LASER DISC  
LTX, THX, AC3

Also on Laser Disc:

- Seven, LTX, AC3 ..... \$44.99
- Under Siege 2 - Dark Territory, LTX ..... \$29.99
- Usual Suspects, LTX ..... \$34.99
- Crimson Tide, LTX, THX, AC3 ..... \$39.99
- Die Hard With A Vengeance, LTX, THX, AC3 ..... \$44.99
- Waterworld, LTX, THX ..... \$39.99
- Batman Forever, LTX ..... \$34.99
- Star Trek Movie Voyages Letterboxed Collection with all Star Trek features including "Generations" ..... \$199.99

### Hi-Fi Stereo VCRs

#### JVC



**JVC HR-VP628U VHS Hi-Fi Stereo Recorder**  
•4-heads •VCR Plus+ with Multi-System cable box controller •Jog/shuttle on unit & remote •Digital AV tracking •1-yr. 8-event programming  
Mfr. Sug. Retail \$499.95  
Our Low Price **\$299.95** (JVC HRVF628)

**Samsung VR8605** ..... \$199.95  
•4-heads, 8-event/1-month timer

**Panasonic AG-2540** ..... \$329.95  
•4-heads, jog/shuttle, industrial quality

**JVC HR-VP720** ..... \$349.95  
•4-heads, VCR Plus+, jog/shuttle, insert editing

**Toshiba M-761** ..... \$389.95  
•6-heads, VCR Plus+, universal remote

**Samsung VR-8905 Top Rated** ..... \$399.95  
•4-heads, jog/shuttle, StarSight TV program guide

**Sony SLV-940HF** ..... \$399.95  
•4-heads, VCR Plus+, shuttle control

### S-VHS Hi-Fi Stereo VCRs/Laser Disc

#### JVC



**JVC HR-S7100 S-VHS Hi-Fi Recorder**  
•VCR Plus+ with multi-system cable box controller •Jog/shuttle remote control with illuminated buttons •Random assemble & insert editing  
Mfr. Sug. Retail \$1099.95  
Our Low Price **\$499.95** (JVC HRS7100)

**RCA VR721HF** ..... \$399.95  
•4-heads, jog/shuttle, VCR Plus+

**Panasonic PV-S4566** ..... \$399.95  
•4-heads, VCR Plus+, tri-lingual on-screen

**Panasonic PV-S4580** ..... \$799.95  
•VCR Plus+, assemble-editing

**Panasonic AG-1980** ..... \$1269.95  
•Pro model, digital TBC, insert/assemble editing

**Sony SL-VR1000** ..... CALL  
•VCR Plus+, cable box control, adaptive picture control

**Panasonic LX-H670** ..... \$399.95  
•Laser Disc Player, auto-rew. play, remote

### Camcorders

#### Panasonic



**Panasonic PV-IQ505 VHS-C Palmcorder IQ Camcorder**  
•Color viewfinder •Digital EIS compensates for unwanted hand movements •Digital zoom with viewfinder display •Built-in light •14:1 4-speed zoom, 20:1 digital zoom  
Our Low Price **\$699.95** (PAN PVIQ505)

**Sony CCD-TR82** ..... \$549.95  
•8mm, Steady Shot, 12x zoom

**Sharp VL-E37** ..... \$599.95  
•8mm ViewCam Camcorder, 3" Color LCD Screen

**JVC GR-SZ7** ..... \$899.95  
•S-VHS C, 12:1 optical/20:1 & 100:1 digital zoom

**Canon ES-5000** ..... \$1699.95  
•Hi-8mm, 20x lens w/ 40x digital zoom

**Panasonic AG-456U** ..... \$1799.95  
•S-VHS, Pro Model, 12x zoom, built-in speaker

**Sony CCD-TRV70** ..... CALL  
•Hi8™, 12x-optical/24x-digital zoom, 4" color monitor

### DJ Equipment



**Gemini CD-9500 Professional Double CD Player**  
•Pro features instant start, cue to music, jog wheel (forward/reverse at 6 different speeds), variable pitch (+/-8%) & pitch bend •8x oversampling •Wired remote  
Our Low Price **\$728.95** (GMI CD9500)

**NESS PS38** ..... \$23.95  
•Professional Spotlight

**Gemini PMX-15A** ..... \$118.95  
•Scratchmaster DJ Mixer, removable fader

**Gemini FG-2000** ..... \$148.95  
•Professional Compact Fogger

**Audio Technica AM200** ..... \$149.95  
•DJ Mixer, sound effects generator

**Gemini KM-707** ..... \$498.95  
•Preamp/Mic, Mixer, Karaoke features

**Pioneer CDJ-500II** ..... CALL  
•DJ CD Player, jog dial, tempo control

### Universal Remotes/Antennas

#### SONY



**Sony RM-V11 Universal Remote Control**  
•Control TV, VCR & cable box •Pre-programmed codes of most ma or brands •Includes des-c-top stand •Requires 2 "AA" batteries (not included)  
Our Low Price **\$14.95** (SON RMV11)

**One For All URC-2099** ..... \$19.95  
•Universal Remote, replaces 4 units, preprogrammed

**Sole Control SC460** ..... \$24.95  
•Universal Remote, for up to 6 units, OSS control

**Recoton V-900SX** ..... \$79.95  
•Wireless Video Sender, VCR - TV without cable

**Terk TV15** ..... \$29.95  
•TV antenna, pin-dot pre-tuning, frequency matching

**Recoton TV800** ..... \$79.95  
•Amplified TV(UHF/VHF) & FM Stereo Antenna

**Terk AM-FM Q** ..... \$79.95  
•Powered Indoor Stereo AM/FM Antenna

### Portable CD Players

#### Panasonic



**Panasonic SL-SW404 Portable CD Player**  
•SHOCKWAVE concept water resistant with tough body •10-sec. anti-shock memory •MASH 1-bit DAC •XBS bass •24-track programming •AC adaptor & headphones  
Our Low Price **\$229.95** (PAN SLSW404)

**Panasonic SL-S140** ..... \$79.95  
•24-track programming, headphones & AD adaptor

**Sony D-153** ..... \$99.95  
•Rechargeable Discman, headphones

**Panasonic SL-S240** ..... \$119.95  
•3-sec. anti-shock memory, headphones, AC adaptor

**Sony D-242CK** ..... \$149.95  
•Car Discman with 3-sec. ESP (anti-shock)

**Aiwa XP-R800** ..... \$179.95  
•CD player/digital AM/FM tuner, 3-sec. ESP

**Sony D-848K** ..... \$249.95  
•Car Discman with 3-sec. ESP, interactive remote

### Headphones

#### SONY



**THE CLASSICS ARE BACK!**

**Sony MDR-V6 Monitor Quality Headphones**  
•Enclosed ear design •Lightweight & very comfortable •Uni-Match™ plug for use with both home & personal stereo listening •Great for demanding digital sources  
Our Low Price **\$69.95** (SDN MDRV6)

**Koss PortaPro** ..... \$39.95  
•Lightweight, adjustable headband dual plugs

**Sennheiser HD414 Classic** ..... \$49.95  
•50th Anniversary Open-Air® Special Edition

**Koss Pro 4AA** ..... \$89.95  
•Studio Pro Headphones, Closed-ear

**Beyerdynamic DT990 Pro** ..... \$129.95  
•Pro quality, lightweight, great bass!

**Sony MDR-V900** ..... \$179.95  
•Circumaural Digital monitor, UniMatch™ Plug, case

**Sennheiser HD580** ..... \$279.95  
•Audiophile precision, Circumaural, TOP RATED

### Turntables/Phono Preamp

#### THORENS



**3-SPEEDS 33-45-78**

**Thorens TD180 3-Speed Belt Drive Turntable**  
•33 45 78 rpm •Automatic shut-off & auto-retract •Synchronous motor •Adjustable anti-skating •External power supply •Includes Stanton cartridge  
Mfr. Sug. Retail \$429.95  
Our Low Price **\$299.95** (THN 180)

**TEAC P-595** ..... \$89.95  
•Semi-Auto Turntable, belt-drive, with cartridge

**TEAC PA-400** ..... \$109.95  
•Mini-size Turntable, built-in phono preamp & cartridge

**Technics SL-BD22K** ..... \$154.95  
•Semi-auto, belt-drive, pitch control

**Gemini XL-DD50IV** ..... \$248.95  
•DJ Manual Turntable direct-drive, pitch control

**Technics SL-1200II** ..... \$499.95  
•Manual Direct Drive, for DJs Pro, pitch control

**Music Hall MMF-1** ..... \$99.95  
•Phono Preamp, connects to line-level input

### Phono Cartridges

#### audio technica



**Audio Technica DC30 Phono Cartridge**  
•Universal mount •0.3 by 0.7 mil elliptical stylus •10Hz-27KHz frequency response •1.0 to 1.5 grams tracking force  
Our Low Price **\$29.95** (AT DC30)

**Stanton L500AL** ..... \$24.95  
•P-mount, for DJs, spherical stylus

**Shure SC35C** ..... \$39.95  
•Standard mount, for pro use, spherical stylus

**Audio Technica AT-316EP** ..... \$39.95  
•Universal mount •Spherical stylus

**Stanton 680EL** ..... \$79.95  
•Standard mount, for DJs, includes extra stylus

**Audio Technica AT-440ML** ..... \$99.95  
•Standard mount, MicroLine™ stylus

**Ortofon CCDJ5** ..... \$129.95  
•Geminate DJ Cartridge Headshell, spherical, extra stylus

Get our **FREE** mail order catalogues now!



ORDER TOLL-FREE 24 HOURS, 7 DAYS A WEEK  
**800-221-8180**

**ASK ABOUT OUR EXTENDED WARRANTY CALL US TOLL FREE FOR ITEMS NOT LISTED IN THIS AD**

**TO ORDER BY MAIL:** SEND MONEY ORDER, CERTIFIED OR CASHIER'S CHECK, MASTERCARD, VISA AMERICAN EXPRESS OR DISCOVER CARD (Include Interbank No. expiration date & signature) To: J&R MUSIC WORLD, DEPT. SR0796, 59-50 QUEENS-MIDTOWN EXPRESSWAY, MASPETH, QUEENS, NY 11378. Personal & business checks must clear our Authorization Center before processing. Shipping, handling & insurance charge (for Continental US) is 5% of total order with a \$4.95 minimum for orders up to \$500; 4% for orders over \$500 to \$1000; 3% for orders over \$1000. For heavy/oversized items, shipments by air, or to Canada, Alaska, Hawaii, Puerto Rico or Virgin Islands please call for information. DO NOT SEND CASH. Sorry, no COD's. NY residents, please add sales tax. ORDERS SUBJECT TO VERIFICATION & ACCEPTANCE. SOME QUANTITIES MAY BE LIMITED. NOT RESPONSIBLE FOR TYPOGRAPHICAL OR PICTORIAL ERRORS. ALL MERCHANDISE SHIPPED BRAND NEW, FACTORY FRESH, AND 100% GUARANTEED. Copyright 1996 J&R Music World



# ABSOLUTE Sound Decisions

OVER THE PAST 10 YEARS, WE HAVE BEEN SELLING AND INSTALLING SOME OF THE BEST MID & HIGH END HOME THEATER SYSTEMS IN THE NEW YORK METRO AREA...NOW WE BRING OUR EXPERTISE TO THE REST OF THE COUNTRY!

SPECIALIZING IN  
DOLBY, THX, AC3 SURROUND SYSTEMS

COMPLETE THX SYSTEMS FROM

**\$2599**

COMPLETE AC3 SYSTEMS FROM

**\$2999**

VMPS...One Of The World's  
Finest Audio Speakers

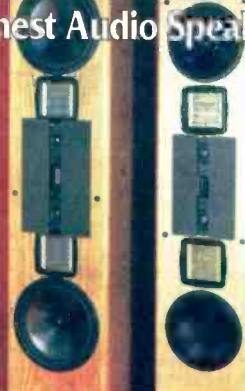

JAMO...The World's Finest  
THX System



AUTHORIZED DEALER FOR OVER 200 BRANDS OF  
SPEAKERS AND ELECTRONICS INCLUDING PROJECTORS  
FREE DELIVERY — FREE IN-HOME CONSULTATION  
FULL MFG'S. 5-YEAR PARTS/LABOR WARRANTY

1-800-689-7236

## POPULAR MUSIC

### QUICK FIXES

#### JUNIOR BROWN: *Semi-Crazy*.

MCG/CURB 77843 (35 min).

Country musician Brown is an off-the-wall songwriter, a gonzo vocalist, and an instrumentalist to knock your socks off. On "Semi-Crazy" he segues from serious heartbreak ballads to clever novelty numbers, with stops at rockabilly, honky-tonk, surf, and even Hoagy Carmichael. In an era when country is dominated by cookie-cutter acts, Brown not only breaks the mold — he eats it. *A.N.*

#### LAIKA AND THE COSMONAUTS:

##### *Zero Gravity*.

UPSTART 006 (37 min).

Vintage tracks from 1988 and 1990 by the world's greatest Finnish surf-music combo. The production isn't quite as cinematically lush as in Laika's more recent



"Amazing Colossal Band," but frankly, you haven't lived until you've heard the twang-bar take on *A Night in Tunisia*. Hang ten, Dizzy! *S.S.*

#### NOIRIN NI RIAIN: *Celtic Soul*.

LIVING MUSIC 31 (55 min).

Ni Riain's clear soprano evokes tradition and the unpolluted bogs of old Ireland. The backing by the Paul Winter Consort gives her work a contemporary feel, and extra universality is added by a couple of songs from India. Singing in Gaelic and Hindi, Ni Riain is convincing in her search for truth and purity. *William Livingstone*

#### NRG ENSEMBLE: *This Is My House*.

DELMARK 485 (67 min).

The death of leader Hal Russell hasn't silenced the NRG. The emphasis remains on simultaneous saxophone eruptions, with Ken Vandermark going against Mars Williams as fiercely as Russell used to. And the rhythm section remains unexcelled at demonstrating the applicability of rock-and-roll's bump to free jazz. *F.D.*

#### BILLY SQUIER: *Reach for the Sky: The Anthology*.

POLYGRAM/CHRONICLES 529 296

(two CD's, 158 min).

Time was, Squier's aching voice could steal a girlfriend — and his whipcrack

guitar could give a guy ample compensation. Both sexes stopped paying attention after 1984's "Signs of Life," but "Reach for the Sky" proves that Squier's career is

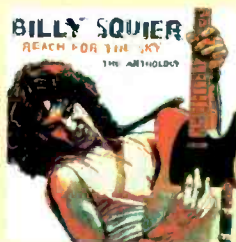

as deep as it is long. Sell that Capitol knockoff from last year ("16 Strokes," sheeeesh) and buy this generous, well-annotated, better-sounding set. *K.R.*

#### VOICE OF THE BEEHIVE:

##### *Sex & Misery*.

DISCOVERY 77036 (46 min).

Initial signs aren't promising: The two American sisters who keep Voice of the Beehive have lost their Brit-guitar backup, the opening songs of "Sex & Misery" are too damn rubbery, the sound is often heavy with producer Peter John Vettese's keyboard hooey, and Melissa Belland is now going by the name of "Missy." But the heart of the album shows that Tracey Bryn Belland can still write smart pop — and choose co-writers as neat as Andy Partridge and Zodiac Mindwarp. It's no "Let It Bee," old fans, but the band remains worth following. *K.R.*

#### DEAD MAN WALKING: *THE SCORE* (original motion-picture soundtrack).

COLUMBIA 67637 (60 min).

This is the film's incidental music — not to be confused with the collection of its rock-oriented songs. Composer/guitarist David Robbins has welded musical elements from Russia, Ireland, Armenia, and India, with Pakistani Sufi chanting predominant, and it's all a cut above most world-music fusions. The many excellent performers include Nusrat Fateh Ali Khan, Eddie Vedder, Ry Cooder, and Amina Annabi. *W.L.*

#### THE BEST OF THE NATIONAL LAMPPOON RADIO HOUR.

RHINO 72263 (three CD's, 200 min).

Before there was *Saturday Night Live* there was *The National Lampoon Radio Hour*, a syndicated show (originally aired between 1973 and 1975) featuring an astonishing array of soon-to-be-famous comic talent: John Belushi, Chevy Chase, Bill Murray, Gilda Radner, Billy Crystal, Harold Ramis, Richard Belzer, Joe Flaherty, Christopher Guest, and scads of others. Some of the sketches have necessarily dated, but most of them remain savage and hilarious, and Rhino has packaged the set with its usual encyclopedic thoroughness. Essential. *S.S.*

a "mood" album, "Now Is the Hour" is the opposite of those many jazz albums a reviewer dutifully listens to from beginning to end and then, a few weeks later, can't remember if he's ever heard. Like Haden's "Haunted Heart" and "Always Say Good-bye," this one stays with you largely on the strength of its sensibility, equal parts bebop and Bogart. Broadbent's sophisticated string arrangements give his and Haden's distinguished ballads the power and luster of the best movie scores, and the stringless reinterpretations of Charlie Parker, Bud Powell, and Lee Konitz come close to capturing the careening angularity of the originals. This is a band with an identity, one whose every release is well worth hearing. *F.D.*

**HERBIE HANCOCK:**

**The New Standard.**

VERVE 529 584 (72 min).

**Performance:** Back on track

**Recording:** Excellent

I was dismayed when Herbie Hancock seemed more intent on running up his electric bill than making good music. But I never gave up on him. He made occasional amends with the V.S.O.P. group — and now he has really shaped up. While "The New Standard" is not as pure as anything by V.S.O.P., it demonstrates that jazz does not have to be sacrificed when flirting with pop.

Hancock sparkles in Stevie Wonder's *You've Got It Bad Girl*, creating a blur over the keyboard as bassist Dave Holland and

drummer Jack DeJohnette come to a full boil. Michael Brecker's tenor takes charge after that, but he seems less inspired on Sade's *Love Is Stronger Than Pride*. Simon and Garfunkel's *Scarborough Fair* has Brecker back in line form, along with guitarist John Scofield. Prince's *Thieves in the Temple* is dominated by Brecker's tenor shrieks and Scofield's guitar twang, and Nirvana's *All Apologies* becomes a throbbing blues for which no apologies are needed. That goes for the entire album. *C.A.*

**NICHOLAS PAYTON: Gumbo Nouveau.**

VERVE 531 199 (57 min).

**Performance:** Often interesting

**Recording:** Quite good

For his second Verve album, trumpeter Nicholas Payton offers tunes he grew up hearing in his hometown of New Orleans. The idea was to take old material, including Crescent City classics, and present it in modern dress. Not an original concept, but it has its merits — and it often works on "Gumbo Nouveau."

The opening track, *Whoopin' Blues*, is a basic blues tune in a mundane arrangement, but there are noteworthy solos by Payton, alto saxophonist Jesse Davis, and tenor saxophonist Tim Warfield. The sextet's treatment of *When the Saints Go Marching In* shows more imagination — so much, in fact, that the song is mercifully difficult to recognize until the very end. Another standby, *Way Down Yonder in New Orleans* (p-

dated exquisitely in 1938 by Lester Young with the Kansas City Six, on Commodore), gets a stunning makeover that brings it into the Coltrane Era.

Payton plays with authority and flair throughout the set. Yes, some of the charts are pedestrian, and tunes like *Down in Honky Tonk Town* are best left there, but "Gumbo Nouveau" demonstrates that Payton is a gifted musician capable of powerhouse performances. *C.A.*

**STRING TRIO OF NEW YORK:**

**Blues . . . ?**

BLACK SAINT 120148 (54 min).

**Performance:** "A"-list chamber jazz

**Recording:** Good

Whether performing its members' open-ended originals or interpreting idiomatic material as unlikely as Lee Morgan's *Speedball*, the String Trio of New York here proves itself to be the most cohesive chamber-jazz unit this side of the Modern Jazz Quartet. Violinist Regina Carter blends handsomely with charter members James Emery (guitar) and John Lindberg (bass) and also contributes the program's most diverting original, the stop-and-start, vaguely Eastern European *Hurry Up and Wait*. Here's hoping the group's next release includes the ambitious work it commissioned from Anthony Davis and performed with him on tour along with breathtaking interpretations of Ellington and Monk. Until then, this will do nicely. *F.D.*

Stunning!

That's the word being used to describe the sound and performances on these two new discs from Blue Note.

RECORDED BY MARK LEVINSON WITH THE CELLO RECORDING SYSTEM  
THESE TWO SESSIONS CAPTURE SOME OF THE MOST TALENTED PLAYERS IN JAZZ AT THEIR SONIC AND MUSICAL PEAKS.



JACKY TERRASSON  
"REACH"  
#35739

The most interesting pianist in jazz raises the stakes for all trio records to come.

With bassist Ugonna Okegwo and drummer Leon Parker.

Winner Grand Prix Du Disc, France's highest recording honor.



THE CARNEGIE HALL JAZZ BAND,  
JON FADDIS MUSIC DIRECTOR  
#36728

"I've never heard big band jazz recording even close to this one. It's a religious experience"  
-JON FADDIS

"Guaranteed to push any system to its outer limits...and then some"  
-MARK LEVINSON

BORDERS  
BOOKS • MUSIC • CAFE



# 6<sup>th</sup> AVE IS BEST!

## BEST PRICE

Nearly Two Decades Of America's Best Prices... Guaranteed!

## BEST DELIVERY

"I speak highly of you and the company you are associated with to the many architects and engineers that I call on in southern CA., OR., and WA.

Bob Peterson  
San Diego, California

## BEST SERVICE

Over 1 Million Happy Customers!

## BEST ADVICE

OUR SALES PEOPLE ARE THE INDUSTRY'S BEST! Call us and you'll be pleasantly surprised!

CALL NOW!

# 1-800-394-6283

CALL 7 DAYS A WEEK • MON-FRI 9AM-8PM • SATURDAY 10AM-6PM • SUNDAY 11AM-5PM

### JUST A FEW OF OUR BEST BUYS

	RETAIL PRICE	6 <sup>th</sup> AVE PRICE
DENON ..... DCM-360 ..... 5 CD Changer .....	\$329	\$219
SONY ..... CDP-CE500 ..... 5 CD Changer .....	\$300	\$199
HARMON KARDON PA-2100 ..... 120W Power Amp .....	\$479	\$249
LUXMAN ..... M-375 ..... 300W Power Amp .....	\$999	\$749
YAMAHA ..... DSP-A3090 ..... AC-3/THX Amp .....	\$2500	On Sale
ADVENT ..... HERITAGE ..... Top Rated Speaker .....	\$700	\$449pr
CERWIN VEGA ..... L7B ..... Top Rated Speaker .....	\$340	\$149pr
JBL ..... PSW1200 ..... 120W 12" Subwoofer .....	\$499	\$349ea
KLH ..... KG-4.5 ..... Floorstanding Spk. ....	\$828	\$549pr
NILES ..... OS-10 ..... Indoor/Outdoor Spk. ....	\$350	On Sale



**BOSE** 301 SERIES III  
BOOKSHELF SPEAKERS  
• Top Rated Speaker  
• 100W Power Handling  
• Direct Reflecting  
Retail Price...\$369  
**\$199**  
PER PAIR

### AT THESE PRICES YOU KNOW WHO'S BEST

	RETAIL PRICE	6 <sup>th</sup> AVE PRICE
DENON ..... AVR-2500 ..... Pro-Logic Receiver .....	\$1000	\$669
ONKYO ..... TXSV828THX THX Receiver .....	\$1499	\$1049
TECHNICS ..... SAEX-500 ..... Pro-Logic Receiver .....	\$329	\$249
YAMAHA ..... RXV-590 ..... Pro-Logic Receiver .....	\$549	\$429
AIWA ..... NSX-V9000 ..... 120W Mini System .....	\$599	\$449
MITSUBISHI ..... CS-35313 ..... 35" P-I-P Stereo TV .....	\$1700	\$1299
PANASONIC ..... PV-4651 ..... 4-Head Hi-Fi Stereo .....	\$279	\$199
SONY ..... CCD-TRV21 ..... 2.5" 8mm Camcorder .....	\$999	\$799
SONY ..... CDX-S100 ..... Am/Fm Car CD Player .....	\$350	\$249
SOUNDSTREAM ..... SA-244 ..... 60Wx4 Car Amp .....	\$479	\$299

# WHY BUY ANYWHERE ELSE!

• MUCH LOWER PRICES! • GUARANTEED FAST DELIVERY! • 14 DAY MONEY BACK SATISFACTION GUARANTEE • ALL THE BEST BRANDS-INCLUDING HARD TO FIND • WELL TRAINED AND FRIENDLY SALES PEOPLE, SPECIALIZING IN HOME THEATRE SYSTEM DESIGN AND MULTI SYSTEMS!

## WE CARRY

AUTHORIZED DEALER FOR...

**BOSE** **BIC** **ROGA** **SHARP** **TELEVISIONS-VCR'S** **PROJECTION TV'S** **MINI SYSTEMS** **CAMCORDERS** **ACCESSORIES** **CAR STEREO** **LASERS** **AUDIO**

**MONSTER CABLE** **XLO** **CELESTION** **BLAUPUNKT** **PHILIPS** **CARVER** **TEAC** **audioquest** **JBL** **ZENITH** **PIONEER** **PREMIER** **BAZOOKA** **APOGEE** **KICKER** **LUXMAN** **TOSHIBA** **HITACHI** **AudioSource** **AND MANY MORE!**

**ADVENT** **Nakamichi** **SOUNDSTREAM** **harman/kardon** **Cerwin-Vega!**

**Atlantic** **Yokford/Fosgate** **Sherwood** **ALTEC** **AudioAlchemy** **SONY** **AudioControl** **NILES** **ADVENT** **Nakamichi** **SOUNDSTREAM** **harman/kardon** **Cerwin-Vega!**

### RETAIL LOCATIONS

- 331 ROUTE 4 WEST, PARAMUS, NJ  
6 DAYS • SATURDAY 10-9 • MONDAY - FRIDAY 10-9:30
- 22 ROUTE 22 WEST, SPRINGFIELD, NJ  
6 DAYS • SATURDAY 10-9 • MONDAY - FRIDAY 10-9:30
- 577 ROUTE 10 EAST, LIVINGSTON, NJ  
6 DAYS • SATURDAY 10-9 • MONDAY - FRIDAY 10-9:30
- 545 ROUTE 18 S., E. BRUNSWICK, NJ  
6 DAYS • SATURDAY 10-9 • MONDAY - FRIDAY 10-9:30



**WE WILL BEAT ANY ADVERTISED PRICE IN THIS MAGAZINE! GUARANTEED!**

**FREE PIONEER LIMITED EDITION T-SHIRT** WITH YOUR 6<sup>th</sup> AVE. PURCHASE. CALL TODAY • LIMITED QUANTITIES

Member of the Better Business Bureau. We Welcome VISA, MASTERCARD, AMERICAN EXPRESS, DISCOVER CARDS. ®+ Registered Trademark Dolby Laboratories Licensing Corporation. Not Responsible For Typographical Errors. ▼ No Dealers, Proof of Advertising a Must for Guaranteed Lowest Price (Must be an authorized dealer). Does Not Apply to Demo's, Clearance, or Limited Quantity Sales - Must Be For Identical Model Numbers. Shipping Not Refundable. Call for Details-Customer Service 201-467-0100 - Fax 201-467-9268. Valid Thru 8/1/96



# CLASSICAL MUSIC

NEW RECORDINGS REVIEWED BY ROBERT ACKART,  
RICHARD FREED, DAVID HALL,  
JAMIE JAMES, GEORGE JELLINEK, AND ERIC SALZMAN

## ARNE: *Artaxerxes*.

Christopher Robson (*Artaxerxes*), Catherine Bott (*Mandane*), Ian Partridge (*Artabanes*), Patricia Spence (*Arbaces*), others: Parley of Instruments, Roy Goodman cond. HYPERION 67051/2 (two CD's, 140 min).

**Performance:** Sparkling  
**Recording:** Vivid

We tend, not quite fairly, to think that English opera consists of Purcell's *Dido and Aeneas* and then Benjamin Britten, with nothing in the intervening 250 years except *The Beggar's Opera* (which isn't really an opera) and Gilbert and Sullivan (ditto). Yet the opera scene in London during the late eighteenth century was among the liveliest in Europe. Handel, of course, was far and away the most successful composer for the British lyric stage, and there were numerous Italian imports, but there were also some estimable homegrown opera composers. Thomas Arne foremost among them.

When Haydn heard Arne's *Artaxerxes*, in 1791, he reportedly said that he "had no idea we had such an opera in the English language." Arne's melodic gift was remarkable: There are at least half a dozen arias in



*Artaxerxes* that I would have identified as by Handel if I hadn't known better. Yet Arne was no mere Handel imitator; his orchestrations, for instance, are sparkling and original (he was the first English composer to use the clarinet).

The British cast makes a strong case for the piece. Veteran countertenor Christopher Robson makes lovely sounds as the belea-

guered Artaxerxes, and soprano Catherine Bott shines brilliantly as Mandane, making the most of the opera's best-known aria, "The soldier tird." One of the oddities of this opera is that it has a tenor villain, and Ian Partridge's thin, pallid voice and poorly focused ornamentation make Artabanes distinctly unmenacing. Roy Goodman elicits a brisk, colorful performance from the Parley of Instruments. *J.J.*

## CORIGLIANO: *Tournaments; Fantasia on an Ostinato; Elegy; Piano Concerto*.

Barry Douglas (piano): Saint Louis Symphony Orchestra, Leonard Slatkin cond. RCA VICTOR 68100 (67 min).

**Performance:** First-rate  
**Recording:** Splendid

Canny programming, superb sonics, and brilliant performances under Leonard Slatkin mark this CD of music by John Corigliano, which leads off with the splashy and virtuosic *Tournaments*, a highly accessible 1966 piece marked by a three-note Stravinskian motto. A somewhat somber tone is struck with the 1985 *Fantasia on an Ostinato* (the *ostinato* derives from the slow movement of Beethoven's Seventh Symphony), a spellbinding affair that could almost be called "Phantasmagoria on an Ostinato"; this is the first recording of the orchestral version. The appealing, bittersweet 1965 *Elegy*, Corigliano's first orchestral piece, was dedicated to Samuel Barber but comes off as rather Coplandesque.

The 1967 Piano Concerto alternates razzle-dazzle with genuinely affecting passages. The first movement features another three-note motto, this one à la Copland rather than Stravinsky. The slow movement, with its echoes of the *Dies Irae*, is one of Corigliano's major lyrical-dramatic inspirations. The finale is a stunning, fugal-textured rondo, and pianist Barry Douglas forges through it relentlessly. Overall, his sizzling reading stands up handsomely against the two other recordings of the concerto. This CD is a winner! *D.H.*

## GRIEG: *Piano Concerto*. CHOPIN: *Piano Concerto No. 1*.

Olli Mustonen (piano): San Francisco Symphony, Herbert Blomstedt cond. LONDON 444 518 (70 min).

**Performance:** Deeply expressive  
**Recording:** Resonant

Grieg is primarily known as a founder of the Scandinavian school, yet his single great work for the concert hall, the Piano Concerto in A Minor, is one of the masterpieces of high Romanticism, firmly in the Middle European mainstream. What an inspired idea to unite the young Finnish virtuoso Olli Mustonen and the Danish conductor Herbert Blomstedt with the San Francisco Symphony (and London's talented engineers) in a recording of this work! The performance blazes with color and emotional power, and as much high-strung Romantic sensibility as the piece can carry—so much for Scandinavian reserve.

Chopin's First Piano Concerto is an insightful coupling. Both composers were also renowned public performers on the piano (as Mustonen, himself a composer, points out in a sensitive essay in the CD booklet), and Chopin, as a Pole, was just as much an outsider to the Middle European musical establishment as was Grieg. Although he was only six years old when Chopin died,



Grieg was deeply influenced by the elder composer's extremely personal view of the piano's expressive power. Mustonen and Blomstedt bring exceptional sympathy and warmth to the piece, and also infuse it with rare dignity, never lapsing into the schmaltz that sometimes mars performances of the meltingly lovely *larghetto*. *J.J.*

## HAYDN: *Piano Sonatas Nos. 30, 42, 49, and 50*.

Tom Beghin (fortepiano). EUFODIA/ALBANY 1230 (67 min).

**Performance:** Spirited, smart  
**Recording:** Excellent

Haydn's keyboard music is one of the great neglected treasure troves of classical music. Depending on who does the counting, and how, there are around fifty or sixty sonatas, some of them of an astonishing originality and force. They certainly jump out when performed, as they are here, on instruments like the ones for which they were conceived, especially when the performances are this good.

Tom Beghin is a spirited young Dutch pianist who studied with Malcolm Bilson at Cornell (where these excellent Dutch broadcast recordings were made). Contrary to a popular impression, Haydn, prolific as he was, never used a cookie-cutter mold.

# Chailly's Concertgebouw

**A**msterdam's famous Concertgebouw Orchestra, designated "Royal" on the occasion of its centenary in 1988, has been regarded as one of the world's finest from its earliest years. The remarkable hall for which it is named has had a great deal to do with defining its character, but so, of course, have its distinguished conductors — Willem Mengelberg, Eduard van Beinum, Bernard Haitink. That Riccardo Chailly, the incumbent since the centenary year, has managed to put his own stamp on the orchestra without altering its essential character is the good news delivered in virtually all of their recordings together so far, and in the two latest ones in particular.

softest choral entries and the offstage instruments are heard to maximal effect in utterly natural balance.

Stunning as the *Daphnis* is, though, Chailly's unprecedentedly convincing account of Debussy's seldom-performed *Khamma* on the same disc can only be called a revelation. This concise ballet score has always suffered from comparisons with *Jeux*. Debussy began both works at about the time *Daphnis* was introduced, but while *Jeux* had his full attention, having been commissioned by Diaghilev, with scenario and choreography by Nijinsky, *Khamma* was an assignment of lesser importance, and he left the orchestration to Charles Koechlin. But Chailly has his troops fired up with the proprietary zeal of true believers, and it comes off as music of real character and substance rather than a curiosity with some exotic coloring and a great composer's name on it. Far from being anticlimactic after the shimmering *Daphnis*, it might just be what makes this disc indispensable.

Nothing, I would think, could make yet another disc of orchestral Wagner indispensable, but Chailly's superbly recorded new one is not just "yet another." The balance of majesty, vitality, and good humor in the *Meistersinger* prelude and the vibrant, unself-conscious nobility in the *Götterdämmerung* excerpts (with Dawn preceding the Rhine Journey and Siegfried's Death similarly linked to the Funeral March) are, like the fine electric tension Chailly maintains within each piece, things that can never be taken for granted; they inform this thrice-familiar music with an exciting freshness almost beyond imagining.

Similarly, the performances of the Ride of the Valkyries (from *Die Walküre*) and the prelude to Act III of *Lohengrin*, with the awesome Concertgebouw brass, simply shatter any notion that these exhilarating pieces are overexposed. Don't fret over possible duplications: the whole well-contrasted hour is downright glorious, and the pleasure it affords seems only to deepen with repeated hearings. *Richard Freed*

**RAVEL: Daphnis and Chloe (complete). DEBUSSY: Khamma.**

Netherlands Radio Chorus; Royal Concertgebouw Orchestra, Riccardo Chailly cond. LONDON 443 934 (74 min).

**WAGNER: Die Meistersinger, Prelude; Die Walküre, Ride of the Valkyries; Götterdämmerung, Rhine Journey and Siegfried's Death; Tannhäuser, Overture and Venusberg Music; Lohengrin, Prelude to Act III.**

Royal Concertgebouw Orchestra, Riccardo Chailly cond. LONDON 448 155 (64 min).

The four middle and late sonatas here are completely individualized, and Beghin treats them as such. For starters he plays on three different fortepianos — two modern ones, modeled on instruments by two different Viennese makers, and a restored Broadwood from the early 1800's — each chosen for its appropriateness to the expression of a particular sonata. Particular features include not only contrasting dynamics, but also clean articulation, extensive use of the sustaining pedal, and, with the English fortepiano, contrasting textures, long singing phrases, and a soft pedal. Beghin's playing is smart, crisp, witty, architectural, dramatic, energetic, and, when required, sweet and songful. He is, in short, a very persuasive advocate for this wonderful music. *E.S.*

**MOZART (arr. Grieg): Piano Sonatas in C Major (K. 545) and F Major (K. 533/494); Fantasia in C Minor (K. 475).**

Elisabeth Leonskaya, Sviatoslav Richter (pianos). TELDEC 90825 (62 min).

**Performance: Fluent  
Recording: Excellent**

If you take a purist approach to Mozart, this CD will seem very odd, if not a case of vandalism. It seems that in 1877, when Grieg was busily involved in piano teaching, he took it upon himself to provide, presumably as a pedagogical tool, a "freely added accompaniment for a second piano" for five of Mozart's keyboard works, including the three here: the so-called Sonata in F Major (an amalgam of unrelated movements), the great Fantasia in C Minor, and the popular Sonata in C Major. While the results may have delighted amateur players of the time, as a listener I was left unmoved, though still mildly fascinated from a historical standpoint. Grieg's special harmonic touches and added material amount to something more like a commentary on Mozart's music than an arrangement in the usual sense.

As long-time partners in two-piano and four-hand repertoire, Elisabeth Leonskaya and Sviatoslav Richter are charmingly mellifluous in communicating the Romantic drawing-room atmosphere of the Grieg arrangements. The recorded sound is eminently satisfying. *D.H.*

**PROKOFIEV: Romeo and Juliet (excerpts).**

San Francisco Symphony, Michael Tilson Thomas cond. RCA VICTOR 68288 (78 min).

**Performance: Powerful  
Recording: Excellent**

Prokofiev extracted no less than three different orchestral suites from his famous Shakespearean ballet score, but it has become fashionable for conductors to make their own versions. For his double debut as music director of the San Francisco Symphony and as an RCA contract artist, Michael Tilson Thomas has taken a long series of familiar and less well-known sections — over an hour and a quarter's worth — and arranged them so that they follow the course of the story and also make a coherent whole. Unlike Prokofiev's cantata-like film scores,



SHUMAN ASSOCIATES

**Conductor Riccardo Chailly**

Several happy factors combine to give their gorgeous new account of Ravel's complete *Daphnis and Chloe* ballet a strong claim to be considered first choice among recordings of this work. Chailly is a bit more sinewy in his approach than most of his current rivals, but perhaps no more so than the authoritative Pierre Monteux (who presided over the première in 1912), and the performance lacks nothing in the way of evocativeness, sensitivity, or all-round persuasiveness. Both the superb playing of the orchestra and the burnished warmth of the hall have been captured with exceptional transparency and detail; the



**EXPRESS  
SHIPPING  
AVAILABLE!**

# ALL Brands Electronics INC.

**Don't Be Misled...Buy It Right The First Time!  
100's Of Brands...1,000's Of Models!**



**Home  
Theater  
Specialists**  
**AC3 • THX**



**ALL BRANDS AT THE ABSOLUTE BEST PRICES!**

**CAR STEREO / SHELF SYSTEMS / SPEAKERS / RECEIVERS  
FRONT & REAR PROJECTION / SATELLITE EQUIPMENT...WE'VE GOT IT ALL!**



**7 1 8 3**  
**1-888-312-SAVE**

44 Route 23, Little Falls, NJ 07424

**16 PAGE CATALOG ON THE INTERNET!!!**

**FOR INSTANT PRICING AND MONTHLY  
SPECIALS VISIT OUR WEB SITE!**

**e-mail:** [order2save@aol.com](mailto:order2save@aol.com)

**url:** <http://www.avhts.com/allbrands>

**EASY  
ORDER!**

All products sold with a manufacturers warranty. 14 day defective exchange.

# QUICK FIXES



**BEETHOVEN: Septet for Strings and Winds; Serenade for Flute, Violin, and Viola.**

Chamber Music Society of Lincoln Center; others. DELOS 3177 (64 min).  
The two early and agreeable chamber works on this Delos CD, titled "Beethoven in New York," feature guest artists and members of the Chamber Music Society of Lincoln Center: Joseph Silverstein, Paul Neubauer, Fred Sherry, Edgar Meyer, Milan Turcovic, David Shifrin, and Robert Rouch in the septet and Ransom Wilson, Ani Kavafian, and Neubauer in the serenade. The performances are graced with elegance and spirit, and except for the somewhat recessed presence of Silverstein's violin, the sonics are just fine. I suspect that Beethoven wrote these pieces as intimate *Hausmusik*, and this CD will serve the same purpose admirably for a dinner party nowadays. *D.H.*

**BOCCHERINI: Cello Concertos in D Major and G Major; Quintet in E Major, Menuetto. VIVALDI: Cello Concertos in A Minor, B Minor, and C Minor; Concerto in A Minor, Largo.**

Mischa Maisky (cello); Orpheus Chamber Orchestra. DEUTSCHE GRAMMOPHON 447 022 (73 min).  
Mischa Maisky's previous recordings have encouraged us to expect more than this one delivers. The heavy-handed performance of the famous minuet from Boccherini's E Major Quintet, here presented as a cello solo with discreet accompaniment from a quartet of first-chair players, in a sense sums up the entire program. The performances are technically very polished but without much individual character or a consistent sense of style. *R.F.*

**DVORAK: Symphony No. 2; Overture, My Home.**

Czech Philharmonic, Libor Pesek cond. VIRGIN 45127 (65 min).  
There is much bucolic atmosphere and lots of Wagnerian resonance in the youthful Second Symphony. The predominantly lyrical scherzo with its horn calls comes closest to the real Dvorak. While *My Home* is a mature work, it's a second-drawer affair compared with such contemporaneous

pieces as the *Hussite Overture* or *Scherzo Capriccioso*. The performance is good in terms of lyric emphasis, but the strings seem to get a bit lost in Prague's high-ceilinged Rudolfinum. *D.H.*

**STRAUSS: Sonatinas Nos. 1 and 2.**

Orpheus Chamber Orchestra. DEUTSCHE GRAMMOPHON 445 849 (72 min).  
The Orpheus Chamber Orchestra presents these intriguing late works (the second of which is sometimes labeled Symphony for Winds) with efficiency and clarity, but the performances are not particularly gratifying in the dryish acoustic, which fights the fluid character of the music. The Netherlands Wind Ensemble under Edo de Waart is far more ingratiating in their two-disc Philips set of *all* of Strauss's wind music. *R.F.*

**WAGNER: Overtures and Preludes.**

Chicago Symphony, Daniel Barenboim cond. TELDEC 99595 (63 min).  
Having taken much pleasure in Daniel Barenboim's Wagner opera recordings, I expected something at least as good or better in this collection of favorite selections with the Chicago Symphony, including curtain-raisers for *The Flying Dutchman*, *Tannhäuser*, *Lohengrin* Acts I and III, and *Die Meistersinger*, as well as the *Tristan* and *Isolde* Prelude and Liebestod. The ethereal *Lohengrin* Act I Prelude fares best. The remainder is routine, and the microphone pickup is on the close side, favoring the brass (especially the tuba) in the *Meistersinger* Prelude. The *Tristan* selection also needs more sonic elbow room than it gets here. *D.H.*



**GALINA GORCHAKOVA: Verdi and Tchaikovsky Arias.**

Galina Gorchakova (soprano); Kirov Orchestra, Valery Gergiev cond. PHILIPS 446 405 (60 min).  
Galina Gorchakova, one of the brightest luminaries nurtured by Valery Gergiev's Kirov Opera, emerges triumphant in her first solo CD as well. Tracing the predicaments of the troubled heroines of Verdi and Tchaikovsky (the Leonoras of *Forza* and *Trovatore*, Desdemona, Aida, Tatiana, and Lisa), she discloses an attractive voice of ample range and power and innate expressive qualities. Temperament is there, but wisely controlled so as not to impinge on the musical line. I could wish for more dynamic variety. Subdued accompaniments, good but unexceptional sound. *G.I.*

*Romeo and Juliet* has no solo and vocal numbers to help sustain its length. But because the final sections develop and recapitulate earlier music, and because of the strength of the music nearly throughout, Thomas's version holds together surprisingly well as a multidimensional orchestral fresco.

The recording was made in concert in September 1995, at the very beginning of the conductor's tenure with the orchestra. Thomas, a polymath and perpetual wunderkind in the Bernstein tradition, achieves a breadth and maturity of vision in this project that augur well both for his own career and for the orchestra's future. *E.S.*



**RACHMANINOFF: Piano Concertos Nos. 1 and 3.**

Jean-Yves Thibaudet (piano); Cleveland Orchestra, Vladimir Ashkenazy cond. LONDON 448 219 (71 min).  
**Performance: Refined**  
**Recording: Very smooth**

Jean-Yves Thibaudet brings enormous resources of intellect and refinement, as well as dexterity, to his recordings of the Rachmaninoff concertos, and he could not have asked for a better companion on the podium than Vladimir Ashkenazy, whose long immersion in these works as a soloist has given him insights into their orchestral as well as pianistic aspects.

Thibaudet is never content to play on the music's surface, and Ashkenazy is always eager to provide both the detail and the integration in the orchestral contribution that he himself would treasure as soloist. The two really respond to each other at every point, and they always find a convincing tempo and balance. There is not a phrase in either performance that is less than profoundly beautiful.

The level of visceral excitement, though, is lower than I might have wished — certainly below that of Thibaudet's earlier recordings of Liszt and D'Indy with Charles Dutoit, and lower than Ashkenazy has generated as conductor on other occasions. It may be that, surprisingly from this source, the recording itself is a little too smooth, tending to homogenize the different performing elements instead of allowing them their respective moments of prominence. Whatever the cause, at no point does the music quite come to a fizzy head; at no point does either the piano or any part of the orchestra stand out in a gesture of intensity or urgency — the way it does, say, in Martha Argerich's supercharged live performance of the Third Concerto with Riccardo Chailly on Philips. On its own terms, however, what Thibaudet and Ashkenazy have

# One

# Call



## GETS IT ALL!

PRICE ♦ DELIVERY ♦ SERVICE

## AUDIO

AV Receivers  
Separates  
Speakers  
CD's  
Book Shelf  
Car  
Portable  
AC3-THX  
Pro Logic  
Interconnects

## VIDEO

DSS  
Camcorders  
VCR's  
TV's  
Home Theater  
Projection  
Laser  
Videonics

— *Best in the West* —

# 1-800-540-0900

## FAX: (509) 838-4387

[onecall@iea.com](mailto:onecall@iea.com)

[www.onecall.com](http://www.onecall.com)

7 Days a Week - 7am to 6:30pm PST  
418 W. Riverside - Spokane, WA 99201



P.O.'s ACCEPTED

CIRCLE NO. 47 ON READER SERVICE CARD

# CLASSICAL MUSIC

to offer is certainly worth hearing and likely to wear very well. *R.F.*

## SCHUBERT: Winterreise.

Wolfgang Holzmaier (baritone); Imogen Cooper (piano). PHILIPS 446 407 (70 min).

**Performance: Smooth and lyrical**  
**Recording: Excellent**

Schubert's *Winterreise* song cycle invites a wide range of interpretations. A singer may triumph over all the musical requirements and still leave listeners searching for

more interpretive and psychological insights. The great baritone Dietrich Fischer-Dieskau, who recorded the cycle several times, cautioned that "the singer must vary his interpretation, for a continuous flow of lovely tone spread over twenty-four songs would lead to monotony."

In fact, "a continuous flow of lovely tone" is what we get here from Wolfgang Holzmaier, and I should be the last person to complain. His light baritone achieves beautiful effects with soft head tones in *Die Wer-*

*terfahne* and delicate *piano* gradations elsewhere. (Seven songs are rendered in the original tenor keys, the rest transposed down a tone or semitone.) This dejected wanderer is clearly a young man, but the tone he sets with the opening *Gute Nacht* is that of nostalgic and elegiac resignation. Remembering other, more probing interpretations, I'd like to hear more defiance in *Mut*, more eeriness in *Die Krähe*, and a more unsettling *Der Leiermann* at the end.

Nonetheless, this is a beautiful and by no means "monotonous" *Winterreise*, admirably supported by Imogen Cooper at the piano. Holzmaier will no doubt approach the cycle differently in ten years or so, and I'd like to be around to compare the two recordings. *G.J.*

## SHOSTAKOVICH: Violin Concerto No. 1. PROKOFIEV: Violin Concerto No. 2.

Vadim Repin (violin); Hallé Orchestra, Kent Nagano cond. ERATO 10696 (59 min).

**Performance: Very good, but . . .**  
**Recording: Splendid**

Maxim Vengerov's recent Erato recording (with Mstislav Rostropovich) of Shostakovich's great Violin Concerto No. 1, one of the composer's most deeply probing statements, is a hard enough act to follow — never mind the historic David Oistrakh readings. Nevertheless, Vadim Repin, with strong backing from the Hallé Orchestra's American-born musical director, Kent Nagano, turns in a strong account. The opening nocturne is bleakly lovely, succeeded by a blazingly satanic scherzo. The gripping passacaglia is a shade disappointing; the fast pace makes it less ominous than it should be. But the brief cadenza and final burlesque have all the flamboyance one could want.

Pacing is again a problem in the lighter-weight Prokofiev concerto. There is a fine, lithe quality to the opening movement, but the memorable main melody of the slow movement loses its otherworldly quality at Nagano's brisk pace. I have no complaints whatever about the kinetic, dance-imbued finale. Good, comfortably roomy sound all the way. *D.H.*

## STENHAMMAR: Symphonies Nos. 1 and 2; Excelsior! (Symphonic Overture); Serenade in F Major.

Gothenburg Symphony, Neeme Järvi cond. DEUTSCHE GRAMMOPHON 445 857 (two CD's, 139 min).

**Performance: Spirited**  
**Recording: Good**

Wilhelm Stenhammar was a slightly younger Swedish contemporary of Finland's Jean Sibelius and Denmark's Carl Nielsen. He enjoyed close friendships with both (Sibelius dedicated his Sixth Symphony to him), and on a number of occasions he invited them to conduct his Gothenburg Symphony Orchestra. Although he was unable to develop a body of creative work comparable to that of his colleagues, the finest pages of the two symphonies, the two piano concertos, the serenade, and the six string quartets are notable for their musical strength and deep humanity.

# UNCLE'S STEREO

Everything In Electronics For Less!

SONY • PANASONIC • DENON
HITACHI • AIWA • CELESTION • TECHNICS • PINNACLE • AMPEX • CARVER • DYNACO • MAXELL • KOSS • JVC

**Uncle's Safety Shipping**  
 Double Boxed     Extra Packing  
 Fully Insured     Computer Tracking  
 Initial Defective Exchange

Ask About Our Extended Service Protection Plan!

## aiwa Panasonic



**NXS-V70**  
HiFi Mini System  
\$429

For a full featured great sounding system with a small footprint look no further than this gem from AIWA. It's got it all: 100W, DSP, EQ, 9-Band Spectrum Analyzer, 3 Disc Changer, Dual Auto Reverse Cassette, Super Woofer 3-Way Speakers, 4-Position Remote, and more.



**CW-1006FU**  
10,000 BTU  
10.0 EER  
Window Air Conditioner  
\$499

Small, quiet, & super efficient this deluxe featured, mid-sized window air conditioner is a terrific value. IC Thermostat control, 12-hour delay Start/Stop Timer, 3 cooling fan speeds (& fan only), 4-way air deflection system,

### AIR CONDITIONERS

WESTINGHOUSE WACO53 5200 \$269  
EMERSON 10GC12 10,000 BTU \$399  
FRIEDRICH CALL FOR BEST PRICE!  
SHARP AF505 5000 BTU \$259  
SHARP AF605 6000 BTU \$279  
AMANA CALL FOR BEST PRICE!  
PANASONIC CW500RU 5000 BTU \$249  
PANASONIC CW806TW 7800 Best! \$299  
CALL FOR PRODUCTS NOT LISTED!

### SPEAKERS

CAMBER 3.5TI Audiophile's Choice \$799/pr  
KEF CALL FOR BEST PRICE!  
NHT 2.5 Tower Speakers CALL!  
ATLANTIC TECHNOLOGY FULL LINE!  
VELODYNE VA1012X Subwoofer \$479/pr  
CELESTION NEW IMPACT CALL!  
INFINITY ALL MODELS BEST PRICE!

### HOME THEATRE SPEAKERS

BIC-VENTURI FULL LINE IN STOCK!  
PINNACLE AC650 Bookshelf \$179/pr  
CAMBER 2.0TI Bookshelf \$499/pr  
JBL CALL FOR BEST PRICE!  
NHT SUPER ZERO Surround \$178/pr  
AR SPEAKERS ALL MODELS CALL!  
DYNACO VIDEO SPEAKERS CALL!  
CALL FOR PRODUCTS NOT LISTED!

### DAT DECKS

SONY DTC790 Home DAT \$649  
JVC ALL MODELS CALL BEST \$!  
TASCAM ALL MODELS BEST PRICE!  
SONY TCDD8 IN STOCK CALL!  
SONY DTC60ES Home DAT CALL!  
CALL FOR PRODUCTS NOT LISTED!

### AUDIO TAPES

TDK D60 Cassette \$0.65  
MAXELL XLII560 Cassette \$1.69  
SONY 74 min. Mini Disc \$10.49  
BASF/FUJI DCC CALL!  
DENON 74 min. CPR \$9.49  
DENON HDM100 CALL!  
AMPEX/MAXELL 7 Reels IN STOCK

### MINI SYSTEMS

AIWA NSX-V900 New Model! CALL!  
DENON DCI Micro Syst. 6 CD's CALL!  
JVC MXC330 6 Disc + 1 CALL!  
ONKYO PCS7 Top Rated! \$499  
SONY MHC405 100W x 2.5 CD Changer \$429  
YAMAHA GX-5 Top Rated! \$439  
YAMAHA CG75 "True" Mini Components \$599  
CALL FOR PRODUCTS NOT LISTED!

### RECEIVERS

YAMAHA RXV2090 AC3 CALL!  
SONY STR6X300ES Dolby Pro Logic CALL!  
YAMAHA DSPA3090 Built In AC3 CALL!  
YAMAHA RXV890 100W x 25W x 2 CALL!  
ONKYO TXSV828TXH DSP 24 Bit CALL!  
ONKYO TXSV919 THX + AC3 BEST \$\$  
DENON AVR2500 Dolby Pro Logic CALL!  
CALL FOR PRODUCTS NOT LISTED!

### HOME THEATRE RECEIVERS

KENWOOD KRX1000 IN STOCK CALL!  
NAKAMICHI FULL LINE CALL!  
PIONEER FULL LINE CALL BEST \$\$  
CARVER CALL FOR BEST \$\$  
JVC RX817VTN 105W x 3 + 25W x 2 \$379  
NAD FULL LINE IN STOCK CALL!  
TECHNICS CALL FOR BEST \$\$  
CALL FOR PRODUCTS NOT LISTED!

### MULTI SYSTEMS

AIWA HVMX1 BEST PRICE!  
PANASONIC NVST200 BEST PRICE!  
TRI-STANDARD VCR'S IN STOCK!  
AIWA, GRUNDIG, TOSHIBA, JVC, PANASONIC, ALL MODELS CALL FOR BEST PRICE!

### PRO TAPES

PANASONIC R60 60 min. DAT \$5.45  
DENON R90 90 min. DAT \$6.15  
DIC D120HQ 90 min. DAT \$5.49  
DIC 3 Hour DAT \$6.99  
SONY PDP124 Pro DAT \$9.49  
AMPEX 488 Hi-8 Audio \$9.95  
AMPEX 489 A DAT \$9.99  
AMPEX/SONY 34' UMATIC IN STOCK  
FUJI/SONY BETA 30 SP \$21.50

### CD PLAYERS

YAMAHA CDC755 5 Disc ProBit \$284  
SONY CDPCA9ES 5 Disc Carousel \$495  
DENON DCM560 5 Disc Carousel CALL!  
NAKAMICHI CALL FOR FULL LINE!  
ONKYO DXC320 6 Disc Changer CALL!  
TECHNICS SLPD1010 5 Disc \$229  
NAD IN STOCK CALL FOR BEST \$\$  
KENWOOD CALL FOR BEST PRICE!  
JVC XLF252 5 Disc Changer CALL!  
CALL FOR PRODUCTS NOT LISTED!

### CASSETTE DECKS

JVC TDW318 2-Auto Rev., Pitch Contr. CALL!  
NAKAMICHI DR1 Single 3-Head CALL!  
SONY TCW9ES Dual Record BEST \$\$  
YAMAHA KXW582 2-Auto Reverse \$299  
DENON FULL LINE BEST PRICE!  
ONKYO FULL LINE IN STOCK CALL!  
TECHNICS RSTR575 Dual Record \$199

All products are new USA merchandise covered by the manufacturer's warranty or Uncle's Stereo's exclusive limited warranty and are backed by our 14 DAY MONEY BACK GUARANTEE. Not responsible for typographical errors. All prices subject to change without notice. Shipping costs are non-refundable. A restocking fee may apply on returns. © 1996 Uncle's Stereo

UNCLE'S STEREO 216 W. 72nd. St. New York NY 10023 Store Hrs. Mon-Sat 10:30-7:30 Sun 11:00-5:30

Order Toll-Free **800-978-6253** Fax your order 212-721-7587

9am-Midnight



# ELECTRONICS DEPOT

OUR NEW POLICY

# ALL PRICES TOO LOW TO PRINT!

## Don't Waste

## Any More Time...

# CALL TODAY & SAVE!!

# 1-800-500-1553

- WE CARRY...**
- BOSE AUDIO • JVC • ONKYO
  - AUDIO ALCHEMY • HITACHI
  - JBL • DENON CAR STEREO
  - B-I-C • KENWOOD • NILES
  - PANASONIC CAMCORDERS
  - AR • MITSUBISHI • PIONEER
  - LASER PLAYERS • SONY
  - YAMAHA • CERWIN VEGA
  - KEF MULTI SYSTEMS
  - SONANCE • CELESTION
  - PROJECTION TV'S • RCA
  - NAD • ADS • ADVENT • AIWA
  - ALTEC LANSING VCRS
  - ACCESSORIES • KLIPSCH
  - HARMAN KARDON • SHARP
  - TECHNICS MINI SYSTEMS
  - TOSHIBA • BLAUPUNKT
  - TELEVISIONS • PHILIPS
  - M&K • MONSTER CABLE
  - HOME THEATRE SYSTEMS
  - AND MANY OTHER HIGH QUALITY MANUFACTURERS

HOURS: MON-FRI...9AM-8PM • SAT...10AM-6PM  
6 DAYS A WEEK FAX: 201 467-9308

WE OFFER MORE WITH YOUR PURCHASE

**FREE**  
Extended  
Warranty

**FREE**  
Scheduled  
Maintenance

**FREE**  
Money Back  
Guarantee

**FREE**  
Price  
Protection

**FREE**  
Cables Or  
Interconnect



## CALL FOR OUR FREE MONTHLY NEWSLETTER

Find out about the latest, hottest new technology and inside industry news, new product reviews and direct international prices. Receive tips on getting the most from your equipment as well as exciting special offers!



WE ACCEPT VISA, MASTERCARD, AMERICAN EXPRESS AND DISCOVER CARDS. ALL PRODUCTS ARE COVERED BY THE MANUFACTURER'S WARRANTY OR ELECTRONICS DEPOT'S EXCLUSIVE WARRANTY. SHIPPING NOT REFUNDABLE. \* WITH ELECTRONICS DEPOT PURCHASE. VALID THRU 8/1/96

# PROTON Car Audio



Model CV616  
Cassette/  
CD Changer Controller

#60-2785

\$159



Model CD870F  
CD Changer

#60-2900

\$249

Prices subject to change.



FREE  
CATALOG

Call Today

1-800-543-4330



MCM ELECTRONICS®  
650 CONGRESS PARK DR.  
CENTERVILLE, OH 45459-4072  
A PREMIER Company

Hours: M-F 7 a.m. - 9 p.m., Sat. 9 a.m. - 6 p.m. EST.

MCM EXCLUSIVE

## Closer To The Musical Truth

MCM Electronics proudly introduces Proton Car Audio to the U.S. market. The Proton name is famous throughout Europe for quality audio at affordable prices. Whether upgrading an existing factory system, or gearing up for a sound off competition, Proton delivers state-of-the-art technology at competitive prices. For the complete Proton offering, contact your MCM sales representative.

Let MCM be your connection for all of your car audio needs. Head units, amps, speakers, primary wire, terminal blocks, installation kits, boomer caps, alarms and more are just a phone call away.



CODE:  
SR13

CIRCLE NO. 25 ON READER SERVICE CARD

## CLASSICAL MUSIC

*Excelsior!* dates from 1896 and finds the 25-year-old Stenhammar torn between dreamy introspection and the propulsive style of Richard Strauss's tone poems. The First Symphony, in F Major, has resonances of Bruckner, Brahms, and Wagner without the heaviness. It is not merely derivative: Stenhammar's spirit speaks its own special language in the wonderful ensemble horn scoring in noble chorale style and the slow movement's haunting solo oboe episode.

The *Serenade* in F Major, dating from 1911-13, offers an entrancing listening experience, and Sibelius may have picked up a few ideas from it for his Sixth and Seventh Symphonies. Stenhammar's Second Symphony (1911-15) is in the same heroic vein as Nielsen's Third, the *Sinfonia Espansiva*, especially in its use of modal harmony and fugal texture. The double-fugue finale can have overwhelming impact in an ideal performance.

Neeme Järvi and the Gothenburgers play all this music with enormous spirit and conviction. The recording is superbly detailed as to texture and color, but I wished for a bit more heft at the low end — a little more presence in the miking would have helped. The finale of the Second Symphony suffers to some degree as a result, as well as from the somewhat hasty tempo Järvi adopts for the main fugue subject. *D.H.*

**WEBERN: Passacaglia, Op. 1; Five Movements, Op. 5; Six Pieces, Op. 6; Im Sommerwind; Bach and Schubert orchestrations.**

Berlin Philharmonic, Pierre Boulez cond.  
DEUTSCHE GRAMMOPHON 447 099 (67 min).  
**Performance: Crystalline**  
**Recording: Flawless**

**W**here the first installment of Pierre Boulez's Webern survey was devoted mainly to the mature instrumental and vocal works, this one is divided between relative-

## Stereo Review SUBSCRIBER SERVICE



PLACE  
LABEL  
HERE

1(303)604-1464  
FAX 1(303)604-7455

STEREO REVIEW  
P.O. Box 55627, Boulder CO 80322

**MOVING?** Please give us 8 weeks advance notice. Attach label with your old address, and write in new address below.

**RENEWING?** Check box below and attach label with corrections marked, if any.

**SUBSCRIBING?** Check box and fill in coupon. For gift subscriptions attach a separate sheet.

Send **STEREO REVIEW**  
for 1 year at \$17.94

- New Subscription     Renewal  
 Payment enclosed     Bill me

Canadian and foreign orders  
add \$8 per year.

NAME \_\_\_\_\_

ADDRESS \_\_\_\_\_

CITY \_\_\_\_\_

STATE \_\_\_\_\_

ZIP \_\_\_\_\_

**COPYRIGHT © 1996 BY HACHETTE FILIPACCHI MAGAZINES, INC.** All rights reserved. Stereo Review, July 1996, Volume 61, Number 7. Stereo Review (ISSN 0039-1220) is published monthly by Hachette Filipacchi Magazines, Inc. at 1633 Broadway, New York, NY 10019; telephone (212) 767-6000. One-year subscription rate for the United States and its possessions, \$15.94; Canada, \$23.94 (includes 7% GST, GST registration number 126018209, Canadian Sales Agreement Number 99236); all other countries, \$23.94; cash orders only, payable in U.S. currency. Second-class postage paid at New York, NY 10001, and at additional mailing offices. Authorized as second-class mail by the Post Office Department, Ottawa, Canada, and for payment of postage in cash. **POSTMASTER / SUBSCRIPTION SERVICE:** Please send change-of-address forms and all subscription correspondence to Stereo Review, P.O. Box 55627, Boulder, CO 80322-5627. Please allow at least eight weeks for the change of address to become effective. Include both your old and your new address, enclosing, if possible, an address label from a recent issue. If you have a subscription problem, write to the above address or call (303) 604-1464; fax, (303) 604-7455. **PERMISSIONS:** Material in this publication may not be reproduced in any form without permission. Requests for permission should be directed to: The Editor, Stereo Review, 1633 Broadway, New York, NY 10019. **BACK ISSUES** are available. Write to ISI/Stereo Review, 30 Montgomery Street, Jersey City, NJ 07302. For each copy ordered, enclose a check or money order for \$5.95 in U.S. funds (\$7.25 for orders sent to Canada, \$12.95 for other foreign locations); add \$2 to those prices for each copy of the 1996 *Stereo Buyer's Guide* annual. For telephone credit-card orders, call (201) 451-9420. **EDITORIAL CONTRIBUTIONS** must be accompanied by return postage and will be handled with reasonable care, but the publisher assumes no responsibility for the return or safety of unsolicited manuscripts, art, or photographs.

The Home Theater Company!

# The Original Sound City

Since 1986

Call For Our FREE Catalog!

Meadtown Shopping Center • Rt 23 • Kinnelon, NJ 07405

# 1-800-542-7283

### HOME SPEAKERS

**Advent A1065 Prodigy Tower**  
 • Video shielded  
 • 8" Woofer with an aluminum coil form  
 • 3/4" Ferrofluid-filled parabolic soft dome tweeter  
 • 75W RMS Power handling  
 • FR: 45Hz - 23kHz  
 Stock#1339

**SALE** **\$199<sup>pr</sup>**

**Monitor Audio Monitor 1 Bookshelf Speaker**  
 • 2-Way speaker system  
 • Gold dome tweeter  
 • 70W Handling  
 Stock#2688

**\$199<sup>pr</sup>**

**Spica TC-60 Loudspeakers**  
 • 6.5" Cone woofer + 1" Tweeter  
 • 120W Peak power handling  
 • Walnut only  
 Stock#8046

**\$399<sup>pr</sup>**

### IN/OUTDOOR SPEAKERS

**STEREOSTONE**  
 "LOOKS AND SOUNDS NATURAL"

**Indoor/Outdoor Rock Formation Speaker System**

All STEREOSTONE speakers feature triple element protection, Soundsealth technology to provide speakers that sound as good as they look. AS LOW AS **\$139<sup>ea</sup>**  
 250W power handling, 93dB sensitivity and a 3 year warranty!

**NILES**  
 Indoor/Outdoor Speaker Systems  
 OS1 • OS5 • OS10

**Niles SPS-4 Speaker Selector**  
 • Accommodates 4-pairs of speakers  
 • Power handling: 100 watts/channel  
 • Low profile design  
 • Accommodates up to 14 gauge wire  
 Stock#2799

**CALL**

### RECEIVERS

**JVC RX-817/TN A/V Receiver**  
 • 105W x 3 Front L/R/C  
 • 25W x 2 for surround  
 • Dolby® Pro Logic  
 • Digital acoustics processor  
 • Dolby® 3-channel Logic  
 • Smart A/V illuminated multi-brand remote control  
 • 40 AM/FM Stereo presets  
 Stock#10119

**\$339**

Full Line Of NEW JVC Available

**Brand Name A/V Receiver**  
 • Dolby® Pro Logic surround  
 • DSP w/6 environments  
 • Programmable remote  
 Stock#13455

**\$299**

**Brand Name THX® Receiver**  
 • Home THX® certified  
 • 130W L/R/C +40W x 2  
 • Digital Dolby® Pro Logic  
 • Universal remote control  
 Stock#9516

**\$799**

### CD PLAYERS

**Technics SLMC50 60+1 Mega CD Changer**  
 • Quick disc change  
 • Front loading mechanism  
 • Program play, random play and repeat play  
 • Easy disc replacement system  
 • Quick single play function  
 • MASH 1-DAC and digital servo system  
 • Wireless remote control  
 Stock#14751

**\$249**

**JVC TDW709 Dual Cassette**  
 • Dual auto reverse  
 • Dolby® B/C NR  
 • Dolby HX Pro  
 Stock#2529

**BEST BUY \$189**

**Technics RS-DC10 DCC Player/Recorder**  
 • Digital record/playback system  
 • Analog playback compatible with analog cassettes  
 • Remote control  
 Stock#4106

**\$189**

## CAR AUDIO HEADQUARTERS

**Brand Name CD Changer**  
 • 10 Disc changer with RF modulator and remote commander  
 • 1-Bit D/A w/ 8X OS  
 • Compact remote  
 • Standard antenna input/output connections  
 Stock#15141

**\$369**

**JVC CS-103 Car Stereo Speakers**  
 • Baffleboard type 2-way design  
 • 4" High carbon cone-woofer  
 • 1" Tweeter  
 • 60W Power handling  
 • Door/rear deck mountable  
 • 4 Ohm  
 Stock#7296

**\$49<sup>pr</sup>**

**Sony CDX-5290 CD Receiver**  
 • 8X OS digital filter  
 • 1-bit pulse D/A converter  
 • 18 FM +6 AM Presets, BTM  
 • 30W x 4 High power output  
 • Front/rear preamp outs  
 • Dual illumination  
 • Full detachable face  
 Stock#10068

**Limited quantities \$249**

**a/d/s/ Car Subs**  
 RS10 10" Sub and RS12 12" Subwoofers...  
 Soundstream Reference 405 stock#4776 **CALL \$469**  
 4 Channel bridgeable car stereo amplifier  
 Hafler MSE88 Stock#2209 **\$99**  
 4/2 Channel car amp • 76W x 2 • MOSFET

**Soundstream Reference 500 2/1 Channel Power Amp**  
 • 125W x 2 @ 12v into 4Ω  
 • 150W x 2 @ 14.4v into 4Ω  
 • 500W Total RMS 1 ohm  
 • Drive delay muting  
 • High power/high current  
 • Two stage input gain control  
 Stock#4777

**\$399**

### SPECIAL PACKAGE PRICE

**Brand Name Cassette Receiver**  
 • 30 Station presets  
 • 25W x 4 Internal amplifier  
 • Pre out x 1 • Auto reverse  
 • Dolby® B NR  
 • Full detachable face  
 Stock#6647

**Brand Name 6 CD Changer**  
 • 6 Disc changer w/8X OS and 1-bit pulse D/A converter  
 • Horizontal/vertical mount  
 • Rapid disc change  
 • Small cabinet design  
 Stock#10095

**\$449**

### AUDIO Alchemy

**Audio Alchemy DTI-Pro32 Digital Transmission Interface**  
 • Breakthrough advancement in digital audio reproduction  
 • State-of-the-art jitter reduction w/bandwidth down to 5Hz  
 • Supports new jitter free I2S bus format on in/output  
 • On-board DSP running software designed to take 16-bit data in and output up to 24 bits  
 Stock#16179

**In Stock**

**Audio Alchemy DITB Dac-In-the-Box A/V International Grand Prix Winner - 1995**  
 • The world's best selling D-to-A converter  
 • Perfect upgrade for ANY CD-based or LaserDisc A/V  
 • Accepts both TosLink and coaxial inputs  
 Stock#16101

**Low Price Guarantee**

### VCRs

**JVC HRVP628U Hi-Fi Stereo VHS VCR**  
 • Hi-Fi VHS stereo with built-in MTS decoder  
 • VCR Plus+ with multi-system cable box control  
 • Flying erase head  
 • Multi-brand remote  
 • Digital A/V tracking  
 • 181-Ch tuner  
 Stock#13446

**\$299**

**Quasar VHQ660 VHS HiFi Stereo VCR**  
 • 4 Head double azimuth  
 • Digital auto picture  
 • One touch recording  
 • 181-Channel TV/CATV timer  
 • All channel auto set  
 • Auto daylight savings  
 Stock#87715

**\$199**

### CAMCORDERS

**JVC GR-AJ200U VHS-C Camcorder**  
 • 12:1 Variable speed hyper zoom  
 • 2-Lux low-light sensitivity  
 • Program AE with special effects  
 • Full-range AF system with auto macro  
 • Flying erase head  
 Stock#12547

**\$449**

**Sony D840K Portable Car CD Player**  
 • 3-Second electronic shock protector  
 • Backlit key/displays  
 • 1-Bit D/A converter  
 • 6 Playback modes  
 • Digital Mega Bass sound system  
 • Car accessory kit supplied  
 Stock#14718

**\$159**

### AR CLOSEOUTS

**AR 218V Bookshelf Loudspeakers**  
 • 2-Way acoustic suspension  
 • 3/4" Exposed dome tweeter  
 • 6 1/2" Woofer  
 • 150W/Ch max  
 • FR: 55Hz - 20KHz  
 • 8 Ohm  
 Stock#1102

**\$199<sup>pr</sup>**

**LIMITED QUANTITIES!!!!**

**AR 302** Stock#1104/1105 **\$699<sup>pr</sup>**  
 3-Way speaker w/10" woofer • 250W

**AR 302 Tower** Stock#16175/16176 **\$599<sup>pr</sup>**  
 Same as 302, but floorstanding tower

**AR 338** Stock#15149/15150 **\$429<sup>pr</sup>**  
 3-Way speaker w/8" woofer • 150W

**AR 338 Tower** Stock#16177/16178 **\$399<sup>pr</sup>**  
 Same as 338, but floorstanding tower

**AR 228** Stock#1103 **\$279<sup>pr</sup>**  
 2-Way speaker w/8" woofer • 150W Cherry

Dolby® is a registered trademark of Dolby Laboratories. THX® is a registered trademark of Lucasfilm LTD.

# FACTORY AUTHORIZED

ADS • Advent • Audio Control • Aiyra • AKG • Altac Lansing • Audio Quest • Acoustic Research • Audio Alchemy • Audio Source • Atlantic Technology • B&K • Bang & Olufsen • Bazooka • BBE • Beyerdynamics • Bell & Howell • Brother • Canon • Canton • Carver • Cerwin Vega • Celestion • Clarion • CodeAlarm • CWD • Denon • Dynamat • Grado • Harman/Kardon • Hitachi • Infinity • Jamic • JBL • JVC • K40 • Koss • Lexicon • Monitor Audio • Monster Cable • Nakamichi • Niles • OrmniMount • Onkyo • Orion • Panasonic • Philips • Pinnacle • Pioneer Home/Car • Panamax • PPI • Proscan • PS Audio • Rane • Rockford Fosgate • Runco • Samsung • Sennheiser • Sherwood • Sharp • Sony • Sonance • Soundcraftsmen • Soundstream • Spica • SSI • Stewart • Tannoy • Target • Technics • Tert • Thorens • & More!

FOR INFORMATION & CUSTOMER SERVICE  
**201-263-6060**

WE SHIP TO CANADA  
 WE SHIP WORLDWIDE  
 No Credit Card Surcharges  
 See Habler Est-anol

RETAIL HOURS  
 Mon - Fri  
 10am - 9pm EST  
 Sat: 9am - 6pm EST  
 Sun: 11am - 5pm EST

MAIL ORDER HOURS  
 Mon - Fri  
 9am - 10pm EST  
 Sat 9am - 6pm EST  
 Sun 10am - 5pm EST



Factory Authorized for all brands we sell • Not responsible for typographical errors • NO refunds on video or car stereo products • 14 Day defective exchange from date of receipt • All returns must be made within 14 days of receipt of merchandise and are subject to a restocking fee • Items must be in original condition and packaging • Shipping and handling not refundable • This ad and its contents supercedes all other magazine pricing  
**SC# SR796**  
 CIRCLE NO. 42 ON READER SERVICE CARD

# CLASSICAL MUSIC

ly early pieces and the Bach and Schubert transcriptions from the 1930's.

The richly romantic *Im Sommerwind*, an "idyll for large orchestra," dates from Webern's nineteenth year but did not come to performance until 1962. Add this Boulez version to the two fine ones already available from Riccardo Chailly and Christoph von Dohnanyi (both on London). Boulez's reading suggests late Debussy, and the massive Richard Straussian climaxes are most impressive. With the twenty-three variations comprising the Op. 1 Passacaglia we are in the world of post-Fourth Symphony Brahms. Boulez extracts a kind of fiercely grim drama from the score, most notably in the closing pages.

The Five Movements, Op. 5, for string quartet are heard in their string-orchestra version. Here we enter Webern's own world of intense, gnomic sonic evocations. The Berlin Philharmonic strings achieve prodigies of delicacy in this walking-on-eggs music. For me the high point of this CD is the Six Pieces for Orchestra, Op. 6, essentially Webern's memorial to his beloved mother. The fourth section, *Marcia Funebre*, scored chiefly for winds and percussion, says in less than 4½ minutes all that can be expressed about loss, grief, and rage. The performance here of the original large-orchestra version is simply superb.

The transcriptions of Schubert's German Dances, from piano originals unearthed in 1931, have their own special delicacy and

charm. The elaborate orchestration of the six-voice *ricercare* from Bach's *The Musical Offering*, however, finds Webern having a scholarly field day applying his *Klangfarbenmelodie* (tone-color melody) manner to what is already a tour de force.

Boulez and the Berliners have the benefit of crystal-clear yet full-bodied sonics. For those who find a full CD of mature Webern a bit much, this one offers fascinating content and a stimulating variety of musical discourse. Go for it. *D.J.*



### WOLF: Spanish Songbook.

Anne Sofie von Otter (mezzo-soprano); Olaf Bär (baritone); Geoffrey Parsons (piano). EMI 55325 (two CD's, 109 min).

**Performance: Superb**  
**Recording: Intimate**

**H**ugo Wolf's *Spanish Songbook* remains one of the most enigmatic masterworks of late Romanticism. Eccentric, intensely emotional, complex in tone, these songs elicit a very personal response from every

singer who undertakes their challenges. Yet Anne Sofie von Otter and Olaf Bär come about as close to a definitive interpretation as anyone is ever likely to get.

Based on German translations of Baroque Spanish poems, the songbook comprises ten sacred hymns and thirty-four love songs. Most singers pick and choose among them, but Von Otter and Bär have recorded the lot, arranged in a new performing order. They have reimagined the love songs as a conversation between lovers, imparting a sense of erotic urgency to these ballads of lament and longing. The ploy isn't entirely successful — the texts are just too diverse — but it does give a semblance of dramatic shape to the shifting moods of the music. When Bär sings, "*Herz, verzage nicht geschwind*" ("Heart, do not hastily despair"), a bitter condemnation of woman's fickleness, the listener can visualize not only his passionate impatience but also the sly smile on his lover's face.

Bär and Von Otter are among the best lieder singers performing today, and they have honed these songs to a keen edge of expressiveness that is enhanced by the intimate recording, which almost sounds live. Wolf referred to his songs as poems for voice and piano, putting the accompanist on an equal footing with the vocalists. Certainly there is no other pianist today who performs this difficult, highly chromatic music with greater skill and sensitivity than Geoffrey Parsons. *J.J.*

## The Largest Selection Of Name Brand Electronics At The Absolute Lowest Prices! From 20%-60% Off List!

### the home theater system



We have all the technology your looking for, Super Flat, SFT Perfect, Ultra Vision and more!

- 200" LCD Front Projection .....\$1995
- 46" Wide Aspect Projection w/PIP .....\$1599
- 41" High Resolution TV PIP.....\$1399
- 35" Picture Tube TV .....\$999

Samman's offer hundreds of different Models!

### 8mm, beta, & vhs vcrs

all at the guaranteed lowest prices

- JVC HRS-5200 S-VHS.....\$479
- JVC HRS-7100U S-VHS Front Edit/Inpt...\$499
- JVC HRS-7200U S-VHS New! Loaded.....\$589
- JVC 4 Head HiFi Flying Erase Hd VCR+...\$299
- Panasonic PVS-4366 4 Head S-VHS.....\$349
- Hi-8mm Record & Play.....\$499
- Toshiba, Sony, Hitachi & Panasonic .....CALL

### BLOW OUT SPECIALS!

- NADY 201LT-HT Wireless Mic.....\$259
- JVC Wireless headphones.....\$59

### hi fi stereo receivers

- panasonic Dolby Pro Amp 100wpc .....\$149
- AC-3 Doldy Pro Logic Reciever .....\$1099
- THX/Dolby Pro Logic Receiver .....\$799

We carry a full line of name brand Amps, CD Players, Cassette Decks, DAT and More!

### laser combi players

- 425 lines of resolution & CD audio all wrapped into one package!
- Laser Video with auto reverse & AC3 ..\$389
- Pioneer CLDV-860 Laser Karaoke .....\$599
- 60 Disc CD Changer .....\$239
- 24 Disc CD Changer.....\$199
- 100 Disc CD Changer (Name Brand) ..\$319

To finish the system off a great pair of room shaking loudspeakers

- Bose, Advent, BIC & JBL!
- Panasonic 5 Speaker Surround Sound.....\$1399
- 3 Speaker L/R & Sub-Woofer Pkg.....\$1999
- 100 Watt Amplified Sub-Woofer.....\$1999
- ADVENT AV-170 Powered Spkr .....\$799
- Mitsubishi 8" passive Sub-Woofer.....\$999
- ADVENT or BIC Center Channel Spkr.....\$999

### bookshelf mini systems

- Duel Cassette, 24 CD Changer 200 watts...\$369
- Duel Cassette, 3 CD Changer 100 watts....\$299

We carry all your favorite makes and models. Please call for your best delivered price!



# AUTHORIZED ELECTRONICS

SAVE ONE CALL DOES IT ALL

## 1-800-937-3537

SAMMAN'S ELECTRONICS 1166 HAMBURG TPKE. WAYNE, NEW JERSEY

All prices quoted include Manufacturer's standard accessories & U.S. Warranty.

All units are factory sealed. We ship within 24 hours. Customer Service 201-696-8855



AUTHORIZED

IRCA GO.VIDEO SHARP. TOSHIBA SONY. Panasonic JVC BOSE



**IMAGINE THUNDEROUS, GORGEOUS BASS IN YOUR RIDE WITH NO SUBS! NONE! NADA!**

*Introducing*  
**MILLENNIUM 240 SUB SYSTEM**

**THE WORLDS LARGEST 240FT SUB  
24,000 WATT AMP WITH A 24,000 BTU  
AIR CONDITIONER! 20 FOOT, 500LB MAGNET  
240 VOLT/60HZ AMP, INDUSTRIAL STRENGTH.**

**SET UP YOUR 240 SUB**

- IN YOUR BEDROOM
- IN YOUR DORM ROOM
- IN BASEMENT OR ATTIC

**RICH, DEEP, THUNDEROUS BASS WILL  
BE FELT IN YOUR CAR UP TO 35 MILES  
FROM YOUR INSTALLATION SITE !!!**

SORRY, MILLENNIUM 240 NOT FOR SALE IN CALIFORNIA  
DUE TO EARTHQUAKE PREVENTION LAWS.





**PRICED UNDER \$24,000**

**24,000 WATTS**



**SORRY, OUR FOUR  
"WITH-IT" CAR AUDIO  
DEPARTMENTS IN NEW  
JERSEY DO NOT CARRY  
THE NEW MILLENNIUM  
240 SYSTEM, IT HAS  
FREON IN THE AIR  
CONDITIONING UNIT!  
OH WELL!**

**FREE**  
SCHEDULE OF  
ALL IASCA  
EVENTS AND  
SOUND-OFFS FOR  
**1996**  
CALL: 201-467-0100  
**MEMBER OF**  
IASCA

-  22 RTE. 22 WEST, SPRINGFIELD, NJ  
MON-FRI 10-9:30 SAT 10-9 • SUN 10-7  
**201-467-3905**
-  331 RTE. 4 WEST, PARAMUS, NJ  
MON-FRI 10-9:30 SAT 10-9 • SUN CLOSED  
**201-489-0666**
-  577 RTE. 10 EAST, LIVINGSTON, NJ  
MON-FRI 10-9:30 SAT 10-9 • SUN 10-7  
**201-716-7073**
-  545 RTE. 18 SOUTH, E. BRUNSWICK, NJ  
MON-FRI 10-9:30 SAT 10-9 • SUN 10-7  
**908-390-5100**
-  **INFORMATION HOT LINE:  
201-467-0100**

**AUTHORIZED DEALER FOR:**  
NAKAMICHI • ALPINE • PIONEER "PREMIER"  
BLAUPUNKT • JBL • SOUNDSTREAM  
ROCKFORD FOSGATE • BAZOOKA  
STREETWIRE • ALTEC LANSING • OZ  
PRECISION POWER • KEF • KICKER  
HiFONICS • WHISTLER • BELTRONICS  
CODEALARM • VIPER **JUST TO NAME A FEW!**



# new west electronics

*north america's  
home theater  
specialist!*

Audio Separates • A/V • Receivers • DSS  
AC3 • THX • Laser Disc • VCRs • TVs  
Bigscreens • Subwoofers • Speakers  
Camcorders • Mobile

PIONEER • HARMAN KARDON  
CELESTION • KENWOOD • JVC  
INFINITY • AIWA • SONY • RCA • AR  
TOSHIBA • HITACHI • PREMIERE  
MONSTER CABLE • VELODYNE  
GO-VIDEO • PANAMAX • B&K  
KIMBER • AUDIO ALCHEMY  
OMNIMOUNT & MUCH MORE!

**new west electronics credit card**

*Card holders enjoy special discounts & benefits.  
Call 1-800-733-1366 for application & details.*

**Great Prices - Excellent Service**

# 800-488-8877

**All Prices Include Federal Express Delivery**

*Please ask about our Return & Exchange policies*

All Times PST: M-F 6:30A to 6:30P • SAT 7:00A to 6:00P SUN 8:00A to 5:00P

*COD's & PO's Welcome!*



A Division of Clarity Electronics LTD.

4120 Meridian • Bellingham WA 98226 • Fax (360)734-3314

CIRCLE NO. 27 ON READER SERVICE CARD

Looking for more info?

**<http://www.newest.com>**

*It's new west on the net!*

# CD STORAGE CONNECTION

## Storage Solutions

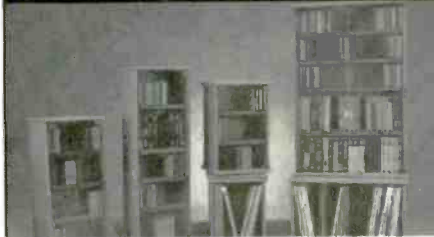

**CD, Audio and Video Storage** ▶ Fully Assembled!  
 Call or write for a **free** color brochure ▶ 100% Solid Oak!  
**1-800-858-9005** ▶ 30 Day Money Back Guarantee!  
 ▶ Made in U.S.A.  
 ▶ Smoked Glass Doors  
 ▶ Adjustable Shelves  
 ▶ No Hidden Costs  
 ▶ Just One Low Price!

AGM Woodworking  
 870 Capitolio Way #5  
 San Luis Obispo, Ca. 93401  
 (805) 544-8668

## The STEREO REVIEW CD STORAGE CONNECTION

puts manufacturers of CD storage units in touch with the ideal audience...  
 CD purchasers unsurpassed in size, buying activity & the need for storage of their ever-growing CD collections!  
 For advertising information call:

**1-800-445-6066**  
 (Monday-Friday, 9-5 EST)  
 or Fax 212-767-5624

## MODULAR STORAGE CABINETS

Design your own entertainment center. This modular grouping accommodates a large rear projection TV & A/V equipment and up to 1,600 CDs or 360 videos, lasers, LPs, liquor, photos, etc. All for only \$1,394. Let your imagination run wild.

**Open Wide & Say Ahhhh!**  
 This Cabinet holds **800 CDs**  
 or **180 videos**  
 Caddy Optional

The Look of Leather  
**CAN-AM**  
 The Strength of Steel

**800-387-9790** or **905-475-6622** <http://www.lo.org-canam>

## CD/VHS CASE

5 Foot Tall Holds 500 CD's

**\$159<sup>95</sup>**

- ▶ Furniture Quality Oak Construction
- ▶ Fully Adjustable Shelves
- ▶ Hand Rubbed Danish Oil Finish
- ▶ Immediate Delivery in Oak or Black
- ▶ Free Color Photos

We offer a complete line of products: 300 glass door case, 250 shelf unit & much more in oak and black

**1-800-878-7458**

Hy-Q Enterprises • 14040 Mead St. • Longmont, CO 80504

**Classified Advertisers...**

Millions of your prime prospects can be found in the industry leading titles of *Habette Filipacchi Magazines, Inc.*

To place a classified ad, simply call **toll-free** and reserve your space today!

**1-800-445-6066**  
 (9am - 5pm EST)  
 or  
 Fax your order to 212-767-5624

## BILLY BAGS AUDIO/VIDEO FURNITURE DESIGN

"We will even design a piece to your exact specifications!"

AUDIO RACKS ▶

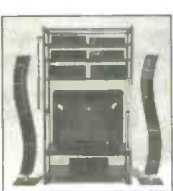

◀ MEDIA RACK



PRO AMP STAND ▶



◀ COMPONENT CENTERS



CD PLUS STORAGE RACKS ▶



Call us today for your local dealer and a copy of our detailed Newsletter with product photos and specifications...

4147 TRANSPORT STREET • VENTURA, CA 93003  
 (805) 644-2185 • FAX (805) 644-0434

# CD STORAGE+™



No. A300 (Shown in Solid Brown Oak)

## SORICÉ SYSTEMS Include... Video, Cassette, LP, Laserdisc and Component Storage Units.

- ❖ Our A300 Model shown stores 300 CD's.
- ❖ Impeccably crafted in these Premium Solid Hardwoods: Oak, Walnut, Teak or Cherry.
- ❖ Adjustable Shelves store any combination of CD's, Videos & Cassettes - all in One cabinet.
- ❖ Adjustable Solid Brass Bookends keep Discs & Tapes upright and in place.
- ❖ Cabinets can be stacked, wall mounted or left free standing.
- ❖ Optional Wood or Glass Doors are available.
- ❖ Enclose back provides dust protection.
- ❖ Compact size: 39 1/2" H x 23 1/2" W x 7 1/2" D. Cabinet comes assembled.

## SORICÉ

PO Box 747-21, Nutley, NJ 07110  
 Credit Cards, Checks and Money Orders accepted.  
 30 Day Money Back Guarantee and a Full One Year Warranty on all Models.

For FREE Color Literature & Prices on our Full Line of Quality Products  
**Call: 1-800-432-8005**  
**Fax: 1-201-667-8688**

# CLASSIFIED

For Advertising Information Call 1-800-445-6066, 9am-5pm EST

**PLEASE NOTE:** It is impossible for us to verify all of the claims of advertisers, including product availability and existence of warranties. To confirm that an advertiser is authorized to sell a product, we suggest you contact the manufacturer directly. Please review our *Tips for Mail Order Purchasers* in this section.

### RECORDS

LV/CD/RECORD COLLECTOR'S SUPPLIES. Jewel boxes, record jackets, sleeves, storage boxes, 78 sleeves, dividers, much more! Free brochure: CABCO PRODUCTS, ROOM 641, POB 8212, COLUMBUS, OH 43201. (614) 267-8468

NEEDLES/CARTRIDGES & Belts--Expert Consultations, All Major Brands, One of Largest Stocks in Country including Old/Obsolete Models. NEEDLE EXPRESS. 1-800-982-2620.

### AUTHORIZED

OUR 20TH YEAR! CALL 1(800) 826-0520. ★ NAD ★ SONY ES ★ ONKYO ★ CARVER ★ HARMAN KARDON ★ KEF ★ GRADO ★ LEXICON ★ ATLANTIC TECHNOLOGY ★ PSB ★ AUDIOCONTROL ★ MONSTER CABLE ★ NILES AUDIO ★ SONY DSS ★ THORENS ★ PROAC ★ PANAMAX ★ CWD ★ CELESTION JAMO ★ ALTEC LANSING ★ SANUS SYSTEMS ★ RECOTON ★ STAX ★ OMNI MOUNT ★ TARGET ★ SOUNDSTREAM ★ SOUND ANCHORS ★ KICKER ★ MTX ★ CLARION ★ ROCKFORD FOSGATE ★ SOUND SELLER, BOX 224, 2808 CAHILL, MARINETTE, WI 54143-0224.

## the Sound Seller

Authorized Dealer For:

- |                       |                 |                    |
|-----------------------|-----------------|--------------------|
| • ADCOM               | • KICKER        | • PSB              |
| • ALTEC LANSING       | • LEXICON       | • RECOTON          |
| • ATLANTIC TECHNOLOGY | • MONSTER CABLE | • ROCKFORD FOSGATE |
| • AUDIOCONTROL        | • MTX           | • SANUS SYSTEMS    |
| • CARVER              | • NAD           | • SONY DSS         |
| • CELESTION           | • NAKAMICHI     | • SONY ES          |
| • CLARION             | • NILES AUDIO   | • SONY VIDEO       |
| • CWD                 | • NITTY GRITTY  | • SOUND ANCHORS    |
| • GRADO               | • OMNIMOUNT     | • SOUNDSTREAM      |
| • HARMAN KARDON       | • ONKYO         | • STAX             |
| • JAMO                | • PANAMAX       | • TARGET           |
| • KEF                 | • POLK AUDIO    | • THORENS          |
|                       | • PROAC         |                    |

2808 Cahill Road, P.O. Box 224  
Marinette, WI 54143 • (715) 735-9002

**1-800-826-0520**

FRIENDLY ADVICE! FREE SHIPPING! MIRAGE, PS, KINERGETICS, NAD, PARASOUND, KEF, AUDIOQUEST, KIMBER, JOLIDA, STRAIGHTWIRE, CARVER, MORE!! READ BROTHERS, 593-B KING, CHARLESTON, SOUTH CAROLINA 29403. (803)723-7276.

STEREO WORLD IS YOUR DISCOUNT SOUND SOURCE WITH SUPER DEALS ON: SONY, PYLE, DENON, PPI, JVC, HIFONICS, POLK, PIONEER, SCOSCHE EFX, ORION, KITS, BASSBOXES, AND MUCH MORE! CALL OR WRITE FOR FREE SALES FLYER. FREE UPS! OUR 8TH YEAR. VISA/MC: COD. P.O. BOX 596, MONROE, NY 10950. (914) 782-6044.

SAVE 40% ON HIGH-END home speakers, subwoofers, amplifiers. FREE CATALOG! RTRD, 3021 Sangamon Ave., Springfield, IL 62702, 1 (800) 283-4644.

### AUTHORIZED

SAVE - BUILD YOUR OWN LOUDSPEAKERS. We have the parts you need. Meniscus Audio (616) 534-9121. meniscus@IServ.net.

the Happy Medium

Expensive Electronics Without the Expense!

<ul style="list-style-type: none"> <li>• ARCHITECTURAL AUDIO</li> <li>• DAT</li> <li>• MINIDISC</li> <li>• WORLD BAND RADIO</li> <li>• PRO WALKMAN</li> <li>• CABLES</li> </ul>	<ul style="list-style-type: none"> <li>• FIELD RECORDERS</li> <li>• DSS</li> <li>• SONY DST</li> <li>• CUSTOM INSTALLATION</li> <li>• HOME THEATER</li> <li>• ACCESSORIES</li> </ul>
---	--

<ul style="list-style-type: none"> <li>• ADS</li> <li>• ATLANTIC TECHNOLOGY</li> <li>• BANG &amp; OLUFSEN</li> <li>• CARVER</li> <li>• CELESTION</li> <li>• ENERGY</li> <li>• GRADO</li> <li>• HARMAN KARDON</li> <li>• JVC</li> <li>• KEF</li> <li>• LEXICON</li> <li>• MONSTER CABLE</li> <li>• NAD</li> </ul>	<ul style="list-style-type: none"> <li>• NAKAMICHI</li> <li>• NILES AUDIO</li> <li>• ONKYO</li> <li>• POLK AUDIO</li> <li>• PSB</li> <li>• PROAC</li> <li>• SANUS</li> <li>• SONY DSS</li> <li>• SONY ES</li> <li>• SONY VIDEO</li> <li>• SENNHEISER</li> <li>• TARGET</li> <li>• THORENS</li> </ul>
--	--

430 State St. Madison, WI 53703 • FAX 1(608)255-4425

1-800-906 HI-FI (4434)

### FOR SALE

### PLEASE NOTE:

A ★ AFTER A PRODUCT INDICATES THE ADVERTISER IS AN AUTHORIZED DEALER FOR THAT PRODUCT.

LOW PRICES!!! ●●● Polk-NAD-Nakamichi-B&K-Carver-Velodyne-KEF-Onkyo-NHT-Snell-PSB-Parasound-M&K-Denon-Sound Shop 360-692-8201. Call us for our FREE OW-OUT SPECIALS LIST!

ComputAbility

SINCE 1972

AUTHORIZED DEALER

DSS	Panasonic	JVC
TOSHIBA	SONY	Canon
JBL	VIDEONICS	RECOTON
SHARP	CARVER	MITSUBISHI

Panasonic **\$599<sup>95</sup>**

LX-900

Laser disc movies, video, karaoke and CD entertainment. Rely on Panasonic for advanced digital technology.

<p>VCRs &amp; AMPLIFIERS</p> <p>CASSETTE DECKS</p> <p>A/V RECEIVERS</p> <p>CD PLAYERS</p> <p>AUDIO/MINI SYSTEMS</p>	<p>LASER DISC PLAYERS</p> <p>CAMCORDERS</p> <p>DSS &amp; 13"-35" TVs</p> <p>EDITING EQUIPMENT</p> <p>SPEAKERS</p>
---	---

HOURS (CST):  
MON. - FRI. 8AM-8PM SAT. 9AM-5PM

800-554-2183

## Buy the perfect system.

Call us first and ask us how to buy the perfect system. Our staff is widely recognized in the industry as being highly knowledgeable and the most courteous. From state-of-the-art audio to sophisticated home theater systems, we carry only what we feel is the best.

To get started, call us today... and ask us how.

REFERENCE  
AUDIOVIDEO  
ASK US HOW.

800 947-HiFi

310 517-1700 SO. CALIF.  
310 517-1732 FAX

18214 DALTON AVENUE, DEPT S  
GARDENA, CA 90248



AUTHORIZED DEALER: ANG • ATLANTIC TECHNOLOGY • AUDIBLE ILLUSIONS • AUDIOQUEST • AUDIO ALCHEMY • AUDIO CONTROL • BEYER DYNAMIC • BOSE • CAL AUDIO LABS • CARVER • CELESTION • CLEARFIELD • COUNTERPOINT • CWD • DAHLQUIST • DCM • FAROUDJA • FOSGATE • GENESIS • GRADO • HATLER • HARMAN KARDON • HUGHES/SRS LABS • INFINITY • JAMO • JBL • LEXICON • MAGNUM DYNALAB • MELOS • MERIDIAN • NAD • NESTORONIC • NILES • OHPYO • PARASOUND • PHILIPS • PIONEER • POWER WEDGE • PRITON • PROAC • PSB • ROOMTUNE • SONANCE • SONIC FRONTIERS • SONY • STAX • TARGET • THORENS • TICE • VPI • XLO and more.

BUY DIRECT FROM JAPAN & SAVE \$\$\$! SUPPLIERS OF FAMOUS JAPANESE BRANDED ELECTRONICS. WE HAVE THE LATEST ITEMS AT COMPETITIVE PRICES. WORLDWIDE SHIPPING & INSURANCE AVAILABLE. TELEPHONE: 6-271-6185-7. FAX: 6-271-6183. E-MAIL: 71124.755 @CompuServe.com SINCE: 1967. RAMSONS CORPORATION (JAPAN) LTD.

## SHOP US LAST

FACTORY AUTHORIZED DEALERS  
HOME THEATER  
CAR STEREO

SINCE 1979

ADS • ALPINE • ATLANTIC TECH • BOSE • CARVER • DENON • INFINITY • KENWOOD • NAKAMICHI • ONKYO • SONANCE • SONY ES • VELODYNE • YAMAHA  
*and many we can't print!*

The Sound Approach

6067 Jericho Tpke., Commack, NY 11725  
**800-368-2344**

FOR SALE

TIPS FOR MAIL ORDER PURCHASERS

It is impossible for us to verify all of the claims of advertisers, including product availability and existence of warranties. Therefore, the following information is provided for your protection.

- 1. Confirm price & merchandise information.
2. Understand the seller's return & refund-policy.
3. Understand the product's warranty.
4. Keep a copy of all transactions.
5. If the merchandise is not shipped within the promised time or if no time was promised, 30 days of receipt of the order, you generally have the right to cancel the order and get a refund.
6. Merchandise substitution without your prior consent is not allowed.
7. If you have a problem with your order or the merchandise, write a letter to the seller.
8. If you are unable to obtain satisfaction from the seller, contact the consumer protection agency in the seller's state or your local Post Office.

If, after following the above guidelines, you experience a problem with a mail order advertiser that you are unable to resolve, please let us know. WRITE to Susan Ross, Special Marketing, 45th floor, Hachette Filipacchi Magazines, Inc., 1633 Broadway, New York, NY 10019. Be sure to include copies of all correspondence.

FOR SALE

WHOLESALE CONNECTION

To Order Call 1-800-226-2800

Table listing various audio equipment categories such as Receivers, Home Speakers, Car Stereos, and Mini Disc Recorders with model numbers and prices.

Table listing more audio equipment categories including Laser Disc Receivers, Car Amplifiers, and Laser Discs.

24 HR. FAX (718)997-6652 P.O.'s Welcome
HRS MON-SAT 9 A.M.-6 P.M. Est Prices subject to change. Prices exclude shipping & handling. Not responsible for typographical errors. MasterCard, Visa, American Express and C.O.D. accepted. Products come with W.C. Warranty. We ship UPS & FEDEX.
Wholesale Connection 63-48 108th St. Forest Hills, NY 11375

FOR SALE

S.B.H. ENTERPRISES

(800)451-5851

MON.-FRI. 8-7 SUNDAY 9-6 24 HR. FAX: (718) 438-4621

NY (718) 438-1027 1678 53RD ST. BURLY, N.Y. 11204

Large table listing various audio equipment categories including Radar Detectors, Car Stereos, Laser Disc Receivers, Cassette Decks, CD Players, and Mini Systems.

NEW WORLD AUDIO BUY WHOLESALSA OVER 100 BRANDS OF HOME & CAR AUDIO 800-311-0392

DJ & Nightclub Sound, Lighting & Video CATALOG FREE 88-Page Catalog with a huge selection of name brand professional gear for DJ's, Clubs & Musicians all at discount prices! Call Today 800-945-9300

Infinity 4225 6 1/2" 2-way basketweave speakers 6 1/2" (W) woofer 1 1/2" tweeter polycarbonate tweeter 100% cast ABS case (16.99) LOW PRICES ON THE OTHER SIDE OF THE EARTH! 149.95 www.theadvantage.com

FRIENDLY PEOPLE AND EXPERT ADVICE! ABC American Buyer's Club Home Theater Specialists 1-800-354-1324

Table listing various audio equipment categories such as Receivers, Speakers, Laser Discs, and Cassette Decks.

All products are new USA merchandise covered by the manufacturer's warranty or ABC's exclusive limited warranty and are backed by our 10 DAY MONEY BACK GUARANTEE. MEMBER OF THE BETTER BUSINESS BUREAU.

SINGERS! REMOVE BACKGROUND MUSIC FROM ORIGINAL STANDARD Recordings! Does Everything Karaoke does... Better and gives you the Thompson Vocal Eliminator! Free Brochure & Demo Tape. LT Sound Dept. SR-15 7980 LT Parkway, Lithonia, GA 30058

## MOVIES/FILMS/VIDEOS

FREE SEARCH SERVICE: every title worldwide. Buy • Sell • Trade • Rent • Auction. Anytime: 1-800-849-7309; FAX: 1-770-227-0873.

## BLANK TAPES

1-800-TAPE WORLD or 1-800-245-6000

We'll beat any price! 5.95 SHIPPING • FREE CAT.

SONY	MAXELL	TDK	FUJI
DAT-120 5.99	XLIJ-90 1.59	D-90 .79	SVHS-T120 6.49
DAT-124 PRO 8.99	XLIJ-100 1.99	SA-90 1.49	HI 8 120 5.99
T-120V 1.79	XLIJ-S 90 1.99	SAX-90 1.99	BMM-120 3.49
L7503THG 3.99	T-120 HGX 2.49	SAX-100 2.49	DCC-90 6.99
SI-150 7.99	SI-120 6.99	T-120 BHG 2.49	DVC-90 .69
CDR-74 6.99	DAT-124 max 9.99	DAT-120 6.49	LVC ST120 5.99
MDW-74 9.99	UD35-90 8.99	CDR-74 6.99	XELI-30 max 9.99

TAPE WORLD 220 SPRING ST. BUTLER PA 16003 FAX 412-263-3398  
OVER 500 DIFFERENT. SAME DAY SHIPPING. M-F 8-5

## CAR STEREO

CALL FOR CHEAP PRICES - FREE SHIPPING on ADS, Alpine, Audio Control, Bazoooka, Blau, Boston(Non-Auth.), Clarion, Denon, Kenwood, Kicker, Orion, Pioneer, Polk, PPI, Quart, Soundstream & Sony. SOUND IDEAS, (516) 864-6548, E MAIL: sound—ideas@HTp.com, P.O. BOX 124, COMMACK, NY 11725. FAX: (516) 225-6664.

## WANTED TO BUY

LP's & CD's BOUGHT & SOLD: Classical, Rock, Jazz, Audiophile, Etc. PRINCETON RECORD EXCHANGE, 20 Tukan St., Princeton, NJ 08542. (609) 921-0881.

CASH FOR USED AUDIO & VIDEO EQUIP. BUYING and SELLING by PHONE. CALL FOR HIGHEST QUOTE. (215) 886-1650 Ext. SR. Since 1984. The Stereo Trading Outlet, 320 Old York Road, Jenkintown, PA 19046.

McIntosh and Marantz tube type Hi-Fi; and old JBL, Altec, Tonnoy, EV Patrician and Western Electric speakers. David: 1-800-356-4434.

## LASER VIDEO

**WIDE SCREEN MOVIES ON LASERDISC**  
NEW RELEASES BOX SETS  
IMPORTS OLD FAVORITES  
800-893-0390  
FREE IN STOCK CATALOG

**LASERTOWN VIDEO DISCS**  
50 SCHOOL HOUSE RD BOX 406A  
KUPLSVILLE, PA 19443

215-721-8688 FAX 215-721-4539  
"HOME ENTERTAINMENT AT ITS BEST"

## EMPLOYMENT INFORMATION

MUSIC CONSULTANT to lay out, test, and modify musical production such as: 1) Kurzweil K-2000 Synthesizer. 2) Akai S-3200 Sampler. 3) Mackie 32 XB Recording Console. 4) Lexicon PCM-70 Effects Processor. 5) Hard Disk Recording Systems, such as protocols & Akai DRS Multitrack. To apply principles and theories of electronics, electrical circuitry, music, MIDI, and acoustics. To assist customers in analyzing their needs, assembling electronic circuitry, prototype models. To recommend changes in circuitry or installation specifications to meet individual needs. To synthesize or program sounds for a variety of musical styles, and productions. To perform engineer music production to specific customer needs. 35 hours per week, 9 A.M.-5 P.M., \$592.67 per week, 4 years experience required. Send resume with Social Security number to The Indiana Department of Workforce Development, 10 North Senate Avenue, Indianapolis, IN 46204-2777, Attention Gene R. Replogle. Include I.D.#3379662.

## LOUDSPEAKERS

# SPEAKER CATALOG

Parts Express is a full-line distributor of electronic parts and accessories geared toward the consumer electronics industry and the technical hobbyist. We stock an extensive line of speaker drivers and accessories for home and car. Call for your FREE 228 page catalog today.



Parts Express® 1-800-338-0531  
340 E. First Street Source Code: SRV  
Dayton, Ohio 45402-1257  
Phone: 513/222-0173 • Fax: 513/222-4644



### ROTTEN FOAM?

- Simply Speakers - Factory Authorized Service - All Brands JBL, Bose, Advent, EPI, CV, AR, Infinity & More!
- Worldwide Service - Re-coning & Re-foaming.
- Huge selection of D.I.Y. Foam Kits - We Ship Daily!
- Foam Rot Preventative Kits.

**CALL TOLL FREE TODAY!**

1-800-767-4041 = SIMPLY SPEAKERS. MC/VISA/NOVUS/AMEX. 11203 49TH STREET N., CLEARWATER, FL 34622. E-MAIL: simplyspkr@aol.com. D.I.Y. KITS INCLUDE: ILLUSTRATED INSTRUCTIONS, ADHESIVE & TECHNICAL SUPPORT. BEST PRICES / SERVICE / WARRANTY—GUARANTEED!!

D.I.Y. NEW FOAM KITS

WISHING FOR YOUR SPEAKERS TO WORK AGAIN?  
YOUR PHONE IS A MAGIC LAMP. RUB.

# NEW-FOAM

CALL TOLL FREE

Speaker Repair & Replacement Parts  
Nationwide Service Since 1979

1-800-NEW-FOAM = 1-800-639-3626 NATIONWIDE SPEAKER REPAIR, PARTS, AND ACCESSORIES. Call us with your speaker problems. VISA/MC/AMEX/DISC. EMAIL NEWFOAM@MSn.com

STATE OF THE ART CROSSOVER NETWORKS. UPGRADE ANY SPEAKER. SOFTWARE AVAILABLE. FREE DESIGN GUIDE. ALLPASS TECHNOLOGIES, INC., 2844 CHARMONT DR, APOPKA, FL 32703-5972. (407) 786-0623.

ONLY THE **Ohm** BRAND

Speaker Service, Upgrades and Trades. Ohm Acoustics, Corp. 241 Taaffe Pl., Brooklyn, NY 11205. (800) 783-1553, Fax (718) 857-2472 email: OhmSpeaker@aol.com WWW-OhmSpeaker.com

**Repair Foam Rot Yourself!**

- Save hundreds of dollars w/orig. kit!
- Kits to fit any speaker - Advent, AR, JBL, Bose, Infm, EV, etc
- Inc. surrounds, adhesive & instructions
- MC/VISA/Discover - No CODs
- Call last for Best Price
- Order by phone 24 hrs 704-697-9001

or call Toll Free 800-747-3692  
P.O. Box 1088 • Flat Rock, NC 28731



**STAPP**  
AUDIO TECHNOLOGIES

## CABLE TV

**CABLE TV DESCRAMBLERS**



Best Buys  
Best Service  
Full Warranty

# 800-835-2330

## CABLE TV

LINK YOURSELF TO THE FUTURE WITH OUR EXPERIENCE! CABLE TV CONVERTERS & DESCRAMBLERS. QUALITY, SERVICE & SATISFACTION GUARANTEED! VISA/MC/AMEX/C.O.D. ACCEPTED. QUANTITY DISCOUNTS. CABLE UNX, INC., MINNEAPOLIS, MN: 1-800-501-0095.

The Rules Have Changed!

## The New INFINITY 3000

BIG 125 Channel Capacity!



**\$349.00** One-year Warranty, includes: parts, labor, and FREE decoder upgrade

FREE DECODER UPGRADES the First Year!

Don't get left behind with inferior equipment that can't grow with you.

TO ORDER-CALL TOLL FREE  
1-800-624-1150

**Features Include:**

- 125 Channel Capacity
- Volume Control/Mute
- FREE Decoder Upgrade
- Automatic Fine Tuning
- Advanced Parental Control
- Audio Video Ports
- Dynamic memory
- 3/4 Switchable
- Favorite Channel memory

**MD Electronics**  
Member of National Consumer Cable Association  
5723 F Street • Omaha, NE 68127





FREE CATALOG!

CABLE T.V. CONVERTERS & DESCRAMBLERS: Replacements for most models. 30 Day Trial—1 Year Warranty! Dealer Inquiries Invited. Visa/MC/Disc/Amex/COD FOR QUALITY, PRICE & SERVICE CALL: 1-800-259-1187. Eagle Electronics Inc., #1, 1301 Railhead Blvd., Naples, FL 33963. No Florida Sales.

Why Rent?

1 YEAR WARRANTY!

## CABLE TV CONVERTERS & DESCRAMBLERS



ABSOLUTELY LOWEST WHOLESALE/RETAIL PRICES!

MASTERCARD • VISA • DISCOVER • AMEX • COD  
NO FL SALES

# 1-800-430-4301

30 DAY MONEY BACK GUARANTEE!

CABLE TV DESCRAMBLERS—We beat all prices...get cable direct! All Boxes Guaranteed 2 years!! 24 Hour delivery! CABLE DIRECT SOURCE: 1-800-540-3868; Ext. 41.

**CABLE TV**

C.D. ELECTRONICS IS NOW SELLING CONVERTERS/DESCRAMBLERS DIRECT TO THE PUBLIC AT WHOLESAL PRICES! 30-DAY TRIAL QUANTITY DISCOUNTS! 1-800-842-9670.

**CABLE T.V. DESCRAMBLERS**  
**CFS ELECTRONICS**  
 Lowest Prices! (800) 995-1749  
 Visa, MC, AMEX, C.O.D.

REVOLUTIONARY TECHNOLOGY. Does All Boxes - For Free Catalog Please Call Mega Electronics 1-800/676-6342.

**NU-TEK ELECTRONICS**  
 Leading the way to excellence

**Cable TV Converters & DESCRAMBLERS**



30 DAY MONEY BACK GUARANTEE ONE YEAR WARRANTY

**FREE CATALOG**  
**1-800-228-7404**

WE'LL BEAT ANY PRICE ON CABLE CONVERTERS & DESCRAMBLERS. SAVE ON CABLE RENTAL & CONNECTION CHARGES. VISA/MC/DISCOVER/COD. QUALITY 1(800)-72-BOXES.

**STOP!** We have the best in converters & descramblers. Call: **FOX ELECTRONICS**  
**1-800-888-5585**

CABLE DESCRAMBLERS/CONVERTERS. BUY DIRECT—ROCK BOTTOM PRICES! #1 IN CUSTOMER SERVICE & LOW PRICES. ALL MAJOR BRANDS, MONEY-BACK GUARANTEE. THE CABLE OUTLET: 1-800-203-7077.

**30 Day FREE TRIAL**  
**CABLE TV DESCRAMBLERS**  
 CONVERTERS FILTERS ACCESSORIES  
 1 Year Warranty on All Products  
 Call the Cable Professionals 24 Hours A Day!  
**1-800-379-3976**  
 Orion Electronics [HTTP://WWW.ORION-ELECTRONICS.COM](http://www.orion-electronics.com)

CABLE DESCRAMBLERS. BELOW WHOLESAL PRICES. ABSOLUTELY LOWEST PRICES GUARANTEED! NOBODY BEATS US! THE CABLE CONNECTION: 1-800-411-2662.

**SATELLITE TV**

**NEW 18" Dish**  
 MORE Programming Choices!  
 Save 30-60% on Programming!  
 Compare to Cable and other 18" Dishes!

Small Dish Big Programming  
 Call Now! **800-500-9264**  
**Skyvision**  
 1070 Frontier Dr. Fergus Falls, MN 56537

**SATELLITE TV**

**RCA 18" DSS Disk**  
 Now *Descrambled*  
 ALL Channels, Movie, Local Blackout Sports, Special Events, *ALL* Sports  
 Buy New Access Card Today  
 Where To Get One & How Much  
 Send \$12.50 to: **DSS DESCRAMBLERS**  
 Unit 133, 6822 22nd Ave. No. St. Petersburg, FL 33710



**PUBLICATIONS**

GOLDMINE, your bi-weekly news & ad source for collectible records, CDs & memorabilia. 6 issues for \$9.95. Call toll-free 800-258-0929 Dept. ABAMTY or visit Goldmine Online! <http://www.krause.com/goldmine>.

**FOR SALE**



WE ARE HERE TO SERVE YOU!! WE HAVE OVER 27 YEARS EXPERIENCE IN THE AUDIO/VIDEO BUSINESS. WE OFFER NATIONWIDE INSTALLATION, TECHNICAL ADVICE. OUR FACTORY TRAINED TECHNICIANS INSTALL MOST HOME THEATER SYSTEMS IN ONE DAY. CALL TODAY AND INQUIRE ABOUT OUR PACKAGE DEALS!!

USA Manufacture Warranty  
 30 Day Return Policy

CALL FOR GREAT PRICES ON THE FOLLOWING..

ADCOM..ATLANTIC TECHNOLOGY  
 BIC..BOSE..DENON..HITACHI  
 HARMON KARDON..JVC..KEF  
 KLIPSCH..MARANTZ..MIRAGE  
 M&K..NAD..ONKYO..NHT..POLK  
 PARADIGM..PSB..YAMAHA  
 AND MORE..

**CALL TODAY..TOLL FREE!**  
**1-888-862-8600**

15 MINNEAPOLIS RD., RARITAN TWP., NJ 08822

**ATTENTION ADVERTISERS**

Reach proven mail order buyers!

They turn to us when they are looking for purchasing information and advise. Advertise your products and services in a low-cost environment that sells.

Millions of your prime prospects can be found in the industry leading titles of

**Hachette Filipacchi Magazines, Inc.**

To place a classified ad, simply call us *Toll-Free* and reserve your space today!

**1-800-445-6066**  
 (9am- 5pm EST)  
 or  
**FAX: 212-767-5624**

**Index to Advertisers July**

Reader Service No.	Advertiser	Page Number
—	Absolute Soundings	84
2	Acoustic Research	C3
1	Adcom	9
4	Advent	37
—	All Brands Electronics	89
7	API/Mirage	21
—	Bacardi	19
—	The Basic Repertory on CD	34
—	Blue Note Records	85
—	Bose	2-3
6	Cambridge SoundWorks	10-11, 12
—	Camel	48a,b
—	Car Stereo Review	65
—	Columbia House	7
11	Crutchfield	45
15	Definitive Technology	30-31, 32, 33
—	Electronic Wholesalers	96
—	Electronics Depot	93
21	J&R Music World	82-83
20	JVC	25
22	Kenwood	4
23	Magnepan	27
—	Marlboro	C4
25	MCM Electronics	94
26	Mobile Fidelity	74
27	New West	98
28	NHT	39
16	Niles	14
29	NuReality	29
47	One Call	91
—	PARA	66
35	Paradigm	42, 43
—	Pioneer	C2-1, 22-23
34	Polk Audio	17
—	Radio Shack	13
—	6th Avenue Electronics	86, 97
42	Sound City	95
43	Spatializer	35
—	Uncle's Stereo	92
—	Warner Bros.	81

# Wynton Marsalis

BY KEN SMITH



JANUSZ KAWA/SONY CLASSICAL

“Can we do this outside, man?” Wynton Marsalis pleaded with me, his tie slightly loosened, basketball in hand, when I arrived to interview him. “C’mon, I’ve been in here all day.” He glanced longingly at the Hudson River through the windows of his Manhattan apartment before settling down to business.

At 35, Marsalis still has the mischievous air of a precocious student who constantly goads his teachers even as he dispatches his assignments dutifully. Scattered trumpets and stacks of mail, though, reveal how far his status has come since 1984, when he first picked up Grammys in both the jazz and classical categories. Given his current duties as artistic director of Jazz at Lincoln Center and the heap of other projects on his plate, Marsalis’s wishes to get outside were easy to take at face value.

The most recognizable jazz player of his generation, Marsalis has nonetheless made efforts to keep in touch with his classical roots. Two years ago, the trumpeter rerecorded the Haydn, Hummel, and Leopold Mozart concertos that garnered his first Grammy, revealing a richer sound and a greater interpretive depth. His latest recording, “In Gabriel’s Garden” on Sony, returns to the Baroque with Anthony Newman (playing harpsichord and organ)

and the English Chamber Orchestra. The CD offers a collection of trumpet favorites including Bach’s Brandenburg Concerto No. 2 and works by Torelli, Clarke, Mouret, Purcell, and Charpentier.

“I want to keep developing myself as a complete musician,” Marsalis told me, “so I take on projects either to teach me something new or else to document some development. With this new Baroque album, I felt that I’d never really played that music before with the right authority or rhythmic fire.”

Marsalis has been playing both classical music and jazz since his childhood, although those paths rarely converged. His father, Ellis, is a prominent jazz pianist and educator, and Marsalis’s first trumpet teacher, John Longo, was schooled in both traditions. “He would play me a record of the Chicago Symphony, saying, ‘Now this is an example of a sound on the instrument.’ It was against all the clichés,” Marsalis said. “I mean, you wouldn’t think two guys in our community would be sitting up listening to *Ein Heldenleben* — that’s just not an image you would have.”

But having already been excited by a Clifford Brown recording, the young Marsalis soon discovered another role model when a trumpet player from a local college saw him on a streetcar carrying a

trumpet case and handed him a record by Maurice André. “Maurice’s playing was soulful,” Marsalis said, “and he had real good rhythm, too.”

With composers, though, Marsalis’s picks cut a wider swath. “My favorite composer is Beethoven,” he said, “more for the consciousness of his music than its style. But he didn’t write for the trumpet. My favorite period of classical music is the twentieth century, but outside of the Hindemith sonata I don’t really like a lot of the trumpet literature. The questions are the same today as for the Baroque: How are you going to play a fanfare? How are you going to play lyrical passages?”

“I like the Baroque instrumentation, the thickness of its texture, its energy, the way the music’s organized,” he said. “Plus, that period really shaped the whole conception of the trumpet as an instrument to herald something. All that music is very tonic-dominant, and its character and nature is very trumpetistic.”

Though he makes the case for the Baroque as a defining era in Western music, and for jazz as a Western art form, Marsalis still draws the line at linking the two sides of his career directly.

“They’re all music, so I’m sure they come together somewhere, but I don’t consciously link them,” he said. “Each thing has an integrity of its own, and you have to work it until it sounds the way you want it to.” He reached again for the basketball. “It’s like basketball and baseball. You just don’t walk up to the baseball diamond thinking about basketball. Now maybe you might develop some skills in one that will help you in the other — eye-hand coordination, maybe — but those things just happen.”

Preparing for his first classical recording back in the early 1980’s, Marsalis took several months off from his jazz schedule, not so much to shift his musical perceptions, he says now, but simply to get the pieces under his fingers. “You can’t be working, traveling from gig to gig and city to city, and still be interested in practicing Haydn at the end of the day.”

But time off is a luxury for Marsalis these days. With two published books, a four-part PBS series (*Marsalis on Music*), his NPR radio show *Making the Music*, and his work producing the Olympic Jazz Summit this summer in Atlanta, his non-performing projects run the risk of crowding out his musicmaking.

“My first responsibility is to develop musically,” he said. “I want to keep playing my horn, playing classical music on a higher level, to become a better jazz musician, to write better music. I like doing all these extra things, but I’m a musician, and it’s important that that’s where I spend most of my time.”

Ken Smith writes for *Newsday* and *Time Out New York*.



For nearly half a century Acoustic Research has been innovating breakthrough technologies that have become standards in the audio industry. Home Theater and Dolby Digital 5.1 channel sound systems are now replacing traditional two channel stereo. AR's new digital-ready High Output Series was designed for these revolutionary new formats.

# High Output Higher Fidelity

For the first time, high efficiency and audiophile sound quality have been combined in beautifully hand-crafted furniture to deliver both the delicacy and dynamics of multi-channel sound. With exclusive technologies such as Energy Control Contour Baffle, MultiPort Slot Loading and Voice Balanced Tonal Matching, Acoustic Research is leading the way into the digital future with its new High Output Series loudspeakers

**AR**  
Higher Fidelity

To experience the future of audio today  
call 1-818-407-4820 for the  
location of your local AR dealer.

Acoustic Research is a trademark of Christie Design Corporation,  
a wholly owned subsidiary of Recoton Corporation.

CIRCLE NO. 2 ON READER SERVICE CARD

SURGEON GENERAL'S WARNING: Smoking By Pregnant Women May Result in Fetal Injury, Premature Birth, And Low Birth Weight.

10 mg "tar," 0.8 mg nicotine av. per cigarette by FTC method.

# Marlboro Lights

The spirit of Marlboro in a low tar cigarette.

