

A Mike or Two Around the House by Charles Fowler



high fidelity

NOVEMBER

THE MAGAZINE FOR MUSIC LISTENERS

60 CENTS

1960

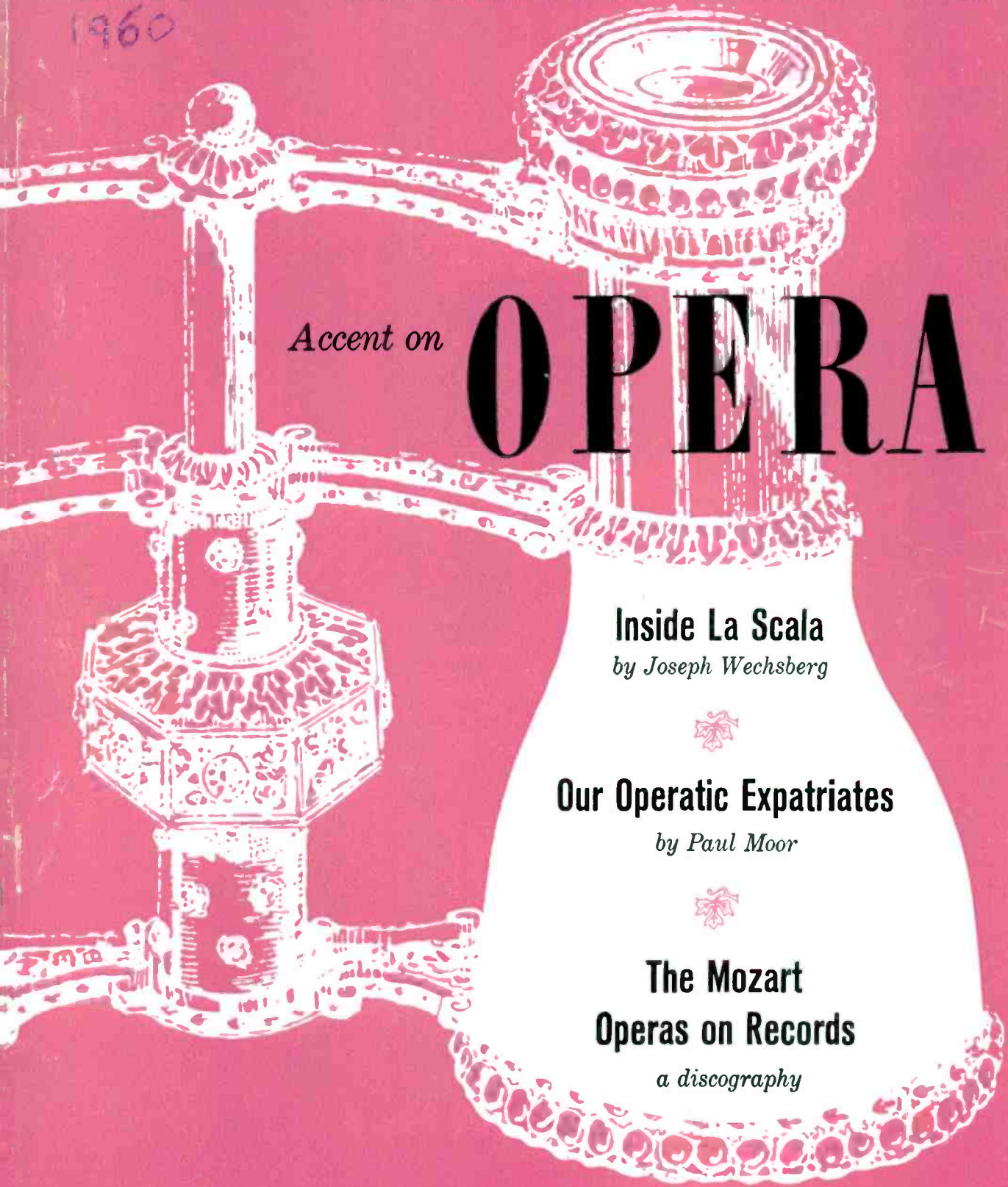

Accent on

OPERA

Inside La Scala

by Joseph Wechsberg



Our Operatic Expatriates

by Paul Moor



**The Mozart
Operas on Records**

a discography

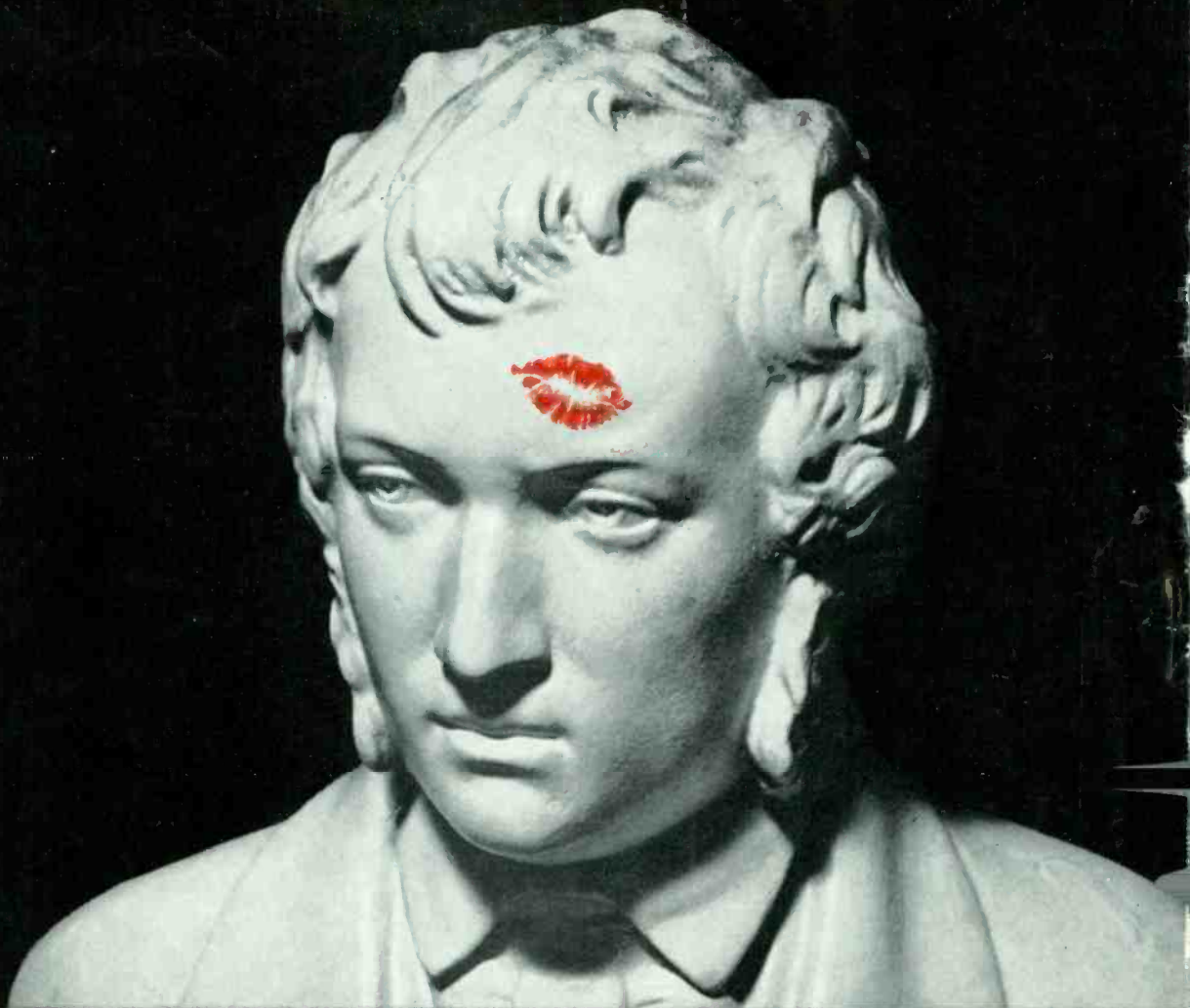

CLASSICS THAT MADE THE HIT PARADE

DETAILS OF THE PROGRAM

"Classics that Made the Hit Parade" includes these popular symphonic themes:

Borodin	Polovtsian Dances from Prince Igor (Stranger in Paradise)
Tchaikovsky	Symphony No. 5 in E (Moon Love)
Waldteufel	Espana Waltz (Hot Diggity)
Chopin	Polonaise No. 6, in Ab Major (Till the End of Time)
Tchaikovsky	Symphony No. 6 in B (The Story of a Starry Night)
Rachmaninoff	Piano Concerto No. 2 in C Minor (Full Moon and Empty Arms)
Chopin	Fantasia Impromptu in C# Minor (I'm Always Chasing Rainbows)
Tchaikovsky	Romeo and Juliet Overture (Our Love)

DETAILS OF THE OFFER

This exciting recording is available in a special bonus package at all Audiotape dealers. The package contains one 7-inch reel of Audiotape (on 1½-mil acetate base) and the valuable "Classics that Made the Hit Parade" program (professionally recorded on Audiotape). For both items, you pay only the price of two reels of Audiotape, plus \$1. And you have your choice of the half-hour two-track stereo program or the 55-minute monaural or four-track stereo versions.

See your Audiotape dealer now.

— a new bonus reel from Audiotape

Some of our greatest popular songs — hits like "Full Moon and Empty Arms," "Till the End of Time," "Stranger in Paradise" — took their melodies from the classics. Eight of these lovely themes — in their original classical setting — are the basis for "Classics that Made the Hit Parade," a program with strength, variety, and, of course, rich melodic beauty.

This unusual program, professionally recorded in sparkling full fidelity on Audiotape, is available RIGHT NOW from Audiotape dealers everywhere. (And only from Audiotape dealers.) Ask to hear a portion of the program, if you like. Then, take your choice of a half-hour of two-track stereo, or 55 minutes of four-track stereo or dual-track monaural sound — all at 7½ ips. Don't pass up this unique opportunity.

"Classics that Made the Hit Parade" makes an ideal addition to Audio's first two bonus reels, "Blood-and-Thunder Classics" and "High Spirits," still available at Audiotape dealers.



audiotape
TRADE MARK

"It speaks for itself"

AUDIO DEVICES, INC., 444 Madison Ave., N. Y. 22, N. Y.
In Hollywood: 840 N. Fairfax Ave. • In Chicago: 5428 N. Milwaukee Ave.

Beautiful...
Small... and
wonderfully
better!

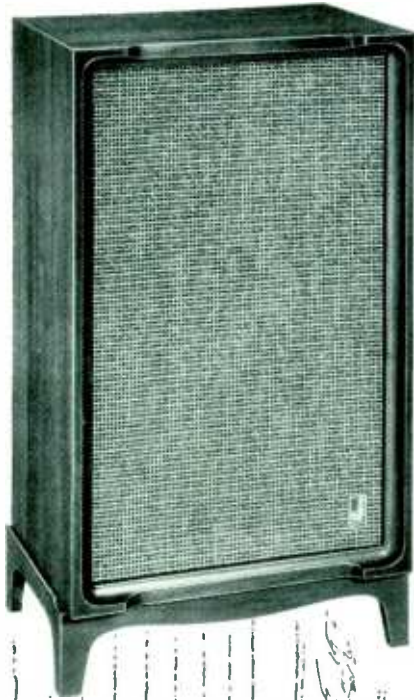

... it's the new **Jensen**

TR-30 TRI-ETTE* 3-WAY LOUDSPEAKER SYSTEM

We believe you will agree that the new Jensen TR-30 TRI-ETTE is the finest small speaker system produced regardless of cost. Superior quality precisely engineered components, brilliantly matched and balanced, provide the ultimate in home speaker performance. And you have the choice of styling that includes smart Danish in warm Walnut, subtle Contemporary in clean Limed Oak, the elegance of Traditional Mahogany, authentic Provincial in lustrous Cherry or a special unfinished utility model to paint or stain as you choose... excellent for custom building-in, too. Furniture models are finished on all four sides providing the versatility of horizontal or vertical placement. The accessory matching base creates a small-scaled console table if you prefer. See and hear the TR-30 TRI-ETTE soon... it's wonderful for mono hi-fi... superb as a stereo pair.

**TR-30 TRI-ETTE furniture models—\$159.50 (without base)
Unfinished model \$134.50 Console base \$9.95**



CHOOSE
FROM FIVE
"DECORATOR
GROUP"
FURNITURE
STYLES

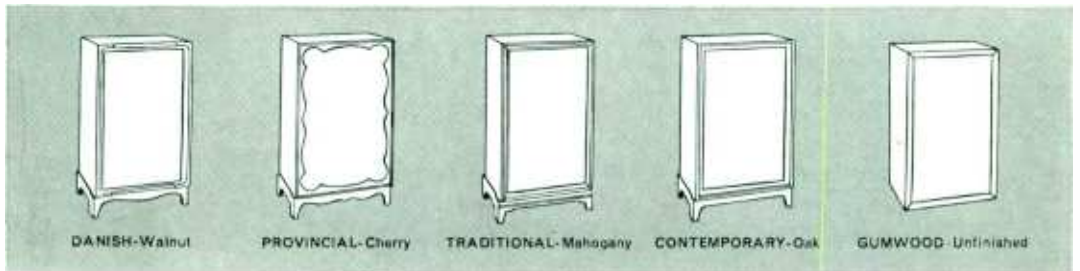

DANISH-Walnut

PROVINCIAL-Cherry

TRADITIONAL-Mahogany

CONTEMPORARY-Oak

GUMWOOD-Unfinished

TR-30 TRI-ETTE FEATURES NEW COMPONENTS

Featuring a new advanced-design 12" FLEXAIR* woofer with powerful SYNTAX-6* magnet and low distortion full 1" travel... precisely coordinated with the BASS-SUPERFLEX* enclosure to carry bass down lower and better than ever before. Advanced design improved compression midrange and supertweeter units for smooth, balanced, extended response. Be sure to see and hear the TR-30... you'll make a wonderful discovery!

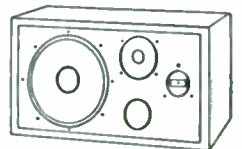

Write for free illustrated Brochure "KU"

*T.M.

CIRCLE 81 ON READER-SERVICE CARD

Jensen
DIVISION OF THE MUTER CO.

MANUFACTURING COMPANY
6601 S. Laramie Ave., Chicago 38, Illinois
In Canada: Renfrew Electric Co., Ltd., Toronto
In Mexico: Universal De Mexico, S.A., Mexico, D.F.

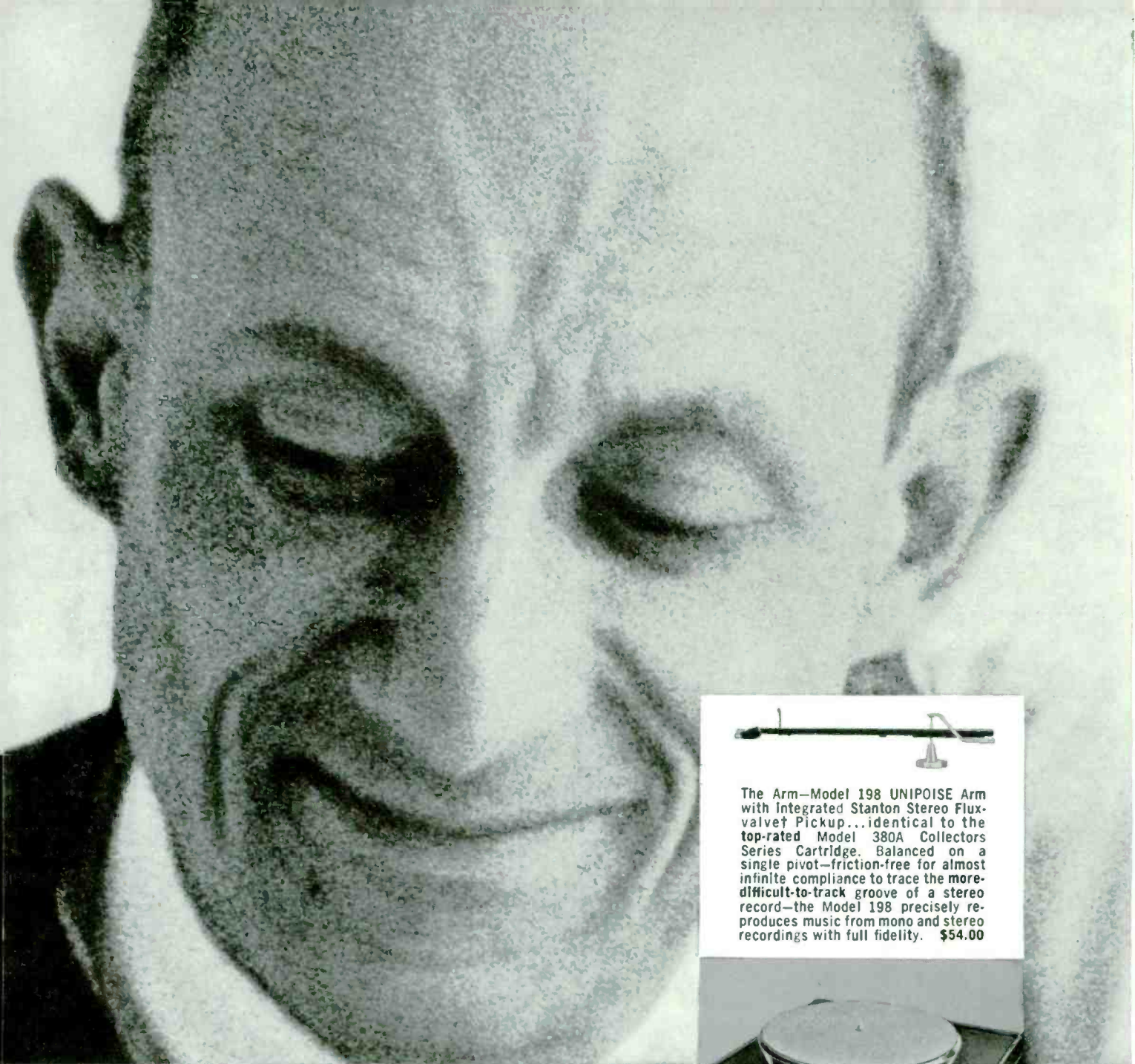

The Arm—Model 198 UNIPOISE Arm with Integrated Stanton Stereo Fluxvalve† Pickup...identical to the top-rated Model 380A Collectors Series Cartridge. Balanced on a single pivot—friction-free for almost infinite compliance to trace the more-difficult-to-track groove of a stereo record—the Model 198 precisely reproduces music from mono and stereo recordings with full fidelity. \$54.00



The Stereotable—GyroPoise 800... the only magnetically balanced high fidelity turntable...actually revolves on a cushion-of-air. Without a trace of rumble—horizontal or vertical—the GyroPoise 800 is the perfect-mute in a Stereoplayer, keeping the record in quiet motion at precisely 33 1/3 rpm. less base \$66.00

two...perfect for stereo

Perfect Stereo-mates for the best Stereoplayer ever!*

Silent partners...the 198 and 800 reproduce only the music in a record...perfectly...faithfully...without adding a whisper of sound. Here is responsible performance—for all who can hear the difference. From a gentle pianissimo to a resounding crescendo—every movement of the stylus reflects a quality touch possessed only by the Stanton Stereo Fluxvalvet.

LISTEN! Ask for a Pickering Stereoplayer demonstration at your Hi-Fi Dealer today!

FOR THOSE WHO CAN HEAR THE DIFFERENCE

 **Pickering**

PICKERING & CO., INC., PLAINVIEW, NEW YORK

Send for Pickering Tech-Specs—a handy guide for planning a stereo high fidelity system... address Dept. A110

†U.S. Patent No. 2,917,590

*The Model 198 and GyroPoise 800 are sold separately

STEREO-MATES, STEREOPLAYER, UNIPOISE, GYROPOISE, STANTON STEREO FLUXVALVE ARE TRADEMARKS USED TO DENOTE THE QUALITY OF PICKERING & CO., INC. PRODUCTS

CIRCLE 105 ON READER-SERVICE CARD

high fidelity

NOVEMBER 1960
volume 10 number 11

including **AUDIOCRAFT** and **HI-FI MUSIC AT HOME**

MUSIC

Roland Gelatt
Editor
Jean Griffiths
Executive Editor
Ralph Freas
Audio Editor
Norman Eisenberg
Technical Editor
Miriam M. Landis
Managing Editor
Frances A. Newbury
Associate Editor
Shirley Fleming
Assistant Editor
Roy Lindstrom
Art Director
H. C. Robbins Landon
European Editor

Editorial Board

John M. Conly
Chairman
E. Power Biggs
Nathan Broder
R. D. Darrell
Alfred Frankenstein
Howard Hanson
Jullan Hirsch
Robert C. Marsh
Francis Robinson
Joseph Szigeti

Warren B. Syer
General Manager
Claire N. Eddings
Advertising Sales Manager
Walter F. Grueninger
Circulation Director

Publication Policy

Charles Fowler
Lawrence Gatto
W. D. Littleford
Warren B. Syer

ADVERTISING

Main Office
Claire N. Eddings, The Publishing House
Great Barrington, Mass. Telephone 1300

New York
1564 Broadway, New York 36
Telephone: Plaza 7-2800
Sy Resnick, Andy Spanberger

Chicago
10 East Huron St., Chicago 11
Telephone: Michigan 2-4245
Pete Dempers, Tom Berry

Los Angeles
1520 North Gower, Hollywood 28
Telephone: Hollywood 9-6239
George Kelley

- Inside La Scala** 46 Joseph Wechsberg
A conducted tour behind the scenes at the world's most famous opera house.
- Our Operatic Expatriates** 50 Paul Moor
Why many American singers make their livings—and their reputations—abroad.
- "Bless Thee! Thou Art Translated"** 53 Charles Cudworth
To behold real enormities, see what translators of opera librettos have sometimes wrought.
- The Mozart Operas on Record** 56 Nathan Broder
A HIGH FIDELITY discography.
- Having Wonderful Time** 58
Die Fledermaus—Taped in Vienna
- The Missing Ingredient** 45 Conrad L. Osborne
An editorial.
- Palermo's Foresighted Massimo** 10 William Weaver
In Sicily's capital, the opera house looks to the future.
- Notes from Abroad** 24
Our correspondents report . . . from London and Vienna.
- Music Makers** 71 Roland Gelatt

EQUIPMENT

- A Mike or Two Around the House** 60 Charles Fowler
Authoritative advice for the home recordist.
- Cartridges** 147 Norman Eisenberg
Clean mono sound now, quick stereo conversion later.
- Equipment Reports** 64
 **Grado Laboratory Series Tone Arm • Quad Electrostatic Loudspeaker
Allied Knight-kit 60-Watt Amplifier • Ampex 970 Tape Recorder
Rolls A.E. 8-3b Speaker System**
- High Fidelity Newsfronts** 141 Ralph Freas
- Audio News From Europe** 145 The Gramophone

REVIEWS

- Feature Record Reviews** 73
Paisiello: Il Barbiere di Siviglia (Fasano)
A Sviatoslav Richter Miscellany
Ives: Symphony No. 2. (Bernstein)
Mozart: Don Giovanni (Leinsdorf, Giulini!)
- Other Classical Record Reviews** 77
The Lighter Side 107
Jazz Record Reviews 119
The Tape Deck 133

Cover design by Roy Lindstrom: opera glasses, Bettmann Archive

NEW! Lafayette 50-WATT Complete Stereo Phono System

COMPONENTS

Lafayette LA-250A 50-Watt Amplifier.....	99.50
Garrard RC 210 4-Speed Record Changer.....	44.50
New Pickering 380C Diamond Stereo Cartridge	29.85
Lafayette Wood Changer Base	3.95
2 Lafayette SK-58 Famous Free Edge 12" Co-axial Speakers @ 29.50 each.....	59.00
Regular Catalog Price	236.80

COMPLETE STEREO SYSTEM

YOU SAVE \$42.30 **194.50**
\$5.00 DOWN

YOUR GUARANTEED BEST STEREO SYSTEM BUY!

Add a new dimension of music with all the excitement and realism of a live concert. The new Lafayette LA-250A 50-watt Stereo amplifier forms the heart of this outstanding stereo hi-fi music system — the features, versatility and advanced circuitry of this unit are second to none. The famous Garrard RC 210 intermix 4-speed automatic record changer with manual or automatic operation is supplied with your choice of stereo cartridges — the new Pickering 380C (.7 Mil) diamond stereo cartridge or the Shure M7D (.7 Mil) diamond stereo cartridge. The Lafayette wood base, cut for the RC 210, is supplied in your choice of finishes. These components are coupled with the 2 famous free-edge Lafayette SK-58 12" coaxial speakers. System supplied with plugs, cables and easy-to-follow instructions. Shpg. wt., 67 lbs.

HS-103WX Hi-Fi Stereo Phono System with choice of cartridge, and mahogany, walnut or blonde changer base (please specify) 5.00 Down Net 194.50
 HS-104WX Same as HS-103 plus 2 Lafayette Eliptoflex Series Bookshelf Enclosures (please specify finish). Shpg. wt., 143 lbs. 10.00 Down Net 257.50
 HS-105WX Same as HS-103 except speakers furnished are the new Lafayette SK-180 10" 3-way speakers. Shpg. wt., 67 lbs. 5.00 Down Net 198.50
 HS-106WX Same as HS-105 plus 2 Lafayette Eliptoflex Series Bookshelf Enclosures (please specify finish). Shpg. wt., 143 lbs. 10.00 Down Net 261.50
 HS-107WX Same as HS-103 plus Lafayette LT-50 FM-AM stereo tuner. Shpg. wt., 85 lbs. 10.00 Down Net 309.50



(OPTIONAL) LAFAYETTE ELIPTOFLEX SERIES

Finished on 4 Sides

KT-500A FM-AM STEREO TUNER KIT

\$5.00 DOWN

KT-500A
IN KIT FORM **74.50**

LT-50A
COMPLETELY WIRED **124.50**



Made in U.S.A.

- Multiplex Output for New Stereo FM
- Armstrong Circuit with Dual Limiters and Foster-Seeley Discriminator
- Extreme Sensitivity and Wide Frequency Response
- Easy-To-Assemble Kit Form.

Separate FM and AM tuning sections, each with its magic eye. FM: automatic frequency control, 2 microvolts sensitivity for 30 db quieting, frequency response 20-20,000 cps \pm 1/2 db, full 200 kc bandwidth. AM: efficient broadband circuitry, built-in antenna. Two printed circuit boards make wiring simple. 13 3/4 x 10 3/4 x 4 1/2". Shpg. wt., 22 lbs.

KT-600A PROFESSIONAL STEREO CONTROL CENTER

\$5.00 DOWN

KT-600A
IN KIT FORM **79.50**

LA-600A
COMPLETELY WIRED **134.50**



Made in U.S.A.

- Response 5-40,000 cps \pm 1 db.
- Precise "Null" Balancing System
- Unique Stereo and Monaural Control Features
- Concentric Input Level Controls
- Easy-To-Assemble Kit Form.

Sensitivity 2.2 mv for 1 volt out. Dual low impedance "plate follower" outputs 1500 ohms. Less than .03% IM distortion; less than .1% harmonic distortion. Hum and noise 80 db below 2 volts. 14x10 3/4 x 4 1/2". Shpg. wt., 16 lbs.

FREE!

Lafayette Radio, Dept. WK6-1
P.O. Box 190
Jamaica 31, N. Y.

The NEW
1961

Lafayette Electronics
Catalog No. 610

Name _____
Address _____
City _____ Zone _____ State _____



LAFAYETTE RADIO

NEW YORK 13, N. Y.	BRONX 50, N. Y.	NEWARK 2, N. J.
JAMAICA 33, NEW YORK	PLAINFIELD, N. J.	PARAMUS, N. J.
		BOSTON 10, MASS.

CIRCLE 87 ON READER-SERVICE CARD

AUTHORitatively Speaking

As a schoolboy in Vienna, Joseph Wechsberg spent most of his pocket money buying tickets for the Staatsoper, where he was a near-permanent occupant of a seat in the Fourth Gallery. Since that time Mr. Wechsberg's finances have, we suspect, bettered (he's the well-known authority on good living whose by-line appears frequently in the *New Yorker*, *Esquire*, and other publications); and his view of opera has become considerably more intimate—in fact, he's a welcome visitor behind the scenes. Which happy circumstance results for us in a personally conducted tour of the Mecca of all opera lovers everywhere: see "Inside La Scala," p. 46.

Texas-born Paul Moor has lived in Europe since 1949, for the most part in Germany, where he is now Berlin correspondent for *Time-Life International*. Consequently he has formed acquaintance with other Americans who live abroad, including those who earn their living through the arts. In "Our Operatic Expatriates," p. 50, he writes of their experiences in European opera houses. But don't expect a Tom Wolfe tale of "you can't go home again"; Mr. Moor himself was back in the Lone-Star State not long ago—among other things, to attend the golden wedding anniversary of his parents.

"Bless thee! thou art translated . . ." And what happens to opera librettos in the hands of well-meaning translators (see p. 53) is no less strange than poor Bottom's metamorphosis. Charles Cudworth, Curator of the Pendleton Library in the University School of Music (Cambridge), obviously takes great delight in the grotesqueries committed. We think you will too.

This month *HIGH FIDELITY* also takes great pleasure in presenting two of its own, in the persons of Nathan Broder and Charles Fowler. Mr. Broder—associate editor of the *Musical Quarterly*, university lecturer, author, but probably best known to readers of this magazine as a member of its Editorial Board and regular monthly record reviewer—gives us a critical discography of Mozart operas (p. 56). Mr. Fowler—high fidelitarian from way back, co-founder and former publisher of this journal, now part of its Publication Policy committee—shares with us his expert knowledge on the selection and use of microphones (p. 60).

High Fidelity, November 1960, Vol. 10, No. 11. Published monthly by The Billboard Publishing Co., publishers of The Billboard, *Vend*, *Funspot*, and The Billboard, Overseas Edition. Telephone: Great Barrington 1300. Member Audit Bureau of Circulations.

Editorial Correspondence should be addressed to The Editor, *High Fidelity*, Great Barrington, Mass. Editorial contributions will be welcomed. Payment for articles accepted will be arranged prior to publication. Unsolicited manuscripts should be accompanied by return postage.

Change of Address notices and undelivered copies should be addressed to *High Fidelity*, Subscription Fulfillment Department, 2160 Patterson Street, Cincinnati 22, Ohio.

Subscriptions: Subscriptions should be addressed to *High Fidelity*, Great Barrington, Mass. Subscription rates: United States, Possessions, and Canada, 1 year, \$6; 2 years, \$11; 3 years, \$15; 5 years, \$20. Elsewhere \$1 per year extra. Single copies 60 cents.

FA-4

the only
tape formulation
that captures the full
dynamic range of
music at no
extra cost!



exclusive with
SOUNDCRAFT TAPES

FA-4

FREQUENCY
ADJUSTED
FORMULATION

In the year since their introduction, Soundcraft Tapes with FA-4 frequency adjusted formulation have won unprecedented acclaim from professional and home recordists. The ability of these tapes to capture more of the full dynamic range of sound...to reproduce subtler "highs" with full clarity, was instantly hailed as a major improvement in tape recording—and a particular boon in 4-track and slower speed applications. Whether your equipment is new or old—you will never enjoy its full capabilities until you hear your first reel of Soundcraft Tape with FA-4!

REEVES SOUNDCRAFT CORP. Great Pasture Rd., Danbury, Connecticut ■ Chicago: 28 E. Jackson Blvd. ■ Los Angeles: 342 N. LaBrea ■ Toronto: 700 Weston Rd.

CIRCLE 111 ON READER-SERVICE CARD

"THE CITATION SOUND"

"...FOR THE SAKE

"Over and above the details of design and performance, we felt that the Citation group bore eloquent witness to the one vital aspect of audio that for so many of us has elevated high fidelity from a casual hobby to a lifelong interest: the earnest attempt to reach an ideal—not for the sake of technical showmanship—but for the sake of music and our demanding love of it."

A truly remarkable commentary about a truly remarkable group of products—the Citation Kits by Harman-Kardon.

Mr. Reid's eloquent tribute to Citation is one of many extraordinary reviews of these magnificent instruments. We are proud to present a brief collection of excerpts from Citation reviews written by outstanding audio critics.

"When we first heard the Citations our immediate reaction was that one listened through the amplifier system clear back to the original performance, and that the finer nuances of tone shading stood out clearly and distinctly for the first time . . . bass is clear and firm, and for the first time we noted that the low frequency end appeared to be present even at low volumes without the need for the usual bass boost . . . The kit is a joy to construct." C. G. McPrud, Editor, Audio Magazine

"The unit which we checked after having built the kit, is the best of all power amplifiers that we have tested over the past years . . . none have had distortion that was quite as low as we found in this new Citation II . . . the amplifier should provide the very finest in hi-fi stereo reproduction . . ."

William Stocklin, Editor, Electronics World

PRESENTING THE 1961 CITATION LINE FEATURING



The CITATION I
Stereophonic Preamplifier
Control Center

Here is the first brilliant expression of the advanced design concepts which sparked the new Citation Kit line—the incomparable Citation I, Stereophonic Preamplifier Control Center. The Citation I consists essentially of a group of circuit blocks termed "active" and "passive" networks. The "active" networks are treated as one or two stage amplification units, flat over an extremely wide frequency range and each is surrounded with a feedback loop. This results in levels of distortion so low as to prove unmeasurable. The "passive" networks provide precise equalization with no phase shift.

The use of professional step type tone controls overcome the limitations of continuously variable potentiometers. Each position on a step control is engineered to perform a specific function—which is absolutely repeatable when necessary. The many professional features and philosophy of design expressed in Citation I permit the development of a preamplifier that provides absolute control over any program material without imparting any coloration of its own. Citation I—\$159.95. Factory Wired—\$249.95. Walnut Enclosure, Model WCI—\$29.95.



The CITATION II
120 Watt Stereophonic
Power Amplifier

This remarkable instrument has a peak power output of 260 watts and will reproduce frequencies as low as 5 cycles virtually without phase shift, and frequencies as high as 100,000 cycles without any evidence of instability or ringing. At normal listening levels the only measurable distortion comes from the laboratory test equipment.

Video output pentodes are used in all low level stages for exceptional wide frequency response and low distortion. Multiple feedback loops for increased degree of usable feedback (30 db overall) result in lower distortion without sacrificing stability. The power supply consists of four silicon diode rectifiers, choke, heavy duty electrolytics and potted power transformer for precise regulation and long life. The use of rigid component boards, heavy duty components, special Cable Harness assure the kit builder that the unit he constructs will be the exact duplicate of the factory built instrument. Because of its absolute reliability and exceptional specifications the Citation II has gained widespread acceptance among professionals as a laboratory standard. The Citation II—\$159.95. Factory Wired—\$229.95. Metal Enclosure, Model ACII—\$7.95.

CIRCLE 73 ON READER-SERVICE CARD



The CITATION III
Professional FM Tuner

Citation III is the world's most sensitive tuner. But more important—it offers sound quality never before achieved in an FM tuner. Now, for the first time Harman-Kardon has made it possible for the kit builder to construct a completely professional tuner without reliance upon external equipment. To meet the special requirements of Citation III, a new FM cartridge was developed which embodies most of the critical tuner elements in one compact unit. The cartridge is completely assembled at the factory, totally shielded and perfectly aligned—eliminating the difficult problems of IF alignment, oscillator adjustment and lead definition.

The Citation III's front end employs the revolutionary Nuvistar tube which furnishes the lowest noise figure and highest sensitivity permitted by the state of the art. A two-stage audio circuit patterned after the Citation II is employed. By utilizing a high degree of feedback and providing a frequency response three octaves above and below the range of normal hearing, the Citation sound quality is maintained and phase shift is eliminated. The Citation III is styled in charcoal brown and gold to match all the other Citation instruments. Citation III—\$149.95. Factory Wired—\$229.95. Walnut Enclosure, Model WCI—\$29.95.

HIGH FIDELITY MAGAZINE

OF MUSIC AND OUR DEMANDING LOVE OF IT.”

“Its listening quality is superb, and not easily described in terms of laboratory measurements. Listening is the ultimate test and a required one for full appreciation of Citation . . . there is a solidity, combined with a total ease and lack of irritation which sets this amplifier apart . . . The more one listens to the Citation II, the more pleasing its sound becomes . . . Anyone who will settle for nothing less than the finest will be well advised to look into the Citation II.”

Hirsch-Houck Labs, High Fidelity Magazine

“At this writing, the most impressive of amplifier kits is without doubt the new Citation line of Harman-Kardon . . . their design, circuitry, acoustic results and even the manner of their packaging set a new high in amplifier construction and performance, kit or no.”

Norman Eisenberg, Saturday Review

“Specifications published by the manufacturer are so astonishing that our sister publication, Electronics World, has subjected them to critical examination and found performance wholly consistent with claims . . . Nothing can faze it . . . we have heard this particular amplifier loaded with four big speaker systems glide over the steepest orchestral hurdles without the slightest trace of strain . . . The realism of the virtually distortion-free music was nothing less than startling. Our initial amazement soon gave way to an easy, relaxed enjoyment that was sustained for hours without a trace of that tension known as “listening fatigue.” Here was a sound system that fulfilled the most difficult of all high fidelity requirements: to provide an awareness only of music, and oblivion of technicalities.”

Herbert Reid—Hi Fi Stereo Review

THE NEW CITATION III PROFESSIONAL FM TUNER

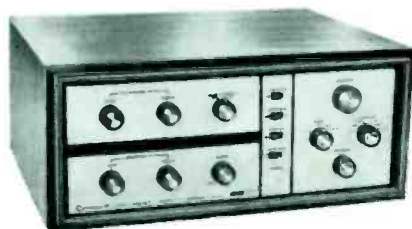

The CITATION IV
Stereophonic Preampifier
Control Center

The new Citation IV is a compact stereophonic preampifier designed in the best Citation tradition. It offers performance and features rivaled only by Citation I. Square wave tracings at 20 and 20,000 cycles reveal no difference between the response of the Citation IV and the signal generator.

The Citation IV provides separate bass and treble tone controls for each channel which may be switched out of the circuit completely to eliminate phase shift and transient distortion inherent in all tone controls. D.C. on all heaters and the use of low noise resistors in critical places reduce thermal agitation and hum. A zero to infinity balance control allows complete cut-off for either speaker. Military type terminal boards make for rigid, professional appearance and facilitate construction. The control over program material provided by the new Citation IV enables the user to perfectly recreate every characteristic of the original performance. The Citation IV is handsomely styled in charcoal brown and brushed gold. The Citation IV — \$119.95. Factory Wired — \$189.95. Walnut Enclosure, WCI — \$29.95.

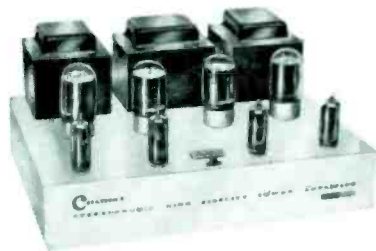

The CITATION V
80 Watt Stereophonic
Power Amplifier

The Citation V is a compact version of the powerful Citation II. Designed with the same lavish hand, it is conservatively rated at 40 watts RMS per channel with 95 watt peaks at less than 0.5% distortion.

The availability of rated power at the extreme ends of the frequency range enables the amplifier to effortlessly drive any of today's most inefficient speakers. It clips clean without breakup. The output stage consists of two 7581's per channel operating conservatively in a fixed bias, ultra-balance circuit. A bias meter is provided to statically and dynamically adjust each pair of output tubes. The power supply consists of four silicon diodes (hermetically sealed) and heavy duty electrolytics for excellent B+ regulation and long life. This results in instantaneous recovery time and superb transient response.

Here is an all new power amplifier which truly reflects The Citation approach to audio design: no compromise in quality regardless of cost. The Citation V is styled in charcoal brown and brushed gold. The Citation V — \$119.95. Factory Wired — \$179.95. Metal Enclosure, ACV — \$7.95.

CITATION KITS by

harman kardon

INCORPORATED
PLAINVIEW, NEW YORK

For complete information on the new Citation Kits, including reprints of independent laboratory test reports, write to: Dept. HF11, Citation Kit Division, Harman-Kardon Inc., Plainview, New York.

All prices slightly higher in the West.

CIRCLE 74 ON READER-SERVICE CARD

endowed with uncanny intelligence

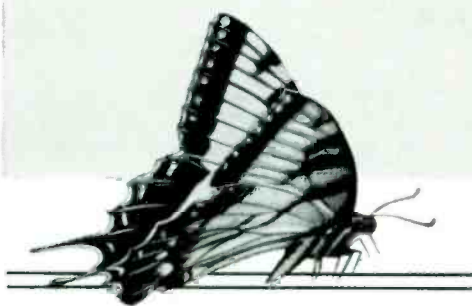

GENTLY AUTOMATIC

GLASER ★ STEERS

GS ★ 77

You can entrust your treasured records to the Glaser-Steers GS-77, secure that they will be treated with all the care you would want them to receive. Handling your records manually, you may not even do as well, for the automatic GS-77 has no human frailties — is not inclined to fumble, and can't leave fingerprints.

The GS-77 is seemingly endowed with an uncanny intelligence. It seems to know better than to let one record drop on another that's moving. It seems to sense that the momentary grinding between the two record surfaces will damage the delicate grooves, and irreparably deteriorate the quality of reproduction.

And so, the GS-77 behaves in this manner: when one record has been played, the turntable immediately stops turning; the next record drops gently onto the stationary disc; and the turntable does

not resume its motion until the stylus is in the lead-in groove, ready for play. And, it does this all in only 9 seconds.

"Turntable Pause" protects and preserves the quality in your stereo and mono records. Everything else about the GS-77 works to preserve that quality so that it can be faithfully reproduced through your high fidelity music system. Priced at \$59.50, the GS-77 is the world's only record changer with "Turntable Pause". Its modestly priced companion, endowed with many of the quality features found in the GS-77 is priced at \$47.50. See them and hear them at your high fidelity dealer today, or write: DEPT. HF-11

GLASER-STEERS CORPORATION
155 Oraton St., Newark 4, New Jersey
A subsidiary of American Machine & Metals, Inc.
In Canada: Alex L. Clark, Ltd., Toronto, Ontario
For Export: M. Simons & Sons Co., Inc., N. Y. C.

CIRCLE 69 ON READER-SERVICE CARD

BULLETIN...BULLETIN...BULLETIN...BULLETIN...BULLETIN...BULLETIN...BULLETIN...BULLETIN...BULLETIN...

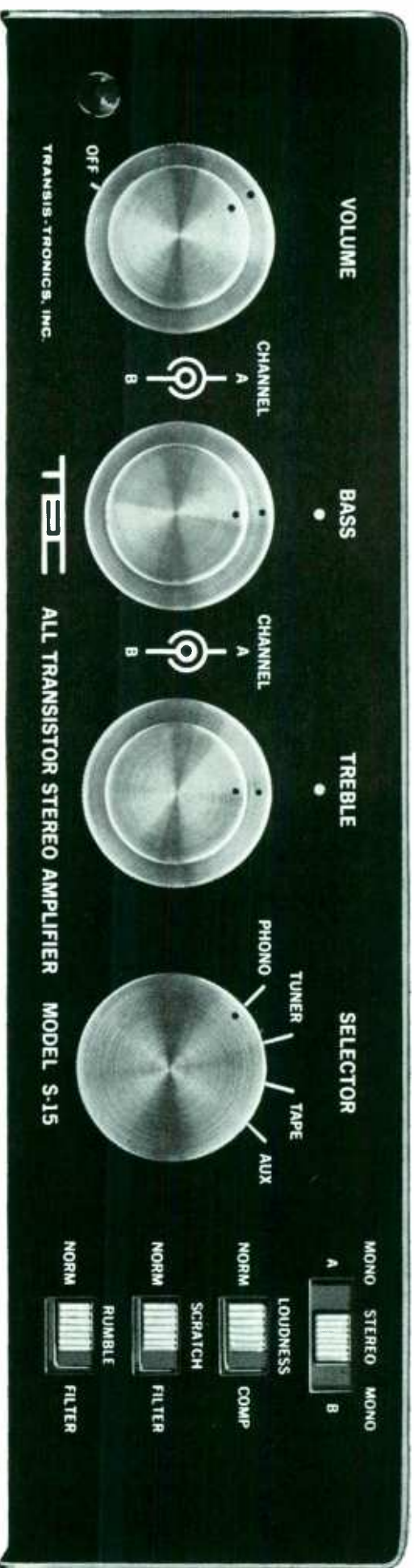

THE TEC S-15 NOW IN PRODUCTION

ACTUAL SIZE

TEC NEW ALL-TRANSISTOR OUTPUT TRANSFORMERLESS (OTL) STEREO AMPLIFIER STOP GREAT ENGINEERING ACHIEVEMENT, SURPRISING LOW PRICE STOP JUST 129.50 AUDIOFILE NET STOP TRANSISTOR CIRCUIT ELIMINATES OUTPUT TRANSFORMER RESULTING IN HIGH QUALITY, LOW DISTORTION STOP NO HEAT, NO HUM, NO MICROPHONICS STOP MUSIC POWER RATING 40 WATTS (20 WATTS EACH CHANNEL), DISTORTION UNDER 1%, FREQUENCY RESPONSE -3DB, 8 CYCLES TO 45,000 REPEAT 45,000 CYCLES, POWER REQUIREMENTS 117 VAC OR 12 VDC STOP NOTHING LIKE IT. GO

TEC TRANSIS-TRONICS, INC.
1650-21st STREET, SANTA MONICA, CALIFORNIA

CIRCLE 128 ON READER-SERVICE CARD

biggest sound

you ever heard from
a bookshelf speaker

AUDAX CA-60

\$59.95 only
9"x10½"x18"



Among many individuals, there is a need to minimize on the space to be devoted to a component stereo system. A rash of "bookshelf" types have appeared in an attempt to meet this need. In practice, however, they seem neither fish nor fowl...either too large for compactly spaced bookshelves or too small for use as free-standing units.

The AUDAX CA-60 is a true bookshelf speaker system, measuring only 9" high by 10½" deep by 18" wide. It houses a 6" woofer and separate tweeter in a ducted-slot enclosure constructed of ¾" thick wood, finished in oiled, hand-rubbed walnut on four sides. The grille is shaped in an attractive parabolic contour, giving the unit a character which blends with a variety of surroundings.

A real powerhouse... handles 20 watts in integrated program material! Hear it at your dealer's.

**DO YOU KNOW ABOUT THE FULL LINE OF
AUDAX-ENGINEERED REPLACEMENT SPEAKERS
AND COMPLETE SPEAKER SYSTEMS?**

AUDAX Division of Rek-O-Kut Co., Inc.
Dept. HFA11, 38-19 108th St., Corona 68, N.Y.

Please send full information on:

- Model CA-60 And Other Systems
- Audax Replacement Speakers
- Enclosed is 25¢ for book of 6 plans "How to Build Your Own Audax Enclosure"

Name _____

Address _____

City _____ Zone _____ State _____

Morhan Export Corp., 458 Broadway, N. Y. 13
Atlas Radio Corp., 50 Wingold Ave., Toronto.

CIRCLE 17 ON READER-SERVICE CARD

by William Weaver

Palermo's Foresighted Massimo

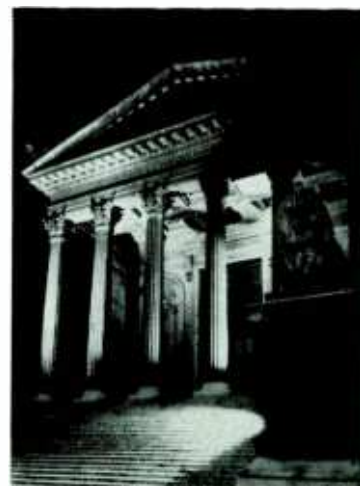

Opera in Sicily has a contemporary spirit.

LAST YEAR, when Maria Callas' marital-legal troubles caused her to cancel some performances with the Dallas Civic Opera, a young Italian singer named Eugenia Ratti was flown to Texas to make her United States debut as Rosina. It was a great success, and this season Miss Ratti will reappear in the same city in another opera that has brought her luck in Italy: Donizetti's *La Figlia del reggimento*, a work that hasn't been heard in America since the days when Lily Pons sang it at the Met. The production of *La Figlia* is being imported, courtesy of Neiman-Marcus, from Palermo's Teatro Massimo. This is not the first time that Palermo has collaborated with Dallas, and despite architectural and national differences, the two organizations have much in common.

I was, in fact, at the Palermo opening of *La Figlia* two years ago, and I remember the scene in Miss Ratti's dressing room after the final curtain. She was holding a bouquet of roses in one hand and gesturing dramatically with the other.

"Where else," she asked emphatically, "where else would they give an unknown a chance like this?" In her eyes there were tears of excitement and gratitude.

The young singer had just finished singing the taxing, gratifying role of Maria for the first time in her career. It was also the first time the opera had ever been given in this theatre. Perhaps because the Teatro Massimo is young itself (opened in 1897, the most recently inaugurated of Italy's major opera houses), it has shown in the last few seasons a courageous partiality not only towards young singers, but towards young conductors, directors, and designers—as well as a taste for out-of-the-ordinary programing.

The physical appearance of the Teatro Massimo, at first glance, seems improbable. There you are, in the capital of Sicily, an island of long history and rich tradition. Palm trees grow along the streets, where crumbling baroque palaces house *pensionari* on the former *piano nobile* and pharmacies on the ground floor. Splendid Norman monu-

ments survive, with exotic traces of Saracen influence. The last thing you expect to see is a bit of Louis Napoleon's Paris; yet that is what the Massimo at first suggests. *Art nouveau* lampposts decorate the entrance and Barye-like lions flank the broad staircase leading up to the imposing foyer, where you get your first glimpse of the neo-Pompeian (or is it neo-Aida-ian?) interior, with its huge proscenium in heavy, dull gold and its flat ceiling with panels of nymphs or muses in faded pastels.

The history of the building and its construction might have been written by a nineteenth-century librettist; it is that complicated and full of intrigue. The project apparently originated with King Francesco II in 1860, but it was dropped a few months later when Garibaldi and his "thousand" landed at Marsala. Four years later, when the city was proudly a part of the new realm of Italy, a public competition was organized for plans for a house worthy of the capital's new status. At this point the story of the Massimo assumes a certain *opera buffa* quality.

Who was to judge the entries? First somebody suggested Charles Garnier, whose Opéra in Paris, still under construction, was considered the very last word in modern opera houses. But the French were highly unpopular in Italy just then, so the Palermisani sent Garnier to the devil and decided to pick themselves a German jury. They announced the names in 1867: Gottfried Semper (later the designer, with Wagner, of the Bayreuth Festspielhaus), Eduard van der Null (one of the architects of the Vienna Opera), and Karl Friedrich Schinkel (a theatre architect from Berlin). After the jury had been invited to meet, the Palermo committee found out to its immense surprise that both Van der Null and Schinkel had died (the latter more than a quarter-century earlier). Semper, however, was alive; and with the help of some Italian architects, he presided over the selection of a local man,

Continued on page 12

HIGH FIDELITY MAGAZINE

Outstanding Hit

OF THE NEW YORK HIGH FIDELITY SHOW!

FISHER *FM-200*

0.5 Microvolt Sensitivity! Sensational MicroTune!
SIX IF Stages! Golden Cascode Front-End! FIVE Limiters!



WORLD'S MOST SENSITIVE TUNER

■ The FISHER FM-200 represents a major revolution in tuner design! For the first time ever high fidelity enthusiasts can now have a tuner with 0.5 Microvolt sensitivity for 20 db of quieting with 72 ohm antenna! For the first time ever a tuner with a capture ratio of only 1.5 db, the finest ever achieved, eliminating all unwanted background noise! For the first time ever a tuner with a Golden Cascode Front-End, SIX

IF Stages and FIVE limiters, resulting in selectivity and sensitivity of a quality never before achieved and giving complete freedom from interference and noise! For the first time ever, a tuner with FISHER MicroTune, the invention that makes absolutely accurate FM tuning child's play! Now even the most unskilled user can select and tune FM stations for maximum signal and minimum distortion! **\$229.50**

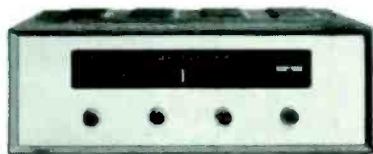

Quality FM Tuner At Moderate Cost

THE FISHER FM-50

■ Distortion-Free Wide-Band circuitry assures high fidelity reception of strong and weak signals, maximum stability and selectivity! ■ Four IF Stages! ■ MicroRay tuning indicator for precise FM tuning and Tape Recorder level indicator! ■ Local-Distant switch! **\$129.50**



Professional Standard FM Tuner

THE FISHER FM-100

■ Golden Cascode Front-End and Four Wide-Band IF stages for uniform frequency response (20 to 20,000 cps) and less than 0.5% harmonic distortion! ■ Remarkable sensitivity insures optimum reception of even distant stations! ■ Automatic interstation noise suppression! **\$169.50**

Write today for complete specifications!

FISHER RADIO CORPORATION • 21-25 44th DRIVE • LONG ISLAND CITY I, N. Y.

Export: Morhan Exporting Corp., 458 Broadway, New York 13, N. Y. ■ Available in Canada through Canadian-Marconi

CIRCLE 63 ON READER-SERVICE CARD

“RESEARCH MAKES THE DIFFERENCE”*

For Good Living
And Good Giving
SONY®
FM-AM
All-Transistor
Portable Radio



can also be used as tuner
for your hi-fidelity system

Receives both FM and standard broadcasts with world-famous SONY precision and clarity. Works instantly and with equal excellence indoors or outdoors. Can also be used as tuner with your Hi-Fi system! And as a very special gift, it has few equals.

(Ill. above) SONY TFM 121 with 12-transistors, self-contained telescopic dipole antennae. Measures 2¼" x 5" x 9¼". Weighs 3½ lbs. Complete with batteries.



(Ill. directly above) SONY TR 812—3-band 8-transistor portable. Receives AM, Short Wave and Marine broadcasts. Size 10¼" x 7¼" x 3¾". Telescopic antenna.

"The Peak of Electronic Perfection"
SONY CORP.
OF AMERICA

514 Broadway, New York 12, New York
Canada: Gen'l Distributors, Ltd., 791 Notre Dame Ave., Winnipeg 3
At fine radio & dept. stores, or write
Dept. HF for name of nearest store.

* T/M

CIRCLE 119 ON READER-SERVICE CARD

PALERMO

Continued from page 10

G. B. Filippo Basile, whose sumptuously bearded bust now adorns the foyer of the theatre.

As soon as the design was chosen, there began a kind of Thirty Years' War among Basile, the city, the press, and the workmen. Everything cost more than had been estimated; work was suspended several times, and once came to a stop for six whole years (1882-88). Basile died in 1891, with his mammoth creation still unfinished, though he had meanwhile successfully built theatres in other Sicilian cities. His son carried on the job, and at last, in 1897, the Massimo opened with a gala performance of Verdi's *Falstaff*, then four years old.

The theatre is one of the biggest in Europe. Its stage is the largest in Italy (in Europe, only Paris and Vienna surpass it); the house holds 2,228 people in its ample orchestra and five tiers of boxes crowned with a magnificently decorated royal box. Operagoers can also offer silent thanks to Professor Basile for the roomy bar.

Being of such recent date, the Massimo is a little hard up for tradition, but Palermo does have its distinctions. Several composers are associated with the city, notably Wagner, who composed a part of *Parsifal* on a harmonium in his room at the Albergo delle Palme. To Sicilians, however, the most important composer of all is Vincenzo Bellini, born in their second city, Catania; and in the years since the war, the Massimo has taken the lead in the revival of this composer's lesser-known operas. After a fine revival of his *I Capuletti ed i Montecchi* a few years ago, the 1958 season was inaugurated with a splendid production of *Il Pirata*, beating La Scala's production to the draw by several months. The 1959 season opened with Bellini's even more rarely performed *Beatrice di Tenda*, the composer's next-to-last opera, which was not only a fiasco at its first production but had never had a success in its few revivals since. The Massimo's edition, however, was a triumph, hailed by the public and by visiting critics alike.

The last three seasons—under the Sovrintendenza of Baron Leopoldo de Simone and the artistic direction of Maestro Corrado Tramonti—have been particularly adventurous and successful. In addition to *Il Pirata*, the 1958 repertory featured the first Sicilian performance of Ravel's *L'Enfant et les sortilèges*, with an all-French cast. During the same season, an Italian cast sang in Latin for Stravinsky's *Oedipus Rex*, an opera occasionally performed in Italy on the concert stage but seldom in the opera house. From the stark modernity of Stravinsky, the Massimo turned to Gian-Carlo Menotti at his frothiest, with *The Old Maid and the Thief*, also being given in Sicily for the first time.

For those a little weary of endless repetitions of standard repertory, the 1959 season

Continued on page 14

The Result Is Perfection

MOST POWERFUL
RECEIVER
IN THE WORLD!

THE 80Q



MOST EFFICIENT IN THE WORLD!
FEATURING THREE SIX-POUND
MAGNET STRUCTURES!

THE XP-3

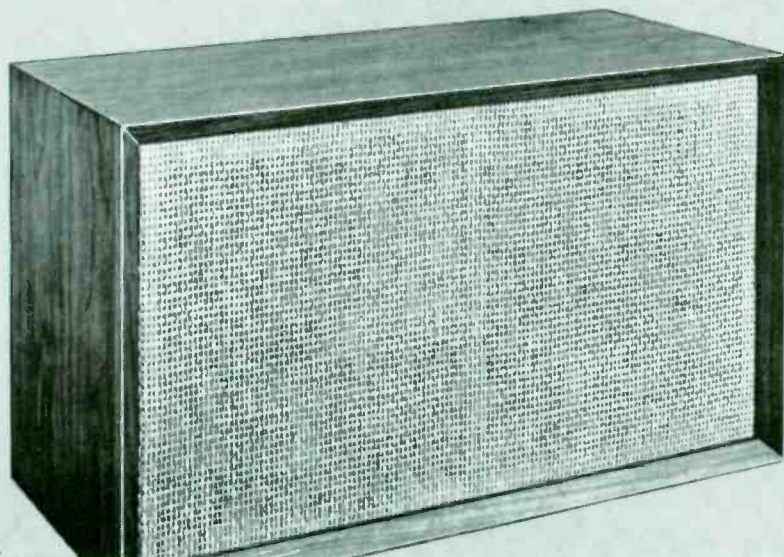

WHEN THE COMPONENTS ARE BY

FISHER®

THE *800*

THE *XP-3*

■ *Twice as sensitive* as any competitive stereo receiver—and easily the *most powerful*, with a conservative rating of 60 watts *distortion-free* music power! The 800 incorporates the famous Golden Cascade front-end for outstanding FM sensitivity! The AM signal is of FM calibre! *Unlimited flexibility* for every application, including Center Channel, Tape Monitoring and Multiplex Stereo! **\$429.50**

■ New FREE-PISTON Three-Way Speaker System. Exclusive six-pound FISHER encapsulated magnet structure and two-inch voice coil used on *all three* speakers makes the XP-3 *the world's most efficient compact system!* Achieves unexcelled bass and transient response and performs with total absence of parasitic coloration. Frequency Response: 30 cps to beyond audibility. Unstained Birch \$219.50
Mahogany, Walnut and Cherry \$224.50

Write today for complete specifications!

FISHER RADIO CORPORATION • 21-25 44th DRIVE • LONG ISLAND CITY I, N. Y.

Export: Morhan Exporting Corp., 458 Broadway, New York 13, N. Y. ■ Available in Canada through Canadian-Marconi
CIRCLE 64 ON READER-SERVICE CARD

You're 'on Bourbon Street' with Koss stereophones

Add dramatic new realism to your recorded music
With Koss Stereophones, you'll thrill to new worlds of stereo sound reproduction. Your records or tapes sound just as if you were actually on "Bourbon St. in Old New Orleans". Through these comfortable Stereophones, you hear music as perfectly as it can be recorded. Add personalized listening and sound perfection to your high fidelity stereo installation. **\$24.95**



Ask your
Hi-Fi Dealer
or write

Koss Inc.
2227 N. 31st Street
Milwaukee, Wisconsin

CIRCLE 86 ON READER-SERVICE CARD

PALERMO

Continued from page 12

was equally appealing. After *Beatrice di Tenda*, an evening of one-act operas offered Hindemith's *Ilin und Zurück*, Stravinsky's *Mavra*, and Falla's *El Retablo de Maese Pedro*, all Sicilian premieres. Another important event was a production of Rimsky-Korsakov's *Ivan the Terrible*, for which Herbert Graf was summoned from the Met and Nicola Benois, the designer, from La Scala. The 1960 season was distinguished especially by the Palermo debut of soprano Joan Sutherland (who will not be heard at La Scala until this winter) in the *Lucia* which brought her such a resounding success at Covent Garden.

Not only does the Massimo offer the Palermitani a varied operatic fare (and it is significant that the "popular," lower-priced nights are always better attended than the chic openings), but it has also engaged Italy's most imaginative choreographer, the Hungarian-born Aurel Milloss, to prepare the *corps de ballet* and present a ballet evening every season. Innovations have resulted. In 1959, for instance, the daring Milloss presented a ballet called *The Sonata of Anguish*, to Béla Bartók's Sonata for Two Pianos and Percussion. The Palermo audience was partly stunned and partly delighted. In any case, this ballet—and the Stravinsky *Capriccio* which followed—started arguments.

Good theatre thrives on such controversy—and also on fresh talent. The grateful exclamation of Miss Ratti, after her *Figlia del reggimento*, is thoroughly justified. Unlike most opera houses, the Massimo is extraordinarily hospitable to unknown artists, including foreigners. Four or five seasons back, it hired Thomas Schippers to conduct *Tales of Hoffman*, before this young American had become a regular conductor at the Met. The star of the Offenbach was the then equally unknown American soprano Franca Duval, who later created the title role of Menotti's *Maria Golovin* at the Brussels Fair and repeated it on Broadway and at the New York City Center. The *Beatrice di Tenda* of 1959 was remarkable also for its cast. An opera that requires two excellent sopranos, in Palermo it was ideally sung by the Spanish artist Consuelo Rubio (familiar to City Center audiences, but unknown in Italy) and the Italian soprano Ilva Ligabue, just beginning what is clearly going to be a brilliant career, in which her more recent performances at Glyndebourne are another important step. The same welcome extended to performers has also brought to the Massimo the best of the young designers and directors of the new generation currently enlivening Italian opera.

For the artists themselves, the important thing about Palermo is that it's exciting to work there. "Things may be better organ-

Continued on page 152

HIGH FIDELITY MAGAZINE

For the Stereo Perfectionist

T W O S U P E R B S Y S T E M S B Y

FISHER®

SYSTEM NO.

1

THE FISHER SA-300-B
Distortion-Free 90-Watt
Power Amplifier
\$199.50



THE FISHER 202-T
Golden Cascade Stereo FM-AM Tuner
with Master Audio Control
\$349.50

THE FISHER XP-3
Three-Way Speaker System
Unstained Birch \$219.50
Mahogany, Walnut and Cherry \$224.50

SYSTEM NO.

2

THE FISHER SA-100
Laboratory Standard 50-Watt
Power Amplifier
\$119.50



THE FISHER XP-1
Three-Way Speaker System
Mahogany, Walnut and Cherry \$129.50
Unstained Birch \$124.50

THE FISHER 100-T
Stereo FM-AM Tuner with Master
Audio Controls
\$249.50

The practiced ear, the discerning eye—immediately detect something special about Stereo by FISHER. Something special in its handsome appearance, and particularly something special in its superb performance. And there is something special about the person who buys Stereo by FISHER—he makes a habit of quality. Buy the best *first*—buy FISHER.

Write today for full information about component Stereo by FISHER!

FISHER RADIO CORPORATION • 21-25 44th DRIVE • LONG ISLAND CITY I, N. Y.

Export: Morhan Exporting Corp., 458 Broadway, New York 13, N. Y. ■ Available in Canada through Canadian-Marconi

CIRCLE 65 ON READER-SERVICE CARD

Special 5th Anniversary Offer from the World's Largest Record Club

MORE JOHNNY'S GREATEST HITS



Small World
A Certain Smile
plus 10 more

JOHNNY MATHIS

9. Also: Let It Rain, Stairway to the Sea, Flame of Love, etc.

**Rhapsody in Blue
An American in Paris**



Leonard Bernstein
plays
Gershwin

6. A new recording of these 2 ever-popular Gershwin scores

BEETHOVEN SYMPHONIES No. 4 and 5



BRUNO WALTER
Columbia Symphony Orchestra

7. Walter displays "depth of understanding"—N.Y. Trib.

OUTSIDE SHELLEY BERMAN



A VICTOR Record

24. Berman's latest record—even funnier than the first!

stereo records for every musical taste!

STRAUSS WALTZES



ANDRE KOSTELANETZ

25. Tales from the Vienna Woods, Blue Danube, 8 others

PORGY AND BESS



ORIGINAL SOUNDTRACK RECORDING
From The Samuel Goldwyn Motion Picture Production

20. Bess, You Is My Woman Now; It Ain't Necessarily So; etc.

PERCY FAITH AND ORCHESTRA



VIVA

MUSIC OF MEXICO

15. Estrellita, El Rancho Grande, La Paloma, 11 others

SCHERAZADE



BERNSTEIN
NEW YORK PHILHARMONIC

14. "A persuasive, sensuous performance"—Listen

DAVE BRUBECK QUARTET—NEWPORT 1958



32. Perdido, Jump for Joy, C Jam Blues, Flamingo, 3 more

Kostelanetz LURE OF PARADISE



Ball Ha'i
Sweet Lei'ani
Moon of Manakoa
12 MORE

4. Also: Song of the Islands, On the Beach at Waikiki, etc.

1812 OVERTURE TCHAIKOVSKY



Philadelphia Orchestra
Eugene Ormandy

19. Also: Night on Bald Mountain, Polovtsian Dances, etc.

PIPES, PEDALS AND FIDELITY



BUDDY COLE, Organ

35. Serenade In Blue, Willow Weep for Me, 9 others

Moussorgsky PICTURES AT AN EXHIBITION

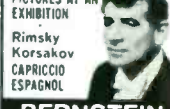

Rimsky Korsakov
CAPRICCIO ESPAGNOL
BERNSTEIN
NEW YORK PHILHARMONIC

23. "Led with fire and dash"—St. Louis Globe Democrat

ELLINGTON INDIGOS



37. Solitude, Where or When, Dancing in the Dark, 5 more

ROUMANIAN RHAPSODIES 1 & 2 HUNGARIAN RHAPSODIES 1 & 2



PHILADELPHIA ORCH. ORMANDY

33. "Superbly played...exciting listening"—Amer. Record Guide

Now—if you wish—you may select this smash Broadway hit as one of the 6 records you receive for \$4.98

RODGERS AND HAMMERSTEIN'S THE SOUND OF MUSIC



retail value \$6.98

49. The complete score including: The Sound of Music; Do-Re-Mi; My Favorite Things; Sixteen Going On Seventeen; Climb Ev'ry Mountain; 18 songs in all.

MARY MARTIN in RODGERS & HAMMERSTEIN'S THE SOUND OF MUSIC



with Original Broadway Cast

TCHAIKOVSKY MENDELSSOHN Violin Concertos



ISAAC STERN
Philadelphia Orchestra
Ormandy

31. "...the tone is like shimmering silk"—High Fidelity

SAMMY KAYE MIDNIGHT SERENADE



It Had To Be You
I'll Get By
Very Thought of You
9 more

16. Too Marvelous for Words, Where There's Life, etc.

THE NORMAN LUBOFF CHOIR BUT BEAUTIFUL



42. Blue Moon, Fools Rush In, Don't Worry 'bout Me, 9 more

FLOWER DRUM SONG



ORIGINAL BROADWAY CAST
RODGERS & HAMMERSTEIN

26. Complete score. "A hit, another R&H winner!"—Newsweek

THE FOUR LADS



BREEZIN' ALONG

34. Come to Me, That Old Feeling, Long Ago, 9 more

Strings Of The Philadelphia Orchestra



EUGENE ORMANDY, COND.
Erne Kleime Nachtmusik,
Air On The G String, etc.

11. Also includes works by Corelli and Mendelssohn

Frankie Laine



29. You've Changed, Body and Soul, I Got It Bad, 9 others

CHOPIN Piano Concerto No. 2 UNINSKY Pianist



Hague Philharmonic
Van Otterloo

21. Expertly played by "a fabulous technician"—N. Y. Times

MILES DAVIS



KIND OF BLUE

40. Blue in Green, Flamenco Sketches, All Blues, etc.

MARCHING ALONG WITH SOUSA



Stars and Stripes Forever
Semper Paratus—10 more!

39. Also: Crusader March, King Cotton, The Thunderer, etc.

BRAHMS: SYMPHONY NO. 1



CLEVELAND ORCH. SZELL

45. One of the most melodically beautiful of all symphonies

cupat cavalcade



HIS GREATEST HITS

43. Tico-Tico, My Shawl, Besame Mucho, 9 others

Records from every field of music!

CLASSICAL! POPULAR! DANCE MUSIC! BROADWAY HITS! JAZZ!

MORE THAN 1,000,000 FAMILIES NOW ENJOY THE MUSIC PROGRAM OF

COLUMBIA RECORD CLUB

TERRE HAUTE INDIANA

CIRCLE 42 ON READER-SERVICE CARD

... a convenient method of acquiring, systematically and with expert guidance, a stereo record library of the music you enjoy most—at tremendous savings!

USE THE POSTAGE-FREE CARD TO RECEIVE 6 RECORDS FOR \$4.98

If you now own a stereo phonograph, or plan to purchase one in the near future — here is a unique opportunity to obtain SIX brand-new 12" long-playing stereo records for only \$4.98!

And what a tremendous selection you have to choose from — 49 records in all! Whether you prefer classical or popular music, Broadway hit shows or jazz — you're sure to find six stereo records to suit your musical taste.

TO RECEIVE YOUR 6 STEREO RECORDS FOR ONLY \$4.98 — simply fill in, detach and mail the handy postage-free card provided. Be sure to indicate which one of the Club's two musical Divisions you wish to join: Stereo Classical or Stereo Popular.

HOW THE CLUB OPERATES: Each month the Club's staff of music experts selects outstanding recordings for your library. These selections are fully described in the Club's music Magazine, which you receive free each month.

You may accept the monthly selection for your Division . . . take any other records offered (classical or popular) . . . or take NO record in any particular month.

Your only obligation as a member is to purchase five selections from the more than 200 Columbia and Epic records to be offered in the coming 12 months. Thereafter, you have no further obligation to buy any additional records . . . and you may discontinue your membership at any time.

FREE BONUS RECORDS GIVEN REGULARLY: If you wish to continue as a member after purchasing five records, you will receive a Columbia or Epic stereo Bonus record of your choice free for every two selections you buy — a 50% dividend.

The records you want are mailed and billed to you at the regular list price, generally \$4.98 (Classical \$5.98), plus a small mailing and handling charge.

THIS SPECIAL 5th ANNIVERSARY OFFER may never be repeated. Mail the postage-free card today to receive SIX stereo records for only \$4.98!

NOTE: Stereo records must be played only on a stereo phonograph



36. Rain in Spain, I Could Have Danced All Night, etc.



47. Wild Man Blues Fine and Mellow, I Left My Baby, 5 more



13. Also: Billy the Kid, In the Valley, Strawberry Roan, etc.



38. "Enormous talent and technique" — Chicago News

COLUMBIA RECORD CLUB

now makes this extraordinary offer to new members

any six

of these \$4.98, \$5.98 and \$6.98 long-playing 12" stereo records

FOR ONLY **\$4.98** Retail Value up to \$36.88

If you join the Club now and agree to purchase as few as 5 selections from the more than 200 to be made available during the coming 12 months



10. The exciting score of this fabulous Broadway hit



22. Also: Beyond the Blue Horizon, A Love is Born, etc.



48. This brilliant musical painting is an American classic

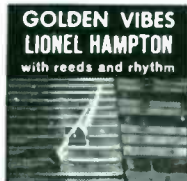

27. My Funny Valentine, Smoke Gets In Your Eyes, 10 more



41. Superbly played by one of Europe's finest orchestras



1. Skip to My Lou, On Top of Old Smoky, Oh Susanna, 12 more

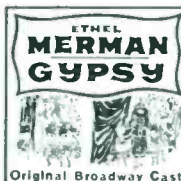

2. "Best musical I've seen in years" — N. Y. Herald-Tribune

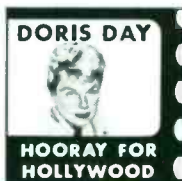

12. Over the Rainbow, Night and Day, Easy to Love, 9 more



18. Also: Blessed Are They That Mourn, Come Ye Saints, etc.



17. 12 great Gershwin hits: Man I Love, But Not For Me, etc.



30. "A choice item. Sheer magnificence of tone"—Hi-Fi Rev.



44. "One of the great, great albums"—San Francisco Examiner



3. "Music of singular breadth"—Philadelphia Inquirer



46. Alexander's Ragtime Band, Cheek to Cheek, Always, etc.



28. Played with "dazzling brilliance"—Boston Globe

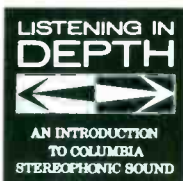

8. An exciting array of 16 classical and popular selections



5. Also: Tony Bennett—Smile; Vic Damone—Gigi; etc.

© Columbia, © Epic, © Marcas Res. © Columbia Record Club, Inc., 1960 271

CIRCLE 43 ON READER-SERVICE CARD

REVIEWS LIKE THESE...

The PR-500 Turntable . . .

"... a single speed (33 $\frac{1}{3}$ -rpm) turntable with an integrally mounted arm . . . employs a somewhat unconventional drive system which results in a totally inaudible rumble level, and low wow and flutter. The arm is simple yet effective, with a mounting system which makes the unit relatively insensitive to shock and vibration."

"The arm tracks well at the lowest stylus forces recommended by the cartridge manufacturer."

"The hum field surrounding the PR-500 is very low, and no difficulty should be experienced from this source even with poorly shielded cartridges."

"... the Stromberg-Carlson PR-500 performs in a manner comparable to that of the most expensive turntables and arms, yet sells for much less."

"The PR-500 is an excellent value at \$69.95."

Hirsh-Houck Laboratory—
High Fidelity Magazine, May '60

...hint at the performance of new

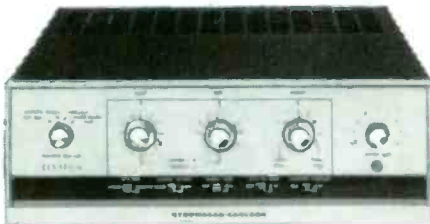

New Amplifiers . . .

ASR 660—an extremely clean, beautifully designed stereo amplifier • Continuous power: 36 watts (18 watts per channel) • Music power: (IHFM standard): 44 watts (22 watts per channel) • Total harmonic distortion: 0.6% at 18 watts per channel • Intermodulation distortion: 1% at rated output (4:1 ratio, 60 and 7,000 cps) • Frequency response: ± 0.5 db, 20-20,000 cps • Separate channel, clutch-type bass and treble controls • Scratch filter (18 db/oct); Rumble filter "Twin T" filter, null at 20 cps • Loudness contour switch; Balance control; Channel reverse switch; Program selector; Master gain control • DC on pre-amp heaters for low noise; A plus B center speaker terminals.

Suggested Audiophile net: \$159.95

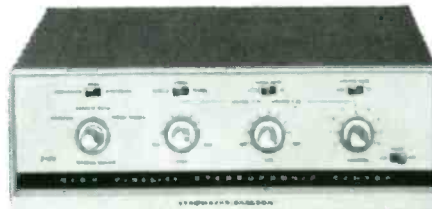

ASR 220C—an unusually versatile medium power stereo amplifier • Continuous power: 24 watts (12 watts per channel) • Music power (IHFM standard) 28 watts (14 watts per channel) • Total harmonic distortion: 0.7% at 12 watts per channel • Intermodulation distortion: 2% at rated output (4:1 ratio, 60 and 7,000 cps) • Frequency response: ± 0.5 db, 20-20,000 cps • Separate channel clutch-type bass and treble controls • Scratch filter (18 db/oct); Rumble filter "Twin T" filter, null at 20 cps • Magnetic phono pre-amp with new, low noise tubes • A plus B center-speaker terminals.

Suggested Audiophile net: \$119.95



New Speaker Systems

Three new, wide range speaker systems. A new elliptical tweeter with a heavily silver-plated voice coil prevents harshness caused by cone breakup in conventional circular speakers. Woofers of extra-heavy cone stock are capable of long, linear excursions for outstanding low frequency power handling without distortion. Tweeter level switches included on all models. Enclosures are carefully matched to the woofer.

Suggested Audiophile net: RS511 59.95 to 84.95
(prices vary with finish) RS514 74.95 to 99.95
RS516 105.00 to 135.00

For the sheer joy of listening . . . "There is nothing finer than a Stromberg-Carlson"

CIRCLE 122 ON READER-SERVICE CARD

The FM-443 Tuner . . .

"The Stromberg-Carlson FM-443, one of the least expensive FM tuners on the market, approaches the performance of more expensive equipment. It is therefore an especially good value for anyone who wants to obtain the highest level of performance in a moderate-priced system."

"The distortion at 100% modulation is about 1% for signals stronger than 10 microvolts."

"The sensitivity measurement of the FM-443, according to IHFM standards, is amazing. Its usable sensitivity is 3 microvolts, a figure not usually found in tuners in this price range. This high sensitivity has not been obtained at the expense of IF bandwidth."

"The tuner sells for **\$79.96.**"

Hirsch-Houck Laboratory—
High Fidelity Magazine, June '60

The ASR-880 Amplifier . . .

"... a compact integrated stereo amplifier rated at 32 watts per channel. Noteworthy . . . it exceeds its rated power substantially over most of the audio range, has excellent power-handling capabilities at both ends of the spectrum."

"Each channel delivered 50 watts at 2% harmonic distortion, or 48 watts at 1% distortion. This is unusual in an amplifier rated at 32 watts . . ."

"The distortion of the ASR-880 is very low at usual listening levels when correctly operated . . . it has a rare combination of very high gain and very low hum. The amplifier has a number of special features, such as center channel output and a very effective channel-balancing system, as well as the usual stereo control functions found in all good amplifiers."

"Only 0.6 or 0.7 millivolts at the phono inputs will drive the amplifier to 10 watts output per channel. At normal gain settings . . . the hum level is better than 70 db below 10 watts even on phono input. This is completely inaudible."

"With a listening quality matching its laboratory response, the Stromberg-Carlson ASR-880 must be considered a very good value at its **\$199.95** price."

Hirsch-Houck Laboratory—
High Fidelity Magazine, Sept. '60



Stromberg-Carlson components like these:



New Tuners

FM-443A—an improved version of the highly rated FM-443 • New, high-accuracy, precision dial • Precision components in de-emphasis network, giving improved frequency response: 20-20,000 cps \pm 1 db • Sensitivity: 3.5 microvolts for 20 db quieting • Improved local-distance control in RF stage for lowest distortion and best signal-to-noise ratio on both local and distant stations • Total harmonic distortion; less than 1% full deviation.
Suggested Audiophile net: **\$79.95**

SR-445A—a combination of the FM-443A and an entirely new, wide-band AM section. FM specifications: identical to FM-443A • AM frequency response: Broad: 25 to 9,000 \pm 1 1/2 db • Sharp: 25 to 2,500 cps \pm 1 1/2 db • AM noise level: 60 db below 1 volt output • AM harmonic distortion: less than 1% at 100% modulation • Separate tuning indicators for AM and FM.
Suggested Audiophile net: **\$139.95**

All the new Stromberg-Carlson components have so many impressive features, you'll find a visit to your Stromberg-Carlson dealer most rewarding. He will be glad to demonstrate either an individual component or a complete Stromberg-Carlson Component Ensemble. See him or write: Stromberg-Carlson, 1419—011 North Goodman Street, Rochester 3, New York.

STROMBERG-CARLSON
A DIVISION OF **GENERAL DYNAMICS**

CIRCLE 123 ON READER-SERVICE CARD



Look! 4 inches thin because Utah put the pot inside

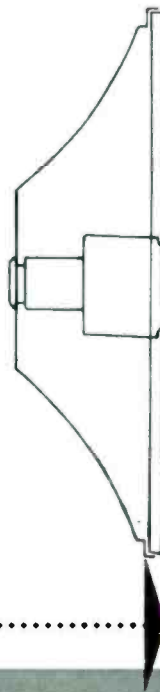

A Utah first!
Magnetic Structure inside
—No loss of gap energy

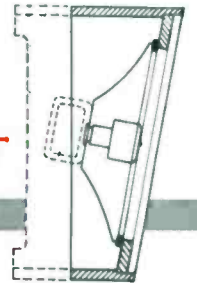

NO POT

THINK THIN!

Here's how Utah's
New **Shape of Sound**
packs more speaker
into less space!

First, Utah cuts speaker weight with *more power per pound* of magnet in the new Dual Diameter circuit. Then Utah lops off the bulk—by putting the pot *inside* the cone. Result: an ultra-compact, thin-profile speaker and a whole line of baffles that open new possibilities in sound system design.

You have less weight, less depth, easier installation . . . with Utah's "new shape of sound" speakers.

SEND NOW

Please rush me free literature on "new shape of sound" thin-profile speakers and baffles.

Name _____

Address _____

City _____ Zone _____ State _____

Utah

developers of

More Power Per Pound Speakers

Utah Radio & Electronic Corp.
Huntington, Ind.

CIRCLE 134 ON READER-SERVICE CARD

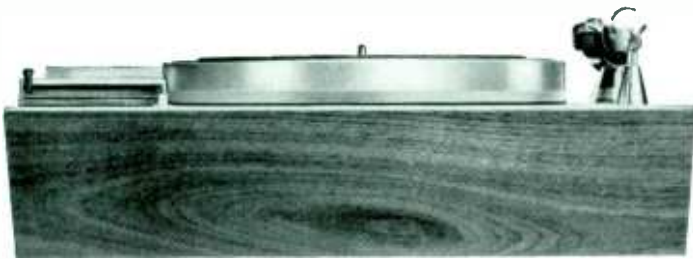

“REK-O-KUT”— *the safest word you can say to your dealer*

For sixteen years, Rek-O-Kut has been synonymous with

quality and integrity in the design of turntables. As other brands have risen, fallen and even completely disappeared, Rek-O-Kut has won consistent acclaim as the overwhelming choice in its field. In performance ratings and engineering contributions to the art of turntable design, Rek-O-Kut has compiled a record unchallenged by any other turntable producer. Now, this tradition is again emphasized by the introduction of the magnificent new N-34H StereoTable...a professional quality two-speed (33 $\frac{1}{3}$ and 45 rpm) turntable. Quiet power is furnished by a Rek-O-Kut hysteresis synchronous motor and an efficient new belt-drive system. Speeds can be changed even while the table is rotating, merely by pressing a lever.

The N-34H is a symphony of crisp, clean lines accentuated by the unusual deck design. Mated with the new tapered base, the N-34H becomes one of the proudest and most beautiful components ever to grace a home music system. Insist on seeing it at your dealer's.

N-34H STEREO TABLE only—\$79.95 net. Shown with new Rek-O-Kut Micropoise Stereo Tonearm, Model S-220, \$29.95 net. Tapered base in hand-rubbed, oiled walnut, \$14.95 net.

**A NEW DIMENSION
IN TURNTABLES —12 $\frac{5}{8}$ " x 19"—
DESIGNED TO FIT
NARROW CABINETS
AND BOOKSHELVES!**



SPECIFICATIONS: Noise Level:—53db below average recording level; Wow and Flutter: 0.15%; Drive: Nylon, neoprene-impregnated endless belt. 2-Speeds, 33 $\frac{1}{3}$ and 45 rpm. Simple lever-action changes speeds.

NOTE: COMING SOON... ANOTHER GREAT DEVELOPMENT... Rek-O-Kut AUTO-POISE —makes any Rek-O-Kut tonearm you buy now—fully automatic!



**REK-O-KUT
STEREOTABLES**

Export: Morhan Exporting Corp., 458 Bway, N.Y. 13
Canada: Atlas Radio, 50 Wingold Ave., Toronto 19



Rek-O-Kut Company, Inc., Dept H-11
38-19 108th Street, Corona 68, N.Y.

Please send me complete details on the new N-34H STEREO TABLE:

Name _____

Address _____

City _____ Zone _____

State _____

CIRCLE 112 ON READER-SERVICE CARD

YOUR NEEDLE IS DESTROYING YOUR LP'S

(if it isn't a Fidelitone Pyramid Diamond)

Ordinary ball point needles contact record micro-grooves at only two microscopic points. This causes a tremendous concentrated pressure that accelerates record wear, and reduces the life of quality reproduction.

Fidelitone's new Pyramid Diamond, shaped like the original recording stylus, allows more surface contact between needle and record. This distributes the tone arm weight over a larger surface area, and lowers unit area pressure. Your LP records will last many times longer.

HERE'S WHY...



Recording Stylus Ordinary Needle Pyramid Diamond

Fidelitone's new Pyramid Diamond is shaped similar to the stylus that recorded the original sound. It perfectly follows every contour created by the recording stylus.



In an unmodulated, or low frequency groove, the recording stylus (A) cuts a groove (W-1) wide enough to let an ordinary ball point needle (C) and the Fidelitone Pyramid Diamond (B) track the centerline of the groove accurately, and contact all recorded sound impressions.

As the groove is modulated by high tones, the groove width (W-2) cut by the recording stylus (A-1) narrows. This causes the ordinary ball needle (C-1) to rise and "pinch out" of the record groove. It bridges modulation crests, mistracks centerline and distorts sound impressions. The Pyramid Diamond (B-1), because of its new shape, stays solidly in the record groove, smoothly glides along the centerline positively driven by the groove walls.

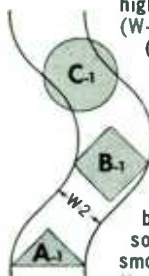

BALL POINT DIAMOND PYRAMID DIAMOND

And the new shape of the Pyramid Diamond allows more surface contact between needle and record, substantially reducing contact pressure. This greatly increases needle and record life.

See your record dealer or hi-fi specialist today. Demand the Fidelitone Pyramid Point. You owe it to your records and your listening pleasure.

For the complete story on the revolutionary new Pyramid Diamond, or the name of your nearest dealer, write Fidelitone, Chicago 26, Illinois.

Fidelitone

"Newest shape on records"

CIRCLE 62 ON READER-SERVICE CARD

Notes from Abroad



LONDON—The long pause on Wagner in Decca-London quarters had begun to look cataleptic. At last it is broken. Early this fall, John Culshaw (head of classical a & r) and his recording team left for the Vienna Sofiensaal, scene of their *Rheingold* triumph, to record *Tristan und Isolde*, a project that occupied fifteen sessions spread over three weeks. Cast: Birgit Nilsson as Isolde, Regina Resnik as Brangäne, Solti conducting the Vienna Philharmonic.

And the *Tristan*? For months—years, indeed—London officials have been combing Europe for a likely Heldentenor. In Munich, Culshaw heard Fritz Uhl. Uhl is about thirty years old and has been singing at the Munich Opera for three or four years. Culshaw flew him to London. For two days he and his technicians listened to Uhl's singing of *Tristan* and Siegmund excerpts with piano accompaniment in the Broadhurst Gardens studio, sometimes with microphone, sometimes independently of it. The playbacks seem to have pleased everybody. If Uhl acquits himself in *Tristan* as expected, we may expect to hear him some day in Decca-London's resumed *Ring* enterprise. Culshaw says he's prepared to spend five years recruiting a satisfactory cast before moving on from *Rheingold* to a definitive *Walküre*.

For Act III of *Tristan*, by the way, Wieland Wagner has lent Bayreuth's unique "wooden trumpet," an instrument of the alpenhorn type, which, as specified in a Wagner footnote, is to be played in preference to the routine *cor anglais* for the joyous tune that signals the sighting of Isolde's ship.

Tenor Corelli. Walter Legge of EMI came back recently from Milan, having supervised a *Pagliacci* with Lucina Amara, Tito Gobbi, a new baritone called Zanasi (of whom he speaks warmly)—and tenor Franco Corelli, of whom more in a moment. The recording is not expected in the shops until next year. While halting in London, Legge blueprinted various home recordings, including Bartók's *Music for Strings and Percussion* which is listed for Von Karajan and the Philharmonic Orchestra; and a *Traviata*, which will be sung at Kingsway Hall, probably this fall, by Maria Callas and Giuseppe Taddei, under Giulini (to be issued on Angel in the States).

Having perfected his blueprints, Legge packed again for Milan to watch over Maria Callas' new *Norma* (stereo) under Serafin's direction. Others in the *Norma* cast are

Christa Ludwig, Nicola Zaccaria—and Franco Corelli.

It looks as if Corelli is going to be a recurring name on EMI labels. Victor Olof, the HMV a & r manager, had an avuncular talk with Corelli in Biffi's restaurant, on the Scala doorstep, last year. The outcome was a long-term, exclusive contract—"with one or two options, however." Everybody at EMI uses exactly the same phrases about Corelli. He is described as the best young tenor in the world; charming and modest; rather nervous in temperament, preferring to listen to playbacks alone; a great critic of himself.

Due to open the Milan season with Callas in December and to appear also at the Metropolitan, Corelli is doing better at twenty-eight than I had envisaged when he was twenty-five. I have been looking up my notes of his Covent Garden debut, as Cavara-dossi, in 1957: "Frantically handsome. Aware of it. Before '*Recondita armonia*' he tossed his hat buoyantly to the sacristan. When grilled by Scarpia, feigned indifference, flicking imaginary specks from his lapels and cuffs. At the news of Marengo, fell on his knees and laughed helplessly. Clung desperately to his F sharp and A sharp in '*Vittoria*,' and had *tenuto* fanciers in the gallery clapping wildly before releasing them."

Beecham and *Love in Bath*. Reports from Sir Thomas Beecham's convalescent quarters agree that much of the old ebullience is back. He lives surrounded by scores and tape players, his head full of recording projects for the Royal Philharmonic Orchestra.

His next disc, *Love in Bath* (Angel), a suite of numbers selected from Handel operas and rescored by Sir Thomas himself, is due out in January or February. The history of the suite and of the recording alike is checked. In its first form it was known as *The Great Elopement*. Beecham assembled and scored it during his wartime years in America. His original intention was that, like its predecessor *The Gods Go a-Begging*, it should accompany ballet action. He himself wrote the story and scenario, which tells how, in eighteenth-century Bath, Elizabeth Lindley, singer and beauty, affianced to a dull squire, elopes—to her papa's consternation—with young Richard Brinsley Sheridan, future author of *A School for Scandal*. The score was first heard in America over the air, and a few days later was performed at a Rochester Philharmonic concert in April 1945. Apart from certain additions, the present version of the suite is substantially the same as that of fifteen years ago. Why Beecham changed its title to *Love in Bath* is not clear.



Corelli

Continued on page 26

Revere T-2200 STEREO RECORDER

IT'S NEW!
IT'S 4-TRACK!
IT'S THINLINE!



4 TRACK STEREO RECORDING / PLAYBACK... AND SO LIGHTWEIGHT!

• Records stereophonically on 2 or 4 tracks. Also records 4 monaural tracks for doubled time. Makes stereo tapes from stereo records or broadcasts, or records microphone on one channel with record or radio accompaniment on the other. Powerful 8-watt max. output on upper channel. Built-in stereo playback preamp for connection to phono jack of Hi-Fi, radio and TV. 7½ and 3¾ speeds. Automatic shut-off when tape runs out. Size 7½"x14"x14". Weight 25 lbs. With microphone, hi-fi cable, radio-TV attachment cords, audio cables, 7" reels and tape. See, try, compare the Revere T-2200 now at authorized Revere dealers.

\$239.50

Monaural Model No. T-2000—Same general features as 2200 but with twin-track, high fidelity monaural recording.

\$199.50

MODEL T-2200—Frequency Response: (Both Channels) 40-18,000 C.P.S. ± 3 db at 7½ I.P.S.; 40-13,000 C.P.S. ± 3 db at 3¾ I.P.S. (NARTB Standard Equalization) SIGNAL FROM LOWER CHANNEL PRE-AMP OUTPUT: 0.5-1.5 volts; CROSS TALK: -50 db; EXTENSION SPEAKER OUTPUT IMPEDANCE: 8 ohms.



Revere Model T-204-4 Stereo

2 and 4-track stereo playback and monaural recording. Lower stereo channel with built-in preamp. Simplified keyboard controls "Balanced-Tone."

\$237.50

Model T-202 same as above with monaural recording and playback

\$207.50

REVERE CAMERA COMPANY, CHICAGO 16 • LOS ANGELES 7

CIRCLE 113 ON READER-SERVICE CARD

knight-kit®

A PRODUCT OF ALLIED RADIO

a pleasure to build and you own the best

you get more with a Knight-Kit:
 custom quality...exclusive design developments...
 maximum savings...supreme listening enjoyment



knight-kit Stereo Tape Record-Playback Preamp Kit

Complete record-playback preamp for any 2 or 3 head stereo tape transport. Separate dual-channel recording and playback preamps. Permits tape monitoring, "sound-on-sound" and "echo" effects. Features: Accurate VU meters; adjustable bias and erase voltages; concentric clutch-type level controls for mixing of mike and auxiliary inputs on each channel, for channel balance and for master gain adjustment; 6-position selector switch selecting every possible stereo and monophonic function. Printed circuitry for easy assembly. Extruded aluminum panel in Desert Beige and Sand Gold; 4 1/4 x 15 1/2 x 9". Shpg. wt., 15 lbs. 83 YX 929. \$5 Down. Only \$79.95 (less case).

new
and
exclusive

wide choice of money-saving stereo hi-fi knight-kits



70-Watt Stereo Amplifier Kit
 83 YU 934. \$119.95



40-Watt Stereo Amplifier Kit
 83 YU 774. \$76.95



Stereo FM-AM Tuner Kit
 83 YU 731. \$87.50



20-Watt Stereo Amplifier Kit
 83 YX 927. \$39.95



32-Watt Stereo Amplifier Kit
 83 YU 933. \$59.95



FM-AM Hi-Fi Tuner Kit
 83 YX 928. \$49.95

Prices include case

FREE 1961 ALLIED CATALOG

See the complete Knight-Kit line of hi-fi components. For everything in build-your-own hi-fi, for everything in Electronics, get the 444-page 1961 Allied Catalog. Send for Free copy today.

Easiest Terms:

Only \$5.00 down (or less) on orders up to \$200; up to 24 months to pay.

: Knight-Kits are available in Canada



Knight-Kits are products of and unconditionally guaranteed by

ALLIED RADIO

ALLIED RADIO, Dept. 12-L
 100 N. Western Ave., Chicago 80, Ill.

Ship the following Knight-Kits: _____

\$ _____ enclosed

Send FREE 1961 Catalog featuring Knight-Kits.

Name _____

Address _____

City _____ Zone _____ State _____

CIRCLE 6 ON READER-SERVICE CARD

NOTES FROM ABROAD

Continued from page 24

Recorded originally in 1958, the tapes were duly passed. Not so the pressings. When these were played to Beecham at Cap Ferrat, he found certain movements lacking in charm or dramatic point. "It won't do," he pronounced. Re-recording was put in hand. Further delays were entailed by unforeseen debates and negotiations over copyright. When it reaches your record shops, *Love in Bath* will have been two years en route.

Russian Visitors. After appearing here (their first visit to Britain) at the Edinburgh Festival and at three London concerts, the Leningrad Symphony Orchestra was caught on the wing by Deutsche Grammophon. While in London they shuttled by bus between their Kensington hotel and Wembley Town Hall for nine sessions under Eugene Mravinsky and Gennadi Rozhdestvensky. The project included stereo recordings of Tchaikovsky's Symphony No. 4, *Rococo Variations*, and *Romeo and Juliet Fantasy-Overture*; Khachaturian's *Gayne Suite*; and the Schumann Cello Concerto, with Mstislav Rostropovitch playing solo.

Postscript. The Columbia-Angel *Norma* (see above) is now taped and being edited. Piano rehearsals began on September 1 and the last recording session was held twelve days later.

Further note about Christa Ludwig: Adalgisa was to have been sung by the Italian contralto Lazzarini, who, however, fell ill and canceled out. Walter Legge sent one of La Scala's experienced coaches to Salzburg, where Miss Ludwig was scheduled for six festival performances. He worked with her for ten days. When she reached Milan her singing of Adalgisa is said to have made the local *maestri* exclaim admiringly. A *Cavalleria rusticana* recording had been listed to follow immediately but has been deferred, since one of the leading singers was not *au point* with his role.

There seems nothing at all in rumors of Scala cancellations by Maria Callas. Present arrangements are that she and Corelli open the season on December 7 with a Donizetti rarity, *Poliuto*. With the *Norma* recording safely out of the way, Miss Callas had a cordial meeting with Signor Ghiringhelli, the Scala *soprintendente*, and received from him the bristling difficult *Poliuto* vocal score which most of the world (Miss Callas included) had never laid eyes or hands on before. She said: "I must rest. Tomorrow I go to sail a boat on the Mediterranean. After that I take the mud bath cure on Ischia. But I shall have *Poliuto* with me all the time."

CHARLES REID

VIENNA—Step by step Karl Böhm is tightening again his connections with Dres-

Continued on page 28

there are mixers . . . then, there are the fabulous

new **CustoMixers**

designed and built by **OLIVER BERLINER**, internationally known sound systems authority



At last professional MONOPHONIC and STEREOPHONIC mixer amplifiers for Motion Picture and Public Address Systems, Broadcasters and Recordists . . . the CustoMixers incorporate features not found in any other mixers, regardless of size or cost; with quality equal or superior to anything in their price range.

The incredible UltraAudio CustoMixers,* customized because you select only the facilities needed to meet your personal requirements, are styled to compliment the most discriminating home or studio decor, and are perfect for portable* or permanent installation. All CustoMixers incorporate the amazing professional LINE-ATEN^o Straight-Line volume controls and Plug-In amplifiers and transformers.

*handsome carrying case optional at extra cost.
^opatent pending. * trade marks of Oberline, Inc.

COMPARE THESE EXCLUSIVE CustoMixer FEATURES:

- * Every control and indicator is Straight-Line for easier operation of multiple mixers and easier viewing of settings and levels.
- * All input transformers and Shock-Mounted preamplifiers plug in. Buy only those items you need. Virtually failproof . . . no need to repair; just replace in seconds and you're back "on-the-air" with a spare.
- * Plug-in accessory TONE GENERATOR. (Remove any preamplifier; plug in Oscillator to put sustained tone on the output line for level setting. Remove Oscillator; replug preamplifier.)
- * Input impedances 50 to 600 ohms and hi-z; low or high level.
- * Output impedance 50 to 600 ohms and hi-z; illuminated standard vu meter on each output line.
- * 5¼x19 inch front control panel for standard rack, carrying case or console mounting. Fused silicon rectifier power supply.
- * Separate output connection for stereo or monophonic headphones, monitor amplifier and public-address system feed.
- * Extremely light weight with easy-on-the-eyes military specification rugged finish, beige with white lettering.
- * Unique replaceable designation strips indicate use of each mix position.



Model M-5: Five independent mixing positions plus master gain control. Phono equalizing and cueing switches on front panel for mixers 2 & 3. A 60db pad switch enables mixer-1 to accept a high level, low impedance source. Single channel output.



A 2-channel fully stereophonic mixer (shown in optional carrying case) with two mix positions and a master gain control per channel. Special "MIX" switch permits all mix positions to feed both channels simultaneously with sub-master on each channel. Model D-4.

For technical and factory-direct purchasing information,

write to **Oliver Berliner** at . . . Dept. 1-11

UltraAudio
P R O D U C T S

7471 Melrose Avenue / Los Angeles 46, California / U.S.A.

CIRCLE 130 ON READER-SERVICE CARD

SOUND TALK

NOTES FROM ABROAD

Continued from page 26



Protect your heads

REALLY EXCELLENT RECORDING depends on two heads . . . the one you use in selecting equipment, tape and methods and the one on your recorder, which needs tender care. You can use one head to protect the other by making sure you use "SCOTCH" Brand Magnetic Tapes.

ABRASIVE ACTION of some tapes on the head can cause wear resulting in a frequency drop of as much as a full octave. That can't happen if you use "SCOTCH" Brand Tapes with patented Silicone Lubrication, which lasts the life of the tape. "SCOTCH" Brand is the *only* tape that has it!

MAXIMUM HEAD PROTECTION is assured, but there is nothing gummy to attract dust or clog the head gap. No mechanical polishing is involved in the making of "SCOTCH" Brand Tapes, so there is no need to worry about breakdown of oxide quality. And Silicone Lubrication is impregnated throughout the coating . . . nothing haphazard or temporary about it.

MUTUAL ADMIRATION of tape and head results. Tape glides over the head without abrasion. The head doesn't gouge or scratch the tape, which keeps lubricating the head, and so on to longer tape life and better tape recording.

SILICONE LUBRICATION plus the finest uniform high potency oxides have made "SCOTCH" Brand Tapes the standard of the broadcast industry. You cannot buy better tapes.

"SCOTCH" BRAND TAPES are made by the 3M Company, whose pioneering research leads the magnetic tape field. This is the only company able to meet the fantastic standards of Video Tape. Play the favorite . . .



"SCOTCH" and the Plaid Design are Registered Trademarks of the 3M Co., St. Paul 6, Minn. Export: 99 Park Ave., New York. Canada: London, Ontario.

MINNESOTA MINING AND MANUFACTURING COMPANY
...WHERE RESEARCH IS THE KEY TO TOMORROW



CIRCLE 100 ON READER-SERVICE CARD

den, where he was director of the Opera House between 1934 and 1942. Recording activities for Deutsche Grammophon play a prominent part in linking Böhm, who likes to call himself a "disciple of Strauss," with Dresden, where *Salome*, *Elektra*, and *Der Rosenkavalier* were first performed. When he had completed his DGG recording of the last-named in December 1958, his final words to the members of the orchestra, the Sächsische Staatskapelle, were: "Whilst working with you I felt as if I had left you only a fortnight ago."

In fact, Böhm had not been in Dresden since he gave up the directorship there in order to take on similar duties in Vienna—not without taking along a number of prominent singers such as Elisabeth Höngen and Martha Rohs. Dresden was further depleted of many of its well-known artists when the Opera House was bombed in 1944 and still more so when the establishment of the Iron Curtain led many singers to move from Eastern Germany to the West.

It looks as if Deutsche Grammophon is bent on making Dresden a recording center for Strauss's operas. Rehearsals for a complete recording of *Elektra* under Böhm's baton started during the second week of October. The singers, of course, came from the West, but the *genius loci* was duly represented by the orchestra. Böhm says: "There are passages in the scores of Richard Strauss which at the first reading cause difficulties to almost every orchestra in the world; yet to the Dresden musicians these very passages come most naturally." (Incidentally, Böhm's praise seems to be affirmed by recent efforts to give the Staatskapelle standing on this side of the Iron Curtain too; in Salzburg last summer I was given to understand that Dresden's orchestra would be scheduled for next year's Festival.)

No complete recording of *Elektra* has been made in Europe since Cetra issued its two discs from the Maggio Musicale Fiorentino with Anny Konetzni in the leading role and Mitropoulos conducting. That, of course, was at the beginning of the LP era. Assembling a cast for the new stereophonic version presented problems, but finally DGG officials in Hamburg were able to relax. Inge Borkh is *Elektra* (she did a few scenes on the RCA Victor label, it will be remembered); for the role of Chrysothemis, Marianne Schech, who sang the Marschallin in DGG's *Der Rosenkavalier*, was chosen; Jean Madeira sings Klytemnestra. The part of Orest is taken by Dietrich Fischer-Dieskau.

Fischer-Dieskau *Avalanche*. I still remember one of the first recitals Fischer-Dieskau gave in Vienna, a number of years ago, to a public that only half filled the Mozartsaal. Word of the young baritone's talents got round very quickly, and his reputation is now

Continued on page 30

HIGH FIDELITY MAGAZINE

"Yes, son...
 and you can
 use it
 as a
 24 watt mono
 or stereo
 amplifier,
 or to
 convert
 the other
 amplifier
 I gave you
 last
 Christmas
 to Stereo!"



"GOSH!"

It's the DB212 we're talking about! A unique STEREO AMPLIFIER/CONTROL CENTER by BOGEN-PRESTO, designed to bring good cheer (and greater value) to one and all with its unique 3-way adaptability.

As a conventional stereo amplifier it provides 12 watts per channel, more than enough power for most home speakers. • Or, the two channels, electrically combined by the flick of a switch, make the DB212 a 24 watt monophonic amplifier capable of handling the lowest efficiency speaker. • And, for higher powered stereo or conversion of existing mono systems, one channel of the preamplifier can drive an external amplifier, while its 24 watt amplifier operates on the other channel.

The DB212 also features low distortion (less than 1%), equalized tape-head inputs, switched hi-lo filters, separate recorder outputs, speaker phasing switch, and more. A value-packed component, this BOGEN-PRESTO top quality amplifier will add spice to holiday listening for many Christmases to come. Available in gold or grey at \$119.95 less enclosure.

Our youngster above adamantly demands superior FM-AM reception despite weak stations, crowded wave bands, and local interference. That's why Santa selected the ST442 STEREO FM-AM TUNER, esthetically and technically compatible with the DB212. High sensitivity (better than $1\mu\text{V}$ on FM and $3\mu\text{V}$ on AM) assures noise-free reception even in the weakest signal areas. Flat to ± 0.5 db from 20 to 18,000 cycles, the ST442 even exceeds the broadcast bandwidth capabilities of FM Stations. Visual meter tuning, distortion controlling circuits (AFC and AGC on FM, AVC on AM), low impedance cathode followers for long amplifier connections, and provision for adaption to stereo multiplex, are just some of the features that contribute to BOGEN-PRESTO quality, designed to protect the high-fidelity investment and to ensure listening pleasure. Available in gold or grey at \$149.50 less enclosure.

For more information on the DB212 and the ST442 plus many other fine tuners, amplifiers, and turntables, write for free literature:

BOGEN-PRESTO



DESK 608—PARAMUS, N. J. • A DIVISION OF THE SIEGLER CORPORATION

60-8

Prices slightly higher in the West



the fastest growing name in hi-fi

because people who appreciate integrity in design and manufacture and who appreciate value, recognize these qualities in Knight fine products



KNIGHT High Fidelity Amplifiers
...from \$39.95 to \$169.50...
See the new KN775 75-Watt Stereo Amplifier with such new features as front panel headphone jack, Monitor control and Separation control

KNIGHT High Fidelity Tuners... from \$49.95 to \$139.95... all with Cathode Ray Tuning Indicators. See the new KN150 Deluxe FM Tuner with unique multiplex indicator, exclusive Dynamic Sideband Regulation and 1 microvolt sensitivity

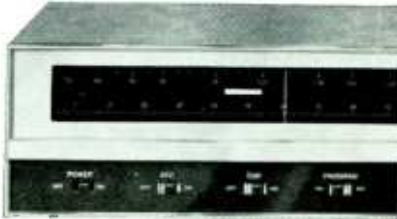

KNIGHT High Fidelity Tape Recorders
...from \$86.95 to \$249.95... See the new KN4300 featuring dual illuminated VU meters and complete stereo record and playback facilities with 3 speeds and 1/4 track and 1/2 track all in one unit



KNIGHT High Fidelity Speakers... from \$9.95 to \$124.50... See the wide selection of speakers with magnet weights up to 6 1/4 lbs. ... Choices include Polyethylene Foam Cones, American-made Electrostatics and exclusive die cast frames... All with verified specifications

KNIGHT High Fidelity Cabinetry... from \$34.95 to \$129.95... Choose from the world's largest selection... striking new Room Divider Sets... beautiful American Colonial, French Provincial and Danish Modern Cabinets



EASIEST TERMS: Only \$5.00 down (or less) on orders up to \$200; up to 24 months to pay

products of and unconditionally guaranteed by

ALLIED RADIO

ALLIED RADIO, Dept. 49-1
100 N. Western Ave., Chicago 80, Ill.

Send FREE 1961 Catalog featuring the complete line of money-saving KNIGHT products and the world's largest selection of hi-fi equipment.

Name _____

Address _____

City _____ Zone _____ State _____

FREE 1961 Catalog featuring everything in hi-fi and electronics



NOTES FROM ABROAD

Continued from page 28

international. Yet he does not often appear on the stage outside Berlin. Some time ago he confided to me: "I dislike the idea of squeezing myself into a ready-made production of an opera; I believe in steady work with an ensemble under the firm guidance of good producers and conductors." Although lately F.-D. seems to have made some concessions in this respect, the idea of adapting his individual interpretation to the spirit of a genuine ensemble is still dear to him. Hence his numerous recording activities, which cover a wide range of roles.

Early in the fall Fischer-Dieskau appeared before the microphones in DGG's Berlin studios to sing Count Almaviva in *Le Nozze di Figaro*, a part which earned him much praise at the last Salzburg Festival. Deutsche Grammophon hopes that its *Figaro* will match its DG success (DG standing this time for *Don Giovanni*, which earned a "Grand Prix" in Paris). Ferenc Fricssay is the conductor; Renato Capecchi and Irmgard Seefried impersonate Figaro and Susanna; Maria Stader sings the part of the Countess and Hertha Töpfer is Cherubino.

In spite of the wide acclaim for the earlier *Don Giovanni*, some of the German singers in the cast were rightly rebuked for their rather slapdash pronunciation of the Italian text. Newly established cooperation between DGG and La Scala is bound to improve matters as far as recordings of Italian operas by the German firm are concerned. DGG has just recorded a new *Ballo in Maschera* in Milan—with Antonietta Stella (Amelia), Ettore Bastianini (Renato), Adriana Lazzarini (Ulrica), Gianni Poggi (Riccardo), and Giuliana Tivolio (Oscar). The conductor is Gianandrea Gavazzeni.

Resuscitating Soler. I don't mean Martin y Soler, from whose opera *Una cosa rara* Mozart quoted a few bars in *Don Giovanni*, but his Spanish contemporary Padre Antonio Soler (1729-1783), whose piano music the American pianist Frederick Marvin unearthed from Iberian archives. Although Marvin's recordings of twenty-one sonatas and the *Fandango* on two discs for Decca have not yet been released in Europe, he will play Soler's sonatas and piano quintets (along with the Berlin Bastiaan Quartet) in a number of German concert halls this fall, as well as in Copenhagen and Oslo. And the two radio stations in West Berlin (RIAS and Sender Freies Berlin) will record a number of the quintets, to be broadcast during the winter.

Marvin hopes to do even more to reestablish Soler's reputation. He has been granted a Fulbright Fellowship which will enable him to return to Spain and continue his researches. His immediate aim: to add some of Soler's chamber music to his five-volume edition of the Piano Works which Mills Music Ltd. of London has brought out.

KURT BLAUKOPF

CIRCLE 7 ON READER-SERVICE CARD

Incomparable multi-record sets... are any missing from your record library?

(NOTE: THEIR NATIONALLY ADVERTISED PRICES RANGE FROM \$21.98 UP TO \$41.98)

IN A SHORT TRIAL MEMBERSHIP

THE RCA VICTOR SOCIETY OF GREAT MUSIC
OFFERS YOU

ANY SET FOR \$4.98

IF YOU WILL AGREE TO BUY SIX ADDITIONAL 12-INCH DISCS DURING THE NEXT YEAR

AVAILABLE IN STEREO UNLESS OTHERWISE INDICATED



Regular L.P. \$34.98

A SEVEN-RECORD SET

Not available in stereo

THE NINE BEETHOVEN SYMPHONIES
Conducted by **ARTURO TOSCANINI**



A SEVEN-RECORD SET

EIGHT GREAT SYMPHONIES
Performed by the

BOSTON SYMPHONY ORCHESTRA

CHARLES MUNCH and
PIERRE MONTEUX, conductors



Regular L.P. \$34.98
Stereo \$41.98

BEETHOVEN: Symphony No. 3 (*Eroica*)
MENDELSSOHN: Symphony No. 4 (*Italian*)
MENDELSSOHN: Symphony No. 5 (*Reformation*)
BRAHMS: Symphony No. 1
BRAHMS: Symphony No. 4
FRANCK: Symphony in D minor
TCHAIKOVSKY: Symphony No. 5
TCHAIKOVSKY: Symphony No. 6 (*Patétique*)



A SIX-RECORD SET

TCHAIKOVSKY
OMNIBUS

Regular L.P. \$29.98
Stereo \$35.98

Piano Concerto No. 1 VAN CLIBURN
Fifth Symphony PIERRE MONTEUX conducting the Boston Symphony
Pathétique Symphony FRITZ REINER conducting the Chicago Symphony
Violin Concerto JASCHA HEIFETZ
Nutcracker Suite ARTHUR FIEDLER conducting the Boston Pops
Capriccio Italien KIRIL KONDRASHIN conducting the RCA Victor Symphony

Excerpts from the Sleeping Beauty
PIERRE MONTEUX
conducting the London Symphony



A FOUR-RECORD SET

Vienna Philharmonic
Festival

Conducted by

HERBERT VON KARAJAN

MOZART: Symphony No. 40 • HAYDN: Symphony No. 104 • BEETHOVEN: Symphony No. 7 • BRAHMS: Symphony No. 1 • JOHANN STRAUSS, JR.: *Tales from the Vienna Woods*; *Overtures to Die Fledermaus and The Gypsy Baron*; *Annen Polka*; *Auf der Jagd* • JOSEF STRAUSS: *Delerien Waltz*

De Luxe SORIA Album
Regular L.P. \$21.98 Stereo \$25.98

A FOUR-RECORD SET

Handel's Messiah

COMPLETE

Conducted by
SIR THOMAS BEECHAM
BART., C.H.

De Luxe SORIA Album

Regular L.P. \$21.98 • Stereo \$25.98

A FIVE-RECORD SET

The Five
Beethoven
Piano
Concertos

Played by

ARTUR RUBINSTEIN

Regular L.P. \$24.98 • Stereo \$29.98

A SIX-RECORD SET

Not available in stereo

Bach's Well-Tempered Clavier

COMPLETE

Performed on the
harpichord by
WANDA LANDOWSKA

Regular L.P. \$29.98

A SIX-RECORD SET

Not available in stereo

Rubinstein
Plays Chopin

69 selections

POLONAISES
WALTZES
NOCTURNES
IMPROMPTUS
PRELUDES

Regular L.P. \$29.98

THE BASIC IDEA: SYSTEMATIC COLLECTION UNDER GUIDANCE

MOST MUSIC-LOVERS certainly intend to build up a truly representative record library, but, unfortunately, almost always they are haphazard in carrying out this aspiration. Systematic collection not only means that they will ultimately build up a record library of which they can be proud, but that they can do so at an IMMENSE SAVING.

The one-year membership offer made here is a dramatic demonstration. In the first year it can represent a saving of AS MUCH AS 40% over the manufacturer's nationally advertised prices.

After purchasing the six additional records called for in this trial membership, members who continue can build up their record libraries at almost a ONE-THIRD SAVING through the Club's Record-Dividend plan; that is, for every two records purchased (from a group of at least 100 made available annually by the Society) members receive a third RCA Victor Red Seal record FREE.

A cardinal feature of the plan is GUIDANCE. The Society has a Selection Panel whose sole function is to recommend "must-have" works. The panel includes: DEEMS TAYLOR, Chairman; composer and commentator; JACQUES BARZUN, author and

music critic; SAMUEL CHOTZINOFF, General Music Director, NBC; JOHN M. CONLY, music editor, *The Atlantic*; AARON COPLAND, composer; ALFRED FRANKENSTEIN, music editor, *San Francisco Chronicle*; DOUGLAS MOORE, composer and Professor of Music, Columbia University; WILLIAM SCHUMAN, composer and president of Juilliard School of Music; CARLETON SPRAGUE SMITH, former Chief of Music Division, New York Public Library; G. WALLACE WOODWORTH, Professor of Music, Harvard.

HOW THE SOCIETY OPERATES

EVERY month three or more 12-inch 33½ R.P.M. RCA VICTOR Red Seal records are announced to members. One is singled out as the *record-of-the-month* and, unless the Society is otherwise instructed (on a simple form always provided), this record is sent. If the member does not want the work he may specify an alternate, or instruct the Society to send him nothing. For every record members pay only \$4.98—for stereo \$5.98—the manufacturer's nationally advertised price. (A small charge for postage and handling is added.)

CIRCLE 30 ON READER-SERVICE CARD

RCA VICTOR Society of Great Music V12-11
c/o Book-of-the-Month Club, Inc.
345 Hudson Street, New York 14, N. Y.

Please register me as a member of THE RCA VICTOR SOCIETY OF GREAT MUSIC and send me the multi-record set I have indicated below, billing me only \$4.98 (plus postage). I agree to buy six additional RCA VICTOR Red Seal Records from the Society within 12 months. For each of them I will be billed the manufacturer's nationally advertised price—\$4.98 for monaural recordings, \$5.98 for stereophonic recordings—plus a small charge for postage, sales tax and handling. I may cancel my membership any time after buying six discs from the Society (in addition to those included in this introductory offer). If I continue after my sixth purchase, for every two records I buy from the Society I will receive a third RCA VICTOR Red Seal record free.

INDICATE BELOW THE MULTI-RECORD SET YOU WANT

MR. }
MRS. }
MISS } (Please print plainly)

Address:

City: Zone: State:

NOTE: If you wish your membership credited to an authorized RCA VICTOR dealer, please fill in here.

Dealer's Name: (Please Print plainly)

Address:

CHECK THE DIVISION YOU WISH TO JOIN

Regular L.P. Stereo

PLEASE NOTE: Records can be shipped only to residents of the U.S. and its territories, and Canada. Records for Canadian members are made in Canada and are shipped duty free from Ontario.

**A MAJOR IMPROVEMENT in the
MATCHLESS BOZAK MIDRANGE SPEAKER**

***Now Makes ALL Bozak Three-Way Systems
Better Than Ever!***

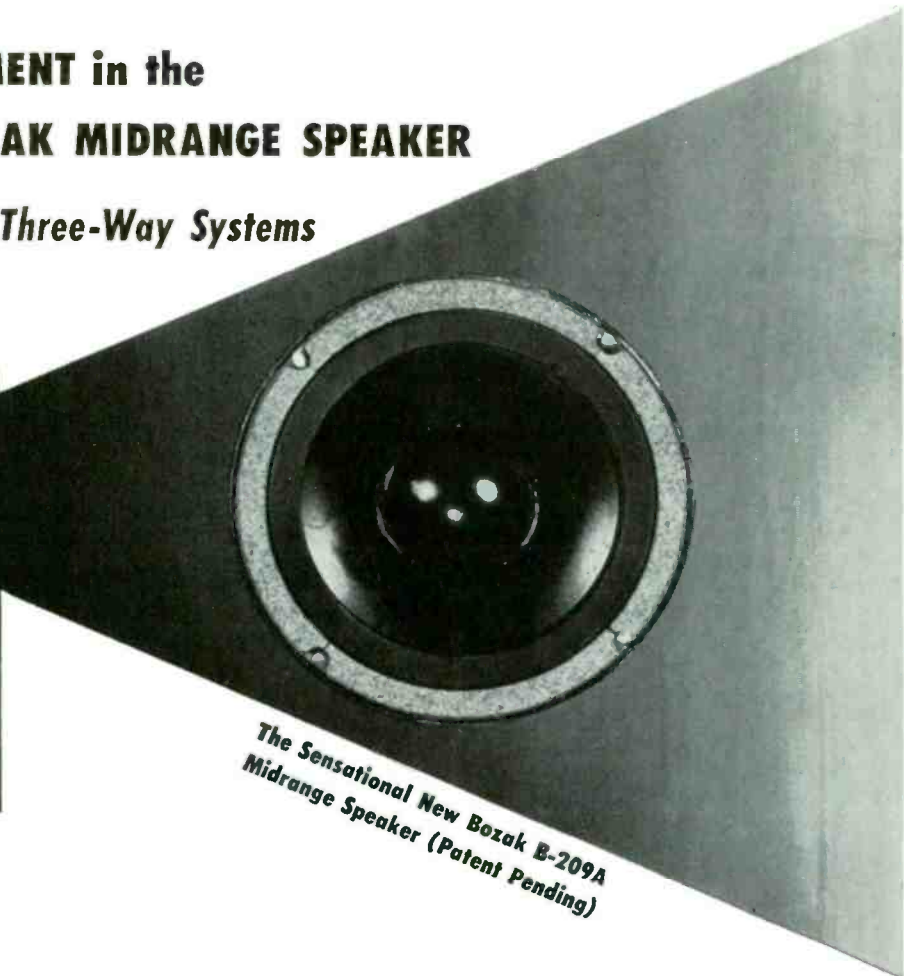
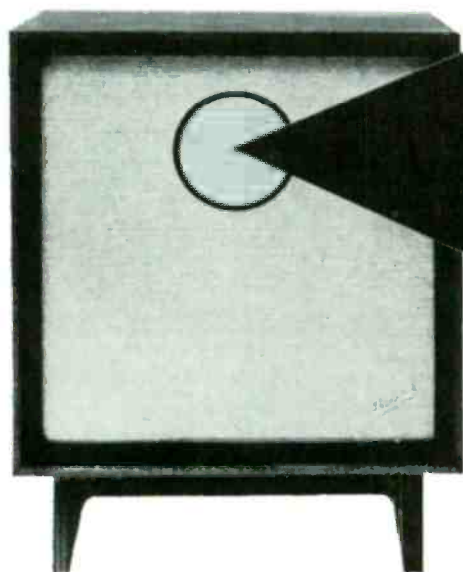

*The Sensational New Bozak B-209A
Midrange Speaker (Patent Pending)*

All Bozak Three-Way Speaker Systems now incorporate the new B-209A Midrange, featuring a revolutionary and altogether different diaphragm. The result is an overall excellence of musical performance beyond anything previously attained!

The new speaker is a radically improved version of the matchless B-209, hitherto generally accepted as the best midrange in musical reproduction. To its many exceptional qualities there has now been added an instantaneously precise transient response that is simply unequalled. The speaker retains every subtlety and nuance of all vocal and instrumental music, and must be heard to be appreciated. Ask a Bozak Franchised Dealer for a demonstration.

TO OWNERS OF BOZAK SPEAKER SYSTEMS:

Arrangements are being made with Bozak Franchised Dealers under which you can have your speakers brought up to the minute at nominal cost. See your dealer for information.

Bozak

DARIEN, CONN.

T H E V E R Y B E S T I N M U S I C

CIRCLE 31 ON READER-SERVICE CARD



RATED "Best Buy"
NOW EVEN BETTER

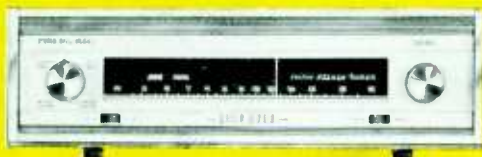

List Price \$110.50*

only for those who want the ultimate

SHERWOOD S-3000 III

FM/MX STEREO TUNER

The FM tuner that has everything . . . 0.95 μ v sensitivity, Interchannel Hush noise muting system, "Acro-Beam" tuning eye cascade balanced input, automatic frequency control, "local-distant" switch . . . now brings you the only

FM TUNER with "CORRECTIVE" INVERSE FEEDBACK

Every high fidelity amplifier today incorporates "corrective" inverse feedback for lower distortion and improved response. Now, Sherwood brings the same performance benefits to the S-3000 III FM Tuner; these include reduction of distortion due to overmodulation by the FM station and better quality long-distance reception.

READY FOR FM STEREO

Stereo via FM multiplex broadcasting is just around the corner. The S-3000 III contains chassis space and all control facilities to plug in a stereo multiplex adapter. Other features include flywheel tuning, plus 7" expanded slide-rule tuning scale, cathode-follower output, and front panel output level control. Sherwood Electronic Laboratories, Inc., 4300 N. California Ave., Chicago 18, Ill.

(*) Other fine Sherwood Tuners:
S-2000 AM-FM Tuner \$145.50 S-2200 AM-FM MX Stereo Tuner \$179.50

FOR COMPLETE TECHNICAL DETAILS WRITE DEPT. HF-11

CIRCLE 117 ON READER-SERVICE CARD



CAPTURE THE STRENGTH AND DELICACY OF EVERY SOUND

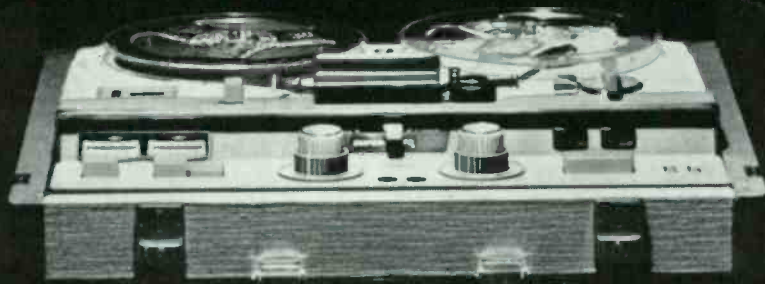

Stereorecorder

NEW SONY Stereorecorder 300

4 TRACK & 2 TRACK STEREOPHONIC RECORDER

Here, through your fingertips, you take complete control of sound, blending it to magnificent perfection.

A great symphony to record? With this superb instrument you are a professional. Touch your stereo level controls — feel that sensitive response. Dual V.U. Meters show precision readings as you augment the strings, diminish the brass. The richness of that low resonance is captured with your bass boost. The strength and delicacy of every sound — now yours to command.

On Sale only at authorized dealers, known for integrity.

Four and two track, stereo and monophonic, recording and playback, the SONY STERECORDER 300 — with its hysteresis-synchronous motor, built-in stereo pre-amps and power amps, and a dozen more professional features — is truly *the ultimate* in tape recorder engineering. \$399.50, complete with two dynamic microphones, two extended range stereo speakers all in one portable case. For custom mounting, \$349.50.

Other new Recorders from world-famous SONY:
262-SL \$199.50 — 4 and 2 track stereo playback. 4 track monophonic recorder. Sound-with-sound for language, voice and music students. Complete with F-7 dynamic microphone.

262-D \$89.50 — A complete 4 and 2 track stereo recording and playback tape transport.

101 \$99.50 — Bantam transistorized precision dual-track monophonic recorder. Complete with F-7 dynamic microphone.

SONY SUPERSCOPE *The tapeway to Stereo*

For literature and name of nearest franchised dealer, write Superscope, Inc., Dept. 7, Sun Valley, California.

CIRCLE 124 ON READER-SERVICE CARD

AR-3



Shortest
Loudspeaker
report
on
record

from

AUDIO ETC.

(Edward Tatnall Canby)

I planned to talk about the AR-3 and I haven't left myself room. Everybody's had his say about that Acoustic Research speaker but me . . .

"I'll only state then, that I have been using the two AR-3 units since last June for most of my listening and intend to continue using them indefinitely. That's for the record and it's enough."

AR-3's (and other models of AR speakers) are on demonstration at the AR Music Room, on the west balcony of Grand Central Terminal in New York City. No sales are made or initiated at the Music Room, but AR speakers are played continuously in stereo, from 10:30 to 7:00 on weekdays, 11:30 to 5:30 on Saturday.

ACOUSTIC RESEARCH, INC., 24 Thorndike Street, Cambridge 41, Massachusetts

Combines the matchless performance of the empire 208 belt-driven, 3-speed turntable and empire 98 transcription arm. With matching walnut base (less cart-ridge) \$145.50* **new** Free "do-it-yourself Stereo/Balance Kit" at your high fidelity dealer.

empire troubador

(record playback system)



audio empire
STEREO/BALANCED HIGH FIDELITY COMPONENTS DYNA-EMPIRE, INC.
1075 STEWART AVE., GARDEN CITY, N. Y.

* SLIGHTLY HIGHER WEST OF ROCKIES

The Missing Ingredient

IF THERE IS ONE THEME that is popular among music critics and other writers on opera these days, it is this: what's the matter with America? In Europe, we're constantly reminded, towns of moderate size (Graz, for example, or Darmstadt, or Rovigo) are able to offer opera seasons of fair length and considerable variety. Why not in America? If German cities smaller than Wichita, Kansas, can offer opera, drama, and operetta eleven months of the year, why can't Wichita manage three months a year?

It's a valid question. Most of the concerned pundits have one of two solutions. The first is to educate the public to opera. The second is to make opera palatable to Mr. Average American—by translating it, updating it, Broadway-izing it, or by pretending it isn't opera at all. Opera will presumably be "popular" either when the potential consumer is sufficiently enlightened to savor the grand and noble, or when the grand and noble has been sufficiently diluted to be easily swallowed.

Possibly the push for popularity is unreasonable. Opera originated and flourished as an aristocratic art, as the design of any traditional opera house will illustrate, and it will very probably survive without the endorsement of the American millions. Just the same, it is quite legitimate to ask why America lacks a European-style operatic structure.

Perhaps it is gratuitous to reply that the missing ingredient is the operas. It's worth repeating, just the same, for all our other operatic problems are really peripheral to the one of developing a native repertory. In Germany, France, Italy, Russia, and even (to a lesser extent) in Poland and Czechoslovakia, there exists a group of native works for the lyric stage that forms the basis for day-in, day-out repertory. Not all of these works are masterpieces, but many of them are close enough to merit repeated performances for native audiences. Naturally, foreign works are given too—always in translation during the winter and in the original at summer festivals and "international" seasons.

The existence of even a small group of durable American operas would go far toward easing many of our difficulties. Consider the matter of decentralization. Before opera in America can be termed healthy, it must support seasons of fair length by basically resident companies in more than just one of its cities. But as long as producers are forced to depend on the limited pool of imported talent to mount an entire slate of works in

varied foreign styles, decentralization is essentially impractical. The Metropolitan maintains what amounts to three separate companies of performing personnel, but that is because it is an international house—one of not more than five or six in the world. It would be ridiculous to try to organize a company in Cedar Rapids or Des Moines along Metropolitan Opera lines, just as it is ridiculous to demand that the Met act as popularizer or *avant-garde* spearhead.

Decentralization is making some headway, to be sure. Apart from expanded activities in New Orleans, Washington, Dallas, and other cities, there are recent signs of awareness in places like Kansas City and Seattle. But none of these towns is going to have a resident company of even Darmstadt stature until there is a core of native operas on which to center its efforts. Attempts to decentralize opera through head-on attack are certainly laudable, but grass-roots American repertory companies dependent almost exclusively on foreign works in translation face an uphill struggle. Try suggesting to a European general manager that he schedule an entire season without a single native work!

Unhappily, the development of new composers for the lyric stage is not something we can control very efficaciously. We can establish this organization, or create that post, and hope that it will have thus and such desirable effect. The fact remains that American composers will start turning out playable operas as soon as they're able, not before; and there isn't a great deal we or they can do to hurry the process along.

This is not to say that the sincere and energetic efforts of various groups and people on behalf of "The Cause" should be discouraged—they are all to the good. Assuredly, a larger proportion of funds (those administered by the State Department as well as those available from foundations and private industry) should go to the creators of opera than to its interpreters; after all, there's small sense in training mobs of singers if we have no steady employment to offer them. We should at least admit for sober discussion the taboo subject of subsidizing both composer and performing company, if only on a civic level. And recording companies might even consider the advisability of commissioning operas.

We should, in short, face up to the fact that the growth of a real American operatic culture depends directly on the emergence of first-rate American opera composers.

CONRAD L. OSBORNE

as *HIGH FIDELITY* sees it





Inside La Scala

A behind-the-scenes tour of the bluest of blue-chip opera houses.

BY JOSEPH WECHSBERG

TOSCANINI once said that there exists no "second" opera house on earth; every important house considers itself the world's first. But the Maestro himself never had any doubt that "his" house, the Teatro alla Scala in Milan, was the greatest of all. Certainly the "Theatre at the Stairs," called after a flight of stairs that no longer exists, is the most famous. The number of great composers and artists intimately associated with it, its record of historical first nights, and its annual dividends by way of fine performances make La Scala the bluest of the blue-chip opera houses. Its only two serious competitors are New York's Metropolitan and Vienna's Staatsoper. But the Met has not yet become an integrated part of America's musical theatre—most Ameri-

cans would think in this connection of a Broadway musical, Gershwin, or *My Fair Lady*. And Vienna's Staatsoper, which shares with La Scala the distinction of being a national shrine with a great tradition, doesn't always demonstrate the high artistic principles that keep the fires of operatic passion burning between the Piazza della Scala and Via Giuseppe Verdi.

There are many political parties in Italy's parliament and in Milan's municipal government, but all Italians and particularly all Milanese are fierce partisans of La Scala. I know quite a few who never attend a performance but take a personal and proprietary interest in the house; they are happy to help make up its deficit, which is the real test of love. A first night at La Scala is the

greatest artistic and social event in Italy, and there are as many as twenty first nights every season.

From the outside, La Scala is a rather shabby brown masonry box that could do with a new coat of paint. Only the Met looks worse. As a piece of real estate La Scala can't compare with the noble edifices of the Staatsoper or the Paris Opéra. Inside, however, you are in a different world, a fairyland—gray and white Carrara marble, chandeliers and mirrors, columns and carpets, statues of Toscanini, Puccini, Verdi, Rossini, Bellini, Donizetti, and others. With its beautifully dimensioned five rows of boxes, the auditorium conveys a sense of warmth and intimacy despite its size. (There is space for three thousand people; the Metropolitan has a capacity of 3,800, Vienna of 2,200.) La Scala doesn't give you the sense of cold elegance that you feel at the Opéra or the cavernous impression of the Met. It is a lived-in opera house, and there is immediate contact between stage and audience.

La Scala's acoustics are the world's best, on a par with those of Bayreuth (which, however, isn't a regular opera house). When American bombers badly damaged La Scala on August 16, 1943, some Milanese feared that Giuseppe Piermarini's great eighteenth-century structure might never be resurrected. La Scala's management wisely used the old blueprints, again putting in two wooden ceilings, and rebuilt the old house down to the last detail. It's a bewitching place. When the electric clock above the stage shows "IX" (9 p.m.), the overhead lights dim, and for a few moments one light remains on in each box, which is a miraculous effect. You settle back in your seat with a sense of elation and anticipation. Opera is a tricky business, depending on many intangibles, but you have a better chance at La Scala than anywhere else to hear a carefully rehearsed, powerfully staged, beautifully sung and well-conducted performance that has style, artistic unity, and complete integration of all components.

A well-run opera house can never be a democracy. To fuse the various artistic personalities and high-strung individualities into a veritable ensemble there is needed the strong hand and the pure heart of an idealistic fanatic who also happens to know the value of money. Dr. Antonio Ghiringhelli, La Scala's *Sovrintendente* (general manager), is what the Viennese call an *Opernmarr*, an amateur who is crazy about opera. (Egon Hilbert, the present Vienna Festival *Intendant*, is another one.) Ghiringhelli came into La Scala after World War II "for a few months" to coordinate the speedy reconstruction of the bombed house. He has been there for the past fifteen years. A fifty-year-old, silver-haired bachelor who has no family, few friends, and practically no interests outside opera, Ghiringhelli comes from a poor family in nearby Varese. As a boy he sold newspapers and carried out telegrams; later he made a fortune as an industrialist. Then he fell, as he says, "under the magic spell of Toscanini." Since then, he's carried on a passionate love affair

with La Scala. He goes there every day around noon and is still there after midnight. He is always there during the performance, watching from his box, or in his small backstage office, and everybody knows it. He gets on well with his artists and is respected by everybody.

Ghiringhelli works in Toscanini's former office under a picture of the Maestro, and he carries on in the great Toscanini tradition. "Toscanini," says Ghiringhelli, "was a great artist and a great manager. He rose from the ranks to become a general. He knew that the bloodstream of an opera house must always be flowing and that one must always build for the future." Ghiringhelli is advised on musical matters by a committee of three *maestri*: Victor de Sabata (now living in semiretirement in Santa Margherita), Ildebrando Pizzetti (best known as the composer of *Murder in the Cathedral*), and Francesco Siciliani. It is Ghiringhelli, however, who makes the final decisions on policies, programs, casts, and all administrative and financial matters.

Every season La Scala produces sixteen different operas. Six of them are popular favorites chosen from about thirty durable box-office successes. *Aida*, *La Traviata*, and *Rigoletto* are La Scala's all-time hits. Italian opera naturally comes first. An unwritten tradition dictates that every season at least one work by Rossini, Bellini, Donizetti, Verdi, and Puccini must be performed, as well as one each by Mozart and Wagner. The sure-fire hits which conveniently fill the house are not repeated year after year as elsewhere, but only every five or six years. La Scala doesn't make it easy for itself. In exceptional cases, when a particular star is available, an opera may be repeated in successive seasons. Last season they repeated the new *Turandot* of the year before, "because we were lucky to have Mme. Nilsson," says Ghiringhelli.

In addition, La Scala performs annually three works



Milan's most famous edifice seen from its busy piazza.



Angel records

La Scala in full dress—"a different world, a fairyland."

of great sixteenth-, seventeenth-, and eighteenth-century music; also three masterpieces that have not yet achieved popularity in Italy (last season they were *Parsifal*, Berlioz's *Trojans*, and Humperdinck's *Hansel and Gretel*); and four—repeat, *four*—new, contemporary works, two by Italian and two by foreign composers. No other musical theatre on earth has such an ambitious program. (The Met rarely performs modern operas, Vienna produces one every season. La Scala is the world's most progressive-minded opera house, but still there are professional *avant-gardists* and critics in Milan who attack Ghiringhelli for his "conservative attitude.") In addition, La Scala also puts on two new ballets every year. "Never one with bad music," says Ghiringhelli. "Stravinsky, Prokofiev, De Falla, Ravel. Toscanini used to say that the dance must not kill the music."

There are also to be taken into consideration the productions of the Piccola Scala, which performs six infrequently played historical masterpieces, two from the seventeenth, two from the eighteenth, and two from the nineteenth century. La Piccola Scala was opened in 1951 in a nearby building to bring to life a favorite idea of Toscanini, who had always dreamed of a small, intimate house of about five hundred seats where some very old and some very new operas could be given for small groups of connoisseurs. Last year La Piccola Scala put on Pergolesi's *Lo Frate 'Nnamorato*, Paisiello's *Barbiere di Siviglia*, Cimarosa's *Le Astuzie femminili*, Egk's *Revisore*, Malipiero's *Sette Canzoni*, Stravinsky's *Mavra*, Rota's *Notte di un neurastenico*. Ghiringhelli intends to build a special orchestra for the small house and to present more performances there.

Ghiringhelli is a perfectionist who hates any attempt at improvisation and is devoted to the principle of long-term planning. Performances are prepared down to the

last detail two years ahead. There are several reasons, however, for the superlative finish of many Scala productions. The most important is the absolute, unlimited power given to conductors in all musical matters. Until Toscanini came, at the close of the last century, La Scala was mainly known as a singer's house. Now it is definitely a conductor's house, a turn of affairs which is another Toscanini legacy. (You can't get away from Toscanini when you are inside La Scala. His spirit is everywhere. His disciples are all around.) The conductor selects his cast, asks for a certain amount of rehearsal time, studies the work, and conducts *all* performances. Except in an emergency no conductor would take over a performance rehearsed by a colleague. Except for illness, the same singers remain in the cast, even to the secondary parts. Thus a new Scala production never degenerates into mere repertory "routine," with the fifth or sixth performance conducted by an inferior man, sloppily sung and badly acted by unrehearsed singers. Last year's conductors were Bruno Bartoletti, André Cluytens, Gianandrea Gavazzeni, Herbert von Karajan, Rafael Kubelik, Dimitri Mitropoulos, Nino Sanzogno, Hermann Scherchen, and Antonino Votto. Votto, a Toscanini disciple and now the oldest of the Old Scala Hands, is as strict a disciplinarian as the Maestro was. At La Scala the conductor conducts the works he loves and does best, and *not* because there happens to be no other conductor available that night.

The amount of rehearsing depends on the difficulties involved and on other considerations (for instance, the number of performances planned), but La Scala has one hundred and fifty rehearsals for about twenty works, more than any other house. Operas produced by Luchino Visconti, who is famous for his painstaking attention to detail and for the grandeur of his productions, are often rehearsed for thirty or forty days. A reading rehearsal and individual rehearsals are followed by chorus rehearsals, ensembles, whole acts with piano, later with orchestra, and so on. Rehearsals never stop; even after the twelfth or thirteenth performance the producer or conductor is apt to schedule another rehearsal to keep the performance at its original level. There can't be Sunday every day at an opera house, but La Scala has a great many Sundays during its season.

Celebrated singers who have performed their favorite parts many times elsewhere often admit, with some puzzlement, that they always learn something new at La Scala. Some even admit that they sing better there. Maria Callas has certainly performed more impressively at La Scala than at any other house. At La Scala there is an intuitive feeling for drama without which there can be no good opera. And there is awareness of singing as a great art. Scala conductors are forceful men who mold their ensemble into complete unity. The greatest singers have learned some painful lessons here. Unless they are willing and able to fit in, vocally, dramatically, and otherwise, they will not be asked to come back. Foreign-

trained singers often have trouble in acquiring the mysterious Scala finish, a combination of clear enunciation, pure style, perfect phrasing, and faultless singing in the great *bel canto* tradition.

The sounds of beautiful music are heard eleven months every year at La Scala. Preparations for the new season start on November 15. The opera season begins on December 7 and runs through June 2. Performances take place on all days except Monday and Friday, when they shift to La Piccola Scala. During June there is a symphony season, followed in July by another opera season at popular prices for workers. August is (paid) vacation month for everybody. During the first two weeks in September recordings are made, afterwards there is another symphony season until November 15, and at that time the new cycle begins. Owing to this extensive schedule La Scala has no trouble in keeping its orchestra of 107, Italy's best and best-paid, its great chorus of one hundred, its not-yet-so-great ballet of sixty, its expert technical staff of about a hundred, its ten *comprimari*, and about thirty administrative employees. The four hundred people who work for La Scala enjoy the sort of social security, health and pension benefits that are standard practice in Italy's industries. Everybody gets thirteen monthly salaries a year and is pensioned at the age of sixty-five. The average orchestra and chorus member makes about \$200 a month, which is considered good money in Italy.

The financial background of La Scala is as unique as everything else about this house. When Toscanini gave La Scala its new Constitution in 1921, he decreed that above all La Scala must always keep its artistic and economic autonomy. There must be no outside inter-

ference whatsoever. ("No one ever worked here who was recommended by a minister or senator," says Ghiringhelli.) Toscanini wanted neither a privately backed house (like the Met) nor the straight state opera type (like Vienna or Paris), and he demanded that the autonomy of La Scala be made into a law so there would be no hustling for money from one year to the next. Such a house can be managed only by people with a perfect sense of artistic responsibility and deep civic attachment, and it can exist only in a city which is truly devoted to its opera house.

La Scala sells over 500,000 tickets a year and takes in more money than all other twelve Italian opera houses together. Unlike the Met, La Scala receives not one lira from private patrons. (Such gifts would not be recognized as deductions by Italy's income tax collectors.) Half of La Scala's expenditures is covered by ticket sales. In comparison, other Italian opera houses recover from ten to twenty per cent of their expenses. La Scala's fifty per cent deficit is (cheerfully) made up by the city administration of Milan (through a small tax on movie tickets and other entertainment), and by the provincial government (through a tax on the national football pool). "There must be a balance between what the public pays and what the city and province contribute," says Ghiringhelli. A fifty-fifty balance seems eminently fair.

Of the 160 performances given every year by La Scala and by the Piccola Scala, 75 at La Scala and 25 at the Piccola Scala are subscription performances. But even the unsubscribed performances are nearly always sold out. An American tourist arriving in Milan in the afternoon has not much of a

Continued on page 149



Above: La Callas at La Scala recording La Gioconda. At left: Able manager Dr. Ghiringhelli greets one of his advisory committee, Maestro Ildebrando Pizzetti.



Frau Edith Lang of Chicago, Illinois—her professional address is the Hamburg Staatsoper.

Our Operatic Expatriates

**America has produced some
of today's finest operatic talent,
but a good many of these singers
can be heard only in Europe.**

Guess why!

BY PAUL MOOR

MY APPOINTMENT was with Frau Lang, first soprano of the Hamburg State Opera. I arrived a few minutes early at the stage entrance of the beautiful, controversially "modern" opera house, where the *Pförtner* regaled me with an account of Frau Lang's most recent triumphs. "We're proud of her in Hamburg," he said. "And so young, too—but even so she shares the same repertory as Frau Ebers." And Clara Ebers, who belongs to a substantially older generation of German opera stars, is a top name not only in Hamburg but in the opera houses of Munich, Berlin, Vienna, and elsewhere on the Continent.

Promptly at the appointed time, Frau Lang appeared with a smile and greeted me in good English. As soon as she and the *Pförtner* had exchanged a few remarks in German, she turned to me and said, "Where shall we go? Do you know Hamburg? There's a pleasant little café just across the street, if you don't have any place special in mind."

We crossed the street. As we waited for the heavy traffic to open up, I noted the unpretentiousness of Frau Lang's appearance. Here was not the flamboyant, narcissistic diva of the old school, but a simple person wholly without "side," in spite of her great successes in Hamburg, where since 1955 she has been a regular member of the company, and in other leading European opera houses where she has frequently sung guest appearances.

When we entered the café, the face of every waiter, waitress, and cashier lit up with welcome when they looked our way, and as we moved towards the rear to find a free table, every one of these people bowed—not with obsequiousness, but with genuine affection and esteem. "Schön guten Tag, Frau Lang," "Wie geht es Ihnen, Frau Lang?" and so on, they greeted her, to all of which Frau Lang replied informally and graciously. This sort of special treatment for opera stars is routine in Central Europe, but I couldn't help reflecting how many, or rather how few, places there are in the United States where such attention would be a matter of course.

I also wonder, in writing this, how many American readers have even yet heard of Frau Lang, whose reputation in Hamburg has already, in the course of only five years, brought her invitations from the top houses in Europe, including one from Herbert von Karajan and the Vienna State Opera. It is indicative of Frau Lang's present success that she had to decline the Karajan offer simply because her schedule was too full. But at the moment, for the purposes of this article, the most interesting thing about the first soprano of the Hamburg State Opera is that Frau Lang is actually Miss Edith Lang, born, reared, and to a decisive extent trained, in Chicago, Illinois, U.S.A.

West Germany at the present time has the highest concentration of opera companies of any country in the world, with over fifty resident ensembles performing, in most cases, eleven months out of the year. In several of these companies every third singer is a foreigner, and of the foreigners Americans are far and away the biggest contingent. A German opera company today without one or two resident American singers is a rarity, and it is nothing unusual to find four or five. The Hamburg State Opera, possibly the best West German company, last year carried the names of six Americans as regular members of the company. They included such established singers as Astrid Varnay, of the Metropolitan and Bayreuth; Anne Bollinger, the Idaho beauty whom Lotte Lehmann trained to win the Metropolitan Auditions of the Air; Lawrence Winters, who made his debut in Broadway's ex-GI show *Call Me Mister*; and James Pease, also of Covent Garden and Glyndebourne. But Hamburg and other German cities have also become headquarters for many less well-known American singers who have been forced by circumstance to quit their homeland in order to exercise their art and earn a living. An informed estimate places the number of such



Berlin favorites Mr. & Mrs. Thomas Stewart (Almaviva and Cherubino, respectively) prepare for "Figaro".

Americans, in Germany alone, at around a hundred. When Westminster Records taped Douglas Moore's *The Devil and Daniel Webster* in Vienna, its musical director, Kurt List, had no difficulty recruiting the entire cast—principals and chorus—from among American singers resident in Central Europe.

Heinz Joachim, music critic for the leading West German daily, *Die Welt*, says that due to war and its aftereffects, standards of German singers have sunk and those of foreign singers risen. "This rise," Joachim says, "is especially true of the U. S. A., which, with its hundred and eighty million inhabitants and its staggeringly numerous and heavily endowed music schools and universities, has only three major opera theatres, so that only the tiniest fraction of the absolute élite out of a great number of highly qualified applicants can make any headway on an American operatic stage. It's no accident that most of the foreign singers in our opera houses today are Americans."

The life of an American opera singer abroad is not, of course, one long unadulterated success story. At a major German house, for instance, with a good contract and good parts, he will probably start at 1,000

Marks a month, which is exactly \$238.09. Yet more than a few American singers who have earned up to \$500 a week in summer stock or television in the United States have accepted such beginning contracts in Germany with alacrity. The reason is, quite simply, that such a contract represents an opportunity for them to *sing*, to put into active practice the ability they have spent long years developing and trying to perfect. As for the money—well, you don't get rich at the New York City Opera on \$75 a week, either. There is another important aspect; as one young American soprano put it, "If you're good, in Germany you'll be recognized. For a number of reasons—the managerial monopolies, and so on—you can't say the same thing about the United States."

Two American singers who have become recognized in Germany in the past few years are Evelyn Lear, soprano, of New York, and Thomas Stewart, baritone, of San Saba, Texas. Both are regular members of the Städtische Oper in West Berlin—a situation which is very convenient, since in private life Miss Lear is Mrs. Stewart and the mother of two young Stewarts. Miss Lear is an intelligent, musical singer (Cherubino, Giulietta, Octavian) endowed with dark good looks and a solid knowledge of what she wants out of a work of music. Mr. Stewart is a strapping, affable man whose open personality enables him to range amply from the psychological subtleties of Golaud and Renato onstage to such regional idioms as "Dang it" or "That simply scared the *fool* out of me" off. The couple met at Juilliard, where both studied. After they married, they earned relatively high fees, for brief periods, in television, night clubs, and summer stock. After a time, though, they came to the conclusion that the United States offered them no opportunity to make their livings as serious singers. They applied for, and received, Fulbright fellowships, and headed for Germany. Stewart was promptly engaged by the opera in West Berlin beginning with the 1958/59 season, and his wife was signed the following May. A year later they have each scored wild successes farther afield: Mr. Stewart as Amfortas in *Parsifal* at Bayreuth and Mrs. Stewart in Alban Berg's *Lulu* at the Vienna festival.

Both Evelyn Lear and Tom Stewart have by now become familiar figures in Berlin's musical community, accorded the affection which the city gives its musicians without any consideration of their origin. They were lucky in finding a delightful house at an extremely reasonable rental, and, what with their added income (about equal to their operatic earnings) from radio dates in Berlin and elsewhere in West Germany, each of them now tools about town in his own automobile. Since German opera houses are government-run, after fifteen years the Stewarts will be entitled to very decent pensions, which they can draw anywhere in the world. Both have won the respect and good will of their German colleagues, who have been lavish in scattering recommendations for them. Thanks to such felicitous cir-

cumstances, Miss Lear recently was chosen to do the last four Strauss songs with Sir Adrian Boult in London; and when illness prevented Dietrich Fischer-Dieskau from doing a Brahms Requiem in Berlin last winter, it was "Herr Stay-vart" whom the conductor immediately invited to take his place. Thirteen-year-old Bonni and eleven-year-old Jan Stewart attend Berlin public school, and already are almost completely bilingual.

The only thing unusual about the Stewarts is that *both* are singers; otherwise they are reasonably representative of this sizable, amorphous colony of involuntary American expatriates. California-born Keith Engen, formerly of the United States Navy and now a pillar of the Bavarian State Opera in Munich, has even developed such a reputation in Germany that for audiences there he has altered his name to Kieth: whereas they used to call him Kite, now they at least say Keet. Milan is home base of Chloë Owen, originally of Tennessee, an outstanding *lirico spinto* of unusual musicianship and intelligence. Miss Owen made brilliant debuts in Berne in *Lohengrin* and *Mathis der Maler* and has appeared and recorded repeatedly with Munich's youthful Bach specialist Karl Richter. Larry Winters has developed such a following that the fortnightly *Berliner Kulturspiegel* gives his guest appearances almost unprecedented star billing: "Lawrence Winters in. . . ." Winters, a Negro, jokes about not making up for the roles he is given but making *down*—and, incidentally, says he has never once encountered racial prejudice in a German opera house. (One hears the same from American Jewish singers.) Two other American Negroes whose superlative attainments have won them secure positions are the soprano Lenora Lafayette (a protégée of Dusolina Giannini) and the contralto Lucretia West; surely these are two of the most sumptuous, opulent voices in the world today.

THE LIST goes on and on and on. Most of these American singers are in Germany, but far from all. Would the Vienna State Opera of 1960 be complete without such Viennese favorites—Americans all—as Teresa Stich-Randall, Jean Madeira, and Eugene Conley? Is any Carmen more discussed in Paris than Gloria Lane? In recording such a typically, completely British opera as *Peter Grimes*, was it not noteworthy that the composer selected an American, Claire Watson, for the feminine lead and another, James Pease, for the leading baritone?

These artists are a far cry from the beard-and-sandal St. Germain des Prés set, for whom expatriation is its own justification. I have never, in the course of coming to know a number of American operatic expatriates, encountered a single one who professed not to miss the United States; some of them missed it badly. But reality is reality. Evelyn Lear sums it up succinctly: "Certainly I feel myself an American—I always will. But I am also an artist, and I'm happy only when I'm active in my profession."

**An uncharitable disquisition on
the horrors perpetrated by translators
of opera librettos.**



“Bless Thee! Thou Art Translated”

by CHARLES CUDWORTH

WHEN during the remarkable events of *A Midsummer Night's Dream* poor Peter Quince sees his old friend Sweet Bully Bottom suddenly bedecked with the head and ears of an ass, his horrified astonishment is as nothing compared with the shocked chagrin of a composer who encounters his best work in a bad translation. Sweet Bully Bottom himself, you may remember, was something of a music lover although unexpectedly modest in his musical claims: “I have a reasonable good ear in music—let us have the tongs and the bones. . . .” Bottom’s creator himself poked gentle fun at amateur players and the doggerel they rehearsed, but how much more fun he might have had if he had lived on into the palmy days of Italian opera.

Since Shakespeare’s time a mountain of sorry verse has been foisted on the opera lover (and the concertgoer) in the sacred name of music. And when that “verse” has to be rendered into a tongue different from the original—well, we can indeed echo Quince’s “Bless thee! thou art translated.” Mind you, there are some translators who are masters of their craft, and often improve on their originals; such a one was Edward J. Dent, whose English versions of Mozart’s operas are models of their kind. But, as often as not, the job of translating “words for music” has been left to pitiable hacks, who have understood neither the words *nor* the music, and who have written in a curious kind of English that can only be labeled “Translatorese.”

One of the greatest sufferers at the translator’s pen was Giuseppe Verdi. Luckily his knowledge of English was slight. Otherwise he might have been considerably alarmed at such oddities as this apparently innocent stage direction in the English version of *Aida*: “The Egyptian troops, preceded by trumpets, *defile* before the king.” Again, one Aidan character makes the strange statement: “And bootless proved my flame,” while another poses the leading forensic question: “Hast thou consulted the will of Isis?” My own favorite snippets of second-hand Verdiana come not from an opera, however, but from the English version of his *Requiem*, in which occurs the startlingly candid admission: “Hark! the trumpet sounds appalling!”; a little later comes this plaintive Mendelian plea: “With the sheep, Lord, deign to mate me, From the he-goats separate me. . . .”

Puccini also fared rather badly at the hands of some of his translators. It may surprise you to learn that Tosca, in spite of living c. 1800, had distinct premonitions of our own age of scientific marvels; at one exciting point in the opera she is obviously thinking of elevators: “They are going . . . going down . . . down!” She also gives a realistic preview of space flight: “We shall soar high above the globe terrestrial!” Best of all, perhaps, is Cavaradossi’s original style in invective: “Tremble, Scarpia, thou butcherly hypocrite!”

Another work which has some curiously modern pre-echoes is Rossini’s *Semiramide*, in which one character inquires, possibly suggesting our tabloids, “What paper is that Which with thy tears thou waterest And dost with horror view?” Later on we find strong advice for union members: “Be firm, of nothing else now think, but



strike!" In another version of *Semiramide* the heroine takes the hero by the hand, "and arrests him with tenderness." The same translation also embalms one of the most topsy-turvy of all pieces of Translatorese: "It is now three lustrums Since of the husband The dreadful shade When all is darkness The unworthy wife Is ever menacing." There is a similarly baffling item in Sarti's *Giulio Sabino*: "He has buried himself along with his infants"—a feat comparable with that of Gilbert's Lord High Executioner engaged in cutting off his own head.

Like Bottom himself, many operatic characters tend to mixed metaphors. Nasolini's *Merope*, for example, laments that "Heaven is deaf to my tears," and she also complains that her heart "pants" (by analogy perhaps with the words of the psalmist, but to him it was the "hart" that panted, not the "heart"). In Gounod's *Romeo and Juliet* too we have a real Bottomism: "O beetle-brows, that blush for me!" But best of all I like these two fragments from Meyerbeer's *Huguenots*: that intriguing meteorological phenomenon, "The sky today rains females in a shower . . .," followed a little later by the slightly salacious "Youth and beauty here may rest Or sport beneath the shady vest."

Some translations of *Carmen* are especially worthy of remembrance. There's that chorus of Dragoons which comments, very impolitely, it seems to me: "Oh what a sight these people are, Oh what a sight!" And as a musician I cannot restrain my pleasure in the couplet: "Guitars, the worse for being cracked, By nimble fingers were attacked!" In fact, operatic choruses, although admittedly lacking in originality (they'd always rather repeat what someone else has just said than think up something for themselves), are often blunt to the point of rudeness. We all know that huntin' people, the world over, tend to be self-centered, so perhaps it's only natural for the Chorus of Huntsmen, in *William Tell*, to sing disparagingly of "The tiresome voice of the monotonous shepherd." Operatic arias may be overlong and operatic court life may be boring, but it seems a little tactless when the courtiers in *Lucrezia Borgia* sing, very pointedly: "I shall sleep—When he has finished, awake me."

Clumsy stage directions, of course, can lead to any amount of unseasonable mirth, and operatic stage directions tend to be even more mirth-provoking than those found in what is sometimes still referred to as The Legiti-

mate Drama (is one to infer that opera is Illegitimate Drama?). Take, for instance, that delicious stage direction in *Le Roi s'amuse*: "Enter Marquis, pursued by dominoes"—nearly as good as Alice's playing cards. And of course no Englishman, or Welshman either, can restrain a hoot of derision upon encountering Donizetti's "Mountains outside Liverpool" (a setting almost as imaginary as Shakespeare's "Seacoast of Bohemia"). In one libretto of *Semiramide* "a noise of dubious steps is heard," while in *Tosca*, "Spoletta enters the torture chamber, from which he promptly emerges . . ." (wise fellow!). And what about that odd direction in Handel's *Rodelinda*? "Hadwig measures with astonishment Grimwald, who bows to her coolly . . ."; who wouldn't, after being measured with astonishment? After all, most gentlemen's vital statistics are a matter for private contemplation. I think my own favorite operatic stage direction is that reference in Donizetti's *Parisina* to "A Chorus of Watermen on the Po." At which point we had perhaps best draw a decent veil, and return to the text proper.

Some of the most riotous specimens of Translatorese occur when the translator is himself translating into a foreign language. Among such mimetic masterpieces, pride of place must be awarded to a world classic, Fr. Charley's *The New Opera Glass*, written in Germany in the late nineteenth century. This one has to be believed (it's available in a good modern edition by Robert Elkin, published in London by The Sylvan Press). But Charley's eminence is challenged to some extent by the early Anglo-German translation of Haydn's *The Creation* and *The Seasons*. The texts of these oratorios had checkered histories; stemming from English originals, they were translated into German, and then back again into English. And the lazy German printer didn't help matters; not only did he omit most of the clefs and instrumental indications throughout the scores, but he also lost heart halfway through most of the choral items, leaving long stretches of his native German to speak for itself, without benefit of English. The result can be imagined. Of the two works, *The Creation* comes off lightest, although most choral singers have chuckled over such zoological gems as "Cheerful roaring stands the tawny lion" or "In sudden leaps, the flexible Tyger appears," and best of all: "In long dimensions creeps with sinuous trace The worm. . . ." Almost all of us have puzzled our way through the curious *non sequiturs* in

that baffling chorus "The heavens are telling," but these aberrations fade into insignificance compared with the English text of *The Seasons*. Like many other human affairs, it all begins in Spring, when "From those craggy rocks the snow In livid torrents melted runs . . ." and the husbandman prays that "By soft'ning dews Let earth be wetted." Then comes the invitation to "See the lucid air" and give thanks with "From thine abundant meals Hast thou re-pasted us." Later, with night coming on "To gloomy cells repairs of fun'ral birds The lurid tribe." But do not despair; before long, "With rosy steps young day pours in." Summer catches up with us; "The sun shoots thro' th' air serene and calm His mighty blaze in torrents down . . . Of gleaning and reflected rays a dazzling deluge reigns; Distressful nature sinks. . . ." But still, we can always retreat to where "lofty roofs of aged oak refrigerant shelter yield." Autumn brings the Vintage Festival to "brim the panting cup": "There's scraping the fiddle Is squeezed the bag" (and not the sort of bag you're thinking about, either); "See skipping the boys And frisking the youth"; "Then let us sing in chorus full The bright and cheerful juice of grape" and "brim the panting cup." Autumn also brings a bit of shootin', complete with dog—such a clever dog, too: "See how the spaniel sweeps the grass And stooping draws along the turf." Unfortunately, Winter is upon us: "By frost cemented stands the lake," and the poor traveler has a dreadful time. When he does at last find shelter, he becomes more than a little infantile and "Springs With joyful panting breast to gain The welcome cot." Meanwhile "Old mothers spin on the distaff, On rotary wheels the daughters," perhaps because they are mystified by the direction "Get the wheel a-going Make it snore a-turning."

Rather later in the nineteenth century, when Wagner began to cast his spell on English ears, his alliterative, pseudo-saga style of verse writing posed a difficult problem for the translators. They solved it, to their own satisfaction at least, by going all out to imitate him. The result is Translatorese of the ripest quality. The *Ring* is undoubtedly the best source of such collectors' items, but even such a work as *Tristan* can provide one or two fine examples, as in the following brief dialogue:

Tristan: "The ship—dost thou see it?"

Kurvenal (eagerly): "O rapture! Transport!"

As for *The Ring*, the shape of lines to come already occurs in *Rhinegold*, when Alberic says "Delightfully deep is Loki." In *The Valkyrie*, Siegmund, having flung himself down before Hunding's fire, calls out "A draught! A draught!" (Someone seems to have left the door open; however, Siegmund soon reassures us with the information that his sinews are firm.) The fun really gets going in *Siegfried*. When that "sapient dwarf" Mime begs Siegfried to "Trust me, dearie" one might be excused for wondering if that callow young man has gotten mixed up with a barmaid. Mime goes on to warn Siegfried about

"Fafnir the wicked worm" and follows up his description with the dread warning "Potent poison He pours with his breath" (Dragons don't go in for deodorants, apparently). Nevertheless, S., nothing daunted, goes on to fight the dragon. Somewhat alarmed by the size of the beast, he bursts out, rather as if Fafnir were proprietor of a supermarket "An extravagant frontage You turn on me." Finally, Siegfried manages to kill the dragon, and eventually goes off to win his promised bride Brünnhilde. Unexpectedly enough, that tough young divinity behaves more like a coy Victorian miss than the hefty heroine we have been led to expect, and she even has poetic horrors at the prospect of a fate worse than death, when sex, in the shape of young Siegfried, raises its ugly head: "Dismallest blackness Dazes my sight . . . In vaporous mists Foully up-forces a grisly fear. . . ." In spite of all this, that "Babe of prowess," Siegfried, is still ardent and declares "Now bounds my blood In blissfullest blaze. . . ." Indeed, by now he is so worked up that in spite of being a "high-minded boy" he forgets all about grammar, to say nothing of poetry: "My glances are feasting With feverish thirst I feel my own burning Till the eyes' refreshment they taste of. . . ." I could go on, but I'll conclude my remarks on *Siegfried* with Waylinda's naïve inquiry, which has all the marks of Madison Avenue: "Are you annoyed by a gnome?"

ENOUGH of this. Let me end with two quotations from sober musicological prefaces, just to prove that it isn't operagoers alone who suffer from Translatorese. Here is a preface to the modern edition of an old Italian concerto: "The concerto that we are publishing was discovered by . . . and was revealed in an execution conducted by the same at the Conservatory in Florence . . . For the violin part we had the peculiar coöperation of the violinist G.M." And here is the now almost classic description of Vivaldi's Concerto "in Tromba marina": "Violins 'in tromba marina' . . . represent a specialty which has not reached us. It is generally believed that said wording means only violins imitating the full and coarse sonority of a sea syphon; instrument that, notwithstanding its picturesque name, was not a wind instrument and had nothing to do with the sea, but consisted of a long harmonic case, pyramid like very pointed, almost as tall as man . . . The wording 'tromba marina' applied to violins, might be in reference to the brilliant style, somewhat rude, in which these instruments are treated; just as it happens in the orgiastic concert cited above. The definition is still uncertain." Finally, may I conclude with one more paragraph from an Italian source, making it my own apologia, as well as its author's: "However, this catalogue, more than putting in evidence abuses perpetrated up to now, has among its most cherished aims also that of preventing new possible arbitres since they are always detrimental to art and would, from now on, be readily noticed by everybody. . . ."



HIGH FIDELITY DISCOGRAPHY NO. 49

The Mozart Operas on Record

BY NATHAN BRODER

IT HAS TAKEN one assiduous operagoer and Mozart fan, living in as metropolitan a music center as New York City, some fifteen years to see fully staged performances of all of Mozart's mature operas except *La Clemenza di Tito*. Four of these works were seen at the Metropolitan Opera, over a long period of time; the Met seldom produces two Mozart operas in the same season. For *Idomeneo* our operagoer had to travel to a rare revival at the Berkshire Music Festival in Lenox, Massachusetts, and for *Die Entführung* to an equally rare if less distant revival at the Juilliard School. Now take a look at the list of Mozart operas on records that follows. Anyone with the price can have the music of all six of the operas in question (again without *Tito*, which, by the way, doesn't deserve quite this neglect) in performances every bit as good as one is likely to hear at the Met and sometimes better. I am not, let me hasten to say, trying to intimate that a recorded performance is preferable to a good live one. I am simply saying that a good recorded performance is far better than *no* live one.

There are seven *Don Giovanni* now available on discs. This is a larger number of complete recordings than any other full-length opera in the standard repertory has been accorded, except *Bohème*, *Tosca*, and *Butterfly*. A fair conclusion to be drawn from this fact, I think, is that the musical taste of record buyers as a class must be considerably higher than that of operagoers as a class.

I shall not be so presumptuous as to try to characterize these masterpieces in a few words. Whole books have been written about them. Whole books have been written merely on the subject of *staging* these works. I assume that most users of this discography are familiar with the mature operas. For those who are not, I recommend Edward J. Dent's *Mozart's Operas* as the best detailed study in English and Section V of Alfred Einstein's *Mozart* as the best summary treatment of the subject.

The order of the album listing at the end of each entry is *not* intended to be a qualitative one. In only two cases where there is more than one edition—*Bastien und Bastienne* and *Figaro*—is the choice of the best version clear-cut, in my opinion.

All performances are sung in the original language unless something is said to the contrary, and librettos in that language with an English translation are provided unless otherwise indicated. The operas are listed in order of composition.

La Finta semplice, K. 51

La Finta semplice was written in Vienna in 1768 and first performed the following year in Salzburg. The libretto, mostly by Carlo Goldoni, is far from that lively author's best, and a mature Mozart would probably not have bothered with it. But to the twelve-year-old boy (and his proud and ambitious father) it represented a chance to show the Imperial Court at Vienna what he could do. There is no use pretending that the outcome, Mozart's first real opera, is a masterpiece. But here and there are touches that point to the future master, like Cassandro's aria "*Ella vuole ed io torrei*," whose text, with its opportunities for fooling, must have delighted the high-spirited boy; or Rosina's "*Amoretti*," which in spirit anticipates some of the lyric moments in *Così fan tutte*; or Cassandro's "*Ubbriaco non son io*," with the violins reeling around in their ritornel as drunk as the singer; or the pantomime bit in Act II, where the music, subdued and poetic, is on a much higher level than the silly scene being enacted. Elsewhere Mozart does what any competent but uninspired adult composer of the time would have done, and does it in a smooth and highly professional manner.

The singers in the only available version vary from adequate to very good: in the latter class belong Walter Raming, Edith Oravez, and George Maran. Paumgartner turns in one of his better conducting jobs. All of the secco recitative is omitted, most of the coloratura sections in Rosina's arias are excised, and several of the other numbers are cut; the singers sometimes sing an octave higher or lower than what is written. None of this, however, is very serious under the circumstances. The violin tone is rather coarse, but otherwise the sound is acceptable. —Dorothea Siebert (s), Rosina; Edith Oravez (s), Donna Giacinta; Karin Küster (s), Ninetta; George Maran (t), Fracasso; August Jaresch (t), Don Polidoro; Alois Pernstorfer (bs), Don Cassandro; Walter Raming (bs), Simone. Camerata Academica of the Salzburg Mozarteum, Bernhard Paumgartner, cond. Epic SC 6021, two LP.

Bastien und Bastienne, K. 50

The late George Jean Nathan once pointed out that it was possible for a performance to be awkward and at the same time utterly enchanting—witness the dancing of a little girl. The description seems to me an apt one for Mozart's performance in this little work. It was composed only a couple of months after *La Finta semplice*, but it was not written to impress the Court. Rather, it was commissioned by Dr. Mesmer (the same who later became famous as a hypnotist) for performance in his own little theatre; it was not a three-act piece with a large cast of principals, each of whom had to have his own arias, but a one-act affair with only three characters. The plot is simple to the point of

childishness, the characters naïve country folk, and the language the twelve-year-old composer's native tongue. The awkwardness resides in a certain lack of variety in mood and pace—most of the sixteen numbers are in a moderate two-four or three-four meter. But within this limited sphere the boy writes some charming melodies. Many of them, as was to be the case whenever Mozart set German texts, have a folklike flavor. The most elaborate number for Colas, a distant and bucolic ancestor of Don Alfonso, the wise old philosopher of *Così fan tutte*, is one in which he pretends to be casting a magic spell; here Mozart mockingly imitates some of the gestures of the big *opera seria*. All in all, the music has more character than does that of *La Finta semplice*.

The Decca performance is delightful. Rita Streich is an ideal Bastienne, and her colleagues second her ably. In the Cetra version, which is sung in Italian, three numbers are omitted, another is cut, the soprano is not in the same league with Streich, and by a strange error Bastien and Bastienne sing a whole aria (No. 13) in unison when they are supposed to alternate; moreover there is some distortion in the sound towards the end of the disc, and no libretto is supplied. Nevertheless, this version is not without virtues, notably a tender and serious approach, a rather strong tenor, and a more dramatic rendition of Colas' conjuring aria. —Rita Streich (s), Bastienne; Richard Holm (t), Bastien; Toni Blankenheim (bs), Colas. Munich Chamber Orchestra, Christoph Stepp, cond. Decca DL 9860, LP.

—Gianna Galli (s), Bastienne; Amilcare Blaffard (t), Bastien; Otello Borgonovo (bs), Colas. Orchestra Sinfonica di Torino della Radiotelevisione Italiana, Arturo Basile, cond. Cetra 1263, LP.

Idomeneo, K. 366

Idomeneo is often dismissed as an opera whose twenty-five-year-old composer merely followed closely the footsteps of Gluck—a type of work obsolescent in Mozart's time. It is true that the libretto is that of an old-fashioned *opera seria*, with a subject from Greek legend, stereotyped characters, and a creaking plot—the kind of libretto that Mozart never touched again until, in the last year of his life, he had to set *La Clemenza di Tito*. It is also true that this opera more than any other of Mozart's does show the influence of Gluck: in the importance given to the chorus, in the unusually numerous accompanied recitatives. But the music lover who is persuaded by such facts to ignore *Idomeneo* will miss some remarkable music. An opera that boasts several powerful and moving choruses, at least two arias of exquisite beauty (Ilia's "*Se il padre perdei*" and "*Zeffiretti lusinghieri*"), and a great quartet, as well as the aforementioned accompanied recitatives, many of which are extraordinarily trenchant and expressive—an opera

like that does not, it seems to me, belong permanently on the shelf.

The single recorded performance is in most respects excellent. Sena Jurinac as Ilia is in fine form: her voice is extremely attractive, tender or heroic according to the occasion, and with good round top tones. Léopold Simoneau as Idamante is his usual dependable self, providing skillful, solid singing of flexibility and pleasing quality. Elettra's big, dramatic arias are sung with power and sweep by Lucille Udovick; in her more lyric music the slightly metallic quality evident when she sings *forte* disappears. The singing of Richard Lewis as Idomeneo is musicianly but not as firmly supported or as accurate in intonation as it might be; there seems to be more taste here than technique. The conductor, John Pritchard, is constantly alert for both musical and dramatic values, and his orchestra plays with considerable nuance. Balances and sound in general are good. The work is considerably, but by no means fatally, cut: only one aria is omitted but many are shortened.

—Sena Jurinac (s), Ilia; Lucille Udovick (s), Elettra; Richard Lewis (t), Idomeneo; Léopold Simoneau (t), Idamante. Glyndebourne Festival Chorus and Orchestra, John Pritchard, cond. Angel 3574, three LP.

Die Entführung aus dem Serail, K. 384

Here there is no clear-cut superiority of one album above the others. All three are strong in some respects and weak in others, but none of the three is poor. On balance, I should think that the Beecham set for Angel might come out ahead by a few points. There is first of all Sir Thomas himself, who is for the most part in excellent form here. His slow tempos tend to be a little more deliberate than those of the other conductors considered here and this, coupled with his usual care in phrasing, results in a deepening of the emotional quality of the sections in question. Despite the fact that this opera is a romp, certain portions of the text must have stirred Mozart deeply. The accompanied recitative preceding the duet of Belmonte and Constanze, for example, is one of those portions: the situation, in which the two lovers resign themselves to imminent and certain death, evoked music of extraordinary expressiveness, even for Mozart. Beecham gives such passages their full value. On the other hand, he does a few things that are difficult to justify, such as adding accents in Blonde's "*Welche Wonne*," or slowing up now and then in Osmin's "*Ilia! wie will ich triumphieren*," or shifting "*Murtern aller Arten*" from the second act to the third.

Simoneau, the Belmonte, is another asset of this performance. He sings with smooth and well-focused tone, and with nuance. One of the finest things in the set is his ecstatic "*O wie ängstlich*." The Pedrillo, too, Gerhard Unger, is

Continued on page 125

Having Wonderful Time

The past summer saw an impressive portion of London Records' array of musical and technical talent gathered in Vienna (naturally) for the taping of a new Die Fledermaus. Besides getting the job done, everyone involved had a ball—as the photos here clearly show.



The bubble blower on the left is a London engineer, impersonating an obstreperous Viennese coffee-making machine. The lady with pencil and script is Regina Resnik (Orlofsky), in search of a Russian mood, while to the right is Andre Mattoni, chief assistant to conductor Von Karajan, preparing to deliver a line in the last act. At bottom, pre-recorded prison noises prove too much for Erich Kunz (Frosch), to the delight of Eberhard Waechter (Frank).



At the left is Herbert von Karajan, caught during a pause in recording the second act. The lighthearted couple below are Walter Berry (Falke) and Erika Köth (Adele), enjoying a minor rehearsal mishap involving Kunz and an exploding beer glass. A large noise, but no casualties reported.

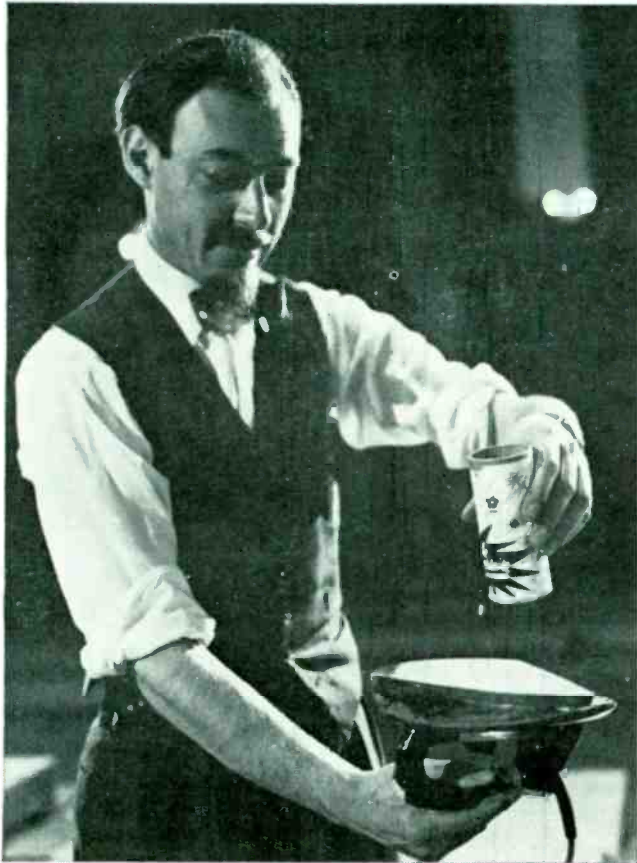
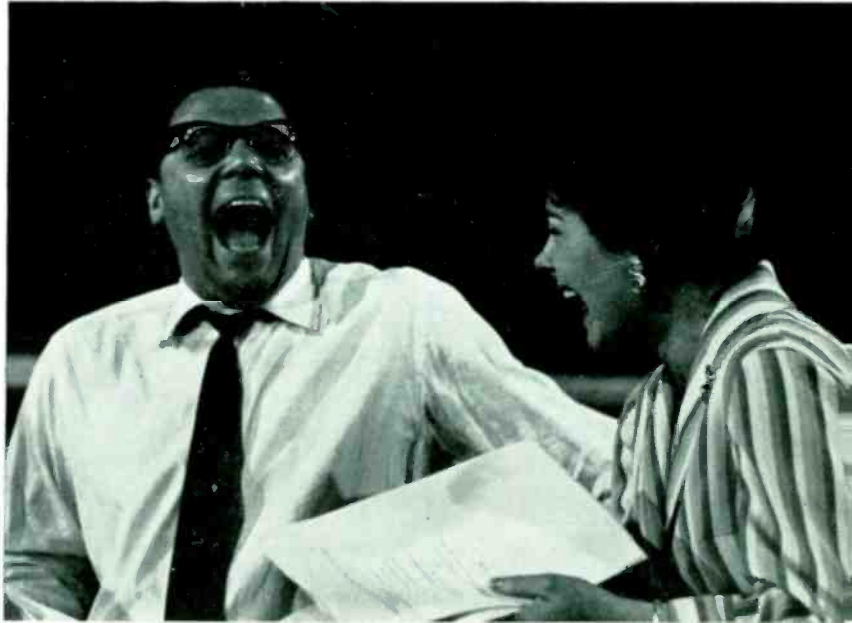

The goateed man with can and iron is London's Christopher Raeburn, producing hissing steam for that troublesome coffeemaker. Above is T. A. McEwen (r), Manager of London's Classical Division, on a busman's holiday, matching high C's with tenor Giuseppe Zanpieri (Alfred).



BY CHARLES FOWLER

A MIKE

OR TWO

AROUND THE HOUSE

Microphones courtesy of Dynaco, Inc.

Wherein is a reason or two to own microphones — together with expert, detailed guidance on what kinds to get for your particular purposes.

DO YOU NEED a microphone?

Before you hastily answer, "Of course not, I don't even have a tape recorder," think of some of the many things you could do with a mike. If you did have one, you could use it for. . . .

Well, how about getting the neighbor's dog under control at midnight, without getting out of bed? Simply roll over, speak gently into the microphone, using whatever well-chosen epithets you think appropriate, and the sound, issuing from your patio speaker, will shatter the stillness of the night as well as some of your neighbor's windows and cause his animal to pause—at least momentarily. For that matter, you could call your own dog, without getting up from the easy chair. (The fact that he is already in, asleep on the living-room rug, does not affect the validity of this application.) You could also rig up a microphone near the bird's nest outside the kitchen window, to hear the little ones chirping. Or if you have your own little ones, put the microphone in the nursery.

Naturally, owning a tape recorder makes having a microphone more logical. In fact, it is difficult to buy a nonprofessional tape recorder *without* getting a microphone. The question then becomes: should you buy another microphone? Unless your recorder is used only for the most rudimentary live recording, the answer should almost certainly be yes. You can get noticeably better results by using a microphone designed to make full use of the capabilities of your recorder and at the same time to handle the type of recording work in which you are most interested.

Let's start a discussion of microphones and of which ones to use for what purposes with a review of tape recorders, since this is part of the problem.

Tape recorders can be divided into three and a half categories. Category No. 1 is professional equipment. It is easy to identify because it costs a young fortune, probably operates at 15 inches per second as well as $7\frac{1}{2}$ ips, and can accept the big $10\frac{1}{2}$ -inch NAB reels holding 2,400 feet or more of tape. Category No. 2 is the semi-professional group. Such equipment costs between \$300 and \$1,000 (for stereo models). Most operate at $7\frac{1}{2}$ ips; some at this speed plus a second one, either slower or faster. Most accept nothing larger than 7-inch reels. The familiar Ampex 600 series is typical. Recorders in category No. 3 can be identified by the fact that they include in the case a loudspeaker (or two, sometimes, though usually the second speaker required for stereo is at least in a separable part of the case). Naturally, there are amplification components in the package to drive the speakers. The half category sits between No. 2 and No. 3 and consists of tape decks (transport mechanisms with or without electronic accessories) designed specifically for use in conjunction with component high-fidelity systems.

As is the case with all attempts at neat classification, there are exceptions. Never mind; we are setting up



This Shure microphone is a typical ribbon-type strongly directional. Medium price.



This dynamic type, also from Shure Brothers, has a cardioid-shaped polar response.



Altec's dynamic microphone is omnidirectional and has good frequency response.



Professional in quality, Altec's "Lipstick" is very small and unobtrusive. High price.

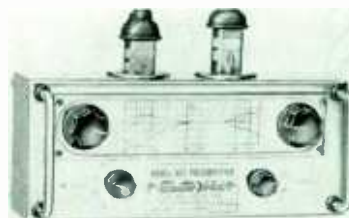

This Electro-Voice preamp is used with 50-ohm dynamic microphones. It adjusts output, bass, and treble, is battery operated.

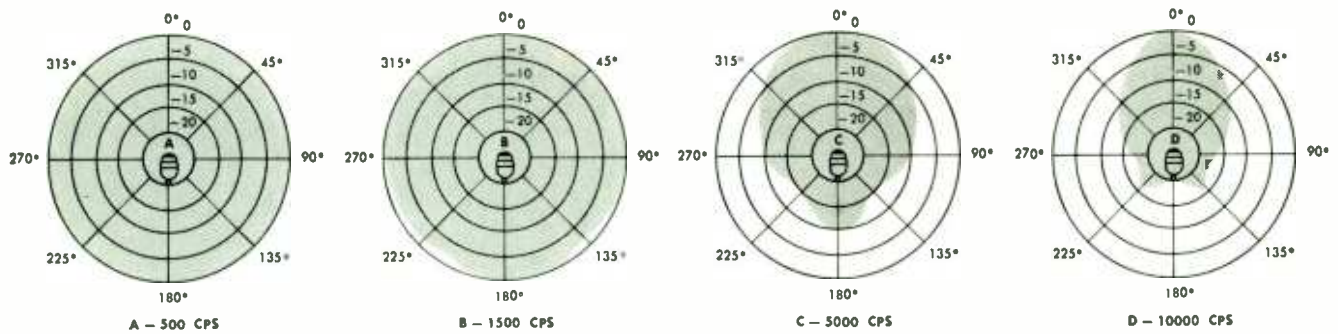

Microphone sensitivity varies with frequency range and direction of sound related to front of microphone.

general categories only relative to microphone selection.

The microphone characteristic of these different categories is impedance. Units in the first category use low impedance microphones. Units in category No. 3, almost without exception, use high impedance microphones. The other categories are mixed.

Impedance? For the purposes of this article, it will suffice to say that impedance is the resistance a device offers to the flow of alternating electric current, which is what sound becomes when it strikes, and actuates, a microphone diaphragm. That's what a microphone is, basically—a diaphragm, or something similar to it, which moves when sound strikes it. The motion is converted to alternating electric current.

Classifying mikes according to their electrical characteristics would divide them into low and high impedance units. The practical application of this specification is simply this: a high impedance microphone cannot be used with a long wire connecting it to a tape recorder. A low impedance model can. The length of the connecting cable upsets high frequency response. Too long a cable cuts highs. To give a specific example: according to data in a booklet about microphones from Electro-Voice, it takes 920 feet of connecting cable, between mike and tape recorder or preamp input, to cause a loss of one decibel at 10,000 cycles with a microphone having an impedance of 50 ohms. With a microphone having an impedance of 250 ohms, the same loss results with a cable 190 feet long. Both of these mikes are considered low impedance units. With a high impedance mike, as little as ten feet of cable could cause this much loss. Therefore, if you intend to use the microphone more than ten to twenty feet from its tape recorder (or an electronic connection of some sort), a low impedance model must be used, unless you are willing to sacrifice some fidelity.

Yet the tape recorders that most people are likely to have fall into category No. 3, which we said are designed almost without exception for high impedance microphones. Why? In a nutshell: because of cost. In a moment, we'll classify microphones in another way, by types, and we'll find that most of the inexpensive ones have high impedances. Most of the expensive ones are

low impedance; that's just a characteristic resulting from their design.

Another characteristic of inexpensive, high impedance mikes is that they put out a lot of electricity. This is an advantage in several ways. It makes them more sensitive to sound. They are less troubled by hum and noise in the wires and electronic circuitry. And since they do have a high electricity output, the design and construction of the tape recorders with which they are to be used can be simplified.

High impedance microphones are also apt to have less adequate frequency response than those with low impedance. There is no direct relation between response and impedance insofar as design is concerned; it just happens that way. It is possible for a high impedance mike to have wide frequency response, but it's not usual.

Professionals use low impedance microphones because they can then use long connecting wires, which—among other advantages—lessen the danger of the mike's picking up noise from the tape recorder itself. And, by coincidence, the designs that produce good frequency response operate at low impedance. Some types have such a low impedance that it has to be raised by electronic means to the desired 50 to 250 ohms.

Some microphones, by the way, can operate at both high and low impedance. A switch on the mike provides this selection.

If you have a recorder of the high impedance type and want to use a low impedance microphone, the answer is a matching transformer. Transformers can be inexpensive, with moderately good fidelity, or expensive and provide fine fidelity. The prices range from \$3.00 to about \$30. This is another reason why manufacturers of recorders in category No. 3 avoid low impedance arrangements; they would have to supply the transformer.

Yet they should, really. Time was, a few years ago, when the average home tape recorder in this class had such poor frequency response that using a better microphone wouldn't make any significant difference. Today, recorders in this group have improved remarkably, and a good mike is well worth the investment in improved sound.

The different types of microphones—dynamic, ribbon, capacity, etc.—and their relevant characteristics can be set forth in tabular form. So doing lets us consider another and much more important aspect of microphonedom: directional characteristics. This is not related to impedance, and not much related to type. It's related to design.

You'd think, to listen to them, that loudspeakers spewed sound out in all directions. This is not true; most are directional and noticeably so, if you listen carefully. It is particularly true of the high frequencies; directionality increases with frequency. Precisely the same is true of microphones. Depending on design, they pick up sounds not from all directions equally but according to a pattern that is carefully plotted by their manufacturers and is available as a published specification.

The drawings shown here are of the polar response, as it's called, of a microphone classified by its manufacturer as omnidirectional. This mike picks up about equally well from all directions a sound having a frequency of 500 cycles. It still does well at 1,500 cycles, but at 5,000 cycles it is far from omnidirectional and at 10,000 cycles it has become decidedly directional. The charts, by the way, are copied from the published specifications for this microphone, which indicate a commendable degree of honesty on the part of the manufacturer.

Directional characteristics of a microphone are important to the recording enthusiast. It is a rare micro-

phone indeed that is truly omnidirectional at all frequencies. The very fact that the diaphragm has to be enclosed in some kind of case precludes true all-frequency omnidirectionality; the case interferes. And actually, although omnidirectionality may sound like a real achievement and therefore highly desirable, it is more often than not a hindrance to good recording. It takes a high degree of skill, and good acoustic surroundings, to make successful recordings with an omnidirectional mike. Why? Because such a mike picks up the reverberation (and also the noise) of a room as well as the desired sound. To position such a microphone properly, one should start near the musicians (or vocalists, or whatever) and move away slowly until exactly the right balance between direct sound and reverberation or reflected sound is achieved.

It might be well to add here that many microphones have a presence peak in their response—that is, they catch the middle highs better than the rest of the frequencies. In many cases, this is deliberate. Remember that the reverberation characteristics of a room emphasize low frequency sounds and speed the decay of high frequency sounds. Thus, for recording purposes, most rooms tend to be dull, and a presence peak produces results more pleasing to many people. In an acoustically correct recording studio, on the other hand, such a peak in a microphone would be intolerable.

Almost any degree of directionality is available. Microphones that are quite strongly *Continued on page 148*

MICROPHONE CHARACTERISTICS

TYPE	FIDELITY	POLAR PATTERN	IMPEDANCE	OUTPUT	COST	REMARKS	
						PRO	CON
CARBON	Poor	Omni	Very High	High	Low	High output Rugged	High noise level Poor fidelity Requires power supply
CRYSTAL	Generally Poor	Omni	High	High	Low	High output	Sensitive to temperature and to humidity
CERAMIC	Fair to Good	Omni	High	High	Low	Not affected by temperature and humidity	High impedance Mediocre fidelity
DYNAMIC	Good to Excellent	Normally Omni (1)	Normally Low (2)	Low	Moderate to High	Available with both low and high impedance Wide range of price and performance Rugged	Good fidelity expensive
RIBBON (velocity)	Excellent	Figure 8 (3)	Low	Low	High	Excellent fidelity	Delicate Sensitive to wind
CONDENSER (capacitor)	Excellent	Omni	Low (4)	High (4)	High	Excellent fidelity	Cost Preamp required

NOTES: all classifications, remarks and specifications above are "in general"; exceptions can be found in everything.

(1) Directionality can be controlled by structure of housing.

(2) Dynamics normally have low (i.e., 50 to 150 ohms) impedance but many are available with effectively high impedance through use of built-in transformer.

(3) Sometimes more or less mono-directional.

(4) Condenser mikes require power supply and preamp; output of preamp is normally of low impedance and high level.

*The consumer's guide
to new and important
high-fidelity equipment*

high fidelity

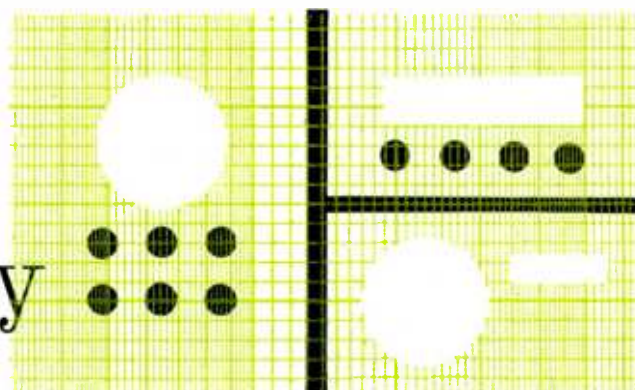

EQUIPMENT REPORTS

AT A GLANCE: The Grado Laboratory Series tone arm is designed for balance in both vertical and lateral planes. It has a quickly removable cartridge holder, and no soldering is required in the installation of either the arm or cartridge.

Tracking error and bearing friction are low. The grounding system of the arm is carefully designed to minimize any hum pickup. Made of walnut and aluminum, the arm is both attractive and easy to handle. This tone arm is available in three versions: (a) as a universal tone arm, \$39.50; (b) with a matched custom cartridge, \$69.50; (c) with a matched master cartridge, \$85.

IN DETAIL: Although the Grado Lab. Series tone arm bears certain superficial resemblances to the standard Grado arm in its materials and bearing designs, it differs from the standard model in many important respects.

The arm itself is slendrer than the original Grado, and the pivots are supported by a sturdy aluminum extrusion. The lateral pivot is a steel rod with a sharp point which bears on a hardened insert in the base. The vertical pivots engage the arm near its lower edge, thus placing them nearly in the plane of the stylus and record. This pivot position is desirable in reducing wow from warped records.

There is relatively little overhang in the rear of the arm. This, in itself, has no effect on the arm's performance, but it does make for a more compact and generally easier-to-use design. A sliding counterweight balances the mass of the cartridge. It is fitted with several removable weights so that it can always be used without requiring excessive overhang, regardless of the weight of the cartridge.

A unique feature of this arm is its lateral balance weight, which slides on a rod fastened to the extrusion containing the pivots. The weight does not move vertically, but follows the lateral motion of the arm. When the vertical component of the cartridge's own weight has been counterbalanced, the lateral component is eliminated with the sliding weight of the arm. Then, with the arm fully balanced, it remains stable no matter in which way the turntable is tilted. All the downward tracking force is from a multi-turn coil spring in the arm, which is pressed down by an adjustment screw on the pivot housing.

The cartridge fits onto a plastic "carriage" or mounting plate. This carriage, in turn, is fitted to the arm and held in place by a knurled nut on the top of the arm. The four wires are presoldered in place and fitted with sleeve-type clips which mate with the pins on Grado cartridges (and on many other types as well). Thus no soldering is needed for the cartridge installation. At the end of the plastic cartridge mount are flexible fingers with contacts at their ends. When the cartridge is screwed into the arm, these fingers make electrical contact with corresponding points in the body of the arm. The cartridge then can be slid along the length of the carriage until its stylus lines up with reference marks on the side of the plastic carriage. At this point, assuming the arm is correctly installed, correct overhang will be assured and the tracking angle error will be a minimum, regardless of the cartridge type.

The four-conductor shielded cable in the Grado arm is unusual for its lightness and flexibility. It is composed for four strands of very fine enameled solid wire, woven

Grado Laboratory Series

Tone Arm



with a light metallic braid. The entire cable is not more than $\frac{1}{32}$ in. in diameter. No cloth or insulation other than the coating on the wires is used. This wire can be dressed in a loop and offers very low resistance to the motion of the arm.

The arm base mounts in a single $\frac{1}{4}$ -in. diameter hole. The rubber disc which supports the base is slightly thicker on one side than on the other, so it can be rotated to tilt the arm one way or the other until the stylus is exactly perpendicular to the record surface, when viewed from the end of the arm.

An interesting feature is the steel arm rest. Cemented to the bottom of the arm is a small ceramic magnet, which is attracted to the rest when the arm is placed in it. This seats the arm firmly when it is not in use.

The Grado Lab. Series arm comes with a pair of shielded phono cables with molded-on plugs for ready connecting to preamp input jacks. At the "turntable end," they come preconnected to a terminal strip with five screw-type terminals. Four screws are for the signal leads coming from the arm, and the fifth is for grounding the shield around those leads. This shield is pregrounded to the cartridge case, and to all metal portions of the arm, such as the finger lift, thus insuring against any increase in hum when the arm is handled.

The four leads from the arm are simply inserted under the screw heads on the terminal strip and the screws tightened. The ground lead goes to the fifth screw. Again, no soldering is needed.

We found the Grado arm quite easy to install. Only three $\frac{1}{4}$ -in. holes (one for the shielded cable) are needed. The arm comes with a simple though accurate lever-type stylus force gauge, which uses pennies as counterweights. The entire installation can be completed in a few minutes.

The handling ease of the Grado arm makes it a pleasure to use. Needless to say, no drag or friction can be felt. The listening quality is as good as the cartridge will allow, and it is evident that the arm has a minimum of effect on cartridge performance, which is as it should be. We did notice—happily—a pronounced reduction in the degree of acoustic feedback at high volume levels in our system (a chronic trouble) when using the new Lab. Series arm. It seems likely that the excellent balance of the arm reduces its susceptibility to motor board vibrations from the speaker system.

Some care is needed in inserting the cartridge holder to insure that all the fingers are making contact. Unnecessary removal of the cartridge is to be avoided, we suspect, to minimize the likelihood of a poor contact.

The tracking error was zero at 6 in. and a $2\frac{1}{4}$ -in. radius, and reached a maximum of $2\frac{1}{2}$ degrees at a 3- to 4-in. radius. This is quite satisfactory, particularly with the error approaching zero towards the inner grooves of a record, where the effects of tracking error are most serious.

H. H. LABS.

AT A GLANCE: The Quad is a full-range electrostatic loudspeaker, covering from slightly below 50 cps to well above the limits of audibility. Having no heavy cone or voice coil, it possesses very low mass and correspondingly fine transient response. The price is \$300.

The Quad has several limitations of a technical, aesthetic, and economic nature that may limit its general acceptance. In our opinion, however, it represents, by a wide margin, the closest approach to truly natural reproduction of sound in the home that we have yet heard.

IN DETAIL: An electrostatic speaker differs from the usual dynamic speaker by not using a voice coil in a magnetic field to move a paper cone. Instead, a very thin plastic film, with a conducting metallic coating, is located near a grid of parallel wires or mesh. The two electrodes form the plates of a capacitor. When an electric charge is put on a capacitor, a force is developed which tends to move the two electrodes together. In the simplified case being described, a steady DC polarizing voltage can be used to establish an initial condition in which the flexible film is drawn partially towards the

Quad Electrostatic Loudspeaker

Equipment tested by HIGH FIDELITY is taken directly from dealers' shelves. We report only on regular production-line models. The choice of equipment to be tested rests with HIGH FIDELITY'S editorial department. Most equipment reports appearing here are prepared for us by Hirsch-Houck Laboratories, a completely independent organization whose staff was responsible for the original Audio League Reports. A few reports are prepared by members of the HIGH FIDELITY staff or by other independent testing organizations working under the general supervision of Hirsch-Houck Laboratories. All reports are signed.

REPORT POLICY

open grid. If an AC signal is superimposed on the DC, the film will alternately move toward and away from the stationary electrode. The displacement of the air by the moving film produces the sound which we hear.

In order to obtain low distortion at large signal amplitudes, all good quality electrostatic speakers are of the push-pull type. The reasons for this, as well as the various construction techniques, are beyond the scope of this report.

To obtain a sufficiently strong electrostatic field, the electrode spacing must be small. This precludes large excursions of the radiating membrane, and in fact the physical properties of the materials of which these membranes are constructed do not permit large excursions. For this reason, most electrostatic speakers are tweeters, confining their response to frequencies above 1,000 cps, since only very small amplitudes are required from a reasonably sized membrane at these frequencies.

The British-made Quad has extended its frequency range downward by employing a large radiating area. It is 34 in. x 28 in., and practically all of this area is involved in radiating sound. At the higher frequencies, the radiation is from a narrow vertical strip in the center of the speaker, to minimize directional effects.

The electrode spacing is also greater than is customary in tweeters, and a much higher polarizing voltage is used. The result is a frequency response extending to below 50 cps with reasonably low distortion. The efficiency of the Quad is somewhat higher than that of some of the better American electrostatic tweeters, and the manufacturer recommends using a good quality 15-watt amplifier (such as the Quad amplifier). It is worth mentioning that this is one speaker which probably should not be used with a very high-powered amplifier, since the speaker has a definite upper voltage limitation making powers in excess of 30 watts inadvisable, even momentarily.

The surface of the Quad is slightly curved outward (towards the listener), for better projection in the listening area. It is mounted on three short legs. The high voltage power supply is built in, as is a matching transformer designed to be driven from the 16-ohm output of the amplifier.

Unlike other types of speakers, the Quad should not be installed closer than two feet to a wall, or three feet to a corner. The bass performance is degraded by such improper positioning. As may be imagined, this large and uniquely designed speaker assumes considerable prominence when it is standing in the clear, undisguised as a piece of furniture or anything else but what it is—a radiator of sound. For this reason, those interested in décor more than fine sound may regard it as not readily adaptable to the usual living room. In stereo pairs this visual problem may be further accentuated.

The instruction booklet accompanying the Quad is quite specific in limiting its application to rooms of less than 5,000 cubic feet. Our experience suggests that it will perform to best advantage in rooms considerably smaller than that, and in fact will do a fine job in a room too small to accommodate any conventional speaker. Unlike cone radiators, the electrostatic speaker is literally a window opening on the concert hall, and one can listen to it in comfort at a two-foot distance as well as at twenty feet or more.

In using a Quad some modification of listening habits will probably be necessary for people accustomed to conventional speakers. This speaker should not, and cannot, be subjected to the room-shattering levels beloved by some audiophiles. To do so is to invite breakup and distortion well below the level where the windows rattle. The Quad should be listened to at *natural* levels. When it is heard somewhat above normal level, the effect is that of being transported towards the orchestra; softer levels move the listener to the rear of the auditorium. This effect is very real, and we have not experienced it to anything like this degree in conventional speaker systems.

The Quad sounds quite different from any other speaker we have heard. It is crisp and taut at all frequencies, including the middles and bass. There is not a trace of the boom or boxiness present to some degree in most conventional speakers. The separation of instruments in the orchestra, even in monophonic reproduction, is strikingly superior to anything we have previously heard. Any doubts as to its bass performance were dispelled when records having large bass drum sounds were played. A comparison against the best cone speakers we could muster showed that the cone speakers had much more apparent bass below 50 cps. A thump from the bass drum shook the room in a most satisfying manner. Switching to the Quad eliminated the strong, room-filled bass which we had come to equate with the best in high-fidelity sound. The drum sounded just like a large bass drum—no more, and no less. The absence of bass hang-over and excitation of room resonances probably had a lot to do with this naturalness. Others who heard our Quad were equally impressed in its favor.

Having established by listening that this was a superior speaker we were curious to see what our measurements would show. Frequency response, taken out-of-doors, follows the contour of our microphone calibration rather closely. A line drawn through



ON OFF ON OFF

Tone burst at 2.85 kc.

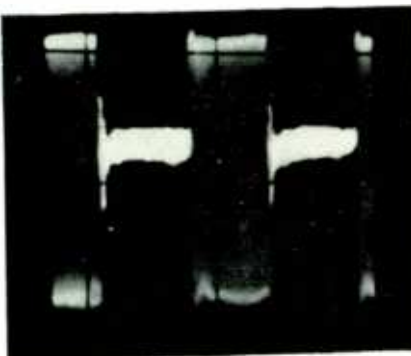

ON OFF ON OFF

Tone burst at 5 kc.

the centers of the many small peaks and dips in the response lies within 5 db of the microphone response from 60 to 15,000 cps. More important is the absence of any of the huge holes or peaks often found on lesser speakers. The low frequency radiation shows a slow, smooth decline starting at a few hundred cycles, but without the sudden change of slope characteristic of box speakers having a system resonance.

Bass frequency distortion is not outstandingly low between 50 and 80 cps, and rises sharply below 50 cps, which we consider to be the effective lower limit of the speaker's response. At moderate levels and with some increase in distortion, a useful output can be obtained at 45 cps. Obviously, this speaker will not reproduce the lower pedal notes of the pipe organ as well as some conventional systems may, but this is probably the only type of music with which it shows any limitation. On bass transients, such as those produced by drums or keyboard instruments, the loss of extremely low frequencies is more than compensated for by the lack of resonance and hangover.

The polar response (not plotted) is a smooth cardioid pattern, down about 10 db at 45 degrees off center axis. The Quad booklet shows a 70-degree effective angle in the horizontal plane, and our measurements confirm this. We measured it at 7 kc, but polar response of the Quad changes relatively little with frequency. This no doubt also contributes to its listening quality.

Tone burst patterns revealed one frequency at which ringing occurred (2.85 kc). At all other frequencies, however, the tone burst pictures were virtually ideal, resembling the 5-kc burst shown.

The Quad should be listened to carefully, and preferably in one's own home, before buying. Don't be surprised if the result is a feeling of dissatisfaction with your present speaker system.

H. H. LABS.

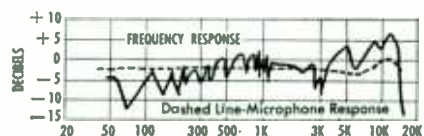

AT A GLANCE: The Knight-Kit 83 YU 777 is a dual 30-watt stereo power amplifier of remarkably high quality. It is sold in kit form, with two printed boards containing most of the components. The chassis is handsomely chromed, and a metal dust cover is available. Distortion and hum level of this amplifier are extremely low, combined with very high gain and power output. It is conservatively rated in all respects. Price, without cover, is \$84.50; metal cover is \$6.50.

IN DETAIL: Although the amplifier sections are on two printed boards, the kit builder must mount all components to the boards and then solder. In our opinion, construction of this amplifier is not a project for a novice, unless he is adept at soldering. Careless soldering on a printed board can cause more trouble than in conventionally wired circuits.

Each amplifying channel has a pair of EL37 output tubes, rated at 30 watts output in the tapped-screen output configuration used. Each tube has a jack in its cathode circuit for balancing the currents with an external milliammeter. Each amplifier has its own level control, a feature particularly desirable in view of their rather high gain. About 0.5 volts — less than many preamplifiers normally deliver — will drive them to full output.

A number of "deposited carbon" resistors are used in the low level circuits, in the interests of low noise through these stages. Precision 1% resistors are also provided for accurate circuit values in the phase inverter and feedback stages. A common power transformer is used for both channels, but the filter resistors and capacitors are entirely separate. This thoroughly decouples the two amplifiers from each other. A pair of slow-heating GZ-34 rectifiers are used, eliminating warm-up surges on the components.

The two channels may be paralleled for mono operation by a switch on the chassis. The output terminals are strapped together in this mode of operation. A very effective means is provided for exactly matching the gains of the two channels when they are operated this way, an important detail not always found in dual power amplifiers. One channel of the Knight-Kit amplifier is designed with slightly higher gain than the other. To balance them, you temporarily connect a speaker between the two amplifier outputs and press a test button. This injects a 120-cps signal into both channels. The gain of the more sensitive amplifier then is reduced until the level of the buzz is at a minimum. This indicates that the two gains are matched. The outputs may now be paralleled.

The performance of the Knight-Kit amplifier proved to be a pleasant surprise. Although it is rated at 30 watts per channel or 60 watts for both, we found IM distortion to be only 0.3% at 45 watts from one channel and 0.35% at 90 watts from both chan-

Allied Knight-Kit

60-Watt Stereo Amplifier



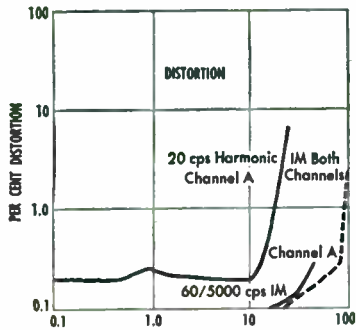

nels. At 2% IM (the usual point for rating maximum power) the output was over 100 watts. At any listening level distortion was unmeasurable. The 20-cps harmonic distortion was only 0.2% up to 10 watts, and reached 1% at about 20 watts. The IHFM power bandwidth rating of this amplifier is 20 to 20,000 cps at 15 watts and 1% distortion (per channel).

Hum and noise were 85 to 90 db below 10 watts output in each channel, which is far too low to hear and difficult to measure. The amplifier was stable with capacitive loads of less than 0.15 mfd, which suggests its suitability for use with some electrostatic speakers. Frequency response was as flat as one expects a basic power amplifier to be, down less than 1 db at 20 and 20,000 cps.

In listening tests, each channel of the Knight-Kit amplifier was as clean-sounding as it measured, and had sufficient power to drive any speaker system. Our few criticisms of this amplifier are directed at some design details in the metering and balancing circuits. Plugging a meter into one jack, then another, and then repeating this procedure several times while adjusting the balance control proved a cumbersome process. Actually, there is no means to adjust the absolute operating currents through each of the output tubes and therefore no need to measure them. What *is* measured here is the relative balance of the output tubes. While the amplifier will perform quite satisfactorily with slight unbalance at this stage, careful balancing is essential to obtaining the extremely low distortion levels measured in our tests; and the prescribed balancing procedure does permit the user to achieve this balance. The meter jacks themselves were fragile, and liable to crack on installation. Finally, the manual correctly cautions against inserting a plug into a jack unless a meter is connected to the other end of the plug. The reason for this caution is to avoid opening the output circuit which could place a sudden overload on the output tubes. Yet the same thing can happen, if only for an instant, even when the plug is inserted correctly. And if the plug fails, possibly after long periods of use, the open circuit and resultant overload could conceivably damage an output tube.

In any case, the need for a better designed jack is, in itself, no major fault. The overall features and performance of this amplifier left us very favorably impressed.

H. H. LABS

Ampex 970 Stereo

Tape Recorder

AT A GLANCE: The Ampex 970 is a complete portable tape recorder with built-in stereo monitoring speakers. It has separate record and playback amplifiers and heads, and therefore can be used to monitor programs as they are being recorded. Equipped with both 7.5-ips and 3.75-ips tape speeds, and both half-track and quarter-track playback heads, the Ampex 970 offers high flexibility and good performance. Weight is 43 lb., price \$750.

The Ampex 960 is similar to the 970, except for the omission of playback power amplifiers and speakers.

IN DETAIL: Although many preamplifiers have provision for monitoring a signal from the tape recorder output while the recording is being made, the Ampex 970 is one of the surprisingly few machines designed for home use which have the three heads and separate record and playback preamplifiers necessary for this type of operation.

In addition, there are separate sets of recording level controls for the radio (high level) inputs and for the microphone inputs. The two inputs are mixed, which allows for still more flexibility in combining several inputs. A variety of special effects may be produced by re-recording the output of one track, delayed by the time difference between the record and playback heads, onto the other track. This procedure can provide an echo chamber effect of almost any desired degree. Other special types of recordings include sound-on-sound (adding to an already recorded tape without erasing it), and language or music instruction tapes, where the instructor is recorded on one track and the student on the other.

The playback preamplifiers have their own level controls. A control labeled (not very informatively) **SELECTOR** contains a pair of concentric switches that perform unrelated functions. The inner knob contains the **ON-OFF** power switch, and three positions marked **MONITOR**, **SINGLE**, and **STEREO**. In the **MONITOR** position, the incoming signal is fed to the built-in speakers for monitoring. In the **SINGLE** and **STEREO** positions the

speakers reproduce the outputs of the playback amplifiers, and the over-all operation of the recorder is changed from stereo to mono or vice versa. The outer knob switches the recording level meter (only one is provided) between the two channels, or to read the single recording level for mono recording. Although this seems a bit inconvenient, recording gains are normally set up at the beginning of a recording session and are not likely to be changed during recording, nor is the relative balance of left and right signals likely to change much once the proper conditions have been established.

A bar-handled switch places the tape in motion for either record or playback. A button, mounted flush with the surface of the recorder panel, must be depressed while the tape transport knob is actuated in order to make a recording. It is quite impossible to erase a tape unknowingly.

A second knob places the tape in either fast-forward or rewind. In any mode of operation, a stop button is used to bring the tape to a halt. All transport switches return to their off positions when the stop button is pressed. Although there is no tendency for over-run or tape spillage, the tape coasts to a stop rather slowly when a rewind or fast-forward operation is being completed. This makes it somewhat awkward to return to a previously logged spot without several "passes," since the tape usually overshoots or undershoots the mark.

A button between the reels is pulled out for 7.5 ips and pushed down for 3.75 ips. A small button protruding from the tape head cover shifts the heads for quarter-track operation. Tape spillage is prevented by a shut-off device which turns off the tape drive if there is no tension supplied by the take-up reel (a situation normally occurring when the tape has passed completely through the machine, but also resulting if the take-up reel is obstructed in any way).

Playback equalization and frequency response of the Ampex 970 were measured with an NCB Alignment Tape, recorded with the NARTB characteristic. Frequency response proved to be smooth from 50 to 10,000 cps, being slightly up at the low end and down at the high frequency end. Test tones were recorded and played back on the machine, at a level 20 db below the indicated maximum level on the meter. The combined record/playback response was within ± 2.5 db from 25 to 12,500 cps at 7.5-ips tape speed, and 25 to 3,500 cps at a 3.75-ips tape speed.

The signal-to-noise ratio, referred to the maximum indicated recording level, was 45 db (7.5 ips, half-track) and 40 db (3.75 ips, half-track). Quarter-track figures were 3 db less satisfactory in both cases. These measurements, though indicating satisfactory performance for home use, did not seem consistent with our listening appraisal of the recorder. A clue to the matter was the low audio output from the playback amplifiers when a "maximum level" signal was recorded—about 0.3 to 0.4 volts. Distortion measurements showed that harmonic distortion in the reproduced output, at 1,000 cps, reached 2% only at a level 10 db over the meter maximum value. Most home recorders are rated at the point where harmonic distortion reaches 2 or 3%. Using this as the basis for signal-to-noise ratio measurements, the values improve by 10 db, making them quite respectable.

Incidentally, a signal only 4 db over maximum will "peg the meter," so it appears that any recordings made within the range of recording meter indications will be very good from the standpoint of distortion. Distortion falls to a small fraction of a per cent at "on scale" recording levels.

Mechanically, the Ampex 970 is as good as it is electronically. Wow and flutter are 0.03% and 0.07% respectively at 7.5 ips. At 3.75 ips wow does not exceed 0.1%.

Worthy of mention is the unique "Stereograph" or slide-rule instructions for operating the recorder. Practically any type of recording or playback function is listed across the top of the slide rule. When the slide is moved to line up an arrow with the desired mode of operation, all the correct control settings are shown through windows on the rule. On the reverse side there is a larger window, which reveals hints on inter-connection and other aspects of the recorder's operation. Even though this gadget may at first seem more formidable than the recorder itself, it can be very useful.

As is generally the case with recorders having built-in playback power amplifiers and speakers, the quality of sound emanating from the monitor speakers cannot even remotely suggest the performance potential of the machine. Patently, these playback channels can prove a convenience for on-the-spot monitoring of recordings but the stereo effect from the speakers, facing sideways and spaced about 30", cannot compare with the sound possible from better speakers better spaced.

To summarize, the Ampex 970 is an outstandingly fine instrument in respect to distortion, signal-to-noise ratio, and tape speed constancy. Although its frequency response at 3.75 ips is so limited that we would question its value for playing four-track stereo tapes at that speed, at 7.5 ips its response is smooth and more than adequate for any high-fidelity needs. The slight loss in response above 10 kc is more than outweighed by the low end response, which holds up better than that of any other comparable recorder we have tested.

H. H. LABS.

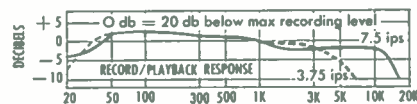



Rolls A.E.8-3b

Speaker System



Tone burst at 1.3 kc.

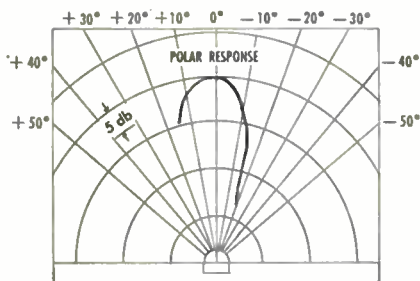

AT A GLANCE: The Rolls A.E.8-3b is a small integrated speaker system of the ducted-port bass reflex type. Although it can claim no new or advanced design features, its single 8-in. woofer and 3-in. cone tweeter produce a pleasingly balanced, musical sound which we believe superior to many competitively priced speaker systems and indeed to some systems costing over twice as much as the Rolls' modest \$89.

IN DETAIL: The Rolls speaker, though certainly compact, is not one of the so-called bookshelf types. It stands on four legs, with its top 24½ in. from the floor. It is 14½ in. wide and 12½ in. deep. The port opening is underneath the speaker cabinet.

Instead of opening directly from the interior of the enclosure, as in the ordinary bass reflex enclosure, the port of the Rolls is separated from the cabinet interior by a tube, or duct. This has the effect of lowering the cabinet resonant frequency, which accounts for the satisfactory low frequency performance of this small speaker with its conventional driver units.

The small dimensions of the cabinet prevent any low frequency resonances from developing within it, and the internal resonances occur in the 1,000- to 2,000-cps region. These are well damped with an internal lining of ½-in.-thick Fiberglas.

According to the manufacturer, the acoustic crossover from front radiation to port radiation occurs at 120 cps. The crossover to the tweeter is at 7,500 cps. The nominal speaker impedance is 8 ohms, and the power rating is 20 watts of program material.

The cabinet, incidentally, is covered with a wood-grain formica or similar veneer, in walnut, mahogany, blond, or maple finishes. It is said to be practically damage proof and is certainly very attractive.

Prior to performing any tests on the Rolls speaker, we spent many hours listening to it and comparing it to other speaker systems. From the beginning we were struck by the pleasing balance between highs and lows, and the freedom from unnatural coloration. The quality was good enough for the speaker to be used as half of a stereo pair with a three-way system employing a very good electrostatic tweeter, without requiring any tone control juggling and without degrading the sound significantly.

Our frequency response measurements, taken out-of-doors, do not show the Rolls to be unusually smooth or unusually rough. We would judge it to be about average, with variations of perhaps ± 6 db from 80 to 15,000 cps. Our high frequency response tests were not carried above 11 kc, but all indications are that response is maintained to at least 15 kc.

The low frequency harmonic distortion begins to climb below 80 cps, and we would consider 60 cps to be the lower usable limit of the Rolls speaker, allowing for normal bass reinforcement when used indoors.

The high frequencies are beamed quite sharply, as the 7-kc polar curve shows. This was one of the more sharply directional speakers we have tested.

A fairly clear clue to the good listening qualities of this speaker came in making tone burst measurements. These are a good qualitative indication of a speaker's transient response, and provide the best correlation we have found between a test measurement and the subjective qualities of a speaker. The middle frequencies are not particularly good in this respect, as the 1.3-kc tone burst picture shows. This is representative of the worst response we obtained in testing this speaker. On the other hand, at higher frequencies (such as 11.5 kc), the tone burst pictures are clean and free from hangover. In most of the region above 2 or 3 kc, this is the type of response obtained.

Certainly no one of these tests shows the Rolls speaker as being superior in any single aspect, but in the aggregate they suggest a unit better than average in this price range. Listening tests are even more flattering than any of the measurements, largely due, we believe, to better than average transient response, freedom from spurious responses, and a generally smooth over-all response.

H. H. LABS.

NEXT MONTH'S REPORTS

Sony Sterecorder 300 Tape Recorder

H. H. Scott 399 Stereo Tuner/Amplifier

Karg CT-2 FM Tuner . . . and others

Music Makers

by ROLAND GELATT

JUSSI BJOERLING left two major recordings in the "icebox" at the time of his death in September. One is the Verdi Requiem, recorded in Vienna this June, which RCA Victor has just issued. The other is *Madama Butterfly*, recorded in Rome in August 1959, which Capitol will release in January.

Two complete opera recordings were scheduled for Bjoerling's 1960 summer agenda, but neither got very far. One was a stereo remake of *La Bohème* with Victoria de los Angeles, for EMI-Capitol. Everyone concerned had agreed to this project in principle, but it bogged down in a mire of scheduling problems.

The other undertaking, *Un Ballo in maschera*, which Bjoerling was to have recorded for London Records, progressed further. The tenor arrived in Rome early in July along with the other members of the cast (Nilsson, Simionato, Stahlmann, and MacNeil), the conductor Georg Solti, and John Culshaw and his team of engineers. It has always been Solti's practice to require a sizable amount of preliminary piano rehearsal for his opera recordings, but Bjoerling did not want to go along with this method of working. He knew his role, he said, and would be prepared to sing in customary form when the tapes started rolling. Solti insisted. At length, an uneasy truce was arranged in which Bjoerling agreed to arrive half an hour before each session for a short piano rehearsal with the conductor.

The first session in which Bjoerling took part proceeded with reasonable smoothness. Observers are agreed that Solti went out of his way to be polite to the great tenor, and in this atmosphere of near-cordiality the Act I and Act II ensembles were taped. They proved to be the last recordings Bjoerling ever made. At his next session Bjoerling was asked to run through his Act I aria, "*La rivedrà nell'estasi*," during the preliminary rehearsal period. He refused—on the grounds that he knew this short aria as well as anyone present. Solti was adamant, feeling that the most familiar piece of music merited rehearsal.

In this clash of artistic temperaments (doubtless aggravated by Bjoerling's poor health), London Records had to choose between conductor and tenor. Bjoerling went home to Sweden the next day, the cast broke up (perhaps to be reassembled in 1961, with Bergonzi as tenor), and the rest of us are left to speculate about the recording that might have been. Bjoerling fans can console themselves with the news that Capitol intends to reissue most of his old (i.e., 1936-48) recordings of Swedish origin. A miscellany of opera arias will come out in January, to be followed shortly thereafter by an LP of songs and operetta excerpts.

LAST DECEMBER we reported on the operatic plans of Columbia Records' new artist-and-repertoire chief, Schuyler Chapin. Since then, no operas have been issued on the Columbia label, and when we met Mr. Chapin recently we asked him what had happened. The opera project, we were assured, is still very much on his mind.

"You see," he told us, "we thought we would approach the problem scientifically. We did considerable market re-

search to measure the potentialities of the opera album business. It lasted many months, and when it was completed we were back just about where we had started. We learned that the only sure sellers were the old standards. Occasionally something off the beaten track might hit the jackpot (as London's *Rheingold* did), but you couldn't count on it.

"Well, as I told you before, we're dead set against recording old standards just for the sake of loading the market with another *Aida*. But we also can't indulge our repertoire convictions to the point of losing a lot of money. In this business you've got to have your head in the clouds and your feet in the box office. At length we decided to go ahead and record the operas that made artistic sense to us, provided—and here's the sticker—that we can at least break even in the process."

The first item on Columbia's operatic agenda is Stravinsky's fairy tale opera *Le Rossignol*, to be recorded under the composer's direction in Washington, D. C., this month. Stravinsky has apparently made several significant changes in the score, which dates from 1909-13.

Next, if all goes well, comes *La Juive*, by Jacques Halévy, a mid-nineteenth-century French opera which had a considerable vogue at the Metropolitan and Chicago Civic Opera companies between the wars, but which has been almost totally neglected for twenty-five years. The role of Eléazar, in which Caruso and Martinelli did some of their most notable singing, will be taken by Richard Tucker; Eileen Farrell will follow in the footsteps of such potent predecessors as Rosa Raisa and Rosa Ponselle in the role of Rachel; and the conductor will be Leonard Bernstein, who has a particular affection for this opera.

But note the "if" clause above. The recording of *La Juive* hinges on holding down costs to manageable proportions. Schuyler Chapin is now in Europe investigating possible locales for the sessions. Provided it makes economic sense, work on *La Juive* will begin some time next spring.



The late Jussi Bjoerling.

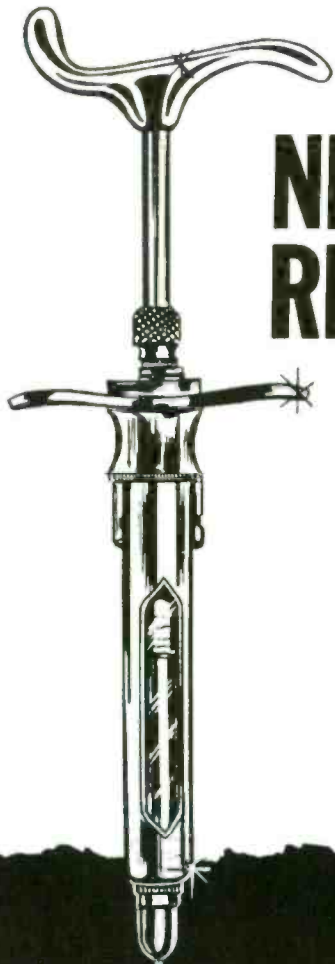

NEW **AF**[®] RELEASES

DFM3002
DFS7002

) FIDELITY DFS 7002
STEREOPHONIC

per-cus'sive JAZZ

The Man With The Golden Arm
Mack The Knife
Harlem Nocturne
Peter Gunn
Dragnet
and others

**DOCTORED
for Super-Stereo**

PERCUSSIVE JAZZ . . . Thrilling ricochet sound in the swinging, modern jazz idiom. Pete Appleyard on vibes and six percussionists pace a throat-lumping beat for the brilliant rhythm and clarion brass sections.

If you never buy another record,
make sure your Dealer plays for you
the NEW **AF** **AUDIO FIDELITY**[®]

DOCTORED for SUPER-STEREO SERIES

) AUDIO FIDELITY DFS 7003
STEREOPHONIC

per-cus'sive
Latino
Cha
Cha
Cha

doctored for **SUPER-STEREO**

PERCUSSIVE LATINO. CHA, CHA, CHA . . . Torrid Latin rhythms pulsating as never before with a crisp, distinct definition and directionality of sound. A modern, musical miracle! Selections include: Nicolasa, El Bodeguero, Cero, Codazos, Clap Your Hands Cha Cha, Cha Cha Castanetas, Sambia, Mambo Inn, and others. DFM3003/DFS7003

) AUDIO FIDELITY DFS 7001
STEREOPHONIC

per-cus'sive VAUDEVILLE

the **BIG** theatrical sound

**DOCTORED
for Super-Stereo**

PERCUSSIVE VAUDEVILLE . . . The fantastic sound of vaudeville pit orchestras! Exciting sound effects include tap dancers, wood blocks, soft shoes . . . the works! Outstanding favorites such as: Wild Cherries, Sidewalks of New York, Daisy Bell, Hey Rube, Whistler & His Dog, etc. DFM3001/DFS7001

Here are the recordings you've been waiting for! Ultimate stereo directionality! Dynamic monaural presence! The realization of the audiophile's dream. Just listen!

DFM Series (Monaural)—\$4.98
DFS Series (Stereo)—\$5.95

For **FREE** catalogs and technical information in monaural and stereo records and tapes, write:

Dept. HF11 **AUDIO FIDELITY, INC.**
770 Eleventh Avenue, New York 19, N.Y.

CIRCLE 22 ON READER-SERVICE CARD

reviewed by

PAUL AFFELDER
NATHAN BRODER
O. B. BRUMMELL
R. D. DARRELL
ALFRED FRANKENSTEIN
HARRIS GOLDSMITH
JOHN F. INDCOX
ROBERT C. MARSH
CONRAD L. OSBORNE
JOHN S. WILSON

Records in Review



Graziella Sciutti: a tender Rosina.

Paisiello's *Barber* Brought Back to Life

In a First and Fine Recording

by Conrad L. Osborne

THANKS TO the postwar renaissance of interest in pre-Verdi Italian opera, we are being given a chance to reevaluate (or, more accurately, to evaluate) a whole repertory of previously "dead" operas. Of these, none has been deader until recently than *Il Barbiere di Siviglia* by Giovanni Paisiello, who in his day (1740-1816) was an immensely successful, internationally admired composer. Paisiello died certain of his lasting fame, but he had not reckoned on a young composer named Rossini, who with a single stroke drove Paisiello's most popular creation into oblivion almost overnight.

Well, here is Paisiello's *Barber* brought back to life again, and the first thing we shall want to know is how it compares with Rossini's version of the same story.

Paisiello composed his *Barber* in 1782 in St. Petersburg for the Tsarina Catherine, who had been much impressed by a performance of the play by Beaumarchais. Consequently, it is not surprising that Giuseppe Petrosellini's libretto hews much more closely to Beaumarchais than does Cesare Sterbini's text for Rossini. Figaro's first entrance provides an excellent case in point. Rossini, of course, uses the occasion for one of the greatest of all bravura arias, "*Largo al factotum*." Paisiello and Petrosellini, on the other hand, place a paper and pencil in Figaro's hand, and in his opening aria ("*Diamo alla noja il bando*"), have him improvise a song—exactly what Figaro does on his first appearance in the play. Beaumarchais's delightful scene for Barthole and

his two impossible servants, to give another example, does not turn up in Rossini at all, except in the vestigial character Ambrogio; in the Paisiello version, it becomes an uproarious trio, with one servant (the dullard Brightboy) yawning almost uninterruptedly, the second (the senile Youthful) sneezing continuously, and Bartolo maintaining an incessant scolding patter. Altogether I think it fair to say that from a dramatic standpoint Paisiello's opera is the better of the two. Its characters are more completely filled out than Rossini's, its plot more subtly woven, its libretto more stylish.

To be sure, comparisons can be somewhat misleading here, for we judge the Rossini opera largely on the basis of the tasteless, anything-for-a-laugh performance it is gen-

erally accorded—Rossini's *Barber* has disappeared almost as completely as Paisiello's. And, of course, there is the matter of the music. It is not hard to see why Rossini's work, with its string of inspired arias and ensembles, so quickly replaced Paisiello's in the public affection. The pleasing little serenade sung by Paisiello's Almaviva sounds a bit prosaic after the melting beauties of "*Ecco ridente*" and "*Se il mio nome*," and the *Calunnia* aria of Paisiello's Basilio, evocative as it is of slander's storm, is not the malevolent *tour de force* that Rossini gave to his Basilio. Nevertheless, if the listener will accept Paisiello's music on its own terms, he will find this score full of charm and wit. The melodies fall very easily on the ear, and as in Mozart, the working of them contains countless unexpected little turns that keep the theatrical pot bubbling. Everything is done with the simplest of materials, but done with precision and dramatic shrewdness.

Mercury's production is a model for future projects of this kind (and let's hope that the *Barber* is only a beginning). A critic, naturally, must find something to complain of, and in this instance it is possible to complain of the cuts. They are not lengthy, and they are mostly in recitative, but they include sections that are important dramatically, and a third record would have been worth the price to retain them. Otherwise, there is simply nothing wrong with this recording. Fasano and his Virtuosi di Roma are of course in their special *métier* here, and they play magnificently. The talented and—to judge from her photos—beautiful Graziella Sciutti makes a tender, provocative Rosina; particularly instructive is the way she points the *secco* recitative—every line counts. Nicola Monti puts his pure, flowing tenor to its best natural use as Almaviva. Panerai's steady, ringing baritone and intelligent characterization make him a first-rate Figaro—how much more ingratiating he is in a part like this than when he is battering his way through the high-lying dramatic roles! Capecchi again demonstrates the range of his art with a fine portrait of Bartolo, and Mario Petri deals as well as anyone might with the very high tessitura of Basilio's aria. The two servants (Florindo Andreolli and Leonardo Monreale) are superb.

Mercury's engineering is the best I have yet heard from that company—clear, natural sound with not a trace of distortion in either the mono or stereo version. The accompanying booklet, with notes and libretto, is handsome and informative. Altogether, this is a prize—don't miss it.

PAISELLO: *Il Barbiere di Siviglia*

Graziella Sciutti (s), Rosina; Nicola Monti (t), Count of Almaviva; Florindo Andreolli (t), Youthful and An Alcalde; Rolando Panerai (b), Figaro; Renato Capecchi (bs), Dr. Bartolo; Mario Petri (bs), Basilio; Leonardo Monreale (bs), Brightboy and A Notary. Virtuosi di Roma, Renato Fasano, cond.

- MERCURY OL 2-110. Two L.P. \$9.96.
- MERCURY SR 2-9010. Two SD. \$11.96.



Richter's First Beethoven, and Three Others

by Harris Goldsmith

EVERY great artist (and Sviatoslav Richter is unquestionably great) has many facets to his make-up. One of them, however, usually tends to dominate the others. Hence, Toscanini was noted for his driving force, although his interpretations were also tender and compassionate. Bruno Walter, despite his abundant energy, is primarily regarded as a *genial* conductor.

But Richter's numerous recordings present a somewhat enigmatic picture. The pianist has been revealed as a classicist, romanticist, extrovert, introvert, impulsive thunderer, and deliberating miniaturist. Each of the qualities is, in turn, equally prominent, but none emerges as a prime characteristic of his playing. His recordings cover so wide a range that they seem to represent separate personalities. I believe that this exciting variety in Richter's playing, combined with his unusual sensitivity and already legendary technique, accounts for his preëminence among Soviet pianists.

Of the four releases reviewed here, three are of transcendental quality and one is a comparative dud. The unsuccessful disc is the Rachmaninoff performance. Richter's interpretation is authentically romantic, though his rendition is more similar to Moiseiwitsch's delicately crafted one than to Rachmaninoff's own. I find his tempos too erratic, and rather on the lethargic side, though the singing quality of his tone is captivating. Unfortunately, the low price of the record is largely offset by the quality of the reproduction, which is shallow, congested and garbled by artificial echo. The effect is not enhanced by the vibrato-ridden playing of the Leningrad Orchestra. At any rate, Richter has recorded the same work for Deutsche Grammophon, and since that

version has good sound and contains a bonus of six Rachmaninoff Preludes, it is well worth the extra money.

The pianist's first Beethoven recording is a revelation. The *Pathétique* Sonata is performed with intensity and profundity. Approaching the work as a dramatist and colorist, Richter plays with enormous brio and with considerable projection of the piece's forward thrust. His performance here remains a singing one, avoiding the four-square inflexibility that has been erroneously touted as "German Tradition." Along with this *cantabile* emphasis goes a subtle rubato, plastic but strong. The pianist's variation of tempo, especially in the last movement, may cause some eyebrows to be raised, but the spirit of his convincing interpretation is unmistakably Beethovenian. The *Bagatelles* are accorded the same sort of treatment, but since these pieces are shorter and more rhapsodic, the freedom of tempo and phrasing is less apparent and more conventional-sounding. These performances eclipse even such admirable competition as Denis Matthews' of the complete sets (I have not heard Schnabel's version of Op. 126), not so much by any greater pianistic ability as by their sheer perception and personality. For instance, Richter's slower tempo in Op. 126, No. 1 conveys a tranquil nobility that makes Matthews' rendition sound constrained and restless, and in Op. 126, No. 4 (a particularly wonderful piece, incidentally!), Richter's playing is stormy and brooding while Matthews, by comparison, is merely metronomic and forthright. Another instance is the Prokofiev sonata, which has humor, melting lyricism, and a touch of irony in this reading. By a judicious inflection of tonal color, Richter imparts a

broad poignancy to the second movement, and his deliberate but perfectly maintained pulse in the *precipitato* finale is incomparably more thrilling than the helter-skelter dash of Ashkenazy. (One of Richter's most admirable traits is his ability to maintain rhythmic symmetry.)

Those who believe diseases are communicable by autosuggestion are advised to stay away from Columbia's version of *Pictures from an Exhibition*. This recording, which has already received a *Prix-du-Disque* in Paris, was made at a public performance in Sofia, Bulgaria, on February 25, 1958. The city was just recuperating from a severe flu epidemic at that time, and the audience's wracking coughs are immortalized with virulent splendor. In addition, the first side of the disc is recorded at very low volume and has a ferocious background roar. (The quality improves somewhat as the performance progresses.) The disc, then, is emphatically *not* recommended for its sound quality, but in its noise-ridden grooves is enshrined the greatest piano performance of the *Pictures I* have ever heard, on records or off. There have been reports concerning Richter's aversion to making records, and the artist himself has said that microphones "scare" him. This concert performance lets

us hear an "unscared" Richter. [Presumably, those who are hearing him during his current U.S. tour will have the same experience.] The pianist is simply amazing here; the reading is utterly hypnotic in its dynamic force, its humor, and its staggering virtuosity. Richter's evocation of an entire symphony orchestra is all the more remarkable since the pianist eschews the "improvements" that are often inflicted on Mussorgsky's very effective piano writing. The Artia *Pictures* is from a studio session, and is better recorded and more comfortably executed. It lacks some minor dynamic miscalculations and wrong notes, but it also misses the tremendous impact and excitement of the live version. *Goldenburg and Schmuyle*, so pompous and imposing on the Columbia disc, sounds pallid here. *Catacombs* and *Con Mortuis in Lingua Mortua*, despite some sensitive shading, fall short of the chilling impact conveyed in the Sofia performance, while *Baba-Yaga* and *The Great Gate at Kiev* sound disappointingly domestic and urbane on the studio-made disc. Heard by itself, the Artia version is subtle, colorful, and evocative, and since this fairly well-reproduced disc also offers the Prokofiev sonata, it seems rational to prefer it to the wretchedly recorded, economically stingy Columbia.

However, one cannot be rational when confronted with a miracle—both of these discs are truly indispensable. Indispensable, too, is the great pianist who created them.

BEETHOVEN: *Sonata for Piano, No. 8, in C minor, Op. 13; Bagatelles for Piano: Op. 33: Nos. 3 and 5; Op. 119: Nos. 2, 7, and 9; Op. 126: Nos. 1, 4, and 6*

Sviatoslav Richter, piano.
● ARTIA ALP 162. LP. \$4.98.

MUSSORGSKY: *Pictures from an Exhibition*

Sviatoslav Richter, piano.
● COLUMBIA ML 5600. LP. \$4.98.

MUSSORGSKY: *Pictures from an Exhibition*

† Prokofiev: *Sonata for Piano, No. 7, in B flat, Op. 83*

Sviatoslav Richter, piano.
● ARTIA ALP 154. LP. \$4.98.

RACHMANINOFF: *Concerto for Piano and Orchestra, No. 2, in C minor, Op. 18*

Sviatoslav Richter, piano; Leningrad Philharmonic Orchestra, Kurt Sanderling, cond.
● PARLIAMENT PLP 134. LP. \$1.98.

From Bernstein and the Philharmonic— Ives's Second Symphony, Grandly Conceived

by Alfred Frankenstein

LET US begin by rising, facing the East, and bowing three times to F. Charles Adler, the Vienna Symphony Orchestra, and the Society of Performing Artists, which put out records under the label S.P.A. They recorded Ives's Second Symphony many years ago. For a long time it was the only obtainable record of a big symphonic work by this composer; now it is rendered obsolete, but one recalls it with pleasure and gratitude.

The Second Symphony is one of Ives's most endearing, melodious, richly colored, and grandly constituted works, and represents perhaps the most successful fusion he was ever to make between his favorite type of thematic material and the European sym-

phonic tradition. It is full of old New England hymn tunes, Civil War marches, sentimental Victorian ballad melodies, patriotic songs, and reminiscences of improvisation in the organ lofts of small Connecticut churches, but in form, texture, warmth, and grandeur of build it belongs to the tradition of Schumann and Brahms. Its fourth movement—a slow introduction to a fast finale—reminds one mightily of the so-called "Cathedral Scene" in the *Rhenish* Symphony of Schumann; and, just as Schumann turns from the grandeur of a solemn service in the Cathedral of Cologne to the bustling folk life of the Rhineland, so Ives turns from the visionary revelations of his organ playing

to Stephen Foster, country fiddlers, and *Columbia, the Gem of the Ocean*.

This, then, is the first American symphony to set beside Schumann and Brahms, and it is still one of the noblest, most beautiful, and most entertaining. Bernstein gave it the first performance it ever had, in 1951, just fifty years after it was completed. His interpretation possesses that charm and blandishment which are uniquely his. No conductor of the present day possesses a more markedly personal style, especially in the performance of slow movements. Bernstein is an irresistible lyricist, even when, as here, one sometimes feels he is indulging in a bit of schmaltz, the lovely F major tune which



Charles Ives

BMI

forms the second theme of the first movement in this symphony is marked *meno allegro*, not *con sentimento*, but Bernstein plays it that way and, I must admit, gets away with it.

The recording is absolutely superb, in both mono and stereo. Everything tells, nothing is buried in the mass of the sonority, and yet the disc abounds, as it should, with massive sonorities of the grandest and most colorful kind.

The record sells for a dollar more than most because it is accompanied by a six-page, full-size brochure called "The Ives Country." This contains twenty-four photographs—of the composer, his family, his home, and so on—and is by far the most extensive Ives iconography ever published. For this reason it is all the more regrettable that it is printed in a hideous ox-blood color which completely wrecks whatever photographic quality the plates had to begin with.

There are very interesting notes on the symphony, by Bernstein himself and by David Johnson. Bernstein exaggerates, however, in the long list of symphonic works which, he claims, are quoted in this one. Many of these "quotations" are merely accidental resemblances of the kind that occur in the work of every great composer. It is true, for instance, that in Ives's third movement one may find these three notes:



and that in the second movement of the first symphony of Brahms one may find these three:



but if the notes of the tonic chord in descending order and in an unaccented part of the bar amount to a quotation, then everybody who has ever written a symphony has quoted from everybody else.

Both Johnson and Bernstein observe that the symphony ends with a wild, 11-note tone cluster, but neither points out the one note which is omitted from it. It is B, the home-base tone for the first movement, and the one note which, according to the "classic" laws, ought to be present in the symphony's final chord. *Reveille*, a call to wake up, sounds in the trumpets just before this final tone cluster. Its meaning could not be clearer.

IVES: *Symphony No. 2*

New York Philharmonic, Leonard Bernstein, cond.

- COLUMBIA KI 5489. LP. \$5.98.
- COLUMBIA KS 6155. SD. \$6.98.

by Nathan Broder



Carlo Maria Giulini

Two *Don Giovannis*, Each a Happy Event

THERE ARE SOME operas—*Boris Godunov* or *Carmen*, for instance—in which a first-class performance in the title role is enough to raise an otherwise routine production to brilliance. There are many more in which two fine singers can and often do mean the difference between failure and success. Sometimes, indeed, in these latter operas only one singer may do the trick, as we saw last season at the Metropolitan when Birgit Nilsson singlehandedly made an exciting event of *Tristan* again. But Mozart is more demanding, in this respect as in others. Especially in *Don Giovanni* he poured glorious music into every role. There are shorter parts than others among the eight in that opera, but there are no minor parts. A third-rate Masetto, a hoarse or quavery Commendatore can ruin important scenes. And every one of the other six characters has arias to sing that are, musically and technically, among the most difficult, as well as the most beautiful, in the repertory.

It is therefore not surprising that completely satisfying performances of *Don Giovanni* are rare and a completely satisfying recording nonexistent. Nevertheless, each of the available recordings (the five sets already in the catalogues are discussed on p. 127 of this issue) has strong assets. This is especially true of the two latest ones.

The new RCA Victor recording has strength in several departments. Miss Nilsson makes a remarkably fine Anna. The voice has a rather individual, and to me appealing, color, and the ease with which it attacks high notes, as in "*Non mi dir*," or dwells in high regions, as in the duet with Ottavio near the beginning, is a joy to observe. Rapid runs are executed accurately and usually with assurance; only in the sixteenth-note roudades of "*Non mi dir*" is there a certain lack of confidence. Musically, the style is unexceptionable. Elvira, too, is very

well sung here. Miss Price has developed the power and technique to do justice to almost all of Elvira's music; at the same time her voice has a womanly quality that helps make Elvira a sympathetic, as well as pathetic, character. She is as concerned with the musical quality of the *secco* recitative allotted to her as with that of the set numbers. There are a few moments when the lower part of her range does not have the presence it might, but whether this is a fault of the voice or of the recording setup I cannot tell. Miss Ratti's voice sounds light and lacks some of the sensuousness that belongs in the part, but it is a sweet voice, skillfully handled. Siepi is uneven. Much of the time, as in the trio in Act 2, the succeeding serenade, "*Là ci darem*," the champagne song, he is in good form. In other places, like the finale of Act 2, his singing is less secure, the pitches uncertain. Corena's Leporello and Valletti's Ottavio are thoroughly acceptable performances; if they do not have any especially individual character, neither do they have any marked stylistic or technical weaknesses. Arnold van Mill makes a competent Commendatore. Blankenburg's Masetto does not go very far in reflecting the emotions of the character but his is one of the most attractive voices I have ever heard in this role.

Leinsdorf does a fine job here. The fast sections are spirited; the slow ones do not drag. There are a few flyspecks: a couple of passages in the second finale where singers and orchestra are not quite together; another, in the sextet, where orchestral nuances are flattened out. I am not sure that the tam-tam crash in the finale is needed. But he makes up for these by including the duet for Leporello and Zerlina, "*Per queste tue manine*," together with its surrounding recitative, which was among the new portions Mozart wrote for the first Vienna performance and which is not in any of the other

orded versions. The duet is an extremely in cresting piece, if not quite up to the rest of the work. This version is consequently the most complete ever recorded, containing every note (except for a tiny snippet of recitative) in Einstein's edition of the score.

The sound is excellent. Balances are carefully calculated. As one example among many that could be cited: in "Batti, batti" voice, solo cello, woodwinds, and strings are so disposed that everything is heard in the right relationship in a luminously transparent texture. There is much spaciousness and sensible separation. There is also some clearly audible and effective "movement."

The new Angel set is noteworthy for a very musical conductor and a strong line-up of ladies; it also has some minor-league singing from the men. Let us take the points up in that order. Giulini, in the recorded performances I have heard him conduct, has impressed me as not only an able technician, but a musician seeking to convey the essence of what he is playing with color and flexibility. The present recording makes it clear that he also has a flair for the dramatic. After Leporello's aria, a taut excitement is maintained throughout the opening scene. It is hard to spoil the finale, but few conductors bring in the trombones there with such golden tones and with so imposing, yet unemphatic, an effect. Throughout the work Giulini does not miss a single instrumental point.

Miss Sutherland has been creating considerable stir in England, and her work here indicates why. She does not hit her stride until "Or sai chi l'onore," but there she shows power and the ability to encompass all of her high-lying music with accuracy and without

faltering or losing quality of tone. In the first part of "Non mi dir" her singing is ravishingly beautiful; in the *allegretto* section her coloratura is clean, rhythmic, and on pitch. She makes positive contributions to most of the ensembles in which she participates. I am happy to report that Miss Schwarzkopf is in top form here. Her Elvira is a noble and unhappy lady, not a nag. The style is big and confident. In "Ah chi mi dice mai" the high A flats and B flats are firm; "Ah fuggi il traditor" is strong and passionate; the wonderful accompanied recitative preceding "Mi tradi quell'alma ingrata" is sung with poignant beauty, and the aria itself is extremely well done. Miss Sciutti makes a pleasing Zerlina, as she did in the Epic recording; her voice sounds a bit thin, but it is not sharp, and she handles it in very musical fashion.

The Don Giovanni is unfortunately not in a class with these artists. Waechter sings the serenade nicely, but elsewhere when he is not crooning ("Là ci darem"), he shouts (the champagne song). In the recitative he heavily underlines every point. He gives the impression not of an aristocratic libertine, but of a petulant and rather foolish man. The Leporello, Giuseppe Taddei, also overacts and shouts in the recitative. In his set numbers he is less clownish, and in the graveyard scene he is convincing. Luigi Alva reveals in "Il mio tesoro" a large chest-capacity and a good high A, but otherwise his contribution is workmanlike rather than distinguished. Cappuccilli as Masetto displays considerable feeling in "Illo capito," but he too has a tendency to yell. Frick, the Commendatore, is the only one of the men who is thoroughly satisfactory. His singing, espe-

cially in the finale, is splendidly imposing and resonant.

The quality of the stereo is variable. In some numbers the voices and some of the instruments seem to be on one track and the rest of the instruments on the other. This is a particular problem here because there is not a great deal of difference in timbre between the voices of Waechter and Taddei or Sutherland and Schwarzkopf. Consequently when both voices of one of these pairs come out of one speaker, the peculiar advantage of stereo is not being put to use. In other numbers, however, notably the quartet in Act I and the sextet, the voices are separated, and effectively. The sound in general is clear and well balanced.

MOZART: *Don Giovanni*

Birgit Nilsson (s), Donna Anna; Leontyne Price (s), Donna Elvira; Eugenia Ratti (s), Zerlina; Cesare Valletti (t), Don Ottavio; Heinz Blankenburg (b), Masetto; Cesare Siepi (bs), Don Giovanni; Fernando Corena (bs), Leporello; Arnold van Mill (bs), Commendatore. Vienna State Opera Chorus; Vienna Philharmonic Orchestra, Erich Leinsdorf, cond.

- RCA Victor LM 6410. Four LP. \$14.98.
- ● RCA Victor LSC 6410. Four SD. \$17.98.

Joan Sutherland (s), Donna Anna; Elisabeth Schwarzkopf (s), Donna Elvira; Graziella Sciutti (s), Zerlina; Luigi Alva (t), Don Ottavio; Piero Cappuccilli (b), Masetto; Eberhard Waechter (bs), Don Giovanni; Giuseppe Taddei (bs), Leporello; Gottlob Frick (bs), Commendatore. Philharmonia Chorus and Orchestra, Carlo Maria Giulini, cond.

- ANGEL 3605 D/L. Four LP. \$19.98.
- ● ANGEL S 3605 D/L. Four SD. \$23.98.

CLASSICAL

BACH: *Toccatà and Fugue in D minor, S. 565; Toccatà, Adagio and Fugue in C, S. 564; Passacaglia and Fugue in C minor, S. 582; Fantasia and Fugue in G minor, S. 542*

Fernando Germani, organ.

- CAPITOL G 7225. LP. \$4.98.
- ● CAPITOL SG 7225. SD. \$5.98.

Four masterworks are played here on the organ in the Royal Festival Hall, London. Germani's performances are marked by vital rhythm and imagination. He conveys the excitement of the more improvisational sections, such as the D minor Toccata, and the grandeur of the other pieces without fussiness or exaggeration. His registrations, indeed, are for the most part confined to the fundamental stops that are common to organs of various periods and styles. Especially moving and impressive is the Passacaglia here, owing in part to Germani's skillful treatment of dynamics. The sound in both versions is first class. N.B.

BALES: *The American Revolution*

Peggy Zabawa, soprano; Jule Zabawa, baritone; Cantata Choir of the Lutheran Church of the Reformation; National Gallery Orchestra, Richard Bales, cond.

- COLUMBIA LL 1001. LP. \$10.
- ● COLUMBIA LS 1002. SD. \$11.

This is the first release in Columbia's elaborate new "Legacy" series, but it is the third of its albums having to do with the music of American history as performed at the National Gallery in Washington by Mr. Bales and his orchestra. The score is actually a pastiche of eleven different compositions arranged by Bales, and such shape as it has is dictated by historical rather than musical considerations.

The first and longest piece in the series is James Hewitt's sonata *The Battle of Trenton*, which belongs in a great tradition of which far too few examples have been recorded. Hewitt's sonata is a very amusing specimen of the tradition, and Bales's orchestral version of it is very skillfully brought off. From the purely musical point of view, however, the high point of the collection is Francis Hopkinson's song *Beneath a Weeping Willow's Shade*, beautifully sung by Miss

Zabawa. Hopkinson had a real genius for the simple, perfectly polished lyric; he was the gentleman amateur in his most perfect eighteenth-century embodiment, and this is one of his finest songs. (There ought to be a whole LP of Hopkinson songs, but with the piano or harpsichord in accompaniment, as the composer intended. Bales's orchestral accompaniment is good, but it isn't Hopkinson.) Another utterly delightful song here is Henri Capron's *Delia*, which is reasonably well sung by Mr. Zabawa; the song has a decidedly Haydnesque character, and Haydn himself might have been proud to sign it.

The rest, in my opinion, does not quite measure up to the three pieces so far mentioned. Andrew Law's *Bunker Hill* is falsified by an arrangement which makes it sound like the processional chorus one hears just before the death of Boris Godunov. William Billings' *Chester* is a Revolutionary masterpiece but is not performed with much Revolutionary fervor. *Yankee Doodle* is slickly done, and there are some pieces, notably a group of five dances clustered under the heading *The Birthnight Ball*, which may be historically valuable as Americana but are of very slight interest as music.

One suspects, indeed, that the musical production as a whole serves mainly as an

excuse for the rather pretentious printed material that comes in the package with the record. It occupies no less than fifty-eight huge pages and is an art director's orgy, with countless reproductions of drawings, paintings, engravings, music, newspapers, and whatnot. In addition to notes on the eleven compositions contained on the record, these pages include a very interesting study of the causes of the Revolution by Arthur M. Schlesinger, Sr., and a no less interesting study of the Revolution itself by Marshall Davidson. A queer essay by Robert Graves about the state of mind of the Loyalists during the Revolutionary period suggests that Columbia hopes to recoup some part of its investment in the English market. Toward its end the pamphlet runs off into high if unintentional comedy with the reproduction of Larry Rivers' recent painting *Washington Crossing the Delaware* and the publication of an essay by the artist attempting to explain how he happened to paint that mild and dreamy picture. A.F.

BARTOK: *Concerto for Orchestra*

New York Philharmonic, Leonard Bernstein, cond.

- COLUMBIA ML 5471. LP. \$4.98.
- ● COLUMBIA MS 6140. SD. \$5.98.

The recording is gorgeous, and the perform-

ance has that irresistible, blandishing warmth which has put Bernstein where he is. At the same time, Bernstein's worst fault is frequently demonstrated here—that of taking a tempo so fast that the shape of a melodic line has no chance to register. Reiner still has the edge so far as this particular work is concerned. A.F.

BEETHOVEN: *Concerto for Piano and Orchestra, No. 2, in B flat, Op. 19; Sonata for Piano, No. 14, in C sharp minor, Op. 27, No. 2 ("Moonlight")*

Wilhelm Backhaus, piano; Vienna Philharmonic Orchestra, Hans Schmidt-Isserstedt, cond.

- ● LONDON CS 6188. SD. \$5.98.

The idea of coupling a popular sonata with a less celebrated concerto strikes me as a good one—particularly when the concerto performance is as immediately ingratiating as this one. The Beethoven Second (it's really the First, but we needn't go into that) can give a unique impression of being midway between Mozart and the Beethoven we know best. Backhaus and his collaborators find this distinctive character in the music, and project the concerto as successfully as they do the other four in the now complete series of Beethoven piano concertos.

As for the new *Moonlight*, I am sure you

will find it among the most rewarding of the two dozen versions that are now currently in print. R.C.M.

BEETHOVEN: *Concerto for Piano and Orchestra, No. 3, in C minor, Op. 37*

Clara Haskil, piano; Lamoureux Orchestra, Igor Markevitch, cond.

- EPIC LC 3726. LP. \$4.98.
- ● EPIC BC 1097. SD. \$5.98.

Elegance is the quality primarily in evidence here. Mme. Haskil is a specialist in this music. You may prefer a more vigorous reading, such as Backhaus provides in the set that remains my favorite, but in polish, nuance, and the consistent development of an interpretative approach these artists assert their viewpoint effectively. The recording is good, but the Backhaus disc has an edge in engineering. R.C.M.

BEETHOVEN: *Sonata for Piano, No. 8, in C minor, Op. 13; Bagatelles for Piano, Op. 33; Nos. 3 and 5; Op. 119: Nos. 2, 7, and 9; Op. 126: Nos. 1, 4, and 6*

Sviatoslav Richter, piano.

- ARTIA ALP 162. LP. \$4.98.

For a feature review including this recording, see p. 74.

BEETHOVEN: *Symphony No. 3, in E flat, Op. 55 ("Eroica")*

Berlin Philharmonic Orchestra, Ferenc Fricsay, cond.

- DEUTSCHE GRAMMOPHON LPM 18576. LP. \$5.98.
- ● DEUTSCHE GRAMMOPHON SLPM 138038. SD. \$6.98.

A lightly inflected performance, paced rather fast at times but essentially orthodox in its approach, this *Eroica* belongs among the better accounts of the score. Its primary weakness is lack of body and bite in the sound, due to such failings as too distant microphone placement and insufficient registration of the lower frequencies. Both the stereo and mono sets share these faults, although the monophonic editions by its nature, gives a more compact effect. My own preference remains the Solti version on the London label. R.C.M.

BEETHOVEN: *Symphony No. 4, in B flat, Op. 60; Overture, Zur Weibe des Hauses, Op. 124*

Philharmonia Orchestra, Otto Klemperer, cond.

- ANGEL 35661. LP. \$4.98.
- ● ANGEL S 35661. SD. \$5.98.

With this release we now have the Beethoven nine in a Klemperer edition, although only six of the series exist in stereo versions. The fine qualities of the earlier Klemperer performances are abundantly manifest in this as well, but a gentler, more lyric statement of the Fourth can yield something that escapes us here. Klemperer's scherzo is a marvel, and none can best him in the final *moto perpetuo*, where the performance is recorded with astonishingly good ensemble

Continued on page 80

NEXT MONTH IN

high fidelity

Huneker in Retrospect

The distinguished elder statesman of American letters writes of James Huneker, this country's first great music critic and a lively connoisseur of all the arts.

by Van Wyck Brooks

The Pick of '60

The Christmas shopper's only problem need be what discs he himself can bear to forego.

by Herbert Kupferberg

The Sound of Ambiophony

If we don't yet have the ultimate even in stereo sound, new reverberation techniques involving the reproduction of music may point the way.

by Robert Gorman

The Weavers

America's most successful folk-singing group has earned its place the hard way.

by Robert Shelton

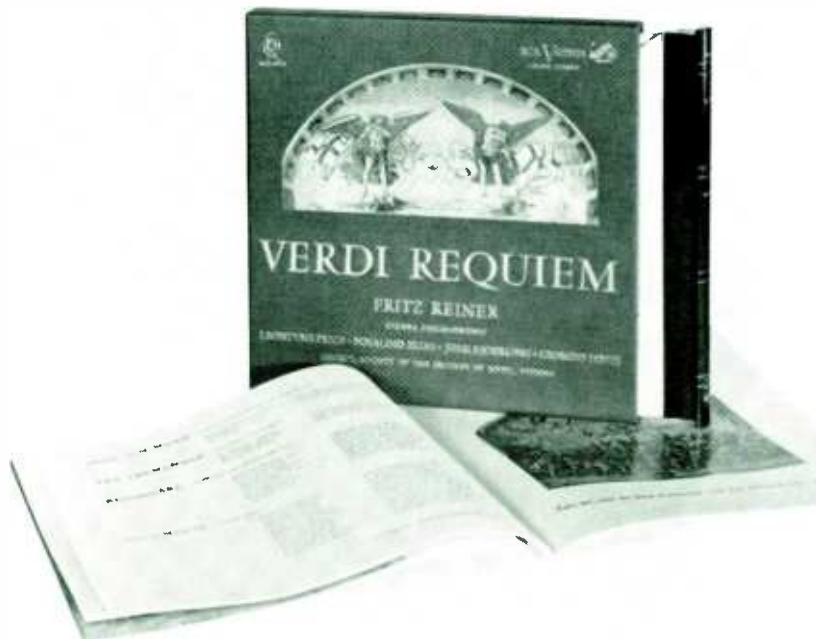

R IN THE GALA SORIA SERIES:
THE VERDI "REQUIEM"

First stereo recording of this great work. Fritz Reiner conducts the Vienna Philharmonic. Soloists: Leontyne Price, Rosalind Elias, Jussi Bjoerling, Giorgio Tozzi. This is Bjoerling's last recording. Cloth-bound, gold-stamped, 2-record album features magnificent Skira Art Book illustrated with Signorelli's famous frescoes of "The Last Judgment." In Living Stereo and regular L.P.

OTHER SORIA SERIES ALBUMS NOW AVAILABLE :

- BERLIOZ: REQUIEM.** Charles Munch and the Boston Symphony with chorus. 2 L.P.'s.
HANDEL: MESSIAH. (complete) Sir Thomas Beecham, Royal Philharmonic Orch. and Chorus. 4 L.P.'s.
HANDEL: MESSIAH. (highlights) Sir Thomas Beecham, Royal Philharmonic Orch. and Chorus. 1 L.P.
RICHARD STRAUSS: ARIADNE AUF NAXOS. Leinsdorf, Vienna Philharmonic. 3 L.P.'s.
POULENC: LA VOIX HUMAINE. Denise Duval in one-character opera.
VIENNA PHILHARMONIC FESTIVAL. Karajan conducting. 4 L.P.'s.
RICHARD STRAUSS: DON QUIXOTE. Reiner, Chicago Symphony. Cellist: Janigro.
ROYAL BALLET GALA PERFORMANCES. Ansermet, Royal Opera House Orch. 2 L.P.'s.
MACLEISH: J. B. Original Cast in Pulitzer Prize-winning play. 2 L.P.'s.

RCA VICTOR
TRADE MARK RADIO CORPORATION OF AMERICA

registration. Elsewhere, you may find the classical austerity a bit unnerving.

It is well to note that the situation is balanced by Klemperer's very grand account of the overture. If you love this mighty fugal exercise as I do, you will find it well worth the price of the disc. R.C.M.

BEETHOVEN: *Symphony No. 7, in A, Op. 92*

New York Philharmonic, Leonard Bernstein, cond.

- COLUMBIA ML 5438. LP. \$4.98.
- ● COLUMBIA MS 6112. SD. \$5.98.

Bernstein is one of several conductors who have exploited the Seventh as an effective "knock 'em dead" vehicle for touring purposes, but when one gets down to a careful examination of the performance we have on this disc, it fails to stand up. The main trouble is a lack of a long line, due to the shifting rhythmic foundation and the generally episodic treatment of the work. Exaggerated accents, heavy ensemble textures, and a lack of subtlety account for the rest. The recorded sound, however, is good.

R.C.M.

BENNETT: *Commemoration Symphony ("Stephen Collins Foster"); Symphonic Story of Jerome Kern*

Mendelssohn Choir of Pittsburgh (in the Foster); Pittsburgh Symphony Orchestra, William Steinberg, cond.

- ● EVEREST SDBR 3063. SD. \$4.40.

Pièces d'occasion seldom seem to achieve greatness nowadays; and although Robert Russell Bennett's elaboration on Foster tunes (purportedly styled in the manner of the Troubadour's contemporaries) may have effectively served to celebrate the City of Pittsburgh's bicentennial festivities, its interest for other listeners is likely to be limited to a momentary admiration for the orchestrator's ingenuities in tackling a tricky and basically impossible problem. The *Kern Story* already enjoys considerable popularity, but it too merely encrusts some of the richest American melodic jewels in luxurious settings which more often distract from than enhance their inherent appeal.

In any case, Steinberg has scant feeling for the idioms here, so he is reduced to precisely impersonal readings which, like the prosaic singing of the Mendelssohn Choir and its frankly undistinguished soloists (in the overcrowded vocal medley of the symphony's finale), communicate no enthusiasm at all. It is probably this over-all lack of fervor, rather than any deficiency in the moderately stereoisitic, immaculately clean recording, which also accounts for the relative lack of tonal body and aural appeal. R.D.D.

BLOCH: *America, an Epic Rhapsody*

American Concert Choir; Symphony of the Air, Leopold Stokowski, cond.

- VANGUARD VRS 1056. LP. \$4.98.
- ● VANGUARD VSD 2065. SD. \$5.95.

Those who have been around awhile will remember this. The work won a large cash prize offered by *Musical America* in 1928.

The judges were Stokowski, then conductor of the Philadelphia Orchestra; Serge Koussevitzky of Boston, Frederick Stock of Chicago, Walter Damrosch of New York, and Alfred Hertz of San Francisco. Each of these five conductors performed it during the third week of December in the year mentioned. It proved to be a pompous, gassy, inflated, ridiculous score which no one has bothered to look at since; at the time, everyone was disposed to laugh, wish Bloch well, and forget the whole thing as speedily as possible.

Well, here it is on records for the first time, followed by a little speech of Bloch's in his high-pitched voice. The disc is part of a series called "Landmarks of American Music" and is sponsored by something called West Projects, Inc. Unfortunately, West Projects, Inc. does not go into the real question: how did it happen that a composer who had done great things and was to do many more turned out a piece so totally lacking in creative spark as soon as he started working for a prize? How did it happen that five men who really knew something about the orchestral literature selected a thing so shallow and obvious? What ghastly corruption of taste was at work on all sides of this



Walter: for the Brahms of romantic song.

performance; and is it likely to happen again? American composers were not well established in the orchestral repertoire in 1928; now they are, and that, one hopes, makes a difference. The only value of this release is that it shows us how far we have come. A.F.

BRAHMS: *Concerto for Piano and Orchestra, No. 2, in B flat, Op. 83*

Rudolf Serkin, piano; Philadelphia Orchestra, Eugene Ormandy, cond.

- COLUMBIA ML 5491. LP. \$4.98.
- ● COLUMBIA MS 6156. SD. \$5.98.

Since the new Serkin-Ormandy Brahms Second differs from its predecessors to a remarkable degree, devotees of the earlier sets had better hear it before buying. There is greater relaxation on this disc; in this reading, monumental breadth and calm introspection prevail, instead of nervous drive and leonine virtuosity. Certain sections

of the music, such as the opening pages of the first movement and the *più adagio* of the third, have greater freedom and emotional expanse in this performance, but in terms of over-all continuity and proportion the older recordings have a slight edge. By all evidence, Serkin's temperamental make-up is hyperkinetic, and I suspect that the pianist's "inner metronome" conflicted with the slow tempos adopted here. Some of the phrasing, as a result, is slightly awkward, and there is a tendency (on Ormandy's part as well as Serkin's) to anticipate ritards and crescendos. However, it should be noted that these are minor lapses and do not significantly detract from a basically superior reading.

I prefer the sound of the stereo pressing because Serkin's tone is leaner and more centralized. The monophonic disc is certainly acceptable, but a shade overblown for my taste. H.G.

BRAHMS: *Concerto for Violin, Cello, and Orchestra, in A minor, Op. 102; Tragic Overture, Op. 81*

Zino Francescatti, violin; Pierre Fournier, cello (in the Concerto); Columbia Symphony Orchestra, Bruno Walter, cond.

- COLUMBIA ML 5493. LP. \$4.98.
- ● COLUMBIA MS 6158. SD. \$5.98

The Messrs. Fournier, Francescatti, and Walter recognize that, besides being a nineteenth-century classicist, Brahms was also one of the greatest composers of romantic song. Nowhere has he sung more eloquently than in the second subject of the first movement or in the whole of the *Andante* of his Double Concerto. And songfulness is the keynote of this performance. Throughout, there is a feeling of relaxation, as if all the participants were enjoying themselves to the fullest extent and were in no hurry to reach the final double bar.

The resultant glow is irresistible. Fine as is the other stereo performance of the Double Concerto by Oistrakh, Fournier, and Galliera, it cannot match this new one for warmth, brilliance, or quality of reproduction. Francescatti plays with a richer, sweeter tone than Oistrakh, and even Fournier sounds rounder and richer here. Columbia's microphone placement is closer than Angel's, the sound is brighter, and the two soloists are realistically separated just to left and right of center, which gives the stereo version a slight advantage over the otherwise highly commendable monophonic one.

Walter's reading of the *Tragic Overture* is the most satisfying I have ever heard. Broad tempos again emphasize the lyric qualities inherent in the score; yet the middle section, so often dragged when the work is played in this fashion, moves along at a pleasing pace. Here Galliera is outstanding at every turn. P.A.

BRAHMS: *Symphony No. 2, in D, Op. 73*

Vienna Symphony Orchestra, Wolfgang Sawallisch, cond.

- EMI LC 3722. LP. \$4.98.
- ● EMI BC 1093. SD. \$5.98.

The reproduction is highly satisfactory, and the orchestral execution is good (except for the failure of the trumpet to enter at the very close of the first movement). But

the Sound: **THE LOOK** : the Label:

RACHMANINOFF: Piano Concerto No. 2, Lewenthal, Piano.
RIMSKY-KORSAKOFF: Russian Easter Overture, Abravanel. WST 14076 Stereo
VAUGHAN-WILLIAMS: Fantasia on "Greensleeves"; English Folk Song Suite; Fantasia on a Theme by Thomas Tallis. Sir Adrian Boult.

XWN 18928 Monaural WST 14111 Stereo
BUXTEHUDE, SCHEIN, FUX, ALTENBURG, & SHAHAN: High-Fidelity Brass: Ancient and Modern. Sayard Stone.

XWN 18931 Monaural WST 14113 Stereo
J. S. BACH: Scherchen Conducts Bach Brandenburg Concertos, Nos. 1 & 2 in F; Nos. 3 & 4 in G; No. 5 in D; No. 6 in B Flat. Complete set or singles.

XWN 3316 (3 records) Monaural
 WST 307 (3 records) Stereo

J. S. BACH: Keyboard Concerti. Concerto in D Minor, Concerto in E Major. Paul Badura-Skoda and Joerg Demus.

XWN 18925 Monaural WST 14109 Stereo

J. S. BACH: Keyboard Concerti, Concertos for 2 Keyboard Instruments: C Major and C Minor. Concertos in F Minor and A Major. Paul Badura-Skoda and Joerg Demus. 18926 Monaural 14110 Stereo

DELIBES, CHOPIN AND ADAM: Best of Ballet. Abravanel.

XWN 18935 Monaural WST 14117 Stereo

BEETHOVEN: Quartet, Op. 59, No. 2, Performed by the Janacek Quartet.

XWN 18936 Monaural WST 14118 Stereo

BEETHOVEN: Quartet, Op. 59, No. 3. Quartet, Op. 18, No. 4. Smetana Quartet.

XWN 18937 Monaural WST 14119 Stereo

BIZET: Carmen Suites, Nos. 1 & 2, and Music to L'Arlesienne.

WST 14120 Stereo

LALO: Symphonie Espagnole, Op. 21.
WIENIAWSKI: Violin Concerto, No. 2, Op. 22. Olevsy (violin), Rudel.

XWN 18938 Monaural WST 14121 Stereo

LISZT: Piano Concerto No. 1 in E Flat. Piano Concerto No. 2 in A. Farnadi, Piano. Sir Adrian Boult conducting.

WST 14125 Stereo

LISZT: Hungarian Rhapsodies, Nos. 1, 4, 5, and Battle of the Huns. Hermann Scherchen.

WST 14100 Stereo

MOZART: Eine Kleine Nachtmusik; Symphony No. 40 in G. Minor. Sir Adrian Boult conducting.

XWN 18942 Monaural WST 14126 Stereo

MOZART: Symphonies Nos. 6 through 9. Leinsdorf. (Vol. 2.) XWN 18862 Monaural

TSCHAIKOVSKY: 1812 Overture, Capriccio Italien.

RIMSKY-KORSAKOFF: Capriccio Espagnol, Russian Easter. Abravanel.

XWN 18924 Monaural WST 14107 Stereo

VILLA-LOBOS: A tribute. Jose Eschaniz, Piano. XWN 18929 Monaural

A DRY MARTINI, PLEASE: Cy Walter, Piano WP 6120 Monaural WST 15054 Stereo

SOUNDS FROM THE ALPS: (Jodlers)

WP 6123 Monaural WST 15057 Stereo

AMBASSADOR OF JAZZ: Max Kaminsky and His Orchestra.

WP 6125 Monaural WST 15060 Stereo

BROADWAY IN BRASS: Eric Johnson.

WP 6126 Monaural WST 15061 Stereo

WHILE MAKING LOVE: Eric Johnson.

WP 6127 Monaural WST 15062 Stereo

TESTING TESTING TESTING: The most comprehensive Stereo Testing Tool.

SRX Stereo

AMERICAN BAND MARCHES: Salvation Army Band. Major Richard Holz.

WP 6122 Monaural WST 15056 Stereo



WESTMINSTER

1960



Collectors: The Westminster Catalogue is yours for the asking. Write to Dept. HF 11 Westminster, 275 Seventh Ave., New York 1, N. Y.

WESTMINSTER

CIRCLE 137 ON READER-SERVICE CARD

Sawallisch's leadership is undistinguished and, in the end movements, decidedly on the stiff, heavy side. As a stereo Second, this one cannot compare with those by Klemperer and Kubelik. P.A.

BRAHMS: *Symphony No. 4, in E minor, Op. 98*

Vienna State Opera Orchestra, Vladimir Golschmann, cond.

- VANGUARD SRV 116. L.P. \$1.98.
- ● VANGUARD SRV 116SD. SD. \$2.98.

A workmanlike account. There is nothing especially distinctive about Golschmann's reading; it is orthodox and, at the modest price, quite acceptable. The strings seem a shade thin in the monophonic version but amply full and well distributed in the unexaggerated stereo edition. P.A.

CHOPIN: *Ballades (4)*

Philippe Entremont, piano.

- COLUMBIA ML 5442. L.P. \$4.98.
- ● COLUMBIA MS 6118. SD. \$5.98.

It is unfortunate for Entremont that his disc comes out hard on the heels of Rubinstein's recording of the Chopin Ballades. Despite the young French pianist's sensitive handling of slow sections, a singing tone, and some provocative stressing of inner voices, he is no match for the mature Polish artist. Nor, despite the greater warmth in his playing, is his version as satisfactory as Graffman's recent recording, which has an analytical approach and precision of execution to recommend it. The piano sound is praiseworthy natural. RAY ERICSON

CHOPIN: *Ballade, No. 4, in F minor, Op. 52. Nocturnes: No. 8, in D flat, Op. 27, No. 2; No. 5, in F sharp, Op. 15, No. 2; No. 18, in E, Op. 62, No. 1. Mazurkas: No. 2, in C sharp minor, Op. 6, No. 2; No. 31, in A flat, Op. 50, Nos. 2 and 3. Polonaise, No. 6, in A flat, Op. 53. Scherzo, No. 3, in C sharp minor, Op. 39*

Charles Rosen, piano.

- Epic LC 3709. L.P. \$4.98.
- ● Epic BC 1090. SD. \$5.98.

Charles Rosen's playing on this disc is rather erratic. Most of the time, he is an intelligent, musicianly player and a fine technician, but the general high level of his pianism takes a few disconcerting nosedives here. He is at his best in the Mazurkas, which are played with flexibility and rhythmic flair. The balance and continuity is present in the Nocturnes, but not the personal involvement with the music. Of the larger works, the Scherzo and Polonaise are both given tidy, well-proportioned readings that are nevertheless rather small-scaled and pedestrian. All of the pianist's undeniable quality mysteriously deserts him in the F minor Ballade, which is technically foggy, tonally bleak, and lacking in structural comprehension. The piano sound is fine, although slightly hard in tone. H.G.

CHOPIN: *Concerto for Piano and Orchestra, No. 2, in F minor, Op. 21—See Schumann: *Concerto for Piano and Orchestra, in A minor, Op. 54.**

CHOPIN: *Preludes for Piano: Op. 28, Nos. 1-24; Op. 45; Op. Posth.*

Sergio Fiorentino, piano.

- ROULETTE R 75004. L.P. \$3.98.

This disc includes the two additional preludes which are usually omitted from the standard recorded collections. The posthumous one is a buoyant salon piece of no great consequence, but Opus 45 has a plaintive, brooding inwardness that places it on a level with the best of the great Opus 28 set.

Sergio Fiorentino is a fleet, virtuosic technician and he is obviously capable of delicately graded tonal shading. He seems, however, overly concerned with tone color and pedal effects for their own sake, and he doesn't incorporate them into a really satisfying musical statement. Given decent engineering, the interpretations would, perhaps, convey more than is apparent on this record, which is hollow in tone, full of distortion, and plagued with preëcho. H.G.

DVORAK: *Symphony in C minor, Op. 3 ("The Bells of Zlonice")*

Prague Symphony Orchestra, Vaclav Neumann, cond.

- ARTIA ALP 140. L.P. \$4.98.

DVORAK: *Symphony in B flat, Op. 4*

Prague Symphony Orchestra, Vaclav Neumann, cond.

- ARTIA ALP 141. L.P. \$4.98.

These two discs complete Artia's project of recording the four early Dvořák symphonies—the ones before the currently num-

Continued on page 84

ARCHIVE PRODUCTION

A thing of beauty is a joy for ever

IKÉATSI

FROM THE HISTORY OF OCCIDENTAL MUSIC
CLASSIFIED IN TWELVE RESEARCH PERIODS

From Research Period IX:

GEORGE FREDERICK HANDEL

Utrecht Te Deum

Jlse Wolf, Soprano · Helen Watts, Alto · Wilfred Brown, Tenor
Edgar Fleet, Tenor · Thomas Hemsley, Bass · Geraint Jones Singers
Geraint Jones Orchestra · Geraint Jones, Conductor

Jubilate

Jlse Wolf, Soprano · Helen Watts, Alto · Wilfred Brown, Tenor
Edgar Fleet, Tenor · Thomas Hemsley, Bass · Geraint Jones Singers
Geraint Jones Orchestra · Geraint Jones, Conductor

Four Coronation Anthems, Zadok, The Priest

Geraint Jones Singers · Geraint Jones Orchestra · Geraint Jones, Conductor

ARC 3133 - ARC 731 33 (Stereo)



DIRECT IMPORT

FACTORY SEALED

CIRCLE 71 ON READER-SERVICE CARD



\$288 includes cage

*... the finest performance available
in a stereo power amplifier*

McIntosh 240

Cooler Operating The 240 operates well within the long-life recommendations of the tube manufacturers. Put your hand on the transformers, you can feel the difference. This cooler operation assures you of long, trouble-free life.

Practical Flexibility Multiple input sensitivity ranges of the 240 make it easier to connect any preamplifier ... stereo or monophonic. McIntosh output facilities provides two 40 watt stereo channels or one 80 watt monophonic channel. Includes all voice coil impedances, 600 ohms and 70.7 volts.

Designed For A Long Life Traditional McIntosh design extends your investment through the years ... protects you against obsolescence.

Availability Your Franchised McIntosh Dealer has the 240 in stock now.

A "Mark of Excellence" Product by
CIRCLE 97 ON READER-SERVICE CARD

www.americanradiohistory.com

McIntosh
LABORATORY, INC.
4 Chambers St., Binghamton, N. Y.

bered five. At hand are the composer's very first two works in this form, both offered for the first time on discs. Both were written in 1865, and both are overloaded with thematic ideas not too well organized. But the germs of future masterpieces are to be found here—the darker aspects in the Symphony in C minor, the brighter ones in the Symphony in B flat, whose second movement is particularly appealing. Neumann gets about the maximum out of these scores, and with the exception of a wobbly-toned solo oboe, the orchestra plays well. The recorded sound is full and generally pleasing.

Though these two symphonies are inferior to Dvořák's more mature works, they provide an interesting historical background and prove that there is still something of

merit under the musical sun that hasn't been recorded to death. P.A.

DVORAK: Symphony No. 4, in G, Op. 88; Carnival Overture, Op. 92

London Symphony Orchestra, Antal Dorati, cond.

• • MERCURY SR 90236. SD. \$5.98.

The only thing that can be said about this record is that it is *loud*. Dorati rides roughshod over the music, stopping neither to phrase nor to allow for any subtle nuances. Though the stereo distribution is quite good, it is wasted on an insensitive reading. Szell's stereo Fourth is definitely to be preferred. P.A.

FRANCK: Grande pièce symphonique, Op.

17; Fantaisie in A, Op. 16; Pastorale, Op. 19

Marcel Dupré, organ.

• MERCURY MG 50228. LP. \$4.98.
• • MERCURY SR 90228. SD. \$5.98.

The eminent French organist, Marcel Dupré, has been making a series of records for Mercury on the Cavallé-Coll organ in the Gallery of the Church of St. Sulpice in Paris, of which this constitutes Volume 3. Though St. Sulpice was not Franck's church, its organ was built by the same man who constructed the instrument at Ste. Clotilde. Franck was one of the few nineteenth-century composers to leave exact instructions about the registration desired for the performance of their music. Since his indications were based on the instrument he knew best, the Cavallé-Coll organ at Ste. Clotilde, it should be possible to reproduce his ideas best on an instrument constructed by this same builder, and that is what has been attempted here.

There can be no question of the sincerity and devotion of Dupré's performances, but they are not of a nature to excite or stimulate the listener. Possibly the main reason for this is the music itself. Neither the *Grande pièce symphonique* nor the *Fantaisie* is inspired Franck, the former being an especially ponderous work. But Dupré elects to play them both at rather slow tempos and quite heavily, while the faster passage work in the *Grande pièce symphonique* is occasionally uneven. There is a further difficulty: the organ is not absolutely in tune, a flaw which shows up most obviously in the *Pastorale*.

The monophonic version is superior to the stereo, having a sharper sonic focus—though both are quite lifelike.

This recording of the *Fantaisie*, however, suffers in comparison with the one by Pierre Cochereau on the organ at Notre Dame (Omega); on that disc the focus was sharper, the sound a bit brighter, and the interpretation more animated and interesting. P.A.

GERSHWIN: Concerto in F; Rhapsody in Blue

André Previn, piano; Andre Kostelanetz and His Orchestra.

• COLUMBIA CL 1495. LP. \$3.98.
• • COLUMBIA CS 8286. SD. \$4.98.

GERSHWIN: Rhapsody in Blue; An American in Paris

Jesús María Sanromá, piano (in the *Rhapsody*); Pittsburgh Symphony Orchestra, William Steinberg, cond.

• • EVEREST SDBR 3067. SD. \$4.98.

Neither of these disc serves Gershwin as well as could have been expected. Previn and Kostelanetz invest the end movements of the *Concerto* with fine clarity and much spirit, but the middle movement is over-phrased, and there is too broad a jazz vibrato from the solo trumpet. As for the *Rhapsody*, it is rather raucously and unevenly played, with an inexcusable cut of about thirty-five measures in the middle. Disappointing, too, is the quality of the sound, especially that of the piano, which emerges in both versions with a particularly

Continued on page 86

LABOR OF LOVE

We are sometimes rudely reminded that producing records is a business. But it never stops being also a labor of love. Perhaps this is so because the performances we record are also a "labor of love." There is for example *Mogens Wöldike's* affectionate shaping of every phrase in Haydn's *Mass in Time of War*, and *Mischa Elman's* tender and penetrating treatment of three 18th century concertos, by Bach, Vivaldi and Nardini. There is the happy collaboration of violinist *Paul Makanowitzky* with conductor *Vladimir Golschmann* in Vivaldi's *La Cetra* (you'll also love the price of this Bach Guild special). Also, the haunting beauty of the voice of *Joan Baez* as she re-lives each folk song she sings, makes us proud to assist at the recording debut of a new star. In the same dedicated spirit the Vanguard engineers work out a *Lab Test Record* that will be a public service to all owners of stereo outfits.



Send for Catalogue to: Vanguard Recording Society, Inc., 154 West 14 Street, New York
CIRCLE 135 ON READER-SERVICE CARD

Frans Jozef Haydn
Mass in Time of War



HAYDN: MASS IN TIME OF WAR
Davrath, Rossi-Majdan, Dermota, Berry; Cho. & Orch., Wöldike cond.
Mono VRS-1061
Stereo VSD-2065

BACH: E MAJOR CONCERTO
VIVALDI: G MIN. CONCERTO
NARDINI: E MIN. CONCERTO
Mischa Elman, violin; Golschmann cond.
Mono VRS-1059
Stereo VSD-2073

VIVALDI: LA CETRA, OP. 9
(12 Concertos, complete)
Makanowitzky, violin; Chamber Orch., Golschmann cond.
A Bach Guild Anniversary Special.
3-12" Mono BG-607/9 \$9.98
Stereo BGS-5033/5 \$11.90

PURCELL: SUITES
(Abdelazer, Gordian Knot, Virtuous Wife, Married Beau).
Hartford Chamber Orch., Mahler cond.
Mono BG-605
Stereo BGS-5032

JOAN BAEZ
Accompanying herself on guitar.
Mono VRS-9078
Stereo VSD-2077

ENESCO: RUMANIAN RHAPSODIES 1 & 2
LISZT: HUNGARIAN RHAPSODIES 5 & 6
Golschmann & Fistoulari, cond.
Hi-Fi & Stereo Demonstration Disc.
Mono SRV-119 \$1.98
Stereo SRV-119SD \$2.98

VANGUARD STEREO LAB TEST RECORD
(For Aligning, Calibrating & Balancing Stereo Disc Playback Systems) VSD-100 \$2.98
Mono \$4.98, Stereo \$5.95. Except special price records listed above.



LOUIE and the DUKES OF DIXIELAND ... Another first in Dixieland Jazz by Audio Fidelity Records teams LOUIS ARMSTRONG with the DUKES. Outstanding! **AFLP1924/AFSD5924**



IRMA LA DOUCE ... Hit tunes from the new Broadway musical acclaimed in Europe. JO BASILE weaves a magical spell to set a new high fidelity recording standard. **AFLP1949/AFSD5949**

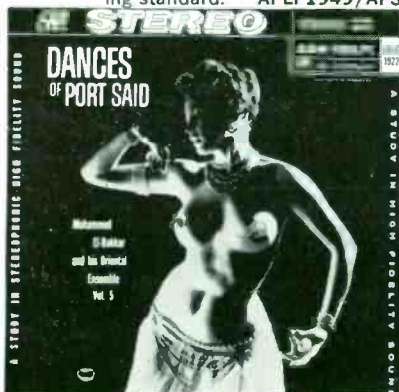

DANCES OF PORT SAID—Vol. 5 ... Provocative music of the Middle East with MOHAMMED EL-BAKKAR. Reeds, bells, cymbals, strings and native percussive devices. **AFLP1922/AFSD5922**

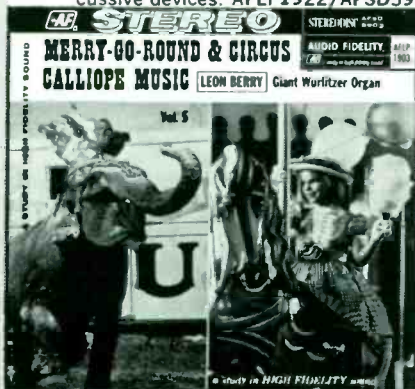

MERRY-GO-ROUND & CIRCUS CALLOPE MUSIC ... LEON BERRY at his joyful best. A carnival of sound ... bigger than Barnum, brighter than brass. **AFLP1903/AFSD5903**

NEW **AF** RELEASES

AUDIO FIDELITY

records with excitement!



MOSCOW WITH LOVE ... Haunting melodies of an ancient city, beautifully interpreted by the incomparable JO BASILE, accordion and orch. **AFLP1940/AFSD5940**



BANJO AT THE GASLIGHT CLUB ... Ever popular tunes bring back the care-free, speakeasy era with "Bye-Bye Blues", "Bill Bailey", "Shine On Harvest Moon". **AFLP1933/AFSD5933**



ENCORE ITALIANO ... Irrepressible JOHNNY PULEO and his Harmonica gang, display their rare expressive gifts in a creamy blend of popular espresso melodies. **AFLP1931/AFSD5931**



PERSONALITY SERIES
MYRON COHEN ... Master of dialect, Myron Cohen spins his celebrated and riotous yarns of human foibles, **AFLP701 ... \$4.98**

AFSD INDICATES RECORDS AVAILABLE IN STEREO ... \$6.95
EACH 12 INCH LONG PLAY ... \$5.95

For FREE catalogs and technical information on monaural and stereo records and tapes write: Dept. HF11 AUDIO FIDELITY, INC.
770 Eleventh Avenue, New York 19, N.Y.

CIRCLE 23 ON READER-SERVICE CARD

artificial, lifeless, and wooden tone.

Mercury's coupling of the Concerto and Rhapsody, with Eugene List and the Eastman-Rochester Symphony under Howard Hanson, is preferable in all respects.

Sanromá's conception of the Rhapsody is slower, more serious, and more analytical than either Previn's or List's. The piano, which has been well reproduced, stands out in bold relief from the orchestra, which is not quite as brightly recorded as on the Columbia or Mercury discs.

Steinberg, however, who sounds a trifle self-conscious in his accompaniment for the Rhapsody, is even more so in *An American in Paris*, and the whole work is played with a stiff literalness that suggests the conductor was more concerned with the instrumental

trees than with the jazz-oriented forest. Gershwin is obviously not the Pittsburghers' dish of tea. P.A.

GINASTERA: *Overture to the Creole Faust*
—See Still: *Sabdj*.

GRIGNY: *Organ Music*

Robert Lodine, organ.
● TONE 2. LP. \$4.98.

Nicolas de Grigny (1672-1703) published in 1699 a volume of organ music, containing a Mass and versets on five hymns. It is from this collection, which the young Bach copied out for himself, that the present selection is taken. The first side offers the

five versets on the Kyrie of the Mass and two of those on the Gloria. This is noble music, of a spiritual quality, and the third of the Kyrie versets—*Cromorne en taille à deux parties*—seemed to me particularly lovely. But it does not lend itself well to continuous listening because much of it has a sameness of texture—a florid line or lines over a slow-moving, sustained bass. In the hymn versets, on Side 2, the music is no less fine and the textures are more varied. Here I was especially struck by the *Point d'orgue sur les grands jeux*, in which Grigny sends his melodies cavorting over the firm rock of a bass tone sustained throughout. The performance, on an organ rebuilt by M. P. Möller in 1956 in the Hyde Park Baptist Church, Chicago, is good, and so is the recording. N.B.

GROFE: *Grand Canyon, Suite; Concerto for Piano and Orchestra*

Jesús María Sanromá, piano; Rochester Philharmonic, Ferde Grofé, cond.
● ● EVEREST SIDR 3044. SD. \$4.98.

The *Grand Canyon Suite* is too well known to warrant special comment at this late date; the Piano Concerto makes its initial appearance on this disc. It is little more than a gushing mass of treacly banalities peppered with a few dominant ninth chords and other pop-tune clichés. In this instance, the capable performances deserve better music. The sound is spectacular. H.G.

GUARNIERI: *Three Dances*—See Still: *Sabdj*.

HANDEL: *Acis and Galatea (excerpts)*

Maria Harvey (s), Galatea; Richard van Vrooman (t), Acis; David Bruce (bs), Polyphemus. Oberlin College Choir and Camerata Academica des Salzburger Mozarteums, Bernhard Paumgartner, cond.
● EPIC LC 3724. LP. \$4.98.
● ● EPIC BC 1095. SD. \$5.98.

With Oiseau-Lyre's splendidly performed, almost complete *Acis* available on two records, this highlight version has little to offer. The Camerata Academica plays very well, and Handeliens may be interested in comparing the individual tempos adopted by Paumgartner and Boult. But of the soloists, only Richard van Vrooman is up to scratch, and even he is never more than pleasant—no match for Pears. Galatea's arias just jog along, and the bass who takes the part of Polyphemus will destroy his basically sound voice in short order unless given some expert advice. Oberlin's choir, which performed the score with the Camerata under the Conservatory's "Salzburg Plan," sings with fair tone, good musicianship, and a rather jarring midwestern American accent. Sound in the stereo version is quite clear and spacious—I have not heard the monophonic. C.L.O.

HARKNESS: *Barcelona Suite; Gift of the Magi*

Symphony Orchestra, Sylvan Levin, cond.
● VANGUARD VRS 1058. LP. \$4.98.
● ● VANGUARD VSD 2071. SD. \$5.98.

Continued on page 88



In Audio, Edward Tatnall Canby says this regarding the Dual-1006:

"The MOST STARTLING thing

ABOUT THE DUAL-1006 is its unique method of record-indexing . . . using roller-feeler guides in the tonearm to find the lead-in groove for each record." **BUT OF PRIME SIGNIFICANCE** is the fact that this indexing concept eliminates the need for any mechanical linkages to the tonearm. When cycling, the tonearm is engaged only by a slip-clutch; during play it floats completely free. This ensures professional tonearm and turntable performance regardless of how you choose to play any of your records . . . *manual* single play, *automatic* single play, or *automatic* changer. (And this is the *only* machine that permits all three!) As Electronics World says, "Make sure the dealer demonstrates this one for you." \$79.95 at authorized dealers. Write for descriptive brochure, Dept. E-11.

united Audio

WIGO • PRODUCTS OF DISTINCTION • DUAL
12-14 W. 18th St., N. Y. 11, N. Y.



CIRCLE 52 ON READER-SERVICE CARD

ENGINEER'S MASTERPIECE

music lovers dream

The Patrician 700 is the most effective recreator of great music that has ever been made. And, while the exciting aspects of its physical design and performance are interesting to many, they should not and need not be misunderstood by those whose backgrounds lie in the creation and appreciation of music rather than in the means of reproducing it. For, if the Patrician 700 can reproduce with distinction the more esoteric sounds of earthquake, railroad train or thunderstorm, so can it recreate the sound of the big bass drum, the mighty pipe organ and the majestic sweep of the full symphony orchestra as can no other loudspeaker. It is for this reason that every music lover will be thrilled by the effortless ease with which the Patrician 700 handles large masses of sound, and the order it reveals in complex sonic tapestries—where lesser reproducers can present only chaos.

The world's greatest loudspeaker system is a fitting companion to the world's greatest music. Ownership of the Patrician 700 is an appropriate expression of devotion to the music you love.

Designed around the tremendous new Electro-Voice thirty-inch woofer, (1) the unparalleled might of the Patrician 700 in the region of deepest bass is a thing of fascination in itself, but this is only one facet of its truly fabulous overall performance. A premium quality 12" speaker, (2) heavily damped magnetically and mounted in a separate, liberally padded sub-enclosure, delivers solid and precise reproduction of midbass frequencies from 100 to 700 cps. The sound of the magnificent T250, (3) recently brought to a new height of excellence through closer specialization of its design to the requirements of the treble range, is outstandingly smooth, distortionless and free from peaks or unnatural colorations. The T350 very high frequency driver (4) adds a wonderful transparency to the clarity established in the midrange, maintaining its beautiful, shimmering sound undiminished to the limits of audibility, and having significant response as high as 40 kilocycles. In both the treble and high frequency ranges, E-V diffraction horns spread brilliance evenly over the whole listening area, illuminating the finest musical detail through perfect accuracy of reproduction.

True audiophiles need not restrict their enjoyment of owning this remarkable instrument to the purchase of the complete system—they can build the enclosure themselves, buy the individual components separately, or experiment with the development of their own original system incorporating these components. A booklet thoroughly describing the Patrician 700 is available on request.

You can order factory blueprints of the system direct from Electro-Voice for \$2.00. Or you can write for a special bulletin on the uses of the 30 W woofer which details enclosure and system design information.

Electro-Voice®

Dept. 11H Consumer Products Division
ELECTRO-VOICE, INC., BUCHANAN, MICHIGAN

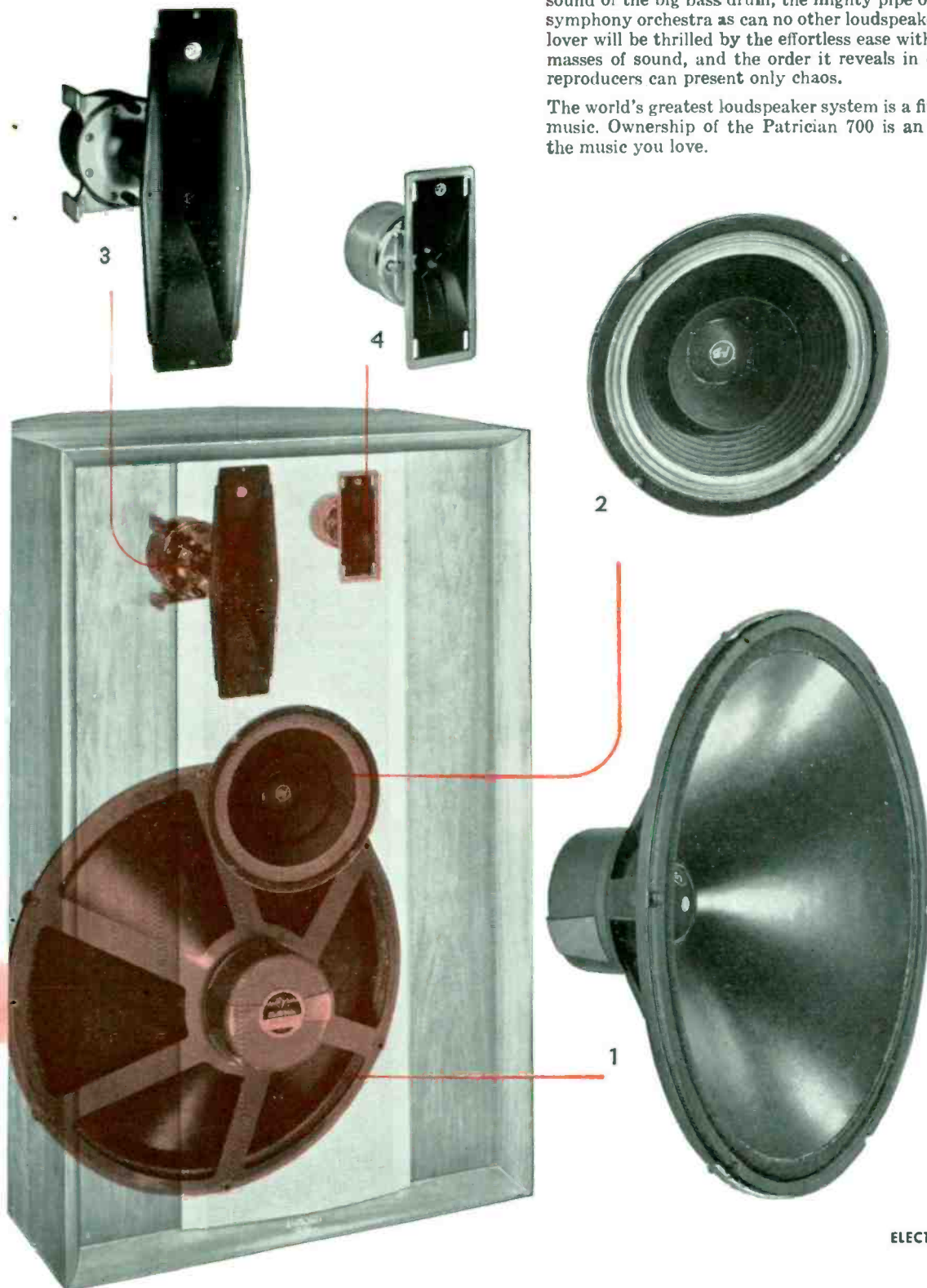

CIRCLE 60 ON READER-SERVICE CARD

Another in the series "Landmarks of American Music" sponsored by West Projects, Inc. Rebekah Harkness' *Barcelona Suite* has, we are told, been performed with great success in Tucson, Arizona, and that, apparently, makes it a landmark. Both works are such as any composer of background music for television turns out by the mile, but there are some pleasant tunes in *Gift of the Magi*, which is the score for a ballet based on O. Henry's famous story of that name. It is quite impossible, not knowing the score, to tell if music of this kind is well played or not; the recording seems to be quite good. A.F.

HAYDN: *The Creation*

Mimi Coertse, soprano; Julius Patzak, tenor;

Dezso Ernster, bass; Singverein of the Gesellschaft der Musikfreunde, Vienna; Orchestra of the Vienna Volksoper, Jascha Horenstein, cond.

• Vox PL 11452. Two L.P. \$9.96.

In no respect, unfortunately, does this recording compare favorably with the other two now in the catalogues. There are sections that are nicely done—the soprano aria "On Mighty Pens Uplifted" is one—but the general approach is lacking in finesse, none of the soloists is particularly distinguished, and the performance as a whole gives only fleeting glimpses into what Haydn was really after. Even technically the recording is not impeccable: there is a perceptible drop in pitch from the D major cadence of Uriel's *secco* recitative to the

D major opening, immediately following, of his "In Splendor Bright." The work is sung in German; no printed text is supplied. N.B.

HAYDN: *Symphony No. 103, in E flat ("Drum Roll"); Symphony No. 104, in D, ("London")*

Lamoureux Orchestra, Igor Markevitch, cond.

- Epic LC 3725. L.P. \$4.98.
- • Epic BC 1096. SD. \$5.98.

HAYDN: *Symphony No. 103, in E flat ("Drum Roll"); Symphony No. 94, in G ("Surprise")*

Philharmonia Hungarica, Antal Dorati, cond.

- • Mercury SR 90208. SD. \$5.98.

Neither of these discs really can compete with the Beecham performances in his complete edition of the Salomons. Dorati's performances are leaden, studied, and quite without the vivacity and grace the music requires. Markevitch gives No. 103 a moderately effective reading that smells slightly of Eau de Cologne, but his interpretative intrusions in the *London* Symphony are as vague in intention as they are ineffective.

The engineering of both discs is of only average quality. R.C.M.

IVES: *Symphony No. 2*

New York Philharmonic, Leonard Bernstein, cond.

- Columbia KL 5489. L.P. \$5.98.
- • Columbia KS 6155. SD. \$6.98.

For a feature review of this recording, see p. 75.

LISZT: *Concerto Pathétique, for Piano and Orchestra* (arr. Burmeister); *Spanish Rhapsody* (trans. Darvas)

Istvan Antal, piano; State Symphony Orchestra, Victor Vaszy, cond. (in the Concerto); Radio Symphony Orchestra, Gyorgy Lehel, cond. (in the Rhapsody).

- Parliament PLP 124. L.P. \$1.98.

The *Concerto Pathétique*, composed by Liszt for two pianos, was a recasting of a *Grand Solo de Concert*, for piano and orchestra, which in turn was a recasting of a *Grosses Konzertsolo*, for piano alone. According to the record notes, Richard Burmeister, a pupil of Liszt, freely reconstructed the *Concerto Pathétique* into a work for one piano and orchestra, as a vehicle for his concert tours. Nowhere along this complicated path has anything of consequence emerged, for the music, as it appears here, is clumsy, bombastic, tiresome, relieved only by a typically sentimental slow section, which gives Mr. Antal a chance to show how fine a pianist he can be. The work would make a suitable accompaniment to a silent film melodrama.

The excellent, if superficial, *Spanish Rhapsody* is moderately well known in its original solo version and in Busoni's arrangement for solo piano and orchestra. The version for orchestra alone (by a Hungarian composer) as played here is colorful enough,

Continued on page 90

GRADO "Truly the world's finest..."

NEW
LABORATORY SERIES TONE ARM



<p>Gunstock walnut wood Smaller in size and mass Vertical balance adjustment Lateral balance adjustment Tracking force adjustment</p>	<p>Vertical azimuth adjustment Interchangeable cartridges Adjustable overhang alignment Completely wired to preamp Ultrafine shielded cable</p>
---	---

LABORATORY SERIES TONE ARM \$39.50
With Custom Cartridge \$69.50 — With Master Cartridge \$85.00
Custom Cartridge \$32.50 — Master Cartridge \$49.50 — Micro Tone Arm \$29.95

For further information write: **GRADO LABORATORIES, INC.**
4614 Seventh Ave., Brooklyn 20, N. Y. • Export — Simonrice, 25 Warren St., N. Y. C.

CIRCLE 70 ON READER-SERVICE CARD

"... PERFORMANCES SHINE WITH LIGHT AND CLARITY, ARE PRECISELY AND ELEGANTLY PHRASED, GLEAMING IN TONE..."

HIGH FIDELITY MAGAZINE, JUNE 1960

"RICHTER'S VIRTUOSITY IS STAGGERING..."

"INCREDIBLE PRECISION..."

RECORD REVIEW, JUNE 1960

"... LEAVES NOTHING TO BE DESIRED..."

AMERICAN RECORD GUIDE, JUNE 1960



presents the world

renowned pianist

Sviatoslav Richter

in a series of new high fidelity recordings.



MUSSORGSKY
Pictures at an Exhibition
PROKOFIEV
Sonata No. 7 in B-Flat Major,
Opus 83
ALP 154



BACH
Concerto No. 1 in D Minor
PROKOFIEV
Concerto No. 1
in D Flat Major
ALP 123



BEETHOVEN
Sonata No. 8
in C Minor, Opus 13,
"Pathétique";
Eight Bagatelles
ALP 162

SUGGESTED LIST PRICE \$4.98

FIRST IMPORTS FROM THE USSR ON MK

TCHAIKOVSKY: Piano Concerto No. 1 in B Flat Minor, Op. 23, Leningrad Philharmonic, Mravinsky. **MK 1501**

BRAHMS: Piano Quintet in F Minor, Op. 34, Borodin Quartet. **MK 1516**

BEETHOVEN: Sonata No. 23 in F Minor, Op. 57 "Appassionata" **HAYDN:** Sonata in C Minor, Op. 20. **MK 1550**

SUGGESTED LIST PRICE \$5.98

AN INCREDIBLE BARGAIN ON PARLIAMENT

ONLY \$1.98

TCHAIKOVSKY: Piano Concerto No. 1, Czech Philharmonic Orchestra, Ancerl. **PLP 120**

RACHMANINOFF: Piano Concerto No. 2, Leningrad Philharmonic Orchestra, Sanderling. **PLP 134**

FOR FURTHER INFORMATION, PLEASE WRITE
ARTIA RECORDS, 38 WEST 48 STREET, NEW YORK 19, N. Y.

CIRCLE 15 ON READER-SERVICE CARD



mercury living presence



TCHAIKOVSKY Piano Concerto No. 1 in B flat minor. Byron Janis; London Symphony, Menges. SR90266/MG50266

BRAHMS Symphony No. 1 in C minor. London Symphony, Dorati. SR90268/MG50268

SUPPÉ OVERTURES: Poet and Peasant; Pique Dame; The Beautiful Galatea; Light Cavalry; Morning, Noon and Night in Vienna; Boccaccio. Detroit Symphony, Paray. SR90269/MG50269

PERGOLESÌ La Serva Padrona (complete). De luxe album with libretto booklet. Scotto, Bruscantini; Virtuosi di Roma, Fasano. SR90240/MG50240



SR90266/MG50266



SR90268/MG50268



SR90269/MG50269



SR90240/MG50240

OTHER OPERAS IN MERCURY LIVING PRESENCE

CHERUBINI Medea (complete). De luxe album with libretto booklet. Callas; Soloists, chorus, and orchestra of La Scala. Serafin. SR3-9000/OL3-104

DONIZETTI Lucia di Lammermoor (complete). De luxe album with libretto booklet. Di Stefano, Scotto, Bastianini; Chorus and orchestra of La Scala; Sanzogno. SR2-9008/OL2-108

PAISIELLO The Barber of Seville (complete). De luxe album with libretto booklet. Sciutti, Monti, Panerai, Capecchi; Virtuosi di Roma, Fasano. SR2-9010/OL2-110

SR indicates the stereo album number; MG, the monaural album number.

MERCURY RECORD CORPORATION
745 FIFTH AVENUE • NEW YORK 22, N.Y.

CIRCLE 99 ON READER-SERVICE CARD

London Symphony Orchestra, Sir Malcolm Sargent, cond.

• • EVEREST SDBR 3053. SD. \$4.98.

This is far more than just the sixteenth currently available recorded version of *Pictures from an Exhibition*. As a demonstration of how far the art of recording has progressed, it is one of the most convincing discs I have encountered. Moreover, the wonderfully spacious sound conveys a sensitive, transparent interpretation. And for once *The Great Gate at Kiev* comes as a glorious climax, without a trace of sonic distortion. Stereo addicts can have their gimmicked percussion, trains, auto races, and the like. For demonstrating or testing any stereo system, I'll cast my vote for this new, unbelievably lifelike *Pictures*. P.A.

ORFF: *Carmina Burana*

Janice Harsanyi, soprano; Rudolph Petrak, tenor; Harve Presnell, baritone; Rutgers University Choir; Philadelphia Orchestra, Eugene Ormandy, cond.

• COLUMBIA ML 5498. LP. \$4.98.

• • COLUMBIA MS 6163. SD. \$5.98.

Ormandy's performance is notably straightforward, emphasizing the tunefulness of the piece rather than its more sensational qualities. This, in other words, is an almost "classical" *Carmina Burana*, enhanced by superb recording and the most legible and eye-winning printing of the text in any American recorded edition. The principal soloist, Mr. Presnell, sings his part with rather more rubato than is necessary; he was "discovered" in Hollywood and here seems intent on finding his way back there as fast as possible. A.F.

PAGANINI: *Caprices for Unaccompanied Violin, Op. 1 (24)*

Ruggiero Ricci, violin.

• • LONDON CS 6163. SD. \$4.98.

If nothing else, this must be one of the longest microgroove records ever made. Normally, the traversal of the complete twenty-four caprices occupies four disc sides; here the whole thing is complete on two sides, with Side 1 running to 36:47 and Side 2 to 32:21. The main concern, however, is the music. Ricci doesn't rush in order to get it all in one disc, yet one sometimes has the feeling that he could have been a trifle more relaxed. He could also have been more careful about his intonation, which often gets thrown off kilter in the faster, more complex passages. The spirit of Paganinian virtuosity and display is certainly omnipresent in Ricci's playing; but I find the recent Capitol two-record album by Michael Rabin more pleasingly accurate in intonation, as well as highly satisfactory in performance. Though the sound is good, stereo for this work adds little. P.A.

PAISIELLO: *Il Barbiere di Siviglia*

Graziella Sciutti (s), Rosina; Nicola Monti (t), Count of Almaviva; Florindo Andreolli (t), Youthful and An Alcalde; Rolando Panerai (b), Figaro; Renato Capecchi (bs), Dr. Bartolo; Mario Petri (bs), Basilio; Leonardo Monreale (bs), Brightboy and A Notary. Virtuosi di Roma, Renato Fasano, cond.

- MERCURY OL 2 110. Two LP. \$9.96.
- • MERCURY SR 2-9010. Two SD. \$11.96.

For a feature review of this album, see p. 73.

PROKOFIEV: *Lieutenant Kije: Suite, Op. 60*—See Shostakovich: *Symphony No. 9, Op. 70.*

PROKOFIEV: *Quartet for Strings, No. 2; in F, Op. 92*—See Ravel: *Quartet in F for Strings*

PROKOFIEV: *Symphony No. 5, in B flat, Op. 100*

- Cleveland Orchestra, George Szell, cond.
- Epic LC 3688. LP. \$4.98.
 - • Epic BC 1079. SD. \$5.98.

Minneapolis Symphony Orchestra, Antal Dorati, cond.

- MERCURY MG 50258. LP. \$4.98.
- • MERCURY SR 90258. SD. \$5.98.

The Dorati is somewhat the bigger and more brilliant-sounding record, but the Szell is the finer, more carefully delineated interpretation. If the phrase "epic classicism" means anything (this, according to the composer's official biographer, Israel Nestyev, is the phrase for the Fifth Symphony), then Szell has it over Dorati. But if a very warm romanticism in the performance of this music is to your taste, Dorati certainly makes an eloquent case for your point of view. A.F.

PUCCHINI: *Turandot (highlights)*

Renata Tebaldi (s), Liù; Inge Borkh (s), Turandot; Mario del Monaco (t), Calaf; Renato Ficolani (t), Pong; Mario Carlin (t), Pang; Nicola Zaccaria (bs), Timur; Fernando Corena (bs), Ping; Ezio Giordano (bs), A Mandarin. Chorus and Orchestra of Accademia di Santa Cecilia (Rome), Alberto Erede, cond.

- • LONDON OS 25193. SD. \$5.98.

This collection of highlights from the stereo version of London's complete recording is distinguished primarily for Tebaldi's luminous singing of Liù's excerpts, Corena's pleasant rendition of "Ho una casa di Honan," and good sound. Borkh handles the rough tessitura of the last act well, and Del Monaco does a fairly smooth "Non piangere." (His "Nessun dorma" is less acceptable, though, despite the ringing high tones, and he does not approach Bjoerling.)

It should be noted that *Turandot* is poorly suited to the "highlight" form. There are few real set numbers, and *Turandot's* one big solo, "In questa reggia," is probably the dullest piece of extended writing ever perpetrated by the composer. As a result, there are some awkward breaks, and several sections are brought to an end only by virtue of the fade-out. C.L.O.

RACHMANINOFF: *Concerto for Piano and Orchestra, No. 2, in C minor, Op. 18*

Sviatoslav Richter, piano; Leningrad Philharmonic Orchestra, Kurt Sanderling, cond.

- PARLIAMENT PLP 134. LP. \$1.98.

For a feature review including this recording, see p. 74.



Deutsche
Grammophon
Gesellschaft



HIGHLIGHTS FROM THE GREAT D.G.G. LIBRARY

MOZART:

Don Giovanni (Complete) • Dietrich Fischer-Dieskau, Baritone • Sena Jurinac, Soprano • Maria Stader, Soprano • Irmgard Seefried, Soprano • Ernst Haefliger, Tenor • Other Soloists • RIAS Chamber Choir • Berlin Radio Symphony Orchestra • Ferenc Fricsay, Conductor DGMO-302, DGSO-7302*

HAYDN:

Missa Sanctae Caeciliae • Maria Stader, Soprano • Marga Hoeffgen, Alto • Richard Holm, Tenor • Josef Greindl, Bass and Choir.

HANDEL:

Organ Concerto in F Major • Michael Schneider, Organ • Symphony Orchestra of the Bavarian Radio • Eugen Jochum, Conductor. LPM 18545/46, SLPM 138028*/29*

STRAUSS, R.:

Der Rosenkavalier (Complete) • Marianne Schech, Soprano • Irmgard Seefried, Soprano • Rita Streich, Soprano • Kurt Bohme, Bass • Dietrich Fischer-Dieskau, Baritone • Other Soloists • Dresden State Opera Chorus • Saxon State Orchestra • Karl Bohm, Conductor. DGMR-301, DGSR-7301*

MOZART:

Piano Concerto No. 20 in D Minor, K. 466 • Sviatoslav Richter, Piano • Stanislaw Wislocki, Conductor.

PROKOFIEFF:

Piano Concerto No. 5 in C Major, Op. 55 • Sviatoslav Richter, Piano • National Philharmonic Symphony Orchestra of Warsaw • Witold Rowicki, Conductor. LPM 18595, SLPM 138075*

WEBER:

Der Freischutz (Complete) • Richard Holm, Tenor • Irmgard Seefried, Soprano • Rita Streich, Soprano • Eberhard Waechter, Baritone • Kurt Bohme, Bass • Other Soloists • Chorus and Orchestra of the Bavarian Radio • Eugen Jochum, Conductor. LPM 18639/40, SLPM 138639*/40*

LIEDER OF THE LATE ROMANTIC PERIOD:

Mahler, Pfitzner, Strauss • Dietrich Fischer-Dieskau, Baritone • Karl Engel, Piano. LPM 18590, SLPM 138058*

BERLIOZ:

La Damnation de Faust (Complete) • Consuelo Rubio, Mezzo-Soprano • Richard Verreau, Tenor • Michel Roux, Baritone • Pierre Mollet, Bass • Choeur Elizabeth Brasseur • Lamoureux Orchestra of Paris • Igor Markevitch, Conductor. LPM 18599/600, SLPM 138099*/100*

BRAHMS:

Symphony No. 4 in E Minor, Op. 98 • BEETHOVEN: *Namensfeier Overture, Op. 115* • Lamoureux Orchestra of Paris • Igor Markevitch, Conductor. DGM 12017, DGS 712017*

* Stereo

Distributed by

DECCA® DISTRIBUTING CORPORATION

CIRCLE 47 ON READER-SERVICE CARD

RAVEL: *Quartet for Strings, in F*
 †**Prokofiev:** *Quartet for Strings, No. 2, in F, Op. 92*

Carmirelli Quartet.

- LONDON CM 9251. LP. \$4.98.
- ● LONDON CS 6174. SD. \$5.98.

A notably warm, robust, and well-recorded Ravel, and a very good Prokofiev too. A.F.

RESPIGHI: *Fontane di Roma; Pini di Roma*

Chicago Symphony Orchestra, Fritz Reiner, cond.

- RCA VICTOR LM 2436. LP. \$4.98.
- ● RCA VICTOR LSC 2436. SD. \$5.98.

Whether the present choice of repertory is the conductor's own or that of his recording company, it turns out to be an almost classic example of miscasting. Although the scores of these showpieces are "read" with the customary Reiner precision, crystalline clarity of details, and tremendous—but always perfectly controlled—power, the music itself never has sounded more empty rhetorical. For the poetry and "atmosphere" that alone can redeem these works, one must turn to the far more sympathetic and evocative Goossens *Fountains* and Stokowski *Pines*. Technically, too, the latter recordings (Capitol and United Artists respectively) are more satisfactory over-all, for the RCA Victor engineers seem to have lost the magic touch that has distinguished their earlier (and later) series in Chicago's

Orchestra Hall. At its lower levels the extremely wide-range stereo disc boasts superbly rich, "floating" sonorities, but there is scant depth, and in the climaxes the high strings and brass are painfully intense and strident (qualities which must be attributed to the "master" recording rather than to the disc processing, since they are equally apparent in the simultaneously released 4-track tape version, FTC 2012, 37 min., \$8.25). These passages are more tolerable in the apparently less heavily modulated LP disc, but that seems tonally constricted even in the second pressing (distinguished by the matrix number K2 RP4734 6S on the *Fountains* side), which was hastily issued to replace the original "5S" edition. R.D.D.

SCHOENBERG: *Verklärte Nacht, Op. 4*
 †**Loeffler:** *A Pagan Poem, Op. 4*

Symphony Orchestra, Leopold Stokowski, cond.

- ● CAPITOL SP 8433. SD. \$5.98.

There ought always to be a Stokowski recording of *Verklärte Nacht* in the catalogues, just as there ought always to be a Beecham recording of the *Prague* Symphony or a Monteux recording of *La Mer*. This most obviously beautiful of Schoenberg's works is, to be sure, somewhat falsified in the string orchestra version; nevertheless Stokowski wrings a passion and loveliness out of it which are incomparable. In fact, it was Stokowski's 78-rpm recording of *Verklärte*

Nacht which, more than any other single thing, was responsible for Schoenberg's early reputation in this country, and one is happy to welcome the work back into the recorded repertoire in this interpretation.

It is now a quarter of a century since the death of Charles Martin Loeffler. He was a famous man in his time, but today he is almost totally forgotten, and only one short work of his has hitherto appeared in the LP lists. The *Pagan Poem* is based on the idyll of Theocritus called *The Sorceress*, wherein a young girl, deserted by her lover, tries, by means of magic, to lure him back. The work is scored for orchestra with obligato parts for piano, English horn, and three trumpets, which are heard backstage most of the way. This arrangement seemed very tricky when *A Pagan Poem* was new; now, however, the work sounds merely academic, well made, and about to burst at any given moment into Vincent d'Indy's *Symphony on a French Mountain Air*.

Loeffler's piece had one very important if quite unexpected result, however. Roger Sessions once heard it in concert, got interested in the poem, and ended up by setting the entire immense, unabridged, unbowdlerized thing for soprano and orchestra. This is the greatest American work yet written for voice and orchestra, and there is a gorgeous, little-known record of it, by Audrey Nossaman and the Louisville Orchestra, in the Louisville series. If you don't know this work

Continued on page 96

Columbia's brightest stars now appear on

24 AND 3 track stereophonic tape

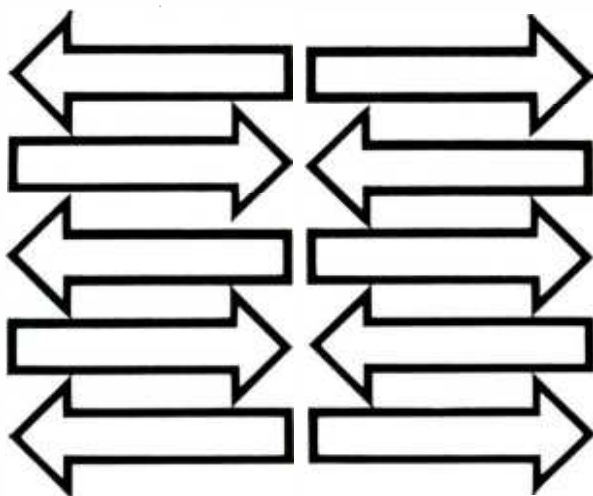

STARRING:

JOHNNY MATHIS

More Johnny's Greatest Hits
CQ 300 (4-track) / GCB 74 (2-track)

MITCH MILLER and the Gang

Christmas Sing-Along with Mitch
CQ 313 (4-track) / GCB 85 (2-track)

MY FAIR LADY—Original Broadway Cast

OQ 310 (4-track) / TOB 43 (2-track)

THE SOUND OF MUSIC—Original Broadway Cast

OQ 311 (4-track) / TOB 58 (2-track)

LEONARD BERNSTEIN conducting the Columbia Symphony Orch.

Gershwin: Rhapsody in Blue (Leonard Bernstein, soloist)

MQ 322 (4-track) / FMB 69 (2-track)

THE MORMON TABERNACLE CHOIR—The Spirit of Christmas

MQ 315 (4-track) / GMB 87 (2-track)

AND MANY MORE . . .

See your Columbia  dealer

CIRCLE 40 ON READER-SERVICE CARD

CLOSE-OUT

Reductions of 50% or more

Minimum Order—\$1.00

No C.O.D.'s or charge orders

Records in Review—1958

Contains reviews of classical and semiclassical music, and the spoken word, that appeared in HIGH FIDELITY Magazine from July 1957 through June 1958. The reviews discuss performances, interpretations, and sound qualities; in addition they compare recordings with earlier versions.

\$2.95

Also available at regular price

Records in Review—1959

\$5.95

FM Stations—1958

This booklet lists over 700 United States FM stations, taken directly from FCC records and accurate to January 2, 1958.

15¢ each.

HIGH FIDELITY Record Review Indexes

Indexes for 1954, 1955, 1956, 1957, 1958 are available at 25¢ each.

Each index is a complete listing of all classical, semi-classical, jazz, and spoken word reviews which appeared in HIGH FIDELITY Magazine for any given year. Each index is arranged alphabetically by composer or by collection-title, with the issue and page on which you will find the review you wish.

HIGH FIDELITY Magazine Great Barrington, Mass.

I enclose \$ for which please send me the following:

- copies Records in Review—1958 @ \$2.95
- copies Records in Review—1959 @ \$5.95
- copies 1954 Index @ 25¢
- copies 1955 Index @ 25¢
- copies 1956 Index @ 25¢
- copies 1957 Index @ 25¢
- copies 1958 Index @ 25¢
- copies FM Stations 1958 @ 15¢

NAME
STREET
CITY, STATE

audiolab TEST REPORT reprints

5¢ each

The "pull-no-punches" reports of high-fidelity equipment prepared by Hirsch-Houck Laboratories. Numbers 101 through 120 were published in 1958, and the last ten during 1959.

Use the coupon below to order any of the reports listed.

HIGH FIDELITY Magazine Great Barrington, Mass.

Please send me reprints of Audio Test Reports as checked here. I have indicated the quantity of each reprint I want in the space in front of the reprint title.

- | QUANTITY | EQUIPMENT |
|----------|--|
| — | 101 McIntosh C-B Audio Compensator |
| — | 102 Eico HF 52 Control Amplifier |
| — | 103 McIntosh MC-60 Power Amplifier |
| — | 104 Weathers K-730D Turntable and Pickup |
| — | 105 General Electric PA-20 Amplifier |
| — | 106 Gray 212 Tone Arm |
| — | 107 ESL C-60 Series Cartridge and Dust Bug |
| — | 108 Thorens Model TD 124 Turntable |
| — | 109 Shure Professional Dynetic Cartridge |
| — | 110 Harman-Kardon Solo II, Model TA-12 |
| — | 111 Sargent-Raymer SR-570 Power Amplifier |
| — | 112 Scott 330C FM-AM Tuner |
| — | 113 Marantz 40-Watt Power Amplifier |
| — | 114 Gray AM-3 Preamp-Control Unit |
| — | 115 Marantz Audio Console |
| — | 116 Chapman FM-AM-SW Tuner |
| — | 117 Scott 3108 FM Tuner |
| — | 118 Peri-50 Power Amplifier |
| — | 119 Connoisseur Turntable |
| — | 120 Norelco Magneto-Dynamic Cartridge |
| — | 121 Garrard 301 Turntable |
| — | 122 Fairchild 24B Stereo Preamplifier |
| — | 123 Connoisseur Mark II Pickup |
| — | 124 Miracord XS-200 Changer |
| — | 125 Pentron TM-4 Tape Deck and CA-13 Preamplifiers |
| — | 126 Stereotwin 200 Cartridge |
| — | 127 General Electric MS-4000 Stereo Amplifier |
| — | 128 Heath PT-1 AM-FM Stereo Tuner |
| — | 129 General Electric GC-5 Stereo Cartridge and TM-2G Stereo Tone Arm |
| — | 130 Bell 3030 Stereo Amplifier |

Name _____
Street _____
City, State _____

of Sessions, don't grow much older before you do. A.F.

SCHUMANN: Concerto for Piano and Orchestra, in A minor, Op. 54

†Chopin: *Concerto for Piano and Orchestra, No. 2, in F minor, Op. 21*

Eugene Istomin, piano; Columbia Symphony Orchestra, Bruno Walter, cond. (in the Schumann); Philadelphia Orchestra, Eugene Ormandy, cond. (in the Chopin).

- COLUMBIA ML 5494. LP. \$4.98.
- • COLUMBIA MS 6159. SD. \$5.98.

Istomin and Walter give the work a "Eusebius" reading that stresses genial lilt and

sailboat like grace. In contrast to this, the Fleisher-Szell conception—which I happen to prefer—has powerful phrase-tensions and architectural underlining that give their interpretation a decidedly Florestanian impact. Walter's contribution is magnificent. His Schumann conducting has an ideal *Sturm und Drang* surge and a golden tonal glow. (How about a complete set of the symphonies, Columbia?)

Mr. Istomin plays the Schumann with such admirable taste and restraint that I was rather shocked and disheartened by his Chopin performance overside. Chopin's music has been subjected to prolonged abuse from pianists, and it is high time that they stopped declaring open season on it. Istomin's fussy aberrations and salon rubato

are as unsuitable for the honest simplicity of the F minor Concerto as a hot-fudge topping would be for pot roast. Ormandy accompanies well, but his orchestra is too large and the opening tutti is foreshortened. Excellent sound in both editions, with a little more fullness in the two-channel version. H.G.

SHOSTAKOVICH: Symphony No. 9, Op. 70

†Prokofiev: *Lieutenant Kije: Suite, Op. 60*

London Symphony Orchestra, Sir Malcolm Sargent, cond.

- EVEREST LPBR 6054. LP. \$4.40.
- • EVEREST SDBR 3054. SD. \$4.40.

Shostakovich's Ninth Symphony had a bad press when it was new because ninth symphonies are supposed to be big and noisy and dedicated to what H. L. Mencken used to call The Uplift; what, then, can you do with a composer who has written several big, noisy, heroic symphonies but whose ninth work in this form turns out to be his shortest, his most lighthearted and ebullient? You can call "Off with his head!" as critics in Russia and elsewhere did in 1945—but fifteen years later the piece is still going strong and is one of the most completely delightful things Shostakovich has to his credit; nowhere is his mastery of the satiric and grotesque so perfectly displayed. This is by far the best record of it in current catalogues, both in performance and registration.

As to the piece on the other side—everybody plays *Lieutenant Kije* well, so why not one of the half dozen finest conductors in Britain? A.F.

STILL: *Sahjji*

†Guarnieri: *Three Dances*

†Ginastera: *Overture to the Creole Faust*

Eastman-Rochester Orchestra, Howard Hanson, cond.

- MERCURY MG 50257. LP. \$4.98.
- • MERCURY SR 90257. SD. \$5.98.

The tremendous ferment now at work in Negro Africa is bound to have enormous cultural repercussions, and must certainly arouse curiosity regarding the present state of cultural affairs in that part of the world. Folkways has quite a few good records of African folk music and a disc of an extremely interesting American work, the *Dahomey Suite*, for oboe and piano, by Mieczyslaw Kolinski. William Grant Still's trashy ballet will not do, however. The pieces on the other side are trash, too, but rather more sophisticated in their structure. Camargo Guarnieri's *Three Dances* are on Brazilian folk themes and go through the standard paces. Alberto Ginastera's *Overture to the Creole Faust* is actually a kind of tone poem based on the *Faust* of Estanislao de Campo. In this literary work an Argentine cowboy goes to Buenos Aires and attends a performance of Gounod's opera. On his way home he tells a rustic friend all about it—and in this way De Campo retells the *Faust* legend and adds his own philosophic comment to it. Ginastera's overture is full of themes from Gounod, some of them woven together with Argentine country dance material and some han-

A MOST UNUSUAL OFFER from Tandberg

ONE OF THE WORLD'S MOST RESPECTED NAMES IN HIGH FIDELITY TAPE RECORDERS.

ASK YOUR DEALER TO DEMONSTRATE ANY TANDBERG MODEL

See and hear for yourself the magnificent clarity that can be yours with a Tandberg Series 5 recorder/playback... the first self-contained, fully portable stereo-monaural 3 speed, 4 track system.

Or, listen to the incomparable response from the Tandberg 6 Stereo Tape Deck with 3 separate heads, push button control, plus portable or built-in versatility. Then, investigate the Tandberg Series 2, 3 or 4... those excellent general purpose recorders that have no peer in value or economy.



Model 5
from \$419 retail

ALL TANDBERG UNITS FEATURE 1 7/8 I.P.S. . . . "THE PROFESSIONAL'S SPEED OF THE FUTURE"

If you decide to buy any new Tandberg unit between Sept. 1, 1960 and Nov. 30, 1960 you may select, as your own, any 1 of these valuable gifts . . .

SPEAKER

An 8" Tandberg hi-fi component for added versatility. Dual cone type. Model #165-BK



TAPES

3 large 1200 ft., fine quality 7" lp plastic tapes with metallized leader. Model #1251



MICROPHONE

A new Tandberg design, mounted in shock insulated cover; with desk stand attachment. Model #CM-6



SEE YOUR AUTHORIZED TANDBERG DEALER OR
WRITE FOR THE NAME OF THE FIRM NEAREST YOU.

Tandberg of America, Inc. 8 Third Ave., Pelham, N. Y.

CIRCLE 125 ON READER-SERVICE CARD

Continued on page 98

Epic Records seeks out the unique qualities of music, the most provocative and unconventional (listen to the explorations in sound of "Ping Pong Percussion" or the wild gypsy spirit of the Hungarian ballet troupe). Epic's recording artists reflect this vital repertoire—it is impossible to remain unstirred by the genius of Eduard van Beinum or the guitar-plucking glee of the Raunch Hands. The wonderful surprise of music is always yours on Epic Records.



CLASSICS...

GRIEG: TWO ELEGIAC MELODIES, Op. 34;
 PEER GYNT—SUITE No. 1, Op. 46;
 PEER GYNT—SUITE No. 2, Op. 55.
 Eduard van Beinum and Jean
 Fournet conducting the Concertgebouw
 Orchestra of Amsterdam;
 Annette de la Bije, Soprano
 LC 3732/BC 1099*

MEDELSSOHN: SYMPHONY
 NO 4 IN A MAJOR, Op. 90
 ("ITALIAN"); BRAHMS:
 VARIATIONS ON A THEME BY
 HAYDN, Op. 56a ("ST. ANTHONY
 CHORALE") Vienna Symphony
 Orchestra/Wolfgang Sawallisch,
 Conductor
 LC 3731/BC 1098*

CLAIR DE LUNE—A DEBUSSY
 RECITAL: Première performance of
 Giesecking's protégé, pianist Werner
 Haas
 LC 3733/BC 1100*

THE HUNGARIAN NATIONAL
 BALLET COMPANY—A Program of
 Songs and Dances
 LC 3735/BC 1102*

HANDEL: ORGAN CONCERTOS,
 Op. 4, Nos. 1-3—The only single
 recording of these works in stereo—
 Johannes Ernst Köhler, Organist;
 String Orchestra of the Leipzig
 Gewandhaus Orchestra/Kurt Thomas,
 Conductor
 LC 3734/BC 1101*

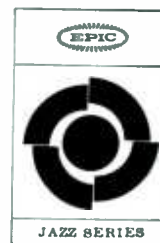

**THE ACT OF JAZZ—
 John Mehegan—A
 fascinating explanation
 and illustration of an
 actual jazz performance
 LA 16007/BA 17007***

**ONE FOOT IN THE
 GUTTER—A
 jam session recorded
 before a live audience—
 Dave Bailey and his
 Sextet
 LA 16008/BA 17008***

**PARIS CONCERT—
 Recorded live at Olympia
 Music Hall in Paris—
 Art Blakey's Jazz
 Messengers
 LA 16009**

NOVELTY...

PING PONG PERCUSSION—Musical
 fireworks showcasing the entire range
 of percussion instruments
 Chuck Sagle and Orchestra
 LN 3696/BN 568*

ANYONE CAN PLAY BONGOS—Oral and
 written instructions by virtuoso bongo
 player Willie Rodriguez with Chuck Sagle
 and his Orchestra
 LN 3741/BN 583*

THE RAUNCH HANDS PICKIN' AND
 SINGIN'—A lively group of button-down
 folk singers with material to match
 LN 3698

*Stereorama

CIRCLE 61 ON READER-SERVICE CARD



WEATHERS

TrioPhonic **STEREO**

**WITH ITS OWN BASS AMPLIFIER
GIVES YOU UNPARALLELED
BASS REPRODUCTION!**

You asked for it! . . . Now after intensive research and engineering design, Weathers has developed a remarkable non-directional bass with its own amplifier! . . . enables you to enjoy the finest true stereo and you don't have to buy an extra amplifier! You'll be introduced to the wonderful miracle of "equalized sound" . . . Weathers calls it TrioPhonic Stereo! Sit anywhere in your room and experience the same magnificent tonal realism and fidelity of full-range stereo! This amazing new audio dimension is produced by two book-size Harmony stereo speakers, plus Weathers unique non-directional hideaway bass with its own amplifier. Smartly designed like a book, you can place your Harmony speakers on shelf, table or inconspicuously in your library . . . tuck the non-directional bass under sofa or chair. Space and sound problems solved with one sensational stereo speaker system!

Harmony Speaker each, **\$29.75**
 Bass Speaker and Amplifier **\$119.50**
 Use bass speaker and amplifier with your present speaker system to extend the low frequency response

For free folder about TrioPhonic Stereo or the name of nearest dealer, write to:

WEATHERS INDUSTRIES

DIVISION OF ADVANCE INDUSTRIES, INC.
 66 E. Gloucester Pike, Barrington, N. J.

"Weathers Technical Magic is Sound"

CIRCLE 136 ON READER-SERVICE CARD

dled in elaborate counterpoint. The total effect is to increase one's affection for Gounod. A.F.

STRAUSS, JOHANN II: *Die Fledermaus*

Gerta Scheyrer (s), Rosalinda; Wilma Lipp (s), Adele; Louise Martini (ms), Ida; Christa Ludwig (ms), Orlofsky; Anton Dermota (t), Alfred; Karl Terkal (t) and Fred Liewehr (speaker), Eisenstein; Erich Majkut (t), Dr. Blind; Eberhard Waechter (b), Dr. Falke; Walter Berry (b), Frank; Erich Kunz (speaker), Frosch. Philharmonia Chorus and Orchestra, Otto Ackermann, cond.

- ANGEL 3581 B/L. Two LP. \$10.96.
- ● ANGEL 3581 S/L. Two SD. \$12.96.

There is nothing really objectionable about this performance, but its total effect is somewhat staid and not very exhilarating. Most of the responsibility lies, I'm afraid, with the late Otto Ackermann, who favors a smooth, reasonable (!) reading that never quite takes wing. Polished as the Philharmonia's playing is, the feeling persists right from the overture on that Ackermann isn't really digging into the score.

The Rosalinda of Gerta Scheyrer, a singer new to me, is quite adequate, both vocally and histrionically, but she does not bring to the role the aura of *Weltklasse* that would carry the recording. If I remember Wilma Lipp's Adele of the Clemens Krauss set aright, there was more quicksilver to it in its earlier incarnation, though it's still fresh and free. Ludwig sings well, but makes too much of a good thing with Orlofsky's accent. Dermota and Terkal are both excellent, as are Kunz and Majkut in their smaller assignments. Berry and Waechter are solid enough, though the latter is a bit thick-sounding in the Act II finale. The sound is fine in both editions, though the listening level of the dialogue is much better in the stereo version. C.L.O.

TCHAIKOVSKY: *Symphony No. 6, in B minor, Op. 74 ("Pathétique")*

Philadelphia Orchestra, Eugene Ormandy, cond.

- COLUMBIA ML 5495. LP. \$4.98.
- ● COLUMBIA MS 6160. SD. \$5.98.

The *Pathétique* is an old favorite of Ormandy's. He has recorded it on earlier occasions, most notably on an older Columbia LP. There his reading was full of passion and fire but here I find it on the cautious side. Everything is set forth with the utmost clarity, and as usual, is exquisitely played by the magnificent Philadelphia Orchestra. But there is a certain spark missing, especially in the two middle movements, which lack rhythmic buoyancy. Columbia's sonics leave nothing to be desired, either in the well-rounded monophonic version or in the admirably distributed stereo edition. From the standpoint of interpretation, however, my choice still rests with Monteux. P.A.

VERDI: *Overtures*

Philharmonia Promenade Orchestra, Charles Mackerras, cond.

- ANGEL 35751. LP. \$4.98.
- ● ANGEL S 35751. SD. \$5.98.

This collection contains some unusual items

as well as oft-played popular favorites. The crudely bombastic opera *Alzira* is justifiably regarded by Verdians with embarrassment and condescension. Its overture, however, is worth an occasional hearing, potboiler though it is. Much more attractive are the colorful ballet interludes in *I Vespri* and *Il Trovatore* (written for the Paris production of the opera). Mackerras secures crisp, energetic playing from the orchestra; and although he doesn't point up felicities in the music with the sensitivity of a Toscanini, he is much more attentive to the finer dynamic markings and instrumental blends than most conductors are in this not-so-subtle repertory. H.G.

VERDI: *La Traviata*

Victoria de los Angeles (s), Violetta; Silvia Bertona (s), Annina; Santa Chissari (ms), Flora Bervoix; Carlo del Monte (t), Alfredo; Sergio Tedesco (t), Gastone; Renato Ercolani (t), Giuseppe; Mario Sereni (b), Germont; Vico Polotto (b), Douphol; Silvio Maionica (bs), D'Obigny; Bonaldo Giaiotta (bs), Dr. Grenvil. Chorus and Orchestra of the Rome Royal Opera, Tullio Serafin, cond.

- CAPITOL GAR 7221. Three LP. \$17.94.
- ● CAPITOL GCR 7221. Three SD. \$20.94.

I have never been happy with Tullio Serafin's Angel recording of *La Traviata*, and while some of the difficulties can be traced to the unattractive singing of the principals, others are the Maestro's own responsibility. His Angel reading strikes me as jerky and diffuse, inordinately dragged-out in some passages, precipitate in others (as in the big ensemble finale of Act III). His new effort is in better balance, and much less arbitrary-sounding, but it still does not have the tightness or incisiveness that seems to me essential. I might add that I say this as a devotee not of the Toscanini *Traviata*, but of the Monteux, which is far from a sledgehammer interpretation.

De los Angeles fans will want the recording come what may, and they won't be disappointed. As sheer singing, her Violetta couldn't be better, even in the florid Act I music which has given her some trouble in the opera house. Nevertheless, I listened straight through the opera dry-eyed, and had difficulty even paying proper attention during the key Violetta/Germont scene. This is partly because the admirable De los Angeles restraint (is she never going to do the Marschallin for us?) is misplaced in many of these bars, and partly because Sereni does not really take command of his music. After an initial Metropolitan season in ill-chosen roles, this warm-voiced baritone has settled into well-routined performances in lyric parts, but he is hardly a galvanic artist. Carlo del Monte nurses his slender resources along quite creditably, and comes up with an Alfredo preferable to Poggi's or Francesco Albanese's, although it's never exciting. Capitol's sound is topnotch, whether you prefer the monophonic edition or the stereo. I have a preference for the stereo edition, both for the greater clarity and depth in the ensembles and for the sense of distance imparted to the revelers' music in the last act—an excellent effect. C.L.O.



Verdi's "Heart-Felt Impulse..."



"A heart-felt impulse... a crying need," compelled Verdi to compose his Requiem Mass.

Maestro Tullio Serafin, the world's foremost interpreter of Verdi's music, captures this passion in a truly definitive

recording of what many music lovers, including George Bernard Shaw, consider the greatest work of the Italian master.

Featuring the Orchestra and Chorus of the Opera House, Rome, and four distinguished soloists.

Deluxe boxed album: 2 records, Latin-English libretto. (S)GBR 7227



Ravel's luminous piano colors glow under Pennario's brilliance. *Le Tombeau de Couperin, Pavane pour une Infante défunte, Jeux d'eau, Sonatine.* (S)P 8533



For the first time in stereo! An incomparable performance by "the greatest of contemporary sopranos." (*High Fidelity*) 3 records, libretto. (S)GCR7221

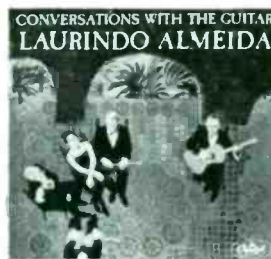

Almeida's fluent guitar speaks with clarinet, flute, viola and voice in tones old and new, exciting and serene. Gifted Miss Salli Terri sings. (S)P 8532



Erich Leinsdorf and Capitol engineers respond to Tchaikovsky's emotional demands with incredibly wide dynamic range. (S)P 8530



Sir Thomas Beecham's first recording of the Seventh is "fit to take its place with the very best on record." (*Gramophone Record Review*) (S)G 7223



The stamp of Stokowski's genius imprints a rich, new dimension on the best known compositions of Schönberg, Loeffler. (S)P 8433

Album numbers shown are for stereo; omit prefix (S) for monophonic.



©CAPITOL RECORDS, INC.

FREE! BRILLIANT 64-PAGE COLOR CATALOG

570 classical and popular albums fully described and illustrated. Write today: Capitol Records, Dept. L, 1750 N. Vine Street, Hollywood 28, California

Name _____
 Street & Number _____
 City & State _____

CIRCLE 36 ON READER-SERVICE CARD

KLEMPERER conducts WAGNER



THE PHILHARMONIA ORCHESTRA

“It is plain from these four sides that Klemperer is a great Wagner conductor, probably the greatest in the world.”

(The Gramophone)



To celebrate the 75th Anniversary of Otto Klemperer, Angel Records proudly releases this 2-record set of magnificent interpretations of the orchestral Wagner.

Included are:

RIENZI, Overture

DER FLIEGENDE HOLLÄNDER, Overture

TANNHÄUSER, Overture

LOHENGRIN, Preludes to Acts I & III

DIE MEISTERSINGER VON NÜRNBERG, Overture & Dance
of the Apprentices and Entry of the Masters

TRISTAN UND ISOLDE, Prelude & Liebestod

GÖTTERDÄMMERUNG, Siegfried's Funeral March

Also available by Klemperer, “the supreme interpreter of the classics”
(London Observer)

THE COMPLETE BEETHOVEN SYMPHONIES

THE COMPLETE BRAHMS SYMPHONIES

ANGEL 

VIVALDI: *Concertos: in C, P. 73; in D minor, P. 310; in D, P. 155* (“*Del gardellino*”); *in C, P. 50; in G, P. 143; in G minor, P. 360. Sinfonia in B minor* (“*Al Santo Sepolcro*”); *Trio in C for Violin, Lute, and Continuo, in C; Sonata for Two Violins and Continuo, in F*

New York Sinfonietta, Max Goberman, cond.

• • Library of Recorded Masterpieces, Vol. 1: Nos. 5 (P. 73, 310, 155, Trio) and 6 (P. 50, 143, 360, Sinfonia, Sonata). Two SD. \$8.50 each on subscription; \$10 each non-subscription.

Another interesting and varied batch of works, at least four of them (P. 50, 155, 310, 360) apparently not otherwise available on records. P. 310, a violin concerto, is a stunt piece: the soloist is not supposed to use his E string at all, and for the finale he is instructed to tune his G string up to A. But in addition to tricks this finale has a good deal of feeling and some harmonic pungency. P. 155 and 360 are not concertos in the modern sense but pieces for flute, oboe, violin, bassoon, and continuo. The former (*Of the Goldfinch*) has a chirpy, perky first movement that put me in mind of the ritornel of a Gilbert and Sullivan song. The slow movement of this work is for flute and bassoon alone, but a harpsichord has been added here, to good effect. Other sections that struck me as especially appealing are the jolly first movement of P. 73 and the fine one of P. 50. The most impressive piece of all is the Sinfonia. Unfortunately it is just this gem that is cut, some thirteen Adagio measures being excised—the only occasion in the whole series so far where the performances have not been completely faithful to the Ricordi scores, which are bound into each album. Once more, as in earlier volumes, the continuo is imaginatively realized, especially in P. 310 and 155.

Stereo is sometimes used effectively, as in the sonata, where the two violins are clearly separated. But at other times its possibilities seem to have been overlooked: a more noticeable division of the oboes in P. 73 and the first and second violins in the finale of P. 50 would have been advantageous. Except for portions of the Trio, where the lute is too far forward, and of P. 50, where the oboe is similarly dominant, the balances are good and the sound in general realistic. N.B.

WAGNER: *Tannhäuser: Act II: Introduction; “Dich, teure Halle”; “Dich treff’ ich hier”; Arrival of the Guests and Speech of the Landgrave. Götterdämmerung: “Hier sitz’ ich zur Wacht” (Hagen’s Watch); “Hoibo! Hoibo!” (Hagen’s Call and Gathering of the Vassals)*

Elisabeth Grümmer, soprano; Gottlob Frick, bass. Chorus and Orchestra of the German State Opera (Berlin), Franz Konwitschny, cond.

• ANGEL 35844. LP. \$4.98.

• • ANGEL S 35844. SD. \$5.98.

This recording can be recommended solely on the basis of Frick’s work. This bass is one of the very few contemporary German male singers to employ what most of us regard as a “singing” tone, with at least some vibrato and forward roll, as opposed to flat func-

CIRCLE 12 ON READER-SERVICE CARD

tional bellow, and the rich, weighty tone puts his voicing of Hagen's excerpts very close to the classic ones by Weber and Andresen. His singing of the Landgrave's music (practically the entire role) is even more exciting; the Landgrave is so often little more than a befuddled onlooker that one is shocked to hear the role brought to life—a most rewarding experience. "Dich, teure Halle" proves rather heavy sledding for Grümmer, whose voice simply hasn't the color or thrust needed for the music.

Konwitschny does an orderly job with the big *Tannhäuser* processional, but Hagen's Call and the assembling of the vassals is pretty tame. It is really impossible to pass judgment on the chorus, for the harsh and over-reverberant recording makes aural slush of all the mass effects. Few stereo releases have brought us such unnatural quality or such poor definition, and the collector may as well save money with the mono-phonics edition. C.L.O.

RECITALS AND MISCELLANY

E. POWER BIGGS: "The Organ in America"

E. Power Biggs, organ.

- COLUMBIA ML 5496. L.P. \$4.98.
- • COLUMBIA MS 6161. SD. \$5.98.

When we think of historic organs, we almost always think of European cathedrals, but there are many elegant old organs in American churches and historical societies, as a photo spread in this magazine recently proved ("America Has Old Organs, Too," August 1960). E. Power Biggs here provides nine American compositions on seven of these instruments. Included among the nine compositions are James Hewitt's *The Battle of Trenton* (which sounds quite dull on the organ compared to Richard Bales's orchestral transcription of it in *The American Revolution* album), Billings' inevitable *Chester*, and Philip Phile's *President's March*, better known as *Hail, Columbia*. The best things here, however, are a fugue by the little-known but very able contrapuntist William Selby of Boston; a sonata by John Christopher Moller, in the Mozartean style; Oliver Shaw's priceless Victorian descriptive piece *A Trip to Pawtucket* (from Providence, where the composer lived); and Charles Ives's *Variations on "America"*.

This last is the most important thing in the set. We hear much about Ives the organist—in fact, the organ in the New England church is to the Ives legend as cut-off ears are to the legend of Van Gogh—but we hear little of Ives's own organ music, and this is the first sample of it to be recorded. Ives composed these variations in 1891, when he was sixteen years old, but the piece nevertheless contains bitonal passages and some of the grandest dissonances ever snorted by a Congregationalist keyboard.

The sounds of the seven organs involved have been perfectly recorded, and they are all enchanting to hear. All have the clear, firm, transparent timbre which is the true, classic organ tone, though some are almost as small as music boxes in their volume and

THE BOLD

SO SOUND

OF

TIME

SERIES 2000

FOR THOSE WHO DARE! The dramatic achievement of TIME's SERIES 2000 has electrified the entire world of recorded music. Reviewers and musicians alike have greeted this new series with words like... "outstanding sound quality"... "sweeping, imaginative arrangements"... "impeccable"... "the most advanced recording on any label." TIME's SERIES 2000 has attained new heights of consistent distinction and musical excitement without tricks or "gimmicks," through the unstinting, imaginative cooperation of the finest arrangers, musicians and recording engineers in the field, using the most advanced equipment and techniques yet developed. NOW, HEAR THE BOLD NEW SOUND OF TIME IN FULL-RANGE STEREO AND MONAURAL RECORDS, AND 4-TRACK STEREO TAPE.



Pure excitement in music, magnificently scored for a big brass-and-percussion group by Hugo Montenegro. 12 selections in this big album ranging from *Slaughter on Tenth Avenue* to *In the Hall of the Mountain King*, *Limehouse Blues* to *Laura* and *Take the A Train*. S/2014, Mono 52014

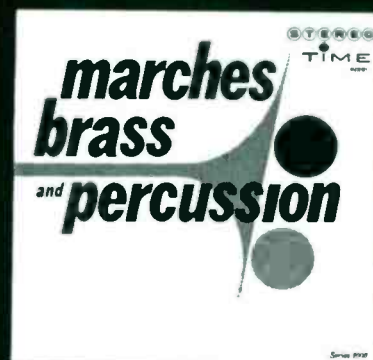

The truly great marches of all time, scored by Kermit Leslie for 29 brass and percussion, in stirring, overwhelming stereophonic sound: *The Thunderer*, *El Capitan*, *Washington Post March*, *Stars & Stripes Forever*, *Field Artillery*, *Col. Bogey*, *On the Mall*, etc. S/2017, Mono 52017

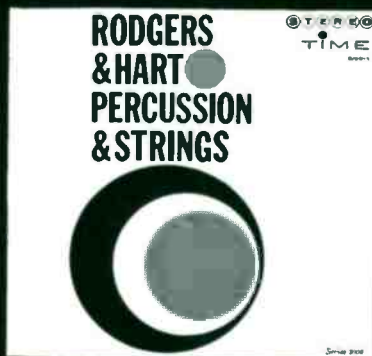

The deathless songs that made Rodgers & Hart favorites, exquisitely arranged for a powerful orchestra of strings, percussion and trombones by George Siravo: *Where or When*, *Funny Valentine*, *Blue Moon*, *Lady is a Tramp*, *My Heart Stood Still*, etc. S/2015, Mono 52015



All the richness and melodic flow of Kern, arranged and conducted by Hal Mooney with a big, rich orchestra for all-encompassing sound: *Who, Ol' Man River*, *Last Time I Saw Paris*, *Make Believe*, *Smoke Gets In Your Eyes* and seven other favorites. S/2012, Mono 52012

STEREO RECORDS \$5.98 ■ MONAURAL RECORDS \$4.98 ■ 4-TRACK STEREO TAPE \$7.95

Send for complete catalog of the full TIME SERIES 2000 TIME RECORDS INC. 2 W. 45 St., N. Y.

CIRCLE 127 ON READER-SERVICE CARD

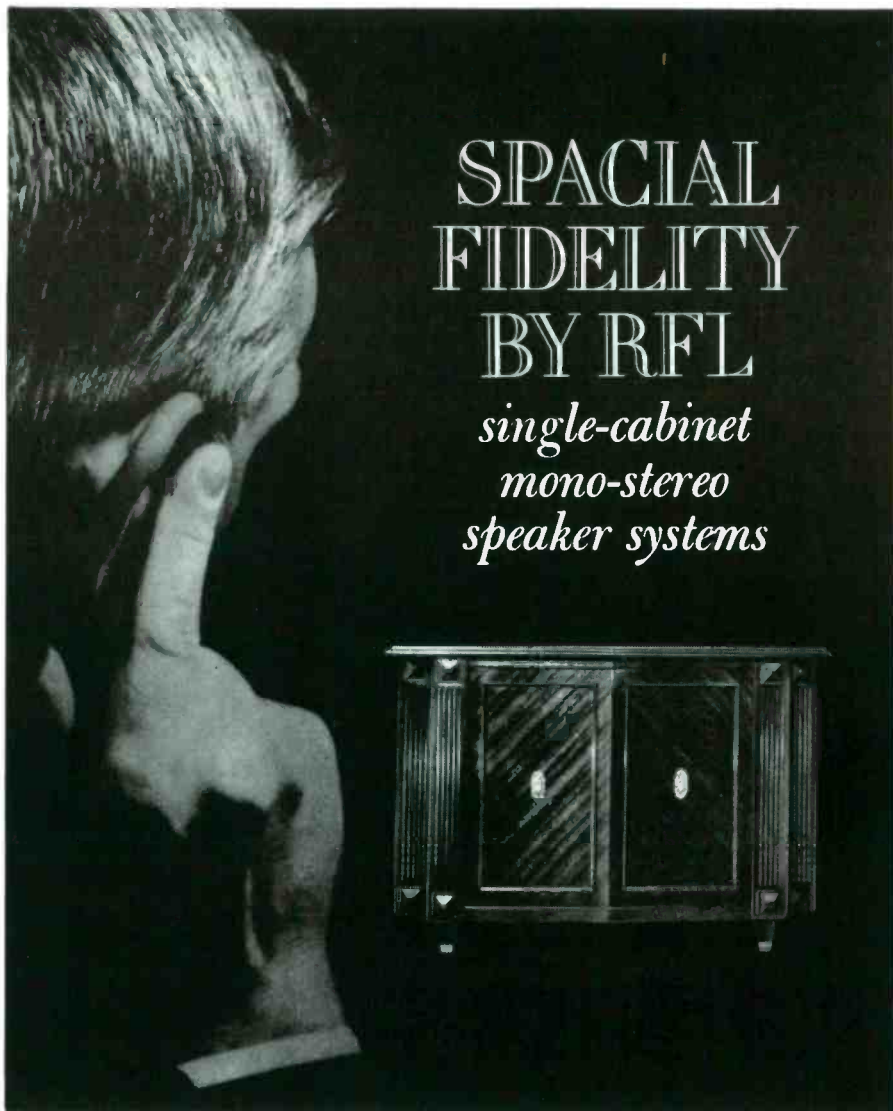

SPACIAL
FIDELITY
BY RFL
single-cabinet
mono-stereo
speaker systems

This dramatic 5-minute test-demonstration will prove the most compelling musical experience you ever enjoyed outside a concert hall

Any Spacial Fidelity dealer will be happy to give you this exciting 5-minute demonstration. He will first select a famous, brand-name speaker system in his stock, or you may suggest one. He will then select a Spacial Fidelity system. Both will be connected to a high fidelity music system so that he can switch instantly from one to the other.

Your dealer will then play a high fidelity *monophonic* record through the first speaker. After about one minute he will switch the music to the Spacial Fidelity system, so you can hear the difference. There will be no mistaking it.

So startling is this difference in performance between Spacial Fidelity and conventional speaker systems, that in similar test-demonstrations for random groups, eight out of ten listeners identified the *monophonic* performance of the Spacial Fidelity speaker system as *stereo*.

Your next question will probably be about stereo. Your dealer will point out that a Spacial Fidelity speaker system is actually a complete stereo reproducer in a single cabinet enclosure—and that if, at some later date, you convert your high fidelity system from mono to stereo, no additional speakers will be required. To demonstrate this point, he will play a stereo record or tape through the Spacial Fidelity speaker system.

If you have ever attended a concert, an opera, a musical—any live performance—you know the sensation, the unmistakable dimensional quality which the environmental surroundings impart to the music. Stereo Spacial Fidelity can offer you no more—only the delightful realization that you can now recreate this experience—at will—in the comfortable privacy of your own home.

The Classic (illustrated) a stately decorator piece designed by Petruccelli — captures the luxurious warmth and elegance of the formal drawing room — magnificently handcrafted and superbly finished. Available in red or brown mahogany, \$765. Other models from \$225 to \$795. Prices slightly higher in West.

Arrange today for a personal 5-minute test-demonstration of Spacial Fidelity. For the name of the dealer nearest you, and descriptive literature, write to: Dept. HF-11

Ⓜ AUDIO PRODUCTS DIVISION, RADIO FREQUENCY LABORATORIES INC., BOONTON, NEW JERSEY

CIRCLE 109 ON READER-SERVICE CARD

others are characteristically grand. Delightful notes by Biggs himself and by Barbara Owen, president of the Organ Historical Society, complete a set of highly unusual interest. A. F.

WILLI BOSKOVSKY: "*Philharmonic Ball*"

Johann Strauss II: *Auf der Jugd; Frühlingsstimmen; Blue Danube; Egyptian March; Perpetuum mobile*. Joseph Strauss: *Delirien; Ohne Sorgen; Transaktionen*. Johann and Joseph Strauss: *Pizzicato Polka*.

Vienna Philharmonic Orchestra. Willi Boskovsky, cond.

• • LONDON CS 6182. SD. \$5.98.

Boskovsky conducts this attractive, lightweight music with elegance and sensitivity, and the Vienna Philharmonic's playing here has a precision, delicacy, and graceful transparency all too often missing in its playing of more substantial fare. The only thing I can cavil at is that these performances are a shade overrefined and lacking in vigor. Compare this *Blue Danube* with Bruno Walter's equally Viennese but more robust version and you will understand what I mean: in the present performances one listens with rapt admiration, but Walter's infectious lilt makes you want to dance. Magnificently suave stereo sound. H.G.

COLLEGIUM MUSICUM (KREFELD):
Music of the Renaissance

Erika Metzger-Ulrich, soprano; Otto Pingel, tenor; Collegium Musicum (Krefeld), Robert Haas, cond.

• LYRICHORD LL 86. LP. \$4.98.

The eighteen pieces on this disc extend in time from the middle of the fourteenth century to the beginning of the sixteenth and on the map from Burgundy through Germany and Italy to Spain. In addition to anonymous pieces there are compositions by Dufay, Binchois, Landino, Tromboncino, Peñalosa, De la Torre, and Escobar. Some are familiar, others are not. Together they present an interesting and generally lively sampling of the secular music of the period (Dufay's *Veni creator spiritus* and *Flos florum* are the only sacred works here). Haas varies his performing media, using recorders, viols, lutes, and bells, and generally chooses animated tempos—perhaps a bit too animated in Binchois's *De plus en plus* and Landino's *Gram pian' ag'occhi*, both of which love songs are more effective when the melodic line is curved more caressingly. Both singers are competent, and the sound is good. N.B.

GIUSEPPE DE LUCA: *Operatic Recital*

Giuseppe de Luca, baritone.

• ROCOCO R24. LP. \$5.95.

This collection brings us a younger De Luca than is offered on Camden's worthy reissue of Victor's from the baritone's Metropolitan days. The present compilation is drawn from the G&T and Fonotopia catalogues, and dates from the 1902-1907 period. The originals were, of course, all acoustics, and beset by a fair amount of surface noise; the accompaniments are for piano only.

De Luca's voice retained its characteristic quality from the outset of his recording career right up through the late Thirties. It was steady, pliable, colorful—and its possessor was a master of the noblest Italian singing tradition. Of unusual interest on this record are the elegantly sung *Favorita* excerpts, an exemplary "Vision *fuggitiva*," a feather-light rendition of the *Pique Dame* serenade, and an *Ideale* so finely turned as to rate with Battistini's. Mozart purists will find his "*Deh vieni alla finestra*" lugubrious, though no one can deny the effectiveness of the vocalism *qua* vocalism. The De Luca versions of Mephisto's arias from *Damnation* are more idiomatic than one might suppose, the Italian translation notwithstanding. The only misfire here, for my taste, is "*Bella siccome un angelo*"—not because it is poorly sung, but because this unobtrusive little aria is treated as a *gran scena*, complete with long fermatas, a pretentious cadenza, and so on. It is probably close to what Donizetti had in mind, but it seems disproportionate. There are informative annotations by Keith Hardwick.

C.L.O.

JASCHA HEIFETZ: "Heifetz Encores"

Jascha Heifetz, violin.
 • RCA Victor LM 2382. LP. \$4.98.

Heifetz's way with these short pieces is definitely that of a twentieth-century virtuoso. Whereas old-style violinists, such as Fritz Kreisler, stressed warmth and intimacy in their playing, he goes all out for high-powered precision and tonal glamour. Occasionally Heifetz's emphasis on physical virtuosity tends to make these miniatures sound a trifle glossy and Hollywoodish, but I dare say no other contemporary violinist can equal his sylphlike purity of tone or the gossamer crispness of his attack. Some of the music is not very much, but the playing is *magnifique!*

The recordings are of varying vintages. The Saint-Saëns *Havanaise* was made around 1949 when William Steinberg was a principal accompanist for RCA Victor, and some of the selections recorded with Emanuel Bay may date back even further. The remaining items, made with Brooks Smith, are presumably of recent origin. The recorded sound is fairly consistent. Although it is sometimes rather thin, it is always agreeable. My copy had a few pre- and post-echoes on Side 1. Both pianists, incidentally, provide rather negative accompaniments.

H.G.

KROLL QUARTET: "Presenting the Kroll Quartet"

Haydn: *Quartet in D, Op. 64, No. 5* ("Lark").
 Schubert: *Quartet No. 14, in D minor* ("Tod und das Mädchen").
 Prokofiev: *Quartet No. 1, Op. 50*.
 Tchaikovsky: *Quartet No. 1, in D, Op. 11*.

Kroll Quartet.
 • Epic SC 6037. Two LP. \$9.98.
 • • Epic BSC 108. Two SD. \$10.98.

A bit of folklore which flourishes among string players maintains that a quartet named after its leader is apt to be dominated by him to a greater extent than one labeled more impersonally. The Kroll, which

THE HIT OF THE N.Y. HIGH FIDELITY SHOW

Most of the manufacturers of quality components, tape machines and sets used **COMMAND** records and tapes to demonstrate their equipment



The greatest advance in sound since high fidelity was invented!

Command records



PERSUASIVE PERCUSSION
Vol. 1

AMERICA'S
BEST
SELLING
STEREO
ALBUMS

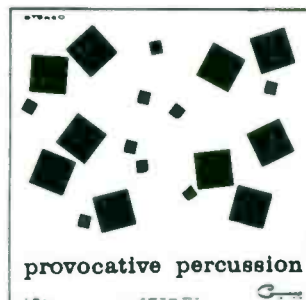

PROVOCATIVE PERCUSSION
Vol. 2

These are the most unusual records you have ever put on your turntable. What's on these records? MUSIC—not sound effects—but music. Brilliantly recorded music, played on fascinating percussion instruments with new and exciting tone textures; music planned and arranged to bring out the whole spectrum of sound on your stereo equipment even while it puts your system through series of acoustical alignment tests—tests which will tell you if your speakers are properly balanced, if your pickup is tracking correctly and if your pickup arm is balanced.

OTHER EXCLUSIVE COMMAND RECORDS

NEW RELEASES

PROVOCATIVE PIANO
RS 33-811 RS 811 SD

BONGOS/FLUTES
/GUITARS
RS 33-812 RS 812 SD

TWO PIANOS &
TWENTY VOICES
RS 33-813 RS 813 SD

PERTINENT PERCUSSION
CHA CHAS
RS 33-814 RS 814 SD

PERSUASIVE PERCUSSION
RS 33-800 RS 800 SD

THE DIXIE REBELS
RS 33-801 RS 801 SD

THE MILLION DOLLAR SOUND
RS 33-802 RS 802 SD

Vol. 2. THE MILLION
DOLLAR SOUND
RS 33-804 RS 804 SD

THE PRIVATE LIFE OF A
PRIVATE EYE
RS 33-805 RS 805 SD

PROVOCATIVE PERCUSSION
RS 33-806 RS 806 SD

MR. BIG
RS 33-807 RS 807 SD

PERSUASIVE PERCUSSION
Vol. 2
RS 33-808 RS 808 SD

BONGOS
RS 33-809 RS 809 SD

PROVOCATIVE PERCUSSION
Vol. 2
RS 33-810 RS 810 SD

MONAURAL 4.98 Mfr's list—STEREO 5.98 Mfr's list

FOUR TRACK STEREO TYPE \$7.95 MFR'S LIST

COMMAND RECORDS ARE ON SALE AT ALL LEADING RECORD STORES

for the discriminating Audiophile who insists
on the finest in sound reproduction . . .

ACROSOUND

presents the

ULTRA-LINEAR STEREO 120 KIT

60 full clear watts in each channel



Kit \$159.50
Factory Wired \$219.50

*Pat. Pending

Power reserve for even the most inefficient speakers with perfect stability for electrostatic speakers. Expenses have not been spared to bring you the most advanced Stereo amplifier kit . . . easy and enjoyable to construct. The circuit is based on world famous Ultra-Linear II, an amplifier which has won acclaim as the most stable low distortion feedback amplifier devised. The Ultra-Linear 120 offers you the combination of this famous circuit, plus Acro designed and Acro manufactured output transformers with exclusive Hybrid* feedback winding for new highs in stereo listening.

Only the Acrosound Ultra-Linear 120 gives you these 6 features



METER
To conveniently set bias
and check performance.



VARIABLE DAMPING
To get the best from
your speaker.



PRINTED CIRCUIT
Locked-in performance with
preassembled and tested
printed circuit assembly.



**ULTRA-LINEAR
OUTPUT TRANSFORMER**
Uses the famed Ultra-Linear trans-
former and circuit invented by Acro's
Herbert I. Keroes and recognized as
the best audio circuit known.

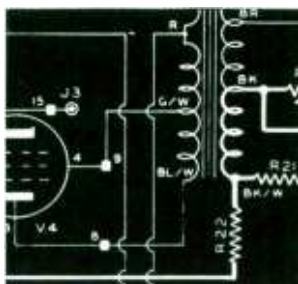

HYBRID* FEEDBACK
An exclusive Acrosound circuit
feature which provides for the
high degree of stability in-
herent in this amplifier.

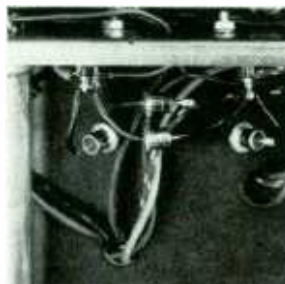

SILICON POWER SUPPLY
Full wave bridge type Silicon rec-
tifier power supply — providing an
extremely light-weight, yet excel-
lent regulated power supply.

changed its name from the Coolidge in 1945 (five years after Elizabeth Sprague Coolidge first sponsored the ensemble at her Library of Congress chamber music series), could conceivably be cited in support of this theory: there is a driving, rather Prussian quality in the playing which, I suspect, emanates from the fiddle and the temperament of Mr. Kroll himself. He has shaped an alert ensemble which is, however, not so subtle as some, and it fares best in music which makes the least demand for nuance and shading of tonal color. Haydn's *Lark*, for instance, is a vivid affair. You are not likely to hear the catlike tread of the opening chords played with greater springiness—the cat almost pounces; and at the same time there is nothing prissy here. Even in so carefully articulated a passage as the grace-note measures of the Minuet the approach is thoroughly healthy. There is more warmth in other versions; the Vienna Konzerthaus Quartet, for one, is mellower and more benevolent, but in comparison to the present performance it sounds almost anemic.

The Kroll's *Death and the Maiden* does not match the Juilliard's—but then, whose does? Even the Budapest version has some rough edges beside the formidable finesse of that performance, and the Krolls, for all their vigor, do not achieve an equal degree of intensity and dramatic contrast. The Prokofiev First, while rhythmically very much alive, loses some of the emotional dimension to be found in the Endres Quartet performance, where an unexpected *dolce* in the score evokes not merely a quiet legato but an actual sweetening of tone. As for the Tchaikovsky, there is lyric grace aplenty. The folk tunes which abound in this work are sung out with spirit and fluidity, and the heavy-footed dance of the Trio is played in good peasant style. It would be hard to miss with this piece—which is no belittlement of the Kroll Quartet, but merely a commentary on the music's simplicity and directness.

I found both mono and stereo recordings somewhat shrill. The stereo does not make the mistake of spreading the sound too broadly, so you can take your choice of versions. The records, incidentally, are available separately, the Haydn/Schubert as LC 3690 and BC 1081, and the Prokofiev/Tchaikovsky as LC 3691 and BC 1082.

SHIRLEY FLEMING

PAUL MAYNARD: "Keyboard Music of the French Court"

Paul Maynard, organ and harpsichord.

● AMERICAN SOCIETY CONCERTS-IN-THE-HOME AS 1006. LP. \$4.98.

● ● AMERICAN SOCIETY CONCERTS-IN-THE-HOME SAS 1006. SD. \$5.98.

A varied selection of seventeenth- and eighteenth-century pieces. On the Holtkamp organ at the General Theological Seminary in New York, Paul Maynard, who is favorably known for his work with the New York Pro Musica, plays pieces by Pierre du Mage, Nicolas le Bègue, Nicholas de Grigny, Pierre Dandrieu, Claude Balbastre, and François Couperin. On the harpsichord he plays works by Louis Couperin, Jacques de Chambonnières, and Elizabeth de la Guerre. Maynard is equally at home with both instruments and in the

Acrosound. . . the finest name in audio! Hear it at your dealer now!

ACRO PRODUCTS CO., 410 SHURS LANE, PHILA. 28, PA.

CIRCLE 2 ON READER-SERVICE CARD

various styles called for here, from the simple but lovely variations on French Christmas carols by Dandrieu and Balbastre to Du Mage's brilliant *Grand jeu* and the most elaborate work on the disc, the great Couperin's majestic *Offertoire sur les grand jeux*. N.B.

JOSEPH ROSENBLATT: "Songs of My People"

Massenet: *Elégie*. Traditional: *Schlof in Sisser Ruh*; *My Yiddische Momme*; *Yohrzeit*; *Eili, Eili*; *Lomir sich iberbeten*; *Aheim, aheim*; *Sog ze rebenju*; *Shofar shel Moshiac*; *Shir Hamuaalos*.

✓ Cantor Joseph Rosenblatt, tenor.
● RCA CAMDEN CAL 597. LP. \$1.98.

HENRY ROSENBLATT: "Sings Liturgical Masterpieces"

Traditional: *Sholom Aleichem*; *Ki K'shimco*; *Hodu*; *M'chalkeil chayim*; *Chassidic Kaddish*; *Yism'chu*; *Akaryo*; *Tal*; *Shivisi*; *Ma toru*.

Cantor Henry Rosenblatt, bass-baritone.
● FIESTA FLP 1260. LP. \$3.98.

These releases will probably be of interest to different people for different reasons. To some oldsters the voice of Joseph Rosenblatt, who died in 1933, may arouse nostalgic memories satisfied only by his singing of *My Yiddische Momme* and the great lament *Eili, Eili*. But his singing should appeal also to *aficionados* of vocal culture in general. Although not exactly "high fidelity," these selections from his recordings are clear enough to show why the vocal technique and quality of the great cantor have been compared to those of Caruso. For here is the same compact, closely knit tone—the only kind, somehow, which can ever be truly limpid; the same ability to step precisely from the middle of one note to the middle of the next; and the same equal capacity for staccato and legato. It is true—good singing is good singing is good singing.

The singing of Joseph Rosenblatt's son, Henry, an eminent cantor in his own right, will probably be of greatest use to those interested in contemporary cantorial style. Perhaps I should say "styles," for the Jewish liturgy has developed over a long period of time and a wide diversity of places. It ranges from the florid, almost wordless, intimate cry of the individual alone in the universe to the dancey, highly rhythmic impersonalization of such numbers as the *Chassidic Kaddish* and the *Yism'chu*. The range of ritual songs presented here sufficiently demonstrates that in the Jewish religion, joy is not apart from reverence. A fine scholar as well as a singer, Cantor Henry Rosenblatt is on sure ground in his interpretations, and is especially good in the light, rapid, intricate passages. On high, sustained notes his voice loses focus and tends to depart from pitch. Part of this may be due to the fact that he seems to have been too close to the mike. Vocally, Cantor Henry Rosenblatt is not in the same league with Cantor Joseph Rosenblatt, but who is? The organ accompaniments are of interest, as the notes beg us to observe, but the effect here is muddy and ill defined and in any event, the organ as an instrument of the dance is always slightly comic. CLIFFORD OSBORNE

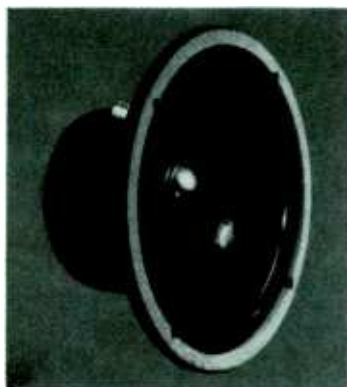

Here's great news

**The Sensational BOZAK
B-800 FULL-RANGE SPEAKER**
(PATENT PENDING)

is yours for only \$45.00!*

An 8-inch speaker of unique design, the B-800 provides unbelievably fine music and voice reproduction over a frequency range of 50 to 15000 cycles! Its clean bass, detailed midrange, and smooth highs combine to give exceptional transient response and remarkably satisfying tone. It works beautifully from a small, infinite-baffle bookshelf enclosure, or can be mounted flush in an ordinary interior wall.

You'll be proud to own the B-800! Now, at last, you can extend your music system to other parts of your home—bring Bozak musical sound to den, playroom, kitchen, bedrooms—at a truly moderate cost!

**and,
THE BOZAK B-801
SPEAKER SYSTEM**
**a B-800 Full-Range Speaker
Mounted in a Handsome,
Well-Built Enclosure**
is only \$89.50!*

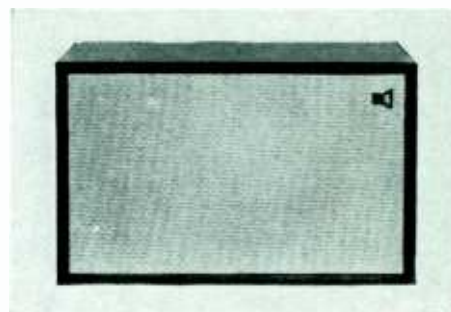

Your chance to own a Bozak Speaker System! Thousands who heard this instrument at the New York and other High Fidelity Shows were delighted with its musical quality and amazed at its price! You'll agree that it's the biggest bargain ever in really fine sound!

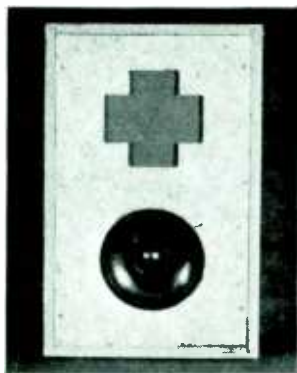

Consistent with the Bozak principle of providing for systematic growth, your B-801 can achieve a broader dispersion of highs through the addition of a Bozak B-200X Dual Tweeter. A cutout is provided for vertical or horizontal mounting of the B-200X, as shown in the adjacent photo of the enclosure with grille cloth removed.

**Hear this great
new speaker soon at a
Bozak Franchised Dealer!**

*SLIGHTLY HIGHER IN SOUTH AND WEST.

Bozak
DARIEN, CONN.

THE VERY BEST IN MUSIC
CIRCLE 32 ON READER-SERVICE CARD

FOR HIGHEST ACHIEVEMENT IN BLENDING RECORDED SOUND AND MUSIC

dedicated to the listener who is ready for perfection



■ THE SOUND OF TOP BRASS, Volume 2

The Peter London Orchestra
No other section of the orchestra can compel the excitement of brilliant 'biting' trumpets, rich trombones and mellow French horns. Includes: Beyond The Blue Horizon • The Continental • Tenderly • Bugter's Holiday Tico Tico • and others. MS 7508*

■ THE SOUND OF 8 HANDS ON 4 PIANOS

The Medallion Piano Quartet
From sonorous plangent chords to rippling arpeggios—and every pianistic effect in between. The unusual and inimitable sound of four great pianists each with 88 glorious keys of his own on which to create excitement. Includes: I Could Have Danced All Night • Sophisticated Lady • Ritual Fire Dance • Ebb Tide • Wrong Note Rag • and others. MS 7510*

■ THE SOUND OF A MINSTREL SHOW

MR. INTERLOCUTOR
The Medallion Minstrel Men
All the nostalgia and the humor of the Good Old Days... so "live," you'll feel you're on a Mississippi stern-wheeler! Includes: Hot Time In The Old Town Tonight • Are You From Dixie? • Waiting For The Robert E. Lee • When The Saints Go Marching In • Long Time Ago • Dixie • and others. MS 7506*

■ THE SOUND OF STRINGS, Volume 2

Frank Hunter and His Orchestra
Rich beyond comparison! High-flying violins, mellow violas, throbbing cellos—once again the orchestra creates a brilliant new chapter in The Sound of Strings. Woven with infinite delicacy, flamboyant contrasts and a harlequinade of sparkling colors. Includes: Dancing In The Dark • Avalon • Fools Rush In • & others. MS 7509*

■ DECK THE HALLS

The Sound of Christmas
The Medallion Orchestra & Chorus
The joyful peal of bells; voices raised in traditional songs, from simple carols breaking the silence of the night to choristers inviting you to the warmth of a candle-bright church; the colorful strains of the village brass band—all the music that makes this the season of singing—and singing hearts! MS 7512*

■ THE SOUND OF A MARCHING BAND

120 Cadence
Thundering drums, crashing cymbals, blazing brass! A whole parade of college and military marches! Includes: Roar Lion Roar • Fight on Pennsylvania • The Victors • On Wisconsin • Anchors Aweigh • U.S. Air Force Song • 76 Trombones • The Thunderer • Colonel Bogey • and others. MS 7507*

■ THE SOUND OF LATIN BRASS

Tarragano and his Orchestra
You never had it so exotic! The pulsating excitement of Latin America: sensuous rhythms; sparkling melodies; brilliantly colored orchestration—feverish brass, soaring woodwinds, throbbing percussion. Samba, Cha Cha, Merengue—a swirling sweep of South American music. MS 7511*

■ THE SOUND OF DYNAMIC WOODWINDS

The Jack Elliott Orchestra
A brilliant showcase of woodwinds and reeds, highlighting them against brass and other instruments. Includes: Fascinating Rhythm • After You've Gone Birth Of The Blues • Trolley Song • Play A Simple Melody • The Song Is Ended • Chiu Chiu • and others. MS 7505*

■ THE SOUND OF CONVERSATIONS IN MUSIC

The John Parker Orchestra
Famous showstoppers in which music takes the form of conversations—from heated arguments to whispered love-talk. Includes: Makin' Whoopee • Go To Sleep Baby It's Cold Outside • Let's Call The Whole Thing Off Anything You Can Do • Let's Put Out The Lights • and others. MS 7504*

*Also available in monaural, and 4 track 7½ ips stereo tape.

MEDALLION RECORDS & TAPES

Send for our latest MEDALLION catalog. A product of Kapp Records, 136 East 57th Street, New York 22, N. Y.

CIRCLE 98 ON READER-SERVICE CARD

The Lighter Side

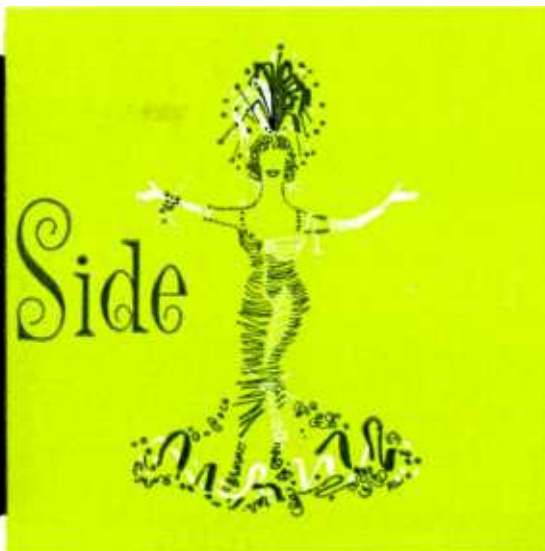

POPULAR • THEATRE • FOLK



Sellers

Very, Very Funny—and Without Malice

“The Best of Sellers.” *Peter Sellers, Irene Handl, Fred Flange; Orchestra, Ron Goodwin, cond. Angel 35884, \$4.98 (LP); Angel S 35884, \$5.98 (SD).*

FOR THE past year or so, a series of highly amusing and sharply etched portraits of fairly familiar English citizens have been flitting across American film screens. All have been the creation of Peter Sellers, a young English comedian and mimic of extraordinary talent. These little masterpieces of observation, which present only a slightly exaggerated picture of some easily recognizable types, can hardly be called caricatures. Sellers is more often kind than caustic in his methods, and it is this absence of malice which makes his delineations so very funny. Until now, these delights have been mainly visual, but with the arrival of this new Angel recording, we discover that Sellers has an equally wonderful ability to create a characterization merely with words. Or I should say, a combination of words, dialect, inflection, and a first-rate actor's sense of timing.

The Angel disc offers the comedian in a veritable

galaxy of comical vignettes, some funnier than others, as is the usual nature of omnibus recordings, but all certainly highly amusing. Sellers can be the perfect bumbling political candidate promising his constituents everything, yet nothing, in a speech that is as windy as it is platitudinous, and follow it up with the pathetic lament of a nine-year-old singer of pop songs, who feels he is “over the hill” because he has not had a record in the Top Twenty in three weeks. In a travelogue to end all travelogues, he gives a devastating take-off of the voice that for so many years accompanied the filmed journeys to exotic lands. Sellers confines his spiel to the beauties (?) of BalHAM, a London borough where nannies regale their charges with horror tales, the local handicraft is “toothbrushholesmanship,” and everything on the local café menu is “Off.” As Sellers recounts this grim tale, BalHAM is definitely a place to pass up.

Some years ago, Sellers did a hitch with the RAF, being stationed in India. The excruciatingly funny accent of the English-speaking Indian, which he has mastered to a T, is put to good use in an interview between a newspaperman and the producer of the Delhi version of *My Fair Lady*. In this, we discover that some song titles will be changed, with *Get Me to the Taj Mahal on Time* and *I've Grown Accustomed to Your Dhoti* being considered more appropriate for the Indian production than the originals.

The BBC, always a prime butt of English comedians, comes in for its share of Sellers' humor, with a sly poke at the sort of program of youthful reminiscences that used to belong to the late Sir Max Beerbohm. And a funnier session is the one lampooning panelists on a very arty program, in which it seems no member has been properly advised as to what he should discuss.

In *Shadows on the Grass* Sellers must play second fiddle to Irene Handl, who gives a really remarkable study of a

vulgar, middle-class English widow getting acquainted with a Frenchman at a seaside resort she describes as "Private but not insulated, if you know what I mean." This is an unforgettable little cameo, in which the coyness, the gaucheries, and the pathetic desperation of a fading female are brilliantly caught. Yet with it all, it is very, very funny.

There are a number of other delights in this extremely amusing program, but I'm sure you will want to sample them for yourself. I promise you that you are not likely to be disappointed.

The stereo version makes very effective use of movement, particularly in *Shadows on the Grass*, where the Frenchman starts out in the left speaker, the woman in the right; as the pick-up progresses, he moves to join her right, and they exit, obviously arm in arm, up right center. It's a convincing illusion. My review copy of the stereo was afflicted with some strange squeaks, which may well be confined to this pressing. J.F.I.



Terry

The Excitement of a Band on Parade

"The Sound of a Marching Band: 120 Cadence." *Medallion Marching Band*, David Terry, cond. Medallion ML 7507, \$4.98 (LP); MS 7505, \$5.98 (SD).

✓ **WHAT CONDUCTOR** David Terry and engineer C. R. Fine have done here is as simple as it is sensible: they have remembered that perhaps the most thrilling of all "live" aural experiences is hearing a first-rate band in rousing out-of-doors parade music, and they have exerted every possible executant and engineering effort to reproduce, as vitally as possible, not only the familiar sounds themselves, but also their natural ambience.

An unspecified but obviously big and virtuosic band plays a skillfully chosen and varied selection of well-known college and service marches interspersed with favorites by Sousa, Bagley, Alford, and Willson. The performances are as high-spirited and precise as I have ever heard on or off records. If an electronic metronome has been used, as claimed, to maintain throughout exactly 120 beats to the minute, it does nothing to inhibit the players' gusto or freeze their rhythmic resilience. Yet what gives this program its supreme distinction is the recording. Every technological resource (not excluding stereoisitic enhancements and channel switchings) is

utilized, not as a display of electronic gimmickry, but as a flawlessly transparent, broadly panoramic *medium* which never calls attention directly to itself and manages to re-create every coloristic and dynamic detail of the music—even the intangible breeziness of the very air in which it was first formed.

Here we are spared the fruitless contest between art and science, and we can learn anew how fertile their harmonious marriage can be. The only thing "new" here may be our own personal response to so electrifying and dramatic an aural experience, but this is incalculably more thrilling, as well as satisfactory, than any sonic eccentricity or synthesis ever can be. And the final proof of the wisdom of subordinating stereo technics to music (and atmosphere) is that this extraordinary recording sounds no less invigorating when it is divested of its ingenious channel antiphonies and heard in monophony alone. There have been many fine band recordings, but surely none has matched the over-all dynamism, impact, and authenticity of this one. R.D.D.



Whiting

Kern Sung with Love and Devotion

“Margaret Whiting Sings the Jerome Kern Song Book.”

Margaret Whiting; Orchestra, Russell Garcia, cond.

Verve MGV 4038, \$9.96 (Two LP).

THIS may not be *the* “Jerome Kern Song Book,” but unless I miss my guess, we are hardly likely to get a more delightful presentation of some of Kern’s loveliest songs for a long, long time. From the thousand or more songs that Kern wrote for Broadway and Hollywood, Margaret Whiting has selected twenty-four, and done so in what seems to me the only sensible and honest way. She has chosen her numbers because they are personal favorites of hers, because she knows she can do them justice, and (with an eye on more possible sales returns) because they are nearly all songs the public knows and loves. Should you happen to find a particular favorite of yours missing from her program—and I’m sure you won’t be alone in that respect—consider the problems involved. To please everyone, Miss Whiting would have had to increase the contents of this album at least fourfold, and even then there would be complaints.

As a singer of romantic ballads, Miss Whiting has long enjoyed an enviable reputation, and it is therefore no surprise to find her program replete with some of Kern’s most beautiful romantic songs, with *Smoke Gets in Your Eyes*, *The Way You Look Tonight*, *All the Things You Are*, *Lovely To Look At*, heading the list. These the singer handles with the greatest assurance and tremendous vocal style, and with the sort of affection that only a true artist brings to a song. *Why Was I Born* and *Why Do I Love You*, two of Kern’s most successful efforts at writing a sort of restrained torch song, are treated as sad laments, and with fine results. If her version of *Why Was I Born* does not quite erase memories of Helen Morgan’s

wistfully pathetic rendition, it quite easily surpasses any other recorded version since. A very special Whiting favorite is *Poor Pierrot*, from Kern’s memorable score for *The Cat and the Fiddle*. Her devotion is stamped on every phrase of this lovely, and neglected, song, and I can assure Miss Whiting that Odette Myrtil never approached her tender account of this number.

When it comes to songs originally written in a lively tempo, such as *She Didn’t Say Yes* (also from *The Cat and the Fiddle* and not, as the record cover states, from *Show Boat* or *I Won’t Dance*), the singer tends to slow them down, which gives her program a certain monotony of tempo. Her account of *I’m Old-Fashioned*, although enlivened by Russell Garcia’s delightful arrangement, could be much sprightlier, and *D’ye Love Me* from *Sunny*, originally written as a duet, would be improved by a gayer lilt than the singer brings to it.

But these are minor complaints against a very successful account of so many wonderful songs. It is perfectly obvious from Miss Whiting’s affectionate and utterly charming performances that the entire project was a labor of love. Since she has the ideal voice and style for these songs of a not-so-distant past, can’t someone induce her to select twenty-four more Kern songs to make up Volume Two? I, for one, hope so. And should the venture materialize, I hope Miss Whiting will insist on having Russell Garcia as her arranger and conductor. His excellent arrangements here, beautifully tailored to complement the singer’s style, constitute a major contribution to this excellent volume.

J.F.I.



“Percussive Latino Cha Cha Cha.” René Hernandez Orchestra. Audio Fidelity DFS 7003, \$5.98 (SD).

“Percussive Vaudeville.” Harry Breuer and Orchestra. Audio Fidelity DFS 7001, \$5.98 (SD).

For sheer commercial candor it would be hard to beat the slogan (illustrated by a giant

hypodermic needle) of Audio Fidelity’s new series, “Doctored for Super-Stereo.” But nothing could be more characteristic of the irrepressible Sid Frey, the commander-in-chief of Audio Fidelity. As one of the first to produce startling wide-range recordings and the very first to lead a hesitant industry over the stereo-disc brink, Mr. Frey could not

have been expected to stay out of the stereospectacular sweepstakes. Needless to say, his “super-stereo” is exactly that, with so much going on at extreme left and right, and in the extreme highs and lows, that both the spatial and frequency “middles” seem relatively empty.

Percussive Vaudeville, a program which

If you listen to the critics...
you'll listen to

STEREO[®] by LONDON

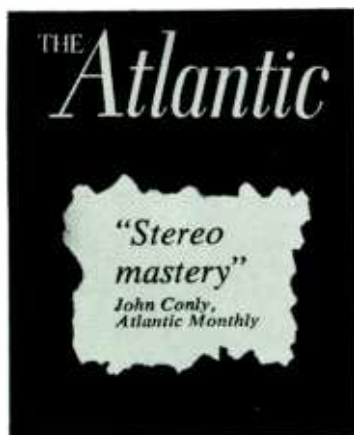

POPULAR SUGGESTIONS

DANCING WITH ROS

Edmundo Ros and His Orchestra. *Magic Is The Moonlight; Cuban Love Song; Brazil; Toku; Lua Do Brazil; Te Quiero Y Oie; Tany's Cha Cha Cha; Paa Paa Cha Cha Cha; Divine Mujer; Capocabana; Rio Brazil; Lo moreno de me Copla; The Puerto Rican Pedlar; Fanfare Cha Cha Cha.* PS 205

POP HITS FROM THE CLASSICS

Ted Heath and His Music. *Stranger In Paradise (Borodin's "Prince Igor"); Concerto For Two (Tchaikovsky's "Piano Concerto No. 1"); The Story Of A Starry Night (Tchaikovsky's "Pathétique Symphony"); Dai's Love (Bizet's "Carmen"); Till The End Of Time (Chopin's "Polonaise"); I'm Always Chasing Rainbows (Chopin's "Fantasia Impromptu"); Moon Love (Tchaikovsky's "Romeo and Juliet"); The Can Can (Ollenbach); On The Isle Of May (Tchaikovsky's "String Quartet"); So Deep Is The Night (Chopin's "Etude No. 3").* PS 171

SONGS TO REMEMBER

Mantovani and His Orchestra. *With These Hands; Faraway Places; A Very Precious Love; Jamaica Farewell; Tenderly; Blue Star; Gigi; When I Fall In Love; No Other Love; Vaya Can Dios; Two Different Worlds; Tonight.* PS 193

IN A MONASTERY GARDEN

(The Immortal Works of Ketelbey) The New Symphony Orchestra of London—Robert Sharples. *In A Monastery Garden; Wedgewood Blue; In A Chinese Temple Garden; Sanctuary Of The Heart; Appy Amstead; In A Persian Market; Phantom Melody; Bells Across The Meadows; In The Mystic Land Of Egypt.* PS 186

THE SOUND OF MUSIC

Edmundo Ros and His Orchestra. *The Sound Of Music (Cha Cha Cha); An Ordinary Couple (Mambol); Maria (Schottish); Edelweiss (Merenque); So Long, Farewell (Bolero); Da-Re-Mi (Pasa-Doble); My Favorite Things (Vals Creole); Sixteen Going On Seventeen (Baion); No Way To Stop It (Samba-Batuque); Climb Ev'ry Mountain (Bolero Mambol); The Lonely Goatherd (Baion); How Can Love Survive (Marcha).* PS 198

THE ALL-TIME TOP TANGOS

Stanley Black and His Orchestra. *La Cumparsita; Rostta; Amorosa; A Media Luz; Mama, Yo Quiero Un Novia; Jealousy; Adios, Pampa Mia; Oh, Donna Clara; Olé Guapa; Adios Muchachos; Ecstasy; El Choclo.* PS 176

CUBAN MOONLIGHT

Stanley Black with Latin Rhythms. *Vereda Tropical; El Truco de Pernambuco; Stars In Your Eyes; Nostalgia; Frenesi; Rumba Matumba; Hold Me Close Tonight; Siboney; Majorca; The Moon Was Yellow; Os Quindins de Ya Ya; Ay Ay Ay; Green Eyes; Perlidia.* PS 137

ALL AMERICAN SHOWCASE

Mantovani and His Orchestra. **THE BEST OF VICTOR HERBERT:** *Ah! Sweet Mystery Of Life; A Kiss In The Dark; Sweethearts; I'm Falling In Love With Someone; Indian Summer; Kiss Me Again.* **THE BEST OF SIGMUND ROMBERG:** *Lover, Come Back To Me; When I Grow Too Old To Dream; Softly, As In A Morning Sunrise; The Desert Song; Will You Remember; Serenade ("The Student Prince").* **THE BEST OF RUDOLF FRIML:** *The Donkey Serenade; Indian Love Call; Rose Marie; Only A Rose; Sympathy; Love Everlasting.* **THE BEST OF IRVING BERLIN:** *The Girl That I Marry; Marie; Remember; Always; For The Very First Time; What'll I Do.* [2 records] PSA 3202

OPERETTA MEMORIES

Mantovani and His Orchestra. *"Die Fledermaus" Overture; Waltzes from "Gypsy Love," "The Merry Widow" and "The Gypsy Princess"; My Hero from "The Chocolate Soldier"; Your Eyes Shine In My Own from "The Gypsy Baron"; Selection from "The Count of Luxembourg"; Oh Maiden, My Maiden from "Frederika"; Serenade from "Frasquita"; Play Gypsies, Dance Gypsies from "The Gypsy Baron."* PS 202

THE BIG BAND DIXIE SOUND

Ted Heath and His Music. *That's A Plenty I Wish I Could Shimmy Like My Sister Kate; The Darktown Strutter's Ball; Muskrat Ramble; Riverboat Shuffle; Chicago; King Porter Stamp; Someday, Sweetheart; South Rampart Street Parade; High Society; At The Jazz Band Ball; Copenhagen.* PS 184

pulverizes old-time vaudeville tunes in a nightmare combination of what used to be called "livery-stable" jazz with the latest channel-hopping and switching technology, is a gasser. For the ultimate in pandemonium, just listen to this treatment of *There'll Be a Hot Time in the Old Town Tonight*, or the scarcely less riotous *Mr. Tambo and Mr. Bones*, *Georgia Camp Meeting*, and *Daisy Bell*. Dixieland, slapstick, and ragtime styles are outrageously parodied; and if laughing trombones, oom-pah tubas, honky-tonk pianos, etc. (to say nothing of klaxons and slide-whistles) never sounded like this in real life, it was only because they have hitherto lacked Mr. Frey's galvanic needle. It all makes for a trying test of one's sound (and visceral) system, but at least it never lacks the saving graces of immense gusto and brash humor.

The cha-cha disc, for all its incisiveness and insistence, is less startling and soon becomes (like most of its kind) insufferably monotonous if one isn't actually dancing to it. R.D.D.

"Cole Porter in Percussion." Orchestra, Irving Joseph, cond. Time S/2009, \$5.98 (SD).

One of the better current spectacles: notable for the conductor's effective if sometimes overelaborate arrangements of fine Porter tunes (*What Is This Thing Called Love?*, *Love for Sale*, *Anything Goes*, *Easy to Love*, and *Get Out of Town* in particular); for the virtuosic performances by a 59-man orchestra; for extremely clean, stereoscopic, and gleaming moderate-level recording; and for its handsome album-folder including detailed personnel and technical notes. R.D.D.

"Gershwin and Guitars." Al Caiola and Orchestra. Time S/2010, \$5.98 (SD).

This is a Gershwin (George) minus Gershwin (Ira), and definitely not a recording for the dedicated Gershwin *Frères* fan. But those who do not object to having these familiar Gershwin tunes serve as a peg on which Al Caiola can hang some really fascinating, occasionally eccentric, arrangements will have a great time. The music is scored for five guitars, a host of woodwinds, percussion and piano, and obviously written for maximum stereo effect. The separation is extremely wide, and there is a good deal of channel-switching between bands, so that it is never easy to pinpoint the position of any one instrument. The piano, for instance, opens right in *The Man I Love*, moves over left in *Mine*, reverts to right again in *Swanee*, finally coming to rest at left in *Soon*. But out of this constantly shifting instrumental positioning comes some of the finest stereo sound I have heard, and since the music itself is of higher quality than most of that found in these sonic spectacles, I recommend the disc most highly. J.F.I.

"Just Say I Love Her. . . ." Remo Capra; Orchestra, Frank DeVol, cond. Columbia CL 1496, \$3.98 (LP); CS 8287, \$4.98 (SD).

By day, we are told, Italian-born Remo Capra plies his trade in New York as an engineer with an excavating company; by night, he croons into Columbia's mikes. Capra's baritone proves to be pleasant and

Continued on page 112

Write for free complete catalog

LONDON ffss
RECORDS

full frequency stereophonic sound

Dept. CF, 539 W. 25th St., N.Y.C.

STEREOPHONIC PICKUP ARM

A SCOTT
SOUND SYSTEM

To take full advantage of the remarkable technical excellence of ffss records, we recommend the new London-Scott stereophonic Pickup and Arm.

CIRCLE 93 ON READER-SERVICE CARD

THE A.E.S. *Gigolo*



A MIRACLE IN SOUND

After two years of research and development a speaker system we can unconditionally guarantee to be the finest bookshelf unit you have ever heard, REGARDLESS OF PRICE, or your money back.

Over 2500 test systems are now in use in private homes in the Ohio and Michigan area. The acceptance has been unbelievable. Never before a sound so realistic to so many people in so many different homes! These are the facts that enable A.E.S. to make this bold offer.

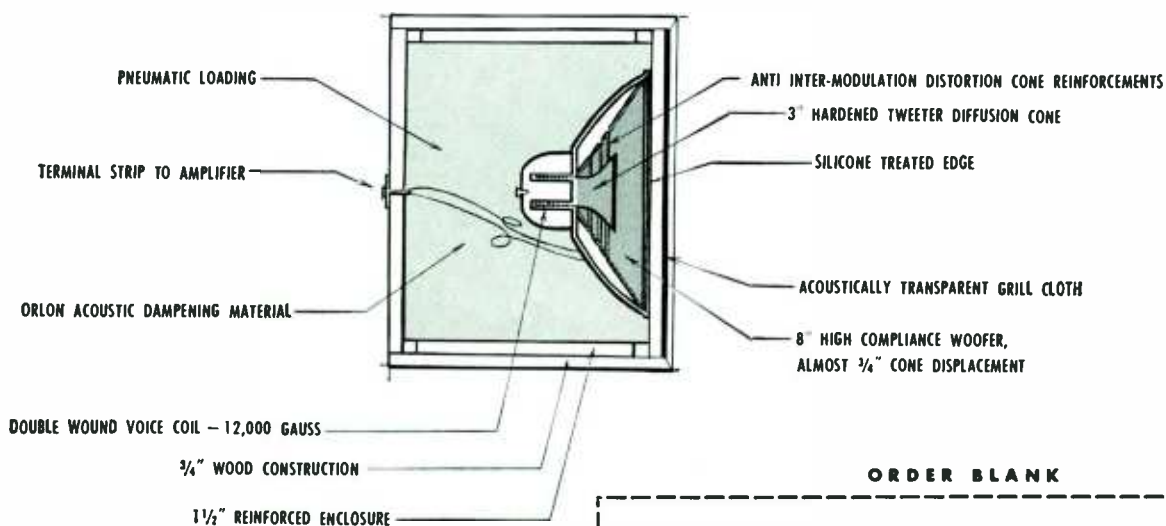

Response: 19-21,000 CPS

This unit will operate at maximum efficiency with amplifiers from 8 to 75 watts.

In limited quantity, and for a limited time only, \$15.00 complete, plus shipping.

ORDER BLANK

A.E.S., Inc.
 3338 Payne Avenue, Cleveland, Ohio

Gentlemen please ship.....GIGOLOS.

I understand these units are guaranteed and if I am not satisfied I may return for a full refund of sales price, \$15.00 each.

Name.....

Address.....

City and State.....

Enclosed find check.....money order.....

CIRCLE 4 ON READER-SERVICE CARD

ingratiating, with a fugitive trace of accent for added charm. His interpretations of such as *Day by Day*, *My Foolish Heart*, and *Once in a While* may lack the suppleness of the full-time pro, but on the whole he emerges as a performer of superb promise. The LP equals its stereo cousin in virtually every important respect. O.B.B.

"The Sound of a Minstrel Show." The Medallion Minstrel Men, John Krance, cond. Medallion ML 7506, \$4.98 (LP); MS 7506, \$5.98 (SD).

Medallion's imaginative repertory men were really inspired when they came up with the notion of re-creating the music of the famous old-time minstrel shows, and they wisely have made no attempt either to resurrect or imitate the less viable verbal jokes and patter of the originals. There may be some anachronisms in the present scoring (surely there should have been some fiddling, and I doubt whether any actual show band ever mustered so large and varied a percussion section as this one), but the tones themselves are authentic throughout. There's a lusty chorus, and the tenor and bass solos are wonderfully evocative of the old times and styles, as is the florid display trumpeting of Bernard Glow and Carl Poole in the inevitable *Carnival in Venice* showpiece. All the performances, indeed, are marked by infectious zestfulness with never a hint of parody. The recording is ultrabrilliant in both editions and surprisingly broadspread even in monophony, but of course it's more expansive and realistic in stereo. R.D.D.

"Popular Piano Concertos of the World's Great Love Themes." George Greeley, piano; Warner Bros. Orchestra, Ted Dale, cond. Warner Bros. WS 1387, \$4.98 (SD). These one-movement piano concertos follow the pattern established by Jack Fina and the Freddy Martin Orchestra, back in the days when *Tonight We Love* was standard, and inescapable, radio fare. Naturally enough, *Tonight We Love* reappears in this program, along with the Love Music from *Tristan and Isolde*, and some trivia (*Love Letters*, *My Love*, *Secret Love*) which hardly qualify as "Great Love Themes." By injecting just the right amount of schmalz into his interpretations pianist George Greeley manages to make them all sound quite attractive, and with the Warner Bros. Orchestra providing a rich-sounding orchestral support, the whole emerges as a decidedly pleasant concert of light music. J.F.I.

"Stagestruck." Ralph and Buddy Bonds, organs. Epic LN 3710, \$3.98 (LP); BN 574, \$4.98 (SD).

As someone allergic to the sound of one electric organ, I naturally expected my allergy to be compounded by the sound issuing from two of them at the same time. Oddly enough, it didn't work out that way. In fact, I was most agreeably surprised by the sounds the Bonds Brothers manage to coax from their twin Baldwin organs. These organs, it seems to me, are more mellifluous and more sonorous than most electrics, and they are capable of greater tonal coloration. Both these assets are very prominent in this well-

realized program of numbers from musicals of the past and present. A further advantage is the complete understanding that exists between the twin performers, and the high level of musicality that informs their performances, making this an excellent disc of background music, and an even better one for just plain listening. J.F.I.

"Swinging at the Opera." Orchestra, Fred Karlin, cond. Everest SDBR 1097, \$3.98 (SD).

Al "Jazzbo" Collins' notion of utilizing familiar opera airs as springboards for jumping-jazz performances is energetically worked out here by a skillful group (starring trumpeter Harry Edison, trombonist Bob Brookmeyer, and saxophonist Phil Woods). It gets off the ground buoyantly enough in a *Lohengrin* "Bridal Chorus" and *Rigoletto* Quartet. There are some interesting treatments, too, of "*Là ci darem la mano*" and the *Aida* Grand March, but here—and even more so elsewhere—the arrangements tend to become chaotic and the performances emptily raucous. Magnificently recorded throughout, this is an experiment that warrants a second attempt—more carefully planned and less intensely executed. R.D.D.

"German Army Chorus." Soldier Chorus of The Training Battalion, Officer's Training School #2, with 6th Music Corps of the German Federal Army, Capt. Gerhard Scholz, cond. London SW 99007, \$4.98 (SD).

Well, the Germans didn't lose the musical

A mediocre tube is like a mediocre musician!



DON'T SETTLE FOR MEDIOCRITY... USE GENERAL ELECTRIC HI-FI TUBES!

GENERAL  ELECTRIC

411-202C

CIRCLE 67 ON READER-SERVICE CARD

war—and this record proves it. The robust, confident voices of an army chorus swell in martial vigor through *Wenn wir marschieren*, *Panzerlied*, *Lili Marlene*, and other such favorites of the Waffen SS. No one can sing brassy anthems of this type quite like a German chorus, and London has here captured one of the best in splendid, sweeping stereo. The songs themselves are ardent and melodic, but old World War II hands will have the depressing feeling that they have already attended this concert. London provides texts, but no translations. O.B.B.

“Tonight at 8.30.” Carol Lawrence; Orchestra, Peter Matz, cond. Chancellor CHL 5015, \$4.98 (LP); CHLS 5015, \$4.98 (SD).

If *Tonight at 8.30* is as firmly implanted in your memory as it is in mine as the title of an entertainment Noel Coward wrote for himself and the late Gertrude Lawrence, you may be disappointed to find that Carol Lawrence has not included a Coward song in her program. What you won't be disappointed in is the young star's quite captivating performances of the songs she has selected from Broadway shows for her solo recording debut. This is an ambitious and highly diversified program, ranging from Arlen's dainty *Sleepin' Bee* and the quiet reverie of *Lazy Afternoon* to the excitement of *Something's Coming* and the sly suggestiveness of *Do It Again*. Miss Lawrence handles all of them with the aplomb of a veteran, bringing to them a vocal artistry that is quite rare in these days of mediocre musical comedy singing. J.F.I.

“Good Housekeeping's Plan for Reducing Through Exercise and Sports.” Julie Conway and Rosemary Rice, narrators; the Bob Prince and Tony Aless Quartets. Columbia CS 8280, \$4.98 (SD).

“Learn to Play Bongos with Mr. Bongo.” Ira Cook, narrator; Jack Costanzo and Ensemble. Liberty LRP 3177, \$3.98 (LP).

My first encounters in a long time with didactic recordings impress me anew with their suitability for do-it-yourself attempts to learn practically anything. I have had no chance to test out the bongo lessons, but I don't see how it's possible for anyone who seriously studies the present explicit directions and examples to fail to learn the basic techniques, at least to the extent of happily “playing along” with Costanzo's rather harsh-toned ensemble, if not necessarily with the dexterity of “Mr. Bongo” himself. For the reducing and keeping-fit exercises (lucidly explained, clearly illustrated, and made practically painless by the catchiest of rhythmic musical accompaniments), I had a most enthusiastic guinea pig who couldn't wait to seize the album from me, and who reported that the exercises themselves are “wonderful—but very exhausting.” R.D.D.

“Gala Russe.” Don Cossack Choir, Serge Jaroff, cond. Decca DL 10026, \$4.98 (LP); DL 710026, \$5.98 (SD).

One of the selections on this release, *Cossacks in Captivity*, showcases the organlike tonalities of the Don Cossacks at their best; another, the Orthodox *Cherubim Hymn*—sung with a melting tenderness—is deeply mov-

ing. Yet, the program is not wholly felicitous. A group of student songs miss the mark completely, and a kind of sameness afflicts the Cossack ballads. Perhaps, after his long and honored stint on the podium, it is graceless to suggest that conductor Serge Jaroff could better delineate his material. However, the fact remains that *Back from the March*, a somber account of a Cossack who kills his faithless wife, comes off as a lighthearted vocal gallop, complete with piercing whistles. Turgid over-all sound casts a shadow across both editions. O.B.B.

“Our Leader.” Paul Miller, banjo; Ensemble. Fantasy 3287, \$3.98 (LP).

“Saloon Favorites.” Lou Stein, piano; Ensemble. Mercury MG 20271, \$3.98 (LP).

A pair of raffish offbeat programs strictly for old-timers with vulgar tastes, but what a welcome relief from the suavities of most current pops! Miller's four-string banjo picking and strumming dominates the exuberant performances of the San Francisco Marching, Trotting, and Walking Band in a batch of tunes from the Twenties, augmented by happy revivals of the earlier *Under the Bamboo Tree* (1902), *Golden Arrow* (1906), and *Cubanola Glide* (1909), plus Miller's own ragtime-era evocations, *Blues for Banjo* and *Goodbye Mr. Banjo*. Lou Stein cavorts on his honky-tonk piano (one with more substantial tonal qualities than most) along with a similarly brash and casual sax, guitar, xylophone, and rhythm section in such old favorites as *The Sheik of Araby*, *Ain't Misbehavin'*, *Doodle Doo Doo*, and

33 years of advanced circuitry design...

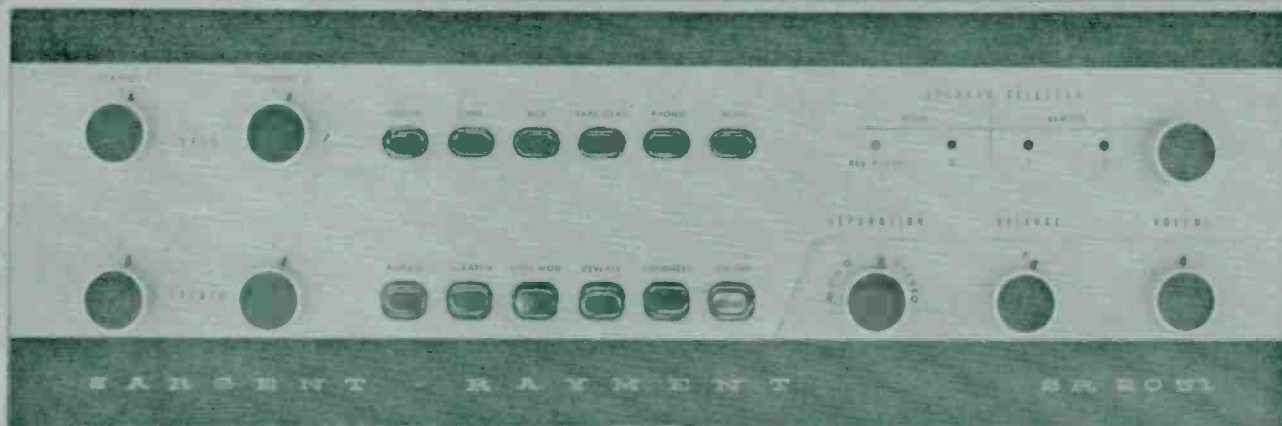

another reason why

SR means
Superior **R**eproduction

From SR's maturity of experience and tradition of leadership in design comes the SR-2051, the most versatile and powerful stereo control amplifier available from any source at any price. See it at your authorized SR dealer's today, or send for detailed description and engineering specifications.

SARGENT-RAYMENT CO. • 4928 E. 12th St. • Oakland 1, California

CIRCLE 114 ON READER-SERVICE CARD

Can you see the difference between these two needles?



A quality Clevite "Walco" W-75

Differences in needles may *defy the eye* but not the *experienced ear*. There is no visual difference in the above needles, but a *world of difference* in the sound qualities reproduced by them. Superficial similarities of size, shape or tip material do not determine a needle's effectiveness, but critical differences — inherent in the nature of the metal and the quality of workmanship — can and *do* effect the compliance of the shank and the frequency response transmitted.

Don't be misled by *look-alike* needles. Your Clevite "Walco" dealer has the needle that not only *fits* your cartridge . . . but is *right* for it, giving the compliance and frequency response your player must have for proper reproduction.

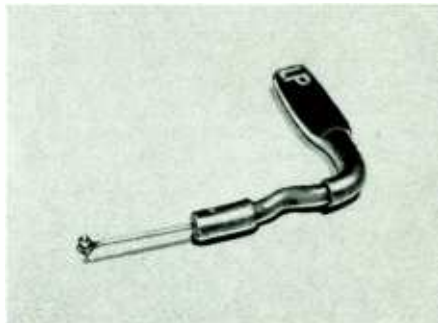

"Unlicensed" inferior foreign imitation

All Clevite "Walco" needles are fully guaranteed. When you buy a Clevite "Walco" *exact* replacement needle, you get the same *quality* and *precision* that is put into all Clevite "Walco" *original equipment needles* . . . needles that are specified and installed in the cartridges of virtually every leading manufacturer.

Write for **FREE Sample Disc** — protective plastic record sleeve.



CLEVITE 'WALCO'

60 Franklin Street
East Orange, New Jersey

ACCESSORIES: DisCovers • Stati Clean • DisCloth
DisClean • Stylus Pressure Gauge • DisCleaner Kit

REPLACEMENT PHONOGRAPH NEEDLES • RECORD CARE ACCESSORIES • CLEVITE BRUSH HI-FI HEADPHONES
CIRCLE 39 ON READER-SERVICE CARD

"THE LOOK OF PERMANENCE"

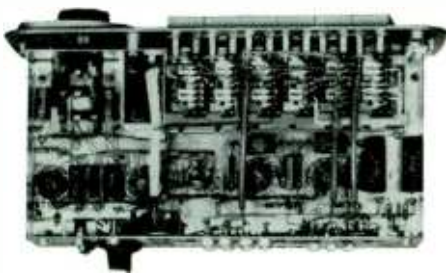

QUAD 22 Mono-Stereo Control
"inside permanence."



QUAD 22 Mono-Stereo Control
"outside permanence."

Prudent purchasers today are graduating from mass produced "hi-fi" products, with their built-in "planned obsolescence," to the definitively engineered and hand-crafted **QUAD** products.

The **QUAD** Mono-Stereo Amplifier, AM and FM Tuners, and Full Range Electrostatic Loudspeaker represent enduring investments in natural sound reproduction. Their engineering is world recognized as the most advanced, their workmanship the very finest.

QUAD products are sold only thru selected, franchised dealers—who also feature the superb **SME** Precision Pickup Arm and other advanced no-compromise products. Further information and dealers' names available by letter request.

ELECTRONICS of CITY LINE CENTER, INC.
7644 CITY LINE AVENUE, PHILADELPHIA 31, PA.

CIRCLE 90 ON READER-SERVICE CARD

several more recent songs (*I'll Get By* and *Stars Fell on Alabama*) that respond almost as well to his jaunty treatment. R.D.D.

"Around Midnight." Julie London; Orchestra, Dick Reynolds, cond. Liberty LRP 3164, \$3.98 (LP); LST 7164, \$4.98 (SD).

Julie London, who for a long time threatened to become the only inaudible singer on records, has suddenly acquired a little more vocal power. The barely whispered singing style, doubtless designed to establish her as the *femme fatale* of the phonograph, is replaced by a more robust manner. I'm not suggesting that she has become a Teresa Brewer or Ethel Merman overnight, but at least it is possible, without effort, to hear what she is singing. And what she is singing here are some pretty fine standards, including expert versions of *Black Coffee*, *Lush Life*, and *How About Me*. If she is not quite as successful with the balance of the program, the difference is very slight. Credit Dick Reynolds with some superior arrangements and the Liberty engineers with equally excellent sound. J.F.I.

"Sweet and Spanish." Lourdes Guerrero Otis; Orchestra, Mercury MG 20570, \$3.98 (LP).

The voice of Lourdes—born Lourdes Guerrero in the Dominican Republic—will bring new and exciting palpitations to your speaker system. Rich and solid, yet flickering with dark Spanish fire, her vocal style captivates both the ear and the spirit upon first contact—and the captivation endures. The beautiful *Dominicana's* recital, sung in Spanish, ranges from *Amor to Tea for Two*; perhaps her best number is *Duerme*, known to American audiences as *Time Was*. In any case, all shine with a new luster in Lourdes' interpretations. Outstanding engineering throughout. O.B.B.

"Connie Francis Sings Spanish and Latin-American Favorites." M-G-M E 3853, \$3.98 (LP).

To judge from what little intelligible sound filters through these grossly overechoed grooves, Miss Francis seems to handle this array of staples—*Siboney*, *Magic Is the Moonlight*, *Malagueña*—with intelligence and discernment. However, the fullness of her voice never penetrates the sonic syrup; her *Green Eyes*, for example, sounds as if taped in a submerged bathysphere. O.B.B.

"Robert Merrill and Vivienne della Chiesa Sing Vincent Youmans and Cole Porter." Everest LPBR 9001, \$4.98 (LP); SDBR 8001, \$4.98 (SD).

I'm sure that everyone involved in this project went into it with the best of intentions, but somewhere along the way, things went sadly awry. Part of the blame for this catastrophe may be laid to Gordon Jenkins' pretentiously dull arrangements, but most of it can be placed squarely on the shoulders of the two vocalists. Although Merrill is in good voice, he shows little enthusiasm for his material, lumbering through the songs with astonishing disinterest. His partner, once a soprano, now boasts a rather unmusical contralto (or is it tenor?) voice which she uses without any distinction whatever. Her version of *I Love Perris* (her pronunciation) must be the least enthusiastic tribute to the

City of Light on records. It is really difficult to imagine that these fine songs could have been made to sound any drearier. J.F.I.

“Adventures in Paradise.” Charles K. L. Davis; Orchestra, Hal Mooney, cond. Everest LPBR 5106, \$3.98 (LP); SDBR 1106, \$4.98 (SD).

There is no mystery as to why Charles K. L. Davis should stake out a claim that Hawaii is a synonym for Paradise. He was born there. To advance his claim, the young tenor offers a beguiling assortment of languorous songs from the Islands, plus one or two (*Red Sails in the Sunset* and *Now Is the Hour*) which, given a Hawaiian inflection, do not seem to be out of their usual habitat. Davis' light tenor voice is the perfect instrument for implementing the appeal of these lovely ballads, and there is added appeal in Everest's superlative sound. J.F.I.

“Big” Tiny Little's Singing Honky-Tonk.” “Big” Tiny Little, piano; Chorus and Orchestra, Charles Bud Dant, cond. Coral 57335, \$3.98 (LP); 757335, \$4.98 (SD).

Even though this recording is not labeled a “Sing Along With” session, it is obviously designed to entice the listener into joining the gang for thirty minutes of vocal fun. Few listeners will be able to resist the invitation. Most of the songs are reasonably familiar (*Daddy, Lazy River, Marie, In a Shanty in Old Shanty Town*, etc.), the arrangements uncomplicated, and the chorus work excellent—though possibly a bit restrained in view of the implied environment. Since the sound has been kept at a reasonable level, attending participants need have no fear that their contribution will be drowned out. The gusto of the pianist's playing gives a great deal of atmosphere to the proceedings. J.F.I.

“Kick Thy Own Self.” Brother Dave Gardner. RCA Victor LPM 2239, \$3.98 (LP); LSP 2239, \$4.98 (SD).

For too many years the Southern epitome of wit has been the pratfall. So the listener's delight doubles when beneath Dave Gardner's rich amalgam of Southern accent, ecclesiastical unction, and hip patter glistens a humor sometimes subtle, sometimes broad. Gardner is primarily a raconteur, and his punch lines tend towards drollness rather than the belly laugh. True, Gardner is on the edges of the “sick” ranks, but basically his roots are deep in the humorous soil that produced Will Rogers. O.B.B.

“Nice 'N' Easy.” Frank Sinatra; Nelson Riddle and His Orchestra. Capitol SW 1417, \$5.98 (SD).

Sinatra is back, after a year's sabbatical, with a bouquet of fine songs, nearly all of which he has recorded previously, though not for his present company. Except for the easy-swinging title number (a new song), these are all slow, slow ballads, in which The Voice appears to be going back to its middle Columbia-Axel Stordahl period. There is the usual impeccable Sinatra phrasing and feeling for the lyric, but I thought the voice sounded tired, and there is occasional evidence of strain. The unusually restrained, though completely appropriate, support from the Riddle Orchestra is always helpful. J.F.I.

The Music Box

OFFERS

Discriminating Audiophiles Throughout the World

A Mail Order Service on all Long Playing Records and Stereo Tapes that is unrivaled anywhere

OUR UNIQUE PERSONAL SERVICE features . . .

Meticulous inspection of every brand new, factory fresh, unplayed record for visible imperfections.

Careful dusting, cleaning and de-stating of each selected record, which is then enclosed in one of our own polyethylene sleeves.

Greatest possible care in packing, ensuring that all records reach you in perfect condition.

Domestic Orders mailed POST FREE to anywhere in the U.S.A. Overseas orders at usual parcel post rates.

Extremely fast shipment to all parts of the world.

All records, on all labels, including the following world famous import labels, Odeon, Pathe, Electrola, Cantate, Cetra and Rococo. Also we can supply, to special order, any Long Playing records in the current English Catalogs.

Personal advice, by a well known authority, on all matters pertaining to records and tapes.

All records are sold at the manufacturer's suggested list price only. Check or money order should accompany your order. Sorry . . . No C.O.D.'s.

We have a limited number of deleted and hard to find records on all labels. Please send in your want list.

THE MUSIC BOX *Main Street*
GREAT BARRINGTON, MASS.

CIRCLE 102 ON READER-SERVICE CARD

BRAHMS
Hungarian Dances

DVOŘÁK
Slavonic Dances

REINER
Vienna Philharmonic

Stereo: CS6198 Mono: CM9267

ffrr mono LONDON RECORDS ffss stereo

Write for free complete catalog: London Records, Dept. CE, 539 W. 25th St., N. Y. C.

CIRCLE 94 ON READER-SERVICE CARD

INTRODUCING ALTEC 707

STEREO AM-FM TUNER-AMPLIFIER

Advance with Altec to the new, true sound of music—the larger-than-life sound of stereo at its finest! The all-new Altec 707 Stereo AM-FM Tuner-Amplifier brings you Altec engineering at its best—the same engineering which has made Altec sound the universal standard of theatre and broadcast sound. Here is that all-in-one control unit every stereo enthusiast has demanded—but one which makes no sacrifice in circuitry or component performance. In the 707, there is no compromise with quality! It took Altec speaker engineering to turn the trick—the

kind which created the matchless sound of Cinerama and Todd-AO for theatres, the speaker used by almost all major broadcast and recording studios.

Enjoy the sure simplicity of professional controls, the unequalled performance of the 707 in your own stereo set-up. Compare the specifications, then listen to it at your Altec dealer's. Experience that great moment when you are introduced to the true sound of music—the Altec sound of music. Priced at only **\$387.00.**



NOW AT LAST, a home-sized 800 cycle speaker with components similar to those used in the world-famous A7 Altec "Voice of the Theatre" system.

Visit your Altec professional high fidelity consultant and ask him to demonstrate the new 837A "Avalon" speaker system and the new 707 Stereo AM-FM Tuner-Amplifier, that will bring the full range and dynamics to your living room.

The 837A "Avalon" is a professional 2-way system with frequency response of 40–20,000 cycles. 25 watt capacity. Dimensions, 29¾" H by 35" L by 17¾" D.

Other complete speaker systems from **\$89.50.**



Compare ALTEC advances and superior specifications at your ALTEC DEALER'S. ALTEC offers you the most complete line of quality stereo and mono high fidelity amplifiers, speakers, and systems in the world. Write for descriptive brochure. Address Dept. HF-7D

ALTEC LANSING CORPORATION, a subsidiary of Ling-Temco Electronics, Inc.
1515 S. Manchester Avenue, Anaheim, California 92704 161 Sixth Avenue, New York 13, New York

CIRCLE 9 ON READER-SERVICE CARD

THE ALL-NEW



FM

Antenna: Standard 300 Ohm.
 Maximum Sensitivity: 2 Microvolts.
 Quieting Sensitivity: 2.9 Microvolts for 20 db.
 7.0 Microvolts for 30 db.
 Frequency Range: 86.5 to 109 mc.
 Image Rejection: 45 db.
 IF Rejection: 55 db.
 Detector Peak Separation: 450 kc.
 Frequency Response: ± 1 db 20—20,000 cps.
 Antenna Radiation: Meets FCC Requirements.

AUDIO

Power Outputs: 80 watts Stereo Program Peak Power (40 watts per channel); 48 watts Music Power Output (24 watts per channel); 40 watts, rms continuous, Stereo or Monophonic (20 watts per channel).
 Distortion: Less than 1% THD at 20 watts, 1,000 cps, each channel.
 Frequency Response: $\pm .5$ db 20—20,000 cps at 1 watt.
 Tone Control Range: ± 12 db at 50 cps, 12 db at 10,000 cps.
 Rumble Filter: 12 db per octave below 30 cps.
 Input Sensitivity for 20 watts output: Tape, Multiplex—350 mv 1 kc; Magnetic Phono—3.0 mv 1 kc; Tape Head—1.5 mv 250 cps.
 Input Impedance: Phono—47,000 Ohms; Tape Head—47,000 ohms; Multiplex—100,000 Ohms; Tape Machine—100,000 Ohms.
 Load Impedance: 4, 8 and 16 Ohms.
 Noise Level: Phono—55 db below 20 watts; Tape Head—52 db below 20 watts; Tape Machine—78 db below 20 watts; Multiplex—78 db below 20 watts.

AM

Antenna: Built-in Ferrite Antenna, plus external antenna connection.
 Maximum Sensitivity: 3.2 Microvolts.
 Loop Sensitivity: 35 Microvolts per meter.
 Frequency Range: 537 to 1630 kc.
 Image Rejection: 65 db.
 IF Rejection: 50 db.
 Selectivity: 6 db bandwidth, 13 kc "Broad", 6 kc "Sharp".
 Whistle Filter: 10 kc Attenuation better than 40 db.

GENERAL

Front Panel Controls: Input selector switch, channel balance control, Dual gain control, Dual bass control, Dual treble control, Dual Broad-Sharp selectivity switch, FM AFC defeat switch, Stereo-Monophonic Mode switch, Stereo Standard-Reverse switch, Loudness contour switch, Rumble filter switch.
 Internal Control: Squelch threshold control.
 Inputs: 9, Stereo or Monophonic—Magnetic Phono, Tape Head, Tape Machine, Multiplex Input, FM antenna, AM external antenna.
 Outputs: 6, Stereo or Monophonic—Channel A and Channel B Recorder, left and right speaker, Center speaker, Multiples Outputs.
 Tubes: 1-6GY8, 1-6AL5, 5-6BA6, 1-6BE6, 2-EM84, 1-12AU7, 5-12AX7, 4-7355.
 Power Consumption: 145 watts, 117 volts, 60 cps.
 External Power Available: One AC outlet controlled by power switch.
 Color: Platinum gold or platinum pink. Weight: Apx. 35 lbs.
 Dimensions over knobs and antenna: 5 $\frac{7}{8}$ " H x 15" W x 12 $\frac{5}{8}$ " D.

Copyright 1960 Altec Lansing Corporation



THE TRUE SOUND OF MUSIC

CIRCLE 10 ON READER-SERVICE CARD

OCTOBER 1960

117

THE ONLY STEREO RECORD THAT PLAYS ON ANY PHONOGRAPH



Yes, it's true! Now you buy the one and only **DESIGN COMPATIBLE TWO-WAY STEREO RECORDS** and you will have full fidelity sound on *any* monaural phonograph and full two-channel response on *any* stereo phonograph. The product of many years of engineering research in cooperation with Fairchild Recording Corporation and Keel Manufacturing, these **DESIGN COMPATIBLE** records end obsolescence at last . . . let you build one marvelous record library that is perfect for any type system and *any* phonograph for now and for the future. In addition the dilemma of not knowing whether to buy stereo or monaural records that previously confronted you when giving records as gifts has been eliminated. There is an exciting selection of new **DESIGN** releases waiting at your record shop. Buy them once—buy them now—and you are ready for the phonograph of today and tomorrow.

INTRODUCTORY OFFER! BUY THREE, GET ONE FREE

Buy your first 3 Design Compatible records and get the 4th FREE!
(Coupon in every record jacket.)

Introductory price

\$298
EACH

A few of the great new **DESIGN COMPATIBLE** albums

- | | |
|----------|---|
| DCF 1033 | THE TWIN STRING ORCHESTRAS play George Gershwin |
| DCF 1034 | JOHNNY PINAPPLE from Hawaii |
| DCF 1035 | PIANO ROLL MUSIC of Phantom Foley plus two |
| DCF 1036 | SWINGIN' PRETTY & ALL THAT JAZZ Mat Mathew |
| DCF 1037 | THE WORLD'S GREATEST BALLETS Milan Symphony |
| DCF 1038 | ARIAS FROM THE WORLD'S GREAT OPERAS
La Scala Di Milano |
| DCF 1039 | NORO MORALES Holiday in Havana |
| DCF 1040 | THE INK SPOTS |
| DCF 1041 | GOLDEN ERA OF GLENN MILLER Vol. II |

UNI-GROOVE STEREO SYSTEM

DESIGN COMPATIBLE FIDELITY

A Product of Pickwick Sales Corp.
Pickwick Bldg., Dept. HF, Long Island City, N. Y.

CIRCLE 48 ON READER-SERVICE CARD



Count Basie and His Orchestra: "Not Now, I'll Tell You When." Roulette 52044, \$4.98 (LP); S 52044, \$5.98 (SD).

Slick, smooth, monotonous, and showing strong evidence of hardening of the orchestral arteries—that is the over-all impression one gets from this set. The first side is promising—there is the airy Basie piano, trombonist Al Grey growling up an Ellington atmosphere, some honest vitality by tenor saxophonist Billy Mitchell, and a muted trumpet. But then comes a stage show version of *Ol' Man River* and a second side that limps heavily most of the way. There are glimpses of the light-stepping Basie swing through the heavy mist, but they are only enough to be tantalizing.

Basso-Valdambrini Quintet. Verve 20009, \$4.98 (LP).

Saxophonist Gianni Basso and trumpeter Oscar Valdambrini lead an Italian group which seems to take its cues from the latter-day manifestations of the cool school in the United States. Valdambrini sometimes suggests the languidity of Chet Baker, at other times he has the more forthright attack that one used to hear from Jon Fardley. Basso is a pleasant but undistinguished performer. The effect is one of low-keyed background music made a little heavier than should be by a monotonous rhythm section.

Art Blakey and The Jazz Messengers: "The Big Beat." Blue Note 4029, \$4.98 (LP).

Blakey's Jazz Messengers, at their peak during Benny Golson's brief incumbency as musical director, have slid down hill since Golson's departure. Although the group retains some vestiges of the quality that Golson drilled into it, its material has deteriorated badly. Trumpeter Lee Morgan and tenor saxophonist Wayne Shorter do reasonably well as soloists, and Blakey propels the rhythm section with his usual muscularity, but the tunes are routine. The only variation from the endless, anonymous chomp-chomp of almost all the pieces is an odd and urgent *It's Only a Paper Moon*.

Les Brown and His Band: "Jazz Song Book." Coral 57311, \$3.98 (LP); 757311, \$4.98 (SD).

Brown has spiced up the usually bland playing of his band by bringing in four guest soloists—Zoot Sims, Buddy DeFranco, Frank Rosolino, and Terry Gibbs—to play arrangements

written by another guest, Bill Holman, as well as by his staff arrangers, Wes Hensel, J. Hill, and Frank Comstock. Holman's arrangements give Brown's ensemble more body and swing than it normally has (the contrast of the stage-show production writing of Comstock is startling) and Sims, Gibbs, and De Franco provide strong solo voices. De Franco, in fact, sounds warmer and easier in this big-band setting than when playing with small groups. Even with this support, Brown's band is still not comparable to the major big jazz bands, but this disc has more jazz than Brown has offered in some time.

Dave Brubeck Quartet: "Bernstein Plays Brubeck Plays Bernstein." Columbia CL 1466, \$3.98 (LP).

Howard Brubeck's *Dialogues for Jazz Combo and Orchestra*, with brother Dave's Quartet as the Jazz Combo and the New York Philharmonic as the Orchestra, is conducted by Leonard Bernstein on one side of this disc. Because this is a jazz-cum-symphony concerto grosso, Brubeck's piece invites comparison with the Sauter-Finegan-Chicago Symphony recording of Rolf Liebermann's *Concerto for Jazz Band and Orchestra*. It is strictly no contest, however, for both Howard Brubeck and Bernstein have an understanding of jazz that goes far deeper than that of Liebermann and Fritz Reiner (who conducted the Chicago). Even so, the *Dialogues* are carried almost entirely by what are, presumably, ad-lib sections played by the Brubeck Quartet, which is in its best form. Dave Brubeck holds to simple piano lines, Paul Desmond is in his airiest, swinging style on alto saxophone, and the usual dependable rhythm support is provided by Gene Wright, bass, and Joe Morello, drums. The Philharmonic brass shows commendable crispness during an interlude with Desmond in the first section, but for the most part the symphony men play a subordinate role. On the opposite side of the disc the Brubeck Quartet tries its hand at some of Bernstein's show tunes with scarcely any success aside from a gently lyrical version of *Maria* from *West Side Story*.

Cab Calloway and His Orchestra: "Hi De Hi De Ho." RCA Victor 2021, \$3.98 (LP); LSP 2021, \$4.98 (SD).

Nostalgians, beware! This is a disc calculated to make you very unhappy. Calloway, singing in an excessively mannered and (to my ear) offensive fashion, ruins several of his early hits, including *Minnie the Moocher*,

as well as some helpless ballads. The studio band accompanying him has no jazz qualities whatever.

Benny Carter and Hal Schaefer: "Cole Porter's 'Can-Can' and 'Anything Goes.'" United Artists 3055, \$3.98 (LP).

The combined talents of Carter, Schaefer, and Cole Porter might, one suspects, have been used more effectively than they are on this disc. Carter has arranged five tunes from *Can-Can* and Schaefer five from *Anything Goes*. Both are played by quintets which include Carter, playing alto saxophone, and Schaefer on piano. Carter's arrangements are simple and functional, serving as uncluttered frames for his own elegant, clean-lined solos and for Schaefer's slightly eccentric manner of digging into his piano parts. Schaefer's arrangements, on the other hand, tend to be gimmicky. There is so much emphasis on cleverness that the soloists are often lost in the shuffle although Carter manages to cut through *Allez-Vous En* to create a gentle, moving solo. Of the three principals involved, only Carter comes through satisfactorily.

Ornette Coleman: "Change of the Century." Atlantic 1327, \$4.98 (LP).

The latest serving of specialties by the current *enfant terrible* of jazz does little to clarify his cause. On one selection, *Ramblin'*, Coleman's performance on alto saxophone is organized and stated sufficiently clearly to reveal the strong jazz feeling at the heart of his playing, and his trumpeter, Don Cherry, also achieves a relatively positive approach. Otherwise, however, the seven selections which make up this disc (all Coleman originals, as usual) consist largely of spastic, bop-pish riffs and lunges expressed with the unattractive harshness that seems to be an essential characteristic of Coleman's work. In the midst of all this mauling, one cannot help but be impressed by the swinging vigor of Charlie Haden's bass playing.

Eddie Condon's All Stars: "Tiger Rag! and All That Jazz." World Pacific 1292, \$4.98 (LP).

The situation facing us here is a set of tunes from the original Dixieland Jazz Band's repertory pounded out suddenly by a generally inappropriate group of Condonites and deadened even more by heavy, echoing recording. Trombonist Cutty Cutshall stands out as a beacon of light in this morass, but

Distinguished Recordings

is proud to announce their

**DISTINGUISHED CONCERT
SERIES**

A catalogue of superb recordings never before available to the public.

Virtuoso performances transcribed in full range high fidelity at the peak of the careers of

**PROKOFIEV
PADEREWSKI
BUSONI • CORTOT
HOFMANN • FRIEDMAN
GANZ**

These releases are available now. Future recordings to include performances by Landowska, Hess, Bauer, Leginska, Backhaus, Grainger, etc.

write for free catalogue

DISTINGUISHED RECORDINGS

Nationally Distributed by SCEPTER MUSIC, INC.
1650 BROADWAY, NEW YORK 19, NEW YORK

CIRCLE 49 ON READER-SERVICE CARD

\$1.98
1 monitor
special

RICHTER: "One of the world's great pianists." — TIME



In conjunction with Sviatoslav Richter's tour of America, MONITOR offers his recording of the Bach and Schubert Concertos at the special price of \$1.98! (MC 2050)

The brilliant Russian violinist LEONID KOGAN in a new release playing the Prokofiev Violin Concerto No. 2, Saint-Saens Havanaise and Tchaikovsky Serenade Melancholique.

Also Specially priced at \$1.98 (MC 2051)

If unavailable at your local dealer write

monitor
high fidelity recordings

413 West 50th Street, New York 19, N.Y.
Complete catalogue available upon request

CIRCLE 101 ON READER-SERVICE CARD

Rex Stewart and Bud Freeman try to solve their problems by blowing as raucously as possible. The group copes successfully with only one tune—significantly, not an OJB piece—*Lazy River*. Why they bothered to do the rest is beyond understanding.

Floyd Cramer: "Hello Blues." RCA Victor LPM 2151, \$3.98 (LP).

Cramer's disc is mentioned here only as a warning. Victor lists its contents as "Swinging Blues for Boppers." Cramer, a pianist, plays stiff, diluted, commercial blues figures, totally lacking in sensitivity, accompanied by a saxophone ensemble in the Billy Vaughn idiom. No bop, no swing, no blues.

Miles Davis: "Sketches of Spain." Columbia CL 1480, \$3.98 (LP).

The Spanish folk-derivations that make up this disc would seem to be the ultimate refinement of the technique that Miles Davis and arranger-conductor Gil Evans have explored earlier on *Miles Ahead* (Columbia CL 1041) and *Porgy and Bess* (Columbia CL 1274). The wailing, searing sound of Davis' trumpet is ideally suited to the mood and tone on which the five selections—*Concierto de Aranjuez* by Joaquin Rodrigo, *Will o' the Wisp*, from Manuel de Falla's *El Amor brujo*, and three original developments of Spanish folk themes by Evans—are based. And the ominous, hanging background of sound in which Evans now habitually sets Davis' trumpet is extremely effective. Within this relatively narrow scope, Davis' playing is more consistently to the point than on any of his earlier discs. But all these selections are so much alike in performance that what can be an effective device when it is used sparingly is here driven doggedly into the ground. As he develops his skill along this specialized line, Davis seems to be withdrawing from jazz. In this set, he is moving in the direction of a form of concert music that has only a tenuous relationship to jazz.

Richard Evans Trio: "Richard's Almanac." Argo 658, \$4.98 (LP).

There seems to have been little point in issuing this disc. Made up of Jack Wilson, piano, Evans, bass, and Robert Barry, drums, the trio shows that it has studied the Ahmad Jamal technique, the Horace Silver down-home style, and various brands of society jazz. It's all competent enough, but there ought to be more reason for making an LP than mere competence.

Jimmy Giuffre: "Western Suite." Atlantic 1330, \$4.98 (LP).

The three selections which make up this disc (*Western Suite* takes up one side, the other is split between *Topsy* and *Blue Monk*) were recorded in December 1958, just before Giuffre gave up the trio composed of himself, Bob Brookmeyer, valve trombone, and Jim Hall, guitar. All three pieces are far too long (18, 11:28, and 8:51 minutes, respectively) to be sustained by these three instrumentalists. The playing of both Giuffre and Brookmeyer has a drab, flat quality; and when this is joined to the dry, repetitive jiggling style that characterized most of this trio's playing, the effect becomes extremely labored. This is particularly true of Giuffre's *Western Suite*.

Topsy and *Blue Monk* both start out promisingly but they soon deteriorate, mumbling aimlessly into the doldrums.

Benny Golson Quintet: "Gone with Golson." Prestige/New Jazz 8235, \$4.98 (LP).

Golson is teamed with trombonist Curtis Fuller, who was briefly one of his colleagues in the Jazztet, and a strong rhythm section made up of Ray and Tom Bryant and Al Harewood on five varied selections. So varied, in fact, that it scarcely seems as though the two long, unraveled pieces that make up Side B could really have been played by the disciplined, full-bodied group that creates three striking selections on Side A. All three have the dark, tight voicing that is the hallmark of Golson's arrangements. Two are loosely hinged originals on which Golson, Fuller, and Ray Bryant produce solos that bristle with propulsive assurance while the third, a ballad, *Autumn Leaves*, is attacked with much more bounce than one ordinarily expects in a ballad. Both Golson and Bryant build solos bubbling with rugged piquancy on this tune. Why such a capable group should have been able to do so little with the material on the second side of the disc remains a mystery.

Johnny Griffin Orchestra: "The Big Soul Band." Riverside 331, \$4.98 (LP); 1179, \$5.98 (SD).

Tenor saxophonist Johnny Griffin's effort to use spirituals and spiritual-like material as the basis for big-band performances has blossomed promisingly here largely because Griffin has found in Norman Simmons an arranger with original ideas who is not satisfied simply to sketch an outline and call it an arrangement. Simmons has steered clear of the currently omnipresent heavy gospel backbeat, relying instead on the more open, freer expression of exaltation associated with earlier spiritual performances. Within that area, he has managed a great deal of variety in tempo, attack, and shading. Griffin's solo work is contained and thoughtful without losing the full-bodied urgency he has shown in less well-organized circumstances and there are several complementary solos by Clark Terry, Matthew Gee, and Bobby Timmons. The basic idea of this album may be too constricting to be carried much further, but it has at least two fine performances in *Meditation* and *Nobody Knows the Trouble I've Seen* and it serves to make known the highly promising arranging talents of Simmons.

Ted Heath and His Music: "The Big Band Dixie Sound." London LL 3138, \$3.98 (LP).

The Bob Crosby band came as close as any big band ever has to catching the Dixieland idiom. Ted Heath isn't anywhere near the target on this disc. He has settled for slick, swing arrangements of tunes from the Dixieland repertory through which a small, two-beat group occasionally pokes its anxious head. The soloists, too, are in the swing tradition rather than Dixieland. It's all a waste of the real merits of Heath's band.

Claude Hopkins: "Yes Indeed!" Prestige/Swingsville 2009, \$4.98 (LP).

Hopkins, who led one of the outstanding big bands of the Thirties, still plays very pleasant

piano (he has some good solos on this disc), but he has surrounded himself with such a strong rhythm section (Wendell Marshall, bass, and Osie Johnson, drums) and with such masterful front line men (Buddy Tate, tenor saxophone, and Emmett Berry, trumpet) that, even though he plays well, he is the bottom man on this totem pole. Top man in this fast company is Tate, whose stirring, willowy saxophone sends every selection soaring. He is, it seems to me, the most consistently exciting tenor saxophonist playing today. Certainly no one could match his lithe solos on these selections. Berry is not far behind him and the rhythm men give them lusty, walloping support. Barring such brief moments as the lumpy thematic statement of *Yes Indeed*, the title selection, the disc teems with wonderfully loose-jointed, swinging jazz.

Ahmad Jamal Trio: "Jamal at the Pershing, Vol. 2." Argo 667, \$4.98 (LP).

Jamal's trio recorded these selections in January, 1958, the night following the recording session that produced *But Not for Me*, Argo 628, a disc that helped lift the group to wide popularity. If that LP had its fascinations more than two years ago, the present one might have been equally well received then, too. For there is slick, quirkish piano work by Jamal and Israel Crosby's powerful bass is a constantly lifting force. But in two years' time the Jamal repertoire of tickling, teasing piano lines over a strong, steady rhythm has become so familiar that performances such as these no longer carry the sound of surprise, to use Whitney Balliett's apt phrase, that they once had. They remain, nonetheless, pleasant, lighthearted demonstrations of an airy brand of cocktail jazz.

"Jazz Scene 1 and Jazz Scene 2." Epic LA 16000 and LA 16001, \$3.98 each (Two LP). Although the intent of these two discs appears to be to offer a capsule survey of jazz, their actual range is much more modest. *Jazz Scene 1* covers the Thirties in performances by Bunny Berigan (his classic *I Can't Get Started*), Count Basie (with Lester Young), Art Tatum, Artie Shaw, Earl Hines, Roy Eldridge, and four Ellington small groups led by Johnny Hodges, Cootie Williams, Barney Bigard, and Rex Stewart. As a miscellany, this is a fine set of performances (notably the Basie-Young *Lady Be Good*, Williams' fervently growling *Delta Mood*, and Bigard's joyous *Caravan*) but it is scarcely representative either of the Thirties—the Swing Era is caught only once, and glancingly at that, in Shaw's early *Just You, Just Me*—or, as the notes claim, of the "artists who have influenced jazz growth and the direction it would take." But while this disc has much to recommend it regardless of its asserted purpose, *Jazz Scene 2* is another matter entirely. Not only does it offer a very limited report on modern jazz (its declared intent), but aside from a romping saxophone duet by Zoot Sims and Al Cohn and a buoyant piano solo by Ray Bryant, the performances are quite run-of-the-mill. They are played by Ahmad Jamal (in the days when his trio included a guitarist instead of his current drummer), Kenny Clarke, Herbie Mann, Phil Woods, Bengt Hallberg, Conte Candoli (whose name is misspelled four times in four tries in the notes), and the Mitchell-Ruff Duo.



rarely

does a product happen along in the crowded high fidelity components field that warrants any extraordinary attention. There is, of course, an exception to every rule. In this case, the new DMS-900 magnetic stereo cartridge is the exception.

Here are a few of the findings from an exhaustive test made at our request by Hirsch-Houck Laboratories, a leading independent research organization:

- "Tracks well at less than 2 grams . . . indicating it is easy on records."
- "Channel separation superior to practically any cartridge we have tested . . . being maintained all the way up to 15 KC."
- "Frequency response and output voltages of the two channels are well matched."
- "Few cartridges have as symmetrical channel separation properties as does the DMS-900."

Ask your dealer to demonstrate the fabulous DMS-900...the new magnetic stereo cartridge that tracks feather light!

With .7 mil diamond stylus, \$34.50.

united audio
WIGO • PRODUCTS OF DISTINCTION • DUAL
12-14 W. 18th St., N. Y. 11, N. Y.

CIRCLE 53 ON READER-SERVICE CARD

THE "440" BI-PHONIC COUPLER

The first complete full range reproducer, so radically different that it is classed as a musical instrument. Like a precious violin, the Bi-Phonic Coupler is hand-crafted of selected woods — with the panel structure radiating bi-directionally (unlike the usual restricted "boxed-in" speakers) — reproducing the full realm of sound with acoustic depth, fundamental tonal purity and realism. The wafer-thin Bi-Phonic Coupler beautifully blends into any decor arrangement.

ADVANCED ACOUSTICS CORPORATION
391 Lakeside Avenue, Orange, New Jersey
A subsidiary of Electronic Research Associates, Inc.

In mahogany, oiled or lacquer
walnut \$134.40
Ebony base (optional) \$7.50

CIRCLE 3 ON READER-SERVICE CARD

TWO JEWELS

to enhance your listening pleasure

STATICmaster®

and your DIAMOND NEEDLE



The Polonium Strip does the trick

ONLY \$14.95

The amazing **STATICMASTER** Record Brush operates on a simple nuclear principle. When the record is brushed, a shower of alpha particles neutralizes the static charge. Soft jaguar hair bristles provide the exact degree of stiffness to remove the static free dust and lint from the record grooves. A few circular sweeps of a rotating record make dust and lint vanish like magic. **STEREO AND MONAURAL RECORDS SOUND BETTER AND LAST LONGER.**

Buy **STATICMASTERS** from your local audio dealer or order direct—sent postpaid—cash with order.

NUCLEAR PRODUCTS CO.

10173 E. RUSH STREET, EL MONTE 1, CALIF

CIRCLE 104 ON READER-SERVICE CARD

THE EAR THAT HAS HEARD EVERYTHING, HAS HEARD NOTHING UNTIL IT HEARS



LARRY KERT SING LEONARD BERNSTEIN

Identification of a singer with a song generally makes for success. In the case of Larry Kert success is insured through identification not only with a song, but with the entire score of "West Side Story" in which he plays the male lead "Tony"

This album includes selections not only from "West Side Story" but from "Wonderful Town", "Candide", "On the Town" and "Peter Pan". In this his first solo album Larry Kert gives to the public a truly fine rendition of Bernstein's best. Bernstein music, and Kert singing, the formula for wonderful entertainment.

HI-FIDELITY STEREOPHONIC



RECORDS



CELP 467—CELP 4670 (Stereo)

SEECO RECORDS, 39 W. 60 ST., N.Y.C.

CIRCLE 116 ON READER-SERVICE CARD

Johnny Lytle Trio: "Blue Vibes." Jazzland 22, \$4.98 (LP).

This is a debut recording for Lytle, a vibraharpist who has a strong feeling for melody and lean, pulsing rhythms, even on such an ethereal tune as *Autumn Leaves*, on which he manages to be both gutsy and lyrical. He has, the liner notes tell us, been endorsed by Lionel Hampton. This is not surprising since he is very much in the Hampton vein, but without the tastelessness that afflicts so much of Hampton's playing. Lytle plays a bright, moving set of seven numbers with reasonably helpful support from Milton Harris, organ, and Albert Heath, drums, who have the good sense to stay out of Lytle's way.

"Mainstream Jazz." RCA Camden 554, \$1.98 (LP); S 554, \$2.98 (SD).

Having successfully launched and promoted the term "mainstream jazz" to identify the musicians associated with the period between traditional jazz and modern jazz, Stanley Dance now seems bent on running it into the ground. On one side of this disc, which he produced, the Mainstream Sextet plays three selections of interest whenever trumpeter Shorty Baker can be heard and occasionally when tenor saxophonist Jimmy Forrest and trombonist Vic Dickenson are to the fore. But despite their best efforts, the performances as a whole are flat and undeveloped. The other side is devoted to a single selection by a big band led by Andy Gibson—a series of solos which show that a mainstreamer with too much space to fill can hang himself just as effectively as modernists can.

Les McCann: "Plays the Truth." Pacific Jazz 2, \$4.98 (LP).

McCann, a pianist (accompanied by Leroy Vinnegar, bass, and Ron Jefferson, drums), is coming in a little late on the gospel funk fad to get much distance out of it. He is a capable pianist but here his work is quite derivative. When he ventures away from the down-home riffs, as he does on *I'll Remember April*, he becomes involved in slowly rising crescendos in the Garner manner, but without the badly needed foundation of Garner's rhythmic impulse.

Jelly Roll Morton: "Rags and Blues." Riverside 140, \$4.98 (LP).

The third set of solos extracted from Morton's Library of Congress recordings is a distinct letdown after *Mr. Jelly Lord* (Riverside 12-132) and *Jelly Roll Morton Plays and Sings* (Riverside 12-133). The first disc was devoted to Morton's own compositions and the best parts of the second were also his own works. This time he concentrates largely on pieces written by others. This might have been all right since his singing and playing almost always made everything come out "Jelly Roll style." His reason, however, for playing these selections on the Library of Congress recordings was to illustrate a point he was making in his commentary. That commentary has been removed on this disc and, with it, a great deal of the validity of the performances is removed, too. He builds *Tiger Rag* to a brilliant climax in the portion of his Library of Congress performance that is included on this disc and, taken by itself, it is satisfying work. But a large part of the interest in the origi-

The latest of London's great opera recordings



DEL MONACO



SIMIONATO



MAC NEIL

Mascagni

CAVALLERIA RUSTICANA

COMPLETE RECORDING

Conducted by Tullio Serafin

SantuzzaGiuletta Simionato
AlfioCornell MacNeil

TuridduMario Del Monaco
LolaRaquel Satre

Mamma LuciaAnna Di Stasio

Chorus and Orchestra of L'Accademia di Santa Cecilia, Rome

Stereo OSA-1213

Mono A-4240



Write for free complete catalog: London Records, Dept. CG, 539 W. 25th St., N. Y. C.

CIRCLE 95 ON READER-SERVICE CARD

nal recording lay in Morton's demonstration of how *Tiger Rag* was developed from a quadrille, all of which has been omitted from this excerpt. And to include, without the relevant commentary, *Randall's Rag*, which Morton played simply to show what was *wrong* with Randall's playing, seems ludicrous. There are, of course, some fine moments—especially his singing of *See See Rider* and *If I Was Whiskey and You Was a Duck*—but most of the material on this disc is presented better in its original form on Riverside's Library of Congress series.

Red Nichols and His Pennies: "Parade of the Pennies." RCA Victor LPM 1455, \$3.98 (LP).

Red Nichols was over the peak of his career as a band leader and on the road down in the selections that make up most of this album. They are the products of his 1939 big band, a time when he had abandoned the format which had brought him fame in the Twenties and was trying to compete with the swing bands. There are moments of nostalgic interest here—Nichols' brisk treatment of *My Melancholy Baby* and his once familiar theme, *Wail of the Winds*—but not even the most willing nostalgist can deny the generally routine quality of the arrangements, the utter wretchedness of many of the tunes, the saccharinity of the singing, and the inanity of the attempts at comedy. Nichols' trumpet pokes through the surrounding trivialities from time to time, clean, precise, and coolly positive, as it was in the Twenties.

Andre Previn Trio: "Like Previn!" Contemporary 3575, \$4.98 (LP).

The glibness and derivativeness which have often played too prominent a part in Previn's jazz recordings are not in evidence on this disc. Here he is an unselfconscious, relaxed, and charming performer. The fact that all of the tunes are his own compositions may have contributed to the pleasantly unpretentious nature of this set, for the pieces are quite modest and Previn wisely does not try to make too much of them. They serve as suitable foundations for piano work that is generally light and lilting, seasoned with occasional dashes of casual muscle flexing. Bassist Red Mitchell is a bulwark of strength in support of Previn.

Pee Wee Russell: "Swingin' with Pee Wee." Prestige/Swingsville 2008, \$4.98 (LP).

Pee Wee Russell and Buck Clayton, heard here with the all-purpose rhythm section of Tommy Flanagan, piano, Wendell Marshall, bass, and Osie Johnson, drums, have made individual recordings in their long and honorable pasts that are better than anything heard on this disc. But still the general level of the set is high and it is a pleasure to hear so much straightforward swinging playing on one LP. Pee Wee is a charmer who twists every phrase and bends every note into fascinating designs, while Clayton punches away enthusiastically even on those occasions when he has nothing particular to say. The tunes lean towards standards of the stripe of *Wrap Your Troubles in Dreams*, *The Very Thought of You*, and *Lulu's Back in Town*.

Bette St. Claire: "At Basin Street East." Seeco 456, \$3.98 (LP).

There's a fine instrumental quartet to be heard in brief snatches on this disc—Stan

Free, piano, Mundell Lowe, guitar, George Duvivier, bass, and Ed Shaughnessy, drums—but their talents are wasted on Miss St. Claire, a drab, earth-bound singer. This is the same group that used to back Chris Connor. Strange that they don't seem able to find a singer more worthy of their backing.

Jack Teagarden: "Jazz Maverick." Roulette 25119, \$3.98 (LP); S 25119, \$4.98 (SD).

A relatively wan collection from Teagarden and his current group. The material is a mixture of hard-shell standards (*Tin Roof Blues*, *High Society*, *Riverboat Shuffle*) and extremely dispensable new material. Teagarden's singing and playing is, of course, as unruffled as ever, but his cohorts show understandable signs of desperation or depression.

Tyree Glenn Quintet: "Let's Have a Ball." Roulette 25115, \$3.98 (LP); S 25115, \$4.98 (SD).

Glenn, who discovered the popular potential of a muted horn with rhythm section even before Jonah Jones, weaves his wah-wah trombone way through a pretty tiresome set of performances made frustrating not only because they waste Glenn's real abilities, but even more because they make almost no practical use of a superb rhythm section—Tommy Flanagan, Mary Osborne, Charlie Potter, and Jo Jones. Glenn also sings in rather aimless fashion—particularly unfortunate when he attempts Gene Austin's wonderful tune *Take Your Shoes Off, Baby* (and *Start Runnin' Through My Mind*), a song almost totally neglected on records since Hot Lips Page sang and played it so memorably with Artie Shaw's band about fifteen years ago.

Bob Wilber: "New Clarinet in Town." Classic Editions CJ 8, \$4.98 (LP).

With each succeeding record, it becomes increasingly apparent that Bob Wilber is one of the very few jazz musicians of the younger generation (assuming that at thirty-two a jazz musician is still younger than some other jazz musicians) who has thought sufficiently about what he is doing, explored his field, studied his instrument, and achieved enough personal maturity to make what is referred to in some quarters as a "contribution" to jazz. The irony of Wilber's situation is that he is all but ignored amid the prattle from the opinion makers hailing plastic, unformed musicians who are still trying to feel their way to first base on their hands and knees. On this excellent disc, Wilber, playing clarinet, is heard with two different groups—a quintet which includes Charlie Byrd, guitar, Dave McKenna, piano, George Duvivier, bass, and Bobby Donaldson, drums; the other group is made up of the quintet plus a string quartet and French horn. The selections are by a group of composers that suggests the breadth of Wilber's jazz interest—Django Reinhardt, Duke Ellington, Eddie Sauter, Dave Brubeck, and John Lewis, among others. Wilber's clarinet is firm and full-bodied all through the disc (he is a wonderfully lyrical performer), and Byrd and McKenna inject several highly individualized solos. The selections involving strings have their inevitable troubles, but even these are generally charming and the disc as a whole is far superior to the general run of jazz releases.

FOR THE
FIRST TIME



Great Folk Music

IN STEREO



The Southern Folk Heritage Series

recorded in the field by

ALAN LOMAX

SOUNDS OF THE SOUTH 1346

Broad survey of white and Negro folk music: spirituals, blues, old ballads, work and game songs from all over the South.

BLUE RIDGE MOUNTAIN MUSIC 1347

Pickin', fiddlin' and singin' in the authentic "blue grass" style.

ROOTS OF THE BLUES 1348

Country blues, train blues, field hollers and levee camp songs from Alabama, Mississippi and Arkansas.

WHITE SPIRITUALS 1349

Lively hymns dating back to frontier America. Unusual are examples of the "lining hymn" and the songs of the Alabama "Sacred Harp" singers.

AMERICAN FOLK SONGS FOR CHILDREN 1350

Jingles, riddles, game songs, lullabies, jiggy tunes and silly ballads that make up "The People's Mother Goose."

NEGRO CHURCH MUSIC 1351

The best of the older Negro church music: soul-stirring spirituals and gospel songs recorded in Southern country churches.

THE BLUES ROLL ON 1352

Supplements "Roots Of The Blues," concentrating on more modern types of the country blues, recorded in honky tonks, prisons and the hill country.

Available stereo \$5.98
and monaural \$4.98

Write for complete catalogue.
ATLANTIC RECORDS

157 West 57th Street, New York 19, N.Y.

CIRCLE 16 ON READER-SERVICE CARD

IMPORTANT PRICE REDUCTIONS ON OPERA PACKAGES

Now, prices on all Opera Packages of 3 or more L.P.'s have been reduced by as much as \$6.00! Choose from brand-new recordings and brilliant Collectors' Favorites. All are complete operas, packaged with illustrated texts and bilingual librettos.

3-Record Living Stereo: formerly \$17.98, now \$11.98*

3-Record Monaural: formerly \$14.98, now \$9.98*

4-Record Living Stereo: formerly \$23.98, now \$17.98*

4-Record Monaural: formerly \$19.98, now \$14.98*

RCA VICTOR
A DIVISION OF RCA BROADCASTING SYSTEMS, INC.

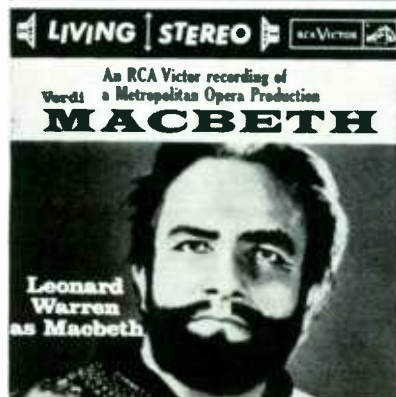

*MANUFACTURER'S NATIONALLY ADVERTISED PRICES.

CIRCLE 108 ON READER-SERVICE CARD



The Mozart Operas on Records



satisfactory. Neither Lois Marshall, as Constanze, nor Ilse Hollweg, as Blonde, is quite up to her male companion. Miss Marshall's singing may be described as neat and a little reserved; Miss Hollweg is a bit uncertain in "*Durch Zärtlichkeit*," and the upper half of her register is of better quality than the lower. Osmin is nicely sung by Gottlob Frick but without any trace of the villainy that this character should exude. The sound is clear and faithful in the monophonic edition as well as in stereo.

The Decca performance has different values, which to some listeners may outweigh those of the Angel. Outstanding here are the women. Miss Streich not only makes an ideal Blonde, but the beauty of her voice and the skill with which she handles it throughout its wide range make hers the finest singing in all three sets. Maria Stader lends more color to the part of Constanze than does Miss Marshall; and if in the horrendously difficult "*Martern aller Arten*" she sometimes scoops a bit and a few of the high Ds are a little scream, she carries off the rest, scale passages and all, with accuracy and bravura. Ernst Häfliger as Belmonte provides some good legato singing, limited in color, with top notes that have rather too much of an admixture of falsetto for my taste. Martin Vantin is quite acceptable as Pedrillo, and Josef Greindl occasionally suggests something of the character of his role, as in his really exultant "*Ha! wie will ich triumphieren*." Fricisay holds everything together nicely, and the sound is as good as Angel's LP version.

Wilma Lipp, the Constanze in the London set, begins unpromisingly but improves considerably as she goes on. In "*Ach, ich liebe*" the voice seems thin, dry, and lacking in warmth; although the high notes are good, others seem insufficiently supported. In "*Traurigkeit ward mir zum Loose*" there is more feeling and the singing is more secure. "*Martern aller Arten*," finally, is very well done. Walther Ludwig, as Belmonte, begins tight-throatedly and sometimes off pitch; but he too gets better as he goes on, and if he is not impeccable technically, he does sing musically. The voice of the Blonde, Emmy Loose, sounds a bit hard but otherwise acceptable, and Peter Klein, the Pedrillo, has trouble only with some of his high notes. Endre Koreh, as Osmin, has the right vocal

color but he does not seem able to shade it much. Both he and Frick (Angel) make hash out of the fast triplets in "*Ha! wie will ich triumphieren*." (Greindl, for Decca, manages to do a little better, but only by slowing up.) Krips is entirely capable. The "Turkish" instruments are more prominent in this London set than in the others, but the violin tone is streaked.

—Lois Marshall (s), Constanze; Ilse Hollweg (s), Blonde; Léopold Simoneau (t), Belmonte; Gerhard Unger (t), Pedrillo; Gottlob Frick (bs), Osmin. Beecham Choral Society; Royal Philharmonic Orchestra, Sir Thomas Beecham, cond. ANGEL 3555 B/L, two LP; S 3555 B/L, two SD.

—Maria Stader (s), Constanze; Rita Streich (s), Blonde; Ernst Häfliger (t), Belmonte; Martin Vantin (t), Pedrillo; Josef Greindl (bs), Osmin. RIAS Symphony Chorus and Orchestra (Berlin), Ferenc Fricisay, cond. DECCA DX 133, two LP.

—Wilma Lipp (s), Constanze; Emmy Loose (s), Blonde; Walther Ludwig (t), Belmonte; Peter Klein (t), Pedrillo; Endre Koreh (bs), Osmin. Chorus of the Vienna State Opera; Vienna Philharmonic Orchestra, Josef Krips, cond. LONDON A 4301, three LP.

Le Nozze di Figaro, K. 492

The closest thing to a completely satisfactory recorded performance of a Mozart opera, or indeed of any opera, that I have heard is London's *Figaro*, conducted by the late Erich Kleiber. A few staged performances stand out in one's memory because for some reason—an inspired conductor, or something in the atmosphere, a kind of divine afflatus—all the performers gave of their very best. In recordings, of course, such an occurrence is still more rare. As readers of this magazine are well aware, a recording of an opera is practically never a single "take." Many passages are done over, and the final result is a splicing together of what are regarded as the best versions among many, done at different times, in different states of mind, with different degrees of readiness and control. It is therefore something of a miracle when an opera recording, made in a studio under such conditions, nevertheless has the impact of shining spontaneity, with a group of picked, topnotch artists alert and consistently in their best estate giving all

they have in the service of one of the greatest masterpieces in their repertory.

It is such a miracle, it seems to me, that takes place in the London *Figaro*. Della Casa, Gueden, Danco, and Siepi are caught up in the electric current that flows from Kleiber's baton and with great beauty of tone and faultless technique express the warmth and gaiety and sadness of this immortal comedy. To be sure, the performance is not perfect: Alfred Poell, the Count, is not on a par, technically or musically, with his colleagues; but this is the only flaw of any consequence that I could hear. Even the singing of the minor roles is better than average. The opera is recorded complete. The balances, between singers and between singers and orchestra, are just what they should be. The sound is ravishing, in both versions. A complete vocal score is provided with the monophonic set.

RCA Victor's album, conducted by Leinsdorf, deserves careful attention on several counts. It contains a good deal of fine singing, especially by Della Casa, Roberta Peters, and the versatile and dependable Giorgio Tozzi. Although George London is not quite up to these, his Count is superior to Poell's in the Kleiber set. The sound is excellent, and the stereo version is of special interest because it reflects the movement of the characters about the stage. This kind of "realism" is effective in some scenes but in others proves, it seems to me, to be a not unmixed blessing. When two or three sopranos are bunched together on one sound track, as is sometimes demanded by the exigencies of the "staging," the listener unfamiliar with the work will not know who is singing what, and to those who have never seen a performance, much of the motion will be meaningless. Della Casa's Countess is just as dignified and human and endearing as in the Kleiber set. Miss Peters' Susanna, however, while wholly admirable from a technical point of view, seems to me to lack personality. The whole performance, indeed, is rather cool and impersonal at the start and takes a couple of acts to warm up fully. And while Leinsdorf does a thoroughly capable job, it seems to me to lack the penetration of Kleiber's.

An outstanding feature of the Epic set, conducted by Karl Böhm, is the Susanna of Miss Streich. Her singing here is not only

with **DYNAKIT**
you know you have the **BEST!**

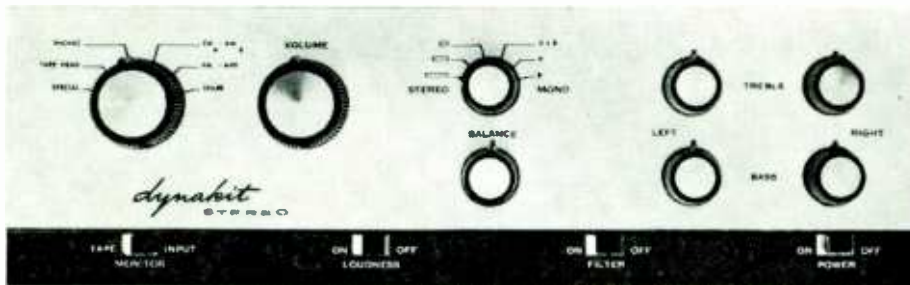

PAS-2 \$59.95 kit, \$99.95 assembled

The new Dynakit Stereophonic Preamplifier has *all* the quality features which you require for the finest high fidelity reproduction. This handsomely styled control unit is a model of classical quality and contemporary simplicity.

BEST IN EVERY WAY

In either kit or wired form, the new Dynakit Stereo Preamp represents both the finest quality and the finest value available. It utilizes the basic circuitry of the famous Dynakit monophonic preamplifier without compromise of quality. This circuit has the lowest possible distortion, an absolute minimum of hum and noise, superior transient response, and every other attribute which can contribute to natural, satisfying sound quality.

Dynakit's basic philosophy of simplicity of layout and control action, along with impeccable performance, is well exemplified in the design. Every useful function is incorporated, but the operation of the unit is not complex since the controls are arranged and identified in a functional manner. Operation of controls and switches is smooth, noise-free, and non-interacting. The unit is a pleasure to assemble, a pleasure to operate, and a pleasure to hear.

It is not necessary to spend a lot of money to have the best sound available. Dynakit equipment has no compromises in quality. It is designed to be the finest and to be used by those who are not satisfied with less than the best. We suggest that you listen to it at your Hi Fi dealer, or write for our brochure which gives complete specifications on all Dynakit high fidelity components.

★ Best Performance

Frequency response within 1 db 10 cps to 40 kc. Distortion (either 1M or harmonic) less than .05%. Response and distortion unaffected by settings of volume control. Undistorted square wave performance demonstrates outstandingly fine transient performance. Noise and hum inaudible at normal listening levels. High gain permits operation with lowest level cartridges. (1 millivolt input gives 1 volt output on RIAA input.)

★ Finest Quality Components

1% tolerance components used in critical equalization-determining circuits. Tone control components matched to provide **absolutely flat response** at center settings. Highest quality plastic molded capacitors, low noise resistors, conservatively operated electrolytics, plated chassis and hardware, all lead to long life with unchanging specifications. One year guarantee on all parts.

★ Greater Flexibility

7 stereo inputs (or 14 monophonic ones) provide for all present and future sources. "Special" input provides option for special equalization characteristics. Provision for tape head, tape playback amplifier, and monitoring tape recordings. **Independent** tone controls for each channel. Exclusive Dyna "Blend" switch to control stereo separation. Unique feedback scratch filter takes out the hash and leaves in the music. Rear panel ac outlets enable switching other components with preamp on-off switch. Self-powered (with dc heater supply) permits use with any amplifiers.

★ Outstanding Appearance

Choice of bone white or charcoal brown textured finish cover. Solid brass, etched front panel. Designed by Racul Ibarquen, prominent industrial stylist. Requires only 13" by 3 3/4" panel space and can be readily mounted on any thickness of panel with convenient PM-3 auxiliary mounting kit.

★ Easiest Assembly

About 8 hour average assembly time—from one-third to one-fourth that of other kits. Assembly speeded by use of pre-assembled printed circuit boards plus ultra-simple and accessible layout of parts. Complete pictorial diagrams included plus step-by-step instructions so that no technical skill is required. Also available fully wired and individually tested.

clean and accurate but has a captivating charm. Christa Ludwig, the Cherubino, is also excellent: both of her arias are nicely done, "Non so più" having a properly excited, youthful tremor. The other principal singers inhabit a somewhat lower plane in this performance. Miss Jurinac, the Countess, is a little sharp on some high notes and not entirely secure in "Porgi amor," and in the finale when she is angry or emphatic tends to hoot. Paul Schöffler, the Count, and Walter Berry, the Figaro, are experienced and competent artists but neither is particularly impressive here. Böhm is surprisingly lackadaisical: there is not much tension, and several of the numbers are rather slow and draggy ("Dove sono," "Deh vieni non tardar") or lack grace and animation (the Letter Duet). Some of the conventional cuts are made (Marcellina's "Il capro e la capretta," Basilio's "In quegli anni"). The sound is good most of the time; woodwinds are too faint in the opening duet, and there is some distortion in tutti in the second-act finale.

The Pathé set, conducted by Rosbaud, was made from open-air performances at Aix-en-Provence in 1955. It is, under the circumstances, remarkably good. Streich is as delightful a Susanna here as in the Epic set. Rolando Panerai's Figaro is pleasant-voiced if limited in color. The other principals too have much in their favor. What inhibits one's enthusiasm here is a lack of repose, an unyielding motion from recitative to aria to recitative to ensemble that is less a matter of dramatic tension than of a kind of musical conveyor belt. Whether this is a fault of the conductor or of a tape editor is hard to say for one who was not present at the performances in question. Another drawback—a serious one in Mozart—is the rather harsh sound of the orchestra, whose playing seems to lack subtlety. In this version, too, the conventional cuts—some recitative and the above-mentioned arias for Marcellina and Basilio—are made. A handsome booklet includes the libretto in Italian and French.

Some first-rate singing, along with some that is a good deal less than that, may be found in the Electrola set, conducted by Karajan. Outstanding here are Erich Kunz, who sings Figaro with a steady, accurate voice of very attractive quality; Miss Jurinac, who makes a youthful-sounding Cherubino with lovely tone, although her "Voi che sapete" is a bit square; and Elisabeth Schwarzkopf, the Countess, who conveys considerable intensity of feeling without sacrificing a velvety legato. George London as the Count makes a pretty good showing too, singing with richness of tone, if with not much nuance. Irmgard Seefried's is a disappointing Susanna: her voice sounds "white" practically throughout, and she seems to do nothing but croon. All the *secco* recitative is omitted here, as are the two arias for Marcellina and Basilio. No libretto is supplied.

The Cetra set, conducted by Fernando Previtali, has some commendable aims, but the execution is often second-rate or worse.

DYNACO, INC., 3916 POWELTON AVENUE, PHILA. 4, PA.
 CABLE ADDRESS: DYNACO, PHILA.

CIRCLE 56 ON READER-SERVICE CARD

Despite some nice touches here and there, mostly on the part of the conductor, this performance seldom leaves the ground. Italo Tajo as Figaro and Jolanda Gardino, the Cherubino, offer some respectable singing, although the former does not resist the temptation to get hammy in "Non più andrai," but the others are less acceptable. In addition to the usual cuts, the Count's big recitative and aria "Vedrò, mentr'io sospiro" is omitted. The sound is a little coarse and dry (the recording was issued in this country about ten years ago), and the libretto is in Italian only.

—Lisa Della Casa (s), Countess; Hilde Gueden (s), Susanna; Suzanne Danco (s), Cherubino; Alfred Poell (b), Count; Cesare Siepi (bs), Figaro. Chorus of the Vienna



State Opera; Vienna Philharmonic Orchestra, Erich Kleiber, cond. LONDON NLLA 35, four LP; OSA 1402, four SD.

—Lisa Della Casa (s), Countess; Roberta Peters (s), Susanna; Rosalind Elias (ms), Cherubino; George London (b), Count; Giorgio Tozzi (bs), Figaro. Vienna State Opera Chorus; Vienna Philharmonic Orchestra, Erich Leinsdorf, cond. RCA Victor LM 6408, four LP; LSC 6408, four SD.

—Sena Jurinac (s), Countess; Rita Streich (s), Susanna; Christa Ludwig (ms), Cherubino; Paul Schöffler (bs), Count; Walter Berry (bs), Figaro. Vienna State Opera Choir; Vienna Symphony Orchestra, Karl Böhm, cond. ERIC SC 6022, three LP.

—Elisabeth Schwarzkopf (s), Countess; Irmgard Seefried (s), Susanna; Sena Jurinac (s), Cherubino; George London (b), Count; Erich Kunz (b), Figaro. Vienna State Opera Chorus; Vienna Philharmonic Orchestra, Herbert von Karajan, cond. ELECTROLA C 90292/94, three LP.

—Teresa Stich-Randall (s), Countess; Rita Streich (s), Susanna; Pilar Lorengar (s), Cherubino; Rolando Panerai (b), Figaro; Heinz Rehfuss (bs), Count. Orchestre de la Société des Concerts du Conservatoire de Paris, Hans Rosbaud, cond. PAVINE DTX 206/08, three LP.

—Gabriella Gatti (s), Countess; Alda Noni (s), Susanna; Jolanda Gardino (ms), Cherubino; Sesto Bruscantini (bs), Count; Italo Tajo (bs), Figaro. Orchestra Sinfonica e Coro di Roma della Radiotelevisione Italiana, Fernando Previtali, cond. CETRA LPC 1219, three LP.

Don Giovanni, K. 527

The two latest recordings of *Don Giovanni* are discussed in detail on p. 76 in this issue.

Here, the other five in the current catalogue will be dealt with. A thoroughly satisfactory *Don Giovanni* does not exist on records. Nor does a thoroughly bad one. To try to imagine a completely first-class performance from sections of those already on discs might be fun, but—artists' contracts being what they are—it would also be futile. Let us therefore cast an eye over the merits and faults of the available versions and decide, each for himself, which one we want to live with until a better one comes along.

Especially noteworthy in the Deutsche Grammophon set is the carefully thought out and multicolored portrayal of the title role by Dietrich Fischer-Dieskau. He brings to his performance the nuance and attention to detail characteristic of the Lieder singer, yet he manages at the same time to convey much of the sweep and vitality of the role. Steady, rich-voiced singing is contributed by Karl Kohn as Leporello. Häfliger's Ottavio is another asset: both of his arias are done with skill and musicianship. The ladies in the cast are less consistent. Miss Jurinac as Anna produces much sensitive and fine-spun singing, as in "Non mi dir," the masked trio, and the opening scene; but sometimes, especially in "Or sai chi l'onore," the tone becomes metallic in its higher reaches. Miss Stader is much more uneven: while her "Mi tradi" is nicely done, elsewhere there is some unsteadiness and other evidences of a technique not functioning at its best. The Zerlina of Miss Seefried is pleasantly sung, though there could be a little more cream in the mixture. This is one of Ferenc Fricsay's better conducting jobs. The sound is clear and properly balanced (except in the scene with the three orchestras, which seldom comes off in a recording) but stereo effects are not usually very noticeable.

The London recording does not attain the exalted level established in that company's *Figaro*. Since the same five artists sing principal roles in both, one can only suppose that Kleiber inspired them to outdo themselves in the earlier opera. Nevertheless the *Don Giovanni* has considerable merit. Siepi makes a noble Don, though his portrayal lacks any hint of the superhuman nature of the part. All of the other men perform capably, if without special distinction. Miss Danco's voice seems a bit light for Anna, and in "Or sai chi l'onore" it is not as firmly focused as elsewhere. Miss Della Casa's Elvira is on the whole well sung; it is only in "Ah fuggi il traditor" that one feels the need of a more heroic tone. The Zerlina of Hilde Gueden is wholly charming. Josef Krips keeps things moving nicely, but he sometimes overlooks nuances in dynamics. Strangely, the mono version seems to have a wider dynamic range than the stereo. A complete vocal score is supplied with the former.

Two singers stand out in the Pathé recording: Antonio Campo as the Don and Suzanne Danco as Elvira. Campo's baritone has something of the dark quality of Pinza's bass, but without the velvety surface that voice had in its prime. He uses it with accuracy and intelligence. Miss Danco's El-

DYNACO

MAKER OF THE WORLD'S FINEST
HIGH FIDELITY COMPONENTS

*proudly presents
the all new*

dynatuner

*superb companion
to your*

DYNAKITS



\$79.95 Kit
\$119.95 Wired

EASIEST TO ASSEMBLE

Dyna's traditional streamlined circuits and etched circuit boards enable complete construction and alignment in 6 hours.

SIMPLEST TO ALIGN

You achieve minimum distortion and maximum sensitivity—yourself—without any instruments.

UNPARALLELED PERFORMANCE

Highest effective sensitivity plus lowest distortion plus superior quieting plus precise, drift-free tuning.

Hear and compare it at your favorite dealer's showroom.

Write for complete specifications

DYNACO, INC.

3912 Powelton Ave. • Phila. 4, Pa.
CABLE ADDRESS: DYNACO, PHILA.

CIRCLE 57 ON READER-SERVICE CARD

FM TUNER SALE!*

H. H. SCOTT



Model 310C Wide Band Broadcast Monitor FM Tuner

The highest rated FM tuner ever built! Features Silver Sensitive Front End—1.5 uv sensitivity—Tuning Meter—Interstation Noise Suppressor—plus a host of other exclusive Scott features.

REGULAR PRICE \$184.95

SALE PRICE

ONLY \$124.95

SAVE \$60!

* This Sale an Audio Exchange Exclusive

TRADE IN
YOUR PRESENT
FM TUNER FOR THE
310C

† If you trade . . . The 310C costs you only

Fisher FM400	\$95.00
Fisher FM80	79.00
Fisher FM90X	59.00
HH Scott 311A	92.00
HH Scott 311B	85.00
HH Scott 311C	79.00
HH Scott 310A	68.00
HH Scott 310B	48.00
Bogen FM50	92.00
Browning RV 31	92.00
Pilot 530	92.00
Harmon Kardon C'nterp'nt I	99.00
Harmon Kardon C'nterp'nt II	92.00
Eico HFT 90	99.00
Sherwood S 3000	79.00

† Your present FM Tuner must be in good working condition to qualify for the trade allowances shown above.

Write Dept. K for our
unique Trade-Back plan,
Trading Information and Catalog

**audio
exchange**
The Hi-Fi Trading Organization

Closed Sunday and Monday
Mail orders to

153-21 Hillside Ave., Jamaica 32, N. Y.
AXtel 7-7577

Other Hi-Fi centers at:

367 Mamaroneck Ave., White Plains, N. Y.
WHite Plains 8-3380

836 Flatbush Ave., Brooklyn 22, N. Y.
BUckminster 2-5300

451 Plandome Ave., Manhasset, L. I.
MANhasset 7-5737

CIRCLE 20 ON READER-SERVICE CARD

vira, curiously, is much stronger than her Anna in the London set. Her difficult arias are sung with much verve, and technically they are impeccable. Teresa Stich-Randall's Anna gets off to a poor start, with some booting and lack of polish, but her part in the quartet of Act I and much of "Non mi dir" flows beautifully and with great purity. Anna Molfo's voice seems a little thin and edgy for Zerlina. Nicolai Gedda is a capable Ottavio, Marcello Cortis an acceptable, if rather serious, Leporello. Rosbaud is a skilled and authoritative conductor. There are some places where the balance is poor: the solo cello in "Batti, batti" is only a smear, and the woodwinds in "Il mio tesoro," as well as the entrance of the trombones in the finale, are too faint. These faults may be due to the difficulty of recording open-air performances (given at Aix-en-Provence in 1956), as may be the occasional distortion. The libretto is in Italian and French.

The virtue of the Cetra set resides mainly in the conducting, by Max Rudolf. This is one of the most dramatic and intense of the recorded performances. In the first-act finale the attempted attack on Zerlina stirs up real excitement, instead of the mild confusion that occurs in the other sets; the three orchestras are more clearly audible here, too. Add to this a more than usually imaginative Leporello by Tajo, and the tale of this set's merits is told. The Don of Giuseppe Taddei is uneven, and all the ladies, unfortunately, are second-rate, as is the sound.

Outstanding in the Epic recording is the splendid Elvira of Miss Jurinac. Although in "Mi tradi" she seems to attack high notes with less than complete confidence, everywhere else her singing is strong, true, and heroic. It is her excellent work that sparks the trio "Ah, taci, ingiusto core," and in other ensembles too she seems to inspire her colleagues to greater efforts. Ottavio is sung by Simoneau in his usual very able fashion, and the Leporello of Berry is intelligently and pleasingly performed. Graziella Scutti has the somewhat pointed type of voice that is better suited for Despina than for Zerlina, but she uses it well and achieves a good deal of tenderness in her two arias. George London does not seem to have been ready for the demanding role of the Don when this recording was made. He is shouty in *forte*, constricted in *piano*, and generally lacking in technical security and finish. Even less capable of doing justice to a major Mozart role is Hilde Zadek, the Anna. Not all the dynamic indications in the score are observed by the conductor, but this is one recording where all three orchestras in the first-act finale are clearly differentiated.

—Sena Jurinac (s), Donna Anna; Maria Stader (s), Donna Elvira; Irmgard Seefried (s), Zerlina; Ernst Häfliger (t), Don Ottavio; Dietrich Fischer-Dieskau (b), Don Giovanni; Karl Kohn (bs), Leporello; Ivan Sardi (bs), Masetto; Walter Kreppel (bs), Commendatore. RIAS Chamber Choir; Berlin Radio Symphony Orchestra, Ferenc Fricsay, cond. DEUTSCHE GRAMMOPHON DGM 302, three LP; 7302, three SD.

—Suzanne Danco (s), Donna Anna; Lisa Della Casa (s), Donna Elvira; Hilde Gueden (s), Zerlina; Anton Dermota (t), Don Ottavio; Cesare Siepi (b), Don Giovanni; Fernando Corena (bs), Leporello; Walter Berry (bs), Masetto; Kurt Böhme (bs), Commendatore. Vienna State Opera Chorus; Vienna Philharmonic Orchestra, Josef Krips, cond. LOSPOS NLLA 34, four LP; OSA 1401, four SD.

—Teresa Stich-Randall (s), Donna Anna; Suzanne Danco (s), Donna Elvira; Anna Molfo (s), Zerlina; Nicolai Gedda (t), Don Ottavio; Antonio Campo (b), Don Giovanni; Marcello Cortis (bs), Leporello; André Vessières (bs), Masetto; Raffaele Arié (bs), Commendatore. Orchestre de la Société des Concerts du Conservatoire de Paris, Hans Rosbaud, cond. PATHE DTN 218/21, four LP.

—Maria Curtis Verna (s), Donna Anna; Carla Gavazzi (s), Donna Elvira; Edda Ribetti (s), Zerlina; Cesare Valletti (t), Don Ottavio; Giuseppe Taddei (b), Don Giovanni; Italo Tajo (bs), Leporello; Antonio Zerbini (bs), Masetto; Vito Susca (bs), Commendatore. Cetra Chorus; Symphony Orchestra of Radiotelevisione Italiana (Turin), Max Rudolf, cond. CETRA C 1253, three LP.

—Hilde Zadek (s), Donna Anna; Sena Jurinac (s), Donna Elvira; Graziella Scutti (s), Zerlina; Léopold Simoneau (t), Don Ot-



tavio; George London (b), Don Giovanni; Walter Berry (bs), Leporello; Eberhard Waechter (bs), Masetto; Ludwig Weber (bs), Commendatore. Wiener Kammerchor; Wiener Symphoniker. Rudolf Moralt, cond. Epic SC 6010, three LP.

Così fan tutte, K. 588

The oldest of the available recordings of this opera is the Columbia version, sung in English. It came out in 1952 and was greeted by reviewers with a rather pointed lack of enthusiasm. In my opinion it deserved, and still deserves, better. Anyone who had the good fortune to see Alfred Lunt's production at the Met will remember what a delight it was, and the recording proves that not all the charm was visual. There are defects, to be sure: Fritz Stiedry's tempos are sometimes too fast, his rhythm sometimes too rigid; Blanche Thebom has some poor moments, as in the second finale, when she

lands some distance from the high A flat that is her goal; Lorenzo Alvary's English has a foreign accent (but is his "epple-cart" worse than the "qvestas" and "qvellas" heard in the other sets?); the overture lacks dynamic nuance. But to offset these flaws there are a number of positive qualities. Miss Peters, to my mind, makes an excellent Despina, better than either of her opposite numbers: she has the pertness and her voice has the slightly sharp edge that belong to the role, and musically as well as technically she is completely successful here. Eleanor Steber almost throughout and Miss Thebom much of the time are in good form, singing steadily, accurately, and with agreeable quality. Richard Tucker turns in some good, solid singing, taking high G sharps and As without forcing, and Frank Guarrera uses his attractive voice with intelligence. As for the translation, by Ruth and Thomas Martin, it has always seemed to me an uncommonly good one. Let us not now rehearse the pros and cons of opera in English. My own feeling, for whatever it is worth, is that in a fast, volatile comedy like this one, more is gained than lost if the audience can follow every turn of the dialogue and plot.

The London set has lovely things in it. Böhm carries off many of the ensemble numbers beautifully—the mock tragedy, for example, of the farewell quintet in the first act, and the murmuring caress of the trio that follows. Schöffler is a rich-voiced philosopher, and Kunz, too, is easy on the ear, though his "*Donne mie, la fate a tanti*" could be more pointed. Anton Dermota, acceptable throughout, makes his "*Un' aura amorosa*" exceptionally languorous and sensual. Miss Della Casa hits a ringing high B flat in "*Come scoglio*"; her triplets here are clean and her voice maintains its fine quality in various registers; she lacks only the furious bravura needed to give this showpiece its full effect. Her "*Per pietà*" is very fine. Miss Ludwig's voice sounds rather light-textured but clear and steady; and Miss Loose makes a competent but colorless Despina. This version is the most heavily cut of the three. Not only does it employ the customary excisions, but it is generous with new ones (among the latter, two pages in the quintet No. 6, in Dorabella's "*Smania implacabile*," and in the duet No. 23, a larger slice than usual out of Fiordiligi's "*Per pietà*," Dorabella's entire aria "*E amore un ladroncello*," and a seven-page chunk out of the second finale).

The best all round performance seems to me to be the Angel. Karajan is no less stylish than his confrères, and he conducts with a verve that makes Siedry seem in comparison sometimes a hard driver and Böhm sometimes a little slack. In addition to its thorough musicality this version conveys more decidedly than either of the others the impression that each singer has a complete understanding of his role and of every word in his part. Lisa Otto is not as perfect a Despina as Miss Peters, and Miss Schwarzkopf is hardly more daredevil a singer here than Miss Della Casa, but all six vocalists perform steadily on a high plane. More im-

The world's new stereo standard ... loaded with new advantages:

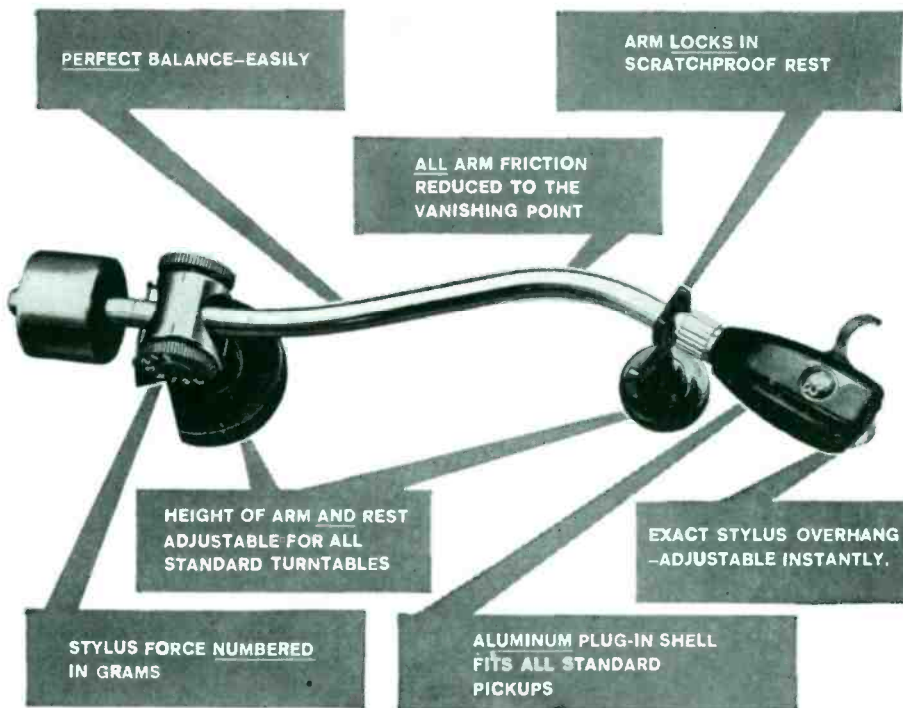

...and many more, yet only \$34⁹⁵
at your dealer's.

FOR LISTENING AT ITS BEST
ESL Electro-Sonic
Laboratories, Inc.

FIRST IN BEAUTY...FIRST IN PERFORMANCE

Dept. H • 35-54 38th St. • Long Island City 8, N.Y.

CIRCLE 59 ON READER-SERVICE CARD

new UHER Stereo Record III



performance equal to the big tape consoles ... and
with more features than are offered anywhere else!

40-20,000 CPS • Wow and flutter, 0.1% • S/N -55 db • records Q-track mono or stereo • 3 speeds • Voice actuated • slide projector sync • sound on sound • record on 1 track, playback on the other ... simultaneously • with 2 dynamic high impedance microphones, amplifiers, speakers, carrying case. \$399.50. At leading hi-fi dealers, or write: WARREN J. WEISS ASSOCIATES • 346 West 44th Street • New York 36, New York

CIRCLE 129 ON READER-SERVICE CARD

With
marantz
model 8
stereo amplifiers
you will
get well over

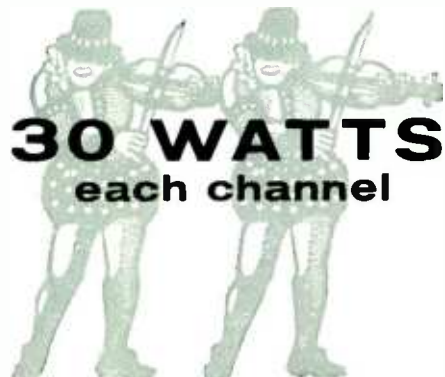

30 WATTS
each channel

or more than...

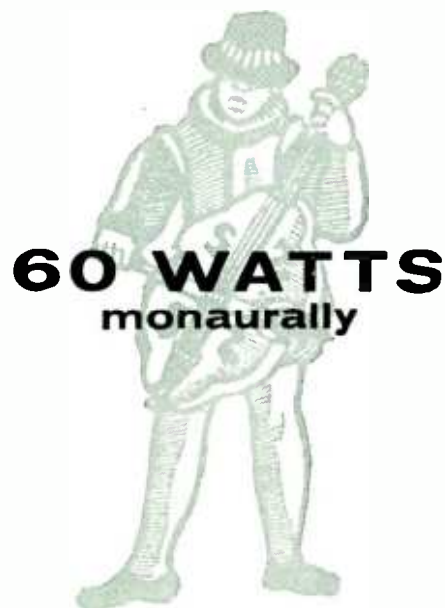

60 WATTS
monaurally



Write for Free booklet No. 41F

marantz
25-14 Broadway
Long Island City 6, New York

CIRCLE 96 ON READER-SERVICE CARD

portant than the solos in this opera are the ensembles. All of these are beautifully balanced, and the orchestra—Mozart at his most sparkling—is always audible in the right relation to the voices. This is the most complete of the three versions, the only cuts being an aria of Ferrando that was omitted by Mozart himself, and sections of recitative.

From the standpoint of sound the London stereo has more spaciousness than the monophonic versions and more clarity and definition than the Columbia, but not more than the Angel.

—Elisabeth Schwarzkopf (s), Fiordiligi; Lisa Otto (s), Despina; Nan Merriman (ms); Dorabella; Léopold Simoneau (t), Ferrando; Rolando Panerai (b), Guglielmo; Sesto Bruscantini (bs), Don Alfonso. Philharmonia Chorus and Orchestra, Herbert von Karajan, cond. ANGEL 3522 C, three LP.

—Lisa Della Casa (s), Fiordiligi; Emmy Loose (s), Despina; Christa Ludwig (ms), Dorabella; Anton Dermota (t), Ferrando; Erich Kunz (b), Guglielmo; Paul Schöller (bs), Don Alfonso. Vienna State Opera Chorus; Vienna Philharmonic Orchestra, Karl Böhm, cond. LOSNOS A 4318, three LP; OSA 1312, three SD.

—Eleanor Steber (s), Fiordiligi, Roberta Peters (s), Despina; Blanche Thebom (ms), Dorabella; Richard Tucker (t), Ferrando; Frank Guarrera (b), Guglielmo; Lorenzo Alvary (bs), Don Alfonso. Metropolitan Opera Chorus and Orchestra, Fritz Stiedry, cond. COLUMBIA SL 122, three LP.

Die Zauberflöte, K. 620

On my shelves of 78s a place of honor is occupied by the Glyndebourne recordings of *Figaro*, *Don Giovanni*, and *Così fan tutte* and by the Beecham *Magic Flute*. One by one the Glyndebourne sets have been supplanted by LPs of other performances; they continue to take up precious space only because for sentimental reasons I cannot bring myself to part with them. The Beecham *Magic Flute*, however, is another matter. Recorded in 1937 and issued then by RCA Victor, it retains in its currently available LP version (Electrola) certain values not to be found in the other two albums, good as the latter are in other respects.

To begin with there is Sir Thomas' contribution. Except for the overture, which is too comfortable (I used to play the Toscanini version instead), the whole conception shows deep insight. Musically, it has the vitality that comes when the surface is molded with a full knowledge of all the underlying elements that give it its shape. Dramatically, it paints vividly the myriad aspects of this kaleidoscopic fairy tale-allegory. The singers are all well suited to their roles, and perform with much skill. Wilhelm Strienz's Sarastro seems to me the most richly sung of the three. At the appropriate moments Heinrich Tessen's voice takes on a nastiness that is just right for his part. There is no point in trying to list all the felicities of the performance. It stands up remarkably well. Even the sound is by no

TELEX®
SUPERIORITY IN SOUND



new *dyna-twin®*

Why shock around the clock? Love thy neighbor by doing your late evening hi-fi stereo listening—fully relaxed and in private—with the all-new TELEX Dyna-Twin.

With TELEX Dyna-Twin *private listening* you can experience the full sound of true third dimensional balanced stereo without arousing the wrath of neighbors.

- Other sound reasons for specifying TELEX Dyna-Twin:
- Matched receivers give perfect stereo balance
 - Frequency response: 30 to 15,000 cps.
 - Sensitivity: 80 db above .000204 dynes per sq. cm. for 1 milliwatt input
 - Comfort for hours, weighs only 9 oz.
 - Perfect weight distribution with seven-way headband adjustment
 - Single, non-tangle cord
 - Sturdy Tenite and stainless steel construction
 - Moisture and rust proof \$23.10

CHOICE OF PHONE PLUGS!

TELEX can provide terminals compatible with your existing equipment.

ITEM	MODEL No.
Dyna-Twin Headset, cord stripped and tinned	HDP-1
Dyna-Twin Headset, standard phone plug—monaural	HDP-2
Dyna-Twin Headset, 2 standard phone plugs—stereo	HDP-23
Dyna-Twin Headset, 3-circuit plug—stereo	HDP-53

For more information and a demonstration, see your TELEX dealer. Or write directly to us.

TELEX

Communications Accessories Division
Telex Park, St. Paul 1, Minnesota, CA-609
In Canada: Atlas Radio Corporation, Ltd., Toronto 19, Ontario

CIRCLE 126 ON READER-SERVICE CARD
HIGH FIDELITY MAGAZINE



Be there!

with the new LH-190
**Stereo
'Sound Stage'**
HIGH FIDELITY SPEAKER SYSTEMS

**A NEW
Concept of Design . . .**

brings you all the sound that was recorded . . . the incredible real sound of every instrument and voice . . . NATURAL spaciousness, depth, and directionality . . . as if you were there, during the live performance!



Listen to the LH-190's at your dealers now, or send for FREE brochure.



Leonhardt
Engineering Company
Dept. A - 1300 Railroad Ave.
Rockford, Illinois

CIRCLE 91 ON READER-SERVICE CARD
NOVEMBER 1960

means hopeless, though it cannot of course compare with modern recording in clarity and realism. There is no dialogue, and Electrola does not furnish a libretto.

Neither of the other two performances is as consistently well directed as the Beecham. Böhm's high competence is apparent everywhere except in some of the slow numbers or sections, where he seems to dawdle. The gifted and reliable Simoncau makes an excellent Tamino, singing with full tone and, seemingly, no effort. Miss Gueden matches him beautifully; she sings with lovely tone in lyric fashion. Miss Lipp is less impressive in the slower sections allotted to her than in the brilliant ones, which she carries off with considerable bravura. Berry's Papageno is competently sung and conveys the humor of the role without clowning too much. The Sarastro of Kurt Böhm is a bit quavery in "In diesen heil'gen Hallen," but steadier elsewhere. The three Ladies deserve mention; they are unusually good. The sound is satisfactory. There is no dialogue.

Fricsay, in the Decca set, is not very imaginative. Sometimes he misses important dynamic nuances, like the small crescendos in "Dies Bildnis." He is given much attractive singing by Miss Stader and Häfliger as the two lovers; by Fischer-Dieskau, whose "Ein Mädchen oder Weibchen" is even better than his "Der Vogelfänger bin ich ja"; and especially by Miss Streich, whose coloratura is very fine in both her big arias but who manages to get more of the requisite demonic quality into the first. The Sarastro of Greindl is better in the low register than in the middle or top, and Martin Vantin's Monostatos is acceptable if somewhat neutral in character. There is steadier singing by the three Boys here than by the trio of Ladies. The dialogue is spoken by a separate cast of actors. Sometimes, as in "Der Vogelfänger," a soloist is too far forward, and in some cases the dynamic level shifts from one side to the next, but otherwise the recording is good.

—Hilde Gueden (s), Pamina; Wilma Lipp (s), Queen of the Night; Léopold Simoncau (t), Tamino; August Jaresch (t), Monostatos; Walter Berry (b), Papageno; Kurt Böhm (bs), Sarastro. Vienna State Opera Chorus; Vienna Philharmonic Orchestra, Karl Böhm, cond. LONDON A 4319, three LP.

—Maria Stader (s), Pamina; Rita Streich (s), Queen of the Night; Ernst Häfliger (t), Tamino; Martin Vantin (t), Monostatos; Dietrich Fischer-Dieskau (b), Papageno; Josef Greindl (bs), Sarastro. RIAS Chamber Choir and Berlin Motet Choir; RIAS Symphony Orchestra (Berlin). Ferenc Fricsay, cond. DECCA DX 134, three LP.

—Tiana Lemnitz (s), Pamina; Erna Berger (s), Queen of the Night; Helge Roswänge (t), Tamino; Heinrich Tessmer (t), Monostatos; Gerhard Hüsch (b), Papageno; Wilhelm Strienz (bs), Sarastro. Berlin Philharmonic Chorus and Orchestra, Sir Thomas Beecham, cond. ELECTROLA E 80 471/73, three LP (live sides).

Get the best in Electronics

- For today's enjoyment
- For Christmas giving
- For year 'round pleasure

Send for Radio Shack's

FREE

Electronics CATALOGS

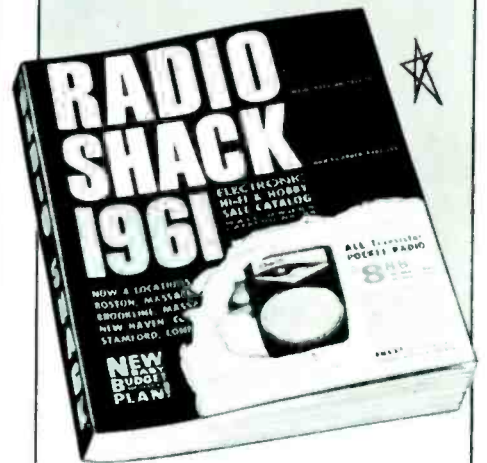



Mail coupon for latest free 192-page Radio Shack catalog plus every new issue for full year.

See world's largest line of electronics items: Hi-Fi, Ham Radio, Stereo, like values shown below.

Buy on Easy Budget terms, up to 2 years to pay. Money-back guarantee on every item always.

TYPICAL VALUES IN RADIO SHACK CATALOGS

 All Transistor Pocket Radio . . . \$8.88	 T-5 FM-AM Stereo Tuner \$59.50
 3.98 & 4.98 Stereo Records . . . Each \$1.00	 Duo Remote Control Speaker \$3.98

RADIO SHACK CORPORATION

730 Commonwealth Ave., Boston 17, Mass.

MAIL COUPON NOW

Radio Shack Corp. Dept. 60L14
730 Commonwealth Ave., Boston 17, Mass.
Send latest Electronics Catalog plus every new issue for one year, FREE.

Name _____
Address _____
Postoffice _____
or City _____ Zone _____ State _____

CIRCLE 110 ON READER-SERVICE CARD



Dance with
LAWRENCE WELK



"Julie is her name"
JULIE LONDON—Vol. II



'Pat's Great Hits"—Vol. 2
PAT BOONE



"Benny Rides Again"
BENNY GOODMAN



LOUIS and KEELY



TCHAIKOWSKY'S
1812 OVERTURE



"Golden Saxophones"
BILLY VAUGHN

Now look what
bel canto
has for you on
2 and 4-Track and Cartridge
STEREO TAPE
(and there's more
where these came from)

bel canto Stereophonic Recordings
a subsidiary of Thompson Ramo Wooldrige Inc.
1977-1985 McAllister Avenue • COLUMBUS 5, OHIO

WRITE TODAY FOR FREE BEL CANTO
CATALOG OF STEREO TAPE HITS



"Soul of Spain"
101 STRINGS



The GOLDEN AGE
of DANCE BANDS

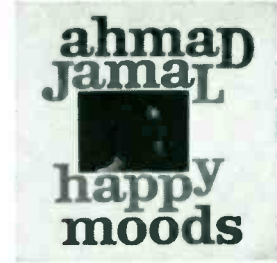

"Happy Moods"
AHMAD JAMAL



"Leave it to Jane"
ORIGINAL CAST

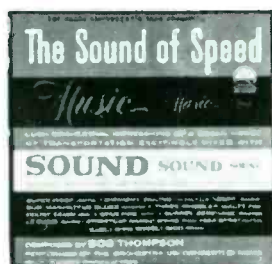

"Sound of Speed"
(Exciting Sounds of
Vehicles in Motion)



Voices and Strings of
LAWRENCE WELK

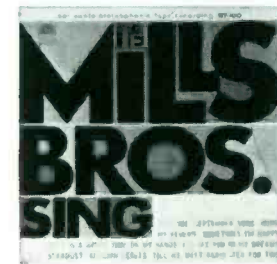

The MILLS
BROTHERS SING

CIRCLE 28 ON READER-SERVICE CARD



the **Tape Deck**

Reviewed by R. D. DARRELL

The following reviews are of 4-track 7.5-ips stereo tapes in normal reel form.

BRAHMS: Symphonies: No. 3, in F, Op. 90; No. 4, in E minor, Op. 98

Vienna Philharmonic Orchestra, Rafael Kubelik, cond.

•• LONDON LCK 8005 (twin-pack). 77 min. \$11.95.

BRAHMS: Symphony No. 3, in F, Op. 90

Southwest German Radio Orchestra (Baden-Baden), Jascha Horenstein, cond.

•• SMS/TANDBERG S 44. 36 min. \$8.95.

Horenstein's Third, which first appeared in a 2-track taping as well as a stereo disc from Vox in 1958, can be quickly dismissed as a routine performance, now hard-driven, now lethargic, which despite considerably improved processing and channel balancing remains sonically thick-textured. But notice should be taken of the deceptive box (if not reel) labeling: the disc-coupled *Variations on a Theme of Haydn* is not included here.

Kubelik's interpretation is also a broadly romantic reading in more orthodox Teutonic style, made to seem even more expansive by a repeat of the exposition in the first movement. The Viennese performance, however, is under better control and is much more attractive for its warmly rich sonics, admirably captured in unusually sweet and well-blended, if not particularly brilliant or stereoisitic, recording. His Fourth, too, is leisurely and glowing, lacking only in arrestingly dramatic drive and forcefulness. Neither version can be ranked among the best available on discs, but the Fourth is the only 4-track taping and the Third the only alternative to Stokowski's superbly recorded but extravagantly idiosyncratic Everest reel, and in any case the present combination is an appealing one, particularly to listeners of conservative tastes.

DVORAK: Symphony No. 5, in E minor, Op. 95 ("From the New World")

Vienna State Opera Orchestra, Vladimír Golschmann, cond.

•• VANGUARD VTC 1622. 39 min. \$7.95.

Not all reviewers have liked Golschmann's *New World* as well as I did in its bargain-

price disc versions, but after rehearing it on tape I am more certain than ever of my pleasure in its straightforward lyricism and grace, while the unexaggerated but luminous recording now sounds even better since the tape processors have somehow managed to combine here the greater tonal bite and solidity of the LP version with the delectable airiness of the SD. Even at its present nonbargain price, the work remains a recommended investment—in particular to those who have hitherto known the music itself only in less engaging, harder pressed, and more pretentiously sealed readings.

GERSHWIN: Song Book

Ella Fitzgerald; Orchestra, Nelson Riddle, cond.

•• VERVE VSTC 215/19. Five 7-in. reels. 34/37 min. \$7.95 each.

As a wholehearted admirer of both Gershwin and Ella Fitzgerald, I could barely restrain my impatience to hear this sumptuous set which was so enthusiastically greeted on the release of its disc versions. Perhaps I expected too much, or more probably I cherish too fondly the way Gershwin himself used to play many of these songs and the jaunty verve with which his best interpreters sang them when they first appeared. Anyway, I can only hope that my own disappointment in this edition is a strictly idiosyncratic reaction.

The fifty-three songs here (including several recorded for the first time) strike me as better than ever. Ira Gershwin's occasional text revisions are wholly in keeping, Miss Fitzgerald sings as enchantingly as always (although here only intermittently with full interpretative conviction), and the only flaws in the recording are occasional suggestions of soloist echo-chambering and an exaggeratedly heavy bass throughout. What I can't accept is the general slowing of tempos, rhythmic enervations, and the neutralizing effects of Nelson Riddle's "contemporary-styled" arrangements and small orchestral accompaniments. Granted that the soloist works frequent miracles with the lethargically paced "ballads," far too much of the original lilt and zest seems to me to be irretrievably lost. Unfortunately, too, the more effective performances here (i.e., those which seem to me to depart less radically from the characteristic spirit of the individual songs) are so widely scattered that it's hard to nominate any of the five reels as the "best," although if pressed I'd probably have to

settle on Vol. 2 (VSTC 216) for its *That Certain Feeling*, By Strauss, and *The Real American Folk Song Is a Rag* in particular.

GILBERT & SULLIVAN: H. M. S. Pinafore (or, The Lass That Loved a Sailor)

Jean Hindmarsh (s), Joyce Wright (c), Gillian Knight (c), Thomas Round (t), John Reed (b), Jeffrey Skitch (b), Donald Adams (bs); D'Oyly Carte Opera Chorus, New Symphony Orchestra, Isidore Godfrey, cond.

•• LONDON LOH 90024 (twin-pack). 98 min. \$12.95.

Like probably many another nonfanatical G & S fan who knows the operettas better from recordings than in stage performances, I was extremely dubious about the wisdom of the present set's inclusion of the full spoken dialogue—that is, until the reels themselves started to unwind. I'm still not sure that the speech will continue to stand up as well as the music in repeated hearings, but on first acquaintance it fits in beautifully (despite—or for—its naïveté) with the songs themselves to make truly relishable home entertainment. A considerable part of the credit goes to the largely unfamiliar new members of the D'Oyly Carte Company, who both speak and sing with ingenuous charm and a refreshing lack of mannerisms. Perhaps even more goes to the stereo recording's realization of theatrical presence, and to the discreet but invariably effective use of sound and movement effects. But the major honors surely go to the conductor, who stimulates his fine chorus and orchestra to uncommonly vivacious, yet always well-controlled and proportioned, performances. Before deciding that you must have a maximum of Sullivan with a minimum of Gilbert, or that you'll remain faithful to your prestereo D'Oyly Carte *Pinafore* with its more famous cast, I urge you at least to sample the present set—it well may surprise you as pleasantly as it has me.

GRIEG: Peer Gynt: Suite No. 1, Op. 46

†Tchaikovsky: *Swan Lake, Op. 20: Suite*

London Philharmonic Orchestra, Kenneth Alwyn, cond.

•• RICHMOND RCE 40005. 35 min. \$4.95.

A delectable "sleeper," which must be recommended for far more than its inexpensiveness. Indeed I don't think I've ever heard a more piquantly lyrical and delicate

EVEREST

CLASSICALS

NOW

ON

4-TRACK
STEREO TAPE



• Commemoration
Symph. —
Stephen Foster/
Jerome Kern
• American In
Paris/Rhapsody
In Blue —
Steinberg —
Twin-Pak —
TT 43-001

• Schubert —
Symph. No. 8
• Mozart —
Symph. No. 40
Leopold Ludwig
— London
Symphony
Orchestra
T43046



• De Falla — The
3-Cornered Hat
Jorda — London
Symph. Orch.
• Khachaturian —
Gayne Ballet
Fistoulari —
London Symph.
Orch. — Twin-
Pak—TT 43-003

• Stravinsky,
Petrouchka/
Rite Of Spring
Goossens —
London Symph.
Orch. — Twin-
Pak — TT 43-002



MUSIC
SOUNDS
BEST
ON TAPE

AND THERE'S
MORE
Everest on 4-track
stereo tape. For
complete UST 4-
track catalog write:
1024 Kifer Road,
Sunnyvale, Calif.
UNITED STEREO
TAPES



CIRCLE 132 ON READER-SERVICE CARD

Peer Gynt, nor one which better restores the freshness of its miniature tone poems. Alwyn's five *Swan Lake* excerpts are perhaps a bit oversweet at times and lack a large enough orchestra for the more dramatic moments, but his *Danse des cygnes* and *Czardas* are distinctively vivacious and the treatment of the suite as a whole is more noteworthy balletic than that of many larger orchestras and better-known conductors. The recording too is beautifully airy and transparent, and from all reports on the original SD edition the processing here is notably superior.

MENDELSSOHN: *Concertos for Piano and Orchestra: No. 1, in G minor, Op. 25; No. 2, in D minor, Op. 42*

Rudolf Serkin, piano; Philadelphia Orchestra, Eugene Ormandy, cond.

• • COLUMBIA MQ 308. 42 min. \$7.95.

Columbia's belated though welcome acceptance of the 4-track medium could scarcely be demonstrated in a more distinctive debut release than the present coupling. It should do more than any previous Mendelssohnian release to redeem its composer from the quasi-salon status to which he has been so long relegated by interpreters and by the listening public. The normally reserved Serkin and Ormandy are startlingly passionate here in their determination to restore the intensity of feeling, sinewy strength, and rhapsodic virtuosity of these depreciated concertos. The engineers too match the performers' enthusiasm and precision in an ideal choice of the coolest and boldest of stereogenic qualities, which avoid any suggestion of conventional romanticism, but which miss nothing of the superb playing's lucidity of texture and sensitive nuance of color and expressive details.

(For the benefit of tape addicts who have not yet converted to 4-track operation, it should be noted that Columbia is one of the few companies which have both maintained their earlier 2-track catalogue in print and are continuing to add to it by simultaneously releasing their current tapes in the older as well as newer form. The present work, for example, is also available in a 2-track reel under the order number GMB 78.)

MOZART: *Overtures (8)*

Don Giovanni; Die Entführung aus dem Serail; Le Nozze di Figaro; Così fan tutte; Titus; Der Schauspieldirektor; Idomeneo; Die Zauberflöte.

Hamburg Pro Musica Orchestra, Harry Newstone, cond.

• • FORUM FTB 601. 42 min. \$6.95.

Although the conductor is presumably British, his readings as well as the present orchestral performances are emphatically Teutonic—which is to say that they are overweighty, hard-driven in the fast passages and too romantically expressive in the slow ones. Even so there is such a varied wealth of Mozartean delights here, and such attractive snatches of woodwind playing, that I should still want to recommend the program, at least to nonconnoisseur listeners, if it were not so bottom-heavily and overreverberantly recorded, and moreover fatally plagued (quite exceptionally among current four-track tapes) with preëchos.

MOZART: *Symphony No. 35, in D, K. 385 ("Haffner")*

†Schubert: *Symphony No. 8, in B minor ("Unfinished")*

Vienna Philharmonic Orchestra, Carl Schuricht, cond.

• • RICHMOND RCE 40006. 30 min. \$4.95.

A well-received London LP coupling of 1957, praised particularly for its "euphony," this makes an attractive inexpensive reel, since the very modest early stereoism (seemingly a bit more marked in the Mozart than the Schubert) shows off the warmly colored performances to even better advantage, and while the recording itself is obviously not of the latest vintage (especially in sonic depth and presence), its tenderness is perhaps all the more suitable for the present music. Unfortunately, however, there is excessive background noise.

RIMSKY-KORSAKOV: *Scheherazade, Op. 35*

Chicago Symphony Orchestra, Fritz Reiner, cond.

• • RCA VICTOR FTC 2017. 44 min. \$8.95.

London Symphony Orchestra, Sir Eugene Goossens, cond.

• • EVEREST T4 3026. 43 min. \$7.95.

At least two miracles must have come to pass in Chicago last February: in the same Orchestra Hall where only a few months earlier the same RCA Victor engineers failed to do full justice to Reiner's Respighi tone poems, they achieved here as luminously rich, immaculately transparent, balanced, and blended stereo recording as can be heard anywhere; more surprisingly, Reiner himself, who one would hardly imagine holding this Rimskian warhorse in special esteem, gives it one of the finest performances in his—or the phonograph's—entire repertory. Best of all, he restores its quintessential character, which is not that of a showpiece, as such, but of a vividly colored Russian fairy tale for youngsters of all ages. There is virtuoso playing here, of course, especially in the finespun violin solos by Sidney Harth and the rhapsodic cadenzas by the first-desk woodwind men, but the dominant feeling is one of sheer poetry and imaginative fantasy. The many veteran listeners who have long since come to think of this hackneyed symphonic suite as tiresomely naïve and showy will scarcely recognize it in so complete a metamorphosis. And the Chicagoans play it with such relaxed spontaneity, as well as sensuously plastic sonics, that their achievement is made to seem all the more miraculous when one learns (from producer Richard Mohr's remarkably candid and informative annotations) that the whole last movement, at least, was recorded in one uninterrupted or spliced "take."

Against such competition the normally admirable, if orthodox, Goossens performance seems only blandly expressive and often sluggish. Even its distinctively strong and clean recording is quickly forgotten once our ears have been bewitched by the incomparable siren song of the Reiner version. One work is first-rate technically; the other is miraculous.

Continued on page 136

HIGH FIDELITY MAGAZINE



Why Licia Albanese makes her personal recordings on tough, long-lasting tapes of MYLAR®



No need for fussy storing with tapes of "Mylar"; they're unaffected by heat or cold. They're thinner, save valuable storage space.

"An interpretation of an operatic role is a growing, living thing that changes from year to year," says famous Metropolitan Opera soprano Licia Albanese. "That's why I always use tapes of 'Mylar' when I study a role. These tapes never dry out or get brittle with age. So no matter how far in the future I play back and check my interpretations, I know they will be the same as the day I recorded them."

Today, only tapes of "Mylar" give you

such long life and lasting fidelity. Only these super-tough tapes have a 300% safety margin against stretching and breaking. Only these superior tapes give you 50% or more extra playing time per reel without sacrificing strength.

The next time you buy a reel or cartridge of tape, look for these exclusive advantages. Then, like Licia Albanese, get your favorite brand, made with "Mylar"® polyester film.

NOTE: NEW LOW PRICES ON HEAVY-DUTY TAPES OF "MYLAR" GIVE YOU THEIR ADVANTAGES AT A COST JUST A TRIFLE HIGHER THAN ORDINARY TAPES.

"Mylar" is Du Pont's registered trademark for its brand of polyester film. Du Pont manufactures "Mylar," not finished magnetic recording tape. All manufacturers make tapes of "Mylar".



Better Things for Better Living
... through Chemistry



CIRCLE 51 ON READER-SERVICE CARD



FOR
THE
FINEST
SOUND
ON
TAPE

DEMAND
RCA

**SOUND
TAPE**

The most expensive hi-fi rig in the world cannot supply the truly superb sound reproduction you expect unless every component is carefully selected for top performance and reliability. Even the finest amplifiers and speakers cannot correct for an inferior recording tape...so you cannot afford anything but the finest tape! RCA Sound Tape assures you high fidelity reproduction...full frequency response from the thrilling highs to the powerful lows... and the best recording and reproduction your tape recorder can deliver.

RCA Sound Tape is available in the popular and economical 5" and 7" reel sizes, on splice-free Mylar* and acetate bases. Ask for RCA Sound Tape wherever superior quality magnetic recording products are sold. Electron Tube Div., Harrison, N. J.



*Du Pont registered trademark

The Most Trusted Name in Electronics
RADIO CORPORATION OF AMERICA

SCHUMANN: Concerto for Piano and Orchestra, in A minor, Op. 54

Van Cliburn, piano; Chicago Symphony Orchestra. Fritz Reiner, cond.
●● RCA VICTOR FTC 2042. 30 min. \$8.95.

The aptest one-word description of Cliburn's Schumann is "dreamy." For all its appropriate moments of power and sparkle, this reading is essentially an introspective poetic soliloquy of almost mesmeric sweetness. It is likely to seem too slow and too reserved to listeners accustomed to more outspoken or heroically romantic interpretations, but even though I personally prefer one which is more tautly organized and passionately eloquent (such as the memorable one by Lippatti), this strikes me as a wholly legitimate and perhaps even more Schumannesque approach. At any rate, it is warmly persuasive, and it is accompanied and recorded with more sensitivity and sheer tonal beauty than probably any other version on record today. Certainly the enchanting combination of sonic authenticity and dream-world atmosphere is an incomparable realization of the stereo medium's finest potentialities.

TCHAIKOVSKY: Manfred, Op. 58 ("Symphony")

London Symphony Orchestra, Sir Eugene Goossens, cond.
●● EVEREST T4 3035. 48 min. \$7.95.

Even a Toscanini was never able to convince the majority of listeners that *Manfred* is as fine a work as its composer felt it (or at least its brooding first movement) to be. The verdict might well have been different if Tchaikovsky himself had never written his only too similar, but more skillfully organized *Pathétique* Symphony, but as it is *Manfred* remains a kind of masterpiece *manqué*—which gives it a special appeal for some listeners who willingly endure its *longueurs* and lapses of inspiration to relish its great moments. Goossens is no Toscanini, of course, but he is no less obviously fascinated by this sprawling music and, if he is not always able to lend it conviction, he at least endows it with notable vigor and poignance, and his fine orchestra is given the best of stereo's dramatic power.

"Leroy Anderson Conducts Leroy Anderson." Decca ST 78865, 38 min., \$7.95.

Another batch of the perennially fresh favorites (*Bugler's Holiday*, *Sandpaper Ballet*, *Phantom Regiment*, *Plink Plunk Plunk*, etc.), plus two newer ballet pieces drawn from the *Goldilocks* score (a festive *Pyramid Dance* and *Lady in Waiting* Waltz), all done with the composer's own quite inimitable rhythmic vivacity and delicacy of coloristic nuance. Only moderately well recorded in the earlier Decca series, the "return" performances are now given Decca's best.

"Bayanihan Philippine Dance Company."

Monitor MOTO 903, 39 min., \$7.95.
Monitor gets off to a flying start in the tape sweepstakes with one of the most attractive and novel of recent ethnological documentaries: that representing the remarkably varied talents of the Bayanihan Company

directed by Lucrecia Kasilag, and its spirited "Rondalla," or little string orchestra, conducted by Juanito Gonzales. If you heard the company itself in its American tour sponsored by S. Hurok, this program is an essential souvenir; if you missed the live appearances, it is a delectable introduction both to the curious Muslim and Polynesian influences in Philippine music (especially the gong- and bamboo-stick-dominated *Singkil*, *Bangibang Funeral Dance*, *Tahing Baila*, *Sultana*, and the *Bontoc War Dance* with its poignant nose-flute soliloquy), and to the more conventional Spanish influences (in the Rondalla's gay *Polkabal*, *Maglalatik*, *Itik Itik*, etc.). Mostly instrumental, often with footstamping and handclapping accents, there are also occasional vocal solos and choruses in the Tagalog language.

"Bongos, Bongos, Bongos." Los Admiradores, Enoch Light, cond. Command RS 4T 809, 34 min., \$7.95.

Effective as these stereogenic arrangements, performances, and recording seemed in their original SD release several months ago, the present lower modulation level and more warmly reverberant taping reveals them in an altogether new light. The whole program now seems not only one of the most imaginatively scored of all the recent spectaculars, but the most poetically and engagingly played. New attractions mark the subtle timbre differentiations in the multitudinous bongos themselves, the atmospheric flute and bass clarinet solos by Stanley Webb, and the no less glowing guitar, vibes, and piano passages by Tony Mottola, Artie Marotti, and Moe Wechsler respectively. Even the most fanatical of tape propagandists usually find it difficult to demonstrate the clear-cut superiority of their favorite medium over a first-rate stereo disc of the same master recording, but here the aural evidence is conclusive.

"The Day of the Bullfight." Sabicas, guitar; Orchestra, Kenyon Hopkins, cond. ABC-Paramount ATC 814, 35 min., \$7.95.

Although the market for Sabicas' more orthodox flamenco guitar-and-dance programs remains insatiable, this ingenious departure from the norm should win him an even larger audience without alienating his established one. What he does here is to improvise an eight-movement suite depicting the scenes and moods of *toreros* and *aficionados* during the day of the bullfight (*Dawn*, *Selection of the Bulls*, *Street Scene*, *Fiesta*, *Lovers in the Night*, etc.), each section of which is introduced by an atmospheric orchestral and sound-effects prelude. Sabicas' own playing is as virtuoso as ever, but even more rhapsodic and varied than usual, and both he and his supporting forces are ultra-realistically and stereoscopically recorded.

"Pete Fountain Day." Coral ST7 57313, 39 min., \$7.95.

Presented by the New Orleans Jazz Club in actual performances at the Municipal Auditorium, the reformed Welk Orchestra clarinetist and his sidemen (Godfrey Hirsch, vibes; Merle Koch, piano; Don Bagley, bass; and Jack Sperling, drums) combine the

Continued on page 139

HIGH FIDELITY MAGAZINE

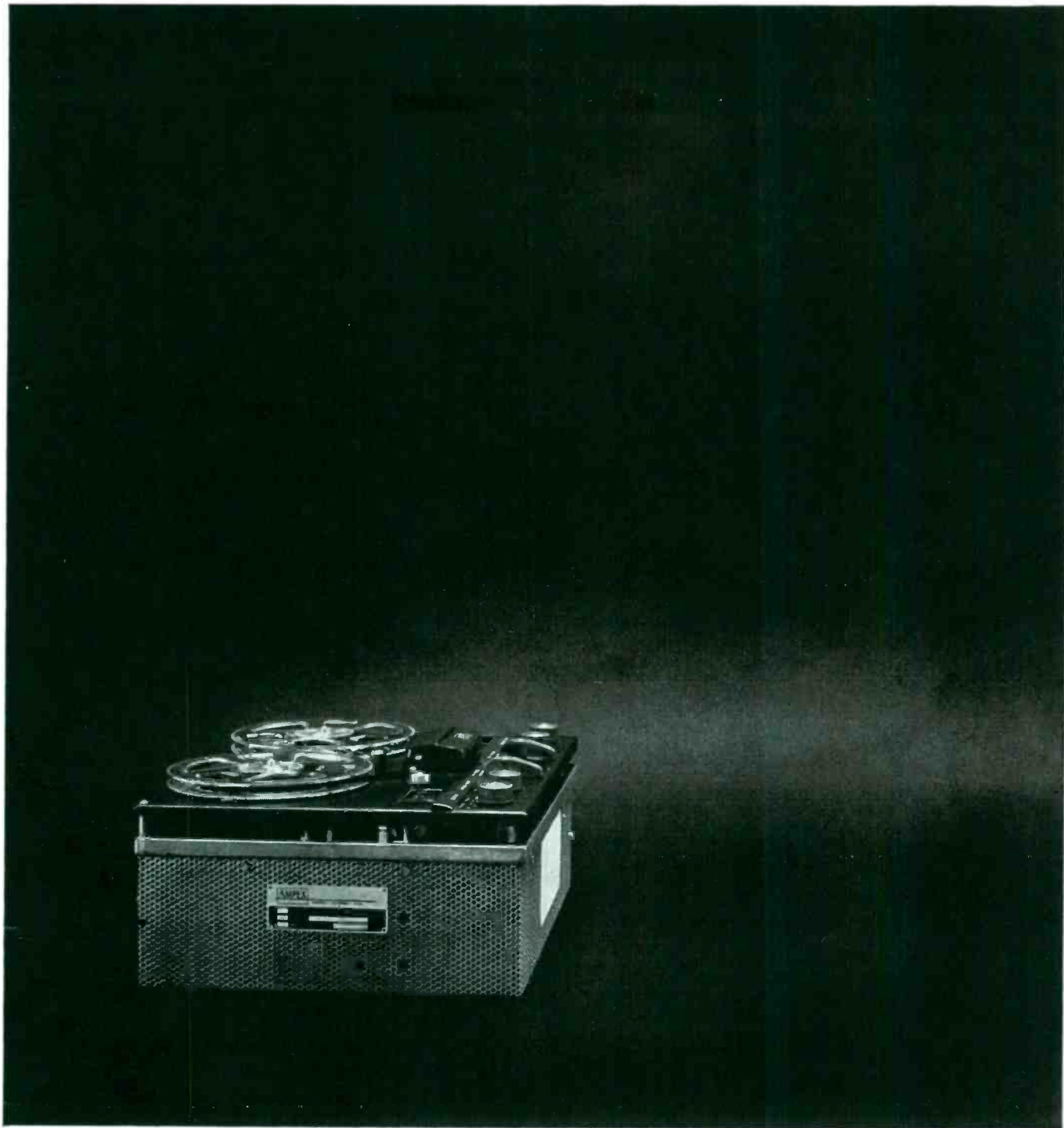

This Christmas you can afford an Ampex

(Now priced from \$349.50 to \$595)

The work of science no longer is costly. Ampex prices are down, but the quality of its tape players and recorders remains brilliantly Ampex. At last these coveted instruments are within reach of every stereophonic high fidelity enthusiast.

The 970, in portable case with built-in speakers, records monophonic and stereo, plays single, 2-track, and 4-track tape. Price reduced from \$750 to \$595.

The 960, in portable case, records monophonic and stereo, plays single, 2-track, and 4-track tape. Reduced from \$650 to \$495. The 952, unmounted deck, records stereo, plays single and 2-track tape. Reduced from \$595 to \$450. The 902, unmounted deck, records monophonically, plays single and 2-track tape. Reduced from \$449.50 to \$349.50.

For listening, more than 1,000 pre-CIRCLE 11 ON READER-SERVICE CARD

recorded tapes are available now — 10 times as many as last year. And don't forget the recording fun of starting a new kind of souvenir — the family album on tape for hours of pleasant playback.

Tape players and recorders by Ampex, world leader in magnetic recording, at your dealer everywhere. See and hear them today. Ampex Audio Company, Sunnyvale, Calif.



The most important FM News for 1961!

Pilot

ANNOUNCES

A

**QUALITY
FM TUNER**

\$49.95



DIMENSIONS: 9 $\frac{3}{4}$ " wide x 3 $\frac{3}{4}$ " high x 6 $\frac{1}{2}$ " deep

Only Pilot, the first manufacturer of FM tuners, could offer so much quality at such a modest price. The MARK II delivers performance that will amaze even the most critical audiophile. A value packed instrument, the MARK II features: ■ Complete power transformer operation ■ Wide band detector for 100% modulation with minimum distortion ■ New high gain 6GM6 and 6EW6 IF tubes ■ Separate logging scale ■ Shielded front end ■ Built-in line cord antenna ■ Multiplex output jack. Each MARK II is sweep aligned on the industry's most modern test equipment. In its handsome black and brass enclosure, the MARK II makes a handsome addition to any component system. Use the MARK II for FM reception through most TV sets, table radios, phonographs or tape recorders. See and hear the MARK II at your nearest authorized Pilot Dealer today. Write for complete technical specifications.

Pilot

RADIO CORP. 37-02 36th STREET, LONG ISLAND CITY 1, N. Y.

CIRCLE 106 ON READER-SERVICE CARD

best of Dixieland gusto with the swinging verve of the early Goodman ensembles. An exuberantly fleet *China Boy*; the buoyantly jumping *Ja-Da, I've Got Rhythm*, and *'S Wonderful*; and one of the most interesting and understated *divertissements* ever played on *Tiger Rag* are the high points here; but the program is a joy throughout, not least for brighter recording than usual in "on location" technology and for the promptness with which the enthusiastic audience applause is faded out.

Handel: Royal Fireworks Music and Water Music Suite. Vienna State Opera Orchestra, Edmond Appia and Felix Prohaska, conds. Vanguard VTC 1621, 39 min., \$7.95.

If this Handelian introduction coupling had been released on tape at a demonstrator bargain price, I could recommend more heartily these technically fine recordings of Prohaska's precise and alert, but not notably illuminating, performance of the familiar *Water Music* Suite and Appia's more pedestrian complete *Fireworks Music*. As it is, I wish the tape devotee's first meeting with these delectable works could be in more idiomatic and lilting interpretations. He isn't likely to be at all disappointed here, but he hardly can realize how much he's still missing.

✓ **"Here We Go Again!"** The Kingston Trio. Capitol ZT 1258. 28 min., \$6.98.

The sensational success of the Kingstons' unique blend of folk and pop ballad techniques and materials can be better explained by a few moments' sampling of the present tape than by any verbal descriptions. Just listen to their far-from-authentic yet irresistibly attractive chanteys *Across the Wide Missouri* and *Haul Away . . .* oddly rhythmical, bluesy *Wanderer . . .* catchily lilting *Round About the Mountain* and *Oleanna . . .* or the hauntingly poetic *San Miguel . . .* In strongly stereoisitic yet admirably natural recording, these distinctive performances must exert a well-nigh compelling appeal.

✓ **"Livingston Masterpieces" Nos. 2 and 3.** Various orchestras and conductors. Livingston (via SMS) 4T 100 2-3, 102 min. each, \$10.95 each.

Two more brimful reels in the 100-minute series which offers more (if more heterogeneous) music than probably any other classical tapings. The major items are Albert and the Mannheimers' Tchaikovsky Fifth (in Vol. 2) and Brahms First (in Vol. 3), but the former also is noteworthy for Gui's fine Schumann *Manfred* Overture, Grieg *Peer Gynt* Suite No. 1, and Borodin *Poloetsian Dances*, plus the apparently more recently recorded *Nabucco* and *Marriage of Figaro* Overtures by Caradis and Albert respectively; and the latter for Wolf's Haydn *Military* Symphony and Albert's Good Friday Music from *Parsifal* (both of which are new to tape, I think), as well as for the older *Flying Dutchman* Overture, *I false triste*, and *Afternoon of a Faun* by Gui and the Florence May Festival Orchestra. Performances and recordings naturally vary considerably in quality, but at their best are very good indeed. I never fail to be amazed at how impressive the earliest Livingston stereo recordings (some of which go back to

1954) still remain for their spaciousness, realism, and vividness.

✓ **"Reunion with Chet Baker."** Gerry Mulligan Quartet. World Pacific WPTC 1007, 36 min., \$7.95.

Baker himself is strangely lackadaisical here, but since his trumpet solos are infrequent and he mostly supplies somewhat pallid counterpoints to Mulligan's own assured and indefatigably jumping baritone sax, these often overly emphatic and repetitious performances achieve moments of commanding forcefulness, especially in *Ornithology*, *Jersey Bounce*, and *My Heart Belongs to Daddy*. Yet the main attraction here for Mulligan fans probably will be the marked improvements in channel differentiation and openness of the recording over the early stereo disc release.

✓ **"Side by Side."** Duke Ellington, Johnny Hodges, and Ensemble. Verve VSTC 237, 46 min., \$7.95.

Although the Duke himself participates in only three of the nine pieces here (*Stompy Jones*, *Squeeze Me*, and *Going Up*), this is perhaps an even more attractive and varied program than the earlier Ellington-Hodges "Back to Back" tape of last March, since Billy Strayhorn's piano playing is also an imaginative delight, Hodges is lyrically superb throughout, and there are magnificent solo contributions by Lawrence Brown, Roy Eldridge, Harry Edison, and others. In every respect this release is a sure candidate for any "best" permanent library as an outstanding example of relaxed, infectiously lilting, and endlessly inventive conversational jazz.

✓ **"Songs of the Fabulous Fifties" and "Till."** Roger Williams, piano; Orchestra. Marty Gold and Hal Kammer, conds. Kapp KT 45008 (twin-pack), 73 min., \$11.95, and KT 41022, 37 min., \$7.95, respectively.

Another big collection of recent cocktail hour favorites (topped by a catchy *Mr. Sandman* and *Hey There*, and the more romantic *Moulin Rouge* and *Picnic* themes), plus a shorter but more varied program in which Williams ranges deftly from the rich sentiment of *Tammy*, through dramatic variations on *Jalousie*, to poetic mood music versions of the Brahms A flat Waltz and Debussy's *Clair de lune*—all warmly recorded in luminous stereoisim.

✓ **"The Sound of Music."** Mary Martin and Original Broadway Cast. Frederick Dyonch, cond. Columbia CQ 311, 57 min., \$6.95.

Admirers of what tragically turned out to be the last of the great Rodgers & Hammerstein Broadway triumphs will surely yearn to trade in their already scratchy copies of the stereo disc edition for this more wear-resistant (as well as more cleanly channel-differentiated and theatrically realistic) taping—or its companion 2-track version TOB 58. Others may find, however, that it reveals only too candidly the lack of spontaneity and overabundance of mannerisms which for many of us make the performances by Martin, Neway, Bikel, *et al.* seem self-consciously constrained and largely lacking in the naive charm which the music at its best calls for—and which it has been given so far only in the Trapp Family's own album.



NOW—first FOUR-TRACK STEREO TAPES

from the wonderful library of

CAPITOL RECORDS 

POPULAR STARS

Frank Sinatra: *Only the Lonely* ZW 1053
Nat King Cole: *Love is the Thing* ZW 824
Kingston Trio: *Here We Go Again* ZT 1258
George Shearing: *Satin Brass* ZT 1326
Guy Lombardo: *Berlin by Lombardo* ZT 1019
Fred Waring: *Waring in Hi-Fi* ZW 845

SHOW MUSIC

Fiorello! (Original Broadway Cast) ZO 1321
The King & I (Kerr, soundtrack) ZW 740
The Music Man (Original Cast) ZO 990
Carousel (MacRae, soundtrack) ZW 694

DRAGON, HOLLYWOOD BOWL

Concertos Under the Stars ZP 8326

ANGEL RECORDS

Soviet Army Chorus and Band ZS 35411

FULL DIMENSIONAL STEREO



CIRCLE 37 ON READER-SERVICE CARD



CROWN

Professional Tape Recorder

"800" Series
SUPRA
"Professional" Recorder



The world's Most Magnificent Recorder and Greatest Performance Quality per Dollar!

FEATURES: Crown "X" All-Electric Control—Micro Queing—Third Head Monitor—Photo-Cell Automatic Stop—Full Remote Control—Standard Rock Mount.

Write for complete information and prices.

CROWN INTERNATIONAL
Division of
INTERNATIONAL RADIO & ELECTRONICS CORP.
ELKHART, INDIANA

CIRCLE 80 ON READER-SERVICE CARD

IF YOU LOVE TO CREATE... BUILD **EICO** KITS

In **STEREO** and

Mono Hi-Fi...
the experts say
your Best Buy
Is EICO

Over 2 MILLION EICO instruments in use throughout the world. Add 5% in the West.



Stereo Amplifier-Preamp HF81t



Stereo Preamp HF85t



FM Tuner HFT90t
AM Tuner HFT94t
FM/AM Tuner HFT92t



100W Stereo Power Amplifier HF89
70W Stereo Power Amplifier HF87
28W Stereo Power Amplifier HF86



Stereo Integrated Amplifier AF4t



3-Way Speaker System HF53
2-Way Bookshelf Speaker Systems
HF55 and HF51

NEW!



Stereo Automatic Changer/
Player 1007



- Exclusive advanced systematized engineering
 - Latest and finest quality parts
 - Exclusive "Beginner-Tested" easy step-by-step instructions
 - Exclusive TRIPLE quality control
 - Exclusive LIFETIME guarantee at nominal cost
- IN STOCK — Compare, then take home any EICO equipment — right "off the shelf" — from 1500 neighborhood EICO dealers throughout the U. S. & Canada, most of whom offer budget terms.

HF81 Stereo Amplifier-Preamp selects, amplifies, controls any stereo source & feeds it thru self-contained dual 14W amplifiers to a pair of speakers. Provides 28W monophonically. Ganged level controls, separate balance control, independent bass and treble controls for each channel. Identical Williamson-type, push-pull EL84 power amplifiers. "Excellent" — SATURDAY REVIEW. "Outstanding... extremely versatile." — ELECTRONICS WORLD. Kit \$69.95. Wired \$109.95. Incl. cover.

HF85 Stereo Preamp: Complete master stereo preamp/control unit, self-powered. Distortion borders on unmeasurable. Level, bass, & treble controls independent for each channel or ganged for both channels. Inputs for phono, tape head, mike, AM, FM, & FM-multiplex. One each auxiliary A & B input in each channel. "Extreme flexibility... a bargain." — HI-FI REVIEW. Kit \$39.95. Wired \$64.95. Incl. cover.

New HF89 100-Watt Stereo Power Amplifier: Dual 50W highest quality power amplifiers. 200W peak power output. Uses superlative grain-oriented steel output transformers for undistorted response across the entire audio range at full power, assuring utmost clarity on full orchestra & organ. 60 db channel separation. IM distortion 0.5% at 100W; harmonic distortion less than 1% from 20-20,000 cps within 1 db of 100W. Kit \$99.50. Wired \$139.50.

HF87 70-Watt Stereo Power Amplifier. Dual 35W power amplifiers identical circuit-wise to the superb HF89, differing only in rating of the output transformers. IM distortion 1% at 70W; harmonic distortion less than 1% from 20-20,000 cps within 1 db of 70W. Kit \$74.95. Wired \$114.95.

HF86 28-Watt Stereo Power Amp. Flawless reproduction at modest price. Kit \$43.95. Wired \$74.95.

FM Tuner HFT90: Prewired, prealigned, temperature-compensated "front end" is drift-free. Prewired exclusive precision eye-tronic® traveling tuning indicator. Sensitivity: 1.5 uv for 20 db quieting; 2.5 uv for 30 db quieting, full limiting from 25 uv. IF bandwidth 260 kc at 6 db points. Both cathode follower & FM-multiplex stereo outputs, prevent obsolescence. Very low distortion. "One of the best buys in high fidelity kits." — AUDIOCRAFT. Kit \$39.95*. Wired \$65.95*. Cover \$3.95. *Less cover, F.E.T. incl.

AM Tuner HFT94: Matches HFT 90. Selects "hi-fi" wide (20-9000 cps @ -3 db) or weak-station narrow (20-5000 cps @ -3 db) bandpass. Tuned RF stage for high selectivity & sensitivity. Precision eye-tronic® tuning. "One of the best available." — HI-FI SYSTEMS. Kit \$39.95. Wired \$65.95. Incl. cover & F.E.T.

FM/AM Tuner HFT92 combines renowned EICO HFT90 FM Tuner with excellent AM tuning facilities. Kit \$59.95. Wired \$94.95. Incl. cover & F.E.T.

AFA Economy Stereo Integrated Amplifier provides clean 4W per channel or 8W total output. Kit \$38.95. Wired \$64.95. Incl. cover & F.E.T.

HF12 Mono Integrated Amplifier (not illus.): Complete "front end" facilities & true hi-fi performance. 12W continuous, 25W peak. Kit \$34.95. Wired \$57.95. Incl. cover.

HF53 3-Way Speaker System Semi-Kit complete with factory-built ¾" veneered plywood (4 sides) cabinet. Bellows-suspension, full-inch excursion 12" woofer (22 cps res.) 8" mid-range speaker with high internal damping cone for smooth response, ¾" cone tweeter. 2¼ cu. ft. ducted-port enclosure. System Q of ½ for smoothest frequency & best transient response. 32-14,000 cps clean, useful response. 16 ohms impedance. HWD: 26¾" x 13¾" x 14¾". Unfinished birch. Kit \$72.50. Wired \$84.50. Walnut or mahogany. Kit \$87.50. Wired \$99.50.

HF55 2-Way Speaker System Semi-Kit complete with factory-built ¾" veneered plywood (4 sides) cabinet. Bellows-suspension, ¾" excursion, 8" woofer (45 cps res.), & ¾" cone tweeter. 1¼ cu. ft. ducted-port enclosure. System Q of ½ for smoothest freq. & best transient resp. 45-14,000 cps clean, useful resp. 16 ohms.

HWD: 24" x 12½" x 10½". Unfinished birch. Kit \$47.50. Wired \$56.50. Walnut or mahogany. Kit \$59.50. Wired \$69.50.

HF51 Bookshelf Speaker System complete with factory-built cabinet. Jensen 8" woofer, matching Jensen compression-driver exponential horn tweeter. Smooth clean bass; crisp extended highs. 70-12,000 cps range. 8 ohms. HWD: 23" x 11" x 9". Kit \$39.95. Wired \$47.95.

HF52 Omni-Directional Speaker System (not illus.) HWD: 36" x 15¼" x 11½". "Fine for stereo" — MODERN HI-FI. Completely factory-built. Mahogany or walnut \$139.95. Blond \$144.95.

New Stereo/Mono Automatic Changer/Player: Jam-proof 4-speed, all record sizes, automatic changer and auto/manual player. New extremely smooth, low distortion moisture-proof crystal cartridge designed integrally with tonearm to eliminate mid-range resonances. Constant 4½ grams stylus force is optimum to prevent groove flutter distortion. No hum, turntable attractions, acoustic feedback, center-hole enlargement. Only 10¾" x 13". 1007S: 0.7 mil, 3 mil sapphire, \$49.75. Incl. F.E.T. and "Magnadaptor."

†Shown in optional Furniture Wood Cabinet WE71: Unfinished Birch, \$9.95; Walnut or Mahogany, \$13.95.

††Shown in optional Furniture Wood Cabinet WE70: Unfinished Birch, \$8.95; Walnut or Mahogany, \$12.50.

EICO, 33-00 N. Blvd., L.I.C. 1, N. Y. HF-11
Show me how to SAVE 50% on easy-to-build top-quality HI-FI. Send FREE catalog, Stereo HI-FI Guide plus name of neighborhood EICO dealer.
Name.....
Address.....
City..... Zone..... State.....

Listen to the EICO Hour, WABC-FM, N. Y. 95.5 MC, Mon.-Fri., 7:15-8 PM.

© 1960 by EICO, 33-00 N. Blvd., L. I. C. 1, N. Y.

CIRCLE 58 ON READER-SERVICE CARD

High Fidelity Newsfronts



by RALPH FREAS

Impressions. We recently asked a Veteran Observer of high fidelity shows what he thought of the September exhibit in New York. His arches evidently still ached from four days of strenuous show-going, because his comment was: "Same old stuff."

"What about the . . .?"

"Just a minute," cut in the V. O., "I didn't mean it was a bad show. Compared to those of five years ago, this one was a dazzler. In 1955, you'd find maybe one good amplifier—I mean, *really good*. Now, there are half a dozen. The worst—I should say 'cheapest'—of amplifiers today are about as good as the best five years ago. The same is true of tone arms, cartridges, tuners, and the rest. Whereas only one or two were really first-rate a few years back, today many have reached a high degree of excellence."

Few visitors to the 1960 New York exhibit would dispute his view.

Tape Trends. Recorder manufacturers offer stereo "record" features in almost all new equipment. Most offer a patch cord enabling the user to transfer stereo discs to tape and one (Telectro) even includes a pair of microphones in the original purchase price.

In our view, a development that would affect strongly the amount of stereo recording done in the home is the settling of the FM multiplex question. A great many owners of stereo tuners can easily convert to whichever multiplex system the FCC adopts and they will easily be able to tape stereo broadcasts. Attention was focused on the Crosby Multiplexing System at the New York Show by virtue of a "closed circuit" FM stereo broadcast in the show building.

Down from the Bookshelf. Speaker systems, which have been getting smaller and smaller, may be reversing their trend. KLH now has a Model Nine with the impressive dimensions of (almost) six feet high, two feet wide, and three inches thick. The thickness figure is no typographical error, and we hasten to point out that the Model Nine is a full-range electrostatic speaker. It has a total radiating surface of 28 square feet (14 square feet in front and 14 in back) and will be sold only in pairs at \$1,030 for the two. Electrostatics, well known for smooth response at high frequencies, are incapable of good low frequency response *unless* the radiating surface is substantial. KLH's Model

Nine goes very low—full output at 30 cps, according to the firm.

To the nonbookshelf speaker category add the Citation X. Like the tuner and amplifiers in Harman-Kardon's Citation line, this speaker system owes its design (in part) to Stewart Hegemen, with an assist from Lowther Manufacturing Company.

The Citation X stands pillar-fashion and measures three feet high, twenty inches wide, and fifteen inches deep. The enclosure is a folded-horn design equivalent to a seven-and-a-half-foot length. The speaker mounting and cone design achieve an omnidirectional dispersion which, in practice, gives a pleasing stereophonic effect.

Altec-Lansing, while not offering a new, large speaker, has designed a large cabinet (the 854A-B) for their 605 speaker. They thus provide an enclosure which the user once had to construct from plans provided by the firm. The new cabinet sells for \$99.

Heart of Quartz. A few years ago, a new type of tweeter appeared which used a tiny quartz tube or horn to reproduce frequencies above 3,500 cps. In practice, the unit worked extremely well but it failed at the marketplace because of cost (about \$150) and longevity (the quartz cell deteriorated after about 300 hours of use).

An improved version, the Ionovac, is now being shown by the DuKane Corporation. The price for the complete tweeter has been lowered to \$79 (\$69 without cabinet) and the life of the quartz cell has quadrupled to 1,200 hours (almost two years of normal listening) after which the quartz may be inexpensively replaced. These improvements result from ultrasonic drilling of the tiny horn. DuKane also incorporates the Ionovac tweeter in several full-range speaker systems.

Cricket Concerto. One of the music-*cum*-electronics events of New York's High Fidelity Music Show was the "live versus recorded" concert sponsored by Acoustic Research and Dynaco. The concert featured the Fine Arts Quartet in the flesh and on tape. Auditors were asked to distinguish between the live portion of the performance and a prerecorded version played over a system consisting of an Ampex 350, a Dynakit PAS-2 preamp, two Dynakit Mark III amplifiers, and two AR-3 speaker systems. Few could separate the live from the recorded portions.

In part, their confusion stemmed from the painstaking care taken in recording the Quartet. This was no ordinary recording. As AR's Edgar Villchur explained it, there had to be a total absence of reverberation in the recording. The reason? In hearing the live portion of the program, an audience receives the natural reverberation of the hall. If there were any reverberation in the recorded section, they would hear hall reverberation on top of studio reverberation and could distinguish between the live and recorded versions. Villchur decided, therefore, to make the original recording out-of-doors, in "God's anechoic chamber" as he poetically puts it.

Actually, the taping was done on the front lawn of his Woodstock, N. Y., home (see photo) where the Fine Arts Quartet encountered unexpected competition from hundreds of crickets. For the first time in their experience, the Quartet periodically swapped stringed instruments for Flit guns to complete the recording. And Villchur occasionally fired a shotgun into the air to silence momentarily birds of all species which watched, listened, and—worst of all—commented on the session from nearby trees.



The Fine Arts Quartet at Woodstock . . .



. . . and at High Fidelity Music Show.

THIS YEAR GIVE A HEATHKIT



NOW ONLY
HEATHKIT®
Brings You
ALL 3!

1.
HEATHKIT
for the do-it-yourself
hobbyist

2.
HEATHKIT
factory-wired &
tested units ready for
immediate use &
enjoyment

3.
HEATHKIT
Science Series . . .
entertaining,
instructive
explorations into
science & electronics
for youngsters

HEATHKIT[®] by DAYSTROM

CIRCLE 76 ON READER-SERVICE CARD

HEATHKIT® HI-FI . . .

the gift that goes on giving pleasure year after year.



Complete ensemble, low as \$133.50
Send for details.

STEREO EQUIPMENT ENCLOSURE ENSEMBLE

Beautifully styled center cabinet and optional speaker wings are factory assembled, ready to use, in choice of finished or unfinished woods. Center unit houses changer, AM/FM tuner, stereo amplifier and optional sliding tape recorder drawer. Speaker wings available in 2 models — for 12" or 15" stereo speakers.



Model AJ-30 (kit) . . . \$9.75 dn. **\$97.50**
Model AJW-30 (wired) . . . \$15.30 dn. **\$152.95**

DELUXE AM/FM STEREO TUNER

Exciting new styling and advance design features rocket this Heathkit to the top of the Christmas value list. Featured are: complete AM/FM, Stereo reception, plus multiplex adapter output; flywheel tuning; individual tuning meters; FM AFC and AM bandwidth switch. 25 lbs.



Model AA-100 (kit) . . . \$8.50 dn. **\$84.95**
Model AAW-100 (wired) . . . \$14.50 dn. **\$144.95**

HI-FI RATED 50-WATT STEREO AMPLIFIER

In the inimitable style of the AJ-30 above, this complete stereo amplifier offers the ultimate in stereo control and mastery of tonal values. Jam-packed with special features including mixed-channel center speaker output; "separation," "balance" and "stereo reverse" controls. 31 lbs.



Model AS-10U (unfinished) **\$59.95**
Model AS-10M or W (mahog. or wal.) **\$64.95**

ACOUSTIC SUSPENSION SPEAKER SYSTEM KIT

It's "bookshelf" size belying its gigantic capabilities, this amazing unit outperforms speakers four times its size. A 10" acoustic suspension woofer and two "dispersed-array" cone tweeters deliver high-fidelity tone with fantastic brilliance over the entire range of 30-15,000 cps. Pre-assembled cabinets in choice of finishes. Measures 24" L x 11½" D x 13½" H. 28 lbs.



Model AJ-10 . . . \$6.00 dn. **\$59.95**

ECONOMY AM/FM STEREO TUNER KIT

Ideal suggestion for your Christmas hi-fi gift list . . . a low cost tuner with every design feature for superb AM, FM or stereo AM/FM listening. Separate "magic-eye" tuning indicators "zero-in" stations while 3-position AFC gives drift-free reception. Output provided for multiplex adapter. 14 lbs.



AUTOMATIC RECORD CHANGER KIT

Jam-proof mechanism . . . quick-change cartridge holder . . . "muting" switch . . . and "size-selector" for intermixing 7", 10" and 12" records of the same speed! Holds up to 10 records, for hours of delightful stereo or mono listening enjoyment.

Model AD-50 \$49.95 to \$54.95 depending on cartridge. Other models from \$22.95. Send for FREE Heathkit catalog today!



MONOPHONIC PREAMPLIFIER KIT

The AA-60 is a monophonic hi-fi preamplifier control center . . . the heart of any good hi-fi system. 6 separate inputs: mag. phono, tape head, microphone, tuner, crystal phono, and auxiliary. Tape head input has NARTB equalization for direct playback from tape head. Features separate tone controls, input level controls, filament balance. 6-position function selector.

Model AA-60 . . . 7 lbs. . . **\$24.95**



PORTABLE 4-TRACK STEREO TAPE RECORDER KIT

What better gift than this? . . . a compact portable tape recorder just waiting to record the caroling, frolicking, family joys of the holiday season! You'll thrill to the natural stereophonic sound of this unit that also serves as a hi-fi center with its versatile input accommodations and controls. Tape mechanism and cabinet are pre-assembled. 49 lbs.

Model AD-40 . . . \$18.00 dn. **\$179.95**

ORDER DIRECT BY MAIL OR SEE YOUR HEATHKIT DEALER



HEATH COMPANY
Benton Harbor 8, Michigan

ORDERING INSTRUCTIONS
Fill out the order blank below. Include charges for parcel post according to weights shown. Express orders shipped delivery charges collect. All prices F.O.B. Benton Harbor, Mich. A 20% deposit is required on all C.O.D. orders. Prices subject to change without notice.

Please send the following HEATHKITS:

ITEM	MODEL NO.	PRICE

Ship via () Parcel Post () Express () COD () Best Way

() SEND MY FREE COPY OF YOUR COMPLETE CATALOG

Name _____

Address _____

City _____ Zone _____ State _____

Dealer and export prices slightly higher.

CIRCLE 77 ON READER-SERVICE CARD



a touch of Crosby...



The deft touch of Murray G. Crosby on electronic gear makes the everyday into something special. This is clearly evidenced by the introduction of two new high fidelity components—a super-sensitive FM tuner and a powerful 28-watt stereophonic preamplifier/amplifier. These twin units bring to home music enjoyment the technical achievement acquired through research and production of sophisticated military electronic equipment. And what makes Crosby's entry into stereo hi-fi even more exciting is the combination of these skills with handsome, compact design at a fair price.

left: Model 680 stereo preamp/amplifier
28-watts—\$119.95

Featuring push-button source selection, colored light mode indicators, exclusive circuit mono/stereo blend control, center-channel stereo output, tape monitor input. Compact size—13½" w. x 4¾" h. x 6¾" d.

right: Model 690 FM tuner—\$99.95
Extremely high sensitivity, dial-variable amplified AFC, variable interstation noise-muting control, chassis ready for Multiplex. Compact size—13½" w. x 4¾" h. x 6¾" d.

stereo BY Crosby

Crosby Electronics, Inc. • 135 Eileen Way • Syosset, L.I., N.Y.

Manufacturers and designers of stereophonic components, speakers and the Crosby Compatible Stereo FM Multiplex System.
Export: Microwave International Corp. • 36 West 44th Street, New York 36, N. Y.

CIRCLE 46 ON READER-SERVICE CARD

THE GRAMOPHONE

EDITOR'S NOTE: *This is the first in a series of reports on audio developments abroad prepared for us by our counterpart in Britain, The Gramophone. Subsequent transatlantic news reports will appear at regular intervals.*

Audio at Earls Court: The first radio exhibition held in London took place in 1922. Each year since then (with the exception of the war years) the British public has flocked to see the new products on display.

The Radio Show now has its Audio Hall, though the more discriminating public regards the London Audio Fair (held in April each year) as the best shopwindow for new equipment. There were, however, several interesting innovations on view at the recent Radio Show, and many of them will be available in the U.S.A. by now.

New Acos Pickup: Under the Acos trademark, Cosmocord, Ltd. has for years produced pickups and microphones using piezo crystal elements, some based on Rochelle salt and more recently on ceramic materials. Cosmocord has now developed a revolutionary new pickup named the Hi-Light with a playing weight of one gram for mono and a separate cartridge with a 2-gram weight for stereo. Due to the very light pressures, wear on both stylus and disc is negligible. The stylus is an integral part of the pickup head, and the entire head is replaced when the stylus becomes worn. A most convincing demonstration was given with the turntable platform oscillating through about $\pm 30^\circ$ without any audible change. The firm also showed a new stereo crystal microphone which should have a ready sale because of the many stereo 2- and 4-track tape machines available. This microphone is designed on the basic British Blumlein principle, giving full coincident-phase operation with the use of a pair of two-crystal pressure differential units in a neat streamlined housing.

Collaro and Garrard: Collaro exhibited a tape deck which, although basically designed for manufactured tape machines, is available in small quantities for people wishing to make up their own equipment. Named the "Studio" Tape Transcriber it has very low wow and flutter figures and can be supplied

with a separate monitor or stereo playback head.

A new piece of turntable equipment, the Laboratory series Auto Turntable, Type A, was shown by Garrard. Besides having the characteristics of a transcription unit, it also plays records automatically. The turntable is a composite type, being a heavy nonmagnetic machined casting with a built-in magnetic shield. Even with hum-sensitive pickups there is a negligible field of interference. Mounted on the base plate is the Garrard TPA12 precision counterbalanced pickup arm.

No Hole in the Center: For a number of years the General Electric Company has marketed an unusual loudspeaker using a metallic diaphragm with discrete depressions to smooth the response curve. By using two of these units in an acoustically corrected cabinet and connected so that the diaphragms operate in push-pull, a loudspeaker with low harmonic distortion is produced. In order to extend the frequency response to the limits of human hearing, one or two small pressure units with crossover networks are also used. Dr. Leakey and F. H. Brittain, two research engineers of the G.E.C. Laboratories, this year demonstrated the use of a center speaker in stereo reproduction. The well-known hole-in-the-center effect was completely absent and, although several such systems are available in the States, the G.E.C. circuitry is new. We should hear more about it in the future.

New Approach from EMI: Electric and Musical Industries, the firm producing records for the His Master's Voice, Columbia, and Capitol labels, has introduced a new high-quality pickup for stereo records. The head operates on the variable reluctance principle, and the tip mass is stated to be as small as approximately 1 milligram with a high lateral compliance of 7×10^{-6} cm/dyne. The arm, balanced both laterally and longitudinally, operates on a viscous damped single pivot. A new approach has been used in mounting the head relative to the arm. Instead of making the tracking error as small as possible, the head is angled for least possible tracing distortion. One can raise and

lower the arm without shock because of a built-in damped lever.

The Stereomic: Almost from the beginning of sound broadcasting the firm of Lustraphone has specialized in microphones—magnetic, moving coil and ribbon types. Last year this company introduced the VR/65 Stereomic stereo ribbon microphone—two independent ribbon units mounted one above the other. The upper unit can be rotated through 100° relative to the lower unit and has a phase reversal switch.

Many technical reviewers who visited the last Audio Fair considered the Lustraphone demonstration of stereo recording one of the best of its kind ever heard. The Stereomic costs 32.10/ (\$91), which considering its features cannot be regarded as expensive for a wide-range stereo microphone. However, by leaving out some of the facilities, but not changing the stereo performance, Lustraphone has now introduced the VR/65NS model at 15.15s (\$45). This brings it into the amateur recordist price range.

Reflectograph: One of the first semiprofessional tape recorders in Britain was the Reflectograph, which had an infinitely variable tape speed between 3 and 8 inches per second. In 1958 the company came under the wing of Multicore Solders, Ltd. (the Managing Director of that company, Richard Arbib, having a ways been a keen musician and recordist). Knowing world markets, he set his engineers, headed by James Cunningham-Sands, the task of producing a range of professional machines at a reasonable price. At present there are four models. Model A is a 2-track recorder; Model B records on four tracks and plays 2- or 4-track stereo tapes with the aid of an external amplifier for the second track. Model C is a 4-track stereo recorder and reproducer. The latest addition, seen for the first time at Earls Court, is Model D which consists of deck and preamplifier and is designed for playing tapes for copying purposes. One of the unusual features of all these machines is the use of a single potentiometer to provide variable speed, fast forward and reverse winding. Demand for them is high in Britain and time may pass before they appear in America—but they're worth the wait!

a
Special Offer
from
Harper's
magazine

Ever notice how Harper's magazine punctuates the conversation wherever you go? It does, if you travel in well-informed circles.

In fact, there may be no greater or more important magazine in our culture today than Harper's. A bracing and distinguished combination of imaginative writing and editing goes into every Harper's article, whether it's on art, politics, popular culture, religion, education, or unpopular culture.

Join the well-informed today. Take advantage of our special subscription offer.

Harper's magazine

49 East 33rd Street, New York 16, New York

I understand that a year's subscription (12 issues) to Harper's magazine is normally \$6.00. But:

- Check One**
- I want to take advantage of your special subscription offer. Please send me the next 12 issues for only \$3.87, and bill me later.
 - I want to take advantage of your special, special subscription offer. I have enclosed my check for \$3.87, so please send me the next 14 issues.

Name _____

Street Address _____

City _____ Zone _____ State _____

HF-11

CIRCLE 75 ON READER-SERVICE CARD

Cartridges

Clean Mono Sound Now, Quick Stereo Conversion Later

MANY AN OWNER of a monophonic high-fidelity system has his ear(s) cocked for the sound of stereo discs and wonders—since his system has not yet been “converted”—whether his next record purchase should be of the mono or stereo version. If the mono disc, won't something be missing when the step to stereo is taken? If the stereo disc, can it play on mono equipment—and if so, how?

The answer to the first question is: definitely yes. To the second: it depends—on the cartridge and how it is connected. A monophonic cartridge *can* be used for playing stereo records, but *should not be*. The lack of vertical compliance of a mono pickup, as well as its stylus diameter (.001-inch as compared to the .0007-inch required for the narrower stereo groove) can damage a stereo record.

But, does it make any sense to use a stereo cartridge in an otherwise monophonic system? Again, definitely yes. Such a cartridge may be hooked up to perform correctly with mono records; what's more, it permits you to buy stereo records and play them monophonically now and stereophonically later when that second amplifier and speaker are added.

In this transitional period between mono and stereo, stereo cartridges are already to

be found in many single-channel systems. Stereo pickups have in fact all but replaced mono versions as available products; this, plus the eye-on-the-future attitude of present mono owners, would indicate that almost any new purchase of a cartridge these days would be of the stereo variety.

There are specific ways to make stereo cartridge, stereo records, and mono records all nicely compatible with each other as well as with the existing single-channel system.

The simplest solution is to connect the stereo cartridge to the leads in the arm as if it were a mono cartridge. This means connecting the “hot” or “signal” terminals for both channels to the same lead in the arm, and similarly tying the two “ground” terminals to another common lead. This wiring should then connect to a single shielded cable which carries the resultant mono signal to an input jack on the mono amplifier or preamp.

An important thing to watch for here is that the “hot” leads from the cartridge connect, via the center conductor of the shielded cable, to the center pin of the phono plug; and that the “ground” leads connect, via the braid or shield of the cable, to the outer portion of the plug. In this way, no “out-of-phase” condition could occur to reduce the available signal level.

Such a hookup will provide a mono signal from both mono and stereo records, and will not damage the latter. It does, however, suggest some future inconvenience when the system is later converted to stereo; for when a second amplifier is added, the cartridge must be rewired in the arm, and a second shielded cable provided. So, to do the trick better, why not arrange for such connections ahead of time, in such a way as to provide for clean mono sound now, and very little bother for stereo later? This means, of course, wiring the cartridge as if it were going to play stereo, but then “fooling it” into playing mono—thus, two sets of signal leads and their respective ground leads, and two shielded cables. Indeed, this is exactly the arrangement you will find in some new record players.

With such a wiring arrangement you have a choice of three dodges.

First, you can simply remove one of the output cables from the tone arm, and connect jumper wires across the two signal, and the two ground terminals under the turntable. This is, in effect, the same as

wiring the cartridge for mono performance in the first place. Then, in the stereo future, you will have to remove the terminal jumpers and reconnect that second cable.

To avoid this bother, you can install a two-pole, two-position switch, wired—as in the drawing—to perform the functions of terminal-jumping, clipping, and reconnecting whenever desired. On one position, the switch combines both channels for mono, and removes one cable from the system. On the other “stereo” position, both channels are operative, each feeding through its own cable. This switch may be installed in any convenient spot as close to the turntable as possible.

A final solution, which is probably more convenient than any other, is to use a “Y connector” that combines the two cables into one. No clipping, no soldering, no switch mounting. “Y connectors” come in different plug-and-jack combinations to accommodate any installation. A type like the Lafayette MS-672, which has two plugs (for accepting the cables from a stereo-wired player) and one jack (for feeding into a mono amplifier) would probably be most suitable. These connectors are securely made, well shielded, and short enough so that their own length will not create additional problems of hum or high frequency loss. An inveterate do-it-yourselfer can fashion his own “Y connector”—but why bother when the ready-made version costs about 60 cents?

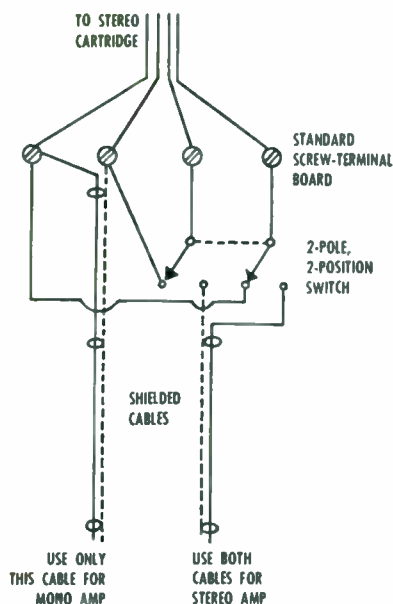

Changing from mono to stereo is made convenient via two-position switch . . .

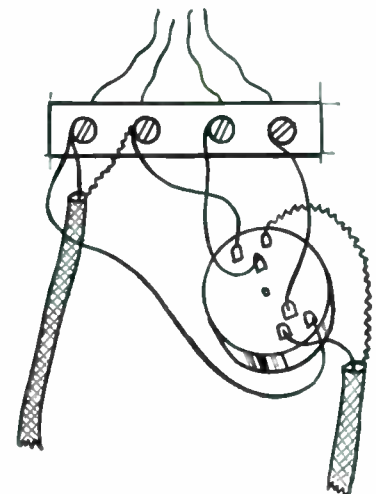

. . . or wire a rotary switch as shown in above drawing to achieve the same end.

TRADER'S MARKETPLACE

Here's the place to buy, swap, or sell used equipment, records or what have you. Rates are only 45¢ a word (no charge for name and address) and your advertisement will reach more than 110,000 music listeners. Remittance must accompany copy and insertion instructions. Copy must be received by 5th of 2nd month preceding publication and is subject to approval of publishers.

AMPEX 350's, 601's, 960's, 620s speaker, Fisher components, Leica camera and projector. Excellent or unused. Scotch recording tape. Big reductions on all. List 25¢. Foster Gunnison, Jr., Suite 806, 600 Asylum Ave., Hartford, Conn.

RENT-A-TAPE/stereo or monaural. No deposits—no minimums. Free catalog. Columbia, 9651 Foxbury Way, Rivera, California.

AMPEX 970 stereo tape recorder, excellent condition, \$495. Berlant Model 30, \$295 including mounting rack. B. Holm, 2512 60th St., Des Moines, Iowa.

CO-ED RECORDS, Artists recorded tapes, top releases, variety selections. Popular—Novelty—College. Co-Ed Records, 12 West 117th, Box 46, Morningside Station, New York 26, N. Y.

RADIO CRAFTSMEN, C-800 preamp, AM-FM tuner, C-500 20-watt amplifier, in custom cabinet: \$145.00. Alan Broder, 98-33 64th Ave., Rego Park 74, N. Y. TW 7-4371.

SELL: Jensen Imperial reproducer. Like new. \$185.00. John E. Alexander, M.D., 609 Hulman Bldg., Evansville 8, Indiana.

WANT: Knight-Kit 25-watt basic amplifier, YU 793, perfect. Bob Pieser, 2545 East Main St., Ventura, Calif.

SELL/TRADE, Ampex 612, Scott 121C. Want 4-track tape Crown transport. Make offer. Major John Parrott, Student Armed Forces Staff College, Norfolk 11, Va.

CHRISTMAS COMFORT in 30 styles of sheepskin slippers, double deerskin mocs, etc. Money back guarantee. Free catalog. Cottage Crafts Shop, Rutland, Vermont.

HARPSICORDS, CLAVICHORDS—Excellent modern German instruments by Sperrhake. Beautiful cabinet, moderate prices. Robert S. Taylor, 8710 Garfield Street, Bethesda, Maryland.

COMPONENTS, RECORDERS, Tapes. Send for wholesale catalogue. Carston, 215-A East 88th Street, New York 28, N. Y.

EXCELLENT QUALITY RECORDING TAPE—7" reels. 30-15000 cps guaranteed. 1200' Acetate, 3/3.90-6/7.50; 1800' Acetate, 3/5.10-6/10.00; 1200' Mylar, 3/4.80-6/9.00; 1800' Mylar, 3/6.60-6/13.00. SPECIAL, 2400' Mylar, 3/7.20-6/14.25. Plus 15¢ PP & Handling per reel. Foto Sound, 88 Harbor Road, Port Washington, N. Y.

SALE: 78 R.P.M. RECORDINGS, 1902-1950. Many types. Free lists. Collections bought. Mr. Ellie Hirschmann, P.O. Box 155 (HF), Verona, N. J.

PRECISION RECEIVER ALIGNMENT—FM—\$5; FM/AM—\$9. HiFi equipment meticulously serviced. Kit problems solved. I. Pollack, Westbury, L. I., N. Y. ED 4-4490.

RENT STEREO TAPES—over 1,500 different—all major labels—free catalog. Stereo-Parti, 811-D Centinela Ave., Inglewood 3, Calif.

COMPONENTS—Best quotations—Sale items. Bayla Co., Box 131, Wantagh, N. Y.

DEEPEN YOUR UNDERSTANDING of music and solve all your record storage and indexing problems. Unique new card file helps make you an armchair critic, compare your record ratings with the critics, and helps you select your next new records. Free brochure shows all this and more. Sample Record Index cards and Composer Guides included. Records (HY), 503 Hyde Park Bank Building, 1525 East 53rd Street, Chicago 15, Ill.

A MIKE OR TWO

Continued from page 63

directional at most frequencies are often labeled cardioid, because their polar response patterns are heart-shaped. And, as already pointed out, the pattern of directionality varies with frequency.

Polar response is the sensitivity of a microphone to different frequencies at varying degrees off axis. Axial response is a plot of the sensitivity of the microphone to all frequencies, but only on axis. This specification is exactly parallel to the frequency response curves often published for loudspeakers. Two axial response curves are illustrated; they show that for different applications, different axial response is desirable. A wide-range mike, wonderful for orchestral recordings, would be impossible for voice pickup in a noisy location.

Similarly, the polar response characteristics of a microphone should be considered in terms of its application. If the mike is to be used primarily in a relatively dead room, where high frequency reverberation is inhibited by draperies, rugs, and the like, then fairly good omnidirectionality, even at the higher frequencies, might be desirable. Since low frequencies continue to bound around inside a room far longer than high frequencies, a drooping low frequency axial response

might not be a bad idea for some rooms. In connection with directionality, we might point out that some microphones have a figure-eight pattern of pickup. These are ideal for cross-the-table interviewing and similar types of work.

As mentioned in passing, earlier, some microphones have very low voltage or power outputs. Some are sold only with the proper electronic devices to boost this output; but if you happen to get a microphone without such a preamplifier and you have a recorder that needs high microphone output for proper operation, you can easily obtain a tiny transistor preamp which will solve the problem.

It should be noted that the power supplies or voltage (or output) boosting equipment required by some microphones may be objectionable under certain conditions (there's convenience in carrying to be considered, for instance). Most microphone specifications include a figure which tells (presumably) something about output; unfortunately, there are several different methods of measuring output and the situation is confusing even to the microphone salesman. Langford-Smith, in his well-known *Radiotron Designer's Handbook*, lists four methods of rating mikes according to voltage output and five more according to power output! He also gives the conversion factors, which you can read if you should feel specification-minded sometime.

Suggestion: don't worry about output. We have yet to discover a combination that won't work.

The size of a microphone has some (generally slight) effect on polar response but otherwise is of no significance to the average home user. Size is mighty important on television, of course, and great strides have been made in reducing microphones until they are thoroughly inconspicuous.

Another requirement originating with television but of some use at home is TV's need for highly directional microphones. It is preferable, on TV, to keep the mike out of sight completely. This means it has to be far from the performer. And this means it has to be highly directional or it will pick up too much background noise. Several manufacturers are working on what they call machine gun mikes, and fine examples have already been achieved.

Finally, stereo. No problem here. Get two good monophonic mikes. Anything more in the way of suggestion would become a highly complex discussion about cross-fire versus. . . . Let's stop right here.

DON'T BUY Hi-Fi components, kits, tape, tape recorders until you get our low, low return mail quotes. "We guarantee not to be undersold". Wholesale catalog free. Hi-Fidelity Center, 1797AC First Avenue, New York 28, New York.

WRITE FOR QUOTATION on any Hi-Fi components. Sound Reproduction, Inc., 34 New Street, Newark 2, N. J.

PROFESSIONAL RECORDING TAPE—First quality of prime manufacturer. Full frequency response. Polished. Lubricated. Money back guarantee. Acetate, 1200', 1½ mil, 4/\$5.00; 1800' 1 mil, 4/\$6.65. Mylar, 1200', 1½ mil, 4/\$5.95; 1800', 1 mil, 4/\$8.20; 2400' ½ mil, 4/\$12.60. Postage 15¢ each. HiSonic, 1212 North Park Road, Hollywood, Fla.

HI-FI DOCTOR—Will solve your hi-fi problems on-the-spot. Acoustic, Audio, Radio engineer. Stereo designing. Professional visits, day, evening. New York area, weekdays. William C. Bohn, 550 Fifth Ave., New York City. PLaza 7-8569.

BEFORE YOU BUY receiving tubes of Hi-Fi components, send now for your giant free Zalytron Catalog No. 166—featuring nationally known Zalytron first quality TV-Radio tubes, Hi-Fi stereo systems, kits, parts, etc. All priced to save you plenty—Why pay more? Zalytron Tube Corp., 220 W. 42nd St., New York, N. Y.

BUY—RENT—ANY RECORDING—Disc or tape. All labels. Definitive Recordings Club, 11024 Magnolia Blvd., North Hollywood, Calif.

TAPE RECORDERS, Hi-Fi components, Sleep learning equipment, tapes. Unusual values. Free Catalog. Dressner, 69-02A, 174 St., Flushing 65, N. Y.

ALL MAKES HIGH FIDELITY speakers repaired. Amprite, 168 W. 23rd St., New York 11, N. Y. CHelsea 3-4812.

HIGH FIDELITY and Gramophone, copies 1954 to date. Write: Seymour D. Folkman, 200 E. Girard Ave., Philadelphia 25, Pa.

CLASSICAL 78 RPM records for collectors. Free lists. Collections bought. The Gramophone Shop, Box 7451 Station "C", Atlanta 9, Georgia.

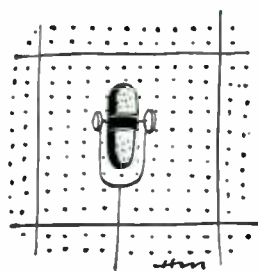

INSIDE LA SCALA

Continued from page 49

chance to get a ticket for the evening unless the hotel porter or his travel agent helps him. "Advance booking is accepted for stalls and boxes," the official Scala pamphlet says. "Requests indicating name and address made by letter, with money order enclosed, or by telegraphic money order or postal order, must reach the Biglietteria del Teatro alla Scala at least seven days before the performance."

For first nights (*prime*) and galas, "evening dress is requested in stalls and boxes," seats sell for \$16, plus eighteen per cent tax. After the first night, prices drop to \$8.00. Third-performance tickets cost only \$5.00. At least forty performances are *Serate per i Lavoratori*, "Workers' Nights," with the most expensive ticket less than \$1.00 and standing room in the galleries for 30 cents, less than the price of a cinema ticket. These are not cut-rate evenings with minor artists. The same stars sing that appeared on the first night, and the same conductor is in the pit. Workers buy their tickets either at their factories or at the offices of the local labor unions. "We try to get the workers and their families and friends into boxes. We try to create a worker's society on these nights, just as there is the bourgeois society on first nights. Sometimes as many as ten people crowd into a box for six. We want everybody here to feel that La Scala belongs to them. We charge the industrialists plenty to be able to sell cheap tickets to their workers." So speaks ex-industrialist Dr. Antonio Ghiringhelli.

This admirable policy has resulted in an entirely new audience in Milan. Workers and small tradesmen go to La Scala with the same feeling of anticipation as rich habitués, and they show similar understanding and excitement. La Scala today is, in fact, an opera house for all the people. Ghiringhelli's plan is to give more performances for impecunious students. "We hope that some day the young people of Milan will study the history of La Scala in school," he says. "And we want everybody in this city to have a chance to hear most of the world's great operas under this roof in the course of the next ten years."

La Scala's audiences are the most discriminating and toughest on earth. They show terrific enthusiasm when they appreciate a performance but sit on their hands when they don't like it. The most celebrated singers are terrified of the devastating Milan silence. Ghiringhelli has seen quite a few of them in tears after getting the silent treatment. Once in a while there is violent hissing and booing, and there have been incidents of dignified first-nighters throwing programs, opera glasses, and even shoes against the stage to show their utter disapproval. No one can fool the people of Milan who grow up with opera, have tradition and

Continued on next page



BURGESS BATTERIES

CHROME PROTECTED
SEALED-IN-STEEL
SELF RECHARGEABLE
GUARANTEED LEAKPROOF



Radar-Lights

CORROSION PROOF
separated head and
battery design

BURGESS BATTERY COMPANY
DIVISION OF SERVEL, INC.
FREEPORT, ILLINOIS • NIAGARA FALLS, CANADA
CIRCLE 34 ON READER-SERVICE CARD

TRADER'S
MARKETPLACE
CLASSIFIED
ADVERTISING

Order Form

Fill in coupon below and mail, with check or money order (no cash). Rates 45¢ per word with no charge for name and address. Print or type your ad below.

HIGH FIDELITY MAGAZINE
Great Barrington, Massachusetts

.....
.....
.....
.....
.....

Name.....

Street.....

City.....Zone.....State.....

\$.....Payment Enclosed



Elegance...in small space

Gracious listening for bookshelf or floor with TWO Jensen speakers. 8-in. woofer, 3½-in. high-dispersion tweeter, superbly matched. Luxurious ¾-in. genuine hardwood in Honey Blonde or Autumn Walnut. 24 x 11 x 10½ in. deep. At your hi-fi store or write Dept. H, Argos Products Co., Genoa, Illinois.

NEW DE LUXE CATALINA
TSE-2AS \$39.95 NET

Argos Products Company

CIRCLE 13 ON READER-SERVICE CARD

GENERAL ELECTRIC VR-22 STEREO CARTRIDGE



4 reasons why it's preferred by just about everyone who knows.

- 1 **Compliance**—It tracks precisely—no stiffness.
- 2 **Channel separation**—Up to 28 db for maximum stereo effect.
- 3 **Response**—Smooth and flat from 20 to 20,000 cycles (VR-22-5), 20 to 17,000 cycles (VR-22-7).
- 4 **Freedom from hum**—VR-22 is triple-shielded against stray currents.

General Electric Co., Audio Products Section, Decatur, Ill.

GENERAL ELECTRIC
CIRCLE 68 ON READER-SERVICE CARD

STATEMENT REQUIRED BY THE ACT OF AUGUST 24, 1912, AS AMENDED BY THE ACTS OF MARCH 3, 1933, JULY 2, 1946 AND JUNE 11, 1960 (74 STAT. 208) SHOWING THE OWNERSHIP, MANAGEMENT, AND CIRCULATION OF High Fidelity, published monthly at Great Barrington, Massachusetts, for October 1, 1960

1. The names and addresses of the publisher, editor, managing editor, and general manager are: Publisher, None; Editor, Roland Gelatt, Bridgewater, Conn.; Managing Editor, Miriam M. Landis, Great Barrington, Mass.; General Manager, Warren B. Syer, Great Barrington, Mass.

2. The owner is: The Billboard Publishing Company, 2160 Patterson St., Cincinnati, Ohio; Mrs. Marjorie D. Littleford, Ft. Thomas, Ky.; J. W. Ross, Sr., Trustee, Ft. Thomas, Ky.; R. S. Littleford, Jr., Port Washington, N. Y.; W. D. Littleford, Roslyn Estate, N. Y.; Jane L. Stegeman, Ft. Thomas, Ky.; Estate of Mariana W. Littleford, Marjorie L. Ross, Ft. Thomas, Ky.; L. M. McHenry, Ft. Thomas, Ky.

3. The known bondholders, mortgagees, and other security holders owning or holding 1 percent or more of total amount of bonds, mortgages, or other securities are: none.

4. Paragraphs 2 and 3 include, in cases where the stockholder or security holder appears upon the books of the company as trustee or in any other fiduciary relation, the name of the person or corporation for whom such trustee is acting; also the statements in the two paragraphs show the affiant's full knowledge and belief as to the circumstances and conditions under which stockholders and security holders who do not appear upon the books of the company as trustees, hold stock and securities in a capacity other than that of a bona fide owner.

5. The average number of copies of each issue of this publication sold or distributed, through the mails or otherwise, to paid subscribers during the 12 months preceding the date shown above was: 105,898.

(Signed) Warren B. Syer

Sworn to and subscribed before me this Twentieth day of September 1960.

(Seal) Lillian F. Bendross, Notary Public
Commission expires June 24, 1961.

INSIDE LA SCALA

Continued from preceding page

knowledge and instincts, are sure of their opinions, remember Toscanini's tempos and Caruso's legati. Genuine connoisseurs are in the stalls, the boxes, and the galleries, where a well-organized claque is operating. The *chef de claque* is a professional, and his cohorts are opera-loving students who get their tickets in return for artistically steered applause at the right moment. At La Scala the applause always comes at the right moment.

La Scala not only discovers new talent but keeps three schools going to develop promising material. The oldest of them, the Ballet School, was founded in 1813. Children from the age of nine get their general and ballet education there. The School of Singing (Scuola del Canto) is a sort of postgraduate school for promising singers who have had their training privately or at conservatories. The best of them participate in a contest every June and the winners get contracts at La Scala. And there is a special school where young singers are trained in the special singing style of earlier centuries. They will in due time appear at the Piccola Scala. Regular auditions take place before Maestro Siciliani, Maestro Antonio Tonini (chief coach), and several conductors.

For its important productions of popular works La Scala competes with the other "first" opera houses of the world for the best singers it can get and pays them about as much as they get elsewhere. Contrary to rumors, La Scala does not pay the highest fees in the opera business. Smaller Italian opera companies that build a short season around a certain star can afford to pay more for a limited number of performances. Don't believe the old legend that the various "first" houses outpay each other. Naturally a star tries to get as much as he can, but opera managers are no fools. They have their budgets. Besides, there are perhaps fewer than six big-name stars today who enjoy a sort of monopoly. They are the ones who worry the managers.

La Scala spends only \$130,000, about four per cent of its annual budget of \$3,200,000, on new sets and costumes. They are made and stored at La Bovisa, a tall building off in the suburbs. La Scala has no backstage storage space for more than two or three productions at one time. Great economy is exercised in making the sets, labor is relatively inexpensive, and sets are later redone and used again. Nothing is wasted. La Scala has an exchange agreement with the Vienna Staatsoper and sells it certain productions. The stage machinery was modernized after the war, and La Scala's lighting apparatus is among the best in the world, connected with three different power plants, in case of a breakdown of one, or even two. There is closed-circuit TV so that the chorus backstage may watch the conductor on a small screen—a useful gimmick when mass scenes are staged. But mechanization has not been pushed to the extreme. La Scala gets along

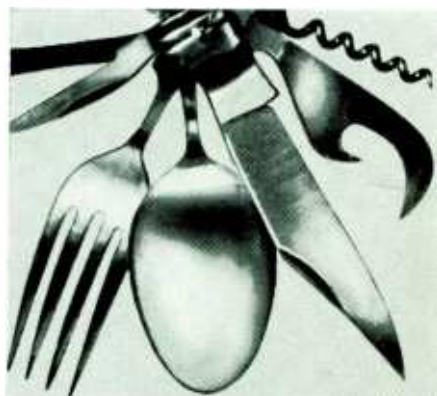

NO GIMMICKS WITH THIS SPEAKER BY

wigo
PRONOUNCE IT WEEGO

... just solid, sensible acoustic engineering. Nothing fancy but the performance ... it's smooth and clean from 30 cps to beyond audiobility. For now at your Wigo dealer.



Model CX-212,
12" Coaxial
\$79.50

united Audio

WIGO • PRODUCTS OF DISTINCTION • DUAL

12 West 18th St., New York 11

CIRCLE 131 ON READER-SERVICE CARD

FREE

GIANT 1961 204 PAGE CATALOG

BA 1961

Since 1947

A Complete Buying Guide for Everything in

RADIO TV ELECTRONICS

HI-FI AND STEREO SYSTEMS & COMPONENTS

SAVE UP TO 50% ON B-A SELECTED KITS

30 PAGES OF BARGAINS NOT IN ANY OTHER CATALOG

100'S OF NEW ITEMS LISTED HERE FOR 1st TIME

BURSTEIN-APPLEBEE CO.

Dept. 18, 1012 McGee St., Kansas City 6, Mo.

Send Free 1961 B-A Catalog No. 611

Name _____

Address _____

City _____ State _____

CIRCLE 35 ON READER-SERVICE CARD

well without platforms that can be raised and lowered and parts of the stage that can be rolled back and folded. Such gadgets shorten intermissions, but Italians who know singing best feel that most singers need twenty minutes of intermission. "We are more concerned about the voices of our singers than about the patience of our audiences," says Ghiringhelli.

There are comfortable dressing rooms, and well-appointed offices. The backstage atmosphere during a performance is electrifying. Whereas bored stagehands often read papers or play cards, La Scala's stagehands and technicians are fervid *aficionados* who hold their breath when a diva sings a difficult aria and cross their fingers before the tenor embarks upon the critical high C that will make or break him. So do ushers, wardrobe mistresses, and other employees. You can see them stand in the rear and listen with critical appreciation. They enjoy the opera as much as the \$16 patrons in the stalls. Every one of them is proud of his house.

Everybody drops in at the Museum from time to time. The Museo della Scala was founded in 1910, and installed in several small marbled rooms just off the second-floor foyer. It was a brilliant idea. During intermission people walk through and refresh their sense of the past. Fortunately the relics were not hit by the bombs. There are scores by Donizetti, Bellini, Verdi, Puccini; letters and sketchbooks; the testament of Paganini; collections of costumes; miniature sets; the furniture of the room at the nearby Grand Hotel where Verdi died, and many other memorabilia dear to the hearts of opera lovers. And there is a reference library of fifty thousand volumes where musicologists come for research.

La Scala's organization is not top-heavy with bureaucrats. The autonomy of La



Scala is guarded by a Council of Administration. The Mayor of Milan is its president, and among its eleven members are Ghiringhelli, delegates of the municipality, the province, the musicians' union, composers. Ghiringhelli's deputy is Dr. Luigi Oldani, the secretary-general. There are seven artistic directors (for the orchestra, the chorus, the ballet, the production department, the *maestri sostituti*, the backstage music, and an artistic secretary). Nicolas Benoit, one of La Scala's stage designers, also is *direttore de l'estimato scenico*, a sort of production coordinator. The press department and a few members of the administrative staff complete the organization.

Though a great deal has been achieved in the recent past, Ghiringhelli is not satisfied. He hopes to improve the pension system, to

Continued on next page

NOW KARG QUALITY IN EVERY PRICE RANGE

From the KARG PRIMATA at \$99.50—
to the FUTURA at \$139.50—
to the exclusive TUNEMATIC XT-1A at \$199.50

... every KARG Tuner is built to just one standard — excellence. The only difference between these models is the number of special features they offer. Ask your dealer, or write for full specifications that explain KARG's superlative performance.

You know the quality of any FM Tuner you buy when it bears the name of
Karg LABORATORIES
South Norwalk, Connecticut
dedicated to the finest FM Tuners at any price



CIRCLE 82 ON READER-SERVICE CARD



Charles Munch

PORTRAIT of a SYMPHONY

By Constantine Manos

Foreword by Aaron Copland

The unique magic of a symphony orchestra is captured for the first time in the pages of this spectacular volume.

Presenting 131 photographs, many of them occupying the full double-page spread of seventeen by eleven inches, **PORTRAIT OF A SYMPHONY** depicts the musicians, conductors, guest soloists, audiences and backstage life of one of the world's leading orchestras, the Boston Symphony.

Here, with evocative text by photographer-author Manos, formerly official photographer of the Boston Symphony, is the subtle interplay of feeling and response among conductor, performers and listeners; the intense dedication of famed solo virtuosi Casals, Heifetz and Serkin, among others; the enormous range of expression of which a well-disciplined orchestra is capable.

Printed by sheet-fed gravure in Europe, **PORTRAIT OF A SYMPHONY** makes it possible at last for the music lover to experience, as Aaron Copland puts it in his Foreword, "the vicarious pleasure of finding oneself... alone in the presence of a great orchestra."

At bookstores, \$10.00

BASIC BOOKS, PUBLISHERS, 59 Fourth Avenue, New York 3, N.Y.,

CIRCLE 27 ON READER-SERVICE CARD

PURCHASING A HI-FI SYSTEM?

Send Us
Your
List Of
Components
For A
Package
Quotation

WE WON'T BE
UNDERSOLD!

All merchandise
is brand new, factory
fresh & guaranteed.

FREE Hi Fi Catalog
Available on Request

AIREX RADIO

CORPORATION

64-HF Cortlandt St., N. Y. 7, CO 7-2137

PARTIAL LIST
OF BRANDS
IN STOCK

Jim Lansing*
Altec Lansing
Electrovoice
Jensen • Hallicrafter
Harley • Gonset
USL Citizen Band
Texas Crystals
University
Acoustic Research
Janszen • Viking
Wharfedale
Concertone
Bell • G. E.
Weathers
Harman-Kardon
Eico • Pilot
Sherwood*
Tandberg*
Acrosound
Quad Amplifiers
& Speakers*
Dual Changer*
Bogen • Leak
Dynakit • Fisher
H. H. Scott
Thorens*
Pentron • Roberts
Amplex • De Wald
Sony • Challenger
Wollensak
Garrard • Miracord
Glaser-Steers
Rek-O-Kut
Components
Norelco • Fairchild
Pickering • Gray
Audio Tape
Magnecord*
Arizon Cabinets
Rockford Cabinets
* Fair Traded

CIRCLE 5 ON READER-SERVICE CARD

save on
stereo
hi-fi



send for the 1961

ALLIED
CATALOG

free

SAVE MOST! Here's your complete money-saving guide to Hi-Fi, including products available only from ALLIED. See how you save on our recommended complete Stereo systems. Choose from the world's largest stocks of famous-name amplifiers, tuners, changers, speakers, enclosures, period-style equipment cabinets, tape recorders, accessories; save most with KNIGHT® deluxe components. Build your own—save even more with our exclusive Hi-Fi KNIGHT-KITS®. For everything in Hi-Fi and Electronics, get the FREE 444-page 1961 ALLIED Catalog!

only \$5 down
on orders
up to \$200

ALLIED RADIO

free

ALLIED RADIO Dept. 144-L
100 N. Western Ave., Chicago 80, Ill.

Send FREE 1961 ALLIED Catalog.

Name _____

Address _____

City _____ Zone _____ State _____

CIRCLE 8 ON READER-SERVICE CARD

voices
from
outer space!

SPECIAL
OFFER,
25¢

**Dramatic Events Recorded First
Time From Short Wave Radio!**

President's voice from outer space ... police capture of a gunman ... radio contact with record altitude flight! Many other fascinating, historic events—ships, planes, foreign stations—all transcribed on a limited-edition recording, "The Amazing World of Short Wave Listening," narrated by world-famous newscaster Alex Dreier. If you're alert, adventuresome, send for this remarkable recording today!

As heard on Hallicrafters precision receivers, \$59.95 to \$395.00.



hallicrafters Department 15,
Chicago 11, Ill.
Enclosed is 25¢. Please rush "The Amazing World of Short Wave Listening."

NAME _____

ADDRESS _____

CITY _____ STATE _____

CIRCLE 72 ON READER-SERVICE CARD

NEW!
Garrard
DUST
COVER

Hard-molded from clear vinyl
...to protect your Garrard
from dust and accidents



\$495



Model #	Fits Garrard Models
DC 1 (illus.)	Model 210
DC 2	RC88 and Model 88 mk II
DC 3	Type A

NOW AT YOUR DEALER

Garrard Div., British Industries Corp., Port Washington, N.Y.
CIRCLE 33 ON READER-SERVICE CARD

HI-FI COMPONENTS

40% OFF
IN THIS SPECIAL PACKAGE

Bell #2221 20 Watt Stereo Amp.	\$ 99.95
Bell #2222 FM/AM Stereo Tuner	109.95
Garrard RC-210 4/Sp. Stereo Changer & Base	54.45
Shure M7D Diam. Stereo Cartridge	24.00
2-University S-80 Spkr. Systems	119.90
Regular Catalog Price	\$408.30
YOUR COST	244.98
Your Save 40%	\$163.32

IF YOU DESIRE A DIFFERENT PACKAGE—Let us quote on your single component, Tape Recorder, or Complete Hi-Fi Package, by return Air Mail, at Guaranteed "We Will Not Be Undersold", prices. WHOLESAL CATALOG FREE.

HI-FI RECORDING TAPE

7" Spools - Splice Free - Freq. Resp. 30-15KC

12A 1200' Acetate	3-11	12-23	24
18A 1800' Acetate	\$1.29	\$1.17	\$.99
18M 1800' Mylar	1.79	1.59	1.45
24M 2400' Mylar	2.09	1.99	1.85
	3.29	2.99	2.75

Any assortment permitted for quantity discount. Add 15¢ per spool postage. 10¢ 24 or more.

PRE-RECORDED TAPES — RCA-VICTOR, BELCANTO 2 & 4 Track. Write for Complete Catalog FREE, & Wholesale Discounts.

Jr. Tape Splicer	Regular....\$ 6.50	Special....\$ 2.95
Deluxe Tape Splicer	Regular....\$ 8.50	Special....\$ 3.95

WE WILL NOT BE UNDERSOLD
IN HIGH FIDELITY COMPONENTS

15 DAY MONEY BACK GUARANTEE

Hi Fidelity
CENTER

1799-A First Ave., New York 28, N. Y.

CIRCLE 79 ON READER-SERVICE CARD

INSIDE LA SCALA

Continued from preceding page

make the ballet more prominent, to be able to give more symphony concerts, and, generally, "to bring La Scala closer to the heart of our people." He is constantly worried about the problem of staging seventeenth-century opera in such a way that our modern audiences will understand it. He has to cope with the problems that bother all opera managers—a critical shortage of new operas, and of tenors and dramatic sopranos.

But Ghiringhelli's and La Scala's most serious problem is the growing influence of the state. The Ministry of Tourism and Spectacles, created two years ago in Rome, is apparently making efforts to reach its tentacles around La Scala. The danger of "reorganization" hangs over the glorious house. Disturbing threats are voiced in faraway Rome (where, the Milanese say, they know nothing about opera) to lump together all Italian opera houses, and to appropriate state subsidies on a percentage basis. But La Scala refuses to be lumped.

"Any interference by the government would mean the end of a noble, independent house with a great past and perhaps an even greater future," says Ghiringhelli. This is exactly what Toscanini fought against. His heirs at La Scala are sworn to continue the fight to the very last high C.

PALERMO

Continued from page 14

ized at the Met," Herbert Graf said, as he was preparing the Rimsky Ivan, "but this theatre has so much *esprit* . . ."

You feel the *esprit* the minute you walk backstage during a rehearsal. The staff—most of them young—are constantly alert. This is a far cry from the somnolent, sun-baked Sicily tourists imagine; here everybody is on the run. And when rehearsals end, late at night, more often than not the cast all troops over to the "Extra-bar." There sleepy waiters snap into action, producing carafes of strong Sicilian red wine as conversation flows rapidly. Singers discuss phrasing, conductor and director come to agreements about this or that fine point, and perhaps Maestro Tramonti and Baron De Simone drop in to say hello.

Sometimes they stay on, and the talk turns to plans for the future. The Massimo has a project afoot to organize, under the theatre's auspices, a National Ballet Academy—something that Italy sorely needs. Or, inevitably, everybody starts suggesting new operas that the Massimo should do; a wild assortment of names flies around the table; Busoni's *Doktor Faust*, Bellini's *La Straniera*, Hans Werner Henze's *König Ilirsch*, Stravinsky, Berg, Poulenc, Britten. . . . Given time, the Massimo may very well do them all.

CALIFORNIA



QUICK-SEE ALBUM FILE

Eliminates bottom jacket wear. Rolls forward for front-view, flip-through selection. 9 models fit any cabinet, closet or shelf. \$7.95 up. Also available with cabinet shown. Dealers inquire.

KERSTING MANUFACTURING COMPANY
504 S. Date Street, Alhambra, California

CIRCLE 83 ON READER-SERVICE CARD



ELECTROSTATIC TWEETER

THRILLING HI FREQUENCY AUDIO RESPONSE ONLY \$19.95



ORDER BY MAIL
1015 South Figueroa
Los Angeles, Calif.

CIRCLE 85 ON READER-SERVICE CARD

DISTRICT OF COLUMBIA

NORELCO SPEAKERS

Famous 9710M, twin-cone 8" speaker, original list \$39.95, usual NET \$23.97, NOW, while they last 1/2 off net \$11.98 plus postage. (discontinued model). Frequency 40-20,000 cy.



Other SENSATIONAL Speaker reductions on a first come, first served bases. SEND FOR SPEAKER SPECIFICATION SHEET.

COMMISSIONED ELECTRONICS CO.
1776 Columbia Road Washington, D. C.

CIRCLE 45 ON READER-SERVICE CARD

IN WASHINGTON, D. C.
Nearly Everyone Buys At...
Myer's EMCO
MAIN STORE:
509 11TH ST., N.W., WASH., D.C.

CIRCLE 103 ON READER-SERVICE CARD

MARYLAND

DIXIE

HIGH FIDELITY WHOLESALERS

Largest discount High Fidelity component distributors in the South. Wholesale prices on package or individual components. All latest models in factory sealed cartons.

Are prices too high?— Write:

DIXIE HI-FI

12402 Connecticut Ave., Silver Spring, Md.

CIRCLE 50 ON READER-SERVICE CARD

NEW JERSEY

WRITE FOR QUOTATION
ON ANY HI-FI COMPONENTS

SOUND REPRODUCTION, INC.

34 New Street, Newark 2, N. J.

Mitchell 2-6816

CIRCLE 121 ON READER-SERVICE CARD

NEW YORK

FOR THE TOPS IN VALUE
AND THE BEST TRADE-IN ON
HIGH FIDELITY EQUIPMENT
Check with Arrow!

ARROW ELECTRONICS, INC.

65 Cortland St., New York 7, N. Y.
Digby 9-4730
525 Jericho Turnpike, Mineola, N. Y.
Planner 6-8686

CIRCLE 14 ON READER-SERVICE CARD



JAMAICA—JA 3-8850
MANHASSET—MA 7-5737
BROOKLYN—BU 2-5300
WHITE PLAINS—WH 8-3380

The Original Hi-Fi Trading Organization

audio exchange
JAMAICA 153-21 Hillside Ave.

CIRCLE 21 ON READER-SERVICE CARD

a Note to the Hi-fi buyer

AIR MAIL us your requirements for an IMMEDIATE WHOLESALE QUOTATION Components, Tapes and Recorders SHIPPED PROMPTLY AT LOWEST PRICES

AUDIO unlimited FREE CATALOG
714-F Lex. Ave., N.Y. 22, N.Y.

CIRCLE 24 ON READER-SERVICE CARD

SOUNDTASTIC!

That's what our customers are saying upon receiving our prices! Write for special low prices on all hi-fi components, tape recorders, etc. INDIVIDUAL QUOTATIONS ONLY!

AUDIO WORLD No catalogs.
2057 Coney Island Ave., Brooklyn 23, N. Y.

CIRCLE 25 ON READER-SERVICE CARD

OUT OF SPACE?

You bet we'd be
If we were to tell you
All about AUDION's
"Out of this World"
Hi Fi Values.
Write for free catalog.
audion
25-HF Oxford Road
Massapequa, New York

CIRCLE 26 ON READER-SERVICE CARD

HI-FI RECORDING TAPE

*made by world famous manufacturer
Sold with 10-day money-back guarantee.

	3+	12+	24+
*1200' 7" acetate.....	\$1.25	\$1.16	\$1.10
*1800' 7" mylar.....	2.82	1.88	1.78
*1800' 7" acetate.....	1.79	1.59	1.49
2400' 7" mylar.....	3.29	2.95	2.75
2400' 7" Tensitized mylar.....	4.25	3.95	3.75

Can be assorted. Add 15¢ postage per reel
10¢ for 24+ orders.

MAIL ORDER HI-FI. You can now purchase all your HI-FI from one reliable source and be assured of perfect delivery. We deliver from NY stock most components, recorders & tape within 24 hours. SEND US A LIST OF YOUR HI-FI REQUIREMENTS FOR OUR WHOLESALE QUOTATIONS and our FREE wholesale catalog.
CARSTON 125-D E. 88 Street
New York 28, N. Y.

CIRCLE 38 ON READER-SERVICE CARD

NEW YORK

TAPE RECORDERS



HI-FI Components
SLEEP LEARN KITS
Unusual Values
FREE 1960 Catalog

MERITAPE
Low cost, high quality recording tape, in boxes or cans

DRESSNER 69-02 FA, 174 Street
Flushing 63, New York

CIRCLE 51 ON READER-SERVICE CARD

F & B RECORDING TAPE

Unconditional 25 Year Money-back Guar.!
Top-Quality Freq. Resp. 30-15,000 cycles. **GUARANTEED FOR 25 YEARS**

1200 ft., 7" reel.....3 for \$3.89
1800 ft., 7" reel.....3 for \$5.22
1800 ft. MYLAR, 7" reel..3 for \$6.59
2400 ft. MYLAR, 7" reel..3 for \$9.93
add 15c per reel for postage & handling
FLORMAN & BABB, Inc.
68 West 45th St. New York 36, N.Y.

CIRCLE 66 ON READER-SERVICE CARD

DRAW...
your own conclusions partner, when you receive our special quotations on your Hi-Fi needs. Write for audio catalog A-10, loaded with double-barreled values.
Key Electronics Co.
120 Liberty St., N. Y. 6, N. Y.
CLoverdale 8-4288

CIRCLE 84 ON READER-SERVICE CARD

OKLAHOMA

GENUINE DIAMOND NEEDLE \$2.95

If your needle is replaceable chances are 10 to 1 that we can replace it for only \$2.95. Simply remove your old needle from the cartridge, tape it to a piece of paper with your name and address, enclose \$2.95 check or money order and mail to us. By return Air Mail postpaid we will send you a brand new genuine diamond needle for exact replacement. Your old needle will also be returned. Complete satisfaction or money back. In rare cases where we cannot furnish replacement your money and needle will be returned by Air Mail. No COD's.

SOUND ACCESSORIES
P.O. Box 3402 Oklahoma City, Okla.

CIRCLE 120 ON READER-SERVICE CARD

PENNSYLVANIA

LOOKING for **LOW LOW QUOTES**
STEREO TAPE and RECORDERS
ORGANS
HiFi COMP.
BUILT 1950 ESTB. 1932
Send us YOUR list. Free bargain sheet & tape Cat. Brochure best & newest ORGANS.
HiFi 1373 EASTON ROAD, ROSLYN, PENNA.
The brand name stereo specialist.

CIRCLE 78 ON READER-SERVICE CARD

SORTS 200 RECORDS

Black wrought-iron cabinet is just waiting for your collection to grow into! "Shows-off" 200 LP albums. Ten compartments to file records by symphonies, operas, ballets, jazz, folk, chamber and show music! Sturdy: 25"x22"x12". Fully assembled! Remit \$9.95, or chg. Diners Acct. Exp. chg. collected on \$9.95 delivery. AIR-MAIL MONEY-BACK GUARANTEE!
©Leslie Creations • Dept. 209 • Lafayette Hill, Pa.

CIRCLE 92 ON READER-SERVICE CARD

ADVERTISING INDEX

Design for
STEREO
the NEW LAFAYETTE
"TRIHELIX"®

3250
 only
 2.00 Down



3-COMpletely INDEPENDENT SPEAKERS WITH 3-SEPARATE VOICE COILS & MAGNETIC STRUCTURES WITHIN A SINGLE COMPACT 10" UNIT

A major breakthrough in three way speaker design... delivers a quality of performance from a bookshelf size enclosure that equals the unmistakable feel, presence and clarity of a 3-way speaker system. Woofer section utilizes a revolutionary "Conical Stiffener" achieving a true piston action with a phenomenally solid, well defined bass response. Eccentric mounting and baffling of the midrange and tweeter completely eliminate interaction between speaker cones. For stereo or monaural the SK-180 "Trihelix" will provide unexcelled smooth distortionless performance. Response 30-18,000 cps ± 3db. Impedance 8-ohms. Power rating 20-watts. Built in crossover network and brilliance control.

6650



ELIPTOFLEX BOOKSHELF ENCLOSURE WITH SK-180 "TRIHELIX" SPEAKER

An ideal combination of speaker and enclosure for optimum 3-way speaker performance. Finished on 4-sides for vertical or horizontal placement. Choice of Mahogany, Blonde, Walnut or Oiled Walnut.

LAFAYETTE RADIO ELECTRONICS

Dept. WK6-2 P.O. Box 190
 Jamaica 31, N. Y.

Please Send.....

FREE 324-page 1961 Catalog 6TD

SK-180 "Trihelix" Speaker

SK-180 with Eliptoflex Enclosure — Specify Finish

\$ _____ *Enclosed*

Name _____

Address _____

City _____ Zone _____ State _____

CIRCLE 88 ON READER-SERVICE CARD

Key No.	Page
1.... Acoustic Research, Inc.....	43
2.... Acro Products.....	104
3.... Advanced Acoustics Corp.....	121
4.... A.E.S., Inc.....	111
5.... Airex Radio Corp.....	151
6.... Allied Radio.....	26
7.... Allied Radio.....	30
8.... Allied Radio.....	152
9.... Altec Lansing Corp.....	116
10.... Altec Lansing Corp.....	117
11.... Ampex Corp.....	137
12.... Angel Records.....	100
13.... Argos Products.....	149
14.... Arrow Electronics.....	153
15.... Artia Records.....	89
16.... Atlantic Records.....	123
17.... Audax Division.....	10
18.... Audio Devices, Inc.	
Inside Front Cover	
19.... Audio Empire.....	44
20.... Audio Exchange.....	128
21.... Audio Exchange.....	153
22.... Audio Fidelity.....	72
23.... Audio Fidelity.....	85
24.... Audio Unlimited.....	153
25.... Audio World.....	153
26.... Audion.....	153
27.... Basic Books.....	151
28.... Bel Canto.....	132
29.... Bogen-Presto.....	29
30.... Book-of-The-Month Club.....	31
31.... Bozak, R. T., Co.....	32
32.... Bozak, R. T., Co.....	105
33.... British Industries Corp.....	152
34.... Burgess Battery Co.....	149
35.... Burstein-Applebee Co.....	150
36.... Capitol Records.....	99
37.... Capitol Records.....	139
38.... Carston Studios, Inc.....	153
39.... Clevite-Walco.....	114
40.... Columbia Records.....	94
41.... Columbia Records	
Inside Back Cover	
42.... Columbia Record Club.....	16
Columbia Record Club 17, 18	
43.... Columbia Record Club.....	19
44.... Command Records.....	103
45.... Commissioned Electronics.....	153
46.... Crosby Electronics.....	144
71.... Decca Records.....	82
47.... Decca Records.....	93
48.... Design Records.....	118
49.... Distinguished Recordings.....	120
50.... Dixie Hi-Fi.....	153
51.... Dressner.....	153
52.... Dual.....	86
53.... Dual.....	121
54.... Dupont "Mylar".....	135
55.... Dyer-Bennett Records.....	90
56.... Dynaco, Inc.....	126
57.... Dynaco, Inc.....	127
58.... EICO.....	140
59.... Electro-Sonic Labs.....	129
60.... Electro-Voice.....	87
61.... Epic Records.....	97
62.... Fidelitone.....	24
63.... Fisher Radio Corp.....	11
64.... Fisher Radio Corp.....	13
65.... Fisher Radio Corp.....	15
66.... Florman & Babb.....	153
33.... Garrard Sales.....	152
67.... General Electric Co.....	112
68.... General Electric Co.....	150
69.... Glaser-Steers Corp.....	8
70.... Grado Laboratories, Inc.....	88
72.... Hallicrafters.....	152
73.... Harman-Kardon, Inc.....	6
74.... Harman-Kardon, Inc.....	7

Key No.	Page
75.... Harper's Magazine.....	146
76.... Heath Co.....	142
77.... Heath Co.....	143
78.... Hi Fi.....	153
79.... High Fidelity Center.....	152
80.... International Radio.....	139
81.... Jensen Mfg. Co.....	1
82.... Karg Laboratories.....	151
83.... Kersting Mfg. Co.....	153
84.... Key Electronics.....	153
85.... Kierulff Sound Corp.....	153
86.... Koss, Inc.....	14
87.... Lafayette Radio.....	4
88.... Lafayette Radio.....	154
90.... Lectronics, Inc.....	114
91.... Leonhardt Engineering Co.....	131
92.... Leslie Creations.....	153
93.... London Records.....	110
94.... London Records.....	115
95.... London Records.....	122
96.... Marantz Co.....	130
97.... McIntosh Laboratory, Inc.....	83
98.... Medallion Records.....	106
99.... Mercury Records.....	92
100.... Minnesota Mining & Manufacturing Co.....	28
101.... Monitor Records.....	120
102.... Music Box.....	115
103.... Myer's Emco.....	153
104.... Nuclear Products.....	122
105.... Pickering & Co.....	2
106.... Pilot Radio.....	138
Professional Directory..... 153	
RCA Tape..... 136	
107.... RCA Victor Division.....	79
108.... RCA Victor Division.....	124
109.... Radio Frequency Labs.....	102
110.... Radio Shack.....	131
111.... Reeves Soundcraft.....	5
112.... Rek-O-Kut.....	23
113.... Revere Camera Co.....	25
114.... Sargent-Rayment Co.....	113
115.... Scott, Herman Hosmer, Inc.....	35-42
116.... Seeco Records.....	122
117.... Sherwood Electronic Labs.....	33
118.... Shure Bros.....	91
119.... Sony Corp.....	12
120.... Sound Accessories.....	153
121.... Sound Reproduction.....	153
122.... Stromberg-Carlson.....	20
123.... Stromberg-Carlson.....	21
124.... Superscope, Inc.....	34
125.... Tandberg.....	96
126.... Telex, Inc.....	130
127.... Time Records.....	101
Trader's Marketplace..... 148	
128.... Transis-Tronics.....	9
129.... Uher Tape Recorders.....	129
130.... UltrAudio Products.....	27
52.... United Audio Products.....	86
53.... United Audio Products.....	121
131.... United Audio Products.....	150
132.... United Stereo Tapes.....	134
133.... United Stereo Tapes	
Back Cover	
134.... Utah Radio.....	22
135.... Vanguard Recording Society, Inc.....	84
136.... Weathers Industries.....	98
129.... Weiss, Warren, Inc.....	129
137.... Westminster Records.....	81
131.... Wigo.....	150

the newest SOUNDS



STRAVINSKY—A SELF- PORTRAIT

IGOR STRAVINSKY—a self-portrait in 3 "Lp's" and a fourteen-page portfolio. Stravinsky conducts x-ray sharp newly-recorded performances of his masterpieces, "LE SACRE DU PRINTEMPS" and "PETROUSHKA." Stravinsky writes, in his own Byzantine prose, about the creation of these epochal works. He tells poignantly about places seen and cherished in a much-traveled life. As personal as his guiding hand on an orchestra is the sound of Stravinsky's voice as he speaks about "Le Sacre." Illustrations include snapshots taken by Stravinsky and his own hand-drawn map of old St. Petersburg.

Stravinsky: Le Sacre du Printemps Petroushka / Igor Stravinsky conducting Columbia Symphony Orchestra / D3L 300 / D3S 614



THE COWBOY AND THE HURRICANE

Brisk as a prairie breeze is AARON COPLAND's brace of ballets—"RODEO" and "BILLY THE KID," newly coupled in high-stepping performances by Leonard Bernstein and the New York Philharmonic. By way of further 60th birthday salute to this celebrated American composer, Bernstein, the Philharmonic and some youthful cohorts present a first recording of Copland's school opera for school children, "THE SECOND HURRICANE."

Copland: Four Dance Episodes From "Rodeo" / Billy the Kid / Leonard Bernstein conducting New York Philharmonic / ML 5575 MS 6175



FROM BACH TO BOLERO

EUGENE ORMANDY and THE PHILADELPHIA ORCHESTRA move with wonderful agility from Bach's majestic Toccatas on one new record to Ravel's turbulent "BOLERO" on another.

J. S. Bach: Toccata and Fugue in D Minor, etc. / Eugene Ormandy conducting The Philadelphia Orchestra / ML 5580 / MS 6180

Ravel: Bolero; Le Tombeau de Couperin; Alborado del Gracioso MS 6169* ML 5569

THE DUKE MEETS TCHAIKOVSKY

Blithe-spirited DUKE ELLINGTON and his aide-de-camp Billy Strayhorn meet a surprising new colleague—Peter Illitch Tchaikovsky. The result is a suave and witty commentary on that hardiest of classics, "THE NUTCRACKER SUITE." In the Ellington book, "Waltz of the Flowers" becomes "Danse of the Floreadores"!

The Nutcracker Suite/Duke Ellington and his Orchestra / CL 1541 CS 8341



WALTER AND MAHLER'S LIED

BRUNO WALTER, Mahler's great friend and most ardent advocate, penetrates to the poetic heart of his "LIED VON DER ERDE." The album cover photograph is a collage of Mahleriana in Dr. Walter's possession—including, appropriately, Mahler's spectacles. Mahler's vision is indeed Walter's. Another noble Walter mission is the furtherance of Anton Bruckner's music, through recordings such as this latest, of the 9th Symphony.

Mahler: Das Lied von der Erde (The Song of the Earth) / Bruno Walter conducting New York Philharmonic / M2L 255 / M2S 617

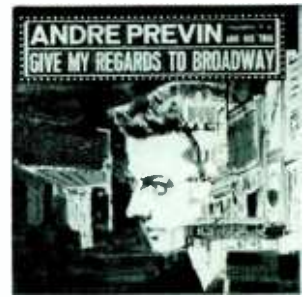

PREVIN'S BROADWAY

ANDRE PREVIN is the guide to a bright new world—the Broadway jazz scene. Pianist-arranger Previn and a limber jazz trio swing subtly but powerfully in ten Broadway hit tunes.

Give My Regards to Broadway / Andre Previn and his Trio / CL 1530 / CS 8330

33 singles: A happy new note. Many of your favorite singers and their songs are now available too on neat 7-inch single records at your favorite speed — 33.

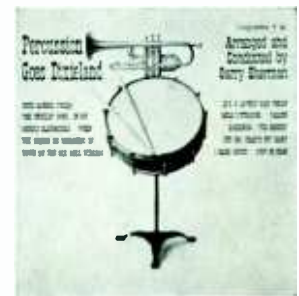

PERCUSSION IN STEREO

"PERCUSSION GOES DIXIELAND" and a number of other riotous directions in a brash new album by arranger-bandleader GARRY SHERMAN. Equally combustible is "Stereo Dialog for Brass" a free-wheeling exchange between trumpets and trombones.

Percussion Goes Dixieland / Garry Sherman / CL 1537 / CS 8337

...always yours on **COLUMBIA** **RECORDS**



**START HERE
TO ENJOY
1½ HOURS
OF BEETHOVEN**

... or Schubert or Brahms or Debussy. With the almost infinite variety of music now available on 4-track stereo tape, you can enjoy music to suit your tastes or moods with a minimum of interruptions. For example, with a 4-track Twin Pak you can enjoy the complete Swan Lake or Nutcracker Suite—all on one reel of 4-track stereo tape equivalent to the playing time of 2 stereo discs. Or with a two-reel set, you can enjoy complete operas like Aida or Madame Butterfly. All this because twice as much music is recorded on the same amount of tape. Thus economy, as well as quality, is another sound reason for switching to 4-track. Select from the wide variety of classical and popular music now at leading hi fi salons, music stores and tape machine dealers. For catalog, write: 1024 Kifer Road, Sunnyvale, California, UNITED STEREO TAPES 

MUSIC SOUNDS BEST ON TAPE / *and you can prove it to yourself... hear it*