

TAPE: THE MAGIC MEDIUM A Special Bonus Section*

high fidelity

THE MAGAZINE FOR MUSIC LISTENERS

The Phantom Philharmonic

a report on
free-lance recording
orchestras

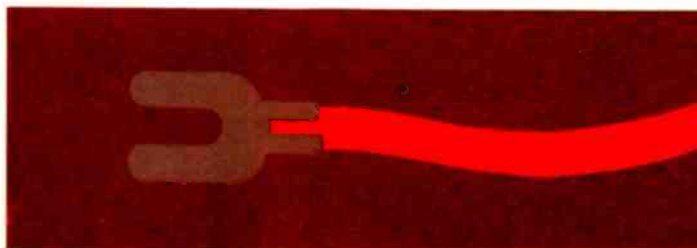

September • 60 cents
1964

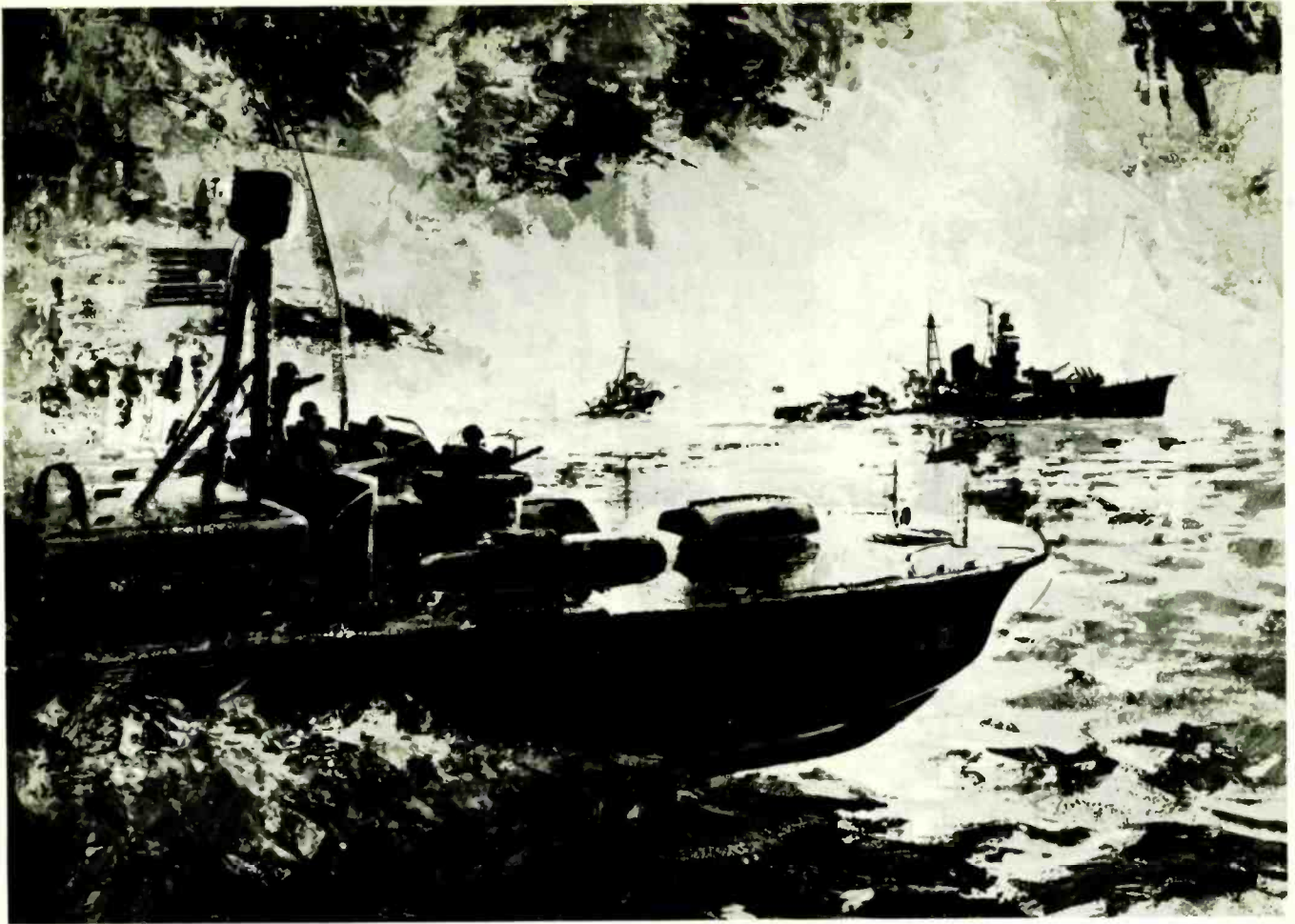

Produced in cooperation with the United States Navy

The Most Spectacular Sound Album of All Time!

VOLUME III OF VICTORY AT SEA

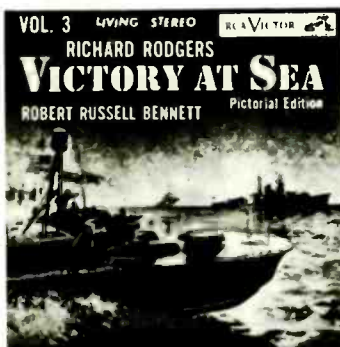

Hear the roaring 16- and 8-inch guns from U. S. battleships and heavy cruisers, AA batteries, screaming kamikazes, submarine crash dives, torpedo attacks, all the blistering cacophony of battle. These tumultuous **authentic** sounds of sea warfare add dramatic impact to Richard Rodgers' award-winning TV score. It's an ear-filling display of recording techniques that will put your rig to the test. Now, for the first time on records, are 6 of the most memorable musical episodes from the great TV series plus a "Symphonic Scenario" based on the fundamental themes.

Included in the de luxe package, at no extra cost, is a 16-page book of dramatic naval-action photos of World War II plus notes on all musical sequences. A great recorded memento of historic, courage filled days.

OTHER NEW RCA VICTOR RELEASES YOU'LL WANT TO OWN:

Ravel: Daphnis and Chloe — Munch, Boston Symph. Orch. ● Schubert: "Unfinished" Symphony and Symphony No. 5 — Reiner/Chicago Symph. Orch. ● Hearts in Three-Quarter Time — Fiedler/Boston Pops ● Beethoven: "Emperor" Concerto — Van Cliburn; Reiner/Chicago Symph. Orch. ● The Immortal Victor Herbert — Robert Shaw Chorale and Orch. ● The Sound of Stokowski and Wagner — Stokowski/Symphony of the Air and Chorus ● Puccini: Highlights from "Turandot" — Nilsson, Tebaldi, Bjoerling, Tozzi; Leinsdorf, Cond. ● Wagner: The Flying Dutchman — London, Rysanek, Tozzi, Liebl, Lewis, Elias; Dorati, Cond. ● The Vagabond King — Mario Lanza ● Verdi: Highlights from "La Traviata" — Moffo, Tucker, Merrill

ALL IN LIVING STEREO OR MONAURAL HI-FI.

THE WORLD'S GREATEST ARTISTS ARE ON



this is the empire^M troubador

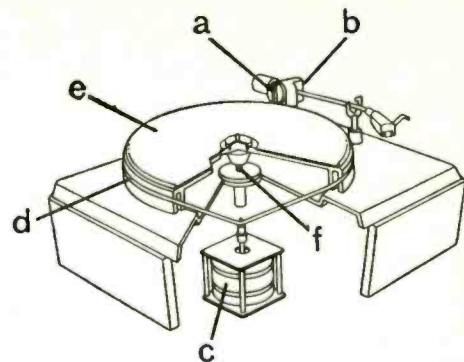

the playback unit that enables you to enjoy all the quality of today's records

With the tremendous advances achieved in record quality, and in amplifier and speaker components, the playback unit assumes a role of unprecedented importance. It is the vital link between the record's promise of performance and its ultimate realization. For, if all the quality in the modern record were extracted from its grooves, and delivered—unaltered—to the amplifier, the result would be almost indistinguishable from the original live performance.

No one playback component can fulfill this requirement. It takes all three. And that is why you can depend upon the Troubador—combining the finest cartridge, arm and turntable—to deliver all the quality in your records to the rest of your music system.

empire 108 mono-stereo cartridge

Low mass and high compliance. Stylus tracks with force as low as 1 gram. Flat from 10 to 20,000 cycles on both channels, balance to $\pm 1/4$ db. Full channel separation over entire spectrum. \$35.00

empire 98 playback arm

Dynamic balance, low inertia and high compliance make the 98 the most stable yet freely responsive arm available. Tracks 108 cartridge at 1 gram. \$37.50

ARM NOTES: (a) Calibrated knob—accurate to ± 0.1 gram—adjusts torque of clock spring for desired stylus force without disturbing arm balance—does not shift center-of-mass. (b) Vertical and lateral pivot bearings suspended in ball races.

empire 208 3-speed turntable

Only two moving parts—motor and turntable—coupled by seamless belt for lowest rumble content. Vertical and horizontal rumble amplitude, less than 1 millionth of an inch. No wow or flutter. \$100.

TURNTABLE NOTES: (c) Hysteresis motor has dynamically balanced rotor and stepped, 3-speed pulley. (d) Neoprene-impregnated seamless belt is ground to uniform thickness $\pm .0005$ ". (e) Turntable platter individually adjusted to dynamic balance. Weighs 6 lbs., and has dual rim for optimum flywheel effectiveness. (f) Lapped mainshaft rotates in micro-honed bearing-well. Tolerance is less than .0001".

See and hear the Troubador at your high fidelity dealer today and discover the wonderful difference it will make in the performance of your music system. Price is \$190, including cartridge, arm, turntable and walnut base. Price, less cartridge, is \$155.00 For descriptive literature, write to:

empire
DYNAPLUS INC. 1075 STEWART AVE.
GARDEN CITY, N.Y.

CIRCLE 45 ON READER-SERVICE CARD

IMPATIENT...



to return to his

STANTON

stereo fluxvalve pickup

PICKERING & COMPANY INC. offers the stereo fluxvalve pickup in the following models: the Calibration Standard 381, the Collector's Series 380, the Pro-Standard Mark II and the Stereo 90. Priced from \$16.50 to \$60.00, available at audio specialists everywhere.

" FOR THOSE WHO CAN HEAR THE DIFFERENCE "

Pickering and Company—Plainview, Long Island, New York

CIRCLE 80 ON READER-SERVICE CARD

high fidelity

SEPTEMBER 1961
volume 11 number 9

Roland Gelatt
Editor

Joan Griffiths
Executive Editor

Norman Eisenberg
Audio Editor

Conrad L. Osborne
Managing Editor

Shirley Fleming
Assistant Editor

Roy Lindstrom
Art Director

H. C. Robbins Landon
European Editor

Ralph Freas
Audio Coordinator

Editorial Board

John M. Conly
Chairman

E. Power Biggs

Nathan Broder

R. D. Darrell

Alfred Frankenstein

Howard Hanson

Robert C. Marsh

Francis Robinson

Joseph Szigeti

Warren B. Syer
General Manager

Claire N. Eddings
Advertising Sales Manager

Walter F. Grueninger
Circulation Director

Publication Policy

Charles Fowler

Lawrence Gatto

W. D. Littleford

Warren B. Syer

ADVERTISING

Main Office
Claire N. Eddings, The Publishing House
Great Barrington, Mass. Telephone 1300

New York
1564 Broadway, New York 36
Telephone: Plaza 7-2800
Seymour Resnick, Andrew Spanberger

Chicago
10 East Huron St., Chicago 11
Telephone: Michigan 2-4245
Peter Dempers, Thomas Berry,
Allen Campbell

Los Angeles
1520 North Cower, Hollywood 28
Telephone: Hollywood 9-6239
George Kelley

MUSIC

- The Phantom Philharmonic** 44 Robert Silverberg
Free-lance recording orchestras have become respected features of the musical scene.
- Maestro Serafin** 51 William Weaver
Portrait of a world-renowned operatic maestro.
- The Murderous Prince of Madrigalists** 54 Robert Craft
The strange tale of Carlo Gesualdo di Venosa.
- A Splash That's Almost Wet** 43 John M. Conly
An editorial.

EQUIPMENT

- Stereo for the Man Who Hates Stereo** 48 Edward Tatnall Canby
A musician explains how stereo serves all kinds of music.
- Equipment Reports** 72
- Acrosound S-1001 Stereo Preamplifier**
- Fairchild 440-2K Turntable Kit**
- Bell T-338 Tape Recorder**
- High Fidelity Newsfronts** 129

REVIEWS

- Feature Record Reviews** 79
- "The American Harmony"*
- Rimsky-Korsakov: Scheherazade (Ansermet)**
- Wagner: Der Fliegende Hollander (Dorati)**
- Other Classical Record Reviews** 82
- The Lighter Side** 109
- Jazz** 118
- The Tape Deck** 123

A SPECIAL SECTION ON MAGNETIC TAPE

- Are You Making the Most of Your Tape Recorder?** 60 Ralph Freas
- Anyone Can Be a Sound Engineer** 63 Norman Eisenberg
- Magnetic Thunder for Macbeth** 67 Frank Rogers
- A True Treasury on Reels** 70 R. D. Darrell

LAFAYETTE RADIO

"Let Your Ears Be The Judge" — Satisfaction

Guaranteed or Money Refunded with Lafayette's 15-Day Free Home Trial.



LAFAYETTE LA-250A
50-WATT STEREO AMPLIFIER



GARRARD
RC210



PICKERING 380C
CARTRIDGE
WITH
DIAMOND STYLUS



LAFAYETTE
SK-58
FREE EDGE
12" COAXIAL
SPEAKERS



(OPTIONAL)
LAFAYETTE
ELIPTOFLEX SERIES
BOOKSHELF ENCLOSURES

The dynamic brilliance of stereo, featuring Lafayette's remarkable LA-250A, 50-watt stereo amplifier.

OUR BEST STEREO SYSTEM BUY

LAFAYETTE 50-WATT STEREO PHONO SYSTEM

MATCHED COMPONENTS

LAFAYETTE LA-250A 50-WATT STEREO AMPLIFIER	99.50
GARRARD RC210 4-SPEED RECORD CHANGER	44.50
PICKERING 380C DIAMOND STEREO CARTRIDGE	29.85
LAFAYETTE WOOD CHANGER BASE	3.95
2 LAFAYETTE SK-58 FAMOUS FREE EDGE 12" COAXIAL SPEAKERS @ 29.50 EACH	59.00
Regular Catalog Price	236.80

HI-FI STEREO SYSTEM with mahogany, walnut or blonde changer base (specify finish).
 HS-103WX 194.50
 Same as HS-103WX, plus 2 Lafayette Eliptoflex Series Bookshelf Enclosures in mahogany, walnut, blonde or oiled walnut finish (specify finish).
 HS-104WX 257.50

LAFAYETTE SPECIAL PRICE **194.50** YOU SAVE **42.30**
 NO MONEY DOWN

LAFAYETTE'S CRITERION LINE

Pacesetter of the High-Fidelity industry . . . renowned for its performance. The ultimate for those who demand the finest.

NEW! KT-550 100-WATT BASIC STEREO AMPLIFIER KIT

KT-550 In Kit Form **134.50**

LA-550
Completely Wired
184.50

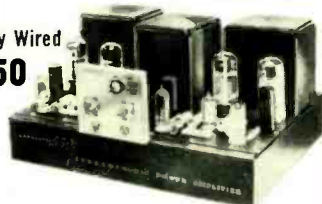

ON
MONEY
DOWN

- Rated at 50-Watts per Channel
- Response from 2-100,000 cps, 0, -1db at 1-Watt
- Grain Oriented, Silicon Steel Transformers
- Multiple Feedback Loop Design
- Easy-To-Assemble Kit Form

A new "Laboratory Standard" dual 50-watt amplifier guaranteed to outperform any basic stereo amplifier on the market. Advanced engineering techniques plus the finest components ensure flawless performance. Distortion levels so low they are unmeasurable. Hum and noise better than 90 db below 50-watts. Complete with metal enclosure. 9 1/4 x 12 1/2" D. Shpg. wt., 60 lbs.

KT-600A PROFESSIONAL STEREO CONTROL CENTER

KT-600A In Kit Form **79.50**

LA-600A Completely Wired **134.50**

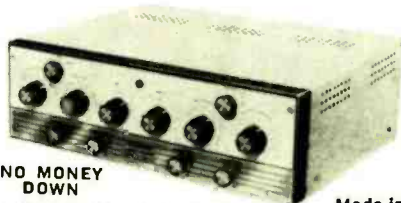

NO MONEY
DOWN

- Response 5-40,000 cps ± 1 db.
- Precise "Null" Balancing System
- Unique Stereo and Monaural Control Features
- Concentric Input Level Controls
- Easy-To-Assemble Kit Form.

Made in
U.S.A.

Sensitivity 2.2 mv for 1 volt out. Dual low impedance "plate follower" outputs 1500 ohms. Less than .03% IM distortion; less than .1% harmonic distortion. Hum and noise 80 db below 2 volts. 14x10 1/2 x 4 1/2". Shpg. wt., 16 lbs.

Lafayette Radio, Dept. w111 P.O. Box 190 Jamaica 31, New York

FREE!



NEW 1962

CATALOG
340 PAGES

Name _____
 Address _____
 City _____ Zone _____ State _____

LAFAYETTE RADIO
 LOCATIONS ▶ JAMAICA 33, NEW YORK

NEW YORK 13, N.Y. BRONX 58, N.Y. NEWARK 2, N.J.
 PLAINFIELD, N.J. PARAMUS, N.J. BOSTON 10, MASS

CIRCLE 65 ON READER-SERVICE CARD

AUTHORitatively Speaking

Since the editors of this magazine wholeheartedly love their work, every moment of it, they are always particularly glad to know that other people too can say they're doing nicely, thank you. This happy fate seems now to have overtaken the performing musician—at least if he's a member of a free-lance recording orchestra. He's not starving in a garret; he often earns an income in five figures. And he's not disparaged because he does not belong to an old-established organization: in fact, his virtuosity and versatility are the subject of encomiums. For his story, turn to **Robert Silverberg's** "Phantom Philharmonic," p. 44.

We have always thought sweet reason preferable to missionary zeal, and we've therefore been in no hurry to present a disquisition on "Stereo for the Man Who Hates Stereo" (see p. 48). When we found the right author, we thought we would. Now we have, and we do. **Edward Tatnall Canby** is a musician, a music critic, and a long-time specialist on sound reproduction. He is the author of *Home Music Systems* and *High Fidelity and the Music Listener* as well as numerous periodical articles; he is director of The Canby Singers, a choral group specializing in a *cappella* music of the Renaissance; he conducts a weekly radio program on station WNYC. In short, Mr. Canby seems the authority *par excellence* to talk sense on the subject of stereo to persons of sensibility.

William Weaver has not appeared in our pages for quite some time; and while we've deplored his absence, we have also found it completely understandable. Mr. Weaver has been busy putting out his own music-and-records magazine, *Discoteca*, published in Rome. As most HIGH FIDELITY readers know, *Discoteca's* editor has for several years been a close observer of musical affairs in Italy, and his present post draws him into even more active participation. From among his recent experiences, he gives us (p. 51) an account of his meeting with the octogenarian conductor Tullio Serafin.

On page 54 of this issue will be found an extraordinary study of an extraordinary personality, the seventeenth-century composer Carlo Gesualdo di Venosa. Its author—currently on a conducting tour which will range from Scandinavia to New Zealand, recently having finished recording several albums of contemporary music for Columbia, and scheduled to visit Russia with Igor Stravinsky in the spring—practices the profession of music almost as a religious is dedicated to his vocation. This has been going on since shortly after **Robert Craft's** student days. His third volume of "conversations with Stravinsky" will be published in January, and his book *Chapters in Contemporary Music* will appear later in the year.

This month we bring our readers a special added attraction in the form of a series of articles on tape and tape equipment. Contributing to this section are staff members **Ralph Freas** and **Norman Eisenberg**; member of the Editorial Board **R. D. Darrell**; and guest writer **Frank Rogers**.

Change of Address notices and undelivered copies (Form 3579) should be addressed to High Fidelity, Subscription Fulfillment Department, 2160 Patterson Street, Cincinnati 22, Ohio.

Now... the world's most distinguished artists—in cooperation with the world's largest record club—make it possible for you to acquire their finest recorded performances—at truly great savings



Leonard Bernstein



Philippe Entremont



Eugene Ormandy



Isaac Stern



Budapest String Quartet



Bruno Walter



Glenn Gould



Rudolf Serkin

35. Gershwin: Rhapsody in Blue; An American in Paris
Leonard Bernstein plays and conducts these two works

40. Tchaikovsky: 1812 Overture; Capriccio Italian
Antal Dorati conducts the Minneapolis Symphony

41. Beethoven: Wellington's Victory; Leonore No. 3 and Prometheus Overtures
Antal Dorati conducting the London Symphony

42. Chopin: 14 Waltzes
A. Brailowsky, pianist

43. Liszt: Hungarian Rhapsodies 1, 2; Enesco: Romanian Rhapsodies 1, 2
Eugene Ormandy conducting The Philadelphia Orch.

44. Eileen Farrell sings Puccini Arias
Arias from Madame Butterfly, La Boheme, etc.

45. Tchaikovsky: Piano Concerto No. 1
Byron Janis, piano; Menges conducts London Symphony

48. Wagner: Tristan und Isolde (Love Music); Falla: El Amor Brujo
Leopold Stokowski and The Philadelphia Orchestra

52. Maria Callas sings Highlights from "Medea"
"Greatest singing actress of our time" — High Fid.

81. Music for Trumpet and Orchestra
Delightful works by Haydn, Purcell and Vivaldi

110. Beethoven: Violin Concerto
Isaac Stern, violin; Bernstein, N. Y. Philharmonic

112. Shostakovich: Symphony No. 5
Leonard Bernstein conducts the N. Y. Philharmonic

113. Mendelssohn: Piano Concertos 1 and 2
Rudolf Serkin, piano; Philadelphia Orch., Ormandy

116. Brahms: Symphony No. 3; Haydn Variations
Walter, Columbia Symphony

118. Gabrieli; Frescobaldi: Music for Organ and Brass
E. Power Biggs, organ; Boston Brass Ensemble, Burgin

133. Beloved Choruses
Mormon Tabernacle Choir singing works by Schubert, Haydn, Sibelius, etc.

135. Beethoven: Symphony No. 7
Bernstein, NY Philharmonic

164. Prokofiev: Peter and the Wolf; Tchaikovsky: Nutcracker Suite
N. Y. Philharmonic, Bernstein narrates and conducts

165. Vivaldi: Four Concerti
Leonard Bernstein conducts the N.Y. Philharmonic

166. Bach: "Italian" Concerto; Partitas 1 and 2
Glenn Gould, piano

167. Orff: Carmina Burana
Ormandy, The Philadelphia Orch., Rutgers Univ. Choir

168. Handel: Water Music and Royal Fireworks Suites
Ormandy, Philadelphia Orch.

169. Beethoven: Quartet No. 7 (Rasoumovsky No. 3)
Budapest String Quartet

170. Rachmaninoff: Piano Concerto No. 2
Philippe Entremont, piano; Ormandy, Philadelphia Orch.

171. Liszt: Piano Works
Ivan Davis, piano

172. Sibelius: Violin Concerto; Swan of Tuonela
Oistrakh, violin; Ormandy, Philadelphia Orchestra

178. Mozart: Piano Concertos No. 11 and 20
Serkin, piano; Marlboro Festival Orch., Schneider

179. Borodin: Polovtsian Dances; Rimsky-Korsakov: Le Coq d'Or Suite
Antal Dorati, London Symphony and Chorus

211. Overtures by Rossini, Beethoven, Berlioz, etc.
Leonard Bernstein conducts the New York Philharmonic

162-163. Handel: Messiah (2-record set)*
Mormon Tabernacle Choir; Ormandy, The Philadelphia Orch.; famous soloists

173-174. Mahler: Symphony No. 2 (Resurrection) — (2-record set)*
Bruno Walter conducts the New York Philharmonic, Westminster Choir, soloists

175-176. Bach: Brandenburg Concertos (complete) — (2-record set)*
Netherlands Chamber Orchestra, Goldberg cond.

*TWO-RECORD SETS
If you select one of these 2-record sets, you are entitled to three additional single records. If you select two sets, you are entitled to one additional single record — five records in all.



Eugene Istomin



Alexander Brailowsky



E. Power Biggs

COLUMBIA RECORD CLUB
now offers new members

ANY 5

of these \$4.98 and \$5.98 long-playing 12" classical records — in your choice of

REGULAR HIGH FIDELITY or STEREO

\$1.97

RETAIL VALUE UP TO \$29.90

If you join the Club now and agree to purchase as few as 5 selections from the more than 200 to be offered during the coming 12 months

Here's an offer that enables you to acquire a superb classical record library — in regular high-fidelity OR stereo — at truly remarkable savings!

All 32 of the recordings described above are now available in both regular high-fidelity and stereo. As a new member, you may have ANY 5 of these records — in your choice of regular high-fidelity OR stereo — ALL 5 for only \$1.97.

AND WHAT A WONDERFUL SELECTION TO CHOOSE FROM — symphonies, concertos, overtures, ballet music, chamber music — brilliantly performed by these world-famous artists. Whether you are a beginner or an advanced music listener, you can surely find 5 records you would like to add to your classical record library!

TO RECEIVE YOUR 5 RECORDS FOR \$1.97 — mail the coupon today. Be sure to indicate whether you want your five records (and all future selections) in regular high-fidelity or stereo. Also indicate which Club Division best suits your musical taste: Classical; Listening and Dancing; Broadway, Movies, Television and Musical Comedies; Jazz.

HOW THE CLUB OPERATES: Each month the Club's staff of music experts selects outstanding records from every field of music. These selections are fully described in the Club Magazine, which you receive free each month.

You may accept the monthly selection for your Division... or take any of the wide variety of other records offered in the Magazine, from all Divisions... or take NO record in any particular month.

Your only membership obligation is to purchase five selections from the more than 200 records to be offered in the coming 12 months. Thereafter, you have no further obligation to buy any additional records... and you may discontinue your membership at any time.

FREE BONUS RECORDS GIVEN REGULARLY. If you wish to continue as a member after purchasing five records, you will receive — FREE — a Bonus record of your choice for every two additional selections you buy — a 50% dividend!

The records you want are mailed and billed to you at the regular list price of \$3.98 (Classical \$4.98; occasional Original Cast recordings somewhat higher), plus a small mailing and handling charge. Stereo records are \$1.00 more.

NOTE: Stereo records must be played only on a stereo record player. If you do not own one, by all means continue to acquire regular high-fidelity records. They will play with true-to-life fidelity on your present phonograph and will sound even more brilliant on a stereo phonograph if you purchase one in the future.

Columbia Record Club, Terre Haute, Ind.

SEND NO MONEY — Mail coupon to receive 5 records for \$1.97

COLUMBIA RECORD CLUB, Dept. 265-1

Terre Haute, Indiana

I accept your special offer and have circled at the right the numbers of the five records I wish to receive for \$1.97, plus small mailing and handling charge.

Send my 5 records and all future selections in (check one) **REGULAR** **STEREO**

... and enroll me in the following Division of the Club: (check one Division only)

Classical **Listening & Dancing** **Jazz**
 Broadway, Movies, Television & Musical Comedies

I understand that I may select records from any Division. I agree to purchase five selections from the more than 200 to be offered during the coming 12 months, at regular list price plus small mailing and handling charge. Thereafter, if I decide to continue my membership, I am to receive a 12" Bonus record of my choice FREE for every two additional selections I accept.

Name.....
(Please Print)

Address.....

City.....ZONE.....State.....

APO, FPO addressees: write for special offer
CANADA: prices slightly higher; 1111 Leslie St., Don Mills, Ont.

If you want this membership credited to an established Columbia or Epic record dealer, authorized to accept subscriptions, fill in:
Dealer's Name and Address.....422

CIRCLE 5 NUMBERS		
35	110	167
40	112	168
41	113	169
42	116	170
43	118	171
44	133	172
45	135	178
48	164	179
52	165	211
81	166	
	162&163*	
	173&174*	
	175&176*	

*Counts as 2 selections

SS-PW (REG) SS-SW (STER)

CIRCLE 30 ON READER-SERVICE CARD

So Compact...



X-10

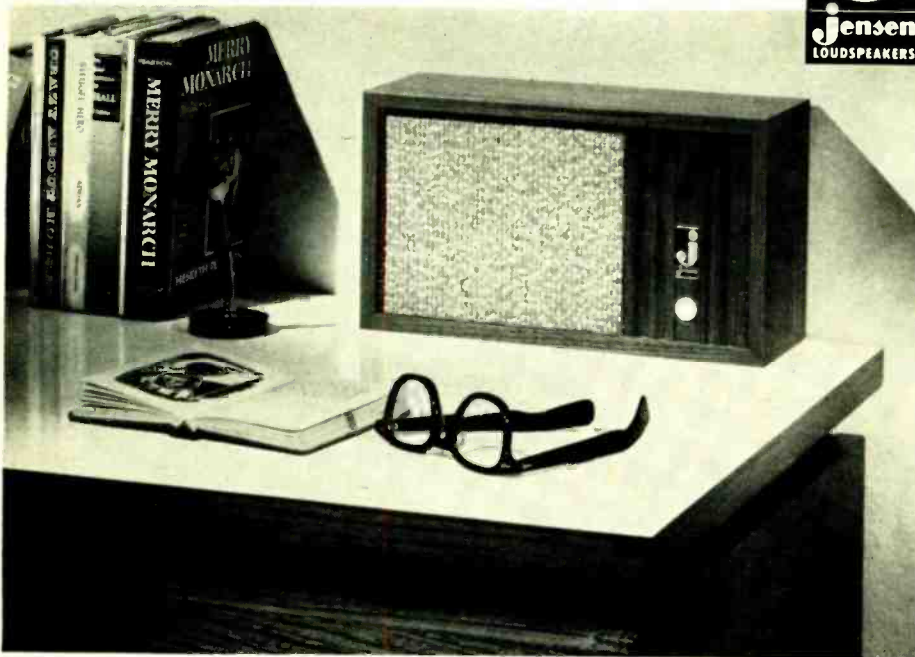

A startling achievement—an ultra-compact (7¼" H, 13" W, 4⅝" D) 2-speaker system capable of sound you'd expect from a much larger unit. Volume control on front. Perfect for FM Multiplex, very low cost stereo, other-room extensions.

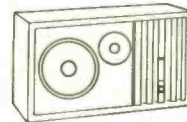

X-10 2-speaker 2-way system for use with amplifier having 4, 8, or 16 ohm output. Power rating 6 watts. Adequate room sound with 1 watt to speaker. In Oiled Walnut.....\$29.75

So Big in Sound...



TF-2 TF-3

Strikingly beautiful compact bookshelf systems—perfect for every stereo or mono hi-fi need. Recent "blindfold" tests by audio experts proved a preference for the TF-3 and TF-2 over "rated" systems costing much more. Make your own careful comparison. You will be delighted with such big sound in small space.

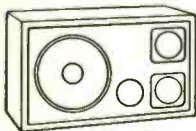
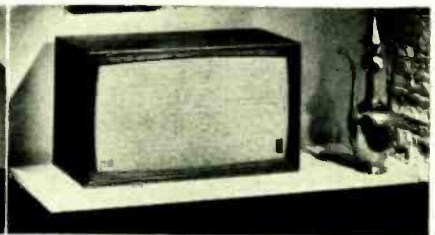
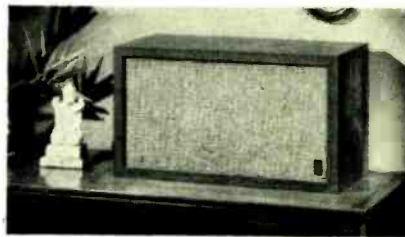
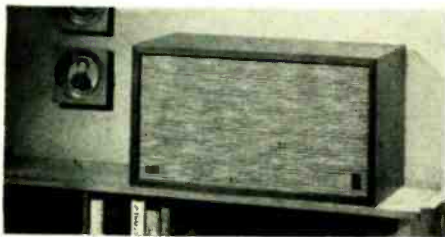

TF-2 3-speaker 2-way system. Full size Flexair* woofer for distortion-free bass response, plus two special direct radiator tweeters giving extended smooth highs. 13½" H, 23¾" W, 11¼" D. In Oiled Walnut.....\$79.50 Unfinished Hardwood.....\$64.50

TF-3 4-speaker 3-way system. Covers full frequency range with Flexair* woofer in Bass-Supreflex* enclosure, two coloration-free midrange units, and the sensational Sono-Dome* Ultra-Tweeter. 13½" H, 23¾" W, 11¼" D. In Oiled Walnut.....\$99.50 Decorator Styling.....\$109.50 Unfinished Hardwood.....\$79.50

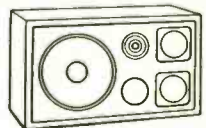

jensen MANUFACTURING COMPANY
DIVISION OF THE MUTER CO.

6601 S. Laramie Avenue, Chicago 38, Illinois

In Canada: Renfrew Electric Co., Ltd., Toronto

In Mexico: Universal De Mexico, S.A., Mexico, D.F.

*T.M. Reg.

CIRCLE 62 ON READER-SERVICE CARD

HIGH FIDELITY MAGAZINE

The ANGEL RECORD CLUB invites you to enjoy these high fidelity

ADVENTURES IN SOUND!

Choose any

4 ALBUMS Pay only 99¢

plus a small charge for postage, packing and mailing



As a member of the Angel Record Club, you will be offered selections from Angel Records' magnificent international repertoire, including Columbia Gramophone (of England), Pathé Marconi (of France), E.M.I.'s historic HMV label, and the world famous Capitol catalog.

When you become a Trial Member of the Angel Record Club and agree to buy as few as six future selections during the next 12 months:

"EXTREMELY HIGH STANDARD... COLORFUL IN SOUND, THE SURFACES PERFECT."—NEW YORK TIMES

The Blood-Tingling Sound of Massed Bagpipers...

...and the fabulous 66-man military band of the Scots Guards! They play 21 pulsating Strathspeys... Reels... Marches... and Patrois, from Hielan' Whiskey and The Wee Macgregor to Garb of Old Gaul and Cock o' the North. One of Angel's all-time best-sellers; hear it once and you'll know why. (702) THE SCOTS GUARDS \$4.98



"FAULTLESS SOUND."—HIGH FIDELITY

The Sound of Tipperary... Sung in Russian!

200 thundering male voices sing Tipperary (in Russian and English). Oh, No! John, plus traditional Russian songs—and the most exciting Volga Boat Song performance you've ever heard! (\$700) THE SOVIET ARMY CHORUS & BAND. \$4.98; STEREO \$5.98



The Stirring Sound of Classic Guitars

...in crystal clear high fidelity! Here are works of de Falla, Ravel, Chopin and others played in the grand tradition of the classic guitar by one of the greatest masters of this subtle and expressive instrument. (S-761) THE SPANISH GUITARS OF LAURINDO ALMEIDA. \$4.98; STEREO \$5.98

The Passionate Sound of Edith Piaf

...singing (as Time Magazine said) "of everything that ever went wrong with love in Paris or anywhere else." Here are 12 songs she has made famous. (759) PIAF. \$3.98



The Sound of Callas in Puccini Operas

What greater roles for the most exciting singing actress of our time than the heroines of Puccini's Manon Lescaut—Madame Butterfly—La Boheme—Turandot! Here is Callas at her artistic climax—as singer, actress and woman. With the Philharmonia Orchestra. (747) CALLAS PORTRAYS PUCCINI HEROINES. \$4.98

The Sound of a Zither in a Bavarian Beer Hall

An authentic evening in Munich with Alfons Bauer, his Zither and Orchestra. The Comedian Quartett, a Bavarian brass band and other native stars. In the highest of Hi-Fi, too! (757) GERMAN BEER-DRINKING MUSIC. \$3.98



"AS SMOOTH AS SILK."—THE NEW YORKER

The Sound of "Angels in Pigtails"

—Dylan Thomas' tribute to 30 golden-haired German girls and 7 boys who sing Snow White (in English); folk songs; and lyric pieces by Schubert, Schumann, Mendelssohn, Tchaikovsky. (765) THE OBERNKIRCHEN CHILDREN'S CHOIR. \$4.98



The Haunting Sounds of the East

A thrilling collector's item! 14 strange melodic pieces recorded on an overland journey from Turkey to India—across Syria, Jordan, Iraq, Iran, Afghanistan and Pakistan. Your album package includes fascinating illustrated notes explaining language, locale, instruments and meaning of the various pieces. (756) MUSIC ON THE DESERT ROAD. \$4.98



18 More Albums to Choose From!

5705. LOLLIPOPS. Sir Thomas Beecham conducts 8 delightful "musical sweet-meats" by Berlioz, Debussy, Mozart, others. \$4.98; Stereo \$5.98.

728. WAGNER OPERA SELECTIONS. The Berlin Philharmonic plays Tannhauser, The Flying Dutchman, Gotterdammerung. \$4.98.

730. BRANMS: SYMPHONY NO. 4. His final symphony, played by the Philharmonia Orchestra, conducted by Herbert Von Karajan. \$4.98.

5731. Sibelius: SYMPHONY NO. 2. Powerfully played by the Philharmonia Orchestra, Paul Kietzka conducting. \$4.98; Stereo \$5.98.

737. Khatchaturian: VIOLIN CONCERTO. David Oistrakh plays, the composer conducts, in a dazzling, unforgettable performance. \$4.98.

5738. Beethoven: PIANO CONCERTO NO. 4. Russia's famed Emil Gilels is soloist with the Philharmonia Orch. \$4.98; Stereo \$5.98.

5741. Prokofiev: CINDERELLA. The ballet's enchanting music. Robert Irving conducts the Royal Philharmonic. \$4.98; Stereo \$5.98.

5733. Prokofiev: SYMPHONY NO. 5. A stunning rendition of a heroic work by Thomas Schnippers with Philharmonic Orch. \$4.98; Stereo \$5.98.

5734. Tchaikovsky: SYMPHONY NO. 4. A superb performance by Constantin Silvestri and the Philharmonia Orch. \$4.98; Stereo \$5.98.

5752. EILEEN FARRELL IN SONGS AND BALLADS. 15 pieces, best-loved and little-known, with George Trovillo on piano. \$4.98.

5753. VIENNESE DANCES #2. The Philharmonie under Vienna-born Henry Krips plays 6 scintillating waltzes. \$4.98; Stereo \$5.98.

5754. THREE RHAPSODIES. The Vienna Philharmonic under Silvestri plays rhapsodies by Liszt, Ravel, Enesco. \$4.98; Stereo \$5.98.

758. SWISS MOUNTAIN MUSIC. Hear the unique Alphorn, yodeling, other vocals and instrumentals in 21 cheerful folk tunes. \$3.98.

760. TWO IN A CONDLA. Dino Oliveri conducts Venetian music aglitter with romantic violins and mandolins. \$3.98.

5762. RUSSKAYA! Hollywood Bowl Symphony. Carmen Dragon conducting Russian music by Rimsky-Korsakov, others. \$4.98; Stereo \$5.98.

USE THIS COUPON TO ORDER YOUR 4 ANGEL ALBUMS!

MAIL TO: THE ANGEL RECORD CLUB—Dept. 2057 Scranton 5, Penna.

SEND ME—AT ONCE—THESE FOUR ALBUMS

All you will bill me is 99¢ plus a small charge for postage, packing and mailing.

<input type="checkbox"/>	<input type="checkbox"/>	<input type="checkbox"/>	<input type="checkbox"/>
--------------------------	--------------------------	--------------------------	--------------------------

Please accept my application for trial membership in the Angel Record Club. As a member I agree to buy six additional records during the next 12 months, from over 100 superb albums to be offered. For these albums—by the world's great artists like those whose albums are shown here with their Club price—I will pay \$3.98, \$4.98 or \$5.98, depending on the record purchased, plus a small charge for postage, packing and mailing 7 days after I receive each album.

You will send me—FREE—each month the illustrated Angel Record Club Review (The Stylus) which pictures and describes the monthly selections and alternate selections.

Whenever I want the monthly selection I need do nothing; it will be sent to me automatically. But if I wish any of the other selections—or wish no record at all that month—I will notify the Club on the form always provided. I will purchase at least one record every two months.

BONUS ALBUMS will be given to me at the rate of one 12-inch album for every two that I buy, after my agreed upon six future selections. I will select my own BONUS ALBUMS from an up-to-date list of current best sellers.

I may cancel my membership anytime after buying six additional records. (Only one membership per family.)

No-Risk GUARANTEE: If not delighted, I will return these FOUR ALBUMS within 7 days and my membership will be cancelled without further obligation.

Check here if you own a STEREO record player and agree to buy your six future selections in stereo which the Club sells for \$1.00 more than monaural. Then the 4 records you have chosen marked "S" will be sent to you in STEREO with a bill for \$1.00 more (Total: \$1.99). BONUS ALBUMS and future selections will also be in stereo. NOTE: Stereo records can be played only on stereo equipment.

PRINT NAME.....
ADDRESS.....
CITY.....ZONE.....
STATE.....

SEND NO MONEY. We will bill you. Slightly higher in Canada: Angel Record Club of Canada, 1184 Castlefield Ave., Toronto 19, Ont. If you wish to join through an ANGEL RECORD DEALER authorized to solicit club subscriptions, write his name and address in margin.

HF-9

COMING
UP!

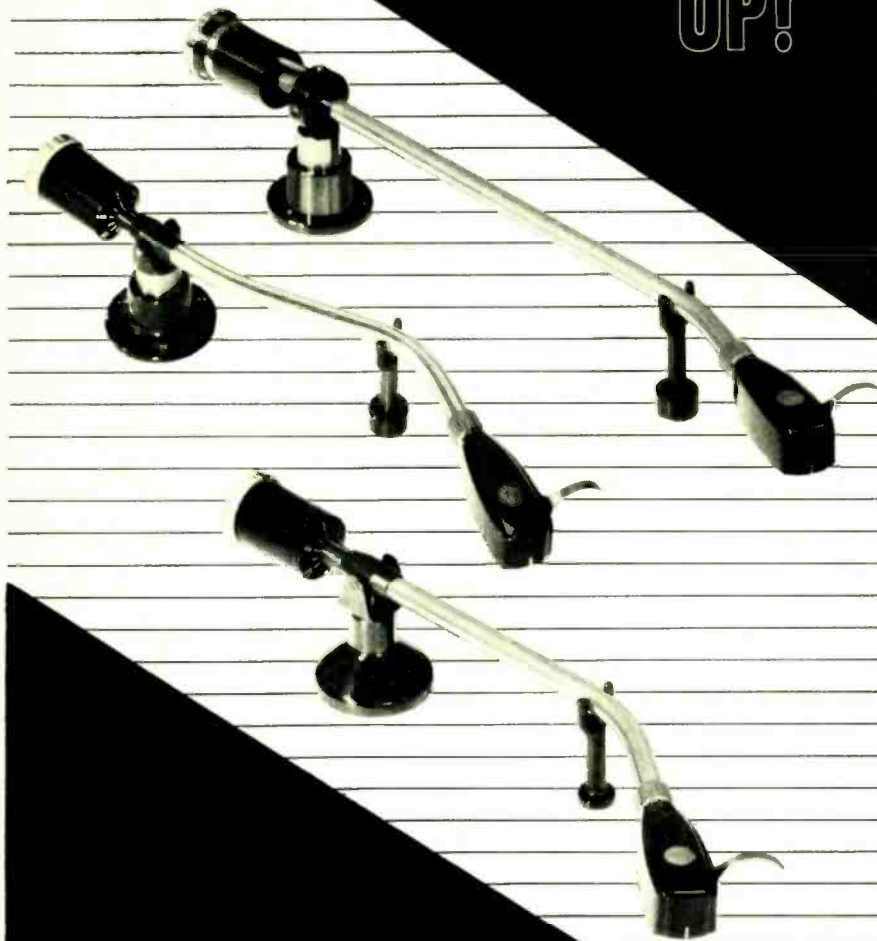

Giant step toward tone-arm
perfection... 20-20,000 cps response!

Now for the first time you'll be able to get the world-renowned Ortofon arms and stereo cartridge at your hi-fi dealer's... a superb companion to your Thorens TD-124... a giant step forward in eliminating residual distortion and response deficiencies from even the finest music systems.

Only Ortofon, supplier of studio recording equipment to the world's foremost recording companies, both in the U. S. and abroad, has achieved the perfection of balance, the precision of tracking, the absolute minimum of inertia needed to play your finest records and preserve their superlative brand-new quality.

See and hear the Ortofon arms and stereo cartridge at your dealer or the New York Hi-Fi Show Room of ELPA Marketing Industries—sole U. S. Representatives for Thorens and Ortofon products.

Guaranteed for one full year. Sold only through carefully selected franchised dealers.

Ortofon

WORLD FAMOUS STUDIO EQUIPMENT

A Division of ELPA Marketing Industries, Inc., New Hyde Park, New York
CIRCLE 105 ON READER-SERVICE CARD

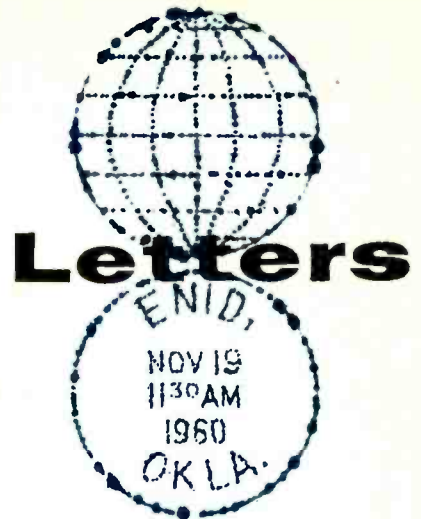

A Reply to Mr. Robbins Landon

SIR:
"A Pox on Manfredini" (HIGH FIDELITY, June) also casts a pox on those who buy recordings in order not to listen to them, the big news item in this field being that those who formerly didn't listen to Mozart are today not listening to baroque music. Since there have always been people who needed music to talk over, the whole matter becomes inconsequential, to say the least. That a listening marathon to baroque music on records will show up some second-rate composers and some second-rate music, I don't doubt for a moment. I believe, however, that for all this music to have been recorded at least once is a good thing, and not a bad thing. What better way is there to find out what is and what is not first-rate? Who is to say what remains on library shelves and what doesn't? We have had enough sad experiences with editors of printed music who decide so easily which are the "best" Haydn quartets, which compositions by Bach rate inclusion in a volume of "selected" works, and which Schubert symphonies should become the "best known." I believe we must try to do away with this same faulty selection process in recording. Most of us could lead rich, full, musical lives without the "forty-some editions currently in the catalogue" (HIGH FIDELITY, June, page 65) of the Tchaikovsky Piano Concerto, Op. 23. I firmly believe, however, that any music worth printing is worth recording, at least once. Yes, I know that this means that a lot of second-rate music would be recorded, but so would a lot of first-rate music which we never get a chance to hear.

Mr. Robbins Landon reports a friend's reaction to the Library of Recorded Masterpieces as being as follows: "All this Vivaldi business—the five hundred concertos on 292 LPs—is just nonsense. Degenerate. It's another symptom of our civilization's sickness: five minutes before twelve; how Spengler would have laughed..." We have just finished making an index record for our first set

Continued on page 10

HIGH FIDELITY MAGAZINE

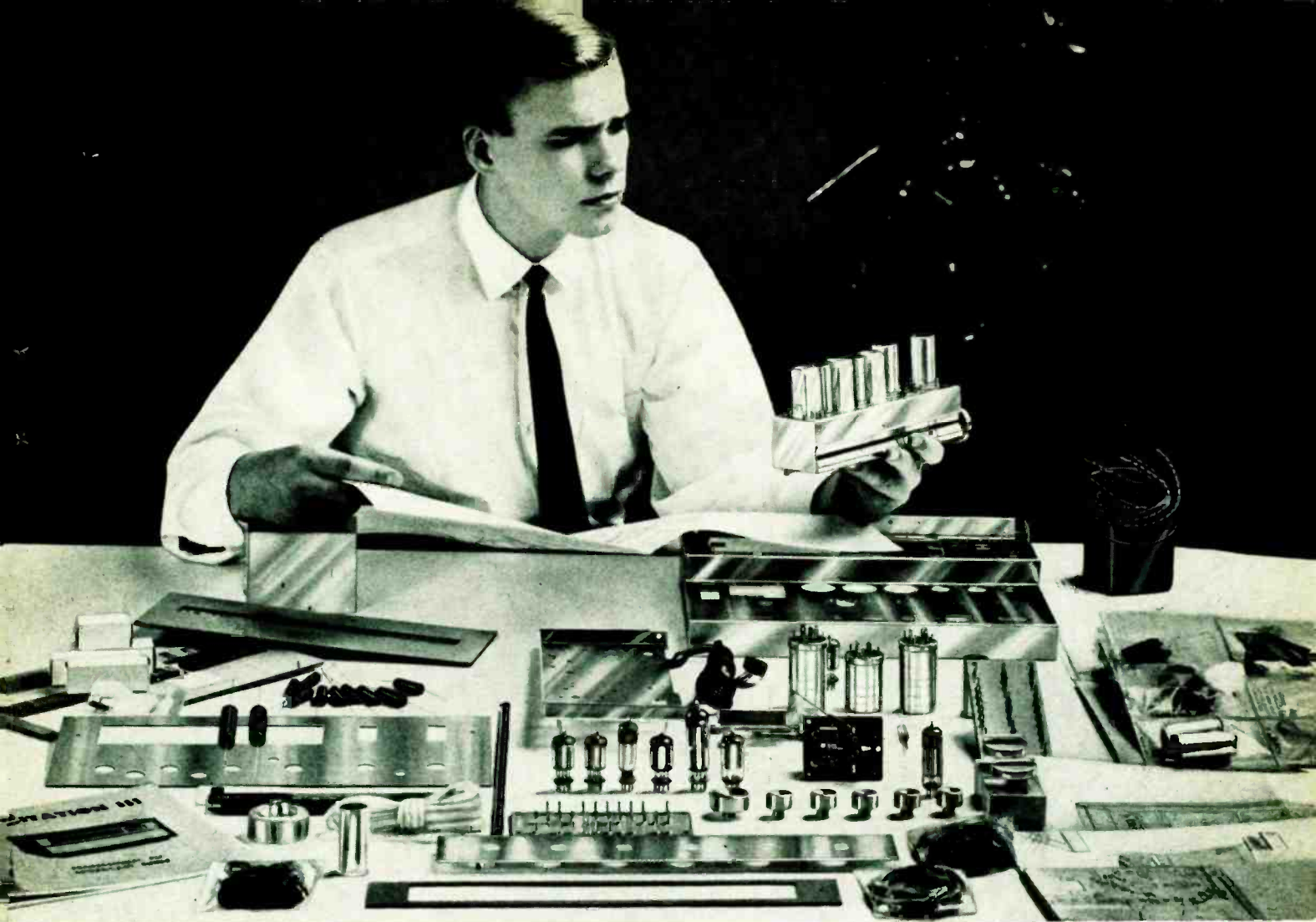

Can You Afford 15 Hours to Build The World's Best FM/Multiplex Tuner?

Fifteen hours. That's all it takes to build the world's best FM/Multiplex tuner.

Citation has the "specs" to back the claim but numbers alone can't tell the story. On its real measure, *the way it sounds*, Citation III is unsurpassed. And with good reason.

After years of intensive listening tests, Stew Hegeman, director of engineering of the Citation Kit Division, discovered that the performance of any instrument in the audible range is strongly influenced by its response in the non-audible range. Consistent with this basic design philosophy—the Citation III has a *frequency response three octaves above and below the normal range of hearing*. The result: unmeasurable distortion and the incomparable "Citation Sound."

The qualities that make Citation III the world's best FM tuner also make it the world's best FM/Multiplex tuner. The multiplex section has been engineered to provide wideband response, exceptional sensitivity and absolute oscillator stability. It mounts right on the chassis and the front panel accommodates the adapter controls.

What makes Citation III even *more* remarkable is that it can be built in 15 hours without reliance upon external equipment.

To meet the special requirements of Citation III, a new FM cartridge was developed which embodies every critical tuner element in one compact unit. It is completely assembled at the factory, totally shielded and perfectly aligned. With the cartridge as a standard and the two D'Arsonval tuning meters, the

problem of IF alignment and oscillator adjustment are eliminated.

Citation III is the *only* kit to employ military-type construction. Rigid terminal boards are provided for mounting components. Once mounted, components are suspended tightly between turret lugs. Lead length is sharply defined. Overall stability of the instrument is thus assured. Other special aids include packaging of small hardware in separate plastic envelopes and mounting of resistors and condensers on special component cards.

For complete information on all Citation kits, including reprints of independent laboratory test reports, write Dept. HF-9, Citation Kit Division, Harman-Kardon, Inc., Plainview, N. Y.

The Citation III FM tuner-kit, \$149.95; wired, \$229.95. The Citation III MA multiplex adapter-factory wired only, \$89.95. The Citation III X integrated multiplex tuner-factory wired, \$319.90. All prices slightly higher in the West.



Build the Very Best **CITATION KITS** by

harman kardon

CIRCLE 57 ON READER-SERVICE CARD

FOR magnificent sound



TARZIAN TAPE

engineered for highest fidelity

- **High Output**—can accept signals with dynamic range to realize the full potential of even the finest professional equipment.
- **Wide-Range Response**—virtually flat response for all recording frequencies.
- **Low Distortion**—distortion is less than 2½% at maximum record level as measured by Navy Specification W-T-0061.
- **High Uniformity**—uniformity within a 1200-foot reel is within plus or minus ¼ db. A new oxide formula and special selectivity of oxides protect recording heads from wear and prevent abrasion.
- **Humidity and Temperature Protection**—special coating, priming, and binding techniques help keep Tarzian tape in new condition longer in ordinary good tape storage conditions.

Given great sound in the first place, Tarzian Tape will keep it for you, and give it back undiminished and undistorted. It is a tape of truly professional fidelity, worthy of your most valued recordings, at a price that lets you use it for all your work (or play).

The proof is in the listening... of course. But you can see the smooth, tightly bonded oxide surface that doesn't flake, that does run smoothly without abrasion and without contributing to wow or flutter. Hold a reel to the light. You can see that Tarzian Tape is wound on the reel at perfect tension. You'll find a written replacement guarantee in every box. The box is well made, with ample identification space. You'll see that the tape is factory sealed in a plastic bag, with labels and a tape-end clip included.

Try Tarzian Tape. Summon the keenest and most discriminating ears you know. Tarzian Tape has what they, and you, will appreciate—highest fidelity! Available on standard 3-, 5-, and 7-inch reels and in professional lengths on reels or hubs, 1½ or 1 mil acetate. Ask your dealer. If he cannot supply you, send us his name and we will see that your needs are promptly supplied.

Helpful new booklet free on request: "The Care and Feeding of Tape Recorders."

Note: Tarzian Tape on Du Pont Mylar base will be available shortly. Your inquiry is invited.



SARKES TARZIAN, INC.

World's Leading Manufacturers of TV and FM Tuners • Closed Circuit TV Systems • Broadcast Equipment • Air Trimmers • FM Radios • Magnetic Recording Tape • Semiconductor Devices
MAGNETIC TAPE DIVISION • BLOOMINGTON, INDIANA
 Export: Ad Auriema, Inc., N. Y. • In Canada, Cross Canada Electronics, Waterloo, Ont.

CIRCLE 91 ON READER-SERVICE CARD

LETTERS

Continued from page 8

of twelve Vivaldi records, containing fifty-two pieces. I decided to take another hard look at them with an eye (and an ear) to discovering the degeneracy of it all. I'm sorry to say I couldn't find any. I wouldn't advise a present-day musician to listen to all fifty-two pieces seriatim. They were never intended for that kind of listening. I'd advise listening in groups of four or five pieces, eight as the outside limit. What would you then hear? You'd hear a bewildering variety of musical ideas, instrumentation, and forms. Perhaps this is why J. S. Bach also found this music so attractive. You would also find authentic performances (and authentic scores) of many pieces which have come down to us only in corrupt versions.

One aspect of this Vivaldi project which no one has mentioned publicly yet is the effect on young students of music. I would have given much as a young student to have heard many of these pieces and to have had the score available to play on the violin. When I think of youngsters all over this country who play flutes and piccolos, oboes, clarinets (yes, Vivaldi wrote for real clarinets; we have three of these pieces in our first volume), bassoons, horns, trumpets, violins, violas (the viola d'amore concertos go nicely on the viola), cellos, and even double basses, and think of what a big event in their lives meeting this music on records, and with scores, could be, I feel a bit proud of the whole idea, and not a bit degenerate. It doesn't feel "five minutes before twelve"-ish at all, and if Mr. Spengler were around, I might say to him, "Wouldn't you like to try this piece on your recorder? It's lovely. I like it."

Max Goberman

Library of Recorded Masterpieces
 New York, N.Y.

SIR:

Mr. Robbins Landon's article tended, at first, to provoke a rising of blood pressure and a bristling of hair. However, a second reading convinced me of the propriety of some of his points. There *does* seem to be a trend recently to extol slavishly anything written in the baroque ("barococo") period. This unqualified acceptance does not extend to other facets of eighteenth-century civilization, as might logically be expected. Perhaps this relates to certain sociological and psychological tendencies of "us moderns." We do not accept eighteenth-century politics in such a fashion because we are too "realistic." We do not accept eighteenth-century art and architecture in such a fashion because our taste for "simplicity" is too "refined" to savor the decorative aspects of a Boucher or a Neumann. Nor do we accept the wit of a Voltaire, the intense sentiment of the *Stürmer* and *Drünger*, or the florid ecstasy of the early romanticists. Eighteenth-century philosophy is too moralizing, too con-

Continued on page 12



THE FINEST OF COMPONENTS COMBINED ON A BEAUTIFULLY ENGINEERED CHASSIS DESIGNED FOR PERFECT INSTALLATION IN MINUTES

Everything You Need, On One Magnificent Chassis

FISHER 800-B

65-Watt AM-FM-Multiplex Receiver

The best of everything—AM and FM-Multiplex Tuners for every existing type of broadcast (mono or stereo), a Stereo Master Audio Control Center of grand organ flexibility and *simplicity*, a stereo amplifier capable of producing 65-watts of pure, undistorted power—all these have been joined on one gleaming chassis whose capabilities belie its easy-to-install size. And the 800-B features Stereo Beam, the Fisher invention that tells you *instantly*

whether or not the FM station is broadcasting in Stereo Multiplex. No need to consult program listings in the paper, or trot between the two speaker systems to know what is going on. There is no easier way to install a complete stereo system in your home—simply add two speaker systems and a turntable and you can look forward to virtually unlimited years of musical enjoyment. **\$429.50**
Fine Cabinets Available In Walnut or Mahogany **\$24.95**

FISHER 500-B

65-Watt FM-Multiplex Receiver

■ Outstanding FM and Multiplex with STEREO BEAM, stereo master control center and powerful, 65-watt amplifier—all on *one* magnificent, easy-to-install chassis. **\$359.50**
Walnut, Mahogany Cabinets, \$24.95



USE THIS COUPON FISHER RADIO CORP. • L. I. CITY 1, N. Y.

Please send the FREE literature on the following:

- Specifications on the FISHER 500-B and 800-B
- Complete Catalogues on FISHER equipment
- Illustrated Custom Stereo Installation Guide

Name _____

Address _____

City _____ State _____

EXPORT: Telesco International Corp., 171 Madison Ave., N. Y. 16, N. Y. • In Canada: Tri-Tel Associates, Ltd.

CIRCLE 48 ON READER-SERVICE CARD

Continued from page 10

cerned with immediate problems to be of any pragmatic value for us. But eighteenth-century music—ah! this is another thing! The serious achievements of a Vivaldi, a Handel, or a Bach are lumped together with the *Tafelmusik* of a Lully, a Torelli, or a Manfredini. Our posterity would do us similar justice by lumping "Music by Muzak" together with the productions of Stravinsky or Hanson.

It has recently been suggested that the sudden popularity of serious music (including, of course, baroque music) in the educated middle class might be attributable to a sort of escapism. People cannot cope with the difficulties of human existence or they do not wish to cope with these difficulties (has that not been said before?!). Reading is too much work—it requires concentration and application of the mental faculties. *Que faire?* Listen to music! Serious music is no longer serious. It has taken on an aspect of background music. I should take exception to the statement that "you can't relax to a Mozart quintet or the *Missa Solemnis* unless you're an idiot," on the basis of the simple fact that that is exactly what our educated middle class is doing. Perhaps, though, there is no contradiction here.

I am neither a musicologist nor a musician of any sort, so I cannot disagree with Mr. Robbins Landon's statement that Manfredini is fourth-rate music. But I would disagree with his assertion that it "never should have left that dusty archive shelf." I realize that it is dreariness work to have to pore over much of this material, but it is necessary in order to understand the past and—perhaps—thus the present.

I myself study the eighteenth century. I like that century with all of its excesses and problems, with all of its mediocrity and greatness. As an integral part of my studies, I listen to eighteenth-century music whenever possible. I cannot say that this listening is dull or intolerable—most of it is extremely interesting, perhaps more for the light that it throws on other aspects of eighteenth-century life than for an inherent musical value—it may seem odd to relate Frederick the Great's flute-playing with the judicial reforms of Samuel von Cocceji, but there is, in my opinion, a very real connection.

Richard A. Jackson
Minneapolis, Minn.

SIR:

What a pity! Mr. Robbins Landon has blown his intellectual gasket. A pox on all of you responsible for the appearance in print of this sort of thing.

Wingate W. Woodard
Norfolk, Va.

High Fidelity Non-Servicing

SIR:

Your editorial, "Audio Doctor in the

Continued on page 14

HIGH FIDELITY MAGAZINE

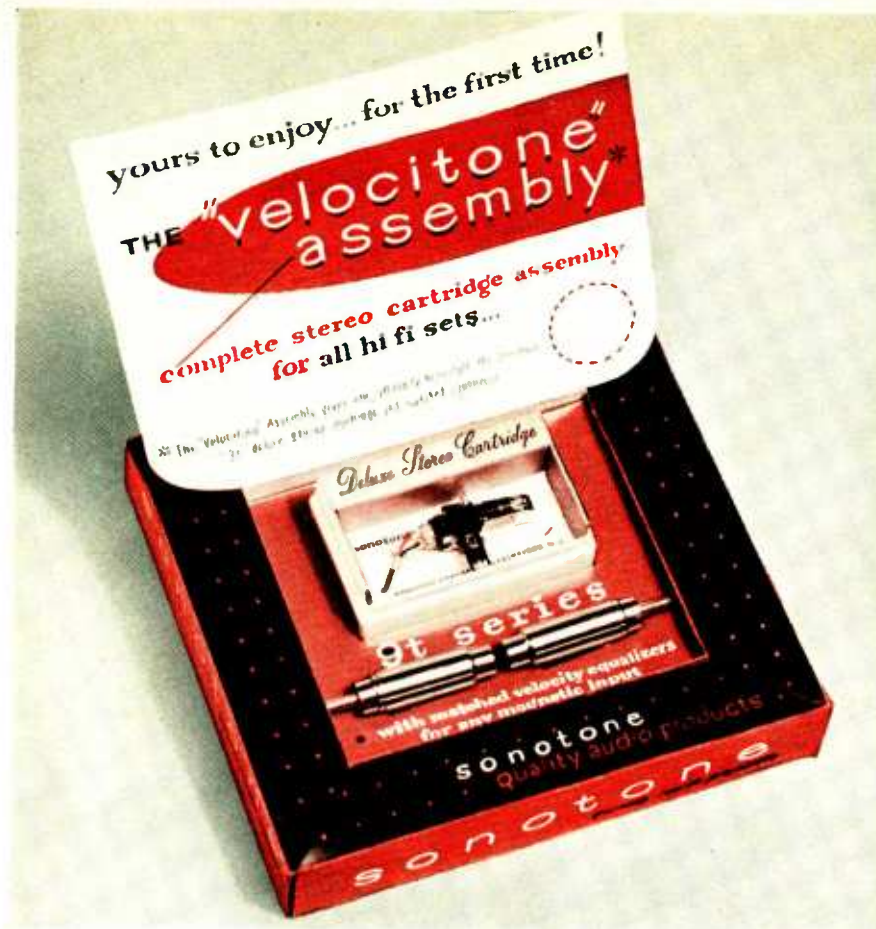

No stereo cartridge in the world outperforms the *Sonotone Ceramic "Velocitone"*

Listen!... with your own magnetic... or with any magnetic you can buy today—at any price. Then replace it directly in your component system with Sonotone's new "VELOCITONE" STEREO CERAMIC CARTRIDGE ASSEMBLY. Listen again! We challenge you to tell the difference. Experts have tried... in dozens of A-B listening tests. And, in every single one, Sonotone's "VELOCITONE" performed as well as or better than the world's best magnetic.

Listen!... perfectly flat response in the extreme highs and lows (better than many of the largest-selling magnetics).

Listen!... excellent channel separation—sharp, crisp definition.

Listen!... highest compliance—considerably superior tracking ability.

Listen!... absolutely no magnetic hum—quick, easy, direct attachment to any magnetic inputs.

Listen!... remarkable performance characteristics unexcelled anywhere. (Write Sonotone Corporation for specifications.)

Now listen to the price. Only \$23.50... about one-half the price of a good stereo magnetic cartridge. Yet Sonotone's "VELOCITONE" stereo ceramic cartridge system cannot be outperformed by any magnetic—regardless of price.

Sonotone[®] CORP.

ELECTRONIC APPLICATIONS DIVISION, ELMSFORD, N. Y., DEPT. C4-91
IN CANADA, CONTACT ATLAS RADIO CORP., LTD., TORONTO

LEADING MAKERS OF CARTRIDGES • SPEAKERS • TAPE HEADS • MIKES • ELECTRONIC TUBES • BATTERIES

CIRCLE 96 ON READER-SERVICE CARD



THERE IS NO OTHER TUNER OF ITS TYPE THAT CAN MATCH THE QUALITY AND FLEXIBILITY OF THE FM-50-B

Leads the Field With Exclusive Stereo Beam

FISHER FM-50-B

Wide-Band FM-Multiplex Tuner

Knowledgeable audio enthusiasts know that certain features are basic in the performance of an FM tuner. In every one of these basic features you will find the FISHER FM-50-B *outstanding*—and in some, *unique*. Take SENSITIVITY (more important than ever for reliable Multiplex reception)—the FM-50-B has 0.7 μ v for 72-ohm antenna. Take SELECTIVITY, HIGH GAIN and BROAD BANDWIDTH—to achieve the best in these the FM-50-B has *four* I.F. stages, more than any tuner in its class. Take MULTIPLEX—the FM-50-B

alone boasts of STEREO BEAM, the FISHER invention that eliminates the "try-and-find-the-Multiplex" problem of other brands (including the high-priced ones.)

Truly, here is a tuner that has from its inception been designed to give virtually unnumbered years of enjoyable, distortion-free FM reception—both monophonic and stereo. It is the newest in the FISHER family of FM tuners, known throughout the world as the finest you can buy.

\$189.50

Fine Cabinets Available In Walnut or Mahogany **\$24.95**

OTHER FINE FISHER FM TUNERS

FISHER FM-1000

FM-Multiplex Wide-Band Tuner with exclusive Stereo Beacon. **\$419.50**

FISHER FM-100-B

FM-Multiplex Wide-Band Tuner with exclusive Stereo Beam. **\$229.50**

USE THIS COUPON

FISHER RADIO CORP. • L. I. CITY 1, N. Y.

Please send FREE literature on the following:

- Complete specifications on FISHER Tuners
- Complete catalogues on FISHER equipment
- Illustrated Custom Stereo Installation Guide

Name _____

Address _____

City _____ State _____

EXPORT: Telesco International Corp., 171 Madison Ave., N. Y. 16, N. Y. • In Canada: Tri-Tel Associates, Ltd.

HF8-3

CIRCLE 48 ON READER-SERVICE CARD

Continued from page 12

Before buying ANY arm,
arm yourself
with
these facts

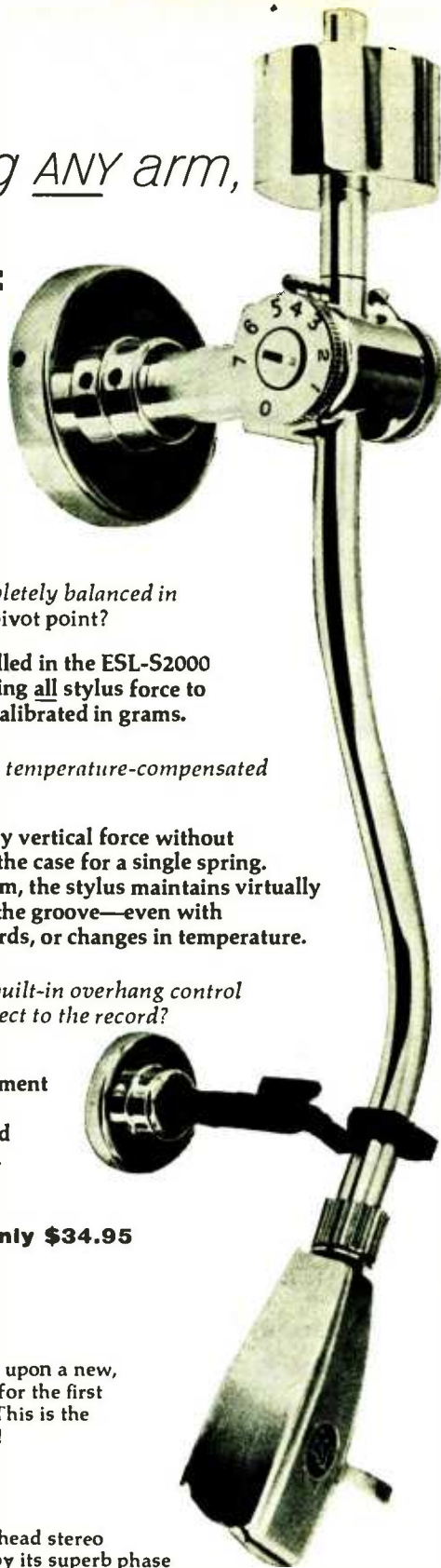

- Q:** Why should a stereo arm be completely balanced in all three planes about a common pivot point?
- A:** All gravitational effects are cancelled in the ESL-S2000 SUPER GYRO/BALANCE arm, permitting all stylus force to be controlled by spring pressure calibrated in grams.
- Q:** Why should a stereo arm use dual temperature-compensated springs to apply stylus force?
- A:** Two springs are necessary to apply vertical force without any sideward thrust, as would be the case for a single spring. In the ESL SUPER GYRO/BALANCE arm, the stylus maintains virtually constant force with both sides of the groove—even with non-level turntables, warped records, or changes in temperature.
- Q:** Why should a stereo arm have a built-in overhang control to adjust stylus position with respect to the record?
- A:** The ESL SUPER GYRO/BALANCE arm permits the exact overhang adjustment necessary with any cartridge, to provide optimum reproduction and reduce distortion and record wear.

See it at your dealer's today—only \$34.95

THE ESL TURNTABLE IS COMING!

Electro-Sonic's ESL-T200 turntable—based upon a new, noise reducing principle—will be unveiled for the first time at the New York High Fidelity show. This is the SMOOTH turntable you've been waiting for!

THE REDHEAD IS HERE!



The triumphant new Redhead stereo cartridge, distinguished by its superb phase control and channel separation, is now available at your dealer's. Only \$14.95, complete with user-replaceable diamond stylus.

ESL® FOR LISTENING AT ITS BEST
Electro-Sonic Laboratories, Inc. • Dept H • 627 Broadway • New York 12, NY

CIRCLE 44 ON READER-SERVICE CARD

House?"; and Mr. Tepfer's article on high fidelity servicing (*HIGH FIDELITY*, July) rang a bell with me. This is a serious problem, and I hope that your magazine will continue to call attention to it.

If your subscribers who live outside a metropolitan area think that they have a corner on service troubles, let them hear this plaint of one who lives within a fifteen-minute subway ride of midtown Manhattan.

I make it a habit to write the manufacturers of components that I own, asking their recommendations for service of their equipment in the New York area. Several of them mentioned a service organization in Manhattan. Consequently, when trouble developed with one of my tape recorders, I decided to take it to this much recommended concern. The problem was that when the function selector was in the "Record" or "Playback" position, the take-up reel would occasionally stop turning, and tape would pile up between the capstan and the take-up reel. Otherwise, the machine was working well.

The service outfit kept the machine for three weeks. The charge was \$37.89, of which \$35 was for labor. And although the specific trouble had been corrected, the machine came back with a new assortment of symptoms involving maladjustments in the braking mechanisms that it had never had before. It is now almost impossible to halt a fast wind without breaking or stretching the tape.

Shortly after this experience I encountered a friend who was fuming about a tape recorder service job on which the charges were even higher than on mine; his machine also came out of the shop in worse condition than it went in. Who did it? The same highly recommended outfit that took me for a ride.

The service organization referred to above probably has an impressive array of test equipment, else it would not be recommended by so many component manufacturers. I have several service jobs that need doing, but I want no more of the outfit that I tried once before. I am willing to pay for really expert service, and I know that such service comes high. Yet here, in the largest city in the world, with hundreds of so-called repair shops for electronic equipment, I don't know where to turn. I hope you will continue to highlight this problem until the manufacturers do something about it.

Joseph H. Chaille
 Brooklyn, N.Y.

Telefunken's "Discovery"

SIR:
 Your Central European correspondent, Kurt Blaukopf, recently mentioned that Telefunken had "discovered" in its

Continued on page 16



ADVANCED CIRCUITRY, INCREASED POWER, DISTINGUISHED DESIGN, ENGINEERING IN THE FISHER TRADITION

A Marvel of Flexibility, and of Simplicity

FISHER X-202-B

75-Watt Stereo Master Control-Amplifier

■ Incorporating all the features normally found only on the most elaborate of separate control units, the FISHER X-202-B combines a remarkably flexible Master Audio Control with a high-powered, dual-channel amplifier having a Music Power Output of 75 watts. Among its outstanding features are, (1) a Stereo Dimension Control, (2) the *exclusive* Fisher Tape Monitoring System that permits the user to

monitor tapes and yet make full use of all controls and switches during playback *without changing cable connections*, (3) two Center Channel Outputs, one permitting a center channel speaker *without an additional amplifier*. With the second, it is possible to install a remote amplifier and speaker, (4) Stereo earphone jack on front panel. **\$249.50**
Fine Walnut or Mahogany Cabinets. **\$24.95**

See us at the New York High Fidelity Music Show, Sept. 14-17, Trade Show Building

Other Fine Stereo Master Control Amplifiers

- FISHER X-1000** 110-Watts
Most powerful control amplifier! **\$329.50**
- FISHER X-101-B** 56 -Watts
Special tape monitoring circuit! **\$189.50**
- FISHER X-100** 36-Watts
Most popular control amplifier! **\$159.50**

USE THIS COUPON

FISHER RADIO CORP. • L. I. CITY 1, N. Y.

Please send FREE literature on the following:

- Complete Specifications on FISHER X-202-B
- Complete Catalogues on FISHER equipment
- Illustrated Custom Stereo Installation Guide

Name _____

Address _____

City _____ State _____

EXPORT: Telesco International Corp., 171 Madison Ave., N. Y. 16, N. Y. • In Canada: Tri-Tel Associates, Ltd.

HF9-2

ELEGANCE, CONVENIENCE AND ECONOMY

IN ACOUSTICAL CABINETRY

for Your High-Fidelity Components



CABINET ENSEMBLE

Model 500-501

Easy way to enjoy an attractive music center with your own choice of famous name high fidelity components. Acoustically-engineered and furniture-crafted. May be placed together or separate—for finer mono or stereo. Easy on your budget, too.



Center Equipment and Record Cabinet (Model 500) is designed to house amplifier and/or preamplifier, tuner, tape recorder, record changer, and transcription table. (See photo at right.) Shelf is adjustable. Blank face panel available. Lower left compartment has space for 150 LP record albums. Sliding doors. Free-Standing Twin Speaker Enclosures (Model 501) permit proper stereo separation or positioning for desired listening in any room. Each houses up to 15" loudspeaker. Also accommodates any size tweeter. Cabinet Ensemble (Model 500-501) is available with base as shown above, or with legs, as shown at right. Choice of Oil Walnut, Hand-Rubbed Mahogany, Blonde, or Ebony finish. (Individual cabinets also available separately.)

BOOKSHELF 8-in. SPEAKER ENCLOSURE



Model 128

Gives you compact utility and sound quality with economy. Acoustically-designed with vented port to enhance reproduction of any 8-in. speaker. Only 9" x 11" x 19". Fits on bookshelf, or may be used horizontally or vertically anywhere else, as initial high-fidelity reproducer or auxiliary unit, or in pairs for stereo. Furniture-crafted and beautifully finished.

Choice of Oil Walnut, Hand-Rubbed Mahogany, Blonde, or Ebony.

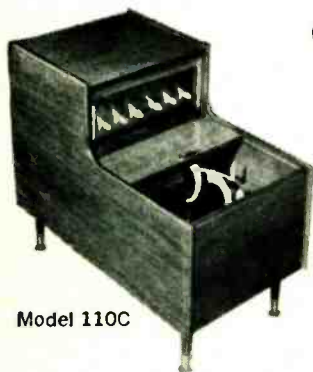

Model 110C

CHAIRSIDE EQUIPMENT CABINET

Provides convenient control of your stereo or mono music system. Smartly furniture-crafted and sturdily built of selected woods to protect the stability of your components. Component section has upper and lower compartments to house amplifier and/or preamplifier or tuner. Lower front section, with blank mounting board, allows ample space and clearance for all makes of record changers. Sliding cover. Choice of Oil Walnut, Hand-Rubbed Mahogany, Blonde, or Ebony finish.

See Your High-Fidelity Dealer or Write Now for Bulletin R-21-H

Most versatile line of high fidelity cabinetry created by specialists in acoustic design and fine furniture manufacture



LETTERS

Continued from page 14

archives recordings by Fritz Heitmann on the Arp Schnitger Organ in the Eosander Chapel at the Charlottenburg Palace (HIGH FIDELITY, May, page 16). I don't know when this information was lost, but it must have been recently, for these recordings were published on 78 rpm as TE-2710/3, and on LP as Capitol-Telefunken P8029, and thus were available in the early 1950s.

A.F.R. Lawrence
New York, N.Y.

Correction and Amplification

SIR:

Robert C. Marsh's article on "The Best of Beecham" in your June issue was an interesting and thoughtful appraisal of Sir Thomas' contribution to the recording art, but he has erred in stating that the Beecham *Messiah* has been deleted from our catalogue. In fact, the *Messiah* recording continues to be a very active catalogue item, and I cannot imagine how Mr. Marsh got the impression that it had been deleted.

Although I disagree with Mr. Marsh's critical comments on the Beecham *Messiah*, I believe that criticism boils down to matters of personal taste and I offer no argument to his views. In this connection, however, it is interesting to read the review of the *Messiah* that appeared in the *Gramophone Magazine*. *Gramophone* says: "There has been nothing like it before and there probably will be nothing like it again. This is not the recording of the month or even the year, but of the century."

Obviously, this statement will not alter Mr. Marsh's opinion, as his comments have not altered my own view. But I would appreciate your advising its readers that the Beecham *Messiah* is very much a part of the RCA Victor catalogue and will continue to be, we hope, for a long time to come.

Alan Kayes
RCA Victor Records
New York, N.Y.

Through an inadvertence, the catalogue numbers of the last Beecham *Messiah* and the conductor's old performance in Victor's LCT series were confused. Mr. Marsh would also like to have it understood that his remarks were not intended as depreciation of the present set, but only as observation to the effect that the score has been reorchestrated, and that the results are controversial.—Ed.



Multiplex Is A PLEASURE, Not A Problem

WITH THE FABULOUS

FISHER MPX-100



AND THE REASON IS

*Stereo
Beacon*

FINDS MULTIPLEX PROGRAMS
AUTOMATICALLY!

THE FISHER MPX-100 CAN BE USED WITH
ALL FISHER TUNERS REGARDLESS OF AGE

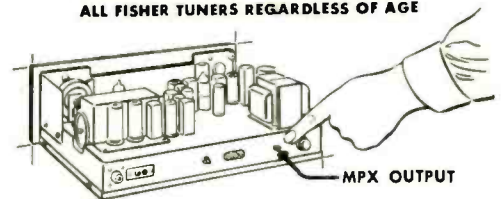

\$89⁵⁰

Fisher engineers tested out production samples of the FISHER MPX-100 on actual, off-the-air Multiplex broadcasts before a single unit was shipped. Reports now pouring in from Fisher MPX-100 users—including radio stations themselves—call it "Superb!" "Excellent!" etc. And every one of these owners has acclaimed the value of STEREO BEACON, the Fisher invention that instantly lights a signal on the front panel when the station is broadcasting in Multiplex, and *automatically* switches from mono to stereo operation. STEREO BEACON eliminates completely the 'try-and-find-the-Multiplex' problem that plagues other adaptors. Remember—only Fisher has STEREO BEACON and your Fisher dealer will be glad to demonstrate the remarkable Fisher MPX-100. See him soon!

USE THIS COUPON

FISHER RADIO CORPORATION
21-25 44th Drive, Long Island City 1, N. Y.

- Please send FREE literature on the following:
- Specifications on the FISHER MPX-100
 - Complete Catalogues on FISHER equipment
 - Illustrated Custom Stereo Installation Guide

Name _____

Address _____

City _____ State _____ HF9-4

EXPORT: Telesco International Corp., 171 Madison Ave., N. Y. 16, N. Y. • In Canada: Tri-Tel Associates, Ltd.

Whether the "take" is for discs or for pre-recorded tapes, nearly all recording companies first capture the newly created performance on SCOTCH® BRAND Magnetic Tape



For the ultimate in fidelity,

use the tape professionals use: "SCOTCH" BRAND!

In the critical job of making "master recordings," where perfect fidelity and wide tonal range are musts, "SCOTCH" BRAND is the performance standard of the industry! Most recording companies specify it exclusively because of its unflinching uniformity. Tapes are held to microscopic tolerances of backing and oxide thickness. This means magnetic properties are identical throughout each reel, and from one reel to another.

Only "SCOTCH" BRAND can draw on 3M's more than 50 years of experience in precision coating techniques. And, all "SCOTCH" BRAND Magnetic Tapes are made with *exclusive* Sili-

cone lubrication that safeguards recording heads, eliminates squeal and extends tape life.

Your dealer can supply you with a "SCOTCH" BRAND Tape for every recording need. Available on 5" and 7" reels in standard and extra-play lengths, with plastic or polyester backing at economical prices. *Play the favorite!*



MINNESOTA MINING AND MANUFACTURING COMPANY



... WHERE RESEARCH IS THE KEY TO TOMORROW

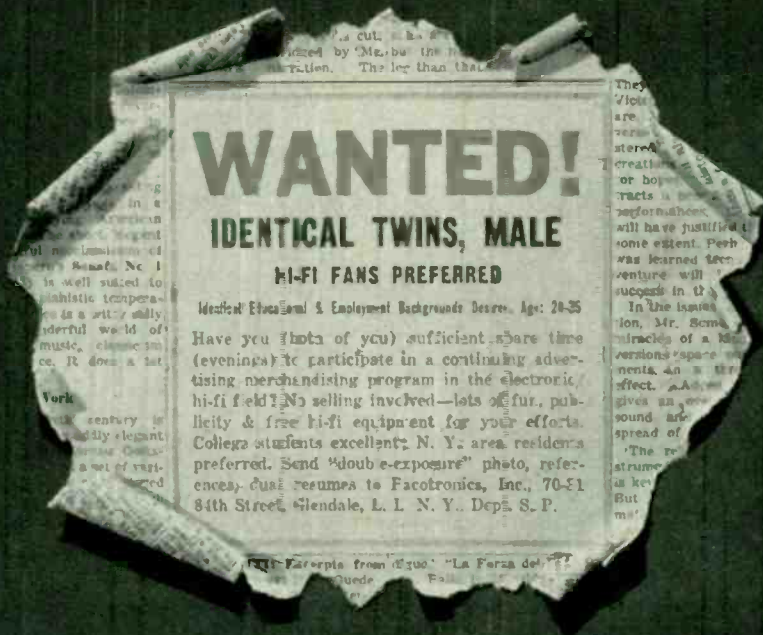

Feb. 5th:

(Paco ran this ad in The New York Times)

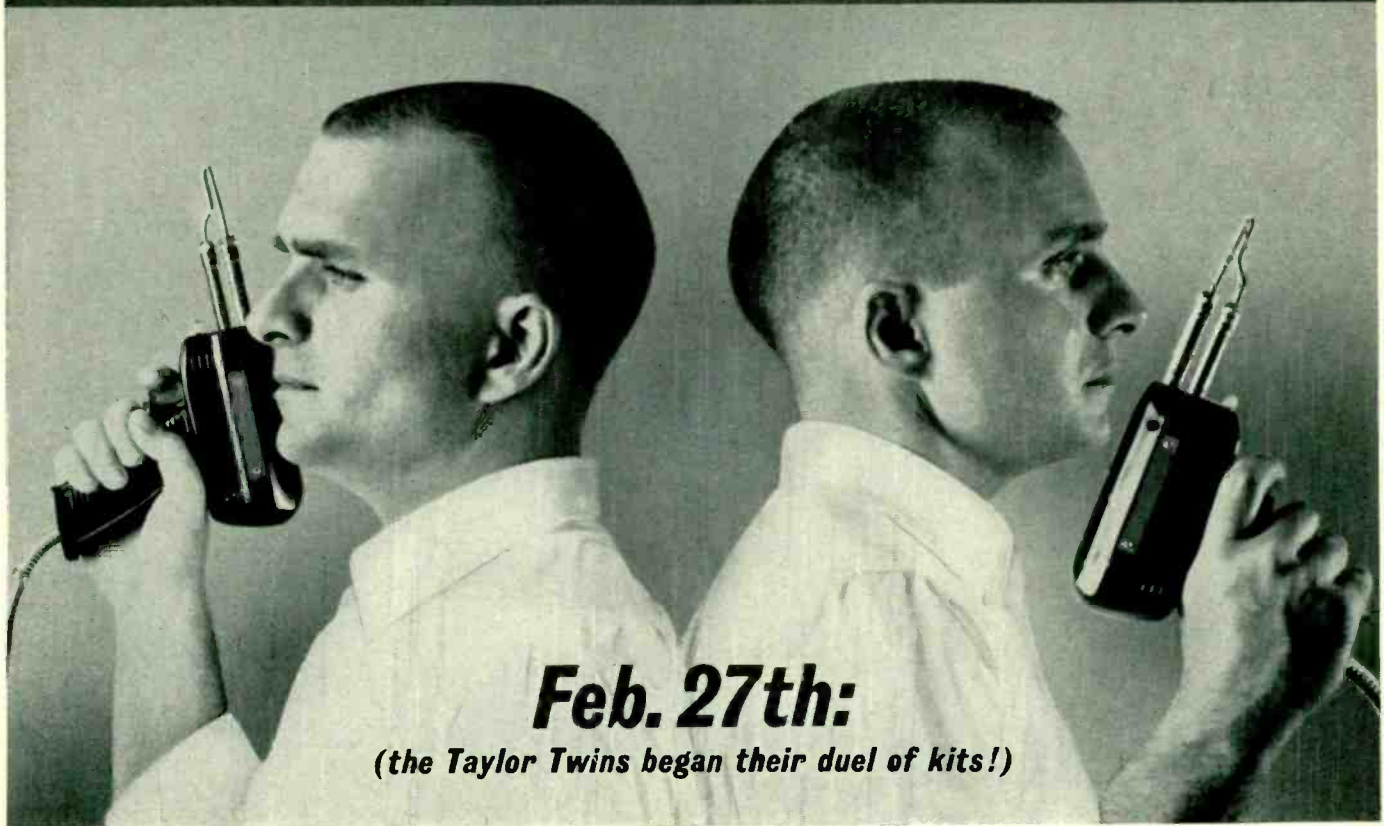

Feb. 27th:

(the Taylor Twins began their duel of kits!)

*Don and Larry Taylor, with twin backgrounds and skills, have competitively built kit after kit, Paco vs. other makes. In one test Don built the Paco, in the next Larry did. Net results: Paco kits proved faster, easier, and better in performance. **For a typical Twin-Test report turn the page.***

HERE ARE JUST A FEW OF
PACO'S NEWEST KITS:



SA-40 STEREO PREAMP-AMPLIFIER: Power: 20W (RMS) per channel, 40W total. Peak, 40W with 80W total. Response: 30 cps to 90 Kc, within 1.0 DB. Distortion: within 0.5% at 20W per channel. Includes: 14 inputs and 14 Panel Controls, black and gold case.
SA-40 Kit with enclosure, "Twin-Tested" operating assembly manual.....\$79.95 net
SA-40W: Factory-wired, ready to operate.....\$129.95 net
SA-50: Stereo Kit as above with different styling, 25w per channel.....TBA*

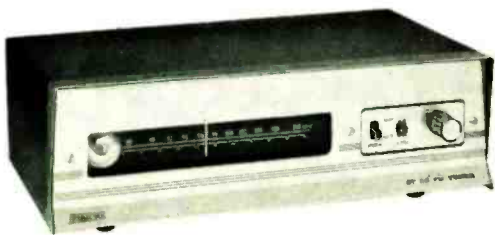

ST-25 FM TUNER: Sensitivity: 1.5 microvolts for 20 DB quieting. Harmonic Distortion: less than 1%. Includes: Dual Limiters, AFC and AFC Defeat, "Eye" type tuning indicator, Multiplex jack. Black and gold case or walnut enclosure at slight extra cost.
ST-25 Kit with fully-wired prealigned front end. "Twin-Tested" manual....\$42.95 net
ST-25W: Factory-wired, ready to operate.....\$59.95 net



FM-TUNER/AMPLIFIER (ST-26) AND SPEAKER (L-3) KIT COMBINATION: This low-cost component high fidelity FM radio system is ideal for professional offices, dens, basement playrooms, stores, etc. They're fun to build thanks to Paco's "Twin-Tested" operating assembly manual.
ST-26 FM Tuner/Amplifier is similar in specification to the ST-25 (above), but contains compact amplifier with phono input. As a kit, with fully-wired prealigned front end. Handsome black and gold case or walnut enclosure at slight extra cost....\$54.95 net
ST-26W: Factory-wired, ready to operate.....\$69.95 net
L-3 Speaker Semi-Kit: Complements the ST-26 in size and appearance. Lifelike response from ultra-compact, high efficiency speaker in walnut finished cabinet.....TBA*



L-2 2-WAY BOOKSHELF SPEAKER SEMI-KIT: A long-excursion 10" Jensen woofer and Jensen compression horn-type tweeter in solid, acoustically-crafted factory-built cabinet for vertical or horizontal mounting. Response: 45 cps to 15 Kc; Nominal Impedance: 8 ohms overall. Includes: Adjustable Brilliance Control; Built-In Crossover Network.
L-2U Semi-Kit: Unfinished. Complete with "Twin-Tested" operating assembly manual.....\$59.95 net
L-2F Semi-Kit: Walnut finish on all four sides. Complete with "Twin-Tested" operating assembly manual....\$69.95 net

DF-90 TRANSISTORIZED DEPTH FINDER KIT: Protect your boat against shoals and underwater hazards with this compact, easy-to-read depth finder. Locates hard-to-find schools of fish, too. A low cost safety device for every boat owner.
Fully Transistorized: 5 transistors, low battery drain for very long battery life.
Fast, Easy Readings: over-sized scale with 1-ft. calibrations from 0-120 ft.
DF-90 Kit: Complete with "Twin-Tested" assembly operating manual...\$84.50 net
DF-90W: Factory-wired\$135.50 net

*Price to be announced

"I built the Paco SA-40 Stereo Preamp Amplifier."

Larry Taylor, 8 Stevens Place, Huntington Station, N. Y. "It took me one-third less time to build the Paco kit than it took Don to make the almost identical preamp-amplifier by another kit maker. But it wasn't just the time; it was knowing you're using the right part, and that you understand the instructions completely. Paco parts are all pictured and labelled, the resistors are neatly mounted on cards for easy identification. And Paco's instruction book doesn't leave you guessing. The fold-out diagrams and drawings are always right beside the instructions, so you're not reading one part of the book and following a diagram in another part. Photographs in Paco's book show how each assembly should actually look. I enjoy building Paco kits, because I wasn't wasting time or worrying."

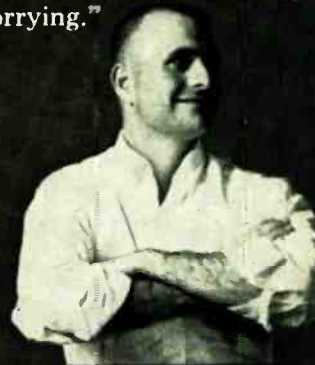

"I built a competing Stereo Preamp Amplifier."

Don Taylor, 39 Cross Street, Smithtown, N. Y. "Neither Larry nor I are speed demons because we're very meticulous about wiring and soldering. So I was even more surprised when it took me 50% more time to finish my kit. My problem began when I tried to separate the parts. The resistors were in boxes, but not in any logical way: identical resistors often wound up in different boxes. The instruction book was clumsy to work from. It caused wasteful mistakes. Once I lost 20 to 25 minutes because I misread a tiny key letter that meant not to solder a certain connection. A lot of the fun of kit-building was lost when I had to spend time making up for shortcomings of the packaging and the instruction manual."



CENSORED

THE PACO KITS YOU WANT ARE AT THESE DISTRIBUTORS:

- ALABAMA**
Anniston Southeastern Radio Parts
Gadsden Southeastern Radio Parts
Mobile Emrich Radio Supply
Montgomery Southeastern Radio Parts
Selma Southeastern Radio Parts
- CALIFORNIA**
Bellflower Grant Electronics
Berkeley Electronic Suppliers
Long Beach R. C. & L. F. Hall, Inc.
Los Angeles L. A. Electronic Supply
Mountainview Ray-Tel Industrial Co.
Palo Alto Peninsula Electronics Supply
Zack Electronics
Pasadena Dow Radio, Inc.
Reseda Dulco Sound Systems
Sacramento Lombards Electronics
Salinas Peninsula Electronics Supply
San Diego Silvergate Radio Supply
San Francisco Market Radio Supply Co.
Zack Electronics
San Jose Electronic Center
Peninsula Electronics Supply
San Jose T. V. Supply
Schad Electronic Supply
United Radio & T. V.
San Mateo San Mateo Elec. Supply Co.
Sunnyvale Sunnyvale Electronics
Vallejo Electronics' Best Buy
Whittier Hi-Fi Haven
- COLORADO**
Denver Electronic Parts Company
- CONNECTICUT**
Bridgeport Hatry Electronic Enterprises
Hartford Del Padre Supply of Hartford
Hatry Electronic Enterprises
Signal Electronic Center
Seeli Electronics
New Britain United Electronics
New Haven American Television, Inc.
Hatry Electronic Enterprises
Norwich Aikens Electronic Supply Inc.
Waterbury Hatry Electronic Enterprises
- Parts Unlimited Stores
See your classified phone directory
- FLORIDA**
Daytona Beach Hammond Electr., Inc.
Jacksonville Hammond Electronics, Inc.
Kinkade Radio Supply
Lakeland Hammond Electronics, Inc.
Melbourne Electr. Wholesalers, Inc.
Miami Electronic Equipment Co., Inc.
Electronic Wholesalers, Inc.
Herman Electronics
Orlando Hammond Electronics, Inc.
Tampa Hammond Electronics, Inc.
Kinkade Radio Supply
Thurow Electronics
- GEORGIA**
Athens Southeastern Radio Parts
Atlanta Southeastern Radio Parts
Gainesville Southeastern Radio Parts
La Grange Southeastern Radio Parts
Rome Southeastern Radio Parts
Savannah Southeastern Radio Parts
- ILLINOIS**
Champaign Electronic Parts Co.
Chicago Arthur Nagel Inc.
Irving Joseph, Inc.
U. S. Radio & T. V. Supplies
Joliet Mainline Industrial Supply Co.
- INDIANA**
Bloomington H. A. Williams Co.
Columbus H. A. Williams Co.
Indianapolis Graham Elec. Supply Inc.
Meunier Electronic Supply Co.
Van Sickle Radio Supply Co.
Lafayette Lafayette Radio Supply
Muncie Muncie Electronic Supply
Richmond H. A. Williams Co.
- KENTUCKY**
Lexington Radio Electronic Equip. Co.
Louisville P. J. Burks Co.
- MARYLAND**
Baltimore Hi-Fi Shops
Hagerstown Zimmerman Wholesalers
Wheaton Key Electronics
- MASSACHUSETTS**
Brockton Tee Vee Supply Co.
Chelsea Lektron, Inc.
Holyoke Kathleen Smith Music Shop Inc.
Jamaica Plain Tee Vee Supply Co.
Milford Tee Vee Supply Co.
Peabody Tee Vee Supply Co.
Springfield Del Padre Music Shop Inc.
Del Padre Supply of Springfield
- MICHIGAN**
Battle Creek Electronic Supply Corp.
Dearborn Hi-Fi Studios, Inc.
Detroit Hi Fidelity Workshop
Hi-Fi Studios, Inc.
Radio Specialties Co.
Grosse Pointe Hi Fidelity Workshop
Kalamazoo Electronic Supply Corp.
Pontiac Hi Fidelity Workshop
Wyandotte Hi Fidelity Workshop
Radio Specialties Co.
- MINNESOTA**
Minneapolis Ken Craft Hi-Fi
St. Paul Electronic Market
- MISSOURI**
Kansas City McGee Radio Co.
St. Louis Olive Electronic Supply
- NEBRASKA**
Scotts Bluff Tri State Electronics Inc.
- NEW HAMPSHIRE**
Concord Evans Radio
- NEW JERSEY**
Bergenfield Arnco T. V. Parts Corp.
Hackensack Emsco Electronics Inc.
Morris Plains Park Electronic Corp.
Newark Terminal-Hudson
North Bergen Arnco T. V. Parts Corp.
Passaic Ed's Electronics Inc.
Princeton Sun Radio & Electronics Co.
Springfield Disco Electronics, Inc.
Westwood Arnco T. V. Parts Corp.
- Parts Unlimited Stores
See your classified phone directory
- NEW MEXICO**
Los Alamos Valley Engineering Co.
- NEW YORK**
Bayside Snyder Electronic Dists. Inc.
Brooklyn Witmal Electronics
Benray Electronic Distributors
Bronx Adamson Electronic Corp.
Elmont Great Eastern Mills-Electronics
Hempstead Newmark & Lewis
Jamaica Harrison Radio Corp.
Peerless Radio Dist. Inc.
Long Island City Electronics Supply Corp.
Mineola Arrow Electronics Inc.
New Hyde Park Dressner Audio Sales Co.
New York City Adson Electronics
Arrow Electronics
Dale Electronics Co.
Grand Central Radio
Harrison Radio Corp.
Hi Fidelity Center
Magic Vue Television Corp.
Magna Electronics Co.
Sun Radio & Electronics Co.
Terminal-Hudson
Wilmar Distributors Corp.
Zalytron Tube Corp.
Rochester Rochester Radio Supply Co.
Scheneclady Grimmers Elec. Parts Sup.
Syracuse Syracuse Radio Supply Co.
- Parts Unlimited Stores
See your classified phone directory
- NORTH CAROLINA**
Concord Mac Victor Electr. Supply Inc.
- OHIO**
Columbus Whitehead Radio Co.
Cincinnati United Radio, Inc.
Dayton Srecco Inc.
Toledo Lifetime Electronics
Warren Radio Co.
Warren Valley Electronics
Youngstown Armies Electronics
- PENNSYLVANIA**
Allentown A. A. Peters, Inc.
Charlertown Barno Radio Co.
Erie Mace Electronics
Harrisburg Electronic Wholesalers, Inc.
Radio Distributing Co.
McKeesport Barno Radio Co.
New Brighton Television Parts Co., Inc.
Pittsburgh House of Audio
Metropolitan Distributors, Inc.
Opus One
Reading George D. Barbey Co.
State College Alvo Electronics Dist. Inc.
Tarentum Huston TV Parts Co.
Wilkes-Barre General Radio & Elec. Co.
- RHODE ISLAND**
Providence Electronic Distributors, Inc.
- SOUTH CAROLINA**
Columbia Hi-Fi Sound & Records Co.
Southeastern Radio Parts
- SOUTH DAKOTA**
Rapid City Dakota Electronics
- TENNESSEE**
Chattanooga Curle Radio Supply
Nashville Electra Distributing Co.
- TEXAS**
Abilene R & R Electronics Co.
Amarillo R & R Electronics Co.
Austin Modern Electronics Co.
Service Electronic Supply
Bay City R. C. & L. F. Hall, Inc.
Baytown R. C. & L. F. Hall, Inc.
Beaumont R. C. & L. F. Hall, Inc.
Conroe R. C. & L. F. Hall, Inc.
Corpus Christi Modern Electronics Co.
Denison Denison Radio Supply
Freepport R. C. & L. F. Hall, Inc.
Galveston Electrofax
R. C. & L. F. Hall, Inc.
Houston Electrofax
Gilbert Co.
R. C. & L. F. Hall, Inc.

(Continued on next page) →

BUILD A HI-FI MUSIC WALL! Don Brann's new book *How to Build a Hi-Fi Music Wall* gives you step-by-step instructions for building a decorator styled cabinet or an entire music wall. Send 50c and your name and address to: PACOTRONICS, INC., Dept. HF-9 70-31 84th Street, Glendale 27, New York.

PACO DISTRIBUTOR LIST (cont'd.)

TEXAS (Continued)

Midland R & R Electronics Co.
Odessa R & R Electronics Co.
Pasadena R. C. & L. F. Hall, Inc.
San Angelo R & R Electronics Co.
San Antonio Modern Electronics Co.
Sherman Electronics Supply Inc.
Texas City Electrolex
R. C. & L. F. Hall, Inc.
Wichita Falls R & R Electronics Co.

WASHINGTON

Seattle Empire Electronic Supply Inc.
Northgate Cameras
Pacific Electronic Sales Co., Inc.
Radio Products Sales Co., Inc.
Spokane E. M. Johnson Co.
Tacoma Branham Hi-Fi
Sound Center

WASHINGTON, D. C.

Elec. Wholesalers, Inc.
Rucker Electronic Products Inc.
Arlington, Va., Key Electronics
Rucker Electronic Products Inc.
College Park, Md. Rucker Elec. Prod. Inc.
Silver Spring Rucker Elec. Prod. Inc.
Silver Spring Electronic Supply

WISCONSIN

Milwaukee Acme Radio Supply
West Allis Hi-Fi Salon

EXPORT:

Morhan Exporting Corp., New York, N. Y.

CANADA:

Atlas Radio Corp., Toronto, Ontario

**PACO
KITS BY**



PACOTRONICS

For free illustrated PACO catalog write:

Paco Electronics, Dept. HF-9
70-31 84th Street, Glendale 27, N. Y.
A subsidiary of PACOTRONICS, INC.

CIRCLE 79 ON READER-SERVICE CARD

Coming:

STEREO

1962 Edition

The third annual
roundup of the lat-
est developments in
stereo and a glimpse
of the future.

For details see
the announcement in
next month's
HIGH FIDELITY.

Anna Moffo

Meet a new Italian

opera star from

Wayne, Pennsylvania



ANNA MOFFO, whose last season's Metropolitan debut in *La Traviata* caused a sensation of the sort that does not happen every year, is a young woman who gives the impression of possessing the vigor and the gifts to reach any goal she cares to set herself. This I comment on only because, having heard reports of the melting delicacy of her Violetta, a role which she sings with an almost introspective tenderness, I was somewhat unprepared to encounter the commanding figure Miss Moffo turned out to be. She told me that while growing up (in Wayne, Pennsylvania) her main interest had been not singing but hockey, and it is easy to see that she would have made a good front line player: she is tall and broad-shouldered, moving with the decisiveness of an athlete and the grace of a professional actress.

Fortunately, hockey lost its hold on Anna Moffo when she won a Curtis Institute scholarship, with almost no previous training and with only one aria, "*Un bel di*," thoroughly in hand. In 1955 she went to Italy on a Fulbright fellowship, and from that point on matters moved very quickly. Her first stop was Venice; while she was there an Italian soprano scheduled to sing several Casella songs in concert fell ill, and no local singer could sight-read well enough to take her place. Miss Moffo, however, *could* sight-read ("there is much better training in things like that in the United States") and did so, with great success. After Venice came Rome, where—almost simultaneously—she "found a marvelous husband" and became a celebrity practically overnight.

The occasion for both events was a Rome television production of *Madama Butterfly*. When Miss Moffo arrived at the studio for the audition, the dramatic director took one look at her statuesque frame, shook his head firmly, and walked out of the room. Exactly what happened after that is a little vague, as Miss Moffo tells it, but within three days she had the role and was engaged to the director. "It happened very fast," she admits. "We went to a movie. Have you ever been to an Italian movie house? It is

bound to lead to something." Her husband, who has a Ph.D. in law but prefers dramatics, continues his work in Rome while his wife pursues her career. "I'm glad he doesn't follow me around," she said. "It is much better for him to keep up his work there."

It would be quite a chore, in fact, to follow Miss Moffo around, for she has made it plain that she intends to keep moving. She does not want any single opera house to become "home," and prefers singing the same opera in different houses to giving many performances of it in any one of them: in this way a role matures, she feels. There is also another reason, about which she is quite frank. A singer is most appreciated when she is not too readily available. With invitations from every major opera house in the world, an artist in Miss Moffo's position can afford to be choosy; bearing in mind, perhaps, the fate of some other prima donnas who have relied too confidently on the affection of a home audience and found themselves eventually out in the cold, Miss Moffo is not going to run the risk of becoming an old shoe.

Having already, at an age in the neighborhood of twenty-six, sung in many different productions on many different stages, Anna Moffo has had a chance to evaluate the operatic scene on a broad scale, and one shortcoming she has encountered everywhere particularly disturbs her. "Singers are such awful hams on stage. What we really need to do is loosen up and *act*. This is true in Europe more than in the United States—Italy is the worst of all." The "we" on Miss Moffo's part was purely editorial, for one of the notable things about her interpretation of both Violetta and Gilda in New York was the sensitiveness with which she portrayed the whole character—accomplished by skillful acting in addition to sheer vocal finesse. "Well, I try, but particularly hard in Europe," she said. "And I don't believe in this Stanislavski business . . . you have to project, all right, but you

Continued on page 24

NOW... a Norelco 'Continental' Tape Recorder for every application



the
Norelco[®]

CONTINENTAL '400'

guild-crafted by Philips of the Netherlands

- ◆ FOUR-TRACK STEREOGRAPHIC RECORDING AND PLAYBACK ◆ FOUR-TRACK MONOPHONIC RECORDING AND PLAYBACK ◆ THREE TAPE SPEEDS — 1 $\frac{1}{4}$, 3 $\frac{1}{4}$ AND 7 $\frac{1}{2}$ IPS ◆ COMPLETELY SELF-CONTAINED, INCLUDING DUAL RECORDING AND PLAYBACK PREAMPLIFIERS, DUAL POWER AMPLIFIERS AND TWO NORELCO WIDE-RANGE LOUDSPEAKERS (SECOND IN LID) ◆ CAN ALSO BE USED AS A QUALITY STEREO HI-FI REPRODUCING SYSTEM WITH TUNER OR RECORD PLAYER ◆ FACILITY FOR MIXING PHONO AND MIKE INPUTS ◆ HEAD-GAP WIDTH — .00012" ◆ FREQUENCY RESPONSE—50 TO 18,000 CPS AT 7 $\frac{1}{2}$ IPS ◆ WOW AND FLUTTER—LESS THAN .15% AT 7 $\frac{1}{2}$ IPS ◆ SIGNAL-TO-NOISE RATIO—48 DB OR BETTER ◆ CROSS-TALK — 55 DB ◆ SIMPLE PUSH-BUTTON PIANO-KEY CONTROLS ◆ RUGGED ◆ PORTABLE ◆ STYLED BY THE CONTINENT'S TOP DESIGNERS

For a convincing demonstration of all of the features that make the Continental '400' the immediate delight of the discriminating music lover, visit your favorite hi-fi center, or photo dealer, or write for your free copy of our illustrated brochure giving all details on the Norelco tape recorders shown here *plus* loudspeakers, record changers and other quality Norelco high fidelity components.



A Norelco dual element stereo-dynamic microphone is standard equipment with the CONTINENTAL '400'

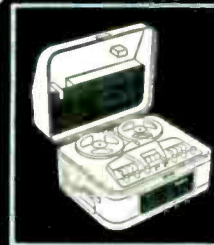

EVERY CONTINENTAL '400' is completely self-contained including 2 Norelco wide range loudspeakers (2nd in lid), dual power amplifiers and dual recording and playback preamplifiers.

- COMPARE**
the special features...
- LOOK**
at the low prices...
- LISTEN**
to the matchless quality...
- CHOOSE**
the Norelco 'Continental'
tape recorder designed
especially for you!

CONTINENTAL '300' TAPE RECORDER (EL3542)

- ◆ 4-track stereo playback ◆ 4-track mono record-playback ◆ 3-speeds ◆ completely self-contained ◆ mixing facilities ◆ 'sound-on-sound' button ◆ suitable for use as a phono/P.A. system ◆ can also play through external hi-fi system ◆ dynamic microphone.



CONTINENTAL '200' TAPE RECORDER (EL3541)

- ◆ 4-track mono record and playback ◆ facilities for 4-track stereo playback ◆ lightweight, compact ◆ mixing facilities ◆ high-quality microphone ◆ 'sound-on-sound' trick button ◆ can also play through external system ◆ self-contained phono/P.A. system.



CONTINENTAL '100' TAPE RECORDER (EL3585)

- ◆ transistorized, battery portable ◆ records/plays back anywhere, 2 hours on 4" reel ◆ tapes interchangeable with 'Continental's' '400' and '300' ◆ rugged, lightweight, simple to use ◆ response 100-6000 cps ◆ complete with speaker and quality microphone.



NORTH AMERICAN PHILIPS COMPANY, INC. High Fidelity Products Division 230 Duffy Avenue, Hicksville, L.I., N.Y.

CIRCLE 77 ON READER-SERVICE CARD

www.americanradiohistory.com

must listen to yourself at the same time. "There are times on stage when being able to act is a godsend. If I'm standing next to a tenor with a frog in his throat—and I can't tell you what it feels like to stand there while someone is in trouble—I want to do anything, turn cartwheels, to divert attention. The audience doesn't leave saying how good the soprano was, you know; they say how awful the tenor was.

"Of course acting is much easier if the character is at least intelligent. But take somebody like Micaëla—can you honestly think of anyone more obnoxious? And Gilda! But costumes help. They make a great difference; and if I don't feel right about the dress I'm wearing, I can't really get into a part. Even when I'm recording I try to wear to the studio the kind of clothes that seem to suit the character."

Having arrived at the subject of records, Miss Moffo did not hide the fact that her feelings about them are mixed. "I was keen about stereo at first, but it makes recording awfully difficult. You can sing much better if you're standing still. If something goes wrong on stage, it usually happens while you're moving, and the purpose of a record is to do better than a live performance. When you have to walk around among microphones, it's that much harder.

"You may not have thought of this, but records have made a singer's career much more difficult than it used to be. The perfection of a record can't be equaled in any one stage performance. Your fans memorize every note on the record and then come backstage after a live performance and say, 'But why did you take a breath in such-and-such a phrase? You never did before.' It means you have to stay *ahead* of your records. So far, I've been able to. I listen, sometimes, to older records I've made and think, how terrible, how could I have done that!"

However critical Miss Moffo may be of past recordings (and I have yet to hear of an artist who isn't), they have only contributed to the reputation which is spreading on all sides. But as for the singer's own views on fame: "I still don't believe it," she says. "I'm hanging on to the end of the train."

SHIRLEY FLEMING

High Fidelity, September, 1961, Vol. 11, No. 9. Published monthly by The Billboard Publishing Co., publishers of Billboard Music Week, Vend. and Amusement Business. Telephone: Great Barrington 1300. Member Audit Bureau of Circulation.

Editorial Correspondence should be addressed to The Editor, High Fidelity, Great Barrington, Mass. Editorial contributions will be welcomed. Payment for articles accepted will be arranged prior to publication. Unsolicited manuscripts should be accompanied by return postage.

Subscriptions: Subscriptions should be addressed to High Fidelity, Great Barrington, Mass. Subscription rates: United States, Possessions, and Canada, 1 year, \$6; 2 years, \$11; 3 years, \$15; 5 years, \$20. Elsewhere \$1 per year extra. Single copies 60 cents.

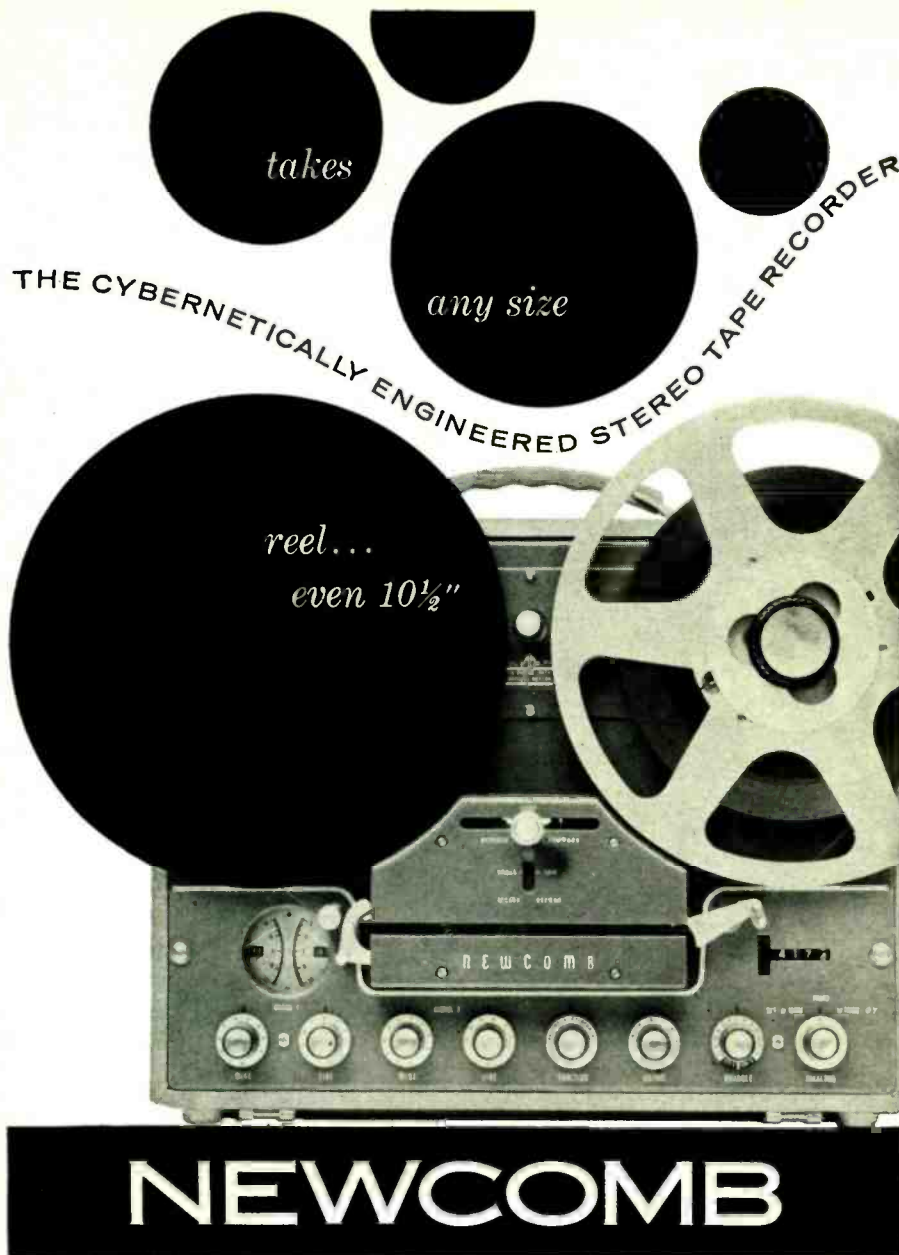

NEWCOMB

MIXING CONTROLS
2 INPUTS EACH CHANNEL
CANNON SOCKETS
AUTOMATIC SHUT-OFF
TWO SPEEDS—7½ or 3¾
NAB HUB EQUIPPED
DUAL-ACTING TENSIONER
PLUG-IN TRANSFORMERS
MONITOR WHILE RECORDING
POINTER-TO-POINTER LEVEL METERS
4-DIGIT COUNTER
INTERLOCKED FUNCTION SWITCH
POWERFUL, COOL-RUNNING, FULLY-SYNCHRONOUS MOTOR

Why is Newcomb's Model SM-310 *the most wanted* stereo tape recorder? Many reasons. One of the first attractions is the fact it takes any size reel including 10½". Then, as acquaintance grows, you become increasingly impressed with its natural ease of operation. Controls are logically arranged. The natural thing to do is the right thing to do. Tape transport is governed by a central joystick. There is now a pause-edit position between "stop" and "play." And this is just one of the features planned with *you*, the operator, in mind. Lighted volume level meters are arranged pointer-to-pointer. The counter displays *four* digits. Tape is loaded easily—in a straight line without looping or threading. And it's so easy on tape...no stretching...no jerking even though the machine reaches playing speed instantaneously. You can operate the Newcomb recorder in any position—vertical or horizontal. All necessary preamplification is built in along with a balance control and ganged volume control. Available in either half-track (SM-310) or quarter-track (SM-310-4) models. The latter records quarter-track and plays back either quarter- or half-track. Matching power amplifier and reproducers are also offered. Learn all the details in your free copy of Bulletin SM-3. Write for yours today.

NEWCOMB AUDIO PRODUCTS COMPANY
Dept. W-9 6824 Lexington Avenue, Hollywood 38, California

CIRCLE 76 ON READER-SERVICE CARD

NO TOOLS . . . NO CONTROLS . . . NO SWITCHES . . . NO PROBLEMS . . .

FM MULTIPLEX RECEPTION AUTOMATICALLY WITH AMAZING PILOT 200



THE AUTOMATIC ANSWER TO FM MULTIPLEX RECEPTION—THE PILOT 200 MULTIPLEXER

The great beauty of stereophonic music till now has been confined to records or tape. NOW, with the Federal Communications Commission ruling on April 19th, 1961, all this great music can be broadcast over the air-waves. The Pilot 200 automatic Multiplexer is the easiest way to enjoy the new stereo Multiplex broadcasts. All connections are external, made with jack cords that simply plug in place. No controls. All switching is done automatically—when the tuned-to station is broadcasting stereo, the Indicator Light goes on and the Multiplexer automatically switches to stereo reception. And, it will not affect reception of monaural FM. Completely self powered. Measures 5" high x 3" wide x 14" long. Contains three tubes plus one rectifier. Housed in an attractive black and brass enclosure designed to match Pilot components. Complete with enclosure **\$7950**

PILOT 100 SEMI-AUTOMATIC FM MULTIPLEXER!

Completely self powered with only one operational control—a simple slide switch to put the Multiplexer into or out of the circuit. All connections can be made externally. Contains two tubes and one rectifier. Dimensions 5" high x 3" wide x 9" long in handsome black and brass styling. Complete with enclosure **\$4950**



FOR COMPLETE TECHNICAL INFORMATION ON THE PILOT 200 AUTOMATIC FM MULTIPLEXER OR THE PILOT 100 SEMI-AUTOMATIC FM MULTIPLEXER, PLEASE FILL OUT AND MAIL COUPON.

Pilot RADIO CORPORATION. 37-16 36th Street, Long Island City 1, N. Y.

Please send me complete information on both Pilot FM Multiplexers. I presently own a (make & model) _____

_____ Tuner or Receiver.

Name _____

Address _____

City _____ State _____

CIRCLE 81 ON READER-SERVICE CARD

announcing

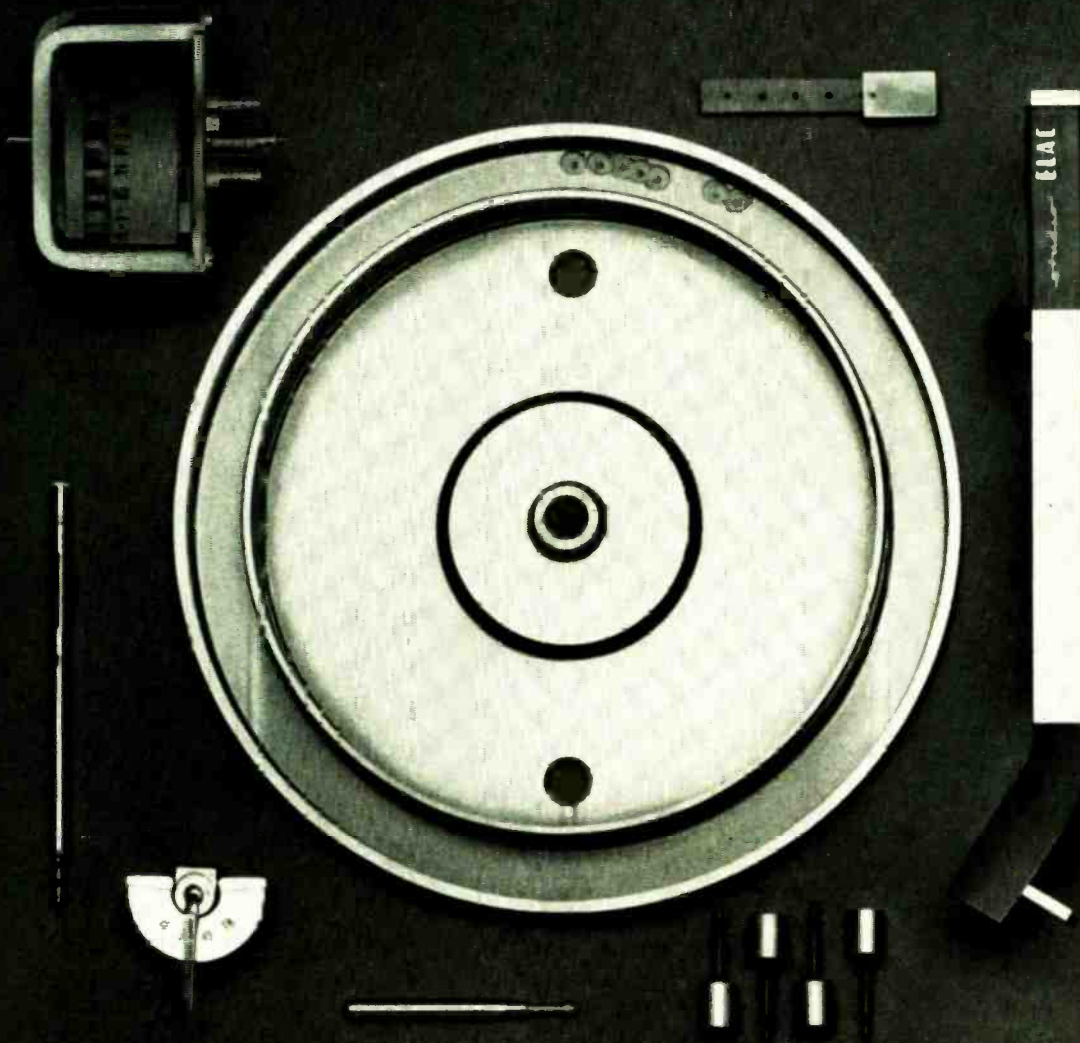

the new **MIRA**

...the first and only automatic turntable and record changer designed to meet the uncompromising requirements of stereophonic record reproduction. The heart of the finest record reproduction equipment is the constant speed hysteresis synchronous motor. This is the heart of the new MIRACORD STUDIO H. Equally outstanding is the one piece, dynamically balanced, seven pound, cast and machined 12" turntable . . . another assurance of uniform speed. The scientifically designed, professional type tone arm with plug-in head is non-resonant and free in all planes. It tracks faultlessly at recommended tracking weights . . .



CORD

The arm is mass balanced and no springs are used. The 4-speed MIRACORD plays all size records as a conventional turntable, an automatic turntable or as an automatic record changer.

STUDIO H with hysteresis synchronous motor — **\$99.50.*** Where line voltage variation is not a problem the **STUDIO** with heavy-duty, shaded 4-pole motor will provide uncompromising stereo performance — **\$79.95.***

*Complete with arm, less cartridge and base.

BENJAMIN ELECTRONIC SOUND CORP., 97-03 43rd Ave., CORONA 68, N.Y.



NEW ROBERTS 1040 TAPE RECORDER

brings professional stereo within reach of millions!

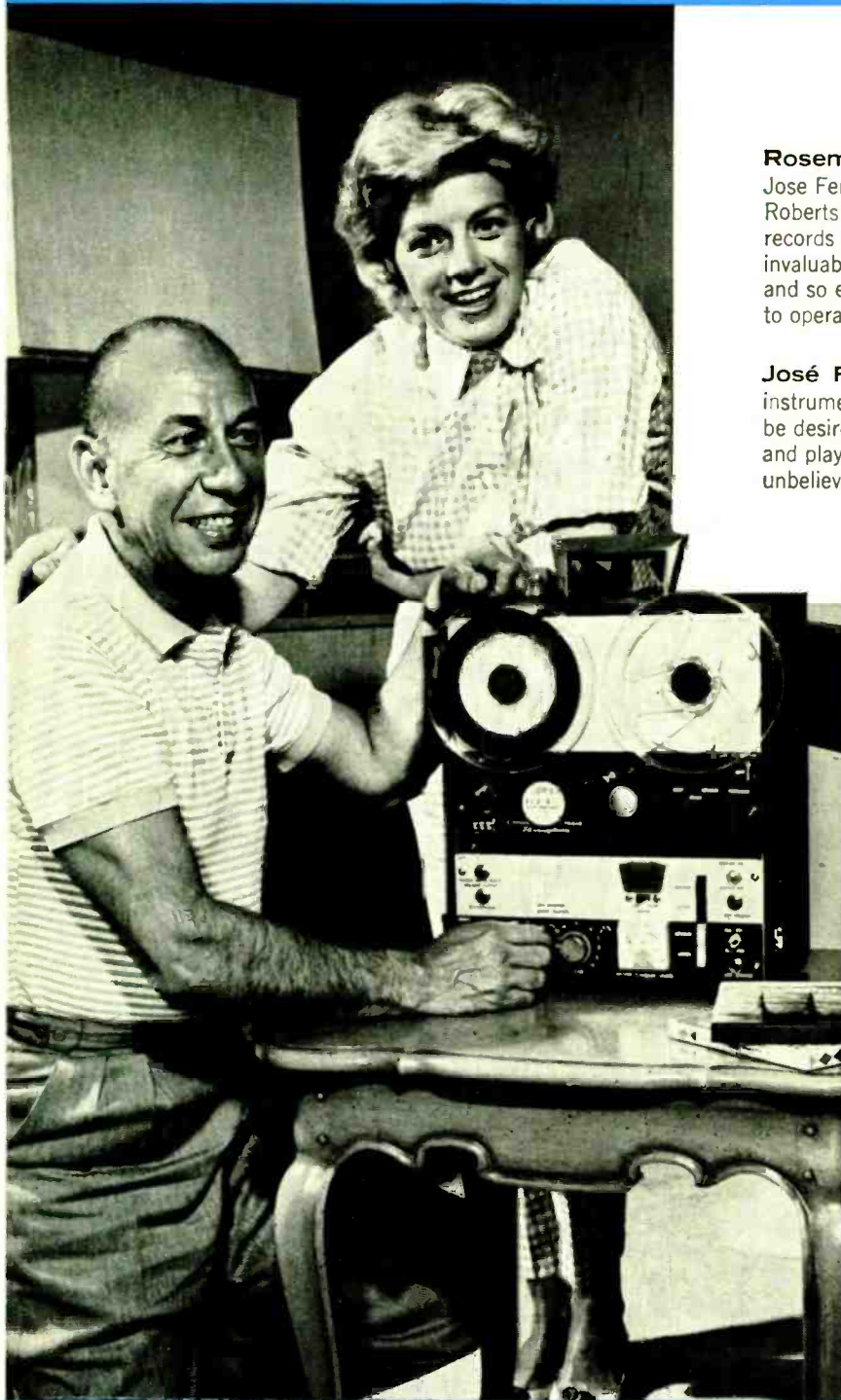

Rosemary Clooney (Mrs. Jose Ferrer) says, "I love my Roberts because it plays and records so beautifully. It's invaluable to me for rehearsal and so easy — easy — easy to operate!"

José Ferrer says, "This instrument leaves nothing to be desired in terms of recording and playback quality. It's really unbelievable at \$299.50."

ONLY THE ROBERTS "1040" STEREO TAPE RECORDER

combines these advanced features:

- Records New FM MULTIPLEX STEREO CASTS.
- 4 track stereo and monaural record/play.
- 2 track stereo and monaural play.
- Sound-with-sound, using either track as basic track.
- Dual, self contained power stereo amplifiers.
- Dual built-in extended range stereo speakers.
- Dual microphone inputs.
- Dual phono/radio inputs.
- Dual pre-amp and external speaker outputs.
- Push button function switches.
- Automatic shut-off.
- Automatic muting on rewind
- Professional edit lever.
- Professional VU meter with channel switch.
- Professional index counter.
- Dual concentric volume and tone knobs with clutch controlled balance.
- Tape Speeds: 3¾ IPS, 7½ IPS (Conversion Kit for 15 IPS Available)

\$299.50

ROBERTS ELECTRONICS, INC.
5920 Bowcroft Ave., Los Angeles 16, Calif.

Roberts Electronics, Inc. Dept. RF-9-L
5920 Bowcroft Ave., Los Angeles 16, Calif.

Please send me:

Roberts Stereo Tape Information Kit containing 39 stereo and monaural applications. I enclose 25¢ (cash, stamps) for postage and handling.

The name of my nearest dealer.

I want a free, no-obligation demonstration.

Name _____

Address _____

City _____ State _____

Get the reasons why ROBERTS Tape Recorder pays for itself! Send for this booklet now:

Manufacturers of Roberts Sonic-Thesa Dental and Medical Equipment

CIRCLE 89 ON READER-SERVICE CARD

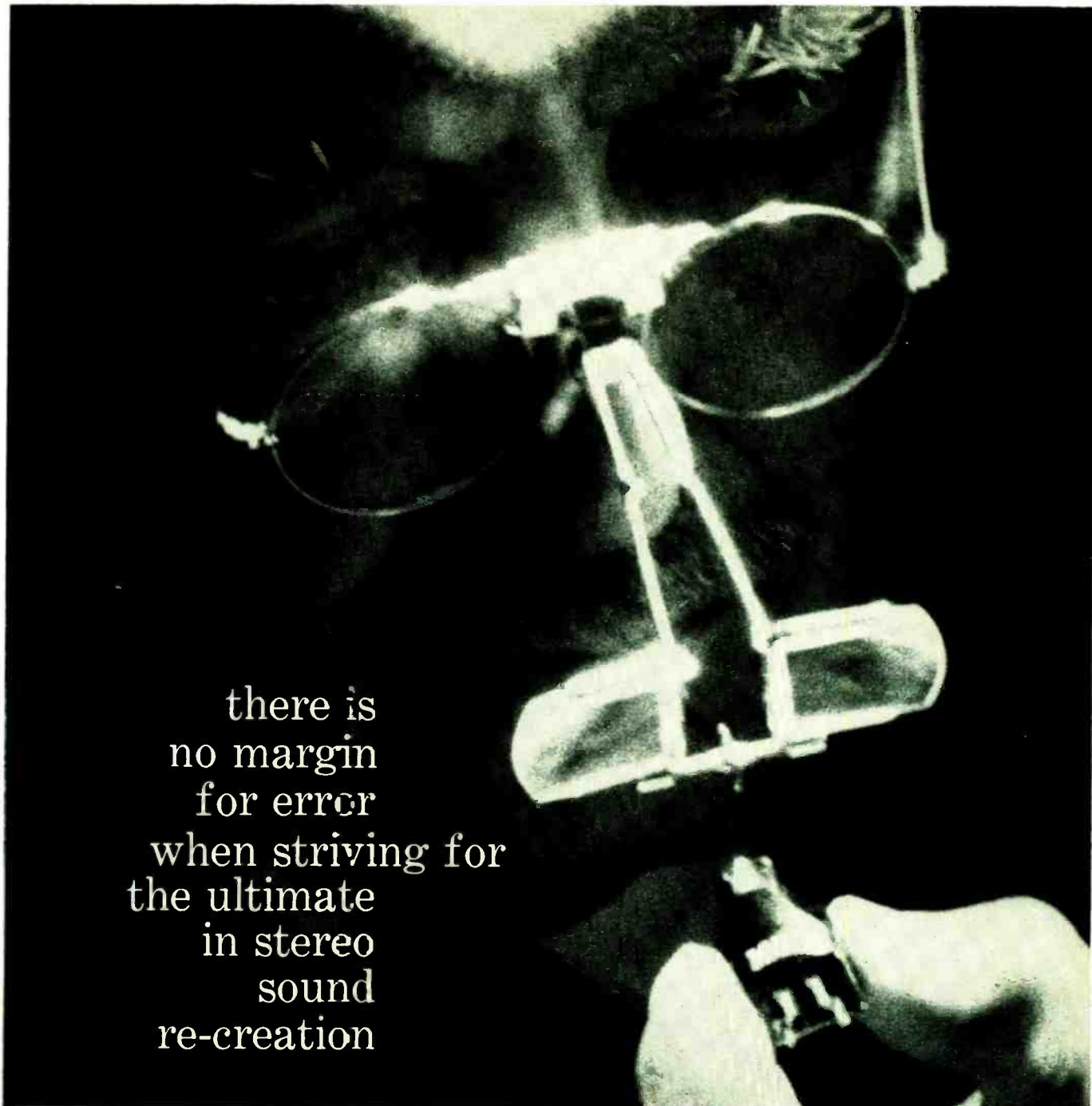

there is
no margin
for error
when striving for
the ultimate
in stereo
sound
re-creation

incomparable Stereo Dynamic ... by **SHURE**

HI-FI PHONO CARTRIDGES

Tiny though it is, the cartridge can make or break a stereo system. For this breath-takingly precise miniaturized electric generator (that's really what it is) carries the full burden of translating the miles-long undulating stereo record groove

into usable electrical impulses...without adding or subtracting a whit from what the recording engineer created. Knowing this keeps Shure quality standards inflexible. Shure Brothers, Inc., 222 Hartrey Avenue, Evanston, Illinois.

select the unit equal to your music system from the premier family of stereo sound reproducers



STANDARD M8D
A superb blend of
quality and economy.
\$1650



CUSTOM M7/N21D
Widely acclaimed;
moderately priced.
\$3675



PROFESSIONAL M3/N21D
Overwhelming choice of
the critics.
\$4725



LABORATORY STANDARD
Individually calibrated,
limited quantity.
Model M3LS **\$7500**



STUDIO DYNAMIC
Integrated arm and cartridge. **\$8950**
Cannot scratch records.



PROFESSIONAL INDEPENDENT TONE ARM
For any quality cartridge
... stereo or mono. **\$2995**

SHURE PERFORMANCE depends on a SHURE replacement STYLUS / ... Look for "Precision Manufactured by Shure"

McIntosh is the best

Only McIntosh amplifiers will deliver the full advertised power* at the lowest harmonic distortion of any currently available nationally advertised amplifiers in the McIntosh power class, at all frequencies, 20 cycles through 20,000 cycles.

We challenge any other manufacturer to prove that his power amplifier in the McIntosh power class, will deliver full advertised power at all frequencies, 20 cycles through 20,000 cycles at less than 0.5% harmonic distortion.

Any impartial testing person or organization can reach these same conclusions when reputable test instruments and procedures are used.

To assure the continued highest quality and performance, every McIntosh amplifier is measured by the use of these quality test instruments:

1. Hewlett Packard #206A Signal Generator.
2. Hewlett Packard #330B Distortion Analyser.
3. Techtronic #502 Dual Beam Oscilloscope.
4. Non Inductive Load Resistor.

Careful, diligent research, meaningful design considerations and meticulous manufacturing produces the highest quality equipment. When you buy McIntosh—you know you are buying **the best**. Only McIntosh is **the best**.

McIntosh LABORATORY, INC.

2 CHAMBERS STREET, BINGHAMTON, N. Y.

*Continuous power as measured by the square of the RMS output voltage, divided by the resistance of the non-inductive load resistor.

Phone—Area Code 607-723-5491

CIRCLE 71 ON READER-SERVICE CARD

**IF YOU BELIEVE THAT ALL RECORDING TAPES ARE THE SAME...
READ THESE FACTS ABOUT SOUNDCRAFT TAPES!**

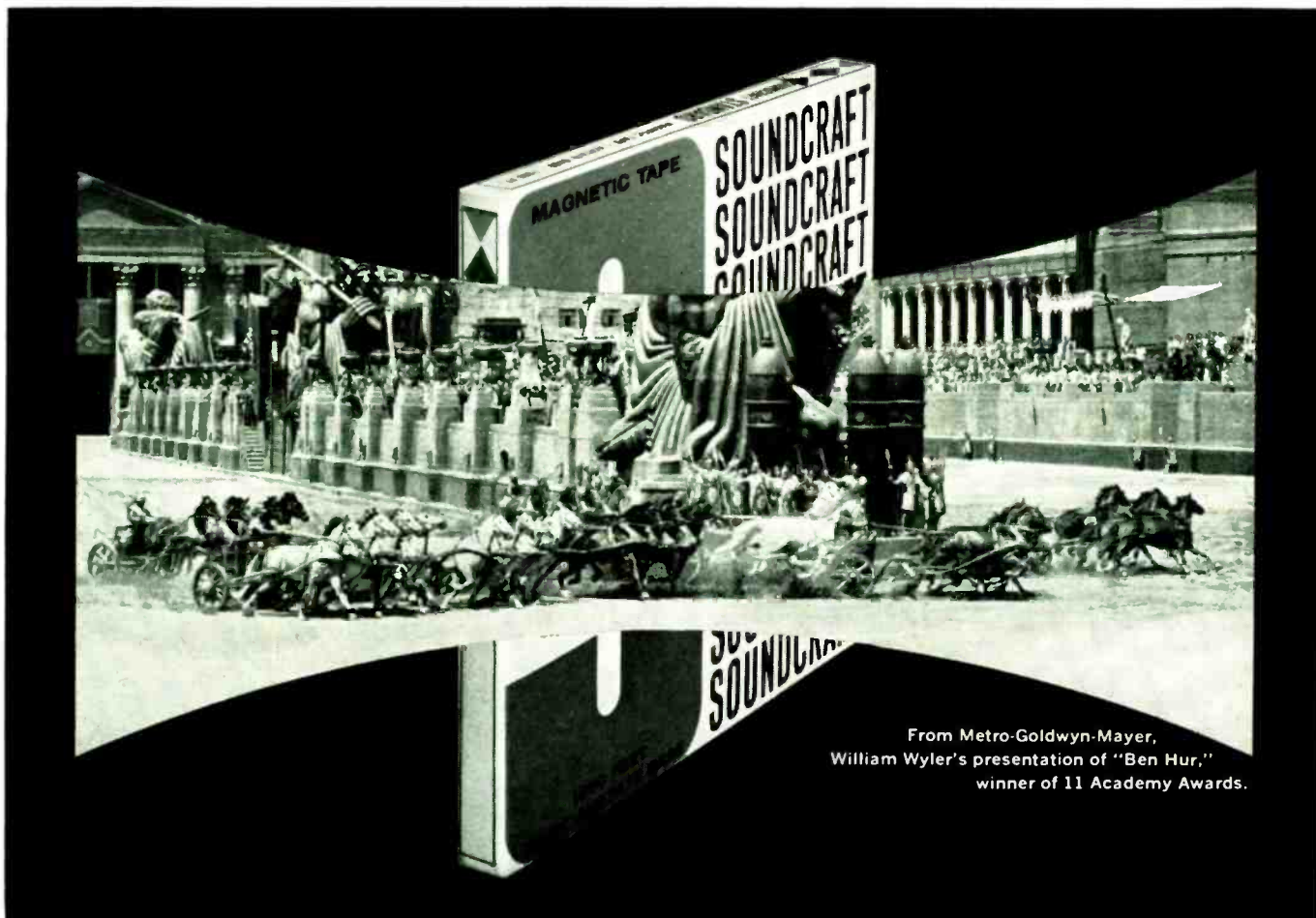

From Metro-Goldwyn-Mayer,
William Wyler's presentation of "Ben Hur,"
winner of 11 Academy Awards.

**IT'S SOUNDCRAFT IN THE
GREAT MOTION PICTURES**

The course of the motion picture industry was revolutionized by the application of magnetic stripes on films! This was a Soundcraft achievement—the famous Magna-Stripe process which has made possible the brilliant stereo sound tracks of great MGM (Camera

65), Cinema-scope and Todd-AO productions.

For this contribution, Soundcraft received The Academy Award — the coveted "Oscar" — first and only tape manufacturer ever so honored. Soundcraft achievement in magnetic recording never stops.



**SOUNDCRAFT WAS
FIRST
TO OFFER YOU:**

- Mylar® based tapes for longer tape life, longer play.
- Plasticizer-free oxide to prevent chipping or flaking.
- Micropolished mirror-smooth tape surface to preserve the "highs" and minimize recorder head wear.
- FA-4 frequency adjusted formulation to capture the full dynamic range of sounds.

Superior performance is yours to enjoy on every reel of Soundcraft Tape you buy, and at no extra cost. Buy The Best—Buy Soundcraft Tapes!

REEVES SOUNDCRAFT CORPORATION

Main Office: Great Pasture Road, Danbury, Connecticut
New York: 10 E. 52nd Street ■ Chicago: 28 E. Jackson Blvd.
Los Angeles: 342 North LaBrea ■ Toronto: 700 Weston Road

R-159

RDU PONT 7, 4.

CIRCLE 87 ON READER-SERVICE CARD

NOW

Ready for FM-MPX
Stereo!

Magnecord 748

(3 3/4 or 7 1/2 IPS)

Olympian

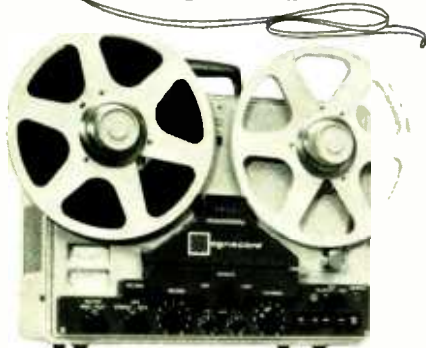

TOPSI!!! the only word that adequately describes the new Magnecord Olympian — the latest of an illustrious line of tape recorders. As the proud owner of a distinguished 748, you will indeed be king of the wonderful world of hi-fi or stereo.

Capture all the intricate tonal shadings of your favorite FM music and preserve your valuable records—stereo or mono—for all time with the Olympian... it's different... it's best... it's ready for FM-Multiplex Stereo.

SOLD ONLY THROUGH FRANCHISED
MAGNECORD DEALERS
For the dealer nearest you... write



Magnecord

SALES DEPARTMENT

MIDWESTERN INSTRUMENTS, INC.

manufacturers of electronic data
acquisition instruments

P. O. BOX 7509

TULSA 18, OKLAHOMA

CIRCLE 69 ON READER-SERVICE CARD

NOTES FROM ABROAD



PARIS

During the winter of 1939-40 René Nicoloy, like thousands of other young Frenchmen, was bored with army routine and the *drôle de guerre*. So

he organized some concerts—and since his soldier audiences were largely untutored, prefaced the performances with short lectures on the works programmed. Then came the French disaster of June, and he went back to his old job with the music publisher Durand. In occupied Paris he organized some more lecture-concerts, this time for lycée students. Soon, helped by prominent musicians and Pathé-Marconi, he found himself leading a crusade—his friends called him Peter the Hermit. In 1942 the movement, powered by the fervor of 20,000 youngsters in Paris alone, broke through Nazi red tape and became a formal organization: *Les Jeunesses Musicales de France*.

Today, Nicoloy is president of the most effective cultural do-good association I have ever encountered. His J.M.F. functions in French and formerly French territory from the Somme to the Congo, and an international federation created in 1945 by an alliance with a similar movement in Belgium now includes nineteen nations (the total has been jumping as ex-colonies get new charters). More than 1,400 educational concerts were given in France during the past season. J.M.F. members, most of whom are between sixteen and twenty-five (although the upper age limit is thirty) pay less than \$2.00 (the amount varies according to region) in annual dues and around 75 cents per concert. A subsidy of \$60,000 a year has been granted by the government, and smaller sums have been allocated by local administrations.



Nicoloy

No Pedagogy Here. The organization now has a record club and offers special ballet, opera, and drama evenings. But the core of its activity is still what it was in the sad Paris of twenty years ago: a thoroughly adult concert plus comment and discussion in which artists, critics, and audience participate. Composers are

often present, and the questions asked them are apt to be candid. Recently a boy politely raised his hand and addressed Poulenc: "Monsieur, don't you think Wagner and Debussy have made the task of their successors impossible?" Poulenc dodged, and remarked later: "It's a mistake to arouse sincerity."

The other day I found Nicoloy in his office above the Salle Gaveau, surrounded by concert programs and young delegates from the provinces, busy as a curé on bazaar day. He was off to Rabat to see how the Moroccans were making out. "Now don't confuse us," he said, "with music-appreciation teachers. We leave solfeggio to the schools. We aren't pedagogues, we are stimulators. We are trying to create and inspire a musical public for the future, and to provide an audience for contemporary composers and young musicians."

For the Happy Few. The Boîte à Musique is a small record shop in Montparnasse that makes its own wares under the label BAM. Compared to the big international record companies, it is the disc equivalent of a Paris bistro: a family enterprise with a special flavor. It exports enough to be known to any alert dealer in the States, however, and American listeners may be interested in a surprisingly large catalogue that contains only one Beethoven item and a lot of rare oriental, medieval, baroque, French classical and avant-garde music. The shop's best sellers are ballads sung by the Left Bank troubadour Jacques Douai, who even has a noticeable fondness for uncommercial composers like Guillaume de Machaut.

BAM's president is M. A. Lévi Alvarès, son of the founder. But since he is also the firm's music editor, recording supervisor, and sound engineer, browsers are likely to find, as I did recently, M. Alvarès' wife and his mother tending store. The younger Mme. Alvarès outlined their policy: "We are self-indulgent artisans. We try not to do what has been done, which means that we tend to avoid the nineteenth century. People are always telling us how wonderful our choices are, and then we may sell only a few hundred records. But we do what we like, and some of our more esoteric things go quite well—people like to escape. And years from

Continued on page 34

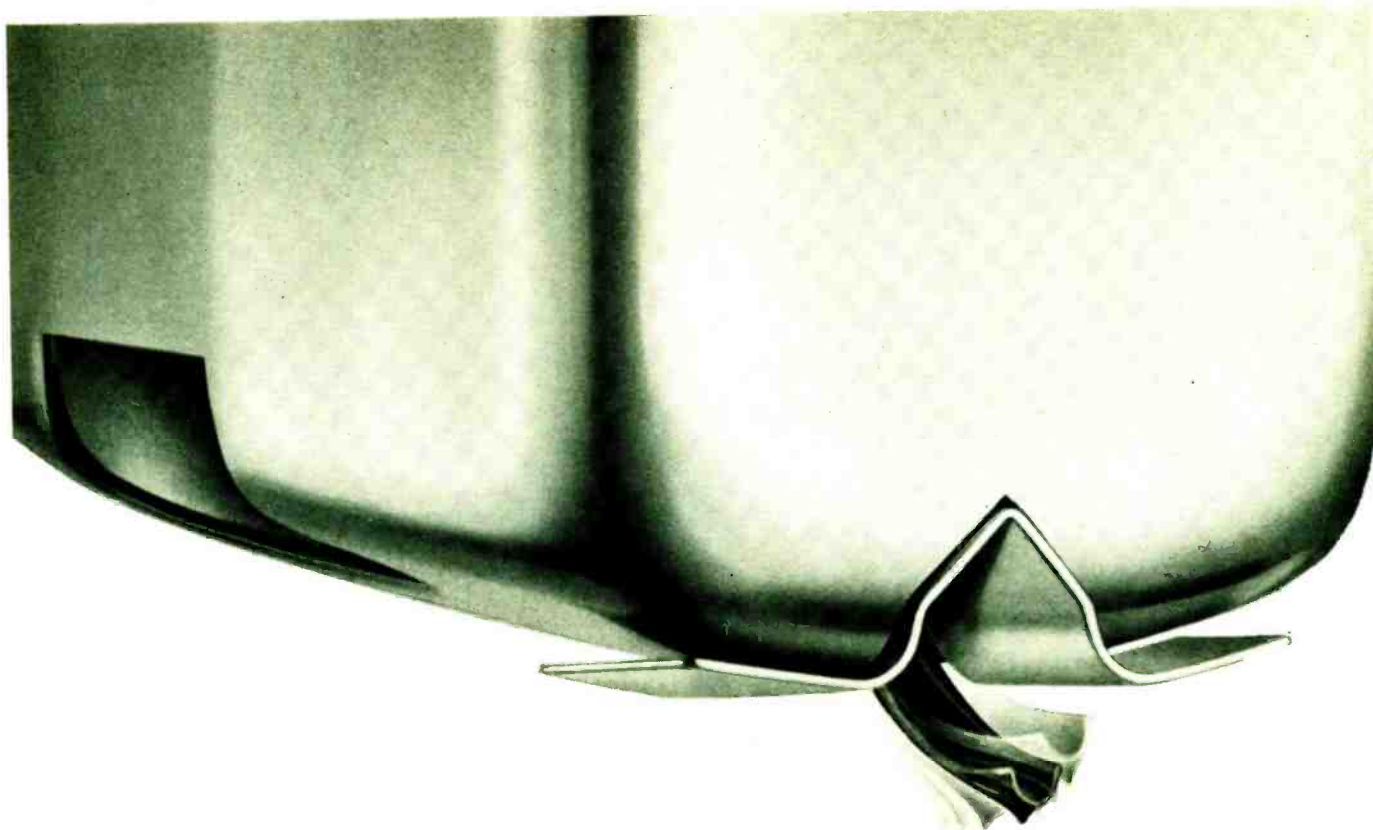

UP, DOWN, SIDEWAYS... the important difference in an Audio Dynamics' cartridge can be felt with your fingertips

Put your finger to the stylus tip of an Audio Dynamics' Stereo Cartridge. Move that tip around... What you feel is compliance. In Audio Dynamics' ADC-1, it is 20×10^{-6} cms/dyne minimum. This compliance, along with a tracking force of less than one gram and an effective stylus mass that measures less than .5 milligrams, represents a design breakthrough by Audio Dynamics' engineers. Result? Now, for the first time, by using any model ADC cartridge, the following *five essentials of true stereo reproduction* are yours:

Essential #1—Highs Free from Peaks & Distortion

Quality stereo cartridges are designed to suppress undesirable peaks and distortions in the high frequency range. These occur when the stylus mass resonates with the vinyl disc. To suppress resonance, since mass cannot be readily reduced, most cartridges are heavily damped.

Damping, however, stiffens the compliance. This creates problems: (1) High tracking forces are required to prevent mistracking and breakup. (2) The suspension becomes non-linear, resulting in distortion.

In one remarkable stroke, Audio Dynamics' engineers lowered the effective stylus mass to just one-half milligram, eliminating forever the previous plaguing need for heavy damping. This spectacular development makes it possible for the stylus tip to resonate with the vinyl disc at a frequency so high, your ear never hears it. Response is smooth... the sound clean and "transparent."

Essential #2—Clean & Well-Rounded Bass Tones

With stylus mass lowered and heavy damping eliminated, high compliance and linear suspension are achieved. This results in tone arm resonance so low it is of no consequence. Only the undistorted recorded bass tones come through.

Essential #3—Record Compatibility

When a stylus is stiffened by damping, a heavy tracking force is required to prevent mistracking and breakup. This

causes distortion and record wear. But high compliance and low stylus mass permit Audio Dynamics' cartridges to track at an extremely low force. Tested by Hirsch-Houck Laboratories the ADC-1 registered a tracking force of $\frac{1}{4}$ of a gram. You can forget about distortion and record wear!

Essential #4—Proper Channel Separation

With resonance removed from the audible range, nothing prevents the stylus from following the groove wall's direction of motion. Audio Dynamics' cartridges attain 30 decibels of separation in the critical 50-7000 cps range. Wandering of sound from speaker to speaker is eliminated.

Essential #5—Reduced Surface Noise

Lack of resonances results in greatly reduced surface noise.

The diamond stylus of an ADC cartridge also contributes to this virtue. It has been selected from perfect crystals, super polished and the sides oriented so only the hardest surfaces touch the grooves.

Many, many plays later, when it is necessary to change the stylus, you'll find the entire assembly comes out with a flick of your finger. No tools or special skills are required.

These five essentials for true stereo reproduction result from high compliance, low tracking force, and low stylus mass — qualities inherent in all Audio Dynamics cartridges.

Experience for yourself the performance advantages provided by Audio Dynamics ADC-1 and ADC-2 stereo cartridges! Hear them at your *dealer* today.

The ADC-1 for high quality tone arms—\$49.50.

The ADC-2 for high quality record changers and tone arms—\$37.50.



AUDIO DYNAMICS CORPORATION
1677 Cody Avenue, Ridgewood, New York

CIRCLE 14 ON READER-SERVICE CARD

Continued from page 32

now, I suppose, someone will walk by the place and say, 'I remember now, those people recorded Gesualdo and *musique concrète*.'

Specialties of the House. For those whose French is fair, one example of BAM's enterprising list might be *La Ralentie*, a powerful surrealist poem by Henri Michaux, recited by Germaine Montero to the accompaniment of surrealist noises by Marcel van Thienen. This is French avant-garde in top form. Also in good form are flutist J. P. Rampal and the Ensemble Baroque de Paris, on a disc of charming French eighteenth-century music—Couperin, Leclair, and three relatively unknown composers: Mondonville, Corrette, and Boismortier. Shinichi Yuize, playing the koto, stars in Japanese seventeenth- and nineteenth-century pieces, recorded during a recent UNESCO conference in Paris. This will give an idea of BAM's variety. "Pour the happy few," Mme. Alvarès said. ROY MCMULLEN

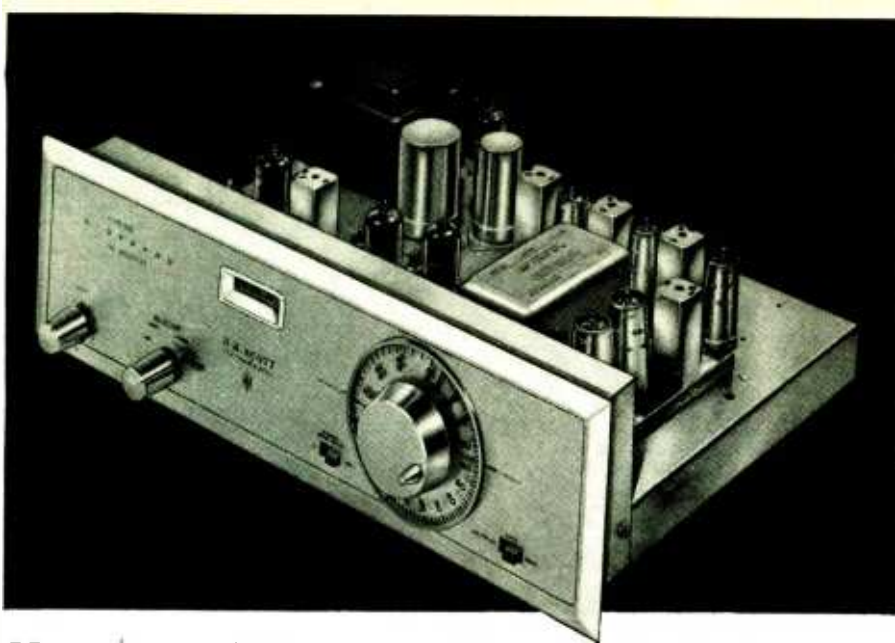

Now . . . an FM tuner with multiplex built-in!

New H. H. Scott FM Stereo Multiplex Tuner uses Wide-Band design for top performance

Here it is! No adaptor needed! The world's first Wide-Band tuner designed specifically for multiplex . . . H. H. Scott's new Model 350 FM Multiplex Stereo Tuner. The FCC, in its recent acceptance of FM stereo multiplex, said that the approved system " . . . like any multiplex transmission system at the edges of the channel involved. Accordingly, for optimum stereophonic reception, the (tuner's) bandwidth . . . must be considerably greater than that of monophonic (tuners) . . ."

From our very first design . . . the revolutionary 310A . . . H. H. Scott incorporated substantially wider IF bandwidth than conventional tuners. This gave better selectivity and usable sensitivity. The new 350 incorporates this same exceptional circuitry allowing reception of even weak multiplex stations with amazing clarity. You get other benefits, too—the 2 MC Wide-Band de-

tector provides superior rejection of interference and complete freedom from drift. The Wide-Band design of the IF's and detector give the new 350 a remarkable usable sensitivity of 2.5 μ v measured by stringent IHFM standards.

If you are considering a new tuner, or addition of an adaptor to a conventional narrow-band tuner, first listen to the new H. H. Scott Model 350 Wide-Band FM Multiplex Stereo Tuner. Its superiority in sound quality is so dramatically different that you will not want to settle for less.

Important Technical Information

Usable (IHFM) Sensitivity: 2.5 μ v. 10 tubes, 11 diodes. Famous H. H. Scott silver plated front end. Tuning meter. Performance matches FCC transmission specifications. Can receive either monophonic or stereo multiplex programs. Special circuitry for perfect stereo tape recording. Dimensions in handsome accessory case 15½"W x 5¼"H x 13¼"D. Matches styling of all H. H. Scott amplifiers. \$199.95 **, case extra.

* see paragraph 36, FCC Report and Order, Docket no. 13506, 4/19/61. Emphasis ours.

** slightly higher West of Rockies.



Wide-Band Multiplex Adaptor

Important News for H. H. Scott Tuner Owners
H. H. Scott has once again protected your investment against obsolescence. Your tuner, regardless of age or model, can be quickly converted to multiplex with the new Model 335 Wide-Band Multiplex Adaptor. Because of H. H. Scott's unique no-compromise Wide-Band design, we can guarantee superior multiplex reception only when the 335 and an H. H. Scott tuner are used together. 5 tubes, 8 diodes. \$99.95, case extra.

See the new Scott components at the New York High Fidelity Show, Trade Show Bldg., Rooms 640 and 642, Sept. 14-17. Plan to attend the AES annual convention, Hotel New Yorker, Oct. 10-13.

CIRCLE 92 ON READER-SERVICE CARD



The enterprising Paris firm of Lumen has now entered an agreement with the Milanese firm of Angelicum, whereby most of the big projects

planned by either firm will be made together, "in co-production." The Vivaldi *Magnificat Ossecensis*, recently discovered in Prague (and just published by the Universal Edition, Vienna), has already been issued on a disc also containing the *Nisi Dominus* (Psalm 126); the Coro Polifonico of Turin is joined by the Angelicum Orchestra of Milan under C. F. Cillario (Lumen AMS 25, a 12-inch LP). Pier Francesco Cavalli's *Messa concertata* for double choir, soli, and orchestra, conducted by U. Cattini, is another new Lumen-Angelicum set (two discs, Lumen AMS 14/15). Next year the two companies issue their most ambitious album to date: Haydn's oratorio *Il ritorno di Tobia*. Written in 1774, *Tobia* is a large-scale work of which Haydn was very fond. He revised it ten years later, and it is this version that Lumen and Angelicum will use. The conductor will be Riccardo Allorto.

Red in the Ledger. Elsewhere in Milan, things are not so rosy. The recording project of the Ricordi publishing firm, which began so brilliantly (*inter alia* with Callas' *Medea* and the Paisiello *Barber of Seville*), has run into serious financial trouble. A recent talk with Dr. Ricordi, the young scion of the famous family in charge of its recording activities, suggested that something was wrong. There were no new projects for the coming season. How were the operatic albums selling? Dr. Ricordi (understandably, as it developed) begged the question; but it turns out—not very well.

Continued on page 36

HIGH FIDELITY MAGAZINE

this Amplifier is NOT what we claim it is!

H. H. Scott's published specifications on the 222B Stereo Amplifier are not correct! Nor are the published specifications for any H. H. Scott component. *Actually, units off our production line far outperform our claims.*

A good example is a recent production run of 222B amplifiers.* Actual measured specifications were as follows: Power—16 watts per channel (published specifications 15); Total harmonic distortion 0.6% (we claim only 0.8); Hum 19 mv (we state 25 mv).

H. H. Scott tuners also exceed their advertised specifications. "High Fidelity Magazine" says the 314 FM tuner "is very sensitive and stable and meets or exceeds the manufacturers specifications in every respect . . . Its sensitivity, rated by IHFM standards, is 2.5 μ v according to Scott and 2.2 μ v by our measurements".

Because of our conservative ratings you can be certain your H. H. Scott components will *always* meet or exceed the specifications on which you base your purchase.

H. H. Scott components give you performance exceeding

*Run #PR222-305. Test Supervisor, Robert Clark.

specifications because our engineers specify expensive but essential design features such as all-aluminum chassis and DC heating on *all* preamp tubes to absolutely minimize hum, and hand selected and calibrated loudness controls to assure optimum tracking at all volume levels. Oversized transformers and tube types that run far below their ratings result in years of trouble-free operation.

The result is that when you choose any H. H. Scott amplifier — the moderately priced 222B, the best-selling 299B, or the high powered 272 — you can be certain it meets or exceeds published specifications and will continue to do so through years of constant use. Our written Laboratory Standard Guarantee backs up these statements.

Write to H. H. Scott Inc., 111 Powdermill Road, Maynard, Mass. for a complete catalog of amplifiers, tuners, kits and speaker systems. But remember . . . the published specifications you receive are only a small indication of the fine performance you'll enjoy!

 **H.H. SCOTT**

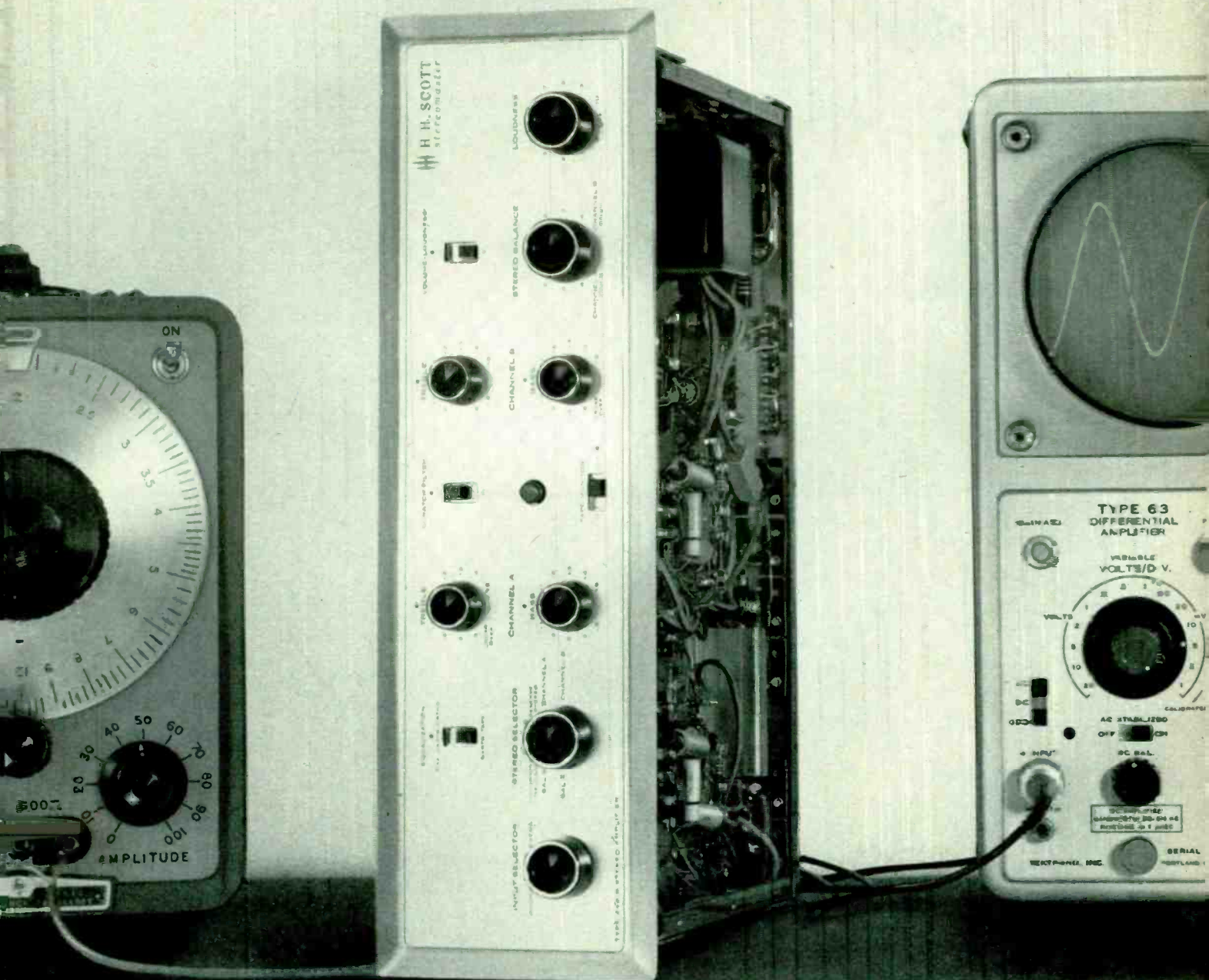

Grommes/MULTIPLEX



Grommes announces a completely new concept in mechanical and electronic engineering excellence to provide Multiplex Stereo with performance and "presence" never before accomplished heretofore. Owners of Grommes FM Tuners will be pleased to know that Grommes Tuners are adaptable for receiving FM Multiplex Stereo broadcasts through the use of Grommes low cost Multiplex adapters. Your Grommes equipment is never obsolete as Grommes engineers always plan ahead for things to come. Remember, when you buy Grommes, you buy the finest in FM-Stereo, regardless of price. Ask your high fidelity dealer to demonstrate Grommes. You will hear music with the new Grommes extra-"presence".

Write today for details on **Grommes Multiplex Adapters.**

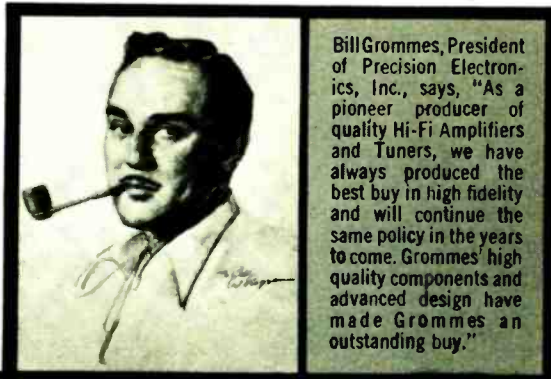

Bill Grommes, President of Precision Electronics, Inc., says, "As a pioneer producer of quality Hi-Fi Amplifiers and Tuners, we have always produced the best buy in high fidelity and will continue the same policy in the years to come. Grommes' high quality components and advanced design have made Grommes an outstanding buy."

Grommes

DIVISION OF PRECISION ELECTRONICS, INC.
9101 King Avenue, Franklin Park, Illinois, Dept. LN

Send coupon today for complete details on Grommes equipment.

Name.....
Street.....
City..... Zone..... State.....

CIRCLE 56 ON READER-SERVICE CARD

NOTES FROM ABROAD

Continued from page 34

Produced in splendid albums (the Paisiello is one of the most beautiful album productions I have ever seen) and recorded with the best artists Italy has to offer, these works, despite highly favorable comment in the press, just don't sell well enough to cover the enormous production costs.

Originally the Paisiello was planned as the first of a whole series of *settecento* Italian operas; and what a series it would have been! But even the Italians are not interested. I talked to the manager of one of Florence's biggest shops. "We've sold half a dozen sets," the clerk said, "but you won't believe it: most of the buyers thought they were getting the Rossini *Barber*. Some of them came back the next day and angrily asked what kind of a joke Ricordi was playing; but some told us they played the set, realized their own confusion, and kept the album just the same. I don't see how Ricordi can go on with it," he concluded, "unless they can get their costs back from abroad. We Italians won't listen to that which we don't know."

Another Bohème, and Another. . . . In Rome, Erich Leinsdorf has recorded a new *Bohème* (Moffo, Tucker, Merrill, Tozzi, Costa, Maero) for RCA Victor. The conductor told us: "I wanted to have a young-sounding cast, the kind that can really recapture the magic spirit of Bohemian Paris. You can't do that, for instance, with X [and he mentioned a famous Italian prima donna]: she's got a gorgeous voice, but she just doesn't sound young any more; and that's what *Bohème* needs." RCA is also doing a new *Walküre* (with Birgit Nilsson), and the day Leinsdorf finished recording in Rome, he flew off to London to start on Wagner. Decca-London was in Rome this summer, too; Sutherland fans will be pleased to hear that the "coming prima donna of them all" (as Italians now refer to her) has recorded her now famous interpretation of *Lucia*.

DGG has also invaded the Italian recording world. The German firm, which is becoming one of the most powerful in Europe, has decided (quite rightly) that Italian operas ought to be recorded south of the Alps. It has signed a contract with the Milan Scala to do a number of works, and in Florence it began taping *Bohème* in the new Teatro Comunale (it has among the finest acoustics of any European opera house) about a week after RCA had finished its version in Rome. In the DGG production, Gianni Poggi is Rodolfo and Renata Scotto is Mimi. I had a talk with Engineer Giuntoli, who supervised construction of the Florence theatre. "What we just don't understand," said Giuntoli, "is why the recording companies go on doing the same things over and over. Two *Bohèmes* in one season in Italy, and seven others available. Who keeps buying them?" It's a good question. No doubt RCA and DGG know the answer. H. C. ROBBINS LANDON



How many new Bell features can you find in this picture?

It's easy to see for yourself at least 6 advanced features of this new Bell Stereo Tape Transport for professional quality playback *and* recording . . . 2 track and 4 track: (1) Record Level Meters on each channel (2) Integrated record-playback Stereo Pre-Amplifier on single chassis, (3) Speed Keys automatically switch record equalization to assure maximum response at both speeds, (4) "Off" Key disengages drive mechanism, (5) Positive Record Interlock with back-lighted indicators as added safeguard against erasure, (6) Mike Inputs on master control panel, always accessible.

And what you don't see here is equally important: Heavy duty 3-motor drive (previously available only on high priced professional machines); electrodynamic braking; wow and flutter less than 0.2%.

Record-playback frequency response of 18-16,500 cps @ 7½ ips, 18-15,000 @ 3¾ ips. New stereo headphone monitor output jack on pre-amp. *Electrical* switching between 2 track and 4 track heads. Styling beauty in walnut grain vinyl-steel matching other Bell components. And a price you can afford.

7 models. Select the model you prefer, at your Bell dealer's, to make your stereo system professionally complete. Or write today, for catalog.

 **Bell** SOUND DIVISION

Thompson Ramo Wooldridge Inc., 555 Marion Rd., Columbus 7, Ohio
In Canada: Thompson Products Ltd., St. Catharines, Ontario

CIRCLE 21 ON READER-SERVICE CARD

for the Newest Kits, the Finest Quality,
the Greatest Values . . . look to Heathkit,
the world's shopping center for Electronic Kits



NEW STYLING



Deluxe . . . tops in Heathkit stereo/hi-fi styling with luggage-tan vinyl-clad cabinets, plastic fronts, refracted lighting. Choose matching tuner and amplifier. Left: AA-100 50 watt stereo amplifier. 31 lbs. \$84.95

Everything is

NEW



New Deluxe Stereo Pre-amp . . . AA-11, the ultimate: two sets of controls for the music lover and the technically inclined; 15 inputs; 19 lbs. \$84.95



New 25-Watt Combination . . . monophonic amplifier and preamp; in the "popular" motif; hi-fi rated; 4 inputs, all controls. AA-181, 21 lbs. \$42.95



New Multiplex Converter . . . plugs into multiplex jack of your present tuner; has two outputs for amps.; separation control. AC-11, 4 lbs. \$32.50



New Multiplex-Engineered FM Tuner . . . high fidelity circuits for FM and Multiplex; has AFC and output jack for AC-11 Converter. AJ-31, 8 lbs. \$39.95

NEW GUARANTEE

We guarantee that you can build any Heathkit!

The Heath Company *unconditionally guarantees* that you can build any Heathkit product and that it will perform in accordance with our published specifications, by simply following and completing our check-by-step instructions, or your purchase price will be cheerfully refunded.

This Heathkit guarantee, unprecedented in the industry, is made possible by our millions of satisfied customers who have proved that building a Heathkit requires no special background, experience, skills or training.

NEW NO-MONEY DOWN TERMS

It's easiest to buy Heathkit! With these new *no-money down* terms you can order the Heathkits of your choice . . . send no down payment . . . and take as long as 18 months to pay! These new, relaxed terms, coupled with our guarantee that you can build any Heathkit, are your assurance of complete satisfaction with your purchase. Any order for \$25.00 to \$600.00 worth of Heathkit equipment is eligible for these new easy time-pay terms; write for details on orders over \$600.00. See the order blank in the new 1962 Heathkit catalog or send for application forms.

NEW is the key word this fall at Heath! NEW KITS . . . in every product line . . . *twenty* in the stereo /hi-fi line alone . . . *forty* in all, giving you over 250 different Heathkits to choose from . . . the world's largest selection of electronic kits! NEW STYLING . . . three new styling concepts grace the stereo /hi-fi line . . . coordinated to provide matching components for each style . . . Deluxe . . . Mid-Range . . . Popular. NEW GUARANTEE . . . assures your kit building success, regardless of your background or experience. NEW NO-MONEY DOWN TERMS . . . easier than ever to buy . . . your assurance of complete satisfaction. NEW FREE CATALOG . . . 100 pages . . . the world's biggest kit catalog . . . better, too, with larger photos, complete descriptions and specifications, and now with kit schematics for your complete buying information. Look to Heathkit for the NEW!



Mid-Range . . . styling combines deluxe and popular motifs; tan vinyl-clad cabs., charcoal-grey fronts, for tuner and amps.
Left: **AJ-11 AM/FM Tuner.**
19 lbs. . . . **\$69.95**



Popular . . . striking charcoal grey steel cabinets with ivory accents. Choose tuners and amplifiers.
Left: **AA-161 14 watt monophonic amp-pre-amp.**
15 lbs. . . . **\$33.54**

at

HEATH



New 28-Watt Stereo Power Amplifier . . . in the new "bronze and black" styling; hi-fi rated at 14 watts per channel. **AA-111,**
21 lbs. . . . **\$44.95**



New Hi-Fi Speaker System . . . 8" woofer; compression-type tweeter with control; cabinet assembled; in mahogany, walnut or unfinished. **AS-51, 26 lbs. \$39.95 up**



The World's Shopping Center for Electronic Kits

Send for your FREE copy of the 1962 Heathkit catalog . . . the world's biggest kit catalog . . . 100 pages packed with over 250 kits . . . big new page size, big photos, complete descriptions, specs., schematics . . . we'll be glad to send your friends a copy too!



HEATH COMPANY
Benton Harbor 8, Michigan



Please send Free Heathkit catalog.

NAME

ADDRESS

CITY

ZONE

STATE



“hello, little girl!”

Remember when birds talked? When toys came to chattering life at midnight and unseen playmates whispered in your ear?

The magic sounds of childhood's imagination are as elusive as smoke. Even Audiotape can't capture them. But fortunately there's magic in reality, too. And there, Audiotape doesn't miss a murmur.

Audiotape has greater clarity, range, more uniform output than others. And only Audiotape comes on the easy-threading C-slot reel . . . Make it your silent (but knowledgeable) partner in capturing every-

thing from Papa Haydn to Pop's bathtub baritone.

Remember: if it's worth recording, it's worth Audiotape. There are eight types . . . one exactly suited to the next recording you make!



audiotape
“it speaks for itself” TRADE MARK

AUDIO DEVICES INC., 444 Madison Ave., N. Y. 22, N. Y.
Hollywood: 840 N. Fairfax Ave., Chicago: 5428 N. Milwaukee Ave.

CIRCLE 13 ON READER-SERVICE CARD

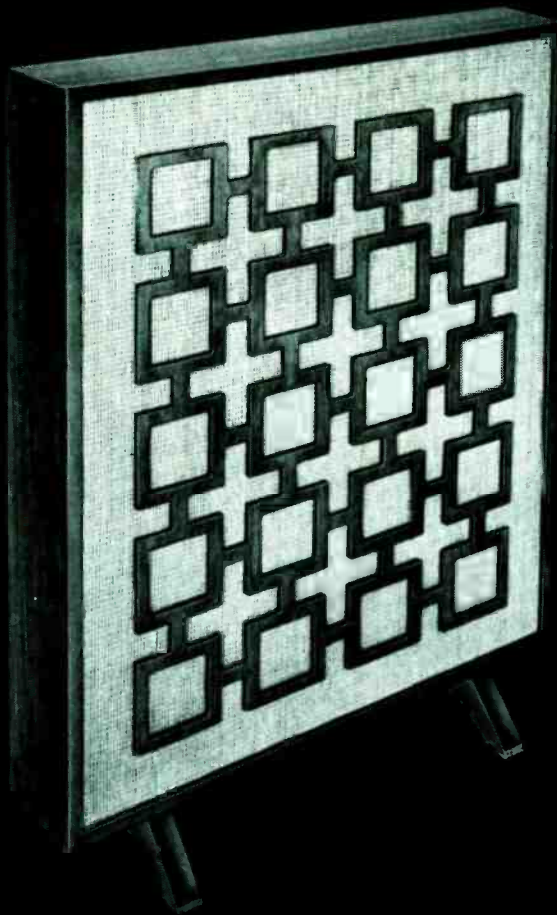

SONOTEER*

5-SPEAKER SYSTEM—ONLY 4 INCHES THIN!
 combines high style with big sound

Rek-O-Kut/Audax Sonoteer provides unique front and back radiation for a spectacular new dimension in sound. New, trend-setting picture-frame size and shape (4" thin, 25" high and 21" across) permit placement of a twin set of Sonoteers for stereo listening on walls... in room dividers... virtually anywhere in your home. So light you can carry it easily! Contains 5 heavy-duty speakers mounted in a slim, richly-textured, solid walnut cabinet that complements any room.

Technical facts: Has 2 woofers for bass, 2 mid-range units to avoid the "hole-in-the-middle," and a super-tweeter for highs. Exceptionally efficient—handles up to 45 watts. Response is a full 40 to 18,000 cps. Write for Sonoteer "How To Decorate" booklet.

Contemporary \$79⁹⁵
 MODEL CA-70 (illustrated) complete with legs
 also available in Provincial Model



REK-O-KUT/AUDAX
 38-19 108th St., Corona 68, New York

Export: Morhan Exporting Corp.
 458 Broadway, New York 13, New York
 Canada: Atlas Radio Corp.
 50 Wingold Ave., Toronto 19, Canada

* (Pat. Pending)

See exciting new Rek-O-Kut products at the New York High Fidelity Show, Rooms 627-628.

CIRCLE 88 ON READER-SERVICE CARD

Wharfedale

COMMANDING NEW SYSTEMS

We are pleased to present the new W40 Achromatic—Wharfedale's remarkable ultra-compact two-speaker system. This is a full range instrument built around a newly developed 8½ inch low frequency driver with an extremely high flux density magnet; and Wharfedale's outstanding 5 inch tweeter. Its size (24" x 12" x 10"), and its unobtrusive, clean, modern design, make W40 the ideal speaker system to fit "anywhere," providing the greatest enjoyment of music in today's modern apartments, the den of a country home, or in larger rooms. **True Wood \$79.50, Unfinished \$69.50**



The inert sand filled panel (exclusive in all Wharfedale systems), damps all vibrations, eliminates false resonances. The speakers perform with the enclosure as a single unit. The full range of sound is exceptionally smooth; transient response in bass and treble is exceptionally clean. A perfectly pure "Achromatic" musical image is achieved without acoustical coloration.

Achromatic speaker systems are available in enclosures skillfully executed in true wood veneers: Oiled Walnut, Polished Walnut, Mahogany. (Provincial Style in Fruitwood, only.) Unfinished utility models in Sanded Birch Hardwood do not have curved molding or dividers.

NEW W40



NEW W60PR

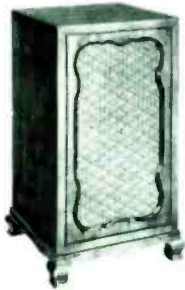

Wharfedale has combined the excellence of W60 and W70 reproduction with handsomely crafted pieces of period furniture. We are sure you will welcome the addition of these authentic Provincial designs in genuine Fruitwood to the Achromatic Series.

\$134.50

\$189.50



NEW W70PR



NEW B67

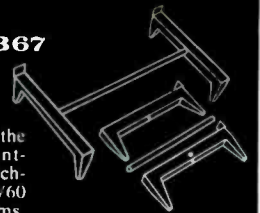

The new B67, the Universal Mounting Base—in matching woods—for W60 and W70 systems. Simple to install. An effective addition to the beauty of these enclosures.

Utility Model \$8.95
True Wood \$9.95



The W60 and the W70 continue to provide the distinguished performance which has won phenomenal acclaim for all the speakers in the Wharfedale Achromatic Series. The decorator designed cabinets will complement modern decor... look "at home," anywhere.

W60

True Wood \$116.50, Unfinished \$101.50



True Wood \$164.50, Unfinished \$146.50

W70



Mail Coupon Dept. WM-21
British Industries Corp.,
Port Washington, N. Y.

Please send me literature regarding
the Wharfedale Achromatic Series.

Name _____

Address _____

City _____ Zone _____ State _____



Wharfedale, a division of British Industries Corp., Port Washington, N. Y.

CIRCLE 24 ON READER-SERVICE CARD

A Splash That's Almost Wet

SOME PAGES REARWARD of this one comes a castigation, by my old and good friend Edward Tatnall Canby, directed against monophonic record snobs. It is very much worth reading. It was ETC who introduced me to postwar high fidelity and, I think, to the odd dichotomy it has brought into music lovers' homes. Canby is, of course, both a working musician and an audio editor, and it has always annoyed him, as it does me, that people of artistic pretensions are so often either timid or disdainful about technical innovations that really have been devised for their own delectation.

Many felt that way about microgroove and about high fidelity: now they feel so about stereo. They didn't want, quote, all those wires and watts, and they had a sort of proprietorial loyalty towards their old shellac Carusos and Weingartners. Against the latter sentiment I have no complaint; Caruso and Weingartner are treasurable acquaintances. But—at least in home music—every technological advance brings an advance in the art of listening, and I mean in both supply and enjoyment.

Go back briefly to 1948. There were then very, very few complete operas on dealers' shelves. Within two years thereafter Dario Soria, through tape and microgroove, made available an enormous bulk of the Italian lyric stage, not always in performances of highest artistry, but much better than nothing, and marvelously inexpensive. This was purely a product of technology's victory over economics, and it has not stopped.

Stereo has stepped in where monophonic high fidelity left off. There was a disturbed period between, naturally. There always is; the horse did not yield readily to the internal combustion motor. But sound is a medium which, more than any other, can benefit from technical progress, and further it is the medium most closely connected with the learning and symbolic logic that goes on in our heads. Deafness retards intellection even more than blindness does.

We have a tremendous heritage of beauty and pleasure in sound, much of which has hardly been explored, let alone put forth for public enjoyment. Only for a short generation has it been possible to print sound accurately; letters and pictures had a long head start. Now we have words and music too, and—since stereophony began—with

verisimilitude that can almost confound the ear.

Of course the verisimilitude varies, as Mr. Canby would not contest. I do not think two-channel stereo can adequately convey the Berlioz Requiem; one would need four channels and four speakers (and perhaps one's own cathedral). It can convey Beethoven's *Wellington's Victory*, though, and here I must put in a note of repentance. It was I who first suggested Mercury's making this great piece of gunpowdered male naïveté. And I do enjoy it. But it has unfortunately helped spread the notion, already too common, that stereophony exists mainly to deliver huge noises.

It does not. Realism can be small as well as large. In fact, I think it is more real that way. Further, I think recording directors are also aware of this, or at least are beginning to be. I am put in mind of several things that I have been most fascinated by on stereophonic records, thinking more or less at random (which is the way I usually think) through my last couple of years' listening. There has been lately, for instance, the disc of six concertos for two organs by Padre Antonio Soler (1729–1783), performed for Columbia in the Cambridge Busch-Reisinger Museum. The organists were E. Power Biggs, whom everyone knows, and Daniel Pinkham, known to some record fanciers as the man who first gave us Purcell's *Fairy Queen*. They sat at opposite organs; Biggs at the Flentrop he had ordered from Holland, Pinkham at a little, impudent Hess portative (both genuinely baroque). The two men had the time of their lives playing these gay dialogues, and so do their listeners. My point is, *I doubt very much that this record would have come into being had stereo not existed*. Maybe the same could be said of a London pair of wonders, *Alice in Wonderland* and *Through the Looking Glass*. The splash in the pool of tears is almost magically wet. The exchange between Alice and the White King makes you forget you're listening to a machine: they're there. There are other gems that I think probably would have been fashioned, stereo or no stereo, but that are much the better for stereo—Beethoven's *Serioso* Quartet, by the Budapests, with the high and low strings talking to each other, for instance. Stereo is making the living room, more than ever, the music room.

JOHN M. CONLY

AS high fidelity SEES IT





by Robert Silverberg

Phantom

SOME OF THE FINEST symphony orchestras in this country have never given a public concert. They have no permanent conductors. Even their personnel changes rapidly from one week to the next. Yet for all their protean character, these orchestras are beloved by conductors, recording directors, and music lovers alike. They go by such names as the Columbia Symphony Orchestra, Capitol's Concert Arts Orchestra, and the RCA Victor Symphony Orchestra—and the same man may play in all three during a single week. These amorphous groups, made up of free-lance musicians unaffiliated with any permanently organized orchestra, play a vital role in today's recorded music making.

The aesthetics of the free-lance orchestra (never call it a "pickup" group within a member's earshot) are a matter for some debate. Old-line critics tend to insist that a permanent body such as the New York Philharmonic or the Boston Symphony develops a unity, a musical integrity, a characteristic "person-

ality" that an *ad hoc* group assembled for a single recording session and then disbanded can never hope to match. Proponents of the free-lance orchestra, on the other hand, maintain that such outfits far surpass the permanent groups in flexibility, versatility, and general all-around tonal skill.

The controversy flared into the open last winter when Robert Lawrence, writing in the *Saturday Review*, discussed the recent Bruno Walter recordings of Brahms symphonies in a way that did much to raise blood pressures at the offices of Columbia Records. Lawrence was generally impressed with Dr. Walter's readings, but leveled a fierce blast at the orchestra he worked with—uttering such pronouncements as, "The Columbia Symphony Orchestra is simply not of Dr. Walter's stature." He went on to praise individual instrumentalists, but complained that the orchestra lacked ensemble.

This criticism brought a hot rejoinder from Columbia Records, where the nonhomogeneity of the

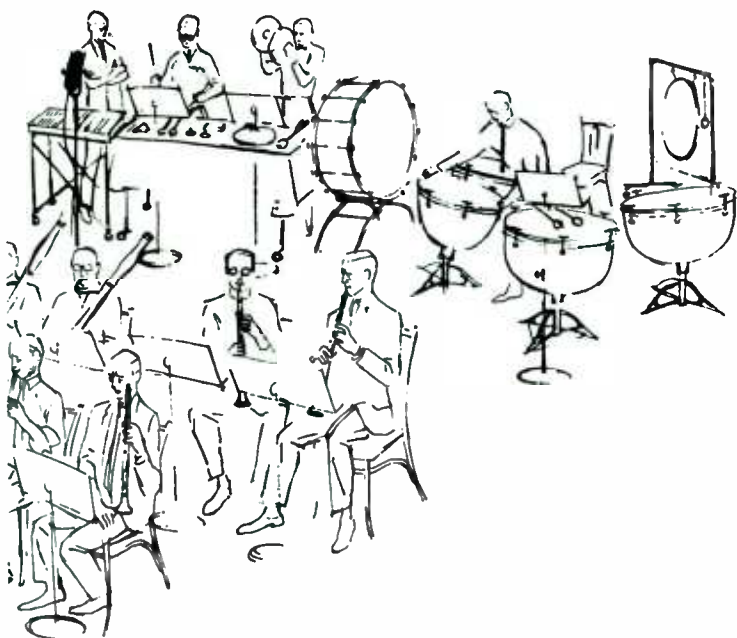

Can a free-lance orchestra assembled for a recording match one of the venerable giants named for their cities—Boston, Philadelphia, Vienna? Some authorities say yes.

Philharmonic

Walter orchestra was angrily denied. According to Schuyler Chapin, director of Columbia's Masterworks Division, "If there's such a thing as musical integrity, this orchestra shows it. Walter had the final word when we put it together for him, and thinks it's a wonderful group. It's tailor-made for him." Mr. Chapin's colleague John McClure, Music Director of Columbia Records, added a few pertinent facts about the Walter orchestra: "Far from being a group pasted together overnight, this orchestra has been playing together for Bruno Walter for years. It's ninety-eight per cent the same outfit that did the Beethoven symphonies with him. The first bass player died, and we switched timpanists—but otherwise it's absolutely the same. The personnel remains consistent from one session to the next, and Dr. Walter has approved of each man personally. He also thinks it's one of the finest orchestras—as a body—that he's ever conducted."

Columbia's problem is, of course, rather special.

The company has on its roster two distinguished elderly conductors, Walter and Stravinsky, both of whom live on the West Coast; its mainstay orchestras are the Philadelphia Symphony and the New York Philharmonic. Instead of transporting two rather fragile gentlemen eastward or an entire orchestra westward, Columbia decided to build its own orchestra in Los Angeles—a group of instrumentalists who can be called together frequently for specific Walter or Stravinsky recording projects.

I have no wish to get involved in the dispute between Messrs. Chapin and McClure on the one hand and Mr. Lawrence on the other in the matter of the Columbia Symphony. Rather, I find interesting the general phenomenon that just such groups (playing under house names or sometimes no name at all, as "Leopold Stokowski and His Symphony Orchestra") are so widely employed in today's recording. In the case of the Bruno Walter orchestra—which is also used, in augmented form, by Igor Stravinsky—the

personnel is drawn largely from the Los Angeles Philharmonic, with a sprinkling of men from the excellent Hollywood film studio orchestras. Other orchestras used by various companies draw on a large pool of talented and unaffiliated instrumentalists—including such soloists-in-their-own-right as violinist Ruggiero Ricci, violists Emanuel Vardi and Walter Trampler, flutist Julius Baker—who may serve as first-desk men one day and show up as back-desk men on another.

Why are such orchestras used instead of “regular” ones?

There are a variety of reasons. Established symphony orchestras have enough work to do preparing their concert hall pieces, without taking on big new assignments solely for recording purposes. But if a large company decides to record a little-known work not in the regular season’s program of the orchestra it has under contract, it can readily put together its own orchestra for the occasion. Smaller companies do not usually have contractual arrangements with a top-rank orchestra in the first place; and rather than sign up a second-rate outfit whose one distinction is the permanence of its organization, most prefer to assemble a group of unaffiliated musicians who in ability, if not collective reputation, can match any of the first-line established orchestras. Thus we see listed on record labels such names as The M-G-M Orchestra, The Kapp Sinfonietta, and Audio Fidelity’s London Virtuoso Orchestra, among others.

Classical artists & repertoire men are often very much on the side of the free-lance orchestra. For instance, Capitol Records’ Richard C. Jones, who frequently supervises sessions with the Capitol Symphony Orchestra and the equally ephemeral Concert Arts Orchestra, goes on record as saying: “A free-lance group has tremendous range and versatility. These are men who have played everything from rock-and-roll to Schoenberg, and do it all equally well. And you can hand-pick your orchestra so that what you’ve got, in essence, is nothing but first-desk caliber right down the line. I frankly don’t think you can match this kind of performance in most of the major organized orchestras.”

Conductors, too, often prefer using such groups. Leopold Stokowski, a man of powerful and often unconventional interpretative opinions, would rather build his own orchestras from scratch than struggle to remold someone else’s orchestra to his own tastes. (He abhors the term “pickup,” by the way.) Another advocate is Morton Gould, who says, “When I have a choice, I’ll take the free-lancers every time. They have a stamina and virtuosity that you never find in an established orchestra. For example, if I’m working with the latter, we don’t get down to recording music until the last half-hour of a three-hour session. And if I use a set orchestra, I have to take the bad with the good—the trumpeter who’s past his prime and gets paid simply for sitting in a chair and fingering his instrument, the violinist who’s really not very good but who doesn’t spoil things because he doesn’t play. I can get the same sound out of eighteen or twenty



Oboist Bloom: onetime NBC Symphony man.

free-lance violinists that it takes thirty-six men in many symphony orchestras to produce. Give me the virtuosos every time. There’s an excitement that they generate the minute they start to play that carries over to the finished recording.”

The construction of a free-lance orchestra involves the use of a contractor, usually a musician himself, who undertakes to assemble a group of his colleagues to fit a recording company’s requirements. The big companies draw on the services of a small group of contractors. Victor uses former NBC Symphony violinist Harry Lookofsky; Capitol another violinist, Julie Held. Bruno Walter’s Columbia Symphony Orchestra was assembled by Philip Kahgan. For East Coast free-lance sessions, Columbia often uses bassoonist Loren Glickman to act as contractor.

The contractor begins putting his orchestra together six weeks to two months ahead of the scheduled recording date. Mr. Held carries a thick notebook listing hundreds of musicians he can tap. “I go for the same key men each time,” he explains. “Of course, some are already booked for other dates, and some may be going on tour or on vacation when I need them. But I try to get the same first-desk men, when possible, and then I fill in the back rows from my little black book.” (This procedure no doubt has something to do with the cohesion and spirit free-lance orchestras develop: most of the musicians are known to each other and have played together many times before.) Each musician is paid \$60 for a three-hour session, and the contractor receives an additional \$60 for assembling the orchestra, taking care of bookkeeping details and such matters as social security and income tax deductions. If he cares to, the contractor may also play in the orchestra, thus earning double pay, but on more complex jobs he usually coordinates affairs from the sidelines.

New York and Los Angeles are the two centers of activity for free-lance orchestras. In each city, a floating pool of unaffiliated instrumentalists goes from job to job as needed. Few of them play classical music exclusively. One day they may do a poplar

number with Elvis Presley, the next day a difficult chamber work by Stravinsky, the day after that rhythm work in a jazz outfit.

Many of America's outstanding musicians prefer the free-lance life to the security of an orchestral contract. They enjoy being their own masters, working as often or as infrequently as they choose, and not having their personal lives disrupted by orchestral tours. The chief incentive for becoming a free-lancer, however, is an economic one. "Free-lance work is vastly more lucrative than playing in a regular orchestra," cellist David Soyer said recently. "The average player in the Philharmonic makes about \$150 or \$175 a week. I can earn that much in a single day, if I want to take on three or four sessions." Sylvan Shulman, once a first violinist in Toscanini's NBC Symphony and now a free-lancer much in demand, amplified: "I can do as many as ten recording sessions a week. Then, with my television work included, a good week can bring me as much as \$1,000. Of course, some weeks are busier than others. Perhaps a week or two may go by without a single date." Shulman went on, "The toughest problem a free-lancer faces is that of scheduling. It's possible on a good day to do three, and perhaps four, sessions. Suppose I schedule four sessions a day, with half an hour leeway between them. The sessions often are for different companies, in different studios in different parts of the city. There's always the possibility that one session will run overtime, or that I'll get held up in traffic. If everything works out properly, I can make \$240 that day. On the other hand, if I allow an hour's leeway, I may have to turn down one of the dates."

But there are rewards for the free-lancer other than monetary ones. An instrumentalist with a regular orchestra often plays a circumscribed repertory—a melancholy annual round of Brahms, Beethoven, and Tchaikovsky, with perhaps a little Mahler or Berlioz thrown in during appropriate commemorative years. The free-lancer leads a livelier life, recording music of a much more varied kind. The daily challenge of unusual music keeps the free-lancer's talent sharp and his spirit refreshed. Scarlatti or Berg or Bruckner—"With us, these are almost in the standard repertoire," says Sylvan Shulman. Thus, a player like flutist Arthur Gleghorn not only takes part in the Bruno Walter standards, but in such projects as Robert Craft's recording of the complete Webern.

The free-lancer does not always know in advance what particular work he's being hired for. He may learn that "Robert Irving will be doing some ballet music for Capitol," or then again he may be told only what time he is to show up at the studio. Oboist Robert Bloom says, "Some men will ask the contractor what they'll be playing. Others don't much care. Bach, Hindemith, Rachmaninoff—it's all the same to them." Free-lancers cultivate a kind of cold-blooded professionalism that endears them to conductors and recording supervisors. They pride themselves on being able to handle any challenge put before them.

There is no prior rehearsal time for a free-lance orchestra. The men show up cold, and play from sight. At the beginning of the recording session, the conductor explains his ideas about the music, a short warm-up takes place while the engineer is setting his balance controls, and then the Ampexes begin to twirl. Union regulations permit only fifteen minutes of music to be recorded in one three-hour session, so there is plenty of time for retakes and polishing as the session continues. Even so, using a free-lance orchestra is more expensive than using an established group which has already rehearsed and performed the music to be recorded. If the Philharmonic, say, has done Mahler's Third under Bernstein at Carnegie Hall one week end, it can record it the following week with a minimum of additional effort. The conductor of a free-lance orchestra has to build his interpretation right on the spot, an often time-consuming procedure.

Free-lance recording is nothing new. As far back as fifty years ago, members of the Philadelphia Orchestra were taking time off to cross the river to Camden and do the third *Leonore* Overture or a fragment of a Beethoven symphony under the *nom de disque* of the Victor Concert Orchestra. In 1911, the Beka Company of Germany began promoting a series of orchestral records played by the Meister Orchestra, billed as "the first orchestra formed specially for the purpose of playing for recording," and other such groups have flourished here and in Europe ever since. But the big boom in free-lance musicianship has, of course, come in the past twenty years.

The use of free-lance orchestras creates some amusing anomalies rarely suspected by the average record buyer. The Columbia Symphony Orchestra used by Walter in Los Angeles is 100% different from the identically named orchestra assembled on the East Coast from time to time by Loren Glickman and used to record items not in the repertoire of the Philharmonic or the Philadelphia (as the recently taped *Boris* excerpts with George London). Similarly, a Capitol record with the

Continued on page 132



Morton Gould: "Give me the virtuosos every time."

by Edward Tatnall Canby

A musician takes to task the folk who affect contempt
of stereophony because it was devised by engineers

Stereo for the Man Who Hates

THE MAN who hates stereo, oddly enough, seems often to be a real music lover. The man who has become an out-and-out devotee is likely, at least in my experience, to be one who knows relatively little about music itself.

This is an interesting paradox and for me a bothersome one as well, because I myself am a music lover and a musician who is so thoroughly convinced of stereo's values in purely musical terms that I rarely hear any recorded music in other than the stereo form these days. When I listen to a monophonic disc, now, it honestly sounds strange to me, false and lacking in realistic impact, until, of course, I readjust my ears to its musical values. Easy enough—for mono records contain a world of great music; the point is that I must make the adjustment from my own "standard" of reproduced sound, stereo, to a sound that already for me is inadequate in fundamental respects, for all music. I mean *all* music, with no exceptions.

In terms of musical effectiveness, stereo is a much more fundamental advance than was the microgroove record, which merely added the conveniences of long play and improved technical quality. The gain in stereo is unique, and it is over and beyond merely perfect electrical and mechanical faithfulness to the original sound signal. I cannot think of any recorded music, whether symphonic or chamber, whether for solo guitar, harpsichord, jazz trio—or for the Mighty Wurlitzer or a band of Mexican marimbas—that is not potentially better listening in stereo than in mono. After long experience, this is so utterly, incontrovertibly evident to me that it is hard for me to understand how any listener could reach any other conclusion. And yet it does not seem to be at all evident to other musical ears just as good as mine. Why?

I am speaking of my more informed musical friends. There are others, too, those who enjoy music and like high fidelity, who go for some heavier

classics and a good deal of pleasant music—from Beethoven to *My Fair Lady* and on to Mantovani, with a Bach *Brandenburg* Concerto and some Guy Lombardo thrown in; I do not mean these people, who seem to have no trouble with stereo at all. I mean people who really know their Brahms and their Chopin, their Schütz and their Schein, their Mozart and their Carl Philipp Emanuel, who enjoy one conductor and dislike another, perhaps, after many dozens of listenings and years of comparisons. These people are musically literate and they go to concerts of all sorts too. They have highly sophisticated record collections and they often sing, or play the piano or the oboe, on the side. Their tastes are as varied as you can imagine, but their musical experience and know-how is very real. They are the core of the informed musical audience for today's recorded music.

To a man, almost (if my friends can be taken as a fair cross section) they distrust or simply ignore stereo. And it isn't necessarily because it costs too much—though that may be a given reason. (My less musical-minded friends of similar incomes seem to have no doubts on this point.) The feeling goes much deeper. So deep, in fact, that only a considerable span of unhurried, top-quality stereo listening can persuade them that stereo is, indeed, good for *them*—for the music which is meaningful to their ears. And how is one to listen to stereo when one will not even try it?

I present two probable reasons for the music-minded person's antipathy to stereo. They form a mildly vicious circle, since one feeds directly into the other. The first is a matter of status. Antistatus is the better term for what I have in mind. The second is simply education. Education in stereo listening.

Status, standing, keeping-up-with-the-Joneses, has taken on an immense complexity in our day. We are all touched by it one way or another, whether through a passion to keep up with the latest in gadgetry or a fond impulse towards Danish Modern in living-room

Stereo



furniture. If we own a Ford, at least it looks mighty like a Thunderbird, as Ford informs us.

Stereo, unfortunately, has taken on the character of a status symbol in terms of the home music center, part of our living. Some of us have taken the hint too literally, too flashily, and too loudly. Stereo has been made into a fine vehicle for many degrees of relative crassness in this statuslike fashion. Sometimes it is downright hard to live with. Musical people who are offended by this unjustified treatment (and who are uneducated as to stereo's real potential value) simply rebel against it. They will have none of it—and their minds are usually made up before they have so much as been able to hear any true stereo within their own area of interest.

Moreover, this antistatus reaction has plenty of healthy musical precedent, to which I could not myself be more sympathetic. It is true, definitely, that even a "squawk box" can project Beethoven to a good listening musical ear! The person who says that for him a fine recorded performance is a fine per-

formance without stereo to help it, is absolutely right. Our forebears could appreciate Caruso on a horn phonograph just as well as we can enjoy him today in his reborn microgroove form. The "message" gets through, in spite of the extraneous hash of meaningless sound that comes along for the ride. Yes, stereo is not absolutely necessary for basic musical communication between you and your records. Nor, for that matter, is high fidelity. Any old fi will do. And so we cannot very well argue with the man who puts this gambit forward to oppose his own use of stereo equipment. It's a very familiar argument. It covers up a very large feeling of antistatus, which is merely the other half of status. Too bad that stereo should have become so involved in this genuine reaction against crassness and crudity in home musical sound. It does not merit it.

For to enjoy stereo you must hear it—not merely once, not merely in a quickie demonstration (nothing could be more likely to prejudice you against it), but, as the phrase goes, "in depth," at length, at leisure,

and, of course, under good circumstances. Stereo's best values are subtle ones. It has a capacity for nuance limited only by music itself—which is limitless.

It is obvious that stereo also has a fine capacity for crudeness, for blatant “ping-pong” sound that does less than nothing for any music worth listening to. Let us take that for granted. Stereo has no will of its own in any case, but is always what it is made into by those who use it. It can be crude, and in its crude form it can offend a musical ear into a quite properly violent antistatus reaction.

What is much more important, I think, is to understand that by their very subtlety, stereo's finer values will *not* jump forth instantly on first hearing—no matter how good the musical ear! One must learn to listen to stereo, as one has learned to listen to music itself. For the really demanding ear, then, stereo is a serious matter of higher education-in-listening, probably more serious than most of us have imagined. Musical knowledge, however subtle, ear-sensibility to music, however highly developed, is no guarantee that stereo will make itself understood in musical terms *a priori*. One must learn to hear the things that stereo can do for music.

There, I think, you have the crux of the problem. For it does not occur to most musical people that on first contact the finer points of stereo will probably escape them! I mean the musical points, the stereo effects that heighten musical communication and meaning. The plain fact is that good stereo, on first try, is more likely to register a total blank on the highly musical ear than on the less complex and more objective mind of the person who just hears what he hears, in front of his nose. I have seen it happen. Time after time I've had sophisticated people tell me outright that they could find no difference at all between stereo and mono sound—when my own ear told me that the difference was immense.

It is not easy for people with good ears and minds to accept this. It comes as a bit of a shock and wounds the musical vanity. All sorts of tact must be summoned up to convince a person of strong convictions that he can't hear what you hear, but that if he tries long enough, maybe he'll learn. Only the weaker-minded go along meekly. The rest fight back.

Ear education, then, is what we need, if we are musical but will have none of stereo: experience—personally, and at length, and under good conditions—listening to music that is loved and understood, hearing it again and again until stereo takes over of its own accord and begins to do things for it, until the music speaks through the stereo medium more clearly than ever in its mono form. That's how I have come to stereo, in any case. I do not think there is any other way for the highly musical listener. Time, patience, a willingness to wait, *to accept a lack of results*, an apparent absence of effect for a long time, an open-ear attitude to go with an open mind, receptive to whatever the senses will in due course bring forth, when good and ready—these are the requirements for musical ear training in stereo

perception. The more you expect out of music, naturally, the longer it will take.

And when you have made this effort and taken this time, what will you find that stereo *does* for music?

Words are always risky in describing musical sensations. Let me look first at the stereo principle, the stereo additive: two sound channels, now, instead of one; two loudspeakers. Like many people, I was once under the mistaken impression that stereo from two loudspeakers would project two images. I imagined double Heifetzes, pairs of Rubinsteins. I foresaw two Isoldes, one on each side of my room! It seems a reasonable danger, after all, and it would be very bad for music. That was awhile back. When I first discovered that a speaking voice out of two “binaural” loudspeakers—this was before stereo—actually appeared to come from a single point in space midway between them, I was on the road to conversion. A monophonic voice will *always* appear midway between two speakers that are in phase and of equal volume. So will a stereo voice, if it is recorded in the middle in the first place. Just one voice, not two. One Isolde, not two. One piano—even from stereo speakers.

Stereo thus began in the middle for me and spread out sidewise. It's a good way to think about it, for the same will be true for you if your system is in good working order and your speakers properly positioned. Monophonic music, on the other hand, will be *entirely* in the middle—all of it. Look at it this way. Mono music, for some seventy-five years, has given us never more than one dimension for listening. And that one, the dimension of distance, is profoundly inaccurate in terms of literal feet and yards. But it *is* there, and in a highly imaginative way, for it allows us to envision a “space” for our music to play in. We invent the other dimensions; they do not exist in any monophonic recording. Now, after all these years, stereo brings us all of two dimensions, one more added to the earlier one. It has the same happily casual relationship to the “facts,” measurable distances and directions. Very vague indeed. It also has the same ability to stimulate the inventive imagination, but now in new ways, via new clues unknown to mono. That's all. It is plenty.

All home reproduction of music is basically an imaginative illusion, derived from a few tangible clues. It is not literal in any sense except the narrow one of an accurate mike-to-speaker signal transmission. We do not hear a concert hall; we imagine one. Fortunately for us, imagination can always soar far beyond literal facts. The more fertile the imagination—the more varied the experience and knowledge behind the imagination—the better are we able to capitalize on what we hear reproduced. We are grasping in our demands. Give us an inch and we take an ell. We can hear Beethoven out of a pocket transistor radio, but only because we fill out our picture by the active working of our imaginative faculties. If one-dimensional sound has been able to give us so much, then presumably *Continued on page 134*



BY WILLIAM WEAVER

If you collect recordings of Italian opera, it's likely that a good many of them are conducted by a cherubic octogenarian named Tullio Serafin.

Maestro Serafin

THE ROUND LITTLE MAN, with the shuffling pace of the very old, moved along the corridor of Rome's Teatro dell'Opera, heading for the door to the orchestra. Though it was hot midsummer, he was wearing a light topcoat and the black fedora traditional among Italian musicians of a certain generation, those of the immediately post-Verdi years. Behind him came a tall woman with a broad, kindly face, but a forbiddingly protective manner.

"That's Tullio Serafin," a friend said to me. And I went over to ask him for an interview.

Frankly, it takes nerve to ask an eighty-two-year-old man to give you some of his time, especially when he is a working musician with a crowded schedule that might exhaust a man of half his years. I was understandably reluctant as I introduced myself and explained my assignment.

"I'm not much for talking," he said, resigned, "but call me tomorrow."

This first meeting took place just before an RCA Victor recording session of *Otello*, and as Maestro Serafin disappeared then into the orchestra, I found my way up to a box from which I was to be allowed to watch the recording. From the box, the sight of the house was unfamiliar and a little depressing, with the seats all removed from the main floor and the shirt-sleeved orchestra spread around below the hanging microphones. But as Serafin came in, there was a change in the atmosphere. The Rome opera orchestra is an unruly bunch, capable of rising to heights with conductors they like and equally capable of playing with small regard for the man standing in front of them. As Signora Rosina, the tall woman who I had learned was Serafin's housekeeper, took



He heard the original Otello, as Verdi heard it.

his hat off for him and helped him to remove his coat, the orchestra began to grow more silent, and when he climbed up on the podium, they were already completely attentive.

In a soft voice (inaudible in the box where I was), he began to speak to them, occasionally humming a passage of the scene that they were to record. At one point, the men all laughed. Then the little red light came on, and engineer Richard Mohr announced the take. They began. A false start. The horns were too loud. Again. This time they were too soft. *Mezzo forte*, the Maestro repeated patiently, and the third time they sailed past the tricky area safely, progressing into the scene.

Unlike many conductors, Serafin prefers to record whole scenes at a time, without interruption where possible. As the music unfolded, the depressing, mothball atmosphere dissolved still further, and the Verdian spell began to work. The bare hall became *l'isola di Cipro*. At the same time, the spell of the music had its effect on Serafin, too. He was no longer the gentle old man who had so slowly come into the room; he was a vigorous and dynamic worker, alive to every nuance in the music, to every shade in the singers' voices. He conducted the long and tiring session standing up (as he conducts always, for recordings, rehearsals, and performances).

At a brief pause after the take, Serafin climbed down from the podium and sat on a little chair. As the faithful Signora Rosina came over and put his hat back on him, members of the orchestra gathered around and again, cursing my distance, I could hear them laugh. For nearly ten years, until the Germans occupied Rome during the war, Serafin was Artistic Director of the Rome Opera (a period Roman opera fans look back on as a golden age), and many of the men in the orchestra had worked

with him then. These first recording sessions were, then, also a kind of reunion.

Later, when the recording began again, with the usual starts and stops, I observed how Serafin asked no concessions for his advanced age, and seemed to ignore it himself. When he wanted to discuss a minor matter of pronunciation with the tenor Jon Vickers, he stepped down from the podium and picked his way through the jungle of music stands, before Vickers had time to get off the stage and over to him.

Though his aim was to record whole scenes, Serafin refused to overlook any detail, and in a later session he spent some time going over with baritone Tito Gobbi the pronunciation of Iago's phrase "*quell'immondo fatto*" in Act II. Serafin felt that Gobbi had been neglecting the double "t," pronouncing the word as "*fato*" (destiny) rather than "*fatto*" (deed).

"No, no," Serafin insisted, "Boito wasn't talking about anything abstract like destiny, he meant the foul deed, the . . ." and here the Maestro used a good Roman word that in English would be spelled with four letters. Gobbi laughed and pronounced the second "t" more clearly next time.

Serafin's apartment, where I went to see him a few days later, is in a dun-colored building in Parioli, the smart residential section of Rome. "I bought this house in 1933," he told me, showing me into the living room, "when I came back after several years in America."

The furnishing is in the high style of that period, especially the imposing bar, with its tubular chrome chairs and its parchment lamp shades stamped with cocktail recipes in English. The living room is naturally dominated by the piano, and my eye ran at once to the silver-framed pictures of Verdi and Wagner. Everything was neat, and the place looked like the house of a man who isn't home much.

Before coming to talk to Serafin, I had tried to read up on him, but I discovered that, despite his long and illustrious activity, little has been written about him. A laconic entry in Grove's *Dictionary* gives the main facts (born in Venice, 1878; studied violin and composition; after conducting in various Italian towns, appointed conductor at La Scala in 1909; later appointed musical director at the Royal Opera, Rome; frequent guest in the major cities of Europe and America). There are also many laudatory references to his work in Irving Kolodin's book on the Metropolitan and Harold Rosenthal's on Covent Garden. But there are few colorful anecdotes, temper tantrums are nonexistent, and feuds are outnumbered by friendships.

Even people who have worked with Serafin find it hard to put their deep esteem into words. "He's marvelous with singers," the American tenor Herbert Handt said to me; and an official of the Rome Radio (a sweet, gray-haired lady) said simply: "He's an angel." And there is, in fact, something cherubic about him. When he comes out on the stage after

a performance, with his affecting little waddle, he looks like a beardless Santa Claus.

Writing to Von Hofmannsthal from Rio de Janeiro in 1920, Strauss referred to him as "the excellent Kapellmeister Serafin"; later, in his *Recollections and Reflections*, speaking of the first performance of the *Rosenkavalier* in Italy, at La Scala in 1911, the composer wrote: "Serafin had rehearsed the opera faultlessly."

I began talking to Serafin about Strauss, whom he had known well and a number of whose works he had conducted. When I mentioned the notorious Scala *Rosenkavalier*, the Maestro smiled. "It was my first year at La Scala," he said. "Everything went fairly well till the beginning of the third act. Then there were sixteen minutes of whistling and yelling. I've never heard anything like it. Sixteen minutes! But I went on, and at the end they applauded. . . ."

His smile broadened and his eyes twinkled: "Strauss said to me afterwards: 'You aren't a man, you're *Der Teufel*. . . . And this is no audience, it's a *Kindergarten*. . . .'"

I mentioned the Rio performance, and Serafin quoted Strauss again. "The Marschallin was superb. . . . Muzio. . . . Strauss took me aside and begged me to help him convince her to sing Salome. He said: 'Oh, to hear Salome just once with a beautiful voice!'"

Then we talked about America, where Serafin conducted at the Met from 1924 to 1933. "First I lived at the Hotel Ansonia, then I took an apartment on Central Park West, *meraviglioso posto*. But we went on tour, everywhere. And since those days I've been to Chicago and Dallas and San Francisco. Then in 1952, I went to the City Center, too . . . a small theatre without money, but you can do good things there."

In Italy, in fact, Serafin has not limited his activity to the big theatres, but has done much interesting work in the smaller and more progressive houses. After conducting the first Italian *Parsifal* at La

Scala, he took the work to Parma. And in recent years he has conducted often in Genoa and Palermo (where he helped introduce Joan Sutherland to the Italians two years ago).

At the beginning of our meeting, Serafin lived up to his self-definition of not being a talker, and I had to prompt him with questions. But after a while, our interview turned delightfully into a conversation, and he rambled easily and fascinatingly over a variety of topics.

Finally we got around to talking about records. In recent years ("They discovered me again at eighty!"), Serafin's record making has been prodigious. In addition to a number of operas for Angel and Capitol featuring Callas and De los Angeles, he has recorded for Columbia-Philips (*Linda di Chamounix*), for Mercury-Ricordi (*Medea*), for London-Decca (*La Bohème*, *Madama Butterfly*, *Mefistofele*, and *Cavalleria rusticana*), and for RCA (the *Otello* in which I watched him at work).

The *Otello* was uppermost in his thoughts the morning we spent together, and he was pondering a phrase in the opening scene, after the "*Esultate*," when the tenor sings "*dopo l'armi lo vinse l'uragano*." The question in his mind was the place where the tenor should breathe. Traditionally, tenors take a breath after "*vinse*," but the sense of the Italian would indicate the pause after "*armi*."

"Of course, Tamagno always sang it with the breath after '*vinse*,' but he managed not to break the phrase somehow." Then, to my surprise, Serafin sang in a vigorous, if cracking voice, the phrase as Tamagno always sang it. With a sudden shock, I realized that Serafin must have heard the original *Otello*, not on scratchy old records as I had, but on the stage of La Scala, as Verdi had.

"Yes, when I played in the orchestra as a young man, he was at La Scala," Serafin confirmed. "A wonderful *Otello*, but even finer in *Guglielmo Tell*. Poor man, how he suffered. . . ."

"Suffered?"

Continued on page 133

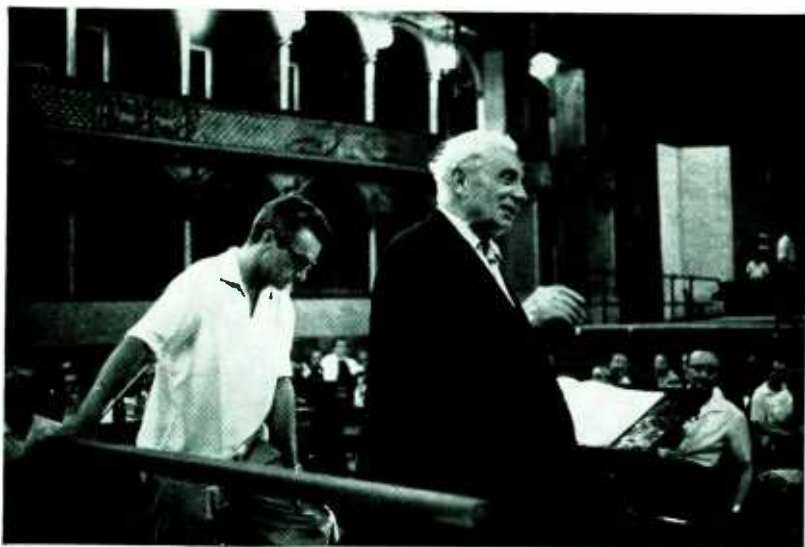

When he mounts the podium for rehearsal, the men, already silent, become more attentive than sometimes they seem in performance.



by Robert Craft

The Murderous Prince of Madrigalists



The author is our prime authority on Carlo Gesualdo di Venosa, who never could separate his three great passions — love, death, music.

GESUALDO'S NAME was well, if not widely, known a decade ago, but his music was only legend; the unreadable scholars said it was unsingable. At present, Gesualdo's name ranks next to Monteverdi's among composers of the late Renaissance, and his music will soon be as well known as his biography. What are the reasons for this change? The interest of modern composers (Stravinsky, Dallapiccola)? The discovery of music four hundred years old that is in no sense archaic and which is often profoundly contemporary? The discovery of a new and "striking" personality among the many vaguely limned sixteenth-century composers? Or the purely musical pleasure of certain groups of singers and their wish to share it?

I can answer only for myself, and only from my own experience. My own passion dates from a chance view of a friend's transcription of *Aestimatus Sum*. Seeking further examples, I learned that only a few pieces existed in modern reprint and that these few were to be found in badly edited, defunct publications. The Library of Congress owned the 1613 complete score edition, how-

ever, and this could be microfilmed and rewritten in a more familiar notation. I did just that, and during a period of about a year, "transcribing" Gesualdo became a suspense-charged late-night diversion. The 1613 edition is handsomely engraved and easy to read; the "transcriber" has only to rewrite the shapes of the notes and rests and occasionally to transpose a few clefs.

I thought to learn an idiom and its formulas—the characteristic harmonic procedures and the lengths to which Gesualdo might be expected to go—but Gesualdo's "characteristic" devices turned out to be new in every piece. I discovered the really ardent beauties of the music only when I began to work with singers, and to sing it myself. Performance technique—the feeling for vocal color, ensemble, and so forth, and even the problems of pronunciation (when to sound the second syllable of a word with two syllables, and one note)—develops only from performance. Since madrigals exist for their singers' pleasure above all, and not for audiences, the community of singers must criticize themselves and find their own char-

acter; madrigal singing is a game of very close cooperation. My singers sang for their delight, and for the excitement of being first in a long time to discover the music.

At that time (1953), I counted myself a highly privileged person. I was enjoying the daily company of Aldous Huxley, who has a discerning musical sense and who is a keen amateur. Mr. Huxley was intensely interested by what I said about Gesualdo and he soon began to attend my rehearsals. He translated the texts of the madrigals for me; he detected literary allusions; and he came forward with the thesis that Gesualdo must have written most of them himself. I asked Mr. Huxley to prepare a lecture on Gesualdo and to read it at a Los Angeles concert dedicated to Gesualdo's music. He consented, and because of the lecture, and its author, this first all-Gesualdo concert was a *coup de foudre* that was even taken on tour.

Mr. Huxley has told Gesualdo's story far better than I am able to do, but like all good tales, it can be told in another way, and is always worth retelling.

IN the winter of 1593/94 Don Carlo Gesualdo left Venosa, the city of his principality, and journeyed towards Ferrara and his bride-to-be. The entourage of this, as we shall see, extraordinary and dangerous bridegroom, was very grand. Many courtiers and their servingmen were in the procession as well as, according to a court diarist, "three hundred pieces of baggage carried by twenty-four mules." Less usual, however, was the fact that several of the Prince's attendants were celebrated musicians. Fabrizio Filamarino, the guitarist, was among them,

and Scipione Palla, perhaps the most famous singer of the day, though he is remembered now only as the teacher of Giulio Caccini. The presence of such excellent musicians is accounted for by the fact that the master of the caravan was not only a powerful prince but the composer of some of the most ardent and affecting music ever written.

Carlo Gesualdo, then thirty-four years old, was a highly pedigreed prince. A descendant of King Roger II, Don Carlo was many times a Duke, Prince, Lord, Count. He was still further ennobled



At left, Don Carlo's country castle in Gesualdo, a town (pictured below) which had little to offer except the "aria salubre" essential to a chronically ill man. At lower left, the Church of Gesu Nuovo in Naples, where the Prince of Venosa lies buried.



Illustrations, courtesy of Columbia Records, from the forthcoming album of Gesualdo madrigals conducted by Robert Craft.



by two eminent family connections in the Church, for one of his maternal uncles was the Archbishop of Naples, and another was the great Charles—later Saint Charles—Borromeo.

Don Carlo's father may also have been a composer. In any case, he kept a musical court, which thus encouraged the younger Gesualdo's precocious passion for music and led him to become a singer and lutanist as well as a composer. In 1578, Torquato Tasso joined the Gesualdo circle, and in the next few years that unhappy poet wrote some forty texts for his young patron. (Only eight of Gesualdo's settings have been identified, but the composer may have borrowed and shaped to his own purpose additional canzoni by Tasso.)

When Gesualdo set out from Venosa for Ferrara, he was marked by events of a strange and shocking nature that had transpired during the three preceding years. In 1586, he had married his first wife, Donna Maria d'Avalos, a handsome woman, as her portrait in S. Domenico Maggiore, Naples, still indicates. (Donna Maria is buried in this church, her wedding to Gesualdo took place there, and her death occurred in the house across the street.) Don Carlo was her third husband. The first had expired from having too often reiterated "*i congiungimento carnali*"—or so a gossip said, though one doesn't quite see how that is possible. The second was granted a Papal divorce. Don Carlo, for his part, had shown no inclination to marry, but the death of his only brother required him to produce heirs as well as airs. Donna Maria had given proof of fecundity, and as Gesualdo's first cousin she was also regarded as dynastically suitable.

Neapolitan society could not have been surprised when she began to compensate for her new husband's neglect, but Gesualdo appeared to be surprised. During the night of October 16, 1590, he returned from a hunt, like King Mark, and discovered his wife and the young Duke of Andria in *fragrante peccato*. At his command, the lovers were stabbed to death. Even more horrifying than the murder, however, is the fact that it does not appear to have been a *crime passionel*, unless Don Carlo had merely intended a surprise party and had then lost his reason: the testimony gathered by the Viceregal Court of Inquiry shows that Gesualdo had been aware of the lovers for a long time, that he had carefully set the trap and as carefully planned his retreat.

But the court papers that have been reprinted (Turin, 1888) indicate that popular opinion and sympathy were not on the side of Gesualdo's honor.

Gesualdo fled to his country castle in the hill town still bearing his name and located about seventy miles east of Naples. The murderer feared reprisals, evidently, even though his wife's relatives were also *his* relatives, for the slopes were razed beneath his fortress and the castle readied for a siege. Doubt as to the paternity of his infant son is then supposed to have assailed Gesualdo who, according to the story at any rate, murdered the child too. (He died by suffocation due to violent rocking in a swing! "Oh, how I love to go up in the sky/Up in the sky so blue . . .")

The elder Gesualdo died in 1591 (no suspicion as to undue cause of decease at the time), and Don Carlo became Prince of Venosa. The new Prince's Neapolitan enemies must have been reconciled soon after, for he had returned to the city of his crime by the beginning of 1592. One year later the Prince began to court a new Princess. Leonora d'Este, the object of his suit, was the only daughter of the Duke of Ferrara. A medallion portrait of her survives, and one wonders if it had been sent to Gesualdo, except that the Principessa's puffy face—an excessive pituitarist?—is so very unprepossessing. Why did Gesualdo marry her? For that matter, where did she get the courage to marry him? Her dowry was high, but Gesualdo's own guarantees of settlements on their first-born son were higher still, and the marriage contract indicates no need of money on his part. The reason could only have been that Ferrara attracted Gesualdo more than any other city in the world by reason of its musical preëminence and that an alliance there would have been his first choice. Gesualdo had abandoned his first madrigal style and "set himself to the imitation of Luzzasco, a man he greatly admired and praised"—this by his own word. Luzzasco Luzzaschi was one of the musical ornaments of Ferrara. The marriage terms were settled in the fall of 1593, and sometime thereafter, Gesualdo embarked on the journey described above.

Ferrara at this late date was still a resplendent Renaissance city and its court was the last true court of the high *cinquecento*. (When, only a few years after Gesualdo's marriage, the Duke died without male issue, Ferrara and all of its territories were escheated to the Pope.) Ferrara's sixteenth-century musical history is the richest in Europe. The pattern of the musical "*camerata*" had been established by Isabella d'Este, in Mantua, Ferrara's sister-state and sometimes political bulwark against Venice, Florence, Milan. Isabella, that super-bluestocking bitch, was herself a musician and therefore an exacting patroness. Isabella's musical court was the model for Ferrara's, just as her Mantegna room was the model for the Bellini-Titian room ("Feast of the Gods") in the Castello Estense.

The servants of the Ferrara court were trained

musicians who kept lutes, cembalos, and other instruments in tune and ready for immediate use. The Ferrarese courtiers wrote madrigals, played musical instruments, sang. Josquin, Obrecht, Brumel, Palestrina, Lasso, Cipriano, Marenzio had worked in Ferrara. Now, at the moment of Gesualdo's arrival, the most "advanced" musicians in Europe were there, for Ferrara was also the focus of the chromatic experimenters and of the new theorists following Vicentino. Scholars are now in some agreement that equal semitone temperament, allowing for exact enharmonic exchanges, was in practical use at the beginning of the sixteenth century. By the middle of that century, several types of keyboard instruments with minute divisions of the octave were also in existence. One of these, the archicembalo, was said to measure no fewer than thirty-seven differentiations of pitch to the octave. Indeed, the archicembalo seems to have been as great a curiosity to composers of Gesualdo's time as the electronic synthesizer is to composers of our time. Gesualdo would naturally have experimented with it, and with other new instruments, while in Ferrara. He would also have heard much new music there, including the later music of Luzzasco. But though little is known of all this, one does know that after Ferrara the characteristics of Gesualdo's own Mannerism were to become even more pronounced and the means of producing them even more extreme.

Don Carlo and Leonora were married in the Castello Estense on February 21, 1594. They retired afterwards to the Palazzo Diamanti, and some days later moved to the Palazzo Marco Pio.* The nuptial festivities included a visit to Venice, after which, sometime in May or June, the Prince and Princess returned to the Kingdom of Naples. Leonora was not happy with her husband, however, and her complaints about his infidelities and other peculiarities of conduct regularly reached her brother, Cardinal Cesare d'Este, of Modena. At one point Cardinal Cesare sought and obtained Pope Paul V's consent for a divorce. The marriage did not terminate this way, however, but with Gesualdo's death on September 8, 1613, in his country castle. The great musician-prince was buried in the Gesu Nuovo, Naples, where he is still remembered by a plaque.

What sort of person was Gesualdo di Venosa, and why should this be a pertinent question to ask? The person is important, I think, because he has identified himself with the passions of his subject matter in an altogether new and exceptional way and because he speaks to us so personally about those passions in his music. The pieces of the portrait are relatively complete—for a composer of that period—though this is because he was Prince of Venosa, of course, and *Continued on page 130*

*Biagio Rossetti, the architect of the latter two buildings—and indeed of most of Ferrara—is now being discovered by architects much as Gesualdo is by musicians. He is heralded, above all, as the first urbanista, or city planner. Ferrara, as Montaigne noted in 1580, abounds in broad avenues and parks, and is like no other Italian ville. A fascinating book, the first full study of Rossetti, was published in 1960 by Einaudi (Torino).

Here's the
one and only
speaker system
you will
ever want

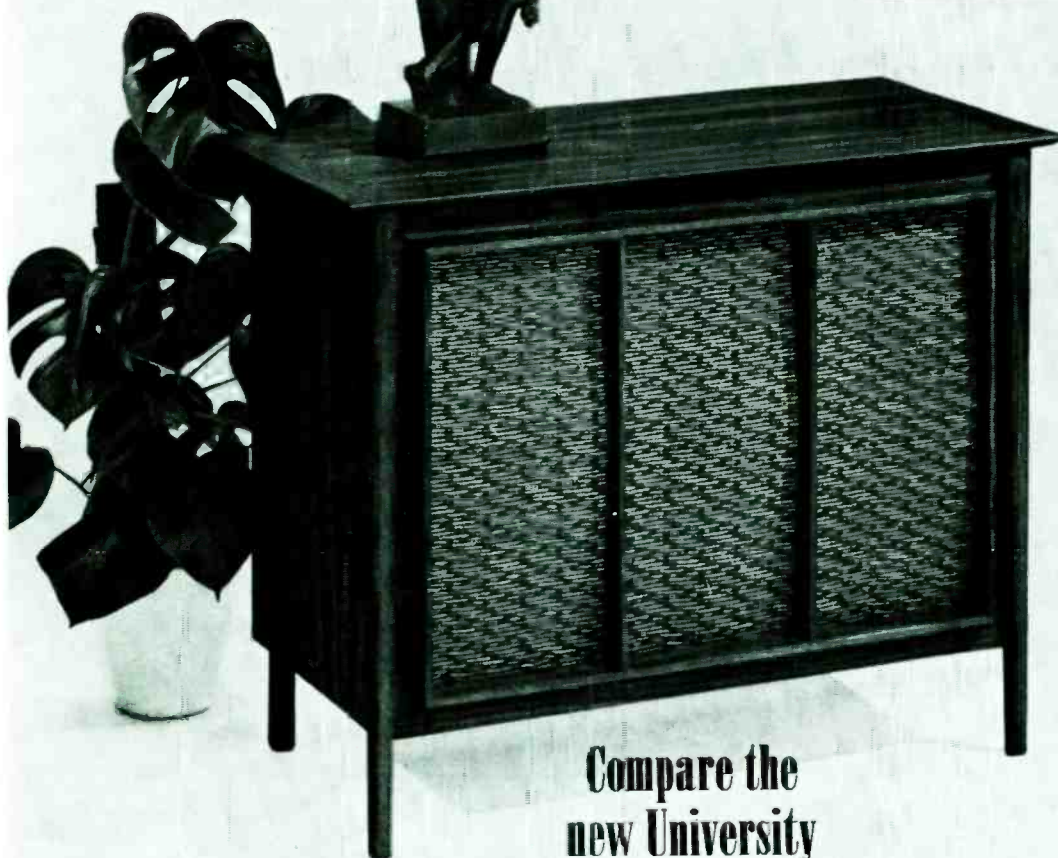
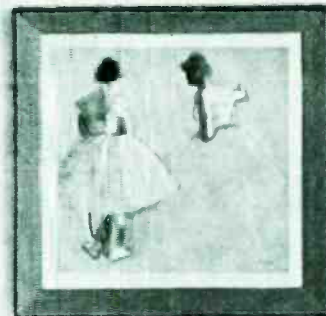

Compare the
new University
Classic Mark II
to all other systems—
regardless of price.

We could list the new CLASSIC's complete specifications. We could commission a poet to describe the sound and the cabinet. Both good ideas, but quite inadequate to the task, for the new CLASSIC is a *living* instrument. You must *hear* it to know why it is the most important speaker system available today. You must compare it to *all* other makes to eliminate any doubt that here is the only system you will ever want.

For large rooms, small rooms—for today and tomorrow—here is the first *sensibly* designed big sound system in

years. It creates a sense of spaciousness typical of yesterday's massive systems—but without making their space demands, and without sacrificing the intimate sonics and texture necessary for the full enjoyment of soloists and small musical ensembles.

A "major acoustic achievement," as many experts have declared. But you decide for yourself. At any quality high fidelity dealer. \$295.00.

3-WAY SPEAKER SYSTEM: high compliance 15" woofer; 8" direct-radiator mid-range; Sphericon super-tweeter. RESPONSE: 20 to 40,000 cps. POWER

REQUIREMENTS: any quality amplifier rated from 10 to 60 watts. DIMENSIONS: 35" X 28¼" and 17½" deep!

Write for the fully-documented CLASSIC MARK II brochure and University's "Informal Guide to Component High Fidelity." Desk P-9, University Loudspeakers, Inc., 80 S. Kensico Ave., White Plains, New York.

Timeless Beauty and the Sound of Truth



A Division of Ling-Tenco Electronics, Inc.

CIRCLE 109 ON READER-SERVICE CARD



RED SEAL MAGNETIC RECORDING SOUND TAPE

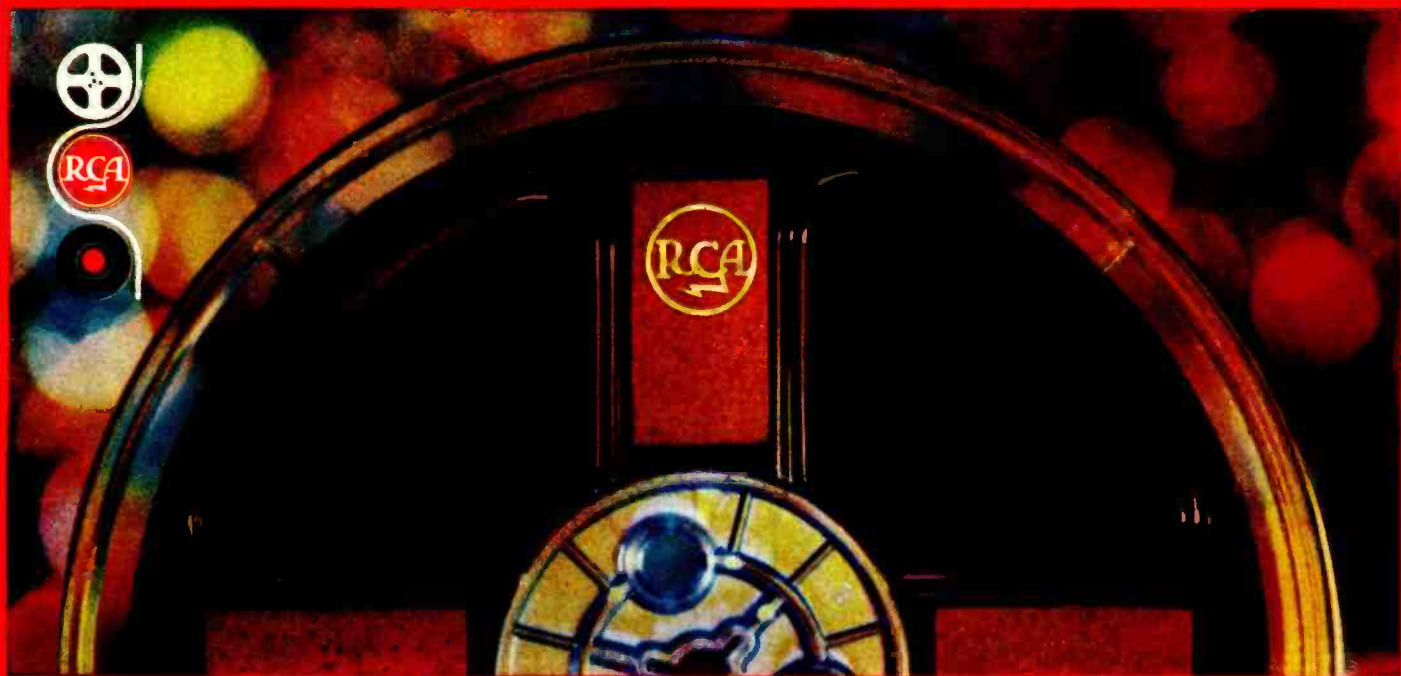

Now available for home use...

RCA RED SEAL SOUND TAPE

*The same superlative quality sound tape
used for RCA Victor master recordings*

The finest in recording tape is now yours to enjoy for home recordings! RCA Red Seal Sound Tape, the tape used by professionals, offers you superb tonal fidelity and wide dynamic range.

Use RCA Red Seal Tape for all home recordings including your favorite music—symphony, opera, pops, jazz. Then listen to the most glorious reproduction of home recorded sound you have ever heard.

RCA Red Seal Sound Tape is available in all popular reel sizes

(3", 4", 5" and 7"), all popular lengths (300, 600, 900, 1200, 1800 and 2400 feet), in acetate, Mylar* or tensilized Mylar bases. For a descriptive flier write to RCA, Section 1-74-MT, Commercial Engineering, Harrison, N. J.

Start now to get more out of hi-fi. Look for this bright new package at your dealer. If he doesn't yet have new Red Seal Tape, ask him to order it for you. Then get set for a new experience in sound!

RCA Electron Tube Division, Harrison, N. J.

*Registered DuPont Trade Mark



The Most Trusted Name in Sound

A Special Section on MAGNETIC TAPE

The Magic Medium

The Second World War left mankind with a memory of horrors, a legacy of troubles, and a handful of benefactions. Magnetic tape is one of its few truly estimable by-products. The Germans developed it as a wartime propaganda tool; it was later "liberated" and further refined by the Americans; and it is now to be found in constant use in every quarter of the globe and in every conceivable set of circumstances.

Magnetic tape, of course, had been preceded by other methods of recording sound. But tape made the art of recording into an everyday accomplishment. With it you could capture sounds as easily as you could capture images with a camera. You had merely to flick a switch and set the reels in motion: a thin ribbon of metallic-coated plastic, winding off from one reel and on to the other, would somehow or other seize and hold for infinite replayings any and all kinds of sound. The medium was indeed magical.

It is no wonder, then, that tape has been rapidly capturing the imagination of the Compleat Fidelitarian. And hence this special section—which explores some of the avenues to its varied fascinations.

by Ralph Freas

ARE
YOU
MAKING
THE
MOST
OF
YOUR
TAPE
RECORDER?

EVERYTHING FROM BETHOVEN TO A BULL-SESSION IS FUN TO RECORD — AND TO HEAR AGAIN. BUT YOU DO HAVE TO TAKE THE RECORDER OUT OF THE CLOSET



ON MAY 5 of this year, some people captured on magnetic tape the sound of history being made as the launching of America's "first astronaut" in a Redstone rocket ballistics shot was broadcast. The sounds of lift-off—the count down, the rocket's roar, the reports on the capsule's occupant—combined all the elements of high human drama. This, then, was a made-to-order subject for home recording. With the simple twist of a dial, the tape recordist could look forward to reliving the suspense and excitement of the occasion. And in view of tape's virtual indestructibility, he could expect to pass on to his children and his children's children a document of extraordinary historic interest. Yet, for all this, it would appear that relatively few recorder owners taped the event from the audio of their television sets or from a radio receiver. Why didn't they?

According to well-informed sources, most of the more than 3,000,000 tape recorders in homes today repose "out of the way" in closets, awaiting occasional use as whim suggests. For this reason, when a recording possibility suddenly comes along (a broadcast of a great musical performance, a play, a significant public occasion), the chance to tape it is often tossed away because the necessary preparations appear too troublesome. Indeed they can be troublesome. First, of course, the recorder must be removed from the closet. Then it must be opened and set up in a convenient place. Its AC cord must be plugged in, which often means first finding an extension cord. A reel of blank tape has to be placed on the recorder's spindle, and patch cords (or other connection) attached to the voice-coil terminals of the receiver's loudspeaker, or a cable connected to the main receiving system's "tape feed" facilities. The power is finally turned on, recording level set, and speed selected. Unhappily, by the time all this has been done, the astronaut may be halfway down the Caribbean or the Boston Symphony well into the second movement of the *Eroica*.

The obvious solution is to be prepared—so that a flick of a switch will start things rolling when an interesting opportunity presents itself. And such preparedness does not mean that one's living room must take on the electro-mechanical aspects of a recording studio. With a little planning, today's tape equipment can be integrated into a high-fidelity system with the same ease as a tuner or turntable.

Of the two considerations basic to such an installation, physical placement and electrical connection, the former is limited only by one's imagination. In general, however, three installation modes are commonly used: vertical (or "rack") mounting, sliding drawer mounting, and lift-top cabinet mounting. Each has specific advantages.

The rack-mounting method makes most sense if the recorder is to be located at higher than waist level on a shelf or in equipment cabinetry. In addition to giving an appearance of professionalism, this mode has a simple practical virtue. As the recording proceeds, one can tell at a glance from

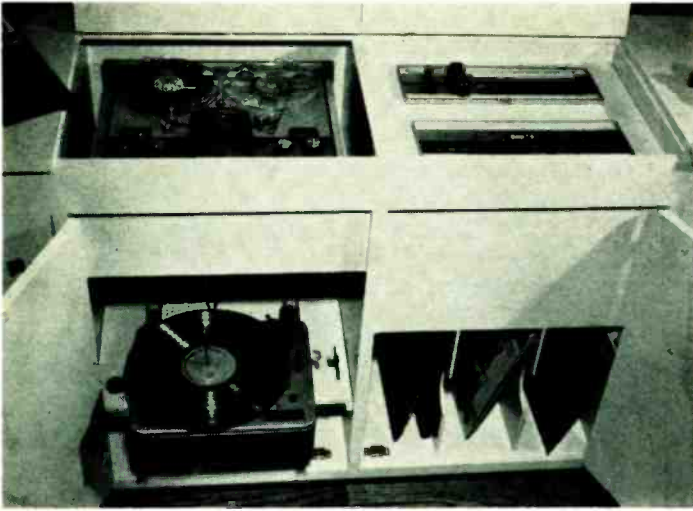

IN A CABINET "WELL"

This cabinet's tape recorder "well" accommodates the recorder in its case. The hinged cover (not shown) of this Ampex 960 is easily removable and replaceable should the recorder be taken from the cabinet and transported for a special recording project outside the living room.

the comfort of an easy chair how much tape has been used and how much blank tape remains on the reel. Some recorders, however, do not perform well in this vertical position, and most of those that do require rubber reel holders, placed over the protruding spindle, to hold the reels firmly in place.

A sliding drawer mounting makes for neatness and compactness, but it demands some skill and knowledgeability on the part of the installer. Ball-bearing chassis slides are essential here—and these have specific limitations of "slide travel" and "load capacity." Available at audio dealers, chassis slides have a slide travel that ranges from 7½ in. to 14½ in. with a load capacity between 30 and 50 lb. The longer the slide travel, the lower the load capacity will be; thus, a chassis slide that pulls out only 7½ in. will be able to carry 50 lb., while 30 lb. is the limit for a slide that pulls out 14½ in. One typical (and popular) self-contained record/playback combination tips the scales at 38 lb.; some weigh more, many less. If the cabinet structure permits easy access to spindles and controls, a slide travel of 7½ in. may be perfectly adequate.

The lift-top cabinet mounting actually is the simplest way to house a tape recorder if one already has a cabinet suited for this use. Cutting a "well," into which the recorder's "mechanics and electronics" will fit snugly, presents no great problem. Most recorder manufacturers provide a template for this purpose. The owner of a self-contained portable unit ought to use a cabinet deep enough to accommodate the entire unit in its case. For recording outside the home, it is then quite simple to remove



AS A PULL-OUT DRAWER

In cantilevered construction, long slide-travel of the tape deck or record changer can result in bad weight distribution. Because of this cabinet's design, the drawers do not have to slide far for access to components.



RACK-MOUNTED

The angle-mounting (85 degrees from horizontal) allows this Bell T-221 tape deck to function better than it would at 90 degrees. The folding doors close off the installation from view and keep everything dust-free.

the machine and tote it along. Some manufacturers make matters even easier by providing portable models that can be easily removed from their carrying case and refitted into the home installation.

One final word about the physical placement of the recorder: with due regard for the restrictions of the three basic modes described above, there's plenty of opportunity for devising your own arrangement. Thus, a recorder may be installed at chair-side, or in a drawer under an end table, or vertically on a bookshelf (happily, most recorders have a narrow profile). In the final view, convenience of operation should be the main consideration.

With today's recorders, electrical hookups are no more complicated than the physical installation. Any possible complexity stems from the variety of equipment available and the consequent flexibility of installation. For example, some manufacturers produce a simple deck with nothing but record/playback heads and the tape transport mechanism—no electronics. Other variants include: heads and transport with playback preamplifiers; with record *and* playback preamplifiers; with preamplifier functions as well as power amplification. Finally, there is the record/playback unit complete with everything, including dual loudspeaker systems.

The buyer of a deck, sans electronics, is able to play recorded tapes through a component system. To record, however, from a microphone or other program source, demands the addition of recording heads on the tape deck, as well as a recording preamplifier. The "tape record" function with its spe-

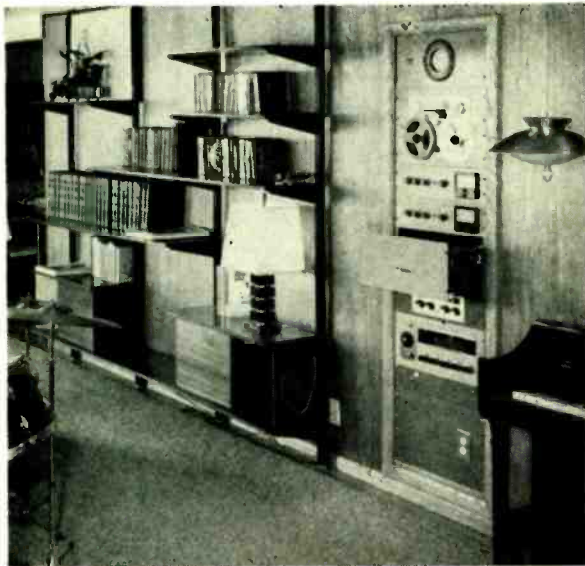

THE PROFESSIONAL TOUCH

The rack-mounted recorder (a Viking deck) in this installation gives an appearance of complete professionalism. An unused closet easily converts to this mode of installing components, but provision must be made for ventilation. Notice speakers on adjoining shelf at left and the diffuser panels to distribute sound more evenly throughout the room.

cial gain, equalization, erase, and bias voltage is not included in any of the regular high-fidelity amplifiers. But these additional parts can be obtained to convert a "playback-only" deck to a recorder. Before attempting such conversion, consult the manufacturer of the deck for his specific recommendations—which, for best results, often will involve equipment of the same make.

To make a recording other than from a microphone, the question is from what point in the sound system to tap the signal to be recorded. Within a high-fidelity component system, there may be several possible "tap off" points, depending on built-in "tape-feed" or tape output facilities. Generally, the best place to tap off is as close to the signal source as possible. The further a signal travels through a system, the more chance there is for the signal to be distorted. In recording an FM radio broadcast, therefore, the best tap-off point is at the tuner. This presupposes that the tuner has a tape output jack in addition to its regular amplifier-feed jack, as indeed many tuners do.

The next possibility for tape take-off in the component chain, and the one that permits recording of *all* signals handled by the system, is a stage in the preamplifier. Since almost all preamplifiers, as well as combination or integrated amplifiers, are built with a tape output, this is the most likely tap-off point. For those who do not own a component system, the tape take-off can be made by patch cord connections to the voice-coil terminals of the loudspeakers. While not the best place to capture a signal, this method is better than placing a microphone in front of the speaker—a practice which provides very poor results acoustically and is to be avoided.

Now that we have stereo FM broadcasting (multiplex signals), a good deal of home recording will go to producing "instant stereo" recordings in the living room—a prospect that would have been viewed as wildly futuristic less than ten years ago.

Of course, recording quality will be only as good as the electronics in the recorder. If the recorder is outfitted with record preamplifiers and is of good quality, the best plan is to stick with the built-in electronics. If the recorder is just average, the wisest course would be to bypass the electronics as far as possible and use only the tape transport and record head. You would then have to provide the record preamplifier. (Kit builders will be interested to know that such units are becoming available in do-it-yourself form).

One final word. Every recorder is provided with a "record level" meter of some kind, a handy recording aid but hardly an ultimate guide to good recording. More effective in judging recording quality is a set of monitor headphones. Even an inexpensive pair will prove extremely helpful, since they shut out random noise and allow the recordist to hear only what is being put on tape. This is as effective as having a sound proof recording studio in the home—and it's a lot less expensive.

by Norman Eisenberg

*Some hints on
mastering the master
recording medium*

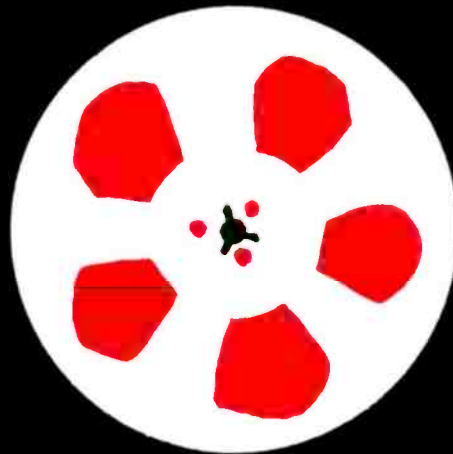

ANYONE CAN BE A SOUND ENGINEER

ASIDE from its use commercially as the master recording medium from which both discs and “pre-recorded” tapes are made, and for a wide range of functions in business and industry, miles of ribbons of magnetic tape are regularly spun out and reeled in for the personal pleasure of countless tape recorder owners. The uses to which tape can be put by the amateur recordist are limited only by his imagination and skill, and most equipment or raw tape producers will, at the drop of a capstan, supply him with dozens of other ideas based on the unique advantages of a machine that captures sound with at least as much ease and convenience as a camera takes pictures and with the added advantage of releasing what has been “taken” without the bother of further developing or processing.

But like any really rewarding pursuit, tape too makes certain demands on its enthusiasts. The recordist’s first care, of course, is the choice of what tape to use.

Tape today is divided into two main classes, according to the plastic backing on which the oxide coating is affixed. (This coating is magnetized to store sound and permit its reproduction by the playback head.) The type most widely used has a cellulose acetate backing, although the more recently developed polyester-backed tape (“Mylar”)—stronger, more durable, less subject to humidity and temperature, and also somewhat more expensive—is coming up fast in popularity. Many experts hold that the acetate type suffices for home recording; others insist that the added cost of Mylar is war-

ranted for all recordings of any serious value regardless of how amateur is the recordist’s status.

The thickness of the tape represents a compromise between the length that may be coiled on a reel (and thus its playing time) versus its ultimate fidelity and physical strength. In assessing these variables, the choice for most serious recording chores would seem to be a 1½-mil (1,200 feet on a 7-inch reel) acetate tape, or a 1-mil (1,800 feet on a 7-inch reel) Mylar. One can get acetate in the 1-mil thickness too, but its relative economy may not compensate for its deficiencies in strength and fidelity. Mylar at 1½-mil is, of course, the strongest tape made and should exhibit the best response characteristics. For maximum playing time the choice would be ½-mil thickness tape (2,400 feet on a 7-inch reel); with its “tensitized” Mylar backing, such a tape can be strong as well as long—though no great claims ever have been made for its fidelity of response.

Often a deciding factor in settling on a particular kind of tape is the anticipated length of a specific “run” or recording chore. This time can be estimated on the basis of the standard 7-inch reel, with its 1½-mil-thick tape of 1,200 feet providing just one hour of playing time for monophonic recording at two-track operation at 7.5 inches per second speed. From these figures, it is fairly easy to reckon other playing times. Thus, the same tape used at half that speed (3.75 inches per second) would naturally provide twice the playing time, or two hours. For stereo, the playing times would be halved: thus, one-half hour for dual-track stereo



At left, tape heads are demagnetized and then (directly below) cleaned to improve response. On underside of chassis a worn belt is discovered which should be replaced. In bottom photo, the pattern formed by the tape's edge on the reel is studied for signs of mechanical defects in the tape recorder.

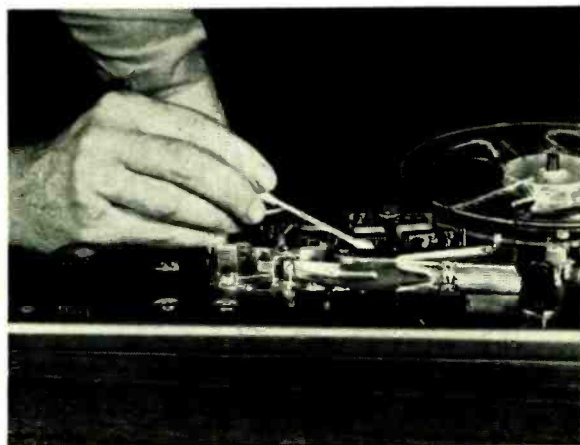

at 7.5 inches per second speed. Similarly, for other thicknesses of tape, the figures vary proportionately. Thus, the 1-mil tape thickness permits 1,800 feet to be coiled on a 7-inch reel, and all figures are accordingly fifty per cent greater. For those disinclined to mathematical calculation, a convenient playing timetable is provided on page 66.

Having selected your tape, it remains for you to scrutinize your recorder, its workings and its electrical relations to other components in the sound system. New recorders as a rule need little or no close attention, although sometimes certain adjustments should be made after shipment. If such are required, they probably will become apparent soon after your first trial run with the machine. Generally these are covered in the equipment instruction manual or—if they result from defects—can be handled under a new equipment warranty. Older machines or units that have not been used for some time should get a fairly thorough going-over, which may include technical work beyond the average owner's scope. (One professional recordist's plan for such work accompanies this article on page 65.)

At the very least, and with any recorder, there are a few simple precautions one can take to assure good results. First, study the instruction manual as closely as if you had to pass a stiff examination on its contents. Refer to the parts of the equipment as they are described in the manual and learn the recommended sequence of operational steps. Avoid the temptation to plunge ahead and push buttons, recalling the recordist's adage that only fools rush in where professionals fear to tread. Above all, learn the difference between the "record" control and the "play" control; operating the former when a recorded tape is on the deck will neatly erase its contents.

Chances are that a recent purchase will have clean heads. Even so, and certainly after perhaps ten to fifteen hours of use, the heads should be cleaned and demagnetized. To clean a tape head, gently swab it with a "Q-tip" that has been dipped in carbon tetrachloride or a similar commercial preparation. While doing this, incidentally, it's a good idea to clean in the same fashion the various parts about which the tape moves, such as guides, capstans, and pressure wheels. To demagnetize the heads, use a head demagnetizer—available for a few dollars at most radio supply stores.

Some experts advise running a reel of tape at fast rewind before actually recording onto it, so that it will feed better during the recording process. And to make certain the tape is *completely* free of unwanted sounds, use a bulk eraser to wipe it clean electrically. This device can, in seconds, erase a

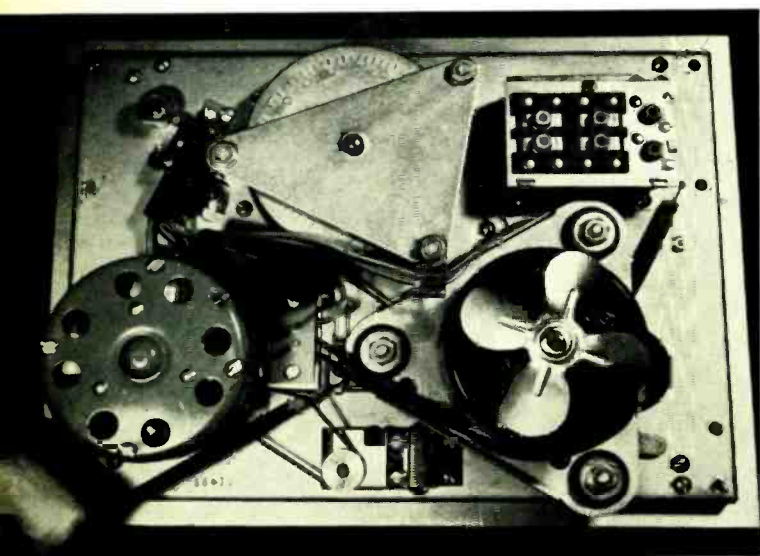

complete reel of tape much more effectively than could be done by running it past the erase head (which will happen in any case during the recording). A decided benefit in re-using a previously recorded tape, the bulk eraser also is credited with being able to reduce residual noise even on fresh tape.

Next, check all interconnections with other components, including of course your program source. Make certain that if your recorder has more than one signal input receptacle, the correct one is being used. You should not, for instance, plug the tape-feed cable from the amplifier into the recorder's microphone jack—neither the gain nor the equalization

provided would be electrically correct. Make certain also that you have not set up a signal feedback loop in which signal paths return on themselves to create squeals and howls. This can happen if cables are incorrectly connected, or if the wrong operating controls are used. Actually, most tape recorder instruction manuals cover these points adequately, but the beginner—and the first-time user of a new machine—would do well to double-check.

Determine how you will monitor your recording. Generally there are two methods for listening during the recording process, depending on the combined facilities of the tape recorder and the rest of your

Some Tips from a Professional

THE UPSURGE of interest in tape recording doubtless will find many an equipment owner casting a new look at a machine that has been sitting on a shelf or stored away in a closet. Tape equipment that has not been used in some time may require special attention. Some pointed advice on this subject is provided by Steven Hahn who, as head of Round Hill Associates of New York (responsible for language laboratories in schools, the simultaneous translation system used at the United Nations, and a transistorized version of the "cordless" telephone), has handled in his time dozens of recorders of varying complexity and quality.

In addition to studying the instruction manual and cleaning and demagnetizing the heads, as described in the accompanying article, Hahn recommends the following program for assuring the best results from a tape recorder that has been a long time dormant:

1. Inspect the recorder for obvious signs of damage or deterioration. Remove it from its housing and look for such danger signs as rust spots on moving parts, broken belts and pulleys, and the like. Rust spots may be removed by rubbing gently with very fine steel wool. Broken (or lost) belts and such can be replaced with new parts from the manufacturer. Generally, tape recorders are permanently lubricated, and no attempt should be made to relubricate them. Any adjustments you make should be only those specified in the manufacturer's literature.

2. It will probably be desirable to replace all tubes with new ones. If possible, get the latest low-noise equivalent types, but don't change the basic types themselves.

3. Thread a reel of tape onto the machine. Turn on the power and check mechanical operation by operating the recorder in its various fast forward, rewind, play, and record functions. If the machine has been stored for a long time, there may be some defects. You may, for instance, find "coasting" (when switching from fast forward or rewind to stop, the reel may continue to spin, driven by the belt rather than by the motor which has been shut off); reel slippage, due to poor brake tension; poor stopping and starting characteristics; or poor tracking. This last shows up as an irregular pattern formed across the edges of the tape as it winds onto the take-up reel. Thus, for an inch or so, the tape will lap on smoothly; but at some point its edge will seem to protrude. A slightly irregular, or occasionally irregular, pattern is of no significance, but a highly irregular pattern—or one in which there actually is an open space between the windings—can cause momentary distortion, as well as the "mashing down" of the tape's edge. Curing any of these difficulties—if they are not spelled out in the instruction manual—is best left to a competent service technician.

4. The alignment of the tape head—or its position with respect to the tape—is critical to the recorder's response. This position has been adjusted at the factory. Often the adjusting screws are set to prevent misalignment, and marked over to indicate their original correct position. Normally, realignment will not be required. If the heads are misaligned, the recorder will suffer a marked loss in high frequency response. As it happens, a similar loss in response also can be

caused by dirt, scratches, or nicks on the head. It is thus not always correct to attribute this loss solely to misalignment. Of course, if the head is loose, or its position appears to have been disturbed, realignment would be called for. One way to determine misalignment would be to play a given tape on another recorder of similar vintage and quality as your own, and A-B performance on both. A surer way is to use an alignment tape with its specially prepared test tones. Although the instructions for many such tapes call for the use of some electrical indicator (a VTVM, for instance), fairly adequate alignment can be made simply by ear. The recorder instruction manual generally indicates which screw to turn to adjust the head. If it does not, then the manufacturer feels alignment need not, or should not, be performed by the owner.

5. Most tape recorders (except the very cheapest and oldest) use an AC signal for recording bias and for erase voltage. Usually the frequency of this signal is around 30 kc for low- and medium-priced machines. Modern, professional recorders may use signals on the order of 60 kc. In any case, to do its job correctly, this signal must be of proper amplitude as well as have a characteristic sine-wave shape. While many recorders do include adjustments for optimizing the AC bias and erase signals, no attempt to use them should be made unless the instruction manual cites the required electrical values and you are equipped with a good AC-VTVM and oscilloscope to determine those values. Obviously, this area of refurbishing a tape recorder, in particular, is best left to the professional technician.

sound system. One method is to listen to the signal at the moment when it is impressed on the tape; in other words, the tape recorder is in "parallel" with the power amplifier and loudspeaker of your original sound system. While adequate, this method does not really let you know—at the time—just what the tape recorder itself is making of that signal. The more professional way of monitoring is to listen to the signal immediately after it is recorded, from the tape recorder itself. Since this method puts the recorder between the signal and its playback channel, it is sometimes known as the "series" monitor technique. It requires that the recorder have separate record and playback heads and that the control amplifier or preamplifier (as the case may be) for the rest of the sound system have a tape monitor function, usually identified by a switch on the front panel. With this technique, you can audition the results of the recording as it is being made and thus know at once whether all is well or whether something is amiss. Details on this type of hookup are found in the instruction manuals—for the control amplifier or preamplifier if it has a tape-monitor switch, and for the tape recorder itself if it has separate record and playback heads.

For live recordings, monitoring (by either technique) is best done with headphones, since the sounds from a loudspeaker, in proximity to microphones, can set up a nasty feedback loop of howls and distortion. What's more, it is virtually impossible for anyone to perform against the same sounds leaping at him an instant later from a loudspeaker. Live recordings can be monitored with loudspeakers, of course, if the performer and microphone are acoustically isolated from the playback equipment, as in a studio divided by soundproof walls with the performer on one side and the recordist and his equipment on the other, but these conditions can hardly be met in the average home.

Before starting the actual recording, try a brief trial run, mostly to determine the correctness of the points thus far described, as well as to determine

how to adjust the input signal level control during the actual recording. Although the recorder's signal level indicator (meter or tube, as the case may be) is a fairly accurate guide, you may find that the points of overload and distortion will vary with different kinds of tape. It is important in any case to adjust this input level before the recording starts; readjusting signal level during the recording will produce erratic volume on the finished tape. Of course, you always can "ride gain" during the recording for a deliberate effect, such as fading in and out, but even so your maximum and minimum signal levels should be determined and known beforehand.

If the recording is a live one, check the placement of microphones from the standpoint of desired acoustic quality as well as with regard to their tendency to pick up stray noises. Remember that the sound of the passing car which you scarcely noticed when a guest was playing your piano may, when picked up by a microphone and recorded on tape, sound outright obtrusive.

If you're recording from discs, tapes, or a broadcast, play safe and start the recorder before turning on the program source. It's much better to waste a foot or so of tape than to risk losing part of a program you want. There is now little for you to do except to note from time to time the signal level indicator and—if you want to take advantage of its convenience—note the tape index counter which will continue to run as long as the reels are spinning. This counter allows you to pinpoint exact portions of the recording; thus, the number 165 might indicate the end of the first movement of a symphony, or number 241 might signal the end of an act of a play, and so on.

When the run is over, stop the machine. If the recording has been finished before the complete reel is used, you can do either of two things: you can cut off the unused tape, rewind the recorded portion onto another (smaller, if indicated) reel, and label it; or you can simply indicate on the original reel where the program *Continued on page 131*

PLAYING TIMES FOR SEVEN-INCH REELS

Tape	7.5 — ips Speed				3.75 — ips Speed			
	Monophonic		Stereo		Monophonic		Stereo	
	2-Track	4-Track	2-Track	4-Track	2-Track	4-Track	2-Track	4-Track
"Standard": 1½-mil, 1,200 ft.	1 hr.	2 hrs.	½ hr.	1 hr.	2 hrs.	4 hrs.	1 hr.	2 hrs.
"Long Play": 1-mil, 1,800 ft.	1½ hrs.	3 hrs.	¾ hr.	1½ hrs.	3 hrs.	6 hrs.	1½ hrs.	3 hrs.
"Extra Long Play": ½-mil, 2,400 ft.	2 hrs.	4 hrs.	1 hr.	2 hrs.	4 hrs.	8 hrs.	2 hrs.	4 hrs.

This table can serve as a guide in estimating the kind of tape needed for specific recording chores from the standpoint of timing. Note that the term "2-track" actually refers to half-track recording, in which the tape is used first in one direction of travel and then in the other (hence "two" tracks). In 2-track stereo, both halves are used simultaneously. Similarly, "4-track" recording refers to the use

of one-fourth of the total tape width; thus "four"-track stereo really indicates the normal two channels of stereo, but first in one direction of tape travel, then in the other. This technique allows for the greatest possible playing time at 7.5 inches per second, presently the industry standard for stereo tapes. The slower speed of 3.75 ips may be used when longer tape playing time is needed.

by Frank Rogers

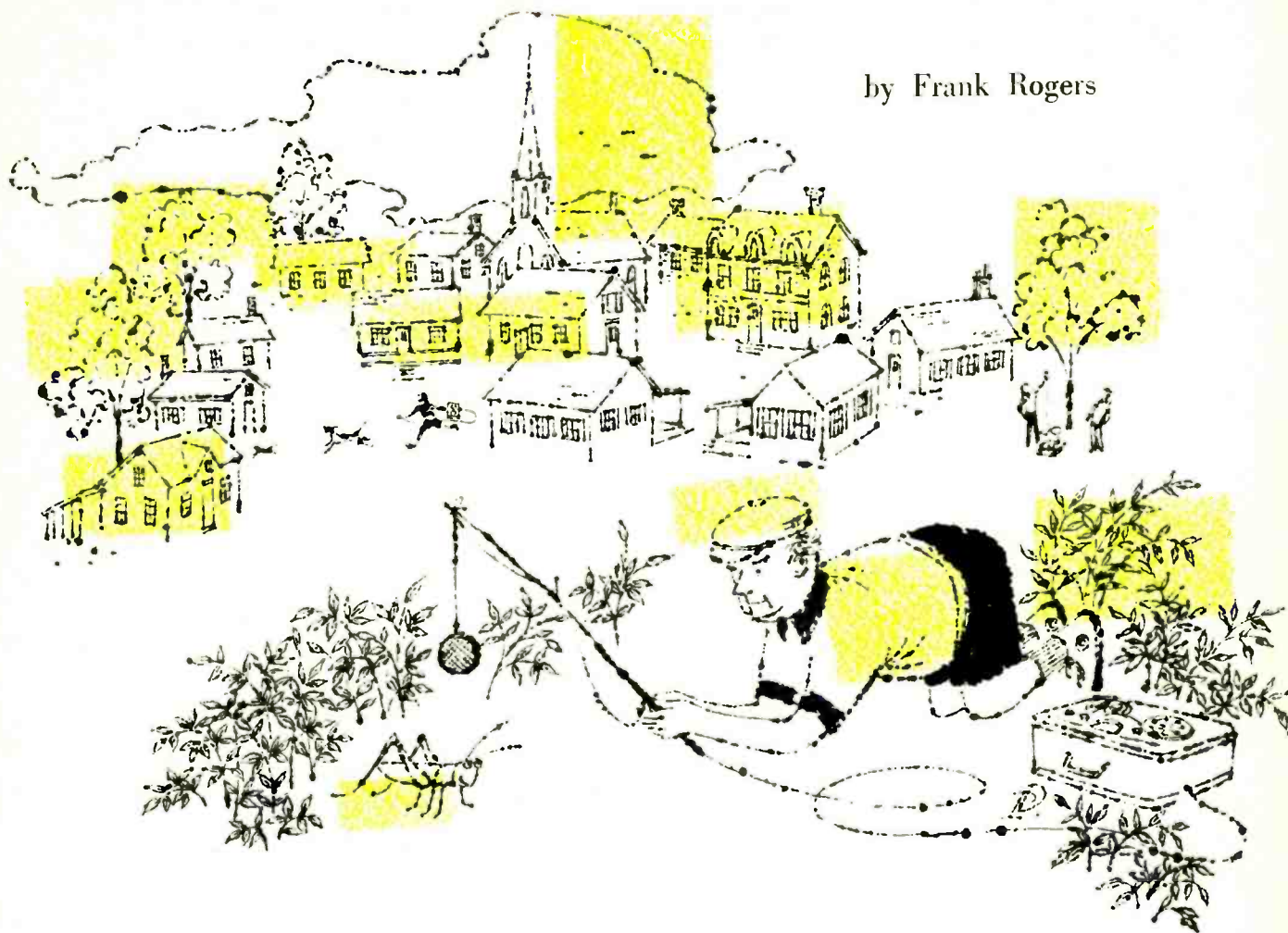

Magnetic Thunder for Macbeth

Amateur theatres with Broadway standards—says the author, speaking from experience—need tape recorders from start to finish of a production.

WHEN YOU LEAVE the city to live in the country year 'round, as we did three years ago when my company—Reeves Soundcraft—built its magnetic tape plant in Danbury, Connecticut, your city friends don't actually send flowers or notes of condolence. They slap you on the back, shake their heads, and say, "Well, good luck, feller." (It is perfectly clear that they don't expect you to have any.) Then they add, "Now, when you want to shop or really dine out, come on in and we'll take in that new restaurant on Fifty-Second Street, everything from champagne cocktails to caviar." (Sherman, Connecticut—pop. 820—has no bars, and sturgeon do not live in our lake; but it's only ten minutes to the shop where we buy our caviar and champagne.) And then the city man's clincher: "How are you going to get along

without the theatre?" (They may not bother to see a play a year themselves, but they pity non-New Yorkers who can't.)

But we can. We *have* "the theatre," the Sherman Players. People come to our productions from other towns, and if we give eight or ten performances of a play, our audiences far outnumber the total population of our village. I know that one can hardly enter a barn in this part of the country without stumbling over a thwarted Hamlet, or pass a Town Hall without hearing choir voices singing (somehow) *The Mikado*. But the Sherman Players are different. We are not summer hams or sunshine dabblers. We give plays in the winter too, when everybody has to come in jeeps or on skis.

We are not stage-struck yokels content to play bit



Ladies in Retirement: a bit in Connecticut too.

parts ourselves and call in third-rate Broadway actors for starring roles. We have found some surprising talent right here in the town and in neighboring communities. One or two of our actors have been tapped for Broadway, and turned Broadway down. We are "amateurs" in the true sense of the word, "lovers" of the theatre. And we can recall that we did get a column-and-a-half review of *Our Town* in the *New York Herald Tribune*.

We have a charming little playhouse, the Sherman Union Church, built in 1837, later used as a library, and finally abandoned. The Sherman Players saved it from falling down. Becoming a nonprofit corporation in 1948, we leased it from the town for a dollar a year, and put back all profits into repairing and strengthening the building. It seats only ninety-four, but we are now, by our own labor, adding thirty seats and a backstage building, with, believe it or not, real dressing rooms. (Up to now, we have had to climb out back doors by ladder, in order to cross to the other side of the wings, and actors dressed in the nearest corner, behind a screen if they were overfussy. The ladies of *Ladies in Retirement*, wearing the full skirts of the Eighties, got stuck and dangled from the ladders.) Our proscenium is being enlarged from fifteen and a half feet to twenty-two feet, the stage depth is being increased from nine feet to twenty-two feet, and we shall have fourteen-foot wings. And our lights and curtains will be the best that we can buy.

Even more important, our tape recorders will be numerous and of the highest quality. Tape, in fact, is one of the most important elements in our success. We use it in many ways: before rehearsals, during rehearsals, for overtures and music-between-the-acts, for mood music and for off-stage sound effects, and, finally, for the complete record of the play which goes into the archives.

Even when we are not preparing a play, we are likely to be sitting around on the floor of one an-

other's houses talking about plays, reading plays and poetry, taping our voices and criticizing the playback. These tape sessions are the finger exercises of dramatics. Then we tape rehearsals too, so that, without too much prodding from the director, we can hear what was wrong with our inflections, our volume, and our timing.

Those who learn better by ear than by eye can tape the whole play from a reading, listen until their own lines are learned, then erase their own voices and replay the tape, inserting their lines live. All this at home and at leisure. If you pop into a friend's house in Sherman without knocking, you may hear a third act echoing from the kitchen or the bathroom, above the sound of splashing waters. If so, it is more polite to sit down and wait for the curtain than to sing out "Terrible!" or even "Bravo!"

For off-stage sounds, tape is indispensable and infinitely versatile. In the touching graveyard scene in *Our Town*, perhaps our most successful venture, we had the added effect of real moonlight on real gravestones outside the doors of our little church. But we felt, though I doubt that Thornton Wilder wrote them in, that we needed crickets. And if it meant some nights of crawling through briars and setting up a recorder, only to have the creatures cease singing, well, *ars is longa* and life is not too *brevis*. Our taped crickets added a fine, thin eeriness to the voices of the dead upon the stage.

We needed a church bell for *Our Town*, too. But our town bell clanged too slowly, and the tone did not seem quite right. We all took to going around whacking with a hammer every metal object that we saw. Finally, we hit upon (literally) a circular sawblade. When we reduced the speed of the tape four times, it made a perfect church bell. Reducing speed lowers pitch, of course.

Betty Bailey discovered that whanging the conical metal squirrel guard on her bird-feeder produced a roll of thunder that would have made Zeus green with envy. This we taped, and then re-taped, reducing speed from fifteen inches per second to three and three quarters.

The music to be played before the opening curtain and between the acts is selected by the director, to suit his idea of the mood or atmosphere of the play. Usually we buy records and tape them the first time they are played, to reduce needle scratch. Occasionally we tape live music played by local musicians. Sometimes we need to "dub in" music. Few of us are expert musicians, but we can fake the fingerwork on a piano, or "lip" a lyric, if you don't watch too closely. A tone-deaf leading lady can sing with the voice of Renata Tebaldi or jazz it up like Lena Horne, though it is usually wiser to choose voices that are not so well known.

Bad music is another matter. In *Ah Wilderness* the young son and daughter of the house sing and play the piano in the next room, faltering as kids do. Well, those of us who could sing or play, even badly, could not act these roles—we were the wrong ages. We wound up with a dignified, though high-

voiced, lawyer singing on tape for the boy, and a middle-aged lady, many years out of practice, playing the accompaniment as badly as required. For the bar scene in the same play we had to get a piano tuner to untune a piano. Shirley Hughson played it as a pianola, to stunning effect. Thanks to tape, we did not have to move the untuned piano—or Shirley—into the Playhouse.

For *Joan of Lorraine* we taped the off-stage crowd—a group of us muttering “rhubarb” in many voices. We also recorded the sound of a “falling bridge,” by setting up on the hardwood floor a small bridge made of wood splinters and pulling it over with a thread while breaking match sticks near the mike, as the tape turned at fifteen inches per second. Played back at three and three quarters, it sounded like the crash of heavy timbers. The crowd tape and the bridge tape were then simultaneously re-recorded on a third recorder. When *Joan* opened, you would have sworn that a victorious French army had just captured a bridge in the wings.

Speaking of French voices—tape helps us with foreign accents. We can call on several polylingual citizens to make tapes for us to imitate. And for special voice sounds, like that of the ghost wife in *Blithe Spirit*, the tape recorder can be used as a direct mike, or with the special echo or sound-chamber device. For telephone voices we mount a small speaker on stage near the telephone, record the voice, and play it back minus most of the high frequencies. Telephone bells and door bells and radios, incidentally, are easier to tape than to set up on stage.

Then, above all, there are soliloquies—yes, even in modern plays, sometimes. But without William Shakespeare and Maurice Evans, they can be pretty funny. (Some heretics in the audience even chuckled at *Strange Interlude*, done with the best Broadway talent.) In *Ah Wilderness*, for instance, a young man

walks along a lonely beach and thinks out loud of youth and love and death and destiny. Our young man was a good actor, but the scene just didn't come off. So we taped it, set him on the beach under dim lights and told him to walk and *think* the words as they came from his taped voice off-stage, with no movements of his lips. It turned out to be the high spot of the play. I should even venture to say that if tapes had existed in Elizabethan England, Shakespeare would have been first to use them.

All taped sound effects for a play must be on one tape, made in time for use in rehearsal. Each sound effect or bit of music is separated, in sequence, from the others by a white “leader tape” marked with the act, scene, and page number of the script. Particular care must be taken with splices so that they do not break during performances, and one must always have a duplicate tape in case of accidental erasure or other damage. The preparation of these tapes may take several weeks. *Joan of Lorraine* had ninety-seven taped sections.

The job of the tape player is as arduous as that of the prompter. He—or she—must sit in the balcony at a point from which all action on stage is visible. He will not only have to be exact in timing, but careful to switch the sound to the right speaker among several that may have been installed on stage or before the proscenium.

For general sound effects, like those of the soliloquy, ghost voices, and the off-stage trains in *Brief Encounter*, we headed a directional speaker towards the back wall, whence sound would rebound to the audience with no directionality. The actors in *Brief Encounter* turned their heads one way or another, to heighten the effect of trains pulling in and out.

There are some tricks about making the final tape of the complete *Continued on page 137*



Hughson

The Sherman Players have no makeshift equipment. Here, the light control booth with sound effects recorder: the operator, Mr. Frank Rogers.

BY R. D. DARRELL



A True Treasury on Reels

Some expert advice on building a basic tape library

When you've reached the happy conclusion that "sound on tape sounds best," you have great adventure before you—but adventure that you will probably find more permanently satisfying if in building your tape library you do a bit of preliminary planning. The following step-by-step approach is suggested as a means of achieving both a varied collection of repertoire and one representative of tape's vast powers.

First Stage

The novice to tape collecting might very well start off by acquiring some manufacturers' "samplers," since such tapes provide the most musical quantity and variety for the money—a vital consideration in getting a collection off to a fast start and supplying immediately a wide range of program materials. The best of these are United Stereo Tape's "Popular," "Classical," "Jazz," and "Sound" samplers (RQ 401/04), which are only \$3.95 each, as are Bel Canto's STDX and several SMS demonstration tapes; the justly famous "Journey into Stereo Sound" (London LPM 70000) and "Sounds in the Round" (Concertapes 3001), \$6.95 each; Mercury's DEMS 3 and Westminster's WTC 144, \$7.95 each.

Several other miscellanies are real bargains if you also have a use for raw tape (they are obtainable only in packages including one reel each of unrecorded and recorded tape, for which you pay the standard raw-tape cost plus \$1.00). The three from Audio Devices ("Blood and Thunder Classics," etc.) feature symphonic favorites; the three from Reeves Soundcraft ("Dixieland Jamfest," etc.) specialize in jazz; and there probably are, or will be, others.

Standard programs in bargain-price (\$4.95 or \$4.98) series are particularly tempting for the beginner, although they merit any tape fancier's investigating; notably the whole Richmond catalogue,

but especially Alwyn's *Peer Gynt/Sleeping Beauty* coupling (RCE 40005), Katin's Rachmaninoff and Tchaikovsky Piano Concertos (RCH 40002-3), and Stapleton's "Top Pop Instrumental Hits" (RPE 45020) Omega's 800 series of pop and jazz programs and the Telectro catalogue, especially for its fine *Porgy and Bess* (TT 411) and Holloway's *Carmen Suite/Bolero* coupling (TT 409).

Higher-priced, but also genuine bargains for sheer quantity per dollar, are Livingston's "Masterpiece" cornucopias of miscellaneous symphonic works. Most of these are uneven in performance and technical quality, but each provides a 100-minute-long concert for \$10.95. Of some eight reels so far, the first (100-1) remains the best buy for its inclusion of an outstanding (at any price) Tchaikovsky *Pathétique* conducted by Mathieson.

Second Stage

Because a good deal of a new owner's tape playing will surely call for display concerts to audiences of family and friends, sure-fire attractions, spectaculars, and outstanding technical as well as musical masterpieces ought to be among the first desiderata. (Unless otherwise stated, the prices for all tapes cited from here on are \$6.95 or \$7.95 for pops, light music, and jazz reels; \$7.95 or \$8.95 for classical and celebrity reels.)

Invaluable both for magnetic appeals to all kinds

of audiences and as stimulating stereo tape appetizers are the following:

- G • Trapp Family's own *Sound of Music* selections (Warner Bros. WST 1377), far more piquantly charming than the slickly histrionic Broadway-cast version.
- G • Robert Shaw Chorale's "Christmas Hymns and Carols" (RCA Victor FTC 2026), in ideally fresh-voiced and heart-warming *a cappella* performances.
- ✓ • Medallion Concert Band's "Sound of Musical Pictures" (Medallion MST 47001), amusing revivals of old-time "descriptive" pieces (*Hunt in the Black Forest*, etc.) with vividly realistic stereo "effects."
- G • Leroy Anderson's delectable light-symphonic genre pieces, brilliantly conducted by Fennell (Mercury STB 90043), more genially by the composer himself (Decca 78865 and 78954).
- ✓ • Mantovani's "Operetta Memories" (London LPM 70041), most sumptuously songful yet least schmaltzy of all the suave Briton's best sellers.
- ? • Lane's "Pop Concert U.S.A." (Epic EC 808); Fiedler's "Song of India" program (RCA Victor FTC 2041); and of course the latter's scintillating Offenbach *Gaité Parisienne* and Khachaturian *Gayne* Ballet Suite (RCA Victor FTC 2045); all representing the most effervescent of summer-symphonic music making.
- Boskovsky's "Vienna Carnival" and "Philharmonic Ball" (London LOL 80039 and 80062), Straussian favorites with the authentic *Wiener* lilt and vivacity.
- Russian *divertissements* by the Soviet Army Band and Choir (Angel ZS 35411) and the Moiseyev Dance Ensemble (Artia ASTA 501), which blazingly demonstrate these celebrated groups' powers to fascinate listeners all over the world.
- L • Weavers' "At Home" (Vanguard VTC 1624), my own favorite balladeers in perhaps the most consistently engaging of their many recorded programs.
- Broadway Show successes, of which the most rewarding first choices surely are Meredith Willson's endearingly homespun *Music Man* (Capitol ZO 990, \$8.98) and the incomparable Lerner and Loewe *My Fair Lady* and *Camelot* (Columbia OQ 310 and 344), priced at \$9.95 each.
- ? • Count Basie's "Basie!" (Roulette RTC 502) and the Ellington and Hodges "Back to Back" and "Side by Side" (Verve VSTC 209 and 237), outstanding examples of jazz which embracingly command the liveliest admiration of both hip and square listeners.

Some of the sonic spectaculars most likely to impress, rather than terrify, potential stereo tape converts are:

- "The Queen's Birthday Salute" (Vanguard VTC 1602), with clarion Herald Trumpeters, a thundering-by mounted band, and a 21-gun cannonade dramatically documenting in sound one of the most colorful British spectacles.
- Morton Gould's Beethoven *Battle Symphony* (RCA Victor FTC 2006), realizing at last the stereo potentials so prophetically prefigured in an 1813 display piece designed for Maelzel's "Panharmonicon."
- ? • Von Karajan's Tchaikovsky (*1812 Overture*), Berlioz, Liszt, Sibelius, and Weber program (Angel ZS 35614), superb interpretative as well as sonic rejuvenations of long jaded warhorses.

- ✓ • Dick Schory's "Wild Percussion and Horns A-Plenty" (RCA Victor FTP 1056), inspired explorations of the poetic (as well as dramatic and motional) resources of percussion in an authentically big-auditorium ambience.
- ✓ • Terry Snyder's and Enoch Light's vogue-setting "Persuasive and Provocative Percussion" series, of which the most arresting single example is perhaps Snyder's "Persuasive, Vol. 2" (Command 808).

Turning to symphonic masterpieces in exceptionally thrilling recorded performances, even the briefest, most arbitrary honor roll cannot exclude:

- ✓ • Ansermet's Debussy *La Mer* and *Prélude à l'après-midi d'un faune*, coupled with the Ravel *Rapsodie espagnole* (London LCL 80013), the quintessence of French musical impressionism.
- ✓ • Szell's Dvořák Fourth (Epic EC 806), a matchless fusion of heart-warming melodism, interpretative lyricism, and sonic luminosity.
- ✓ • Wøldike's Haydn *Military* and *Clock Symphonies* (Vanguard VTC 1609), persuasive evidence that scholarly authenticity can be galvanized by interpretative vitality—and that eighteenth-century orchestral sonorities profit as much as, if not even more than, those of today from stereo air-spacing.
- ✓ • Monteux's Ravel *Daphnis et Chloë* (London LCL 80034) and Stravinsky *Pétrouchka* (RCA Victor FTC 2007), in the still incomparable illuminations of the ballets' first conductor, as well as in the complete scores of which the more familiar suites provide only tantalizing abridgments.
- ✓ • Reiner's Rimsky-Korsakov *Scheherazade* (RCA Victor FTC 2017), a miraculous restoration of the original Russian fairy-tale colors and excitements.
- ✓ • Krips's Schubert Ninth (London LCL 80043), the "symphony of heavenly length," which can be clocked in fifty-five minutes, but in sheerly angelic music making—as well as a triumphant affirmation of the human spirit—is quite immeasurable.
- ✓ • Stokowski's Wagner *Tristan und Isolde* (Columbia MQ 309), concentrated into a tone poem which represents the conductor's most successful "symphonic synthesis."

No less delectable are some sure-to-reward first ventures into concerto, chamber, and solo repertoires:

- ✓ • Gervase de Peyer's angelic Mozart Clarinet Concerto and Barry Tuckwell's two rollicking Horn Concertos (London LCL 80053), which, with the breezy Horn Quintet and piquant Oboe Quartet by members of the Fine Arts Quartet with guests John Barrows and Ray Still (Concertapes 3016), are perhaps the most inviting gateways to the realms of Mozartean magic.
- Narciso Yepes' Rodrigo Guitar Concerto (London LCL 80010), one of the most piquant novelties in the guitar, chamber concerto, and Spanish repertoires.
- ✓ • Janigro's "Eighteenth-Century Concert" (Vanguard VTC 1617), contrasting the gravely lyrical Christmas concerti grossi by Corelli and Torelli with that roistering early children's spectacular, the Leopold Mozart *Toy Symphony* long attributed to Haydn.
- Sviatoslav Richter's Beethoven *Appassionata* and *Funeral March* Sonatas (RCA Victor FTC 2069), impressive demonstrations of both the magisterial pianist's and composer's eloquence.

Continued on page 134

*The consumer's guide
to new and important
high-fidelity equipment*

high fidelity

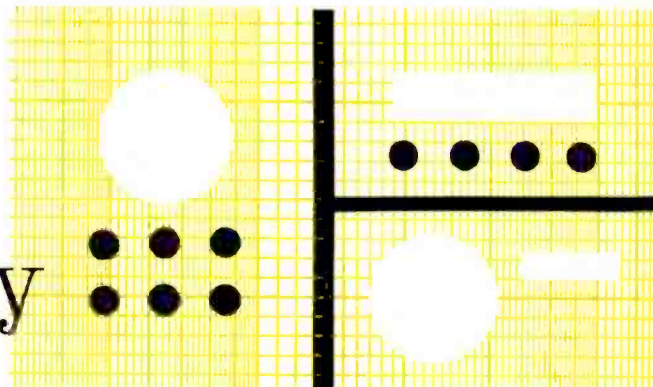

EQUIPMENT REPORTS

Acrosound S-1001 Stereo Preamplifier



AT A GLANCE: The Acrosound S-1001 stereo preamplifier is one of the most versatile and easy-to-use preamplifiers on the market today. It is available either as a self-powered unit (S-1001 SP) or as a unit designed to draw its power from a power amplifier through a connecting cable (S-1001). It is also available either factory-wired or as a kit. Prices: self-powered factory-wired, \$129.50; self-powered kit, \$79.50; externally powered factory-wired, \$114.50; externally powered kit, \$69.50.

IN DETAIL: The Acrosound S-1001 operates very well as a complete audio control center, with appropriate controls for complete switching functions. The input selector is an eight-position rotary switch. The first three positions permit equalization of a phonograph cartridge to either of the 78, LP, or RIAA recording characteristics. The fourth position is a second phono input with RIAA equalization. The fifth position selects an input from a tape head equalized to the standard NARTB equalization curve. The sixth position gives stereo reproduction from the AM-FM system of broadcast while the seventh position provides for stereo reproduction using the new FM multiplex system. The eighth position is an auxiliary input, suitable for piezo-type phonograph cartridges or other high level sources.

The output function selector is a seven-position rotary switch which controls the signal's electrical path between the last stages and the output jacks. It has positions for listening to the left or right channels only; listening to stereo sources monophonically (mixing two

channels together); or listening to monophonic sources through both channels. The particular output function is nicely portrayed in a matrix of six panel lights, easily seen from a distance, which provide a graphic view of which sound channel is feeding which amplifier channel.

An input is also provided for a microphone superimposed on the left channel when using an FM or auxiliary input, and is very useful for mixing a microphone with any other material for mono recording.

High level inputs and outputs are provided for a tape recorder, and a very useful "center channel" output is provided, with its own level control on the rear panel.

Other controls on the Acrosound S-1001 include separate bass and treble controls for each channel, one volume control and one balance control, rumble and scratch filters, and loudness and phase reversal switches.

The low level amplification of each channel is a two-stage feedback pair, the first stage being a high-gain low-noise pentode. The gain of this stage is about 300, and the output of this stage is cascaded into a triode section in the same envelope with a gain of about 14. This tube is a 7199 pentode/triode, and its heater is supplied with DC from a selenium rectifier and filter capacitor contained in the preamplifier. Feedback equalizing networks are used to obtain the proper playback characteristics for phono and tape head.

The medium level amplifying section utilizes the high-mu triode of a 7247 dual triode in a modified tone control of the Baxendall type. Although the usual Baxendall circuit has a gain of unity, a dissymmetrical arrangement

has been used in the S-1001 preamplifier to obtain a gain of 6. The Baxendall stage is followed by a unity gain amplifier stage that is similar to the conventional cathodyne phase splitter. Normal output is taken from the cathode side in each channel in a manner similar to the cathode follower output, and phase reversal is obtained in the right channel by taking the output from the plate side. The output impedance of the preamplifier is about 2,000 ohms with the output taken from the cathode, and about 12,000 ohms with output taken from the plate.

Tests run at the United States Testing Company, Inc., on a factory-wired self-powered version indicate that although the performance of this preamplifier was not spectacular, it would do nicely for all but the most exacting applications. With the tone controls in the flat position, frequency response was measured to be flat from 20 cps to 20 kc within 1.4 db on the left channel and 1.9 db on the right channel. For a rated output of 1.5 volts at 1,000 cps, the low level inputs (phono and tape head) have a sensitivity of better than 2 millivolts and the high level inputs have a sensitivity of approximately 0.5 volt.

Acrosound claims that hum and noise in the phono and tape head position is 60 db below 1.5 volts output, whereas USTC measured 45 db on each channel (which is still quite acceptable). In the high level positions the hum and noise was better than 70 db below 1.5 volts output, and completely inaudible at full volume.

The bass controls provided approximately 14 db of bass boost and 22 db of bass cut at 20 cps, with a crossover frequency of about 400 cps. The treble controls

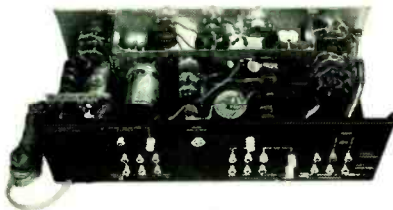

provided 9 db of treble boost and 18 db of treble cut at 20 kc, with a 2,000-cps crossover.

A very effective rumble filter reduces 30 cps rumble from 16 db at the rate of about 9 db/octave. The scratch filter operates at the rate of about 4.5 db per octave and cuts an 8-kc signal approximately 6 db. A loudness control provides about 13 db of bass boost at 30 cps and about 5 db of treble boost at 20 kc.

The tape equalization was fairly close to standard. The RIAA disc equalization was off at the higher frequencies, giving only 9 db of cut at 10 kc instead of the standard 13.7 db. The extra "brightness" in sound that results from this can be compensated by reducing the treble tone control.

Harmonic distortion of the preamplifier is completely negligible through the tuner or auxiliary inputs. Through the phono inputs, the lab measured 3.3% harmonic distortion at 20 cps with 1.5 volt output and a 2-mv input. At 1 kc the lab measured 1.3% distortion and at 20 kc 2.5% distortion, which is less distortion than that introduced by many phonograph cartridges. As the signal level was increased, the per cent distortion also increased, and for a 10-mv signal into the RIAA phono input, the distortion in a 1.5-volt output signal rose to 10% at 20 cps and 11.5% at 20 kc. Harmonic distortion at 1,000 cps with 10 mv input was 1.1%.

Acrosound claims that crosstalk between channels is better than 50 db down at 1 kc and better than 40 db down at 15 kc. Although on the high level inputs USTC found the crosstalk between channels to be better than 56 db at 1,000 cps, 15-kc crosstalk dropped to 35 db

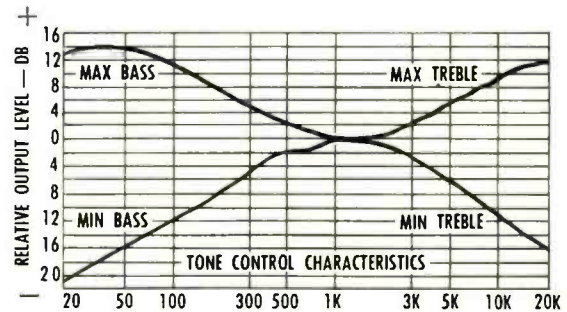
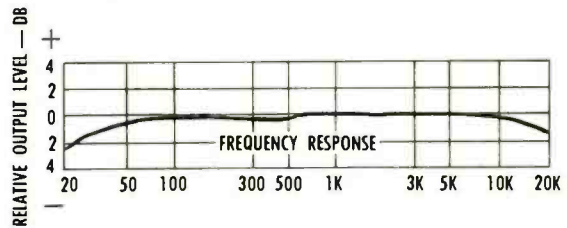

on the high level inputs and went down to as low as 22 db at 15 kc and 34 db at 1 kc on one tape head input.

The preamp's relatively high impedance output (2,000 ohms) may cause a problem when one uses long lengths of cable connecting the preamplifier to the power amplifier. Acrosound says that output cables up to 10 feet in length may be used without adversely affecting the performance of the preamplifier. The lab checked to find out what effect a 50-foot length of shielded wire would have on the high frequency performance of the preamplifier and found that it caused a 6-db loss in signal at 20 kc and a 3-db loss at 10 kc. USTC also checked to determine how well stereo balance was maintained at various listening levels and found that the variation in output level between channels was as great as 6.7 db from low volume to high volume. This of course could easily be corrected by using the balance control.

After a variety of listening tests using the Acrosound preamplifier, the general conclusion was reached that music played through the S-1001 suffered very little in the translation. Considering its relatively low cost and useful features, it is felt that many stereo enthusiasts will find that the S-1001 will suit their needs perfectly, and provide years of pleasurable listening.

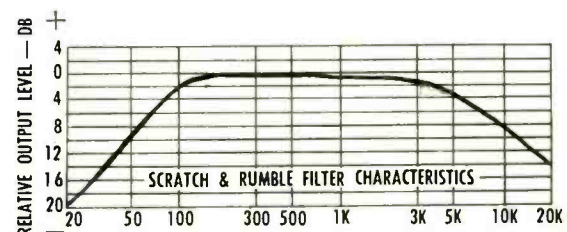
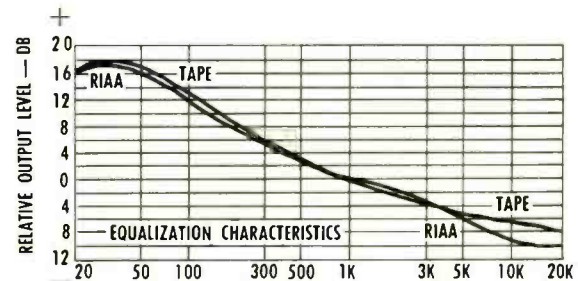



Bell T-338 Tape Recorder

AT A GLANCE: Bell Sound's T-300 series of tape units is built around the same basic tape transport: the models differ with respect to head arrangements for different needs. The transports may be purchased without a matching record/playback preamplifier; however, the preamp (Model RP-320) is required for recording and is a logical choice for playback, although the playback function can, of course, be accomplished via suitable inputs on an external preamplifier.

The unit tested consisted of the Model T-333 transport (4-track stereo record/playback; 2-track stereo playback), and the Model RP-320 stereo record/playback preamplifier. Assembled in a Model 300-CC carrying case, the entire system is designated as Model T-338. It comprises a generally high quality, easy-to-operate, handsome stereo tape system for home use. Price: \$369.95.

IN DETAIL: The tape transport will operate at either of two speeds, $3\frac{3}{4}$ and $7\frac{1}{2}$ inches per second, and will accommodate a maximum reel size of 7 inches. The movement of the tape is accomplished through the use of three 4-pole induction motors, one each for the take-up and the supply reels and one for the tape drive capstan.

The necessary braking action and tape tension is accomplished electro dynamically through the application of a DC voltage to the motor windings which is obtained from a self-contained transformer and full-wave rectifier power supply.

Operation and speed selection are accomplished via "piano" type keys. Suitable interlocks assure that the tape is brought to a stop when switching from one mode of operation to another. An automatic stop is provided to halt the take-up reel after the tape has ended in either the recording or playback modes. In the stop, rewind, and fast forward positions, tape lifters keep the tape away from the magnetic heads. In the play position, felt pressure pads keep the tape against the heads. In the model tested at United States Testing Company, Inc., three heads were used: one for 4-track erase, one for 4-track record/playback, and one for 2-track playback.

In actual operation, the "piano" type keys were found to be conveniently laid out and easy to use. All transport functions could be accomplished with one hand. The keys furnished positive action, provided they were positively and fully depressed. The transport of tape was accomplished smoothly, with sufficient

tape tension to avoid spillage but low enough to preclude tape stretching or breakage. Braking action was fast, and the fast forward and rewind functions were good, offering proper take-up torque and a minimum of strain on the tape.

In the slow speed position, the actual speed was found to be within 0.3% of the nominal speed of $3\frac{3}{4}$ ips. In the high speed position, the actual speed was 2.4% higher than the nominal speed of $7\frac{1}{2}$ ips. Although the latter is considered high by professional standards it is quite adequate for a home recorder.

Both wow and flutter in this transport were very low, and inaudible when playing back a 3,000-cps test tone. Actual measured values for wow and flutter were 0.08 and 0.16 per cent respectively, at a speed of $7\frac{1}{2}$ inches per second.

In general, USTC found that the whole transport system exhibited the smoothness and quality of operation which is characteristic of systems using separate motors for the capstan and the take-up and supply reels. It is commendable for the simplicity of its mechanical system, which should provide a good deal of service with a minimum of care and delicate adjustment.

The RP-320 record/playback amplifier included with the tape transport contains two identical amplifiers for the two stereo channels, and a bias and erase oscillator. Each channel is used as either a recording or playback amplifier through suitable switching and is provided with an individual recording level meter, volume control, microphone input jack, and an interlocking "record" button to prevent accidental erasure. All of these are mounted on the front panel of the transport and are grouped in a pleasing and functional manner.

The output of each amplifier and an additional high level input for each channel are available through standard jacks mounted at the rear of the machine. A monitor jack, suitable for monitoring the stereo signal through a pair of stereo headphones, is also mounted at the rear of the machine.

The first and second stages of each amplifier use a high-gain ECC83/12AX7 twin triode, with tape equalization being accomplished within these stages. This is followed by an ECC81/12AT7 twin triode, the first half of which provides additional gain for the audio signal, feeds the recording heads in the record position, and serves as a high impedance output of the amplifier in the playback position. The second half of the ECC81/12AT7 is used as a cathode follower to drive the recording level

REPORT POLICY

Equipment reports are based on laboratory measurements and listening tests. Data for the reports, on equipment other than loudspeakers, is obtained by the United States Testing Company, Inc., of Hoboken, New Jersey, a completely independent organization which, since 1880, has been a leader in product evaluation. Speaker reports are based on controlled listening tests. Occasionally, a supplementary agency may be invited to contribute to the testing program. The choice of equipment to be tested rests with the editors of HIGH FIDELITY. No report, or portion thereof, may be reproduced for any purpose or in any form without written permission of the publisher.

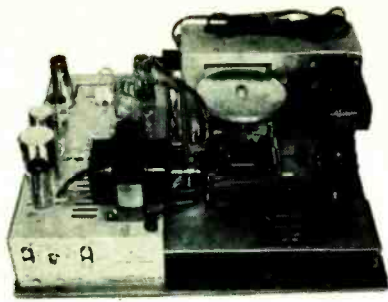

meter and to supply a low impedance output for a set of headphones. The bias oscillator for the recorder uses an ECC82/12AU7 twin triode in a push-pull arrangement.

The power supply utilizes an EA80/6V4 rectifier tube in a full-wave arrangement for supplying the plate voltages, and a separate selenium bridge rectifier to supply DC voltage to the filaments of the amplifier tubes.

The measured sensitivity of the amplifier (for maximum recording level as indicated on the recording level meter) was found to be approximately 3.4 millivolts at the microphone input and 130 millivolts at the high level input. The signal-to-noise ratio at 7½ ips was better than 35 db referred to a 1,000-cycle signal recorded 10 db down from the maximum indication of the recording level meter. At normal listening levels the noise is completely inaudible. Crosstalk ratio between channels was better than 50 db which indicates excellent stereo separation. The erase heads reduced the recorded signal by approximately 40 db, which is adequate.

The over-all record/playback frequency response, at 7½ ips, for a recording made at 20 db below maximum recording level, was uniform within 4 db from 18 cps to 15 kc and within 2 db from 100 cps to 15 kc. Response at 3¾ ips was essentially the same, which for this speed might be considered outstanding. At higher recording levels, the high frequency response is limited by tape saturation which, of course, is to be expected with pre-emphasized signals. This saturation does not normally occur when recording music, since most of the power of an orchestra occurs at the lower frequencies.

Playback equalization, using the Ampex Standard Alignment Tape 5563, at 7½ ips was found to be in accordance with the NARTB standards. The playback curve for the 2-track head was quite uniform, being within plus or minus 1.2 db from 300 cps to above 10 kc.

Although no over-all distortion figures are published in the technical description of the T-338, the amount measured on our test sample seemed normal for this type of equipment. Thus, at maximum recording level, harmonic distortion at 1,000 cps was 3.8 per cent. At a recording level of minus 10 on the recorder's VU

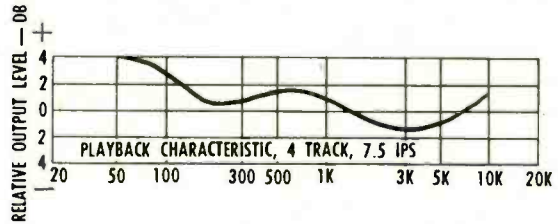
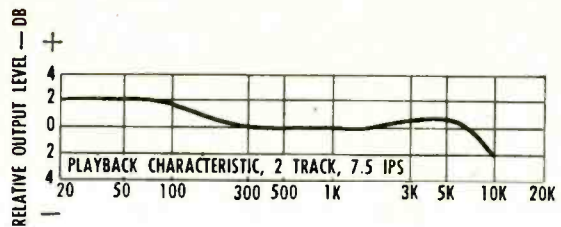
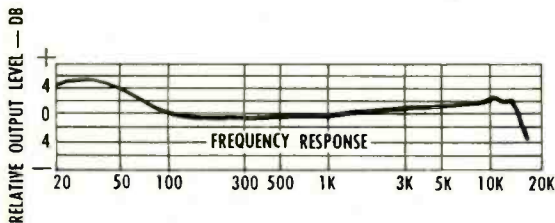

meter, distortion was well below 2% throughout most of the range, rising to 4% at 50 and 14,000 cps. At 20 db below maximum level (the normal average signal intensity with peak loudness at maximum levels) distortion was considerably lower.

In general, USTC reports that the record/playback amplifier is constructed very well, and contains complete provisions for bias oscillator balance, bias level adjustment, record equalizer adjustment, and record level meter calibration. The Bell installation and operation manual is complete, well written, and provides detailed step-by-step instructions for all electronic adjustment. It contains some helpful suggestions for operation and care of the recorder as well as helpful hints to aid the owner in trouble-shooting, should the need arise. All in all, the T-338 constitutes a good high quality recorder which would complement many home audio systems very well.

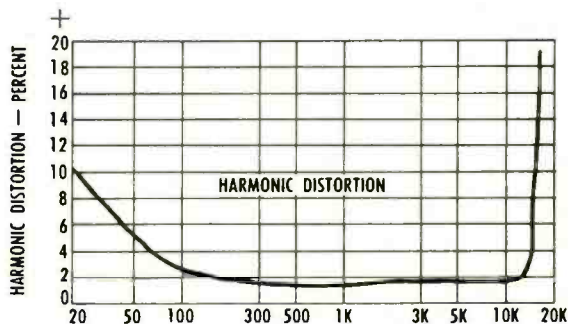
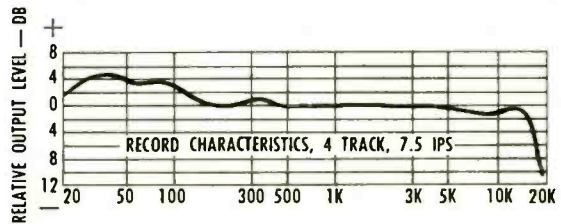

NEXT MONTH'S REPORTS

Citation III FM Tuner
 Revere T-11-4 Tape Deck
 Rek-O-Kut N-34H Turntable

Fairchild 440-2K Turntable Kit



AT A GLANCE: The Fairchild 440-2K is a two-speed, belt-driven turntable sold in kit form. Assembly was judged to be comparatively simple, representing not more than three hours' work. The finished unit, which looks handsome and runs smoothly, may be used for 33 $\frac{1}{3}$ - or 45-rpm discs. Either speed is variable by the user over a range of a few per cents of the nominal setting. Price: \$55 (includes pre-drilled mounting board).

IN DETAIL: A minimum number of parts is used in the design of this turntable. The platter itself is of cast aluminum and, with its shaft, weighs 4.7 pounds. It is driven by a four-pole induction motor via a very flexible rubber belt mounted around its periphery. The motor shaft has a machined two-step pulley for effecting the two speeds. Speed changes are made very smoothly and rapidly by a push or pull action on a knob above the mounting board. This knob operates wire "fingers" beneath the turntable, which slide the belt from one step to the other on the motor pulley.

The motor is designed to drive the turntable at a somewhat higher than nominal speed. To compensate for this, electro-magnetic braking is applied to the motor which brings the unit to the correct speed. A DC voltage of between 0 and 2.5 volts can be applied to the motor windings to set the speed exactly to its correct value. This DC voltage is obtained from a selenium rectifier mounted beneath the turntable; it is controlled by a 100-ohm potentiometer whose shaft extends through the mounting board.

This kit was assembled at the United States Testing Company, Inc., which reports that all necessary parts—including a pre-drilled, unfinished plywood mounting board—were included. Instructions supplied with the kit were adequate; assembly was simple and took about three hours. After assembly, the turntable was given the 24-hour break-in as recommended by the manufacturer

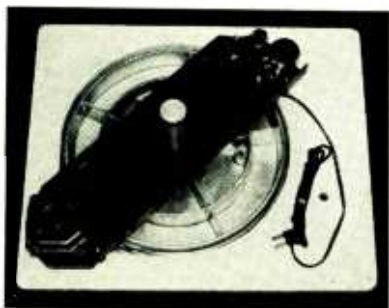

and then subjected to a series of performance tests, conducted by USTC. The net results of these tests indicate a very worthy component. To begin with, the speed of the turntable was found to be quite easily adjusted to exactly 33 $\frac{1}{3}$ rpm using the paper strobe disc supplied with the kit. At the 33 $\frac{1}{3}$ -rpm nominal speed setting, the actual speed could be varied by the control from 32.95 rpm to 34.23 rpm. At the 45-rpm nominal speed setting, the actual speed similarly could be varied from 44.41 to 46.08 rpm.

The inclusion of the variable speed feature might, at first glance, seem to indicate some sort of compensation for line voltage variations. If so, it would hardly be needed in this turntable, since its average speed remained constant despite fluctuations in supply voltage, varying in fact by only 0.15 per cent when the input line voltage was varied from 100 volts to 125 volts. A more likely use of the speed variation feature would be found in terms of specific applications for individual users. For example, amateur musicians who play along with a record for practice, often have to adjust the speed to compensate for slight variations in tune-up pitch. In any case, the speed adjustment is there, and it works satisfactorily. For those not interested in obtaining the special effects provided by the variable speed feature, there is of course the strobe disc which permits exact settings of 33 $\frac{1}{3}$ and 45 rpm. Since the speed of the 440-2K can be so easily varied, it would be a good idea for the user to fasten permanently the strobe disc (a touch of rubber cement would do) to the platter—or at least keep it in a safe place for future reference.

Rumble was measured at minus 55 db from the level of a 100-cps tone recorded at 1.4 cm/sec; it was completely inaudible on any recordings listened to. Flutter was clocked at a very low constant value of 0.03 per cent. Wow was found to be generally in the range of 0.1 to 0.4 per cent, with the meter showing an occasional reading of 0.26 per cent when a 3,000-cps constant test tone was played. It was not noticeable during the playing of regular discs, including those with piano passages.

The turntable has good running torque and comes up to speed from a dead stop in approximately $\frac{1}{4}$ revolution of the platter. The hum field above the platter is extremely low; at normal playing levels it is doubtful that it would be heard through even the most sensitive pickups.

In sum, the 440-2K is a very successful version of the same manufacturer's Model 440 and a worthy addition to the growing number of quality components becoming available in do-it-yourself form. For those willing to take the time building it, the 440-2K represents a saving of \$14.95 over its factory-built counterpart.

Music Makers by ROLAND GELATT

IT'S NO SECRET that London Records has had great success with its broadspread stereo recordings of classical music and that Command Records has done notably well with its sharply separated stereo recordings of popular music. So what's happening this fall? London is coming out with a line of ping-pong-like pop records, and Command is introducing a series of non-gimmicked classical records. It all goes to show that a good thing is a good thing is a good thing.

London's pop program is called Phase 4 Stereo. It's being promoted as the latest development in a sequence that began with "concert hall realism" (Phase 1) and then progressed to "separation of sound" (Phase 2) and "moving sounds" (Phase 3). In the latest phase, says London, "arrangers and orchestrators rescore the music to place the instruments where they are musically most desired at any particular moment and make use of direction and movement to punctuate the musicality of sounds. . . . The musical arranger (who up to now was accustomed only to writing musical figures in the conventional way on ordinary two-dimensional manuscript paper) now has to envisage the sounds he hears in his head as they relate to each other in the extra dimension of space afforded by stereo reproduction."

In addition to the use of custom-made stereo scorings, London's Phase 4 program also relies on four-track master tape. This, we're told, permits far greater flexibility than the

usual three-track tape. To insure utmost definition and clarity of separation, London's engineers recorded the four channels piecemeal. Thus, for Ted Heath's "Big Band Percussion" the first session yielded only Tracks 1 and 2, on which the percussion instruments were recorded playing at opposite sides of a large, reverberant studio. The percussionists were then sent home and the saxophone players brought in. These donned headphones and recorded Track 3 (left) while listening to the playback of the first two tracks. Then the saxophonists withdrew to make way for the trombonists, who recorded Track 4 (right) while listening via headphones to Tracks 1, 2, and 3. Only in this step-by-step way, says a London spokesman, was it possible to maintain complete separation in a big-band recording. Had the entire Heath ensemble been recorded at one time, "leakage" from one channel to another would have seriously "diluted" the stereo effect.

London's most ambitious production in the initial Phase 4 release is a record called "Pass in Review," which features the marching and parade music of several countries recorded "as if the listener were actually on the reviewing stand, watching and listening to the marchers pass in review." This too was built up piecemeal—drums on Track 1, woodwind on Track 2, brass on Track 3, special effects on Track 4, plus three extra tracks for crowd noises and "din." The movement of the marchers from left to right was accomplished electronically; the musicians themselves remained comfortably seated in Walthamstow's Town Hall while playing. HIGH FIDELITY will review this record and other Phase 4 discs next month.

COMMAND RECORDS is initiating its classical catalogue with five releases, four of them taped in Paris and one in Pittsburgh. "We're appealing," says Command's president, Enoch Light, "to the most discriminating musical buyer in the world. These records have not been made for sen-

sation seekers." Nevertheless, Mr. Light can be persuaded to admit that the results are sensational. "We've used 35-mm magnetic film instead of the usual half-inch tape, and this has been a great help. But the main thing," he told us, "is that we've given more thought to what we're doing than is usually the case with classical recordings. We didn't rely on improvisation at the last minute. Before recording the Pittsburgh Symphony I drove all over the city trying to locate the best hall for our purposes. Syria Mosque, where the orchestra gives its concerts, just wouldn't do; it's far too shallow for good stereo. We finally found the acoustic properties we wanted in the Soldiers and Sailors Memorial Hall.

"Then," continued Mr. Light, "we spent a month planning the best microphone setup for the works we intended to record. This meant not only deciding on the most advantageous position for the dozen or so mikes we were using, but also choosing the right kinds of mikes to match the various instrumental timbres we would encounter. At the sessions themselves we had two engineers at the control panels and three musical directors—three, each of us paying attention to a different part of the score. You can't achieve the results we did with one engineer and one musical director."

We'll have more to report on the Command Classics next month, when the records are submitted for review.



Headphoned Ted Heath with his trombonists.



London's four-track recorder (in background).



AUDIO FIDELITY records

The choice of those who demand the finest in sound quality and stereo dimension!



ROME with LOVE
The Italian Accordion of Jo Basile and his orch.
ROMA On Record
AFLP1822/AFSD5822



THE BRAVE BULLS! MUSIC OF THE BULL FIGHT AND LA FIESTA BRAVA
AFLP1801/AFSD5801

...and world famous artists and dynamic performances to choose from!... Louis Armstrong... Al Hirt... Dukes of Dixieland... Brave Bulls... Oscar Brand's Bawdy Songs... Port Said... Johnny Puleo... Jo Basile... Sound Effects... First Component Classics and many more.



JOHNNY PULEO AND HIS HARMONICA GANG
AFLP1830/AFSD5830



BAWDY SONGS and Back Room Ballads, Vol. 1
Oscar Brand sings—Roll Your Leg Over, No Hips At All, etc.
AFLP1906



AL HIRT SWINGIN' DIXIE, Milenberg Joys, Shine, Moonglow, Deep River, etc.
AFLP1927/AFSD5927

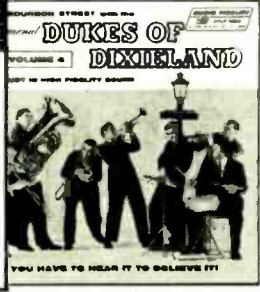

DUKES OF DIXIELAND
ON BOURBON STREET, Dukes of Dixieland—Saints, Sensation Rag, etc.
AFLP1860/AFSD5860



LOUIE and the DUKES OF DIXIELAND—Bourbon St. Parade, Avalon, New Orleans, etc.
AFLP1924/AFSD5924

PORT SAID, Vol. 1, Mohammed El Bakkar and Oriental Ensemble. Music of the Middle East.
AFLP1833/AFSD5833



RAILROAD SOUNDS, Steam Locomotive and Diesel.
AFLP1843/AFSD5843

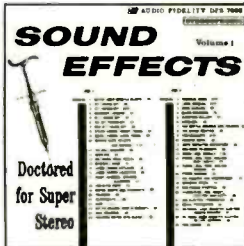

SOUND EFFECTS, Vol. 1 Ocean liners, Jets, Crowds, Shots, Surf. 50 sounds.
DFM3006/DFS7006



LEON BERRY Vol. 3—Pop standards.
AFLP1844/AFSD5844

AF Audio Fidelity Records

THE HIGHEST STANDARD IN HIGH FIDELITY... FOR THOSE WHO CAN HEAR THE DIFFERENCE!

- Unsurpassed sound reproduction with full emotional depth and meaning.
- Maximum clarity, direction, definition and quality of recording.

Available at record shops everywhere or write to:

HAMP'S BIG BAND, Lionel Hampton—Flying Home, Big Brass, Night Train, etc.
AFLP1913/AFSD5913

Mono—\$4.98 (AFLP, DFM); Stereo—\$5.95 (AFSD, DFS, FCS)
Dept. HF9 AUDIO FIDELITY INC. 770 Eleventh Avenue, New York 19, N.Y.



SEND TODAY FOR FREE COMPLETE CATALOGS OF AUDIO FIDELITY RECORDS AND TAPES!

CIRCLE 16 ON READER-SERVICE CARD

reviewed by

PAUL AFFELDER
NATHAN BRODER
O. B. BRUMMELL
R. D. DARRELL
ALFRED FRANKENSTEIN
HARRIS GOLDSMITH
JOHN F. INDCOX
ROBERT C. MARSH
CONRAD L. OSBORNE
JOHN S. WILSON

Records in Review



Courtesy of The New York Public Library

Paul Revere's frontispiece for Billings' New England Psalm Book of 1770.

Some Crude, Quirky, and Moving New Englanders

by Alfred Frankenstein

SOMETIMES it seems as if everything worthwhile has been recorded on micro-groove at least once, if not two or three times, and for a new release to break through to a great school, style, or tradition for the first time on long-play records is a rare event. Now, in "The American Harmony," it has been accomplished—by Irving Lowens, musicologist of the Library of Congress, Fague Springmann and his University of Maryland Chapel Choir, and Washington Records.

"The American Harmony" provides eighteen compositions by fourteen composers of the New England singing-school era, which covered, roughly, the last quarter of the eighteenth century and the first few years of the nineteenth. These singing-school composers were fervently

religious men, and they wrote a crude, strong, wonderfully joyous and sometimes remarkably tender music, full of modal effects and strange, quirky, "original" harmonies. One of them, William Billings, is, of course, very well known, not necessarily because he was the best of the group, but because he was shrewd enough to deposit copies of all his publications in the Harvard library, where they are to this day; the work of the others is not preserved complete at Harvard or anywhere else, and has been recovered only in fragmentary form.

Billings was discovered about thirty years ago, and some of his works were republished at that time. Not long thereafter, a few of them were exquisitely recorded on three 10-inch 78s by a group of madrigal singers led by Lehman Engel.

This Columbia set is one of the milestones in the discography of American music. The madrigalesque style of the singing is more delicate, refined, and sophisticated than is proper from a strictly historical point of view, but it brings out many extraordinarily beautiful things in the music. The singing-school composers were forgotten in New England by 1825, but they have never been forgotten in the South, and there are some prodigious, hair-raising performances of their music in an album of 78s which George Pullen Jackson made for the Archive of American Folk Song in the Library of Congress at the Alabama Sacred Harp Convention in 1940. A genuine folk chorus of white-skinned Americans is a rarity on records, and this is the best thing of its kind we have.

The records of Engel and Jackson are the only ones of any size or importance previously issued in this field. Since their time the reputation of Billings has grown immensely, and the LP catalogues have recently come to include such works as William Schuman's *New England Triptych*, Randall Thompson's *Peaceable Kingdom*, and several pieces by Henry Cowell called *Hymn and Fuguing Tune*. But while Billings has become one of the foci of a national style among contemporary American composers, his own music has been missing from current record lists.

The approach employed by Lowens and Springmann is neither so refined as that of Engel nor so folksy and forthright as that of Jackson's Sacred Harp singers. In some respects it is more authentic than either. The chorus is bass-heavy, in the old New England way; the tenor carries the tune; some of the women sing the tenor part an octave higher than written and some of the men sing the soprano part an octave lower, so that there are actually six strands of sound but only four written parts.

Among composers represented are Billings, with two pieces, Daniel Read, with three, and Jacob French with two. Supply Belcher (my favorite among composers' names), Jacob Kimball, Simeon Jocelin, Timothy Swan, Lewis Edson, Jr., Justin Morgan (the man who gave his name to the Morgan horse), Oliver Brownson, Simeon Coan, Jeremiah Ingalls, an anonymous composer, and an almost anonymous one known only as Dean are drawn upon for one composition each. The selection was obviously made to exhibit the range of the style, which is not wide but is interesting. The naïve grandeur of it is especially noteworthy in French's anthem *The Heavenly Vision* (which Jackson's Sacred Harp singers ascribe to Billings); the bouncy brilliance of it in Belcher's *Jubilant*; the quiddity and crankiness of it in Swan's *China*; the moving, quiet simplicity of it in Read's *Mortality*; and the overwhelming revelatory inspiration of it in the same composer's *Sherburne*.

In his notes, Lowens speaks of all this music as presenting a striking analogue to American primitive painting, and that is true; one thinks at once of the stern, naïvely rendered, immensely powerful faces of New Englanders which were being painted at the same moment by artists like William Jennys, Winthrop Chandler, and Reuben Moulthrop; but these composers, because they were dealing with religious themes, which New England's theology barred to the painters, have an extra fervor all their own. The real analogy is with another painter of the same era who could not have existed then in America. His name was William Blake.

The recording is very fine indeed. Stereo, of course, is particularly effective for choruses.

"THE AMERICAN HARMONY"

University of Maryland Chapel Choir, Fague Springmann, cond.

• WASHINGTON WR 418. LP. \$4.98.
 • • WASHINGTON SWR 418. SD. \$5.98.



Listening to the playback.

Thirty-four Recorded Scheherazades, But Ansermet's New One Stands Out

by R. D. Darrell

WITH thirty-four recorded *Scheherazades* currently in print, nineteen of them in stereo, it is obvious that a new one must be extraordinary indeed to warrant a critic's special attention. Yet in one, somewhat Irish, sense, the only thing truly extraordinary about the new version from Ansermet and the Suisse Romande is that it is a *recording*: what we actually hear, through rather than in or on it, is no more—and only fractionally less—than a first-rate orchestral performance in an acoustically first-rate large auditorium.

Perhaps only a musician or experienced concertgoer can fully appreciate this ultimate triumph of audio technology: its self-effacement. Discophile appetites for sonic sensationalism have been so overstimulated in recent years, and most home listeners have become so accustomed to reproduced sound larger or thicker or brighter or sharper than life, that they well may have forgotten, if they ever knew, the inimitable natural proportions, tang, and warmth of the real thing. Like many other audiophiles, I too have delighted in many of these ever more brilliant flights of aural imagination and technical ingenuity; but it has taken the present recording to jolt me into realizing that the re-creation of authentic orchestral sonorities in their natural hall habitat is always, if less melodramatically startling, far more richly satisfying.

Whether this milestone (as the *Gramophone's* reviewer, Edward Greenfield, claims) marks "another break-through of the sound barrier," or (as I'm more inclined to believe myself) a subtle refinement in and more relaxed mastery of technical means is not very important.

What is significant is the result itself—a closer approximation of a live concert hall performance than I've ever heard via records before and had only dreamed might ever be possible.

The supreme naturalness of the sonic qualities is unmistakable right from the beginning, with its brazen solidity of trombone and tuba tone. It is evident throughout in the refreshing freedom from glassiness and "whistling" in the high-string registers (so long a characteristic of high-fidelity recording and reproduction that most of us have come to accept it as inevitable). But it is perhaps most striking of all in the sudden, superbly expansive, volumetric opening-up of the *Allegro non troppo maestoso* section of the finale and in the apocalyptic gong roar of the climactic shipwreck.

To appreciate fully what "natural" orchestral sound and dynamics involve here, one must know from concert hall experience not only the main tunes, colorings, and effects in *Scheherazade*, but the subtler details of its instrumentation. Mr. Greenfield cites as most remarkable to him the opening violin solo in the second movement, which in the previous Ansermet recording (and indeed all modern ones) is accompanied by "a sort of very very faint whistle hovering faintly round each note," whereas the solo in the new version is entirely free from such a "distracting aura." I am no less impressed by the delicate timbre (but not phrasing) differentiations in the flute's echoing of the solo violin's roulade (p. 32 of the Eulenberg miniature score) . . . the resolution of the kettledrum's double grace-noted "drag" strokes (p. 52) . . . the golden distance of the warmly romantic *piano* horn phrases (p. 93) . . .

the clean-cut distinctions between the first violins' whirring non-legato echoes of the immediately preceding legato flute's cadenzalike phrase (p. 112-3) and between that and the violins' later (p. 134) repetition of the same phrase in a higher register, but this time legato too . . . the infinitesimal yet unmistakable differentiations in timbre among the pianissimo triangle, tambourine, snare drum, and cymbals in the scherzando last four bars (p. 151) of the third movement . . . and the ethereal purity of the solo violin's open-string harmonics in the closing pages (257-9) of the finale. These distinctions I cite almost at random from the multitudinous similar felicities.

Now, none of these features would seem at all extraordinary to an attentive concert hall listener; they seem so marvelous here simply because they never have been captured before with such unstressed vividness and natural lucidity. Even such ultrabrilliant technical miracles as London's famous *Rheingold* and the recent Reiner *Scheherazade* for RCA

Victor now seem contrived when directly compared with the freshness, sweetness, and lucent air-spacing of a near perfect replica of a live performance.

As for Ansermet's interpretation and the Suisse Romande players' performance, the conductor's reading (infinitely superior to the earlier routine one with the Paris Conservatory Orchestra) must be ranked with the uniquely individual one by Beecham and the more broadly powerful one by Reiner, and the playing is surpassed—if at all—only by the latter's more precise, but less serenely gracious Chicagoans. About the electrifying *Prince Igor* dances which fill out the second side, I need only say that everything remarked about *Scheherazade* applies equally to them.

Of stereo qualities as such, one is never specifically conscious of them, since one instinctively compares the transparency and spaciousness here (the latter for its depth and perspective no less than in breadth alone) with concert hall experience rather than with other recordings

in which one is more aware of the engineering involved. For that matter, only a still ineradicable whiff of preëcho at the beginning of the first and last movements of *Scheherazade* makes me consciously aware of its disc processing, which in all other respects never seems to obtrude as an intermediary between listener and orchestra. Of course, all the intermediaries (never excluding our own home sound systems) do remain in actuality, but the present release brings us closer to concert hall authenticity than the art of sound recording and reproduction has ever carried us before.

RIMSKY-KORSAKOV: *Scheherazade, Op. 35*
 †**Borodin:** *Prince Igor: Polovtsian Dances*

Lorand Fenyés, violin; Chœur des Jeunes and Chœur de Radio Lausanne (in the Borodin); Orchestre de la Suisse Romande, Ernest Ansermet, cond.
 • LONDON CM 9281. LP, \$4.98.
 • • LONDON CS 6212. SD, \$5.98.

To Make Choice Hard—

A Second Stereo *Dutchman*

by Herbert Glass



Conductor Dorati.

WAGNERIANS may well consider 1961 to be the year of *The Flying Dutchman*. In March, Angel's release, with Fischer-Dieskau in the title role and Konwitschny conducting, showed just how good this work could sound given interpreters of skill and understanding. Now, only six months later, another *Dutchman*, again with a magnificent cast, comes our way from RCA. Extended

evaluation of the RCA edition vis-à-vis the Angel is, of course, valuable, but comparisons will be but lightly touched upon here since detailed discussion of the four extant versions will be included in the Wagner discography to appear in this journal's November issue.

The first feature of this latest *Dutchman* to startle me was Antal Dorati's conducting. It is difficult to believe that this is the same man who, time and time again, has produced such rushed, hypertense interpretations of the bread-and-butter repertory for another recording company. Now Dorati is revealed as a master of the Wagnerian idiom. In a reading very broad, and rather slowly paced throughout, he makes his fine orchestra supply a crushing solidity of strength, with the brass ringing out with particularly sumptuous, smooth tones. From the opening notes of the overture, we can feel that this is to be a *Dutchman* of stormy majesty.

George London, here in superb voice, is a perfect protagonist of the title role, fitting into Dorati's conception in the

most natural fashion. This singer conceives of the Dutchman as a grim, recalcitrant character, not at all the kind of insinuating sea-wanderer painted for us by Fischer-Dieskau. The present Dutchman steers a course, if you will pardon my literalness, towards his doom, feeding on the seeming hopelessness of his situation and gaining from it an odd sort of defiant strength. In the mighty monologue, "*Die Frist ist um,*" for instance, he lashes back at the sea with the same measure of overwhelming anger it has shown towards him. This is a performance which, to my mind, establishes London as one of the foremost singing actors of our time.

For the first time Leonie Rysanek's voice is captured by the recording microphones in all its sensuous magnificence. She is the personification of Senta, the strangely obsessed girl who broods on the Dutchman's picture. Her singing of the "Ballad" is hauntingly mysterious, while in her exquisite duet with the Dutchman, "*Wie aus der Ferne,*" she displays a passion and tenderness which



Baritone London.

evokes to the very maximum the intensity inherent in their relationship.

The remainder of the cast conform to the high vocal and dramatic standard set by the two central characters. Giorgio Tozzi's Daland is wonderfully vital in characterization and marvelously sung—in fact, it is the only Daland among the several recorded representations available to give us any clear portrayal of what that character really is. Karl Liebl's gentle, mellifluous tenor makes the "Italian-ness" of Erik's music most apparent and totally winning. His range is not great, but the quality of the voice is ravishing and the singer's intelligence is ever in evidence. To these distinguished performances Lewis contributes a charming Steersman; while his manner is perhaps a bit too gentlemanly and his top notes

not negotiated with the greatest of ease, he is patently an experienced and dramatically aware artist. Rosalind Elias handles the only minor part capably.

A final word of praise is richly deserved by the engineers, who have been extraordinarily perceptive of the precise sonic mood required by this singular interpretation. The stereo sound is expansive and deep, with the singers somewhat removed from us in space, in judicious balance with the orchestra. Separation of instrumental timbres is successfully achieved, and the excellent Covent Garden chorus benefits greatly from the clarity afforded by stereo. The recording also provides some striking stage effects: e.g., the fearful crash of the anchor plunging into the water as a wave dashes against the side of Daland's ship (following the

Steersman's song), and the busy whir of the spinning wheel coming at us from the left channel in the "Spinning Chorus."

In fact, everyone involved in the production is to be congratulated. This *Flying Dutchman* represents recorded opera at its best.

WAGNER: *Der Fliegende Holländer*

Leonie Rysanek (s), Senta; Rosalind Elias (ms), Mary; Karl Liebl (t), Erik; Richard Lewis (t), The Steersman; George London (b), The Dutchman; Giorgio Tozzi (bs), Daland. Chorus and Orchestra of the Royal Opera House, Covent Garden, Antal Dorati, cond.
● RCA VICTOR LM 6156. Three LP. \$14.94.
● ● RCA VICTOR LSC 6156. Three SD. \$17.94.

CLASSICAL

BACH: *Sinfonias: No. 3, in D; No. 4, in D minor; No. 9, in F minor*—See Beethoven: *Trio for Strings, Op. 9, No. 2.*

BACH: *Sonatas for Viola da Gamba and Harpsichord, S. 1027-29*

Bernard Greenhouse, cello; Sylvia Marlowe, harpsichord.
● DECCA DL 10036. LP. \$4.98.
● ● DECCA DL 710036. SD. \$5.98.

It is now possible to get these sonatas, recorded on one disc, as played by either a gamba (Archive), a viola (Westminster), or a cello, all with harpsichord. All these versions are commendable, and a choice among them boils down pretty much to a choice of instrument. Mr. Greenhouse, a fine artist whose tone is normally big and rich, has filed it down somewhat for Bach, and does not use much vibrato here. Miss Marlowe adds embellishments in suitable places and plays with her wonted skill. As in the other recordings of the set, the G major Sonata, with its grave and noble Adagio, its joyous Allegros, and its brooding Andante, stands out above the D major and G minor Sonatas. The sound is good in both editions. N.B.

BEETHOVEN: *Quartet for Strings, No. 11, in F minor, Op. 95*—See Hindemith: *Quartet for Strings, No. 3, Op. 22.*

BEETHOVEN: *Romances for Violin and Orchestra: No. 1, in G, Op. 40; No. 2, in F, Op. 50*—See Dvořák: *Concerto for Violin and Orchestra, in A minor, Op. 53.*

BEETHOVEN: *Symphony No. 9, in D minor, Op. 125 ("Choral")*

Elisabeth Schwarzkopf, soprano; Elisabeth Höngen, contralto; Hans Hopf,

tenor; Otto Edelman, bass; Bayreuth Festival Orchestra and Chorus, Wilhelm Furtwängler, cond.

● ANGEL COLH 78/79. Two LP. \$11.96.

Cited in the April issue of this magazine as one of the forty great recordings of the past decade, this performance "lays an obligation upon everyone to hear it." These words, from C. G. Burke's original review in HIGH FIDELITY, apply even more forcefully to the present edition, since here you really can experience the impact of the master tape.

NEXT MONTH IN

high fidelity

The Music Wall

Beautiful sounds need not mean ugly sights.

by Phoebe Eisenberg

The Symphonies of Haydn

A discography.

by Robert C. Marsh

Sir John Barbirolli— Up the Years from Kingsway

Half a century of music-making already lies behind the new leader of the Houston Symphony.

by Charles Reid

FM Stereo—A Progress Report

by the audio staff

Noel

Presenting Mr. Coward.

by R. A. Israel

It must be made clear that this is a great performance captured with the technical imperfections of a recording made from a live concert. (Furtwängler's death denied us a Ninth with the refinements of studio engineering.) The podium creaks, the horn burbles, the audience coughs, and the words of the chorus run together—but the disc remains one of the major musical documents the tape recorder has given us.

Of the various transfers issued here and abroad, this seems to be the most successful equalization of the tape original. The tubby quality that marred some of the releases is gone, yet there is adequate bass to support a firm ensemble line. In general, frequency emphasis has been moved up, clarity is improved at times, and quiet surfaces give Furtwängler's eloquent pauses their proper effect. (The next best transfer job was RCA Victor's for their now deleted first American edition.) R.C.M.

BEETHOVEN: *Trio for Strings, Op. 9, No. 2*

†Schubert: *Trio for Strings, No. 2, in B flat*

†Bach: *Sinfonias: No. 3, in D; No. 4, in D minor; No. 9, in F minor*

Jascha Heifetz, violin; William Primrose, viola; Gregor Piatigorsky, cello.

● RCA VICTOR LM 2563. LP. \$4.98.
● ● RCA VICTOR LSC 2563. SD. \$5.98.

The present disc gives us a complete set of the Op. 9 trios from this incredible group. It is obvious in everything they do that they are themselves filled with delight in their results, and, indeed, why not? The technical problems of this music are so simple for artists of this caliber that they can concentrate on matters that make chamber music a unique form of expression, a synthesis of instrumental lines, adding up to more than the sum of the parts.

The Bach pieces are short but splendidly achieved. The Schubert is a flood of youthful melody, here beautifully sung and providing an ideal foil for the Beethoven. The engineering, particularly in stereo, is outstanding. R.C.M.

Continued on page 84

the virtuoso piano

Distinguished Recordings proudly announce the new additions to their collection of historic recitals by the world's greatest virtuosi.



PERCY GRAINGER PLAYS GRIEG

Concerto in A Minor, Op. 16. Peer Gynt Suite, Op. 46. Ballade.....Op. 24.
DR 108

ETHEL LEGINSKA

in a piano recital of compositions including works by:
TCHAIKOVSKY, LISZT, SCHUMANN, STRAUSS, WEBER and BEETHOVEN
DR 109

IGNAZ FRIEDMAN

in a program of piano masterpieces including compositions by:
CHOPIN, SCHUBERT, LISZT and STRAUSS
DR 110

Other releases by: PADEREWSKI, BUSONI, HOFMANN and CORTOT.

D
R
**DISTINGUISHED
RECORDINGS, INC.**
1650 Broadway, N.Y.C.

CIRCLE 37 ON READER-SERVICE CARD

BEETHOVEN: *Variations on "Ich Bin der Schneider Kakadu," Op. 121a*

†**Brahms:** *Trio for Piano and Strings, No. 2, in C, Op. 87*

Albeneri Trio.

• • MUSIC GUILD S 9. SD. \$4.87 to members; \$6.50 to nonmembers.

Neither of these works is duplicated in Schwann, although we've had both in the catalogue in the past. The Beethoven is a robustly good-humored work, characteristic of both the composer's later years and his salty jokes. Since the Albeneri Trio plays it with an affectionate regard for its good and bad points, this performance should see us through nicely even if we have to wait another thirty years for a new version.

It's good too to have the Brahms back, particularly in a performance that catches the ripe Brahmsian manner so well.

Technically this is the best stereo reproduction of a piano trio I've heard. The three performers are beautifully placed across the listening room and project vividly as individuals. R.C.M.

BERG: *Lyric Suite*

†**Webern:** *Five Pieces, Op. 5; Six Bagatelles, Op. 9*

Juilliard String Quartet.

• RCA VICTOR LM 2531. LP. \$4.98.
• • RCA VICTOR LSC 2531. SD. \$5.98.

When Alban Berg's *Lyric Suite* first came out on records, not long after its composition in 1926, it seemed like the last

word in puzzling modernism. Its six movements, with their striking tempo indications—*Allegretto gioviale, Andante amoroso, Allegro misterioso, Adagio appassionato, Presto delirando,* and *Largo desolato*—seemed the last word in musical expressionism. Returning to it today, in this elegant performance and recording, one finds it no more problematical than a string quartet by Brahms. It also, I am shocked and sad to report, seems a bit of a bore.

The superlatively beautiful pieces by Webern, however, are certainly not a bore. The *Five Pieces* were written in 1909 and the *Six Bagatelles* in 1913, but they are still modern music in a way that the *Lyric Suite* can never be. And they are stunningly beautiful. After hearing a good performance of Webern, I want to hear no music at all for a while. A.F.

BERLIOZ: *Symphonic fantastique, Op. 14*

Vienna State Opera Orchestra, Vladimir Golschmann, cond.

• VANGUARD SRV 120. LP. \$1.98.
• • VANGUARD SRV 120 SD. SD. \$2.98.

If Vanguard was seeking to show off the fine quality of its sound on this low-priced demonstration disc, it has succeeded admirably. The monophonic edition may be classed as first-rate, the stereo version as outstanding. Instrumental definition is generally very clear (one can actually hear the characteristic buzz of the contrabassoon in the first statement of the *Dies Irae* in the finale), while distribution and blending are quite life-like. Golschmann's reading is something less exciting. Except for the slow movement, which he treats most expressively (and which Vanguard splits in the middle between disc sides), his is a decidedly businesslike approach, thoroughly acceptable but without much inner fire. P.A.

BORODIN: *Symphony No. 2, in B minor; Prince Igor: Polovtsian Dances*

Chorus of the Society of Friends of Music (in the Dances); Vienna Philharmonic Orchestra, Rafael Kubelik, cond.

• CAPITOL G 7249. LP. \$4.98.
• • CAPITOL SG 7249. SD. \$5.98.

Kubelik's highly respectable readings of both these colorful works may not set the world on fire, but they are correct in every detail. I personally prefer the added snap that Jean Martinon put into his interpretation of the Symphony in his recent recording for RCA Victor. In both the present mono and stereo recordings the chorus in the *Polovtsian Dances* sounds too distant, though it enjoys a better sonic spread in the two-channel edition. P.A.

BRAHMS: *Concerto for Piano and Orchestra, No. 2, in B flat, Op. 83*

Gyorgy Sandor, piano; Southwest German Radio Orchestra (Baden-Baden), Rolf Reinhardt, cond.

• VOX PL 10990. LP. \$4.98.
• • VOX STPL 510990. SD. \$4.98.

The performance here is highly satisfying, certainly one of the better versions available. Both Sandor and his conductor

GRADO "Truly the world's finest..."

What customers say about the new GRADO STEREO CARTRIDGES

"Fantastic sound, equal to the finest tape I have ever heard"

"That one year unconditional diamond warantee plus the five year guarantee against wear, is the best yet. Excellent sound"

"I was only able to purchase an inexpensive system, but my Grado makes it sound like twice the money"

"The greatest improvement to my system for the least money. Difficult to believe I am listening to records"

"The quietest surface I have ever heard. The sound is a dream come true"

NEED WE SAY MORE?

GRADO SENATOR SERIES STEREO CARTRIDGE audiophile net \$24.95

GRADO CLASSIC SERIES STEREO CARTRIDGE audiophile net \$37.50

GRADO LABORATORY SERIES CARTRIDGE audiophile net \$49.50

LABORATORY SERIES TONE ARM \$39.50

For further information write: **GRADO LABORATORIES, INC.**
4614 Seventh Ave., Brooklyn 20, N. Y. • Export — Simontrice, 25 Warren St., N. Y. C.

CIRCLE 52 ON READER-SERVICE CARD

adhere to the solidly Germanic tradition of Brahms playing, and they give a boldly extrovert reading graced by a firmly held basic tempo, a robust tonal framework, and a certain degree of poetry. The pianist is a strong technician; and if he drops or smears a few bass notes, that is forgivable in view of the over-all flair of his interpretation. The stereo recording is cleanly defined, and agreeably spacious. I would place this disc second only to the stereo readings of Serkin and Rubinstein. H.G.

BRAHMS: Trio for Piano and Strings, No. 2, in C, Op. 87—See Beethoven: Variations on "Ich Bin der Schneider Kakadu," Op. 121a.

BRAHMS: Trio for Violin, Horn, and Piano, in E flat, Op. 40
†Schubert: Auf dem Strom, Op. 119

Benita Valente, soprano (in the Schubert); Michael Tree, violin (in the Brahms); Myron Bloom, horn; Rudolf Serkin, piano.
 • COLUMBIA ML 5643. LP. \$4.98.
 • • COLUMBIA MS 6243. SD. \$5.98.

The Brahms Trio, presented here in Columbia's series of Marlboro chamber music discs, receives a fine-grained interpretation, beautiful in tone, with carefully balanced ensemble, yet plenty of spirit. One could not ask for a more appropriate reading. The same is true of Schubert's *Auf dem Strom*. Written for soprano, horn, and piano, this work is one continuous lyrical outpouring; and although it is somewhat repetitious and rather long, it contains some exquisite music, especially for soprano and horn, the latter playing far more than a mere obbligato. Benita Valente has a lovely lyric soprano voice, which she uses intelligently; and again, as in the Brahms, the ensemble work is above cavil.

The recording, made in a rustic studio at Marlboro, gives the illusion of spaciousness and resonant depth without sacrificing presence. P.A.

BRUCKNER: Symphony No. 9, in D minor

Hamburg State Philharmonic Orchestra, Joseph Keilberth, cond.
 • TELEFUNKEN TC 8043. LP. \$1.98.
 • • TELEFUNKEN TCS 18043. SD. \$2.98.

Like Schubert's B minor Symphony, Bruckner's Ninth is among the most complete of unfinished symphonies. Although he lived to complete only three of its projected four movements, the two slow movements surrounding a scherzo make a work that is surely an expressive and often deeply moving entity. Keilberth, however, does not always bring out all the expressiveness and power in the score. His slow movements are inclined to be a trifle weak at times, heavy-handed at others, and lacking conviction. The scherzo, also heavy, fails to provide much of the necessary contrast. (While the scherzo in Bruno Walter's recent Columbia recording is also a bit slow-footed, that conductor infuses the entire symphony with much greater warmth and meaning.) The sound on the present discs is clean but is without much depth or resonance, particularly in the mono-phonetic edition. P.A.

CARTER: Symphony No. 1
†Haieff: Divertimento

Louisville Orchestra, Robert Whitney, cond.

• LOUISVILLE LOU 611. LP. Obtainable on special order only.

Elliott Carter has come forward in recent years as a composer of very abstruse and formidable works; it is a little surprising, therefore, to discover that nineteen years ago he wrote a symphony whose thematic material, in his own words, "suggests the characteristic beauties of Cape Cod . . . and something of the extraordinary cultural background of New England which this landscape brings to mind." This statement may be a bit naïve, but the music is not. It is perfectly beautiful, with proper bows in the direction of Mr.

Ives and Mr. Copland, but maintaining its own rather light-textured, rhythmically very inventive style from start to finish. The finale is especially magnificent, particularly from the rhythmic point of view; this should make one of the greatest dance scores of the century. Mr. Balanchine—and other choreographers—please notice.

The *Divertimento* by the Russian-born American Alexei Haieff, presented on the other side, is, like so much of that composer's music, entertaining but lacking in distinctive character. The performances from the Louisville Orchestra under the baton of Robert Whitney seem to be most authoritative, and sonically speaking the recording is good enough. A.F.

Continued on page 88

artists and accolades



VIRGIL THOMSON: The Plow That Broke the Plains; The River. Orchestral Suites. Symphony of the Air cond. by LEOPOLD STOKOWSKI. VRS-1071 & *VSD-2095
 "A performance seldom matched by Leopold Stokowski in his long and illustrious career." *Saturday Review*, on Stokowski's recording of Bloch's *America* (VRS-1056)



SAMUEL BARBER: Second Essay for Orchestra; A Stopwatch and an Ordnance Map; Music for a Scene from Shelley; A Hand of Bridge (Chamber Opera), etc. Soloists, Chorus and Symphony of the Air, cond. by VLADIMIR GOLDSCHMANN. VRS-1065 & *VSD-2083
 "The best Barber record we've heard . . . Barber never sounded better." *Washington Star*



CISCO HOUSTON sings songs of WOODY GUTHRIE. VRS-9089
 "A testimonial to Guthrie's genius as folk poet and composer . . . Cisco sings with soft lilt and lovely musical quality . . . This disc is a must." *American Record Guide*



RONNIE GILBERT sings a program of folk songs
 "COME AND GO WITH ME." VRS-9052
 "A sensitive performer, singing with honesty and a lusty appreciation of her art." *The Cash Box*
 "Excellent recording."
Los Angeles Herald



THE NEWPORT FOLK MUSIC FESTIVAL, 1960. Vol. 1—Jimmy Driftwood, John Lee Hooker, Tom Makem, Alan Mills, Jean Carignan, New Lost City Ramblers, Pete Seeger. VRS-9083 & *VSD-2087
 Vol. 2—Bob Gibson, Bob Camp, Lester Flatt, Earl Scruggs, Cisco Houston, Ed McCurdy, Peggy Seeger, E. MacColl. VRS-9084 & *VSD-2088
 "These discs are alive with presence and the immediacy of inspiration." *Musical America*



GIOVANNI GABRIELI: Sacrae Symphoniae and Canzoni for Double Choir, Brass and Organ. Choir and Brass Ensemble of the Gabrieli Festival, HANS GILLESBERGER, conductor. BG-611 & *BGS-5037
 "Following its own high tradition, this company has scored another hit. . . . A record to delight in, revel in." *American Record Guide*



BALLET SUITES OF RAMEAU, GRETRY AND GLUCK. Hartford Symphony Orchestra cond. by FRITZ MAHLER. VRS-1075 & *VSD-2098
 "Their interpretation is most penetrating." *High Fidelity*, on Mahler conducting Bloch's *Three Jewish Poems* (VRS-1067)

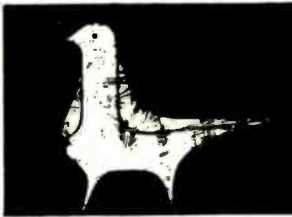

RESPIGHI: The Birds; Tritico Botticelliano. Vienna State Opera Orchestra cond. FRANZ LITSCHAUER. VRS-1076
 "Litschauer has polished these gems with pointillistic delicacy." *Boston Globe*, on Litschauer in Respighi's *3 Suites of Ancient Airs and Dances* (VRS-466)



MARTHA SCHLAMME at the GATE OF HORN. VRS-9091
 "As always, Miss Schlamme's clear, light soprano illumines the drama of each song to the fullest." *High Fidelity*, on Martha Schlamme at Town Hall (VRS-9070)



VANGUARD

recordings for the connoisseur

*Stereo lab

Send for Catalogue to: Vanguard Recording Society, Inc., 154 West 14 Street, New York 11, N. Y.
CIRCLE 110 ON READER-SERVICE CARD

Command Records Introduces



The first time you hear this record will be one of the most startling experiences of your entire life.

For the very first time you will hear sound that is completely liberated, sound that is totally free—pure, full, honest sound with no mechanical restrictions whatsoever.

No record like this has ever been made before.

It reveals the most astounding development in recording techniques since the first fabulous Command Record, *Persuasive Percussion*, completely revolutionized the accepted concepts of sound on records.

You will hear sound so intensely real that you can actually *feel* the presence of each individual musical instrument.

For the first time you will hear music reproduced in *all* its full power and glory, with *all* of its widest, widest breadth and with every last element of imposing depth. The sound is so pure, so totally true, that it is possible to reproduce music of such great intensity that it actually approaches the threshold of pain.

Listening to this record can be a shocking experience. It can be exhausting, it can be exhilarating. But it won't be a casual experience. This is an adventure in listening that you will never forget.

Three main elements have made this fantastic record possible:

(1) The unique Command recording techniques that have made Command the most distinguished name in sound recording,

(2) *Plus* the *natural* acoustics of the greatest sound chamber in the world—the auditorium of Carnegie Hall in New York,

(3) *Plus* a miraculous *new method* of recording on film.

The key to this startling breakthrough to a whole new world of sound recording lies in new techniques for using 35 mm magnetic film for recording that have been devised by Command's research team, C. R. Fine, Chief Engineer and Enoch Light, Director of Artists & Repertoire. They began to explore the possibilities of film recording when it became apparent that tape recording had been developed, largely through their research, to such a point that further development was limited by the very nature of the tape itself.

These limitations were of such a minor nature that they would be of no consequence in normal, run-of-the-mill recording situations. But Command's recordings have always been designed for an especially discriminating and demanding audience, true connoisseurs of sound. Because of this, it is Command's policy to seek out every possible advance in sound reproduction, no matter how marginal it may seem or how costly it may be.

Perfect, Unadulterated Sound

In attempting to achieve perfect, unadulterated sound reproduction, in the recording of large orchestras, even the most advanced tape techniques are faced with two mechan-

CIRCLE 31 ON READER-SERVICE CARD

ical limitations which create minor distortions that affect the ultimate purity, freedom and fullness of the reproduced sound. These two limitations are hiss and flutter. Flutter, caused by the path taken by the tape through the tape machine, creates a distortion so slight that most listeners would not be aware of it. But to the connoisseur of good music, it is evident that some peculiar non-musical sound is present, something mechanical. High frequency flutter creates raspiness in violins or, in other instruments, a sound that is not quite as clean as it should be.

A more serious limitation of tape is its physical dimensions. Most stereo recording is done on ¼-inch tape (two channels) or ½-inch tape (three channels). In either case, each stereo track is less than half the width of a monaural track on the same tape and there is a proportionate decrease in the ratio of signal to noise. That is, the noise level is raised and this increased noise level results in tape hiss. Moreover, since tape is only 1½ mils thick, very often at least an infinitesimal amount of print-through is bound to occur and this, too, has a slightly degenerating effect on the sound.

Superb Recording

Despite the combination of both flutter and hiss, it is possible to do excellent recording on tape. But Command's goal is not just excellent recording. Its goal is superb recording. And the slightly unreal instrument-sound resulting from the intermodulation effect of flutter and hiss stood in the way of that goal.

In 35 mm film, Command's engineers saw a solution. Film has no flutter because it runs on a closed circuit loop and is held tightly against the recording head. It is able to carry the equivalent of three ¼-inch tape tracks with more than enough space between each track to guarantee absolute separation of channels. And because the film is 5 mils thick, the possibility of contamination by print-through is negligible.

The result is a milestone on the road to absolute perfection in recorded sound: A signal-to-noise effect that is absolutely ghostly. There is no background noise whatever!

New Ear Perceptibility

But film did more than provide solutions to the minor drawbacks of tape. It also opened up new possibilities. The much wider track used on film offered

tremendous, previously unheard-of leeway in dynamics—and as a result distortion was reduced to a bare minimum. The wider track on film allowed for tremendous peaks and transients, factors which make for wonderful *ear perceptibility*. What sounds your ear is willing to receive is conditioned by the presence or absence of transients. Lack of transients results in a distorted sound. When the ear hears distortion, it closes down just as the eye responds to a bright light by contracting. When sounds are lacking in transients, you hear less. The amazingly *clean* sound on film gives the ear a wonderful feeling of well-being, makes it increasingly receptive so that you actually *hear more*.

Film, of course, has been used for recording sound for motion pictures to be reproduced in theatres. But it has never proved satisfactory for recordings in the distinctly different circumstances of home use. This was a basic flaw in choosing film as a solution to the limitations of tape.

But, just as Command's engineers expanded the value and scope of tape recording, they applied their creative skills to the roadblocks that faced them in 35 mm film and, one by one, solved them. To do this, they had to make adaptations in equipment at almost every step of the recording process.

Utter Clarity and Truth

For the first time it is possible to record with utter clarity and truth from triple piano (*ppp*) to triple forte (*fff*). Even in a full crescendo, the individuality of each instrument is preserved, not lost in a mass of sound. With the orchestra playing fortissimo, it is now possible to give the full spectrum of sound with absolutely clean musical color.

The one hitch in this glorious vista of sound developed by Command's engineers was cost—film recording (cost of material) is an appalling *ten times* as expensive as tape recording. Were the results worth this vast difference in price?

Enoch Light, originator and producer of Command Records, decided that the only way to find out was to test film recording under the best possible circumstances.

For his recording studio, he hired Carnegie Hall which is recognized by sound experts and master musicians alike to have the finest acoustics in the world. He took advantage of the Hall's

natural acoustics by using the auditorium as a big sound chamber (it is part of Command's highly successful recording technique to use only true, natural sound). Normally from one to three microphones are dropped from the ceiling of the auditorium to record an orchestra. But Light used fourteen microphones with a twelve-position control board to give proper perspective to each instrument or group of instruments in relation to the whole orchestra.

Tremendous Sonic Leeway

For his orchestra, Light brought together more than sixty of the most skilled musicians in New York including many who were thoroughly familiar with the special recording techniques used by Light to create his unique Command Records in the past. Arrangements were written by Lew Davies that deliberately exploited the critical point of sound, using the full extremes of every instrument in all timbres and in all colors.

The musicians, keyed up by the excitement of the astonishing results they heard in the first playbacks, played at the very top of their form. The precision, the impact, the intonation in their playing and the balance that the musicians established among themselves reached a level of high perfection that matched the superb acoustics of the Hall and the brilliant fidelity of the miraculous recording technique for which they were playing for the first time.

Because every single sound can be heard so clearly and so individually, this was one of the most demanding series of recording sessions ever held. Not even the slightest error could be covered up.

"Everything is so exposed," Light remarked between takes, "if the least little thing goes wrong, we're in trouble."

That sort of full exposure was the goal. It is revealed in these astonishing, breathtaking recordings—performances that are an overwhelmingly, unprecedented combination of musical brilliance and startlingly real, completely unlimited sound reproduction.

Arrangements include: Heat Wave, The Man I Love, I've Got a Crush on You, All the Way, My Romance, You Do Something to Me, Zing Went the Strings of My Heart, Someone to Watch Over Me, Love for Sale, I'll See You Again, I See Your Face Before Me and With A Song in My Heart.

*the greatest advance
in sound since
hi-fi was invented*
Command
records

SUGGESTED NATIONAL PRICE LIST: COMMAND STEREO #826SD "STEREO/35MM": \$5.98. COMMAND MONAURAL #RS826 "SOUND/35MM": \$4.98. COMMAND 4-TRACK TAPE #4T826: \$7.95.

CIRCLE 31 ON READER-SERVICE CARD

The development of stereo from 1958 to "phase 4 stereo"

Since the introduction of the revolutionary stereo record in 1958, the art of recording has undergone a rapid evolutionary process.

Phase 1 stereo: "Concert Hall Realism." In this phase (1958 to 1961), stereo recordings attempted to recreate a true stage presence. The instruments of the orchestra were placed "soundwise" in their normal positions, with the result that for the home listener they appeared to come from an imaginary sound-stage spread between the listener's two loudspeakers. The record buyer no longer needed to be content with listening to his favorite artists in the restricted medium of "compressed" monophonic sound. This type of stereo recording reflected the "purist" approach and applied most generally to stereo recordings in the field of classical music. When London Records introduced its first stereo record in 1958, it had years of preparation and refinement behind it. The result was that London's "fss" (full frequency stereophonic sound) offered the most advanced and finest definition of "concert hall" sound ever heard on records.

Phase 2 stereo: "Separation of Sound." In this phase (1959 to 1961), stereo recordings proved that an orchestra could be "split in half"; that voices could be "full left" while the orchestra was "full right"; that a ping-pong ball could be heard hitting the table on the left and then on the right, and that sounds could be reproduced "left-right" without any center "leakage." Sounds emanating from two loudspeakers lent themselves to a seemingly endless variety of juxtaposition, separation, and other strictly mechanical processes, and a fascinating display of unusual sound pyrotechnics it was that followed. . . . bongos jumped from left to right speakers while saxophones and trumpets answered back and forth between speakers: it was the technical "glimmic" that was in command, the technique was the end-in-itself.

Phase 3 stereo: "Moving Sounds." In this phase (1961), it was demonstrated that the sounds of a whole section of an orchestra or a single instrument could be moved and followed by the listener's ears as the sounds passed through the space from left to right speakers and back again electronically. . . . In certain opera, drama and musical comedy recordings, the voices could be followed moving before one's ears as in a true-to-life stage presentation.

"Phase 4 stereo": In this phase (1962), arrangers and orchestrators re-score the music to place the instruments where they are musically most desired at any particular moment and make use of direction and movement to punctuate the musicality of sounds. The effect is more sound—more interest—more listening pleasure. "Phase 4 stereo" recording (and this term is used in its broadest sense here to include the arrangements—the musicians—and the engineers) allows you to enjoy the music actively. Recording in this fashion was made possible technically as a result of London's new 4 Track Master recording system. Now, for the first time, the musical arranger was given a whole new technical capacity with which to work, and with which to create new musical entertainment and enjoyment. To take advantage of this new musical framework afforded him, the musical arranger now has to envision the sounds he hears in his head as they relate to each other in the extra dimension of space afforded by stereo reproduction: the musical arranger has to create new forms of musical annotation and scoring to convey his full musical concept. Through a complicated network of microphones, switches and dials, the music envisioned by the arranger comes into reality as the engineer captures on 4 Track Master tape, the complete and true musical concept of the arranger. From the 4 Track Master tape, the four tracks of sound have to be carefully rebalanced in the reduction to two channels of sound which eventually reach the listener via his two-channel stereo record groove, and ultimately through his two loudspeakers.

Look for the stereo series featuring the "4" design on the LP cover—it's your guarantee of more sound—more interest—more entertainment—more participation—more listening pleasure.



LONDON RECORDS, INC.
539 W. 25 St., New York 1, N. Y.

CIRCLE 67 ON READER-SERVICE CARD

COPLAND: *Concerto for Piano and Orchestra* Menotti: *Concert for Piano and Orchestra*

Earl Wild, piano; Symphony of the Air, Aaron Copland, cond. (in the Copland); Jorge Mester, cond. (in the Menotti).
• VANGUARD VRS 1070. LP. \$4.98.
• • VANGUARD VSD 2094. SD. \$5.95.

The Copland concerto, composed in 1926, is very young Copland, of the jazz period, but the fingerprints of the master are all over it, and it is a most endearing monument to its period. The Menotti is a busy, prickly, motoric, neo-classical sort of piece, at least in its fast movements: its lyrical slow movement drops the neoclassical pretense, but the whole thing is pleasant listening, at least once. Wild does a terrific job of playing, the orchestral part is just as well done, and the sound is first-class. A.F.

COUPERIN: *Leçons des Ténèbres*

Alfred Deller, countertenor; Wilfred Brown, tenor; Desmond Dupré, viola da gamba; Harry Gabb, organ.
• VANGUARD BG 613. LP. \$4.98.
• • VANGUARD BGS 5039. SD. \$5.95.

These three settings of portions of the Lamentations of Jeremiah, for the Wednesday of Holy Week, were published by Couperin in 1714. The first two are for a single voice with continuo; in the third another voice is added. The music is of a striking gravity, with long melodic lines and simple but affecting harmonies. Deller sings with his customary care in phrasing and skill in ornamentation; and since his lower register is called upon a good deal here, there is more variety of color than is usual with him. In the third and finest of the Lessons, Brown complements his partner well, even managing to produce the vocal ornaments in the same way. The performance of this Lesson, it seems to me, is superior to that on Westminster, owing to Brown's superiority to the second tenor there, but a choice between the two recordings with respect to the first two Lessons will depend on whether one prefers a tenor (Hugues Cuénod in the Westminster) to a countertenor. My own choice is a recording by two French sopranos on a Haydn Society disc no longer available. The sound in both versions of the present recording is first-rate. N.B.

COWELL: *Symphony No. 7*—See Kerr: *Concerto for Violin and Orchestra*.

DEBUSSY: *Sonata for Violin and Piano, No. 3, in G minor*—See Fauré: *Sonata for Violin and Piano, No. 1, in A, Op. 13*.

DELIBES: *Sylvia: Ballet Suite. Coppélia: Ballet Suite*

Orchestre de la Société des Concerts du Conservatoire de Paris, Hugo Rignold, cond.
• RCA VICTOR LM 2485. LP. \$4.98.
• • RCA VICTOR LSC 2485. SD. \$5.98.

This makes the tenth coupling of these two ballet suites in the current catalogue, and there are many more that

have come and gone—which would seem to indicate that if there is anything we don't need, it's another *Sylvia-Coppélia* combination. Nevertheless, this new version is welcome. Rignold, an experienced ballet conductor, has combined the dance and concert elements of the music most eloquently here. What's more, he elicits some exceptionally polished playing from this Paris orchestra, which has been reproduced in ravishingly bright colors in both mono and stereo. P.A.

DONIZETTI: *Operatic Highlights*

Don Pasquale: Com'è gentil (Aristodemo Giorgini, t); *Tornami a dir* (Maria Galvany, s; Giorgini, t). *L'Elisir d'amore: Una furtiva lagrima* (John McCormack, t); *Obbligato* (Fernando de Lucia, t; Ernesto Badini, b). *Lucrezia Borgia: Di pescatore ignobile* (Carlo Albani, t); *Come è bello* (Maria de Macchi, s). *Lucia di Lammermoor: Cruda, funesta mania* (Riccardo Stracciari, b); *Tu che a Dio* (Hipolito Lazaro, t). *Linda di Chamounix: Ambo nati* (Mattia Battistini, b); *Un buon servo* (Mosciosa, s; Battistini). *La Favorita: Una vergine* (Aureliano Pertile, t); *A tanto amor* (Stacciari). *Maria di Rohan: Bella è di sol vestita* (Gino Manoli, b). *La Figlia della reggimonte: Pompe e feste* (Francesco Dominici, t). *Poliuto: Di quei soavi lagrime* (Maria de Macchi, s). *Don Sebastiano: In terra solo* (Alfred Piccaver, t).

Various soloists, named above.
• ETERNA 739. LP. \$4.75.

If I think back seven or eight years to the time when the current enthusiasm for Donizetti, Bellini, and Rossini was just getting under way, I can remember hearing the first recordings of their operas and reflecting that, while it was interesting to have the music on discs, the attempted revival of interest would never succeed, simply because the singers were not good enough. The revival has certainly taken place, but I can't quite dislodge the original feeling; it still seems to me that, whatever the histrionic and musical merits of most of the singers engaged in contemporary Donizetti performances, they are not giving the composer his vocal due. Tones that are hooted or quavered, runs that are scattered with "h's," high-lying phrases marked "dolce" that are strenuously muscled out—these have no place in Donizetti.

A listening of the two Battistini selections here will demonstrate what I mean. I am not referring to the ornamentation, which is assuredly dubious, but to the simple, easy, uninterrupted flow of relaxed melody, unbroken and completely at the artist's command. It is also present in the arias sung by Stracciari—especially his magnificent "A tanto amor," which can stand with Battistini's and Magini-Coletti's—in the perfectly turned "Una furtiva lagrima" of John McCormack, and in the "In terra solo" of Alfred Piccaver. To a lesser extent, it is present also in the *Don Pasquale* excerpts by Giorgini and Galvany, though the "Tornami a dir" is by no means one of the soprano's better discs. And I have not even mentioned the deliciously sung "Obbligato" by De Lucia and Ernesto Badini, on which the sound is surprisingly good. On the other hand, Lazaro's

Continued on page 90

Quoted from

"ASSEMBLING A GOOD STEREO SET"

by Ken Winters,
music and recordings editor
of the

Winnipeg Free Press:

“ I chose the AR-2a speakers over other extremely good systems because of their self-effacing dispositions. They seemed to intrude less in the music than did other speakers with more markedly individualistic sound-producing natures. ”

A number of articles have appeared recently in which the author (or magazine staff, or consumer organization) selects components for a complete high fidelity system. Most of these systems have included Acoustic Research speakers for the same reason given by Mr. Winters: the ability of AR's to reproduce music naturally, with minimum coloration.

We will be glad to send you a reprint of Ken Winters' article, discussing his choice of components for a stereo system in the medium-price range. Other lists of preferred high fidelity equipment are also available on request: a reprint of down beat magazine's "Picks of the Year" in stereo components,[°] and a description of four stereo systems,^{°°} each selected for *Gentlemen's Quarterly* by a different audio expert as the ultimate in quality.

AR speakers are priced from \$89 to \$225.

[°]AR-2a's chosen for medium-price system, AR-3's for luxury system

^{°°}AR-3's included in three of the four lists

AR-2a

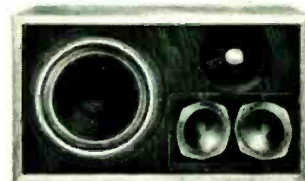

ACOUSTIC RESEARCH, INC. 24 Thorndike Street Cambridge 41, Massachusetts

Virtuoso



FREDERICK FENNEL

thrives on variety. Whether he is conducting a spirited Sousa march, a contemporary masterpiece by Stravinsky, or a witty suite by Leroy Anderson, he is the music's unmistakable master. Hear him demonstrate his flawless taste and versatility on these recent MERCURY recordings:

WAGNER FOR BAND. Fennell leads the Eastman Wind Ensemble through inspired interpretations of: Entry of Gods into Valhalla ("Das Rheingold"); Parsifal Good Friday Music; Lohengrin Prelude to Act III; Bridal Procession; Elsa's Procession. SR90276/MG50276

FREDERICK FENNEL CONDUCTS GERSHWIN—Fennell's exhilarating conducting of the toe-tapping, show-stopping melodies that made the 20's roar and the 30's swing. In MERCURY's Perfect Presence Sound Series. PPS6006/PPS2006

FREDERICK FENNEL CONDUCTS VICTOR HERBERT. A freshly perceptive performance of the bittersweet and nostalgic lyricism of the beloved operettist. In MERCURY's Perfect Presence Sound series. PPS6007/PPS2007



CIRCLE 72 ON READER-SERVICE CARD

"Tu che a Dio" is a disgrace to that artist's reputation, and the contributions of Manoli and Dominici won't win any prizes, either.

The sound, in general, is quite tolerable, but I am puzzled by Eterna's apparently incurable habit of fading the sound at the end of each selection; in some cases, there is simply no need for this. C.L.O.

DVORAK: Concerto for Violin and Orchestra, in A minor, Op. 53
†Beethoven: *Romances for Violin and Orchestra: No. 1, in G, Op. 40; No. 2, in F, Op. 50*

Joan Field, violin; Berlin Symphony Orchestra, Arthur Rother, cond.
• TELEFUNKEN TC 8046. LP. \$1.98.
• • TELEFUNKEN TCS 18046. SD. \$2.98.

The American violinist Joan Field has a sweet tone but not a very forceful interpretative style. As a result, she is more at home in the unassuming Beethoven *Romances* than in the richly romantic Dvořák Concerto (where, in addition, her intonation is not always letter-perfect). Rother's support is more than adequate, and the sound in both mono and stereo is quite good. But there are better versions of the Beethoven by Grumiaux and Heifetz, of the Dvořák by Milstein and Martzy. P.A.

DVORAK: Quintet for Piano and Strings, in A, Op. 81; Humoresque, in G flat, Op. 101, No. 7; Mazurek, Op. 49

Jan Panenka, piano; Smetana Quartet (in the Quintet); Libor Hlaváček, violin; Josef Hála, piano (in the *Humoresque* and *Mazurek*).
• SUPRAPHON LPV 114. LP. \$5.98.

The novelty on this record is the *Mazurek*—or *Mazurka*—which now appears for the first time on microgroove. Composed in 1879 and dedicated to Sarasate, this brief work for violin with either orchestral or piano accompaniment is in style and spirit an extension of the composer's *Slavonic Dances*. The technical demands on the soloist are not overly great, though there is a long succession of double stops in the principal section. I imagine that this little piece might have emerged as something a bit more exciting had it been played with more polish by Hlaváček and had it been dressed up with orchestral accompaniment. As for the far more important Piano Quintet, it receives a well-integrated performance that captures the spirit of the music and delivers it forthrightly. The recorded sound is well balanced and reasonably faithful. P.A.

FAURE: La Bonne Chanson, Op. 61
—See Schoenberg: *Verklärte Nacht, Op. 4.*

FAURE: Sonata for Violin and Piano, No. 1, in A, Op. 13
†Debussy: *Sonata for Violin and Piano, No. 3, in G minor*

Berl Senofsky, violin; Gary Graffman, piano.
• RCA VICTOR LM 2488. LP. \$4.98.
• • RCA VICTOR LSC 2488. SD. \$5.98.

Two of the loveliest, most sensitive of French violin sonatas are here performed with interpretative flexibility and considerable tonal warmth by two young American solo artists who apparently find immense pleasure in sitting down for a session of chamber music. Their approach to the melodic Fauré Sonata is ideal; in the Debussy, I would have liked slightly less rhythmic freedom and more suggestion of mystery. For instrumental balance and tonal fidelity, I prefer the mono version. In stereo, the tone appears less rounded, particularly in the piano. In that version too the violin is distinctly on the left and the piano just as distinctly on the right. There is no "hole in the middle," yet some of the feeling of chamber music rapport is missing. P.A.

FETLER: Contrasts—See Schuller: Seven Studies on Themes of Paul Klee.

GLINKA: A Life for the Tsar (highlights)

Vera Firsova (s), Antonida; A. Ilyin (t), A Soldier; Ivan Petrov (bs), Ivan Susanin. Chorus and Orchestra of the Bolshoi Theatre, Vassily Nebolsin, cond.
• MK-ARTIA 1554. LP. \$5.98.

A generous helping of music from this noble opera. Petrov's round, black bass does full justice to Susanin's towering "They Guess the Truth," though it does not eclipse recent versions by Reizen and Christoff. Vera Firsova has the kind of cool, clear, full-bodied voice that characterizes a good German *Hochsopran*. It is absolutely even and free, and a joy to hear in both of her demanding arias. The overture is given a spirited reading. I would suggest that every operaphile own a copy of the complete (or nearly so) Capitol edition, under Markevitch. For those who are in search of a highlights album, though, the present version is an admirable choice. The sound is fine for the soloists, and never less than sufficient, though one could wish for more depth and clarity in the mighty closing scene for chorus. C.L.O.

HAIFF: Divertimento—See Carter: Symphony No. 1.

HANDEL: Sonatas, Op. 1: No. 2, in G minor; No. 4, in A minor; No. 7, in C; No. 11, in F

Ferdinand Conrad, recorder; Johannes Koch, viola da gamba; Hugo Ruf, harpsichord.
• ARCHIVE ARC 3158. LP. \$5.98.
• • ARCHIVE ARC 73158. SD. \$6.98.

Of the twelve sonatas for a treble instrument and continuo that were published as Handel's Op. 1, four are marked as for the recorder, and it is this quartet of works that is offered here. No. 4 is an especially attractive sonata, and the others have some points of interest, such as the occasional thematic independence of the bass line. Mr. Conrad plays them skillfully and adds many ornaments (there are some amusing ones in the Presto of No. 2), dotted rhythms, and brief fill-in figures, in accordance with baroque practice. Good sound. N.B.

Continued on page 92

HIGH FIDELITY MAGAZINE

the year's most wanted components...

BOGEN

featuring

BUILT-IN MULTIPLEX

in all

RECEIVERS and TUNERS



RP200 Fun Couple FM/AM, 40 watt, Stereo Receiver \$299.95*

Top quality, handsome styling . . . and the Industry's first complete line of receivers and tuners with built-in Multiplex...all from BOGEN, the only major high fidelity manufacturer with five years experience in the production of commercial Multiplex receivers.

For example, take just one unit from the all-new Stereo Line . . . the superb RP200 Fun Couple receiver. Inspired by the novel "the fun couple," and dedicated to fun couples everywhere . . . the RP200 offers compact, contemporary design, unexcelled performance, sensitivity, balance, and many features found only in receivers costing far more.

The all-new Bogen Stereo Line is the result of 30 years leadership in the precise art of sound engineering. Write for the BOGEN Stereo Hi-Fi Catalog.

*Prices slightly higher in the West

BOGEN-PRESTO

Desk H-9 - Paramus, N. J. • A DIVISION OF THE SIEGLER CORPORATION



CIRCLE 23 ON READER-SERVICE CARD



TP200 Fun Couple FM/AM Stereo Tuner . . . Noise Free reception in weakest areas. Pair it with the AP200 for a matchless system. \$199.95*



AP200 44-watt Fun Couple Stereo Amplifier . . . offers amazing flexibility and control at a modest price. \$154.95*

PX60 Multiplex Adapter . . . designed especially for all pre-multiplex Bogen equipment currently in use . . . but excellent for any good quality receiver or tuner. Self-powered with external connections. Complete with Seville textured cage. \$69.50*





have you
heard
the

IONOVAC

hi-fi &
stereo
speakers?
...one of
the most
publicized
products in
the industry's
history

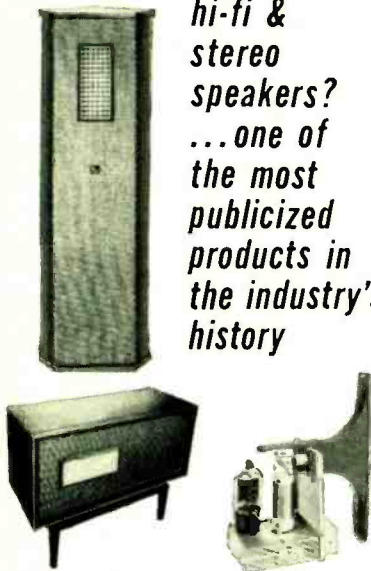

From coast to coast, editors and writers of the nation's top magazines and periodicals have been exuberant about the IONOVAC High Fidelity and Stereo Speaker Systems. The revolutionary "ionic cloud" which replaces the conventional speaker diaphragm has been lauded Nationwide—and why—because nothing moves but the sound waves. Only a "live" demonstration of the IONOVAC can thrill listeners with a quality of sound reproduction that far exceeds anything ever heard before. IONOVAC response amazingly flat from 3,500 to 20,000 cps and above.

IONOVAC High Fidelity and Stereo Speakers are available in a wide range of styles from add-on units to complete Columnar Speaker Systems. Choose from a broad selection of handsome finishes—or unfinished, if you desire. Consumer or dealer inquiries invited. Fill out the coupon below for full details, and the location of your nearest dealer.

IONOVAC DIVISION

DUKANE CORPORATION

ST. CHARLES, ILLINOIS

DEPT. HF-91

Where can I hear a demonstration?

Send free literature.

NAME _____

FIRM (IF DEALER) _____

ADDRESS _____

CITY _____ STATE _____

CIRCLE 40 ON READER-SERVICE CARD

HANDEL: *Tenor Arias*

Xerxes: Ombra mai fu. Acis and Galatea: Love in Her Eyes Sits Playing. Ptolemy: Silent Worship. Jephtha: Waft Her, Angels. Messiah: Comfort Ye; Every Valley. Semele: Where'er You Walk. Judas Maccabaeus: How Vain Is Man; Sound an Alarm.

Kenneth McKellar, tenor; Orchestra of the Royal Opera House, Covent Garden, Sir Adrian Boult, cond.

- LONDON 5603. LP. \$4.98.
- • LONDON OS 25234. SD. \$5.98.

The Scottish tenor does not give us the vocal excitement of Crooks, or the penetration of Webster Booth; but he has his own contribution to make with these wonderful arias. His voice is of the right sort—light and flexible, but not white. He handles it expertly, carrying off the runs with dash, and sustaining the long, soft phrases with ease. The voice has enough metal for the extended dramatic recitative preceding "Waft Her, Angels" (which is movingly sung), if not quite enough for the call to "Sound an Alarm."

I do not care much for the rather nervous-sounding "Where'er You Walk" (this is probably Boult's fault more than McKellar's), or for the advanced-conservatory Italian employed in "Ombra mai fu"; otherwise, there's nothing to complain of on this disc. Most impressive of all are the "How Vain Is Man" (a notorious tenor-slayer which gave even Booth a run for his money) and the *Messiah* selections—the news that McKellar will be the tenor on a new Boult *Messiah* with Sutherland is altogether welcome. Boult's accompaniments (excepting the aforementioned "Where'er You Walk") are incisive and well paced, London's sound topnotch. C.L.O.

HAYDN: *Mass No. 10, in B flat* (*"Theresienmesse"*)

Anny Felbermayer, soprano; Dagmar Herrmann, contralto; Julius Patzak, tenor; Alfred Poell, bass; Choir of the Vienna State Opera and Vienna Symphony. Clemens Krauss, cond.

- Vox DL 700. LP. \$4.98.

This set is at least ten years old and sounds it, but it remains all we have on records to introduce us to one of Haydn's greatest works. H. C. Robbins Landon feels that the six Masses of the years following 1795 represent a continuation of Haydn's symphonic writing in which, as his student Beethoven was to do at the close of his career, Haydn turns to voices for the extra dimension needed to bring fulfillment to his noblest ideas. Those who glory in eighteenth-century music and missed this edition on its first trip through the catalogue are therefore advised to acquire it while the opportunity lasts. It conveys in its best moments the solemnity and strength of Haydn's most mature and deeply felt idiom. R.C.M.

HINDEMITH: *Quartet for Strings,* *No. 3, Op. 22*

†Beethoven: *Quartet for Strings, No.*
11, in F minor, Op. 95

- Kroll Quartet.
- EPIC LC 3779. LP. \$4.98.
- • EPIC BC 1133. SD. \$5.98.

It's about time we had a Hindemith quartet in the catalogue again, even if it is a nearly forty-year-old one such as this. (Hindemith has written three more quartets in the intervening decades, the most recent of them in 1945.) I assume that the popularity of this score comes from the fact that it is youthful, strongly lyric at times, and generally unforbidding. It lacks the stature of Hindemith's *Muthis der Mahler* or the Bartók quartets, but it has distinct merits of its own, chief of which is a good slow movement. The Kroll Quartet gives it a sympathetic performance which Epic has recorded well; and the Beethoven performance is another good one, although unequal to the recent version of that work by the Budapest. R.C.M.

KERR: *Concerto for Violin and Orchestra*

†Cowell: *Symphony No. 7*

Wolfgang Stavonhagen, violin; Imperial Philharmonic Symphony Orchestra of Tokyo (in the Kerr), Vienna Symphony Orchestra (in the Cowell), William Strickland, cond.

- COMPOSERS RECORDINGS CRI 142. LP. \$5.95.

Here is as interesting a contrast as American music affords. The Cowell, like all of that master's later work, is bland, tuneful, folksy, and eminently entertaining; it is Ives with the notes in all the right places. The Kerr, on the other hand, is knotty, highly dramatic, strongly influenced by the 12-tone system, but not orthodox in its use of the 12-tone principle. It is a work of strong individuality and great expressive power, and is the first major work by its composer to appear on discs. Harrison Kerr is sixty-four years old and has been dean of the College of Fine Arts at the University of Oklahoma for many years, and so it is high time. A.F.

KODALY: *Háry János*

Magda Tiszay (ms), Orsze; Judit Sandor (ms), Marie Louise; Endre Rösler (t), Knight Ebalastin; Imre Palló (b), Háry János; Oszkar Maleczky (b), Old Marci; Andor Lendvay (b), Emperor Francis; György Melis (b), Napoleon; others (in speaking parts). Chorus; Budapest Philharmonic Orchestra, János Ferencsik, cond.

- QUALITON HLPX 1023/25. Three LP. \$17.94.

To American record collectors, Kodály's *Háry János* has always signified a witty and colorfully orchestrated suite, drawn from an opera which, one assumed, an American would never have the chance to hear short of a trip to Budapest. Now, thanks to Artia's important "Cultural Exchange" program, through which an extensive catalogue of Russian and Czech recordings have already been made available, we are presented with an authentic version of the complete work, recorded under the Qualiton label in Hungary.

The first thing to make clear is that *Háry János* is not an opera at all—it is a play with incidental music. The second is that the album contains no translation, and though Peter Varnai's accompanying essay is intelligent and informative (if

Continued on page 94

LESS THAN 3 GRAMS TRACKING PRESSURE

new
new new
new new
new



the
Electro-Acoustic
7000 series
automatic
record player
...made
to protect
the original
fidelity of your
recordings

The selected Diamond Stylus pickup of the 4-speed Electro-Acoustic 7000 Series stereophonic record player, with its high compliance and extremely low stylus pressure combine to extend record life and maintain the original fidelity of your fine recordings.

The dynamically-balanced 4-pole, 4-coil motor and turntable, micro-honed motor spindle, precisely machined bearings, and the custom-fitted turntable drive . . . limit rumble to -40db, wow to less than 0.15% RMS and flutter to 0.06% RMS (better than NARTB standards). Turntable speed is certified to be within $\pm 1\%$ of absolute.

The Electro-Acoustic 7000 series handles your records more carefully than human hands. It is designed to capture the full beauty of every recording for hundreds of playings. \$69.50 Audiophile Net.

CERTIFIED QUALITY

Each record player is laboratory tested and is sold with a written test report coded to the serial number of that particular record player, certifying that performance is within specification limits.



Write today for free illustrated literature and the name of your nearest dealer.

ELECTRO-ACOUSTIC PRODUCTS COMPANY

2135 South Bueter Road, Fort Wayne, Indiana

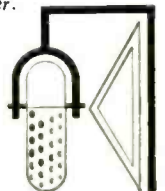

CIRCLE 43 ON READER-SERVICE CARD

not a model of English syntax), it is no substitute for the text of a work which, unfamiliar in itself, is in an unfamiliar language as well. The actors seem to be having a fine time for themselves, and their good will is contagious; still, we'd like to be in on the fun.

The play's story is concerned with the legendary exploits of Háy János, a pompous but endearing braggart. The *Contes d'Hoffmann* structure is used, with a prologue and epilogue set in a village inn, and Háy's exploits taking up the intervening acts in flashback form. In his first exploit, Háy settles a border incident. A Ruritanian sentry who is in a bad mood (his side of the border is dark and icy, the Hungarian side cheerful and sunlit) is allowing no one passage over the frontier—and this includes the Princess Marie Louise herself, with her

retinue. Háy puts matters right by simply yanking the sentry's watch house to the Hungarian side of the border. (This is rather reminiscent of the old story of the Soviet commissar who, faced with certain liquidation because a broken-down locomotive cannot meet its schedule between two towns, simply orders the names of the two towns officially switched every four hours, thus placing the train in the right station at all times.) This feat so impresses the Princess that she invites Háy and his peasant sweetheart, Orsze, to Vienna, where she shows a decided preference for Háy over Sir Ebalastin. The latter arranges a war with Napoleon, sure that Háy's death will result. Háy, however, defeats the *Grande Armée* single-handed, and dictates a humiliating peace to a cowed Napoleon. Marie Louise determines to

marry Háy, but on the very day of the wedding Háy cannot help expressing nostalgia for his simple Hungarian homefolk. The Emperor grants Háy's wish to leave, and Háy, after pleading with the Emperor to cease oppressing his people, moves on to his greatest adventure—he returns to the village of Nagybony and to Orsze.

Much of the music, most of it based on Hungarian folk tunes, will be familiar to those acquainted with the suite. Several of the movements—notably the striking of the carillon and the battle with Napoleon—are humorously inventive. There is a lovely little minuet song for Marie Louise, and a haunting duet for Háy and Orsze—"Tiszan innen, Dunan túl" ("River Danube, Beyond Thee"). The final choral hymn to the Hungarian people is also moving, and nearly all the music has a definite charm. The performance sounds to me like a splendid one, well sung and played, and acted with gusto. There have been more brilliant renditions of the orchestral sections, but they would not integrate as well with the play as the present one. The set's Háy János, Dr. Imre Palló, was the creator of the role in 1926. This makes him an old man as singers go, and he vocalizes amazingly well, in addition to creating a characterization that comes through even this considerable language barrier. The recording, done in 1958, is of top quality. C.L.O.



take Fine Music with you... WHEREVER YOU GO!

SONY® TFM-121

RESEARCH MAKES THE DIFFERENCE

FM/AM PORTABLE ALL-TRANSISTOR RADIO

If you want to enjoy FM and AM indoors and outdoors... listen to this SONY All-Transistor Portable at your favorite dealer. Note the instant signal the same second the set is turned on... the quick power surge when the volume is turned up... the velvet ease of tuning... the remarkable sensitivity that picks up even remote signals without shading, fading or drifting. You'll be pleased with the new SONY dimensions in distortion-free sound... so fine, it can also be used as a tuner. Make this portable your constant companion for music, news and weather. Complete with batteries, earphone and leather carrying case. **\$99.95**

FEATURES: 12 transistors • 3 self-contained telescopic antennas (Ferrite bar for AM-dipole for FM) • two step tone control • built-in jack for earphone or for extension speaker • Operates on 4 flashlight batteries • Weighs only 3 lbs. • Size: 5½" high, 9¼" wide and 2¼" deep



SONY TR 812... 3-Band, All-Transistor Portable. Perfect dependability, durability and stability in a superbly designed radio for boat owners, travellers and radiophiles who expect the matchless performance for which all SONY products are famous. **FEATURES:** AM, SHORT WAVE (6 to 18 mc) & MARINE BANDS (2 to 6 mc.). Telescopic antenna. Pinpoint frequency tuning • instant power warm-up • weighs only 5 pounds. Size only 10¼x7¼x3¾ inches. Complete with batteries. **\$99.95**

At radio centers in your community or write Dept. HF for name of your nearest store

SONY CORP. OF AMERICA 514 BROADWAY, NEW YORK 12, N. Y.

Civil Defense recommends a battery-operated radio in every home. Every SONY radio clearly shows the two Conelrad frequencies.

LALO: *Symphonie espagnole, Op. 21*
†Tchaikovsky: *Sérénade mélancolique, in B flat minor, Op. 26*

Leonid Kogan, violin; Philharmonia Orchestra, Kiril Kondrashin, cond.

• ANGEL 35721. L.P. \$4.98.

• • ANGEL S 35721. S.D. \$5.98.

Once the technical intricacies of the Lalo have been solved, its easy romanticism presents few musical difficulties. It follows, therefore, that the work ought to "play itself," and the fact that it so often fails to do so is chiefly the result of the shopworn violinistic window dressing that so many of our leading virtuosos are reluctant to part with—those only too familiar throbs, scoops, and blubbery wails.

This fine new performance by Kogan (in an earlier edition he was accompanied by Charles Bruck and the Paris Conservatory Orchestra) follows on the heels of RCA Victor's superlative Szezyng-Hendl disc. Of the other stereo versions which also present this work in its complete, five-movement form, Menuhin's (Capitol) has an attractive lyricism and homespun grace (although I sometimes am bothered by this violinist's "Spanish" mannerisms and find his tempos just a shade stolid). Ruggiero Ricci is brought excessively to the fore on his disc (London), with the consequence that his tone sounds rather nasal and threadbare. The choice, it seems to me, lies between Kogan and Szezyng. The latter favors a lean, *sec* tone (*à la* Heifetz, but musically purer), and his muscular, angular phrasing imparts dynamism rather than lyricism to his interpretation. Hendl goes along with his soloist, and provides clean-limbed, square-cut support. Kogan's sound has a more conventional warmth and sweetness, although he is far removed from the honeyed richness favored by Stern,

Continued on page 96

For the finest music reproduction in the World



This system featured in the SHURE "20th Century" Music Room Contest.

...the finest amplifier system in the World!

Since time immemorial, Man has taken personal pride in fine possessions. Whether chariots or automobiles, sundials or chronographs, crossbows or hunting rifles, he has always derived deepest pleasure from the knowledge that they were superb examples of their kind—that their beauty, dependability and perfection of performance were unquestioned.

Only through inspired design concepts, careful craftsmanship and conscientious testing and adjustment can one hope to produce instruments of the quality offered by the Marantz model 9 amplifier and model 7 stereo control. Here, again, one will take deep pleasure in the knowledge that his Marantz installation is second to none—that its precision, sensitivity, and its distortion and noise figures have never quite been equalled—that its superior performance, dependability and quality of construction are uniquely Marantz.

Model 9 Amplifier—A truly massive 70 watt basic amplifier • Response at 70W, ± 0.1 db, 20 cps to 20 kc. • Harmonic distortion, less than 0.1% in most of range, 0.3% at 20 cps, 0.5% at 20 kc. • Hum & Noise, better than 90 db below 70 watts • Completely stable to reactive loads • Built-in metered tests and adjustments • Price \$324 each. **Model 7 Stereo Console**—Its magnificent performance and precision have won world-wide acclaim • 1M distortion @ 10 V ea. pt. RMS, 0.1% typical • Hum and Noise, 80 db below 10 mv phono input • Sensitivity, 400 microvolts (0.4 millivolts) for 1 volt output • Equalizer and tone curves matched to 0.5 db • Volume tracking, 1 db typical • Price \$264 (cabinet extra)



Model 8B Dual Amplifier
35 W per channel. For
typical Marantz performance
at a lower cost \$249.

Write for literature #56 F

marantz 25-14 BROADWAY, LONG ISLAND CITY 6, NEW YORK

ALL MARANTZ PRODUCTS ARE WARRANTED FOR TWO FULL YEARS
CIRCLE 70 ON READER-SERVICE CARD

Oistrakh, *et al.* There is more emphasis on line and nuance in Kogan's interpretation, and Kondrashin matches the soloist's style with a light-textured, beautifully piquant orchestral color.

Since both competing discs are splendidly engineered in both the one- and two-channel versions, which you choose will depend largely on the kind of violin tone you favor. I believe I prefer Szeryng. It is worth pointing out, however, that the Angel disc offers a bonus of the little Tchaikovsky piece, performed magnificently. H.G.

LEHAR: *Schön ist die Welt* (highlights)

† Millöcker: *Die Dubarry* (highlights)

Lotte Rysanek (s), Elisabeth; Christine Spierenburg (s), Mercedes; Karl Terkal

(t), Georg; Horst Heinrich Braun (b), Sascha; Leo Heppé (b), King; *et al.* (in the Léhar). Christine Spierenburg (s), Marie-Jeanne; Else Liebesberg (s), Margot; Karl Terkal (t), René; Karl Weber (b), Brissac (in the Millöcker). Chorus of Radio Vienna, Vienna Grand Opera Orchestra, Kurt Richter, cond.

• EPIC LC 3758. LP. \$4.98.
• • EPIC BC 1117. SD. \$5.98.

Both of these operettas contain some charming numbers, and they are presented here in an idiomatic and spirited fashion. Karl Terkal sings his romances well in both works, and Lotte Rysanek (a sister of the more famous Leonie) sails through her portion of the Léhar quite engagingly. Else Liebesberg and Karl Weber also are charming in their *Dubarry* duets, particularly the bouncy

"Wenn verliebte bummeln gehn" and the exhilarating "Reisen wir durchs Liebesland." In sum, an entertaining fifty minutes' worth of schmaltz. C.L.O.

LISZT: *Sonata for Piano, in B minor; Sonetto del Petrarca No. 104; Hungarian Rhapsody, No. 12, in C sharp minor; Etudes d'exécution transcendante: No. 10, in F minor*

Agustin Anievas, piano.

• ST/AND SLP 407. LP. \$4.98.

Agustin Anievas, a recent graduate of Juilliard, has been the recipient of several prizes. He made his Town Hall debut in New York City two years ago, and at that time he received a glowing press for his interpretations of Liszt. Hearing this disc makes one realize why.

The twenty-six-year-old pianist has a flair for the dramatic. He gives these pieces splendidly expansive performances, which are tonally and musically stimulating. Furthermore, while his Liszt playing is always exciting and brilliant, it is also always in good taste, characterized by symmetry and rhythmic discipline. His large-scaled readings of the Sonetto, Etude, and Twelfth Rhapsody somewhat resemble Cziffra's in style, but they have a vein of added poetry and suppleness. The Sonata, too, is given a convincing performance, but Anievas' rendering of this work is confronted by Leon Fleisher's great interpretation, which stands head and shoulders above all available recorded versions.

The piano tone is full-bodied and spacious, the processing of the disc faultless. H.G.

MENDELSSOHN: *Songs Without Words* (14)

Guiomar Novaes, piano.

• Vox PL 12000. LP. \$4.98.

• • Vox STPL 512000. SD. \$5.98.

Novaes is one of the few pianists now before the public who stress the tonal values of the instrument. Under her fingers the music pleads, caresses, and almost purrs. She also uses the pedal more generously than is the general custom nowadays, and this too largely accounts for the moist, rounded sound she produces.

These performances are unusually emotional for Mendelssohn's little salon pieces. Novaes evokes a different frame for each one, and many of her dramatic innovations are effective and resourceful. For example, she skillfully differentiates between the lilting sharpness of the first *Venetian Gondola Song*, and the flowing *longueur* of the other two. Her angular hesitations in the *Spinning Song* give the music impetus and profile. *May Breezes* sounds fragrant and new when played as it is here. *Sweet Remembrances*, however, sounds saccharine as a result of the Novaes mannerism of anticipating a beat with her left hand. This sort of coyness should have gone out of fashion with the pianola, but the same might be said for one or two of Mendelssohn's pieces themselves.

Altogether, the disc is a distinguished addition to the Mendelssohn literature, abetted by stereo sound of precision and sparkle. H.G.

MENNIN: *Symphony No. 5*—See Rodrigo: *Concerto galante*.

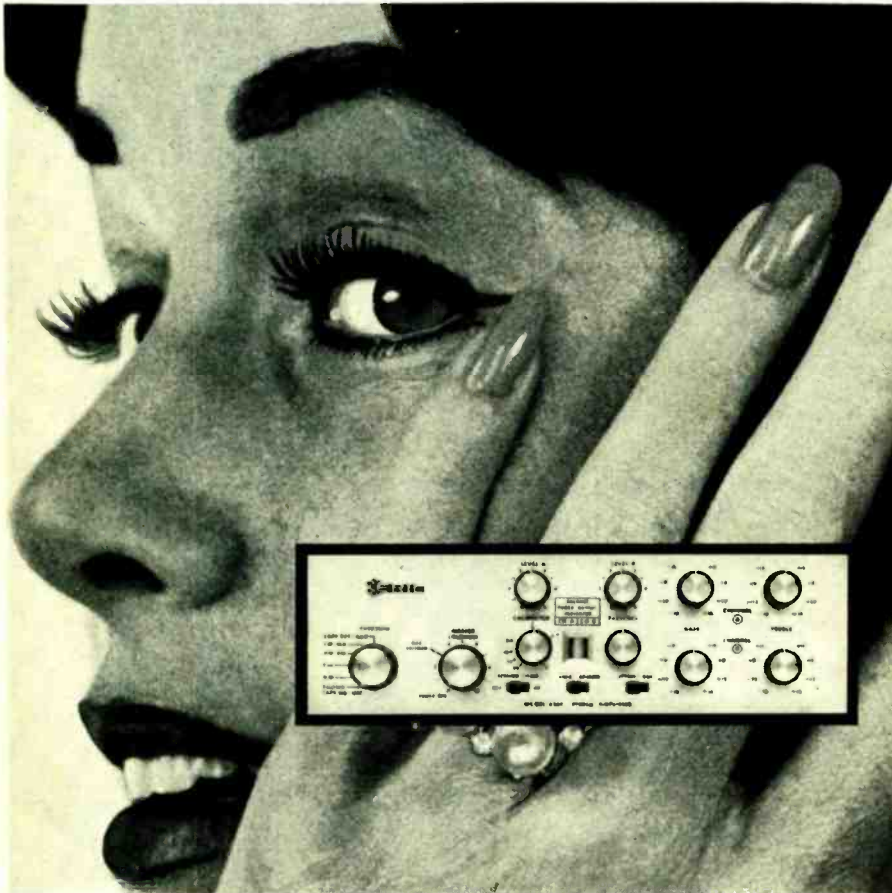

LOOK AGAIN...

IT'S THE EXCITING NEW ERIC 3560T, 3 CHANNEL STEREO 50 WATT "MUSIC POWER" AMPLIFIER. Ladies admire the satin-gold decor finishes... men can't resist the realism of sound reproduction. Here is tomorrow's amplifier... today! Exclusive visual balanced power output indicator lets you pre-set and determine actual output to speakers. Clean response—20 to 20,000 cps; total harmonic distortion less than 1% and individual controls for the ultimate in sound reproduction.

A touch of the finger and sound comes alive in a way you've never experienced before! Pure sound... excitingly crisp... brilliant! Only Eric, the West's leading AM-FM tuner manufacturer, could develop this advanced amplifier so perfect in engineering and so low in price. \$149.95... slightly higher in the East. Write today for complete specifications.

Ask for Eric... highest quality at the lowest price.

ERIC MULTIPLEX ADAPTOR, MX 600D. Another example of Eric fine engineering and low price! Only the MX600D has the exclusive "Stereo Announcer" which automatically lights up when stereo is being broadcast. The unit is compatible with all Eric tuners and most other makes using wide bandwidth. Additional amplifier stage assures strong "fringe area" reception. Separate balance control for optimum separation. Audiophile net... \$59.95. MX600 semi-automatic... \$39.95.



ERIC ELECTRONICS CORPORATION
1823 COLORADO AVE., SANTA MONICA, CALIF.
CIRCLE 46 ON READER-SERVICE CARD

MENOTTI: *Concerto for Piano and Orchestra*—See Copland: *Concerto for Piano and Orchestra*.

MILLOECKER: *Die Dubarry* (highlights)—See Lehár: *Schön ist die Welt* (highlights).

MOZART: *Mass No. 16, in C, K. 317* ("Coronation Mass"); *Concerto for Bassoon and Orchestra, in B flat, K. 191*

Maria Stader, soprano; Oralia Dominguez, contralto; Ernst Häfliger, tenor; Michael Roux, bass. Maurice Allard, bassoon (in the Concerto); Elizabeth Brasseur Choir (in the Mass); Lamoureux Orchestra, Igor Markevitch, cond.

• DEUTSCHE GRAMMOPHON LPM 18631. LP. \$5.98.

• • DEUTSCHE GRAMMOPHON SLPM 138131. SD. \$6.98.

R—This is the Mozart Mass with the elements most likely to make for widespread appeal, and Markevitch's performance employs them with great effect. His earlier version for Decca was notable, and this is likely to supplant it without difficulty. The engineering is striking, the orchestra plays well, and the vocal forces are particularly good. Nonetheless, I wish the resonance had been better controlled so that the text could be followed. If this recording had been more tightly focused sonically, it could very well have been a great one instead of merely a good one.

Professor Allard of the Paris Conservatoire plays Mozart's Concerto as if it were a work of Ravel's and written for saxophone at that. Brooke's version (with Beecham) gives us the wit, the gallantry, and the bubbling bassoonisms (the latter word comes from Leonard Bernstein) that Mozart surely intended here. R.C.M.

✓ **MOZART:** *Quartets for Strings: No. 18, in A, K. 464; No. 19, in C, K. 465; No. 20, in D, K. 499; No. 21, in D, K. 575; No. 22, in B flat, K. 589; No. 23, in F, K. 590*

Barchet Quartet.

• Vox VBX 14. Three LP. \$7.95.

These performances of the last six quartets of Mozart, issued on single discs in the course of the 1950s, are now brought together in an inexpensive "Vox Box." In my opinion they are a bargain. This foursome of players seems strong in each member, and it plays with subtlety, smoothness, and refinement. There are moments when it does not rise to the greatness of the music—the opening Adagio of K. 465 lacks the depth and mystery it can have, and the dialogues between first violin and cello in the slow movement are not as ecstatic as they should be—but by and large the performers do justice to these wonderful works.

Except for some continuous background noise in the second movement of K. 590 the sound is perfectly acceptable. There are no bands between movements in K. 464 and 465 (doubtless because there was no room for them), and Side 6 contains K. 589, although the label calls for 590 to appear there (the music for which is on Side 5, labeled "K. 589"). N.B.

MUSSORGSKY: *Pictures at an Exhibition*

†Ravel: *Jeux d'eau; Miroirs: No. 4, Alborada del gracioso; No. 5, La vallée des cloches*

Rudolph Firkusny, piano.

• DEUTSCHE GRAMMOPHON LPM 18679. LP. \$5.98.

• • DEUTSCHE GRAMMOPHON. SLPM 138679. SD. \$6.98.

Firkusny has always been a first-class artist with a finely wrought musicality and patrician technique. Recently, however, his playing has taken on additional firmness, passion, and continuity; and this progress is clearly reflected in the Mussorgsky performance here reviewed.

This rendering of the *Pictures* is conceived on a large canvas, broad and unhurried throughout. *Bydlo, Gnomus, and*

the *Great Gate at Kiev* really benefit from the expanse they are allowed here; the *Scene at the Limoges Market Place* is projected with appropriate bustle and activity; *Goldenburg and Schmuyle* has a bit more intimacy than usual in the present reading, but the essential character of that essay is not falsified; *Tuileries* and *The Ballad of the Chicks in Their Shells* are deftly portrayed with elegant humor. And while the dimensions of Firkusny's reading are unquestionably large throughout, he brings a certain salonlike lucidity to bear on the writing.

The subtle pianistic craft of this artist's playing is, in fact, very much akin to that displayed in the Richter performances, and it is those discs which present Firkusny with his most important competition. (I am disregarding the Horowitz disc because of that virtuoso's bombastic revisions of Mussorgsky's text; both

Double your Listening Pleasure with

REVERSE--MATIC[®]

NEW... exclusive on
the famous 4-track

Concertone
S505

Stereo Recorder



This new, deluxe version of the famous Concertone 505... in gleaming brushed stainless

steel... will meet your most exacting demands for reproduction of professional quality. Its *exclusive* playback feature, Concertone's REVERSE-O-MATIC, plays 4-track stereo tapes from start to finish, reverses, then plays the other stereo tracks... automatically! It doubles listening pleasure and unattended playing time *with no changing of reels*. Concertone's new Model S505 plays 4-track, records qtr. track stereo and monaural. Priced from \$589.50. Other stereo models of the famous Concertone 505 recorders are priced from \$495.

A limited-time special bonus: Four Bel Canto tapes FREE with your purchase of a Concertone 505 to start your stereo library—a \$32 value!

Write today for brochure which shows complete details on this magnificent recorder that doubles your listening pleasure with professional quality.



AMERICAN CONCERTONE, INC.

A DIVISION OF ASTRO-SCIENCE CORPORATION

9449 W. Jefferson Boulevard • Culver City, Calif.

Dealer inquiries invited. EXPORT: Telesco International Corp.,
171 Madison Ave., New York 16, N.Y.
CIRCLE 4 ON READER-SERVICE CARD

Relieve that "HEAD" ache!



Call your dealer to replace with Nortronic Magnetic Recording Heads found in most original equipment. See what a difference a Nortronic Replacement Head or 4-Track Stereo Conversion can make.

World's largest manufacturer of laminated heads... the heart of your tape recorder.
Send 25¢ for Tape Recording Manual



THE Nortronics CO., INC.

"Music sounds best on tape -
tape sounds best on Nortronic Heads!"

1019 South Sixth St., Minneapolis 4, Minn.

CIRCLE 78 ON READER-SERVICE CARD

Study for Library of Congress finds

LEKTROSTAT®

best for cleaning records

"Routine cleaning was accomplished by using . . . prior to playback or packaging; a sparingly applied detergent solution with an applicator of sheared acetate velvet fibres.*

"Other systems of dust control, cleaning (such as spray on anti-static compounds, treated cloths, dampened synthetic sponges, and radioactive air ionization) were tried but did not prove as satisfactory."

*Lektrostat Record Cleaning Kit, Dexter Chemical Corp.

Only \$2.00 net at your high fidelity dealer's, or write to:

DEXTER

Chemical Corporation
Consumer Prod.
Division
845 Edgewater Rd.
New York 59, N. Y.



CIRCLE 36 ON READER-SERVICE CARD

Richter and Firkusny play the original score.) I find that Firkusny generates more drive and contrast in his performance than Richter managed on his Artia disc. The Columbia Richter, however, is something of a special case. It was made at an actual recital, and it has a white-hot inspiration which I feel that no artist could reach in the confines of the recording studio. Even the thin, brittle piano tone on that disc assaults the ear in a hypnotic way which the far mellower DGG engineering fails to do. But, if the Columbia release remains, as I once wrote, "the greatest performance of the *Pictures* I have ever heard, on records or off," this new release runs it a close second.

The *Jeux d'eau* and *Miroirs* excerpt No. 5 are lucid and shimmering. The *Alborada del gracioso* is also finely played in a similar style, but I feel that this piece should be more vibrant and athletic (rather more on the order of the old Lipatti recording). These works, like the Mussorgsky, have been exquisitely reproduced. H.G.

OFFENBACH: *Orphée aux Enfers* (highlights in English)

Soloists; Chorus and Orchestra of the Sadler's Wells Theatre, Alexander Faris, cond.

- ANGEL 35903. LP. \$4.98.
- • ANGEL S 35903. SD. \$5.98.

June Bronhill is a delectable Euridice, and Alan Crofoot a wryly funny King of the Boeotians for the duration of his one song. The music itself, of course, is lilting and bracing, and is well played here by the Sadler's Wells orchestra. On the other hand, the joke wears pretty thin pretty quick, and the English lyrics seem merely clever solutions to an impossibly coy problem. The Concerto Duet, in fact, bears a dispiriting resemblance to one of those dreary TV skits in which classical heroes are shown to be (ho, ho!) domestic strawheads. In any event, nearly all the music is available elsewhere (and not merely as segments of *Gaité Parisienne*—there are vocal excerpts on Pathé and Renaissance). Angel bills this album as "Offenbach's Racy Romp." C.L.O.

POULENC: *Sextet for Piano and Woodwind Quintet*—See Riegger: *Concerto for Piano and Woodwind Quintet, Op. 53.*

PROKOFIEV: *Concerto for Piano and Orchestra, No. 3, in C, Op. 26* †Ravel: *Concerto for Piano and Orchestra, in D (for the left hand)*

John Browning, piano; Philharmonia Orchestra, Erich Leinsdorf, cond.
• CAPITOL P 8545. LP. \$4.98.
• • CAPITOL SP 8545. SD. \$5.98.

John Browning's ultrabrilliant performance of the Prokofiev masterpiece captures to perfection the caustic bite so essential to this music. Like Van Cliburn in his recent RCA Victor release, Browning favors rather leisurely tempos; but whereas Cliburn merely uses the easy pace to play matters safe, with stodgy results, the present artist takes advantage of the leeway thus given him to furnish tremendous accent and stress. Furthermore, Browning's phrases are shaped with conviction and character, and he re-

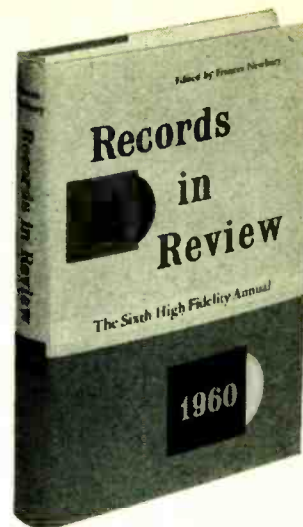

BRINGS YOU HUNDREDS OF PENETRATING REVIEWS

Records in Review—1960 brings you in one convenient volume the reviews of stereo and mono records and stereo tapes which appeared in *HIGH FIDELITY* Magazine over the eighteen months from July 1959 through December 1960—classical and semiclassical music exclusively.

This hardcover book of more than 450 pages, edited by Frances Newbury, is the most complete and authoritative book of its kind—the standard reference work that gains in value as the years roll by.

The reviews discuss the composition, performance, and sonic fidelity. And they compare the new recordings with earlier ones.

Records in Review—1960, the Sixth High Fidelity Annual, sells for \$6.95. To record and tape buyers, it's worth immeasurably more!

A Few Copies Available— 1959 and 1958 Editions

The 1959 Edition covers the twelve months ending June 1959, the 1958 Edition the twelve months ending June 1958. While they last—\$5.95 each. Payment requested with all book orders—but satisfaction guaranteed or your money back!

The Wyeth Press, a Division of High Fidelity Publishing House, Great Barrington, Mass.

I enclose \$_____ Send me

- RECORDS IN REVIEW—1960 \$6.95
- RECORDS IN REVIEW—1959 5.95
- RECORDS IN REVIEW—1958 5.95

Name _____

Address _____

City _____

State _____

961

Foreign orders sent at buyer's risk. Add 25¢ per order for postage except Canadian.

HIGH FIDELITY MAGAZINE

veals a full understanding of the irony of the music.

The performance of the Ravel emphasizes the dynamic, ruthless side of the piece. With Browning at the helm, one is constantly reminded of huge metal structures, skyscrapers, welding machines, and other uniquely twentieth-century phenomena. Samson François, on his Angel disc, also gives a most dynamic rendition, but his reading is tempered with a bit more color and nostalgia than Browning's. Either way is valid.

Leinsdorf and the Philharmonia give fiercely efficient orchestral support to Browning, with the brass, in particular, notable for its extraordinary lung power. The piano-orchestra balance is exemplary (that of the Ravel certainly better achieved than in the François recording). The stereo has brilliant details but the LP perhaps more aural subtlety. H.G.

RAVEL: Concerto for Piano and Orchestra, in D (for the left hand)— See Prokofiev: *Concerto for Piano and Orchestra, No. 3, in C, Op. 26.*

RAVEL: Jeux d'eau; Miroirs: No. 4, Alborada del gracioso; No. 5, La vallée des cloches— See Mussorgsky: *Pictures at an Exhibition.*

RIEGGER: Concerto for Piano and Woodwind Quintet, Op. 53

†Poulenc: *Sextet for Piano and Woodwind Quintet*

Frank Glazer, piano; New York Woodwind Quintet.

• • CONCERTDISC CS 221. SD. \$5.98.

Riegger's Concerto has a magnificent finale in the vigorous, intensely rhythmical manner of his famous *New Dance*; the other two movements sound as if they had been written to pad the piece out. The famous sextet by Poulenc scarcely requires comment; it is in the extremely tuneful, wide-eyed, false-naïve manner with which this composer won his reputation, but which, for better or worse, he has since outgrown. Performances are first-class and recordings are out of this world, as woodwind recordings are likely to be. A.F.

RIMSKY-KORSAKOV: Scheherazade, Op. 35

†Borodin: *Prince Igor: Polovtsian Dances*

Lorand Fenyés, violin; Choeur des Jeunes and Choeur de Radio Lausanne (in the Borodin); Orchestre de la Suisse Romande, Ernest Ansermet, cond.

• LONDON CM 9281. LP. \$4.98.
• • LONDON CS 6212. SD. \$5.98.

For a feature review of this recording, see page 80.

RIMSKY-KORSAKOV: The Tale of the Invisible City of Kitezh

N. Rozhdestvenskaya (s), Fevronia; V. Ivanovsky (t), Prince Vsevolod; D. Tarkhov (t), Grishka Kuterma; Ivan Petrov (bs), Prince Yuri; et al. U.S.S.R. Radio Chorus and Orchestra, Vassily Nebolsin, cond.

• MK-ARTIA 209 D. Four LP. \$23.92.

We now have two of Rimsky-Korsakov's



RADIO SHACK Corp.
730 Commonwealth Ave., Boston, Mass.

See the greatest line of electronics...

top quality equipment and parts for "pro," amateur, music lover! Mail coupon and receive Radio Shack's exciting 1961-62 all-new Buying Guide of 336 pages PLUS all value-packed supplements for one full year.



You'll see famous brands and our own private label Stereoa, Hi-Fi, Ham Radio, Tapes, Records, 30 pages of easy-to-build kits. Your satisfaction guaranteed.

New No Money Down Credit Terms!

MAIL THIS COUPON TODAY

RADIO SHACK Corp. Dept. 61J148

730 Commonwealth Ave., Boston 17, Mass.

Gentlemen:

Please send me Radio Shack's famous electronics catalogs for the next 12 months, all FREE and POSTPAID.

Name _____

Address _____

City & Zone _____ State _____

CIRCLE 83 ON READER-SERVICE CARD

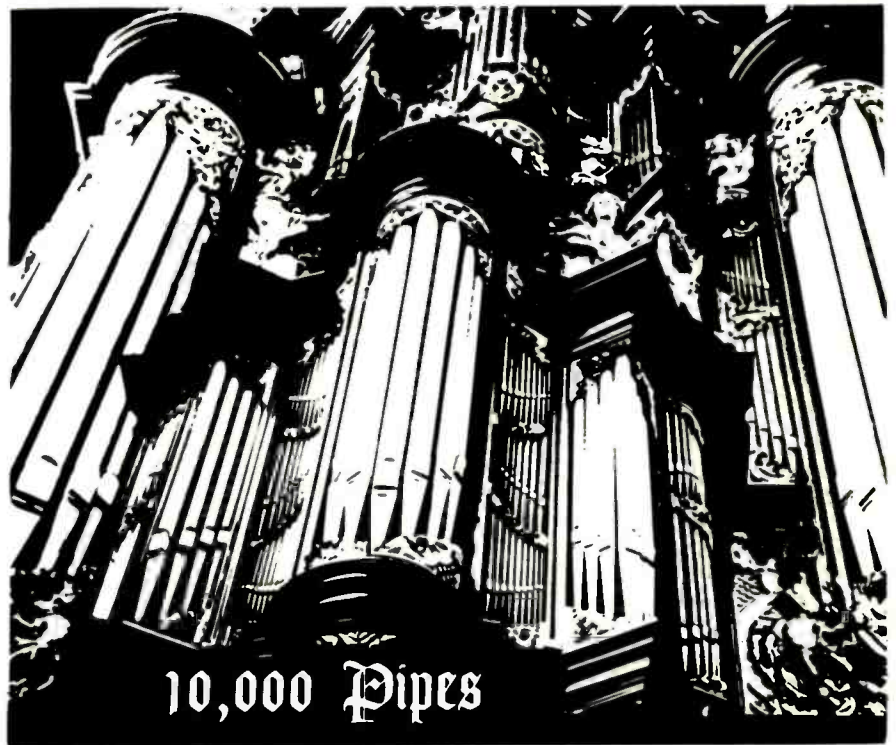

"Vale of Dreams" is an astonishing adventure in sound! Virgil Fox, one of the world's leading concert organists, plays the magnificent Aeolian-Skinner organ of New York's Riverside Church. Its five manuals and the voices of 10,000 pipes offer an immense tonal range. And, for stereophiles, there is the added excitement of true depth of sound... the organ pipes are placed in four different parts of Riverside Church.

In "Vale of Dreams" Virgil Fox performs familiar pieces chosen for their dream-like richness. Included are "Clair de Lune, Meditation from Thais, The Old Refrain, and Liebestraum." As rewarding as Virgil Fox's other great favorites...

"Silhouettes" (S) P-8509... "Organ Music From France" (S) P-8544... "The Virtuoso Organ" (S) PAR-8499.

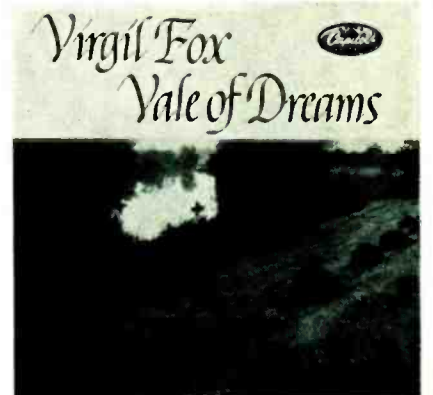

(S) P-8557

© CAPITOL RECORDS, INC.

CIRCLE 27 ON READER-SERVICE CARD

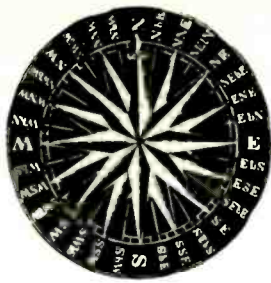

DISCOVER DVORAK

ON

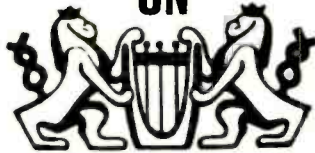

ARTIA RECORDS

THE NINE SYMPHONIES

C Minor, Op. 3	ALP 140
F Flat Major, Op. 4	ALP 141
E Flat Major, Op. 10	ALP 136*
D Minor, Op. 13	ALP 137*
D Major, Op. 60, "No. 1"	ALP 172
D Minor, Op. 70, "No. 2"	ALP 177
F Major, Op. 76, "No. 3"	ALP 171
G Major, Op. 88, "No. 4"	ALP 178
E Minor, Op. 95, "No. 5"	ALP 190

FOUR SUPERB SETS

Slavonic Dances, Opp. 46 & 72	ALP 186/7*
Piano Concerto in G Minor, Op. 33	ALP 179
The Devil and Kate	ALPO 81-C/L
Stabat Mater	ALP 182/3

*ALSO AVAILABLE IN STEREO

Dvorak compositions now available on SUPRAPHON imported by Artia.

The Wood Dove • The Golden Spinning Wheel • Symphonic Variations • Theme and Variations for Piano • Piano Quintet in A Major • Humoresque for Violin and Piano • Legends • Slavonic Rhapsodies • Scherzo Capriccioso • Serenade in E Major for Strings • Serenade in D Minor • Highlights from the Opera "Jacobin" • Highlights from the Opera "Rusalka"

For further explorations of
the Artia Catalogue write:

Artia Recording Corp.
38 West 48th Street
New York 36, New York

CIRCLE 10 ON READER-SERVICE CARD

significant fairy-tale operas in complete Russian versions—*Tsar Saltan* and *Invisible City of Kitezh*. Let us hope that *Snow Maiden*, *Sadko*, and *Le Coq d'or* will follow soon. In *Kitezh*, Rimsky was obviously attempting a most ambitious and important work. Its plot is too complex to recount here, but it resolves itself into this pattern: a young maiden, Fevronia, lives with the animals of the forest and is at harmony with Nature and Earth. The young Prince Vsevolod encounters her while on a hunt. They fall in love, and he decides to call her to Kitezh and marry her. As Fevronia's train proceeds towards Great Kitezh, however, it passes through Little Kitezh, which is attacked and destroyed by Tartars. Fevronia is taken prisoner, and with her Grishka, a drunken cynic without hope or faith. Grishka betrays the City of Kitezh by leading the Tartars to it, but the prayers of Prince Yuri and the people, and the faith of Fevronia, are rewarded—a golden mist descends about the city, hiding it from view. Though the city is invisible, its reflection appears in the Lake Svetly Yar; the Tartars, seeing this, flee in confusion. Kitezh is transformed into a heavenly city; Fevronia is summoned by the birds of Paradise and Happiness, Alkonost and Sirin, to an eternal life.

The essential conflict is between Fevronia and Grishka; if Rimsky proposed beauty as the ultimate good in *Tsar Saltan*, he proposes faith as the ultimate good in *Kitezh*. Grishka is a memorable figure. If he does not have the monumental stature of the great villains of the German or Italian lyric stage, it is because he does not act from evil strength, but from evil weakness—abject faithlessness and fear. His chief weapon is a cynical mockery, and he invokes not the deities of the underworld, but the miseries of the human condition. It is hard to restrain the feeling that he has the best of the argument (imagine what Brecht and Weill would have done with this material! One can view the whole thing as a well-orchestrated humbug), but that is inescapable, for Rimsky and his librettist, Vladimir Belsky, are apparently saying that salvation lies not through rationality (Grishka is the only rational character in the opera, unless we count the Tartar chieftains), but through an irrational faith that can be explained only in its own terms. The sound of the ocean that washes the enchanted Buyan pervades *Saltan*; in *Kitezh*, it is the sound of the city's bells, combined with themes associated with Fevronia and her forest, that strikes the keynote.

Musically, the work is more consistently interesting than *Saltan*, even if it does not reach quite the exalted level of that work's final interlude. The entire opening scene, consisting of a long solo for Fevronia and an even longer duet for Fevronia and Vsevolod, is exceptionally beautiful; Yuri's utterances have great nobility; Grishka is sharply characterized in the music; and the closing act, in which Fevronia feels the return of Nature's powers and is transported to the heavenly Kitezh, is magnificent. Fortunately, the three leading roles are very well taken. Ivan Petrov is, as usual, darkly sonorous as Yuri, ruler of Kitezh, though his low notes make a rather poor showing. The soprano, N. Rozhdestvenskaya, has a round, lush voice that one would not at all mind hearing in Verdi and Puccini. D. Tarkhov has a steely tenor, pinched but live-sounding, which

is perfectly suited to Grishka's music, and his vocal acting is superb. V. Ivanovsky also is a serviceable tenor for the role of Vsevolod, and the other soloists—a long list—fill in capably.

The orchestra and chorus under Nebolsin do their work well enough, but the sound leaves much to be desired. There is considerable distortion on the high end (I found the use of the high filter imperative), and a long scene between Fevronia and Grishka is totally ruined by echo and distortion (Side 6). In general, though, not even this negative factor, nor the regrettable absence of a libretto, can offset the enjoyment that any reasonably adventurous operaphile should derive from the work. C.L.O.

RODRIGO: *Concerto galante* †Mennin: *Symphony No. 5*

Grace Whitney, cello (in the Rodrigo); Louisville Orchestra, Robert Whitney, cond.

• LOUISVILLE LOU 613. LP. Available on special order only.

The blind composer Joaquin Rodrigo has a fine, romantic feeling for folk music and the courtly atmosphere of the distant past in Spain. He has expressed this particularly well in a series of works for guitar and orchestra, one of which, the *Concierto de Aranjuez*, is a minor masterpiece and very popular to boot. The *Concerto galante* is rather similar—light in vein and in orchestration, full of folk tunes and nostalgia but surprisingly "modern" at the proper moments. Rodrigo takes nothing too seriously except the craftsmanship with which his smiling view of things is made apparent. The performance, with the Louisville Orchestra's first cellist as soloist, is excellent, and the recording may well be the best in the entire Louisville series.

Peter Mennin's Fifth Symphony, on the other side, is impeccably clean in texture, perfectly proportioned, and as zestful and invigorating as a cold needle shower on an August day. It is the very model of the modern American symphony of the more conservative persuasion, with its roots in Harris and Hindemith. That type of thing is becoming history now—the symphony was written in 1950—but some monuments of the species, like this one, improve with time. The performance is first-class and the recording adequate. A.F.

SCHOENBERG: *Verklärte Nacht*, Op. 4

†Fauré: *La Bonne Chanson*, Op. 61

Martial Singher, baritone (in the Fauré); Marlboro Ensemble.

• COLUMBIA ML 5644. LP. \$4.98.
• • COLUMBIA MS 6244. SD. \$5.98.

One of Columbia's series entitled "Chamber Music from Marlboro," this disc offers *Verklärte Nacht* in its original sextet version. The sextet version is more plastic, colorful, and expressive than that for string orchestra which one commonly hears, and the present performance is full of rich and dramatic shadings. But thanks to some quirk of interpretation or recording, it reminds me of nothing so much as one of those still lifes wherein hens' eggs are drawn as big as footballs and apples as big as Volkswagens.

The version of *La Bonne Chanson* provided here will interest lovers of Fauré. The famous song cycle is re-

corded in a most unusual arrangement, with a string quartet added to the piano in the accompaniment. According to the jacket notes, this version was advertised on the cover of the original voice-and-piano edition but was never published, and Singher possesses a unique set of manuscript parts for it. To my taste, adding the strings does the cycle no good at all. Fauré tends to be oversweet in his songs, and the fiddles only make *La Bonne Chanson* that much more saccharine. The performance of this work is quite good, however, and so is the recording. A.F.

SCHUBERT: *Auf dem Strom, Op. 119*—See Brahms: *Trio for Violin, Horn, and Piano, in E flat, Op. 40.*

SCHUBERT: *Deutsche Messe, in F; Kyrie; Salve Regina*

Regensburger Domspatzen and Cathedral Choir; Bavarian Radio Orchestra, Theobald Schrems, cond.

• DEUTSCHE GRAMMOPHON LPM 18676. LP. \$5.98.

• • DEUTSCHE GRAMMOPHON SLPM 138676. SD. \$6.98.

✓ Schubert's *German Mass* was written when the composer was about to enter the final year of his brief life. It is in German rather than Latin, and the form is more like a series of hymns or chorales than the usual sung Mass. Parts of it are very beautiful, although the total effect is quite different from that of most Masses by a great composer. If simplicity, sincere faith, and fine melodic writing will suffice to please you, this is a work easily cherished for its abundance of those virtues. The performance is a very good one, made all the more effective by exceptionally successful recording.

The two other works come from Schubert's sixteenth and seventeenth year, respectively, and are chiefly of interest for what they prophesy of the masterpieces to come. R.C.M.

SCHUBERT: *Octet for Strings and Winds, in F, Op. 166*

Harold Siegel, double bass; Fine Arts String Quartet; Members of the New York Woodwind Quartet (David Glazer, clarinet; Arthur Weisburg, bassoon; John Barrows, horn).

• • CONCERTDISC CS 220. SD. \$4.98.

With the possible exception of the Mozart Clarinet Quintet, I can think of no chamber music work with more universal appeal for novice and aficionado alike than the Schubert Octet, despite the fact that it is one of the longest chamber works in the entire literature. Nor can I imagine a more felicitous performance than that accorded it on this record. Not only is it full of the proper *joie de vivre* with which this music abounds, but each member of the ensemble plays with such expressiveness and beauty of tone that every note is sheer pleasure. The stereo distribution is most natural, too, without too much pinpointing of individual instruments. London's earlier stereo recording by the Vienna Octet may be a bit more polished, but that version sounds routine when it is compared to the present really outstanding interpretation. P.A.

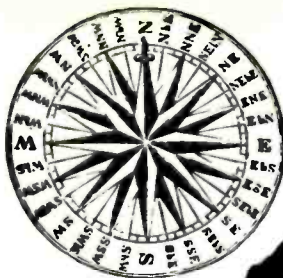

in september

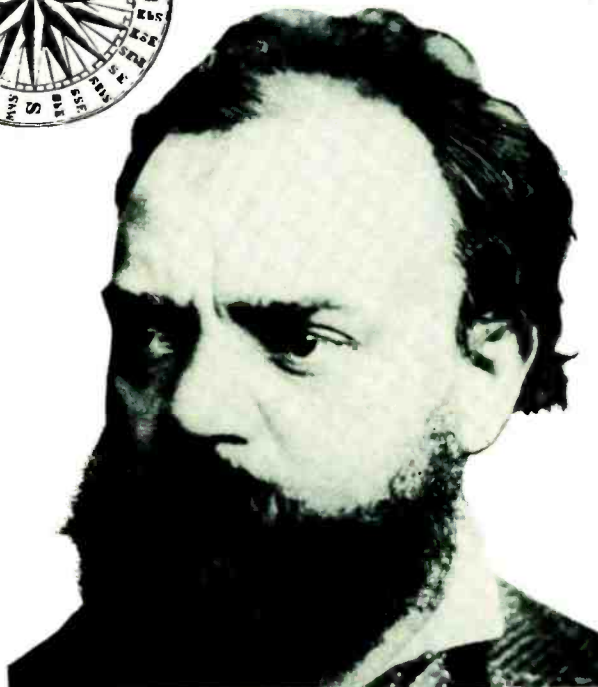

DISCOVER DVORAK

Antonin Dvorak's name is one of the most familiar in all music. Yet few have explored this master's vast output beyond the "New World" Symphony. Even informed musicians were surprised and delighted to learn that Dvorak composed Nine Symphonies! Artia has now provided the adventurous listener with the unprecedented opportunity to discover a comparatively unknown world of musical treasures by making the complete Symphonies of Dvorak available on records for the first time. These, as well as many other musical masterpieces, are brilliantly and authoritatively performed by the leading conductors and orchestras of the composer's native Czechoslovakia.

"I defy anyone to work his way through the full sequence of these works, never before available in its entirety, without a vastly enlarged appreciation of Dvorak as one of the greatest composers of the nineteenth century, and one of the greatest symphonists of all music. To make all of these symphonies accessible in a consistent and authentic quality of presentation is a contribution for which we owe Artia a great debt." AMERICAN RECORD GUIDE

Sept. 8, is the 120th Anniversary of the birth of Dvorak

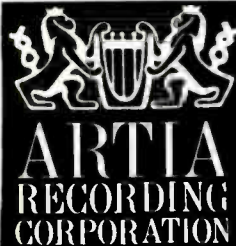

IN SEPTEMBER OF 1513 VASCO BALBOA DISCOVERED A BODY OF WATER WHICH HE CLAIMED FOR THE SPANISH CROWN. IN HIS REPORTS HE CALLED IT THE GREAT SOUTH SEA; TODAY WE KNOW IT AS THE PACIFIC OCEAN.



CIRCLE 10 ON READER-SERVICE CARD

RECORDS SOUND BEST
with

DYNACO **B&O**
STEREODYNES

Choose either the Stereodyne II (mounts in all standard arms) or the slim, trim TA-12 arm-cartridge combination for the most natural sound from both stereo and mono recordings.



TA-12
\$49.95 net

\$29.95 net

DESIGNED TO THE HIGHEST
DYNACO STANDARDS

- ★ unequalled performance
- ★ outstanding engineering
- ★ unsurpassed value

Rigorous laboratory testing of every unit assures that your cartridge will exceed every specification.

- Smoothest response: ± 2 db from 30 cps to 15 KC. With standard Westrex 1A test disc.
- True stereo: More than 22 db channel separation effectively maintained throughout the audio spectrum, with accurate balance and proper phase relationship.
- Superior tracking: highest compliance, low mass, plus exclusive symmetrical push-pull design for minimum record wear and lowest distortion.
- Complete freedom from hum.

Hear and compare it at your favorite dealer's showroom.

Write for complete specifications

DYNACO, INC.

3912 Powelton Ave. • Phila. 4, Pa.
CABLE ADDRESS: DYNACO, PHILA.

CIRCLE 41 ON READER-SERVICE CARD

SCHUBERT: Trio for Piano and Strings, No. 2, in E flat, Op. 100

- Alma Trio.
- DECCA DL 10033. LP. \$4.98.
- • DECCA DL 710033. SD. \$5.98.

This recording marks the stereo debut for the Schubert E flat major Trio, one of the supreme joys of the chamber music repertoire. Though the Alma Trio is a thoroughly routinized ensemble, it plays this work in anything but routine fashion. There is attention to every fine detail, coupled with a good sense of phrasing and of dramatic tension where that quality is required. This Trio has long been in need of a modern recording, and the present one, clean-sounding in mono and naturally laid out in the stereophonic version, fills the bill very well indeed. P.A.

SCHUBERT: Trio for Strings, No. 2, in B flat—See Beethoven: Trio for Strings, Op. 9, No. 2.

SCHULLER: Seven Studies on Themes of Paul Klee

†Fetler: *Contrasts*

Minneapolis Symphony Orchestra, Antal Dorati, cond.

- MERCURY MG 50282. LP. \$4.98.
- • MERCURY SR 90282. SD. \$5.98.

This is the first recording to come out of the American Music Center's Commissioning Series (a three-year experiment financed by the Ford Foundation) and it does not, I am afraid, reflect very highly on those—presumably the conductors of the participating orchestras—who actually managed the plan.

Gunther Schuller's *Seven Studies on Themes of Paul Klee* is the cutest piece that has come along since people stopped writing songs on poems by Ogden Nash. A painting by Klee called *Antique Harmonies* brings out—you've guessed it—some antique harmonies; Klee's *Little Blue Devil* inspires, of all things, a blues; and his *Twittering Machine* gives rise to some music that twitters. So it goes. Paul Fetler's *Contrasts*, on the other side, is a breezy neoclassical symphony in four movements. The first movement is especially bracing; after that the piece runs down like a clock, or at least to my ear it seems to.

Recording, as is always the case with Mercury and the Minneapolis Symphony, is as fine as it comes. The interpretation sounds excellent in both cases, and in both cases it probably is. A.F.

SEARLE: Symphony No. 1, Op. 23

†Seiber: *Elegy for Viola and Small Orchestra; Three Fragments from "A Portrait of the Artist as a Young Man"*

London Philharmonic Orchestra. Sir Adrian Boult, cond. (in the Symphony). Cecil Aronowitz, viola; London Philharmonic Orchestra, Matyas Seiber, cond. (in the *Elegy*). Peter Pears, speaker; Melos Ensemble, Dorian Singers, Matyas Seiber, cond. (in *Three Fragments*).

- LONDON CM 9265. LP. \$4.98.
- • LONDON CS 6196. SD. \$5.98.

Humphrey Searle, who was born in 1915, and Matyas Seiber, who was born ten years before that, have both been fixtures on the English musical scene

for many years; they have had works performed at all the international festivals, and are generally among the best-known and most widely respected composers in Europe. Now the American public too will be privileged to reckon with them as major figures on the international scene, thanks to the present London disc.

The symphony by Searle (his first, written in 1952-53) is a 12-tone composition based on a row, first used by Webern, that goes back ultimately to B-A-C-H. It is a very large work—in one movement, four, or six, depending upon how you look at it—and it has the grand, heroic accent that characterizes a symphony in the great tradition. Gordon Stewart, who provides the jacket notes, calls Searle a Romantic; and if depth, weight, and power of sound are romantic attributes, Stewart is certainly right. The Symphony also has the air (and, I am quite sure, the substance) of a profound intellectual achievement, and that also serves to place it in the great line.

For many years it seemed that Vaughan Williams alone was capable of providing British music with symphonies of truly major proportions, but now it is apparent that Vaughan Williams has a successor. I hasten to add that Searle's idiom does not resemble that of Vaughan Williams in the slightest. If Searle resembles anybody, it is Alban Berg, with whom he shares a similar gift for warm lyricism and gorgeous orchestral color within the 12-tone framework. My point is that the musical personality which finds expression here is as authoritative, individual, and commanding as that of the two earlier twentieth-century giants just mentioned.

Seiber's *Elegy*, composed in 1954, is a rather short and quite beautiful piece, not in the 12-tone system, but basically tonal and akin in spirit to Hindemith's famous *Trauermusik*, for viola and strings. His *Three Fragments*, dating from 1958, is, however, like nothing else on earth. In this work the speaker—here none other than the great Peter Pears—recites passages from Joyce's novel in a manner related, if distantly, to Schoenbergian *Sprechstimme*. The second of the three movements is a very violent one labeled *Feroce*. Around this, however, are two slow movements in which the ensemble lays great stress on ecstatic, shimmering, and mysterious effects, with the heavenly pianissimo of a wordless chorus, the bright trembling of the vibraphone, and richly colored solo lines of flute and bass clarinet to the fore. This score, like the Searle symphony, employs the 12-tone system, and its lack of tonal center has much to do with its diffused, floating, ethereal effect.

In these three works is the music we have been waiting for through so many tedious hours at Composers' Forum concerts, modern music festivals, and the like. We have put up with a lot of experiment in the hope that something fully ripened would result, and it has. If music like that of Searle and Seiber is what future generations will remember of our time, our time will be extremely well served.

Performances are beyond criticism, and recordings are excellent except that the ensemble tends to cover the speaking voice in the *Fragments*. Perhaps Seiber wanted it that way; in any case a text sheet would not have been out of place, or at least some indication of the passages from Joyce that are employed.

Everybody has a copy of the book, but finding these particular passages is another story. A.F.

SEIBER: *Elegy for Viola and Small Orchestra; Three Fragments from "A Portrait of the Artist as a Young Man"*—See Searle: *Symphony No. 1, Op. 23.*

STRAUSS, JOHANN II: "*The Irresistible Mr. Strauss*"

Overtures: Die Fledermaus; Der Zigeunerbaron. Polkas: Thunder and Lightning, Op. 324; Tritsch-Tratsch, Op. 214. Waltzes: Emperor, Op. 437; Artist's Life, Op. 316. Perpetuum Mobile, Op. 257. Quadrille on Themes from Verdi's "Ballo in maschera," Op. 272.

Philharmonia Promenade Orchestra, Henry Krips, cond.

- ANGEL 35873. LP. \$4.98.
- ANGEL S 35783. SD. \$5.98.

The younger, "Australian" Krips must have an Indian sign on me: although I've never met the man or heard him in a live concert, on records he can do no wrong to my ears. The same qualities of illuminating insight, precisely planned yet never fussy organization of details, and resiliently vital orchestral playing that distinguished his earlier Waldteufel, Suppé, and two "Viennese Dances" programs are still more evident here—where even the most familiar pieces are given liltingly fresh interpretative life as well as recorded performances which make most others (even by far more celebrated conductors) seem careless, pedestrian, or pretentious. Furthermore, Krips again spices his program with a discovery: here the long and varied, irresistibly danceable Quadrille on Verdi themes, to the best of my knowledge never recorded before. And for sheer charm of tonal coloring and warm, plastically contoured sonorities, the Krips-inspired Philharmonia Promenade Orchestra is quite incomparable either in Angel's purest monophony or its even more luminous stereo.

R.D.D.

STRAUSS, RICHARD: *Don Quixote, Op. 35*

Pierre Fournier, cello; Cleveland Orchestra, George Szell, cond.

- EPIC LC 3786. LP. \$4.98.
- EPIC BC 1135. SD. \$5.98.

There is no question that this set dominates the current listings, although that is a somewhat empty victory since the heaviest recent competition (Reiner's edition) has been withdrawn. It is therefore in order to add that Szell and Fournier offer a performance that would have remained praiseworthy even in such company as the composer's own recording of his wise and splendid score. Possibly the most successful large-scale set of orchestral variations ever written. *Don Quixote* is unique in its ability to present a cast of characters by purely instrumental means. It is a tragicomic opera without singers. For me, no other instrumental work of Strauss seems to wear so well—which is perhaps a way of saying that none of the rest strikes so deeply into human fundamentals and treats them so understandingly.

Szell obviously knows the score to the last dotted semiquaver, and he plays it

Deutsche
Grammophon
Gesellschaft

New Releases

THE LENINGRAD PHILHARMONIC ORCHESTRA

Jewgenij Mrawinsky, Conductor

TCHAIKOVSKY

Symphony No. 4 in F minor

LPM 18 657 · SLPM 138 657 (stereo)

Symphony No. 5 in E minor

LPM 18 658 · SLPM 138 658 (stereo)

Symphony No. 6 in B minor »Pathétique«

LPM 18 659 · SLPM 138 659 (stereo)

✱

Gennadi Rozhdestvensky, Conductor

KHATCHATURIAN

Gayne Ballet Suite

TCHAIKOVSKY

Francesca da Rimini

LPM 18 673 · SLPM 138 673 (stereo)

✱

Mstislav Rostropovich, Violoncello
Gennadi Rozhdestvensky, Conductor

SCHUMANN

Cello Concerto in A minor

TCHAIKOVSKY

Variations on a Rococo

Theme for Cello

LPM 18 674 · SLPM 138 674 (stereo)



For a complete catalogue of
Deutsche Grammophon Gesellschaft records write to:
DECCA DISTRIBUTING CORPORATION NEW YORK
445 Park Avenue, New York 22, N.Y.

CIRCLE 34 ON READER-SERVICE CARD

the 4 pleasures of DYNAKIT HI-FI



MUSICAL

Sheer listening pleasure for you and your family. The delights of the original performance are recreated in accurate detail and perspective. Every nuance of tonal shading and phrasing is clearly delineated without hum, noise, or distortion.



MANUAL

To assemble your own DYNAKIT is a uniquely rewarding experience. Easy . . . fun . . . educational . . . satisfying your creative interests.

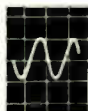

TECHNICAL

The superiority of premium components and the functional simplicity which typify the advanced engineering and design of DYNACO high fidelity equipment add a special satisfaction for you who appreciate excellence. Building your own makes you intimately aware of the quality of DYNACO equipment.



FINANCIAL

The unexpected bonus—substantial savings on high fidelity components of unquestioned technological superiority and unparalleled listening satisfaction.



FM TUNER

\$79.95 kit; \$99.95 semi-kit;
\$119.95 factory wired and tested

Ask your HIGH FIDELITY SPECIALIST
or send for literature below.

Dynaco INC.

3916 Powelton Ave., Phila. 4, Pa.

Please send me complete information on
DYNACO products.

Name _____

Address _____

City _____ Zone _____ State _____

CIRCLE 41 ON READER-SERVICE CARD

forthrightly as a drama. Thoroughly in command of an orchestra that reflects him like a mirror, he produces spectacular results captured here in equally spectacular stereo. (The mono set is equally fine in its own way, but *Don Quixote* is a work that profits so much from the second channel of stereophony that it is distressing not to have it.) In his work here Pierre Fournier seems to me to be precisely the right soloist, a peer among his peers rather than a star on the stage. R.C.M.

TCHAIKOVSKY: *Sérénade mélancolique, in B flat minor, Op. 26*—
See Lalo: *Symphonie espagnole, Op. 21.*

TCHAIKOVSKY: *Swan Lake, Op. 20: Ballet Suite*

Amsterdam Concertgebouw Orchestra, Anatole Fistoulari, cond.
• LONDON CM 9287. LP. \$1.98 (for a limited time).
• • LONDON CS 6218. SD. \$2.98 (for a limited time).

Most of the better-known sections of this popular ballet are included in Fistoulari's bright, exceptionally clean-lined reading. Though he has had wide experience as a ballet conductor, he prefers here to treat the music in concert fashion. The recorded sound is very good, with considerable spaciousness imparted by stereo, and the special price is attractively low. P.A.

TOCH: *Quartets for Strings: No. 10, Op. 28; No. 13, Op. 74*

American Art Quartet (in No. 10); Roth Quartet (in No. 13).
• CONTEMPORARY M 6008. LP. \$4.98.
• • CONTEMPORARY S 8008. SD. \$5.98.

Toch is always skillful and interesting, if not invariably the most inspired of contemporary composers. The best thing here is the totally enchanting slow movement of the Tenth Quartet, which was written in the far-off, innocent days of 1921, when an adagio reminiscent of Dvořák could still be presented at a modern music festival and could stir the interest of the audience.

The Thirteenth Quartet is done in a liberalized twelve-tone style, but the style is almost liberalized out of existence. Performances of both works are quite delightful, and the recordings are very good. A.F.

WAGNER: *Der Fliegende Holländer*

Leonie Rysanek (s), Senta: Rosalind Elias (ms), Mary; Karl Liebl (t), Erik; Richard Lewis (t), The Steersman; George London (b), The Dutchman; Giorgio Tozzi (bs), Daland, Chorus and Orchestra of the Royal Opera House, Covent Garden, Antal Dorati, cond.
• RCA VICTOR LM 6156. Three LP. \$9.98.
• • RCA VICTOR LSC 6156. Three SD. \$11.98.

For a feature review of this album, see page 81.

WEBER: *Five Pieces, Op. 5; Six Bagatelles, Op. 9*—See Berg: *Lyric Suite.*

WILDER: *Quintets for Winds: Nos. 3, 4, and 6*

New York Woodwind Quintet.
• CONCERTDISC M 1223. LP. \$4.98.
• • CONCERTDISC CS 223. SD. \$4.98.

Samuel Baron's notes on this disc expend a great deal of space drawing a parallel between Alec Wilder and Anton Reicha, the nineteenth-century composer of some two dozen quintets for woodwind instruments. The parallel is very precise. A.F.

RECITALS AND MISCELLANY

"THE AMERICAN HARMONY"

University of Maryland Chapel Choir, Fague Springmann, cond.
• WASHINGTON WR 418. LP. \$4.98.
• • WASHINGTON SWR 418. SD. \$5.98.

For a feature review of this recording, see page 79.

BUDAPEST MADRIGAL ENSEMBLE: *Madrigals and Motets*

Budapest Madrigal Ensemble, Ferenc Szekeres, cond.
• MONITOR MC 2054. LP. \$3.98.
• • MONITOR MCS 2054. SD. \$4.98.

How can they get so many wonderful things on a single record? All told, there are twenty-five compositions by fifteen different composers here. The least of these compositions is delightful, and the best are truly magnificent.

The first side is devoted almost entirely to masters of the past—Scandelli, Viadana, Jannequin, Lassus, and Certon, of the sixteenth century; Gesualdo and Monteverdi, of the seventeenth; Giardini, of the eighteenth; and, rather unexpectedly, Liszt, of the nineteenth. (How many choral works of Liszt have you ever heard?) The modern composers, who fill the last two bands on the first side and all of the second, are all Hungarians—Bartók, Kodály, and the more recent Ferenc Farkas, Lajos Bardos, Laszlo Lajtha, and Emil Petrovics.

The greatness of the old masters needs no discussion here; perhaps their works are sung more beautifully in Heaven but they certainly are not anywhere on earth. Among the modern composers, Bartók, represented here with some of his incomparable folk song arrangements, and Kodály, who is represented with a variety of works, sacred and secular, remain supreme. The other writers are quite respectable; and if you never hear anything worse, your fate will be pleasant indeed.

The recording is as good as the singing, which is to say superb, but there was some surface scratch on the review copy. A.F.

CLASSICAL INDIAN MUSIC

K. S. Narayanaswami and Narayana Menon, veenas; Palghat Raghu, mridangam; Yehudi Menuhin, speaker.
• LONDON CM 9282. LP. \$4.98.
• • LONDON CS 6213. SD. \$5.98.

As president of the Asian Music Circle of London, Yehudi Menuhin makes a

HIGH FIDELITY MAGAZINE

Tchaikovsky: *Murche solennelle*, in D.
 Debussy: *Fetes*. Offenbach: *Can-can*.
 Gounod: *Faust*. Walton: *Johann*.
nesburg Festival Overture. Saint-Saens:

ANDRE KOSTELANETZ: "A Kos-
 telanetz Festival"

The portions of the Good Friday office performed on 5598 or OS 25229 are the Passion according to Saint John, which is chanted, and the adoration of the Cross, beginning with the hymn *Ecce lignum Crucis*, continuing with the *Requies* and the antiphon *Crucem tuam*, and ending with *Crux fidelis* and the hymn *Fange, lingua*. The music sung here is solemn and rather consistently syllabic. Stereo becomes meaningful in the *Reproches*, where it conveys the antiphonal effect of the second choir answering the first. The Mass for Sep-tuagesima Sunday (5599 or OS 25230) is given complete (the Gloria is not sung on this day). This is a particularly lovely assemblage of chants. The Gradual and Tract, especially, are luxuriantly melismatic, with garlands of tones hanging off individual syllables. All of the music is sung with the flexibility and great variety of phrasing and accent for which this Choir has long been famous. Good sound. The liner notes are excellent, but it is to be regretted that no texts are supplied.

Choir of the Monks of the Abbey of Saint-Fierre de Solesmes, Dom Joseph Gard, O. S. B., cond. Two LP. \$4.98 each. LONDON OS 25229/30. Two SD. \$5.98 each.

GREGORIAN CHANT: *Good Fri-*
day; Septuagesima Mass

C.L.O.
 er—which is, I suppose, appropriate.

The voice is captured with reasonable fidelity, considering the recordings source, but the piano sound is certainly weakened. There are some hyperbolic jacket notes, devoted entirely to the singer—which is, I suppose, appropriate.

Giuseppe de Luca, baritone; piano.
 • ASCO 124. LP. \$3.98.
 This record presents the eminent baritone on the occasion of his fiftieth anniversary recital at Town Hall, November 7, 1947. It will be of interest chiefly to De Luca fans and to students of singing. De Luca's enunciation—even at the age of seventy-one—was letter-perfect, and even in this last concert he displays a remarkable dynamic range and an extraordinary capacity for coloring his tone. The *Damnation of Faust* arias come off beautifully, as do the little encore songs, and the Monteverdi and Pasquini *arie antiche*. In general, the voice sounds old—rather unsteady, though not quavery or tight. It must further be admitted that several of the songs by Alfano, Tochti, and the like are of small interest, and that the singer's permissive, declaratory way of dealing with "*Arie un po'...*" will meet with scant approval among Mozartians.

Bizzelli: *Cena una volta*. Saniohquido:
Nel giardino. Tochti: *Serenata*; Fila-
 strocca: *Dodici Verdi*; La Traviata: *Di*
Provenza il mar. Encores: *Ninna nanna*;
Dolce Madonna; *Murietta*; *Serenata*
gelata.

CIRCLE 63 ON READER-SERVICE CARD

KAPP RECORDS

A new feather in our Kapp

Yellow Bird • Gigli • An Affair To Remember • Song Of The
 Rain • Greensleeves • Bess You Is My Woman • Two Differ-
 ent Worlds • O, Mio Babbino Caro • Roger's Bumble Bee •
 Marie, Marie • A Lover's Symphony • Forgotten Dreams •
 KL-1244/KS-3244 Free: Send for latest full color catalog and
 record guide. KAPP RECORDS, 136 E. 57 St., N. Y. 22, N. Y.

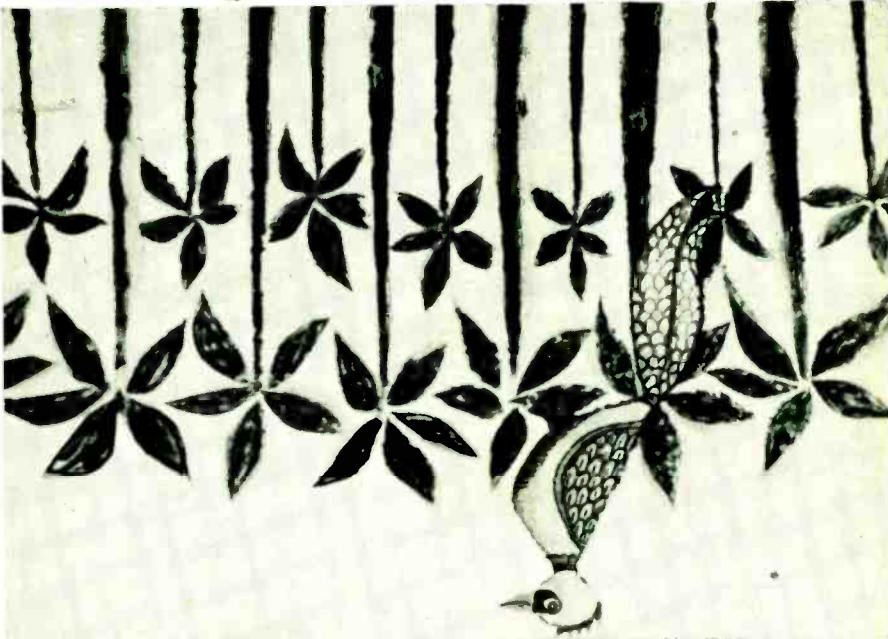

the world's most popular pianist
ROGER WILLIAMS
YELLOW BIRD

CIRCLE 7 ON READER-SERVICE CARD

FROM THE HISTORY
 OF OCCIDENTAL MUSIC

ARCHIVE
 PRODUCTION

Research Period IX
 JOHANN SEBASTIAN BACH

Cantata No. 211 • *Coffee Cantata* •
 Cantata No. 212 • *Bauernkantate* •
 Adele Soite, soprano • Theo Adam, bass
 Hans-Joachim Roitzsch, tenor

Members of the Gewandhaus Orchestra Leipzig,
 Kurt Thomas, Conductor
 ARC 3162 • 73 162 Stereo

9 Spiritual Songs
 from • *Musicalisches Gesangbuch*
 von Georg Christian Schenckell

7 Songs and Arias
 from the Anna Magdalena Bach Book
 Margot Gullilaume, soprano
 Fritz Neumeier, Harpsichord
 ARC 3163 • 73 163 Stereo

Direct Import • Factory Sealed

For further information
 and complete catalogue write:
 DECCA DISTRIBUTING CORPORATION
 Division B. D., 445 Park Ave., New York 22, N. Y.

CIRCLE 66 ON READER-SERVICE CARD

VIVALDI

"Sheer listening joy!" — That's what
 Leonard Bernstein calls the Library of Re-
 corded Masterpieces, exciting new VIVALDI
 recording project which has brought forth
 such comments from listeners as "Astonsish-
 ing accomplishment I have ever heard"
 "Truly magnificent"
 "Superb and delightful"
 ing history, the music lover, music school or
 library receives—

- "Recording in depth" of the complete out-
 put of a great composer played in the style
 of the original following the authentic
 scores as they appear in the composer's
 handwriting;
- Recorded by leading artists with the most
 advanced high fidelity techniques and
 made available in both monaural and
 stereo;
- Permanent availability of all recordings,
 plus replacement of damaged or worn
 records at minimal cost, plus protection
 against technical obsolescence by exchange
 of monaural for stereo recordings when
 desired;
- Provision of remarkable written and re-
 corded musical indices;
- Inclusion of the authentic Record scores
 of all the recorded music.

And all this at less than the scores alone would
 cost. In the words of Dr. Paul Henry Lang, "This
 is not only a good project, it is an exciting one."

If you love music, just ask for VIVALDI
 Library of Recorded Masterpieces, Dept.
 HF-5, 150 W. 82nd St., New York 24.

Write Today for Free Prospectus

Bottegari: *Mi parlo*. Handel: *Non lo dirò col labbro*. Monteverdi: *Maledetto sia l'aspetto*. Pasquini: *Sussurrate intorno a Clorì*. Mozart: *Nozze di Figaro*. *Aprile in po' quegl'occhì*. Berlioz: *Damnation de Faust: Song of the Flea*. *Air of the Roses: Sennade*. Alfano: *Non nascondere il segreto*. Reclì: *Bergarette*.

GIUSEPPE DE LUCA: "Golden Anniversary Concert"

This is Vol. 14 of a continuing series of organ discs being issued by Washington Records in collaboration with the Aeolian-Skinner Organ Company. As might and should be expected, it shows off admirably the sound of the instrument (in the Auditorium of the Reorganized Church of Jesus Christ of Latter Day Saints, Independence, Mo.) with clarity, fidelity, and just the proper amount of hall resonance. Furthermore, Catharine Crozier is a highly accomplished performer. Her playing is a model of clarity, and her interpretations have logic and not a little imagination. For me, the Reubke Sonata is strictly an organist's piece, whose fugal third movement is the only one with any great degree of inspiration; however, the two little pieces by Jean Langlais—especially the ethereal *Arabesque*—are utterly delightful in their simplicity and forthrightness, while the *Fantaisie* by Jehan Alain, typical of that late composer's work, is full of mystery.

- CATHARINE CROZIER, organ.
 - WASHINGTON WAS 14, LP, \$4.98.
 - WASHINGTON SWAS 14, SD, \$5.98.
- Reubke: *Sonata on the 94th Psalm*.
Langlais: *Arabesque sur les Flûtes*.
Logue sur les Mixtures. Alain: *Deuxième Fantaisie*.

CATHARINE CROZIER: "New Dimensions in Organ Sound"

The four pieces are played on two veenas and a mridangam. The veena is a plectrum instrument with a soft, twangy tone. The mridangam is a two-headed hand drum. The four pieces are in different ragas (modes) and talas (rhythms), but to a Western ear they are bound to seem very much alike in ultimate effect. There is a story about an American Indian who went to a song recital offering a typical program of arias and Lieder ranging from Handel to Richard Strauss, and afterward complained that the lady had spent the evening singing the same song over and over again. We are in the same position with regard to the music of the Orient; if we are ever going to understand them, recording, which provides the opportunity for repeated hearing, will show us the way. For this set is the fantastically complex solo on the mridangam towards the end of the first side; this is some of the most magnificent drumming on records.

A.F.

Just as you find information and entertainment and introduces you to colorful music makers and places. HIGH FIDELITY which keeps you abreast of new recordings and equipment and introduces you to colorful music makers and places.

You will hear Sir Thomas sing, joke, roar, entertain. You will enjoy the warmth and humor of the late great conductor rehearsing the *Abduction from the Seraglio* as it appears in Angel Records Set 3555 B/L and the *Symphonies of Haydn* available on Capitol GCR 7198 at your dealer.

BOTH FOR ONLY \$6.98

ONE-YEAR SUBSCRIPTION TO HIGH FIDELITY

SIR THOMAS BEECHAM IN REHEARSAL and a



SPECIAL OFFER

Subscriptions may be new or renewal (no matter when the expiration). The offer expires when our limited supply of Beecham Records reaches zero. Payments with order, please. If we cannot fill your order we will refund in full. Use the convenient order form below.

Please send me the "Beecham in Rehearsal" record and a one-year subscription to HIGH FIDELITY new or renewal, for which I enclose \$6.98.

(Outside of U. S. A., Possessions, and Canada, \$7.98)

Name _____
 Street _____
 City _____
 State _____

760

Samson et Dalila: Bacchanale. Anderson: *Belle of the Ball.* Chopin: *Polonaise in A, Op. 40, No. 1.*

New York Philharmonic, Andre Kostelanetz, cond.
 • COLUMBIA ML 5607. LP. \$4.98.
 • • COLUMBIA MS 6207. SD. \$5.98.

The varied fare on this record is typical of the sort of music Kostelanetz and the New York Philharmonic offer on their Saturday night pop concerts in Carnegie Hall. It is worth attention, if only for the two novelties it contains. The Tchaikovsky *Marche solennelle*, properly pompous and with just a suggestion of the ballet in it, was written for the coronation of Czar Alexander III in 1883; it was also conducted by its composer at the opening of Carnegie Hall in 1891. Walton's *Johannesburg Festival Overture*, also typical of its composer's output, is bright and robust. Save for a slowish reading of *Fêtes*, Kostelanetz performs all the music with verve, and Columbia has provided first-rate sound. P.A.

MANUEL LOPEZ RAMOS: "La Guitarra Clásica"

Bach-Segovia: *Chaconne.* Castelnuovo-Tedesco: *Sonata.* Ponce: *Sarabande and Gavotta.* Tansman: *Barcarole.* Tárrega: *Recuerdos de la Alhambra.*

Manuel López Ramos, guitar.
 • BOSTON B 216. LP. \$4.98.

The young guitarist who makes his disc debut here was born in Buenos Aires in 1929, studied with Miguel Michelone, and has been touring with great success since 1952. It is quite apparent from the outset of this recital that he is a master of his instrument and a musician of importance.

The Segovia transcription of the Bach masterpiece is a tremendous *tour de force*. All the prodigious technical and musical demands of the original are present here, and added to them are the limitations of the strummed, rather than the bowed, instrument. Señor Lopez is completely in control of the technical problems, and projects our attention where it should be: on the music. He gives a vibrant, dynamic performance with wide coloristic range and rhythmic vigor. But in addition to the driving impetuosity of the playing, there is eloquent breadth and profundity.

The Castelnuovo-Tedesco *Hommage à Boccherini* Sonata was written for Segovia, and, as with the Bach Chaconne, it too has been recorded by that master. I found Lopez's rendition to be not one whit inferior. As a matter of fact, I rather prefer the slightly faster tempos and more immediate recorded sound on the present record. The Tansman *Barcarole* is lilting and pleasant, the Ponce (which the composer passed off as a work by Alessandro Scarlatti) urbane and gracious. They are both played with complete fluency, wide dynamic range, and plenty of character. The swirling tremolandos of the Tárrega Etude, (very reminiscent of a Paganini caprice) are given with hair-raising brilliance and bring the disc to a rousing conclusion.

The sound is very close-to, and the guitarist's gutty, plangent fortissimo and cushioned dolce are splendidly captured. My review copy, unfortunately, had a bad scratch just where it hurt the most: in the Chaconne. H.G.

SEPTEMBER 1961

IGOR MARKEVITCH: Russian Orchestral Music

Tchaikovsky: *Francesca da Rimini, Op. 32.* Borodin: *In the Steppes of Central Asia.* Glinka: *Ruslan and Ludmilla: Overture.* Liadov: *Fragment de l'Apocalypse, Op. 66.*

Lamoureux Orchestra, Igor Markevitch, cond.
 • DEUTSCHE GRAMMOPHON LPM 19225. LP. \$5.98.
 • • DEUTSCHE GRAMMOPHON SLPM 136225. SD. \$6.98.

Two novelties brighten this otherwise dismal disc. One is *Francesca da Rimini* in one of its very rare uncut performances. The other is a first recording of a late work by Anatol Liadov, the symphonic picture *Fragment de l'Apocalypse*, whose echoes of the Russian Orthodox Church recall Rimsky-Korsakov's *Russian Easter Overture*. But these are scant attributes when weighed against Markevitch's often colorless, often insensitive interpretations, into which sudden loud passages and instrumental imbalances are allowed to intrude. Furthermore, the execution of some of the difficult runs in *Francesca* is not all it should be from a major orchestra. Some matching colorless sound in mono is greatly enlivened in stereo, which is marked by fairly wide channel separation. P.A.

THOMAS SCHIPPERS: Opera Overtures

Rossini: *Il Barbiere di Siviglia.* D'Indy: *Fervaal.* Mozart: *Le Nozze di Figaro.* Verdi: *La Forza del destino; La Traviata, Act 1.* Smetana: *The Bartered Bride.* Menotti: *Amelia Goes to the Ball.* Weber: *Der Freischütz.*

Columbia Symphony, Thomas Schippers, cond.
 • COLUMBIA ML 5638. LP. \$4.98.
 • • COLUMBIA MS 6238. SD. \$5.98.

The briskly played introduction to *Amelia Goes to the Ball* is a welcome addition to the catalogue, and the *Traviata* prelude is neatly rendered. Otherwise, Mr. Schippers' addiction to crude underlining of brass and percussion, and his selection of tempos that would have left Toscanini huffing far to the rear, are fatal to this music. The results are not even exciting, but merely nervous-sounding and rather ugly, with none of the affection or sense of good humor that should inform the Rossini, Smetana, and Mozart selections, or of the overall sweep that must be present in the Verdi or Weber.

The disc's gesture toward eclecticism is in the introduction to D'Indy's *Fervaal*, discussed in the jacket notes as an alleged musical descendant of Wagner. It makes pleasant, maundering listening. Its primary resemblance to Wagner's music lies in a *Tristan* cadence a bar or two from the end, but it is easily distinguished from Wagner by the fact that it is nowhere near as good. The sound has lots of spread, but little in the way of depth or richness. C.L.O.



UNITED STEREO TAPES

Presents A NEW

SAMPLER SERIES

The Best From A World Of Music

ON 4-TRACK STEREO TAPE

FEATURING

3 NEW UST TWIN-PAKS

The world's greatest bargain in music! Up to ONE HOUR and TWENTY MINUTES of music on ONE TAPE! A complete evening of music for only \$7.95! THREE ALBUMS representing 12 recording companies—60 outstanding artists and orchestras—selected from hundreds of best selling 4-track tapes and put into 3 new Twin Paks:

MOODS Including: Never On Sunday - Lisbon Antiqua - Arrivederci Roma - Adventures in Paradise - Bali Hai - Small Hotel - Fine Romance - Sweet and Lovely
 RL 407

Dance Beat! Including: Just In Time - Patricia - Helen Polka - Continental - Huckle-Buck - Always - Begin The Beguine - Carioca - Got You Under My Skin
 RL 406

BROADWAY! Selections from these hits: Sound Of Music - Do-Re-Mi - Bye Bye Birdie - Guys & Dolls - My Fair Lady - Carousel - One Touch of Venus - Carnival - Bells Are Ringing
 RL 405

• AND •
LONDON THREE SAMPLER ALBUMS from the very best of London—Up to 42 minutes for only \$3.95 or \$4.95 each!

POPULAR Featuring these famous London recording artists: Ted Heath - Mantovani - Edmondo Ros - Frank Chacksfield - Stanley Black
 LPQ 66000

CLASSICAL Including: Beethoven's Symphony No. 3 - Tchaikovsky's Romeo and Juliet - Brahms' Hungarian Dance Strauss' Perpetuum Mobile
 LCE 66001

OPERA Including: Renata Tebaldi, "Un Bel Di" from Madama Butterfly - Brigit Nilsson, "Liebestod" from Tristan and Isolde
 LOE 66002

SEE and HEAR these 6 New 4-Track Samplers at your local tape center—or for complete listings, Write Now:

UNITED STEREO TAPES
 88 Llewellyn Ave./Bloomfield, New Jersey
 United Stereo Tapes a division of AMPLEX

A WARNING

to people
who have purchased

SHURE

Dynetic® Phono Cartridges

You own the world's finest stereo cartridge.

Its superior performance depends upon the Shure Dynetic Stylus Assembly. An inferior stylus replacement will audibly detract from the cartridge performance . . . and increase record wear.

Laboratory Test Findings:

Shure laboratory tests show that the imitation stylus assemblies labeled as replacements for the Shure Model N7D Stylus Assembly vary drastically in important performance characteristics. For example, the compliance varied from a low of 0.9 to a high of 11.5, requiring 9.0 grams to track a record with a low compliance stylus, and 2 grams with a high compliance stylus. The high compliance stylus retracted at 4 grams needle force, allowing the cartridge case to drag on the record surface, thereby becoming inoperative. Response at high frequency (relative to the 1kc level) ranged from a 5.5db peak to a drop of 7.5db. Separation varied from "good" (27db) to "poor" (16.5db) at 1kc. These figures reveal that there is very little consistency in performance characteristics of the imitation Dynetic Styli.

In each of the categories shown above, the results ranged from good to poor. As a matter of fact, only 10% of the samples met the Shure performance standards for the Shure N7D Stereo Dynetic Stylus. In addition to our test findings, our Service Department records show that an increasing number of Dynetic Phono Cartridges are being returned because of poor performance—and our examination has disclosed that most of these returned cartridges are using imitation Dynetic Styli.

Conclusion: Obviously, if an imitation Dynetic Stylus is used, we cannot guarantee that the performance of Shure Dynetic cartridges will meet the published Shure specifications. Accept no substitute.

 *look for this wording:*

"THIS DYNETIC® STYLUS IS PRECISION
MANUFACTURED BY SHURE BROTHERS, INC."

The Lighter Side

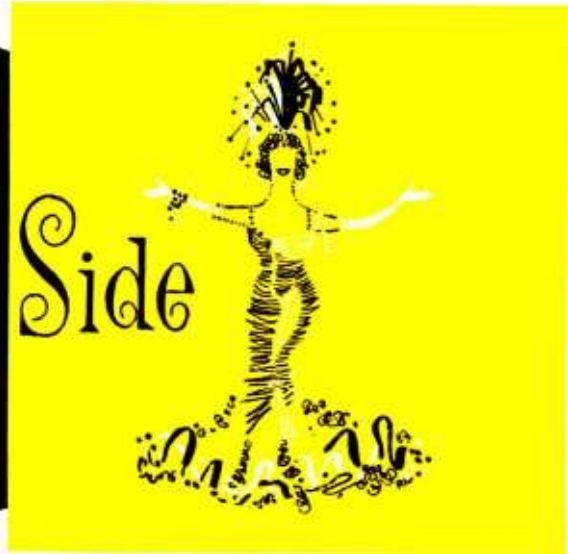

POPULAR • THEATRE • FOLK



Ella Sings Her Heart Out— And Everything's Absolutely Right

L "Ella Fitzgerald Sings the Harold Arlen Song Book."
Ella Fitzgerald; Billy May and His Orchestra.
Verve 4046, \$9.96 (Two LP); 64046, \$11.96 (Two SD).

FROM *Blues in the Night*, the opening number on this wonderful program of Harold Arlen songs, it is immediately apparent that the First Lady of Song has discovered a far more congenial field of show music in which to work than she covered in the Porter, Rodgers and Hart, Berlin, and Gershwin "Song Books." In those issues, her performances struck me as pleasant but superficial, as if she were possibly intimidated by the sophistication of many of the lyrics. To me, her singing there lacked the freedom, the poise, and the verve I associate with her work. It is a vastly different story where these Arlen songs are concerned. On all of them she sounds wonderfully relaxed, completely attuned to

the feeling of every song, free to indulge in improvisatory flights dictated by her own appreciation of any number—and in the course of having a ball for herself, singing her heart out.

In a program of twenty-four songs, where everything is so absolutely right and where many of the performances merit the adjective "definitive," a reviewer can do little but mention certain performances which he considers outstanding. For proof that Miss Fitzgerald is a ballad singer without a peer, there is her deceptively simple and completely effortless singing of *Ill Wind*, one of Arlen's most beautiful songs, or the exceptional way in which she handles the long melodic line of *This Time the Dream's on Me*. Then

too it is certainly going to be a long time before anyone matches, let alone surpasses, Ella's superb performance of *The Man That Got Away*, which some remarkable vocal coloration on her part invests with a feeling of weary disillusionment. And as a singer, she matches Arlen's prodigious range as a composer, which runs all the way from ballads and blues to rhythm numbers and white spirituals. Both *Get Happy* and *Ac-Cent-Tchu-Ate the Positive* fall into the last category, and Miss Fitzgerald sings both with a driving sense of fervor and emotion that can be literally felt. On the lighter side, I particularly admired her wonderfully fey performance of *Let's Take a Walk Around the Block*, where she suddenly sounds as if she were a girl of twenty and somehow reminds one of Celeste Holm in *Oklahoma* (particularly in the verse, which bears some resemblance to

I Cain't Say No). The singer is quite obviously thoroughly enjoying Harburg's clever and very whimsical lyric.

In my opinion the titles mentioned above were the highlights of a marvelous program, but others will undoubtedly have their own favorites. In any case I can assure prospective listeners that there is nothing but sheer pleasure ahead of them. I might also mention that Miss Fitzgerald, God bless her, sings most of the verses to these songs. Other singers, please copy. In fact the only reservation I have about the whole production concerns the Billy May arrangements: they incline to be pretty brassy—in other words, his usual style—and although they seem reasonably well suited to most of the songs, there were times when I wished he were less noisy. But Ella and Arlen are completely triumphant. J.F.I.



A Quintessential Parisienne In Songs of Agony and Ecstasy

“More Piaf of Paris.” Edith Piaf; Orchestra, Robert Chauvigny, cond. Capitol T 10283, \$3.98 (LP); ST 10283, \$4.98 (SD).

ON A BLEAK DECEMBER DAY in 1959, the singing career of Edith Piaf reached a climax of sorts. Three surgical operations in that year alone had left her wan and exhausted for a scheduled concert at Dreux in northern France. At curtain time, a doctor hurried into her dressing room and administered a sustaining injection. Half an hour later she stood alone on the stage, a single spotlight picking her out amid total darkness. As always, she wore a starkly simple black dress and no jewelry save for a gold crucifix at her throat. And as always, her fee for the performance was a flat \$1,000.

She sang her typical songs of ecstasy and agony in the brilliantly harsh voice as famed in Moscow and San Francisco as in her native Paris, but an air of weariness overhung her performance; several times she faltered noticeably. At intermission, Robert Chauvigny, her accompanist for seventeen years, announced that he would refuse to play if she insisted upon continuing. She insisted, saying, “Let me

sing. I will die if I do not sing. I have nothing else in life.” Her electrician wept.

On stage once again, she finished her first song. Then, midway through the second—*Ouragan* (Hurricane)—she collapsed. The curtain dropped, but almost immediately she rose to her feet and waved it up again. Before a hushed audience, she went on to finish her program. Immediately afterwards, she was rushed to a Paris hospital.

Such is the measure of Edith Piaf.

The post-World War II years, the years of her fame, have not been kind to her. Her romance with dashing French boxer Marcel Cerdan ended tragically when he died in an airplane crash en route to the United States. A subsequent marriage ended in divorce. She has been hospitalized times without number. Little more than a year ago, *Paris Jour* published a photo of her haggard face under the headline: *Edith Piaf Must Stop!* But she told *Paris Jour*: “If I stop singing, I die.”

Recurrent illness curtailed Piaf's activities through most of 1960, but on December 30, in Paris, she made a smashing comeback before a crowd of more than 2,000—including several cabinet ministers. This recording now offered by Capitol. "More Piaf of Paris," was taped shortly after her triumphant return. And the record itself is a triumph, a witness that time and stress have only deepened Piaf's art. Her emotions—and her extraordinary projection of them—rage more fiercely than ever. Her voice is clearer, stronger, surer. In short, she has matured to greatness.

Part of Piaf's appeal—beyond her superb vocal qualities—lies in the fact that she is a quintessential Parisienne. Her father was a street acrobat, and she herself sang for her supper on many a street corner. Her voice rings with the vivid realities of these same streets. It is a cry from the pulsing heart of the

real Paris—the Paris of drab faubourgs, zinc bars, shabby cafés; the Paris of hopeful midinettes and streetwalkers with grieving eyes.

This recording frames a typical Piaf program. *Ouragan* is a spectacular curtain raiser; in it her voice shapes a kind of wild fugue on *toi* and *amour*, rising to an almost unbearable emotional crescendo. On the other hand, *C'est l'amour qui fait qu'on s'aime* is all soft-voiced chagrin. Perhaps the finest of her songs, however, is *Cri du Coeur*, a driving, catchy melody that provides a beautiful showcase for the wry, civilized heartbreak of Jacques Prevert's lyrics.

This is absolutely the finest album Piaf has ever recorded, and it will long serve as a cornerstone for any collection of French *chansons*. Both versions are excellent, with stereo giving the orchestral accompaniment greater breadth and depth. O.B.B.

"Jane Morgan Sings the Big Hits from Broadway." Jane Morgan; Orchestra, Frank Hunter, cond. Kapp KS 3247, \$4.98 (SD).

The bare title of this recording gives no indication of the difficult assignment Jane Morgan has set herself. A compendium of show tunes written between 1904 and 1959, ranging from the Cohan corn of *Give My Regards to Broadway* to that epitome of Broadway sweetness, Rodgers' *Sound of Music*, the album also includes several songs originally written for male voice. Miss Morgan makes light of the latter problem, in richly sung versions of *You'll Never Walk Alone* and *The Surrey with the Fringe on Top*, and turns the rest of the program, a mixture of ballads and rhythm numbers, into a completely successful singing spree. In some numbers she is assisted by a male chorus, and throughout by the Frank Hunter orchestra in arrangements which, because of their emphasis on soft strings, might well have been written by Axel Stordahl. J.F.I.

"The Branko Krsmanovich Chorus at Carnegie Hall." Branko Krsmanovich Chorus, Bogdan Babich, cond. Monitor MP 576, \$4.98 (LP).

Here certainly is one of the world's great choruses—quite possibly the greatest. Director Bogdan Babich has shaped these eighty voices into an instrument of taut discipline and breath-taking virtuosity. This program, taped in Carnegie Hall, preserves an actual performance of the chorus during a recent American tour. Their selections range from Carl Orff's *Catulli Carmina* through American, Russian, and Italian folk ballads to a stunningly sung group of Yugoslav traditional airs. Of the last, perhaps the most haunting is the religious anthem *Vospojte Gospodi* (Sing Unto The Lord a New Song), which recalls certain musical configurations of Leoš Janáček's dazzling *Slavonic* Mass. Top-drawer engineering too. O.B.B.

"My Gypsy Love." Frank Chacksfield and His Orchestra. Richmond B 20093, \$1.98 (LP); S 30093, \$2.98 (SD).

Virtuosos as they often are, native gypsy fiddlers seldom can match the sleekness of Chacksfield's string players and never are gathered together in so large a choir. Monti's *Csardas*, the *Gypsy Moon*, and *Tzigane* are particularly well played here, where the always rich Chacksfield orchestral colorings are often effectively spiced by the unique metallic twang of a cymbalom, but all the selections are effectively done. Throughout, the warmly lucent recording matches the best standards of far more expensive releases, in its more sharply focused and higher-level monophonic edition no less than in its airily atmospheric stereo version. Either one is a "best buy" in light musical entertainment. R.D.D.

"The Marches I Played on the Old Ragtime Piano." Eubie Blake, piano. 20th-Century Fox 3039, \$3.98 (LP).

The indifferent sound here cannot conceal the fact that this is some of the most exuberant and authentic ragtime piano playing to be found on records. Veteran Eubie Blake, who was playing ragtime almost sixty years ago, goes back to items once basic in the ragtimer's repertoire, the marches of Sousa, Bigelow, and Hall, and he plays them with a vitality and rhythmic strength simply amazing for a man of his years. Promoting variety in the program are two fine examples of what was once something of a ragtime player's specialty, "ragging the classics," applied on this occasion to Bizet's *Toreador Song* and one of Mendelssohn's *Songs Without Words*. On the final band, Blake talks about some of his personal piano "tricks"—back bass, his use of grace notes, his use of the left hand and its importance in ragtime. His talk is a fascinating little dissertation to wind up a highly unusual disc. J.F.I.

"The Premise." Original Cast Recording. Vanguard VRS 9092, \$4.98 (LP).

Harkening back four hundred years to the Italian *commedia dell'arte* and its tradition of spontaneous dialogue and acting, actor-director Theodore J. Flicker has blended this forgotten form with a spirit of broad satire to create something wholly new in modern theatre. In a Greenwich Village basement café (with no scenery and no props), Flicker and his troupe of three actors—Joan Darling, George Segal, and Thomas Aldredge—shape short sketches on the basis of a suggestion from the audience or a personal inspiration. Each sketch is improvised on the spot, and even repetitions on the same theme are never quite alike. Naturally, not every situation is developed with uniform skill, but when Flicker's sophisticated vignettes succeed, they do so explosively. *The First Men on the Moon* and *A Famous TV Interview*, for instance, are minor classics, and on the whole you will find "The Premise" original, stimulating, and frequently hilarious entertainment. O.B.B.

"London Symphonic Band and Male Chorus." Paul Mickelson, cond. Supreme SS 2004, \$4.98 (SD).

Although as a program of religious music this disc does not quite fit into the "Lighter Side" category, its sonic qualities are so outstanding that it warrants attention here on that basis alone. The small but robust male chorus sings well, the British band (apparently a free-lance group) plays with notable skill, and the intricate arrangements are conducted with marked precision and assurance; but what makes this program so exhilarating to audiophile ears is the truly magnificent bite, impact, and authenticity of its broadly recorded and reverberant sonorities. These are particularly impressive in the Leidzen transcriptions (Bach Toccata and Fugue in D minor, *Lead Kindly Light*, and the *Doxology*) for band alone. Yet the

CONCORD

401

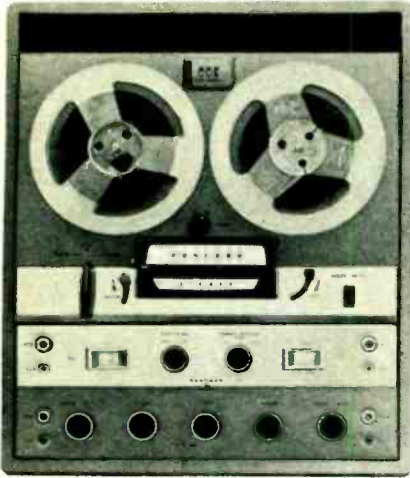

Record stereo... play stereo... with the new Concord model 401

Why settle for a tape player when you can own a Concord 401 stereo tape recorder for no more cost. With the 401 you can record a library of 25 one hour stereo tapes for less than \$50.00 compared with the cost of over \$300.00 for the equivalent in pre-recorded music.

The Concord 401 stereo tape recorder offers superb sound quality in an advanced design precision instrument. The 401 contains both stereo record and playback pre-amplifiers. Records stereo anywhere, plays through any high fidelity system.

Features: 4-track stereo and monaural recording, sound on sound recording, two VU meters, individual channel controls, electric remote control. Mounts vertically or horizontally—ideal for custom installations. Frequency response, 30—16,000 cycles \pm 2 DB at 7½ IPS. Flutter and wow, less than .18%.

Price including custom carrying case \$249.50.

Write Today: Send for Concord's booklet "401—All the Facts" regarding the quality and versatility of the 401 Stereo Tape Recorder.

CONCORD

ELECTRONICS CORPORATION
Dept. HF-9, 809 N. Cahuenga Blvd., L. A. 38, Cal.
CIRCLE 33 ON READER-SERVICE CARD

conductor's own unaccompanied hymn settings (especially that of *God the Omnipotent*) are almost as effective sonically and even more so musically; and there is tremendous breadth in the somewhat pretentious chorus-and-band versions of *Holy, Holy, Holy* (arr. Leidzen), Franck's *O Lord Most Holy*, and *O God Our Help in Ages Past* (arr. Koehler). No connoisseur of sonic authenticity, whatever his musical tastes and religious affiliation, can afford not to hear this quite extraordinary recording. R.D.D.

"The Hits of Benny Goodman." Benny Goodman and His Orchestra. Capitol DT 1514, \$4.98 ("Duophonic"). When this Goodman concert was issued in 1955 as "B. G. in Hi-Fi" (Capitol W 565), *HIGH FIDELITY's* reviewer J. S. Wilson praised it as "The best new recording done by Goodman in years." Now decked out in Capitol's latest technical development, "Duophonic Sound," these swinging versions of standards from the Goodman book sound even more exciting than they did on the original issue. The new process has given them a fatter and more spacious sound, with good depth and even distribution from speaker to speaker. While not, of course, true stereo (although it can be played only on stereo equipment), this reissue is highly welcome indeed. J.F.I.

"A Night with Rudolf Friml." Earl Wrightson; Lois Hunt; Orchestra. Frank DeVol, cond. Columbia CL 1630, \$3.98 (LP); CS 8430, \$4.98 (SD).

The two singers continue their exploration of the operetta repertoire, already productive of enjoyable concerts of Kern and Romberg music, with this lusciously sung program of show tunes by Rudolf Friml. With the solo numbers more evenly distributed than on the earlier issues, Miss Hunt emerges from her secondary role to one of equal importance with her partner. Her voice—a light, lyric soprano—is well suited to the soaring lines of Friml's early songs, and she is heard at her best in charming performances of *Gianina mia* and *L'Amour, toujours l'amour. Song of the Vagabonds* is, of course, tailor-made for the rousing baritone of Earl Wrightson, and he turns in a stirring account of it, though he is just as effective in the jaunty *Donkey Serenade* and in evoking the tender mood of *Ma belle*. And when the singers combine their voices in a number of duets, mostly from Friml operettas of the Twenties, the result is light opera singing at its best. Substantial support from the DeVol orchestra, whose conductor has provided arrangements full of deft touches. The Columbia sound is excellent, although the stereo version seems to have too much echo. J.F.I.

"Polyna Savridi Sings of Greece." Polyna Savridi. St/And SLP 405, \$4.98 (LP). Polyna Savridi's silvery soprano etches these Greek traditional songs with the economy, understatement, and cumulative loveliness a Japanese artist gives to a painting. A piano and flute accompaniment subtly underscores the translucent beauty of melodies that fall upon the ear with a faint Oriental exoticism. Here is a truly different, truly beguiling world of music. You will never regret entering it. Unhappily, neither texts nor translations grace the album. O.B.B.

"Swingin' Band." Carlton LP 12139, \$3.98 (LP); STLP 12139, \$4.98 (SD). Whatever else may be said of Carlton's "impact-sound" series of pop spectacles, it cannot be accused of name dropping. The present program (like its far less striking companions "String Splurge" and "Torrid Trumpet") provides no personnel information whatever, and even its jacket's technical notes (and illustration) are exclusively concerned with the Bell Sound Studio's monstrous "15-channel multidirectional automatic selector and stereo switcher" presumably employed here. But the anonymous performances (especially by the virtuoso if not especially imaginative soloists) exhibit almost overpowering gusto. Despite its frequent raucousness the frantically jumping playing (in *Everything I've Got Belongs to You*, *Southern Fried*, *Undecided*, *Little Girl*, etc.) is mightily exciting, while the at least partially relaxed pieces (*End of a Love Affair*, *Give a Listen*, *Baby Come Here*) and the occasional quiet passages elsewhere are pleasantly attractive. But even the toughest ears are likely to find the stridencies excessive in monophony; the stereo version, for all its acoustical dryness and exaggerated channel separation, makes them a bit easier to take. R.D.D.

"The Music of Jerome Kern." Melachrino Strings and Orchestra. RCA Victor LPM 2283, \$3.98 (LP); LSP 2283, \$4.98 (SD).

Once again, as in his recent recording of Victor Herbert music, the English conductor shows more consideration for an American composer's music than do most of our domestic arrangers and conductors. These are, it is true, some of the most familiar of all Kern songs, but I have seldom heard them treated more musically or tastefully. Over the exemplary string arrangements, the Kern melodies float gracefully and pleasingly, in sound that is velvety smooth. Now, will someone interest Melachrino in lesser-known Kern—say, songs from the Princess Theatre musicals? That would be something to watch for. J.F.I.

"Musical Merry-Go-Round." Sinfonia of London, Robert Irving and Douglas Gamley, conds. Capitol G 7244, \$4.98 (LP); SG 7244, \$5.98 (SD).

The intriguing idea of letting the music go round and round so that it comes out here (left speaker) and later out there (right speaker), thus creating the illusion of revolving sound, is brilliantly successful on two bands of the stereo edition of this concert of light music. In the waltz from *Carousel* and in Oscar Straus's *La Ronde* the sense of circular motion is so vivid that one almost feels impelled to reach out to grab the brass ring. Non-stereo owners will naturally be deprived of this experience, since the effect cannot be achieved on the mono version, but that should not prevent them from enjoying Ibert's pertly Gallic *Clown's Dance*, the lilting waltz from Khachaturian's *Masquerade Suite*, or *Prater Fest*, the Viennese pastiche by Douglas Gamley which makes an obeisance to almost everyone named Strauss. (I'm afraid, though, that I couldn't find any musical ideas in Don Banks's *Coney Island* bearing any relation to New York's playground; to me, it all sounded like *A Day on the Beach at Blackpool*.) Both recordings have extremely vibrant sound, but the merry-go-round stereo sound is vastly more impressive. J.F.I.

"Souvenirs from Sweden." Various performers. Epic LF 18010. \$3.98 (LP). Sweden is cursed with the world's highest per capita suicide rate—due, claim most Swedes, to the long and gloomy winters. As though to compensate for this somberness, Swedish popular music is shot through with sunny melodies and the frothy rhythm of the waltz echoes throughout the land. Epic's neatly sliced cross section of present-day Swedish pops is, on the whole, a pleasant Northern romp. But flecks of haunting melancholy—notably Evert Taube's lovely *Pierina*—add effective counterpoint. Outstanding among the battery of popular performers gathered for this program is Ulla-Bella, whose mellow soprano caresses the ear. Superb sound. O.B.B.

"Carnival." Selections. Living Strings. Johnny Douglas, cond. RCA Camden CAL 678. \$1.98 (LP); CAS 678. \$2.98 (SD).

The British Douglas seems to be Camden's specially commissioned answer to the demand for a poor-man's Mantovani or Melachrino. His quasi-symphonic orchestra (dominated by, but not exclusively confined to, strings) cascades and emotes earnestly enough, but generally sounds more phlegmatic and less polished than its high-powered chromium-plated models. Here, however, in excerpts from the Broadway show *Carnival* (released in the original cast recording by M-G-M), Douglas' group does proffer more attractive materials than in most of its earlier releases and is even stimulated to some vitality in a brisk *Yes, My Heart*, heavily swinging *Direct from Vienna*, and a catchy *Beautiful Candy*—*Golden, Delicious Fish* in which brightly pyramiding trumpets are effectively contrasted with suave cellos. The mono version is the better bargain, since the SD thickens at the low end and in channel balance lists on the port side. R.D.D.

"Welcome to Tyrol." Epic LF 18013. \$3.98 (LP); BF 19013. \$4.98 (SD).

As anybody who has ever attended a Volk-Fest in Innsbruck, Arlberg, or Kitzbuhel knows, the Tyrolese throw themselves into these affairs with such abandon that it soon becomes a question as to who is more exhausted, the performers or the audience. One of the pleasures of this recording is that the visual strain is removed, though the musical pleasure is retained. The record offers no performance of the strenuous *Schuhplattler* nor of any Alpenhorn contest, and I am a little puzzled by the appearance of Robert Thaller and His Gang, who hail from Linz—about as far from the Tyrol as Boston is from New York; but there is a good deal of regional folk music and yodeling (which seems a good deal less earsplitting than I recall), zither solos, and the inevitable and lovable oom-pah-pah music of a Tyrolean band. The recording is excellent, and adds much to this easy way of acquainting oneself with the folk music of a fascinating corner of Europe. J.F.I.

"Harper's Bazaar's Secret Formula for a Beautiful New You." Nicholas Kounovsky, narrator; Bernie Leighton Ensemble. Capitol WAO 1522. \$5.98 (LP); SWAO 1522. \$6.95 (SD).

Here are physical fitness, weight reduction, and relaxation exercises competing with those sponsored by *Good Housekeeping Magazine* for Columbia last November and similarly issued in an elaborately illustrated album complete with

CONCORD



The stereo tape recorder you've been waiting for

At last—a stereo tape recorder with the design and feel of a professional instrument together with the built in performance quality and operating features to make professional stereo recordings. Compare the Concord 880 with any other tape recorder at any price. See why the 880 is in a class by itself. Three Heads Superior stereo recording quality with professional three head arrangement. Three Speeds Superb sound quality with maximum tape economy. Over 16 hours may be recorded on a single 7" reel. Computerized Channel Selector Note at a glance the mode of operation of the recorder—even from across the room. Push Button Operation Easiest to operate of any tape recorder. Operates from PLAY to FAST FORWARD or REWIND without STOP. Electronics Self contained stereo record and playback preamplifiers and 10 watt power amplifier. High impedance outputs for playing through high fidelity system. True stereo sound separation with second channel speaker in case cover. Sound on Sound Recording Perfect for music and language study. Plus Four track monaural recording, setting of record levels without tape moving, individual channel and master level and tone controls. Automatic record equalization shift, automatic pressure roller disengagement, automatic reel end stop, two VU recording meters, records while operating as a stereo public address system. Frequency response 40 to 16,000 cycles \pm 2 DB. Wow and flutter less than .15% at 7½ IPS.

Price including all accessories: \$399.95

Write Today for Concord's booklet "880—All the Facts" explaining why the 880 is the tape recorder you've been waiting for.

CONCORD

ELECTRONICS CORPORATION

Dept. HF-9 809 North Cahuenga Boulevard, Los Angeles 38, Calif.

CIRCLE 33 ON READER-SERVICE CARD

HALF PRICE

for a trial subscription that brings the world's foremost writers in every field into your home



RECENT CONTRIBUTORS INCLUDE:

John Ciardi
 Agnes deMille
 Peter Ustinov
 Lewis Mumford
 James Thurber
 Judge Irving R. Kaufman
 Sen. Joseph S. Clark
 Walter Lippmann
 Edith Sitwell
 Dore Schary
 John P. Marquand
 Mark Van Doren
 Alfred Knopf
 Edward Crankshaw
 Clarence B. Randall
 Alfred Kazin
 Ernest Hemingway
 Leonard Bernstein
 and many others

For a fraction of its regular price you can "discover" America's most distinctive magazine, presenting the world's best writers, greatest thinkers and doers! You can join the thousands of smart ATLANTIC readers who enjoy each month the best combination of news, fun, information and adult entertainment available anywhere. See for yourself how much genuine reading enjoyment is packed between the covers of each issue—by taking advantage of this spectacular half price offer: 8 issues at half the regular price!

(Usual subscription, \$7.50 a year)

SEND NO MONEY
 Mail this coupon today

THE ATLANTIC, Dept. Z-45
 8 Arlington St., Boston 16, Mass.

Please enter my half-price trial subscription to THE ATLANTIC for 8 months and bill me for \$2.50.

Name

Address

City.....Zone...State.....

Remittance Enclosed. Bill me later

CIRCLE 12 ON READER-SERVICE CARD

calorie guide and weight tables, advice on dieting, etc. The drills themselves seem less strenuous than those in the earlier course, but if faithfully carried out should contribute valuably to milady's health and poise—if not necessarily to a "new beauty" comparable with that of the shapely bathing-gal on the album cover. What gives this instruction disc distinctive character is that—in contrast to the businesslike directions of the Misses Conway and Rice for *Good Housekeeping/Columbia*—those by the suave Kounovsky are almost hypnotically chanted to Leighton's seductively rhythmic musical accompaniments. Few susceptible students are likely to resist regimes so persuasive, especially in the atmospheric warmth of stereo! R.D.D.

"Polish Folk Songs." Polish Folk Song Ensemble; Polish Army Song and Dance Ensemble. Artia ALP 184, \$4.98 (LP).

Buffeted for the past six hundred years by the military and political crosswinds of Central Europe, Poland has still managed to preserve a unique musical heritage. Here, handsomely presented, is a generous sample of it—polkas, mazurkas, folk ballads. The Polish Folk Song Ensemble and their counterparts from the Polish Army perform with gusto and authority. The generally excellent recorded sound suffers from slightly muffled passages here and there. Artia's annotation is unusually informative, including texts and translations. O.B.B.

"Exotique." Whittemore and Lowe, duopianists. Capitol P 8550, \$4.98 (LP); SP 8550, \$5.98 (SD).

In the repertoire of music originally written for piano four hands, few compositions qualify for inclusion in a program to be entitled "Exotique." Thus, the two-piano team of Whittemore and Lowe have had to rely on other works, either piano reductions of orchestral compositions or extensions of music originally composed for solo piano. It is perhaps not out of place to say that the latter are generally far more successful. It is almost impossible for pianos, even when as well played as here, to create the same sensuous impression as Debussy or Ravel's orchestrations. On the other hand, Cyril Scott's once popular but now rather neglected Oriental-perfumed *Lotus Land* sounds doubly impressive in its new attire, as does Griffes' imaginatively conceived *White Peacock*. Two works are played as they were originally conceived, Rachmaninoff's *Tears*, the third section of his Suite No. 1, Op. 5 for two pianos, and Arnold Bax's mystical *Poisoned Fountain*. The performances throughout are marvelously well integrated and compellingly musical; and Capitol provides an extraordinarily rich piano sound. J.F.I.

"Yellow Bird." Roger Williams, piano; Orchestra, Frank Hunter, Marty Gold, and Gene Von Hallberg, conds. Kapp KL 1244, \$3.98 (LP).

This time around Roger Williams displays his acknowledged technical prowess in a series of pop *divertissements* culled from the music of Puccini, Rimsky-Korsakov, Gershwin, and Leroy Anderson among other composers. On the whole, this is an appealing program, but one which might have been even more so had the pianist curbed his love of rubato, which turns such a number as *O mio bambino caro*, for instance, in a pretty saccharine

affair. I much preferred his simple performance of the Caribbean calypso song *Yellow Bird*, and of a French number (new to me) called *The Song of the Rain*, in which the soloist appears to be doubling on the harpsichord. I'd prefer to forget another French song, *Marie, Marie*, in the course of which a male chorus intones lyrics that seem to consist solely of the plea, "Marie, Marie . . . Write to Me. Write to Me"—surely the nadir in poetic inspiration. As always, Kapp has given the pianist rich and glowing recorded sound. J.F.I.

"Echoes of Spain." Hollywood Bowl Symphony Orchestra, Carmen Dragon, cond. Capitol DP 8275, \$5.49 ("Duophonic").

"Songs of Stephen Foster." Roger Wagner Chorale, Capitol DP 8267, \$5.49 ("Duophonic").

"The Ritual of the Savage." Les Baxter and His Orchestra, Capitol DT 288, \$4.49 ("Duophonic").

What links three such disparate releases is their "duophonic" processing from best-selling monophonic discs, the first two of which date back to 1954, the third to 1951-52. I haven't the LP versions available for comparison, but the evidence of a separate demonstration sampler (not for public sale) in which some of the present selections are A/B'd in old and new editions testifies to various obvious sonic clarifications and broadenings. Yet even where improvement is most marked (in the *a cappella* Foster program and especially its better separated men's and women's voices), the limitations of the new technique are evident in the lack of acoustical spaciousness and floating quality—the quintessential hallmarks of true stereo. The enhancements of the other two discs do eliminate some of the original constriction, but scarcely to the point where even uncritical ears can accept them as meeting the best present-day standards. In any case, all this metamorphosis processing strikes me as pretty pointless when it is expended (as here) on performances by artists who are still active and quite capable of recording them in authentic stereoisim.

Despite all this carping, however, the programs themselves are by no means uninteresting, particularly to historically minded discophiles: Dragon's for its first examples of the conductor-orchestrator's richly colored transcriptions (of Gade's *Jalousie*, Ponce's *Estrellita*, Padilla's *El Relicario*, etc.), which remain dramatically persuasive, although his straight performances (of *España*, the *Ritual Fire Dance*, and *Goyescas Intermezzo*) reveal all the mannerisms and little of the assurance that distinguish Dragon's matured career; Wagner's for delightfully vivacious readings of the livelier Foster songs, including the seldom heard *Katie Bell* and *De Glendy Burke*, which are far superior to the overly sentimentalized lyric airs; Baxter's as a pioneering, if now seemingly tentative, exploration of the currently fashionable pseudo-exotic and prominent-percussion genres. R.D.D.

"The Versatile Burl Ives." Burl Ives; Anita Kerr Singers; Orchestra, Owen Bradley, cond. Decca DL 4152, \$3.98 (LP); DL 74152, \$4.98 (SD).

Burl Ives, that citizen of many parts, returns to vinylite in an eclectic program that ranges from calypso through country to authentic American folk song. Ives is, as ever, wholly engaging. He has not chosen his selections with noteworthy

wisdom, however. For example, his version of the rollicking Bahamian *Delia* is a feeble failure, and he is dismally incongruous in a religious song titled *The Royal Telephone*. Nonetheless, Ives fans—and their name is legion—will find a gem or two. The chorus and orchestra clutter the recital with saccharine backdrops, but do no real harm. Stereo wins the nod, although the sonic qualities of the LP will disappoint no one. O.B.B.

"Rockin' and Drinkin' Music." Symphony de Paris, Jacques Metehen, cond. Norwood NS 100, \$5.98 (SD). A new company devotes its first release to "originals" by its director, Roy Haney, known mainly by his radio and TV background scores. Skillfully enough turned, if far too elaborately orchestrated (and further "enhanced" by naïve natural-sound effects), these pieces are seldom as humorous as the determinedly comic titles and annotations would suggest, although at their best (*Overture for a Waitress Working Overtime*, *Demon Rum*, a *Bar Fly* travesty of Rimsky's *Bee*, and a heavily derivative Leroy-Andersonish *Off the Wagon* polka) they do boast considerable vivacity. The real distinction here is supplied by the brilliantly precise, colorful, and quite straight-faced performances by a forty-four-man orchestra, vibrantly recorded in well-spread and differentiated stereoism, but too closely miked for much natural acoustical warmth. R.D.D.

"Basin Street East." Peggy Lee; Orchestra, Joe Harnell, cond. Capitol T 1520 \$3.98 (LP).

My enthusiasm for these Peggy Lee performances is several decibels lower than that of her enraptured night club audience, whose frenzied applause has been liberally included on this disc. Usually a fine and dependable singer, Miss Lee has adopted, perhaps especially for this occasion, a vocal style that sounds distressingly artificial. It is compounded of coy vocal tricks, a breathy delivery (I assume this is supposed to sound sexy), and what so many singers consider their natural prerogative, the extemporaneous aside. It all gets pretty tiresome. In addition, I find much of her material banal, and in the case of the Rodgers-Romberg-Friml medley, ill-advised. Even in *Fever*, a Lee staple, she fails to generate as much heat as in the torrid version to be heard on *All Aglow Again* (Capitol T 1366). Miss Lee is shored up by the often exciting work of Joe Harnell and his musicians—for me, the best thing on the record. J.F.I.

"Sea Shanties." Male Chorus of the Robert Shaw Chorale, Robert Shaw, cond. RCA Victor LM 2551, \$4.98 (LP); LSC 2551, \$5.98 (SD).

From a purely vocal standpoint, it would be almost impossible to fault this album of hauling, capstan and windlass, foc'sle, and historical sea shanties. The male chorus has been drilled to respond to its leader's every demand and it produces a lovely resonant sound, both in those shanties sung *a cappella* and those with guitar accompaniment. At all times, the interior choral balances are beautifully contrived and controlled. But having admired all this, I can't become very enthusiastic about the group's exposition of the material. The bloodless and sophisticated performances reveal very little of the lustiness inherent in these songs of the sea. J.F.I.



RADIO SHACK Corp.

730 Commonwealth Ave., Boston, Mass.

CIRCLE 83 ON READER-SERVICE CARD

See the greatest line of electronics...

top quality equipment and parts for "pro," amateur, music lover! Mail coupon and receive Radio Shack's exciting 1961-62 all-new Buying Guide of 336 pages PLUS all value-packed supplements for one full year.

You'll see famous brands and our own private label Stereo, Hi-Fi, Ham Radio, Tapes, Records, 30 pages of easy-to-build kits: Your satisfaction guaranteed.



New No Money Down Credit Terms!

MAIL THIS COUPON TODAY

RADIO SHACK Corp. Dept. 61J14C
730 Commonwealth Ave., Boston 17, Mass.

Gentlemen: Please send me Radio Shack's famous electronics catalogs for the next 12 months, all FREE and POSTPAID.

Name _____

Address _____

City & Zone _____ State _____

CIRCLE 83 ON READER-SERVICE CARD



CLEAR MIRROR-LIKE REPRODUCTION with

BURGESS MAGNETIC RECORDING TAPE

- ★ LOW NOISE LEVEL
- ★ HIGH SENSITIVITY
- ★ SUPERB FREQUENCY RESPONSE
- ★ UNIFORM, TROUBLE-FREE PERFORMANCE

Remarkable Burgess engineering developments have produced an audio tape of superlative quality.

1. Micro-finished surface and built-in lubrication eliminates tape squeal and reduces recording head friction.
2. Improved pre-coating process produces a superior bond, eliminating flake-off so that recording heads stay clean.
3. Revolutionary dispersion process produces tape with high sensitivity, extraordinary frequency response, eliminating print-through, and delivering mirror-like sound reproduction.

Nationally Advertised in top-flight consumer magazines read by tape recording enthusiasts.

BURGESS BATTERY COMPANY

DIVISION OF SERVEL, INC.

MAGNETIC TAPE DIVISION

FREEPORT, ILLINOIS NIAGARA FALLS, CANADA

CIRCLE 26 ON READER-SERVICE CARD

Manufactured by the makers of Burgess Batteries.



Introducing Jan Kit 41

a complete component speaker system in kit form for installation in your own cabinet or for custom installation where the very best sound is desired in minimum space.

Send for literature, installation & construction data.

Comprising the JansZen* Electrostatic mid & high frequency driver and our Model 350 Dynamic Woofer mounted on a 19½" by 16" panel for easy installation.



CIRCLE 61 ON READER-SERVICE CARD

NESHAMINY ELECTRONIC CORP. Neshaminy, Pennsylvania

"Percussion Italiano." Charles Magnante, accordion, and His Ensemble. Grand Award GA 257, \$4.98 (SD).

The leader's deft accordion is predominant here, but Magnante is given spirited if often highly mannered support by three mandolins, two guitars, bass, piano, and no less than four percussionists in Italian pop song arrangements which (except perhaps in *Mamma* and *Marina*) are rather incongruously overloaded with the sonic equivalents of junk jewelry. The curious blend of schmaltz, bounce, and clatter is somewhat drily but very vividly and stereoisotically recorded. R.D.D.

"Songs of the Spanish Civil War, Vol. 1." Pete Seeger and Group; Ernst Busch and Chorus. Folkways FH 5436, \$5.95 (LP).

I first heard the 78-rpm originals of this disc in the middle Forties and found them immensely moving. Pete Seeger and a small ensemble had cut "Songs of the Lincoln Battalion" in 1942 for the Asch label, and in 1940 Keynote had released "Six Songs for Democracy," recorded in Barcelona during the Spanish Civil War by a German chorus under Ernst Busch recruited from the International Brigades. Now, observing the twenty-fifth anniversary of the commencement of the Spanish Rebellion, Folkways has issued a reprise of both these renowned albums on a single LP.

From 1936 to 1939. Loyalist Spain was a political nightmare: Communists, Anarchists, Socialists, *et al.* spent at least as much time sabotaging each other as fighting the common enemy under Franco. But the Spanish struggle against Fascism struck a responsive chord, and eager young men poured into Spain from all parts of the world to take up arms for the Loyalists. These are their songs. The German entries are martial in tone and possess a sinewy class consciousness lacking in their American counterparts. To the Germans, Spain was just one more front in the unremitting struggle of the proletariat, and their songs reflect this. For the American volunteers, however, the struggle was a crisis of conscience, and their songs—*Jarama Valley*, *The Young Man from Alcalá*, etc.—tend to celebrate their own accomplishments. Among the German songs, incidentally, is the famous *Peut Bog Soldiers* and a lyric by the great poet Bert Brecht that—to put it charitably—is one of his least fortunate efforts.

Those songs not in English are translated in the accompanying booklet—sometimes unhappily. "*El pueblo madrileño*," for example, meaning simply "the people of Madrid," comes out "Madrid's anti-Fascist heroes." Throughout, one must allow for such excesses of political zeal. Nonetheless, through the muffled sound of this re-pressing and the disillusionments of twenty-five years, these songs can still evoke an emotional response. The men who fought in the line in Spain believed in their fight. Their ultimate military defeat and idealistic betrayal merely add another dimension to their tragedy. O.B.B.

"Accent." Latin Piano by Jan August; Orchestra. Mercury MG 20618, \$3.98 (LP); SR 60618, \$4.98 (SD).

There are one or two decidedly unconventional alliances in this excellent program of Latin-flavored music. Not the least surprising is the Russo-Latin partnership of both *Dark Eyes* and *Two Guitars*, or Mario Lanza's old ballad,

Be My Love, served up with a South-of-the-Border beat. The other numbers are in more conventional vein, and have been given a Latin accent many times elsewhere. Surrounded by violins, guitars, bongos, bass, and drums, August indulges in some very pretty pianism, although, for him, these seem to be rather subdued performances. Only in *Dark Eyes* and *El Cumbanchero* does he indulge in the sort of pyrotechnics for which he is so famous. The performances have a nice easy-to-dance-to beat, and they can also be recommended to those who prefer just to sit and listen. J.F.I.

"International Songs and Ballads." Frances Archer and Beverly Gile. St/And SLP 408, \$4.98 (LP); SLS 7408, \$5.95 (SD).

Unshamedly, Misses Archer and Gile devote their talents to the conversion of folk songs into art songs—and, on the whole, succeed. Their approach combines respect for the integrity of their material with a willingness to adapt it to broader horizons. Miss Archer's high soprano and Miss Gile's contralto neatly complement each other when they sing together, and each vocalist is a satisfying soloist. Their international program—which includes Yiddish, Japanese, Spanish, and German standards—is highlighted by a Chinese lullaby called *The Bamboo Flute* and an American spiritual, *Rock the Cradle, Mary*. The whole is a tasteful, musical—though not particularly moving—listening experience. The mono version rates high sonic marks, but the crisply separated SD is, save for a slight echo, superb. O.B.B.

"Viva! Montez." Bobby Montez and His Orchestra. World Pacific 1404, \$5.98 (SD).

One of the most enticingly danceable and varicolored Latin-American programs I've encountered to date. There are only five players here: Montez himself on vibes, Carlos Avelar on piano, a bassist, and two drummers, but they play with immense gusto and tonal piquancy, and for good measure some of them double as zestful vocalists. The materials (all composed by the gifted leader) are delightful too, particularly the bouncing *Tremendo Cha Cha*, *My Brazilian*, *Holiday in Havana*, and a more mannered and for once seemingly overlong yet very oddly rhythmized *But Heaven Knows*. The markedly stereoisotonic and vivid recording also is fine, but it is the musical spirit here which makes one shout "Viva, indeed!" R.D.D.

"Through Sick and Sin." Fay De Witt; Orchestra, Joe Harnell, cond. Epic LN 3776, \$3.98 (LP); BN 596, \$4.98 (SD).

There must be a reason, unknown to me, why male comedians always hurl their barbs in prose, while the female of the species prefer to lampoon their subjects in song. There come to mind Anna Russell, Beatrice Lillie, Kaye Ballard—and now Fay De Witt, a young lady who, in a series of comic ditties, pokes fun at some of our modern foibles. Miss De Witt can be pretty strenuous in her attempt to drive home her humorous shafts, and I think her more successful in those songs where she underplays her material. Among these are Harold Rome's *French with Tears*; her acidulous love affair with a tenant of one of Uncle Sam's housing projects, *543987642*; and her reminiscences about *The Old*

Pizza Maker. The Stock Report is pretty obvious, and *These Ghoulish Things* strikes me as decidedly unfunny in subject matter. A mildly amusing disc, which some may find more entertaining than I did. J.F.I.

"More Classical Music for People Who HATE Classical Music." Boston Pops Orchestra, Arthur Fiedler, cond. RCA Victor LM 2470, \$4.98 (LP); LSC 2470, \$5.98 (SD).

This is Fiedler's second recorded effort to combat aversion to classical music. The first, which appeared in 1954 as RCA Victor LM 1752 and is still in the catalogue, offered a great number of short snippets of music. This new album strikes me as much more sensibly planned. Each item played is either a complete entity, or a complete section of a larger composition. Two old Fiedler favorites, the overtures to Hérold's *Zampa* and Suppé's *Fatinitza*, should certainly appeal to even the most unreciprocative listener, and Tchaikovsky's Waltz from the *Serenade for Strings* and Grieg's *The Last Spring* should quickly break down any resistance that's left. I'm less enthusiastic about the inclusion of Liszt's bloated *Hungarian Rhapsody No. 6*.

The performances have all the usual Boston bustle, and they have been recorded in brilliant sound, the stereo edition in particular being a dazzler. And if you do like classical music, don't be put off by that title; this is a musical treat for you too. J.F.I.

"The Persuasive Trombone of Urbie Green and His Orchestra." Command RS 815, \$5.98 (SD).

Now that trumpeter Doc Severinsen has been honored with a gala album of his own, his no less ubiquitous, talented, and versatile trombonist colleague well warrants the same starring opportunity. Green plays superbly, as always, in both the suave and driving styles at his easy command; his featured solos and ensemble passages with three other trombones provide exceptionally rich sonorities to exploit the full-blooded, ultra-stereoisitic recording; and he is energetically backed up by a seventeen-man band. But arranger (and fellow trombonist) Bobby Byrne has been unable to come up with as imaginative or as well-varied scorings as those he provided for Severinsen: however, the soloist's own virtuosity is sure to warrant the analytical study of every trombone specialist. R.D.D.

"Brass Laced with Strings." Vic Schoen and His Orchestra. RCA Victor LSA 2344, \$5.98 (SD).

Most of the "stereo action" here (constant lateral motion of sound sources) is musically inane, although occasionally a pair of trumpets circling each other like wary puppies proves mildly amusing. But Schoen's interplays of brass and low string sonorities (with quartets of trumpets, trombones, and French horns pitted against a cello sextet) give considerable sonic distinction to the best of his not too fancy arrangements—an atmospheric *Summertime* in particular. Elsewhere there is effective contrast between the rich sentiment of *Hello Young Lovers, Trees*, etc., and the rowdiness of *And the Band Played On* and *By Myself*. Yet too often the brass tends to become raucous and the incessant to-and-fro motion detracts from rather than enhances the glittering clarity of the stereoism. R.D.D.

no record collection can be complete without
THE NO. 1 ALBUM OF THE YEAR!

ORIGINAL SOUND TRACK MUSIC

NEVER ON SUNDAY

FROM JULES DASSIN'S MOTION PICTURE
"NEVER ON SUNDAY"
Starring MELINA MERCOURI

MOTION PICTURE ACADEMY AWARD
WINNER FOR THE BEST SONG

UNITED ARTIST ALBUM
UAS 5070 (STEREO)
UAL 4070 (MONO.)

IT'S UNITED ARTISTS RECORDS ALL THE WAY!
729 SEVENTH AVE. • NEW YORK 19 N.Y.

CIRCLE 107 ON READER-SERVICE CARD

FAIRCHILD

COMPANDER®

FOR THE RECREATION OF ORIGINAL PERFORMANCE DYNAMICS

A new, exciting and completely different development from Fairchild... a product so unusual that we believe every serious audiophile will want to know about the Compander. (For your information we have prepared a fully detailed bulletin which is yours for the asking.)

Briefly, the Compander is an automatic dynamic sensing device that overcomes the controls placed upon both disc and tape recordings and thereby restores the full dynamic range of the original performance, as distinguished from the original recording.

Accomplished without the introduction of distortion of any type, the Compander can be easily integrated into any monaural or stereo quality component system. By freeing program material from the usual recording restraints the Compander brings you a giant step closer to the original performance.

One important note—the Compander has been developed and will be manufactured by our Professional Products Division. Production will therefore be limited and distribution will be made through selected Fairchild dealers who will be glad to demonstrate this remarkable development as well as take your orders for early delivery.

The Compander is priced at \$75.00

FAIRCHILD RECORDING EQUIPMENT CORP., 10-40 45TH AVE., LONG ISLAND CITY, N. Y.
CIRCLE 47 ON READER-SERVICE CARD

JAZZ



Cannonball Adderley and His Orchestra: "African Waltz." Riverside 377, \$4.98 (LP); 9377, \$5.98 (SD).

The two Adderley brothers, Cannonball on alto saxophone and Nat on cornet, are heard here with a big band conducted by Ernie Wilkins, playing arrangements mostly by Wilkins (two are by Bobby Brookmeyer). The Adderleys had a more varied background than most current jazzmen before they settled in New York's predominantly small-group surroundings, and they work well in a big-band setting. Both know how to develop a solo *with* a band rather than *against* it. Nat's crisp, economical playing, with its occasional suggestions of Clark Terry, is becoming increasingly interesting as he divests it of the busy trivialities it once had, while Cannonball is continuing to edit his playing in a similar manner. Cannon also shows an unexpectedly warm and lyrical ballad style in an affecting performance of *Smoke Gets in Your Eyes* which, all things considered, is the best piece on a disc that turns out to be rather limited despite the good work of the two featured soloists. Wilkins' arrangements are heavy and repetitious, and neither the Adderleys nor pianist Wynton Kelly, the only other soloist who gets much space, can completely obscure their routine qualities.

Big Bill Broonzy: "The Bill Broonzy Story." Verve 3000/04, \$25 (Five LP).

The day before Big Bill Broonzy was operated on for lung cancer in 1957 he completed the last of three recording sessions during which he talked informally about his life as a blues singer and the origins and development of the blues. He also reminisced about such blues-singing colleagues as Jim Jackson, Tampa Red, Leroy Carr, Big Maceo, Richard M. Jones, Leadbelly, Johnny Temple, Little Brother Montgomery, Georgia White, and Memphis Minnie. And he sang blues of all kinds, spirituals, work songs, pop songs—practically anything that might illustrate whatever point he wanted to make. The ten hours taped at these sessions have been edited to fit five discs, which provide an invaluable insight into a world that is only beginning to be opened up to outsiders. It is revealed here in the experience, the memories, and the singing of a man whose position in the post-Depression urban blues community is roughly equivalent to that of Bessie Smith among the "classic" blues singers of the Twenties. Broonzy's illness occasionally makes itself apparent in a harsh cough when he is talking or in a more moderate use of his voice than he might normally be expected to make.

But he constantly thrusts his pain aside and sings out with typical vigor and intensity. In many ways, this set parallels the recordings Alan Lomax made with Jelly Roll Morton for the Library of Congress in 1938 (disc jockey Bill Randle was the man behind the Broonzy production), throwing light on an era that is almost as misty as the old days in New Orleans that Morton described. But as a summation of Broonzy's work and as a documentation of latter-day blues, this set has great historical importance and is, at the same time, a delightfully entertaining collection.

Dave Brubeck Quartet: "Tonight Only." Columbia CL 1609, \$3.98 (LP); CS 8409, \$4.98 (SD).

This is a strange collection of odds and ends. Carmen McRae, an even unlikely Brubeck collaborator than Jimmy Rushing, is put through a variety of trials. They include a declamatory attempt to cope with a song Brubeck wrote in 1945, a more successful move into an artsy-folksy area in a song written by Brubeck and his wife, another work by Mr. and Mrs. B. that strains her agility, and a fairly good attempt at rhythm singing in a duet with drummer Joe Morello. The selections by the quartet alone might be described as middle area Brubeck—lacking the soaring flights possible under the impetus of Paul Desmond's playing, but avoiding the depths of banality that Brubeck can plumb in his thumping moods. The relatively high points are a piece written by bassist Gene Wright featuring his deft plucking, and another, by Brubeck, in much the same vein.

Kenny Drew: "Undercurrent." Blue Note 4059, \$4.98 (LP).

Pianist Kenny Drew forms a tremendously potent rhythm section with Sam Jones, bass, and Louis Hayes, drums, and distinguishes himself as a soloist by avoiding the current jazz piano banalities. He is a strong soloist who can dig in with both hands for dark, gutty effects, or play one hand against the other to achieve airily light textures. But the potential interest of this disc is diminished by the work of Freddie Hubbard, trumpet, whose solos constantly deteriorate into a series of empty runs, and Hank Mobley, a bland and uninteresting tenor saxophonist.

The John Glasel Brassset. Jazz Unlimited 1002, \$4.98 (LP); \$5.98 (SD).

Glasel's group on one side of this disc consists of two trumpets, trombone, alto horn, tuba, bass, and drums. Dick Cary's

five closely woven arrangements for this ensemble lend themselves readily to swinging performances, and they provide Glasel with good opportunities for displaying his clean, brassily lyrical playing. On the other side a French horn replaces the alto horn, and the writing by Glasel, Johnny Carisi, and Bill Russo is far less provocative. Glasel, however, continues to play well. There is a great deal of low pressure pleasure here, particularly in the Cary arrangements.

Johnny Griffin: "Change of Pace." Riverside 368, \$4.98 (LP); 9368, \$5.98 (SD).

For once, an album title can really be taken at face value. This is a change of pace—not simply for tenor saxophonist Johnny Griffin but as a jazz approach in general. Griffin has set up two situations in these selections: in one, he is heard with drums and two string basses, one bowed, the other plucked; in the second, Julius Watkins' French horn is added to the ensemble. Of the two, the group with Watkins is easily the more interesting because of the variety made possible by the contrast of the woody sound of the horn against Griffin's sharp, cutting saxophone, and because Watkins himself is an unusually consistent and provocative musician. The two basses create a strong background, and seem to point to a successful solution to the problem of supporting jazz horns with strings—the basses have the strength and the rhythmic force to fit into a jazz context, which the customary string quartet does not. The selections without Watkins have their moments, but much of the time they are, by force of circumstances, simply showcases for Griffin's blowing. Even these pieces, however, help to make this collection an unusually imaginative experiment.

"Gut-Bucket Trombone." Riverside 150, \$4.98 (LP).

Two Midwestern trombonists of the Twenties and early Thirties, Roy Palmer and Ike Rodgers, are featured in this collection of reissues from the Champion and Paramount labels, recorded in 1929 and 1931. Palmer plays with the State Street Ramblers, a recording name used by pianist Jimmy Blythe and a group of Chicago South Side musicians. They play wonderfully lusty, carefree, stomping jazz, urged on by shouted encouragements. Palmer's trombone style is driving, stabbing, and rough-toned, much like the present-day work of Jimmy Archey. The group also has a remarkable kazoo player, possibly Albert Bell,

who not only takes solos that have real jazz validity but even gets involved in a kazoo and clarinet duet that comes off very successfully. The bare, economical style of Rodgers, a St. Louis trombonist, is interesting in its very starkness. It is a limited manner, however, and it is just as well that on four of his six selections he plays accompaniment to a pair of blues singers—Edith Johnson and Alice Moore.

Lionel Hampton: "Swing Classics." RCA Victor LPM 2318, \$3.98 (LP).

In retrospect, the pure joy that leaps from the series of records made by Lionel Hampton's studio groups between 1937 and 1940 is tremendously impressive. Scarcely a side turned out by Hampton in those days fails to glisten with lighthearted, swinging spirit. Like the two discs that have preceded it (on the Camden label), this collection is a complete delight from beginning to end. Of course, Hampton always took a superb set of musicians into the studio with him on these sessions but, as experience has often shown, the presence of topnotch musicians does not necessarily result in topnotch performances. Hampton seemed to have an ability to instill a feeling of excitement and well-being in his musicians. Among the sidemen heard in this collection are Cootie Williams, Johnny Hodges, Lawrence Brown, Jess Stacy, Jonah Jones, Ziggy Elman, Chu Berry, Dizzy Gillespie, Benny Carter, Coleman Hawkins, Ben Webster, Charlie Christian, Red Allen, J. C. Higginbotham, Edmond Hall, and Nat Cole. And, of course, Hampton—on vibes, on drums, on piano, and singing.

Jon Hendricks: "Evolution of the Blues Song." Columbia CL 1583, \$3.98 (LP); CS 8383, \$4.98 (SD).

Jon Hendricks, the lyric-writing member of the Lambert, Hendricks, and Ross trio, wrote and produced this presentation of the origin and development of the blues for the Monterey Jazz Festival in 1960; he re-created it at Newport this summer. Casting himself as narrator and using cadenced, rhymed lines in his narrative, Hendricks very simply, directly, and effectively sketches the sources of the blues, introducing examples of the African chant, calypso, and spiritual, and then moving quickly up to various types of vocal blues, to an instrumental blues, and to the relationship of blues to gospel song. The two blues singers who provide most of the illustrations, Big Miller and Jimmy Witherspoon, are adequate for the purpose; their effectiveness is implemented tremendously by the presence of Ben Webster, noodling provocatively on his tenor saxophone. Hendricks himself, in fact, is a more effective singer despite an extremely limited voice, and he projects a couple of songs with much more presence than Miller, Witherspoon, or Hannah Dean, who does the spiritual and gospel singing. Despite its limitations, this is an entertaining and informative introduction to the blues.

Richard "Groove" Holmes: "Groove." Pacific Jazz 23, \$4.98 (LP).

Although this disc is offered as an introduction to Holmes, an organist who is a protégé of Les McCann, and McCann himself plays piano with the group, the interest generated here springs from two other musicians—the veteran Ben Webster on tenor saxophone and a newcomer, Lawrence "Tricky" Lofton, a trombonist.

Sonny Stitt / A slashing, exciting tenor battle between Sonny Stitt and Johnny Board, recorded in person during a scintillating Chicago performance. Argo LP 683

SONNY STITT
at the D.I. lounge



The Jazztet & John Lewis / An unbeatable combination. The music of John Lewis, arranged by him especially for the Jazztet and featuring great performances from Art Farmer and Benny Golson. Argo LP 684

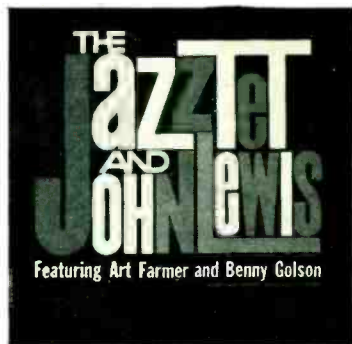

BRILLIANT!
the trumpet of **DON GOLDIE**

Don Goldie / Goldie, Jack Teagarden's dynamic trumpeter, makes his first album a notable and movingly lyric experience. Argo LP 4010



A SWINGING THREESOME
ON
ARGO!

AVAILABLE IN STEREO, OF COURSE, AT NO EXTRA CHARGE

ARGO RECORDS 2120 SOUTH MICHIGAN AVENUE, CHICAGO 16, ILLINOIS
CIRCLE 8 ON READER-SERVICE CARD

trade-in

**YOUR PRESENT HI-FI
EQUIPMENT FOR THE
NEW**

SHERWOOD

**S-3000 III
FM Multiplex Stereo Tuner**



Features 0.95 uv sensitivity; inter-channel hush; "Acro-Beam" tuning eye; AFC; "Corrective" inverse feedback; Front panel level and stereo balance controls; MPLX adaptor mounts on chassis.

Buy SHERWOOD at
**AUDIO EXCHANGE and Take
Advantage of
AUDIO EXCHANGE's UNIQUE**

Services Such As:

- ✓ Fabulous Trade-Ins—
We specialize in trading
by mail
- ✓ Exclusive Trade-Back Plan
- ✓ Time Payment Plan
(Metropolitan N. Y. Customers Only)
- ✓ Experienced and Specialized
Hi-Fi Consultants
- ✓ Famed Hi-Fi Service Laboratory
- ✓ Custom Installations by Experts
- ✓ Hi-Fi Is Our Only Business

Write Dept. HF-91 for our unique
Trade-Back plan, Trading Information
and Catalog

audio exchange

The Hi-Fi Trading Organization
153-21 Hillside Ave., Jamaica
AXtel 7-7577

203 Mamaroneck Avenue White Plains, N Y WH 8-3380
1065 Flatbush Avenue Brooklyn, New York IN 9-6200
451 Plandome Rd. Manhasset, L I MA 7-5737

CLOSED SUNDAY AND MONDAY

In this company, Webster sounds like a musician from another world, moving in on his solos with such commanding authority that the thin, bland playing of Holmes and McCann seems even paler by contrast. Lofton has a big, rough tone combined with an approach somewhat like that of J. J. Johnson—an odd and promising mixture of old and new trombone styles—and he has a strongly swinging instinct. McCann avoids most of his usual soul jazz clichés and plays in a quiet, unobtrusive, and unimpressive fashion, while Holmes's organ serves largely as a muddying influence on the ensembles.

James P. Johnson: "Backwater Blues." Riverside 151, \$4.98 (LP).

The beauty of piano rolls for the present-day listener—possibly the only beauty—is that they can be transcribed to discs with all of today's recording benefits, thereby allowing us to hear a pianist of the Twenties, such as James P. Johnson, under far better audio circumstances than records made in those days could offer. Granted, there are limitations to what can be put on a piano roll, particularly in matters of shading; still, these performances have a great deal of vitality and a becomingly relaxed, confident attack. The program includes four of Johnson's compositions, including two rags and his popular *Charleston*, Bessie Smith's *Backwater Blues*, and several vaudeville-istic tunes of the Twenties. Johnson plays them all with a romping charm that makes even the most routine of them seem to be of lively interest.

Memphis Slim: "Chicago Blues." Folkways FG 3536, \$5.95 (LP); "Just Blues." Prestige-Bluesville 1018, \$4.98 (LP).

Peter Chatman, who is known professionally as Memphis Slim, is a potent, driving pianist and a blues singer of varying merits. The Folkways disc is notable for the lusty piano work, but his singing in this set tends to be high, hard, and strained. He is a far better vocalist than these performances would indicate, and on the Prestige-Bluesville disc he shows what he can do as a singer when he is in the mood, using his big voice perceptively and meaningfully. The Prestige set is, in general, more relaxed than the Folkways, and presents Slim as a blues *artist*, as opposed to his role of entertainer on the former label. He plays both roles extremely well, and on the Prestige selections he gets outstanding assistance from guitarist Lafayette Thomas.

Little Brother Montgomery: "Blues." Folkways FG 3527, \$5.95 (LP).

Eurreal Montgomery is an unreconstructed blues singer and pianist. He makes no concession to the considerations of entertainment. Take him or leave him, he is what he is. And what he is, is a remarkably moving blues man. He sings in a high, plaintive, rough voice, using occasional shouted phrases and extending lines with a strong vibrato. His piano accompaniments are spare and purposeful, well suited to his stark style of singing. But when he undertakes piano solos his limitations are apt to show through. This disc is rather strong stuff for the casual listener, but anyone who has been reasonably well grounded in the blues should appreciate a singer who has remained remarkably unspoiled through his years up north in Chicago.

Kid Ory: "Kid Ory! Favorites!" Good Time Jazz 12041/42, \$9.98 (Two LP); 10041/42, \$11.98 (Two SD).

The Ory group in these 1956 performances includes Alvin Alcorn on trumpet; Phil Gomez, clarinet; Cedric Haywood, piano; Julian Davidson, guitar; Wellman Braud, bass; and Minor Hall, drums. It has the ensemble chunkiness always characteristic of Ory's groups, although Braud gives the rhythm section a lighter, more flexible feeling than such Ory bassists as Ed Garland have provided. Alcorn plays an adequate lead trumpet, but the only real sparkle in the front line is provided by Gomez, a clarinetist with a singing tone and an airy attack who deserves greater recognition. Ory, who was sixty-nine at the time of the recording, plays his trombone with undimmed gusto, but age had begun to reduce his limited singing voice to something less than serviceability. This two-disc set is billed as consisting of "seventeen famous selections associated with" Ory, so the warhorses are trotted out and paraded around once more. But this group fails to give them any new distinction.

Django Reinhardt: "Djangology." RCA Victor LPM 2319, \$3.98 (LP).

Surprisingly, this is not a reissue. It is a set of performances by Reinhardt and violinist Stephane Grappelly, *not* with the Quintet of the Hot Club of France, as the cover blandly claims, but with three Italian musicians. The recordings were made privately in Rome in 1949 and 1950 and, allegedly, have not been released previously. Certainly they have never appeared in the United States. Both Reinhardt and Grappelly are in fine form, and the Italian pianist, bassist, and drummer back them up capably. The selections are a mixture of familiar Reinhardt works of the past—*Minor Swing*, *Djangology*, *Swing 42*, *Honey-suckle Rose*—and pieces that are not so well known in the Reinhardt versions—*Lover Man*, *Beyond the Sea*, *Ou es-tu mon amour*, *Mentilmontant*. (*I Saw Stars*, listed as the third number on Side 2, turns out to be *I Got Rhythm*.) The recording is somewhat tubby but it does not obscure the playing of either Reinhardt or Grappelly. Reinhardtians and anyone else interested in melodic, swinging jazz will greet this set with a real welcome.

Randy Weston: "Live at the Five Spot." United Artists 4066, \$3.98 (LP); 5066, \$4.98 (SD).

Weston, a pianist who has been growing steadily as a strong, individualistic, assured musician, has the even stronger, more individualistic, and almost arrogantly assured company of Coleman Hawkins on this disc, recorded at the Five Spot in New York under circumstances which, the liner notes proudly point out, were extremely hectic and quite unrehearsed. Experience would suggest that the results ought to be terrible but, at least so far as Weston and Hawkins are concerned, they are far from it. They play with tremendous strength and fervor. Kenny Dorham and Clifford Jarvis are also present and are relatively ineffective, but little is heard from them. Brock Peters, a singer, turns up in a slow, ponderous lament that makes harrowing listening but, fortunately, once he gets finished with his long plaint the instrumentalists are able to get things back on the track.

JOHN S. WILSON

CIRCLE 15 ON READER-SERVICE CARD

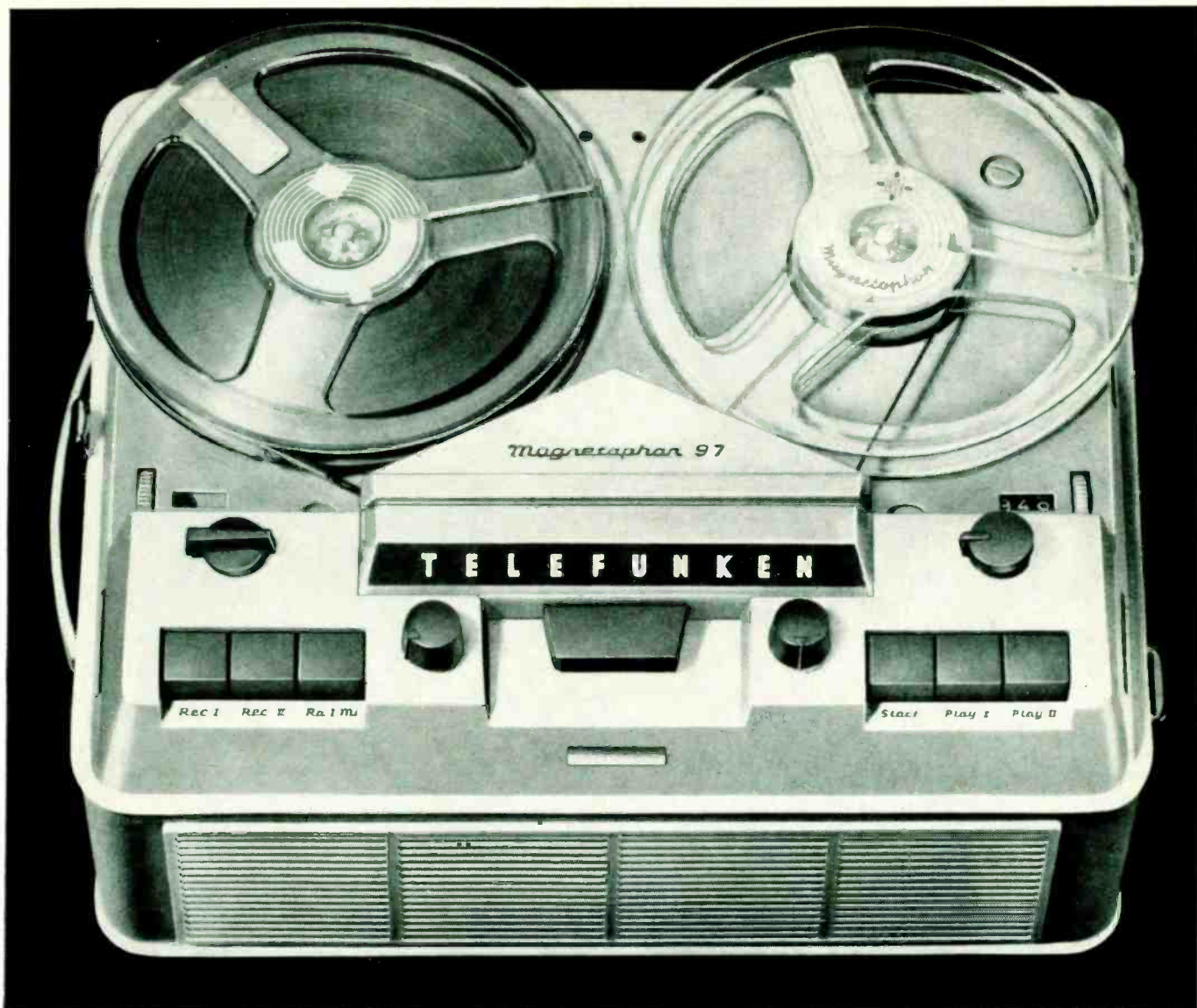

Now . . . listen to

TELEFUNKEN

First name in tape recording . . . last word in audio engineering

From TELEFUNKEN, the inventors of tape recording, comes the new M-97, a complete sound system in itself. Your ear will tell you it was worth waiting for, the specs will tell you why. Records and plays 2 track and 4 track stereo and monaural, at all three speeds. Takes up to 7-inch reel.

SPECIFICATIONS: Frequency response: 30-18,000 cps at 7½ ips; 30-16,000 cps at 3¾ ips; 30-9,000 cps at 1⅞ ips. Wow and flutter: under .15% at 7½ ips. Signal-to-noise ratio: 46 db. Crosstalk: 53 db. Timing accuracy: within less than 0.2%. Power requirements: 110 or 220 volts, 60 cycles, 65 watts.

FEATURES: Dual pre-amps and power amps; special elliptical speakers (8"x3½") for optimum radiation of high and low frequencies, completely contained; D77 Dynamic microphone; electronic eye level indicator; monitoring; counter; automatic end stop; pause button. Size: 8"x12"x16". Weight: 24 lbs. Complete with handsome carrying case . . . \$399.95.

Other Telefunken Tape Recorders: MODEL M-96: Plays 2 track and 4 track stereo and monaural, records monaural only. Other features same as M-97. With microphone, \$269.95. MODEL M-85: A fine instrument for recording and playing monaural only. 6 watt power output of power amp, 7"x4" elliptical speaker. With microphone, \$299.95.

SEE THESE AND 4 OTHER FINE TELEFUNKEN TAPE RECORDERS FROM \$199.95 UP
Visit Your Telefunken Dealer or Use Handy Coupon Now!

AMERICAN ELITE, INC., 48-50 34th St., Long Island City, N.Y.

Telefunken Sales and Service Headquarters for over a decade
CIRCLE 5 ON READER-SERVICE CARD



Model D77 Stereo double dynamic microphone. Consists of two precision-balanced microphone systems, which can be positioned at 60° to 180° angle, can operate up to 8 feet apart. With matching transformer for any kind of stereo recording. Included with M-97 Tape Recorder. Alone . . . \$59.90.



AMERICAN ELITE, INC., Dept. 30
48-50 34th Street,
Long Island City, N. Y.
Gentlemen:

Please send me free brochures on TELEFUNKEN TAPE RECORDERS, and name of TELEFUNKEN DEALER nearest me.

Name _____

Address _____

City _____ Zone _____ State _____

These Best Sellers
NOW ON
STEREO TAPE

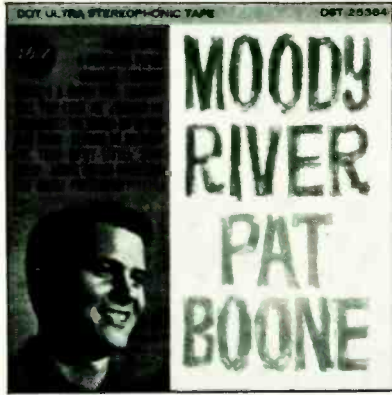

DST-25384 MOODY RIVER Pat Boone



DST-25389 "YELLOW BIRD" Lawrence Welk

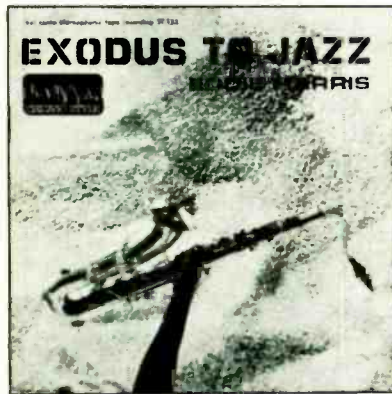

ST-133 EXODUS TO JAZZ Eddie Harris

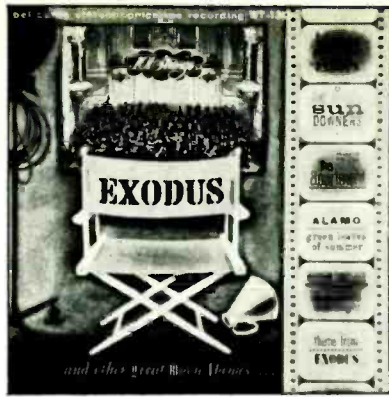

ST-130 EXODUS—101 Strings

Bel Canto offers the finest library of high quality Stereo Tapes available. Top artists—Top selections ranging from the great Classics to the latest Jazz and Popular albums. Only stereo tape provides the exciting full dimension of sound for your listening pleasure.



ST-90054 TCHAIKOVSKY— 1812 OVERTURE



ST-9000 BEETHOVEN—WELLINGTON'S VICTORY



DST-25016 GOLDEN INSTRUMENTALS Billy Vaughn

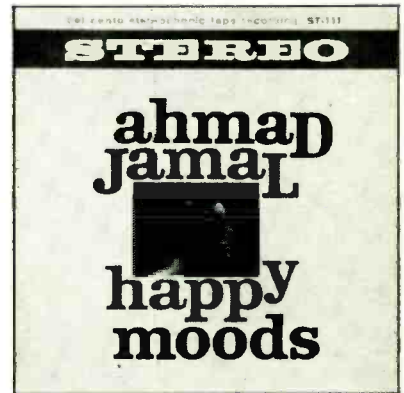

ST-111 HAPPY MOODS - Ahmad Jamal



ST-6000 LATIN PERCUSSION David Carroll

These superb recordings are available from hundreds of popular, jazz, and classical albums in the vast Bel Canto library. Write today for catalog H-12 of all Bel Canto hits!



bel canto STEREOGRAPHIC RECORDINGS

1977-1985 McALLISTER AVE. COLUMBUS 5, OHIO

a subsidiary of Thompson Rama Woolldridge Inc.





the **Tape Deck**

Reviewed by R. D. DARRELL

The following reviews are of 4-track 7.5-ips stereo tapes in normal reel form.

BEETHOVEN: *Sonatas for Piano: No. 12, in A flat, Op. 26 ("Funeral March"); No. 23, in F minor, Op. 57 ("Appassionata")*

Sviatoslav Richter, piano.
● ● RCA VICTOR FTC 2069. 42 min. \$8.95.

R Tape collectors who have met the fabulous Richter only in his Brahms Second Concerto have known only flashes of his most distinctive musical personality. To apprehend his true stature one must hear the present solo sonatas. To the relatively early Op. 26, known best for its *marcia funebre sulla morte d'un eroe*, and to the familiar mid-period *Appassionata* he brings electrifying freshness, expansive eloquence, blazing but always perfectly controlled power, and above all a sense of magisterial authority. It's been many years since I have been so immediately and consistently spellbound by any pianist, and never before have I been so convincingly persuaded that the stereo medium is as vital for a solo instrument as it is for large ensembles and stage works. For, in contrast to the somewhat uneven recording of the Brahms concerto, the technology here achieves a vivid re-creation of Richter's superbly colored and shaped playing. There have been so few outstanding solo piano reels that it's not enough to acclaim this as the best of them: it must be hailed as one of the towering triumphs of the whole tape repertory.

BEETHOVEN: *Symphonies: No. 3, in E flat, Op. 55 ("Eroica"); No. 8, in F, Op. 93. Overtures: Fidelio, Op. 72; Coriolan, Op. 62; Die Geschöpfe des Prometheus, Op. 43*

Orchestre de la Suisse Romande, Ernest Ansermet, cond.
● ● LONDON LCK 80066 (twin-pack). 91 min. \$11.95.

R I relish Ansermet's Eighth because he is one of the few conductors who captures both the radiant warmth and the gusto of this delectable "little" symphony. His *Coriolan* and *Prometheus* Overtures, too, are played and recorded as well as I've ever heard them. The *Eroica*, however, is more idiosyncratic, and is handicapped by the same lack of sonic weight and conceptual grandeur noted in Ansermet's Ninth. Yet I am not at all conscious here of any channel imbalance or loss of low frequency definition, mentioned by some reviewers of the disc edition. Whatever sonic shortcomings there may be here stem, in my opinion, neither

from the orchestral playing (which is resonant) nor from the recording as such, but entirely from the lack of an adequately spacious acoustical ambience.

It would be futile to suppose that as a complete series Ansermet's nine Beethoven symphonies would be the first choice of most collectors. But it would be a great pity if the somewhat lukewarm reception of the best of them, or even the justified criticism of the Third and the Ninth, should discourage their careful study. The oftener I hear them, the more forcibly I am impressed by the illuminations provided by even the most radical of Ansermet's departures from orthodoxy. His distinctively individual French-Swiss approach may be startling at first encounter, but in many ways it is one of the most classically lucid and vividly personal on records. Every performance in the series reveals unsuspected felicities in the familiar scores and is highly provocative. Now that the series is complete on tape I strongly recommend that every catholic Beethovenian investigate them for a novel and stimulating reexperience of the masterpieces themselves, and for an exciting encounter with one of the most vital interpreters of our day.

BRAHMS: *Concerto for Violin and Orchestra, in D, Op. 77*

Isaac Stern, violin; Philadelphia Orchestra, Eugene Ormandy, cond.
● ● COLUMBIA MQ 374. 40 min. \$7.95.

Although the early stereo Heifetz-Reiner version remains in print in RCA Victor's 2-track catalogue, the only 4-track taping of this concerto available until now has been that by Morini and Rodzinski for Westminster—the distinctively feminine and chamber music qualities of which may not be to everyone's taste. The need for a magisterial, large-scaled modern taping is magnificently met by Stern and Ormandy, in this assured, tautly muscular, full-blooded performance. Soloist and orchestra have seldom sounded to better advantage than they do here: their broad flow of richly colored sonorities and superb sense of continuity carry the listener along irresistibly, and even the cadenzas (Kreisler's in the first movement, Stern's own modification of Joachim's in the finale) seem perfectly integrated in the work as a whole. The stereo sound is powerful and reverberant.

DEBUSSY: *La Mer*
†Strauss, Richard: *Don Juan, Op. 20*

Chicago Symphony Orchestra, Fritz Reiner, cond.
● ● RCA VICTOR FTC 2057. 41 min. \$8.95.

As Robert C. Marsh predicted, the tape

version of this coupling definitely does show a sonic improvement over the discs, especially in its elimination of the tubiness and lack of bite in the stereo disc version of *Don Juan*. Indeed there is a sumptuously rich, powerfully incisive orchestral sound here, lending conviction to Reiner's more somber than usual but highly evocative *Mer* as well as to the overtly dramatic contrasts of the Strauss tone poem. We have had a fine taping of Debussy's masterpiece before (by Ansermet for London), but Reiner's is distinctively different: less Gallic and impressionistic but no less valid. His robust *Don* is to my ears markedly preferable to earlier reels by an overemotional Stokowski (Everest) and a Szell somewhat lacking in vigor. (Epic).

DVORAK: *Slavonic Dances, Op. 46; Op. 72*

†Smetana: *The Bartered Bride: Overture; Polka; Furiant; Dance of the Comedians*

Czech Philharmonic Orchestra, Karel Sejna, cond. (Dvořák). Prague National Theatre Orchestra, Zdenek Chalabala, cond. (Smetana).
● ● ARTIA ASTB 504 (twin-pack). 91 min. \$11.95.

I've relished this tape with such delight that I feel quite unable to analyze its charms dispassionately, much less to haggle over any possible flaws. Undoubtedly the Czech orchestras here are less distinguished by polish, precision, and propriety than many other more famous European and American ensembles. But they play with such enthusiasm and spicy piquancy, and their conductors obviously understand and love the music so well, that the listener can only be carried away by them. Certainly I have never heard the galvanic *Bartered Bride* overture and dances played more idiomatically and excitingly than by Chalabala. And while I no longer have the definitive Talich LPs of the *Slavonic Dances* available for direct comparison (his last edition, reissued by Parliament), Sejna's readings seem no less spontaneous, high-stepping, and vivacious. I am further intoxicated by the recorded sound itself, which unlike Artia's Russian masters is markedly stereoisitic, brilliant, and enhanced by the reverberance of a large, acoustically warm auditorium.

Quite possibly some may find that there are excessive color and dynamic contrasts here; certainly the percussion is attacked with a gusto which may seem overexuberant to more inhibited conductors and audiences. But what great fun it is! And how much more dazzlingly kaleidoscopic the Dvořák dances seem when they can be heard in complete, endlessly fanciful sequence rather than in a few scant selections!

In short, the present release ranks

try triton tape

If the quality of Triton Magnetic Recording Tape is deficient for any reason whatsoever, we will replace it with whatever brand you prefer. A complete no-risk Guarantee Certificate is included with every reel. For clean, full-response recordings that only a quality tape can give, try Triton.

Write for your free copy of *The Triton Story*.



TRITON ELECTRONICS, INC., DEPT. H-9
62-05 30th Avenue, Woodside 77, N. Y.
CIRCLE 106 ON READER-SERVICE CARD

high among my personal Delectable Mountains in the tape repertory. I can only hope that many other listeners will share my relish and derive as much stimulation and solid satisfaction from these apotheoses of the incomparable Czech musical spirit.

GOULD: *Fall River Legend: Ballet Suite. Interplay for Piano and Orchestra. Latin-American Symphonette: Tango and Guaracha*

Morton Gould and His Orchestra.
• • RCA VICTOR FTC 2061. 44 min. \$8.95.

To me, Gould's sometimes somber, sometimes folksy music for a ballet based on the Lizzie Borden case seems a kind of poor man's *Appalachian Spring* with little of Copland's tenderness or passion. Yet probably it will have considerable appeal to those who know the actual De Mille choreography, and in any case it is good to have an authoritative composer's version of the widely admired concert suite hitherto represented (on discs only) by Hanson and Mitropoulos editions. What surprises me more than my lukewarm reaction to Gould's most ambitious work is how well his less pretentious concerto-ballet *Interplay*—and even the slighter, almost salonish, Latin-American pieces—stand up. Fine tunes, immense verve, and an uncommonly imaginative command of piquant orchestral colorings make these great fun to hear and rehear, especially when they are played as engagingly (and as brilliantly in the solo piano role) as Gould himself plays them. They are recorded in sparkling stereo.

MASCAGNI: *Cavalleria rusticana*

Giulietta Simionato (ms), Santuzza; Anna di Stasio (c), Manma Lucia; Mario del Monaco (t), Turiddu; Cornell MacNeil (b), Alfio, *et al.* Chorus and Orchestra of L'Accademia di Santa Cecilia (Rome). Tullio Serafin, cond.
• • LONDON LOH 90032. 76 min. \$9.95.

Sonically the best of the *Cavalleria* recordings, the version's rich vocalism, finished orchestral playing, and unexaggerated but effective stereoism are even more evident on tape than on discs (and here there is happily no superfluous "filler" in the form of the disc album's coarse Italian song program by Del Monaco at his worst). Unfortunately, however, the performance itself isn't notably persuasive or dramatic. Unlike the perhaps overly melodramatic companion taping of *Pagliacci*, last February, this one lacks vitality and impact. Probably no conductor alive today knows the music better than Serafin, but his pace is very leisurely indeed, and he seems to expend his primary attention on relatively minor details. Simionato sings admirably, but never brings Santuzza to real life; Del Monaco bawls lustily enough, but neither he nor the more restrained MacNeil seem personally involved in Turiddu's or Alfio's tragedy. I hope that there will be a more exciting *Cavalleria* on tape before long, but meanwhile this one has many musical and technical attractions to compensate for its dramatic deficiencies and for the slight intrusion of background noise in the lower-level

passages—the only flaw in an otherwise transparent recording.

MOZART: *Le Nozze di Figaro*

Lisa della Casa (s), Countess; Hilde Gueden (s), Susanna; Suzanne Danco (s), Cherubino; Alfred Poell (b), Count Almaviva; Cesare Siepi (bs), Figaro; Fernando Corena (bs), Bartolo; *et al.* Chorus of the Vienna State Opera. Vienna Philharmonic Orchestra, Erich Kleiber, cond.

• • LONDON LOV 90008. Two reels: approx. 91 and 90 min. \$25.95.

Since over six years have gone by since this "miracle" recording first appeared on LPs, it may be well to remind collectors that the performance was greeted with resounding applause on all sides. I couldn't concur more heartily, and can only add that the tape processing is a model of its kind, and that these reels provided the shortest and most delightful three hours I've ever spent listening to a single work. For songfulness that only can be called heavenly, wit at its liveliest, ensemble and orchestral writing that has never been matched for inventiveness, *The Marriage of Figaro* would seem to defy ideal performance. The miracle here is how close Kleiber and his forces come to this impossible ideal. The set includes an Italian-English libretto, and if the price seems formidable even in these inflationary days, I can assure you that no musical investment you can ever make will pay more satisfying dividends!

SCHUMANN: *Concerto for Piano and Orchestra, in A minor, Op. 54*
†**Grieg:** *Concerto for Piano and Orchestra, in A minor, Op. 16*

Leon Fleisher, piano; Cleveland Orchestra, George Szell, cond.
• • ERIC EC 812. 60 min. \$7.95.

Hearing this performance here for the first time I can now understand why it is preferred by many even to the "ideal" Lipatti version, which up to now (and despite its obvious technical age) has remained my own first choice. On tape Fleisher easily eclipses his competitors, the only serious one of whom is Van Cliburn (RCA Victor), whose uncommonly individual and Schumannesque reading has very special dreamily romantic charms, but less heroic nobility and bravura. Technically, too, the present recording is outstanding for the big, ringing qualities of both piano and orchestral timbres, ideally captured in broadspread stereoism, with warm, big-hall acoustics.

The Grieg concerto is played and recorded with equal éclat, but here the slighter music is less well suited to such robust dramatization. This is a more brilliantly impressive performance than any other on tape (not excluding Rubinstein's still-in-print 2-track RCA Victor version), but I prefer the smaller-scaled, more delicately lyrical, and more Norwegian-flavored Curzon-Fjeldstad taping for London, reviewed here last May.

"Bells Are Ringing" and "Irma la Douce" Selections. London Repertory Company, Bob Sharples, cond. Richmond RPE 45024. 39 min., \$4.95.
It may be getting a bit monotonous to

praise each new addition to Richmond's bargain-priced London versions of Broadway hits, but I'm impressed anew by their characteristic verve, the bright orchestral playing and recording, and the freshness of the non-"name" soloists (here Janet Blair in both works, with Ian Peterson in *Bells*, Gerry Grant and Dave Carey in *Irma*). Of course Miss Blair is no Judy Holliday or Elisabeth Seal, but she has a charming personality (as well as more voice); in *Irma la Douce* I found these performances more attractive vocally, if not necessarily theatrically, than those in the original Broadway-cast complete version.

"BMOC." The Brothers Four. Columbia CQ 381, 33 min., \$6.95.

The cryptic title is to be translated "Best Music On/Off Campus," and isn't *too* extravagant a claim, since the "Brothers" (Mike Kirkland, Dick Foley, Bob Flick, and John Paine) are as skilled and tasteful a vocal foursome as any university could muster from its under- or post-graduates. They have extremely pleasant voices, precision, and straightforwardness in their ensemble performances (there are few solos) of *I Am a Wandering Gambler*, *Riders in the Sky*, *A Pretty Girl Is Like a Little Bird*, and other quasi-folk and popular songs in which they accompany themselves on guitars, banjos, bass, and cymbal. The stereo recording is so expansively open that it would hardly seem necessary to employ such close miking as is used here; the fresh voices can stand it, but the ensemble blend would certainly be warmer in a more natural acoustical ambience.

"Brass Laced with Strings." Vic Schoen and His Orchestra. RCA Victor FTP 1072, 35 min., \$7.95.

Although the restlessly moving sound sources and occasional moments of raucousness are no less marked here than in the recent stereo disc version, they seem less annoying, while the richness of Schoen's brass and cello sonorities is even more sumptuous, and the subtleties of interplay between various types of muted and open horns are more clearly differentiated. Again top honors go to the expressively atmospheric *Summer-time*, *Trees*, and *Glud To Be Unhappy*; but *By Myself* and *The Band Played On* have a buoyancy in which the constant stereo "action" seems less superfluous.

"Cherry Pink and Apple Blossom White." Jerry Murad's Harmonicats. Columbia CQ 360, 28 min., \$6.95.

In the first of its new Columbia series, the popular harmonica trio produces its finest program to date, notable for the straightforward effectiveness of the arrangements and performances (the atmospherically varicolored *Polka Dots and Moonbeams*, *Lonely Love*, the vibrant *Mack the Knife*, and *Kiss of Fire* in particular), and outstanding for the boldly stereoisitic authenticity of the recording, especially of Don Les's properly subdued yet still impressively weighty bass part.

"Dedicated to You." Ray Charles; Orchestra and Chorus. Marty Paich, cond. ABC-Paramount ATC 821, 38 min., \$7.95.

The only too versatile and mannered Ray Charles seldom fails to confuse me with his variety of styles. This seems to be his most ambivalent program yet, alter-

SAVE TAPE, TIME AND MONEY



EDITALL* TAPE EDITING BLOCKS

- Patented curved groove holds tape without clips for fastest, safest splicing.
- Spliced tape can be used thousands of times and splices never separate.
- For single-track, 2-track and 4-track.
- Only in the EDITALL can shattered bits of tape be put together good as new.
- Splices require NO TRIMMING, NO GOUGING; do not stick or "wow."
- EDITALL remains accurate for over 1,000,000 splices.
- NEW S-2 and KS-2 EDITALL have adhesive-mounting, no hole drilling!
- ¼-inch to 1-inch sizes, \$6.50 up.

THE TALL COMPANY • 27 EAST 37TH ST. • NEW YORK 16
In Canada, Alex L. Clark Ltd., 3751 Bloor St. West, Islington, Ont.

(Dealer inquiries invited) *TRADEMARK

CIRCLE 102 ON READER-SERVICE CARD



FREE ELECTRONICS CATALOGS for 1 full year

from Radio Shack...
fastest growing
electronics house

Don't miss the huge selection, the wonderful values in Radio Shack's better-than-ever catalogs! Just mail the coupon... receive the exciting 1961-62 Buying Guide of 336 pages, ½ bigger than last year! Plus all supplements for 12 months. See over 100,000 items: Stereo, Hi-Fi, Ham Radio, Tapes, Kits, Records. New No Money Down credit terms. Satisfaction guaranteed.

RADIO SHACK CORP.
730 Commonwealth Ave., Boston, Mass.

MAIL THIS COUPON TODAY

RADIO SHACK Corp. Dept. 61J14A
730 Commonwealth Ave., Boston 17, Mass.
Send me Radio Shack's famous electronics catalogs
for 1 full year—FREE, POSTPAID.

Name _____
Address _____
City _____ Zone _____ State _____

CIRCLE 83 ON READER-SERVICE CARD

Closer to the music itself...

A new exciting experience in high fidelity
unlike anything else you've ever heard...

Superex Stereo/Phones



Serious, discriminating music lovers are discovering the one hi-fi component that makes possible a new unique and differently beautiful music experience worthy of their most dedicated listening... stereo earphones — now raised to a new level of perfection by Superex.

Pure stereo — no muddling due to room bounce and scramble. True stereo — separate dynamic woofer, ceramic tweeter in each phone, crossover networks; full 20-20,000 cps range, 3-16 ohms impedance. Made in U.S.A.

Unique stereo... Intimate. Private. Quiet.
The world shut out... just you and the music.

Model ST-M
\$29.95

Superex—the first and only Stereo-Phones with separate woofer and tweeter element in each phone and crossover networks

Superex Electronics Corp., 4-6 Radford Place, Yonkers, New York

"The Mer" by DeBary

CIRCLE 101 ON READER-SERVICE CARD

nating between driving blues or swing numbers accompanied by a jumping big band, and lushly sentimental ballads for which the orchestra is conventionally augmented by schmaltzy strings and chorus. In the first genre I liked best the bouncing *Josephine* and *Marie*; all those in the latter left me lukewarm, although Ray himself projects his personality persuasively enough, and in the interludes tosses off bright bits of pianism and an occasional slapdash sax solo. The bold, clear recording is extremely stereoisitic, while the soloist himself is solidly centered.

"Intermezzo: A Violin Pop Concert."
Arnold Eidus, violin; Gloria Agostini, harp. Ferrodynamics CS 1209 S, 47 min., \$7.95.
These are somewhat oversuave though

lyrically expressive performances in rather extreme channel-separated stereoisim, the main value of which is filling a gap hitherto largely neglected in the tape repertory. The reel notes and labels blithely ignore the basic necessity of a detailed contents list: such fiddlers' standbys as the Massenet *Elégie* and *Méditation* from *Thaïs*, the Granados-Kreisler *Spanish Dance No. 5*, Ravel's *Pièce en forme d'un habanera*, Dvořák's *Humoresque*, Tchaikovsky's *Mélodie*, the Chopin-Milstein C sharp minor Nocturne, D'Ambrosio's *Canzonetta*, Provost's *Intermezzo*, the Debussy-Hartmann *Girl with the Flaxen Hair*, the Bach-Gounod *Ave Maria*, François Schubert's *Bee*, the Gluck-Kreisler *Mélodie*, and—for the sole novelty—Achron's *Stimmungen*.

"Irma la Douce." Original Broadway Cast, Stanley Lebowsky, cond. Columbia OQ 353, 45 min., \$9.95.
While this exuberant tape sharpens my hankering to see the lively French import show on the stage, I'm not as convinced as most of the enthusiastic disc reviewers seem to have been that the music can stand as effectively on its own as that of some other Broadway hit recordings. I suspect that the brash Elisabeth Seal and the robust Keith Mitchell, for all their remarkably vigorous personalities, will appeal most to those who have first enjoyed them "live." Even such rousing ensemble scenes here as the *Sons of France*, *Le Grisbi Is le Root of le Evil in Man*, and *There's Only One Paris for That* (which includes the amusingly clattery Arctic Ballet) must be far more relishable with staged action. The recording itself is realistically open and powerful, but except in some cross-channel duos and well-spread ensembles, little advantage has been taken of stereo's potentialities for localization and movement.

"Italia Mia." Mantovani and His Orchestra, London LPM 40075, 38 min., \$6.95.
Except for a slight edginess in fortissimo high-string passages, the lusciously produced and recorded orchestral sonics here make even Mantovani's most sentimentalized Italian folk and traditional air settings hard to resist. Still better are the vivacious, ingeniously scored *Carnival of Venice* by Frosini, and Milner's arrangements of "*Vissi d'arte*," "*Nessun dorma*," and excerpts from Tchaikovsky's *Capriccio italiano*. A romantic travelogue indeed, but one which Mantovani fans are sure to relish unreservedly, and which even those generally cool to this conductor can respect for its wealth of color and feeling.

"Memories Are Made of This." Ray Conniff and His Orchestra and Chorus, Columbia CQ 361, 33 min., \$6.95.
Whether I'm exerting a reviewer's privilege of changing his mind or whether Conniff himself has refined his popular "vocestration" style to achieve more skillful orchestra-chorus integration, I'm certainly far more impressed by the present program than by any of those from Conniff in the past. His varicolored arrangements of *Young Love*, *Unchained Melody*, *Moments To Remember*, etc. along with a dramatically brilliant *No Other Love* and *Three Coins in a Fountain* (the last featuring a Doc Severinsen trumpet solo) are beautifully played and sung. I am also happy to report that the extremely vivid stereo recording which the Columbia engineers have provided makes the most of both their piquancy and sonority.

"Cole Porter Swings Easy in Stereo." Larry Clinton and His Orchestra, Reeves Soundcraft, 29 min., special offer.
This tape is available to purchasers of a Soundcraft "premium pack," which also includes a reel of blank tape, at the regular price of two blank-tape reels plus \$1.00. It is a bargain on any terms, for these performances are otherwise unavailable. A wealth of new delights in Porter's fine tunes are revealed in the ingenious and tasteful, often *sotto-voce* variations by Clinton's eight soloists. All



Tandberg
for better, clearer,
more natural sound

MODEL 65
3 SPEED 4 TRACK
STEREO PLAYBACK
TAPE DECK
\$199.50

A proud new achievement! For pure playback of 2 and 4 track stereo and monaural tapes. Superb frequency response. Installs in hi-fi systems. Has facilities for adding erase and record heads; 2 outputs for plug-in preamplifiers. Adaptable for language lab and industrial use.

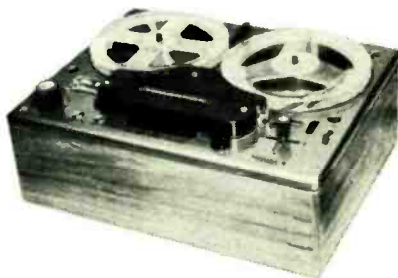

MODEL 6
3 SPEED 4 TRACK
STEREO RECORD/
PLAYBACK TAPE DECK
\$498.

Ask any owner about this magnificent instrument! Incorporates into hi-fi systems. Records 4 track; plays back 2 and 4 track stereo and monaural tapes. Has 3 separate heads and offers Add-A-Track, Sound-On-Sound, Direct Monitor, Silent Pause, Push Button Control. Remote control "F" model available.

SEE YOUR DEALER OR WRITE DIRECT

Tandberg of America, Inc. 8 Third Avenue, Pelham, N. Y.

CIRCLE 103 ON READER-SERVICE CARD

are first-rate, but perhaps the best are Sol Yaged on clarinet and Buddy Weed on piano. The recording itself is a model of stereo transparency, and the processing, at a relatively low modulation level, is immaculate. Only the "A" side is recorded here, and the blank return tracks may be used for checking the vertical alignment of the playback head for minimum cross-talk or reverse-channel "spillover." With a properly adjusted head no spillover whatever should be heard, even at maximum playback level.

"The Previn Scene." André Previn, piano, with various ensembles. M-G-M STC 3908, 38 min., \$7.95.

It is a happy notion on the part of M-G-M to extract from earlier releases the best of Previn's performances with the David Rose orchestra, and to couple them with several still more attractive jazz numbers. The latter, with Shelly Manne and Red Mitchell, are drawn from the sound track of *The Subterraneans* and the Mitchells' great "Get Those Elephants Outa Here" program. The Previn-Rose collaborations are merely pleasant, but the others rank among Previn's best. *Blues for Brian* and the title piece from the "Elephants" program reassure me that I wasn't overenthusiastic in my earlier praise for their original tape appearances. The recording here, not surprisingly, is somewhat variable: bright and clean at its best; occasionally, it seemed to my ears, a bit overbalanced on the left.

"Ring-a-Ding-Ding." Frank Sinatra; Orchestra, Johnny Mandel, cond. Reprise RSL 1701, 31 min., \$7.95.

Frankie sings better than ever in his first appearance on his own label, triumphing even over the inanity of the opening title song and the considerable effort of dragging Mandel's heavy-handed orchestra along with him. The latter never matches the soloist's superb sense of timing or his relaxed assurance, and is somewhat harshly recorded. Nevertheless, the vocalism and personality of the star still are able to give real distinction to *A Foggy Day*, *In the Still of the Night*, *The Coffee Song*, and *I've Got My Love To Keep Me Warm*, among other popular tunes.

"The Soviet Army Chorus in Paris." Alexandrov Song and Dance Ensemble. Artia ASTA 502, 46 min., \$7.95.

Even in its palmiest days the Jaroff Choir never sang with more dramatic virtuosity than Alexandrov's Red Army choristers. In the unexaggerated but brilliant stereoism which characterizes Artia's first tape appearances, the Soviet singers and orchestra are simply tremendous here—that is, if one doesn't check the accompanying text leaflet to discover what banal and arrogant words these fine voices are wasted on! The anonymous soloists are robustly effective, but except in the nostalgic *Soldier Boy*, *Sing* and the emotional *Doobeenoushka* they never bring the house down as do the sensational "patrol" pieces (*Meadowlands*, of course, but also the less familiar *Soldiers' March*, *Song of a Troubled Youth*, and *The Partisans' Anthem*). The only relevancy of the program title seems to be the inclusion of an incisively shouted *Marseillaise* in French, and for no apparent reason there is also an exuberantly swinging chorus ("*Beviam!*")

from Verdi's *Ernani*, sung—unexpectedly but happily—in quite intelligible Italian.

Tchaikovsky-Ellington-Strayhorn: The Nutcracker Suite. Duke Ellington and His Orchestra. Columbia CQ 372, 31 min., \$6.95.

If the Duke has delighted only a portion of his fans with this reworking of the familiar ballet suite, he is likely to intrigue rather than offend longhair listeners, at least in his freest metamorphoses. A few of the less daring rescorings struck me as dull or heavy-handed, but the best of them are great fun: *Sugar Rum Cherry*, *Chinoiseries*, the swinging Overture, and—most distinctive of all—the imaginatively atmospheric *Arabesque Cookie*, starring Russell Procope's bamboo whistle and Johnny

Hodges' alto sax. Full-blooded recording and smoothly widespread stereoism make the most of the mélange of Tchaikovsky and Ellingtonian sonorities.

"Temptation." Roger Williams, piano; Orchestra, Pete King, Frank Hunter, Hal Kanner, conds. Kapp KTL 41028, 32 min., \$7.95.

Even in one of his less distinctive programs, handicapped by schmaltzy orchestral accompaniments, Williams provides disarmingly attractive cocktail-hour music, and at his best does well by the oddly insistent title piece, a happy-go-lucky *One-Finger Symphony*, and a vibrant *Never on Sunday*. The rich recording is perhaps too closely miked, but the stereo channels are effectively differentiated and admirably balanced.

AMERICAN PROFESSIONAL QUALITY
AMERICAN recording tape
GREENTREE ELECTRONICS
1122 SOUTH LA CIENEGA • LOS ANGELES, CALIFORNIA • U.S.A.

MERELY PRESS THE BUTTON

and your tape selection is at your fingertips. NOW! AMERICAN the world's finest recording tape is available in a permanent plastic container at NO EXTRA CHARGE!

- No more worn and torn boxes.
- The beautiful AMERIPAK is decorator designed in fashionable tan and ivory.
- AMERIPAK containers interconnect forming a handsome expanding tape library.

Introducing the AMERIPAK

See your dealer or write to:
GREENTREE ELECTRONICS
 1122 SOUTH LA CIENEGA LOS ANGELES 35, CALIFORNIA

FM Multiplex Stereo broadcasting has arrived!

A top quality stereo tape recorder will permit you to build a stereo tape library of your favorite music at low cost. As your musical interests change, you may record the new music that interests you at no additional cost. See your EICO dealer now for a demonstration of the EICO RP-100.

dedicated to perfection

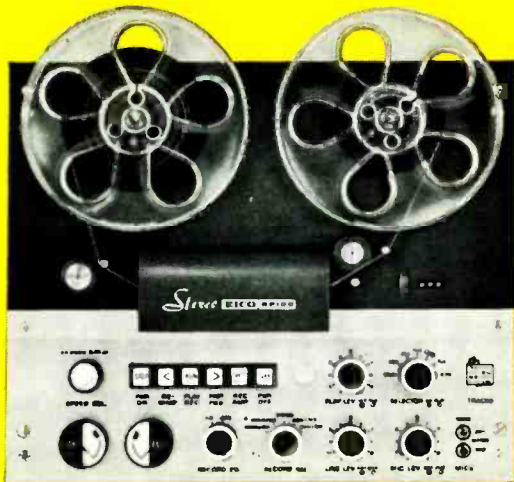

TRANSISTORIZED 4-TRACK STEREO TAPE DECK

MODEL RP-100W
Completely assembled, wired and tested. **\$399.95**

MODEL RP-100K
Semi-kit includes a completely assembled and tested transport, electronics in kit form. **\$299.95**

Perfected 4-track stereo/mono recording, 4 & 2 track playback. True high fidelity transistor electronics, individual for record & playback, plus separate record & playback heads permitting off-the-tape monitor. 2 recording level meters, mixing, mic & level controls, switched sound-on-sound recording. Electro-dynamically braked supply & take-up reel motors; hysteresis synchronous capstan motor. Individual solenoids for pinch-roller & tape lifters. All-electric, interlocked push-button transport control & interlocked safety "record" pushbutton. Precision tape guidance & sweep loading — no pressure pads. No slurring or tape bounce problems. Digital turns counter. Vertical or horizontal mounting. Modular plug-in construction. An original, exclusive EICO product designed & manufactured in U. S. A. (patents pending).

NEW SUPERB SERIES.....

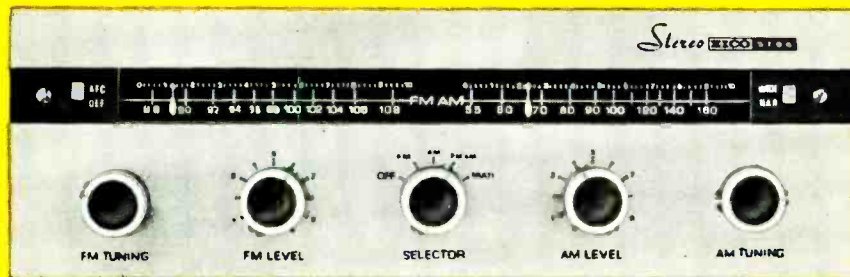

FM-AM STEREO TUNER ST96

Kit \$89.95 Includes Metal Cover and FET Wired \$129.95

FM and AM stereo tuners on one compact chassis. Easy-to-assemble: prewired, prealigned RF and IF stages for AM and FM. Exclusive precision prewired EYE-TRONIC® tuning on both AM and FM.

FM TUNER

Switched AFC (Automatic Frequency Control). Sensitivity: 1.5uv for 20db quieting. Frequency Response: 20-15,000 cps±1db.

AM TUNER

Switched "wide" and "narrow" bandpass. High Q filter eliminates 10 kc whistle. Sensitivity: 3uv for 1.0V output at 20db S/N ratio. Frequency Response: 20-9,000 cps ("wide"); 20-4,500 cps ("narrow").

OF EICO STEREO.....



70-WATT INTEGRATED STEREO AMPLIFIER ST70

Kit \$94.95 Includes Metal Cover Wired \$149.95

40-WATT INTEGRATED STEREO AMPLIFIER ST40

Kit \$79.95 Includes Metal Cover Wired \$129.95

BOTH AMPLIFIERS: Complete stereo centers plus two excellent power amplifiers. Accept, control, and amplify signals from any stereo or mono source.

ST70: Cathode-coupled phase inverter circuitry preceded by a direct-coupled voltage amplifier. Harmonic Distortion: less than 1% from 25-20,000 cps within 1db of 70 watts. Frequency Response: ±½db 10-50,000 cps.

ST40: Highly stable Williamson-type power amplifiers. Harmonic Distortion: less than 1% from 40-20,000 cps within 1db of 40 watts. Frequency Response: ±½db 12-25,000 cps.

Over 2 MILLION EICO instruments in use.

Most EICO Dealers offer budget terms.

Add 5% in West.



FM MULTIPLEX ADAPTOR MX-99

Kit \$39.95 Wired \$64.95

An original EICO contribution to the art of FM Multiplex reception



The new EICO MX-99 Multiplex Adaptor incorporates the best features of both the matrixing and sampling techniques. It is free of phase-distorting filters and provides the required, or better-than-required, suppression of all spurious signals including SCA (67kc) background music carrier, re-inserted 38kc sub-carrier, 19kc pilot carrier and all harmonics thereof. This is very important for high quality tape recording, where spurious signals can beat against the tape recorder bias oscillator and result in audible spurious tones in a recording. This adaptor will synchronize with any usable output from the FM tuner and will demodulate, without significant distortion, tuner outputs as high as 10 volts peak-to-peak (3½ volts RMS). The MX-99 is self-powered and provides entirely automatic stereo/mono operation. A separation of 35 db between channels is typical across the entire audio spectrum. Low impedance cathode follower outputs permit long lines. The MX-99 is designed for all EICO FM equipment (HFT-90, HFT-92, ST-96), and component quality, ratio detector FM equipment provided with a multiplex output.

HF-9
EICO, 3300 N. Blvd., L.I.C. 1, N. Y.
 Send free 32-page catalog & dealer's name
 Send new 36-page Guidebook to HI-FI for which I enclose 25¢ for postage & handling.
Name
Address
City Zone ... State

Listen to the EICO Hour, WABC-FM, N. Y. 95.5 MC, Mon.-Fri., 7:15-8 P.M.

Export Dept., Roburn Agencies Inc., 431 Greenwich St., New York 13, N. Y.

© 1961 by EICO, 3300 N. Blvd., L. I. C. 1, N. Y.

See us at New York Hi-Fi Show, Booth #424, Sept. 13-17

CIRCLE 42 ON READER-SERVICE CARD

High Fidelity Newsfronts



Camouflaged Components. As interest in sound reproduction expands into ever widening circles, news begins to arrive from some (for us) fairly exotic sources. Two novelties recently called to our attention are a new antenna and a new line of speakers. Both seem inspired by a common desire to hide the fact that sound reproducing apparatus is actually being used. The first is an "invisible" TV-FM antenna. Announced by B. F. Goodrich (whose products are very visible on the wheels of many autos), the antenna is described as a silver circuit printed on flexible vinyl of Goodrich's manufacture. The antenna itself was invented by Frank Higgins of Summit, New Jersey, who has set up RF Industries to produce it. The "Mite Site"—as it was dubbed—resembles a pair of butterfly wings with a five-foot wing span and can be tacked onto any concealed surface, or—if one cares to display zoological replicas (after all, thousands of "rabbit ears" have been in plain view for many years)—can be fastened whimsically to the wall.

A similar attempt at camouflage is represented by a new line of speakers offered by Sears, Roebuck and Co. One series hides the speaker inside a framed painting which may be hung on the wall. Another series tucks the speaker inside a simulated set of "books"—something that resembles the phony sets used in store displays or to fill empty shelves to impress visitors. Finally, a third series is disguised as outdoor lighting fixtures. While no fidelitarian would seriously consider these units for quality sound reproduction, they conceivably might have some use as extension or outdoor speakers.

High-Fidelity TV? We are not sure what is meant by this phrase, but presumably it implies improved television sound as well as clear pictures—in a word, the kind of combined audio-video reception that would do justice to TV shows whose musical content is of some interest. In any case, a new line of kits so described has been announced by Transvision of New Rochelle, N. Y. These do-it-yourself TV sets feature, says Transvision, "special circuits . . . to satisfy the sophisticated video-audiophile who is always striving for perfection." The set builder can choose a 23-in., 24-in., or 27-in. picture tube and also may do the job on a "pay as you wire plan" in which he buys the rig in successive steps

of kit packages. For those who are content to let others strive and want only to enjoy the results, the sets also are available in wired-chassis form.

Modular Microphones. University Loudspeakers, Inc., known for some substantial products in use at the output of a sound system, now is offering microphones for use at the other end—in recording as well as public address work. There are two lines of dynamic mikes. A novel feature of one group is their interchangeability. One basic microphone module, with adapters, is said to provide the functional utility of five different microphones. The other group also features dynamic mikes with omnidirectional pickup patterns and impressive performance specs. For details, write to the manufacturer.

Kit News. Audio components in do-it-yourself form continue to pour forth in larger numbers. PACO's new Model ST-25 is a wide-band FM tuner with a



PACO's "semi-kit" FM tuner.

rated sensitivity (IHFM standards) of 4 microvolts. Described as a "semi-kit," it sells for \$42.95 with front end fully wired and prealigned.

To its line of kits, H. H. Scott, Inc., has added two more models. The LC-21 is a stereo preamplifier; the LK-150 is a stereo power amplifier rated at 65 watts per channel. Both new kits have very fine specifications, and feature the same handy packaging and instruction sequence used in Scott's former LT-10 and LK-72 kits. The new preamp is priced at \$99.95; the power amp, \$169.95.

Another stereo powerhouse for the kit builder is Lafayette's KT-550. This dual 50-watter sells for \$134.50 and is built largely with printed circuit boards. From the standpoint of power and response, it represents Lafayette's most ambitious audio entry to date.

Spreading the Spread. The makers of Roberts tape recorders apparently feel

that stereo is just too good to be confined to one room. Comes now a "Stereo Master Distribution Panel, Model 54-01," which can be used to pipe twin channels of sound into eight different locations, all operating off the stereo outputs provided on Roberts recorders. The panel, which is patched to the recorder, also accommodates stereo headphones. Reportedly, as many as sixteen 8-ohm speakers can be driven in this manner without the need for booster amplifiers.

Literature, Free and Otherwise. A booklet explaining FM multiplex stereo has been announced by H. H. Scott, Inc. The new method of broadcasting, as well as advice on how to receive it, is discussed. Free copies are available by writing to the company's Multiplex Division, 111 Powder Mill Rd., Maynard, Mass.

In its new catalogue, AL 1302-1, Altec-Lansing emphasizes "the return of larger speaker systems" and describes its new line of reproducers as well as stereo tuners and amplifiers. Three new microphones also are announced. The handsome illustrated booklet is available free at Altec distributors or by writing to Dept. I.D., Altec Lansing Corp., 1515 South Manchester Ave., Anaheim, Calif.

A revised and updated version of EICO's "Guide to High Fidelity Stereo and Monophonic Sound" is off the press. The booklet naturally emphasizes EICO products but also contains a neatly written primer on sound reproduction. Copies cost 25 cents and may be ordered from Electronic Instrument Co., Inc., 33-00 Northern Blvd., Long Island City 1, N. Y.

For Cleaner Sound. RCA Custom Records is offering antistatic compound—up to now used only in Victor "miracle surface" records—to other customers using any of RCA's record-pressing plants. The chemical, which is compounded with the vinyl record material, is credited with dust-repellent properties which keep playing surfaces cleaner.

Meantime, another approach to improved disc quality has been taken by Command Records. Following the lead of Everest, Command has been recording its masters on 35-mm sprocketed movie film. The photographic emulsion is replaced by a special oxide coating designed to make of the film a hefty bit of recording tape. Better frequency response and improved channel separation are claimed for this process.

DEWALD



presents:

NOT 1, NOT 2, BUT

3 NEW MULTIPLEX UNITS!

- All DeWald Tuners and Amplifiers are designed with exceptional skill, precision, and tone quality. DeWald is a leader in the industry for over forty years, and produces High-Fidelity products with superior quality for the lowest price anywhere! Write for information and catalogs today.



"The Overture"
Model R-1103
A.M.-F.M. Monaural & Stereo
tuner with built-in multiplex.
Audophile Net 119.95—Case
incl.



"The Capriccio"
Model R-1104
F.M. Monaural & Stereo
tuner with built-in multiplex.
Audophile Net 109.95—Case
incl.



"The Scherzo"
Model P-400
F.M. Multiplex adaptor for
wide and medium band F.M.
tuners equipped with multi-
plex jacks. Audophile Net
44.95—Case incl.



"The Concerto"
Model P-1400
Stereophonic Pre-Amp., equal-
izer and power amplifier.
Performs superbly with the
"Capriccio" and "Overture"
Multiplex Tuners shown
above. Audophile Net 99.95
—Case incl.

DEWALD



A DIVISION OF

UNITED SCIENTIFIC LABORATORIES, Inc.

35-19 37th Ave., Long Island City 1, N. Y.

EXPORT DEPT.
25 Warren St.
New York, N. Y.
Cable Address:
SIMONTRICE

In Canada:
L. J. BARDWELL CO.
Box 142—Station D
Toronto 9, Ontario

CIRCLE 35 ON READER-SERVICE CARD

THE MURDEROUS PRINCE

Continued from page 56

not because he was a musician. Gesualdo's actions, those that came under the surveillance of the Ferrara scribes at any rate, were automatically recorded, and about four hundred of his letters survive. These letters are perfunctory family notes, mostly acknowledgments of letters received, petitions for news of the health of his brother-in-law, the Cardinal, etc. His own health, he tells his correspondents at the ends of catalogues of flattery, is always bad. Health has ever been the best excuse, and the demands of his in-laws must be avoided, no matter how often he may proclaim himself their humble servant. Gesualdo was violently asthmatic, however, and he may even have left a musical portrait of this affliction, by hyphenating the syllables of "sospiri" and "sospirava" with pauses; the effect is of a person gasping for breath, and reminds us of the realistic asthmatic music of Dr. Schigolch in Berg's *Lulu*. The "aria salubre" of the town of Gesualdo was the Prince's own avowed reason for living there, in any case (as a visitor there myself, I can testify that a very special reason would be necessary).

The letters of other people are more revealing. From them we learn—if we did not already know it by listening to the music—that Gesualdo was a manic-depressive ("effigie di malinconico"); an insomniac; a fastidious dresser (he wore long robes, as though to conceal his figure; could he have been lame?). Like other composers, he talked too much and his need of music was compulsive. Several hours of every day had to be filled with singing and lute playing. But though music may have eased Gesualdo's pains, pain itself was necessary to him. We read that he was chronically costive, and that he could be relieved only by beatings. Such purgations, considered in the psycho-sexual interpretation of our own time, indicate that Gesualdo had identified death with supreme erotic satisfaction. This fact is made abundantly clear by his every setting of the word *death* in the madrigals; and even in the motets and responses, examples of excruciating pleasure-pain music can be found in abundance—at the words *flagellatum ducitis* in the *Feria Sexta*, for instance.

What did Gesualdo look like? From the historical evidences and the one painting, psycho-physiologists would probably call him a cerebrotonic ectomorph. His head was egg-shaped, his complexion was lifeless, his eyes were dark and narrow, his ears were the large ears common to all composers, and his fingers were the long, lithe digitals without which virtuosity on the lute would have been impossible.

Roundly, 125 of Gesualdo's madrigals survive; and three books of sacred music (including incomplete part books) containing approximately seventy pieces in all. Only two examples of instrumental music, keyboard canzoni both, appear

to be authentic, but these two make us much regret the loss of others, for one of them is, I think, the most remarkable piece in the Prince's entire work. The fact that a considerable amount of music is known to be lost (including what by date and contemporary description might be the most harmonically interesting book of madrigals) also suggests the loss of unmentioned and unlisted music as well. The surviving *corpus musicus*, then, is about 195 pieces, each from two to five minutes long, like most music of that time. The scope, by Wagnerian standards, is small, but it is a measure that we today are able to feel, or at least adjust to, perhaps for the first time since the *cinquecento*. Five minutes of densely packed contrapuntal and harmonic movement, with no repetition beyond an occasional sequence, and no backward loops in the form: this is a musical dimension common again to the mid-twentieth century.

The madrigals of Gesualdo are marked by a new intensification of feeling. The listener cannot imagine music of this period more emotionally charged, and to go to Gesualdo from Wert or even Cipriano is to leap into a whole new theatre of expression. The analytical musical reasons for this are several and easy to enumerate, but essentially they are two: Gesualdo makes greater use of the upper female tessitura than his predecessors; and he exploits a far greater range of harmonic movement. Indeed, the Neapolitan master outstrips all contemporaries in his ability correctly to choose the intensifying step in a harmonic progression and the next step, and the next. Consider, for example, the tonal logic which guides him, with perfect harmonic lucidity, through the final phrases of *Ardita Zanzaretta* to the B flat pivot note in the alto, just before the 6/4-5/3 cadence. Consider, also, the motivic construction of these measures, and the double canonic imitation. However restless Gesualdo's Mannerism may be—seventeen keys are gone



through here and in not so many more beats—the composer remains still a musical architect, with an over-all sense of form.

What is "Mannerism," and why is Gesualdo the musical Mannerist par excellence? The tendency now called Mannerist was first distinguished by

Vasari in reference to a group of his contemporaries among Florentine artists. They had begun to paint, Vasari noted, *di maniera* rather than *di natura*. But another expression of Vasari's can be applied more concretely to music. This is "*lo sforzato*," the strained effect. In fact, Gesualdo might well be dubbed the master of "*lo sforzato*." Many scholars now date the Mannerist movement from Michelangelo, who was perhaps the first of the masters to disregard the Renaissance ideals of serenity and mathematical perfection of form. Michelangelo elongates and distorts. He ignores the rules of proportion and puts his own "expressive purposes" above any rule. The Mannerist art that followed him—Gesualdo's art—is not only extravagant but tortured, and not only dramatic but theatrical. Doubt and conflict are expressed in it too—and so is the *desire* to express these things. The perfect example of musical mannerism—it was made for the demonstration, in fact, like Dr. Pangloss' nose—is Gesualdo's most famous madrigal, *Moro Lasso*. To understand Mannerism, in fact, one has only to compare this flamboyant music to the mathematical simplicity and the expressive control of a motet by Ockegham. But Gesualdo's musical means are the tried and traditional tools of the contrapuntists, too. Gesualdo has only developed and used them in Gesualdo's way.

A SOUND ENGINEER

Continued from page 66

ends, using a small index tab made especially for this purpose or splicing in a section of leader tape. The unused tape may of course be used for later recording.

The recorded tape thus made is your own "master" copy. Treat it carefully and it will provide years of faithful playing, especially if you splice a foot or so of leader tape to both ends to facilitate threading for rewind and playback and to avoid damage to the tape itself during handling or upon "snapping" when the end is reached on fast rewind. An identifying tag (self-adhering labels are available at most dealers) should be affixed to the reel; aside from program data, technical information should also be included: stereo or mono, two-track or four-track, and of course the speed of the recording. To prevent spillage when handling, clip the leading end of the tape to the flange of the reel with any of the little plastic clips made for this purpose. Finally, to store the tape under normal room conditions, simply return it to its original carton. Label the carton, and stand it vertically upright as you would a disc. If you plan to store the tape for a relatively long period or under extremes of temperature and humidity, it will be worth your while to invest in a metal can.

A good many details? Perhaps, but for those who have savored the unique pleasures of tape recording, mastering the art is part of the fun.

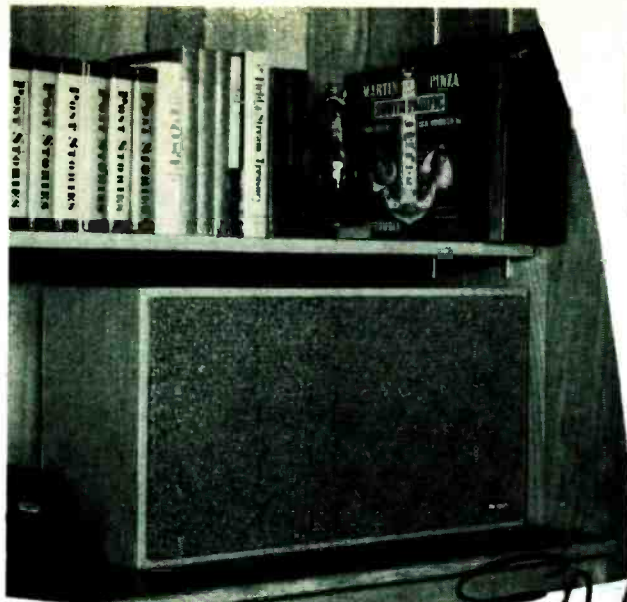

TSE-3AS \$3995 NET

Also available in natural wood kit. 3/4" unfinished select white birch. Assemble it yourself. (TSE-12KS) Only \$38.50 NET

the sight
and sound
of beauty

NEW 12"

Eldorado

WITH 3 JENSEN SPEAKERS

Superbly styled shelf or table-top "compact" with full hi-fi range of fine consoles. Jensen 12" woofer and two 3 1/2" tweeters wired in crossover network to 8-ohm input. Woofer and enclosure perfectly matched with Argos Tuning Tube. Overall range 40 to 17,000 cycles. Polarized screw terminals phased for stereo. Exclusive "wood grain" pyroxylin covering, walnut or blond. 27 1/2" x 14 1/4" x 10" deep.

At your high fidelity store, or write Dept. H, Argos Products Company, Genoa, Illinois.

CIRCLE 111 ON READER-SERVICE CARD

Argos

Products Company

A GRANCO FIRST!

GO WITH EXCLUSIVE GRANCO FM CAR RADIO CONVERTER!

Add the beauty in sound of Granco FM to AM car radio in a marvel of minutes. Superb quality—with Automatic Frequency Control... compact design—only 1 1/4" thick... and ease of installation make this Granco innovation a "must" for every car owner, especially at this low, low price. Available at radio and auto accessory shops everywhere.

ONLY \$49⁹⁵

WRITE FOR FREE LITERATURE



GRANCO America's Leading Specialist in FM

DIVISION · DUMONT EMERSON CORPORATION, Dept. H, 680 FIFTH AVENUE, N.Y. 19

CIRCLE 54 ON READER-SERVICE CARD

Continued from page 47

Concert Arts Orchestra may have been made in California, with one fairly consistent group of musicians, or in New York, with an entirely different assemblage. And a given player may find himself appearing simultaneously in releases for two different labels in direct competition. Robert Bloom, a onetime NBC Symphony man, says with a grin. "Since I've been free-lancing, I've been first oboe for the RCA Victor Symphony, the Concert Arts, the Columbia Symphony, and others I can't even remember the names of." And Mr. Bloom is not unique in his wide-ranging career.

Thus one company's house orchestra may have two distinct sets of personnel under the one name—while members of each set may appear in house orchestras for recordings made by different labels. In other words, an East Coast Concert Arts record will have many players in common with an East Coast Columbia Symphony disc, but none in common with an offering made by the Concert Arts Orchestra which has its home on the West Coast.

Often a kind of genial bamboozlement is perpetrated on the record collector by these multifarious groups. Morton Gould offers the example of his album of Copland's *Billy the Kid and Rodeo*, which was recorded with first one orchestra, then another. "We did most of *Billy* at one session, but didn't get time to finish. So, a few days later, we did the *Waltz* from the suite with a new orchestra with different make-up. If you listen, you can't tell the difference." "Telling the difference" may well become a new parlor game for some listeners.

When Gould is working on several albums of short selections at the same time, Victor will try to group them according to size and make-up of orchestra. He'll record a number of works with small orchestra and a lot of brass, for instance, and Victor will subsequently cut that session's tapes up and assign the various pieces to different albums. Thus the "Morton Gould's Orchestra" cited on the label of one record may be a quite different aggregation from the "Morton Gould's Orchestra" cited on another. The semantics of free-lance orchestraship often defy comprehension.

Despite occasional disparaging references to "pickup" orchestras, free-lance orchestras are likely to be employed with growing frequency in recording classical music. Capitol Records is doing virtually all its orchestral recording with free-lancers. Columbia plans to go ahead with a big program of Bruno Walter and Stravinsky sessions in 1962, using its carefully built up house orchestra. As Mr. Chapin said, in the aftermath of the critical hassle over the Walter/Brahms set, "Some critics and some record collectors make up their minds in advance that a free-lance orchestra just can't possibly be as good as one of the regular outfits. We're hoping to break down the prejudice."

Hundreds of free-lance orchestral musicians hope so too.



FOR THOSE WHO LOVE LIVE MUSIC!

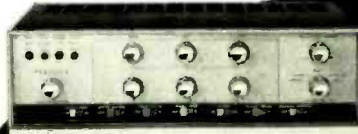

The STROMBERG-CARLSON® ASR-880 stereo pre-amp/power amplifier, with its conservative rating of 64 watts, is one of the most powerful amplifiers available at any price. Only \$199.95 (suggested list price).

STROMBERG-CARLSON
stereo components manufactured by
GENERAL DYNAMICS | ELECTRONICS

For component catalog write: Commercial Products Division, Box AJ, 1409 N. Goodman St., Rochester, N.Y.

CIRCLE 50 ON READER-SERVICE CARD

"Head" gone
FLAT?

Call your dealer to replace with Nortronic Magnetic Recording Heads found in most original equipment. See what a difference a Nortronic Replacement Head or 4-Track Stereo Conversion can make.

World's largest manufacturer of laminated heads... the heart of your tape recorder.
Send 25¢ for Tape Recording Manual

THE Nortronic CO., INC.
"Music sounds best on tape—
tape sounds best on Nortronic Heads!"

1019 South Sixth St., Minneapolis 4, Minn.

CIRCLE 78 ON READER-SERVICE CARD

save most on
stereo hi-fi

see the best values in the 1962
ALLIED CATALOG
free

featuring NEW MULTIPLEX STEREO and ALL-TRANSISTOR STEREO HI-FI

World's largest hi-fi selection, including products and values available only from ALLIED. Save on complete Stereo systems, all famous-name components, hi-fi cabinetry, tape recording. Save most with exclusive KNIGHT® components and quality build-your-own KNIGHT-KITS®. Get our money-saving quotations for component systems of your own selection. Send coupon today for our Free 444-page 1962 Catalog!

ALLIED RADIO **free**
ALLIED RADIO, Dept. 144-J1 444-page
100 N. Western Ave., Chicago 80, Ill. catalog
 Send FREE 1962 ALLIED Catalog.

Name _____
PLEASE PRINT
Address _____
City _____ Zone _____ State _____

CIRCLE 3 ON READER-SERVICE CARD

SAVE OVER 40% ON HI-FI

Easy Time Payment Plan 10% Down—
Up to 24 Mos. to Pay.

Har. Kar. A230-30W Stereo Amp	\$109.95
Har. Kar. T230-FM/AM Stereo Tuner	
w/cage	119.95
Garrard RC 88/11	59.50
Audio Empire =108 Stereo Diam. Cart	34.50
2-Jensen-3 way spks. mounted in walnut bookshelf cabinet	119.00

Send for FREE Quotations on Your Package or Single Component

All Interconn. cables	4.50
Catalog Price	\$447.40
YOUR COST	268.00
You Save Over 40%	\$179.40

We invite your test of our "We Will Not Be Undersold Policy." FREE WHOLESALE CATALOG.

HI-FI RECORDING TAPE

7" Spools - Splice Free - Freq. Resp. 30-15KC

	3-11	12-23	24 & UP
12A 1200' Acetate	\$1.29	\$1.17	\$.99
18A 1800' Acetate	1.79	1.59	1.45
18M 1800' Mylar	2.09	1.99	1.85
24M 2400' Mylar	2.69	2.59	2.49

Any assortment permitted for quantity discount. Add 15¢ per spool postage. 10¢ 24 or more.

PRE-RECORDED TAPES—RCA VICTOR, BEL CANTO 2 & 4 Track. Write for Complete Catalog FREE, and Wholesale Discounts.

Battery-operated Transistor Tape Recorder 9 1/2x5 1/2x3—all accessories. SPECIAL \$24.95
All mds. sold on 15 day money back guarantee.

HI-FIDELITY CENTER
"The House Of Low Low Prices"

220A East 23rd St., New York 10, N. Y.

CIRCLE 60 ON READER-SERVICE CARD

MAESTRO SERAFIN

Continued from page 53

"Stage fright. Not like De Luca, who never felt anything, with nerves of steel. . . . Tamagno suffered terribly. It shortened his life. . . . What was exceptional about his singing was his vowels . . . completely pure." And Serafin repeated "Esultate," to show me what pure vowels should sound like.

We got back to the subject of records. "I like making records, because one can make a little more music with them." *Un po' più di musica* is a hard phrase to translate, but I think he meant that removed from the urgency of actual performance conductor and artists can deepen their conceptions and polish their interpretations.

"Records are important documents. They can show young people how our music should be performed. With German music, it's different. Take the opening of *Die Walküre*. I was listening to the radio the other night, and I heard Knappertsbusch conduct it. *Sostenuto*. Toscanini took it faster, and Kleiber was somewhere in between. But still it was always *stürmisch*, as Wagner marked it. Our music is more delicate, more risky. Violent changes can falsify it all. And some of the younger men try to make an effect by just playing it all fast. . . . Of course, *adagio* music can be boring. . . ."

When Serafin refers to *la nostra musica*, he speaks with the authority of the last representative of Italian opera's great years, and the possessive pronoun is justified. In 1960, with the musicologist Alceo Toni, he published a book entitled *Style, Traditions, and Conventions of Italian Opera in the Eighteenth and Nineteenth Centuries*, in which he discusses the tempos, the cuts, and the



interpretation of various works from his repertoire. The volume is meant to be the first in a series which should be invaluable to younger conductors and scholars.

For the ordinary music listener, Serafin's records are more important. And he fusses over them, to make them correspond to his ideal. With the engineers, he worries about the placing of the microphones. A London-Decca official told me that, when they were making *La Bohème* a couple of years ago, he came to the hall an hour or so before the session and there was Serafin. The conductor had discovered some minor errors in the printed score, and he was painstakingly going from one music stand to the other, correcting in his own hand all the orchestra parts. Tullio Serafin was a shaper of the Italian tradition, and in his old age he does not spare himself in his determination to preserve it.

PURCHASING A HI-FI SYSTEM?

TIME PAYMENTS AVAILABLE
Up to 2 years to pay!

Send Us Your List of Components For A Package Quotation

YOU CAN BUY WITH CONFIDENCE AT AIREX

All merchandise is brand new, factory fresh & guaranteed.

FREE Hi Fi Catalog Available on Request

AIREX RADIO CORPORATION

85-HF Cortlandt St., N. Y. 7, WO 4-1820

- Jim Lansing*
- Altec Lansing
- Electrovoice
- Jensen-Hallcraft
- Hartley* • Gonsel*
- USL Citizen Band
- Texas Crystals
- Internat'l Crystals University
- Acoustic Research
- Janszen • Viking
- Wharfedale
- Concertone
- Bell • G.E.
- Weather's
- Harman-Kardon
- Eico • Pilot
- Sherwood*
- Tandberg*
- ESL • Frazier
- Superscope
- Dual Changer*
- Bogen • RCA
- Dynakit • Fisher
- H. H. Scott
- Thorens*
- TEC • Roberts
- De Wald • National
- Sony • Challenger
- Wollensak
- Garrard
- Miracord
- Glaser-Steers
- Rek-O-Kut
- Polytronics
- Norelco • Conrac
- Fairchild
- Pickering • Sonar
- Audio Tape
- Magnecord*
- Rockford Cabinets
- * Fair Traded

CIRCLE 2 ON READER-SERVICE CARD

EICO new Transistor Stereo/Mono 4-track Tape Deck

Model RP 100W
Completely assembled, wired and tested with 3 heads, and stereo record and stereo playback preamplifiers.

Model RP 100K
Semi-kit. Includes transport completely assembled and tested with 3 heads; and control electronics, stereo record, and stereo playback preamplifiers in easy-to-assemble kit form.

Write for full specifications

TAPE STORAGE OR CARRYING CASE

reg. 9.95, now 5.95
(Heavy wood construction, waterproof vinyl covering. Holds up to 24 tapes.)

reg. 2.45, now 1.49
(Pressed cardboard, holds 10 tapes or 60 45 rpm records.)



SAXITONE RECORDING TAPE

*Outside guaranteed not to rub out or squeak—or money back. Compare ours with other "Bafania" tape. You'll find it's more than our "price" when you deal with us. We are original pioneers in the tape recorder business and our reputation means everything to us.

400' acetate (dual), 8"	1.75
400' MYLAR 2" reel	.95
900' MYLAR (Polyester), 6"	.99
1200' MYLAR, 1 1/2 mil, 2" reel	1.18
1200' Acetate (dual), 7"	1.19
1200' MYLAR, 1 1/2 mil, (Strone)	1.68
1800' acetate (dual), 7"	1.79
1800' MYLAR 1 mil thick, 7"	1.99
2400' MYLAR, unregulated, 7"	2.69
2400' MYLAR, regulated, 7"	2.99

Studios, Large Users Even Lower.
TAPE STORAGE CAN
Unique twist-lock insures dust-free moisture-proof, non-breakable. High impact styrene. Ideal shipping container.
reg. 89c now 59c

Plus Postage
FERRO-DYNAMICS
"Bookshelf" open end case
reg. 1.25, now 89c

30% off Entire Stock Pre-recorded Music Tape 30% off

NORELCO SPEAKER

Famous AD3800M, twin cone 8" (75-19,000 cycles) discontinued model, former list \$8.00, usual net 9.00 going at 4.95 plus postage, (10 for 39.95). Other Norelco speaker sizes at bargain prices — SEND FOR SPEAKER SPECIFICATION SHEET.



SAXITONE TAPE SALES
(DIV. OF COMMISSIONED ELECTRONICS, INC.)
1776 Columbia Rd., NW, Washington, D.C.

CIRCLE 32 ON READER-SERVICE CARD



UNANIMOUS APPROVAL



We approve! Battery-powered devices enable businessmen to turn a telephone call into a company conference. Unanimous approval to BURGESS BATTERIES too. Dependable, long-lasting power; and they're self-rechargeable.

BURGESS BATTERY COMPANY

DIVISION OF SERVEL, INC.
FREEPORT, ILLINOIS NIAGARA FALLS, CAN.
CIRCLE 26 ON READER-SERVICE CARD



"20th Century Successor to the Pipe Organ"

Build an exciting Artisan organ, with either one, two or three manuals. Meets American Guild of Organists specifications.

This 160 page manual gives a wealth of information on this thrilling hobby, plus complete specifications, prices and parts lists. World's largest selection of organ parts and kits. "Horse-shoe" or conventional console.

Housewives, doctors, teen-agers, do-it-yourself fans by the hundreds are now enjoying this creative and rewarding hobby.

Step-by-step instructions are so simple anyone can follow them. If you can handle a soldering iron, you can build your own full size electronic organ and save hundreds of dollars.

SEND \$2.00 with coupon TODAY!

Please send me the Organ Builders Manual Enclosed \$2.00

Name _____
Address _____
City _____ Zone _____
State _____

Artisan Organ Division,
Dorsett Electronics, Inc.

4949 -H York Blvd. • Los Angeles 42, Calif.
CIRCLE 11 ON READER-SERVICE CARD

PRECISION HI-FI ACCESSORIES



HUM-BUCKING TELEPHONE PICKUP COIL
Hum free transcription, no connection to telephone, rugged cast case.

MODEL HP-70 NET \$6.95

TAPE RECORDING HEAD DEMAGNETIZER

Removes permanent magnetism, protects tape from erasure, minimizes noise and distortion, extended pole piece—easy access.

MODEL HD-40M NET \$4.95



MAGNETIC TAPE ERASER

Bulk erasure of recorded tape, restores tape like new, reduces noise, reel size to 10 1/2" x 1/2" W, epoxy case, sealed for life.

MODEL HD-11M NET \$18.95



STEREO 3RD CHANNEL OUTPUT TRANSFORMER

Add speaker to fill "hole-in-middle". Matches impedance, polarity and power level. Rating 30 watts. Response 40 to 20,000 C.P.S.

MODEL HM-90 NET \$6.33

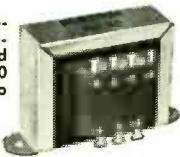

MICROTRAN company, inc.

145 E. Mineola Ave., Valley Stream, N. Y.

CIRCLE 73 ON READER-SERVICE CARD

Quiet Undisturbed LISTENING

with the GENERAL HIGH FIDELITY PHONE

- ★ Comfortable soft rubber cups
- ★ Light in weight—less than one pound
- ★ No annoying 'peaks' 20-18,000 c.p.s.
- ★ All parts are made and assembled in the United States
- ★ Washable removable outer neoprene rings for comfort and exclusion of ambient sounds
- ★ Spring-lock adjustable headband
- ★ Low impedance thongs

For the finest in true, full-range audio realism, order a set of General Hi-Fi Head Phones . . .

the choice of top TV engineers . . . now at leading Hi-Fi centers for the ultimate in listening enjoyment.



Monaural \$25 — Binaural \$30

Order your set today from your dealer

GENERAL PHONES CORPORATION

5711 HOWE STREET, PITTSBURGH 32, PA.

CIRCLE 51 ON READER-SERVICE CARD

TREASURY ON REELS

Continued from page 71

Third Stage

Whether you are content to go on expanding a mainly standard collection or are eager to branch out into individual specializations, you will inevitably face the problem of larger works with the conflict they raise between ambitious desires and limited budgets. Full-length masterpieces for chorus and orchestra or for the operatic stage are undeniably expensive. Yet their price tags may seem less formidable when you consider the infrequent opportunities of hearing these towering dramas in live performance and the inexhaustible gratifications of having them always available to you at home. To cite only a few of perhaps the most rewarding of these investments, there are:

• Munch's Berlioz Requiem (RCA Victor FTC 7000, \$14.95), whose apocalyptic grandeurs and tender sweetness only can be reproduced in adequate proportions and contrasts in the stereo medium.

• Scherchen's Bach Mass in B minor (Westminster WTZ 119, \$19.95) and Handel *Messiah* (Westminster WTW 134, \$23.95), highly individual but inexpressibly thrilling ascents of two of the Himalayan peaks of all Western music.

• The RCA Victor *Trovatore* and *Turandot* (FTC 8000 and 8001, \$21.95 each), a revitalized Verdi warhorse and a magnificent realization of Puccini's last and most ambitious stage creation.

• The London history-making operatic (and stereo) triumphs: Boito *Mefistofele* (LOR 90011), Strauss *Fledermaus* with gala interpolations (LOR 90030), Verdi *Aida* (LOR 90015), and Wagner *Rheingold* (LOR 90006), \$21.95 each; yet even above these panoramic dramas I must recommend still more urgently the perhaps less sensational but wholly incomparable closest approach to the impossible ideal of Mozartean operatic perfection, the late Erich Kleiber's unsurpassed *Nozze di Figaro* (London LOV 90008, \$25.95).

Elsewhere, the combination of two normal-length programs in the distinctive "twin-pack" single-reel format provides, at \$11.95, an almost exact equivalent of the cost of the same works on two stereo discs. Of course this represents a genuine saving only if both, or all, elements in the combination are wanted. If such is the case, there are potent as well as bountiful attractions in such outstanding twin-packs as:

• Ansermet's Beethoven Sixth and Seventh Symphonies (London LCK 80052); Mussorgsky-Ravel *Pictures at an Exhibition* and Bartók Music for Strings, Percussion, and Celesta (LCK 80054); Stravinsky complete *Firebird*, *Pulcinella* Suite, and *Song of the Nightingale* (LCK 80042)—variously demonstrating the Swiss maestro's versatility in endowing

both classical and modern works with his distinctive lucidity, rhythmic propulsion, and kaleidoscopic tonal coloring.

• Krips's Beethoven Ninth and *Leonore* Overture No. 3 (Everest 43006), re-creating the restrained strength and lyrical nobility of the famous Weingartner readings with the dramatic impact of stereo.

• Rodzinski's Tchaikovsky *Nutcracker* Ballet (Westminster WTP 138), most warmly poetic of all the complete versions, although no one can go wrong with the even more brilliant Ansermet London reel or Irving's balletic one for Kapp.

• Backhaus' Beethoven First and Second Piano Concertos (London LCK 80047), perhaps the best first choice among the veteran pianist's virile yet serene recordings of all five works in this series.

• Scherchen's Mozart Requiem (Westminster WTP 122), less idiosyncratic than his Bach Mass and Handel *Messiah*, but sung and played with no less heavenly eloquence.

Fourth Stage

Here at last you do best to indulge your purely individual tastes in systematically expanding the specialized departments which stamp a tape collection with its owner's characteristic and unique signature. No one else can anticipate the delightful discoveries you'll make on your own; no one else's suggestions ever are few enough to be immediately practicable for limited budgets, or ever can be many enough to more than suggest the incalculable riches available today. Arm yourself with a copy of the *Harison Catalog of Stereophonic Tapes*; get what you can; play and enjoy it!

THE MAN WHO HATES STEREO

Continued from page 50

another dimension—suitably vague of course, providing a new set of clues, clues that range over the entire spread of musical sound from top to bottom (should I say from side to side?)—will give us that much more. This is stereo.

You see why I feel that stereo, as such, is beyond questioning, just as recording itself is to be taken for granted as a principle. You see why I can say that virtually every sound that is good in mono *can* be better in stereo, given ears that have taken time to learn to hear what has been added.

In theory, stereo is better than mono because it must be. In practice, of course, it all depends on . . . well, on everything. On taste and judgment, on expertise all along the whole line of manufacture and reproduction, on good musical performance of well-chosen material, recorded for optimum translation of the musical ideas into the new stereo medium. A big bill! Plenty of stereo is dreadful and a lot is mediocre. Plenty of stereo equipment doesn't work as it should. Plenty of musical ears aren't

hearing what they might. Do these facts change the picture? We ask a lot from the makers of stereo—namely perfection. We haven't given them very much time to become infallible; yet even so, perfection comes along in stereo quite often and always it is just around the corner.

Once more, one must learn to listen to stereo. One must grow slowly, along with the music itself, towards really imaginative use of the new sound cues it gives us, which offer values in every sense as infinite as the values of music itself. I do not think I am exaggerating when I say that stereo, in this sense, is music. It is effective, that is, directly in terms of what it does with music; it operates specifically through the musical meaning (and all other meaningful sound) which it conveys. It cannot even exist on its own, any more than a color photograph can be a picture of nothing. And so I do not think we can speak of stereo as a thing we like or do not like. Stereo is a means, a tool, to feed all sorts of imaginations with all sorts of information. It has no quality of its own. It is neither good nor bad.

As for the new information that stereo alone imparts, first, I think, is the sense of immediate space, surrounding and enveloping the music. It is a living space because it is real, in two dimensions out of three. It is *there*, because you can actually hear the multiple wall reflections, bounding about a big hall, which make up the sound of spatial liveness or reverberation. We hear the space, but we apply its realism to the music—the musicians themselves seem more immediate, they too are *there*, before your ears. What marvels the imagination can create out of such minutely increased information! Of all the stereo effects, this one of living space (and living music within it) is to me the most satisfactory. But beginners often don't notice it at all.

Second, for me, is the striking increase in the clarity of musical texture that stereo provides simply by adding a relatively infinitesimal quality of separation between the multiple sound sources of complex musical performance. I am not talking of ping-pong stereo, right and left. I mean the separation which makes a group of first violins sound as a body and yet minutely separate, indetectably so but over-all more lifelike in imaginative terms than any mono group of violins could ever sound.

I mean the tiny spacings that place an oboe vaguely in the middle and a clarinet vaguely also in the middle—but the two clearly apart in a musical sense, two living sounds from the same place. You can't measure the separation in feet or even inches; but you can hear it in the music. So with the whole ambient structure of orchestral sound in stereo—there may be no clear directionality at all as far as pointing to this or that instrument (and in good stereo the directionality should never arouse more than marginal consciousness in any case); but there is a clarity of many sounds together, where in mono there is merely a superimposed unity. Impossible really to describe, infinitely subtle to hear, endlessly satisfying in musical terms.

Thirdly, I must quickly lump all the rest via a few more specialized effects. There is of course the right-left stereo: the ping and the pong, and it has many uses that are far from crude—in spoken drama, for instance, a dialogue between speakers, or a pair of voices opposed to another in dramatic give-and-take from one side to the other. There is the peculiar stereo of opera, unlike any opera house but immensely enhancing the projection of the enormously complex sounds of opera dramatics. The "action" is rudimentary; stereo is not literal enough for active motion of any sort—unless one is willing to risk a sense of sudden flight through the air! But the separation and grouping of the opera elements, the orchestra, the chorus, the solos, is an immense new value.

There is music for double choir or triple, for groups of brass instruments, antiphonal music for sections of the orchestra, music for two pianos, double concertos, music for several orchestras, echo music: there is the Bach *Brandenburg* Concerto No. 3 with a dozen groups of solos, playing spatially discrete parts, but playing together too as their own "orchestra." None of these works has ever been realized in its intended spatial contrast by any mono recording whatsoever. They come to life, each in its own terms, in stereo, and uniquely in stereo.

Enough said—for my account could wander on through most of the music I have ever heard on records. I am still addressing myself to the man who hates stereo. Have I made at least a start in reaching him?



**FREE
ELECTRONICS
CATALOGS
for 1 full year**

from Radio Shack...
fastest growing
electronics house

Don't miss the huge selection, the wonderful values in Radio Shack's better-than-ever catalogs! Just mail the coupon... receive the exciting 1961-62 Buying Guide of 336 pages, 2/3 bigger than last year! Plus all supplements for 12 months. See over 100,000 items: Stereo, Hi-Fi, Ham Radio, Tapes, Kits, Records. New No Money Down credit terms. Satisfaction guaranteed.

RADIO SHACK CORP.
730 Commonwealth Ave., Boston, Mass.

MAIL THIS COUPON TODAY

RADIO SHACK Corp. Dept. 61J14
730 Commonwealth Ave., Boston 17, Mass.
Send me Radio Shack's famous electronics catalogs
for 1 full year—FREE, POSTPAID.
Name _____
Address _____
City _____ Zone _____ State _____

CIRCLE 83 ON READER-SERVICE CARD

THE GRAMOPHONE

"THE GRAMOPHONE" IS TO BRITAIN AS
"High Fidelity" IS TO AMERICA



- ★ Authoritative Record Reviews
- ★ Interesting and Informative Articles
- ★ Technical Reports

"The Gramophone" is available by Annual Subscription \$4 which can be remitted by International Money Order or Personal Dollar Cheque to:

"The Gramophone"
Subscription Department (2),
379 Kenton Road,
Kenton, Harrow,
Middlesex, England.

"THE GRAMOPHONE" also publish quarterly the
LP CLASSICAL and POPULAR RECORD CATALOGUES—
Annual Subscriptions \$3 and \$1.50 respectively

CIRCLE 53 ON READER-SERVICE CARD

PROFESSIONAL DIRECTORY

CALIFORNIA



QUICK-SEE ALBUM FILE

Eliminates bottom jacket wear. Rolls forward for front-view, flip-through selection. 9 models fit any cabinet, closet or shelf. \$7.95 up. Also available with cabinet shown. Dealers, inquire.

KERSTING MANUFACTURING COMPANY
504 S. Date Street, Alhambra, California
CIRCLE 64 ON READER-SERVICE CARD

RENT stereo tapes

- Over 2000 different albums All Labels
- 2-track and 4-track
- No deposit on tapes rented
- Postpaid to and from your home

FREE BROCHURE

stereo-part

811-A CENTINELA AVE., INGLEWOOD, CALIF.
CIRCLE 99 ON READER-SERVICE CARD
DISTRICT OF COLUMBIA

IN WASHINGTON, D. C.
Nearly Everyone Buys At...
Myer's EMCO

MAIN STORE:
509 11TH ST., N.W., WASH., D.C.

CIRCLE 75 ON READER-SERVICE CARD
GEORGIA

REBEL PRICE

Why go north for LOW PRICES in Hi-Fi Components Save your money and deal with us country boys. Write for low quotations

REBEL PRICE
1140 Peachtree St. Atlanta 9, Ga.

CIRCLE 84 ON READER-SERVICE CARD
ILLINOIS

record index

recocards

Accommodates 150 to 500 Albums.

Send for brochure, sample record index card.

Recocards
(H 16) 503 Hyde Park Bank Building
1525 East 53rd St., Chicago 15, Illinois

CIRCLE 85 ON READER-SERVICE CARD
MARYLAND

DIXIE HIGH FIDELITY WHOLESALERS

Largest discount High Fidelity component distributors in the South. Wholesale prices on package or individual components. Latest models in factory sealed cartons.

Are prices too high?—Write:
DIXIE HI-FI
12402 Connecticut Ave., Silver Spring, Md.

CIRCLE 38 ON READER-SERVICE CARD

NEW JERSEY

WRITE FOR QUOTATION
ON HI-FI COMPONENTS
SOUND REPRODUCTION, INC.
34 New Street, Newark 2, N. J.
Mitchell 2-6816

CIRCLE 98 ON READER-SERVICE CARD

NEW YORK

FOR THE TOPS IN VALUE
AND THE BEST TRADE-IN ON
HIGH FIDELITY EQUIPMENT
Check with Arrow!

ARROW ELECTRONICS, INC.

65 Cortlandt St., New York 7, N. Y. Dlgby 9-4730
525 Jericho Turnpike, Mineola, N. Y. Pioneer 6-8686

CIRCLE 9 ON READER-SERVICE CARD

THE HI-FI SERVICE!

90 Day Warranty

JAMAICA—JA 3-8850
MANHASSET—MA 7-5737
BROOKLYN—BU 2-5300
WHITE PLAINS—WH 8-3380

The Original Hi-Fi Trading Organization

audio exchange

JAMAICA 153-21 Hillside Ave.

CIRCLE 15 ON READER-SERVICE CARD

AUDIO unlimited

Specializes in SAVING YOU MONEY

- ✓ FACTORY FRESH COMPONENTS
- ✓ LOWEST POSSIBLE QUOTATIONS
- ✓ FAST DELIVERY

We are FRANCHISED DEALERS for most Hi-Fi lines. Most orders SHIPPED PROMPTLY from stock. RECORDING TAPE at LOWEST PRICES. FREE LIST.

190-F Lex. Ave., Cor. 32 St., New York 16, N. Y. Visit Our Showroom

CIRCLE 17 ON READER-SERVICE CARD

SOUNDTASTIC!

That's what our customers are saying upon receiving our prices! Write for special low prices on hi-fi components, tape recorders, etc. INDIVIDUAL QUOTATIONS ONLY! No catalogs.

AUDIO WORLD

117-20—14th Road, COLLEGE POINT 56, N. Y.

CIRCLE 18 ON READER-SERVICE CARD

OUT OF SPACE?

You bet we'd be... If we were to tell you All about AUDION's "Out of this World" Hi-Fi Values. Write for free catalog.

audion
25-HF Oxford Road
Massapequa, New York

CIRCLE 19 ON READER-SERVICE CARD

NEW YORK

PROMPT DELIVERIES

WE WILL NOT BE UNDERSOLD
AMPLIFIERS, TAPE RECORDERS, TUNERS, ETC.
CATALOG. AIR MAIL QUOTES. COMPARE
L. M. BROWN SALES CORP.
Dept. F-239, East 24 St., New York 10, N. Y.
CIRCLE 25 ON READER-SERVICE CARD

HI-FI RECORDING TAPE

Splice Free (except 2400')
15 day money-back guarantee

		3+	12+	24+	
1200'	7"	Acetate	\$1.29	\$1.17	\$1.09
1800'	7"	acetate	1.79	1.59	1.45
1800'	7"	mylar	2.09	1.99	1.85
2400'	7"	mylar	3.29	2.99	2.75
2400'	7"	tensilized mylar	4.25	3.95	3.75

Can Be Assorted. Add 15¢ Postage Per Reel.
10¢ For 24" Lot Orders.

HI-FI COMPONENTS TAPE RECORDERS available from wide variety of stock and shipped within 24 hours. Write for free wholesale catalogue. "WE WILL NOT BE UNDERSOLD." Write us and see why.

CARSTON
125-D East 88 St.
New York 28, N. Y.

CIRCLE 28 ON READER-SERVICE CARD

TAPE RECORDERS

Hi-Fi Components
SLEEP LEARN KITS
Unusual Values
FREE 1961 Catalog

MERITAPE
Low cost, high quality recording tape in boxes or cans.

DRESSNER 1523 FA Jericho Turnpike, New Hyde Park, New York

CIRCLE 39 ON READER-SERVICE CARD

F & B RECORDING TAPE

Professional Quality

Unconditional 25 Year Money-back Guar.!

Top-Quality Freq. Resp. 30-15,000 cycles.

IS GUARANTEED FOR 25 YEARS

1200 ft. 7" reel...	3 for \$3.89
1800 ft. 7" reel...	3 for \$5.22
1800 ft. MYLAR, 7" reel...	3 for \$6.59
2400 ft. MYLAR, 7" reel...	3 for \$9.93

add 15¢ per reel for postage & handling

FLOMAN & BABB, Inc.
68 West 45th St. New York 36, N. Y.

CIRCLE 49 ON READER-SERVICE CARD

THIS AD IS WORTH MONEY!

TO SERIOUS STEREO · HI FI BARGAIN HUNTERS

Clip this ad and return it to us with your name and address. We will not send a "free catalog." Instead you receive each month, our news list of stereo—hi fi bargains, based on our special purchases and merchandise deals with manufacturers and distributors. We carry latest models of all top makes, delivered in factory sealed cartons—all fully guaranteed.

WHAT EQUIPMENT DO YOU WANT? Tell us what hi fi components you want now. We will rush a bottom-dollar quotation by return mail!

LYRIC STEREO—HI FI CENTER, INC.
1190 Lexington Ave., N. Y. 28, N. Y.
Hours: 11 to 8, Mon.-Sat. LE 5-5710

CIRCLE 68 ON READER-SERVICE CARD

TRADE-INS ACCEPTED

SAVE MONEY on High Fidelity Equipment

Check our prices first on all Hi-Fi and Stereo Equipment. New, fully guaranteed, Prompt service on all inquiries. Write to Arthur Knight

TERMINAL-HUDSON ELECTRONICS, Inc.
236 West 17th St., N. Y. 11, N. Y. Dep't HF

CIRCLE 104 ON READER-SERVICE CARD

MAGNETIC THUNDER

Continued from page 69

performance, for the permanent record. We found early in the game that the cast would look for the mike hung in the proscenium to find out when we were actually taping. If they saw the mike, they got mike fright and gave a poor performance. So now we put the mike up for all performances, and we never tell the cast which night it will be turned on. Under these conditions, each performance tends to be better than the last.

Ten years ago, when we taped a play during performance, we used a professional recorder operating at fifteen inches a second, and hung two American professional mikes in the proscenium. With the advent of recorders using heads with

smaller gaps, we have been able to use a single mike and record at three and three quarters inches per second, with improved results over our original recordings. In the future, plays on our new stage will be taped in stereo.

They say that Hollywood folk will run and hide from their old pictures on the TV Late Show, and that there are writers who never open a book once they have finished writing it. Well, maybe.

It is true that the Sherman Players suffer acute pain when they first hear themselves on tape. So does everybody else. "But I don't sound like that. My voice is lower" is the universal protest. In fact, nobody ever hears his true voice with his ears. The sound is bone-conducted, and bone does not transmit the range of high frequencies conducted through air. So you do sound like that tape recording. Make the best of it.

In Sherman we have good parties. Our Martinis are as dry as the city feller's, and our *pâté* is really from the liver of a stuffed Alsatian goose. And we can always get up a good political argument—not Democrat versus Republican, but Four-Plays-Next-Year versus Three-Plays-Are-Enough; Robert Sherwood versus Berthold Brecht; or Cushions-for-the-Church-Benches-in-the-Playhouse versus Cushions-Cost-Too-Much (cushions won).

People will come to parties when our white silk Martini flag goes up. Of course a few will have to fall out because the baby sitter didn't show up or "There is water in the basement and the plumber hasn't come." But for our Sherman Player parties, when we are going to play the complete tape of the last play, Sherman babies can do without the ten o'clock bottle and Sherman furnaces may take off to sea. *Everybody* comes.

They come nonchalantly, as a "matter of community feeling." There is a good deal of shrugging and eyebrow-raising and "After you, Alphonse." "After you, my dear Gaston" maneuvering for seats. But somehow chairs and sofas are left empty, while everyone sits upon the floor. Sound from the tape recorder seems to bounce better off the floor.

They chat politely, but absently, until I get up and walk towards the recorder. Then you could hear a pin drop. I push a button, the invisible curtain rises, and the play begins. No Broadway show ever had an audience like this. Cocktail glasses are set down quietly. No one scratches a match; it might drown out a priceless syllable.

But like the Red Cross, we do afford "Compassionate Leave." The guests know when it is safe to crawl out to the powder room—they are off the air for this bit of dialogue. And if a glass is empty, the kitchen bar is not too far away. Two of us, not to be heard till the next act, may perch on stools and drink with one ear cocked towards the living room. But neither will be surprised if suddenly he finds himself alone. "I'm on" takes the place of "Good-by, excuse me, see you later."

Good-by, excuse me, see you later. I've got to get this tape recorder over to the Sherman Playhouse.

PROFESSIONAL DIRECTORY

PENNSYLVANIA

LOOKING for LOW QUOTES
Send us YOUR list. Free bargain sheet. Hi Fi COMP. BUILT 1950 EST. 1932. 1373 EASTON ROAD, ROSLYN, PENNA. The brand name stereo specialist.

CIRCLE 59 ON READER-SERVICE CARD

REE BROS. ELECTRONICS

Delaware Valley's Largest Wholesale Distr. of Hi Fi, Stereo, Electronics.

We invite you to check our guaranteed lowest prices on name brand components.

FREE Quotation Given Immediately by Mail. Address Inquiries to Dept. J.

When in Phila. Visit Our Showrooms at 7711 OGONTZ AVENUE

CIRCLE 86 ON READER-SERVICE CARD

TEXAS

We Will Not Be Undersold!
Garrard Type A Changer \$ 79.50
Shure M7-D cartridge 24.00
Harman-Kardon TA 224 AM FM Stereo tuner pre-amp. amplifier. 199.95
2 Sterling Sheriton 2-way speaker systems with enclosures; 35-18,000 cycles, reg. \$49.95 each 99.90
Plus 1 record cloth, 1 record brush
Your Complete Sterling Package Price **\$279.00**
Here in your own backyard is one of the country's largest sources of audio eqpt. 20 yrs. experience. Write for Free catalogue. STERLING ELECTRONICS, INC. P. O. Box 1229, Dept. HF., Houston 1, Tex.

CIRCLE 100 ON READER-SERVICE CARD

WASHINGTON

LEARN WHILE YOU SLEEP
Headquarters
Experiment in this fascinating, educational new field. Use your phonograph, recorder or amazing new "Electronic Educator" endless tape recorder. We carry a full line of endless tapes for standard recorders, plus timers, pillow speakers and complete outfits. Also 200 unusual educational and self-help courses on tape and record for sleep-learning and self-hypnosis experimenters. Write for free 300-item catalog and full details. Sleep-Learning Research Association P. O. Box 24-F, Olympia, Washington

CIRCLE 95 ON READER-SERVICE CARD

TRADER'S MARKETPLACE

This classified section is available without cost only to readers who wish to buy, sell or swap used equipment or records. No dealer ads will be accepted. Please limit your message to 30 words, including name and address. Copy must be received by the 5th of the 2nd month preceding publication and is subject to approval of publishers. Classified advertisements will be limited to one page and advertisements printed on a first-come, first-served basis.

SELL: 3-way, 12"-reflex, horn w/levels, \$30; Record Annuals '55-'58. R. H. Jacob, 21 Fairway Drive, Yardley, Pa.

WANTED: Gieseking 78 R.P.M.'s. Dean M. Elder, 105-10 62nd Road, Forest Hills 75, N.Y.

SELL: Altec 6-4C 15" coaxial speaker, \$100. Michael Henry, 430 Cooper St., Woodbury, N.J.

CITATION I and II, used two months, \$350.00. Paul Borton, 3039 DeCamp Rd., Youngstown 11, Ohio.

WANT: Telefunken Custom Speakers. William Storey, 5738 Oram St., Dallas 6, Texas.

VIRTUALLY COMPLETE run HIGH FIDELITY (54 issues) from Vol. 1, number 1, Summer, 1951, to August, 1957. Missing only two issues—July-August, 1953 and January, 1956. Best offer. R. A. Brewer, Meredith, N.H.

PROFESSIONAL THEATRE Speaker System. The Stan White 4D. Original cost \$1500. Contains 2 15" woofers; 2 mid-range horns and tweeter. Make an offer. J. Dascal, P. O. Box 67, Corona 68, N.Y.

BACK ISSUES complete (or individually). John H. Cone, 775 South Madison, Pasadena, Calif.

FAIRCHILD SM-1 with Gray 212 tone arm. Fine condition, best offer or trade. Robert Bell, 1924 Georgia Ave., Toledo 13, Ohio.

SELL: EICO HF-85K stereo preamplifier, Heathkit UA-12-watt amplifier (new EL-84's). Wired from kits 2 years ago, will accept best offers. Charles Field, Varsity Apt. B, W. Lafayette, Ind.

SELL: McIntosh preamp C108 with separate D101 power supply, mahogany cabinet. Excellent shape, \$29.00. Frank Cappi, 5401 Cornell, Chicago, Ill.

TRADE: Scott 99-D amplifier and two Goodmans 208-8 coaxial speakers for Scott multiplex adaptor. John Guzy, 1920 W. 55th, Chicago 9, Ill.

LIKE NEW Paco 40 watt stereo amplifier, 6 months old. Barrie Bergman, 201 E. Club Blvd., Durham, N.C.

ALTEC 604C speaker in handmade walnut French provincial enclosure with doors, integral record storage, \$250. Dr. Ronald A. Malt, 64 Washburn Ave., Wellesley Hills 81, Mass.

FOR SALE: Newcomb SM310-4 quarter track 2 speed stereo tape recorder. Takes 10" reels. Good condition. \$350. Sumner Northcuff, 75 Bennington St., Newton 58, Mass.

WANTED: Record of original "Musical Gagetry" (some 10 years back?) H. Wixon, 3657 W. 59th Place, Chicago, Ill.

KNIGHT-kit 20-watt stereo amplifier, 4 inputs, \$30. Electro-Voice LS-12, Electro-Voice MF-1, both \$33. Will also trade for other good equipment. M. N. Stosich, 9817 Exchange Ave., Chicago 17, Ill.

EICO HF-52 50-watt integrated control amplifier, good condition, \$49. Speaker system comprising 15" woofer, University T202 "Sphericon" tweeter, University N28 crossover, \$25. N. P. Forcier, Haynes Ave., Middleton, Mass.

TWO AR-1 W woofers, \$100 each. One Janszen Electrostatic model 130, \$100. One Janszen Electrostatic model 65, \$50. All Korina finish. J. R. Wetzel, 312 Chestnut St., Mifflinburg, Pa.

FISHER FM-90 tuner; Berlant 20/20 monaural recorder with carrying case; new unused Scott 100 arm and cartridge. Donald Cain, Skaneateles, N. Y.

INTERESTED in trading tapes of "Live" opera performances with Albanese, Boerling, Baccoloni et al. Send lists and wants. Paul Fornatar, 6328 S. Kildare, Chicago 29, Ill.

WANTED: Bozak 305, 310A, or B207A speakers; Dynakit, Acrosound or McIntosh amp (60 watts). Located within 100 miles of address. George Hawkins, 164 Grant St., Conneaut, Ohio.

SELL: Scott 121C dynaural equalizer-preamplifier; Scott 240 40-watt power amplifier; Sherwood S-3000A FM tuner; Browning L-500 AM-SW tuner. Best Offer. R. Wolfert, Sturtevant, Wis.

COLLECTION of 600 autographs of celebrities: Composers, Pianists, Violinists, Orchestra Leaders and Lyric Artists. Will sell only as complete collection. Write Lucci Alfredo, Via Farini 10, Bagnacalco, Ravenna, Italy.

LAFAYETTE

KT-550

DUAL 50-WATT STEREO
AMPLIFIER KIT

A Lafayette Criterion
Stereophonic Component

Only **5.00** Down
134⁵⁰ in easy-to-build kit form
184⁵⁰ factory wired and tested



Complete with Attractive Metal Enclosure
Made in U.S.A.



- Conservatively Rated at 50-watts Per Channel
- Frequency Response 2-100,000 cps + 0, -1db at 1 Watt
- Hum & Noise Better Than 90db Below 50-Watts
- Multiple Feedback Loop Design (over 50db) Lowers Distortion Without Sacrificing Stability
- Metered Calibration Control Panel With D.C. Bias and AC Balance Facilities.
- Massive Grain Oriented Silicon Steel Transformers In 11 Winding Sections
- New 7027A Output Tubes
- Silicon Diode Power Supply

Compare Performance—The KT-550 provides high power output with an extremely flat response at both ends of the frequency spectrum.



NEW!
LAFAYETTE RADIO ELECTRONICS
Dept., W11-2 P.O. Box 190
Jamaica 31, N. Y.

FREE 340-page 1962 Catalog 620

KT-550 Lafayette Dual 50-Watt Stereo Amplifier Kit

\$ _____ Enclosed

Name _____
Address _____
City _____ Zone _____ State _____

CIRCLE 65 ON READER-SERVICE CARD

ADVERTISING INDEX

Key No.	Page	Key No.	Page
1	Acoustic Research, Inc. 89	40	Ionovac Division 92
2	Airex Radio Corp. 133	61	JansZen 116
3	Allied Radio 132	62	Jensen Mfg. Co. 6
4	American Concertone 97	63	Kapp Records 106
5	American Elite 121	64	Kersting Mfg. Co. 136
6	Angel Record Club 7	65	Lafayette Radio 4, 138
7	Archive Records 106	66	Library of Recorded Masterpieces 106
8	Argo Records 119	67	London Records 88
111	Argos Products 131	68	Lyric Hi-Fidelity 136
9	Arrow Electronics 136	69	Magnecord 32
10	Artia Record Corp. 100, 101	70	Marantz Co. 95
11	Artisan Organ Division 133	71	McIntosh Laboratory, Inc. 30
12	Atlantic Monthly 114	72	Mercury Records 90
13	Audio Devices 40	73	Microtran Co., Inc. 134
14	Audio Dynamics 33	74	Minnesota Mining & Manufacturing Co. 18
15	Audio Exchange 120, 136	75	Myer's Emco 136
16	Audio Fidelity 78	61	Neshaminy Electronic Corp. 116
17	Audio Unlimited 136	76	Newcomb Audio Products 24
18	Audio World 136	77	North American Philips 23
19	Audion 136	78	Nortronics 98, 132
20	Bel Canto 122	105	Ortofon 8
21	Bell Sound Division 37	79	Pacotronics 19-22
22	Benjamin Electronics 26, 27	80	Pickering & Co. 2
23	Bogen-Presto 91	81	Pilot Radio 25
24	British Industries Corp. 42	56	Precision Electronics 36
25	Brown, L.M., Sales Corp. 136		Professional Directory 136, 137
26	Burgess Battery 115, 133		RCA Tape 58
27	Capitol Records 99	82	RCA Victor Division Inside Front Cover
28	Carston Studios 136	83	Radio Shack 99, 115, 125, 135
30	Columbia Record Club 5	84	Rebel Price 136
29	Columbia Records Inside Back Cover	85	Recocards 136
31	Command Records 86, 87		Records in Review 98
32	Commissioned Electronics 133	86	Ree Bros. Electronics 137
33	Concord Electronics 112, 113	87	Reeves Soundcraft 31
34	Decca DGG Records 103	88	Rek-O-Kut 41
35	DeWald Radio 130	89	Roberts Electronics 28
36	Dexter Chemical 98	90	Rockford Furniture 16
37	Distinguished Records 83	91	Sarkes Tarzian, Inc. 10
38	Dixie Hi-Fi 136	92	Scott, H.H., Inc. 34, 35
39	Dressner 136	93	Sherwood Electronic Lab. Back Cover
40	DuKane Corp. 92	94	Shure Bros. 29, 108
41	Dynaco, Inc. 102, 104	95	Sleep Learning Research Association 137
42	EICO 128	96	Sonotone Corp. 12
43	Electro-Acoustic Prod. 93	97	Sony Corp. 94
44	Electro-Sonic Labs. 14	98	Sound Reproduction 136
45	EMPIRE 1	99	Stereo-Parti 136
46	Eric Electronics Corp. 96	100	Sterling Electronics 137
47	Fairchild Recording Equipment 117	101	Superex Electronics 125
48	Fisher Radio Corp. 11, 13, 15, 17	102	Tall Co. 125
49	Florman & Babb 136	103	Tandberg 126
50	General Dynamics/ Electronics 132	104	Terminal-Hudson Trader's Marketplace 137
51	General Phones Corp. 134	106	Triton Tape 124
52	Grado Laboratories, Inc. 84	107	United Artists 117
53	Gramophone 135	108	United Stereo Tapes 107
54	Granco Division of Dumont Emerson 131	109	University Loudspeaker, Inc. 57
55	Greentree Electronics Corp. 127	110	Vanguard Recording Society, Inc. 85
56	Grommes 36	24	Wharfedale 42
57	Harman-Kardon, Inc. 9		
58	Heath Co. 38, 39		
59	HiFi 137		
60	Hi-Fidelity Center 132		



THE COLLECTOR'S CHOICE

THE VIRTUOSO AND THE POET OF CONDUCTORS



An inspired alliance—
Francescatti's luminous virtuosity,
Walter's musical wisdom,
Beethoven's noble Violin Concerto.

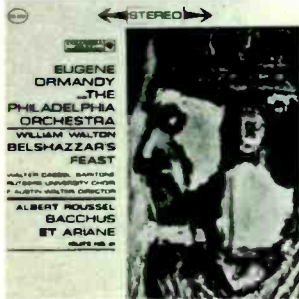

A FEAST OF SOUND

The savage splendor of Old Testament Babylon is pictured in
Walton's choral drama. A gorgeous tapestry
woven by Ormandy, The Philadelphia Orchestra
soloists, two brass bands
and the Rutgers University Choir.



BERNSTEIN'S GALLIC GIFT



Bernstein's warm rapport
with French Impressionism is revealed
in an ardent recording of
Ravel's "Daphnis and Chloe,"
the complete score with chorus.



GOULD'S BEETHOVEN



The greatest young pianist of our time,
perpetually provocative, profoundly perceptive
in Beethoven's Fourth Piano Concerto.



SPANISH IN STEREO



With staccato stamping of feet
and fiery flamenco songs,
Jose Greco's ballet company
sets the stereo microphones ablaze.



BACH BY BIGGS



Best-known organ works of Bach,
masterfully played by Biggs on the
crisply articulate Flentrop Organ
at Harvard University.

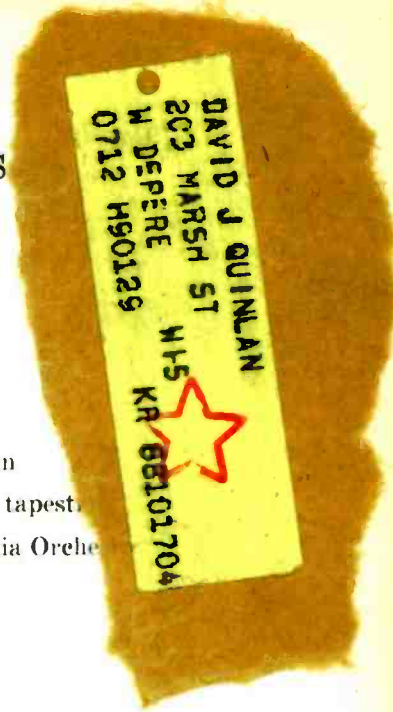

IS ON COLUMBIA RECORDS 

CHOOSE SPECTACULAR STEREO OR MATCHLESS MONAURAL

Pioneer Stereocast Goes On The Air



Edward S. Miller, General Manager of Sherwood cues Frank Kovas, WKFM President, to start the pioneer stereocast.

FM MULTIPLEX STEREO BROADCAST MAKES HISTORY

CHICAGO, Ill.—Station WKFM made the world's first FM stereo multiplex broadcast simultaneous with their usual background music programming. Equipment used was designed, constructed, and installed by Sherwood Electronic Laboratories. Another World's "first" was achieved by Sherwood's sponsoring the FM Stereocast.

PRESS PARTY

Gathered at the Gaslight Club in Chicago were members of the electronics industry and the press. The Stereo Multiplex broadcast was received via the new Sherwood S-8000 FM/MX Stereo Receiver—the first such unit on the market.

For details on the S-8000 or versatile Stereo MX adapters write Sherwood Electronic Laboratories, Inc., 4300 N. California Avenue, Chicago 18, Illinois. Dept. 9-H



John Radtke, Sherwood's Chief Research Engineer, checks out WKFM's stereo multiplex transmitting equipment.



Sherwood's Bud Field and Jerry Fields of Musicraft enjoy the first stereocast over Sherwood's new S-8000 24-watt Stereo FM Receiver.



Reporters from electronics publications enjoy the change of voice at Chicago's Gaslight Club.