

60 cents

high fidelity

THE MAGAZINE FOR MUSIC LISTENERS

MARCH
1962

An Argument for

RICHARD STRAUSS

by Glenn Gould

ALSO

Richard Strauss

On Microgroove

a discography

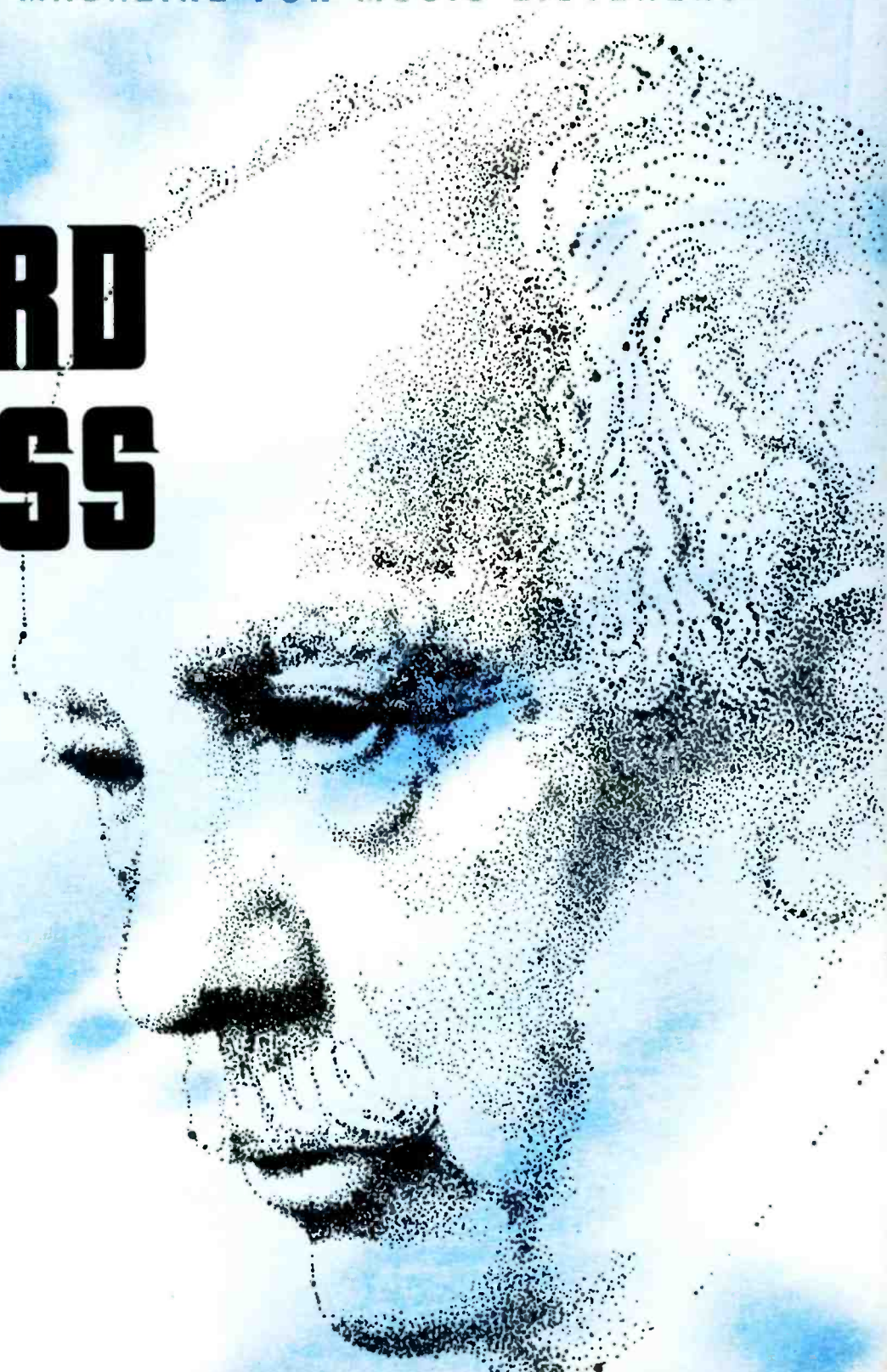

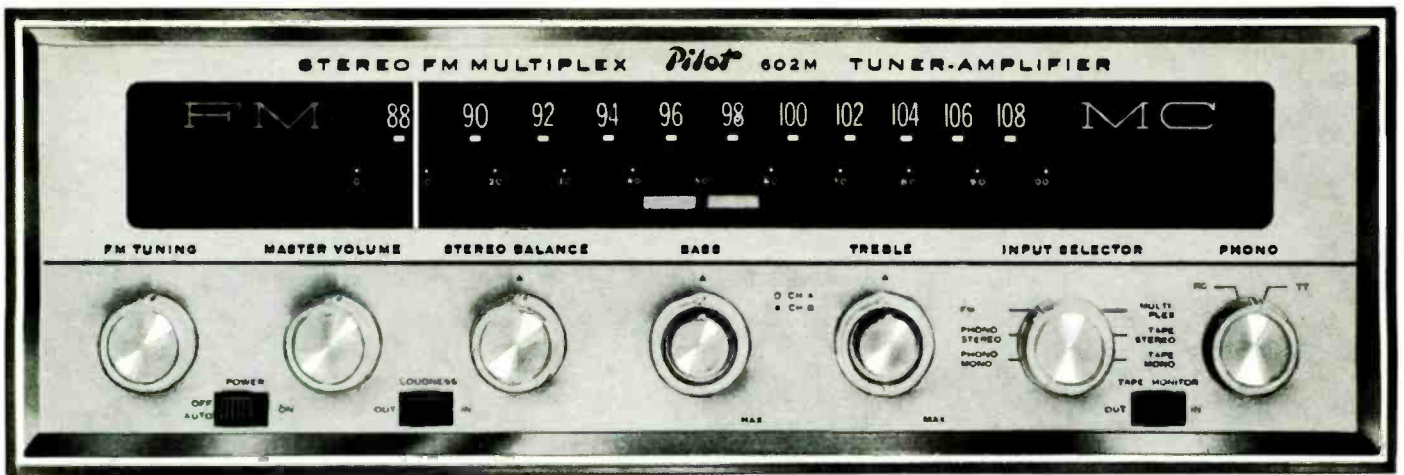

PILOT 602M

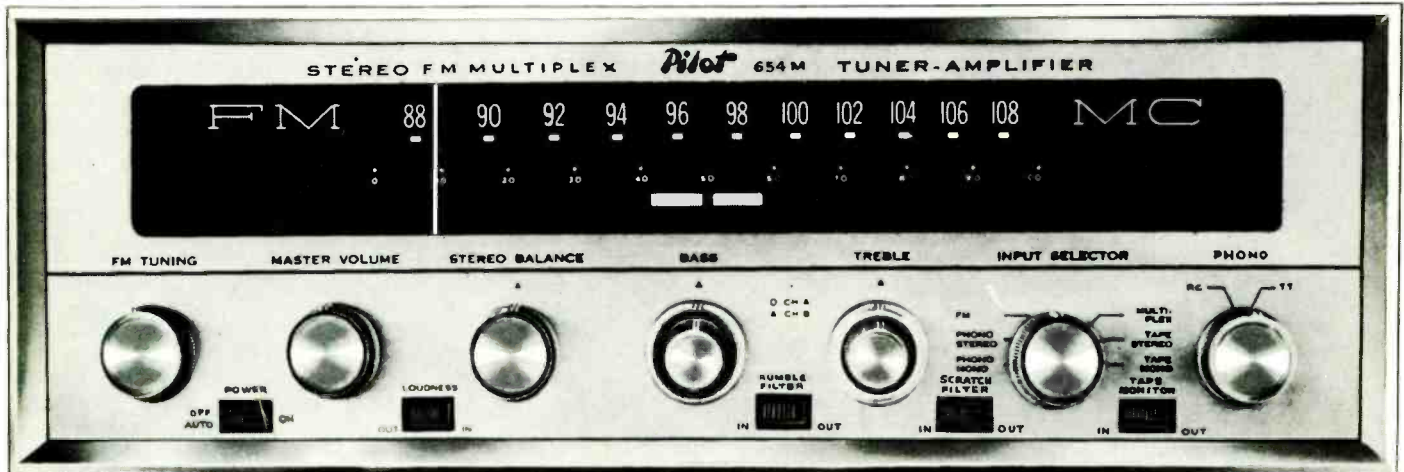

PILOT 654M

CHOOSE YOUR **PILOT** MULTIPLEX STEREO RECEIVER

On one compact chassis PILOT engineers have designed and built the perfect electronic "heart" for a high-fidelity stereo system—FM tuner, FM Multiplexer, stereophonic amplifier and stereo preamplifier all combined to give you perfect reproduction... from stereo records... from stereo tapes... from FM Multiplex stereo broadcasts. Simply connect two speakers and a record changer and you're ready for the finest in music listening enjoyment.

All PILOT FM Multiplex receivers incorporate PILOT's unique signal sampling Multiplex circuitry*... the simplest (NO FILTERS, NO MATRIXING, NO EXTRA CONTROLS)... the most effective (30 db or better separation)... the most trouble-free circuitry yet devised for FM Multiplex reception. PILOT stereo receivers also feature two special speaker terminals to create PILOT's exclusive STEREO PLUS CURTAIN-OF-SOUND.

SPECIFICATION FEATURES—PILOT 602M

30 watts music power—enough to drive any popular speaker system... complete stereophonic and monophonic flexibility from the 12 control preamplifier... FM sensitivity 3 uv IHFM... 6 inputs for connection of turntable, record changer, tape

recorder or tape transport. Measures 5½" high x 14½" wide x 10¾" deep. Complete with cover—\$249.50.

Also available with added AM, PILOT 602S complete with cover—\$299.50.

SPECIFICATION FEATURES—PILOT 654M

60 watts music power—enough for any speaker system... complete control versatility from 14 controls including rumble and scratch filters. FM sensitivity 3 uv IHFM. Six inputs for connection of record changer, turntable, tape transport or tape recorder. Dimensions—5½" high x 14½" wide x 12¾" deep. In handsome black and brass styling complete with cover—\$329.50.

The PILOT 654M is the only Multiplex receiver that has a truly AUTOMATIC stereo indicator light. Regardless of what tuner mode the receiver is set for, if the station is broadcasting stereo the light will light. Unlike other Multiplex receivers, the PILOT 654M will indicate which stations are broadcasting stereo as you tune across the dial regardless of whether you are set to FM stereo or not.

* Patent Pending

See and hear PILOT's complete line of FM Multiplex Stereo components:

STEREO TUNERS (Model 280, \$99.95; Model 380, \$179.50). MULTIPLEXERS (Model 100, \$49.50; Model 200, \$79.50).



FOR FURTHER INFORMATION, WRITE:

PILOT RADIO CORPORATION, 37-16 36TH STREET, LONG ISLAND CITY 1, NEW YORK

"This is the finest Brahms Second in stereo... The Best Classical Orchestral Album of 1961" THE NEW YORK HERALD TRIBUNE



Command 35/MM CLASSICS

A MAJOR BREAKTHROUGH IN RECORDED CLASSICAL MUSIC

Just a few short months ago, COMMAND Records (acknowledged leader in popular stereo albums) entered the highly selective field of classical music with a series of five releases . . . all master-recorded on 35 millimeter magnetic film. The impact this initial set of classical albums created among music critics and connoisseurs alike, was nothing short of sensational. Even though released late in the year, William Steinberg's delicate reading of Brahms' Symphony No. 2 was selected as the No. 1 classical orchestral album of 1961, in the New York Herald Tribune's annual record review.

In this newspaper's same selection of the year's best records, another of COMMAND'S CLASSICS, Pierre Dervaux's version of Ravel's Daphnis et Chloe, Suite No. 2, was also singled out for top classical honors.

These new COMMAND CLASSICS (including the Rachmaninoff Symphony No. 2; the Mussorgsky-Ravel Pictures at an Exhibition, and the two capriccios; Tchaikovsky's Capriccio Italien and Rimsky-Korsakov's Capriccio Espagnol)

revealed to the critics the tremendous potential of the new 35 mm recording technique.

In fact, COMMAND'S total success in faithfully reproducing the sound of large orchestras through the use of 35 mm magnetic film, was neatly epitomized in this statement by The American Record Guide, an independent journal of opinion: "These first five classical issues from COMMAND constitute a technological breakthrough of major proportions. They are the product of multiple microphone pickup of sound recorded on 35 mm magnetic film traveling at 18 inches per second. The results are, beyond question, the most life-like sound any of us has ever heard . . . Enoch Light, producer of the records, deserves our thanks." And, American Record Guide was sufficiently impressed with the COMMAND 35 mm recording technique to terminate their review with the observation that "to all record companies, the message by now should be loud and clear enough: the word is convert —to 35 mm film."

NEW 35/MM CLASSICS FROM COMMAND



The four albums pictured on the left represent COMMAND'S latest contribution to the crusade for true sonic realism in the recording of classical repertoire. Again featuring some of the world's finest classical musicians, these albums reflect the latest advance in the realization of greater range in dynamics, frequency and dimension, now made possible through the use of 35 mm magnetic film as a recording medium.

If your classical library doesn't yet contain the COMMAND CLASSICS . . . it's lacking the most exciting advance in recording history since the advent of high fidelity. And you're missing an adventure in musical listening that will positively exceed your fondest expectations. COMMAND CLASSICS are available in stereo, monaural and 4 track tape versions. See your COMMAND record dealer now!

Send for free descriptive brochure
of all COMMAND releases

Command RECORDS

Manufactured by Grand Award Record Co., Inc.
1501 BROADWAY, New York 36, N. Y.

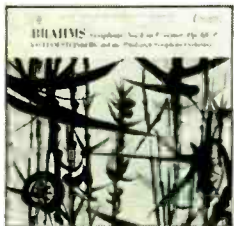

BRAHMS Symphony No. 1 in C minor, Op. 68. WILLIAM STEINBERG and the Pittsburgh Symphony Orchestra.

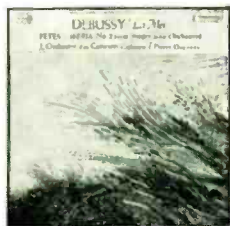

DEBUSSY La Mer/Fetes/Iberia — PIERRE DERVAUX. L'Orchestre des Concerts Colonne.



BERLIOZ Symphony Fantastique, Op. 14—ANDRE VANDERNOOT / L'Orchestre National.



LEONID HAMBRO AND JASCHA ZAYDE, world renowned duo-pianists, now play MOZART/MENDELSSOHN/SCHUBERT.

CIRCLE 30 ON READER-SERVICE CARD

COMPARES...



to his...

STANTON

stereo fluxvalve pickup

PICKERING & COMPANY INC. offers the stereo fluxvalve pickup in the following models: the Calibration Standard 381, the Collector's Series 380, the Pro-Standard Mark II and the Stereo 90. Priced from \$16.50 to \$60.00, available at audio specialists everywhere.

"FOR THOSE WHO CAN HEAR THE DIFFERENCE"

Pickering and Company—Plainview, Long Island, New York

CIRCLE 68 ON READER-SERVICE CARD



Page 55



Page 53



Page 46

high fidelity

Music and Musicians

- 45 The Glories of Late Strauss: an editorial
- 46 An Argument for Richard Strauss *Glenn Gould*
- 50 Richard Strauss on Microgroove: a discography *Herbert Glass*
- 55 A Biedermeier Man in West Berlin: Dietrich Fischer-Dieskau
Peter Heyworth
- 58 Watch Your Jacket: the art of record annotation *Charles Cudworth*
- 16 The Fine Arts Quartet: an interview *Shirley Fleming*
- 22 Notes from Abroad—London, Vienna, Paris
- 67 Music Makers *Roland Gelatt*

Sound Reproduction

- 53 Testing Tubes at Home *Lewis A. Harlow*
- 61 Equipment Reports
 - Lafayette LA-550 Stereo Power Amplifier
 - Electro-Acoustic Model 7002 Record Changer
 - Tannoy "Monitor" Speakers; GRF and Belvedere Enclosures
 - Korting Model 158S Tape Recorder
- 107 High Fidelity Newsfronts

Reviews of Recordings

- 69 Feature Record Reviews
 - Cilea: *Adriana Lecouvreur* (Renata Tebaldi, Mario del Monaco, et al.)
 - Beethoven: Variations for Piano (Alfred Brendel)
- 71 Other Classical Reviews
- 84 The Imports *Gene Bruck*
- 91 The Lighter Side
- 99 Jazz
- 103 The Tape Deck

MARCH 1962 • VOLUME 12 NUMBER 3

Published monthly at Great Barrington, Mass. by The Billboard Publishing Co. Copyright © 1962 by The Billboard Publishing Co. The design and contents of High Fidelity Magazine are fully protected by copyright and must not be reproduced in any manner. Second-class postage paid at Great Barrington and at additional mailing offices. One year subscription in U. S., Possessions, and Canada \$6.00. Elsewhere \$7.00. Indexed in the "Reader's Guide to Periodical Literature." Change of Address: notices and undelivered copies (Form 3579) should be addressed to High Fidelity, Subscription Dept., 2160 Patterson St., Cincinnati 14, O.

LAFAYETTE RADIO

presents

Its Most Popular Stereo Phono System featuring

The FAMOUS LA-250A 50-WATT STEREO AMPLIFIER



LAFAYETTE LA-250A
50-WATT STEREO AMPLIFIER



GARRARD AT-6

CHOICE OF
DIAMOND STEREO
CARTRIDGE



PICKERING
380C



SHURE M7D



LAFAYETTE SK-58
12" COAXIAL SPEAKERS

OUR BEST STEREO SYSTEM BUY
MATCHED COMPONENTS

Lafayette LA-250A 50-Watt Stereo Amplifier	99.50
Garrard AT-6 4-Speed Record Changer	54.50
Pickering 380C Diamond Stereo Cartridge	29.85
Lafayette Wood Base	3.95
2 Lafayette SK-58 12" Coaxial Speakers @ 29.50 each	59.00
Total Price if Purchased Separately	246.80

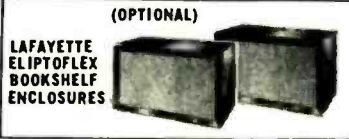

(OPTIONAL)

LAFAYETTE
ELIPOFLEX
BOOKSHELF
ENCLOSURES

LAFAYETTE
SPECIAL PRICE **199.50**

YOU SAVE 47.30

HI-FI STEREO SYSTEM, as above, with choice of Pickering 380C or Shure M7D Cartridge and Walnut, Mahogany or Blonde Changer Base (specify finish)
LS-252WX Only 199.50

Same as LS-252WX but includes 2 Lafayette Elipoflex Series Bookshelf Enclosures in Walnut, Oiled Walnut, Mahogany or Blonde (specify finish)
LS-254WX Only 265.50

LAFAYETTE'S
CRITERION LINE

Pacesetter of the High-Fidelity industry . . . renowned for its performance. The ultimate for those who demand the finest.

NEW! KT-550 100-WATT
BASIC STEREO AMPLIFIER KIT

KT-550 In Kit Form **134.50**

LA-550
Completely Wired
184.50

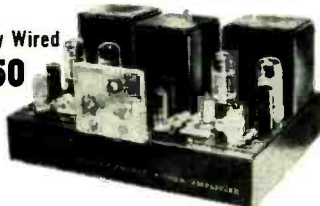

NO
MONEY
DOWN

- Rated at 50-Watts per Channel
- Response from 2-100,000 cps, 0, -1db at 1-Watt
- Grain Oriented, Silicon Steel Transformers
- Multiple Feedback Loop Design
- Easy-To-Assemble Kit Form

A new "Laboratory Standard" dual 50-watt amplifier guaranteed to outperform any basic stereo amplifier on the market. Advanced engineering techniques plus the finest components ensure flawless performance. Distortion levels so low they are unmeasurable. Hum and noise better than 90 db below 50-watts. Complete with metal enclosure. 9 1/2 x 12 1/2" D. Shpg. wt., 60 lbs.

KT-600A PROFESSIONAL
STEREO CONTROL CENTER

KT-600A In Kit Form **79.50**

LA-600A Completely Wired **134.50**

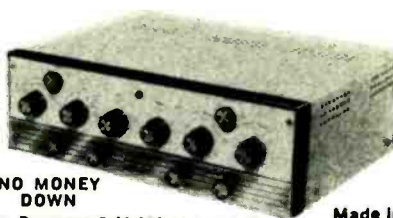

NO MONEY
DOWN

- Response 5-40,000 cps ± 1 db.
- Precise "Null" Balancing System
- Unique Stereo and Monaural Control Features
- Concentric Input Level Controls
- Easy-To-Assemble Kit Form.

Sensitivity 2.2 mv for 1 volt out. Dual low impedance "plate follower" outputs 1500 ohms. Less than .03% IM distortion; less than .1% harmonic distortion. Hum and noise 80 db below 2 volts. 14x10 1/2 x 4 1/2". Shpg. wt., 16 lbs.

Lafayette Radio, Dept. WC2-1, P. O. Box 10, Syosset, L. I., New York

Name _____
Address _____
City _____ Zone _____ State _____

FREE!

NEW
1962
CATALOG
340 PAGES



LAFAYETTE
RADIO
LOCATIONS ▶ JAMAICA 33, NEW YORK

NEW YORK 13, N.Y. BRONX 58, N.Y. NEWARK 2, N.J.
PLAINFIELD, N.J. PARAMUS, N.J. BOSTON 10, MASS

CIRCLE 57 ON READER-SERVICE CARD

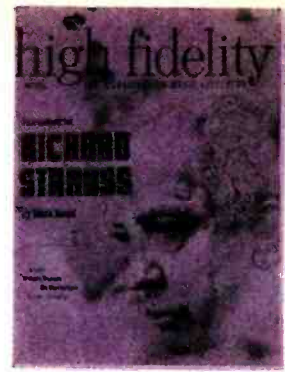

Cover Design: by Roy Lindstrom

Roland Gelatt
Editor in Chief

Joan Griffiths
Executive Editor

Norman Eisenberg
Audio Editor

Sue Severn
Managing Editor

Shirley Fleming
Assistant Editor

H. C. Robbins Landon
European Editor

Roy Lindstrom
Art Director

Nathan Broder
John M. Conly
R. D. Darrell
Alfred Frankenstein
John F. Indcox
Robert C. Marsh
Contributing Editors

Claire N. Eddings
Advertising Sales Manager

Walter F. Grueninger
Circulation Director

Warren B. Syer
Publisher

ADVERTISING

Main Office

Claire N. Eddings, The Publishing House
Great Barrington, Mass. Telephone 1300

New York

1520 Broadway, New York 36
Telephone: Plaza 7-2800
Seymour Resnick, Andrew Spanberger

Chicago

740 N. Rush St., Chicago 11
Telephone: Michigan 2-4245
P. H. Dempers, Thomas Berry,
Allen Campbell

Los Angeles

1520 North Gower, Hollywood 28
Telephone: Hollywood 9-6239
George Kelley

The Best of Two Worlds of musical entertainment



HERBERT VON KARAJAN



...brought to you by the **ANGEL RECORD CLUB!**

Take 5 Albums Pay only \$1.00

plus a small charge for shipping services

When you become a trial member of the Angel Record Club and agree to buy as few as six future selections during the next 12 months.



EDITH PIAF

760. TWO IN A GONDOLA. Dino Olivieri conducts Venetian music aglitter with romantic violins and mandolins. Monaural only. **\$3.98**



702. THE SCOTS GUARDS VOL. 1. The Regimental Band and Matted Pipers in gay marches, reels, strathspeys. Monaural only. **\$4.98**



775. HELTER SKELTER: BAND OF THE WELSH GUARDS. Scintillating Hi-Fi realism! My Fair Lady, more. **\$4.98; Stereo \$5.98.**

709. Grieg: MUSIC FROM PEER GYNT. Sir Thomas Beecham conducts Royal Philharmonic. "Delightful!" **\$4.98; Stereo \$5.98.**



209. FRANK SINATRA. NICE 'N' EASY. Hear Fools Rush In, Mam'elle, Dream, 10 more. Nelson Riddle's Orch. **\$4.98; Stereo \$5.98**

753. VIENNESE DANCES #2. The Philharmonia under Vienna-born Henry Krips plays 6 scintillating waltzes. **\$4.98; Stereo \$5.98.**



730. Beethoven: PIANO CONCERTO NO. 4. Russia's famed Emil Gilels is soloist with the Philharmonia Orch. **\$4.98; Stereo \$5.98.**



729. Berlioz: SYMPHONIE FANTASTIQUE. A striking interpretation by Herbert Von Karajan and the Philharmonia. Monaural only. **\$4.98**

361. STAN FREDBERG. PRESENTS THE UNITED STATES. Offbeat fun! Yankee Doodle Go Home plus 9 other spoofs. **\$4.98; Stereo \$5.98**



756. MUSIC ON THE DESERT ROAD. The haunting music of the East—14 pieces recorded on a journey to India. Monaural only. **\$4.98**

776. KURT WEILL IN BERLIN. Songs from the master tunesmith's hit shows, including Threepenny Opera. **\$4.98; Stereo \$5.98**

355. GEORGE SHEARING. THE SHEARING TOUCH. Superb stylings of Nola, Misty, Bewitched, Honeyuckle Rose, 7 more. **\$3.98; Stereo \$4.98**

777. BITTER SWEET—Moel Coward. Highlights from the wonderful show. I'll See You Again, Kiss Me, 9 more. **\$4.98; Stereo \$5.98**

354. PEGGY LEE. BASIN STREET EAST. Catch her club performance of Fever, Them There Eyes, Yes Indeed, 12 more. **\$3.98; Stereo \$4.98**



761. SPANISH GUITARS OF LAURINDO ALMEIDA. Ravel's Minuet and 10 other classics in stirring guitar performances. **\$4.98; Stereo \$5.98.**

745. Chopin: 8 MAZURKAS: 3 POLONAISES. Malcuzyński at the piano in fiery renditions of 11 notable works. Monaural only. **\$4.98**

770. WHITE HORSE INN—Benatzky and Stolz. My Song Of Love, 11 others from this ever-popular show. **\$4.98; Stereo \$5.98**



755. APERITIFS. The Philharmonia Orchestra in 7 vivacious French concert pieces by Berlioz, Chabrier. **\$4.98; Stereo \$5.98.**



779A & 779B. THE MIKADO Gilbert and Sullivan. Hear the biting wit and enchanting music of the Savoyards in a brilliant new album. Sir Malcolm Sargent leads; the Glyndebourne Festival Chorus and the Pro Arte Orch. **\$9.98; Stereo \$11.98** (2-Record set—Counts as 2 selections.)

780. CHOPIN WALTZES. Malcuzyński plays 14 delightful pieces. Minute Waltz, other favorites. **\$4.98; Stereo \$5.98**

754. THREE RHAPSODIES. The Vienna Philharmonic under Silvestri plays rhapsodies by Liszt, Ravel, Enesco. **\$4.98; Stereo \$5.98.**



757. GERMAN BEER-DRINKING MUSIC. A zither, vocalists and a brass band bring frothy entertainment from Munich. Monaural only. **\$3.98**



780. SOVIET ARMY CHORUS & BAND. 200 thundering male voices sing Russian folk ballads and army songs. **\$4.98; Stereo \$5.98.**



747. CALLAS PORTRAYS PUCCINI HEROINES. Favorite arias from operas Manon Lescaut, Butterfly, Bohème, others. Monaural only. **\$4.98.**

762. RUSSKAYA! Hollywood Bowl Symphony. Carmen Dragon conducting Russian music by Rimsky-Korsakov, others. **\$4.98; Stereo \$5.98.**



349. THE KINGSTON TRIO. GO IN PLACES. Harmonies in many moods: Pastures Of Plenty, Billy Goat Hill, 10 more. **\$3.98; Stereo \$4.98**

766. THE BEST OF PETER SELLERS. England's funniest oddball in Party Political Speech, Radio Today, other spoofs. **\$4.98; Stereo \$5.98.**

730. Brahms: SYMPHONY NO. 4. Played by the Philharmonia Orchestra, conducted by Herbert Von Karajan. Monaural only. **\$4.98**

784. PABLO CASALS. J. S. Bach: Suites for Unaccompanied Violin. No. 3 in C major; No. 4 in E flat major. **\$5.98**

782. DAME NELLIE MELBA. Operatic & Song Recital: Mattinata, Goodbye, other songs and arias from La Bohème, Lucia, Rigoletto, Romeo et Juliette, others. **\$5.98**

785. WANDA LANDOWSKA. J. S. Bach: Italian Concerto, Chromatic Fantasia and Fugue; Partita in B flat major; Toccata and Fugue in D major. **\$5.98**

783. LOTTE LEHMANN. Arias from Der Freischütz, Fidelio, The Merry Wives of Windsor, Die Fledermaus, 4 others. **\$5.98**



752. EILEEN FARRELL IN SONGS AND BALLADS. 15 pieces best-loved and little-known. George Trivulio at piano. Monaural only. **\$4.98**



736. Mozart: 4 HORN CONCERTOS. Flawlessly performed by Dennis Brain with the Philharmonia Orchestra. Monaural only. **\$4.98**

743. Stravinsky: PETROUCHKA. The complete ballet. Erem Kurtz conducts the Philharmonia Orchestra. Monaural only. **\$4.98**



733. Prokofiev: SYMPHONY NO. 5. A stunning rendition of a heroic work by Thomas Schippers with Philharmonia Orch. **\$4.98; Stereo \$5.98.**

735. Dvorak: SYMPHONY NO. 9 ("New World"). Constantin Silvestri conducts the Orchestre National of France. Monaural only. **\$4.98**

731. Sibelius: SYMPHONY NO. 2. Powerfully played by the Philharmonia Orchestra, Paul Kletzki conducting. **\$4.98; Stereo \$5.98.**

734. Tchaikovsky: SYMPHONY NO. 4. A superb performance by Constantin Silvestri and the Philharmonia Orch. **\$4.98; Stereo \$5.98.**



759. PIAF. 12 ballads in the poignant style of France's greatest torch singer, with Robert Chauvigny's orchestra. Monaural only. **\$3.98**

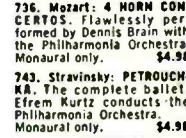

736. Mozart: 4 HORN CONCERTOS. Flawlessly performed by Dennis Brain with the Philharmonia Orchestra. Monaural only. **\$4.98**

743. Stravinsky: PETROUCHKA. The complete ballet. Erem Kurtz conducts the Philharmonia Orchestra. Monaural only. **\$4.98**



733. Prokofiev: SYMPHONY NO. 5. A stunning rendition of a heroic work by Thomas Schippers with Philharmonia Orch. **\$4.98; Stereo \$5.98.**

735. Dvorak: SYMPHONY NO. 9 ("New World"). Constantin Silvestri conducts the Orchestre National of France. Monaural only. **\$4.98**

731. Sibelius: SYMPHONY NO. 2. Powerfully played by the Philharmonia Orchestra, Paul Kletzki conducting. **\$4.98; Stereo \$5.98.**

734. Tchaikovsky: SYMPHONY NO. 4. A superb performance by Constantin Silvestri and the Philharmonia Orch. **\$4.98; Stereo \$5.98.**

If you wish, choose any of these GREAT RECORDINGS OF THE CENTURY by CASALS, LANDOWSKA, MELBA and LEHMANN. Priceless performances now preserved forever—with outstanding clarity and fidelity—on silken-smooth long-play discs.

784. PABLO CASALS. J. S. Bach: Suites for Unaccompanied Violin. No. 3 in C major; No. 4 in E flat major. **\$5.98**

782. DAME NELLIE MELBA. Operatic & Song Recital: Mattinata, Goodbye, other songs and arias from La Bohème, Lucia, Rigoletto, Romeo et Juliette, others. **\$5.98**

785. WANDA LANDOWSKA. J. S. Bach: Italian Concerto, Chromatic Fantasia and Fugue; Partita in B flat major; Toccata and Fugue in D major. **\$5.98**

783. LOTTE LEHMANN. Arias from Der Freischütz, Fidelio, The Merry Wives of Windsor, Die Fledermaus, 4 others. **\$5.98**

Great Recordings of the Century available in monaural only.

HOW THE CLUB OPERATES

If collecting and listening to records is an important part of your life, the Angel Record Club can be of real service to you. For this Club offers you the best of two worlds of musical entertainment—through just one money-saving membership.

You can enjoy, for example, the musical genius of Herbert Von Karajan... the guitar artistry of Laurindo Almeida... plus magical entertainers like Edith Piaf and Frank Sinatra, all made available to you from the Angel Record Club's incomparable international catalog, which includes Columbia Gramophone (of England), Pathé Marconi (of France), Capitol Records and E.M.I.'s historic HMV Label.

If you join now, we will send you any 5 albums on this page with a bill for only \$1.00, plus a small charge for shipping services. Thereafter, your only obligation is to purchase six albums from the more than 100 to be offered to you during the next twelve months, at the price of \$3.98, \$4.98 or \$5.98 depending on the record purchased, plus a small charge to cover shipping services. You pay for your albums after you receive them.

FREE BONUS ALBUMS: After you've purchased these 6 albums, you then choose a 12" FREE Bonus Album of your own preference every time you buy two records from the Club. Here's a wonderful way to build a superb record library at a big saving. Mail coupon to: Angel Record Club, Dept. 2081 Scranton 5, Pennsylvania.

ANGEL RECORD CLUB Dept. 2081 Scranton 5, Pennsylvania

Please send me these 5 Albums and bill me only \$1.00 plus a small charge for shipping services.

WRITE NUMBERS IN BOXES

I agree to purchase 6 selections from the more than 100 to be offered during the next twelve months, at the Club price, plus a small charge to cover shipping services. Thereafter, if I decide to continue membership, I will receive a 12" Bonus Album of my choice FREE for every two records I buy.

STEREO. Check this box if you want your 5 albums and all future selections, including Bonus records, in Stereo (which must be played only on stereo equipment). These selections cost \$1.00 more than monaural, and you will be billed \$2.00 for the five stereo albums you have chosen above.

NAME _____ (Please Print)

ADDRESS _____

CITY _____ ZONE _____ STATE _____

CANADA: Slightly higher prices: 1184 Castlefield Avenue, Toronto. If you wish to join through an Angel Record dealer authorized to accept subscriptions, please write his name and address in the margin.

CIRCLE 7 ON READER-SERVICE CARD

This Fisher tuner outperforms all other makes regardless of price.



The Fisher FM-100-B FM Stereo Multiplex wide-band tuner, \$229.50*

You don't have to buy the costliest Fisher model to obtain better FM tuner performance than any other high-fidelity component manufacturer can offer you.

The Fisher FM-100-B is just one step up in price from the least expensive Fisher FM Stereo Multiplex tuner, yet it yields to no other available brand in sophisticated Multiplex circuitry, nor in the ability to receive even the weakest and most distant broadcast signals with optimum noise suppression, interference rejection and audio fidelity.

The specifications achieved through the use of a high-gain Golden Cascode three-gang front end, five wide-band IF stages and four wide-band limiters are nothing short of spectacular: 0.6 microvolt sensitivity for 20 db quieting at 72 ohms (1.8

microvolts IHFM); 70 db signal-to-noise ratio (100% modulation); 60 db alternate channel selectivity; 2.2 db capture ratio (IHFM); 0.4% harmonic distortion at 100% modulation. But the most remarkable feature of all is the exclusive Stereo Beacon, the ingenious Fisher invention that automatically lights a signal to show whether or not an FM station is broadcasting in Multiplex and automatically switches the tuner to the required mode of operation, Mono or Stereo.

From the solid 'feel' of the tuning dial control and the professional-type tuning meter, to the superb listening quality of the extremely low-distortion output, everything about the FM-100-B reflects the totally uncompromising engineering philosophy that is the Fisher hallmark.

**(Then how good
is this Fisher tuner
for \$70 more?)**

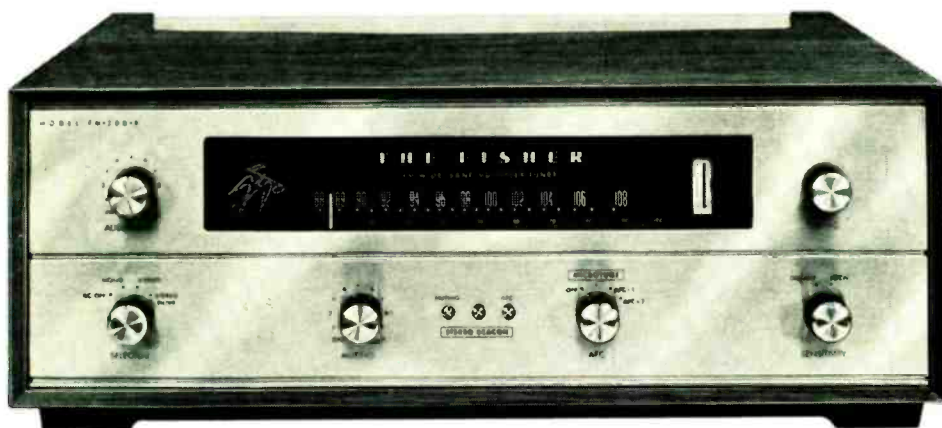

The Fisher FM-200-B FM Stereo Multiplex wide-band tuner, \$299.50*

It took Fisher to improve on Fisher. The FM-200-B tuner is unquestionably an even more advanced instrument than the FM-100-B, well worth the price difference of \$70.00 to the perfectionist. An additional tuned circuit (4-gang instead of 3) plus two of the new Nuvistor tubes in the front end, one more limiter (5 instead of 4) and a specially designed cathode-follower audio output result in the following subtle improvements in specifications: 0.5 microvolt sensitivity for 20 db quieting at 72 ohms (1.6 microvolts IHFM); 74 db signal-to-noise ratio (100% modulation); 64 db alternate channel selectivity; 1.5 db capture ratio (IHFM); 0.3% harmonic distortion at 100% modulation.

In addition, the FM-200-B incorporates not only the Stereo Beacon feature but also the exclusive Fisher MicroTune automatic frequency control system.

To make up your mind between these two engineering prodigies, see and hear both of them demonstrated by an authorized Fisher dealer. You will come away convinced that nothing can surpass a Fisher—except another (and more elaborate) Fisher!

*LESS CABINET—PRICES SLIGHTLY HIGHER IN THE FAR WEST.

FREE! \$1.00 VALUE! Write for the 1962 Fisher Handbook, a 40-page illustrated reference guide and component catalogue for custom stereo installations.



Fisher Radio Corporation
21-25 44th Drive
Long Island City 1, N. Y.

Please send free 40-page Handbook, complete with detailed specifications on Fisher FM Tuners.

Name _____

Address _____

City _____ Zone _____ State _____

HF302

CIRCLE 46 ON READER-SERVICE CARD

4-TRACK STEREO TOO!

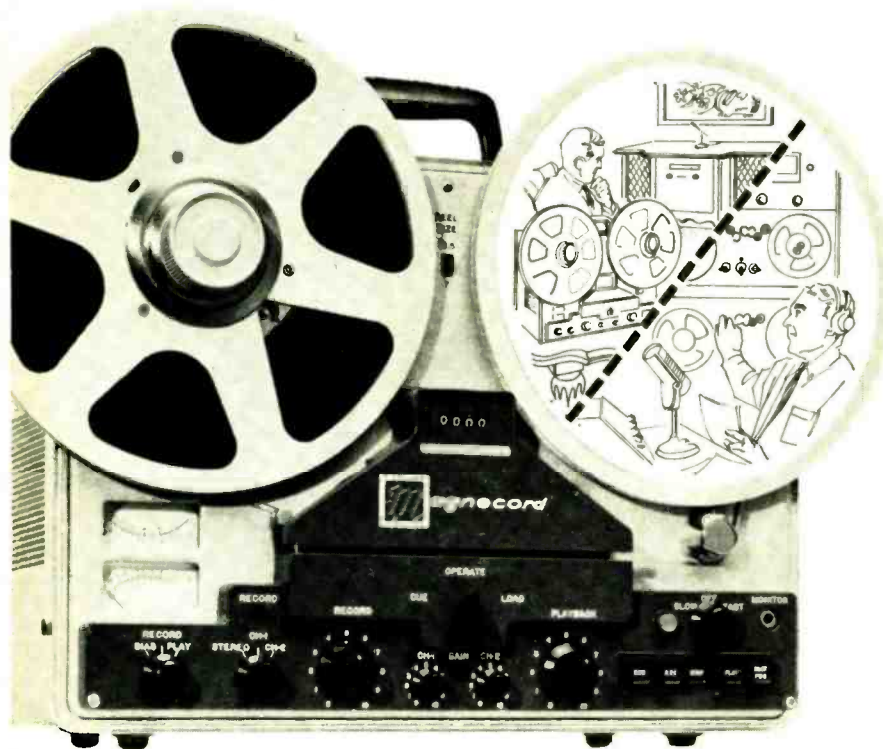

NOW THE MAGNECORD Olympian

has all of those features you would expect in a Magnecorder including 4-track play and record!

The Magnecord Olympian will provide incomparable sound and performance. Buy with confidence because the Olympian's versatility and capability will prove your wisdom and rank you with authorities in the art of tape recording. Friends will admire your judgement when you own the Magnecord Olympian.

The Olympian is for those who want the best. It handles tapes like a dream — protects them from accidental erasure or breakage too. It has all the controls to satisfy the professional yet they are simple enough for the youngsters to use. It is built with satellite precision and custom care to make it the champion of recorders.

Midwestern-built heads allow full frequency response of 40 to 15,000 cps ± 2 db at 7 1/2 ips. Precision construction couples wide dynamic range to a low signal-to-noise ratio. Flutter and wow is held below 0.15% at 7 1/2 ips. NAB standard VU meters are provided for each channel. Tape position is shown by a reliable 4-digit odometer. Record up to 1 1/2 hours of music (7.5 ips. — 1 mil. tape — 10 1/2" reels).



write for additional information and name of your nearest Magnecord dealer

Magnecord SALES DEPARTMENT

MIDWESTERN INSTRUMENTS, INC.

manufacturers of electronic data acquisition instruments

P. O. BOX 7509

TULSA 35, OKLAHOMA

CIRCLE 62 ON READER-SERVICE CARD

AUTHORitatively Speaking

HIGH FIDELITY Magazine rarely publishes love stories. This month, with great pride and pleasure, it does so—in the form of "An Argument for Richard Strauss" (p. 46). That title is the author's own, perhaps deliberately understated to avert any suspicion of sentimentality, although we doubt that such a charge could be made against a somewhat cerebral young writer. The fact is, however, that the title covers not only an objective critique of Strauss's craftsmanship as a composer but a moving and eloquent account "of a life which contains a total achievement of art." This appreciation of a currently rather unfashionable musical figure, thought by many to have far outlived his time, is made none the less interesting by virtue of the fact it comes from a musician not yet thirty. **Glenn Gould** was barely seventeen when Richard Strauss died, an old man of eighty-six.

Mr. Gould at seventeen had, of course, already embarked upon a career as a concert pianist. Graduating from the Royal Conservatory of Music in Toronto at the age of twelve, he made his debut at fourteen as soloist with the Toronto Symphony. His first United States appearances came in 1955, and his European debut in 1957. His reputation is now world-wide and requires no comment from us—except perhaps to say that while famous young men are sometimes known as iconoclasts, Mr. Gould's article here suggests that they can also have heroes.

Newly come to our goodly fellowship of audio writers this spring is **Lewis A. Harlow**, author of "Testing Tubes at Home" (p. 53), but there is nothing new about Mr. Harlow's addiction to high fidelity. Exactly twenty-five years ago, he overcame certain not-unexpected opposition and chopped a hole through the wall between his living room and kitchen; therein he mounted a splendid (vintage 1937) speaker. Other audiophile ventures of varying complexity followed, among the first, and simplest, being the purchase of a tube tester. There's been a tube tester in Mr. Harlow's household ever since. We expect a good many readers will follow his advice to go and do likewise.

Among the many names familiar to our pages we especially note the return in this issue of the Messrs. Glass, Cudworth, and Heyworth. **Herbert Glass's** services as a discographer have been called upon again, this time for "Richard Strauss on Microgroove," p. 50. **Charles Cudworth's** talents as a humorist reappear in "Watch Your Jacket," p. 58. (Lest some readers be misled, perhaps we ought to add that Mr. Cudworth is not a humorist only; officially he's Curator of the Pendlebury Library of the University Music School at Cambridge.) **Peter Heyworth**, of the *Times* (London), again displays his aptitude for the critical profile, with a study of Dietrich Fischer-Dieskau (see "A Biedermeier Man in West Berlin," p. 55).



HIGH FIDELITY MAGAZINE

We have nothing to hide

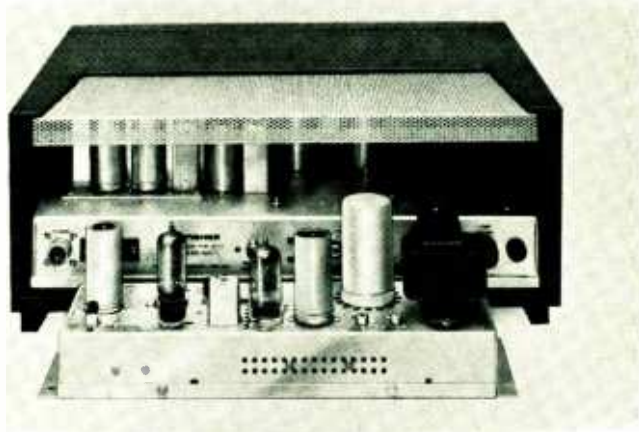

except this new concealable version



of the Fisher universal Multiplex adapter.

There is nothing secret about Fisher components — in specifications, circuitry or construction details. It's easy to come out in the open when you have the best of everything.

But there are quite a few FM tuner owners who don't find it easy to have a Multiplex adapter out in the open. No matter how eager they are to receive the thrilling new FM Stereo broadcasts with the finest possible equipment, they simply don't have room for another control panel out front. For that reason they have been unable to take advantage of the superb Fisher MPX-100, until now the only truly universal Multiplex adapter — the only instrument capable of converting any high-quality FM tuner or receiver of any make or model to FM stereo operation.

The new Fisher MPX-200 now provides an alternative. It can be conveniently hidden anywhere, up to three feet from the FM tuner or receiver, and it completely duplicates the MPX-100 in electronic performance — including universal compatibility, freedom from distortion, unusually great channel separation and a high signal-to-noise ratio.

There's only one essential difference between the MPX-100 and the MPX-200: the former incorporates the exclusive Fisher Stereo Beacon. This ingenious Fisher invention automatically lights a signal to show whether or not an FM station is broadcasting in Multiplex and automatically switches the equipment to the correct mode of operation, Mono or Stereo. Stereo Beacon necessarily requires a front control panel.

The Fisher MPX-100 universal Multiplex adapter, less cabinet, is priced at \$119.50*; the Fisher MPX-200, less cabinet, at \$79.50*.

*PRICES SLIGHTLY HIGHER IN THE FAR WEST

FREE! \$1.00 VALUE! Write for the 1962 Fisher Handbook, a 40-page illustrated reference guide and component catalogue for custom stereo installations.

Fisher Radio Corporation
21-25 44th Drive
Long Island City 1, N. Y.

Please send free Handbook, complete with detailed specifications on Fisher Multiplex Adapters.

Name _____

Address _____

City _____ Zone _____ State _____

HF 306



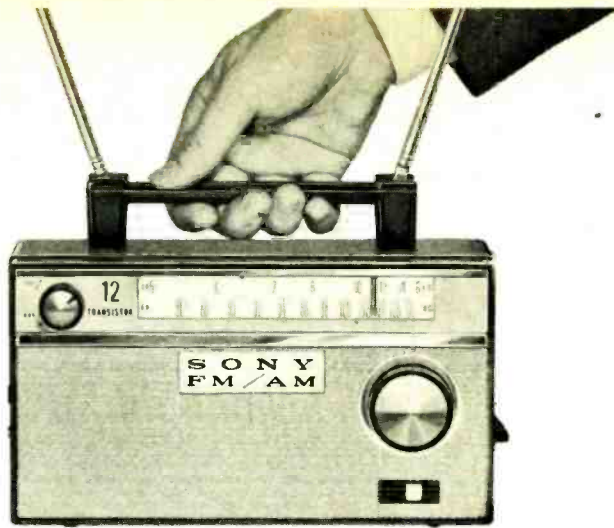

TFM-121A

FM/AM *at Home or Away*



TFM-122

SONY® *is the Ultimate in Sound...*

RESEARCH MAKES THE DIFFERENCE

The sophisticated listener recognizes the inherent superiority of a SONY transistorized radio for many reasons—for its unquestioned leadership in electronics, its compact and rugged construction, its handsome design. But, perhaps for more than any other reason, he recognizes the quality of SONY sound—clean, crisp and with a faithful naturalness, gained through years of research and an unswerving devotion to the highest standards. For example, for pleasure in outdoor listening, the incomparable 12-transistor SONY TFM-121A, with Automatic Frequency Control to lock in the station

and prevent fade and drift. A mere 3 lbs., it tunes both FM and AM bands, and has provision for multiplex adapter to permit reception of stereo broadcasts. Complete with batteries, earphone and leather case, the TFM-121A lists at \$99.95. Or, for indoors, the SONY TFM-122, a 12 transistor cordless radio that matches the decor of every room. With Automatic Frequency Control, tone control, input for record player and twin speakers, it also accepts a multiplex adapter. Complete with batteries, the TFM-122 lists for \$129.95. Either way, you get the ultimate—SONY quality sound!

SONY CORPORATION OF AMERICA 514 Broadway, New York 12, N. Y.

Civil Defense recommends a battery-operated radio in every home. Every SONY radio clearly shows the two Conelrad frequencies.

CIRCLE 82 ON READER-SERVICE CARD

How to test a stereo kit for top performance:



Simply look for this name.

You don't even have to open the box. If it's a Fisher StrataKit, you already have better proof of performance than if you had built any other manufacturer's kit and tested it in one of the world's most elaborately equipped audio laboratories.

How can Fisher make this claim? Very logically. Fisher has one of the world's most elaborately equipped audio laboratories. Fisher did build and test everyone else's kits before the StrataKit engineering program was finalized. The task then set for Fisher engineers was to outclass in every way what they had found in other designs. Which they did. They drew on all the knowledge accumulated in the course of 24 years in high fidelity and the results are in the box. StrataKits are easier to build than others, the StrataKit instruction manuals are clearer than others, the completed StrataKits have more advanced features and perform better than others. And we have yet to hear of someone who could not complete his StrataKit successfully and with the greatest of ease.

The Fisher StrataKits now at your dealer are the KX-200 80-watt stereo control-amplifier and the KM-60 FM Stereo Multiplex wide-band tuner. Both sell for \$169.50. Both are the world's finest in their class. The proof is simply in their name.

USE THIS COUPON
FOR FURTHER INFORMATION

Fisher Radio Corporation
21-25 44th Drive
Long Island City 1, N. Y.

Please send me without charge the
complete Fisher StrataKit catalogue.

Name _____

Address _____

City _____ Zone _____ State _____



HF3311

**THE WORLD'S FIRST
(AND STILL THE FINEST)
AUTOMATIC / MANUAL
TURNTABLE / TURNTABLE**



& RECORD CHANGER!

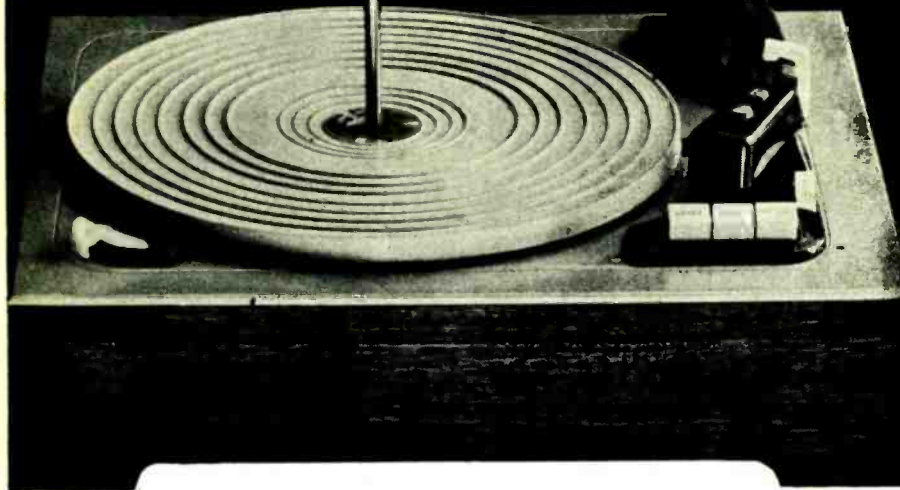

THE DUAL-1006 CUSTOM

We consider the Dual-1006 CUSTOM to compare more than favorably with any other record player now on the market. So much so that we submitted it for testing to a completely impartial authority. A copy of this report is now available upon request. It contains the facts to be familiar with before considering any purchase of record playing equipment. For your copy write: Dept. A-3,

united  Audio

WIGO • PRODUCTS OF DISTINCTION • DUAL
12-14 W. 18th Street, New York 11, N. Y.

CIRCLE 38 ON READER-SERVICE CARD



Letters



More Pay, Less Abuse

SIR:

We note the recent letter of Joseph H. Chaille published under the heading "High Fidelity Non-Servicing" [HIGH FIDELITY, September 1961], concerning the problem of high-fidelity servicing in Manhattan.

In common with all manufacturers and most reputable service shops, we guarantee all our work and materials for a 90-day period, to protect our customer against faulty material or workmanship.

Mr. Chaille, while complaining of the great difficulty in obtaining satisfactory service, proceeds to cut the ground from under possible bases for a service group to exist, by the following implied statements:

a. If a repair is unsatisfactory, it follows that the service agency is incompetent or worse.

b. No credentials from manufacturers are to be given any weight because Mr. Chaille's experience "proves" that a recommended agency is unable to make repairs.

c. Service guarantees are to be ignored because "I want no more of the outfit that I tried once before."

d. Manufacturers have no responsibility for equipment that servicemen are unable to keep repaired. Any failure must be ascribed to faulty servicing.

e. High service costs are *prima facie* evidence of service gouging.

The bias against servicemen, exemplified by Mr. Chaille's letter and the heading supplied by your magazine, is one of the principal reasons why it is difficult to attract and retain people of high caliber in the service industry. The same skills can be used to earn higher remunerations and much less abuse in virtually any segment of the electronics industry.

Your courtesy in publishing this "reply" is very much appreciated.

W. Goldstick
President,
Sigma Electric Co., Inc.
New York, N. Y.

Continued on page 14

HIGH FIDELITY MAGAZINE

Everything

...the power, performance and features of the Award A500

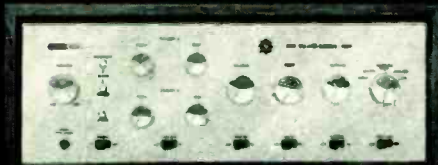

50 Watt Stereo Amplifier PLUS

the distortion-free, wide-band response and sensitivity of
the famed Award Series Tuners



Everything captured in one magnificent instrument!!!!!!!!!!!!!!



The New Award Stereo Festival III, AM/FM Multiplex Receiver

The new Award Stereo Festival actually has everything. Picture a complete stereophonic home music center on one compact chassis: sensitive AM/FM and FM Stereo (multiplex) tuner for unsurpassed monophonic and stereo reception; dual pre-amplifiers with input facility and control for every stereo function and a powerful 50 Watt stereophonic amplifier.

Features include: wide-band Foster-Seeley discriminator and 6BN6 gated beam limiter to insure freedom from distortion and noise; D'Arsonval movement tuning meter which measures discriminator balance and permits perfect visual tuning of all FM stations; convenient front-panel stereo headphone input receptacle; illuminated push-button on/off switch; blend control which eliminates "hole-in-the-middle" effect by introducing a variable amount of blend between the two channels; stereo indicator lights for instant visual identification of mode (FM or Stereo) of operation; individual bass and treble tone controls; zero to

infinity balance control to balance any speaker system regardless of listener's position in the room; stereo contour control to boost base energies at low listening levels.

In the way it looks, and in the way it performs, the Award Stereo Festival is the embodiment of creative engineering at its finest. Simply add two speakers and a record player and your stereo installation is complete. The Award Stereo Festival III, Model TA5000X—\$299.95. Walnut Enclosure WW80—\$29.95; Metal Enclosure CX80—\$12.95. All prices slightly higher in the West.

For further information on the Award Stereo Festival and other fine Harman-Kardon products write Dept. HF-3 Harman-Kardon, Inc., Plainview, New York (Export Office, EMEC, Plainview, N.Y.)

harman kardon

CIRCLE 50 ON READER-SERVICE CARD

ELEGANCE, CONVENIENCE AND ECONOMY

IN ACOUSTICAL CABINETRY

for Your High-Fidelity Components



CABINET ENSEMBLE

Model 500-501



Easy way to enjoy an attractive music center with your own choice of famous name high fidelity components. Acoustically-engineered and furniture-crafted. May be placed together or separate—for finer mono or stereo. Easy on your budget, too.

Center Equipment and Record Cabinet (Model 500) is designed to house amplifier and/or preamplifier, tuner, tape recorder, record changer, and transcription table. (See photo at right.) Shelf is adjustable. Blank face panel available. Lower left compartment has space for 150 LP record albums. Sliding doors. *Free-Standing Twin Speaker Enclosures* (Model 501) permit proper stereo separation or positioning for desired listening in any room. Each houses up to 15" loudspeaker. Also accommodates any size tweeter. *Cabinet Ensemble* (Model 500-501) is available with base as shown above, or with legs, as shown at right. Choice of Oil Walnut, Hand-Rubbed Mahogany, Blonde, or Ebony finish. (Individual cabinets also available separately.)

BOOKSHELF 8-in. SPEAKER ENCLOSURE

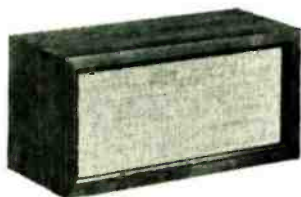

Model 128

Gives you compact utility and sound quality with economy. Acoustically-designed with vented port to enhance reproduction of any 8-in. speaker. Only 9" x 11" x 19". Fits on bookshelf, or may be used horizontally or vertically anywhere else, as initial high-fidelity reproducer or auxiliary unit, or in pairs for stereo. Furniture-crafted and beautifully finished.

Choice of Oil Walnut, Hand-Rubbed Mahogany, Blonde, or Ebony.

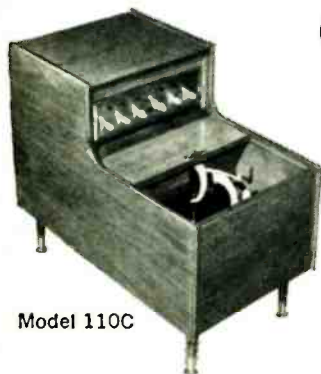

Model 110C

CHAIRSIDE EQUIPMENT CABINET

Provides convenient control of your stereo or mono music system. Smartly furniture-crafted and sturdily built of selected woods to protect the stability of your components. Component section has upper and lower compartments to house amplifier and/or preamplifier or tuner. Lower front section, with blank mounting board, allows ample space and clearance for all makes of record changers. Sliding cover. Choice of Oil Walnut, Hand-Rubbed Mahogany, Blonde, or Ebony finish.

See Your High-Fidelity Dealer or Write Now for Bulletin R-21-H

Most versatile line of high fidelity cabinetry created by specialists in acoustic design and fine furniture manufacture



CIRCLE 76 ON READER-SERVICE CARD

LETTERS

Continued from page 12

Spring in San Francisco

SIR:

As a regular and enthusiastic subscriber, I looked forward to Robert C. Marsh's article on "Opera at the Golden Gate" [HIGH FIDELITY, January 1962]. It was a very interesting story, but I felt it ended too abruptly, without sufficient mention of Spring Opera (note the capital letters).

Spring Opera is a new concept similar to a Volksoper or Piccola Scala. We feature young American professionals (George Shirley, Lee Venora, Richard Verreau, John Macurdy, etc.) under experienced stage directors and conductors with a top seat price of \$3.95. In 1961 we gave six operas, using the San Francisco Opera sets and production staff and reviving *Roméo et Juliette* and *Martha* as well giving the familiar *Bohème* and *Traviata* and *Carmen*. We also mounted a new production of *The Magic Flute* which achieved nationwide recognition. In 1962 we hope to produce *Abduction from the Seraglio* and *Pearl Fishers* for the first time in San Francisco.

Our support has been gratifying, and we are interested in helping other cities in starting this type of opera company to create a stage for our young American artists. I would be delighted to correspond with interested parties.

William Kent III

Chairman,

Spring Opera of San Francisco
San Francisco 2, Calif.

The First-Balcony Ideal

SIR:

The "first-balcony ideal" espoused by reader Slome ["Letters," HIGH FIDELITY, January 1962] is aesthetically conservative. It is not the only solution.

All aesthetic material is composed of two elements: an aesthetic message and its carrier. The elements are directly analogous to audio modulation on a carrier wave.

When a composer writes notes on a staff he is not simply describing a sound; he is expressing a musical thought. The musical fidelitarian is eager to taste the aesthetic red meat of a work, and if close miking or planned reverb-time help, fine.

At bottom, it is a matter of view. If you believe that the concert hall is the ultimate sonic environment, then you favor "concert hall" sound. If you believe each aesthetic message demands its own sonic environment, and that the concert hall is a compromise that modern engineers no longer need accept, you belong to the "tasteful modification" school.

The concert hall school accepts technological advances as beneficial, but limits the use of technology to the (difficult) task of copying an original. The modification school goes back to the composer's intention, tries to discover it, and uses technology to help him express that intention. Both are necessary—both should exist.

Martin K. Barrack
Bronx, N. Y.

HIGH FIDELITY MAGAZINE

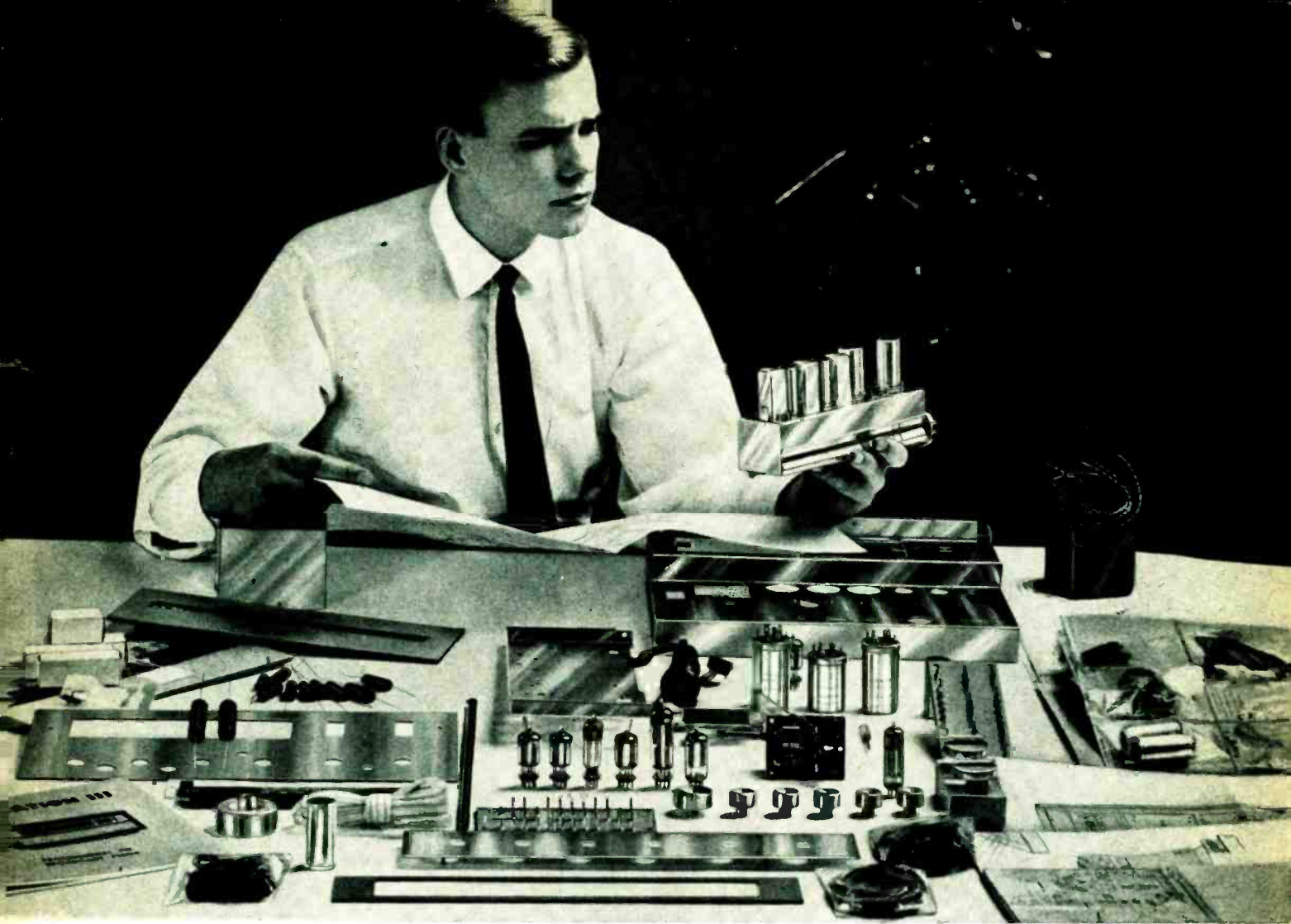

Can You Afford 15 Hours to Build The World's Best FM/Multiplex Tuner?

Fifteen hours. That's all it takes to build the world's best FM/Multiplex tuner.

Citation has the "specs" to back the claim but numbers alone can't tell the story. On its real measure, *the way it sounds*, Citation III is unsurpassed. And with good reason.

After years of intensive listening tests, Stew Hegeman, director of engineering of the Citation Kit Division, discovered that the performance of any instrument in the audible range is strongly influenced by its response in the non-audible range. Consistent with this basic design philosophy—the Citation III has a *frequency response three octaves above and below the normal range of hearing*. The result: unmeasurable distortion and the incomparable "Citation Sound."

The qualities that make Citation III the world's best FM tuner also make it the world's best FM/Multiplex tuner. The multiplex section has been engineered to provide wideband response, exceptional sensitivity and absolute oscillator stability. It mounts right on the chassis and the front panel accommodates the adapter controls.

What makes Citation III even *more* remarkable is that it can be built in 15 hours without reliance upon external equipment.

To meet the special requirements of Citation III, a new FM cartridge was developed which embodies every critical tuner element in one compact unit. It is completely assembled at the factory, totally shielded and perfectly aligned. With the cartridge as a standard and the two D'Arsonval tuning meters, the

problem of IF alignment and oscillator adjustment are eliminated.

Citation III is the *only* kit to employ military-type construction. Rigid terminal boards are provided for mounting components. Once mounted, components are suspended tightly between turret lugs. Lead length is sharply defined. Overall stability of the instrument is thus assured. Other special aids include packaging of small hardware in separate plastic envelopes and mounting of resistors and condensers on special component cards.

For complete information on all Citation kits, including reprints of independent laboratory test reports, write Dept. HF-3A Citation Kit Division, Harman-Kardon, Inc., Plainview, N. Y.

The Citation III FM tuner—kit, \$149.95; wired, \$229.95. The Citation III MA multiplex adapter—factory wired only, \$79.95. The Citation III X integrated multiplex tuner—kit, \$219.95; factory wired, \$299.95. All prices slightly higher in the West.



The
Citation
III

Build the Very Best **CITATION KITS** by

harman kardon

CIRCLE 50 ON READER-SERVICE CARD



Robert Riger

THE MOON was still high over Rockefeller Plaza and darkness was just beginning to fade along Fifth Avenue when I arrived at NBC's Studio 8H (remembered still as Toscanini's old recording kingdom) and stepped into the midst of an extraordinary pre-dawn scene. Under powerful lights, amid a jungle of movable TV cameras, coiled cables, aluminum scaffoldings on wheels, and throngs of undeniably wide-awake cameramen, technicians, and Personalities, the "Today" show was shaping up for its regular morning telecast. In one corner of the room a model fallout shelter was undergoing the scrutiny of a cheerful, smoothly tailored man who seemed to be memorizing its virtues from a script in his hand; an announcer, rehearsing his commercial, stood in front of a dead camera reciting the advantages of a pair of trousers he was wearing; and a few feet to one side, looking decidedly misplaced, four chairs and music stands bespoke the presence, somewhere, of a string quartet.

As the broadcast hour arrived, voices subsided, lights focused on a newscaster hurriedly finishing a piece of Danish pastry, and the show was on the air. Some minutes later, off-camera, four men with stringed instruments tiptoed in and sat down around the music stands; when the camera swung towards them a young woman with the dazzling and familiar smile of one of the former Miss Rheingolds announced the Fine Arts Quartet: Leonard Sorkin and Abram Loft, violins; Irving Illmer, viola; George Sopkin, cello. Without further ado, the four began the pizzicato movement of Bartók's Quartet No. 4.

If the situation—the hour, the place, the music—had an element of the dream-like to the onlooker, it was thoroughly familiar to the participants. This was not the first time that the members of the Fine Arts Quartet had risen in the middle of the night to prepare for a 5 a.m. rehearsal (it was, in fact, their ninth appearance on the "Today" show alone); it was simply the most recent engagement in a fifteen-year career devoted—more intensively than that of any other similar group in the country—to playing chamber music for the widest possible audience. At a time when this least spectacular of art forms is still considered a risk at the box office and a dubious item in the record stores, the Fine Arts has demonstrated—frequently by way of the broadcasting studio—that chamber music can be attractive to listeners who may never before have given it a hearing. Probably the foremost of

The Fine Arts Quartet

Bartok at sunrise: an American ensemble brings an intimate art to a vast audience.

American-trained string quartets (three of its members are alumni of the Chicago Symphony Orchestra), the Fine Arts has made its point without compromise. The group pursues the full schedule typical of a highly regarded chamber ensemble—undertaking a concentrated program of yearly concerts in the United States (to which three enormously successful European tours were added within the past five years) and recording a growing catalogue of works for its own ConcertDisc label—but perhaps their uncompromising attitude is reflected most strikingly in the series of programs which, during the past three years, they have presented for the nation's TV viewers. This rather special facet of the Fine Arts' activities was the main topic of conversation when we sat down to talk after the "Today" show.

"It was back in 1946, before the advent of television, that we began broadcasting, with a regular Sunday morning series over ABC from Chicago," said Leonard Sorkin who, with cellist George Sopkin, is cofounder of the Quartet. "We ran for eight years without a sponsor, and then the program was discontinued because we couldn't find one. Businessmen threw up their hands at the idea of putting money into chamber music."

"But you would be surprised what an impression the program made," added Abram Loft, a Ph.D. in musicology and former assistant professor at Columbia University. "Ever since, on concert tours, people have come backstage and mentioned those broadcasts."

IN 1958, the Educational Television and Radio Center at Ann Arbor commissioned a series of programs which would undoubtedly have sent a shudder through the stanchest of businessmen: twelve hour-long programs, half devoted to the discussion and performance of six of Beethoven's quartets, half to the six of Bartók. These appeared throughout the country on the National Educational Television (NET) network with such gratifying response that in 1961 another series, entitled "Four Score," was produced for NET: half-hour discussion-performances of single movements chosen chronologically from Haydn through Hindemith. "Four Score" is appearing this season on NET's sixty affiliated stations.

A more disarming presentation of an allegedly difficult medium would be hard to imagine. The four players, in shirtsleeves, and unaffectedly good-humored and communicative, not only

demonstrate important thematic developments and point out major turning points in the musical structure; they do not hesitate to bring to hand anything extramusical which may clarify style or historical significance—a painting of Monet, an excerpt from a book of Hindemith's or a letter of Haydn's, a quick sketch with pencil and pad of a Bartók theme. They bring the viewer into their midst and put him at ease.

"We were eating breakfast on the train one morning while we were on tour not long ago," one of the members told me, "and I noticed the waiter kept staring at us. Finally he came over to the table and pointed at our cellist here and said 'You're George!' He told us that he had watched the program from the very beginning."

As befits musicians who have been closely associated with recording during the whole of their ensemble career, the Fine Arts men are particular in the extreme about the sound of their telecasts. Although the old kinescope process has been superseded by the superior videotape, the Quartet resorts to a sleight-of-hand trick on each program to improve the quality of the sound: when the moment arrives for the complete, uninterrupted performance of the movement under discussion, the engineers play back a pre-recorded tape, to which the players silently coordinate their motions with split-second accuracy. Probably few, if any, viewers detect the deception. The Fine Arts, in fact, has caused considerable comment with demonstrations of this kind at high-fidelity shows held in New York in past years: most of the audience present in the room failed to distinguish between moments of actual live performance and moments of stereo tape playback. For the record and tape buyer, the Quartet's televising method has borne fruit: the performances taped for "Four Score" are currently being released, each work entire, on the Concertape and ConcertDisc label.

"We've evolved a front-row balcony sound, not too close and not too dry, which we think is right for our Quartet," said Sorkin. "We had to organize our own recording company because we were so dissatisfied with the records we made for other labels."

The directness of the statement seemed characteristic of these four men who, as American musicians in the peculiarly American medium of television, have brought an intimate art form close to countless members of a large and disparate audience. **SHIRLEY FLEMING**

If you are after immediate savings you should not buy Scott components. They cost more. If, on the other hand, you are interested in the long-term economy of superb performance over many years of continued use, Scott is your wisest investment. Scott components cost more because they incorporate so many refinements and intangibles. Parts are carefully chosen. Specifications are always conservative. Engineering is imaginative and uncompromising. Quality control is implacable. The first Scott amplifiers were built in 1947 and many are still in use. Their owners take pride in choosing the very finest. For full information on new Scott amplifiers, tuners, speakers and kits, write for 20-page "Guide to Custom Stereo". H. H. SCOTT, INC., 11 Powdermill Road, Maynard, Mass.

SOME
PEOPLE
SHOULD NOT
BUY
SCOTT

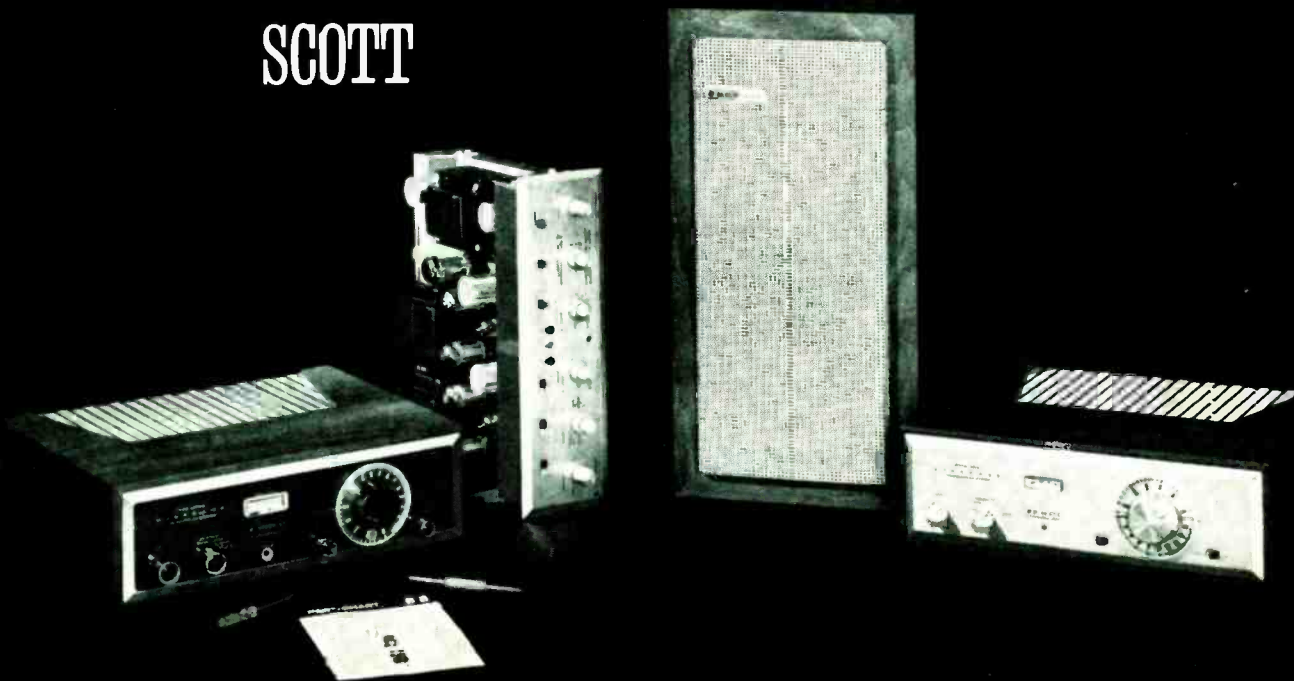

Professionals—Specialists—Publications—Users

PROFESSIONALS



IRVING M. FRIED

Author of Electronics Newsletter and provocative articles:

"In summary, the ADC-1 represented, and represents, a new standard for stereo disc playback; one which we are proud to associate with our reference standard equipment. Other manufacturers are beginning to catch up, but the ADC is still, in our opinion, the same kind of product that our amplifiers, tone arms and speakers are—the standard by which the others can be judged."



RICHARD L. KAYE

Station manager WCRB multiplex pioneer in New England:

"This is just a note to let you know how pleased we are with the performance of the ADC-2 cartridges you brought us. They work beautifully—as a matter of fact, the low frequency response is such an improvement over what we were previously using that now we have to replace a turntable that turned out to have excessive rumble!"

SPECIALISTS



C. MENDELSON

President of Music Age, outstanding Hi-Fi shop in Patuxent, Md.

"It isn't very often that we as high fidelity dealers are impressed by a relatively new product. The ADC cartridges, however, have in a short time earned a reputation that we like to associate our own background with: that is, the most legitimate value we can offer our customers. Consequently, we sell and demonstrate more ADC cartridges than any other brand."



R. COLL

Audio Consultant of Harvey Radio, one of the nation's leading High Fidelity stores.

"We have found the ADC-1 and ADC-2 cartridges to be outstanding performers. In fact, it has become a habit here at Harvey Radio to recommend these units in our finest systems because they reproduce music naturally. We congratulate Audio Dynamics on their contribution to the industry and fine standards they represent."



E. SEELEY

Audio Expert of De Mambro Hi-Fi Center in Boston, Mass.

"The best measure of a product's performance is a satisfied customer. I'm happy to report that our customers are delighted with the ADC-1. Furthermore, I have an ADC-1 in my own system and I believe it's the finest cartridge I've ever used."

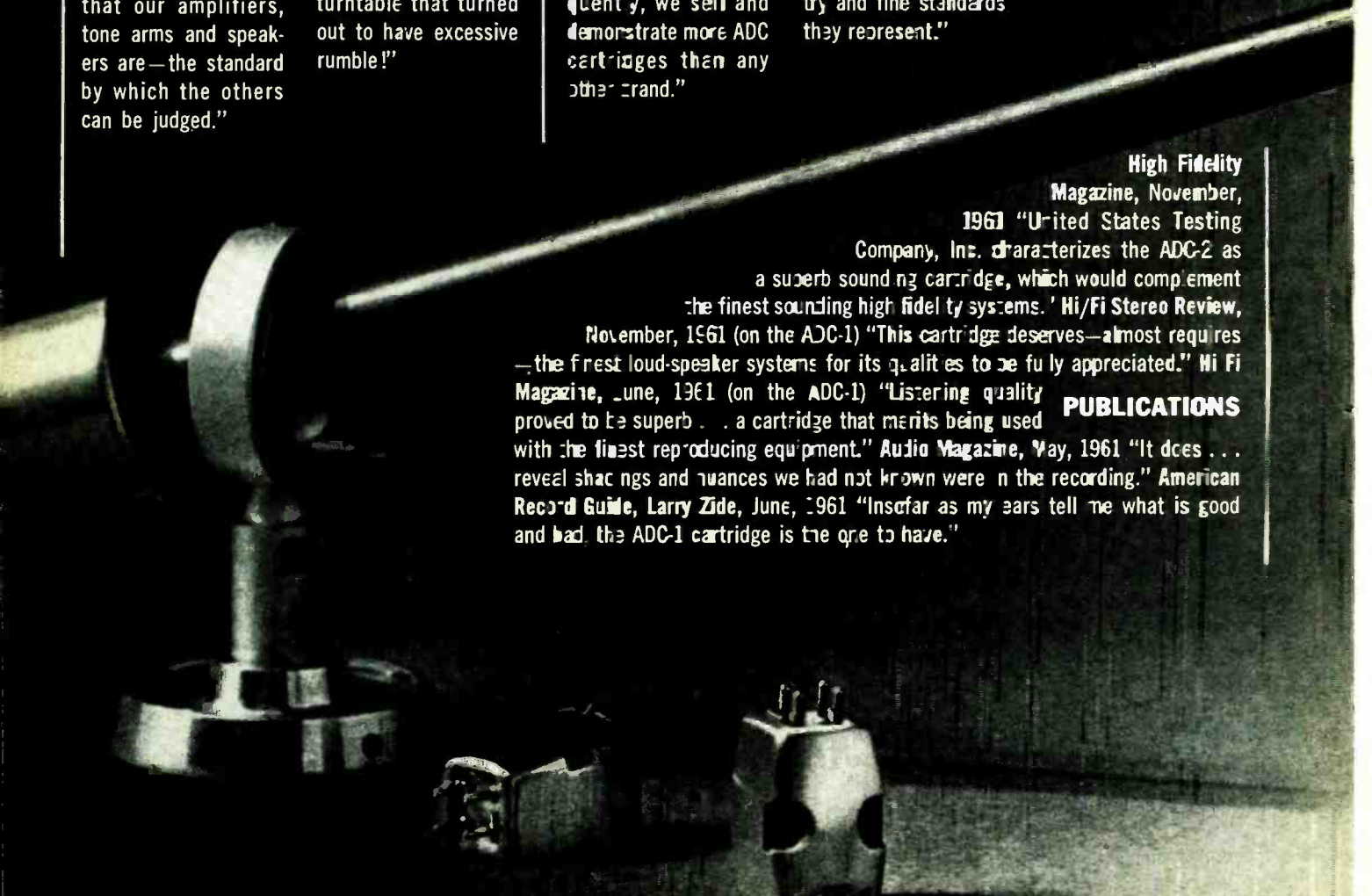

High Fidelity Magazine, November, 1961 "United States Testing Company, Inc. characterizes the ADC-2 as a superb sounding high fidelity cartridge, which would complement the finest sounding high fidelity systems." **Hi-Fi Stereo Review, November, 1961** (on the ADC-1) "This cartridge deserves—almost requires—the finest loud-speaker systems for its qualities to be fully appreciated." **Hi-Fi Magazine, June, 1961** (on the ADC-1) "Listening quality proved to be superb... a cartridge that merits being used with the finest reproducing equipment." **Audio Magazine, May, 1961** "It does... reveal shadings and nuances we had not known were in the recording." **American Record Guide, Larry Zide, June, 1961** "Insofar as my ears tell me what is good and bad, the ADC-1 cartridge is the one to have."

PUBLICATIONS

... all acclaim Audio Dynamics' components

A LOT OF PEOPLE have been saying nice things about Audio Dynamics components. To find out why, we recommend you take a few additional minutes to read the following paragraphs.

Quality stereo cartridges are designed to suppress undesirable peaks and distortion in the high frequency range. These occur when the stylus mass resonates with the vinyl disc. To suppress resonance, since mass cannot be readily reduced, most cartridges are heavily damped.

But this solution creates problems of its own. High tracking forces are required to prevent mistracking and breakup. The suspension becomes non-linear, resulting in distortion.

Then, in one remarkable stroke, Audio Dynamics engineers broke the vicious circle. They lowered the stylus mass to just 1/2-milligram, lowest stylus mass available in a cartridge today.

Now the low mass made it possible to have a highly compliant stylus. In the ADC-1 cartridge compliance is at least 20×10^{-6} cms/dyne. Linear suspension is restored, tracking force reduced to less than 1 gram! Whatever resonances remain are either too high or too low for the human ear to perceive.

With tracking force lowered to less than 1 gram, the problem of record wear and distortion disappeared once and for all!

Now with resonances removed from the audible range, there was nothing to prevent the stylus from following the groove walls direction of motion.

Finally, the absence of resonances results in greatly reduced surface noise. Absence of surface noise is considerably implemented by the use of a super polished diamond stylus with sides oriented so that only the hardest surfaces touch the grooves.

NOW THE PRITCHARD TONE ARM THAT TRACKS AT LESS THAN 3/4 GRAM

In a sense, Audio Dynamics engineers had,

at this point, exceeded themselves. They had produced a cartridge of such excellence, no tone arm could do it full justice. True, it would play with unparalleled quality in fine tone arms, but its full potential could not be realized.

With this "happy" problem in mind, Peter Pritchard, of Audio Dynamics, designed a tone arm that would enable the ADC-1 to track at the low forces for which it was constructed.

Here are the features which, when combined with the ADC-1, make up the Pritchard Pickup System

1. **A heavy adjustable** counterweight which, unlike other systems, occupies minimal space behind the pivot.
 2. **A side thrust compensator** permits the stylus to maintain even pressure on the groove walls by stabilizing the force created between the disc and arm.
 3. **An accurately machined** and treated wooden tone arm that suppresses extraneous resonances.
 4. **Precision ball bearings** on gimbals which minimize friction.
 5. **Low inertia** which insures perfect tracking.
 6. **Entire unit** comes completely assembled and wired with cable ready to plug in. (Should you be happy with your present cartridge, the plug-in head in the tone arm will accommodate it.)
- The combination of the ADC-1 in the Pritchard tone arm achieves results that amazes even experts. A few minutes spent at your dealers listening to this truly remarkable system will convince you that rewards that you never thought possible can be yours. Listen to them. Hear for yourself why the response to Audio Dynamics components won so much acclaim, and why it was merited!

Audio Dynamics also manufactures the ADC-2 cartridge, a cartridge with the same characteristics as the ADC-1, designed for use with quality tone arms and record changers.

For more information on the ADC-1 stereo cartridge for quality tone arms, the Pritchard Pickup System, and the ADC-2 stereo cartridge for quality tone arms and record changers, return the coupon today.

USERS

WASHINGTON, D. C. "I could not find a record in my collection that could make this pickup distort. As hard as I listened I could not recollect EVER hearing such perfect reproduction from a pressed record."
NEWPORT, R. I. "I hope you continue to offer such fine products in the future."
BALTIMORE, MD. "The performance of this pickup has destroyed my faith in my lack of faith in advertising claims. So far the ADC-1 has performed as well as I had been led to expect. In my experience, this is highly unusual. I congratulate you."
SAN MATEO, CALIF. "The effortless grace of the ADC-1 is amazing. It gives me clean sound from many problem pressings, and has revealed groove damage in at least one pressing."

ADC-1 cartridge for high quality tone arms	\$49.50
ADC-2 cartridge for high quality tone arms and record changers	\$37.50
Pritchard Pickup System Model ADC-85	\$85.00
Pritchard Tone Arm Model ADC-40	\$39.50

AUDIO DYNAMICS CORPORATION

1677 Cody Avenue, Ridgewood 27, N. Y.

Please send me descriptive literature on ADC cartridges and the Pritchard Pickup System.

Name _____
Address _____
City _____
Name of My Dealer _____

AUDIO DYNAMICS

ARCHIVE PRODUCTION

HISTORY OF MUSIC DIVISION OF THE
DEUTSCHE GRAMMOPHON GESELLSCHAFT

NEW RELEASES

VI. RESEARCH PERIOD

German Baroque Music (17th Century)

Heinrich Schütz

St. Matthew Passion

with Dietrich Fischer-Dieskau
and other soloists,

Hugo Distler Choir Berlin,
Klaus Fischer-Dieskau, cond.

ARC 3172 · 73 172 STEREO

IX. RESEARCH PERIOD

The Works Of Johann Sebastian Bach

Mass in B minor, BWV 232

Maria Stader, Hertha Töpper,
Ernst Haefliger, Kieth Engen,

Dietrich Fischer-Dieskau,
Münchener Bach-Chor,

Münchener Bach-Orchester,
Karl Richter, cond.

ARC 3177/3179 · 73 177/73 179 STEREO

These records are offered in a presentation box
with libretto and are not available separately.

Concerto for Traverse Flute, Violin,
Harpichord, Strings and Continuo
in A minor, BWV 1044

Ralph Kirkpatrick, Rudolf Baumgartner,
Aurèle Nicolet,

Festival Strings Lucerne

Leader: Rudolf Baumgartner

ARC 3176 · 73 176 STEREO

Overture No. 2 in B minor, BWV 1067

Overture No. 3 in D major, BWV 1068

Aurèle Nicolet, Traverse Flute

Münchener Bach-Orchester

Karl Richter, cond.

ARC 3180 · 73 180 STEREO



For further information
and complete catalogue write:

DECCA DISTRIBUTING CORPORATION
445 Park Ave., New York 22, N. Y.

NOTES FROM ABROAD

LONDON

On hearing of the recording sessions scheduled for Otto Klemperer for far into the spring, I jocosely told Walter Legge, who arranged them all for EMI-Angel, that he was overworking that great, inexhaustible crag of a man. On reflection, though, I realize that it may be Mr. Legge and his Philharmonia players and singers who are in danger of fatigue-neurosis.

At Kingsway Hall, Klemperer concluded a recording of the *St. Matthew Passion*, with Schwarzkopf, Fischer-Dieskau, Peter Pears, Christa Ludwig, and Walter Berry as soloists. Then he sat back expansively for a moment and told



Klemperer: a dream becomes reality.

another of his Jewish stories. How teacher asked little Moritz: "Who wrote *Faust*?" How Moritz defensively replied, "I didn't." How teacher boxed Moritz's ears. How next day Moritz's father protested to teacher: "My Moritz is a truthful boy. He would never tell a lie. But even if he did write *Faust*, why blame him? He always tries hard."

Klemperer at Kingsway. Almost before the shouts of laughter had died away, Klemperer picked up his baton and started on the B minor Mass (with Schwarzkopf, Ludwig, Berry, and Nicolai Gedda). He had conducted this score only once before, in Berlin in 1931, a couple of years after taking over the Philharmonische Chor as successor to its founder, the late Siegfried Ochs. Fol-

lowing the accession of the Nazis, a wanderer on the face of the earth and struck down by illness and mishap, Klemperer was more or less cut off from the world's great choral ensembles for a quarter of a century. At Kingsway he applied himself to Bach's masterpiece with the frowning intentness of a man who sees an old, despaired of dream become reality.

After seven sessions, and with three choruses yet to record, he broke away to the Royal Opera House to produce (as well as conduct) a new *Zauberflöte* with Joan Sutherland as Pamina. He was scheduled to resume the B minor Mass after the end of the *Zauberflöte* run, then to start upon a recording of *Fidelio*, another opera which he has produced here.

Among the purely orchestral recordings by Klemperer and the Philharmonic that are either already taped or planned, make note of: a Tchaikovsky *Pathétique*, which EMI people who have heard it refer to with reverent upward rollings of the eye; an album coupling Johann Strauss waltzes with a Kurt Weill suite, *Eine Dreigroschenmusik*, written by the composer at Klemperer's request soon after the premiere of the *Dreigroschenoper* in Berlin; a quartet of Mozart symphonies; Bruckner's Symphony No. 7, coupled with the *Siegfried Idyll* in the original scoring (solo strings); Richard Strauss's *Tod und Verklärung* and *Metamorphosen*; and a further Wagner album, taking in *The Entry of the Gods, Siegfried's Rhine Journey*, the *Parsifal* Prelude, and *Forest Murmurs*.

Callas Unconvinced. With an incipient chest cold (as she thought), Maria Callas flew into London to begin recording a collection of Donizetti and Rossini arias with the Philharmonia Orchestra under Antonio Tonini. Throughout the sessions she was closely tailed by a maid with a charged throat-spray in either hand. Mme. Callas did not attend the playback of the first takes. "You need not bother checking on them," Walter Legge assured her later. "They're absolutely marvelous!"

"Maybe," muttered Miss Callas. "But are they any good?"

The tape was run again for her bene-

Continued on page 26

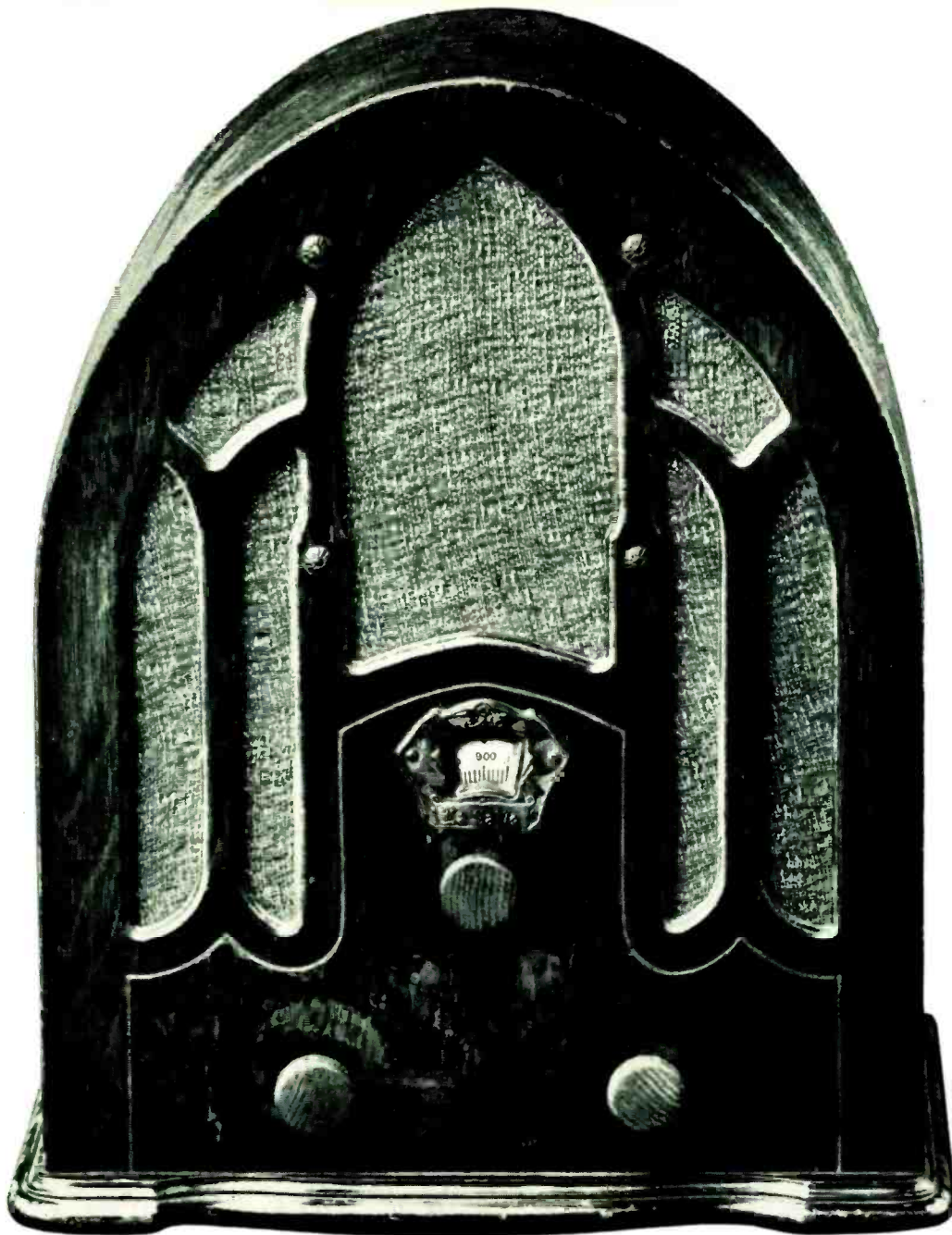

You've Been Listening To Turntables For Years!

From "Dardanella" to "Never On Sunday," from Caruso to Como—as long as good music has been played on radio, it has been played on single-play turntables — **not automatics!***

From the earliest days, broadcasters have known there is no substitute—no equal to the turntable. For professionals concerned with the quality of record reproduction and protection of valuable record libraries, there can be no compromise.

The same reasoning applies to the equipment you select for your home. You want to enjoy all the quality modern records are capable of producing. You want unlimited playback without the noise and distortion of excessive

groove wear. You want simple design—no troublesome gadgetry, no breakdown and repairs. In other words—you need a turntable.

Rek-O-Kut is the only home component manufacturer presently producing and supplying professional turntable equipment to recording studios and radio stations. In broadcasting — turntables are the standard. In turntables—Rek-O-Kut is the standard. Its quality has never been equalled . . . its reputation is unrivalled. Rek-O-Kut — the first name in turntables.



REK-O-KUT

*Write for FREE BOOKLET "Single-play Turntables versus Automatic Turntables."

Rek-O-Kut Co., Inc., Dept. HF-3 38-19 108th St., Corona 68, N.Y. Export: Morhan Exporting Corp., 453 B'way, N.Y.C. Canada: Atlas Radio, 50 Wingold Ave., Toronto 19
CIRCLE 74 ON READER-SERVICE CARD

BRING 'EM BACK ALIVE!



In all E-V compact systems

To the uninitiated buyer, all compact systems may look much alike. But inside there's a big difference — a difference that can spell either lasting satisfaction or eventual disappointment.

That's why we invite you to look closely at the inside components of any E-V compact system . . . at the design and construction of every single speaker in every system. No mystery . . . no mumbo-jumbo. E-V compact systems feature top-quality components throughout, to guarantee the finest original sound plus years of trouble-free performance.

Check the specs . . . check the features! Then choose the E-V compact system that meets your every requirement of appearance, price, quality . . . the system that will bring your favorite music "back to life."

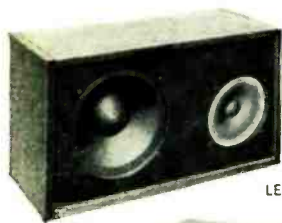

LEYTON

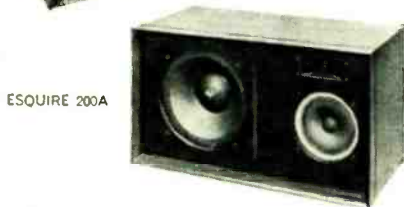

ESQUIRE 200A



ROYAL 400

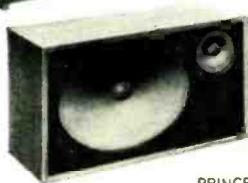

PRINCESS

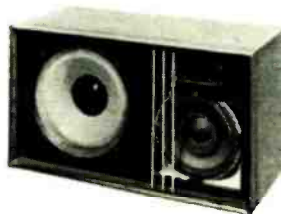

REGAL 300

USE THIS HANDY SPECIFICATION CHART TO CHOOSE YOUR E-V COMPACT SPEAKER SYSTEM

Model	Royal 400	Regal 300	Esquire 200A	Leyton	Princess	Regal 300 Kit	Esquire 200 Kit
Frequency Response	30-19,000 cps	35-19,000 cps	40-19,000 cps	50-15,000 cps	60-15,000 cps	35-19,000 cps	40-19,000 cps
Power Handling, Program	70 Watts	70 Watts	30 Watts	25 Watts	20 Watts	70 Watts	70 Watts
Level Controls	Two	Two	Two	One	None	Two	Two
Crossover Frequencies	200, 3500 cps	200, 3500 cps	800, 3500 cps	2000 cps	2000 cps	200, 3500 cps	200, 3500 cps
Speaker Types	18" foam-cone woofer, 8" cone mid-range, diffraction-horn tweeter	12" foam-cone woofer, 8" cone mid-range, diffraction-horn tweeter	10" woofer, 5" cone mid-range, diffraction-horn tweeter	10" woofer, 5" cone tweeter	8" x 12" woofer, 5" cone tweeter	12" foam-cone woofer, 8" cone mid-range, diffraction-horn tweeter	12" woofer, 8" cone mid-range, diffraction-horn tweeter
Impedance	8 ohms	8 ohms	8 ohms	8 ohms	8 ohms	8 ohms	8 ohms
Finishes Available	Walnut, Mahogany, Unfinished Hardwood	Walnut, Mahogany, Unfinished Hardwood	Walnut, Mahogany, Unfinished Hardwood	Walnut, Mahogany	Walnut	Unfinished Hardwood	Unfinished Hardwood
Size: (Finished Model) (Unfinished Model)	23½"H, 32"W, 14¼"D 22"H, 31½"W, 11¼"D	14"H, 25"W, 13½"D 14"H, 23½"W, 12"D	14"H, 25"W, 13½"D 14"H, 23½"W, 12"D	14"H, 25"W 12"D	10¾"H, 19½"W, 8½"D	(Assembled) 14"H, 23½"W, 12"D	(Assembled) 14"H, 23½"W, 12"D
Shipping Weight	103 lbs.	67 lbs.	30 lbs.	29 lbs.	15 lbs.	63 lbs.	52 lbs.
Price, Finished	\$249.00	\$179.00	\$133.00	\$84.50	\$49.50	—	—
Price, Unfinished	\$199.00	\$149.00	\$107.50	—	—	\$125.00	\$93.00

CIRCLE 43 ON READER-SERVICE CARD

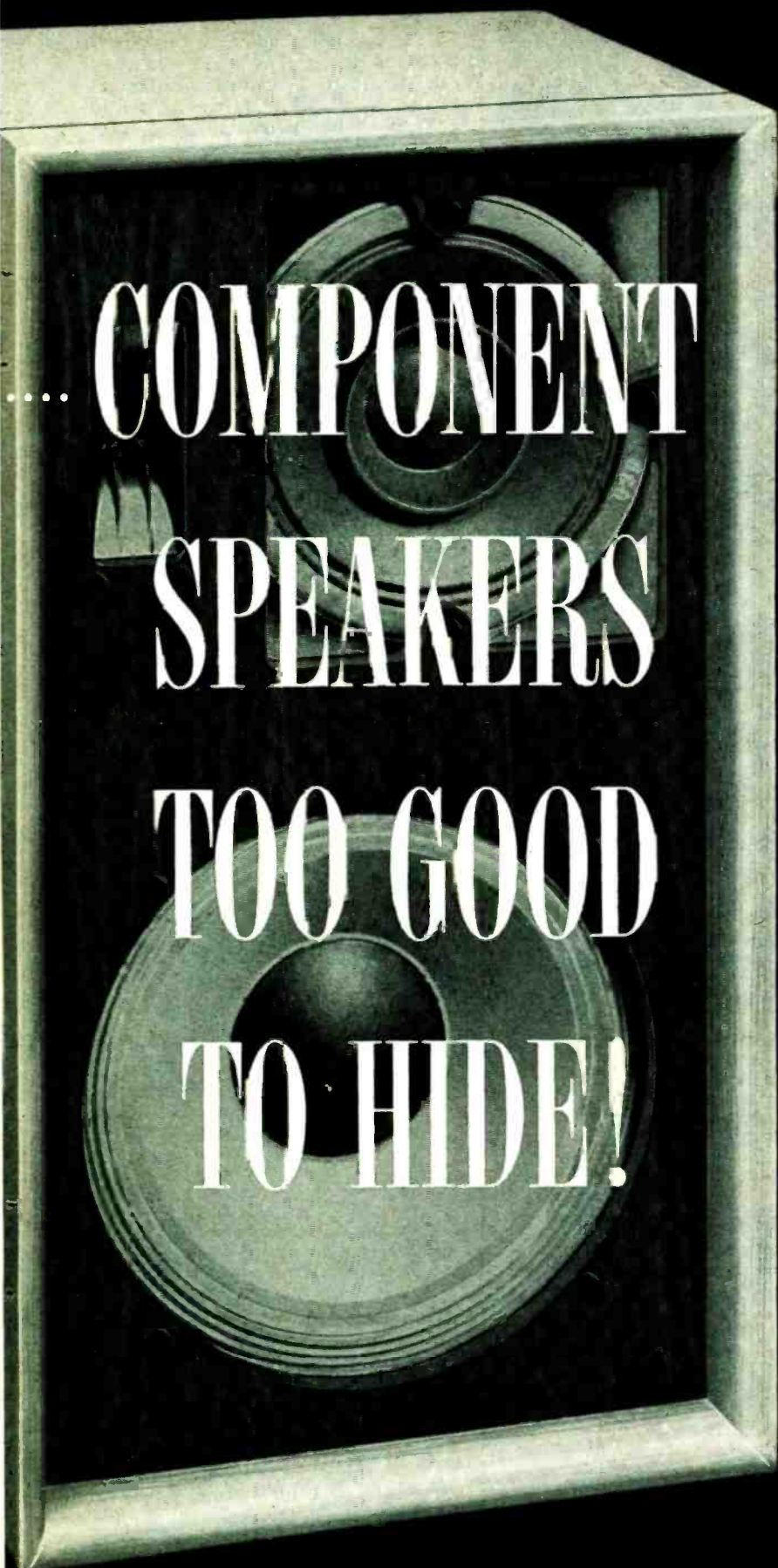

COMPONENT SPEAKERS TOO GOOD TO HIDE!

The textured cane grille cloth featured on all E-V Compact Systems blends smartly with any decor — any period. And you can use your E-V system upright or horizontally . . . all four sides have rich, hand-rubbed finishes.

HERE'S PROOF E-V BUILDS QUALITY CLEAR THROUGH!

All E-V bass speakers, for example, utilize a high-compliance suspension, long-throw voice coil and a high-mass moving system to extend low-frequency response with minimum efficiency loss . . . minimum distortion. Mid-range and high-frequency speakers provide peak-free, wide-angle response balanced to the bass speaker. Crossover points, too, are chosen meticulously to satisfy the strictest engineering and musical requirements. And all mid-range and high-frequency components are isolated from other speakers to eliminate interaction, but distortion.

In E-V compact systems, too, you'll find such features as edgewise-wound voice coils for 18% more efficiency . . . while high-efficiency magnetic circuits and viscously-damped cloth suspensions maintain this efficiency. Rigid steel or diecast speaker frames assure perfect alignment and unvarying performance. Excellent dispersion of highs for greater freedom in stereo speaker placement results from E-V exclusive diffraction horns or new flat-cone tweeters.

These features are wedded by skillful E-V design and engineering know-how to bring you a sound that can best be described as "transparent"—you feel the deepest bass, enjoy the crisp clarity of the treble and literally delight in the brilliance of even the highest overtones!

ROYAL 400 Finest low-resonance system available. Uses giant 18" foam-cone woofer, yet cabinet is only 23-1/2" high, 32" wide, 14-3/4" deep. Features effortless handling of deepest bass plus balanced response throughout entire range. Superbly finished in Mahogany or Walnut. Net each \$249.50. Unfinished utility model, net each \$199.00.

REGAL 300 Premium-quality bookshelf-sized three-way system. Deluxe components throughout. Two level controls. Hand-rubbed Walnut or Mahogany finish. Net each \$179.00. Unfinished utility model, net each \$149.00.

ESQUIRE 200A Completely redesigned with speakers specially built for compact use. Three-way system includes 10" woofer, 5" mid-range and diffraction-horn tweeter. Richly-grained Walnut or Mahogany finish. Net each \$133.00. Unfinished utility model, \$107.50.

LEYTON Value leader in the E-V compact line. New two-way system uses 10" woofer, 5" wide-range tweeter. Lowest cost full-size book-shelf system in line. Walnut or Mahogany finish. Net each \$84.50.

PRINCESS Newest, smallest two-way system in the E-V family of compact systems. Ideal for low-cost stereo . . . just \$99.00 for a pair! Unusual 8" x 12" woofer provides response to 60 cps. Walnut finish. Net each \$49.50.

MONEY-SAVING COMPACT KITS
Three-way systems with 12" woofer, 8" mid-range, compression tweeter. Medium or high efficiency. Simply assemble cabinet, then install speakers. Saves up to 30%! Deluxe Regal 300 Kit for highest efficiency, finest sound. Net each \$125.00. Medium-efficiency Esquire 200 Kit, net each \$93.00.

ELECTRO-VOICE, INC.
Consumer Products Division
Buchanan, Michigan

Electro-Voice

ELECTRO-VOICE, INC., Dept. 324H
Buchanan, Michigan

Please send my free copy of the Electro-Voice high fidelity catalog.

Name _____

Address _____

City _____ State _____

Mated to Perfection!
THORENS
 NEW STEREO TURNTABLE
 WITH INTEGRATED ARM



THORENS TD-135, COMPLETE WITH INTEGRATED ARM

For the first time, Thorens — in the new TD-135 — offers a *component-quality* arm and turntable mated with a precision that insures you perfect tracking, perfect sound . . . always . . . with a minimum of installation effort on your part.

There's no compromise whatever with quality such as you usually find in integrated turntable and arm units. THORENS TD-135 is Swiss-precision crafted throughout . . . true component high fidelity all the way. You get: A precision turntable featuring 4 speeds, all adjustable, with an 8-pound non-magnetic table . . . plus a completely new, advanced tone arm that's so good we also sell it separately (see below) for use with *any* turntable of your choice. Exceeds NAB specs for wow, rumble and flutter. Has same belt-plus-idler drive as famous TD-124. Shuts off automatically at end of record. Many, many more features than we can detail. **\$110 net**



THORENS BTD-125, 12" PROFESSIONAL TONE ARM

Identical arm included with TD-135, but sold as separate unit. Less than 0.5°/inch tracking error. Built-in cueing device. All adjustments: vertical height; calibrated gram-force; stylus positioning slide; balancing counter-weight. Unique vertical pivot keeps stylus vertical for any height adjustment. Resonance well below audible frequencies. Interchangeable 4-pin cartridge shells. Mounted on board for THORENS TD-124, TD-121 turntables. **\$50.00 net**

See and hear the THORENS TD-135 and *ALL* the members of the "TD" family of fine turntables at your franchised dealer's today; there's one for every budget! *For additional information, write us direct.*

THORENS DIVISION

ELPA MARKETING INDUSTRIES, Inc.

New Hyde Park, N. Y.



CIRCLE 91 ON READER-SERVICE CARD

NOTES FROM ABROAD

Continued from page 22

fit. She approved. Meantime the threatened cold drew off. With the album uncompleted, she flew to Milan for rehearsals at La Scala, promising to be back to record the rest of the set later.

Boris on the Way. It is expected that Rita Gorr (Marina), Boris Christoff (name part), and Nicolai Gedda (Grigori) will get to work on an EMI-Angel stereo remake of *Boris Godunov* in Paris next September, a good twelve months after the recording was first mooted. Long before Christmas, EMI's musical staff in Paris was recruiting a chorus on the spot, mainly from second-generation Russian *émigrés*—singers with some cradle knowledge of Russian and therefore preconditioned to the original Pushkin-Mussorgsky text. The conductor will be André Cluytens; and there is some possibility, I hear, that Christoff will sing the roles of Pimen and Vaarlam, in addition to Boris. CHARLES REID

VIENNA

It seems that conductor Wolfgang Sawallisch is building up a new musical empire, somewhat after the Karajan model. Based on Cologne,

where Sawallisch governs the Opera, it is defended at its northern and southern outposts by the valiant troops of the Hamburg Philharmonic and the Vienna Symphony Orchestras, both under his direct command. Each summer there's also a sortie towards Bayreuth. In August 1961 the latter resulted in a recording of Sawallisch's and Wieland Wagner's joint production of *Der Fliegende Holländer*, a live recording in the only true sense of the word, Sawallisch says. "Believe it or not, I was not even aware of the fact that the music was being taped. After the fourth of the eight scheduled public performances in the Festspielhaus, I began to worry because I had not yet seen any of Philips' engineers about. My fears were unfounded. True to style, the recording director, Jaap van Ginneken, and his team had entered the field unnoticed. When I finally discovered the skillfully hidden microphones, it was all over."

The recording is said not only to restore Wagner's sound ideal (Festspielhaus acoustics as opposed to studio acoustics) but also to be a resuscitation of the original score: Senta's Ballad, usually sung in G minor in accordance with the printed score, is to be heard here in the key indicated in Wagner's autograph, i.e. in A minor. Sawallisch hopes to see another live Bayreuth recording this summer ("*Lohengrin* is my tentative suggestion," he says). More immediate plans call for production of the complete *Ring* to be given at the Cologne Opera House in May, with Wieland Wagner actively cooperating.

Continued on page 28

HIGH FIDELITY MAGAZINE

IT'S SOUNDCRAFT IN THE GREAT MOTION PICTURES!

FROM METRO-GOLDWYN-MAYER SAMUEL BRONSTON'S PRODUCTION OF "KING OF KINGS"



If you believe that all recording tapes are the same . . . read these facts about Soundcraft: today's great motion pictures depend on the most extensive stereophonic techniques and effects. To achieve them requires a magnetic product capable of satisfying the most critical demand. For years one name has consistently won virtually 100% acceptance of the uncompromising technicians of this industry. That name—Soundcraft. The fact is the development of the Soundcraft Magna-Stripe Process revolutionized the course of the entire industry—led to the advent of the stereo sound tracks of the great wide screen films. For this, Soundcraft was awarded the only Academy Award "Oscar" ever given to a recording tape manufacturer. Today the sound you hear in the great MGM (Camera 65), Todd AO, Cinemascope and other wide screen productions is reproduced on Soundcraft magnetic products. Motion picture producers investing millions of dollars can't afford to take chances. That's why "It's Soundcraft in the great motion pictures!" You, too, can have this same measure of superior performance and reliability in your own recordings by switching to Soundcraft—where professional performance is the standard and satisfaction the guarantee. See your Soundcraft Dealer today and let him put you on the right "sound" track with Soundcraft.



REEVES **SOUNDCRAFT** CORP.

Main Office: Great Pasture Road, Danbury, Connecticut • New York: 10 East 52nd St.
Chicago: 28 E. Jackson Blvd. • Los Angeles: 342 N. LaBrea • Toronto: 700 Weston Rd.

CIRCLE 73 ON READER-SERVICE CARD

Continued from page 26



FM • STEREO • MULTIPLEX All on One Chassis and in KIT FORM

That's Right — No external Multiplex Adapter required...PACO introduces the new model ST-35MX FM Stereo Multiplex tuner, featuring the finest multiplex circuitry, ALL ON ONE CHASSIS... ALL IN ONE CABINET AND IN KIT FORM (with factory pre-aligned multiplex section).

The ST-35MX FM Stereo-multiplex tuner is designed for the discriminating Audiophile who demands the ultimate in distortionless FM Stereo reception. Its incomparable features include ultra high sensitivity, rock-stable AFC, pin point selectivity combined with broad band response.

The ST-35MX has been engineered to meet the most critical standards. Highly styled in a handsome black and gold case... it is the perfect companion to Paco's popular SA-40 Stereo preamp-amplifier or any other fine quality stereo system.

AVAILABLE THREE WAYS IN HANDSOME GOLD AND BLACK ENCLOSURE

MODEL ST-35MX (Kit) with full pre-aligned multiplex circuitry and PACO detailed assembly—operating manual.

NET PRICE \$99.95

MODEL ST-35PAMX (Semi-Kit) with both tuner and multiplex sections factory-wired and completely prealigned for hairline sensitivity. Complete with PACO detailed assembly — operating manualNET PRICE \$119.95

MODEL ST-35WMX (ready to operate). Factory-Wired, aligned, calibrated and assembled complete with operating manualNET PRICE \$139.95

by **PACO**



Model SA-40
STEREO PREAMP-AMPLIFIER KIT
Kit Net Price: \$79.95
Factory Wired Net Price: \$129.95

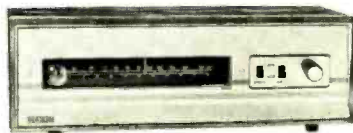

Model ST-25 MX
FM STEREO TUNER KIT
Kit Net Price: \$69.95
Factory Wired Net Price: \$99.95



Model MX-100
STEREO MULTIPLEX ADAPTER
Kit Net Price: \$49.95
Factory Wired Net Price: \$69.95

PACO Electronics Co., Inc.
a division of **PRECISION Apparatus Co., Inc.**
Subsidiaries of Pacotronics, Inc.
70-31 84th Street, Glendale 27, Long Island, New York

See the full line of PACO Hi-Fi Stereo components on display at all leading distributors throughout the world.

Sawallisch, Strauss, and "Stehgeiger." Future recordings of this energetic young conductor—he is thirty-eight—will include Beethoven's Seventh and Tchaikovsky's Fifth with the Amsterdam Concertgebouw Orchestra and *Ein Deutsches Requiem* with Wilma Lipp and Franz Crass (the Bayreuth Dutchman), the Vienna Singverein, and the Vienna Symphony Orchestra. When I saw him recently, however, he had just completed the recording of a couple of waltzes by Johann Strauss and was interested in talking about the widely accepted belief that there is only one manner, the "echt-Wien" style, in which these waltzes should be executed. "I can assure you that it is practically impossible to find two Viennese musicians who would agree on the correct tempo, the proper placing of accents, and the adequate handling of ritardandos and accelerandos in any of the waltzes Johann Strauss wrote." A few hours later I had the opportunity of raising this question with another musician, widely looked upon as an expert in rendering the music of Johann Strauss.

Every year, on January 1, millions of people all over Europe listen to what is considered the true Viennese interpretation of the music created by the Strauss dynasty. Almost all the TV networks in Western Europe broadcast the by-now-traditional New Year's Concert of the Vienna Philharmonic, conducted by Willy Boskovsky in the very manner which Johann Strauss adopted when he played this music. Boskovsky appears in front of the orchestra with his violin, uses the bow to indicate the beat, and occasionally falls in with the first violins. American listeners have become familiar with this music under the baton (or should I say, the bow?) of Boskovsky through the series of recordings (the latest entitled "Thousand and One Nights," recorded in Vienna last summer), issued by London.

The New Year's Concert was created by Clemens Krauss twenty years ago. When Krauss died, in 1954, the Vienna Philharmonic went in search of a conductor of similar stature. "While we were looking around," Herr Boskovsky said, "my colleagues thought that I might as well try my luck in conducting this kind of light music. The idea of leading the orchestra in the old manner of the 'violin-conductor' (Strauss used the German word 'Stehgeiger') came quite naturally. And since this way of conducting found favor with the public and with my colleagues, I stuck to it."

Teacher Willy Boskovsky. His own manner of interpretation, Boskovsky frankly admits, differs from that of Krauss in many details—as a comparison of Boskovsky's discs with those of his predecessor (also on the London label) will immediately reveal. In a sense this may be taken as confirmation of Sawal-

Continued on page 32

Manufacturers of Fine Electronic Equipment for over 30 years.

CIRCLE 67 ON READER-SERVICE CARD



PROTECT YOUR RECORD COLLECTION WITH AUTO-POISE ...first self-powered automatic tonearm

Record scratch is a thing of the past with REK-O-KUT Auto-Poise—the *first self-powered automatic tonearm*. □ For the first time, the flawless performance of the single-play turntable and independent tonearm is combined with convenient push-button operation. □ Auto-Poise, the first automatic self-powered independent tonearm, pays for itself by protecting your record collection and high-compliance cartridge. □ You get ■ *unequaled record protection* ■ *fully automatic operation* ■ *unexcelled single-play turntable and independent tonearm performance* □ Ask for a demonstration of Auto-Poise at your high fidelity dealer. Write for free literature today.

AUTO-POISE AUTOMATIC TONEARM, Model AP-320—\$74.95 net. □ AUTO-POISE CONVERTER, MODEL APK, converts existing Rek-O-Kut Tonearms to automatic tonearms—\$49.95. □ REK-O-KUT STEREO TONEARM, Model S-320, with exclusive Omni-Balance and Micro-poise, for perfect balance and tracking with high-compliance cartridges—\$34.50 net.



Co., Inc., Dept. HF-3A, 38-19 108th St., Corona 68, N.Y. Export: Morhan Exporting Corp., 458 Broadway, N.Y.C. Canada: Atlas Radio, 50 Wingold Avenue, Toronto 19.

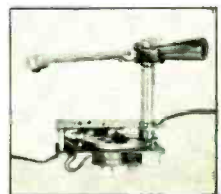

CIRCLE 74 ON READER-SERVICE CARD

HEATHKIT® TAKES THE WORRY OUT OF BUYING, BUILDING, FINANCING THE BEST STEREO SYSTEM FOR QUALITY SOUND

Buy with Complete Confidence of Quality Performance—Heathkit guarantee assures your success. Your Heathkit must perform to factory specifications or your money refunded!

Build with Amazing Ease and Speed—Complete instructions in everyday language show you *what* to do and *how* to do it! No experience needed, no special knowledge required!

Pay as You Enjoy the Music You Love—You can order the kits you want with no money down and up to 18 months to pay on \$25 to \$600! 5% discount on Systems!

A POPULAR-PRICED STEREO SYSTEM WITH SUPERIOR PERFORMANCE

AN OUTSTANDING STEREO SYSTEM FOR THE BUDGET-MINDED MUSIC LOVER

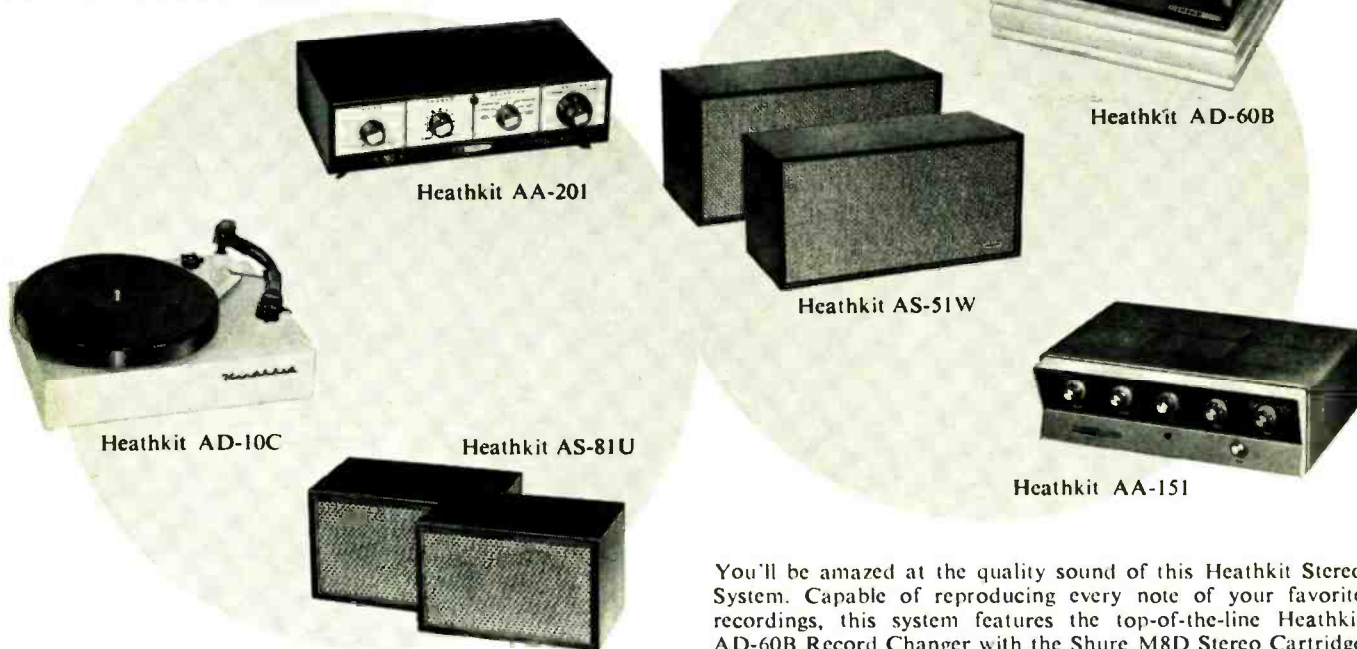

The Heathkit HFS-46 is a low-cost Stereo Phono System that is complete in every way to bring to your home the pleasures of stereo record playing. It is perfect as a "starter" system for newcomers to the world of stereo sound and it is priced well within the reach of every budget for that "extra" system.

Included in this economical system is the Heathkit AD-10C Stereo Record Player with Sonotone 8TA4-SD ceramic stereo cartridge and diamond and sapphire styli; the Heathkit AA-201 6-watt Stereo Amplifier with its exciting new styling concept of black and ivory; and two of the new Heathkit AS-81U Miniature High Fidelity Speakers which feature a 6" woofer of special design and a 3" tweeter for unusual response (cabinet is factory assembled, ready for finishing).

Expandable at any time, you can add the Heathkit AJ-31 FM tuner and AG-11A Multiplex Adaptor for FM Stereo reception.

HFS-46... 33 lbs... no money down, \$10 mo...
.....(with system discount) just **\$94.90**

You'll be amazed at the quality sound of this Heathkit Stereo System. Capable of reproducing every note of your favorite recordings, this system features the top-of-the-line Heathkit AD-60B Record Changer with the Shure M8D Stereo Cartridge equipped with a diamond stylus and the Heathkit ADA-50W Walnut record changer base.

Power is supplied by the Heathkit AA-151 28 Watt Stereo Combination amplifier... 14 hi-fi-rated watts for each stereo channel. This tremendous preamp/amplifier value features the patented Heath **ULTRA-LINEAR**® circuit for extra fidelity, separate bass and treble tone controls, four stereo inputs, speaker phasing switch, and rich modern styling in luggage-tan and charcoal gray.

Ideally matched to the amplifier are the twin speakers, the Heathkit AS-51W duo. The factory assembled cabinets are handsome in walnut veneer. Inside is an 8" woofer, a true compression-type tweeter, and a high frequency level control.

All components are simple to assemble, designed to give your family years of stereo enjoyment, and may be expanded at any time to include other program sources (examples: add the Heathkit AJ-11 AM-FM tuner and AC-11B Multiplex Adaptor or the new AJ-41 Stereo Tuner, opposite, for Stereo off the air. Wt.

HFS-47... 90 lbs... no money down, \$21 mo...
.....(with system discount) **\$211.61**

CIRCLE 51 ON READER-SERVICE CARD

ALL NEW HEATHKIT STEREO TUNER

Superior Circuitry; Beautifully Styled; AM, FM and Built-In FM Stereo Multiplex

Here's the kit tuner you've asked for . . . the new Heathkit AJ-41 . . . ready for you to enjoy AM, FM or FM Stereo Multiplex! It's completely self-contained . . . the FM Multiplex Adaptor is *built-in!* It's convenient . . . separate tuning meters for AM and FM! It's quiet . . . new FM squelch circuit hushes between-station noise! It's automatic . . . the Stereo Indicator light shows when FM station is broadcasting stereo! It's easy to build . . . preassembled tuner, prealigned coils, circuit boards. It's a great Heathkit value . . . no money down, \$11 mo. only \$119.95 in Kit form; \$189.95 assembled.



Heathkit AJ-41

Your "Dream Stereo Home Music Center"—yours with no money down, as low as

\$38⁰⁰
per month

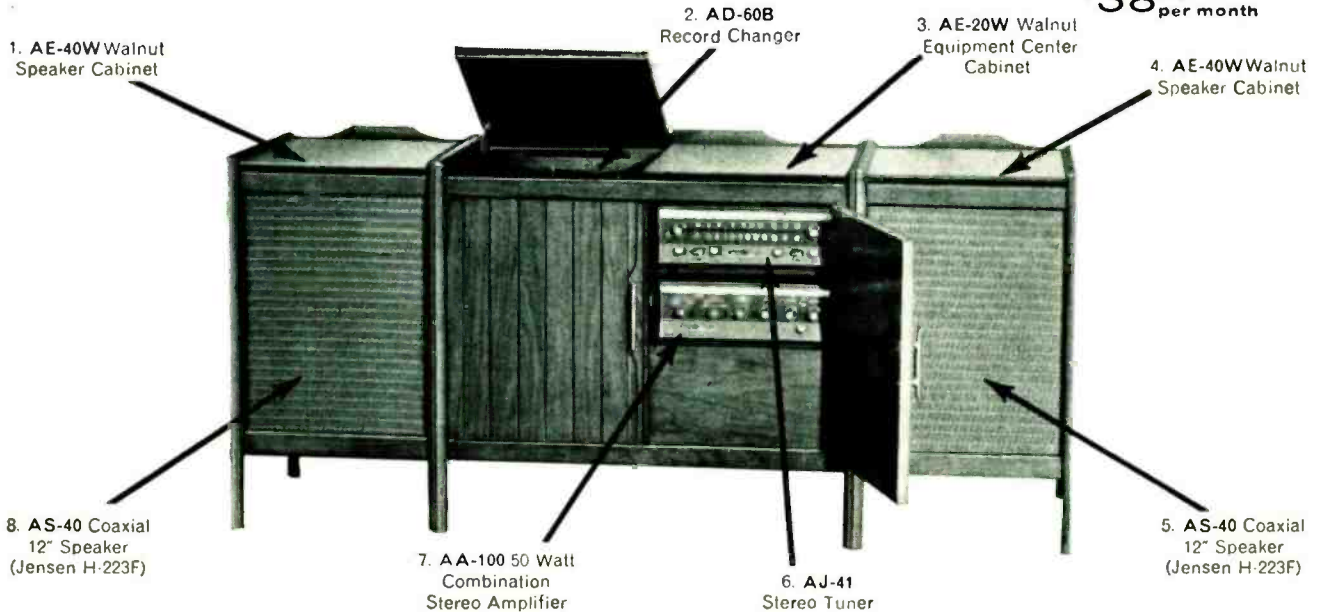

BUILD YOUR WAY TO MORE ENJOYMENT WITH HEATHKIT

You can build your "dream stereo home music center" and enjoy the superior quality of the finest in equipment with the satisfaction of having secured it at a savings of at least 50%! The above Heathkit stereo system presents the ultimate in performance of kit components . . . a fine record changer, the latest in stereo tuners, a powerful and versatile amplifier, superb coaxial speakers, and elegant walnut cabinetry. Check the details of each component in your Heathkit catalog; compare the system with others costing \$500 to \$1000 more! You'll agree there's extra value in Heathkit.

HFS-48 . . . no money down, \$38 mo.
.....(with system discount) **\$572.14**

HEATH COMPANY

Benton Harbor 8, Michigan



Yes, send me my free 1962 Heathkit catalog

NAME _____

ADDRESS _____

CITY _____ ZONE _____ STATE _____

Order direct by mail or see your Heathkit dealer.

Ship Parcel Post Express C.O.D. Best Way

Ordering instructions: Fill out the order blank. Include charges for parcel post according to weights shown. Express orders shipped delivery charges collect. All prices F. O. B. Benton Harbor, Mich. A 20% deposit is required on all C.O.D. orders. Prices subject to change without notice. Dealer and export prices slightly higher.

ITEM	MODEL NO.	PRICE

Free Catalog!



Send in today for your free 100-page catalog. Over 250 kits (more than 40 are new) in this most complete catalog of kits. Every piece is top quality . . . save up to 50%. Get a catalog now and receive 1962 Heathkit supplements.

CIRCLE 51 ON READER-SERVICE CARD



Deutsche
Grammophon
Gesellschaft

NEW RELEASE

WOLFGANG AMADEUS MOZART

THE MARRIAGE OF FIGARO

complete in Italian

Irmgard Seefried

Maria Stader

Dietrich Fischer-Dieskau

Renato Capecchi

Berlin Radio Symphony Orchestra

Conductor: Ferenc Fricsay

Mono 18697/99 · Stereo 138697/99

De-luxe presentation-box edition with illustrated libretto

For the friends of operatic excerpts

Deutsche Grammophon Gesellschaft has released Highlights from complete recordings in original versions on 12" LP's each with such famous singers as Maria Stader, Irmgard Seefried, Rita Streich, Astrid Varnay, Inge Borkh, Dietrich Fischer-Dieskau, Renato Capecchi and others.

Don Giovanni
Mono 19 224
Stereo 136 224

Der Rosenkavalier
Mono 18 656
Stereo 138 656

The Tales of Hoffmann
Mono 19 230
Stereo 136 230

Il Barbiere di Siviglia
Mono 19 270
Stereo 136 270

Tristan and Isolde
Mono 19 193
Stereo 136 030

Elektra
Mono 19 234
Stereo 136 234

A Masked Ball
Mono 19 271
Stereo 136 271

Direct Import · Factory Sealed
CIRCLE 33 ON READER-SERVICE CARD

NOTES FROM ABROAD

Continued from page 28

lisch's contention that within the framework of the "truly Viennese style" there is ample scope for individual variety. Yet it seems that Boskovsky's readings are about to acquire international significance as a sort of model. Orchestras in Paris and London, Stockholm and Amsterdam, have invited him to come "teach them the true Strauss manner." Boskovsky declined to comment on his own competence in this matter, but he did produce a letter from a correspondent in Beverly Hills, California, who had been listening to some of his recordings. The letter was in German, the signature that of Bruno Walter. I quote one sentence, in my own translation: "I feel the inner urge to tell you what joy it gave me to listen to these truly musical and truly Viennese outpourings of the hearts of inspired musicians."

KURT BLAUKOPF

PARIS

A graph of French musical news this season might have the shape of an unstable "U" with a bump in the bottom. Interest in relatively ancient and relatively modern composers is up, if one can judge by concert programs and recording projects. It has sagged into conventional respect so far as the great Romantics are concerned.

The bump in the down curve? That would be Berlioz. The Paris Opéra, after years of promising, has at last added *Les Troyens* to the repertory. The new version is a coproduction with La Scala, and uses the rather conventional sets and costumes already seen at Milan. But Régine Crespin was a splendid Didon on the first night; and young Guy Chauvet, who sang Enée, encouraged the growing belief that in him France has finally found a tenor with a big voice. In short, the Palais Garnier has demonstrated once again that it does not have to be as disappointing as it often is.

Hébé and the Wolf. The French are accustomed to hearing their own eighteenth-century dance music transformed into the rich, German substance of a Bach or Handel suite. It is only since the War that the general public has acquired a liking for the quite different—the drier and whiter—flavor these dances have when utilized by their fellow-countrymen. There are still areas of resistance, but now the Germans themselves are helping the native French cause. Deutsche Grammophon engineers were in Paris not long ago to make a recording of Rameau's *Les Fêtes d'Hébé*, a three-act ballet-opera composed in 1739. The singers and a small orchestra drawn from the Lamoureux Association will be directed by Marcel Couraud, whom American record collectors may recall chiefly as a sensitive interpreter

Continued on page 38

I knew your mother.
She was bulky and boxy...

Your father was
clumsy and awkward.

... a misfit, she didn't
belong anywhere.

Your father was
an eyesore, the ladies
despised him.

Yet I love you. I never saw
a stereo speaker so
graceful, so slim. Tell me,
what do you think of me?

We can make
beautiful music
together!

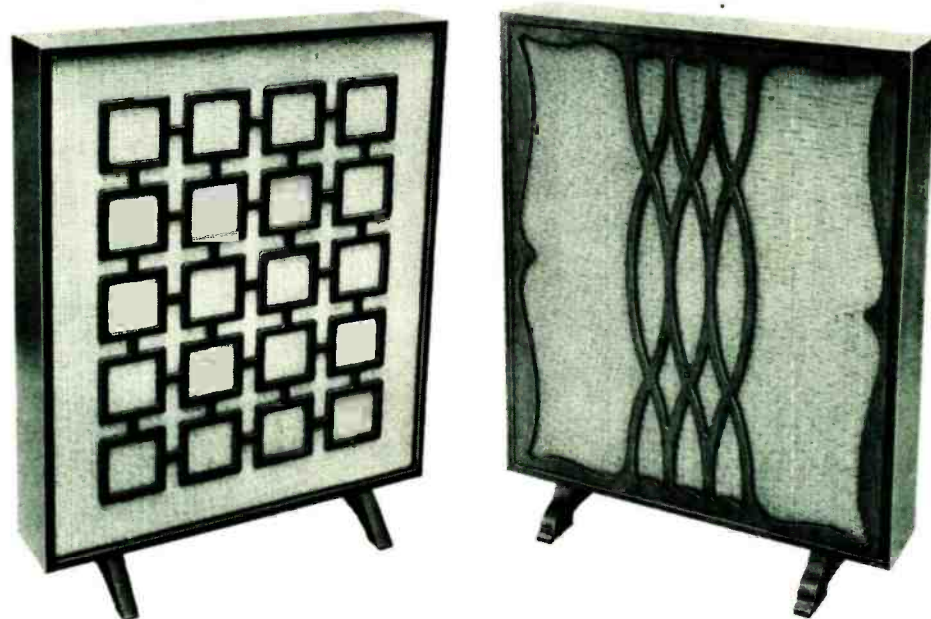

The ugly duckling has turned into a graceful swan—the SONOTEER. This is the first speaker system your wife will be proud to make a part of her home decor. The SONOTEER has five true high fidelity speakers that project a full circle of sound...both front and back. The effect is overwhelming! Hang SONOTEERS on walls, place them in room dividers...anywhere in your home. See them now at your high fidelity dealer's. Write for decorator booklet and technical specifications. *Models Shown:* Left: CA-70 Contemporary, genuine walnut—\$79.95 (CA-70E Mandarin, same style as Contemporary, satin ebony finish—\$89.95). Right: CA-70P Provincial, fruitwood finish—\$89.95.

SONOTEER

Dept. H-S

Rek-O-Kut / Audax, 38-11 108th St., Corona 68, N.Y.

Export: Morhan Exporting Corp., 458 Broadway, N.Y.C. Canada: Atlas Radio, 50 Wingold Ave., Toronto 19.

CIRCLE 14 ON READER-SERVICE CARD

We told you this was a dangerous loudspeaker!

In the fall of 1960 we introduced you to the EMI bookshelf speaker system and warned you about its dangers. ■ We told you that its effortlessly smooth, sweet, free-floating sound would be fatal to some of the bulkiest and most expensive loudspeakers by comparison—let alone other bookshelf speakers. We explained the psychological hazards of listening to the EMI Model DLS 529 after having purchased a larger, costlier, but not nearly as natural-sounding speaker system. And we cautioned you against the risks of exposing mediocre amplifiers, pickups or other equipment to the transient-perfect scrutiny of the EMI bookshelf unit. ■ Despite our warning, thousands of you went out and bought EMI bookshelf speakers anyway. The rest is high fidelity history. ■ Our loudspeaker turned out to be even more dangerous than we had thought possible. We knew we would come out far ahead of all competing designs, but we didn't really mean to start a massacre. When people get rid of three-hundred-dollar speaker systems and switch to our \$159.00* unit, even we begin to feel a bit frightened. ■ Of course, there's nothing we can do about it at this point, except perhaps to put the blame on EMI's world-renowned Dr. G. F. Dutton. It was he who designed the fabulous drivers of the Model DLS 529. He is responsible for the exclusive, hand-made 13½" by 8⅞" elliptical woofer with aluminum cone and special plastic suspension. Not to mention the two specially designed 3½" tweeters, the high-precision 4,500-cps crossover network or the heavily reinforced and damped 24" by 13" by 12¼" enclosure. As for the magnificent walnut cabinet work, the superb finish on all sides (including the back!) and the elegant woven metal grille, certain highly skilled craftsmen must share the responsibility for that. So we have no choice but to go on living dangerously... ■ If you can now overcome your trepidation, we suggest that you listen to a pair of EMI's on good stereo material at your nearest dealer. Like climbing Mount Everest, it will be well worth the danger.

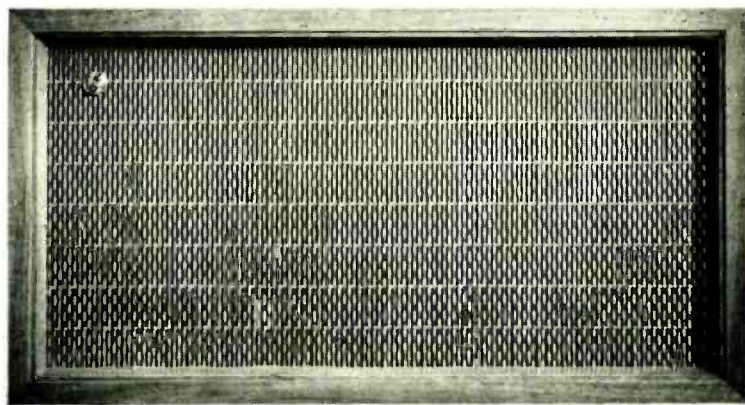

EMI

(ELECTRIC AND MUSICAL INDUSTRIES LTD.) ENGLAND

**Higher in South & West. For further information, write Scope Electronics Corporation, a subsidiary of Symphonic Electronic Corporation, 10 Columbus Circle, New York 19, N. Y., exclusive distributors of EMI Preamplifiers, Amplifiers, Loudspeakers, Tuners, Recorders, Integrated Tone Arms and Pickups.*

CIRCLE 77 ON READER-SERVICE CARD

save on everything in
STEREO HI-FI

see the best values in the

1962 444-PAGE

ALLIED CATALOG

it's the world's biggest
it's value-packed
send for it

free

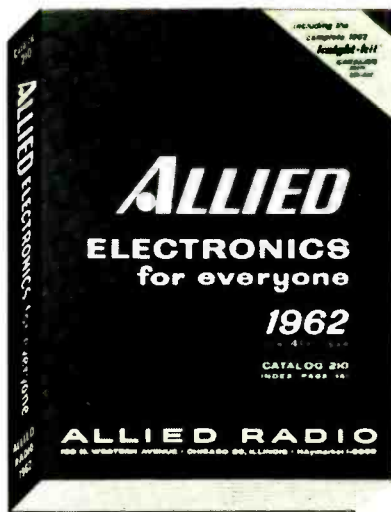

featuring

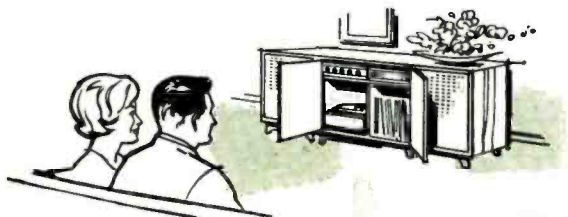

**MULTIPLEX
STEREO FM**

**ALL-TRANSISTOR
STEREO HI-FI**

Money-Saving ALLIED EXCLUSIVES

Send for this value-packed catalog featuring the world's largest Stereo hi-fi selections. See what's new...save on:

- Stereo Hi-Fi Music Systems**
- Stereo Amplifiers and Tuners**
- Hi-Fi Speaker Systems**
- Speaker Enclosures**
- Changers and Turntables**
- Cartridges and Pickups**
- Tape Recorders**
- Recording Tape, Accessories**
- Stereo Records and Tape**
- Hi-Fi Cabinetry**

NO MONEY DOWN
easiest terms available

BIG BUYING ADVANTAGES:

You get *everything* in hi-fi from ALLIED—at money-saving prices. You have our 15-day home trial privilege on systems and components. Satisfaction guaranteed or your money back.

Knight® Stereo

Fastest-growing value name in hi-fi. KNIGHT components and systems are equal to the very best in quality and performance, yet they're far lower in cost, give you most for your money.

knight-kits®

Build your own—build the best at big savings. It's easy, it's fun to assemble your own KNIGHT-KIT stereo hi-fi—and you get absolutely professional performance and appearance.

Lowest System Quotations

Select your own system components from our catalog and get our special money-saving low price!

world's largest selection of hi-fi cabinetry

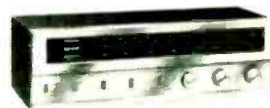

KNIGHT Deluxe Stereo FM-AM Tuner with built-in MULTIPLEX

KNIGHT 75-Watt ALL-TRANSISTOR Stereo Amplifier



ALL-TRANSISTOR 50-Watt KNIGHT-KIT Stereo Amplifier Kit



All-in-One FM-AM Tuner-Amplifier Kit with built-in MULTIPLEX Stereo FM

**For everything in Hi-Fi...
for everything in Electronics...
get the ALLIED Catalog!**

ALLIED RADIO

America's Stereo Hi-Fi Center

free
send for it

ALLIED RADIO, Dept. 110-C2
100 N. Western Ave., Chicago 80, Ill.

Send FREE 1962 ALLIED Catalog

Name _____
PLEASE PRINT

Address _____

City _____ Zone _____ State _____

CIRCLE 3 ON READER-SERVICE CARD

ARE YOU BEING CHEATED?

We at GRADO are constantly asked "How does a consumer know which ads are truthful?" "How can the consumer be sure that what he buys is really good?" "What protection does the consumer have after he spends his money?" He couldn't be sure until now!

100% CONSUMER PROTECTION. Proof of GRADO integrity and superb product quality is what we offer you with absolutely no risk on your part!!

GRADO SENATOR CARTRIDGE A Genuine Moving Coil Stereo Cartridge \$24.95

CERTIFIED SPECIFICATIONS. After carefully controlled Laboratory tests the New York Testing Laboratories certifies the following specifications to be completely accurate. (Note: These specifications will be recertified at various intervals to assure you, the consumer, of consistent quality).

SPECIFICATIONS — CERTIFIED (New York Testing Laboratories)



FREQUENCY RESPONSE:
20CPS—1KC—
±1DB
1KC—10KC—
±1.5DB
10KC—22KC—
±2DB

APPLICATION:
Tone Arm or
Record Changer
Excellent for
Monaural Records

CHANNEL SEPARATION:

Vertical—Lateral
30DB—1KC
18DB—15KC

45°—45° } 1KC
30DB } 15KC
14DB }

Output—
8MV @ 10CMV
Tracking Force—
3 grams
Diamond Stylus

ONE YEAR UNCONDITIONAL GUARANTEE (From date of purchase). If the cartridge becomes defective for any reason (including children) you will receive a brand new cartridge FREE!!

5 YEAR DIAMOND STYLUS GUARANTEE. If the diamond wears from playing within 5 years of the purchase (even in a record changer) GRADO will replace it FREE!!

ADDITIONAL PROTECTION. You may return the cartridge to your dealer for a full refund if you are not completely satisfied after ten days of close listening in your own home.

THE EXPERTS SAY:

"Provided a tape like stereo effect with no instrument wander."
Larry Zide . . . American Record Guide
"Superb sound at any price."
Chester Santon . . . Adventures in Sound, WQXR

If the cartridge becomes defective after the warranty period expires, for a flat fee of \$15.00, you will receive a brand new cartridge.

ONLY GRADO CAN BE PURCHASED WITH COMPLETE SECURITY!!

The above guarantee also cover:

Laboratory Stereo Cartridge \$49.50 • Classic Stereo Cartridge \$37.50

For Ultimate Results Use The **TOP RATED** Laboratory Series Tone Arm \$39.50

ASK YOUR DEALER ABOUT THE **GRADO DUSTAT \$6.95**
VELVET TOUCH RECORD CLEANER • NO MESSY FLUIDS

FOR FURTHER INFORMATION WRITE: **GRADO LABORATORIES, INC.**
4614 Seventh Ave., Brooklyn 20, N. Y. • Export—Simonfrice, 25 Warren St., N.Y.C.

CIRCLE 48 ON READER-SERVICE CARD

NOTES FROM ABROAD

Continued from page 32

of Monteverdi for Discophiles Français. Also on Deutsche Grammophon's Paris schedule is an international version of Prokofiev's *Peter and the Wolf*, with Lorin Maazel directing the Orchestre National. Since there will be a French, a German, and an English edition, the narrators are, at this writing, still a problem. Maazel wanted Ingrid Bergman, but her other engagements conflicted.

Fresh Stock. French ballet music of the nineteenth century, of course, cannot be said to have been neglected by the record industry. A few months ago the Paris office of Pathé-Marconi received from one of EMI's American outlets a desperate message which boiled down to this: Could one have something that is not *Coppélia*?

The company has now elicited a triple response, with the help of conductor Georges Prêtre and the Conservatoire Orchestra. *Non-Coppélians* will soon get: (1) Francis Poulenc's *Les Biches*, sometimes called *The House Party*, which was first produced at Monte Carlo in 1924; (2) Henri Dutilleux's *Le Loup*, produced in Paris in 1953 and presented in New York by the Roland Petit company the next year; and (3) Darius Milhaud's *La Création du Monde*, produced in Paris in 1923 and notable for its use of jazz idioms.

Royal Revival. The French national radio network is an active patron of music, commissioning important works and organizing each winter a series of unusual public concerts for which the admission price is only a dime (officially the tickets are "invitations"). One evening this winter the program included some ballet music, scored for recorders, oboes, and strings, directed by Sorbonne musicologist Jacques Chailley, and composed by Louis XIII while Richelieu was running the country. Beethoven's laurels are still intact, but the piece was not bad for a king anyway. Chailley also included the charming song *Amaryllis*, which is attributed to the same Louis.

ROY McMULLEN

High Fidelity. March, 1962. Vol. 12, No. 3. Published monthly by The Billboard Publishing Co., publishers of Billboard Music Week, Vend. and Amusement Business. Telephone: Great Barrington 1300. Member Audit Bureau of Circulations.
Editorial Correspondence should be addressed to The Editor, High Fidelity, Great Barrington, Mass. Editorial contributions will be welcomed. Payment for articles accepted will be arranged prior to publication. Unsolicited manuscripts should be accompanied by return postage.
Subscriptions: Subscriptions should be addressed to High Fidelity, Great Barrington, Mass. Subscription rates: United States, Possessions, and Canada, 1 year, \$6; 2 years, \$11; 3 years, \$15; 5 years, \$20. Elsewhere \$1 per year extra. Single copies 60 cents.
Change of Address notices and undelivered copies (Form 3579) should be addressed to High Fidelity, Subscription Fulfillment Department, 2160 Patterson Street, Cincinnati 14, Ohio.



DORIS DAY, COLUMBIA RECORDING ARTIST, SAYS: "Now, I Spell Perfection—Roberts!"

PERCY FAITH, famed composer, conductor says: "My Roberts 990 is an invaluable aid in composing and arranging. 'Automatic' is almost the word for its simplicity of operation."



ONLY THE ROBERTS '990' STEREO TAPE RECORDER

combines these advanced features: 4-Track Stereo Record/Play * 2-Track Stereo Playback * 4-Track Monaural Record/Play * Dual Head Outputs * Dual Pre-Amp Outputs * Dual Power Amplifier Outputs * Dual Monitor Speakers * Professional Lever-Type Automatic Shut-off (releasing pinch wheel) * Double-Fast Rewind * 3¾-7½-15 ips Tape Speed * Portable * Recessed handle and vertical operation ideal for custom installation.

399⁵⁰

10½" Reel Adaptor Now Available—\$49.50



ROBERTS ELECTRONICS, INC.
 5920 BOWCROFT AVENUE, LOS ANGELES 16, CALIFORNIA
 MFRS. OF ROBERTS SONIC-THEZIA, MEDICAL EQUIPMENT, STEREO HEAD PHONES,
 NEGATIVE ION GENERATORS, AUDIO EQUIPMENT AND MAGNETIC RECORDING TAPE

ROBERTS ELECTRONICS, INC., DEPT. HF-3-A
 5920 Bowcroft Ave., Los Angeles 16, Calif.
 Please send me:

Roberts Stereo Tape Instruction Manual containing stereo and monaural applications. I enclose 25¢ (cash, stamps) for postage and handling.

The name of my nearest dealer.

Name _____

Address _____

City _____ State _____

CIRCLE 75 ON READER-SERVICE CARD

WIN EMPIRE'S 1ST ANNUAL 'ROUND-



THIS IS THE **new empire troubador** ...world's most perfect record playback system

Have you ever dreamt of attending an *international programme* tour through such cultural centers as Paris, Rome, Edinburgh, Dubrovnik, Bregenz, Bayreuth, Salzburg, and Athens – witnessing in person their presentations of opera, ballet, drama, symphony concerts, chamber music, recitals, and even art exhibitions? Each year thousands of people from all parts of the world attend one or perhaps two of the great music festivals . . . *Now* two people will have the opportunity to attend most of the leading festivals – the winners of the *Empire 'Round-the-World Music Festival*.

It's easy – here's all you do: Listed in alphabetical order are *ten outstanding features* of the new Empire Troubador, world's most perfect record playback system. The collective thinking of the leading high fidelity music editors and critics listed these features in what they felt is the respective order of importance. Your task – **MATCH THEIR LIST.**

That's it! . . . no long, drawn-out essays . . . no jingles . . . no box-tops. Just rearrange the *outstanding Empire features* in the order of importance that you feel will match the master list. You may win *Empire's Round-the-World Music Festival*.

CIRCLE 44 ON READER-SERVICE CARD

OUTSTANDING FEATURES OF THE EMPIRE TROUBADOR

(world's most perfect record playback system)

A. All 3 Speeds – 33 $\frac{1}{3}$, 45, 78 RPM, with fine speed adjustment.

B. Dynamically Balanced Playback Arm – with built in calibrated gram scale accurate to 0.1 grams. Dial exact stylus force required.

C. Lowest Rumble – No Wow and Flutter – Rumble better than -64 DB; Wow and flutter less than .05%.

D. Maximum Compliance – Playback arm pivots use vertical and lateral ball-bearing suspensions.

E. No Acoustic Feedback – Rigidized arm structure eliminates resonance – no turntable isolation required.

F. Rugged – virtually impossible to damage the retractable stylus mechanism or turntable system.

G. Sensational Dyna-Lift – Automatically lifts the arm from the record at the end of the music.

H. Simplicity – only 2 moving parts; flexible belt couples turntable directly to heavy-duty, constant speed hysteresis motor – no intermediate idlers.

L. Tracks at Less than 1 Gram – with no measurable distortion.

J. Truly Compatible Mono-Stereo Cartridge – frequency response 15-30,000 cycles per second; channel separation better than 25 DB.

THE-WORLD MUSIC FESTIVAL (FOR 2)

THE GREATEST MUSIC TOUR EVER PLANNED!

A 'Round-the-World musical trip, lasting 21 days, awaits the lucky winner (and his guest) of Empire's 1st Annual Music Contest. Imagine . . . you'll be attending such greats as the Athens, Dubrovnik, Bregenz, Salzburg, Bayreuth, and Edinburgh Festivals. You'll be taken on personalized tours through many world-famous cultural centers, like Rome, Paris, and Munich; plus special field trips, such as a tour of the MGM factory in Hamburg, etc. And best of all, this is at no cost to you! Transportation, rooms, meals, tickets and tours are pre-paid by Empire . . . your host on this incomparable trip. **Your Hi-Fi dealer has complete itinerary.**

OFFICIAL RULES

1. On an official entry form, or plain stationery, list all the outstanding features (code letters) of the New Empire Troubador in their order of importance. Only one entry per person. Be sure to include your address.

2. Judges will be determined by Empire Scientific Corp. The entry form listing the outstanding features in their order of importance exactly as on the judges' list will be the winner. In the event of a tie, an opinion question on "record playback systems" will be sent to all contestants involved in the tie. The judges, as determined by Empire Scientific Corp., will judge the answers to the opinion question on the basis of originality and aptness of thought. The participant submitting the best answer in the opinion of the judges will be the winner. The decision of the judges will be final.

3. The prize must be accepted as scheduled in advertisements. Any tax or liability pertaining to the award will be the sole responsibility of the winner. No substitution of the prize will be allowed. Empire Scientific Corp. reserves the right at all times to change the festivals and cities named without notice.

4. Entry envelopes must be postmarked no later than midnight June 15, 1962. All entries become the property of Empire Scientific Corp., and none will be returned. Mail entries to Empire Scientific Corp., Box 615, Garden City, Long Island, NY.

5. The contest is open to all residents of the United States and Canada. The contest is prohibited to employees of the Empire Scientific Corp., its selling agents, affiliated companies, its advertising agency, and their families. This contest is subject to Federal, State, and local regulations.

6. Winner will be notified by mail not later than 15 days after final drawing.

7. Winner and guest of his choice will be flown by jet plane across the Atlantic. All connecting intercity transportation will be arranged by Empire Scientific Corp. All hotel accommodations, meals (2 per day), fares, sightseeing, admissions to festivals, and transportation from terminals to airports will be paid for by Empire. The above is only valid if prize is accepted as scheduled.

HINT: Your local dealer has entry blanks . . . and Empire Troubadors . . . ask him for a live demonstration — he'll be happy to oblige. Pay close attention to the "silent" Empire 208 3-speed turntable; Empire 980 dynamically balanced playback arm, featuring the sensational Dyna-Lift—Empire 108 first truly compatible mono-stereo cartridge; and handsome walnut base. Complete: \$200.

CIRCLE 44 ON READER-SERVICE CARD



VISIT YOUR DEALER—ASK FOR A COPY OF THE COMPLETE EMPIRE FESTIVAL ITINERARY—HEAR THE INCOMPARABLE EMPIRE TROUBADOR—YOU'RE ONLY ALLOWED ONE ENTRY.

Official Empire 'Round-the-World Music Festival Entry Blank.

mail to: **empire** SCIENTIFIC CORP.

MATCH THE JUDGES' LIST

- 1 _____
- 2 _____
- 3 _____
- 4 _____
- 5 _____
- 6 _____
- 7 _____
- 8 _____
- 9 _____
- 10 _____

P.O. BOX 615 DEPT. #HM
GARDEN CITY, L. I., N. Y.

1. Fill in name and address
2. List the features (by code letter only) in their correct respective order.

NAME _____ (please print)

ADDRESS _____

CITY _____ ZONE _____ STATE _____

DEALER'S NAME _____

Note: All contest entries subject to Official Rules

AR^{INC.} *loudspeakers*

USED PROFESSIONALLY as monitors for recording sessions, in broadcast stations and laboratories, with medical test equipment for precise reproduction of heartbeats—applications where only an accurate facsimile of the original sound, without pseudo-hi-fi exaggeration, will serve.



New Orleans recording session with Jim Robinson, Ernie Cognolotti, and Louis Cottrell. Note the AR-3 (one of a stereo pair) being used to monitor playback. Courtesy Riverside Records and HIFI/STEREO REVIEW

RATED #1 FOR HOME USE by half a dozen equipment reviewers. Three consumer magazines have reported on AR loudspeakers; two of them adopted AR speakers as reference standards, and the third gave AR its rarely used top rating.

Priced from \$89 (for an unfinished AR-2) to \$225 (for an AR-3 in oiled walnut, cherry, or teak). A 5-year guarantee on all models covers materials, labor, and reimbursement of any freight to and from the factory. Catalog is available on request.

AR speakers are on permanent demonstration at AR Music Rooms—on the west balcony of Grand Central Terminal in New York City and at 52 Brattle Street in Cambridge, Massachusetts. No sales are made or initiated at these showrooms.

ACOUSTIC RESEARCH, INC., 24 Thorndike Street, Cambridge 41, Massachusetts

CIRCLE 1 ON READER-SERVICE CARD

COMPARE STEREO MULTIPLEX SYSTEMS

FEATURE-FOR-FEATURE * DOLLAR-FOR-DOLLAR
NEW ALTEC STEREO DUET IS YOUR BEST BUY!

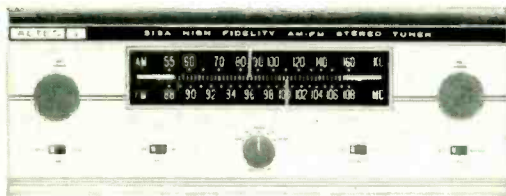

New Altec 313A AM/FM Stereo Tuner

- BUILT-IN MULTIPLEX
- DISTRIBUTED "T" MX-CARRIER (38 KC) FILTER
- FM STEREO, AM/FM STEREO, AM OR FM MONO
- INDIVIDUAL AM AND FM "ELECTRON-RAY" TUNING INDICATORS
- INERTIA-TYPE FLYWHEELS FOR SMOOTH TUNING
- AM LOCAL/DISTANT RECEPTION CONTROL
- FM LOCAL/DISTANT RECEPTION CONTROL
- FM SQUELCH CONTROL FOR SILENT TUNING
- AUTOMATIC FREQUENCY CONTROL FOR POSITIVE STATION-LOCK
- SOFTLY ILLUMINATED TUNING SCALE
- MEETS SCA SUPPRESSION REQUIREMENTS
- MEETS FCC RADIATION REQUIREMENTS
- \$291.00 INCLUDING CABINET



Altec 353A Stereo Amplifier/Preamplifier

- MATRICING NETWORK FOR CENTER STEREO SPEAKER
- CONNECTIONS FOR AUXILIARY SPEAKERS THROUGHOUT HOUSE
- RECORDER OUTPUT FOR PROFESSIONAL-QUALITY RECORDING
- STEREO OR MONO INPUTS FOR AM, FM, MX, TAPE MACHINE, TAPE DECK, TV, MAGNETIC OR CERAMIC PHONO, TWO MICROPHONES
- FULL-SWEEP STEREO BALANCE CONTROL
- STEREO STANDARD/REVERSE CHANNEL SWITCH
- COMPENSATING LOW LEVEL LOUDNESS CONTROL
- STEREO BASS AND TREBLE CONTROLS
- ON/OFF RUMBLE FILTER
- 100 WATTS STEREO PROGRAM PEAK POWER; 50 WATTS RMS CONTINUOUS, STEREO OR MONO
- \$225.00 INCLUDING CABINET

Enjoy balanced stereo with look-alike duet from Altec! The pair is a harmonious stereo system with precise balance of engineering and styling. Price includes self-ventilating matching cabinets in your choice of platinum gold or platinum pink control panels. Compare now at your professional Altec high fidelity consultant's, or write Dept. HD-3

© 1961 Altec Lansing Corp.



ALTEC LANSING CORPORATION

A Subsidiary of Ling-Temco-Vought, Inc.

1515 SOUTH MANCHESTER AVENUE, ANAHEIM, CALIFORNIA

NEW YORK • LOS ANGELES

CIRCLE 4 ON READER-SERVICE CARD

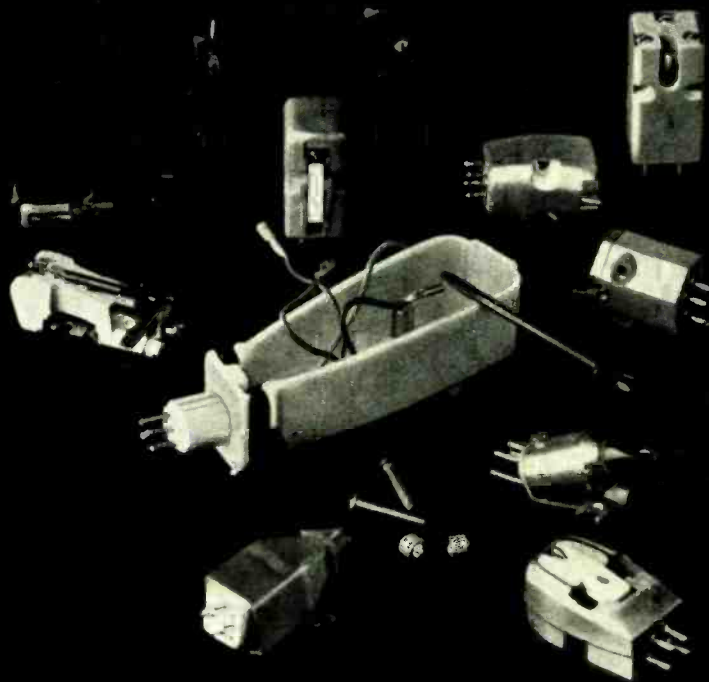

“Which cartridge do you recommend for the Type A?”
 “Can I use the professional models?”

*THE ANSWER IS: Use the cartridge of your choice
 ...any manufacturer, any model!*

The arm on the Type A will bring out the best in any cartridge ... tracking (and tripping) at the lightest pressure specified by the cartridge manufacturer. This includes the professional models, which were developed originally for separately-sold tone arms because of their high compliance. □ Now, Garrard integrates precisely such an arm into the Type A Automatic Turntable. This is a dynamically-balanced, counterweighted arm, designed and built with the same precision, the same balance, the same freedom from friction, the same playback characteristics and low resonance expected in tone arms separately sold, regardless of price. The Type A arm, operating in conjunction

with a weighted, full-size, non-magnetic turntable; a laboratory-balanced, double-shielded motor; and (when you want it) the gentlest automatic record-handling mechanism ever designed; rewards you with the full measure of the magnificent reproduction achieved by any of the latest, finest, stereo cartridges. □ *Extravagant concept, yes...but the price of the Garrard Type A Automatic Turntable is exceedingly modest, only \$79.50.*

For illustrated literature, write Dept. GC-22,
 Garrard Sales Corporation, Port Washington, N. Y.



GARRARD'S LABORATORY SERIES **TYPE A**
AUTOMATIC TURNTABLE

CIRCLE 22 ON READER-SERVICE CARD

The Glories of Late Strauss

THIS issue, with its focus on the music of Richard Strauss, can rightfully be called a labor of love—on the part of Glenn Gould, who took time out from a busy round of concert appearances to write the brilliant and penetrating essay that begins on the next page; of Herbert Glass, who spent hundreds of hours listening afresh to the entire Strauss literature currently available on LP (his discography can be found on page 50); and of the editor, who has been an ardent Straussian ever since he acquired the classic Lehmann-Schumann-Mayr album of *Der Rosenkavalier* back in the dark ages before World War II.

Strauss seems to inspire love—or at least his music does (the man himself, one gathers, was not overwhelmingly lovable). Certainly there has been a clear history of Strauss infatuation in the record industry. How else explain the fact that we have such visionary efforts in the LP catalogue as complete recordings of *Ariadne auf Naxos* and *Die Frau ohne Schatten*, of *Arabella* and *Capriccio*? This is not to imply that these were ventures wholly romantic in conception and impractical in their economics. Perhaps they can all be expected to show a profit, or at least to break even, when the final accounts are totted up. But a hardheaded executive could not reasonably be expected to choose this type of repertoire for a quick and safe return of monies invested. Love obviously entered into the calculations—love and a messianic conviction that the glories of late Strauss should be showered on everybody everywhere and not just on the lucky few who are in a position to attend an occasional festival performance.

But there comes a point when not even the most persuasive lover can hold his own against the cold inexorabilities of dollars and cents. Excursions into the lesser-known operas of Strauss's old age are

hard to promote at a time, like the present, of spiraling costs and squeezed profits. Even though a recording director might be utterly convinced that *Die schweigsame Frau* belongs among Strauss's masterworks (and we would be the first to go along with this view), he would nevertheless be hard put to justify its inclusion in a recording program today. It is difficult enough even to make *La Bohème* show a profit these days.

But somehow or other *Die schweigsame Frau* must be put on records—and *Daphne*, *Die Liebe der Danae*, *Intermezzo*, and all the others. We have a suggestion for accomplishing this seemingly impractical desideratum. These works are performed regularly every summer, and with very superior casts, at the Munich Festival. Surely, an enterprising record company could set up microphones in the opera house, tape all the rehearsals and performances of a given opera, and from this material put together a composite recording that would do splendid justice to the music. London Records was extremely successful with its actual-performance tapings at Bayreuth a few years ago. Now we learn that Philips has also gone to Bayreuth for the same sort of undertaking (see Kurt Blaukopf's "Notes from Abroad" on page 26). If it works for Wagner at Bayreuth, why not for Strauss at Munich?

It is quite true, of course, that an actual-performance taping will not embody all the ingenious sonic effects of a thoroughly planned studio recording. There may be an occasional cough from the audience and a scuffle of footsteps on stage. Horrors, there might even be an occasional imperfect note from one of the singers. Speaking for ourselves, we wouldn't mind in the least. To enjoy *Die schweigsame Frau* in one's living room is worth enduring a few coughs from Munich.

ROLAND GELATT

AS high fidelity SEES IT



"I believe, quite simply, that Strauss was the greatest musical figure who has lived in this century."

GLENN GOULD

AN ARGUMENT FOR
Richard Strauss

by Glenn Gould

A FRIEND OF MINE once remarked that there was probably a moment in every budding musician's teen-age when *Ein Heldenleben* might suddenly appear the work most likely to incorporate all of the doubts, and stresses, and the hoped-for triumphs of youth. He was only half-serious, I suppose, but I think he was also half-right; and, although he didn't intend it disparagingly, his remark did suggest the assumption that if one could grow naturally into a sympathy with the flamboyant extroversion of the young Richard Strauss, so one could be expected, with maturity, to grow just as naturally out of it. My own *Heldenleben* period began, courtesy of Willem Mengelberg, when I was seventeen, but—although I have now patiently waited twelve years—I have never grown out of it. And though it may well be a damning commentary on the waywardness of my own maturing, I rather doubt now if I ever shall!

So it is not easy for me to write objectively about Richard Strauss, although I intend to try to do so, however, because I write from a position of high prejudice: I believe, quite simply, that Strauss was the greatest musical figure who has lived in this century. This is not a very welcome view today because, although Strauss does not really need anyone to extol his merits to the world, his reputation has perhaps suffered more unjustly with the passing years than that of any other musician of our time. At first glance, this may appear a rather surprising statement, since Strauss has never been more frequently or devotedly favored in performance than at present, but I am referring now not to those Teutonic lions of the podium who nightly soar from our midst to be with Zarathustra on his mountaintop, nor do I speak of those artful tigresses of the operatic stage for whom no

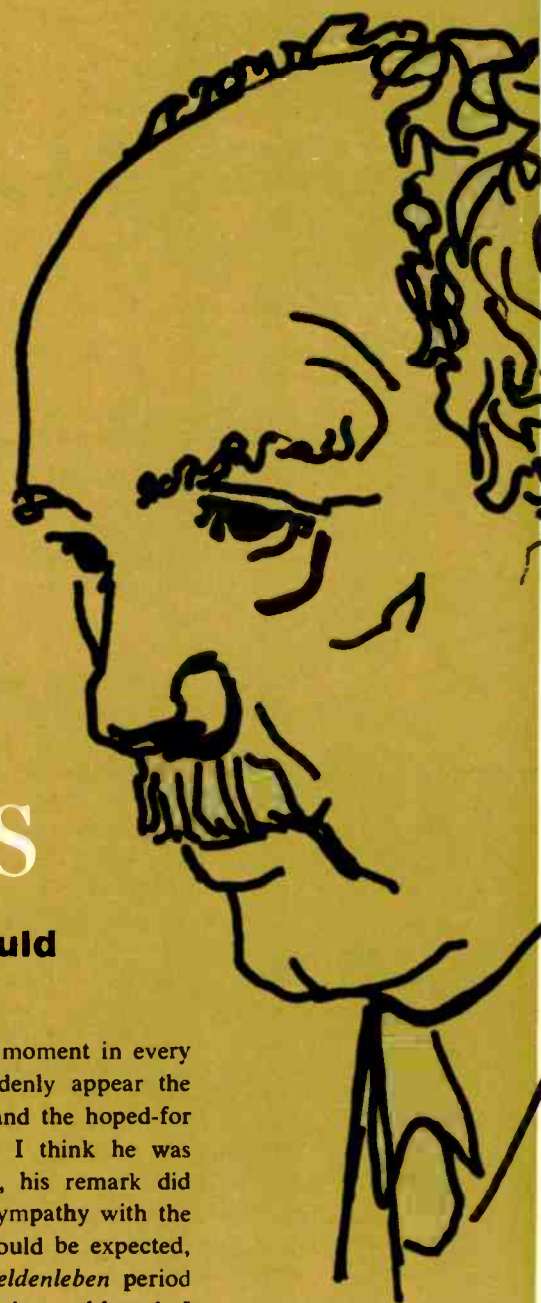



Notes on an enduring passion from a celebrated young pianist

greater challenge nor surer success exists than that which Chrysothemis or the Marschallin assures. I refer, rather, to those cunning currents of fancy which, as they sweep to command the tide of musical taste, make haste to consign old Strauss to the graveyard for romantics, pronouncing him a great nineteenth-century character who had the audacity to live fifty years into the twentieth.

The longevity of Strauss's creative life is pretty staggering, of course—at least sixty-nine years if one reckons his adolescent works as the astonishing creations they really are, or in other words a span equal to the total lifetimes of two Mozarts (if you have a head for that sort of thing). Now, obviously, the length of Strauss's creative life is not important of itself—many composers plan to live to 106, while I myself aim to withdraw into a graceful autumnal senility at thirty—yet the longevity of a creative life is a justifiable yardstick within the extent that it measures, and can be measured by, the development of the composer as a human being.

It is the view shaped by the taste makers of the musical profession that Strauss's evolution as a musician was not consistent with the length of his years. They seem to feel that his development was arrested somewhere within the first decade of this century. They do not always deny him the achievement of his early works: some of them can even whistle a few tunes from the tone poems, and many will admit the dramatic values of his first great operatic successes—the charm and gallantry of *Rosenkavalier*, the strangling impact of *Elektra*. But most of them seem to think that having made himself for twenty-five years or so a bulwark of the *avant-garde*, Strauss in his mid-forties lapsed into a drought of inspiration which was terminated only by death.

Is it a curious accident, I wonder, that the point in Strauss's career at which, with the precision of hindsight, he is presumed to have gone astray is more or less concurrent with the beginning of the most significant musical revolution (or if you prefer, reformation) of modern times, the development of the musical language without tonality? Or is it just coincidence that even well-informed opinion sees Strauss as having reached the climax of his career, just prior to those years in which other composers first broke through the sonic barriers of tonal harmony and that when he appeared to reject the new aesthetic the taste makers and the pace setters would see him only as a man wistfully attempting to recapitulate the achievements of his youth?

The generation, or rather the generations, that have grown up since the early years of this century have considered the most serious of Strauss's errors to be his failure to share actively in the technical advances of his time. They hold that, having once evolved a uniquely identifiable means of expression and having expressed himself within it at first with all the joys of high adventure, he had thereafter, from the technical point of view, appeared to remain stationary—



Bettmann Archive

Composer of the tone poems.

RICHARD STRAUSS

simply saying again and again that which in the energetic days of his youth he had said with so much greater strength and clarity. For these critics it is inconceivable that a man of such gifts would not wish to participate in the expansion of the musical language, that a man who had the good fortune to be writing masterpieces in the days of Brahms and Bruckner and the luck to live beyond Webern into the age of Boulez and Stockhausen, should not want to search out his own place in the great adventure of musical evolution. What must one do to convince such folk that art is not technology, that the difference between a Richard Strauss and a Karl-Heinz Stockhausen is not comparable to the difference between a humble office adding machine and an I. B. M. computer?

Richard Strauss, then, seems to me to be more than the greatest man of music of our time. He is in my opinion a central figure in today's most crucial dilemma of aesthetic morality—the hopeless confusion that arises when we attempt to contain the inscrutable pressures of self-guiding artistic destiny within the neat, historical summation of collective chronology. He is much more than a convenient rallying point for conservative opinion. In him we have one of those rare, intense figures in whom the whole process of historical evolution is defied.

THROUGHOUT those seven working decades the most striking common feature of Strauss's work is the extraordinary consistency of his vocabulary. One can compare, to take virtually the extreme instance, his Symphony, Op. 12, written when he was eighteen, and the *Metamorphosen* for string orchestra, written

at the age of eighty-one, and one will have to admit that neither contains any harmonic progression which would have been necessarily unavailable to the other. Basically, both use a harmonic language available to Brahms, or to Hugo Wolf, or, minus his sequences, to Bruckner; both use a contrapuntal style which, although more in evidence in the later work, is still primarily founded upon the belief that, however many contrarities it may provoke, its fundamental duty is to substantiate the harmonic motion and not to contradict it. And yet for all these similarities the *Metamorphosen* conveys the impression of an altogether different harmonic and contrapuntal scope than the Symphony, and both suggest a unique identity which could not possibly be confused with any earlier master. While there are pages in the teen-age works of Strauss (the first horn concerto, for instance) which, at a diagrammatic harmonic level, could easily have been written by Mendelssohn, or even, surprisingly, by Weber, one needs only a few seconds to realize that here, for all of the influence of the early romantic masters, is a wholly original technique.

Although he reached adolescence at a time when Wagner had anticipated the dissolution of the tonal language and had stretched the cognizance of harmonic psychology to a point that some regarded as the very limit of human endurance, Strauss perhaps was more concerned than any other composer of his generation with utilizing the fullest riches of late-romantic tonality *within* the firmest possible formal disciplines. With Strauss it was not simply a question of compensating for the overrich harmonic ambiguities of his era (as was the case with the intense motivic concentration of the young Arnold Schoenberg); rather, his interest was primarily the preservation of the *total* function of tonality—not simply in a work's fundamental outline, but even in its most specific minutiae of design. Consequently, when one compares any of Strauss's early orchestral scores with, say, a tone poem by Liszt, one is immediately struck with the fact that while Strauss's works are comprised of infinitely greater daring in terms of sheer extravagance of harmonic imagination, they are, nevertheless, painstakingly explicit at every level of their architectural concept, and thus present an impression of a harmonic language at once more varied and more lucid. With this immense harmonic resource laboring within what is frequently an almost rococo sense of line and ornamentation, Strauss is able to produce by the simplest and almost deceptively familiar means an overpowering emotional effect. Who else is able to make the bland orthodoxies of a cadential six-four seem a wholly delectable extravagance?

Rarely among the German romantics is there writing that matches the glorious harmonic infallibility of the young Strauss. Among his predecessors only Mendelssohn and Brahms in their best pages were as conscious of the need to strengthen the vagrant structures of romantic tonality through the emphatic control and direction of the harmonic

bass. One would almost suspect that Strauss conceived of the cellos and basses with his feet (as an organist might do), for at every moment—regardless of the breadth of the score, regardless of its metric complexities, regardless of the kaleidoscopic cross reference of chromatic tonality—the bass line remains as firm, as secure a counterpoise as in the works of Bach or of Palestrina.

It must not be supposed that striving in this way for the ultimate accentuation of linear clarity led Strauss into the contrapuntist's concern for a linear texture which accords to each voice its own independent existence. Strauss was by no means a composer who practiced counterpoint per se. In his music the absolute contrapuntal forms—the fugue, the canon, etc.—appear primarily in the operas (and even there, infrequently) and are almost without exception the occasion for a self-conscious underlining of the libretto. Such occasions are, from a purely academic point of view, quite beyond criticism, but one always has the feeling that Strauss is saying "Look, see, I can do it, too!" and that he regards such diversions simply as a means to enliven an otherwise static situation on the stage; and yet although in the vast body of Strauss's work there are few examples of the sort of contrapuntal devices which most other twentieth-century composers, in their search for motivic interrelation, have used constantly, it cannot be overemphasized that Strauss, on his own terms, was among the most contrapuntal-minded of composers.

The fundamental strength of Strauss's counterpoint does not lie in his ability to provide an

autonomous existence for each voice within the symmetric structure—his whole symphonic orientation is too thoroughly nineteenth-century to make this either possible or, to his mind, I suppose, desirable. Rather, it lies in his ability to create a sense of poetic relation between the soaring, dexterous soprano melodies, the firm, reflective, always cadential-minded basses and, most important of all, the superbly filigreed texture of his inner voices. There are many more contradictory stresses in the linear designs of Strauss than in Wagner, for instance, whose accumulations of density tend to have perhaps more single-mindedness, more uniformity of stress and relaxation than do those of Strauss; but by the very mixture of this finely chiseled contrapuntal style and this vastly complex harmonic language, Strauss's climaxes, his moments of tension and of repose, are—if less overwhelming than those of Wagner—ininitely more indicative of the complex realities of art.

When he came under Wagner's influence, Strauss inherited the problem of translating the dramatic possibilities of the former's harmonic freedom into the realm of symphonic music; for Strauss not only began his career as a symphonist (indeed, at first, a symphonist of a particularly strait-laced order), but was, with all his sovereign mastery of the stage, a man who always thought primarily in symphonic terms. The problem of developing a musical architecture that would relate somehow to the extravagance of a richly chromatic tonality and would make use of all the ambiguities contained therein was, of course, the primary problem for all the composers of Strauss's generation. It was simply unsatisfactory to shape symphonic creations within the mold of the classical sonata structures with all the implied tonal plateaus which tradition begged if one wanted to use material chosen less for its thematic profile than for its genetical probabilities. (The problem was certainly less serious for Strauss than it was for Schoenberg, who seems always to have had a more relentless determination to exhaust all motivic permutations.)

The young Strauss sought a solution in the symphonic poem, in which the logic of the musical contours would stand in supposed relation to a predetermined plot exposition that could suggest the texture, the duration, and tonal plateaus of each episode. It was at best a half-way logic, for most listeners are almost certainly little aware of the legal embarrassments of *Till Eulenspiegel* or the philosophic posings of *Zarathustra* and likely care even less. Probably they recognize, or try to, those correspondences with the purely symphonic structures which Strauss sought to supplant. What is more to the point about the tone poem logic is that in Strauss's mind it provided a sense of architectural cohesion which might not need to be externally observed. Thus an entirely musical logic, which was always present, was simply reinforced at conception by a pseudodramatic one that having fulfilled its role, could easily be

Continued on page 110

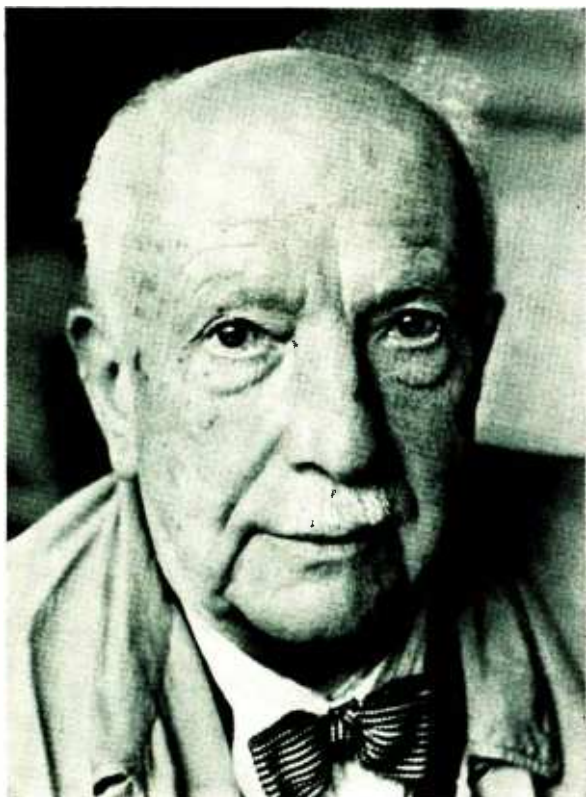

The hero of Ein Heldenleben sublimated.



Richard Strauss

ON MICROGROOVE by Herbert Glass

THE CASE for Richard Strauss is put very persuasively by Glenn Gould elsewhere in this issue, and further prefatory remarks here on Strauss's claim to immortality would be superfluous. But a few words of discographic comment are perhaps in order. Taking all things into consideration, Strauss has been treated handsomely by the record makers. Despite a few conspicuous deletions—the composer-conducted *Don Quixote*, the *Sinfonia domestica* (of which four LP versions were once listed in the catalogue), the Toscanini *Don Juan*—Strauss's current representation on records is impressive. Moreover, the recorded documentation has not stopped at the tried-and-true favorites of the pre-World War I epoch but has extended far into the composer's later production. Much of the music which we lump together under the rubric "late Strauss" is intimate in spirit, recondite in style, ultrarefined in musical vocabulary. These are works conceived for small performing ensembles and small halls, and as such they are ideally suited to the ambience of home listening. *Don Juan* and *Till Eulenspiegel* have found their home in the concert hall, but *Ariadne* and *Metamorphosen* have found a home primarily in our living rooms—and extremely fortunate we are to have them there too. Herewith a guide to the Strauss repertory currently available on microgroove. R.G.

Early Instrumental Compositions

It is convenient to place most of Strauss's works antedating 1888, the year of *Don Juan*, under this single heading. I do not mean to suggest thereby that the music is totally devoid of interest, but it must be admitted that the composer's early education, partially gained from his horn-player father, was conservative, and the conservatism of taste which resulted is mirrored in the music Strauss wrote during his late teens and early twenties. Mendelssohn is a primary influence in these exercises, with Schubert, Chopin, Schumann,

and Brahms often lurking in the background.

Hans von Bülow considered the Op. 3 Piano Pieces (1881) to be the work "of a talent of the kind that requires sixty to make a bushel," and the Piano Sonata, dating from the same year, is impregnated with Mendelssohn and Schumann. The latter work emerges, however, as pleasant, at times even exciting, eclecticism. Alfred Brendel treats the Sonata with his customary attention to detail and strong propulsion.

With the Serenade, Op. 7, also 1881, Bülow did a quick about-face, praising Strauss's work to the

skies and eventually performing it with the Meiningen Orchestra, of which Strauss was later to become second conductor. The Serenade, although thematically rather undistinguished, shows the composer so firmly in command of the materials of his trade that we can understand Bülow's enthusiasm. In it we find some typically Schubertian turns of phrase grafted onto a Mozartean conception of the wind serenade. Eric Simon leads his splendid group in a lyrical and affectionate reading. Frederick Fennell and his hardly less accomplished ensemble are neither as vital nor as well recorded.

The Cello Sonata (1883) is a charming old-fashioned piece which introduces little that is not said more forcefully in the earlier compositions or in the later Violin Sonata. Carl Stern and Perry O'Neill, both expert performers, make as much of the work as is possible.

The Symphony in F minor (1884), admired by both Bülow and Brahms, is not likely to come as a revelation to those in search of neglected masterpieces by the masters. Its thematic materials are slender, but assembled with remarkable skill. Wagner and Liszt begin to make their presences felt in Strauss's music through this symphony, particularly as regards the cyclical form which was to become such a vital ingredient of the symphonic poems. The performance, by the Vienna Philharmonia under Herbert Häfner, seems adequate.

The Sonata for Violin and Piano (1887) remains among the best known and most frequently performed of Strauss's early instrumental efforts. Written simultaneously with the first draft of *Macbeth*, the Sonata is ardent and attractive, partaking as it does of the lyricism of Chopin and Schumann in addition to featuring a slow movement which could only have been produced by the Strauss of the early Lieder. Leonid Kogan and Andrei Mitnik are, as is their wont, superb executants.

—Five Piano Pieces, Op. 3; Sonata for Piano, in B minor. Op. 5. Brendel, piano. SPA 48, LP.

—Serenade for Winds, in E flat, Op. 7. Boston Ensemble, Simon, cond. (with Sonatina and, on SD only, Gavotte from Op. 4). Boston B 406, LP; EST 1016, SD. Eastman Wind Ensemble, Fennell, cond. Mercury MG 50173, LP; SR 90173, SD.

—Sonata for Cello and Piano, in F, Op. 6. Stern, cello; O'Neill, piano. SPA 8, LP.

—Symphony in F minor, Op. 12. Vienna Philharmonia Orchestra, Häfner, cond. SPA 17, LP.

—Sonata for Violin and Piano, in E flat, Op. 18. Kogan, violin; Mitnik, piano. MK-Artia 1561, LP.

Works for Solo Instrument and Orchestra

Burleske (1885)

The clever and diverting *Burleske* is still a favorite piano showpiece. Reminiscent of Brahms at times, the piece also looks ahead to the sentimental waltzery of *Rosenkavalier*. Its tremendous technical difficulties are made to seem like child's play by both Rudolf Serkin

and Margrit Weber. The latter approaches the work in a light spirit, with a crisp attack, which is seconded by conductor Ferenc Fricsay. This reading is impressive enough, but it lacks the hearty ebullience provided by Serkin and Eugene Ormandy. Serkin alternately crashes and caresses his way through the music, making the most of its shifting moods. His interpretation is less refined, more spectacular, and certainly more entertaining than the competitive version.

—Serkin, piano; Philadelphia Orchestra, Ormandy, cond. Columbia ML 5168, LP.

—Weber, piano; Berlin Radio Symphony, Fricsay, cond. Decca DL 9900, LP.

Parergon to the Sinfonia Domestica, Op. 73 (1925)

In response to a commission from Paul Wittgenstein for a concerto for piano, left hand, and orchestra, Strauss reworked themes from his *Sinfonia domestica* (1903)—of which not a single recording out of a onetime total of four remains in the catalogue—to form a separate and, by and large, original composition. The *Parergon*, or "supplement," solves certain obvious problems of writing for left hand alone with large orchestra, but the work as a whole is noisy claptrap. Wittgenstein struggles mightily, and with only moderate success.

—Wittgenstein, piano; Boston Records Orchestra, Simon, cond. Boston B 412, LP; BST 412, SD.

Concertos for Horn and Orchestra: No. 1, in E flat, Op. 11 (1884); No. 2, in E flat (1942)

The two Horn Concertos, although written nearly sixty years apart, are alike in their unflagging verve and in the magical manner by which Strauss has allowed the solo instrument to shine forth in all its splendor without slighting the orchestra. It should be a matter of course to prefer the later work, but I must confess that I consider the two concertos as equally interesting. No. 1 is once more reliant on Mendelssohn, but there are many original touches, notably that delicious dialogue between horn and flute in the final movement.

The Second Concerto is in the more reserved, economical style of Strauss's last years. Horn passages from *Capriccio* and the *Four Last Songs* are immediately brought to mind. In the later work, the horn is somewhat less in the foreground than it was in its predecessor, blending its rolling, chromatic passages to a greater extent with the rich,

but never overscored, orchestra. Humor abounds, as does a gentle melancholy.

There is not much left to say about the manner in which the late Dennis Brain plays these works. Beauty of tone, complete technical facility, and humor—the commonplaces of this artist's lexicon—are here in superabundance. Wolfgang Sawallisch, the Philharmonia, and Angel's engineers are perfect collaborators.

—Brain, French horn; Philharmonia Orchestra, Sawallisch, cond. Angel 35496, LP.

Symphonic Poems

Don Juan, Op. 20 (1888)

I know of no other orchestral staple which has received as many effective recorded interpretations as Strauss's first orchestral masterpiece. The score is so infallibly designed to flatter a conductor's abilities that a poor performance might almost be considered a freakish occurrence. Although different conductors have differing ideas about tempos and dynamics in regard to *Don Juan*, many versions share certain obvious characteristics; for this reason, I shall attempt to group the profusion of recordings according to certain general characteristics.

First there are the Dons of speed, sinew, and toughness: George Szell, Antal Dorati, Fritz Reiner, and Leopold Stokowski. Szell's is the fastest, and it is exciting, albeit insufficiently pliant. Dorati keeps things less rambunctious, eschewing extremes of velocity and dynamics to produce a most satisfying interpretation, which would, however, have benefited from more distant miking. Stokowski's Don dashes into the pursuit of his ideal woman with boundless energy and a good deal less constriction than Szell's. The whole is magnificently hearty and convincing, while the recording, particularly in the widely separated stereo edition, is big, boomy, and distant. It is difficult for Reiner to be a less than efficient interpreter of Strauss, but in this version I feel that he is merely putting a gloss to something in which he is no longer deeply interested.

Wilhelm Furtwängler, Bruno Walter, and William Steinberg represent the old German tradition of *Don Juan*. Their readings are comparatively slow, nobly impassioned, and Wagnerian.

My personal favorites are the versions by Clemens Krauss, Alceo Galliera, and Herbert von Karajan. Krauss's Don is unique. This great Straussian views the score in terms of grandiose chamber music. Tem-

pos are quite fast, even in the most honeyed sections, but the conductor's perfect organization precludes any sense of undue rush. This Don is of a piece; Krauss melts—not smears—one segment into another. He is at the same time both the least sentimental and least bombastic of interpreters. The Vienna Philharmonic responds to his direction with a sturdy delicacy, producing a sound as unlike that of other orchestras as Krauss is unlike other conductors in his approach to the music. The twelve-year-old recording is still acceptable, although the volume level is rather low.

Galliera's treatment is perhaps the most exquisitely suave and sensuous the Don has ever received, a quality heightened by the ineffable cushiness of tone produced by the Philharmonia. Although his rather fast interpretation may not suit all tastes, I find that it wears remarkably well. The recording, mono and stereo, is rich and sharply defined.

Karajan gives us a more sumptuous Don than Krauss. In certain respects this is an interpretation as sophisticated as Galliera's, but less romantic. Tempo contrasts are, as in the Krauss, moderate. There isn't a trace of fuss and bother here. Karajan attacks the music with keen forward motion, avoiding neither excitement nor brilliance en route. London's engineering is dazzling, with the stereo version being but slightly superior to the monophonic edition.

—Vienna Philharmonic, Krauss, cond. (with *Till Eulenspiegel*). Richmond B 19043, LP.

—Philharmonia Orchestra, Galliera, cond. Angel 35784, LP; S 35784, SD.

—Vienna Philharmonic, Karajan, cond. London CM 9278, LP; CS 6209, SD.

—Vienna Philharmonic, Furtwängler, cond. (with *Till Eulenspiegel*). Electrola E 90093, LP.

—New York Philharmonic, Walter, cond. (with *Tod und Verklärung*). Columbia ML 5338, LP.

—Philharmonia Orchestra, Steinberg, cond. (with *Rosenkavalier Suite*). Capitol P 8423, LP; SP 8423, SD.

—Minneapolis Symphony, Dorati, cond. (with *Tod und Verklärung*). Mercury MG 50202, LP; SP 90202, SD.

—Stadium Symphony of New York, Stokowski, cond. (with *Till Eulenspiegel* and *Salomes Tanz*). Everett LPBR 6023, LP; SDBR 3023, SD.

—Cleveland Orchestra, Szell, cond. (with *Tod und Verklärung* and *Till Eulenspiegel*). Epic LC 3439, LP; BC 1011, SD.

—Chicago Symphony, Reiner, cond. RCA Victor LM 2463, LP; LSC 2463, SD.

Tod und Verklärung, Op. 24 (1889)

Strauss's third symphonic poem, *Death and Transfiguration*, was the delight of late-nineteenth-century audiences, surpassing even *Don Juan* in frequency of presentation. Audiences were supplied with an accompanying text (written by Alexander Ritter after Strauss had completed his score) describing the final agonies of an old man, lying on a (figurative) bed of nails constructed by the heartless craftsmen of this purblind world. He relives his past, part of it happy; then commences his losing battle with a burly Angel of Death. Release—i.e., "transfiguration"—is his final reward. Tovey, in a classic understatement, tells us that the intentions of music and poem are "sublime."

Strauss may well have thought that Ritter's programmatic poem was taking his title just a bit too far; but he did concede that somewhat the same ideas had inspired him to write the music. At any rate, *D & T* has managed to hold a place in the modern repertory in spite of the *passé* literary window-dressing.

Poor performances of *D & T* are hardly any more common than with *Don Juan*. The work is set out in simpler fashion than its illustrious predecessor; and beside its successor, *Till Eulenspiegel*, seems virtually archaic in the degree of restraint Strauss has placed on his passion for polyphony. It might be interesting for listeners to compare this work to Liszt's *Tasso*, which it clearly imitates.

Each of the available recordings presents a straightforward exposition of the music. Differences in tempo are slight, although there is some diversity in the various conductors' methods of contrasting sections connotating "mood," conflict, and transfiguration. I can find no fault with versions by such experienced and perceptive Straussians as Karajan, Reiner, Artur Rodzinski, Szell, Toscanini, and Walter. All are appropriately moody, dramatic, and romantic. A choice must therefore be made on the basis of extramusical considerations, as reproduction and coupling. I have chosen the Rodzinski for my own collection. To my mind it represents an ideal confluence of solid performance, fine sonics, and offbeat coupling.

—Philharmonia Orchestra, Rodzinski, cond. (with *Dance Suite After Couperin* and *Salomes Tanz*). Capitol G 7147, LP; SG 7147, SD.

—NBC Symphony, Toscanini, cond. (with *Till Eulenspiegel*). RCA Victor LM 1891, LP.

—New York Philharmonic, Walter, cond. (with *Don Juan*). Columbia ML 5338, LP.

—Vienna Philharmonic, Karajan, cond. (with *Till Eulenspiegel* and *Salomes Tanz*). London CM 9280, LP; CS 6211, SD.

—Vienna Philharmonic, Reiner, cond. (with *Till Eulenspiegel*). RCA Victor LM 2077, LP; LSC 2077, SD.

—Cleveland Orchestra, Szell, cond. (with *Don Juan* and *Till Eulenspiegel*). Epic LC 3439, LP; BC 1011, SD.

Till Eulenspiegel, Op. 28 (1895)

The problems inherent in the nature of program music clearly present themselves when we attempt to discuss *Till*, the only Strauss symphonic poem to have retained a popularity comparable to that of *Don Juan*. No detailed summary of extramusical images accompanies the work, but the title does conjure up a familiar figure. Given the complete title, *Till Eulenspiegels lustige Streiche* ("merry pranks"), our imagination is given free rein to construct the precise nature of these pranks. The information given to us by the composer is restricted to identifying the two motives associated with Till himself.

To choose one "best" from among so many recorded versions of a work which (like *Don Juan* and, to a lesser extent, *Death and Transfiguration*) poses so few problems to an experienced conductor at the head of a good orchestra is a virtually hopeless task. Reiner, Karajan, Krauss, Toscanini, and Furtwängler are the conductors who have probably given the greatest attention to this work, and all are able to project it with a maximum blending of discipline and humor. Each prefers sanity and charm to the kind of frenzy and rigorously masking as ebullience and clarity to be found in the Leinsdorf and Dorati recordings. The conductors grouped together above go along with Strauss in his affection for the central character; the other gentlemen imply, to my mind, censure.

Krauss is as persuasive here as in *Don Juan*, bringing us the ultimate in clarity, warmth, and humor. His Till is a charmingly ubiquitous rascal, making his effects with a hotfoot rather than a conflagration. Krauss's companions in the aforementioned group give us a more succulent, dramatic portrayal; but each manages to keep sight of the whimsical nature of the piece. I have disclosed a prejudice for the Krauss here, although I would not dissuade the prospective purchaser from considering the several other excellent choices. A two-Till collection—Krauss or another of the fine monos, plus Reiner or Karajan in stereo *Continued on page 115*

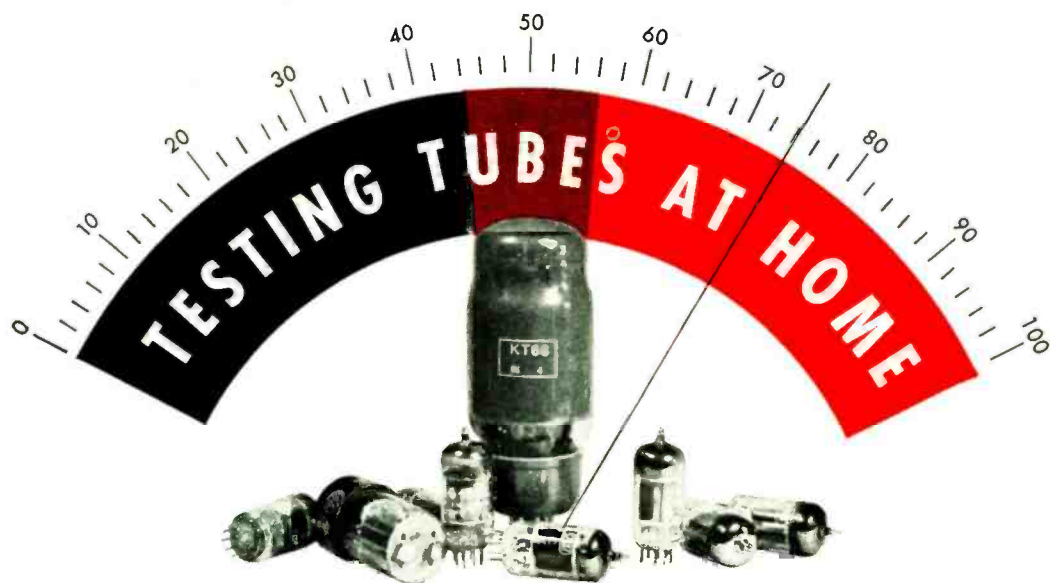

Your household may well employ fifty to one hundred vacuum tubes in various electronic installations. If so, consider the merits of owning a tube tester.

by Lewis A. Harlow

MOST OWNERS of home music systems are quick to learn that tube failure is more common than all other electronic troubles combined; and having made this discovery, they hasten to act upon it whenever a piece of equipment seems defective. The usual procedure is to remove all the tubes, stuff them unprotected into a paper bag, and take them to an electronics service shop to be tested. Some people take them along to a drug store or supermarket and do their own testing.

This practice is inconvenient—and as a system increases in elaborateness, you will find it becoming more so. If your household now includes the means for playing records, a tape recorder, an FM tuner, a television set, and a table radio or two, you actually face a maintenance problem on fifty to a hundred tubes. More important than the inconvenience of indiscriminate removal of tubes for remote testing, however, is the fact that it is unscientific, inefficient—and sometimes damaging. Some years ago, no less an authority than Bell Telephone discontinued the practice of periodic testing of all tubes as a routine step in the Bell program of preventive maintenance. It was found that the promiscuous handling of tubes for the routine test caused nearly as much fresh damage as may have been already present.

The solution to the problem is to test your tubes at home. In the first place, many tube problems do not become noticeable until a tube is thoroughly

warmed up, and this can mean waiting four or five minutes per tube—all the time watching the meter on the tester for evidence in the form of unpredictable needle movement. This slow procedure is hardly feasible in the supermarket or drug store, and a service shop cannot afford to spend so much time on a job from which the only tangible profit may be the sale of a single tube. At home, too, it is possible to remove tubes one at a time, replacing each one before taking out the next. Furthermore, tubes can be removed from the chassis in the order in which they are suspect. The offender is usually found before a third of the tubes have been handled, and the others need not be disturbed. Those tubes most likely to give trouble will be discussed below.

To test tubes at home you will need, of course, a tube tester. Compared with your present investment in sound-reproducing gear, cost of such an instrument will be relatively little. If you're fairly adroit with screw driver and soldering iron, you can buy a suitable tube tester in kit form for less than \$40. If you prefer a factory-wired tester, you should be prepared to pay up to about twice this figure.

As to type, what you want is the reliable old emission tester (the purists call it a tube checker rather than tester), and you should be sure that your choice has the standard row of ten toggle switches across the panel. Even if price is no object, avoid the temptation to buy the more elaborate transcon-

ductance type of tester. This can carry a price tag as high as \$500, and while it is an extremely useful instrument to the professional, its answers—to the layman—may be more confusing than enlightening. Also to be avoided in a tube tester for use at home is the automated type, in which a great multiplicity of tube sockets and other timesaving devices take the place of the trusty toggle switches. In your own listening room you can afford to be leisurely, and the automatic answers from automatic testers are often so arbitrary and concise that valuable information from the test may be overlooked. Again, this is an instrument for the professional.

In addition to the tube tester, you may want a couple of extremely convenient (and happily inexpensive) luxuries: one is a pair of dielike pin straighteners for 7-prong and 9-prong miniature tubes; the other a suction-type tube puller for getting tubes in and out of tight places on the chassis.

For the rest, the *sine qua non* is the technical literature that will provide you with the knowledge as to what basic function a given tube performs. It is this information that enables you to judge which tubes should be tested first and that obviates unnecessary testing. (In general, the first tubes to suspect are physically the largest: they are doing the hardest work, and are designed to maximum size—and glass—for the needed heat dissipation.) The most important source of such information is the literature supplied by the manufacturer of your equipment. Here you will learn, for instance, the all-important facts that your 5V4G is a power supply rectifier, that your EL34 is an output tube, and so on. Another useful handbook for identifying the basic function of a tube is the *RCA Receiving Tube Manual*; having located the listing of your tube by its number, you need only to read the first sentence of the descriptive text to find the information you need.

With your equipment at hand and some knowledge of the functioning of various tubes, you are ready to proceed—with only one general word of caution: follow *exactly* the instructions that come with your tester. Actually, you are seeking answers to four quite unrelated questions.

1. Does the tube light, or doesn't it? This is the first question, and the answer is quickly arrived at. If "no," your problem is solved; all you need is to buy a replacement tube.

2. Is there a sagging element in the tube which is leaning against (and shorting to) another element? Often a considerable warm-up period is needed to reveal this source of difficulty. The process can be expedited, however, by tapping the tube with a finger during the test.

3. Has one of the tube elements become disconnected from its base prong? This may be an elusive trouble. The time to look for it is during the part of the test when you are measuring the fatigue of the tube. Watch the meter very carefully as you release the toggle switches one at a time. If the release of a switch produces no needle change at all, the tube should be considered suspect and is best replaced.

4. How "tired" is the tube? This is the conventional "good-questionable-bad" test that too frequently gives a misleading answer. A tube that tests "bad" should definitely be replaced. A tube that tests "good" can in fact be completely inoperative, due to faults 2 or 3. A tube that tests "questionable" might be inoperative as an oscillator, though as a cathode follower it might give additional months of excellent service. Again, it becomes very important to know what function the tube is expected to perform. Unless identifiable symptoms point to other tubes, test tubes in the following order:

POWER SUPPLY RECTIFIER: this will be the largest or next to largest tube on the chassis. It is the hardest working and should be the most suspect. It is actually two tubes in one, and the two halves should perform—and test—alike. If either half approaches "questionable," replace the tube.

POWER OUTPUT TUBES: in most monophonic high-fidelity amplifiers, there will be a pair of them; in a stereo amplifier, there will be two pairs (one pair for each channel). Power output tubes generally are exceeded in size, if at all, only by the power supply rectifier. If one of a pair is "bad" or "questionable," the pair should be replaced. (More later about matched pairs of power output tubes.)

OSCILLATOR OR MIXER TUBES (in tuners): short of actual performance in the circuit, no test of an oscillator tube is entirely satisfactory. Replace if the test shows "questionable" (or, in fact, anything short of very good). A symptom of a bad oscillator is complete failure over even part of the tuning dial.

PREAMPLIFIER TUBE: this tube is important in the phonograph or tape head function of your amplifier. It should be suspect if phono or tape reproduction is faulty at the same time that the signal from a tuner or tape recorder with its own preamp comes through as it should. A preamp tube is not especially hard-working, but its location in the circuit is such that its slightest fault will be greatly amplified as the signal travels through to the speaker.

ALL OTHER TUBES: this group includes such services as RF Amp, IF Amp, AF Amp, Limiter, Discriminator, Cathode Follower, Tone Control, Tuning Eye, etc. The service in these categories is not exacting. Tubes which test "questionable" may still be performing satisfactorily. Trouble may exist in this group, but most cases of tube failure lie in the groups already described.

Swapping and Matching

Many tuners and amplifiers include as many as four identical tubes for use in different parts of the circuit, and it may be possible to interchange a suspected preamp or oscillator tube with an identical counterpart, say, the IF amp or limiter stage. Often, the offending tube will then continue to give excellent service in the less exacting job.

Many power amplifiers are designed to use output tubes in factory-matched pairs. Thus, if one of the tubes in such a pair becomes defective, both tubes should be replaced with a

Continued on page 111



Dietrich Fischer-Dieskau

A BIEDERMEIER MAN IN WEST BERLIN

A magnificent voice and an old-fashioned dedication to the homely virtues combine to produce today's foremost interpreter of German song.

BY PETER HEYWORTH

NO ONE now believes in the bitch goddess of progress: her altar lies deserted and untended. Still, it is unnerving to watch some art or skill, hard-won by previous generations, decline before your eyes. Singers like Elena Gerhardt considered Lieder singing a calling in itself. Even when they combined it with work in opera they took measure of the technical accomplishment, artistic insight, and painstaking preparation it calls for. In our time most singers appear to regard it as a means of earning a little pin money in their declining years. At the height of their powers, as they rush from Salome at the Scala to Elektra at the Met and back again for Sieglinde at Bayreuth, how should they draw breath for a Lieder recital? And were they to squeeze one in, how should they prepare themselves for this

most demanding of vocal arts? The answer is that precious few of them do so.

I am not old enough to remember the great Lieder singers of the years between the two wars. But I heard Elisabeth Schumann at the end of her career communicate worlds of feeling with a mere thread of a voice. And I have been to lectures by Elena Gerhardt and Lotte Lehmann, in which they apologetically croaked a few bars of Schubert and conjured up an atmosphere or mood with a sureness that lies quite beyond most present-day sopranos. Where are those severe black-laced figures of the past (how scornful they were of obtrusive dress—and rightly so—for in a Lieder recital a singer must fill not one role but twenty) who strode on to the platform and with a brief nod at their audience



A solid domestic existence . . .

FISCHER — DIESKAU

plunged them into the worlds of Schubert, Schumann, Brahms, and Wolf?

There is today only one figure who can stand unashamed by such great predecessors: Dietrich Fischer-Dieskau. With the possible exceptions of Peter Pears and Gerard Souzay, he is the only working singer I can think of who has the full technical and artistic equipment for a great Lieder singer. And he far outstrips the English tenor and French baritone in sheer splendor of voice. If the art of Lieder singing endures in the second half of the twentieth century, its survival will be in large part due to his example.

Albert Dietrich Fischer-Dieskau was born in Berlin on May 28, 1925. His father was a schoolmaster, in official parlance an *Oberstudiendirektor*, who in his spare time wrote poetry and composed a little. His mother is an amateur pianist of some attainment. As a young woman she longed to be a singer, but this ambition was reserved for the youngest of her three sons. Today, a vigorous and clear-minded seventy-five, she still teaches the piano to her two grandchildren, as previously she taught her son. Thus from his earliest days Fischer-Dieskau lived in a household that was both musical and, to use a dreadful but inescapable word, cultivated.

At the age of only sixteen, he began to take singing lessons with Georg Walter, a well-known Bach tenor of his day. At eighteen he entered the Berlin Hochschule für Musik, where he studied with Professor Hermann Weissenborn. Weissenborn was clearly an exceptional teacher, and his influence on Fischer-Dieskau's development was immense. It is a curious fact that few singers are able to give any very lucid account of why they find one teacher better than another, and Fischer-Dieskau is no exception. But he is outspoken in acknowledging the debt he owes to Weissenborn, and that this is much more than a conventional tribute is borne out by the fact that until Weissenborn's death in 1959 at eighty-odd, his former pupil never failed to prepare a new

Lieder program with him and to return for occasional periods of study. This says as much for Fischer-Dieskau as it does for Weissenborn: singers who at the height of their fame return to work with their old teacher are rare indeed.

Fischer-Dieskau's studies at the Berlin Hochschule were soon interrupted by military service, and only a few months after leaving school he was drafted. By all accounts he was not a paragon of Prussian military efficiency. But he served until the end of the war and then spent two years in an American P.O.W. camp in Italy, where he had his first real experience as a concert artist. A copy of *Die schöne Müllerin* was somehow unearthed in Rimini, and Fischer-Dieskau learned and sang it to his fellow prisoners with such success that he found himself traveling from camp to camp giving concerts. It was also as a prisoner that he gained his first stage experience: he both directed and sang in a camp theatre production of an operetta.

In 1947 he returned to Germany and resumed his studies in Berlin with Weissenborn. It was not long before he began to attract attention. In 1948 he recorded *Die Winterreise* for the Berlin Radio, an astonishing achievement for a young singer of only twenty-three, and he also recorded a number of Bach cantatas. In the same year he was given an audition by Heinz Tietjen, then intendant of the West Berlin Opera and a man of legendary experience and shrewdness. Fischer-Dieskau sang for him some Schubert songs. After he had finished, Tietjen remarked casually, "In four weeks you will sing Posa in the new production of *Don Carlos*." That was the beginning of his operatic career.

He was not altogether well prepared for it. Fischer-Dieskau is an extremely tall man, liable to tower over a small stage like a colossus. Great height can, of course, be a distinct theatrical asset, and today he has learned to put it to good use. But his acting abilities are acquired rather than instinctive, and he admits that only the private coaching of Josef Greindl got him through his first performance of *Don Carlos*. For some years Fischer-Dieskau remained a rather stiff figure on the stage, but experience has brought him assurance. Where there was once awkwardness, there is now a commanding presence and considerable dramatic resource. And his intelligence sees to it that his performances are never marred by the crudity and conventional hamming of so many opera singers.

For three or four years the great majority of his appearances on the stage were confined to Berlin, and it was there that I first saw him in a performance of Liszt's *Die heilige Elisabeth*. As word got around of his exceptional voice, invitations arrived from Bayreuth and Salzburg, Vienna, Milan and Munich, but he has resolutely refused to give more than a strictly limited number of operatic performances each year. Even so, his repertory of roles is larger and more varied than that of many singers who devote themselves entirely to opera but who

have made their names in Mozart, Wagner, or the Italian repertoire and stick to their speciality. Fischer-Dieskau is too actively interested in music to allow himself to be circumscribed in this way, and it is partly from the variety of the parts he has sung in the past decade that he has acquired a stylistic versatility which only a few years ago one might not have supposed to be within his powers.

In Mozart he has sung the Count in *Figaro*, Don Giovanni, and Papageno in *The Magic Flute*. To my mind his Count is not altogether convincing. On the last occasion when I heard him sing this role (some time ago I might add), his performance seemed overpowering almost to the point of brutality. If Almaviva has a hand of steel (which I doubt), it is surely gloved in the smoothest of velvets. Fischer-Dieskau's Giovanni is altogether more successful. From the recent recording one can gather an impression of the extraordinary sense of style and musical distinction characteristic of all his Mozart performances. The champagne aria, which unhorses so many Dons, is thrown off with such immaculate ease and precision that one is hardly aware of the hurdles he is clearing and of the pace at which he is taking them. And in the final scene the power and authority of his great voice tells magnificently.

Yet something seems to me lacking, and this is particularly evident when you see the performance on the stage. Unless Don Giovanni is an irresistible Latin charmer, the opera lacks dramatic sense. But this is something that lies beyond the grasp of Fischer-Dieskau—and indeed of most Northern singers. A famous Italian tenor was once asked how he sang. His reply was so crudely physical as to be altogether unprintable. In contrast, Fischer-Dieskau sings with his head and his heart. "*Là ci darem la mano*" is meltingly beautiful as he sings it. But it is not overwhelmingly seductive, and this is reflected in acting that lacks the effortless animal grace before which feminine hearts are as rabbits caught in the headlights of a car. Still, whoever did hear a Giovanni perfect both in voice and manner?

To experience Fischer-Dieskau at his greatest, one must hear him in Wagner. I have always counted that worthy prig Wolfram von Eschenbach as one of the archbores of opera. His song in the second act of *Tannhäuser* is enough to drive the most saintly knight into the lascivious arms of Venus. Yet I shall never forget the extraordinary sense of purity and goodness in Fischer-Dieskau's "*Blick' ich umher*" and the beauty of tone and lyrical warmth with which he sang "*O du mein holder Abendstern*" at Bayreuth some years ago. Virtue is perhaps the hardest of all qualities to portray with the voice. On that occasion Fischer-Dieskau succeeded to a degree I have never heard equaled. This same spirit distinguishes his singing of Bach cantatas.

Yet nothing could be in sharper contrast than his Amfortas in *Parsifal*. Here the man's agony of body and mind, as he pauses while he is borne on his litter through the forest, and even more later,

when he refuses to unveil the Grail, takes on an almost unbearable poignancy. Yet again, how different is the baritone's young, robust Kurwenal in Furtwängler's wonderful recording of *Tristan und Isolde*. Although none of these three roles is of first importance, Fischer-Dieskau's assumption of them shows him to be one of the greatest of living Wagnerians. His very achievements in this field make the fact that he has sung neither of the two supreme Wagnerian parts for his voice—Wotan and Sachs—all the more remarkable.

I asked him whether he felt that his voice was too small and lyrical for those taxing roles. But his reason is not this: he simply feels that he is not yet ripe for them. Here again there is evidence of how Fischer-Dieskau, in his adherence to old standards, stands apart from most contemporary singers; in the Twenties and Thirties, great Wagnerians, such as Max Lorenz and Kirsten Flagstad, felt competent to tackle roles like Tristan and Isolde only as they approached forty. Today this kind of reserve is rare: a singer has only to be capable of singing the required notes in sufficient volume for him to be hurled into the breach like so much cannon fodder. Small wonder that the opera houses of the world, and most strikingly of Italy, are littered with the melancholy debris of shattered voices, once full of promise but ruined through premature exploitation. When, however, Fischer-Dieskau does feel ready to undertake Sachs or Wotan, I have little doubt that he will prove their finest exponent for many years.

Although he naturally tends to sing mainly in German opera, he has *Continued on page 112*



. . . with his cellist wife and two lively sons.

by Charles Cudworth

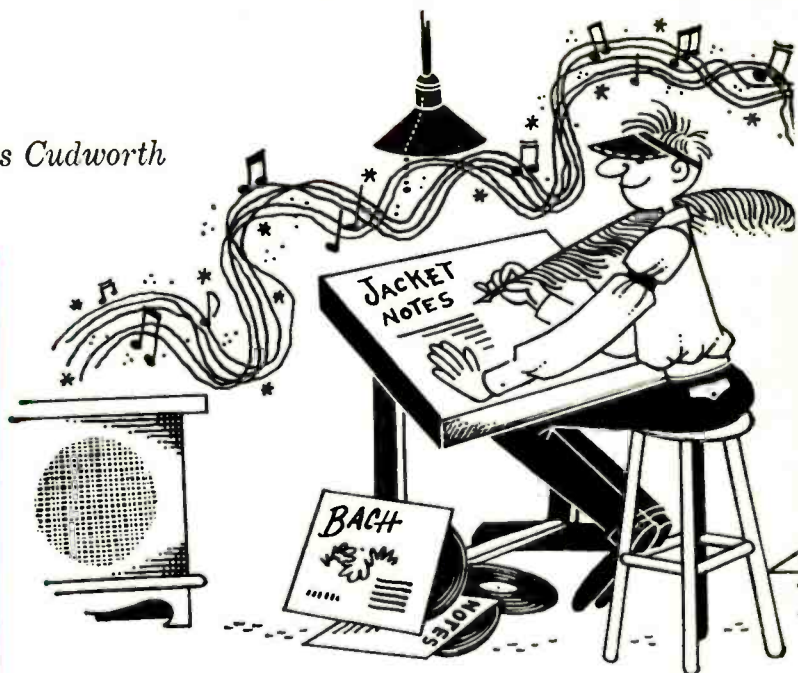

Or, alternatively, "Look at That Liner"—being art of record annotation, as viewed

RELAX, dear reader, relax! I am not about to try to sell you the latest thing in spot, ink, stain, or grease removers. I am merely about to deliver myself of a few words of professional wisdom, caution, and advice on the subject of "liners"—not the ocean-going variety, I hasten to add, but the kind we buy with our phonograph records.

One of the troubles about writing in English is that one never knows which dialect word to use. The late G. K. Chesterton, in a poem which gently quizzed his American friends, pointed out that Americans, in spite of their well-known propensity to hustle, as often as not use a long word where the Britisher makes a short one do. This may not be quite so true now as it was in Chesterton's day, but in a mild way it is true of the transatlantic variants of the words used for record-wrappers. In Britain we usually call them sleeves, whereas in the States you call them jackets or liners. So, while in Britain I might entitle this article "Mind Your Sleeve!," in the U.S.A. it must be "Watch Your Jacket!" (or even "Look at That Liner!"). Anyway, I'll settle for "jacket," for the rest of this article. And now, as the serialists say (I mean those who write for the glossy magazines, not those who make tone rows), Please Read On.

What I'm really writing about is not so much the jacket itself, or even the pretty pictures often printed on its front to catch the potential buyer's eye, but

rather the information detailed on the back. Jacket notes, as we know them nowadays, are a comparatively recent innovation. The flimsy dust covers of the old 78s were mostly innocent of print, beyond the maker's name, a few advertisements, and an occasional half-tone engraving depicting an overly intense violinist drawing his bow across a stringless violin, while a fatuous-looking angel hovered just over his shoulder, in obvious danger of having her (its?) head cut off. The comparatively low price of a single 78-rpm disc did not encourage the makers to venture much further into print than this, certainly not in Britain at any rate. The true ancestors of the modern jacket note, in the direct line, were first of all concert program notes, which date back to the early nineteenth century, and next the little leaflets (sometimes even booklets) of analytical or descriptive notes that were usually included with the bulky 78-rpm album-sets. Those leaflets and booklets were often written by experts—scholars and critics of the caliber of Ernest Newman—and it is in such distinguished footsteps that the modern jacket-note writer must tread. Those old-timers had one luxury rarely permitted their present-day counterparts: the notes written by early practitioners of the art often included musical examples.

With the coming of microgroove, circumstances altered almost overnight. Customers who were used to getting a free leaflet with their old-style album-sets



reflections on the fine

by a veteran scrivener.

now expected something of the same sort when they spent a similar sum for one of the new long-play discs. The LP jackets had to be rather more substantial than the old paper ones, too. Hence the jacket note, as we know it today: briefer, generally, than the old descriptive leaflet; bereft, usually, of musical examples (although some writers try to get round the difficulty by using a kind of alphabetical shorthand notation); informative, as often as not; inaccurate, sometimes; occasionally ludicrous or even silly; but by and large an almost indispensable part of our listening. Even if we guffaw over them, or curse them, I feel sure that we are one and all disappointed when these notes are missing (as on some Continental issues). Many a critic, certainly, has cheated Father Time and his own editor by surreptitiously cribbing handy phrases from the jacket writer—and contrariwise, has damned the record companies who've sent him review copies of a work he's never heard of minus the all-important jacket notes which would have helped him pose as a Great Authority, free of personal brain-fag.

BEING one of the older hands in this newish game of jacket-note writing, I am naturally concerned with its problems and techniques. (The latter, incidentally, are still being evolved, and the boundaries of the jacket-writer's task are by no means clearly defined.) It was with special interest, then, that I read the

rather explosive tailpiece anent this very subject, which appeared as part of that amusing *jeu d'esprit*, "The Claude Hummel Diary," written by Martin Mayer for the Tenth Anniversary Issue of *HIGH FIDELITY* last April. Now I am in accord with much of what Mr. Mayer says in his almost angry final paragraphs; perhaps I may be allowed to quote him: "The function of the notes is to supply some information—about the work, the circumstances of its composition (where significant), and its place in the composer's output, and whatever is really worth noting about its structure—thematic, harmonic, rhythmic, or architectural. If the information is trite, the notes cannot be original—but that is scarcely an excuse for writing notes which do not give information." I couldn't agree more.

Information is what we all want. Unlike some of my loftier academic colleagues, I am far from despising jacket notes; indeed, I'll readily admit that I have learned a great deal from them, even about the music of what I like to think of as my own particular period. I find that the more conscientious members of the jacket-writing profession will go to a lot of trouble to get their facts right (I know, because being a music librarian, I'm often roped in to assist in the research!). And many of them, like Mr. Newman of old, are acknowledged specialists in their own fields. It is, of course, highly desirable that a jacket-note writer should be an expert on the music he is annotating, just as it is equally important for a record reviewer to be well informed about the date and style of any music he may be called upon to review. No one can fully judge a musical performance unless he is sensitive to musical styles and periods, as well as to pitch, harmony, melody, intonation, and expressiveness. Musicology has done this much for us, and without historical awareness any critic is in danger of making a fool of himself.

If a composer is one of the recognized great masters, it's not usually necessary to say much about his life, since the facts can be looked up in any biographical dictionary, but it's often useful to place any given work within the framework of its creator's career, to say when it was composed and which well-known pieces preceded and followed it. Unlike Mr. Mayer, I feel that simple analyses are useful, especially to the beginner, and we must remember that a great many of the people who buy phonograph records are just that—young beginners in the art of listening to music. But they must not be baffled by abstract and overtechnical analyses; analytical notes must help the listener towards an understanding of the music, not drive him away from it. When G. B. S. first suggested trying his hand as a music critic, his prospective editor, the famous "Tay Pay" (T. P. O'Connor) cautioned him with: "For God's sake don't write about Bach in B minor!" One knows what Tay Pay feared, but what would he have said if he had been confronted with the following example, with which we are all too familiar?

"Symptomatically of S . . . 's second neobaroque period and convolute idiomatic genre, this highly

integrated developmental subsection is terminated by a typical advancing of the C 3 version of the principal second motif, which is further reiterated in remote fragmentations, the chordal harmonic motion meanwhile loading a tonic pedal with IV/6 and VI/4 harmonizations until a fermatal point is attained, thus giving opportunity for the rendition by the concertizing soli of cadential flourishing and melismatic figuration, conjoined with accompanimental arpeggiations, eventually terminating S . . . 's otherwise quasi-perpetual motion on an almost imperceptible pause. . . ."

Let us pause too—if only to draw breath. S . . . 's quasi-perpetual motion is already giving me a queasy feeling. Yes, I know; the above passage is a lot of nonsense. I should know, as I've just written it myself. Yet haven't we all encountered real nonsense of the same ilk, in the more highfalutin kind of analytical writing? But analytical notes can be helpful, if the writer does not use too much jargon and language familiar only to the most erudite musicologists. If the writer *must* use the trade jargon, then he ought at least to try to explain his terms. The Golden Rule is "Never use a jargon word or an unfamiliar loan word if there is already an established English word which means the same thing." Why refer to a composer's "*oeuvre*" when you can speak of his "works"? Why say "clavécin" or "cembalo" when you can use the good old English word "harpsichord"? (Professional musicians in Britain even go to the opposite extreme and say "band" when they mean "orchestra" and call everything a "tune" from a sixteen-bar folk dance to *Götterdämmerung*, just as pop instrumentalists in the States call every instrument a horn, from a piccolo to a double bass; but these are professional snobbisms, of a different caliber.)

In this matter of supplying information, it's worth while detailing the instrumentation of a piece, or the voices used, if ascertainable; such information, alas, is not always obtainable, odd though that may seem. It is not always immediately obvious, even to the trained ear, that a harpsichord was used to fill in the harmonies; if the jacket writer does know this, then it's worthwhile saying so in the notes. The orchestra may include a few dozen anvils or a Javanese nose-flute; the players may be using special bows, or recorders instead of flutes; all such points are worth a mention if they are unusual and are known to the

writer. Keys, opus numbers, tempo markings, and all similar information should be checked and set forth, where ascertainable, if only to help the poor music librarians and catalogue compilers. We cannot all indulge in the kind of elaborate data card which is the pride and joy of Archive releases, but we can at least do our best to see that the jacket-note reader is given as much information as is reasonably possible. In the case of vocal music, it is highly desirable that texts be included with the recording, or at least some sort of synopsis. Seventy-five per cent at least of the composer's intention is lost if the listener is unaware of the words to which the music was set.

I list all these desiderata knowing that I am in many cases probably baying for the moon; the jacket-note writer often works with the minimum of information not only about the artist and instruments involved, but even about the work itself. Mr. Mayer's Claude Hummel mentioned a colleague who was in the depths of despair because he had to write some notes about a concerto he had never heard, for which no score was obtainable, and which was by a man famous only for composing operettas. This character may have been imaginary, but he was certainly not mythical. Every jacket writer can feel for him in his predicament, because we've all been in the same sort of quandary ourselves at one time or another.

AMONG the prime requirements of a good jacket writer (and record reviewer, too, for that matter) is an ability to write. This may seem obvious; but to judge from many of the jackets and reviews one has read, it's by no means as obvious as it might appear. To be a good writer of any kind, it is not only necessary to put words down on paper and spell them more or less correctly (it's surprising how many would-be authors cannot do even that; after all, they seem to be saying, what are editors and printers for if not to correct an author's spelling?); it is also necessary to set out one's ideas in an attractive and readable manner. We don't expect a jacket-note writer to be a great stylist, but he can at least try to avoid the nastier kinds of journalese, and perhaps even more horrid, in our line of business, the kind of incomprehensible jargon which I tried to satirize some paragraphs back and which can occur in even the best musical circles. I quote from one well-known musical textbook: "These prolongations of the structural motion reveal not only a mastery of the technical problems, but a conception of the artistic possibilities in contradiction to the theory that the early works represent a period of experimentation. . . ." You'd hardly believe it, but this statement concerns poor, innocent old Papa Haydn! It just goes to show that a good musicologist is not always a good musicographer—to use the latest example of professional jargon.

At the other extreme is the lack of precision in the use of words which *Continued on page 113*

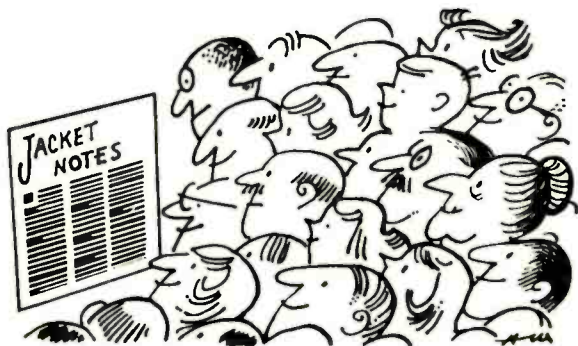

*The consumer's guide
to new and important
high-fidelity equipment*

high fidelity

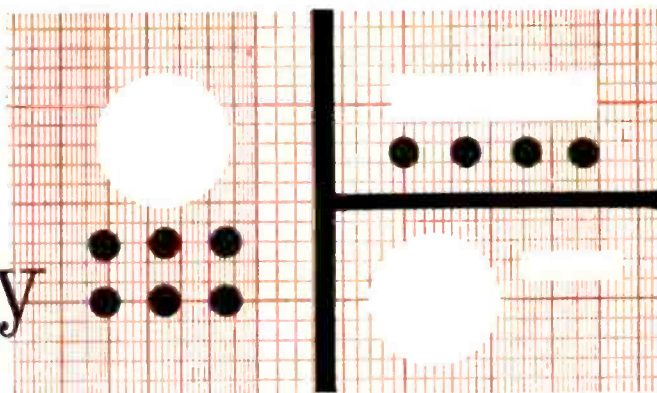

EQUIPMENT REPORTS



Lafayette LA-550
Stereo Power Amplifier

AT A GLANCE: The Lafayette LA-550 is a stereo amplifier rated conservatively at 50 watts per channel, and featuring unusually wide frequency response. It is available as a kit (Model KT-550, \$134.50) as well as in factory-wired form (Model LA-550, \$184.50). We chose to test the latter since, even at its higher price as compared with the kit version, it appeared to represent an unusual value in its class of high-powered, wide-band audio amplifiers. The results of tests conducted at United States Testing Company, Inc., completely confirm this initial impression. The LA-550, regardless of price, is a thoroughly excellent high-fidelity component which merits a place among the top basic amplifiers presently available.

IN DETAIL: Each channel of the LA-550 employs five tubes: 1-6BR8A, 2-6CL6, and 2-7027A. The circuit contains a total of six feedback loops, with approximately 50 db of feedback, to obtain very low distortion at high power levels. The front panel contains a balancing meter and potentiometers for adjustment of the DC bias, and for AC balance of the 7027A beam power output tubes on each channel. A 60-cps test signal is also available to facilitate correct AC balancing under load.

On the rear panel of the LA-550 are located its two input jacks, the off/on switch, an AC outlet, and the audio output terminals, with taps provided for 4-, 8-, and 16-ohm speakers. The entire amplifier is ruggedly but neatly built, with much of its wiring done on printed circuit boards. It weighs approximately 57 pounds, most of which is in its massive transformers. The amplifier is furnished with a metal enclosure.

In USTC's tests, the LA-550 proved to be an outstanding performer. The amplifier develops 57 watts rms per channel at 1 kc before clipping occurs. Its power bandwidth actually extends from 13 cps to 80 kc. Frequency response at the 1-watt level is flat within +0 and -1 db from below 5 cps to approximately 125 kc, and is down 3 db at 152 kc.

The amplifier's total harmonic distortion at 50 watts rms output with a 1-kc signal was 0.63% with one channel operating, and was only 0.64% with *both* channels delivering 50 watts. This totally negligible increase in distortion when both channels are delivering high power indicates a very well-designed and conservatively rated power supply, which, by the way, incorporates five silicone diodes in its rectification circuits. At full power, the amplifier's harmonic distortion was less than 1% from 25 cps to above 20 kc, and at half

REPORT POLICY

Equipment reports are based on laboratory measurements and listening tests. Data for the reports, on equipment other than loudspeakers, is obtained by the United States Testing Company, Inc., of Hoboken, New Jersey, a completely independent organization which, since 1880, has been a leader in product evaluation. Speaker reports are based on controlled listening tests. Occasionally, a supplementary agency may be invited to contribute to the testing program. The choice of equipment to be tested rests with the editors of HIGH FIDELITY. No report, or portion thereof, may be reproduced for any purpose or in any form without written permission of the publisher.

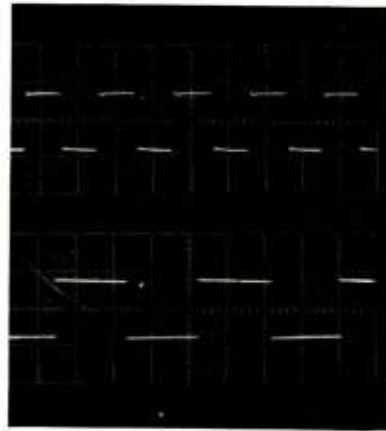
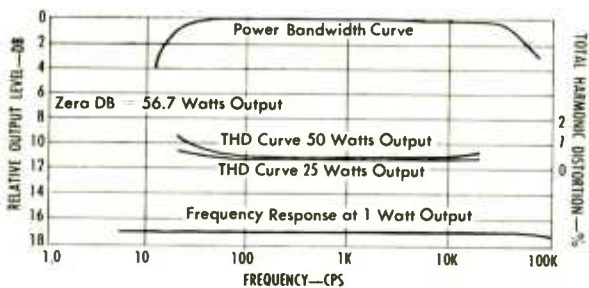
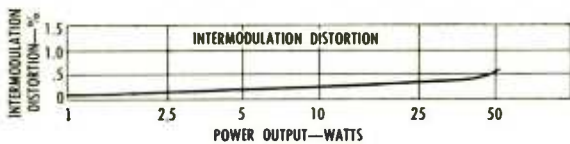

Square wave response of the LA-550.

power was less than 0.7% from 20 cps to above 20 kc. The IM distortion of the LA-550 was less than 0.55% at full power and less than 0.35% at half power, both figures being very good.

The amplifier's signal-to-noise ratio (at 50 watts output) was 83 db, which is excellent. The sensitivity of the amplifier for 50 watts output was 0.98 volt. Its damping factor, on the 8-ohm tap, was 10.

As shown in the oscillogram photos of the amplifier's output, square wave response of the LA-550 was excellent at frequencies of both 10,000 cps and 50 cps.

The 50-cps waveform was especially good, and was very hard to distinguish from the output of the square wave generator used for this test. The 10-kc waveform had the slightest bit of ringing at its leading edge.

As might be expected from these measurements, the listening quality of the LA-550 was superb. It has proven to be an amplifier capable of performing well under the most exacting applications and suitable for use in the finest of music-reproducing systems. USTC feels the LA-550 not only is an exceptionally good value, but is one of the finest amplifiers it has seen.



Electro-Acoustic

Model 7002 Record Changer

AT A GLANCE: The new Series 7000 from Electro-Acoustic Products Company features two different models of a 4-speed record changer. The Model 7002, tested by United States Testing Company, Inc., has an arm with a plug-in head, and will accommodate all standard crystal or magnetic cartridges. Price is \$64.50. The other changer, Model 7001, comes complete with a crystal cartridge and 45-rpm spindle adapter for the 7-inch, 45-rpm pops records. Its price is \$69.50. Otherwise, both changers are the same.

IN DETAIL: The Model 7002 is powered by a four-pole induction motor which has a stepped shaft for speed changing. The 2-pound, 9½-inch platter is driven on its inner rim by a rubber idler wheel. A second rubber wheel engages the motor shaft and is used to drive the 7002's changing mechanism. The speed at which records are changed, therefore, does not depend on the turntable speed in any way (as it does on most

changers), and the complete change cycle is accomplished in approximately six seconds. Over-all construction of the 7002 indicates good design and workmanship.

In operation of the changer, records are piled onto the spindle and an "overarm" is brought into position over the records to hold them in place. When the changer is started, the tone arm rises and moves over until the edge of the arm gently touches the bottom record on the pile. This operation "tells" the changer what size record it is going to play. The tone arm then moves back and the bottom record on the pile drops onto the turntable, after which the tone arm moves into position over the lead-in groove and gently comes to rest on the record. The whole operation is quite smooth.

The tone arm is constructed of plastic, and has provisions for height adjustment as well as for tracking force adjustment. This latter adjustment, made by turning a screw at the rear of the arm which adjusts

the tension on a spring, was found to be somewhat tricky and delicate, but satisfactory once done. No provisions are made for further adjustments, such as static or dynamic balancing of the arm, which of course is preinstalled.

Bearing friction in the tone arm is quite low, enabling the use of fairly low tracking force. In USTC's tests, a high quality magnetic cartridge designed to track at 3 grams was installed in the 7002, and it tracked quite well.

Rumble measurements, using this magnetic cartridge, resulted in a rumble figure of -35 db referred to a recording level of 1.4 cm/sec at 100 cps. This figure indicates that if the 7002 changer is to be used in conjunction with a good speaker system—one with full bass response—the rumble will be apparent in the background. With more modest speakers, such as might be used in a budget-priced music system, the rumble probably would not be noticed. Hum pick-up from the motor was very low and completely inaudible.

Speed accuracy tests were performed at all speeds—first with a single record on the turntable, and then with a stack of ten records on the platter. At 33

rpm, the actual turntable speed varied by slightly less than 1%, being 0.90% fast with one record on the platter, and 0.93% slow with ten records, which is fairly good. At other speeds, the speed accuracy of the turntable was also generally satisfactory, except that with a full stack of ten records at 16 rpm, the speed was slow by 3.3%.

The wow and flutter of the changer were very low. USTC measured an average wow of about 0.08% rms with peaks to 0.12% rms. Flutter was found to be between 0.06% and 0.07% rms.

While the Model 7002, in sum, does not measure up to the performance level of the better turntables, USTC does feel that it is a representative product of fairly high quality within its generic class, which is to say, it stands up as a typically good record changer. Used in conjunction with a good quality cartridge, it will play and change records with a minimum amount of wear of the records, and it can be depended on to provide satisfactory performance under most conditions. When used with a very wide-range speaker system, however, it may introduce low frequency noise, some of which can be removed by the rumble filter on an amplifier.



**Tannoy "Monitor" Speakers;
GRF and Belvedere Enclosures**

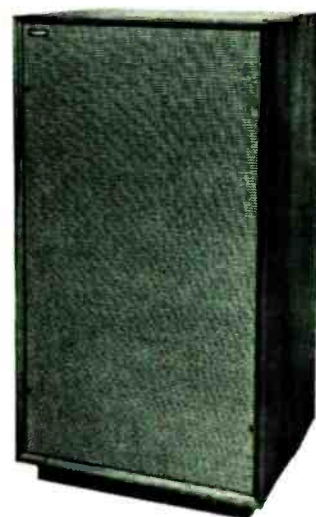

AT A GLANCE: Tannoy is offering a new 12-inch, as well as a 15-inch, version of its "Monitor" loud-speaker. Essentially, this is a coaxial type, or as Tannoy prefers to call it, a dual concentric type. The tweeter nests in the apex of the woofer cone and both are driven from a crossover network. Frequency division differs for each of the speakers, the 15-inch model being crossed over at 1,000 cycles; the 12-inch version at 1,700 cycles. Price of the 15-inch Monitor is \$179; of the 12-inch Monitor, \$138.

Tannoy also offers various enclosures of which the "GRF" horn, shown here, and the "Belvedere Senior" are designed for the best performance of the 15-inch and 12-inch speakers respectively. The "GRF" is available in oiled walnut, measures 42 inches high, 17¾ inches deep, and 23½ inches wide. Price is \$206. The Belvedere Senior comes in walnut or mahogany and measures 34 inches high, 16 inches deep, and 23½ inches wide. Price is \$85. The Belvedere Senior will accommodate either the 12-inch or the 15-inch Monitor; its main opening, in fact, is cut for a 15-inch speaker. When supplied for use with a 12-inch speaker, an adapter baffle with a suitable cutout is provided.

IN DETAIL: Tannoy, apparently ignoring the obvious trend in "integrated" speaker systems (by which a

speaker, or group of speakers, is furnished pre-installed in a specific enclosure designed for it and no other), continues to offer its speakers and enclosures as separate items. Thus, one can buy either the 15-inch or the 12-inch model and install it in a cabinet of his own choosing—or, one can buy a Tannoy enclosure and fit it with a particular speaker. We have heard various Tannoy speakers in enough different types of enclosures and in sufficiently varying acoustic settings to acknowledge that they do work well in enclosures other than Tannoy's own, including that simplest of all types, the large sealed box known as an "infinite baffle." For this report, we used the 15-inch Monitor in the GRF enclosure which is a modified sort of folded horn, and the 12-inch Monitor in the slightly smaller Belvedere Senior, which employs damped ports, a kind of variation of the bass-reflex principle. Additionally, we installed another 15-inch Monitor in an acoustic labyrinth. The results in all three cases were fairly similar, which is to say, quite satisfying—with top honors going to the GRF-15-inch Monitor combination, and preference for second place generally divided between the 15-inch Monitor used in the labyrinth and the 12-inch Monitor in the Belvedere. The differences, it should be pointed out, are fairly subtle and not, in our view, of such character or degree as to rule out using dissimilar Tannoys as a

stereo pair: a 15-inch model with a 12-inch model, or even an older Tannoy housed, say, in a homemade "infinite baffle" with a new model installed in one of the new enclosures. The pervading acoustic impression from Tannoy speakers generally is one of smoothness of response, with very little tendency toward "hard" sound. Some listeners have characterized this quality as similar to what you hear from midway back in a good concert hall. (First row devotees, please note.)

It should be pointed out that if this characterization be a valid one, it actually is in keeping more or less with the design approach behind Tannoy speakers which aims figuratively at opening a large window on the performers rather than attempting to put you right in their midst. To achieve this, Tannoy, in common with a number of British and European speaker manufacturers, prefers the coaxial speaker wherein one general reproducer serves as the total sound source. Such a speaker, in Tannoy's view, serves to "open that window." In the "dual concentric" design used by Tannoy, the tweeter merges almost imperceptibly with the larger, woofer cone so that the curve of the latter serves to expand the high-frequency sound source and spread it evenly into the listening area. Bass response of the woofer is aided by its plastic "surround" or outer suspension. Another feature, or rather lack of it, which is characteristically "Tannoy," is the absence of a tweeter level control, usually found in coaxials or two-way systems employing a crossover network. Tannoy feels that its matching of tweeter and woofer represents a smooth balance as far as the speaker's own response is concerned, and any desired variations—such as may be required by room acoustics—should be compensated by the use of amplifier, not speaker, controls. We must admit that we did not, after considerable listening periods, miss the speaker controls.

Although, as stated earlier, the general musical character of different size Tannoys, or even of Tannoys used in different types of enclosures, remained similar, there were some noticeable differences in specific areas

of response. As might be expected, the GRF-15-inch combination produced the deepest bass and the "biggest" sound. Response, on pure test tones, held up strongly to about 35 cycles, then seemed to roll off gently. Some output below 25 cycles was apparent, though diminished in amplitude. Response throughout the mid- and high-frequency ranges was generally smooth and well balanced. There was a tendency to a slight peak just below 200 cycles and a minor dip observed at about 12.5 kc, with response evident well beyond 15 kc.

The Belvedere, with the 12-inch Monitor, began rolling off at about 55 cycles and remained quite smooth to 35 cycles at which point—with volume turned up quite high—the frame holding the grille cloth began to vibrate. This was easily remedied by a snip of cardboard wedged between the right-hand edge of the frame and the side of the enclosure, and response then continued smoothly to just below 30 cycles. Response at the high end was generally similar to the 15-inch model, except for minor peaks at about 2 kc and 9 kc, and a slight dip between 13 and 14 kc. In comparing the over-all sound of the Belvedere-12-inch combination with the GRF-15-inch system, some listeners allowed that the "bigger" sound of the latter could be attributed to a stronger mid-bass component in its response, a factor which also might account for the more "close-up" feeling they had with the smaller system, particularly on voice. In this respect, the 15-inch Tannoy used in the labyrinth fell somewhere between the other two; its bass was deeper, and with more of a "bite" than the 12-inch model, but not yet quite as rotund as with the GRF. At that, the differences are subtle and must be classified as matters of personal preference. The general consensus is that Tannoy speakers are among the better reproducers presently available, and very easy to listen to for hours on end. Efficiency is moderately high and either Tannoy can be driven quite satisfactorily by a 20-watt amplifier. The 15-inch Monitor has a rated power capacity of 50 watts; the 12-inch Monitor, 30 watts. And both make very musical sounds.



Korting Model 158S Tape Recorder

AT A GLANCE: The Korting Model 158S, manufactured in West Germany and distributed here by Korting Recorder Sales Corp. of New York City, is a self-contained stereo record/playback tape recorder. United States Testing Company, Inc., describes it as distinctly European in appearance, design, and operation. Price, including carrying case and two low impedance dynamic microphones, is \$369.50.

IN DETAIL: The Korting has two speeds (7½ ips and 3¾ ips) and is supplied with three ¼-track stereo heads (erase, record, and playback). Tape motion is controlled by four piano-type push buttons, identified

as Start, Stop, Rewind, and Forward (which actually is fast forward). There is also a pause button which can be used to interrupt the tape motion when recording, but without breaking the electronic circuits, a definite convenience when setting level controls.

Push buttons are also used to select stereo and mono recording and playback modes, as well as to select high level or low level (microphone) inputs. A single "magic eye" type indicator is used on the Korting to show the recording level of either channel. USTC felt that the lack of separate level indicators, one for each channel, made setting the levels when recording stereo a bit of a chore. Each channel does have its own level control,

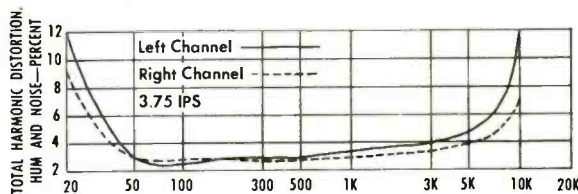
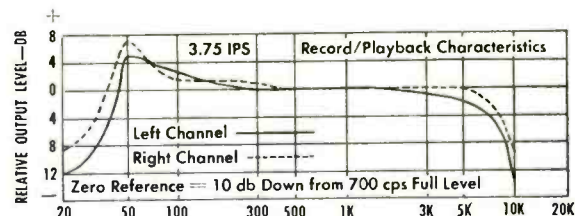
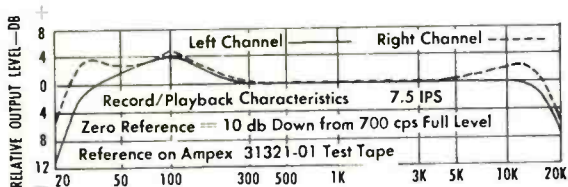
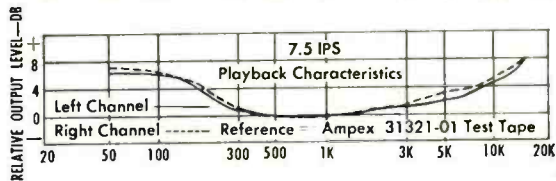
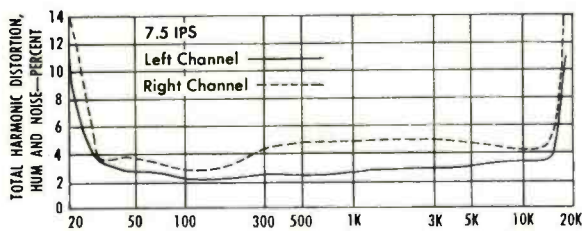

however, which is used for both recording and playback.

A number of very unusual features are incorporated in the design of the Korting, made possible by the use of three heads instead of the two usually found in moderately priced machines. Echo and reverberation effects can be introduced when recording monophonically by the use of a dubbing control, which allows the material recorded on the tape to be picked up by the playback head and fed back into the recording circuit. The delay of the echo thus obtained is 0.2 second at 3¾ ips, and 0.1 second at 7½ ips. This setup also provides for direct tape monitoring while you are recording, and for multiple synchronized recordings ("sound on sound").

The input and output jacks on the recorder are of the European type, and consist of either three or five pin sockets. One adapter cable, for connecting either the audio input or audio output jacks to your existing music system is provided, and additional plugs and cables can be obtained from your dealer.

USTC judged the internal construction of the Korting to be excellent, and its ease of serviceability high. The electronic section of the recorder is built on printed circuit boards, which swing out for easy access. A very complete service manual is supplied with the recorder. The 158S is powered by a single hysteresis-synchronous motor working through a very well-designed and well-constructed system of belts, idler wheels, and brakes.

Although the recorder's operating manual is rather poorly written by American standards, one can—after using the Korting for a few hours—master its operation. The main operating controls work fairly well, except that the "stop" button on USTC's sample did not always work the first time it was pressed. Too, considerable force was required to activate the push-button controls. The recorder's self-contained playback speakers were only fair in their quality, as might be expected in a self-contained tape system. This is offset to a degree by the fact that music recorded on the Korting from a high-fidelity system did sound quite good when played back through that same system, with fairly low distortion and a smooth response. On playback, however, a distinct motor noise could be heard when the music was low in volume, which detracted somewhat from the enjoyment of the music. High frequency noise, however, was adequately low.

The record/playback response of the recorder at 7½ ips was measured as flat within plus or minus 3 db

from 150 cps to 17 kc, and flat within plus or minus 4 db down to about 25 cps. Response at 100 cps was slightly peaked on both channels, and the right channel showed a slight additional peak at about 11 kc.

At 3¾ ips, the 50-cps response of both channels showed a rather sharp peak, below which the response fell off sharply. The high frequency response at 3¾ ips fell off to minus 4 db between 7 and 8 kc.

Harmonic distortion measurements made at 7½ ips speed indicated less than 4% THD on the left channel from below 30 cps to approximately 15 kc. The distortion on the right channel was slightly higher, but remained less than 5% over the same frequency range. At 3¾ ips, both channels had less than 5% THD from 35 cps to above 5 kc. These measurements, as well as the frequency response measurements, were made with the audio signals recorded at a level of minus 10 VU.

The playback response of the Korting at 7½ ips deviated from the NAB standard, with both the 50-cps and 15-kc output levels up 7 to 8 db from the midrange response, giving the music a rather booming sound at the low end and a brilliant sound at the high end. However, the tone controls of any high-fidelity pre-amplifier could be used to compensate for this and flatten out the response to some degree (the Korting has no tone controls incorporated in it).

The low frequency motor noise mentioned earlier showed up in terms of a rather poor signal-to-noise ratio. Referred to an average recording level of minus 10 VU, the signal-to-noise ratio of the Korting was approximately 29 db, but did improve to approximately 39 db referred to the full recording level of zero VU.

The speed accuracy of the recorder was fair, being 1.33% high at 7½ ips and 0.83% high at 3¾ ips. Wow and flutter were very low for a tape recorder, never exceeding 0.1% at either the slow or fast speed.

Aside from the annoyance of the signal-to-noise factor, the Korting shapes up as a very good machine in its price class. In USTC's view, its ability to record and play music is generally quite satisfactory, and its unusual features, such as providing for echo effects, are unique among moderately priced tape recorders.

COMING REPORTS

Grado Lab Series cartridge

EICO ST-96 stereo tuner

and multiplex adapter

Scott LK-72 amplifier kit

Music at the White House

Share that memorable evening when celebrated cellist Pablo Casals was invited to play for President Kennedy and distinguished guests. Recorded in the East Room of the White House.



The Art and Glory of "Swan Lake"

An affectionate view of Tchaikovsky's greatest ballet: a dazzling performance by Ormandy and the Philadelphians, plus the lavishly illustrated history of Swan Lake's triumphs across eighty-five years and three continents.



Stravinsky Conducts "Le Sacre"

From the widely acclaimed three-record set—Stravinsky's definitive recording of his own masterpiece *Le Sacre du Printemps*—"a great, vital, poetic performance." (High Fidelity)



Richter—In Person

Musical history—as it was made: five Carnegie Hall concerts by titan of the piano Sviatoslav Richter, recorded live and complete. Here, the second recital, a two-LP program including Haydn, Schumann and Debussy.



Prince of Madrigalists

A tribute to the astonishing but little-known 16th-century master, Don Carlo Gesualdo—from such admirers as composer Igor Stravinsky, conductor Robert Craft and madrigal singers, organist E. Power Biggs. An adventurous exploration of Gesualdo's special world in word, picture and music.



Stokowski's Bach

Bach, Stokowski, and The Philadelphia Orchestra—a legendary combination—majestic as ever in this new stereo recording.



THE COLLECTOR'S CHOICE IS ON COLUMBIA RECORDS

CHOOSE SPECTACULAR STEREO OR MATCHLESS MONAURAL

© "COLUMBIA" MARCAS REG. PRINTED IN U.S.A.

Music Makers

by ROLAND GELATT

THE SCENE: a hotel suite on Manhattan's upper East Side. Its windows are tightly shut, and a large auxiliary electric heater on the floor fortifies the impression that its occupant must thrive in an atmosphere usually associated with the cultivation of orchids. On an easy chair in the middle of the room someone has carelessly thrown down a heavy fleece overcoat, a wool cardigan sweater, several mufflers, a pair of fur-lined gloves, and a cap with ear flaps. Half-consumed bottles of Poland Water are lodged haphazardly on various end tables, and a leather-topped desk is littered with books—philosophy and poetry—and with a clutter of penciled notes and clippings. There is a pervading aura of disarray which clashes rather disturbingly with the suite's posh and sedate furnishings.

For anyone who knows him, no further description is needed to identify the occupant of these quarters. The hallmarks point unmistakably to Glenn Gould. A few weeks ago we found ourselves in this familiar scene but on an unfamiliar mission. For we were calling on Gould not only as an old acquaintance and respected musician but this time also as a contributor to HIGH FIDELITY. Our mission: to go over the galley proof of the article on Richard Strauss that begins on page 46.

Strauss must be a somewhat frustrating enthusiasm for a pianist to cultivate. In Strauss's lifework the piano is conspicuously slighted. It is not, however, totally ignored, and in May we shall have an opportunity—courtesy, Columbia Records—of hearing Gould in one of Strauss's least-known compositions for that instrument: *Enoch Arden*, a setting of Tennyson's poem for piano and speaking voice—in this case, the voice of Claude Rains. Gould does not pretend that *Enoch Arden* is top-drawer Strauss, but he does consider the 1890 "recitation" well worth an attentive hearing. And be it ever so humble, he intends to continue



Glenn Gould

putting Strauss's piano writing on records. Next year the pianist hopes to tape the *Burleske* for piano and orchestra, and after that he will busy himself with the violin sonata and the songs.

May would seem to be in the nature of Glenn Gould Month at Columbia Records. In addition to *Enoch Arden*, we can expect a first installment of the complete *Well-Tempered Clavier* and a pairing of the Schoenberg Piano Concerto and the Mozart C minor Concerto, in which the pianist collaborates with the CBC Symphony Orchestra (home base: Toronto) under Robert Craft and Walter Susskind respectively.

A Gould recording of the Bach "48" has been planned for years. Before the first sessions took place, early this year, Gould toyed with the notion of performing it on the harpsichord, an instrument concocted by the Steinway people to convey the timbre of the harpsichord with the volume of the piano. At the Stratford Festival, of which he is music director, Gould

has used the harpsi-piano with great satisfaction, both as a continuo instrument and for the solo part in Bach's D minor Concerto. In the end, however, he decided to stick to the piano (undoctored) for an undertaking as long-ranging as the *Well-Tempered Clavier*.

What of the harpsichord itself? Had he ever been tempted, we asked, to forsake the piano for it? "I love the sound of the harpsichord and the effects that are possible with it," Gould conceded, "but it upsets my piano playing. It's just too disturbing to make the transition from one instrument to the other. In any event, I'm really more interested now in reviving my organ playing. Did you know that my debut was made as an organist at the age of twelve in Toronto? I haven't played an organ recital in fifteen years, but recently I did an organ sequence on a TV show about Bach, and now I'm anxious to do an organ record for Columbia." It's something we'd much like to hear.

DEUTSCHE GRAMMOPHON records have long been distributed in this country by Decca, but starting in April the label begins a new association here with M-G-M Records. Better packaging, wider distribution, more aggressive promotion are said to be in the offing for the German product. The first release under the aegis of M-G-M will include two operas (Carl Orff's *Antigonae* and Puccini's *La Bohème*), a recital by Sviatoslav Richter, and a miscellany of contemporary German music. Later in the year we'll be offered a Mozart Requiem under Karajan's direction (with the Berlin Philharmonic and Vienna Singverein) and the Dvořák Cello Concerto played by Pierre Fournier and the Berlin Philharmonic under George Szell. All DGG records will continue to be manufactured and sealed at the Hanover factory. And from now on, we have been assured, there'll be no skimping on texts and translations.

PING PONG STEREO IS NOT A TECHNICAL ADVANCE!

AN IMPORTANT MESSAGE TO STEREO RECORD BUYERS

We feel the time has come to clear the air with regard to the many new "gimmick terms" which some recording companies are now passing off to the consuming public as great, new, stereophonic technical advances.

It is of great concern to me personally that the consuming public is being confused and misled to believe that certain supposedly "new" recording techniques are important steps forward in stereo recording.

I maintain most of these terminologies are purely commercial sales gimmicks to capitalize on the trend of "Ping Pong" stereo records. In my opinion, it is a mistake to present "Ping Pong" stereo as an advance in stereophonic recording technique.

Obviously it is not.

Certainly it is being used as a commercial sales gimmick.

True or real stereophonic recording, as employed on Audio Fidelity Records, utilizing the "Stereophonic Curtain of Sound®" technique, does not require gimmickry such as recording in different rooms or at different times, etc., in an attempt to achieve separation, high signal-noise ratio, brilliance and clarity.

It is my assumption that the "knowing" record consumer is now ready to mature and progress beyond the "Ping Pong" gimmickry stage in stereo records and will evaluate and enjoy stereo as it should be heard.

If this is so, as an outstanding example of Audio Fidelity's stereophonic recording, may I recommend that you listen to our latest "Curtain of Sound" recording—"Paris," featuring Jo Basile, with accordion and Massed String Orchestra. We feel this recording, from the standpoint of musical performance, selection of material and stereophonic sound reproduction, is among the finest Audio Fidelity has ever produced... and certainly one of the greatest stereophonic recordings available at this time.

Sidney Frey, PRESIDENT

P.S. We would be very interested in hearing your own views on this subject. Please write. Send for our NEW, FREE complete catalogue.



AUDIO FIDELITY RECORDS

DEPT. HF3, 770 ELEVENTH AVENUE, NEW YORK 19, N. Y.

CIRCLE 17 ON READER-SERVICE CARD



AFLP 1955
Mono—\$4.98

AFSD 5955
Stereo—\$5.95

reviewed by

PAUL AFFELDER
NATHAN BRODER
O. B. BRUMMELL
R. D. DARRELL
ALFRED FRANKENSTEIN
HARRIS GOLDSMITH
JOHN F. INDCOX
ROBERT C. MARSH
CONRAD L. OSBORNE
JOHN S. WILSON

Records in Review



Tebaldi takes the title role.

by Conrad L. Osborne

Adriana Lecouvreur—An Opera For the Proper Prima Donna

NEXT SEASON, the Metropolitan Opera will revive Cilea's *Adriana Lecouvreur* as a vehicle for Renata Tebaldi. This season, London Records is giving us a chance to preview the work via a new recording, also a vehicle for Mme. Tebaldi. (The two events would have coincided, except that the Met's labor union dolours caused postponement of its presentation of *Adriana*, originally intended for this season.)

Both the opera and its composer have enjoyed a peculiar sort of half-life so far as American opera lovers are concerned. Cilea had a strange career. He wrote only four operas, of which two—*Adriana* and *L'Arlesiana*—met with considerable success in Italy. But after the production of his fourth at La Scala in 1907 (it was a flat failure), he simply withdrew from the operatic world, devoting himself to teaching and to composition

in smaller forms until his death in 1950. As for *Adriana*, it has clung tenaciously to the underside of the repertory in its native country ever since its La Scala premiere (1902, with Caruso as Maurizio). The Metropolitan tried it once, in 1907, but despite the presence of Caruso as Maurizio and the beautiful Lina Cavalieri as Adriana, it was poorly received, and chalked up only two performances before going into its fifty-five year hibernation. Record collectors of a fairly adventurous spirit are familiar with two of its soprano arias, "*Io sono l'umile ancella*" and "*Poveri fiori*"—excellent pieces for the lush *spinto* tone of a Claudia Muzio or a Renata Tebaldi.

The libretto, by Arturo Colautti, is drawn from a play by the indefatigable Eugène Scribe and Ernest Legouvé. It concerns Adrienne Lecouvreur, a leading light of the Comédie Française. She is

admired and loved by all, but she loves only Maurizio, the Count of Saxony and a noted military hero (though his rank is unknown to her at the beginning of the story). They declare their love in Act I. At the start of Act II, we meet the Princess of Bouillon, who is also in love with Maurizio, and who has, on the pretext of a political matter, lured him to the villa of one Mme. Duclos, another actress of the Comédie. When her husband unexpectedly arrives (Mme. Duclos being his mistress), the Princess is forced to hide. The Prince assumes that Maurizio is present for an assignation with Mme. Duclos, and the situation is further complicated by the arrival of Adriana, who assumes the same thing. Maurizio swears that this is not true, and enlists Adriana's help in aiding the unknown woman's flight. In the ensuing scene, Adriana assists the Princess in her escape

through the garden, and the two women realize that they are rivals for Maurizio's love. In Act III, the Princess gives an entertainment at which she and Adriana trade thinly masked insults, capped by Adriana's recitation of a pointedly appropriate speech from *Phaedra*. In Act IV, Adriana receives a bouquet of flowers—flowers which she had given to Maurizio, and which he in turn had given to the Princess as a gesture of loyalty. Adriana assumes that Maurizio has cruelly returned them as a sign that their love is over; he arrives to pledge his love, and for a few moments they are happy. But the Princess has poisoned the flowers, and within a brief time Adriana is dead.

Cilea's selection of dramatic materials and his treatment of them places him in the *verismo* school. His work is at one with the works of Leoncavallo, Giordano, Mascagni, Catalani, Ponchielli. *Adriana Lecouvreur* operates on the simplest musico-dramatic level. The big opening aria for Adriana, "*Io sono l'umile ancella*," is clearly devised so as to persuade us that because Adriana considers herself but a humble servant of her art, she must be a Good and Great Person. Its theme recurs throughout the opera whenever the composer wishes to remind us of this, which is naturally at all moments of sacrifice, devotion, or desertion. Since the theme is an effective one, the device works, at least the first few times around. The music is in general vigorous, schmaltzy stuff, a bit short on inspiration, though certainly not on energy. It sometimes fails to deliver the expected punch; the introduction to the Princess'

big scene at the start of Act II, for example, is good, tense dramatic writing, but the aria itself ("*Acerba voluttà*") is only moderately effective. There are some good passages for the tenor, too brief to be termed arias ("*La dolcissima effigie*," "*L'anima ho stanca*"); strong writing in the "confrontation" scene between soprano and mezzo; and a good many high notes for the tenor and soprano to hold onto. The important baritone role of Michonnet, the *régisseur* of the Comédie, who selflessly loves Adriana, is not terribly interesting musically, but is no doubt theatrically effective—his first-act scene with Adriana contains some touchingly restrained writing. I suspect that anyone fond of *Andrea Chénier* will find *Adriana* quite to his liking.

London has given the opera the sort of performance that will make it go. The title role is made to order for Mme. Tebaldi. She may not sing quite as easily as she once did—in fact, there are moments in this recording when her voice seems fully extended—but the vocal pluck is still very much in evidence, as is her musical sensitivity and temperament, somewhat generalized, but nonetheless compelling. Her chesty dramatic readings, however, are not miracles of declamation. Del Monaco produces a generous quantity of ringing high tones, and some isolated mezza-voce phrases to which he clings possessively. But there are too many passages slurred, and too many others for which there is no accurate word except "ugly." In any event, his singing is virile, and he can at least

match his partner, decibel for decibel, in terms of volume.

Giulietta Simionato is in good form and most authoritative, and Giulio Fioravanti, the excellent Lescaut of Angel's *Manon Lescaut*, sings a smooth, pleasant Michonnet, though his voice is not memorably rich or colorful. There is good work from Franco Ricciardi and Silvio Maionica in important *comprimario* roles. Franco Capuana's conducting is appropriately lively and splashy, and the sound is just fine, though the stereo set has considerably more presence than the mono, at least on my advance copies. There can be small doubt that this production supersedes the old Cetra effort, the only *Adriana* previously available.

In sum, we have an opera worth reviving for the proper prima donna, and we have the proper prima donna for whom to revive it.

CILEA: *Adriana Lecouvreur*

Renata Tebaldi (s), Adriana; Dora Carral (s), Jouvenot; Giulietta Simionato (ms), Principessa di Bouillon; Fernanda Cadoni (ms), Dangeville; Mario del Monaco (t), Maurizio; Franco Ricciardi (t), L'Abate di Chazeuil; Angelo Mercuriali (t), Poisson; Giulio Fioravanti (b), Michonnet; Silvio Maionica (bs), Principe di Bouillon; Giovanni Foianni (bs), Quinault. Chorus and Orchestra of Accademia di Santa Cecilia (Rome), Franco Capuana, cond.

• LONDON A 4359. Three LP. \$14.94.
• • LONDON OSA 1331. Three SD. \$17.94.



Alfred Brendel

by Harris Goldsmith

Variations for Piano Begin a Beethoven Project

WITH the present album, Vox Productions launches a formidable undertaking: the publication on microgroove of the complete piano music of Beethoven. The artist assigned to this marathon project is Alfred Brendel, a young Austrian pianist barely in his thirties who is scheduled to make his United States debut later this year. Sceptics may scoff at Vox's ambitious plans, for in the past many recording ventures

of similar magnitude have failed to materialize. But it might be well to note that this company is the only one to have kept its promise to issue all of the Schubert piano sonatas (one of the rival editions, that of Beveridge Webster on M-G-M, failed to progress beyond the first record!). There thus seems some reason to hope that the Beethoven project may really reach its completion on schedule in 1965.

Alfred Brendel would seem to be an a & r man's dream pianist. He is young, his repertoire is vast (already he has shown himself to admirable advantage in Mussorgsky, Balakirev, Prokofiev, Liszt, Schubert, Dvořák, and Mozart), and—most importantly—his pianism conveys enormous vitality and enthusiasm. The possessor of truly virtuoso technical equipment, Brendel is also happily blessed with a notably strong rhythmic

propulsiveness and an adventurous capacity for exploring unfamiliar paths. Not a particularly "pretty" pianist, this young man has assimilated many of the most admirable traits of his celebrated teacher, Edwin Fischer—most notably a respect for the music at hand and a disinclination to project the "originality" of his views on it simply for the sake of being different. But Brendel has polluted his mentor's sobriety with impetuosity and ardor. He is most definitely a mid-twentieth-century pianist, and his interpretations have the life and animated tension of the contemporary school. There is no prissiness here; rather, there is fire, *brio*, and understanding.

While it is a bit premature to measure Brendel's total capacity as an interpreter of Beethoven (these early variations, after all, are rather less demanding than the late sonatas and *Diabelli Variations*), he handles the works in this album with rare ability. Beethoven's gruff honesty seems to fit this pianist like a glove. The *Eroica Variations* receive a reading that is equal to any that I have ever heard (yes, Schnabel's included). This is a performance that builds and projects. Contrapuntal textures are miraculously clear, there is plenty of rhetorical emphasis, and also that necessary touch of recklessness to differentiate Beethoven's particular brand of keyboard virtuosity from, say, Liszt's or Weber's. Slower-paced than Schnabel's famous recording of the music, Brendel's account tends to be Olympian while the former's was mercurial, but both readings have the essential Prome-thean quality.

The other well-known set of Variations in this album, the 32 in C minor, fare less well. Here, I feel, Brendel is a

shade too rigid in his approach. True, the work is actually a chaconne, and it should build continuously, but Brendel carries the strictness of tempo to excess. Even when a climactic variation indicates a quickening of pulse, the pianist completely resists an acceleration. The music, as a result, sounds stolid. This is the only place where Mr. Brendel seems overly Teutonic, and yet even here his playing has integrity and stature.

Perhaps to a greater extent even than Mozart, Beethoven throughout his lifetime lavished much effort on perfecting and expanding the Variation form. Many of his works in this medium are frankly experimental. In the F major Variations, Op. 34, for instance, the composer tried the novel idea of using a new key for all but one of the six variations. Though he reverted to the conventional approach in subsequent works (even the *Diabelli Variations*, Beethoven's last major keyboard effort, is, with the exception of the fugue, firmly grounded on the tonality of C), the fantasialike effect of this bouquet of key signatures and contrasting tempos must certainly have inspired the great piano suites of Schumann and the other romantics. Yet even these composers left the Variation form, for the most part, in one key. For that matter, Beethoven too must have had misgivings about his innovation: while he retained fondness for his Op. 34, he never again used its ground plan.

On the other hand, the *Variations on Righini's "Venni Amore"* contain most of the vital elements of Beethoven's later work. What is even more remarkable about them, however, is that they contain certain turns of harmony and melody which one usually credits to Schubert's B flat and C minor posthumous Sonatas. Written in 1791, these

twenty-four ambitiously designed elaborations antedate Beethoven's "Opus 1" by four years and the Schubert creations by nearly forty! Similarly, the codas to the *God Save the King* and *Rule Britannia* sequences elaborate on and transfigure the themes in a manner similar to, although naturally less complex than, that used in the codas of the great Variation movements to the Op. 127 and 131 String Quartets.

Brendel's performances throughout are extremely brilliant and discerning. When to these virtues are added the excellent piano reproduction and very economical price, Vox is to be highly congratulated. May the whole series be as successful as this.

BEETHOVEN: *Variations for Piano*

✓ 15 *Variations on a Theme from Prometheus*, in E flat, Op. 35 ("Eroica"); 32 *Variations in C minor*, Grove 191; 6 *Variations on an Original Theme*, in F, Op. 34; 24 *Variations on Righini's Air "Venni Amore"*; 13 *Variations on Dittersdorf's Air "Es war einmal ein alter Mann"*; 9 *Variations on the Air "Quant è più bello"*; 6 *Variations on the Duet "Nel cor più non mi sente" from Paisiello's "La Molinara"*; 12 *Variations on a Russian Dance from Wranitsky's "Das Waldmädchen"*; 6 *Easy Variations on a Swiss Air*; 8 *Variations on Grétry's Air "Une Fièvre brûlante"*; 7 *Variations on "Kind willst du ruhig schlafen" from Winter's "Das unterbrochene Opferfest"*; 10 *Variations on Sussmayr's "Tändeln und Scherzen"*; 6 *Variations on an Original Theme*, in G; 7 *Variations on "God Save the King"*; 5 *Variations on "Rule Britannia"*; 6 *Variations on the Turkish March from "The Ruins of Athens," Op. 76.*

Alfred Brendel, piano.
● Vox VBX 416. Three LP. \$8.95.

CLASSICAL

BACH: *Cantata No. 170, Vergnügte Rub'*; *Christmas Oratorio: Arias*; *Cantatas Nos. 34 and 108: Arias*

Aafje Heynis, contralto; Vienna Symphony Orchestra, Hans Gillesberger, cond. (in No. 170), Netherlands Chamber Orchestra, Szymon Goldberg, cond.
● Epic LC 3805. LP. \$4.98.
● ● Epic BC 1146. SD. \$5.98.

The voice of Aafje Heynis, the young Dutch contralto, does not seem particularly large or rich but it has an attractive silvery, dusky hue. It is firm and true. She can spin a smoothly flowing line when she wants to, but here she often prefers to change the color of her tones constantly in the course of a movement or even a phrase—a procedure that breaks up entities and introduces little air spaces where connection is called for. There is no great emotional

range in the selections chosen; most of them call for tender, lyric treatment, which they get, but the somewhat unusual irregularly crawling line of "*Wie jammern mich doch*" in No. 170 is handled with steady confidence. The arias from the *Christmas Oratorio* are "*Bereite mich Zion*" from Part I and "*Schlafe, mein Liebster*" from Part II; those from the cantatas are "*Wohl euch, ihr auserwählten Seelen*" from No. 34 and "*Was mein Herz von dir begehrt*" from No. 108. The sound is excellent, and German texts and English translations are provided, but there are no visible bands between the movements of No. 170. N.B.

BACH: *Concerto for Two Violins and Orchestra, in D minor, S. 1043*

†Vivaldi: *Concerto grosso, Op. 3, No. 8, in A minor*

†Beethoven: *Romances for Violin and Orchestra: Op. 40, No. 1, in G; Op. 50, No. 2, in F*

David Oistrakh, violin; Igor Oistrakh, violin (in the Bach and Vivaldi); Royal Philharmonic Orchestra, David Oistrakh, cond. (in the Vivaldi), Sir Eugene Goossens, cond.

● DEUTSCHE GRAMMOPHON 18714. LP. \$5.98.
● ● DEUTSCHE GRAMMOPHON 138714. SD. \$6.98.

Father and son give us a Bach Double Concerto that is much slower than the recent Heifetz-Friedman version, and considerably warmer. This is a welcome change of pace, particularly in the slow movement where, without resorting to sentimentality, so much can be said if there is only time to say it. The Vivaldi work too, delicately scored and more open in texture than the Bach, prospers in this warm climate; its grave middle movement achieves really stately proportions.

Igor Oistrakh (who I assume plays the second part, relegated to the right-hand stereo channel) is just a shade less flexible than David and tends, in the Bach, to bite off phrases a bit more abruptly. But otherwise the family front is smoothly unified and the teamwork of a high order.

The Beethoven *Romances* are handsomely done, with the sole exception of one or two moments in which the violin tone sounds rather thin in the high register. Whether this is simply a recording fluke or is characteristic of the solo-

ist is difficult to say. On the whole, the sound is excellent. SHIRLEY FLEMING

BACH, WILHELM FRIEDEMANN:
Polonaises (12); Other Piano Works

Heida Hermanns, piano.

• SOCIETY FOR FORGOTTEN MUSIC M 1009. LP. \$4.98.

• • SOCIETY FOR FORGOTTEN MUSIC S 2009. SD. \$5.95.

When the legends and unverified anecdotes are stripped away from the biography of J. S. Bach's oldest son, what remains is a shadowy and strange figure. Regarded as one of the finest organists of his time and a highly respected teacher, Wilhelm Friedemann evidently could not adjust himself to living in a period when the solid values and unshakable religious faith that had governed his father's household were giving way to a more personal, more romantic view of life. In the last twenty years of his life he could not put down roots anywhere, nor was he interested in, or perhaps capable of, holding a position at a court or in a church.

His music, of which the present disc supplies an interesting sampling, is as erratic as the man himself. Many of the slower Polonaises have a high degree of "sensitivity," a poetic quality more frequently ascribed to his younger brother Philipp Emanuel than to Friedemann. In the fast ones there is considerable originality, but the results are not always convincing. Sometimes, as in the tenth Polonaise, there are curious progressions, but they do not all come off; some give the effect of mere wandering. The other works on this disc are a sad, expressive Fugue in E minor, the most consistently well-written piece in this group; an insignificant March in E flat; a Sonata in A, loosely constructed, with good ideas giving way to meaningless arpeggios; and an early Suite. Miss Hermanns takes the right kind of approach to these pieces, and while her playing would benefit by greater evenness and clarity in rapid runs, it is in the main competent. Good sound in both versions. N.B.

BARTOK: Concerto for Violin and Orchestra, No. 1, Op. posth.

†Viotti: *Concerto for Violin and Orchestra, No. 22, in A minor*

Isaac Stern, violin; Philadelphia Orchestra. Eugene Ormandy, cond.

• COLUMBIA ML 5677. LP. \$4.98.

• • COLUMBIA MS 6277. SD. \$5.98.

Bartók composed his First Violin Concerto in 1907, for Stefi Geyer, a violinist with whom he is said to have been in love at the time. She retained the manuscript all her life, and it did not come to light until after her death, in 1958; this is its first recording, taken after what was, in all probability, its first performance in the United States.

Why Bartók did not publish the Concerto is unknown, but he did publish the first of its two movements as the first of the *Two Portraits* for violin and orchestra; this work is quite well known, at least among lovers of Bartók, and five different recordings of it are listed in the current Schwann. The only thing new here, then, is the second movement of the Concerto; it has only two, slow and fast, as if it were a gigantic Hungarian rhapsody, although it displays no Hun-

garian color at all. That second movement is much weaker than the first, and is, indeed, one of the weakest pages in all of Bartók. The mystery of the First Violin Concerto is therefore easily explained: Bartók discarded its poorer half and saved its better one under a different title. One may be grateful, however, that the publication of the entire work finally brought Stern around to recording its first movement, which is a superlatively beautiful, singing, soaring, lyric masterpiece on a theme strangely like the one that characterizes Don Quixote in the tone poem by Richard Strauss. The *Two Portraits* are said to be musical characterizations of Bartók himself and Stefi Geyer, and the reference to Strauss's knight of the rueful countenance therefore seems deliberate.

The Viotti on the other side is a tuneful, beautifully written piece in classic style, and is a most welcome addition to the recorded repertoire, at least as Stern performs it. The recorded sound in both instances is just as fine as the playing. A.F.

BASSETT: Trio for Clarinet, Viola, and Piano—See Perle: Quintet for Strings, Op. 35.

BEETHOVEN: Piano Works

Sonata for Piano, No. 18, in E flat, Op. 31, No. 3; Ecossaises; Rondo, in G, Op. 51, No. 2; Ländler Tänze, in D (7); Variations, in C minor (32), Grove 191

Maria Greenberg, piano.

• MK-ARTIA 1568. LP. \$5.98.

No sort of notes are included with this

Russian-made recording on the performer's background, but from the evidence here it is apparent that she is a musician well worth our acquaintance. In fact, this is the most idiomatic Beethoven playing I have heard from a Soviet artist (assuming, of course, that Miss Greenberg is that), and these renditions must be counted among the best recorded versions we have had. Basically, Miss Greenberg favors the boldly energetic, amply inflected Beethoven style of Schnabel rather than the crisply symmetrical Gieseking-Solomon school. This energizing stress produces, for example, an exhilarating account of the Op. 31, No. 3 Sonata—a piece which is more susceptible than most of Beethoven's writing to the Gieseking manner, but which responds to the vigor and gusto of a truly Beethovenesque interpretation mightily. My only reservation in the present performance concerns the arbitrary sounding *ritardando* at meas. 63 (again at meas. 238) in the last movement; it disrupts the continuity of the music.

Miss Greenberg's account of the C minor Variations is equally striking. The pianist concentrates on the stormy, expressive content of this work, and chooses to understate the rigid chaconne-like sequence of the variations. By some miracle, this artist manages to work towards a convincing climax despite the greater than usual rhythmic freedom she utilizes. Here is a pianist who is clearly able to differentiate between metronomic stiffness and truly vibrant pulse. The Rondo shows that Miss Greenberg can spin out a sensitively inflected melodic line, while the lively *Tänze* are the happy recipients of the pianist's vital sforzandi. The recorded sound is very acceptable, although the surfaces are a bit coarser than we are accustomed to hearing from the best Western discs. H.G.

BEETHOVEN: Romances for Violin and Orchestra: Op. 40, No. 1, in G; Op. 50, No. 2, in F—See Bach: Concerto for Two Violins and Orchestra, in D minor, S. 1043.

BEETHOVEN: Sonata for Piano, No. 21, in C, Op. 53 ("Waldstein")

†Schumann: *Arabesque, in C, Op. 18; Nachtstück, in F, Op. 23, No. 4; Waldszenen, Op. 82: No. 7, Vogel als Prophet; Romances, Op. 28: No. 2, in F sharp minor*

Guiomar Novaes, piano.

• Vox PL 11990. LP. \$4.98.

• • Vox STPL 511990. SD. \$4.98.

I doubt if even Novaes' most ardent admirers would claim that she is a great interpreter of Beethoven. Although this pianist's intuitive warmth and spontaneity can make an engaging thing out of the G major Concerto or the *Les Adieux* Sonata, she lacks the requisite *furioso* and slashing incisiveness called for in the bravura, and typically Beethovenian, *Waldstein* Sonata. Furthermore, to judge from this disc, her digital symmetry is not what it once was (and ought to be in this basically classical creation). The pianist is altogether too careful in tempo, too constrained in spirit here. The first movement moves at a leaden gait, while the final Allegretto sounds bumptious. Novaes uses a text that features some

Continued on page 74

NEXT MONTH IN
high fidelity

**The Triumphs and Troubles
Of the Met**

An appraisal of America's
famous opera company.

by Martin Mayer

Improvements in Arms

New designs in tone arms
and what they signify.

by Joseph Marshall

**When the Big Bands
Played Swing**

by Martin Williams



The selections in Angel's album *The Young Caruso* COLH 119 were recorded from 1902 to 1904.

In 1902, this was the outstanding operatic recording of the year. The artist was Enrico Caruso.

Now, 60 years later, we still adhere to that tradition. These are our new albums this month:



Highlights (S) 35632
Gorr / Gedda / Blanc / Quilico / The Paris Conservatory Orchestra, George Prêtre, Conductor



Complete (S) 3603 B/L
Micheau / Gedda / Blanc / Mars / Theatre Nationale de l'Opera-Comique, Pierre Dervaux, Conductor



Highlights (S) 35685
Complete (S) 3620 D/L
Hopf / Grümmer / Fischer-Dieskau / Frick / Franz Konwitschny, Conductor



Highlights (S) 35645
Complete (S) 3563, D/L
Schwarzkopf / Edelmann / Wächter / Ludwig (in German) / The Philharmonia Orchestra, H. Von Karajan, Conductor

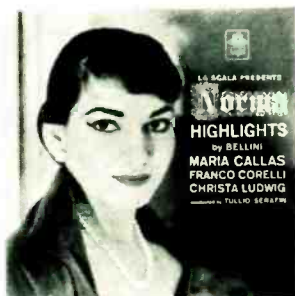

Highlights (S) 35666
Complete (S) 3615 C/L
Callas / Corelli / Ludwig / La Scala Orchestra and Chorus, Tullio Serafin, Conductor



Highlights (S) 35640
Complete (S) 3608 D/L
Schwarzkopf / Wächter / Taddei / Maffo / Cossotto / The Philharmonia Orchestra, Carlo Maria Giulini, Conductor



Highlights (S) 35642
Complete (S) 3605 D/L
Schwarzkopf / Wächter / Sutherland / Alva / Sciutti / The Philharmonia Orchestra, Carlo Maria Giulini, Conductor

CIRCLE 6 ON READER-SERVICE CARD

questionable octave doublings in both the first movement and the finale, but she at least avoids the notorious G in the latter (Meas. 27 *et seq.*) that has crept into so many editions instead of F.

This artist is in more congenial environment in the Schumann selections, although I must confess that I find her heart-on-sleeve romantic manner somewhat excessive even for this material. I miss a certain reticence in her handling of the *Prophet Bird*, and the strange accentuation of inner voices makes for a rather stolid account of the *Arabeske*. The lush, singing tone Novaes produces is a distinct asset in the *Romanze*, however.

The sound is good, although some of the climaxes in the Beethoven are blurred from excessive use of the sustaining pedal. H.G.

BEETHOVEN: *Variations for Piano*

Alfred Brendel, piano.
• Vox VBX 416. Three LP. \$8.95.

For a feature review of this album, see page 70.

BERIO: *Circles*

†Bussotto: *Frammento*
†Cage: *Fontana Mix; Aria*

Cathy Berberian, soprano; Luciano Berio, piano; Boris de Vinogradov and Jean Pierre Drouet, percussion; electronic tapes.

• TIME 58003. LP. \$4.98.
• • TIME S 8003. SD. \$5.98.

Cathy Berberian, the American wife of the Italian composer Luciano Berio, is to modern song what Joan Sutherland is to *Lucia* or Elisabeth Schwarzkopf to *Rosenkavalier*. Neither of these great ladies, however, is faced with the fiendish mixture of singing, *Sprechstimme*, speech, whispering, and assorted vocal noises demanded by practically everything Berberian does, including the four works recorded here. Along with virtuosity, Berberian has a perfect ear and a musical personality of the most compelling kind, as the present recording makes amply apparent.

One side of the disc is devoted to Berio's highly lyrical and extremely beautiful song cycle entitled *Circles*, for voice, harp, and percussion. On the other side is Sylvano Bussotto's *Frammento*, an indescribable piece for voice and piano, and two wildly anarchical compositions by John Cage for voice and tapes—*Fontana Mix* and *Aria*. These works are fascinating, partly because of Berberian's ability to fascinate the listener with anything, and partly because of their extreme character and the formidable nature of the vocal difficulties which the singer solves so easily: compared to Cage's *Aria*, Donizetti's "Mad Scene" is *Twinkle, Twinkle, Little Star*.

The recording is out of this world; one doesn't know how nearly perfect, how subtle and brilliant the sound of recorded music can be until one has heard this disc. It has been poorly annotated, however. The album contains ten pictures of the participants, including six of Berberian, but nary a word of the Cummings texts for *Circles* nor even an indication of the source of the text for the Bussotto and Cage pieces. This is a very great mistake. A.F.

BERLIOZ: *La Damnation de Faust* (highlights)

Rita Gorr (ms), Marguerite; Nicolai Gedda (t), Faust; Gerard Souzay (b), Méphisto. Chorus and Orchestra of the Paris Opéra, André Cluytens, cond.
• ANGEL 35941. LP. \$4.98.
• • ANGEL S 35941. SD. \$5.98.

This is a recording that will appeal mainly to those who want to hear the vocal excerpts well sung. It does not offer an adequate representation of the work (only a complete, or near-complete version can do that—and both the Munch and Markevitch performances are of unusual interest), nor does it give us especially exciting performances of the orchestral excerpts, for which one can easily turn elsewhere. What it does present is some excellent singing from the three soloists. Of special interest is the work of Rita Gorr, the highly regarded French mezzo who will sing at the Metropolitan next winter. Her previous appearances on domestically available records have been confined to such roles as the Nurse in *Pelléas* and Mère Marie in *Les Dialogues des Carmélites*, which are not calculated to show a significant voice at its best. Here, she sings Marguerite's two wonderful pieces, "*Le Roi de Thulé*" and "*De l'amour l'ardente flamme*," and makes it perfectly clear why she has become France's leading mezzo. The voice is Flagstadian in its columnar solidity—it has an easy brightness. While she brings no particular penetration to the Ballad (the voice is almost too lush for the music and the sense of the text), she sings the more passionate "*De l'amour*" with extraordinary sensitivity. I look forward to her creation of Fricka for the new Victor *Walküre*.

Gedda and Souzay are both in fine form, and it's rather a pity that the latter is not given a chance at "*Voici des roses*," which he would surely do well. The sound is broad and full, and while Cluytens is not galvanic, both orchestra and chorus are admirable. C.L.O.

BINKERD: *Symphony No. 1*

†Wagner: *Siegfried Idyll*

St. Louis Symphony Orchestra. Edouard van Remoortel, cond. (in the Binkerd); Columbia Symphony Orchestra, Max Rudolf, cond. (in the Wagner).
• COLUMBIA ML 5691. LP. \$4.98.
• • COLUMBIA MS 6291. SD. \$5.98.

The symphony by Gordon Binkerd, professor of music at the University of Illinois, is a superb example of the genus in its modern American manifestation. In general, it subscribes to a vigorous neoclassicism both in form and instrumentation, but with no academic following of formula. On the contrary, everything about this vivid, grandly shaped score is personal and individual, and what is more important, everything is *right*: there is not a note anywhere that does not add to the effect. The interpretation is presumably good, and the recording is excellent.

Max Rudolf's *Siegfried Idyll* on the other side is a gem of interpretation and recording. This must surely be one of the finest disc editions of Wagner's concert masterpiece. A.F.

BUSSOTTO: *Frammento*—See Berio: *Circles*.

BYRD: *Keyboard Music*

Paul Maynard, organ and harpsichord.
• DECCA DL 10040. LP. \$4.98.
• • DECCA 710040. SD. \$5.98.

The meager representation of this great Tudor master in the domestic catalogues has been confined to his vocal music. Now we have a cross section of his keyboard works, showing his skill and inventiveness in handling the free fantasy, simple and elaborate dances, variations on plainsongs and popular tunes, and the descriptive piece. These compositions are commonly thought to have been written for the virginal, but Mr. Maynard believes that some of them may have been intended for the organ also. Most of those played on the latter instrument here seem to support his contention. In the *Miserere*, the two settings of *Veni Creator Spiritus*, and the variations on *Ut-re-mi-fa-sol-la*, the plainsong or *cantus firmus* is presented in long notes that cannot be sustained on the harpsichord. The polyphonic *Voluntarie* also comes off well on the organ. The *Earle of Salisbury* pavan and galliard, however, seem better suited to the harpsichord. Mr. Maynard enlivens the pieces by adding embellishments, his technique is more than equal to the demands made upon it, and he plays the dances with a good swing. The recorded sound of both organ and harpsichord is very fine. N.B.

CAGE: *Fontana Mix; Aria*—See Berio: *Circles*.

CHERUBINI: *Requiem Mass, in C minor*

Roger Wagner Chorale, Royal Philharmonic Orchestra; Roger Wagner, cond.
• CAPITOL P 8570. LP. \$4.98.
• • CAPITOL SP 8570. SD. \$5.98.

The intensity of Toscanini's leadership lent a very special character to RCA Victor's recording of this work. That character is absent here, since as a conductor Roger Wagner brings no particular insight or impulse to the music; he simply acts as its capable custodian. On the other hand, there are no doubt many listeners who do not care to have their Cherubini Toscanini-ized. The chorus sings with rich, well-blended tone, if not with Shavian (Robert, that is) incisiveness, and the orchestra, though not inspired, is adequate. Recording is excellent in both versions, with the stereo edition (the first stereo version of this *Requiem*, by the way) offering a nice, even spread. C.L.O.

CHOPIN: *Ballades: No. 1, in G minor, Op. 23; No. 2, in F, Op. 38; No. 3, in A flat, Op. 47; No. 4, in F minor, Op. 52*

Stanley Hummel, piano.
• ERSTA 1040. LP. \$4.98.

Hummel's piano is reproduced with a vibrant clarity, and a tonal firmness so real that one can almost touch the sounds as they issue forth from this disc. The performances, for that matter, are also highly tactile. This pianist puts stress on the differing textures of Chopin's tonal fabric; and taking advantage of the ideal spaciousness and separation of the

Continued on page 77

The Instruments:

Tin Tray

Cuckoo

Quail

Butter Dish

The Composers:

Mozart

Bach

Reinecke

Lachner

plus Orchestra

The result: the most unique classical album you've ever heard



When the world's greatest musicians play the music of the masters on toy instruments, the results add up to musical fun for the participants and unique entertainment for you. Toys + Orchestra = Musical Fun is just one of the many unusual records from Kapp. Be sure to look for our latest unique album: "The Wonderful World of Brother Juniper" (KL-1273/KS-3273). We guarantee it will split thy sides. Free: send for full color catalog and record guide. Kapp Records, 136 East 57th St., N. Y. 22.

KAPP RECORDS
CIRCLE 54 ON READER-SERVICE CARD





MOMENT OF EXALTATION!

The reaction to a moment of exaltation in the theatre is intensely personal. Equally personal is the reaction evoked within you by music. Your own ear is the best judge of the ability of a speaker system to re-create the emotional impact of the original musical performance. Technical details can not be expected to answer the question, "Does it sound natural?" Each person must listen and judge for himself. The concept behind the Wharfedale Achromatic Speaker Systems reflect extensive musical training and great respect for musical values. Here is the truly natural reproduction of sound, free of spurious resonance and artificial tonal coloration. An exclusive sand-filled baffle, coupled with special speakers built to match it, projects full, true bass and rich, non-strident high notes. To appreciate this achievement, listen to a recording you know and enjoy as it is reproduced by a Wharfedale speaker system.

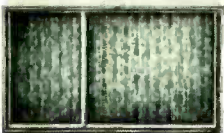

THE WHARFEDALE W60
achromatic speaker system
true wood \$116.50, unfinished \$101.50



Wharfedale

A reprint suitable for framing available on request. Address Dept. WC 22 British Industries Corp., P.O. Washington, N. Y.
CIRCLE 100 ON READER-SERVICE CARD

MARCH 1962

Continued from page 74

studio acoustics, he exposes many inner voices and other details. Basically, these are big expansive renditions, very rhetorical, and perhaps a bit dated in their pianistic outlook. Mr. Hummel is, for my taste, just a little too rococo in his rubato and too cavalier about introducing "effective" dynamic changes and harmonic amplifications (e.g., extra octaves in the bass, open fifths in those already there), but there is no denying that his spare, crisp pedal effects and fastidious digital independence represent capable pianism. The A flat Ballade, incidentally, is a different (and slightly more exaggerated) performance than that on Hummel's "Encore" record released a year or so ago.

Fou Ts'ong's Westminster disc of the four Ballades is, to my mind, a more limpid, artistic, and less self-conscious presentation of these works, and his record also offers some additional music.

H.G.

CILEA: *Adriana Lecouvreur*

Renata Tebaldi (s), Adriana; Dora Carral (s), Jouvenot; Giulietta Simionato (ms), Principessa di Bouillon; Fernanda Cadoni (ms), Dangeville; Mario del Monaco (t), Maurizio; Franco Ricciardi (t), L'Abate di Chazeuil; Angelo Mercuriali (t), Poisson; Giulio Fioravanti (b), Michonnet; Silvio Maionica (bs), Principe di Bouillon; Giovanni Fojanni (bs), Quinault. Chorus and Orchestra of Accademia di Santa Cecilia (Rome), Franco Capuana, cond.

• LONDON A 4359. Three LP. \$14.94.
• • LONDON OSA 1331. Three SD. \$17.94.

For a feature review of this recording, see p. 69.

COUPERIN: *Selected Works*

Anton Heiller, harpsichord.
• VANGUARD BG 619. LP. \$4.98.

Mr. Heiller, well known as an organist and composer as well as a harpsichordist, has made a fine selection of a dozen pieces from the great Couperin's treasury of little keyboard tone poems. Included here are not only such familiar items as *Les Baricades mystérieuses* and *Le Tic-toc-choc* but the grand and powerful *Passacaille*; the suite called *Les Fastes de la grande et ancienne Ménestrandises*, a kind of baroque *Pétrouchka*; and the charming set of variations titled *Les Folies françaises*. All of these pieces are played with technical finish, and some of them—particularly the long ones—with variety of tempo and registration. But in well over half of them there is a squareness in the rhythm, a lack of flexibility in the phrasing, and a rather chilling exactness in the repetitions of sections that drain these fanciful works of their vitality and make them seem longer than they are. The sound of the monophonic recording is excellent. N.B.

DARGOMIJSKY: *Romances*

What's There in My Name; Vertograd; A Youth and a Maiden; I Loved You; The Night Zephyr; To Friends; The Miller; A Tear; I Remember; The Wedding; Titular Counsellor; The Sierra Nevada Is in the Mist; Bewitch Me; I

Am in Love, My Beauty; I Am Sad; Old Corporal.

Boris Gmyrya, bass; Lev Ostrin, piano.
• MK-ARTIA 1566. LP. \$5.98.

This disc offers as much sheer pleasure as any I've heard for some time. The songs, all of them unfamiliar to me, are lovely, evocative ones which project their romantic and humorous moods even in the absence of any sort of text or paraphrase on the jacket. And as for the singer—I cannot remember hearing a bass with a more beautiful quality of tone or a more impressive technical command. His mastery of the music is absolute: dark or bright, loud or soft, low or high, legato or staccato—it simply does not matter to him. Yet he never becomes precious or fussy in his handling of the songs.

In short, we have here fresh captivating music, stunningly sung. Lev Ostrin's accompaniments are altogether fine, and the sound very listenable, though the level suddenly drops on the last song, *Old Corporal*. Despite the deplorable omission of texts, this is a recording to cherish. C.L.O.

DVORAK: *Symphony No. 5, in E minor, Op. 95 ("From the New World")*

Vienna Philharmonic Orchestra, Istvan Kertesz, cond.

• LONDON CM 9295. LP. \$4.98.
• • LONDON CS 6228. SD. \$5.98.

To one perhaps overfamiliar with the *New World Symphony*, there seemed in this recording to be new color and adventure in every phrase, yet without ever violating the composer's intentions. My impression is that the thirty-year-old Hungarian refugee conductor, Istvan Kertesz, brings to Dvořák's music a genuine enthusiasm. General Music Director of the Augsburg Opera, Kertesz is fulfilling guest conducting engagements in Europe, and has appeared here this season with the Detroit and Minneapolis orchestras. He is definitely a young man to be watched. In the present performance, he has the Vienna Philharmonic on its toes all the time, and London's engineers have transmitted this playing with exceptional liveliness and realism. P.A.

GIORDANI: *Concerto for Harpsichord and Orchestra, in C—See Haydn: Concerto for Violin and Orchestra, No. 1, in C.*

GRIEG: *Concerto for Piano and Orchestra, in A minor, Op. 16*

Artur Schnabel, piano; RCA Victor Symphony. Alfred Wallenstein, cond.
• RCA VICTOR LM 2566. LP. \$4.98.
• • RCA VICTOR LSC 2566. SD. \$5.98.

On the jacket of this release appears this quotation from Artur Schnabel: "In its rare coincidence of sound, balance and performance of conductor, orchestra and soloist, this is the most perfect recording I have made." Such a statement by an artist is unusual, to say the least; in the case of Schnabel and the Grieg Concerto, it is even more unusual.

Schnabel has had a long disc association with this concerto. It was the first work he ever recorded in America,

in 1942 with Eugene Ormandy and the Philadelphia Orchestra. With the advent of microgroove, the need arose for a new version, which was duly made in 1949 with the RCA Victor Symphony Orchestra under Antal Dorati. By the time another seven years had elapsed, stereo had reared its two heads—and back to work went Rubinstein, again with the RCA Victor Symphony, but this time conducted by Alfred Wallenstein.

With the Grieg Concerto already committed to stereo, why should we have a second stereo edition from the same performers in 1961? That was the question I asked before I compared the 1956 and 1961 recordings. The answer becomes immediately apparent. Interpretatively, there is little discernible difference. The statements are clear and unhurried, yet full of immense vitality and youthful ardor from an artist over seventy who refuses to grow old. Wallenstein's accompaniments are warm and sympathetic. Where the difference lies is in the sound. What strides have been made in the past five years! By present-day standards, the piano tone in the older recording is more than satisfactory, though even in stereo it is two-dimensional. In the new version it takes on new color, roundness, depth, and vibrancy, characteristics which are to be noted even in the mono edition. Similarly, though the 1956 orchestra has adequate horizontal spread, direction, and fidelity, it is also two-dimensional (as well as having a certain cramped sound, as if the recording had been made in a relatively small studio). Depth is added to width in the 1961 sonics, thanks to more resonant acoustics. In other words, this new release is not a superfluous remake.

Although it might have been more advantageous to round out the second side with another modernized recording of the Liszt E flat Concerto, the companion work on the 1949 and 1956 discs, it is nonetheless pleasant to hear Rubinstein in five of his encore favorites—the romantic Schumann *Romance* and Liszt *Valse oubliée*, the brilliant Villa Lobos *Polichinelle* and Prokofiev March from *The Love for Three Oranges*, and that Rubinstein special *tour de force*, Falla's *Ritual Fire Dance*. P.A.

HANSON: *Symphony No. 1, in E minor, Op. 21 ("Nordic"); Fantasy Variations on a Theme of Youth*

David Burge, piano (in the *Fantasy Variations*); Eastman-Rochester Orchestra, Howard Hanson, cond.
 • MERCURY MG 50165. LP. \$4.98.
 • • MERCURY SR 90165. SD. \$5.98.

Howard Hanson has made more and better records of modern American music than anybody else alive. His achievement in this respect is of major importance, and it is therefore with genuine, heartfelt regret that I report that his First Symphony, composed forty years ago, is a monumental piece of *Kitsch* which might well have been left to its fate in the libraries. The *Fantasy Variations on a Theme of Youth* is, presumably, a much later work (Arthur Loesser's jacket notes do not even mention it); I wish I could say that it is a finer one. The recording has been given gorgeous sound. A.F.

HAYDN: *Concerto for Violin and Orchestra, No. 1, in C*

†Giordani: *Concerto for Harpsichord and Orchestra, in C*

†Mozart: *Divertimentos: in B flat, K. 137; in F, K. 138*

Felix Ayo, violin (in the Haydn); Maria Teresa Garatti, harpsichord (in the Giordani); I Musici.

• EPIC LC 3818. LP. \$4.98.
 • • EPIC BC 1150. SD. \$5.98.

The "official" attitude toward most of Haydn's concertos—including the two or three he wrote for his faithful Esterházy fiddler Luigi Tommasini—has always been somewhat down the nose, but it would take a very long nose indeed to hide from sight the attractive aspects of this work in C major. Its most winning feature is a slow movement in which the violin, over pizzicato accompaniment, sings reflectively and tenderly in a manner that seems made to order (as of course it was) for the fluid, sweet-toned, naturally phrased style characteristic of Italian string players. Felix Ayo revels in it; and if, in the other movements, he lends significance to simple arpeggio figures by the sheer persuasiveness of his playing, I for one cannot scorn them.

Giordani spent much of his life in Dublin, which evidently agreed with him: this concerto is full of sunshine and merriment, and is spun off to perfection by Miss Garatti and her colleagues—who constitute (if any doubt on the subject could possibly linger) one of the very finest string ensembles in the world. Their luminous tone and remarkable sense of ensemble—abetted here by clear, bright, live recorded sound—do excellent service too for Mozart's divertimentos of 1772, which he called quartets but which Einstein designates as "simply symphonies for strings alone." The opening of K. 137 is surprisingly restrained and dark, but the other movements either lyrical or energetic. This record, in short, is a joyous affair. SHIRLEY FLEMING

HAYDN: *Sinfonia Concertante, in B flat, Op. 84; Overture No. 4, in D; Concerto for Trumpet and Orchestra, in E flat*

Adolf Holler, trumpet; Hamburg Chamber Orchestra, Hans Jurgen Walther, cond. (in the *Sinfonia*); Vienna Philharmonica Orchestra, Hans Swarowsky, cond.

• URANIA UR 129. LP. \$4.98.
 • • URANIA US 5129. SD. \$5.98.

"Mr. Salomon gave his fourth concert on Friday night, in which Haydn shone



Egon Petri: octogenarian virtuoso.

with more than his usual luster. . . . A new *Concertante* . . . was performed for the first time with admirable effect. The solo parts were finely contrasted with the 'full tide or harmony' of the other instruments, and they were very ably sustained by the respective performers."

So a London critic of 170 years ago greeted this work, which Haydn had composed at *furioso* tempo for the occasion. Unfortunately, although the symphony of the evening (No. 98) has remained with us, the *Sinfonia Concertante* has tended to occupy that unfortunate category of "neglected masterpieces." It really deserves better. The thematic material is strong and its development is marked by the imaginative invention typical of Haydn's London years. This performance is a good one, filled with the gallant manner and generally more sympathetic to Haydn's stylistic requirements than the rival Ormandy version. The coupling is attractive too. The Overture is a good example of its type, and the Trumpet Concerto is always welcome—although the Longinotti-Ansermet disc is superior to this. R.C.M.

HINDEMITH: *Sonata for Piano, No. 3, in B flat—See Shostakovich: Sonata for Piano, No. 2, in B minor, Op. 64.*

JACOBI: *Quartet for Strings, No. 3; Ballade for Violin and Piano; Fantasy for Viola and Piano*

Fredell Lack, violin (in the *Ballade*); Louise Rood, viola (in the *Fantasy*); Irene Jacobi, piano (in the *Ballade* and *Fantasy*); Lyric Art Quartet (in the *Quartet*).

• COMPOSERS RECORDINGS CRI 146. LP. \$5.95.

The late Frederick Jacobi was a devoted servant of music who nobly upheld a strongly conservative position. It seems inconceivable that the quartet recorded here was written in 1945. It sounds like Dvořák and should by rights be the product of a much earlier era in American composition. It is extremely good Dvořák, however, and it is superlatively well played, although the recording is a bit tinny in sound.

The *Ballade* and the *Fantasy* are exercises in the rhapsodic-dramatic, with impressionistic touches in the former work. Both make very satisfactory listening. Both are magnificently performed and reasonably well recorded. A.F.

LISZT: *Piano Transcriptions*

Egon Petri, piano.
 • WESTMINSTER XWN 18968. LP. \$4.98.
 • • WESTMINSTER WST 14149. SD. \$5.98.

The Liszt paraphrases were frankly composed as keyboard stunts; they belong to a bygone era of pianism, when performers and fellow composers considered it permissible to borrow and alter each other's compositions in the interest of "free expressiveness." Today, most players tend to sneer at these transcriptions—and they often *do* tend to sound dated and overelaborate. But put this music into the hands of a keyboard giant with a true love and understanding for the

Continued on page 80

STEREO



VST 318

Beethoven: **FIDELIO**

KNAPPERTSBUSCH,
cond.

Sena JURINAC

Jan PEERCE

Maria Stader

Murray Dickie

Gustav Neidlinger

Deszo Ernster

Frederic Guthrie

Georg Paskuda

Paul Neumer

Bavarian State Opera Orchestra and Chorus



NOW—A DEFINITIVE FIDELIO FOR THE SELECTIVE LISTENER—ON WESTMINSTER

Westminster has assembled an internationally-renowned cast, including Jan Peerce and Sena Jurinac, for a truly memorable recording of Beethoven's only opera, *Fidelio*, under the inspired direction of Hans Knappertsbusch. This set, which marks the first appearance together on records of Peerce and Jurinac, is a must for the selective listener. This month's releases include 3 masterpieces of liturgical music, Bach's *St. John Passion* and Haydn's *Seven Last Words of Christ*, magnificently interpreted by Hermann

Scherchen conducting the Vienna State Opera Orchestra with distinguished soloists and the Vienna Academy Chorus. A remarkable recording of Campra's *Mass for the Dead* by a French ensemble under the direction of Louis Frémaux rounds out the classical releases for this month. And—in a lighter vein—two albums of Viennese waltzes and an album of Hungarian folk music played by a native ensemble. This is the best in music—for the Selective Listener—on Westminster.

Beethoven: Fidelio. Sena Jurinac, Jan Peerce, Soloists, Bavarian State Opera Orchestra and Chorus conducted by Hans Knappertsbusch. (3-record set) WST-318 (Stereo), \$17.94; XWN-3318 (Monaural), \$14.94.

Bach: St. John Passion. Phyllis Curtin, Soloists, Vienna State Opera Orchestra and Vienna Academy Chorus conducted by Hermann Scherchen. (3-record set) WST-319 (Stereo), \$17.94; XWN-3319 (Monaural), \$14.94.

Haydn: Seven Last Words of Christ. Soloists, Vienna State Opera Orchestra and Vienna Academy Chorus conducted by Hermann Scherchen. WST-17006 (Stereo); XWN-19006 (Monaural).

Campra Requiem: (Messe des Morts), Soloists, Orchestra Jean François Paillard, Chorales Philippe Caillard et Stéphane Caillat conducted by Louis Frémaux. WST-17007 (Stereo); XWN-19007 (Monaural).

Folklore from Hungary: Soloists, Orchestra and Chorus. "Duna" Ensemble, Budapest conducted by Béla Vavrinecz. WST-17008 (Stereo); XWN-19008 (Monaural).

Waltzing in Vienna: 20 waltzes played by the Vienna State Opera Orchestra, Josef Leo Gruber conducting. WST-17010 (Stereo) XWN-19010 (Monaural).

Waltzing to the Strains of Strauss: 20 waltzes played by the Vienna State Opera Orchestra, Josef Leo Gruber conducting. WST-17009 (Stereo); XWN-19009 (Monaural).

The Westminster Listener is the Selective Listener Free . . . for the Westminster Listener—complete new catalog. Write Dept. HF-5, Westminster Recording Co., Inc. A subsidiary of ABC-Paramount Records, Inc. 1501 Broadway, New York 36, New York. Stereo: \$5.98—Monaural: \$4.98.



AVAILABLE AT YOUR RECORD DEALER AFTER MARCH 15TH.

CIRCLE 98 ON READER-SERVICE CARD



A PRECISION
4 SPEED



PLAYBACK UNIT,
SECOND TO NONE

for only \$99⁵⁰ complete

For the ultimate in record playing togetherness, ask your dealer for the ESL Concert Series playback unit — the unique, high performance Gyro/Spension turntable, the famed Super Gyro/Balance arm and the Triumphant new Redhead stereo cartridge — all factory assembled for your instantaneous pleasure. This harmoniously engineered combination assures you the finest reproduction obtainable... just plug it in.

ESL-61 Concert Series
playback unit, complete,
\$99.50



FOR LISTENING AT ITS BEST

Electro-Sonic
Laboratories, Inc.

Dept H · 627 Broadway · New York 12, NY



CIRCLE 42 ON READER-SERVICE CARD

idiom, and suddenly it becomes compellingly vital and satisfying all over again.

The great Egon Petri is just such a virtuoso. The piano playing on this disc is, quite simply, phenomenal. When one realizes that the veteran artist will celebrate his eighty-first birthday this month, one's admiration for this recital becomes near stupefaction. Even if it turns out that these performances date back a few years (not many, since we are given a stereo edition), the free-wheeling ease of execution, the enormous scope, and the ardent sweep of the playing is nothing short of amazing.

Petri's work is hewn rather than chiseled, and yet there are many moments of ravishing delicacy and cultivated feeling here. Enormous pulse is present, gigantic understanding of structure, and perhaps a little squareness now and then; but the quality that stands out the most, in my mind, is the infallible integrity of his interpretations. Although Petri indulges in luxuriant rubatos and many departures from the printed text (as, indeed, Liszt himself must have done!), his emotions have a solid, even devout, quality which eradicates from the music even the slightest hint of sleaziness.

Petri's tonal quality is not particularly colorful, but it is tremendously suggestive of orchestral sonority. One can readily hear trumpets at the beginning of the Mendelssohn *Wedding March*, and the fluid projection of the cantabile in Beethoven's *Adelaide* clearly evokes a human voice. The Waltz from Gounod's *Faust* is truly herculean in its projection of whirling motion, and if the rarely performed *Marriage of Figaro* Fantasy is more suggestive of a World War I marching song than of "Non più andrai," Petri's exposition (slightly cut) makes the most of it. Petri's own master, Busoni, also appears, incidentally. The *Mephisto Waltz* is played here in his edition, which is in many respects more similar to Liszt's orchestral arrangement of that piece than it is to the original piano score. The Busoni cadenza in the *Faust* waltz is also utilized by Petri.

The recorded sound is a bit more crystalline in the stereo version (although my review copy had some obtrusive surface noise in *Adelaide*), but the monophonic disc, mastered at a higher volume level, is also highly satisfactory. In summation, Westminster has come up with a release of the highest distinction. And now won't that company please give us a recording of an important Petri performance so tantalizingly mentioned on the jacket cover: the Beethoven *Diabelli Variations*? H.G.

MENDELSSOHN: *Allegro brillante for Piano Duo, in A, Op. 92*—See Schubert: *Fantasia for Piano Duet, in F minor, Op. 103*.

MENDELSSOHN: *Symphony No. 4, in A, Op. 90* ("Italian"); *A Midsummer Night's Dream: Overture; Scherzo; Nocturne; Wedding March*

Vienna State Opera Orchestra, Vladimir Golschmann, cond.
• VANGUARD SRV 122. LP. \$1.98.
• • VANGUARD SRV 122 SD. SD. \$2.98.

Some of Vanguard's finest performances

and recordings are currently being released at very much reduced prices in its so-called "demonstration" series, of which the present disc is representative. Golschmann's treatment of both the *Italian Symphony* and the *Midsummer Night's Dream* music is clear, correct, and straightforward. His statements are simple, without any interpretative frills. The only complaint I have is that, for some unknown reason, he makes a four-bar cut in the coda of the *Wedding March*. The orchestral playing is precise, and the sonics in both mono and stereo are transparent and well defined. Perhaps these aren't the most imaginative readings, but their very stability gives them lasting power and makes this disc an excellent buy. P.A.

MOZART: *Divertimentos: in B flat, K. 137; in F, K. 138*—See Haydn: *Concerto for Violin and Orchestra, No. 1, in C*.

MOZART: *Sonata for Piano Duet, in F, K. 497*—See Schubert: *Fantasia for Piano Duet, in F minor, Op. 103*.

PERLE: *Quintet for Strings, Op. 35*
† Bassett: *Trio for Clarinet, Viola, and Piano*

Walter Trampler, viola; Beaux Arts String Quartet (in the Perle). Charles Russo, clarinet; Walter Trampler, viola; Douglas Nordli, piano (in the Bassett).
• COMPOSERS RECORDINGS CRI 148. LP. \$5.95.

This is one of the finest discs so far released in the Composers Recordings series. Both works are very mature and impressive, the performances are magnificent, and the recordings are sonically first-class.

George Perle is one of this country's foremost theorists, critics, and apologists for the 12-tone system and all its works. It is therefore surprising, to say the least, to find no use of that system in this, his first major recording, and to read in the jacket notes that he very seldom employs 12-tone devices. Composed in 1958, the *Quintet* is in a rich, eminently tonal, highly emotional vein, with very remarkable use of the medium harmonically, rhythmically, and instrumentally, and a sense of profound musicianship and high integrity behind the whole performance. A big, commanding achievement in every respect.

Leslie Bassett's *Trio for Clarinet, Viola, and Piano* makes a major contribution to a small, distinguished literature. The piece has a certain neo-classical quality, especially because of its very open texture: it is full of high spirits and fine lyricism, is on the conservative side without a trace of *Kitsch*, and is herewith recommended in the highest terms. A.F.

RACHMANINOFF: *Concerto for Piano and Orchestra, No. 3, in D minor, Op. 30*

Byron Janis, piano; London Symphony, Antal Dorati, cond.
• MERCURY MG 50283. LP. \$4.98.
• • MERCURY SR 90283. SD. \$5.98.

Janis here becomes the first pianist to have recorded this piece for stereo twice. The present version is, to my mind, a

substantial improvement over the pianist's recently deleted 1958 RCA Victor set with Munch and the Boston Symphony: the recorded sound, made originally on 35-mm film rather than conventional tape, is much more atmospheric as well as more brilliant; Dorati's accompaniment is more elegant and disciplined than Munch's; and Janis plays with as much virtuosity as he did on the previous recording but with more tonal shading and poetry.

This robustly straightforward reading is essentially in the style of the celebrated Horowitz-Reiner interpretation (Janis studied with Horowitz); and if the playing doesn't quite carry the overwhelming *diablerie* and high-strung rhythmic precision of that still unequalled disc, it is, to my mind, far and away the best stereo version. Compared with the present release, Cliburn-Kondrashin—the only possible rival—sounds stodgy, and its sound (recorded at a live concert) is cramped and dry. H.G.

SCHUBERT: *Fantasia for Piano Duet, in F minor, Op. 103*

†Mozart: *Sonata for Piano Duet, in F, K. 497*

†Mendelssohn: *Allegro brillante for Piano Duo, in A, Op. 92*

Leonid Hambro, Jascha Zayde, piano.
 • COMMAND CC 33/11010. LP. \$4.98.
 • COMMAND CC 11010. SD. \$5.98.

Having distinguished themselves in the art of orchestral recording, Command's engineering staff have now applied themselves to the (in some ways) even more exacting task of faithfully reproducing the sound of two pianos. They have produced a disc with outstanding sonic realism. Even the usual artificialities of even the best recorded sound have been eliminated here. In fact, all barriers having disappeared. I found myself criticizing the tonal values as if this were a live recital in Town Hall: I am disturbed by the dull, clattery quality of these particular instruments themselves. Anything above *mezzo forte* tends to lose color and become percussive.

Both the Schubert Fantasy and the Mozart Sonata are major works in their composer's respective catalogues, and together they form an unusually attractive coupling, with the Mendelssohn tidbit providing an added touch of scintillant virtuosity. Moreover, the disc is most welcome in view of the fact that none of this music is exactly overrecorded. (Two editions of the Schubert—Helen and Karl Ulrich Schnabel for Epic, and Robert and Gaby Casadesus for Columbia—have been withdrawn.)

The present performances are highly competent, more high-powered and virtuosic than those by Badura-Skoda and Demus (Westminster), but perhaps a shade slick and hard-boiled. The two available renderings of these compositions are, in their different ways, just about on a par with each other interpretatively, Hambro-Zayde making up in brilliance for whatever advantages Badura-Skoda-Demus have in intimacy and fluidity. While both can be reasonably strongly endorsed, neither team possesses the tensile phrase shapings and sheer analytical understanding which I, for one, found so attractive in the Schnabel duo's reading of the Schubert work. H.G.

Continued on next page

Only on

ffrr
mono

LONDON
RECORDS

ffss
stereo

SUTHERLAND-TEBALDI-NILSSON



SUTHERLAND

Donizetti:
LUCIA DI LAMMERMOOR

with Renato Cioni, Robert Merrill, Cesare Siepi and other soloists — Chorus and Orchestra of L'Accademia di Santa Cecilia, Rome — John Pritchard

Stereo OSA 1327 3-12"
Mono A 4355 3-12"

other recordings by
Miss Sutherland

Handel: MESSIAH
Stereo OSA 1329 3-12"
Mono A 4357 3-12"

THE ART OF THE PRIMA DONNA
Stereo OSA 1214 2-12"
Mono A 4241 2-12"

OPERATIC RECITAL
Stereo OS 25111 1-12"
Mono 5515 1-12"

Handel:
ACIS AND GALATEA
Stereo SOL 60011 2 2-12"
Mono OL 50179/80 2-12"

Beethoven:
SYMPHONY NO. 9
Stereo CS 6143 1-12"
Mono CM 9033 1-12"

MUSIC OF HANDEL
Stereo SOL 60001 1-12"
Mono OL 50170 1-12"



TEBALDI

Cilea:
ADRIANA LECOUVREUR

With Mario del Monaco, Giulietta Simonato and other soloists — Chorus and Orchestra of l'Accademia di Santa Cecilia, Rome—Franco Capuana
Stereo: OSA 1331 3-12"
Mono: A 4359 3-12"

other recordings by
Miss Tebaldi

Verdi:
OTELLO
Stereo: OSA 1324 3-12"
Mono: A 4352 3-12"

Puccini:
LA BOHEME—Complete
Stereo OSA 1208 2-12"
Mono A 4236 2-12"

Puccini: TOSCA—Comp.
Stereo OSA 1210 2-12"
Mono A 4235 2-12"

Verdi:
La TRAVIATA—Comp.
Mono A 4314 3-12"

Giordano:
ANDREA CHENIER—Complete
Stereo OSA 1303 3-12"
Mono A 4332 3-12"

Verdi:
IL TROVATORE—Comp.
Stereo OSA 1304 3-12"
Mono A 4326 3-12"

Puccini:
LA FANCIULLA DEL WEST—Complete
Stereo OSA 1306 3-12"
Mono A 4338 3-12"



NILSSON

Verdi:
UN BALLO IN MASCHERA

with Carlo Bergonzi, Cornell MacNeil, Giulietta Simonato, Sylvia Stahlman and other soloists. Chorus and Orchestra of L'Accademia di Santa Cecilia, Rome — Georg Solti.

Stereo OSA 1328 3-12"
Mono A 4356 3-12"

other recordings by
Miss Nilsson

Wagner:
TRISTAN UND ISOLDE
with Fritz Uhl, Regina Resnik, Tom Krause, Arnold van Mill and other soloists. The Vienna Philharmonic Orchestra — Georg Solti.
Stereo OSA 1502 5-12"
Mono A 4506 5-12"

Wagner:
TRISTAN UND ISOLDE—Highlights
Isolde's Narrative and Curse (with Grace Hoffman); Prelude and Liebestod. The Vienna Philharmonic Orchestra — Hans Knappertsbusch.
Stereo OS 25138 1-12"
Mono 5537 1-12"

CIRCLE 61 ON READER-SERVICE CARD

SCHUMANN: *Arabeske, in C, Op. 18; Nachtstück, in F, Op. 23, No. 4; Waldszenen, Op. 82: No. 7. Vogel als Prophet; Romances, Op. 28: No. 2, in F sharp minor*—See Beethoven: *Sonata for Piano, No. 21, in C, Op. 53 ("Waldstein")*.

SHOSTAKOVICH: *Sonata for Piano, No. 2, in B minor, Op. 64*
 †Hindemith: *Sonata for Piano, No. 3, in B flat*

Maria Yudina, piano.
 • MK-ARTIA 1567. LP. \$5.98.

The Shostakovich is new to records, at least in this country. It sounds very dull. So does the Hindemith, which is far

from new to American records and has never sounded dull before. A.F.

SIBELIUS: *Concerto for Violin and Orchestra, in D minor, Op. 47; Valse triste, Op. 44; The Swan of Tuonela, Op. 22, No. 3*

Julian Sitkovecky, violin; Czech Philharmonic Orchestra, Nikolai Anosov, cond. (in the Concerto); Prague Symphony Orchestra, Vaclav Smetacek, cond. (in *Valse Triste* and *The Swan of Tuonela*).

• PARLIAMENT PLP 148. LP. \$1.98.
 • • PARLIAMENT PLPS 148. SD. \$2.98.

Violinists who can conquer the technical and stylistic obstacles of the Sibelius Concerto, surely one of the most

difficult and challenging works of its kind ever written, are relatively few. On records, we have had Ricci and Heifetz—and now, Sitkovecky. Whoever this artist may be (the liner notes provide no biographical clues), he comes very close to the mark. Aside from a few slips in intonation in the first movement, he gives a bravura account of the Concerto, especially exciting in the finale. One might ask for greater subtlety in the *Adagio di molto*; but otherwise, this is a highly commendable performance, very well recorded and priced at a bargain figure.

Smetacek's readings of the popular *Valse Triste* and *Swan of Tuonela* are altogether correct, if a trifle matter-of-fact. Here, though the reproduction is satisfactory, there is some noticeable tape hiss. P.A.

STRAVINSKY: *Fire Bird: Suite*—
 See Walton: *Symphony No. 2*.

STRAVINSKY: *Symphony of Psalms; Les Noces*

Chœur des Jeunes de Lausanne, Chœur de Radio Lausanne, Orchestre de la Suisse Romande, Ernest Ansermet, cond. (in *Symphony*). Basia Retchitzia, soprano; Lucienne Devallier, mezzo; Hugues Cuénod, tenor; Heinz Rehfuss, bass; Jacques Horneffer, Renée Petcr, Doris Rossiaud, Roger Aubert, pianos; Motet Choir of Geneva, Ernest Ansermet, cond. (in *Les Noces*).

• LONDON CM 9288. LP. \$4.98.
 • • LONDON CS 6219. SD. \$5.98.

As usual, Ansermet's tempos are on the slow side, but this is incomparably the finest recording ever made of the *Symphony of Psalms*, especially in the stereo version. As I have observed in these columns before, stereo does more for the chorus than for any other musical instrumentality, and for the first time Stravinsky's magnificent choral sonorities are properly liberated from a phonograph record. The choral writing is very tight and up to now has always sounded muddy on discs; here, however, it sounds as gorgeous as it does in the concert hall. The recording of *Les Noces* is also extremely fine, but the failure to provide its text is a very serious drawback to its enjoyment. A.F.

TCHAIKOVSKY: *The Sleeping Beauty, Op. 66: Suite*

Philadelphia Orchestra, Eugene Ormandy, cond.

• COLUMBIA ML 5679. LP. \$4.98.
 • • COLUMBIA MS 6279. SD. \$5.98.

The present monophonic disc of the *Sleeping Beauty Suite* is one of the most impressive I've ever heard, if at full volume almost painfully ultrabright; the less sharply focused but more openly broadspread stereo edition is sheer aural as well as dramatic enchantment. Tchaikovskian specialists, of course, will not be satisfied with only a third or so of the full score, and some listeners will prefer Ansermet's now more relaxed and lyrical, now more vivaciously danceable reading to Ormandy's somewhat impersonal approach. In fact it seems to me that the Ansermet version (nearly complete, on London) is, in its somewhat more distant miking and more spacious reverberation, more atmospherically evocative than this new edition.

Preserve the Genius of the Masters



with the
Natural Sound of RE Tandberg



\$498.



\$199.50

MODEL 6 3 SPEED 4 TRACK
 STEREO RECORD/PLAYBACK TAPE DECK

The remarkable features of this superb unit speak for themselves—records 4 track; plays back 2 and 4 track stereo and mono; records/plays back FM Multiplex Stereocast with magnificent clarity, even at 3¾ ips. Permits sound-on-sound, track adding, direct monitor from source or tape; has push button controls, three separate Tandberg engineered precision laminated heads, hysteresis synchronous motor; installs into HI-FI system. Price \$498. Remote control "F" model also available.

MODEL 65 3 SPEED 4 TRACK
 STEREO PLAYBACK TAPE DECK

Another Tandberg triumph— for pure playback of 2 and 4 track stereo and mono tapes with finest frequency response. Extremely versatile; facilities for adding erase and record heads. Price \$199.50.

Tandberg remains unchallenged for clear, crisp, natural sound!

Tandberg OF AMERICA, INC., 8 THIRD AVENUE, PELHAM, NEW YORK

CIRCLE 88 ON READER-SERVICE CARD

Nevertheless, for sensuously beautiful orchestral playing and gorgeous recorded sonics the present release should meet the requirements of the most demanding listeners. R.D.D.

VERDI: *Un Ballo in maschera*

Birgit Nilsson (s), Amelia; Sylvia Stahlman (s), Oscar; Giulietta Simionato (ms), Ulrica; Carlo Bergonzi (t), Riccardo; Piero di Palma (t), A Judge; Vittorio Pandano (t), A Servant; Cornell MacNeil (b), Renato; Tom Krause (b), Silvano; Fernando Corena (bs), Samuel; Libero Arbace (bs), Tom. Chorus and Orchestra of Accademia di Santa Cecilia (Rome), Georg Solti, cond.
 ● LONDON A 4356. Three LP. \$14.94.
 ● LONDON OSA 1328. Three SD. \$17.94.

The second stereo *Ballo* is in many ways a very impressive one, richly sung and powerfully played a good portion of the time. Yet it adds up to no more than that; it somehow fails to catch hold and draw the listener into the drama. We must grant that *Ballo* is one of the most difficult of Verdi's mature works in this respect: the events of the libretto are such a silly hash, and the two leading characters such stuffy dullards, that the music itself, which includes some of Verdi's most passionate, impetuous writing, must be given full due if a recorded performance is to have much effect. Still, the Toscanini Victor version (by virtue of its incandescent leadership) and the Angel edition (by virtue of compelling characterizations by Callas and Gobbi) manage, despite some grave defects, to involve the listener.

The choice of Birgit Nilsson for the role of Amelia is an interesting one, and she contributes some magnificent singing, pouring her voice over the music with an almost inhuman ease. She sings softly where the score is marked *piano*, loudly where it is marked *forte*; the note values are correct; the pitch is right on the button. But there is no Amelia; there is not even a generalized woman (which is about all Amelia is, anyway). There is no Amelia trembling under the gibbet in the dark of night, or pouring out her heart to Riccardo, or pleading with her raging husband for a final moment with her son, or breaking her heart as she bids her love farewell. If a stream of beautiful, impressive tone is enough for you, then this Amelia will be more than satisfactory—but I think Verdi asks more.

Her tenor, Carlo Bergonzi, also sings extremely well, and can hardly be censured for not having a voice large enough or liquid enough to take the lead among such principals. Yet to have a Riccardo whose voice is considerably less effulgent than the Amelia's, or Renato's, or Ulrica's, does make for anticlimactic moments. Bergonzi's tasteful, well-phrased singing would have been more than welcome on either of the above-mentioned LP sets; on this, it does not match the vocal caliber of the other two leads.

Here I should like to enter a rather strong objection to the engineering policy in force on this recording, which places the singers in an all too realistic perspective. This means two things: 1) Nilsson, MacNeil, and Simionato are all up in the foreground, since they all have big voices; Bergonzi is somewhere in the middle-foreground; and Sylvia Stahlman is virtually out of the picture. 2) The orchestra only occasionally actually threatens to engulf the singers (for

which, to judge by the Solti *Tristan*, we have to thank only the clarity and ingenuity of Verdi's orchestral scoring); but it leaps ridiculously into prominence during voiceless passages. If the argument for this procedure is that it is life-like, then it seems to me to be based on a misapprehension. The fact is that in an opera house the orchestra never sounds this loud in relation to the other elements. The very ending of the first scene is an example; it frankly sounds as if the gain on the microphones had suddenly been increased to make the orchestra seem louder than the entire ensemble or principals and chorus (plus orchestra) at the conclusion of "*Alle tre*." I rather doubt that this was really done, but whatever the cause, the effect is just as artificial as the old technique of close-miking the singers—and in a worse di-

rection. And is Miss Stahlman's voice really that much smaller than Miss Simionato's? Could no way have been found—at least during her solos—of bringing her into reasonable focus? I wish recording engineers would adopt a creed: life is life, theatre performances are theatre performances, and recordings are recordings. And if one's sense of integrity keeps him from balancing the tenor against the soprano, let him find a soprano with a smaller voice or a tenor with a larger one.

Cornell MacNeil contributes some potent, lovely singing—especially in the cantabile portion of "*Eri tu*"—though he hovers a shade above pitch much of the time. Giulietta Simionato is her familiar authoritative self; about Miss Stahlman's

Continued on page 86



FOREGROUND MUSIC

This is not background music. It is music to be listened to.

Listen to internationally famous bass-baritone, William Warfield, and the world's leading concert organist, Virgil Fox, perform 11 inspiring songs of the Christian and Jewish faiths on "*God of Our Fathers*" (S)P-8578. Vibrant voice in duet with the magnificent 10,000-pipe organ of New York's Riverside Church. You will never hear more moving performances of "Deep River," "The Lord's Prayer," "Come, Sweet Death," and "Kol Nidrei," among others.

Listen to the passionate guitar of Mariano Cordoba intertwine with the intriguing rhythm of castanets on "*Flamenco Virtuoso*" (S)P-8574. You will hear and feel the excitement and fire that is Spanish Flamenco, as performed by a master of the art.

Listen to the explosive vigor of two great modern ballet scores—Bartok's "*The Miraculous Mandarin*" and "*The Age Of Gold*" by Shostakovich (S)P-8576. Robert Irving conducts the Philharmonia Orchestra. Brilliant stereo "Firsts"!

These recordings speak for themselves... but by no means softly.



© CAPITOL RECORDS, INC.

CIRCLE 26 ON READER-SERVICE CARD



THE IMPORTS

WHAT A rare opportunity it might be thought to hear Dietrich Fischer-Dieskau and Rita Streich in *La Bohème*, such singers as Hans Hotter and Paul Schoeffler together with Gloria Davy in *Aida*, and Kim Borg as Scarpia in *Tosca*—and the opportunity is now presented, in new stereo recordings issued by Deutsche Grammophon and available for import outside the regular DGG distribution. Intended for the European market, these operas are sung in German, but it could be assumed that such artists would provide us with some thrilling moments in spite of occasional musically misplaced consonants. Unhappily, the three albums vie in ineptitude. Fischer-Dieskau and Streich, as Marcel and Musetta in *Bohème* (SLPM 138720/21), sing their small parts without grace or verve and sound consciously German. Rodolfo is taken by Sandor Konya (a major ornament of the Met this year), who sings with little sense of line, breathes awkwardly, gulps often, and sobs glottally. The fact that lyrical Italian music can be sung intelligently in German is proved by the set's one asset, the Spanish soprano Pilar Lorengar as Mimi—as lovely a Mimi as can be heard on records today. But even she cannot completely overcome the dull, slow pace of conductor Alberto Erede and the covered, distant sound of the recording. The best features of the *Tosca* (SLPM 138722/23) are the energetic and sensitive conducting of young Horst Stein and the sound of the recording itself, which is bright and extremely well balanced. But Konya is disappointing again as Cavaradossi, Kim Borg is a menacing but stiff Scarpia, and the Polish soprano Stefania Woytowicz cannot control her opulent voice in the title role. As for *Aida* (highlights, SLPM 136402), only Paul Schoeffler as Ramfis manages to show any spirit and devotion to pitch; Miss Davy, Konya, and Hotter join conductor Argeo Quadri in a lackluster performance.

Living up to all expectations is the French recording of Offenbach's *opéra bouffe La Périchole*, conducted by Igor Markevitch (monophonic only, Pathé-Columbia LX 786/87). Until now, we have had to content ourselves with the abridged English version of *Périchole* staged by Cyril Ritchard at the Met and issued by RCA Victor, with Ritchard half talking the key part of The Viceroy and the orchestration considerably thinned out. That performance lacks elegance, and this is exactly what the complete French set has. The leading singers—Louis Noguéra as The Viceroy, Suzanne Lafaye as La Périchole, and Raymonde Amade as Piquillo—have voices of excellent timbre and seem to relish each French turn of phrase. The orchestration is diverse and full-sounding,

with the Lamoureux Orchestra at its best and Markevitch striking a buoyant pace. The recorded sound also contributes to the effectiveness of this disc, being bright and spacing voices and orchestra perfectly. What is achieved is a sense of ensemble, and a continuous flow of wit and melody, conveyed with great *esprit*. The libretto, by the way, is in French only.

Remembering what we called "realistic" as little as five years ago, one should be cautious in making any pronouncement about the sonic fidelity of recordings. Yet it is difficult to conceive of anything more startlingly real than the sound of the contemporary Danish organ played by Marie-Claire Alain in her recording of the six Bach Trio Sonatas, issued on two discs by a small French company named Erato (LDE 3140/41). Much of the vivid, room-filling quality achieved is due to the firmness of the organ and Mme. Alain's choice of contrasting stops and vigorous playing. By the same token, her approach to this polyphonic music is abetted by the close-up recording. Differentiation among the three voices is obtained mainly by assorted colors of the stops, chosen boldly yet always in good taste, and by rhythmic incisiveness. This organist's playing contains little of the subtle dynamic gradations to be found in Helmut Walcha's DGG recordings of the same works, nor his feeling for long melodic lines. I feel, however, that Alain's straightforward, joyous approach to this music is more apt than Walcha's softer, reverential way with it. And, again, the sound! The Erato recording, obtainable in either mono or stereo, is equally effective in both versions.

Recorded by the same Danish engineer as the above and released by another small French company—Valois—are Rameau's *Nouvelles Suites de Pièces de Clavecin*, fifteen pieces performed on a twentieth-century harpsichord by Huguette Dreyfus (MB 420). Once more the recorded sound of the instrument is slightly larger than life and exceptional in its clarity, and again it is well suited to the instrument and the player's approach to the music. The Danish harpsichord sounds like a true plucked instrument, somewhat resembling a cross between the classical guitar and the harp, with none of the tinkle and lack of resonance much in fashion today. The fuller sound is put to use emphasizing harmonies, arpeggios, and syncopation rather than close linear development, much more in Handel's baroque style than in Couperin's. Those who like Fernando Valente's lighter touch in such pieces as *La Poïle* and *L'Egyptienne* may find Mme. Dreyfus' ponderous. I my-

self much prefer the lady; her playing is in the tradition of grand ceremony.

Lively and light-textured is the collection of baroque pieces recorded by Karl Haas and his London Ensemble on the English Pye label (CCL 30148). Despite their titles, the music is familiar. The Sinfonia in F major turns out to be a later version by Bach of his *Brandenburg Concerto No. 1*, with the third movement and the orchestration simplified by the omission of the violino-piccolo and by greater use of the violins. The Concerto No. 6 in F major for Harpsichord is a later version of the *Brandenburg No. 4* in G major, with the violin solo given to the harpsichord and made more elaborate. The Handel Harp Concerto in B flat major is probably the original version of his Organ Concerto, Op. 4, No. 6, with the violins muted, the rest of the strings pizzicato, recorders in the tutti, and the continuo played by a harpsichord (providing a delicate background for the smaller solo instrument). With the Haas group playing so gracefully and George Malcolm such an excellent harpsichordist, these pieces are happy alternates rather than substitutes for the more familiar settings. A fourth work on the record, Bach's Sinfonia in D major for Violin and Orchestra, has never been recorded before and is rarely performed. It is the introduction to a lost church cantata and doesn't quite come off here: the violinist, Eli Gorin, has difficulty playing the "opened up" chords with his modern bow, and the ensemble horns seem to have trouble keeping up in the fanfares of the elaborate orchestra. The recording in all four works is crystal-clear.

The initial release of "The History of Italian Music," recorded by RCA Italiana in Rome under the auspices of the Italian State Record Library and the International Music Council, with the collaboration of UNESCO, is now available in the United States through limited RCA distribution. Comprising ten LP records, accompanied by a 100-page illustrated book in English, bound together in a full-leather album, this first volume ranges from Gregorian Chant to the seventeenth-century oratorio of Carissimi. The price is \$85, and worth it from many points of view. The music, for the most part unpublished and previously unrecorded, is performed with great authenticity and enthusiasm, and the book, with color plates, engravings, and illustrations of the finest quality, is a pleasure to read. Used together, records and text unfold the continuous development of Italian music at a leisurely pace and with seemingly complete information. Three more volumes are being produced, which will bring the total to forty records. GENE BRUCK

new proof

McIntosh is the best!

Only McIntosh of all amplifiers made and advertised today has such low distortion with such reserve power. You can see the combination of low distortion and great reserve of the MC-240 in this graph and remember both channels are operating, both channels of the MC-240 are operating at full power, both channels are operating at full power at the same time.

40 watts GUARANTEED POWER 20 cycles thru 20KC.

50 watts TYPICAL PERFORMANCE

60 watts IHFM MUSIC POWER

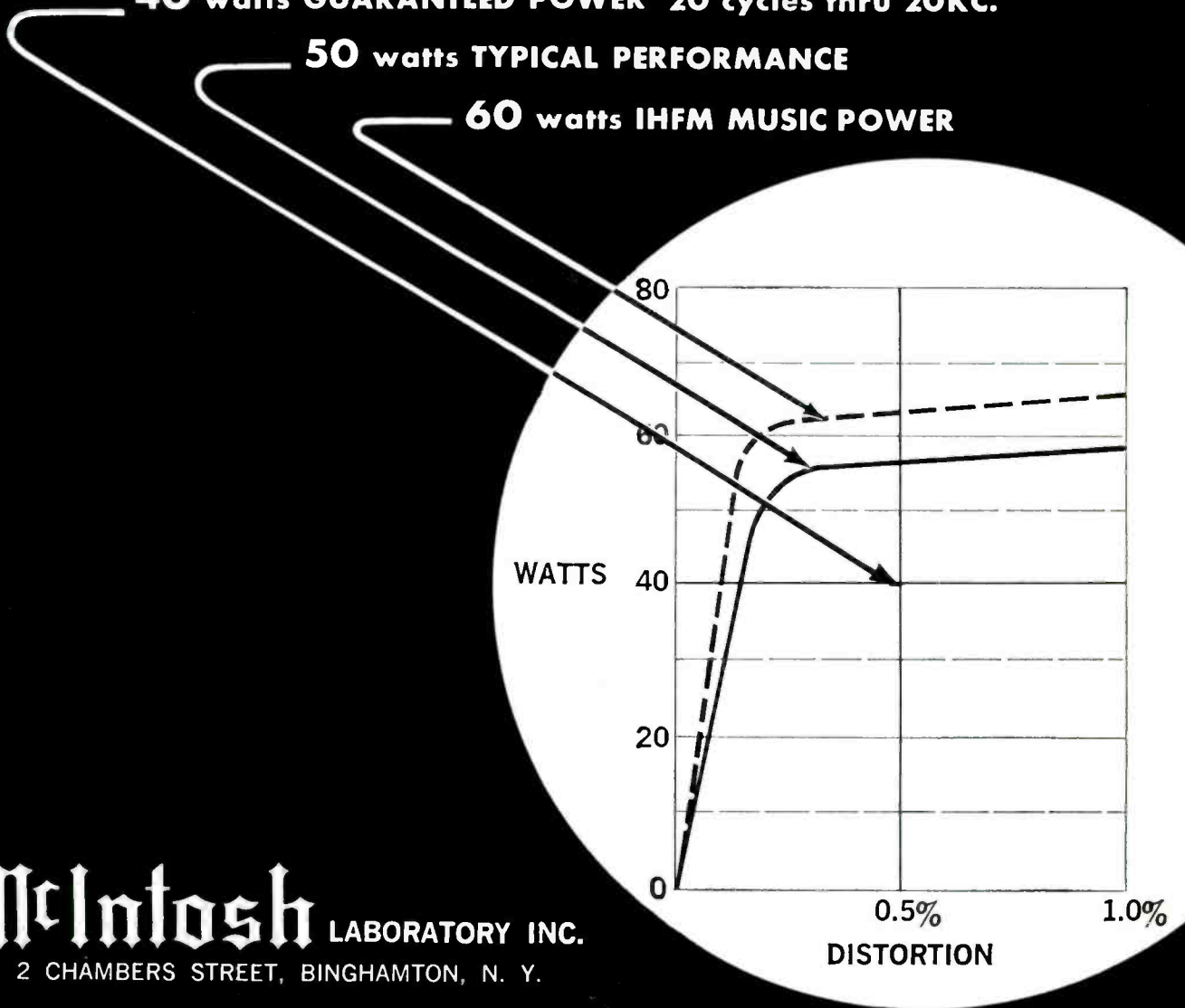

McIntosh LABORATORY INC.
2 CHAMBERS STREET, BINGHAMTON, N. Y.

Continued from page 83

Oscar I can say little, under the circumstances. The orchestra (not a great one) does not sound on its best mettle. Solti's conducting has considerable dramatic punch, but not enough songfulness, and sometimes borders on the mannered.

In sum, we have a *Ballo* that offers splendid, but not particularly dynamic, singing in three of the main roles; recording that is technically good but aesthetically questionable; and disciplined, insufficiently warm leadership. The field is still open. C.L.O.

VIOTTI: *Concerto for Violin and Orchestra, No. 22, in A minor*—See Bartók: *Concerto for Violin and Orchestra, No. 1, Op. posth.*

VIVALDI: *Concerto grosso, Op. 3, No. 8, in A minor*—See Bach: *Concerto for Two Violins and Orchestra, in D minor, S. 1043.*

WAGNER: *Siegfried Idyll*—See Binkerd: *Symphony No. 1.*

WAGNER: *Tannhäuser*

Elisabeth Grümmer (s), Elisabeth: Marianne Schech (s), Venus; Lisa Otto (s), A Shepherd; Hans Hopf (t), Tannhäuser; Fritz Wunderlich (t), Walter von der Vogelweide; Gerhard Unger (t), Heinrich der Schreiber; Dietrich Fischer-Dieskau (b), Wolfram von Eschenbach; Gottlob Frick (bs), Landgrave Hermann; Rudolf Gonszar (bs), Biterolf; Reiner Süss (bs),

Reinmar von Zweter. Chorus and Orchestra of the German State Opera (Berlin). Franz Konwitschny, cond.
• ANGEL 3620D/L. Four LP. \$19.92.
• • ANGEL S 3620D/L. Four SD. \$23.92.

This first stereo *Tannhäuser* (excepting the "duophonic" edition of the Urania performance, which I have not heard) is also only the second on microgroove, and the third in the history of the phonograph. (The old Bayreuth albums, never re-released on LP, offered sterling work from Janssen and Andresen, and some competent singing from Maria Müller and Sigismund Pilinsky. They are all but impossible to obtain.) Since the new Angel performance is a solid one, recorded with modern techniques, it is to be welcomed as an adequate brace for a weak spot in the recorded repertory.

Where it lets us down is in the singing of the title role. This comes as no surprise, for since the disappearance of Melchior, Lorenz, and Ralf, the *Heldentenor* situation has been desperate. Svanholm filled in adequately for a while, and then Windgassen; Vickers obviously has the makings. These operatives aside, the tenor in recent Wagnerian performances has been the one sure element, bound to be poor. Hans Hopf sings with a certain sturdiness, but along with it comes vocal heaviness, ponderous musical conception, and interpretative unimaginationess. In this particular role, he made some ringing sounds when he was younger; some of that is now gone, and it cannot be said that his insight has deepened by way of compensation. The practical-minded will ask who might have done it better, and I am afraid I can offer no confident answer.

There is some very good singing in other roles, though. Elisabeth Grümmer displays purity of voice, an admirable sensitivity to the text, and a fine grasp of phrasing. Her soprano does not possess quite enough body at the top for the climax of "*Dich, teure Halle,*" but apart from this, her work is gratifying. Fischer-Dieskau pays rather too much attention to niceties of inflection for my taste, but the sound of his voice is lovely, and when he shakes loose of his tendency to overrefinement, as in the final plea to Heinrich, he is extremely impressive. Incidentally, he negotiates a turn in "*O du mein holder Abendstern*" (on "*ein sel'ger Engel*") which I do not believe I have heard used before; it differs from the one normally sung, and makes a rather striking effect. Frick is a superb Landgrave, with a rich, firm voice aided by dignity of utterance. There is tenderness in his lines to Elisabeth, nobility in his address to the assemblage—and it is all good singing. Fritz Wunderlich does some very attractive lyric singing during Walter's brief moment in the sun. Marianne Schech, the Venus of the present set, was the Elisabeth of Urania's production, and I can't help feeling that she was better suited to that role. Her voice is free, but it is not dark or sensuous, and she does not seem to have any consistent approach to the character of Venus. As usual, her top tones are strong and beautiful.

Konwitschny's conducting is sometimes a bit lacking in dash or incisiveness, but he is sure of his idea of the music, and follows through thoroughly; his is a dependable, well-considered reading. The orchestra is good, the chorus excellent. Angel's recording does not offer ideal clarity or spaciousness in the big ensembles of Act II, and the soloists—especially Hopf—are frequently uncomfort-

DYNAKIT

there is no finer performance



QUALITY

For the audio perfectionist the FM-Multiplex Dynatuner has set new standards for useable sensitivity under the most difficult conditions, with lower distortion at all signal strengths — faster limiting, simpler and more accurate tuning, better capture ratio, superior interference rejection, no overloading, outstanding AM and multipath rejection, superlative selectivity, and lower hum and noise. For the kit builder, assembly and alignment are completed in just 6 hours, and performance specs are met the first time. FMX-3 Multiplex integrator \$29.95 kit.

FM-1 \$79.95 kit, \$119.95 assembled and tested.

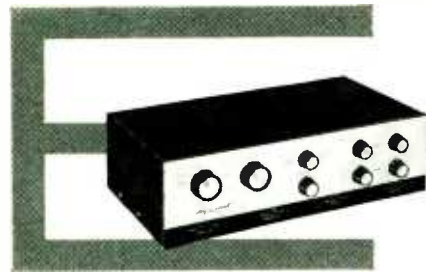

ECONOMY

Easily the finest value in the high fidelity field, this "no distortion" preamp has won acclaim for impeccable performance, at just about the lowest price ever for a stereo preamplifier. Full control flexibility in a simple, modern arrangement makes it easy to build and a pleasure for the non-technical music lover to use. You'll revel in its near-perfect freedom from hum, noise, and distortion. Just \$59.95 buys the most important improvement in your music system.

PAS-2 \$59.95 kit, \$99.95 assembled and tested.



DEPENDABILITY

It's more than two years old, but we've never had to make a single change in the Stereo 70 amplifier. Patented Dynaco output transformers and circuitry, and the superior reliability of the finest etched circuit construction assure continued superiority of performance. In the words of Hirsch-Houck Laboratories (December 1959 issue of High Fidelity Magazine) "This amplifier's components are operated more conservatively than those in any other commercial amplifier we have tested . . . Its power and distortion ratings are completely conservative. Its listening quality is unsurpassed." Could we say more?

Stereo 70 \$99.95 kit, \$129.95 assembled and tested.

QUOD ERAT DEMONSTRANDUM: which was to be proved

write for detailed literature **DYNAKO, INC.** 3912 Powelton Ave., Phila. 4, Pa. Cable Address: Dynaco, Phila.

CIRCLE 39 ON READER-SERVICE CARD

ably close, but there are some beautiful quiet moments, such as the ringing of distant bells at the beginning of the second scene, or the entrance of the off-stage chorus on Wolfram's "nur erteilt" in Act III.

This release clearly supersedes the Urania version, and is good enough to remind us of this opera's beauty and power. *Tannhäuser* may not be what we would term a basic repertory work, and like the rest of the composer's output, it has had to suffer through the Fifties. But give it a respectable performance, and it again becomes moving and exciting. C.L.O.

WALTON: *Symphony No. 2*
†Stravinsky: *Fire Bird: Suite*

Cleveland Orchestra, George Szell, cond.
• Epic LC 3812. LP. \$4.98.
• • Epic BC 1149. SD. \$5.98.

Sir William's new symphony is about what you would expect—a warm, tuneful, grandly scaled, eminently persuasive example of the genteel tradition: it is Elgar brought down to date. The recording is very good and the performance, one must believe, is equally good, since Szell is Sir William's ambassador to the United States. The interpretation of the familiar *Fire Bird* music on the other side is also extremely brilliant and well registered. A.F.

RECITALS AND MISCELLANY

SIR THOMAS BEECHAM: "A
Beecham Anthology"

Delius: *Evening Voices*; Hassam: *Intermezzo and Serenade*. Handel: *Solomon: Arrival of the Queen of Sheba*. Borodin: *Prince Igor: Polovtsian Dances, No. 17*. Wagner: *Die Meistersinger: Church scene*. Berlioz: *Le Corsaire Overture; La Damnation de Faust: Ballet des Sylphes*. Mozart: *Le Nozze di Figaro: Overture; Die Zauberflöte: Overture; "Papagena! Papagena! Papagena!"*; *Symphony No. 35: Finale; Symphony No. 40: Minuet*. Chabrier: *Joyeuse marche*. Sibelius: *Symphony No. 2: Finale (part)*. R. Strauss: *Don Quixote: Finale*. Grieg: *Peer Gynt: First Arabian Dance*. Grétry: *Zemir et Azor: Air de ballet*. Tchaikovsky: *Symphony No. 4: Scherzo*. Schubert: *Symphony No. 3: Minuet*. Haydn: *Symphony No. 100: Finale*. Bizet: *Carmen: Chanson bohème*.

Beecham Symphony Orchestra; London Philharmonic Orchestra; Royal Philharmonic Orchestra and assisting artists, Sir Thomas Beecham, cond.
• ANGEL 3621B. Two LP. \$9.96.

Sir Thomas Beecham made records for more than fifty years. The present collection spans forty-three of them, from 1915 to 1958. Considering all there was to choose from, it turns out to be a bad cross between the usual sort of promotional sampler and the familiar miscellany of purple patches from famous pieces. "Let me hear a bit of it," was a standard Beecham rehearsal line, but the bits here add up to something less than the remarkable man we know Sir Thomas to be. If there are mysterious

thumps and crashes about EMI these days, it could well be his indignant spirit. Sir Thomas never thought except in terms of the whole of a work. To extract a single movement (and invariably a fast one) from the context of a Mozart symphony is bad enough, but to whack the final pages off a Sibelius symphony or Strauss's *Don Quixote* is simply an act of artistic defilement. It honors no one.

For any serious Beecham collector most of Sides 3 and 4 are a total waste, unsatisfactory duplication of material that's already been made available. (Most of the items of Side 4 are in the current catalogue. Side 1 opens with a 1915 acoustical version of the *Zauberflöte* overture that provides an interesting look at the young Beecham's Mozart style. We then find Sir Thomas at the piano, accompanying a song of Delius,

and presto, we are transported to the Thirties. One of the most famous Beecham records from the Leeds Festival was the tempest music of Sibelius as recorded during a veritable thunderstorm. "A most exceptional record . . . quite remarkable," Sir Thomas called it a few years ago. This would be the ideal place for its revival, but no one chose to do so. However, we do have the ballet of the sylphs with its famous spoken addendum. Why not as well the famous *Flight of the Bumble Bee* with its verbal intrusion at the end?

Would not the complete Beecham recordings of the Mozart symphonies Nos. 27, 29, and 31—all of them long out of print—be preferable to isolated movements from familiar, late symphonies which he re-recorded? So it goes. You can cite your own criticisms. R.C.M.

Concertone

Proudly Presents the New SERIES 90

Concertone's new Series 90 represents the first breakthrough in the commercial/professional recording equipment field at a medium price. Designed for rugged reliability under continuous performance conditions, the Series 90 meets the most exacting broadcast requirements.

Note These Outstanding Features

EDIT-O-MATIC—provides the countless advantages of high speed search, cueing and editing.

AUTOMATIC TAPE LIFTERS—eliminate the annoyance of "squeal" in fast mode.

FOUR HEADS—allow reproduction of monaural, 2-track or qtr. track tapes with the flick of a switch. The fourth head position can also be used for special heads.

ELECTRIC RELAYS—provide instant, positive action for stop, start, fast forward and rewind modes.

REMOTE CONTROL—record, stop, start, fast forward and rewind.

NEW TAPE TRANSPORT—precision design and construction. 3 motor drive system, including heavy duty capstan motor.

These exciting features mark the Series 90 as the ultimate in professional recorders. From \$925.

THE NEW 508—AT A MODEST PRICE

Advanced recorder design with professional reliability, extreme fidelity and tape-handling ease. The 508 has no equal for broadcast performance or custom installation. Available as a precision tape player or with separate electronics for mono or stereo recording. In half or full track at \$520.



See Concertone at better professional dealers everywhere. Write for name of nearest dealer and complete information. Dealer inquiries invited.



AMERICAN CONCERTONE, INC.
A DIVISION OF ASTRO-SCIENCE CORPORATION
9449 WEST JEFFERSON BOULEVARD • CULVER CITY, CALIFORNIA

EXPORT: Telesco International Corp., 171 Madison Ave., New York 16, N.Y.
CIRCLE 5 ON READER-SERVICE CARD

Now You Can Rediscover

VIVALDI HAYDN CORELLI BACH

An Unusual Introductory Invitation
To Enjoy the Treasures of LRM

You have probably been hearing about the extraordinary Library of Recorded Masterpieces' recordings—with authentic scores and original instrumentation—of the complete VIVALDI ("Sheer listening joy!", Leonard Bernstein says); of 18 HAYDN symphonies (called by High Fidelity, "The logical starting point for even a restricted Haydn collection."); of the complete CORELLI (the only Corelli recording in High Fidelity's 100 best recordings of the year); and of the exciting BACH BRANDENBURG CONCERTOS with never before recorded alternate versions and original instrumentation and Bach's own 176-page manuscript score in facsimile.

To enable you to make the acquaintance of these treasures, the Library has arranged a highly attractive introductory offer which is truly breathtaking.

Write today for free brochure "INTRODUCTORY"

Library of Recorded Masterpieces,
Dept. IN, 150 W. 82nd St., N. Y. 24, N. Y.
CIRCLE 59 ON READER-SERVICE CARD

DISCOVER PARLIAMENT

At \$1.98*

*SUGGESTED LIST PRICE PER RECORD
the greatest value
in recorded music



A Deluxe 2 Record Set

For Further Exploration
of the Parliament Catalogue
Write:

PARLIAMENT RECORDS
38 W. 48 St., N.Y.C. 36, N.Y.
CIRCLE 12 ON READER-SERVICE CARD

VICTORIA DE LOS ANGELES: "The Fabulous Victoria de los Angeles"

Sacriati: *Proserpina: E dove l'aggiri*.
Alessandro Scarlatti: *Le Violette*. Handel: *Joshua: Oh! Had I Jubal's Lyre*. Schubert: *Der Tod und das Mädchen; Wohin; An die Musik*. Brahms: *Dein blaues Auge; Vergebliches Ständchen*. Fauré: *Chanson d'amour; Clair de lune*. Granados: *Callejeo; E tra la la y el punteado*. Guridi: *No quiero tus avelanas; Como quieres que adivine*. Traditional, arr. Nin: *Granadina; El vito; El paño murciano*. Turina: *Tu pupila es azul*. Valverde: *Clavelitos*. Barrera & Calleja: *Adiós Granada*.

Victoria de los Angeles, soprano; Gerald Moore, piano.

- ANGEL 35971. LP. \$4.98.
- • ANGEL S 35971. SD. \$5.98.

This is a fairly typical De los Angeles recital program, embracing a lengthy group of Spanish songs in addition to the more familiar Italian, French, and German selections. Her voice has never sounded better, and no devotee will be disappointed. Her first group—consisting of the Sacriati, Scarlatti, and Handel numbers—is nearly beyond criticism. Her pure, rock-steady tones have a chilling bite in the powerful "E dove l'aggiri," a melting warmth and charm in *Le Violette*, and a diamondlike brilliance in the extended coloratura of "Oh! Had I Jubal's Lyre."

How well one will take to the remaining interpretations is largely dependent on personal taste, since the singer's own approach is so entirely subjective. I would vote very much in favor of her sensitive work in *Der Tod und das Mädchen* (though the low ending is surely more effective), and of the caressing, romantic rendering of the *Chanson d'amour*. But, though there is illustrious precedent for a woman singing *Wohin?*, I cannot quite accustom myself to the idea of any of the songs from such male cycles as *Die schöne Müllerin*, *Die Winterreise*, or *Dichterliebe* in even the most competent female hands. And surely this *An die Musik* is much too distended: granted that Schubert's tempo markings are not voluminous (this entire song, for instance, bears only the indication "Mässig" at the top of the page—nary an accelerando or ritardando, his phrases still are not made of rubber. The effect of all the dallying at the tops of phrases is to convey the impression that the singer loves music in a soupy, sentimental way, which may suit Schober, but not Schubert. But as previously noted, one's taste plays an important role in such considerations.

I always have a bit of trouble with groups of Spanish songs of the sort offered here, because I think that by and large they are uninteresting as music; and while I'm always happy to hear a well-done *Clavelitos* as an encore, I really can't accept half a recital program built on such items. De los Angeles' performances of them are lovely, though they don't have the final bit of "go" that Supervia or Bori brought to such songs. The singer announces each number in this group—why, I can't imagine. As usual, Moore's accompaniments are pianistically irreproachable, and beautifully matched to the singer's concepts. And Angel has again provided excellent translations and notes, as well as good recording on both the mono and stereo discs. C.L.O.

"KEYBOARD GIANTS OF THE PAST"

Various artists.

- RCA VICTOR LM 2585. LP. \$4.98.

This disc ranges in time from the distant era of De Pachmann, Rosenthal (whose heyday was long before 1942 when the present recording of Liszt's *Chant polonaise No. 5* was made), Paderewski, and Gabrilowitsch, and goes on to include the more recent art of Lhevinne, Rachmaninoff, and Harold Bauer. It culminates with a beautiful performance of the Eleventh Liszt *Hungarian Rhapsody* by William Kapell, whose career would still be flourishing had it not been for the tragic air crash that claimed his life in 1953.

If the present album lacks some of the excitement generated by earlier discs of this sort, it is chiefly because of the fact that most of the performances here reissued have already been made available on microgroove at one time or another. For example, I cannot envision any lover of great keyboard artistry who does not already own Rachmaninoff's complete rendition of Schumann's *Carnival*, either in its first reincarnation as RCA Victor LCT 12 or its second, on Camden CAL 396. The Rosenthal, Lhevinne, and Bauer selections were also available for a time on the RCA Camden reissue series "The Art of. . ." I am not so sure about the Paderewski Minuet in G. This pianist made so many recordings of his hackneyed little trifle that it is hard to keep track of them. If I remember correctly, the performance contained on the "Art of Paderewski" disc was a more recent one than the version we are given here, which dates from 1923.

Of the newly rediscovered performances, De Pachmann's 1923 Chopin F sharp Impromptu shows the performer in a relatively straightforward mood. His playing has considerable flow and continuity despite his rather curious phrase groupings and semi-staccato approach, and the fluid cantabile of his tonal quality is most impressive. The Arensky Waltz in the Bauer-Gabrilowitsch version is still the classic recording of this piece. What ebb and flow, what beautiful give-and-take these two artists achieve here! The Levitzki performance of his own *Arabesque valsante* is of limited interest, chiefly because of the inherent inferiority of the music itself.

The more familiar performances do not really require mention here, although I would like to express my special admiration of Harold Bauer's wonderfully wholesome interpretation of Liszt's *Un Sospiro*. Victor's transfers have a good deal of vitality. The engineers have mastered the disc at a rather high volume level, and have refrained from filtering out the surface noise on the really old items. I approve, for I much prefer scratch to leaden, soggy piano sound.

H.G.

IDA PRESTI and ALEXANDRE LAGOYA: "The Virtuoso Guitars"

Bach: *English Suite No. 3, S. 808; Prélude, Allemande, Courante*. Debussy: *Clair de lune*. Granados: *Oriental (Spanish Dance No. 2)*. Marella: *Suite No. 1, for Two Guitars*. D. Scarlatti: *Sonatas: in E, L. 23; in B minor, L. 33*.

Ida Presti and Alexandre Lagoya, guitars.

- ELEKTRA EKL 208. LP. \$4.98.
- • ELEKTRA EKS 7208. SD. \$5.95.

HIGH FIDELITY MAGAZINE

Sensationally successful in concerts abroad and currently (under Sol Hurok's aegis) in this country too, Presti and Lagoya are patently virtuosos of the first rank. Their showmanship is dazzling; their performance style unusually interesting in its apparent independence from that of the omnipotent Segovia; yet for some reason their playing, on records at least, fails to move me. Their sole original score, by the late eighteenth-century Italian composer Giovanni Batista Marello, is no more than a lightweight, however genial, *pièce d'occasion*; with the exception of the perky L. 23 and nostalgic L. 33 Scarlatti sonatas, Lagoya's transcriptions strike me as nervously tense (as in the Bach) or overmannered (as in the Debussy and Granados). Perhaps other listeners will find more communicative feeling here than I can; certainly the closely miked recording of the players' perfectly blended timbres is extremely attractive. R.D.D.

SERGEI RACHMANINOFF: "The Great Rachmaninoff"

Mendelssohn: *Midsummer Night's Dream: Scherzo: Spinning Song, No. 34, in C, Op. 67, No. 4.* Chopin: *Waltzes: in E minor, Op. posth.; in C sharp minor, Op. 64, No. 2; Nocturne in E flat, Op. 9, No. 2.* Bach: *Partita No. 3: Prelude.* Handel: *Harmonious Blacksmith.* Rachmaninoff: *Preludes: in C sharp minor, Op. 3, No. 2; in F minor, Op. 32, No. 6; Polka de W. R.: Etude in E flat, Op. 33, No. 7; Tchaikovsky: Troika Sleigh Ride.* Schubert: *Serenade.* J. Strauss II: *One Lives but Once.*

Sergei Rachmaninoff, piano.
• RCA VICTOR LM 2587. LP. \$4.98.

Here is a fine cross section of Rachmaninoff's recorded legacy. Of the selections reissued here, the miraculous Mendelssohn Scherzo, the fastidiously controlled, bitingly accented *Harmonious Blacksmith Variations*, and the perverse, but compelling, Chopin E minor Waltz make the journey from 78 rpm to microgroove for the first time. So, too, does the pianist's shattering transcription of the Strauss *Man lebt nur einmal* Waltz, recorded in 1927. The remaining items have all been included in previous LP collections, but only one of them (Rachmaninoff's transcription of the Prelude from the Bach E major Violin Partita) was contained on the recently deleted Camden disc (CAL 486, "The Art of Sergei Rachmaninoff," Vol. II).

Rachmaninoff's bluntly dogmatic, square-cut rhythmic precision and non-coloristic "steel-point etching" tonal quality are best suited to the pieces which call for transparency of texture and firmly delineated contours. Some music, the Chopin for instance, tends to get overpowered by the performer's vitality. The Chopin Waltzes here are really more strenuous than they are vivacious, while the E flat Nocturne is overdrawn and exaggerated. The Mendelssohn *Spinning Song*, on the other hand, generates dizzying momentum, and the Tchaikovsky *Troika Sleigh Ride* from *The Seasons* comes off with beguiling (and unexpected) warmth and charm. The restored sound is very vital throughout, and some of it (the Strauss, for example) much better than one would have expected from such old material.

Even if you find yourself to be in violent disagreement with some of Rachmaninoff's interpretations, you may

well find yourself hypnotized by his playing. Such was the power of conviction of one of the supreme pianistic giants of all time, and that power is here very amply conveyed. H.G.

MARTIAL SINGHER: Operatic Recital

Bizet: *Les Pêcheurs de perles: O Nadir, tendre ami de mon jeune age.* Charpentier: *Louise: Les pauvres gens peuvent-ils être heureux? Berceuse.* Lully: *Alceste: Air de Caron.* Rossini: *Barbiere di Siviglia: Largo al factotum; Dunque io son.* Thomas: *Hamlet: Spectre infernal: O vin dissipe la tristesse; La fatigue alourdit mes pas; Comme une pâle fleur.* Hahn: *Le Marchand de Venise: Air de Bassanio.* Debussy: *Pelléas et Mélisande: Oh! qu'est-ce que c'est? Mussorgsky: Boris Godunov: Monologue.*

Virginia MacWaters, soprano (in "Dunque io son"); Bidú Sayão, soprano (in the Debussy); Martial Singher, baritone; Orchestra.

• INTERNATIONAL RECORD COLLECTORS' CLUB IRCC L 7019. LP. \$5.50.
(Available from International Record Collectors' Club, 318 Reservoir Avenue, Bridgeport 6, Conn.)

Most, if not all, of the recordings presented here were made in the Thirties and Forties, when this fine baritone's voice was in fresher condition—especially in the upper regions—than it has been over the past decade or so. Singher has always been a stylish, incisive artist, and as the Metropolitan's sole resident representative of the best French tradition until his departure from the company a couple of seasons back, he has made himself uniquely valuable to lovers of French opera on this side of the Atlantic. His voice has always inclined to dryness, but it is of fair caliber, and when in his prime he produced it with an ease that allowed him considerable latitude in shading, even in the cruelly high tessitura of the role of Pelléas.

Certainly it is a pleasure to hear these French operatic excerpts presented with such authority and precision in characterization. Most welcome is the series of passages from *Hamlet*, an opera which was revived for him by the Paris Opéra in 1933, with Ritter-Ciampi as Ophélie. These selections, rare enough on records (except for the familiar "O vin, dissipe la tristesse"), are all the more treasurable for the firm vocalism and interpretative insight that Singher brings to them; it is a pity that he was never given the opportunity to sing the role in New York. Despite the fact that his voice could, in those years, have been described as a high lyric baritone, his adeptness at coloration and the immediacy of his attack enabled him to sing convincingly even the *Louise* Berceuse and the *Boris* monologue, both of which usually make their best effect in the hands of a bass.

The selections from *Il Barbiere* and *Pelléas* will evoke nostalgia in long-time Met broadcast listeners. As such recordings go, this offers fine sound. C.L.O.



THE RECORDS THAT WOULD NOT DIE

starring

HAYDN SOCIETY & CONCERT HALL

A MOVING SAGA OF LP
BEAUTIES DISAPPEARED FROM THE
CATALOG BUT REINCARNATED
BY THE RECORD HUNTER

HAYDN SOCIETY: over 40 titles already available..new pressings..original H.S. masters & jackets..INCLUDING: early Haydn Quartets by the Schneider Quartet..entire MASTERPIECES BEFORE 1750 series..LILI KRAUS' MOZART..R. KILPATRICK'S "GOLDBERG" VARIATIONS..EARLY SYMPHONISTS & VOCAL POLYPHONY..CHARPENTIER..HAYDN MASSES..ETC. ETC.

CONCERT HALL: over 30 titles already available..limited, new pressings on The Record Hunter's RARITIES COLLECTION label..Original C.H. masters..MANY MANY "ONLY VERSIONS" INCLUDING: HUMMEL PIANO CONCERTO..SHOSTAKOVICH PLAYS SHOSTAKOVICH (preludes) ..EARLIEST MOZART SYMPHONIES (entire series)..ARRIAGA QUARTETS..several Beethoven rarities: Christus am Oehlberg (complete), Ruins of Athens (complete) & Creatures of Prometheus (complete)..HANDL "APOLLO & DAPHNE" complete..ETC. ETC. ETC.

OUT OF TOWNERS

The Record Hunter periodically mails to Collectors a select list of LPs. Each LP is described with inside musical, critical & discological information. Above labels are listed complete, as are lavish selections on Major & minor labels at doubly-flatted discounts. FREE SUBSCRIPTIONS TO READERS OF HIGH FIDELITY..for current issue send a card now to:

THE RECORD HUNTER

DEPT. "HIGH," 607 5th Ave., New York 17, N. Y.
CIRCLE 72 ON READER-SERVICE CARD



Just Released

THE WEAVERS' ALMANAC

Mono and Stereo



"Listening to the Weavers is a joyful, even uplifting experience... the quartet continues to communicate that 'glad to be alive and singing' feeling, which few others who are working in the folk field have been able to sustain." *New York Times*

Send for Catalogue to: Vanguard Recording Society, Inc., 154 West 14 Street, New York

CIRCLE 95 ON READER-SERVICE CARD



only
marantz
 measures your listening pleasure
 for you . . .

The performance test report packed with your Marantz amplifier or preamplifier tells its own story—it is the actual measurements of the unit you just bought—giving accurate and graphic indications of the listening qualities which will be obtained from it.

It is no accident that Marantz far excels in all of the factors which most directly determine fine listening quality. The four most important of these are: percentage of distortion; completeness of stability; precision of curves and controls, and; amount of relative background noises. Each unit is laboratory tested and adjusted for optimum performance on every one of these points . . . and MANY MORE! Furthermore, this fine performance is assured for many years by the precision quality of its construction.

The performance specifications shown below may appear remarkable in themselves, but your test report will show that these claims are more than fulfilled. Marantz measures better — and sounds better! *Write for literature No. 56F*

marantz

25-14 BROADWAY, LONG ISLAND CITY 6, NEW YORK

Model 7 Stereo Console • 1M distortion @ 10V eq. pk. RMS, within 0.15%, 0.1% typical • Hum and noise, 80 db below 10 mv phono input • Sensitivity, 400 microvolts (0.4 millivolts) for 1 volt output • Equalizer and tone curves matched to better than 0.5 db • Beautiful precision construction • Price \$264 (Cabinet extra)

Model 8B Stereo Amplifier • 35 watts per channel (70 watts peak) • Harmonic distortion, less than 0.1% in most of range, less than 0.5% at 20 cps and 20 kc • Hum and noise, better than 90 db below 35 watts • Exceptional stability assures superb clarity with all types of loudspeakers • Price \$249.

Model 9 Amplifier—70 watt basic amplifier • Response at 70W, ± 0.1 db, 20 cps to 20 kc. • Harmonic distortion, less than 0.1% in most of range, 0.3% at 20 cps and 20 kc. • Hum & noise, better than -90 db • Completely stable for smooth response • Built-in metered tests and adjustments • Price \$324 each.

(higher in West)



CIRCLE 63 ON READER-SERVICE CARD

The Lighter Side



POPULAR • THEATRE • FOLK



John Philip Sousa

More Than Music To March To

✓ "Sousa on Review." *Eastman Wind Ensemble, Frederick Fennell, cond. Mercury MG 50284, \$4.98 (LP); SR 90284, \$5.98 (SD).*

✓ "Touchdown, U. S. A.: The 'Big 10' and Other Great College Marches of the Gridiron." *University of Michigan Band, William D. Revelli, cond. Vanguard VRS 9095, \$4.98 (LP); VSD 2100, \$5.95 (SD).*

INASMUCH AS superlatives are my weakness, I expect I'll have to concede that these two march records may not be in every respect the finest ever made. But it's certainly no exaggeration to rank them among the very best over-all, as well as exceptionally noteworthy for their special contributions: in one case, revelations of the less well-known Sousa repertory; in the other, startling evidence of the performance skills a great conductor can instill in the changing personnel of a college band.

However large (or small) the hard core of march music *aficionados* may be today, sales of band recordings probably primarily depend on strictly sonic appeals to less specialized audiophiles. And here too, while there have been superb examples in the recent past, the present releases match, if not surpass, them in technical excellence—expectedly enough where Fennell is concerned, and not entirely surprising in Vanguard's case, at least to anyone thrilled earlier by this company's overseas recordings of the

Royal Artillery Band. And, as usual in this repertory, it is only the stereo editions which fully capture the expansive authenticity of the master tapes; the Vanguard LP is satisfactory enough by mono standards, but the Mercury LP is much too high in modulation level and harder-toned than its SD counterpart.

Fennell's program is his second devoted entirely to Sousa (the first was "Sound Off!") and—with various inclusions in other less specialized albums, three of which are re-recorded here for the first time in stereo—it brings him up to thirty-one in his monumental endeavor of recording the March King's complete published legacy of 131 pieces. The three re-recordings are *Rifle Regiment* (1886), *Manhattan Beach* (1893), and *Black Horse Troop* (1925). Most of the other selections here are relatively unfamiliar and some of them surely must be record "firsts": *Glory of the Yankee Navy* (1910), *Kansas Wildcats* (early 1920s), *Ancient and Honorable Artillery Company* (1924), *National Game* (1925), *Pride of the Wolverines*, *Gridiron Club*, and *Sesqui-Centennial* (1926), *New Mexico and Golden Jubilee* (1928).

Although the reputation of the century-old Michigan Band and of William D. Revelli (its director

since 1935) has long been firmly established in educational band circles as well as locally (and abroad too, thanks to a triumphal foreign tour in 1961), I was still unprepared for what is to be heard in this typical collection of collegiate favorites. In the first place, the many special arrangements by Jerry H. Bilik are not only more professionally expert than those of most pros but they demonstrate, especially in their arresting introductions, a truly creative imagination and an unflinching mastery of tonal color contrasts and combinations. In the second place, Revelli miraculously endows his amateur players with an assured precision, yet without any curbing of their youthful vigor and zest. If football-game memories or current TV examples have left you with a neutral or low opinion of gridiron bands and music, just listen to their apotheoses here, beginning perhaps with the exhilarating *Rambling Wreck from Georgia Tech*, *Minnesota Rouser*, *Hail Purdue*, *Down the Field*, and *Notre Dame Victory March*. By this time the seasonal excuse for these *pièces d'occasion* is long past: no matter!, the present recorded performances transcend the calendar no less than the genre itself. R.D.D.

✓ "American Folk Songs." Jo Stafford; Orchestra, Paul Weston, cond. Capitol ST 1653, \$4.98 (SD).

Although Jo Stafford's reputation stems primarily from her abilities as a pops balladeer, she is no stranger to the realm of traditional airs. In the past, she has popularized many a folk melody and she has even quietly provided an endowment for scholarly work in American folklore. In this, her first album dedicated to a genre she obviously understands and respects, Miss Stafford picks up all the marbles. Her selections run a full gamut from gaiety to despair, but to my ear she is most effective in the melancholy vein. Her satiny voice explores a new dimension of yearning in *Black Is the Color*, conveys all the profound loneliness of *Johnny Has Gone for a Soldier*, and lends a darkling sheen to the old poignance of *Barbara Allen*. Far from occupying any middle ground, this release will captivate those generally indifferent to folk song as well as its most ardent and scholarly admirers. O.B.B.



Jo Stafford: mistress of folk melody.

Equally beguiling in a less showy way are his mellow-toned and warm performance of *I'm in the Mood for Love* and a gentle, caressing version of *These Foolish Things*. Although the recordings date from the late Forties, and show their age with sound that is cloudy and in the orchestral climaxes often muddy and slightly distorted, these defects should deter nobody from acquiring this fine memento of a unique artist. J.F.I.

"Tropical Nights." Werner Müller and His Orchestra. Telefunken TP 2521, \$1.98 (LP); TPS 12521, \$2.98 (SD).

In its SD edition, at least, this is a bargain-price "sleeper," both technically (for its markedly channel-differentiated, brilliantly big and open recording—the higher-level LP is harder-toned, less bright and natural) and musically (for the verve and vibrancy of its big-orchestral performances of Latin-American

dance favorites). Except perhaps in an overelaborate *Quizas? Quizas?* beguine (which has moments of considerable interest at that), the arrangements are imaginative without fanciness, and the atmospherically evocative playing (in the *Delicado* and *Peanut Vendor* baions, *Adios beguine*, *Tabu rumba*, and *Spanish Harlem bolero*, in particular) is stimulating to both ears and toes. R.D.D.

"Alps to the Sea." Aldo Bruschi and his Ensemble. Cima 113, \$3.98 (LP).

Aldo Bruschi, coproprietor of the New York supper club *In Boboli*—named for a striking Florentine garden—has a Juilliard background and shows it in this virtuoso musical tour of Italy. Directing a small, intimate, and highly skilled ensemble, he accentuates the instrumentalists' efforts with his own contributions on piano, oboe, and accordion. But it is his virile bass voice that weaves the ultimate spell in a splendid repertory of songs. Forsaking the safe and trodden-to-death confines of Naples, Bruschi sweeps the length of the boot, contrasting cool northern melodies with the smoldering anthems of the south. His excursion pays off, for the two most appealing items on the disc are *La Montanara* and *Sul Cappello*—both relatively neglected airs from the Italian Alps. Adequate rather than spectacular engineering cannot deprive Bruschi's debut of a well-merited *bravo*. O.B.B.

"Classics by Chacksfield." Frank Chacksfield and His Orchestra. Richmond B 20092, \$1.98 (LP); S 30092, \$2.98 (SD).

I suppose none of the orchestral cameos in this excellent concert of light classics could be really called unfamiliar, although Elgar's *Salut d'amour*, Rubinstein's *Melody in F*, the *Humoresque* of Dvořák, and perhaps Greig's *Morning Song* seem to be heard less frequently

✓ "Freddy Gardner with Peter Yorke's Orchestra." Capitol T 10296, \$3.98 (LP).

Six of these legendary saxophone solos by the late Freddy Gardner have been in and out of the domestic catalogue since 1950, first on Columbia 78s, then on Columbia CL 6240, and later as part of Columbia CL 623, a twelve-inch LP. All have been unavailable for some time, however, and in reissuing them, Capitol has rendered collectors a great service. Together with two sides not previously released in this country, *Stardust* and *Smoke Gets in Your Eyes*, they provide a stunning showcase for Gardner's unerring musical taste and fabulous instrumental technique. Spectacular and exciting performances of *Body and Soul*, *I Only Have Eyes for You*, and *Valse Vanité* display his virtuosity at its peak.

than they were twenty-five years ago. The balance of the program includes brief orchestral excerpts of well-known works by Bach, Beethoven, Debussy, Liszt, and Tchaikovsky, all tastefully arranged by Eric Rogers and impeccably played by Frank Chacksfield's men. Incidentally, these musicians must be some of the most versatile performers on records, having to their credit a series of really splendid discs that run all the way from Oriental and gypsy music to show tunes and classics, with not a single inferior record to blot their escutcheon. The mono version boasts a rich velvety sound which is infinitely more agreeable to my ear than the reedy quality of the stereo version. J.F.I.

"Scottish Bagpipe Tunes." Pipe Major James MacColl. Folkways FG 3550, \$5.95 (LP).

Probably only Scotsmen can enjoy a long program of solo bagpiping: the trace of Scots in my own blood is apparently in-

sufficient to prevent this series of *ceol aotrom* (relatively short dance pieces) from seeming interminable. Yet even so, a more extensive *piobrach*, the evocative *Lament for the Children* (which occupies a good half of the second side), not only moved me profoundly but held me mesmerized throughout. I can't speak authoritatively, but MacColl certainly seems uncommonly gifted both for his virtuosity (many of the quirky ornaments call for fabulous digital dexterity) and his interpretative artistry. In any case, I've never heard solo bagpipes recorded—in apparently close miking—with spicier authenticity; and to crown the documentary attractions of this notable release, Ed Cray's annotations provide an illuminating history of the "pipes" as well as detailed information on the music. R.D.D.

"Ballads and Balalaikas." Piatnitsky Chorus and The Orchestra of Folk Instruments. Artia ALPS 192, \$5.98 (SD). Spelling each other through fifteen rous-

ing selections, Russia's superb Piatnitsky Chorus and the Osipov Folk Orchestra shape a glittering tapestry of Slavic melody. Balalaikas to the fore, the instrumentalists provide fiery readings of tidbits from Glinka, Glière, and Khachaturian that would set even a gout-ridden toe to tapping. The Chorus furnishes lyric counterpoint with the songs of love and growing things that have been the glory of Russian folklore for centuries. While the Soviet stereo lacks the breadth of today's best efforts, it will adequately serve both channels of your music system. O.B.B.

"Kean." Robert Mersey and His Orchestra. Columbia CL 1732, \$3.98 (LP); CS 8532, \$4.98 (SD).

Some interesting, and occasionally inspired, orchestrations by Robert Mersey give the Wright-Forrest score for the musical *Kean* a piquancy and strength not found in the original cast recording. While some of Mr. Mersey's ideas would

"Considered on its own merits, the FM tuner section of the KLH 8 is of undeniably high fidelity quality. The IHFM usable sensitivity curve shows a 2.5-microvolt sensitivity for 3% distortion. This figure has been exceeded by only two or three tuners in our experience, all of them more expensive than the entire KLH Model 8." (Separate tuner output is available through a jack at the rear.)

"In evaluating such an unconventional unit, the most important consideration is 'how does it sound?' The answer is: astonishingly good, much better than its physical size or response curves would suggest. It is clean, smooth, and definitely of high quality. In our listening tests, everyone was impressed with its sound. In A-B tests with the KLH-8 and an elaborate system of known high quality, many listeners found the differences to be slight. In fact, when listening to solo stringed instruments or small chamber groups, it was difficult to tell the two systems apart. On voices the KLH occasionally sounded better."

(From an independent report by Hirsch-Houck Laboratories in *High Fidelity Magazine*. Copies available on request.)

Have you heard it yet ?

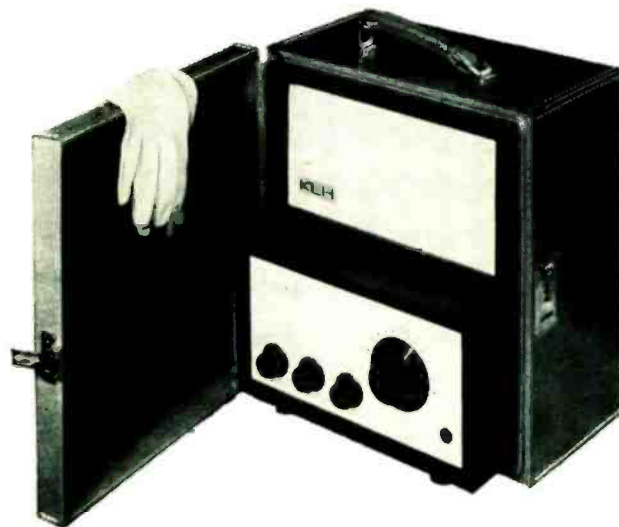

KLH model eight SOLID WALNUT \$159
Includes tuner-amplifier and speaker system
with 30 ft. cable. Custom travelling case:
\$50. Extra speaker system with 30 ft. cable:
\$54. Adapter for tape recorder or magnetic
cartridge record player: \$19. At better audio
stores, or write for literature and the name
of your franchised KLH dealer.



KLH RESEARCH AND DEVELOPMENT CORPORATION
80 CROSS STREET, CAMBRIDGE 39, MASSACHUSETTS

CIRCLE 53 ON READER-SERVICE CARD

hardly work in the theatre, they come off brilliantly on disc. Put down as a major achievement the regal march setting he has devised for *King of London*, which perfectly suggests Kean's position as the monarch of the London theatre. Equally effective in creating the blowsy atmosphere and high spirits of the show's most rousing number, *The Fog and the Grog*, is his use of bleary-sounding trumpets. Strings are used inventively to heighten the romantic overtones of *Sweet Danger* and even more successfully in *Civilized People*, where, played with a certain amount of frenzy, they aptly suggest the squabbling ladies vying for Kean's affections. The arranger directs a superb performance, which in stereo sounds positively brilliant. I might men-

tion that the tableau used by Columbia for the album cover is from a scene deleted from the recent production. J.F.I.

"Sing! It's Good for You." Norman Luboff Choir and Orchestra. RCA Victor LPM 2475, \$3.98 (LP). There's more sing-along infectiousness in the Luboff group's jauntily spirited *Side by Side, Happy Days Are Here Again, Whistle While You Work, Get Out and Get Under the Moon, It's a Good Day*, etc., than in many recorded programs calling more explicitly for audience participation. Text leaflets are lacking, to be sure, and some of the pieces are routinely sung and accompanied, but the closely miked recording is attractively rich and warm. R.D.D.

"The Importance of Being Oscar." Micheál MacLiammóir. Columbia OL 5690, \$4.98 (LP); OS 2090, \$5.98 (SD).

For decades after his death, the tragedy of Oscar Wilde's last years engulfed all memory of the man and shadowed his works as well. But the past decade has seen his plays once more upon the boards, and time is gradually placing his art in true perspective. Wilde was, of course, a flamboyant figure—the apotheosis of the Edwardian Age. While strolling, he often carried a tulip; he once brushed off customs inspectors with, "I have nothing to declare but my genius." But beneath the wit and the affectation, he was also a superlative dramatist, a gifted poet, a critic, and an essayist of the first order.

In a magnificently conceived evening of theatre, which won raves from London to New York, Micheál MacLiammóir has singlehandedly re-created Wilde and his world. This Columbia release covers the first half of his performance: a subsequent recording will present the remainder. Using Wilde's writings as source material, MacLiammóir here traces the poet's career from Dublin through his fantastic successes in London as far as the first rumble of his impending doom. With unequalled versatility, MacLiammóir plays Wilde himself, delineates characters from Wilde books, and acts out entire episodes from Wilde dramas; he plays both Herod and his daughter—in impeccable French—in a key scene from *Salome*; his reading of *The Harlot's House* is a small-scale masterpiece.

This is an extraordinary solo performance, one that calls upon every facet, every nuance of the actor's craft. On the record it provides a vivid, moving, unforgettable hour. Wilde's shade as well as all of us are deeply in debt to Mr. MacLiammóir. In complex acted sequences, the stereo edition channels separate characters into separate speakers, thus lending both additional breadth and clarity to the performance. O.B.B.

"Harp Virtuoso." Verlye Mills, harp. Golden Crest CR 4037, \$4.98 (LP). None of the selections in this exceptionally well-played recital were originally written for the harp, with the possible exception of Reinhold's *Impromptu* (inexplicably missing from the program credits). Like most modern harpists, Miss Mills has delved into literature for the piano that might be suitably transcribed for her own instrument. The results show that she has not been willing to settle for the easiest way out. Mendelssohn's *Rondo Capriccioso*, for instance, a difficult work in its original piano form, becomes doubly so when transcribed for harp. Yet Miss Mills handles it with extraordinary ease, creating a delicate colorful panorama of fanciful, fairylike sound. Equally entrancing are her superb performance of Rachmaninoff's *Prelude No. 5* and a passionate and fiery account of the Spanish Dance No. 3 of Moszkowski. MacDowell's *To a Wild Rose* does not, surprisingly, weather the instrumental change too well, and the performance of Chopin's *Waltz in E minor* sounds rather disjointed and lacking in charm, but when everything else is so charmingly set forth, it would be ungracious to fault the record for two disappointing ventures.

The extremely wide-range recorded sound is brilliantly translucent, and the



an astounding
new sound...
an incredible
new cartridge

SHURE M33

Stereo Dynamic

An extraordinary achievement in superior re-creation:

RESPONSE: 20 to 20,000 (conservatively). Singularly clean and smooth. Goes right through the top limits of audibility without a hint of "break-up" prevalent in most other stereo cartridges.

COLORATION: virtually non-existent. Imparts no false sound to the music. It is transparent, clear, hum-free (special Mu-metal shielding rejects electrically induced hum). Peak-free.

COMPLIANCE: over 20×10^{-6} cm/dyne! Tracks as low as 1 gram... virtually eliminates record and stylus wear. Separation over 22.5 db. at 1000 cps.

THE STYLUS: Choice of .0005" or .0007" diamond tips. Exceptionally rugged. Special plastic grip makes stylus changing easy as plugging in an electric cord.

PRICES: M33-5 (with .0005" diamond) or M33-7 (with .0007" diamond). Tracks at 1 to 3 grams... \$36.50 net.

Model M77 (for tracking at 4 to 7 grams) only \$27.50.



SHURE

Stereo Dynamic

hi fi phono cartridge

Shure Brothers, Inc., 222 Hartrey Avenue, Evanston, Illinois
CIRCLE 80 ON READER-SERVICE CARD

harpist achieves so many extraordinary effects that it is difficult to believe that no multiple taping or overdubbing has been resorted to. The liner notes say not—which merely adds to one's admiration for Miss Mills's talent. J.F.I.

"In Praise of God." Frank Chacksfield and His Orchestra. Richmond B 2105, \$1.98 (LP); S 30105, \$2.98 (SD).

With its tastefulness of arrangements, fervency rather than sentimentalization of performances, and lucidity of sumptuous recording, this program of symphonic hymns and devotional songs reveals persuasive warmth throughout and genuine distinction in its best moments. Among the latter I number Vaughan Williams' nobly sonorous setting of the *Old Hundredth*, a dramatic—and highly stereogenic—"patrol" treatment of *Onward Christian Soldiers*, and Rogers' expansive transcriptions of *All Things Bright and Beautiful* and *O God Our Help in Ages Past*. Sonically alone, the ringing brass chorals, glowing string choir, and full-blooded organ and timpani-roll passages here would be hard to surpass as demonstrations of the power and beauty of high-fidelity monophony (in the LP edition) or of grandly impressive stereo. At their bargain prices, both versions are outstanding best buys. R.D.D.

"A Harvest of Israeli Folksongs." Theodore Bikel; instrumental accompaniment. Elektra EKL 210, \$4.98 (LP).

Israeli folk songs are Bikel's forte, and no one else in the catalogue belts them out with quite the same combination of vocal excellence and *brío*. Bikel, who is actor as well as singer, also seasons his performances with a delightful dash of—pardon the expression—ham. In fact, he involves himself so profoundly and projects so well that he seemingly is a shepherd or a sailor or a ploughman or that most universal of men—a frustrated lover. Of the fifteen selections on this release, the majority are love songs and work songs. The best of the former, *Tse'i Lach* (Come Out) and *Avigayil* (Abigail), hark back to the rich and tender imagery of Old Testament poetry, while the latter are infinitely more than an appeal to exceed the norm. At their best, as in *Arava Ho Arava* (Wilderness Oh Wilderness) and *Shir Ha'avoda* (Work Song), they display a passion for the Israeli land, a stirring sense of the unity of man and his environment. In sum, here are all the ingredients of another Bikel best seller. Recommended most strongly. O.B.B.

"Stereo 35 MM., Vol. 2." Enoch Light and His Orchestra. Command RS 831 SD, \$5.98 (SD).

Having exhausted my supply of superlatives on Volume One of Command's Stereo 35MM series, I am at a complete loss for new ones to describe Volume Two. I can only say that everything that applied to the first release is equally true of this new one. Incidentally, the jacket notes for the present disc quote almost verbatim my remarks on Volume One—which may, or may not, induce you to acquire that album if you haven't already done so. J.F.I.

"All-Star Concert Band, Vol. 2." James F. Burke, Harvey G. Phillips, Lucien Cailliet, conds. Golden Crest CR 4040, \$4.98 (SD).

The two Goldman Band veterans who formed this 38-man, not unjustly titled

"all-star," band divide or share its direction (without individual credits) in the more orthodox pieces here, ranging from a somewhat overcareful Walton *Crown Imperial March* and Berlioz *Roman Carnival Overture* to the more exuberant *National Emblem March*, *Flight of the Bumble-Bee*, *Victor Herbert Medley*, *Bees A-Buzzin'*, and *Blue Mist*. Then, under the guest baton of Cailliet, Burke goes back to his old role as floridly virtuosos fat-toned cornet soloist (in the *Hocus Polka*); Phillips demonstrates that he has lost none of his suavity as a tubaist (in an *Elephant and the Fly* duo with piccolist Andrew J. Lolya); and Vincent J. Abato stars in a brilliant clarinet transcription of the Tchaikovsky Violin Concerto finale, oddly but fascinatingly rescored by Cailliet with ac-

companiment for various types of clarinets only. Hodgepodge as all this may be musically, it should be of special interest to band specialists—not least for the highly professional precision of the playing throughout and for the vivid authenticity of the close miking and strongly stereoisitic recordings. R.D.D.

"The Sound of Folk Music." Vanguard Demonstration Release. Vanguard SRV 125, \$1.98 (LP).

Vanguard has combined the talents of thirteen soloists and three groups from its stellar stable to offer an unusual Open Sesame to the variegated world of folk music. In their specialties these artists are unsurpassed, and here they appear at the top of their form: counter-tenor Alfred Deller limning an Eliza-

new Sony



for portable use*

STERECORDER 464-D

for custom installation

only \$199.50

now both stereo recording & stereo playback!

An unprecedented price for the famed Sony quality! The long-awaited Sony Sterecorder 464-D—dual purpose, dual performance! Dual performance means both 4 track stereo recording and 4 track stereo playback. Dual purpose means custom component installation and portable use. Recording and playback pre-amps are built-in, and such features as sound on sound, language and music training, two speeds, push button track selection and Sony precision engineering make this the most outstanding tape recorder value at \$199.50. ■ All Sony Sterecorders are Multiplex-ready!

*Carrying case optional

SUPERSCOPE

The Tapaway to Stereo

For literature or name of nearest dealer, write Superscope, Inc., Dept. 1 Sun Valley, California

CIRCLE 86 ON READER-SERVICE CARD

The amplifier that DOESN'T sound

A great deal of nonsense has been written about amplifiers in recent years, about their "sound." The truth, of course, is that we listen to loudspeakers in our homes—and the "best" amplifier is that one which permits the loudspeaker to reproduce with the lowest overall distortions.

The amplifier, then, must be so designed that it

- (1) Does not increase speaker distortion.
- (2) Has the proper controls to minimize the distortions in records, tapes and radio.

The QUAD Mono-Stereo Amplifier has no sound with the QUAD Electrostatic, the reference standard speaker of the world. It is the ideal amplifier for the new polystyrene mass loudspeakers (see Newsletter One)—and can clean up the reproduction from the older, paper cone loudspeakers!

NEWSLETTER Three, "The Truth About Amplifiers," has the latest lab data on all amplifiers. Want a copy? It's free.



ELECTRONICS of CITY LINE CENTER, INC.
7644 CITY LINE AVENUE, PHILADELPHIA 51, PA.

CIRCLE 58 ON READER-SERVICE CARD

A GRANCO FIRST!



GO WITH
EXCLUSIVE
GRANCO FM
CAR RADIO
CONVERTER!



Add the beauty in sound of Granco FM to AM car radio in a marvel of minutes. Superb quality—with Automatic Frequency Control... compact design—only 1 1/4" thick... and ease of installation make this Granco innovation a "must" for every car owner, especially at this low, low price. Available at radio and auto accessory shops everywhere.

ONLY \$49⁹⁵

WRITE FOR FREE LITERATURE



GRANCO

America's Leading Specialist in Stereophonic FM

Division of Emerson Radio Inc. 680 FIFTH AVENUE, NEW YORK 19, N. Y.

CIRCLE 49 ON READER-SERVICE CARD

bethan song in a style that died centuries ago; Germaine Montero hard-driving and dazzling in *Los Cuatro Muleros*; Paul Robeson robust of voice and spirit in *Get on Board*; Cisco Houston in a magnificent reprise of Woody Guthrie's bitterly ironic *Jesus Christ*. Joan Baez, Odetta, Erich Kunz, and The Weavers also glitter in this distinguished constellation. All of the selections come from previous releases and represent an engaging advertisement. But at the same time, this sampler is perhaps the finest one-disc anthology of traditional song available. At \$1.98, I know of no greater bargain going. O.B.B.

"Moon River." The Pete King Orchestra and Chorale. Kapp-Medallion ML 7533, \$3.98 (LP).

Although there isn't much variety in this concert of songs, old and new, there are other virtues. The Chorale establishes an unbroken mood of complete relaxation from a smooth-flowing and serene performance of the currently popular *Moon River* to the final notes of *The Day the Rains Came*. The intervening numbers are nearly all songs which have attained hit status at one time or another, and these are presented in beautifully restrained and sensitive interpretations by both orchestra and chorus. Two songs which don't qualify as hits are real charmers: Van Heusen's lovely *Far Away* and an orchestral version of *The Day the Snow Is Meltin'*, a delicate little morsel from Johnny Burke's score for the show *Donnybrook*. The arrangements, presumably by Pete King, are musical and imaginative, without being involved, and they add a great deal to the entire program. J.F.I.

"The Fastest 500: A Sound Report of the 1961 Indianapolis Classic." Riverside RLP 5513, \$5.98 (LP).

"Griff Borgenson Presents Hot Rod Heaven: Bakersfield Smokers." Riverside RLP 5509, \$5.98 (LP).

Unlike most Riverside racing records, prepared by and for *aficionados*, "The Fastest 500" is a commercial broadcast production, in typical popularization style, by the Indianapolis Motor Speedway Network. The pre-race build-up is so interminable and the spot progress and accident reports from various key points are so breathlessly overdramatized that the genuinely thrilling last-minute triumph of A. J. Foyt's Bowes Seal Fast Special is made to seem almost anticlimactic. The sleekly professional recording is effective enough, but the babble of narration almost consistently covers up the sounds of the racing cars themselves.

The other disc is quite a different story. Its sonically wide variety of hopped-up Chevies, Fords, Chryslers, Pontiacs, etc. (not excluding two Triumph motorcycles) undoubtedly can be better differentiated aurally by hot-rod *cognoscenti* than by novices like myself, but the vividly realistic revving-up, roar-off, and zip-by noises, plus the occasional background evidences of an enthusiastic audience, communicate much of the excitement as well as the atmosphere of hard-fought drag races. R.D.D.

"Nightfall." Capitol Symphony Orchestra, Carmen Dragon, cond. Capitol P 8575, special price \$1.98 (LP); SP 8575, special price \$2.98 (SD).

Most of the performances here (Brahms's *Lullaby*, Järnefelt's *Berceuse*, and Rachmaninoff's *Vocalise* in the con-

ductor's own transcriptions; Ravel's *Pavane*, Grieg's *Ase's Death*, Tchaikovsky's *Andante cantabile*, etc.) are frankly mood-music presentations, but the lush string-playing is resplendently recorded in both monophony and even more atmospheric stereo, and there is effective tonal variety provided by Lou Raderman's silken violin solos, William Kosinsky's fat-toned English horn (in Grofé's *Old Creole Days*) and occasional celesta, harp, and glockenspiel decorations. R.D.D.

"Judgment at Nuremberg." Recording from the sound track of the film. United Artists UAL 4095, \$4.98 (LP); UAS 5095, \$5.98 (SD).

It is difficult to judge from the extremely episodic nature of Ernest Gold's music for *Judgment at Nuremberg* how good a score he has actually written. The vignettes which create a musical picture of the moods of German society—despair, false gaiety, hope, etc.—at the time of the Nazi War Trials seem to me to be extremely successful. But when the music tackles the politico-legal aspects of the trial and must accentuate the tremendous drama of the situation, it often sounds like conventional Hollywood melodrama stuff. What will interest most people more than the music are the two spoken narratives, extracted from the sound track and interpolated into the late sequences of the score. Burt Lancaster, as a German jurist trying to defend his position under the Hitler regime, harangues the court for eight minutes in a not very powerful speech during which he sounds more like a West Indian before a local magistrate than a German national. Spencer Tracy is far more convincing as the presiding judge summing up the case against Lancaster, although his performance is strictly a triumph of histrionic ability over the spoken word. The stereo version (the only one to which I have listened) is, as far as its musical excerpts are concerned, one of the best sound-track recordings I have heard in some time. On records, the two speeches from the film emerge less successfully. J.F.I.

"Themes!" Orchestra, Alfred Newman. cond. Capitol T 1652, \$3.98 (LP); ST 1652, \$4.98 (SD).

In case you've assumed that Hollywood alone is responsible for schmaltz from its film composers, it will be disillusioning to hear the lengths to which one of the most eminent among them goes—apparently of his own free will—in heaping whipped cream on the already oversaccharine hit tunes of both his own and colleagues' confection. There may be a few discernible traces of imaginative scoring and interpretative vivacity in *Tammy Tell Me True* and *Back Street*, but elsewhere lushness, sentimentality, and tastelessness prevail soloistically. And of the many featured soloists, only Gordon Pope (on oboe d'amore in *Catana*) makes any attempt to achieve other than strictly homogenized tonal qualities. The smoothly spread stereo recording captures all this only too blandly; the rougher-surfaced LP version adds a bit of grit that for once is almost welcome. R.D.D.

YOU ALWAYS GET THE BEST for LISTENING



TONIGHT plus other Motion Picture & Broadway Hits—as played by Ferrante & Teicher. UAL 3171 UAS 6171 (Stereo)



STANDING ROOM ONLY — The Highwaymen present their authentic folk songs. UAL 3168 UAS 6168 (Stereo)

WE REMEMBER TOMMY DORSEY, TOO—Great Dorsey songs sung by the Modernaires. WWR 3524 WWS 8524 (Stereo)



THE PROUDEST NAME IN ENTERTAINMENT

CIRCLE 93 ON READER-SERVICE CARD



elegant stereo cabinetry...

The new look in "bookshelf" speakers. Place a speaker on each end, amplifier and tuner on the adjustable shelf, and your components are transformed into a striking stereo cabinet which will highlight every interior and accent your fine components. Naturally, crafted from the finest of hardwoods in a choice of finishes. see your dealer or write for free brochure of the complete line.

Audio Originals

474 SOUTH MERIDIAN STREET • INDIANAPOLIS 25, INDIANA
CIRCLE 18 ON READER-SERVICE CARD



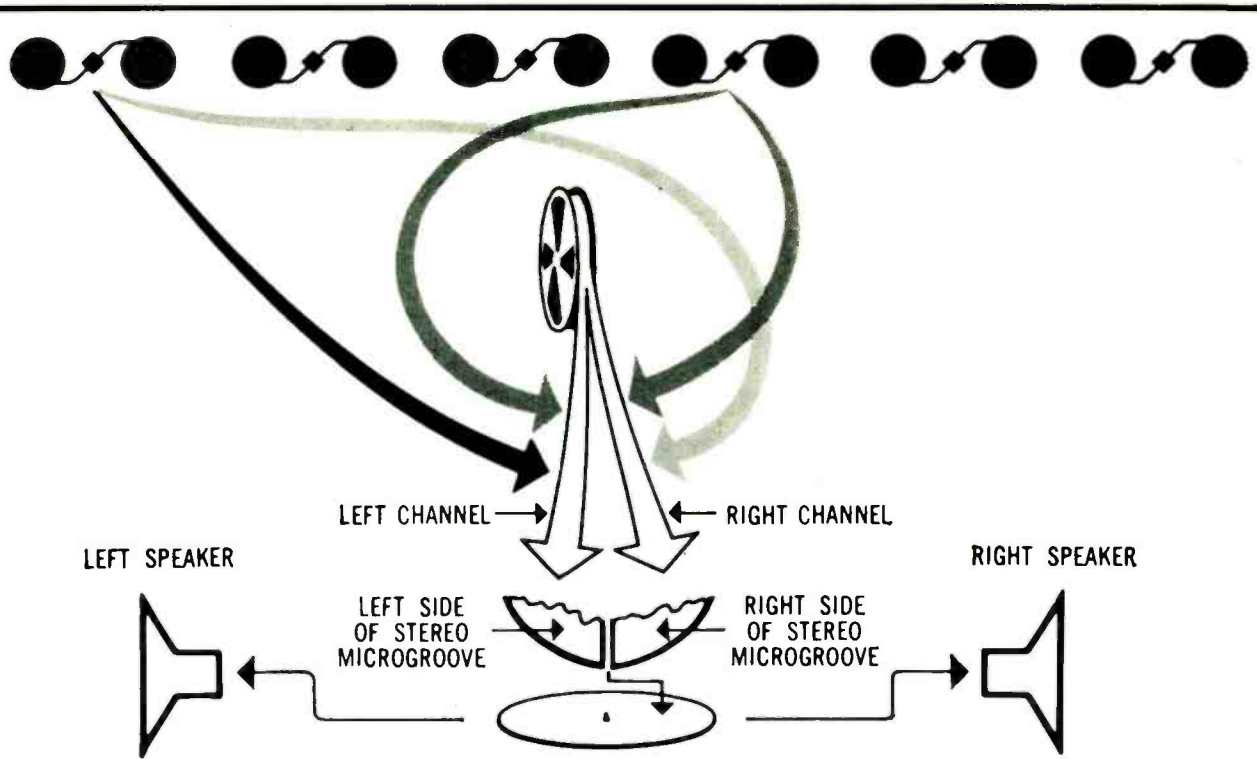

Composition for Stereo, in high Q*

Audio adventures into a 4th dimension await you in our new Stereo Workshop Series. By using six-channels, with at least one microphone for each instrumentalist, our engineers (1) maintain *absolute separation* of up to six sections of the orchestra, and (2) relocate audio signals on *either* of the two ultimate channels.

Thus arrangers for the Series have a new means of musical expression; added to tonal, rhythmic and harmonic perspectives is a fourth—*space*. Listen!

New From Warner Bros.—The Stereo Workshop Series



"NEW PERSPECTIVES IN PIANO SOUNDS"
By DAVID SWIFT,
Pianist with Orchestra
B/BS 1441

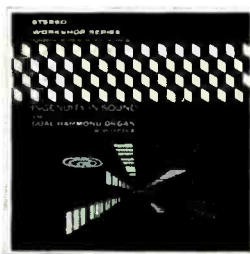

"INGENUITY IN SOUND"
A New Sound Technique
for Dual Hammond Organs
By BUDDY COLE
B/BS 1442



"THE FOURTH DIMENSION IN SOUND"
Produced and directed
by SHORTY ROGERS
B/BS 1443

*Quality, from Warner Bros.—the first name in sound.

WARNER BROS.

• BURBANK, CALIFORNIA



CIRCLE 97 ON READER-SERVICE CARD

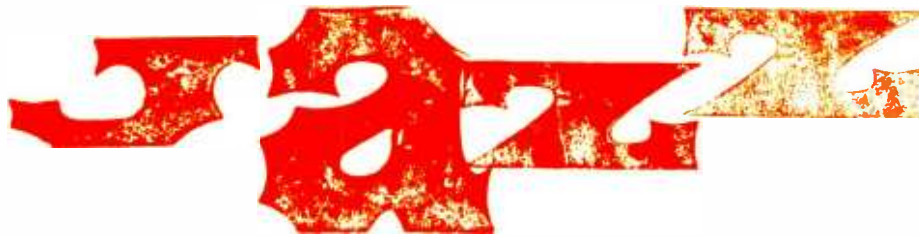

EFFORTS to mate jazz with elements of the longhair branch of the family tend to become entangled in pretentiousness or to create the impression that the kid brother is actually being allowed into the world of adults. In either event, the music rarely has any noteworthy jazz qualities, whatever else it may have.

That is one reason why *Focus* is a most unusual record. Its approach to the conjunction of jazz and longhair is refreshing in that neither side condescends to the other. Eddie Sauter has composed seven pieces for a string ensemble (sixteen strings built around the Beaux Arts Quartet) which are played as written, with no attempt to draw jazz interpretations from the string men. The jazz element is tenor saxophonist Stan Getz, who improvises over Sauter's compositions.

This is a complete departure from the customary methods of composing for a jazz soloist—writing what amounts to little more than a background, or simply leaving holes in the music in which the jazz soloist may improvise. Sauter left no holes. The string ensemble pieces can stand by themselves. But he wrote them with awareness that an additional element—Getz—would be present. Getz's role—when he played, what he played—was left entirely up to him. It was, in effect, total improvisation designed to complete a composition.

This is a challenge which, on the surface, would seem to be of awesome proportions, since it requires

invention not on a given chord progression spanning 12 or 32 bars, as is normally the case in jazz, but invention as part of a constantly developing composition, and always in relation to what sixteen other musicians are playing.

The result is some of the most brilliant saxophone playing I have heard, ranging from pastel loveliness to lusty swinging. Getz's creative virtuosity is at times incredible, for he is "on" from beginning to end of every piece, with no repeats or other safe harbors in which he can rest momentarily and revive his invention. Needless to say, some portions of his playing are superior to others. But the over-all level is remarkable and the music is fascinating.

Sauter's achievement, while not so dazzling, is also extremely noteworthy. For in approaching in this fashion the combination of strings and horn for jazz purposes, he may have found a way out of the dilemma that has always faced strings in jazz—their inability to adapt to jazz terms. What Sauter has written for the strings has beauty and vitality, but it is not jazz and it is not intended to be jazz. It is only through Getz's alchemy that the mixture is turned to jazz.

JOHN S. WILSON

✓ **STAN GETZ:** "Focus." Verve 8412, \$4.98 (LP); 68412, \$5.98 (SD).

Count Basie and His Orchestra: "The Essential Count Basie." Verve 8407, \$4.98 (LP).

Culled from Basie recordings made between 1952 and 1956, this collection hits most of the high spots of the period and, in the process, paints a somewhat misty picture of the band during that time. The mistiness results from the fuzzy, badly balanced recorded sound, which draws the teeth from the bite of the brass and sometimes buries everything under a layer of drumming. But, once adjusted to these conditions, one hears a virile, potent band in the full-blooded Basie tradition, something of a cross between the loose-jointed band of the '30s and the current magnificently suave machine. Three of the selections that established singer Joe Williams are included—*Every Day*, *The Comeback*, and *All Right, O.K., You Win*. Basie's overpopularized *April in Paris* is also present, seeming in retrospect even more threadbare than ever.

Dukes of Dixieland: "Breaking It Up on Broadway." Columbia CL 1728, \$3.98 (LP); CS 8528, \$4.98 (SD).

For their bow on the Columbia label the Dukes of Dixieland have come up with a new rhythm section, a vast improvement over the stodgy thumpers they had before. The heart of this section is bassist Jim Atlas (replacing a tuba player) and—a most unexpected Duke among the Dixielanders—guitarist Jim

Hall. Between them, and with the sympathetic if somewhat light-fingered help of pianist Gene Schroeder, they give the Dukes a swinging basis missing in the past. In addition, the Dukes have moved away from their customary hackneyed repertory, and although tunes from Broadway shows are not always the best material for a Dixieland band, at least they're a little different. As a matter of fact, by astute culling of the Broadway possibilities, some good jazz tunes have been included: *Runnin' Wild* and *Old-Fashioned Love* (both from *Runnin' Wild*), *Ain't Misbehavin'* (from *Hot Chocolates*), *Lady Be Good*, and *I Can't Give You Anything But Love*. Thus enspirited, the Dukes swing out in surprisingly lively fashion on some numbers. Clarinetist Jerry Fuller often sounds like a young and willing Benny Goodman, trombonist Freddie Assunto limits himself to a small, gutty range within which he is quite effective, and Frank Assunto shows strong capabilities as a lead trumpet although he is still an uneven soloist. But it's the rhythm section that's carrying the Dukes now, and a rhythm section can only do so much.

Erroll Garner: "Closeup in Swing." ABC-Paramount ABC 395, \$3.98 (LP); ABC S 395, \$4.98 (SD).

Garner is hailed in these liner notes, quite correctly, as one of the major individualists in jazz. But his individuality has been preserved in amber for several

years now. The stylistic characteristics that originally gave him distinction are preserved intact, but where once they presaged excitement and adventure, they are now as predictable as night and day. Despite this, Garner still plays with enthusiasm and this is a worthy collection of his pieces.

Tubby Hayes: "Introducing Tubbs." Epic LA 16019, \$3.98 (LP); BA 17019, \$4.98 (SD).

Although England seems to be inundated with "trad" bands, it has also developed several noteworthy modern jazzmen, including Ronnie Ross, Don Rendell, and Victor Feldman. To this brief list must now be added the name of Tubby Hayes, a tenor saxophonist and vibraphonist whose fluency, particularly on saxophone, approaches virtuoso proportions. This disc serves as a good introduction to Hayes (even though he has been heard before in this country as a coleader of the Jazz Couriers, on the Carlton label); he is recorded here on both his instruments and in several surroundings—supported by a rhythm section alone; with an eight-man brass section added; and also with five woodwinds. He has the fertility of imagination to sustain the quartet performances and to give them a driving swing, and he also has the virility to dominate the forceful brass group. His big moment here is a remarkably exciting bit of bravado in a breakneck development of *Cherokee*, partly with

Attention Patriots!

The Ancient Churches of Europe, Timeless Fonts of the World's Great Music, are a Monopoly no longer. A Grand & Famous American Church is celebrating its 275 years with a Festival Series of Concerts and a Commemorative Record of Music composed by its Distinguished Organists.

- ☛ The Church: King's Chapel, Boston.
- ☛ The Composers: VIRGIL THOMSON, DANIEL PINKHAM, WILLIAM SELBY.
- ☛ The Record*: CRS412.

Mass for two part chorus and percussion (Thomson).

Partita for harpsichord (Pinkham).

Two anthems (Selby).

\$4.98 mono only from your dealer, or shipped to you postpaid on receipt of check or money order and your dealer's name.

APPEARING SHORTLY: CRS506 & CRS507, a Treasury of early French organ music played by Melville Smith on the Marmoutier Silbermann, where his recording of *The Livre d'Orgue de de Grigny* was awarded the 1961 Grand Prix du Disque (Disques VALOIS, Paris).

*Recorded in unique sound which subtly combines all the tonal elements of music into one easy-for-your-stylus-to-follow groove. Plays on any clockwise 33 $\frac{1}{3}$ rpm record player without the need of bifocals. Sounds great, and up to twice as loud, on stereo systems.

CAMBRIDGE RECORDS, INC.

473 Washington Street
Wellesley 81, Mass.

CIRCLE 25 ON READER-SERVICE CARD

Study for Library of Congress finds

LEKTROSTAT®

best for cleaning records

"Routine cleaning was accomplished by using . . . prior to playback or packaging; a sparingly applied detergent solution with an applicator of sheared acetate velvet fibres.*

"Other systems of dust control, cleaning (such as spray on anti-static compounds, treated cloths, dampened synthetic sponges, and radioactive air ionization) were tried but did not prove as satisfactory."

*Lektrostat Record Cleaning Kit, Dexter Chemical Corp.

Only \$2.00 net at your high fidelity dealer's, or write to:

DEXTER

Chemical Corporation
Consumer Prod.
Division
845 Edgewater Rd.
New York 59, N. Y.



CIRCLE 35 ON READER-SERVICE CARD

the brass but more importantly in an unaccompanied section. Hayes is only a serviceable vibist, but on saxophone he has a combination of technical skill, fire, and direction that gives all his entrances an air of expectation.

Claude Hopkins: "Let's Jam." Prestige/Swingville 2020, \$4.98 (LP).

Delightful dancing jazz is developed from two different bases by a quintet completely at home in this type of music: Hopkins, piano; Buddy Tate, tenor saxophone; Joe Thomas, trumpet; Wendell Marshall, bass; and J. C. Heard, drums. On one side, they play three originals, swinging warmly and loosely in a variety of tempos; on the other, they turn their attention to some standards, including Hopkins' old theme, *I Would Do Anything for You*. Hopkins has a blithe, clipped piano style over which Tate and Thomas improvise with ease and assurance. Tate's billowing, surging attack on tenor saxophone bristles with vitality, and he also shows himself to be an interesting, clean-lined clarinetist. Thomas' trumpet is crisp and biting with an underlying suggestion of leashed power, a heartening assurance that he has overcome the uncertainty which has marked his return to activity in the past couple of years.

Lonnie Johnson with Victoria Spivey: "Idle Hours." Prestige/Bluesville 1044, \$4.98 (LP).

Johnson was getting back into top form after a long period of semiretirement when he recorded these selections in July 1961. The easy lilt was coming more readily to his singing, and he fingered his guitar in a lithe, wiry fashion that produced some delightful extended introductions. Johnson is something of an oddity among singers who are classified as bluesmen. He has a strong liking for ballads, and his vocal style crosses the suavity of the ballad man with the root sound of the blues singer. He does not strain for effects, and in both ballads and blues he is a plaintive and convincing singer. On three selections here he is joined by Victoria Spivey, whose singing style is as mannered as Johnson's is natural. Using material written by Miss Spivey and following her lead in its presentation, Johnson shows adaptability in adjusting himself to her style. But his own way is infinitely superior; one appreciates it all the more when he is allowed to play and sing by himself.

The Gary McFarland Orchestra: "The Jazz Version of 'How to Succeed in Business Without Really Trying.'" Verve 8443, \$4.98 (LP); 68443, \$5.98 (SD).

The fact that these performances are based on Frank Loesser's score for this season's hit musical is far less important than the introduction they provide to McFarland, a young arranger who seems to have grasped the potentials of a big jazz band with greater understanding than most of those who have been turning out big-band scores in recent years. McFarland's orchestrations are consistently inventive as he takes advantage of the variety of textures and colors available to him. Soloists are backed by many different combinations, and their solos are integrated into the full treatment of the piece instead of serving as long rests for the remainder of the band. McFarland's writing ap-

pears to be inherently swinging, for these selections have a light, moving propulsion frequently absent from big band performances in recent years. Performers here are topnotch, and include Doc Severinsen, Clark Terry, Bob Brookmeyer, Willie Dennis, Al Cohn, Phil Woods, Kenny Burrell, and Mel Lewis.

Shelly Manne and His Men: "At the Manne Hole." Contemporary 3593/94, \$9.98 (Two LP); 7593/94, \$11.98 (Two SD).

The quintet led by drummer Shelly Manne at his club in Hollywood has a strong, driving rhythm section (Manne, Russ Freeman, piano, Chuck Berghofer, bass) and two front line men—Ritchie Kamuca, tenor saxophone, and Conte Candoli, trumpet—who can move along brightly at faster tempos. This two-disc set, recorded in the club and made up of long selections (four of them run more than ten minutes), includes two pieces, *Love for Sale* and *The Champ*, played at a tempo at which Kamuca's sinuous drive hits an optimum level, and Candoli, usually a rather static trumpeter, builds a connected solo with a good, full-bodied tone. On these occasions the group is excellent. But, with the exception of Freeman, who is a consistently attractive pianist, it shows decidedly less ability to cope with material at a slower pace. Nor is the problem eased by the inordinate length of the selections chosen for this program.

Fats Navarro: "Classics of Modern Jazz, Vol. I." Jazzland 50, \$4.98 (LP).

Recorded from radio broadcasts in 1948, these performances sound a bit thin, particularly in so far as the rhythm section is concerned. But they have a vitality and spirit belying the fact that bop was fading into a period of lethargy at the time. Navarro was a disciplined and direct trumpeter with an almost unflinching command of structure and tone. His brisk, biting playing glides gracefully throughout this disc. But the most interesting work comes from Allen Eager, whose manner is unbelievably close to that of Lester Young. Eager's rhythmic sense and phrasing are delightful, and even when the group around him sounds tired (which occurs only once, on *Good Bait*), Eager is a paragon of swinging enthusiasm. Another merit of this broadcast recording is that it allows these men to develop a piece at greater length than they could on the 78-rpm records then being made.

Hot Lips Page and Cozy Cole: "Hot and Cozy." Continental 16007, \$4.98 (LP).

Hot Lips Page should have been one of the major figures in jazz during the '30s and '40s. He had periods of brilliance both as a trumpeter and as a vocalist, but he rarely had an opportunity—particularly on records—to show off his talents in an adequate setting. His six selections here show both his great merits and his problems. His singing and playing is almost always superb, but he is often saddled with the cheapest kind of lyrics; and the excellent sidemen with him (Lucky Thompson, Vic Dickenson, Ben Webster, Don Byas) are limited to the most routine playing. Still, good Page on records is so scarce that these performances are worth having. Cozy Cole's selections are basic, riff-based swingers with Byas, Coleman Hawkins, and Charlie Shavers. But they, too, are limited by the material.

Charlie Parker: "The Essential Charlie Parker," Verve 8409, \$4.98 (LP). "Bird Lives," Continental 16004, \$4.98 (LP).

The Verve collection is a sampling of Parker's performances in the early '50s with various small groups which include among their sidemen Dizzy Gillespie, Thelonious Monk, Miles Davis, John Lewis, and Max Roach; there are, in addition, two selections with strings. All have been reissued several times as parts of various Clef and Verve sets. These pieces are not quite as essential as Parker's earlier work on the Savoy label, when bop was young and spirited, but they are among the better performances of his later years. The Continental disc, on the other hand, is almost completely dispensable except as a curiosity. Parker is scarcely in evidence at all, even though he appears on every selection with such men as Gillespie, Clyde Hart, Nat Jaffe, Flip Phillips, and Max Roach. All these men are simply an accompanying band for dismal vocals by Trummy Young (who has never sounded worse), exceptionally trashy vocals by Rubberlegs Williams, and three tentative, early efforts by Sarah Vaughan.

Oscar Peterson: "Live from Chicago." Verve 8420, \$4.98 (LP); 68420, \$5.98 (SD).

This is easily the finest set Oscar Peterson has ever recorded. The tremendous technical prowess at his command, which has always seemed more of a hindrance than a help to him in his jazz efforts, finally becomes sublimated, in these performances, to his obvious jazz instincts. This is due in some measure to the close unity in his present group (Ray Brown, bass, Ed Thigpen, drums), for no pianist could ask for more perceptive, sensitive support. But primarily it is the result of wiping away the surface qualities that have masked Peterson's previous playing. His virtuosity no longer guides him, but is simply part of the arsenal of an enormously talented pianist. He plays up-tempo swingers and lazy ballads here, but they all are strongly jazz-rooted. The superficiality that once reduced him to the level of a highly adept cocktail pianist has been abandoned: Peterson actually plays like the ball of fire his more avid supporters have claimed that he is.

Martial Solal: "The Debut on Discs of Europe's Greatest Jazz Pianist." Capitol 10261, \$3.98 (LP); S 10261, \$4.98 (SD).

Despite the sweeping claim of this title, not only has Solal recorded before, but a ten-inch LP of his work was released in this country several years ago. He has developed considerably since that LP appeared. He now has a glistening technique, and draws on brilliantly executed Tatumesque runs and churningly riding passages in the Bud Powell manner with occasional phrases from Earl Hines used as an adhesive. Yet, despite all these influences, his approach is quite his own. On one side he works out fascinating solo treatments of familiar material—*Round About Midnight*, *Flamingo*, *Lover Man*, etc.—while the other is devoted to trio versions of his own compositions.

JOHN S. WILSON



MARCH 1962

THREE WARM ONES FROM ARGO

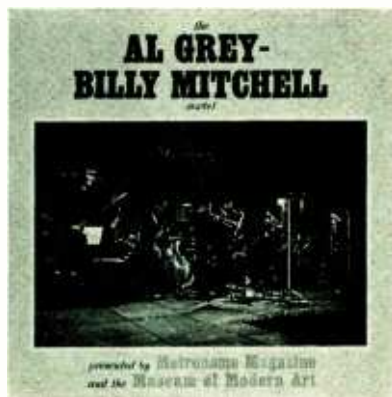

AL GREY BILLIE MITCHELL

LP 689 A fabulous new group, spear-headed by Basie graduates Al Grey and Billy Mitchell. This first album by the sextet was recorded live at the Museum of Modern Art, New York. Beyond a doubt, they know how to get the message across.

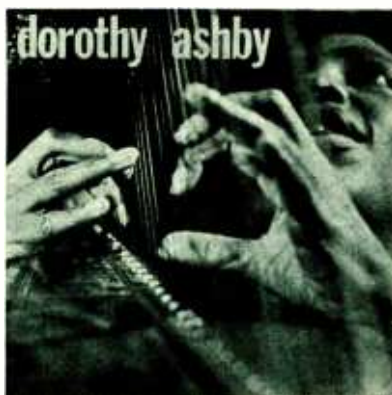

DOROTHY ASHBY

LP 690 The most exciting harpist to enter the jazz scene in two decades! Sounds which will captivate the listener from the first track through the last. Dorothy Ashby, sure to be responsible for making the harp a recognized instrument in jazz.

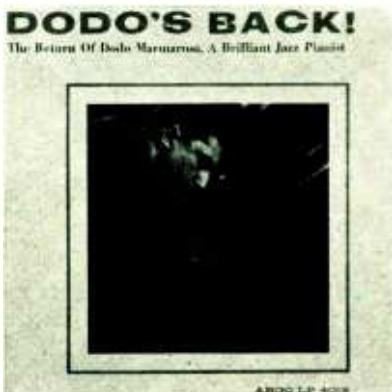

DODO MARMAROSA

LP 4012 Dodo Marmorosa, famed jazz pianist of the 40's is back after a prolonged absence from the jazz world. A solid musician with impeccable taste, he is due to be re-established as the great pianist he is.

■ AVAILABLE IN STEREO, OF COURSE, AT NO EXTRA CHARGE

ARGO RECORDS

2120 S. MICHIGAN AVE., CHICAGO 11, ILL.

CIRCLE 9 ON READER-SERVICE CARD



toot

That first note on an honest-to-goodness instrument of your very own! Can you remember that magnificent moment? Surely no accomplishment since has seemed quite as satisfying, no sound as sweet. We can't provide that kind of sonic bliss. But we can offer the next best thing—Audiotape. Recordings on Audiotape have superb range and clarity, minimum distortion and background noise—all the qualities to delight jaded adult ears. Make it your silent (but knowledgeable) partner in capturing everything from small fry tooters to symphony orchestras.

CIRCLE 15 ON READER-SERVICE CARD

Remember, if it's worth recording, it's worth Audiotape. There are eight types, one exactly suited to the next recording you make. From Audio Devices, for 25 years a leader in the manufacture of sound recording media—Audiodiscs*, Audiofilm*, and . . .



*TRADE MARK

audiotape
TRADE MARK

"it speaks for itself"

AUDIO DEVICES INC., 444 Madison Ave., New York 22, N. Y.
Offices in Los Angeles • Chicago • Washington, D. C.



the Tape Deck

Reviewed by R. D. DARRELL

The following reviews are of 4-track 7.5-ips stereo tapes in normal reel form.

BRAHMS: *Symphony No. 2, in D, Op. 73*

Pittsburgh Symphony Orchestra, William Steinberg, cond.
• • COMMAND CC 4T 11002. 37 min. \$7.95.

RACHMANINOFF: *Symphony No. 2, in E minor, Op. 27*

Pittsburgh Symphony Orchestra, William Steinberg, cond.
• • COMMAND CC 4T 11006. 46 min. \$7.95.

It's as a harbinger of the best tape news that I can affirm that Command has produced reel editions of its recent symphonic discs which faithfully mirror the sonic honesty of the deservedly acclaimed original recordings. Happily, too, they also embody the ideal—if not always as well realized—virtues of tape processing: a minimum of surface noise, lucidly preserved yet seamlessly blended channel differentiations, big-hall dynamic and frequency expansiveness achieved without distortion, and here even the elimination of the faintest preëchoes. To what extent the use of 35-mm magnetic-film mastering or other strictly technical ingenuities may be responsible for the liveness and almost tangible substantiality of both sound and acoustic ambience is far less significant than the unmistakable evidence that musically expert ears and minds have been in authority. There is no "spotlighting," no disequilibrium of natural frequency and loudness spectra, no sensational "effects"—only the true sound of a symphony orchestra reproduced, along with its whole environment, with maximum fidelity and immediacy.

We've already had a fine Brahms Second on tape (Bruno Walter's relaxed and glowing performance on Columbia MQ 373), but Steinberg's is in a class by itself, not only for its even more realistic sonic presence and solidity but as a muscular, affirmative, and exultant reading. The Rachmaninoff Second (the first on 4-track tape) has all the sonic and most of the same interpretative and executant attractions. Here, however, Steinberg is not quite as boldly outspoken, and his finale in particular never quite matches Ormandy's (stereo disc only) in savage propulsion. Except for this—and the regrettable labeling failure to identify the magisterial first-horn (and indeed whole horn-choir) playing in the Brahms—these tapes are representative of the highest triumphs that the marriage of musical artistry and technological skill can provide today.

CHOPIN: *Ballade No. 3, in A flat, Op. 47. Etudes: in E, Op. 10, No. 3; in A minor, Op. 25, No. 11. Fantaisie in F minor, Op. 49. Nocturne No. 17, in B, Op. 62, No. 1. Polonaise No. 6, in A flat, Op. 53. Scherzo No. 3, in C sharp minor, Op. 39. Waltz No. 7, in C sharp minor, Op. 64, No. 2*

Van Cliburn, piano.
• • RCA VICTOR FTC 2091. 53 min. \$8.95.

"My Favorite Chopin" is the title of Cliburn's first recorded solo recital, but it gives a misleading notion of the pianist's approach to these well-known examples of both minor and major Chopiniana. Instead of lavishing soulful expression on this music or using it as a vehicle for bravura displays, Cliburn "reads" it with almost didactic accuracy, deliberation, and lucidity—as if primarily to demonstrate the composer's mastery of architectural form. There have been more overtly exciting performances and others subtler in their treatment of details, but for lyrical fluency and boldly drawn "grand lines," these are models of expository eloquence. And if the pianist himself seldom seems deeply involved personally, he is both tenderly romantic (though not sentimental) in the smaller works, and broadly dramatic in the great Fantasy and Scherzo. Best of all, he elicits from an exceptionally fine-toned instrument a magnificent range of colors, captured to perfection in open and natural stereo. The reel is admirably processed too, with minimal surface noise and preëcho (although in high level playback there may be just a whisper of reverse channel spill-over in a couple of intervals between pieces). It ranks as an outstanding contribution to the still far too scanty solo piano repertory on tape.

DONIZETTI: *Lucia di Lammermoor*

Joan Sutherland (s), Lucia; Ana Raquel Satrié (ms), Alisa; Renato Cioni (t), Edgardo; Kenneth MacDonald (tt), Lord Arturo Bucklaw; Rinaldo Pellizzoni (t), Normanno; Robert Merrill (b), Enrico; Cesare Siepi (bs), Raimondo. Chorus and Orchestra of Accademia di Santa Cecilia (Rome), John Pritchard, cond.
• • LONDON LOR 90036. Two reels; approx. 84 and 62 min. \$21.95.

What a boon for the collector to be offered a taping of this complete opera while it is still red-hot news, and its star the most discussed and exciting personality in the world of music! And for once all the ballyhoo proves to be thoroughly justified. Joan Sutherland not

only lives up to her ecstatic publicity, but richly confirms her earlier promise as a reviver of the fabulous art of *bel canto*. Donizetti's *Lucia* is revitalized, and heard for the first time in many years in its entirety, with all the conventional cuts restored. For good measure it is supplied with an appended aria, "*Perchè non ho del vento*," which in nineteenth-century practice often was substituted for Lucia's Act I Fountain aria, "*Regnava nel silenzio*." Miss Sutherland is admirably supported, too, by one of the most promising of young Italian tenors, Renato Cioni, as well as by the always reliable Merrill and Siepi; and Pritchard's well-controlled, rich-toned orchestra and chorus are captured in extremely pure, open, and vivid recording. There is little sheerly stereoisitic sensationalism apart from the somewhat theatrical background crowd babble in the party scenes and the thunderous storm at the beginning of Act III, but the unexaggerated stage spread is of notable dramatic effectiveness, and the lucid channel differentiations provide an air spacing that wondrously enhances the clarity of the ensemble scenes—the famous Sextet in particular—and buoyantly "floats" the dialogue arabesques of Conrad Klemm's flute and Miss Sutherland's matchless voice in the Mad Scene.

Happily, the vocal and technological attractions here are matched by those of the tape processing, immaculate save for some very slight preëchoes. And since UST has now adopted the practice of supplying—in prompt response to a prepaid postcard request form—a full-sized libretto and illustrated annotations booklet, purchasers of this set need not strain their eyes over miniscule texts reduced to fit reel box dimensions.

RIMSKY-KORSAKOV: *Scheherazade, Op. 35*

Rafael Druián, violin; Minneapolis Symphony Orchestra, Antal Dorati, cond.
• • MERCURY ST 90195. 40 min. \$7.95.

RIMSKY-KORSAKOV: *Scheherazade, Op. 35*

†Borodin: *Prince Igor: Polovtsian Dances*

Lorand Fenyes, violin; Choer des Jeunes and Choer de Radio Lausanne (in the Borodin); Orchestre de la Suisse Romande, Ernest Ansermet, cond.
• • LONDON LCL 80076. 56 min. \$7.95.

In wholly different ways each of these (the sixth and seventh 4-track *Scheherazades*) is a disappointment. Dorati's reading is routine, unevenly pressed for the most part, although tending to go limp in the third movement; the playing, by the instrumental soloists in particular,

**the
Concord
880
is for
connoisseurs***

If you're going after top results in stereo tape you'll want to meet the Concord 880. There isn't a unit 4-track stereo recorder that can match the 880's important professional features: 3 heads, 3 speeds, 2 separate speakers, sound-on-sound, computerized tracking, dual VU meters and many other big advantages in achieving professional standards in stereo recording and playback. Enjoy the luxury of listening to the Concord 880 soon. Certainly before you invest in any tape recorder. And write for your copy of the specification brochure "All The Facts." Priced under \$400.

*naturally it's Bill Moody

CONCORD 880
CONCORD ELECTRONICS CORPORATION

809B N. Cahuenga Blvd., Los Angeles 38, Calif.
CIRCLE 32 ON READER-SERVICE CARD

lacks both color and refinement; and even the recording, acclaimed for its brilliance when the stereo disc edition first appeared, seems deficient in tonal body and warmth by current standards, although no serious fault can be found in the tape processing itself. The new Ansermet reel presents a more unusual problem, which may not be immediately apparent to most tape listeners, since on first encounter both reading and performance are infinitely superior to those of the earlier Ansermet taping with the Paris Conservatory Orchestra. The re-recording, too, seems improved, in sonic richness, dramatic impact, and stereoisitic lucidity. What, then, can be disappointing?

The answer is obvious to those who have heard the stereo disc edition properly reproduced: it has not only much of the tonal sumptuousness of the present taping but in addition a scintillant glitter and supreme concert hall authenticity which made the original recording one of the—if not *the*—outstanding triumphs of musical and audio technology. At first I thought that the softening of the highs in the present taping (where the cymbals, snare drum, etc., tend to retreat backstage instead of cutting crisply through the other orchestral textures, even in low level passages) must represent a throw-back to an earlier era of high frequency losses in high speed dubbing. But the processing is excellent in most other respects (although at such a relatively low modulation level there is considerable surface noise or hiss, however smooth-textured it may be), and since no other current UST (or other) releases reveal comparable high frequency weaknesses, I can only conclude that in editing the 4-track sub-master an engineer has had the effrontery to tamper with the equalization characteristics. Certainly the sharp-edged highs have been smoothed down and the solid lows given even greater substance. But if one's ears are soothed, the electrical excitement and miraculous auditorium naturalness of the original master have been inexcusably lost.

Thus, the golden opportunity to provide the finest of all tapes has been stupidly tossed away. Until UST or London provides an entirely new tape edition with restored response characteristics, I can recommend only the disc version. For those who must have a *Scheherazade* on tape now, the fine RCA Victor reel of the scarcely less dazzling Reiner-Chicago recording remains the preferred choice.

Joan Baez: Folk Songs. Vanguard VTC 1635, 45 min., \$7.95.

After listening to the very young Miss Baez's first solo program, I am convinced that her devotees have, if anything, understated their case. Hers is one of the loveliest voices I've heard on records, and she possesses an utterly captivating interpretative eloquence. Singing without mannerisms yet with abundant personality (with deft guitar support by Fred Hellerman and herself) she is a consistent charmer. Highlights of the program are *All My Trials*, *Fare Thee Well*, and *Rake and Rambling Boy*, to mention but a few. As befits one of the finest folk programs ever released, the recording is a model of gleaming clarity and the present tape processing without a flaw.

TAPE

"Music Made Famous by Glenn Miller."

Tex Beneke, Ray Eberle, The Modernaires, and Members of the Glenn Miller Orchestra. Warner Brothers WSTC 1428, 33 min., \$7.95.

This documentation of a concert in the Santa Monica (California) Civic Auditorium on May 26 (1961, presumably) has leading Miller associates re-creating their old successes in an atmosphere of nostalgic sentiment and obviously fervent audience enthusiasm. More objectively considered, the best moments are Eberle's (for his disarming spoken reminiscences, rather than his somewhat tremulous vocals), the orchestra's lilting *In the Mood* and *Moonlight Cocktail*, and its spirited pair of Jerry Gray transcriptions—the *Anvil Chorus* and *American Patrol*. The full-blooded recording admirably evokes the atmosphere of the live concert and the well-processed taping is free from preëchoes.

"Sinatra Swings." Frank Sinatra with Orchestra, Billy May, cond. Reprise RSL 1704, 33 min., \$7.95.

Frankie's fans apparently differ widely on the merits of both his own performances here and those of Billy May's orchestra. I find myself with the pros on the former score: although not all the materials are really Sinatrian, he sings with admirable freedom from mannerism and remarkably relaxed yet potent powers of projection—especially in *Don't Cry Joe* and *Love Walked In*, and—best of all—a lilting *Have You Met Miss Jones*. I'm with the cons, however, as far as May's incongruously styled, blustery, and hard-plugging orchestral playing is concerned. The recording is O.K., if hardly outstanding except for the skill with which the soloist is centered between the markedly differentiated orchestral channels. First-rate processing.

"Stereo Dialogue for Brass." The Stereo Brass Choir. Columbia CQ 387, 39 min., \$6.95.

Arranger Lew Davis (who probably doubles as conductor here) has had the eminently logical idea of choosing his stereo-spectacular materials from "dialogue" hit-show tunes in which the boy-girl duos are transposed to well-separated brass-and-guitar choirs, held together by vibes, xylophone, and rhythm section in the center. This treatment is notably effective with *Love Is a Simple Thing* and *Let's Call the Whole Thing Off*. Attractive but less striking are *You're Just in Love*, *Thanks for the Memory*, and *Wonderbar*. But in general the playing tends to be somewhat heavy-handed and the extremely stereoisitic high-level recording too sharply focused—although less so than in the earlier stereo disc edition.

"Yellow Bird." Roger Williams, piano, with Orchestra. Frank Hunter, Marty Gold, and Gene von Hallberg, conds. Kapp KTL 41037, 36 min., \$7.95.

Apparently this is, at least in part, an anthology of the pianist's best-liked hits, for I remember several of the performances here (the brightly bouncing title tune, the hauntingly expressive *O mio babbino caro*, and *Greensleeves*, in particular) from the 1960 tape "With These Hands." It's a delight to hear them again in any case, along with the new (to me) bravura *Roger's Bumble Bee* and others. Brightly recorded, this should serve as a best-selling introduction to one of the most ingratiating of popular pianists.

while you've been recording...so have we!

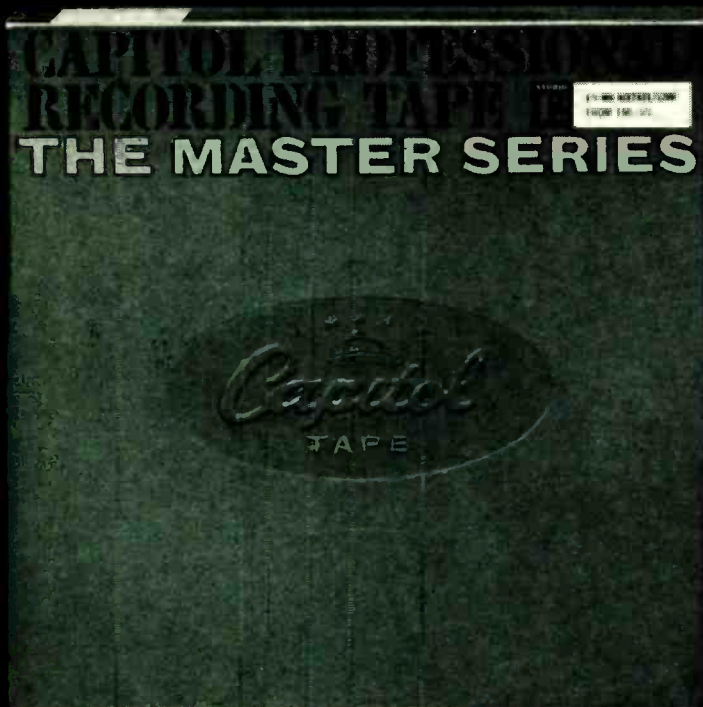

Garland, Sinatra, Lee, Cole, Kingston Trio, top shows, classics, etc., etc., etc. - all on Capitol 4-Track Stereo Tape Albums!

Judy at Carnegie Hall - Judy Garland Only the Lonely - Frank Sinatra Come Dance With Me! - Frank Sinatra Latin ALA Lee! - Peggy Lee Love is the Thing - Nat King Cole The Touch of Your Lips - Nat King Cole Make Way! - Kingston Trio Here We Go Again! - Kingston Trio Music for Lovers Only - Jackie Gleason Sounds of the Great Bands - Glen Gray Fred Waring and the Pennsylvanians in Hi Fi Satin Brass - George Shearing Berlin by Lombardo Your Guy Lombardo Medley: Volume 3 The Shearing Touch Music for my Love - Paul Weston Dream Dancing - Ray Anthony Billy May's Big Fat Brass Ports of Paradise - Alfred Newman & Ken Darby Stan

Kenton's West Side Story Oklahoma! Carousel, Can-Can The King and I The Music Man Fiorello! The Sound of Wagner - Erich Leinsdorf Americana - Carmen Dragon Hallelujah! - Alfred Newman Concerto Under the Stars - Leonard Pennario Charge! - Felix Slatkin Tchaikovsky: Overture "1812" - Herbert von Karajan Soviet Army Chorus and Band Poulenc: Gloria In G Major Concerto For Organ String & Timpani. **CAPITOL PROFESSIONAL RECORDING TAPE - The Master Series.** By any and all criteria, there is no finer tape available. Precision-produced in nine types to meet every professional need. Ask for it at your favorite hi-fi specialty store.

FM MULTIPLEX

STEREO

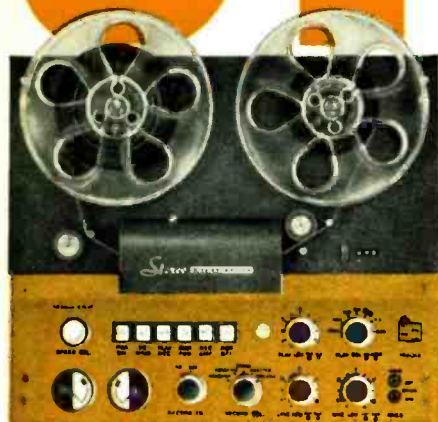

**TRANSISTORIZED
4-TRACK STEREO TAPE DECK RP100**
Completely assembled, wired and tested.
\$399.95
Semi-kit includes a completely assembled and tested transport, electronics in kit form.
\$299.95
Luggage-type Carrying Case—\$29.95
Standard 19-inch Rack Mount—\$9.95

A top quality stereo tape recorder permits you to build a stereo tape library of your favorite music at low cost. As your musical interests change, you may record the new music that interests you at no additional cost.

Perfect 4-track stereo/mono recording, 4 & 2 track playback. True high fidelity transistor electronics, individual for record & playback, plus separate record & playback heads permitting off-the-tape monitor. 2 recording level meters, mixing, mic & level controls, switched sound-on-sound recording. Electro-dynamically braked supply & take-up reel motors; hysteresis synchronous capstan motor. Individual solenoids for pinch-roller & tape lifters. All-electric, interlocked push-button transport control & interlocked safety "record" pushbutton. Precision tape guidance & sweep loading — no pressure pads. No slurring or tape bounce problems. Digital turns counter. Vertical or horizontal mounting. Modular plug-in construction. An original, exclusive EICO product designed & manufactured in U.S.A. (patents pending).



FM-AM STEREO TUNER ST96
Kit \$89.95 Wired \$129.95
Includes Metal Cover and FET

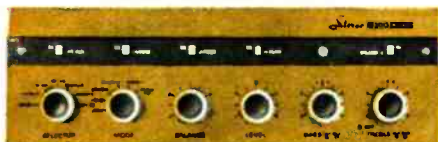

70-WATT INTEGRATED STEREO AMPLIFIER ST70
Kit \$94.95 Includes Metal Cover Wired \$149.95
40-WATT INTEGRATED STEREO AMPLIFIER ST40
Kit \$79.95 Includes Metal Cover Wired \$129.95

ST96: FM and AM stereo tuners on one compact chassis. Easy-to-assemble: prewired, pre-aligned RF and IF stages for AM and FM. Exclusive precision prewired EYETRONIC® tuning on both AM and FM.

FM TUNER: Switched AFC (Automatic Frequency Control). Sensitivity: 1.5uv for 20db quieting. Frequency Response: 20-15,000 cps ± 1 db. Multiplex-ready: Regular and MX outputs built in.

AM TUNER: Switched "wide" and "narrow" bandpass. High Q filter eliminates 10 kc whistle. Sensitivity: 3uv for 1.0V output at 20db S/N ratio. Frequency Response: 20-9,000 cps ("wide"), 20-4,500 cps ("narrow").

BOTH AMPLIFIERS: Complete stereo centers plus two excellent power amplifiers. Accept, control, and amplify signals from any stereo or mono source.

ST70: Cathode-coupled phase inverter circuitry preceded by a direct-coupled voltage amplifier. Harmonic Distortion: less than 1% from 25-20,000 cps within 1 db of 70 watts. Frequency Response: $\pm 1/2$ db 10-50,000 cps.

ST40: Highly stable Williamson-type power amplifiers. Harmonic Distortion: less than 1% from 40-20,000 cps within 1 db of 40 watts. Frequency Response: $\pm 1/2$ db 12-25,000 cps.



**NEW FM MULTIPLEX
AUTODAPTOR MX99**
Kit \$39.95
Wired \$64.95
Cover optional, \$2.75.
An original EICO contribution to the art of FM Multiplex reception.

(Patent Pending)

Designed for all EICO FM equipment (HFT90, HFT92, ST96) and any other component quality, wide-band FM tuners having multiplex outputs, the new MX99 incorporates the best features of both matrixing and sampling techniques. It is free of phase-distorting filters and provides the required, or better-than-required, suppression of all spurious signals including SCA (67kc) background music carrier, re-inserted 38kc sub-carrier, 19kc pilot carrier and all harmonics thereof. This is very important for high quality tape recording, where spurious signals can beat against the tape recorder bias oscillator and result in audible spurious tones in a recording. This adaptor will synchronize with any usable output from the FM tuner and will demodulate without significant distortion tuner outputs as high as 7 volts peak-to-peak (2.5 volts RMS).

The MX99 is self-powered, provides entirely automatic stereo/mono operation and includes low impedance cathode follower outputs to permit long lines. An indicator lamp turns on when the station selected is broadcasting multiplex stereo. A separation of 35db between channels is typical across the entire audio spectrum. An over-all gain of unity is provided from input to output on both stereo and mono.

EICO, 3300 N. Blvd., L.I.C. 1, N. Y. HF-3
 Send free 32-page catalog & dealer's name
 Send new 36-page Guidebook to HI-FI for which I enclose 25¢ for postage & handling.

Name
Address
City Zone State.....

Over 2 MILLION EICO instruments in use.
Most EICO Dealers offer budget terms.
Add 5% in West.

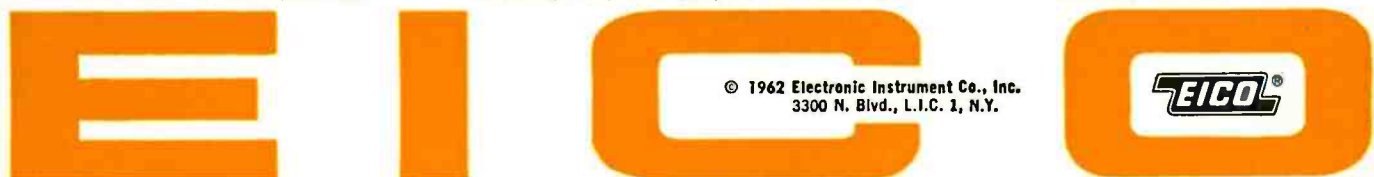

© 1962 Electronic Instrument Co., Inc.
3300 N. Blvd., L.I.C. 1, N.Y.



Listen to the EICO Hour, WABC-FM, N.Y. 95.5 MC. Mon.-Fri., 7:15-8 P.M. Export Dept., Roburn Agencies Inc., 431 Greenwich St., New York 13

CIRCLE 41 ON READER-SERVICE CARD

High Fidelity Newsfronts



Fisher Park. Of the 300 persons who attended the dedication ceremonies for the new Fisher plant in Milroy, Pennsylvania, none was prouder than Avery Fisher, who now owns what is probably the largest high-fidelity manufacturing plant in the industry. All of the company's audio components will be produced in a modern building reposing in the midst of twenty acres in a picturesque valley, formerly farm land and now named Fisher Park. Local residents are



Stereo comes to the hinterlands.

not in the least put out by the invasion of modern technics into the rural hinterland, since the arrival brings the prospect of three hundred new jobs, virtually all of which will be filled by residents of the area.

Governor David L. Lawrence of Pennsylvania headed the roster of well-wishers at the plant's dedication, which included twenty press people who were flown in from New York for the occasion.

At one point during a tour of the 62,000-square-foot plant, Fisher explained that the site has room for an additional 900,000 square feet of working space. We suggested that that would represent, apparently, only the first story; what about the second and third? For once, the usually verbal Fisher had no answer; he laughed along with everyone else.

"Add-A-Tape." Collectors of pre-recorded tapes who prefer the cautious, piecemeal approach may be interested in a new "Add-A-Tape" line announced by Coleman Electronics of 133 East 162nd St., Gardena, California. The tapes come on three-inch reels, each carrying four popular selections recorded in quarter-track stereo at 3.75-ips speed. Splicing tape

and label tabs are supplied with each reel so that the buyer can "mix-and-match" to create a special program or build up his own tape library on a fairly selective basis. The "Add-A-Tape" we auditioned had clean, wide-range sound and excellent stereo separation. As an added bonus, two of the quarter-tracks are left unrecorded so that the owner can reverse the tape and do his own recording on it.

Same Species. New Variety. One bug made welcome in our own high-fidelity system has been the Dust Bug, a convenient and reliable record-cleaning gadget. Two varieties have been available, one for separate arms and turntables, the other for changers.

With either, a tiny brush sweeps a record groove to dislodge dust which is then picked up by an impregnated plush pad. The changer model now has evolved a new variety, in which the positions of the brush and pad have been reversed. Oddly enough, this turnabout does not seem to bother the Dust Bug in the least. According to John McConnell of Electro-Sonic Laboratories, the new version actually works better for the changing heights of stacks of records used on an automatic player.

In a somewhat backhanded manner, we tested the new Bug on a separate arm-and-turnstile system and found that it does indeed clean a record beautifully, despite its reversed direction. Of course, using a Dust Bug on a professional type arm may unbalance the arm, and for such an installation, the original long Bug still is preferred. But coming or going—which is to say, for manual turntable or automatic player—the Bug remains a fine scavenger of record dirt.



Unorthodox, but effective.

Free Audio Clinic. Things are looking up for the servicing of high-fidelity components—at least in one area. Hi-Fi Systems Co., Inc., a Detroit dealer, is cooperating with Hewlett-Packard Co., manufacturer of test equipment, as well as with Viking of Minneapolis and McIntosh Laboratories, component manufacturers, in offering—from time to time—professional examinations of equipment. Anyone can bring in any tape recorder or amplifier and have it checked out on the laboratory bench by experienced technicians using the Hewlett-Packard instruments. At specified times, announced in advance by the dealer, this service—which ordinarily would cost \$15—is given free. The first such clinic was attended by 1,600 persons.

Still Room for Improvement. FM stereo programs from WGFM, Schenectady—the station which proclaims itself as the first in the U.S.A. to broadcast FM stereo—have improved noticeably since their advent half a year ago, but not to a point commensurate with a concept of what the nation's "first" FM stereo station should, or could, be. To be sure, the stereo effect, and the response on both channels, are good enough to permit perception of the same spatial and depth characteristics available on good stereo recordings. In fact, it now is possible to discern different ambient qualities in the recordings WGFM itself plays, a fact which speaks well for the station's engineering as well as for the new FM stereo tuners we have been using. And the background noise on the right or "B" channel has been reduced considerably; often it is barely discernible. But aside from this (sometime) annoyance we still detect inconsistent channel balance, with the left channel often lower in volume. This flaw is readily corrected with an amplifier balance control but, ideally, it should not exist in the first place. But to our ears the worst bug in WGFM's stereo programs is not technical but "procedural": this station thinks nothing of playing three hours of music with nary an announcement of what is being heard or who is performing it. The only spoken interruptions are those for station breaks, ill-timed, by the way, since you may be left dangling in the middle of someone's cadenza to be informed

Now! The identical world-acknowledged
FAIRCHILD
 components are available in
 EASY-TO-ASSEMBLE
KITS

The same electro-mechanical know-how that for over a quarter century has established FAIRCHILD as a leader in quality components is now available to the astute audiophile and kit builder in quality controlled ready-to-assemble kits.

FAIRCHILD 412-1K
 Turntable Kit

For the astute audiophile who dreams of owning only the finest the famous FAIRCHILD 412 is now available in kit form. The

FAIRCHILD 412-1K is identical as its assembled counterpart which

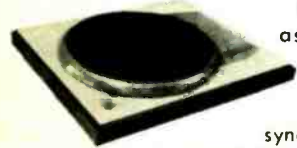

includes locked in synchronous 33 1/2 speed, 8 lb. turntable and the famous exclusive FAIRCHILD Double-Belt Drive. Comes complete with mounting board.

KIT \$74.95

Assembled \$95.00

FAIRCHILD COMPANDER®
 Model 510K

Dynamic Realism in kit form! Through the use of the FAIRCHILD COMPANDER you can now



add Dynamic Realism to all your disc and tape recordings. Acclaimed by music and audio experts the COMPANDER restores many of the dynamic values that are necessarily controlled in recording or broadcast. Can also be used as a compressor for background music.

KIT \$59.95

Assembled \$75.00

FAIRCHILD 440-2K
 Turntable Kit

This Fairchild single-belt drive, two-speed turntable, 33 1/2 and 45 rpm., has performance characteristics similar to the famous FAIRCHILD 412. This



robustly designed FAIRCHILD 440-2K kit with fast speed change, accurate speed control through use of FAIRCHILD Speed Sentinel, unusual low low rumble and practically immeasurable wow and flutter makes this a desired addition to any quality component system. Comes complete with mounting board.

KIT \$58.00

Assembled \$69.95

All these FAIRCHILD KITS are available at your audio dealer. Write for complete details.

FAIRCHILD
 RECORDING EQUIPMENT CORPORATION
 10-40 45th Ave., Long Island City 1, N. Y.

CIRCLE 45 ON READER-SERVICE CARD

that you are listening to wonderful stereo sound. Can it be that the station first to broadcast FM stereo is also the first to do away with the rites of normal programming?

Goad for a Code. Hammurabi had a code, spies have a code, even plumbers have a code. Everyone, it seems, has a code—except the high-fidelity industry. We are not talking now of such statutory ambitions as an advertising code or a manufacturing code, but only of the humble matter of color coding the wires that lead into, around, and out of a home sound system—specifically, the wires for cartridges in tone arms, the signal cables between components, and the wires to speaker terminals. As things stand now, there is a rainbow profusion of colored leads in use, and let no man think, for instance, that just because green represents the "hot side" of channel B in one pickup system it will indicate the same thing on another manufacturer's system. Resistors and capacitors, whose electrical values involve astronomical digits, have been color-coded for years and everyone who works with these parts knows that he can tell at a glance what's what regardless of who manufactured them. If only the same feeling of confidence could be bestowed, say, on stereo cartridge connections! Look at it this way: there are a score of available tints. Agree, oh industry leaders, on four of them for the critical leads in a stereo arm, another two for left and right channels, and two more for speaker polarity, and you will have taken a real step toward making life easier for service technicians, installation men, and testing personnel—as well as helping to lift—if only a little—the veil of mystery between "electronics" and the "public."

(Fast) Changing Times. No sooner had our report on the Fisher MPX-100 multiplex FM stereo adapter gone to press for last month's issue, than we learned that this unit has been superseded by an improved version, termed by Fisher the Universal MPX-100. Readers of the February equipment reports will recall that the original MPX-100 was tested with five different makes of FM tuners and found to work well with all of them. Presumably, the revamped MPX-100 will work with a lot more tuners since it incorporates a separation control which reportedly permits exact matching to all quality component FM sets. The circuitry employs a time division system, and the dimension control of the older adapter has been replaced with a three-position noise filter. All these additions cost more, too—the new MPX-100 is priced at \$109.95.

Music for Motoring. A 45-rpm record player, said to be an improvement over Columbia's "Hi-Way Hi-Fi," which got detoured a few years ago because of technical difficulties, has been announced by Automotive Electronic Specialties of Torrance, California. Known as "Car-Fi," the units plays through the car radio. Reportedly, a new kind of tone arm permits smooth tracking of the disc

groove despite bumps on the road. List price is \$69.95.

Anyone for Venice? Contests must be judged before they are won, and judges must meet in advance to help plot against the contestants. Having been invited to help select the ten most important characteristics of the "Troubador" record player, in preparation for Empire's new contest, we found ourselves recently transplanted *pro tem* in the *Fontana di Trevi*. This, we hasten to add, was the New York restaurant and not one of the famous fountains of Rome, although memories of the original namesake as well as strains of Respighi's music came to mind—the former because it is partly involved in what the contest's lucky winner will receive; the latter because, after all, the contest involves music or at least the machinery for playing it.

The conclave included, in addition to press people like us, such "performing" personalities as Dr. Sigmund Spaeth, whom we had seen earlier in the week on television in his role of tune detective, and Skip Weshner, Jr., who has been conducting a nightly session of music and commentary on WNCN-FM, N.Y. Our host was busy Herbert Horowitz, president of Empire Scientific Corp., who left his attaché case and portable dictating machine in a parked car long enough to spend the better part of an afternoon to explain, between courses, that we were assembled to eat, drink, be merry—and judge.

Sometime before the desserts arrived, sheets of printed matter were distributed, which listed ten outstanding features of the Empire "Troubador" turntable, arm, and stereo cartridge. We were to score,

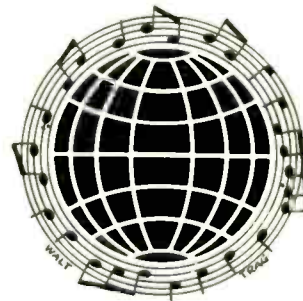

by a point system, the order of importance of these ten features. From the twenty or more judges' lists, a master list will be compiled to serve as the terms of surrender of the prize—which is a twenty-one day tour of the music festivals of Europe, for two, with all expenses paid. The contest, which is open to just about everyone, ends June 15, 1962.

For the next few months, we are steadfastly refusing to tell anyone what we think the most important features of the Empire "Troubador" are. For one thing, the judges themselves disagreed—as was expected—on the order of importance, and no one judge (this one included) really knows the final order of the ten features. Besides, we could use a tour of Europe ourselves.

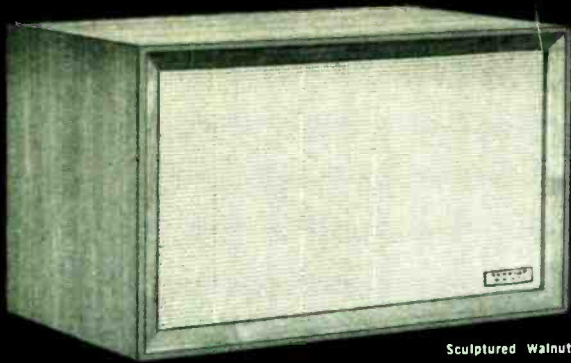

Sculptured Walnut

"ASTONISHING!"
"EXCELLENT!"
"TERRIFIC VALUE!"

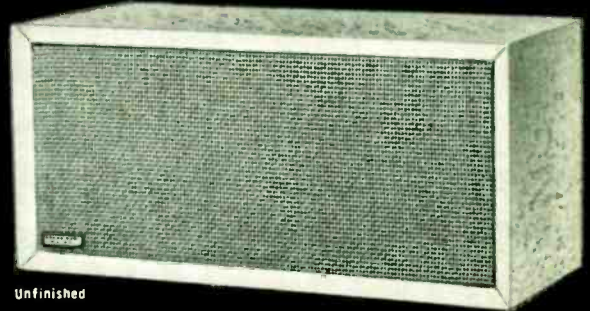

Unfinished

CABINART

SPEAKER SYSTEMS

OUTPERFORM HIGH RATED, HIGHER PRICED SYSTEMS

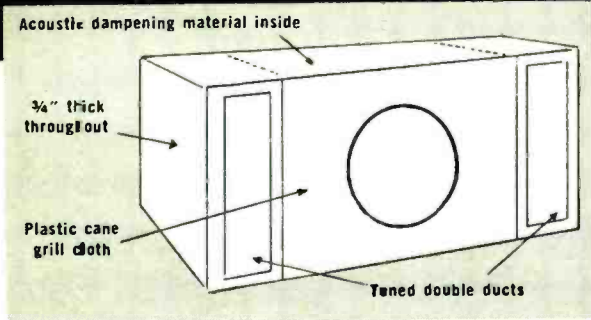

mark I 8" model

11" high x 9 1/2" deep x 23" long
 Shipping Weight: 27 lbs.
 Sculptured Front Walnut Veneer, Oiled Finish \$30.00 F.O.B. Factory

\$18⁰⁰
 Unfinished

Extended range domestic speaker with new hi-efficiency magnetic circuit. Ideal for medium and low level monaural or stereo reproduction. 1" voice coil with 8 ohms impedance. Speaker response 45 to 13,000 cps. 3.16 oz. new type magnet. Nominal power rating 10 to 15 watts.

mark II 12" model

14" high x 11 1/2" deep x 23 3/4" long
 Shipping Weight: 37 lbs.
 Sculptured Front Walnut Veneer, Oiled Finish \$43.20 F.O.B. Factory

\$27⁰⁰
 Unfinished

12" coaxial 6.8 oz. Alnico V magnet with 1" voice coil, heavy one-piece cone and specially designed 3" Alnico V PM tweeter mounted coaxially with built in high pass filter, capacitor type. Power rating 15 watts; impedance - 8 ohms. Speaker response 40 to 15,000 cps.

CABINART CABINETS are made of extremely dense pressed wood, unfinished. Walnut and Mahogany models are genuine hardwood veneers with CABINART's famous, superlative finish. Construction is 3/4" thick throughout, solidly glued using the most modern electronic techniques. Extra heavy construction achieves maximum possible speaker response. CABINART's unique principle of acoustic resistive loading effectively improves the low end response resulting in balanced full fidelity reproduction not heretofore available in systems of comparable size or price. Each system is tuned and double ducted, acoustic insulation is used to every advantage.

Edward Tatnall Canby reviews Cabinart in Audio, November, 1961 "The Cabinart speaker system . . . is really an astonishing piece of equipment at its price which is an unbelievable \$15 (mfr's note: now \$18) - speaker and enclosure, complete and integrated . . . with an 8" speaker inside of quite extraordinary quality. I am really impressed by the sound and by the simple ingenuity of the entire construction."

Reprint of Mr. Canby's complete review of Cabinart speaker systems is available on request.

These units are also available from dealers everywhere. If your dealer does not have these items in stock, place your order **DIRECT WITH US FOR IMMEDIATE DELIVERY!** Your order will be shipped one day after it is received!

CABINART GUARANTEES

You must be satisfied with our speaker systems for 10 full days or your money back . . . no questions asked.

ONE FULL YEAR WARRANTY

Written registration card and warranty included with each unit.

Pioneers in hi fi quality since 1948.

CABINART

ACOUSTICAL DEV. CORP.
 GEYER STREET, HALEDON, N. J.

Cabinart Acoustical Dev. Corp.
 33 Geyer St., Haledon, N. J.

Please ship the following to be used in my home for 10 full days. I understand unit (s) may be returned and my money refunded within that time unless fully satisfied.

-Mark I Unfinished \$18.00 each
-Mark II Unfinished \$27.00 each
-Mark I Oiled Walnut \$30.00 each
-Mark II Oiled Walnut \$43.20 each

(Please make check or money order payable to Cabinart Acoustical.)

Name _____
 Address _____
 City _____ State _____

CIRCLE 24 ON READER-SERVICE CARD

STEREO

DEMANDED IT!

TANNOY

ENGINEERED IT!

THE NEW

"MONITOR"

DUAL CONCENTRIC



"MONITOR"
10", 12" AND 15"

the most advanced co-axial
to date

- ★ New revolutionary magnetic shunt circuit increasing useful low frequency flux by more than 20%.
- ★ Unique treatment of low frequency diaphragm surround providing improved response and stability.
- ★ New acoustic balance cavity improving high frequency response, reducing distortion.

Tannoy engineers have produced a speaker of unsurpassed quality, already being used as a 'Monitor' by world wide recording, radio, and television companies. The extended range and increased efficiency of the low frequency unit make it ideal for use in relatively small enclosures, whilst still maintaining the "presence" of unrestricted sound. This, combined with the fully integrated sound source of the 'Monitor' Dual Concentric, makes it especially suitable for stereophonic reproduction.

WRITE FOR DETAILS

TANNOY (AMERICA) LTD.
BOX 177, EAST NORWICH, L. I., N. Y.

TANNOY (CANADA) LTD.
36 WELLINGTON ST. EAST, TORONTO, ONT.
CIRCLE 89 ON READER-SERVICE CARD

AN ARGUMENT FOR STRAUSS

Continued from page 49

abandoned at birth. The entangling of musical events with dramatic ones is a risky business; and although Strauss took great pride in his ability to describe extra-musical circumstances musically (a talent which was later to make him the greatest operatic composer of his time), the essence of the tone poem structure did not depend on the circumstance that a series of dramatic occurrences appeared in a recognizable paraphrase. Rather, it lay in the fact that the harmony of dramatic events could be used as a focus for musical form. (Fascinating that Thomas Mann was always talking about the reverse procedure—building the novelette like a sonata-allegro.)

As Strauss grew older, his desire to overwhelm us with the musical equivalent of an epic novelist's entangled plot line abated, and as the tone-poem period came to an end he began to enjoy what was, at first, a coy flirtation with the "style-galant," and then to visit with increasing ardor the spirit of tonal rebirth and reemphasis which dominated the preclassical generations. It has always seemed to me that the pivotal work in Strauss's career is one of the less spectacular, and certainly in North America least well known, of his works—*Ariadne auf Naxos*. *Ariadne* is neither the most brilliant, the most effective, nor the most likable of Strauss's operas, and yet from its conception date those qualities which can now be numbered as the outstanding traits of the mature composer. (There may be some amusement in the fact that this statement, however open to challenge, should be made of a work written in the same year as Stravinsky's *Sacre du Printemps* and Schoenberg's *Pierrot Lunaire*—1912.) *Ariadne* finally confirms what must surely have been suspected of Strauss long before—that at heart his instinct, if not neoclassic, is essentially that of a highly intellectualized romantic.

From *Ariadne* onward his textures will on the whole become ever more transparent, and the buoyancy and stability of his harmonic style will be even more magnificently served. Strauss always fancied himself as a kind of twentieth-century Mozart, and this is not an altogether insupportable conceit: indeed, in many of the operas of the middle-late years from *Ariadne* to *Schweigsame Frau* we find again and again the delicious transparency which makes these works, in my view, the most valid outlet for the neoclassic instinct. And so, once again, Strauss's concern for the total preservation of tonality finds not only a sanctuary but a point of departure.

I DO NOT WANT to suggest that Strauss's creative life did not at some time actually undergo that terrifying evaporation of inspiration which plagues the subconscious of all creative people. It has always seemed to me there was some justification for the concern expressed about his artistic future during the pe-

riod immediately following the First World War. Certainly, the decade following the Great War was the least productive decade of Strauss's life, and his work at that time, while possessed as always of an enormous technical competence, cannot by any stretch of the imagination be regarded as equaling his earlier achievements. Strauss himself, of course (utilizing the composer's and the parents' privilege of making a special pet of the unwanted child), swore to his dying day that *Die Frau ohne Schatten* was the greatest of his operas and besieged major opera houses with requests for its production. He even insisted that, although his health could not possibly permit him to endure the rigors of conducting *Rosenkavalier* (because of its length), he would nonetheless be most happy to conduct *Frau ohne Schatten* (which is slightly longer). The middle operas like *Frau ohne Schatten* are certainly not without admirable qualities; we no longer feel, however, quite that same wondrous stroke of inevitability which in the earlier works—and, indeed, the later ones—bound the first note with the last and made all the ingenious technical diversions not the aim but simply, and rightly, the means.

And so we come to that incredible rejuvenation of Strauss the artist—the fluent, warm, infinitely moving works of his late years. Here, surely, is one of the most fascinating revitalizations of the creative spirit to which we could ever be witness. One could, I suppose, attempt a parallel with the last works of Beethoven by pointing to the fact that they too follow upon a dreary desert of inactivity, from which Beethoven emerged to find not only the assured step of his youth but, indeed, a means to express the mature deliberation of his later years. It is my view that the late works of Strauss afford much the same opportunity to contemplate the mating of a philosophic stance and a technical accomplishment indivisible from it. I feel that in virtually all of his late works Strauss's youthful tendency to celebrate through the techniques of art the human conquest of material order, to applaud the existential character who flings himself unquestioningly against the world—in other words to be the hero of *Ein Heldenleben*—is now sublimated, indeed, wholly vanquished, by a technical mastery which no longer needs to prove itself, to flaunt its virility—but which has become inseparable from those qualities of sublime resignation that are the ultimate achievements of great age and great wisdom.

Indeed, short of the last quartets of Beethoven, I can think of no music

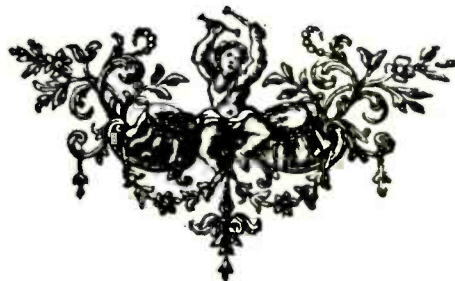

HIGH FIDELITY MAGAZINE

which more perfectly conveys that transfiguring light of ultimate philosophic repose than does *Metamorphosen* or *Capriccio*—both written when their composer was past seventy-five. In these late works the vast harmonic imagination always characteristic of Strauss remains; but whereas in the earlier years it had the positive, convinced, untroubled assurance of metric simplicity, now it is sometimes tentative, sometimes wayward, sometimes deliberately asymmetric, and thus conveys a vivid sense of one who has experienced great doubt and still finds affirmation, of one who has questioned the very act of creativity and found it good, of one who has recognized the many sides of truth.

And yet I wonder how vivid the comparison with Beethoven really is. Beethoven, after all, in the last quartets did, virtually, bridge the entire romantic era and afford a link with the taut motivic complexities of the Schoenbergian generation. On the other hand, at least from our present point of view, Strauss, in the late years, can hardly be supposed to have suggested any such stylistic o'erleaping of future generations. He has, if my view of him is substantial, simply brought to an inevitable and poignant conclusion his own existence as a creative man; he has promised nothing whatever for the future. And this, I submit, is where the estimation of my generation has passed Strauss by.

I do not for one minute suggest that, with all of my admiration for Richard Strauss, I could possibly imagine that the future of music will somehow be influenced in any actual, stylistic sense by his works. But then what is it that really provides the influence of one generation upon another? Is it simply the retention of stylistic similarities within an ever moving historical front? Or can it not also be the inspiration to be drawn from a life which contains a total achievement of art? Certainly Richard Strauss had very little to do with the twentieth century as we know it. No more perhaps did he belong in the age of the atom than Sebastian Bach in the Age of Reason or Gesualdo in the High Renaissance.

By all the aesthetic and philosophic yardsticks that we must apply he was not a man of our time. Can we really conceive of *Frau ohne Schatten* being launched in the inflation-ridden ragtime-infested roaring Twenties? Is it really possible that *Capriccio*, that autumnal saute to a world of gallant poise and quiet literacy, could really have been born while the flames of war swept our world of 1941?

The great thing about the music of Richard Strauss is that it presents and substantiates an argument which transcends all the dogmatisms of art—all questions of style and taste and idiom—all the frivolous, effete preoccupations of the chronologist. It presents to us an example of the man who makes richer his own time by not being of it; who speaks for all generations by being of none. It is an ultimate argument of individuality—an argument that man can create his own synthesis of time without being bound by the conformities that time imposes.

TESTING TUBES AT HOME

Continued from page 54

new matched pair. However, some amplifier designers recognize the fact that matched-pair replacements may not always be readily available, and consequently they may provide an adjustment on the amplifier which will compensate for most of the inequalities of unmatched tubes. If your amplifier chassis is not equipped with this adjustment, and if you are unable to find a matched pair of replacement power tubes, your tube tester will enable you to do a very fair job of matching. Even better is to get the replacements tested when and where you buy them. On a meter whose scale runs to "100," tubes that test within two or three points of each other can provide satisfactory (though not perfect) service as a "matched pair." Of course when you need new tubes you will follow the advice given by almost all component manufacturers: make exact replacements by type and brand.

Whatever the tube or its trouble, a sound system made up of separate components is much easier to service than a package-set built as a single unit. Difficulties can be localized in a specific component, with fair certainty, even before the tube tester is brought into the picture. For instance, if records can be heard, but not the tuner, look for a defective tube in the tuner; if the tuner works and the phono doesn't, the trouble is in the pre-amplifier. If nothing works, try plugging the tuner directly into the power amplifier: if this solves the problem, the bad tube is again in the preamplifier; if the system remains dead, the fault is in the power amplifier. Once the offending unit has been isolated in this way, fewer tubes need be tested, and the success of the test procedure is reasonably assured.

Fight
Mental Illness



National Association
for Mental Health

portable
perfection
for
hi-fi fans



From Denmark comes this aristocrat of portables. Superb AM-FM-Shortwave performance with all the features you've ever wanted in a portable: 12 transistor power with push-pull output and a 5" x 7" speaker, flywheel tuning, full range independent tone controls, pushbutton selection, loudspeaker - earphone output and separate tuner output, plus plug-in connection for an auto antenna for over-the-road hi-fi.

Complete information is available on request. Write for the name of your nearest dealer.



By appointment
to the Royal Danish Court

DYNACO

DYNACO, INC.
3912 Powelton Ave., Phila. 4, Pa.

CIRCLE 40 ON READER-SERVICE CARD



automatic turntable

M
I
R
A
C
O
R
D

the new Miracord is both

Here's the best of two worlds in one exciting package . . . the all-new Miracord automatic turntable and record changer. Enjoy perfect record reproduction only a professional turntable and tone arm offers . . . or the convenience of uninterrupted music, hours on end. Choose either model: the **STUDIO H** with hysteresis synchronous motor—**\$99.50**; or the **STUDIO** with heavy-duty, shaded 4-pole motor — **\$79.95**.



record changer

For complete information write:

BENJAMIN
ELECTRONIC SOUND CORP.

Dept. HF 3/62 — 97-03 43d Ave., Corona 68, N.Y.

FISCHER-DIESKAU

Continued from page 57

recently had considerable success as Verdi's Falstaff. I confess that I myself do not find it very easy to conceive of him in this role, and unfortunately I cannot here speak from personal experience. But I am assured by several competent judges that this is one of the most successful things he has done—not only immaculately sung, which I well believe, but also richly humorous. Be that as it may, Fischer-Dieskau excels primarily in serious parts, and notably in complex and intellectual characters. He is, for example, a most distinguished Mathis in Hindemith's impressive but somewhat lumbering opera, and recently he has tackled the very different part of Wozzeck. But particularly close to his heart is Busoni's *Dr. Faust*, which he believes to be a neglected masterpiece. This huge part calls for all Fischer-Dieskau's vocal and dramatic talents, and he rises to its demands with extraordinary authority, portraying with equal success the brooding philosopher, the carefree hedonist and philanderer, and the last fearful hour of reckoning. By any standards this is one of the most remarkable performances to be seen on the European operatic stage of the present day.

But opera is not the center of Fischer-Dieskau's career. He generally sings a role or two at the Salzburg and Munich festivals in August and occasionally at Bayreuth. In addition, he always devotes a certain amount of time to his parish opera house in West Berlin, where he can be heard during the stimulating autumn festival. But he remains first and foremost a Lieder singer.

If his operatic repertory is individual and large in proportion to the limited number of appearances he makes, his concert repertory is immense. An astonishing amount of it is already available on discs. (It is said that at the age of thirty-six he has already recorded three times as many Lieder as any other singer, past or present.) Fischer-Dieskau is not, I think, particularly sympathetic to the more radical sort of contemporary music and he stands apart from the rather self-conscious progressivism of present-day German musical life. When he does enter this field, he does so with understanding: his lively recording of Hans Werner Henze's "Five Neapolitan Songs" shows an insight into the melisma of Neapolitan popular song unexpected in a sensibility so essentially German as Fischer-Dieskau's.

He has also recently recorded a certain amount of French song. I have heard only his recording of Fauré's *La bonne chanson*, and here, adroitly though he avoids all the pitfalls of a foreigner venturing into a highly idiosyncratic idiom, he impresses by intelligence rather than by instinctive grasp. But of course the field in which he is unchallenged is German romantic song from Beethoven to Mahler, where his intellectual grasp coupled with profound instinctive insight makes his performances wholly authoritative. By good fortune his achievements

in this field are lavishly represented on records, so lavishly indeed that any adequate discussion of them is quite beyond the scope of this article. But there is one disc that seems to me to be worth special mention: Schumann's *Dichterliebe*.

I choose *Dichterliebe* partly because the recording seems to me one of Fischer-Dieskau's most remarkable achievements *qua* singing, and partly because the work itself is the essence of the German romanticism of which he is such a unique interpreter. The human voice is a fallible instrument, and the singer who is without technical problems and weaknesses does not exist. Perhaps the most persistent failing in Fischer-Dieskau's earlier recordings is a tendency to lose evenness and steadiness of tone when he presses his huge voice, so that the sound comes in blurts, while the line thickens and grows blotchy. This tendency is far less apparent in his recent recordings, and it is totally absent from his *Dichterliebe*. *Im Rhein, im heiligen Strome* is thundered out with vast majesty and rocklike solidity of tone. If unevenness is his main technical blemish, artistically his principal failing is an occasional surplus of interpretation. As so often happens when an intelligent and sensitive artist has thought long and hard about a role, Fischer-Dieskau sometimes makes one more conscious of the interpretation he is giving the song than of the song itself: one is more aware of countless vocal shadings and inflections than of the basic line. Fischer-Dieskau has developed his voice as a uniquely subtle and expressive instrument, and he can on occasion be accused of using these accomplishments for their own sake. But this is diminishing with age. In, for instance, *Am Leuchtenden Sommermorgen* he penetrates with utter simplicity and directness into the very heart of this typical and evocative song.

The spirit of German romanticism turns on the bitter contrast between the poignant beauty of the world around us and the unhappy tumult in our own hearts. This is the theme that links Schubert, Schumann, and Mahler and that makes *Die schöne Müllerin*, *Dichterliebe*, and *Das Lied von der Erde* all part of a single tradition. It is a *Weltanschauung* of which Fischer-Dieskau has profound understanding. He seems to be able to strike down to the very roots of romantic anguish without any false pathos or emotional gesturing.

Of course he is not the only singer who can enter this world. Others may challenge him in one song or another. But in a cycle he seems to me unchallengeable because he commands such a great range of expression. It is all too easy to deliver Lieder in an emotionally stereotyped manner—this song is jolly and that one sad, and that's that. But Fischer-Dieskau seizes the emotional ambivalence in Heine. The gentle lyricism of *Und wüssten's die Blumen* is sung with such heart-easing limpidity that the sudden bitterness of its conclusion strikes like a lash. His voice has an astounding range of color and expression. To speak of *mezza voce* here is pointless, for it is in itself a rainbow of finely

graded timbres. In the latter part of *Ich grolle nicht* his slow and gradual transition from a subdued opening to a great cry of pain gives some idea of the range of tone at his command. And his ability to fill his mezza voce singing with content is wonderfully shown in the tension and subdued desperation of *Ich träumt' du verliesst mich*. In none of the songs does he convey the feeling of singing to a formula: each is given its individual expressive quality and yet the cycle is grasped as a whole, moving towards its culmination with unflinching sense of direction. It is this that makes Fischer-Dieskau's singing of the greatest of all song cycles, *Die Winterreise*, so overwhelming an experience.

Where a man derives gifts such as these no one can say. But Fischer-Dieskau's background and way of life no doubt play their part. Germany has seen galvanic changes in the past century, and its old world of romanticism lies buried beneath the ruins of Bismarck's and Hitler's empires. Today that world lingers on only in odd corners, far from the busy centers of the *Wirtschaftswunder*, the *Autobahnen*, and the tourist circuits. In some curious way Fischer-Dieskau reflects this old, forgotten Germany—"das land der Dichter und Denker." There is something old-fashioned about him. He lives in the city in which he was born, in a solid, comfortable house, surrounded by his family. He occupies his spare time with a mammoth collection of records, catalogued with obsessive precision, and a whole library of pictures and illustrations of anything to do with composers. Occasionally he likes to prepare little lectures in which the records are played and appropriate illustrations are projected. He has evenings of *Hausmusik* (his wife is a cellist and he himself a competent pianist). He reads a good deal.

All this may sound a little dull, and his lectures are much mocked in Berlin. A solid, domestic existence such as this is rare in the busy, thrusting, and rootless Germany of the present. Once it was the traditional background of Germans of his class—solid, cultivated, a little pedantic perhaps, and unexciting—before Bismarck and Wagner transformed their country. Is it fanciful to see in this Biedermeier atmosphere some reflection of Fischer-Dieskau's ability to reënter a romantic world of bitter joy and sweet tears to which so many artists of consummate proficiency have lost the key?



MARCH 1962

WATCH YOUR JACKET

Continued from page 60

can lead to the following kind of unintentional doubletalk: "This band reveals the players as instrumental in making overtures with no strings attached. . . ." And only yesterday I heard one of the BBC's top reviewers of opera recordings say something like this concerning an eminent soprano: "A beat is inclined to set in and the tone isn't really solid. . . ." For one horrid moment I thought the speaker had wandered into the wrong Tin Pan Alley; I nearly advised him to "dig, man, dig." He obviously hadn't learned always to be wary of words which in addition to broad connotations also have specialized meanings.

Another thing that the jacket writer should always remember is that his humblest contribution is likely to be read over and over again, far more often, indeed, than his most learned articles. Yet sleeve notes must also be easy enough to read so that they can be assimilated almost at a glance. The reason? Not only are they picked up and skimmed over in the record shop, but they're almost sure to be read while the record itself is being played. A reprehensible habit, no doubt, but there it is; let us admit it—we all err in this direction. The first thing most listeners do when a record begins to play is to reach for its jacket and start to read. In defense of this malpractice I recall what a great Dutch violinist once said to me: "One should neffer haaf to listen to music for de first time!" There is, after all, something to be said for letting the music just seep into one's subconscious.

How long should a jacket note be? I'm not thinking here of the kind of elaborate booklet which one finds in the two- or three-record set, but of the notes printed on the back of an ordinary I.P. record jacket. The permissible length for such notes seems to vary in different countries and with different companies. In the United States it seems that longer notes are possible than in Britain, say, or France. Fifteen hundred words seems a reasonable sort of length: the thousand-word note is popular with some companies; and if the writer can restrain his eloquence and enthusiasm to eight hundred words, he will be the Artist Managers' fair-haired boy.

I wrote just now of "enthusiasm" and "eloquence." Mr. Mayer distrusts at least the first of these qualities, but, you know, I don't think we shall get far without either of them. In general, jacket-note writers are hardened professional scribes, but in spite of this they are, as often as not, enthusiasts as well. If the jacket-note writer loves and understands the music he is discussing, then that truth will out; and if real enthusiasm is there, why should he not try to convey it to his reader? The music critic without enthusiasm had much better go and try to sell insurance or real estate. Above all, the notes should make the reader who casually picks up a disc and glances at the jacket simply long to hear the music; if he doesn't, then the jacket writer has muffed his job!

Hard to get...you bet!...but

WORTH WAITING FOR!

the Viking 86 STEREO-COMPACT

It's selling so fast dealers are constantly out of stock. We're sorry for the delay in getting delivery on enough 86 Stereo-Compacts, but that's how good this new all-in-one component recorder is.

The 86 Stereo-Compact will likely continue to be in short supply through the next few months. We hope you will be willing to wait the necessary two to three weeks for delivery of this year's hottest stereo product.

We promise you the ultimate in performance; a carefully-built, quality-built stereo recorder, unmatched in the current market.



Check these quality and performance features of the 86 Stereo-Compact.

- 25-18,000 cps ± 3 db • two track, four track and combination models • Auto-Equalized Recording/Playback • Built-in Playback Equalization • Recording Interlock • Multiplex-Ability for FM Stereo Recording.

AUDIOPHILE NET \$297.50

See your Viking Dealer or send today for FREE detailed technical catalog.



Viking of Minneapolis, Inc.

Viking of Minneapolis HF-2
9600 Aldrich Ave. So., Minneapolis 20, Minn.

Please send technical catalog on

86 Stereo-Compact 76 Stereo-Compact

NAME _____

ADDRESS _____

CITY _____

STATE _____

CIRCLE 96 ON READER-SERVICE CARD

TRADER'S MARKETPLACE

This classified section is available without cost only to readers who wish to buy, sell, or swap used equipment or records. No dealer ads please. Messages limited to 30 words, including name and address. Copy must be received by the 1st of the 2nd month preceding publication and is subject to approval of publishers, who cannot in anyway guarantee the accuracy of statements or condition of merchandise advertised. Classified advertisements will be limited to one page and advertisements printed on a first-come, first-served basis.

TWO Goodmans 208 Triaxial speakers, ideal for bookshelf enclosure. Retail each \$60 as new, 16 ohm impedance. Will swap for Scott 99-D amplifier or J. B. Lansing 131 speaker. John Guzy, 1920 W. 55th St., Chicago 9, Ill.

WANTED: Good quality used tape recorder, dual track monoaural. Pay \$50 top. Also G. I. disc recorder assembly, magnetic cutter. Frank Buzzell, 215 S. Buchanan, Spring Lake, Mich.

SELL: Scott 130 stereo preamplifier, 2 Dyna Mark III power amplifiers. Best offer over \$200. Guaranteed excellent condition. Dr. W. Maslowski, 1072 W. Market, Lima, Ohio.

FOR SALE: Crosby 650 stereo receiver, walnut cabinet and Crosby MX-101 FM stereo multiplex adapter. Excellent condition, \$170 plus shipping charges. John G. Zeros, 1265 Morrison Ave., Bronx, N.Y.

WANTED: High quality recordings of music by early American composers (especially Paine). Can reciprocate with taped music of British composers, artists not available elsewhere. R. Williamson, 78 Helena Road, Norwich, England.

FOR SALE: Acoustic Research AR-3, Bogen DB130A and Rek-O-Kut N33H with Fairchild 5M1 cartridge and walnut base. Excellent condition, \$175. W. E. Thompson, 510 Columbus Drive, Savannah, Ga.

FOR SALE: All or any part of collection of stereo, mono discs—concert music, mostly unplayed, 1/3 off. Free list. Richard Treat, 725 West 24th St., Billings, Montana.

WILL SELL: Recorded tapes and records including hillbilly, popular and religious music. David Thompson, Route 2, Box 200-A, Mena, Arkansas.

WANTED—Weingartner's early Columbia 78 recording of Symphonic Fantastique and "Me and Juliet," Victor LP, LOC 1012. E. D. De Voe, 902 W. Wildwood Ave., Fort Wayne, Indiana.

WANTED: Giannini-Pertile-Sabajaino Aida. Joseph Borome, 372 Central Park West, New York 25, N.Y.

WANTED: Good used stereo tape cartridge recordings. Send your list to: Steve Ridlon, 9 Powsland St., Portland, Maine.

SELL: JBL Metregon mahogany. Has D130A's, 275's, 075's, N600's and N700's. One year old. Flawless condition. Cost \$1300, sell \$650. No offers please, must sell. Charles Sweet, 1213 Crow Ave., Visalia, Calif.

WILL SELL or Trade Brociner model 4 corner enclosure plus Gray 106-SP tone arm, both in perfect condition, for new AR-3 enclosure. Dr. Abraham Tannenbaum, 352 B-12 Street, Far Rockaway, N.Y.

SELL: Ampex 600 (\$350) and 401A (\$395) half-track recorders, portable, low impedance; Telefunken U 47 condenser mike (\$350). Top condition. Reason: military. \$950 for all. Dr. C. F. Tuma, 13201 Miles, Cleveland 5, Ohio.

WANTED: Hora Staccato RCA EP played by Al Caiola guitar; Dragonetti, Double-Bass Concerto, Classic 1035, or these on tape. Githon Reid, Naturita, Colo.

HIGH FIDELITY 1-108, \$50. Delivered free NYC area. R. Berthold, 186-40 139 Ave., Jamaica 13, N.Y.

BEST OFFER Takes: new Fairchild 500 arm, Empire cartridge, 35-watt Knight mono amplifier. Paul Montgomery, 40 N. E. Tenth, Oklahoma City, Okla.

SALE: 1000 78's, 100 LP's—collector's items—operas, arias, overtures, symphonies, instrumentals, lieder, oratorio excerpts, folk songs, Shakespeare, etc. M. J. Weinberg, 2925 Kanawha St., N.W., Washington 15, D.C.

WANTED: two Wellcor S-1215 speaker enclosures preferably in limed oak. M. Halko, 6229 S. Kedvale, Chicago, Ill.

BUY: Mint copy CL871, Pretty Wild, Wild Bill Davison; HL7080, Dixieland in Hi Fi, George Wetling. Premium price. Will consider near mint. State condition. Tom Cannon, Murfreesboro, Tenn.

BRAND NEW Stereophoner by Herman Scherchen. Bought two, but only need one. Cost me \$16, yours for \$10 postpaid. William I. Congdon, 307 Barker St., Ridley Park, Pa.

FOR SALE: two brand new University CBW 8" woofers in cartons. Original price, \$15 each. Sell both for \$20. Jack Brannigan, 9222 S. Sacramento, Evergreen Park 42, Illinois.

FOR SALE: HIGH FIDELITY 1-109 complete. Best offer. J. Hartley, 37 Woodside Rd., Waldwick, N. J.

WANT TO BUY: Met broadcast recordings—Ernani, Nabucco, Macbeth, Simon Boccanegra, Traviata, Forza, Ballo, Norma (Milanov), Lucia (Callas). John Schweger, 1675 Juniper Dr., Green Bay, Wis.

WANTED: Columbia 10" ML-2185 of Grandma Moses film music. Also all issues of Schwann LP Catalog before 1952. Ronald Chandler, 3540 Monterey Blvd., Oakland 19, Calif.

JIM LANSING D-131 12" speaker in Aristocrat cabinet, \$100; Rek-O-Kut N-34H stereotable, S-320 arm, base, Shure M7/N21D cartridge, Acoustimounts. 5 months old, \$120. John J. Kempel, 1154 Irwin, Pontiac, Mich.

WANTED TO BUY: back issue of Opera News Magazines, pictures of Maria Callas and opera vocal scores and librettos. Advise what you have. Richard White, RFD #1, Lilburn, Ga.

WANTED the REL 646 FM tuner in good condition or the REL "Precedent" FM tuner. Will pay good price. Alex S. Labounsky, 60 Hill Drive, Oyster Bay, N. Y.

SELL: Fairchild 412-1A turntable, \$69; Audio Empire model 98 arm, \$29; Pickering 381A cartridge, \$38; together, \$130. Scott 320 FM-AM tuner, \$80. Robert Keathley, 246A Cochran, Memphis 5, Tenn.

SELL: Sherwood S-5000 stereo amplifier and case. Like new—used only few months, \$95 plus shipping. D. R. Deneen, 33 E. Cedar St., Chicago 11, Ill.

FOR SALE: Fisher 400 CX Master Audio Control stereo preamp, \$140. Two Dyna Mark III 60-watt amplifiers, \$60 each. Entire package, \$240. Excellent condition. FOB New Haven, Jack Fleischer, 271 Cooper Place, New Haven 15, Conn.

WANTED two JansZen 130 in mahogany finish. Kerry Hull, RR 4, Columbus, Indiana.

WANTED: Complete recordings of Le Coq D'Or (opera) and Heart of the Opera (Camden—six records). Please state condition, price. Bruce Brewer Jr., Rte. 10, Box 219-H, San Antonio, Tex.

WANTED: RCA LC1A or S1552 speakers, one or a pair, with or without baffles. Must be perfect and never damaged. Captain Matthew Kabrisky, Box 3494, IT, Wright-Patterson AFB, Ohio.

SELL: Electro-Voice SP-15 in mahogany Wellcor reflex enclosure or trade for tape deck, Citation preamp, AM-FM tuner. Capt. Boesch, Box 3901, Laughlin AFB, Texas.

SELL Ferroglyph JAN recorder; Bogen DB-130 control amplifier; Racon CHU-5 horn tweeter; Simon Sound "Cadenza" ribbon mike; Connoisseur table, mono arm, base. Write John Margosian, 9210 Skidmore Ave., Brooklyn 36, N.Y.

FOR SALE: Concertone Mark 10-26C professional tape deck, excellent condition. 7 1/2-15 IPS, 10 1/2" reel, Bodine motors. Can be converted to stereo, \$400. Ed Pineiro, 4800 Rhodes Ave., North Hollywood, Calif.

WANTED: JBL 175 DLH and N1200 crossover. Jack Chaney, Box 25, Hillsboro, Ohio.

WANTED: Eddie Heywood, Coral 12" LP 57095, also old 78 RPM of Billie Holiday, "All of Me" Okeh 6214, Michael A. Piccinini, 6922 Chaucer St., Pittsburgh 8, Pa.

WANTED JBL 075 tweeter and N2400 or N2600 crossover network. State price and condition. R. C. Mechanic, 222 Norman Rd., Rochester 23, N.Y.

FOR SALE: Electro-Voice "Leyton" speaker system, walnut. \$60 or best offer. Thomas Thompson, 314 S. 50th St., Philadelphia 43, Pa.

WANT TO BUY—Bozak 302-A without cabinet or Bozak speaker components. Sell or swap—Sherwood S-3000 FM tuner, Bozak E-300 enclosure. Dave Mosemann, 304 Lebanon Road, Manheim, Pa.

SACRIFICE: Professional Ampex recorder 354, three weeks old, guaranteed perfect, \$1400. Two Marantz-9 amplifiers, a month old, impeccable condition, extra tubes, \$500. H. Walker, 76 Elm St., Northampton, Mass.

TRADE: LP's and albums—played only once—list available. Charles Cain, 15 Grant, Mt. Ephraim, N. J.

FOR SALE: Viking 85R deck and RP62-C record/playback amplifier, 1/2-track monoaural erase, record and playback, like new \$75. Paul Strisk, Rockport, Mass.

BRUCKNER Symphony No. 5, stereo, 2 London CSA-2205, new, \$7.50. Want book, "A Russian Tome-poet, Scriabine" by Eaglefield Hull, Pub. London 1916. Horace Butterworth, 2708 Gaither St., S.E., Washington 21, D.C.

SELL: Heath AM-FM tuner PT-1 and stereo preamp SP-2A, both in excellent operating condition, \$125 plus shipping. E. L. Baker, 35 Windsor Road, Cranston 5, R.I.

GRUNDIG Majestic stereo console AM-FM-SW and Telefunken changer, cabinet perfect. Needs tune-up. Complete with Grundig TK20 tape recorder—list over \$750. Act fast—\$250. James Kowalski, 2626 Weisman Rd., Wheaton, Md.

AMPEX 601-2 stereo recorder with input transformers. Very good condition. Best offer over \$700 takes. David Johnson, Box 517, Avoca, Iowa.

SELL: Fisher 400-C stereo preamp with all new tubes, \$65. Two track stereo tapes also wanted at discount. John Whitfield, 2616 Hanover Ave., Richmond 20, Va.

FOR SALE: Two Dyna 60-watt amplifiers, both \$115; Bogen AM-FM, \$75; Leak FM, \$100; Grado arm with Master cartridge, \$35. All in new condition. C. B. Sullivan, 84 Howard St., Cambridge, Mass.

WANTED: Stephens 15" coaxial 206AXA speaker. Enclosure not important due to difficulty of matching present enclosure, but will consider enclosure purchase if necessary. David C. Hardshaw, 903 North Mallory St., Hampton, Va.

SELL: Sony CS-300 stereo tape recorder, \$275. Will Trade for any of the following: Two AR-1W's, two AR-1W's, Ampex 934 and \$25, or Ampex 934 and \$75. Robert Moore, 5 B Orange, Goleta, Calif.

WANTED: Tape recording preamp—Viking RP 61-62, Heath, etc., one or two. Reasonable. Rudy Pucel, 2010 View Road, Cleveland 9, Ohio.

USED University HF206 hypersonic tweeter, includes 4-mfd crossover. \$17 postage included. Francis Gallagher, 3375 Sedgwick Ave., Bronx 63, N. Y.

FOR SALE: Scott tuner type 310, excellent condition, best offer over \$75. D. J. McBride, Montgomery Woods, Hockessin, Del.

WANTED: RCA Victor LCT-1136 (Rachmaninoff); Kingsway 291 (Glazunov); Urania 7073 (Dvorak) and Heritage 1205 (Gliere). E. C. Magnuson, 2224 Livingston Ave., Duluth 3, Minn.

WANTED Tape recording of the sound track of film "New Orleans," primarily interested in numbers Billie Holiday sang in film. Fred Cox, 132 East 2d St., Oswego, N.Y.

FOR SALE: Citation I stereo preamp, \$145; Scott 121C mono preamp, \$55; Pickering 380A stereo pickup, \$15; Shure M3D stereo pickup, \$15. All perfect. R. J. Vanderbilt, 38 West River Rd., Rumson, N.J.

TRADE \$400 (factory net) professional AM rcvr. Swiss Sondyna E306 tunes LF, BC to 60 Mc, ideal music or comm., 10W monitor. Wanted: mono preamp, amp, FM tuner, full or half track 7 1/2-15 ips tape recorder. Shipping arranged. Send details. Werner, Pf. 1424, Berne 2, Switzerland.

SELL: Viking 85 RQ deck and RP 62C amplifier in carrying case, \$125. Hardly used—excellent condition. Samuel Gittleman, 2340 Valentine Ave., New York 58, N.Y.

WANTED: Bloch—Col ML 4679, Benny Goodman—Col CL 524, Thelonious Monk—French Swing, M33342, Coleman Hawkins—Joe Davis 78s 8250-8251. Lawrence Levy, 2658 E. 64th St., Brooklyn 34, N.Y.

FOR SALE: Bogen Lenco turntable with Fairchild mono cartridge, Browning FM tuner. Both in perfect condition. Best offer, plus shipping. Herman Loewenthal, 181 Frey St., Rochester 12, N.Y.

SELL: Rek-O-Kut B-12, Fairchild 280 arm, Grado custom stereo, \$70. Garrard RC-98, Elac turnover, \$45. Want or will sell Scott 121C preamp. W. M. Boice, 211 The Prado, Atlanta 9, Ga.

Richard Strauss

ON MICROGROOVE

—seems the easiest way out of another quandary caused by the incomparable clarity of Strauss's writing.

✓—Vienna Philharmonic, Krauss, cond. (with *Don Juan*). Richmond B 19043, LP.

—NBC Symphony, Toscanini, cond. (with *Tod und Verklärung*). RCA Victor LM 1891, LP.

—Vienna Philharmonic, Reiner, cond. (with *Tod und Verklärung*). RCA Victor LM 2077, LP; LSC 2077, SD.

—Vienna Philharmonic, Karajan, cond. (with *Tod und Verklärung* and *Salomes Tanz*). London CM 9280, LP; CS 6211, SD.

—Vienna Philharmonic, Furtwängler, cond. (with *Don Juan*). Electrola E 90093, LP.

—Minneapolis Symphony, Dorati, cond. (with *Rosenkavalier* Suite). Mercury MG 50099, LP; SR 90099, SD.

—Philharmonia Orchestra, Leinsdorf, cond. (with *Frau ohne Schatten* Suite and *Salomes Tanz*). Capitol P 8545, LP; SP 8545, SD.

Also sprach Zarathustra, Op. 30 (1896)

None of Strauss's symphonic poems has been more damaged by the excessive literalization of critics than *Zarathustra*. The composer was alternately chided and cursed for his completely mad and unsuccessful translation into music of Nietzsche's philosophical book. The subject matter is, of course, so immense and complex that any composer attempting that of which Strauss has been accused would indeed be a madman. Strauss was quite sane. The full title of this composition is *Thus spake Zarathustra, freely after Nietzsche*. The word "freely" unequivocally informs us that Strauss is doing nothing more than projecting a series of nonliteral, subjective associations.

The modern listener is, I suggest, best able to appreciate *Zarathustra* as absolute music. Let us simply listen to what Strauss has written, for in spite of certain obvious banalities this work is a creation of unique majesty and color.

Stereo has played a major role in bringing about a revival of serious musical interest in *Zarathustra*. Reiner's version, the first to have been released in this medium, should satisfy all hearers. Reiner's conception is easily the most brilliant and immediately accessible of the three currently in circulation, and the marvelous clarity and incisiveness of his direction is captured with supreme skill by RCA's engineers. Reiner lunges into

the music with vitality and obvious relish for its lushness. (He readily gives in to the temptation of sentimentalizing the "waltz," treating it as he would any comparable section of *Der Rosenkavalier*.) His "sunrise" is stupendous; and from this auspicious beginning to the final and justifiably famous B major woodwind chord over the pizzicato C of the strings, he exhibits his mastery of the Straussian idiom.

London's stereo is not nearly so effective as RCA's. The English engineers have turned out a superlative mono disc, but its stereo counterpart is recorded at much too low a volume level. Karajan is otherwise a worthy competitor to Reiner. The former leads what is essentially an introspective performance with less emphasis on brilliance. Sentimentality is a quality not to be found in Karajan's *Zarathustra*, yet his reading projects as much of the essence of the score as Reiner's.

Karl Böhm, another highly regarded Straussian, begins his *Zarathustra* with what is surely the most eloquent "sunrise" since Koussevitzky. Böhm prefers slower tempos, greater expansiveness than his rivals; and he employs this approach to maximum effect. Decca's stereo is spacious and full, although less sharply defined than London's; my copy had a good deal of surface noise. The mono edition was not available for review.

✓—Chicago Symphony, Reiner, cond. RCA Victor LM 1806, LP; LSC 1806, SD.

—Vienna Philharmonic, Karajan, cond. London CM 9236, LP; CS 6136, SD.

—Berlin Philharmonic, Böhm, cond. Decca DL 9999, LP; DL 79999, SD.

Don Quixote, Op. 35 (1897)

Description of extramusical matters seems to me a more meaningful procedure in *Don Quixote* than in the majority of programmatic compositions. The classical variation form is brilliantly utilized to depict the Don's changing mental states and attitudes. The story is told vividly, without being overburdened by superfluous literary allusions, via transformations of the theme representing the Don. Again I will leave it to the reader to decide upon the degree to which his appreciation will be influenced by knowledge of Cervantes. I cannot separate one from the other.

Don Quixote is an extraordinarily difficult work to perform. The conductor

who loses sight of the central character is himself lost. This symphonic poem, to an even greater extent than *Don Juan* and *Till*, must be uninterrupted in its flow from episode to episode.

Two conductors, Reiner and Szell, have succeeded in giving us this story in all its richness, humor, pathos, and drama. Reiner has a broader view of the whole and one that is essentially the more romantic. His *Don* is flowing and large-scale, without stinting on lightness and wit where they are required. The voice of Don Quixote, the solo cello, is treated as part of the orchestral texture. Antonio Janigro's treatment of this part is warm and always better than competent. I would, however, have preferred a tone with more bite, less spread. Withal, any reservations about his contribution become minimal since Reiner views this work as an orchestral composition with cello obbligato. Reiner's greatest moment is the third variation, wherein the Don paints his aspirations to the highest ideals of knight-errantry to a somewhat cynical Sancho Panza. Here the conductor makes his splendid Chicago Symphony surpass even its many notable prior achievements. The orchestra, led by the cellos, bursts forth with arching tones of rare smoothness and beauty.

Szell is in command of an orchestra every bit as accomplished as Reiner's, and he too illumines the magnificence of the music; his reading is, however, a bit faster and considerably drier, with the emphasis on textural clarity rather than richness of tone. Szell's third variation is not quite on a level with Reiner's, for here the conductor restrains his orchestra and the music is robbed of that final degree of lusciousness which contributes to making these pages so moving. This is but a slight blemish on an undeniably successful reading. Pierre Fournier has all the darting crispness and vitality lacking in Janigro's playing. We are always aware of his contribution, for Szell (and his engineers) have placed greater emphasis on the solo contributions than has the RCA team.

My recommendation of the Reiner is based on my affection for that third variation and on the belief that in *Don Quixote* the orchestra should be the dominant voice at nearly all times. Szell nevertheless manages to make a strong case for his view. Both Reiner and

Continued on next page



ASPEN MUSIC FESTIVAL

- CONCERTS
- LECTURE
RECITALS
- SPECIAL EVENTS
- CONFERENCE
ON
CONTEMPORARY
MUSIC

(Piston, Messiaen, Sauguet,
Milhaud, C. Jones)

Summer 1962



ASPEN MUSIC SCHOOL

- DISTINGUISHED
ARTIST-FACULTY
- DEPTS.: piano, voice,
opera, diction, strings,
chamber music, winds,
percussion, conducting,
composition
- PRIVATE INSTRUCTION
- FESTIVAL EVENTS

For Information Write:

Music Associates of Aspen, Inc.
Dept. F, 111 West 57th St.
New York 19, New York
CIRCLE 13 ON READER-SERVICE CARD

STRAUSS ON MICROGROOVE

Continued from preceding page

Szell have received monophonic engineering that is beyond cavil. Stereo, on the other hand, exposes beauties in both which are not completely realized in the single-channel versions.

The two remaining editions are indeed small beer in comparison. Rudolf Kempe-Paul Tortelier are lean and clear in exposition, but lacking in whimsy and romantic sweep. Gregor Piatigorsky's big, bold solo work is totally negated by conductor Charles Munch's fidgety, choppy, and generally colorless leadership.

—Janigro, cello; Milton Preves, viola; Chicago Symphony, Reiner, cond. RCA Victor LD 2384. LP: LDS 2384. SD.

—Fournier, cello; Abraham Skernick, viola; Cleveland Orchestra, Szell, cond. Epic LC 3786, LP; BC 1135. SD.

—Tortelier, cello; Berlin Philharmonic, Kempe, cond. Capitol G 7190, LP; SG 7190, SD.

—Piatigorsky, cello; Joseph de Pasquale, viola; Boston Symphony, Munch, cond. RCA Victor LM 1781, LP.

Ein Heldenleben, Op. 40 (1898)

Controversy over *Heldenleben* still has not completely died down, sixty-odd years after it was written. We no longer bother to excoriate its "obscene modernity," but many critics who have not ceased to fight the wars of long ago persist in their condemnation of the section entitled "The Hero's Battlefield" as noise for its own sake and sheer vulgarity. Strauss was, and perhaps still is, condemned for unanimously electing himself to the composers' pantheon at the age of thirty-four through this music. I must confess to feeling detached from this point of view. I am aware that *Ein Heldenleben* has its moments of pure bombast, but I also find it to be a composition of great power—provided that exposure to its very full-blown sentiments is not too frequent.

Heldenleben is a stupendous showpiece for any conductor who cares to make it such. It is also a work which has, partially as a result of the polemics attending it for so long, brought about a wide variety of conductorial reaction.

The most recent, and the most generally praised, of *Heldenlebens* is Sir Thomas Beecham's. I am beginning to suspect that its many admirers do not care very much for the music. Beecham is, I will grant, an incomparable interpreter of the deeply moving final sections, "The Hero's Works of Peace" and "The Hero's Release from the World." His conception of this hero (Strauss) is, however, too elegant. The pompous "hero's theme" is too tame and gentlemanly. The battle is fought with velvet gloves. Impressive as it all may be, I feel that Beecham's unique and intelligent views make this work into something which it is not—an easygoing and, on the whole, rather mild romantic work.

Leopold Ludwig and Eugene Ormandy take an opposite view, although they are hardly alike in their approaches. Ludwig

is big and hearty, noble and fairly noisy. Details emerge clearly, although a more precise orchestra could have been desired; and we always feel in the presence of the composer's powerful ego. Ludwig recognizes the richness and strength of the music, as well as its bombast. Everest has afforded him stunning reproduction in mono and stereo, with the latter downright stupendous in its ability to lay bare Strauss's orchestral virtuosity. Ormandy's reflective sections are not successful, but the noise does come through superbly. I will not claim that Ormandy has performed any great service for Strauss. I would, on the other hand, be the last to deny that he and his band have provided moments of sheer aural splendor. Anshel Brusilow's treatment of the solo in "The Hero's Helpmate," which sounds for all the world like Elman playing Wieniawski, may be stupefyingly bloated in its archsentimentalism, but stupefying it is—as is Columbia's stereo.

Böhm treads a middle path in his recording. He is neither as refined as Beecham, nor as vigorous as Ludwig, nor as unabashedly showy as Ormandy. His version partakes of all three elements at the proper moments, and for this reason I feel him to be the music's most satisfying interpreter—in spite of the fact that his work does not have the advantage of stereo reproduction. Böhm keeps his head amid the battle without dulling the excitement. His final sections are smooth and romantic in the Beecham manner, with sentiment downgraded in favor of a strong romantic impulse. Clarity and balance are always maintained, and never at the expense of propulsion or grandeur. The Dresden orchestra's unnamed concertmaster is the most successful of all in giving us the romantic sweetness and strength of Strauss's helpmate. The playing is neither sugary nor excessively subdued. In all, a beautiful *Heldenleben*. Decca's mono sound is good, although more spaciousness would not have been amiss.

—Saxon State Orchestra, Böhm, cond. Decca DL 9927, LP.

—London Symphony, Ludwig, cond. Everest LPBR 6038, LP; SDBR 3038, SD.

—Royal Philharmonic, Beecham, cond. Capitol G 7250, LP; SG 7250, SD.

—Philadelphia Orchestra, Ormandy, cond. Columbia ML 5649, LP; MS 6249, SD.

Eine Alpensinfonie, Op. 64 (1915)

The *Alpine Symphony* was produced after a respite of more than a decade from the composition of large-scale orchestral music. After the *Sinfonia domestica* (1903) Strauss had turned irrevocably, or so it seemed, towards the operatic stage. Joy was therefore rampant among German audiences when in 1915 Strauss announced the completion of another symphonic poem, this one dealing with impressions of his beloved Bavarian Alps. It was generally agreed that Strauss had retained his old wizard's touch in this grandiose tonal picture. There was general rejoicing by the mass of listeners over Strauss's seeming dis-

avowal of the "revolutionary" tendencies displayed in the likes of *Salome* and *Elektra*.

The "Symphony" made the rounds of the major musical centers, was fiercely applauded, and then disappeared. It has never become a repertory piece; revivals are rare—even among those great ensembles which can afford the enormous financial outlay which is a natural concomitant to Strauss's orchestral demands.

Superficially, the work would seem to be in the vein of what preceded in Strauss's catalogue of symphonic poems. Indeed, the orchestration is as superbly colorful as ever. The musical ideas, however, are stale and insubstantial.

It becomes increasingly clear that by 1915 Strauss's interests had turned to other forms and a more spare, classical style than that in which the "Symphony" was written. This is definitely a piece intended to make its listeners gasp with worshipful astonishment at the composer's passion, vigor, orchestral technique, etc., etc. Actually it was too late for Strauss to attempt a return to this stage of his past.

Böhm, who conducts an excellent orchestra in the only available recording, displays considerable affection for the work, but his scrupulous reading only succeeds in displaying the music's noisy posturing. The conductor cannot be blamed for this; it is the composer who has offended.

—Saxon State Orchestra, Böhm, cond. Decca DL 9970. LP.

Later Instrumental Works

Der Bürger als Edelmann, Op. 60 (1918)

Strauss composed his incidental music to the Bierling-Hofmannsthal version of Molière's *Le Bourgeois Gentilhomme* in 1912. During that year the play with the Strauss score, plus the original version of the Strauss-Hofmannsthal *Ariadne* (inserted as a "divertissement") was presented in Stuttgart. The Suite, Op. 60, comprising the nine most substantial numbers from the incidental score, was fashioned by the composer six years later.

In this music Strauss displays his preoccupation with a distant artistic past, going even farther back in time than the age of Mozart, to the music of the court of Louis XIV and, in particular, to Lully. The music to *Der Bürger als Edelmann* (the title given it in German) is uniquely Strauss, but a different Strauss from the man who composed *Elektra* and even *Rosenkavalier*. Here Strauss is witty, elegant, and restrained. A comparatively small group of instrumentalists suggests the spatially restricted subject matter of the play. The seventeenth-century atmosphere is wonderfully captured in Ferdinand Leitner's scintillating performance. This is conducting of supreme lightness, warmth, and humor. The recording is appropriately dry and unresonant, although the surfaces are far from silent. Reiner's version (with quiet surfaces) is worthy of our attention; but it is a grander and less warmhearted view of the score. In keeping with Reiner's conception, RCA's engineers have pro-

vided his ensemble with a spaciousness of sound which comes close to destroying the innate intimacy of the music. In addition, Reiner gives us only seven of the nine numbers, omitting the celebrated *Minuet of Lully* (a reorchestration by Strauss of a section composed by Lully for the original production of the play in 1670) and the *Courante*. We might as well have all of this wondrous music, and I do not see how in a realization as exquisite as Leitner's it can fail to bring forth at least a low murmur of delight even from those most antipathetic to Strauss.

—Berlin Philharmonic, Leitner, cond. Decca DL 9903, LP.

—Chicago Symphony, Reiner, cond. (with excerpts from *Salome* and *Elektra*). RCA Victor LM 6047, Two LP.

Schlagobers, Op. 70 (1922)

This work, Strauss's second and last ballet score (following the *Josephslegende* ballet of 1914), stems from that period in the composer's life which must be considered his least productive in regard to quality of output. Although there was glory in the years between *Le Bourgeois Gentilhomme* and *Arabella* (1932) (to wit, the second *Ariadne* and the songs of Opp. 68 and 69), such dross as *Intermezzo*, *Die Aegyptische Helena*, and the *Parergon* suggested to the composer's audiences that he had indeed run dry.

Schlagobers ("Whipped-Cream"), like *Die Frau ohne Schatten*, represents neither the best nor the worst of this curious period of groping. The long ballet score has its delightful moments, notably in the first three of its eighteen numbers; but major rewards are scant. In the *Ländler*, Strauss—obviously a little hard up for original ideas—digs into *Rosenkavalier*, cleverly expanding a delicious fragment which passes virtually unnoticed by conductors and audiences amid the melodic wealth of that opera. In the opera we hear it as the orchestral accompaniment to Ochs's line "Nun plauder' Sie" (Act II; page 197 of the Boosey & Hawkes vocal score).

I must confess to a certain, perhaps perverse fondness for this "Very Merry Viennese Ballet," although I would not rise up in righteous defense of its slender values. It is, after all, as insubstantial and lacking in nutritive value as the cream puffs and chocolate sausages with which the scenario is peopled. It is music to listen to while doing the household chores. Erich Kloss makes an eloquent plea for the work. His reading is spirited and well played. The recorded sound is unexceptionable.

—Frankenland State Symphony, Kloss, cond. Lyricord LL 41, Two LP.

Dance Suite after Couperin (1923)

Strauss's attraction to the French baroque did not end with *Der Bürger als Edelmann*. The Dance Suite might be considered as a logical continuation of this interest, which in fact lasted to the end of the composer's life. These arrangements of pieces from the first three

Continued on next page

BUILD THE FINEST Professional Quality CUSTOMIZED TV KIT

On Easy "Pay As You Wire" Terms
Only \$15 for the Starting Package!

The
"PROFESSIONAL"
Series—designed for
the perfectionist seeking
the finest in TV performance.
Easy to assemble. No technical
knowledge required. An ideal
"Learning" Kit with a Complete
Course of Study is available.



Also available:
**WIRED
CHASSIS**
for custom
installations
with a choice
of vertical or horizontal
controls and the newest
19", 23" or 27"
CRT.



Beautiful Cabinets —
designed to enhance sound quality and blend with
modern decor. For TV or combination TV and Hi-Fi.

A few of the Professional Quality Features:

Choice of push-pull 10-watt audio or output to your Hi-Fi system . . . D.C. restoration . . . Ultra-linear sweep circuits . . . Newest Standard Coil Model PKO Automatic Fine Tuner . . . Super-sensitivity for fringe areas . . . Complete line of Accessories for Custom Installations.

Choice of 19", 23" or 27" CRT. Prices range from \$119 to \$199.

U.S. Armed Services and over 4000 schools and colleges have selected Transvision Receivers for educational television.

Interested in Electronics?

Learn the basic principles of electronics from the Course available with the Kit.

ASSEMBLY MANUAL—\$2.00

See how easy it is to assemble the Transvision Kit. Cost of Manual refunded on purchase of Kit.

TRANSVISION New Rochelle, N.Y.
NE 6-6000

START NOW — MAIL THIS COUPON —

TRANSVISION Electronics, Inc., New Rochelle, N.Y. Dept. HIY
 Send FREE 8-page Catalog... I enclose \$2 for Assembly Manual, refundable on purchase of Kit.
 I enclose \$15 for Starting Pkg. on pay-as-you-wire plan. (Complete Kits range from \$119 to \$199.)

Name _____
Address _____
City _____ Zone _____ State _____

CIRCLE 92 ON READER-SERVICE CARD

YOU SAVE MONEY!

RUSH US YOUR LIST OF HI-FI COMPONENTS FOR A SPECIAL QUOTATION

WRITE FOR FREE AUDIO DISCOUNT CATALOG A-15

New low prices on amplifiers, tuners, tape recorders, speakers, etc.

KEY ELECTRONICS CO.
120 LIBERTY ST.
NEW YORK 6, N.Y.

CIRCLE 56 ON READER-SERVICE CARD

EICO new Transistor Stereo/Mono 4-track Tape Deck

Model RP 100W
Completely assembled, wired and tested with 3 heads, and stereo record and stereo playback preamplifiers.

Model RP 100K
Semi-Kit includes transport completely assembled and tested with 3 heads; and control electronics, stereo record, and stereo playback pre-amplifiers in easy-to-assemble kit form.

Write for full specifications

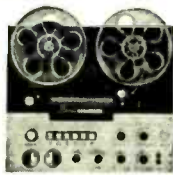

TAPE STORAGE OR CARRYING CASE

reg. 9.95, now 5.95
(Heavy wood construction, waterproof vinyl covering. Holds up to 24 tapes.)
reg. 2.45, now 1.49
(Pressed cardboard, holds 10 tapes or 60 45 rpm records.)



SAXITONE RECORDING TAPE

*Oxide resistant not to rub off or squeak—or money back. Compare ours with other "Bargain" tape. You'll find it's more than just "price" when you deal with us. We are original pioneers in the tape recorder business and our reputation means everything to us.

600' MYLAR (plastic), 5"	.75
600' MYLAR 5" reel	.95
900' MYLAR (Polyester), 5"	.99
1200' MYLAR, 1/2 mil, 5" reel	1.18
1200' Acetate (plastic), 7"	1.19
1300' MYLAR, 1 1/2 mil, (Strong)	1.26
1800' acetate (plastic), 7"	1.79
1800' MYLAR 1 MIL, thick, 7"	1.99
2400' MYLAR, tensitized, 7"	2.99
2400' MYLAR, tensitized, 7"	2.99

Studios, Large Users Even Lower. PLUS POSTAGE



Save 30% on 4-Track STEREO MUSICON TAPE!

Empty 3 in. Plastic Reels 7¢ ea.

BARGAIN PRICES! SEND FOR OUR FREE Tape Recorder/Blank/Pre-recorded Tape Catalog

NORELCO SPEAKER

Famous AD3800M, twin cone 8" (75-19,000 cycles) discontinued model, former list 16.00 usual net 9.90 going at 4.99 plus postage (2 for 9.00). Other Norelco speaker sizes at bargain prices — SEND FOR SPEAKER SPECIFICATION SHEET.



SAXITONE TAPE SALES
(DIV. OF COMMISSIONED ELECTRONICS, INC.)
1776 Columbia Rd., NW, Washington, D.C.

CIRCLE 31 ON READER-SERVICE CARD

STRAUSS ON MICROGROOVE

Continued from preceding page

Livres de Clavecin of François Couperin (*Le Grand*) are tastefully conceived and thoroughly delightful. Strauss has preserved something resembling a baroque sound in his small ensemble of winds, strings, two horns, trumpet, trombone, harp, celesta, glockenspiel, and harpsichord. The late Artur Rodzinski's performance of a slightly abridged version of the suite—he omits Nos. 2 and 7—is so accomplished and vivacious that other conductors might as well not bother to record this piece. This is one of those rare recordings in which everything seems to be right. Orchestral execution is faultless, as is Capitol's reproduction, with no noteworthy differences between mono and stereo.

Kloss gives us the complete suite, but his disc—shortly to be deleted—is a dry performance, indifferently recorded.

—Philharmonia Orchestra, Rodzinski, cond. (with *Tod und Verklärung* and *Salomes Tanz*). Capitol G 7147, LP; SG 7147, SD.

—Frankenland State Symphony, Kloss, cond. Lyrichord LL 58, LP.

Divertimento after Couperin, Op. 86 (1941)

In his second work based on Couperin harpsichord pieces, Strauss is less intent on creating a baroque atmosphere than he was in the *Dance Suite*. The arrangements and orchestration of the *Divertimento* are actually closer to the more full-blown style of Respighi's *Antiche Arie* than to Strauss's earlier evocation of the French court. Withal, the music sounds uncluttered and appealing in its modern dress.

The sole recorded edition is little better than a stopgap. Arthur Rother has a competent orchestra at his disposal, but there are signs of lack of adequate rehearsal. The shaky intonation of solo violin and solo cello passages leads me to believe that this may be an actual performance taping.

—Radio Berlin Symphony, Rother, cond. (with *Tailliefer*). Urania UR 7042, LP; US 57042, SD.

Sonatina in F (1943)

What lovely, gracious music this is! The *Op. 7 Serenade* for winds is the creation of a young man of enormous potential. This *Sonatina* for winds is the total realization of that potential. Strauss's alternating moments of classical elegance, romantic melancholy, and *Till*-like wit display him as an old man who has mastered every facet of his craft while still being capable of summoning up musical inventions of freshness and substance.

Eric Simon leads his crack group of sixteen instrumentalists in a performance of loving expertness and *Gemütlichkeit* which realizes the great worth of this beautiful and neglected child of a master's old age.

—Boston Wind Ensemble, Simon, cond. (with *Serenade* and, on SD only, *Gavotte*). Boston B 406, LP; BST 1016, SD.

Metamorphosen (1945)

The published score of this work, a "study for 23 solo string instruments," contains the following words by the composer: "In Memoriam! Garmisch, 12 April 1945." Strauss does not inform us of the identity of the person or event to which he is referring, nor is the fact very important. The collapse of Germany, visions of the end of life (his own as well as that of the millions who perished during the war then drawing to its conclusion) have been suggested. That the work is intended as a sort of *Lebewohl* cannot be doubted.

Metamorphosen and the so-called *Four Last Songs* are closely related works, both being imbued with autumnally nostalgic, passionate sentiments of the composer nearing the end of his life. His longing is expressed in a chromatic language bearing some relationship to that found in *Tristan* and Schoenberg's *Verklärte Nacht*. Comparisons should, however, be kept to a minimum; this is music which could only have been written by Strauss, and I would not hesitate to place it among his supreme accomplishments. Words will not give the reader any reasonable impression of my reaction toward this work, nor of the music itself. The descriptive function is assumed by Jascha Horenstein and his heavenly band of string players. The variegated colors and haunting melodic permutations to be found in this sublime fantasia are lovingly and expertly set forth by these artists. More complete justice to the music is inconceivable.

—Orchestre National de la Radiodiffusion Française, Horenstein, cond. Angel 35101, LP.



Songs

While Strauss was still engaged in the struggle to evolve a personal language in his early instrumental efforts, he had already produced several songs—*Zueignung*, *Die Nacht*, and *Allerseelen* being the best known—which are the works of a composer of original genius. Strauss's uncanny ability to write sensuously and effortlessly for the voice is as much in evidence in these songs of 1882 as in the *Four Last Songs* of 1948.

It is disheartening to note that two of the most satisfying recitals of Strauss songs produced in the LP era suffered such neglect from the record-buying public that manufacturers were forced to discontinue their production. The glorious Hilde Gueden-Friedrich Gulda disc (London LL 1591), which included fourteen songs, known and unknown, is the most important of these casualties; and that by Anny Felbermayer, Alfred Poell, and pianist Viktor Graef (Vanguard

VRS 431) has also, lamentably, vanished. This is not to say that we are totally without first-rate Strauss recitals today. But most of these are transfers from 78s; and we are left with the impression that contemporary audiences, and perhaps even many singers, have lost their interest in this music.

The most generous sampling of the Strauss Lieder still in the catalogue is contained on the oddly inconsistent Dietrich Fischer-Dieskau recital with Gerald Moore as accompanist. The singer's interpretations vary in quality from a somber, powerful, and surpassingly effective *O wirst du mein* to an irritatingly mannered and uningenuous *Ständchen*. Many of the most familiar songs are included, among them *Morgen* (which is beautifully sung, but stretched to interminable length), *Die Nacht* (in which Fischer-Dieskau gives us a ravishing display of sustained mezza voce), and *Zueignung* (wherein the singer insists on exploding final consonants like so many angry rifle shots).

Erna Berger's recording (with Michael Raucheisen accompanying) of the six songs to texts by Clemens Brentano is an example of Strauss Lieder singing at its most refined. The singer's technical execution is astoundingly graceful, liquidly pure in tone, and dead-center in intonation. The *Lied der Frauen* (No. 4 of the set), a soprano-killer if ever there was one, is projected with a tonal beauty and technical security that I have heard matched only by Elisabeth Schumann, whose recital of a group of generally lighter, more "diverting" songs is available in Angel's "Great Recordings" series. I will not deny that I could easily do without the treacly playing of the Lawrence Collingwood orchestra in the Schumann renditions of *Morgen* and *Ständchen*. Yet the irresistible charm and vocal artistry brought to these songs by the singer override any negative reactions. *All mein Gedanken* is my favorite in this group; but in each of the eight songs Schumann's interpretations deserve to rank among the most captivating on records.

Another distinguished singer of the past, Herbert Janssen, is represented by a recital that includes three songs with orchestral accompaniment: *Caecilie* (originally with piano), *Pilgers Morgenlied*, and *Hymnus*. Of the three, only the first is well known. The other two are, however, just as effective, and deserving of wider exposure. Janssen's ability to sustain a long, *forte* line in these songs is awe-inspiring; and the richness of this beautiful voice, whether singing *piano* or *fortissimo*, could be envied by even the most gifted of present-day baritones. The sound is old and very scratchy, but in the light of Janssen's matchless interpretations, sonic considerations become unimportant.

Several Strauss songs are included in Volumes II, III, and IV of Decca's tribute to the incomparable Heinrich Schlusnus (accompanied by Sebastian Peschko and Otto Braun). Of the seven songs, however, only *Ich liebe dich* and *Nachtgang* display him at anything near his best as singer and interpreter. A very

bland delivery and exasperatingly slow tempos mar the remaining songs.

The *Four Last Songs* for soprano and orchestra are about as touching a finale to a composer's career as has ever been created. These are songs of deeply felt nostalgia and sensuous beauty, with the soprano part rapturously gliding over the shimmering orchestra. Both recorded performances honor the composer's final inspiration, although Lisa Della Casa's almost naive projection of the text and her soaring vocal grace coupled with the gentle, reflective conducting of Karl Böhm is more appealing than Elisabeth Schwarzkopf's opulent, worldly interpretation with Otto Ackermann simply following the singer's lead.

The first four recordings listed below present various selections of songs.

—Fischer-Dieskau; Moore, piano. Angel 35600, LP.

—Janssen; various pianists; unidentified orchestra. Eterna 491, LP.

—Heinrich Schlusnus; Peschko and Braun, piano. In Decca DL 9621/23. Three LP.

—Elisabeth Schumann; various pianists; orchestra, Lawrence Collingwood, cond. Angel COLH 102, LP.

—*Six Brentano Songs, Op. 68*. Erna Berger; Raucheisen, piano. Decca DL 9666, LP.

—*Four Last Songs*. Lisa Della Casa; Vienna Philharmonic, Böhm, cond. (with *Arabella*). London A 4412. Four LP.

—*Four Last Songs*. Elisabeth Schwarzkopf; Philharmonia Orchestra, Ackermann, cond. (with closing scene from *Capriccio*). Angel 35084, LP.

Choral Music

Tailliefer, Op. 52 (1903)

Strauss's setting of Uhland's ballad about the Battle of Hastings is as unabashedly a vulgar, show-off piece as anything written during the past hundred years. The composer piles sonority upon sonority, climax upon climax, until the listeners' eardrums are fit to bust. It is a genuine monstrosity; and I am genuinely fond of it. In *Tailliefer*, one of the most gifted musical technicians of them all exhibits his entire bag of technical tricks without a moment's regard for "good taste" or subtlety. The effect is exhilarating, to say the least. Rother, employing forces which must number considerably fewer than the four hundred which took part in the premiere performance, whips up a heady entertainment. Chorus and orchestra scream, scratch, blow, or bang—as the case may be—to their hearts' content; and no more is required of them. Soloists Maria Cebotari, Walther Ludwig, and Hans Hotter are thrilling in their brief assignments. Urania's sound, although somewhat cramped, is sufficiently clear to enable us to hear nearly all of the raucous goings-on.

—Cebotari; Ludwig; Hotter; Rudolf Lamy Choir; Radio Berlin Symphony, Rother, cond. (with *Divertimento after Couperin*). Urania UR 7042, LP; URS 57042, SD.

Continued on next page

DEWALD



presents:

The Sensational New MULTIPLEX SYSTEM with the Famous DeWald Quality STEREO HI-FIDELITY

- DeWald Tuners and Amplifiers are designed with exceptional skill, precision, and tone quality. DeWald, a leader in the industry for over forty years, produces High-Fidelity products of superior quality at popular prices! Write for information and catalogs today.



"The Overture"
Model R-1103
A.M.-F.M. Monaural & Stereo tuner with built-in multiplex. Audiophile Net—Case incl. **119.95**



"The Scherzo"
Model P-400
F.M. Multiplex adaptor for wide and medium band F.M. tuners equipped with multiplex jacks. Audiophile Net—Case incl. **57.95**



"The Concerto"
Model P-1400
Stereophonic Pre-Amp., equalizer and power amplifier. Performs superbly with the "Scherzo" and "Overture" Multiplex Tuners shown above. Audiophile Net—Case incl. **99.95**

DEWALD



A DIVISION OF
UNITED SCIENTIFIC LABORATORIES, Inc.
35-19 37th Ave., Long Island City 1, N. Y.

EXPORT DEPT.:
25 Warren St.
New York, N. Y.
Cable Address:
SIMONTRICE

In Canada:
L. J. BARDWELL CO.
Box 142—Station D
Toronto 9, Ontario

CIRCLE 34 ON READER-SERVICE CARD

PURCHASING A HI-FI SYSTEM?

TIME PAYMENTS AVAILABLE
Up to 2 years to pay!

Send Us
Your List of
Components
For A
Package
Quotation

**AIREX WON'T
BE UNDERSOLD**

All merchandise
is brand new,
factory fresh &
guaranteed.

FREE Hi-Fi
Catalog Avail-
able on Request

AIREX RADIO

CORPORATION

85-HF Cortland St., N. Y. 7, WO 4-1820

Jim Lansing*
Altec Lansing
Electrovoice
Jensen*Hallicrafter
Hartley* • Gonset
USL Citizen Band
Texas Crystals
Internat'l Crystals
University
Acoustic Research
Janszen • Viking
Wharfedale
Concertone
Bell • G.E.
Weathers
Harman-Kardon
Eico • Pilot
Sherwood*
Tandberg*
ESL • Frazier
Superscope
Dual Changer*
Bogen • RCA
DynaKit • Fisher
H. H. Scott
Thorens*
TEC • Roberts
De Wald • National
Sony • Challenger
Wollensak
Garrard
Miracord
Glasers-Steers
Rek-O-Kut
Polytronics
Norelco • Conrac
Fairchild
Pickering • Sonar
Audio Tape
MagneRecord*
Rockford Cabinets
* Fair Traded

CIRCLE 2 ON READER-SERVICE CARD

SAVE OVER 40% ON HI-FI

USE OUR EASY-PAY-PLAN Up to 24 months to pay

2418/Bell 30 Watt Stereo Amp. \$109.95
RC88/11 Garrard 4/Speed Stereo changer 59.50
108-Audio Empire Diam. Stereo Cart. 35.00
2-Famous make 3-way speakers mounted
in walnut bookshelf cabinets 119.90
All Interconn. Cables & Inst. 4.50

Send for FREE
Quotations on
Your Package or
Single Components

Catalog Price...\$328.85
YOUR COST.... 195.00
You Save
Over 40%.... 133.85

BEFORE YOU BUY HI-FI write for no obligation
quotation on your Hi-Fi requirements. We guar-
antee, "We Will Not Be Undersold." FREE
WHOLESALE CATALOG.

ELECTRONIC WORLD HI-FI RECORDING TAPE

7" Spools Splice Free Freq. Resp. 30-15KC

	3-11	12-23	24-100
12A 1200' Acetate	\$1.29	\$1.17	\$.99
18A 1800' Acetate	1.79	1.59	1.45
18M 1800' Mylar	2.09	1.99	1.85
24M 2400' Mylar	2.69	2.59	2.49

Any assortment permitted for quantity discount.
Add 15c per spool postage. 10c 24 or more.

ALL MDSE. SOLD ON 15-DAY
MONEY-BACK GUARANTEE.

HI-FIDELITY

CENTER

"The House Of Low Low Prices"

220-A East 23rd St., New York 10, N. Y.

CIRCLE 52 ON READER-SERVICE CARD

STRAUSS ON MICROGROOVE

Continued from preceding page

Operas

Salome, Op. 54 (1905)

The new London recording of *Salome*—made in Vienna under the direction of Georg Solti with Birgit Nilsson in the title role—was unfortunately not ready in time to be included in this discography. The album will be reviewed in the next issue of HIGH FIDELITY. Because of its imminent release, comment here on the two older versions of *Salome* would be superfluous.

Elektra, Op. 58 (1908)

My feelings regarding the generally excellent vocal work in DGG's virtually complete recording of this pivotal composition in Strauss's output are precisely the same as those initially expressed by Conrad L. Osborne in the November 1960 HIGH FIDELITY. I would, however, add certain qualifications pertaining to conducting and engineering. I feel that Böhm has gone somewhat too far in subduing some of the work's searing intensity. The underplayed "Recognition Scene" is a case in point. Here Böhm rises to the fevered pitch of the music only with Elektra's outburst on "Orest!"—which here comes not in the form of a release from the suspense created at her brother's entrance but as an isolated explosion. Böhm also often seems to be accompanying the singers, a practice which is hardly well suited to this very "symphonic" orchestra-dominated opera. The orchestra is subdued by the engineers as well. DGG's solution to the "problem" of vocal-orchestral balance has been, I feel, handled with lopsided attention to the singers. I am not asking that the engineers drown out the singers, but rather that they allow the orchestra to assume that prominent position intended for it by the composer. In short-changing the orchestra, DGG has also shortchanged the potential impact of the opera. These complaints do not negate the definite virtues of the set. So much work evidently has gone into this production and so magnificent are the contributions of Borkh and Madeira that I may find my reservations diminishing in importance after a time.

The most successful live performances of *Elektra* I have ever heard were those given several years back by Mitropoulos, the New York Philharmonic, and a cast headed by Borkh, Blanche Thebom, and Giorgio Tozzi. Cetra's Mitropoulos-led recording (also a live performance) is so hopelessly botched by poor microphone placement and, at times, inferior singing and slipshod orchestral execution, that future generations may well wonder at our veneration of the late conductor.

If RCA had given us a complete *Elektra* with the same cast as that heard in its set of fragments, the problem of a "best" version would have been resolved long ago. Borkh is just as effective here as in the DGG; and she is assisted by the dark-voiced, thrillingly dramatic Orestes of Paul Schoeffler. Most im-

portant is the fact that Reiner projects all the massive sonority and hair-raising intensity realized only in part by Böhm. It is frustrating to have less than half of the opera, but I would not part with LM 6047 for the world.

The Decca disc of excerpts is distinguished by excellent characterizations from Goltz and Höngen. These ladies are, nevertheless, vocally too unsteady to be compared favorably to Borkh and Madeira. Frantz brings a good deal of dramatic excitement to his part, while producing some exceedingly harsh sounds. Solti's fiery conducting is counteracted by Decca's cloudy reproduction of the orchestra.

—Inge Borkh (Elektra), Marianne Schech (Chrysothemis), Jean Madeira (Klytemnestra), Fritz Uhl (Aegisthus), Dietrich Fischer-Dieskau (Orestes); Dresden State Opera Chorus and Saxon State Orchestra, Böhm, cond. Deutsche Grammophon LPM 18690/91, Two LP; SLPM 138690/91, Two SD.

—Anny Konetzni (Elektra), Danitz Ilitsch (Chrysothemis), Martha Mödl (Klytemnestra), Franz Klarwein (Aegisthus), Hans Braun (Orestes); Chorus and Orchestra of the Maggio Musicale Fiorentino, Mitropoulos, cond. Cetra LPC 1209, Two LP.

—Excerpts. Borkh (Elektra), Frances Yeend (Chrysothemis), Paul Schoeffler (Orestes); Chicago Symphony, Reiner, cond. (with *Salome* excerpt and *Der Bürger als Edelmann*), RCA Victor LM 6047, Two LP.

—Excerpts. Christel Goltz (Elektra), Elisabeth Höngen (Klytemnestra), Ferdinand Frantz (Orestes); Bavarian State Orchestra, Solti, cond. Decca DL 9723, LP.

Der Rosenkavalier, Op. 59 (1910)

No opera by Strauss stands in need of less comment by latter-day critics than *Rosenkavalier*. London's 1955 recording (chosen by HIGH FIDELITY a year ago for inclusion among the greatest recordings of the decade) may require equally little comment. I am unable to find fresh superlatives with which to describe a performance displaying so much warmth, dedication, and faithfulness to the composer's directions.

Angel's more recent version offers some competition, but it is on the whole a display of individual talents rather than a genuine ensemble effort. The singers under Karajan's slick, often sugary, direction are at least as accomplished vocally as their London counterparts. They are, however, evidently a group which has been assembled for recording purposes rather than a stage-experienced unit. The ability to project unaffected warmth, possessed in such remarkable degree by Erich Kleiber and his cast, eludes Angel's high-powered aggregation. Technical perfection is their goal; and they have achieved it. I would never suggest that a stage performance of this caliber would leave us unimpressed. But on records this kind of perfection is all too common, and pales beside the very human, less perfect realization by the London soloists.

A third complete version, the oldest of

the three, has in Lemnitz a wonderfully sexy, love-smitten Octavian and in Kempe a man who knows his Strauss as well as any living conductor. Böhme is in robust voice; but his constant clowning becomes tiresome before the first act has ended. The remainder of the cast varies from execrable (Bäumler) to so-so (Richter). An inferior Marschallin is sufficient reason for eliminating any *Rosenkavalier* from the competition. Urania's sound is decidedly antiquated.

Angel's famous set of excerpts cannot be considered a substitute for the complete London, although it is a must for supplementary listening. Lehmann, Schumann, Mayr, and the generally underrated Olszewska project the brilliant characterizations of London's cast and an even more astounding technical facility than the modern Angel's performers. Although Robert Heger may not be fully on Kleiber's level, his elegant, mellifluous conducting merits a larger reward than the title of "accompanist" which he is usually given. Angel, as is usual in its "Great Recordings" series, has done a remarkable job of breathing new sonic life into the 78 originals.

A single disc of excerpts from Decca deserves mention only as an example of how inadequate were Lemnitz's vocal powers (at the end of her career) for the role of the Marschallin. Her supporting colleagues are quite dreadful and Leitner somnambulates.

—Maria Reining (Feldmarschallin). Hilde Gueden (Sophie), Sena Jurinac (Octavian), Ludwig Weber (Ochs); Vienna State Opera Chorus; Vienna Philharmonic, Kleiber, cond. London A 4404, Four LP.

—Elisabeth Schwarzkopf (Feldmarschallin), Teresa Stich-Randall (Sophie), Christa Ludwig (Octavian), Otto Edelmann (Ochs); Philharmonia Chorus and Orchestra, Karajan, cond. Angel 3563, Four LP; S 3563, Four SD.

—Margarete Bäumer (Feldmarschallin), Ursula Richter (Sophie), Tiana Lemnitz (Octavian), Kurt Böhme (Ochs); Dresden State Opera Chorus; Saxon State Orchestra, Kempe, cond. Urania UR 201/4, Four LP; URS 5201/4, Four SD.

—"Abridged Version." Lotte Lehmann (Feldmarschallin), Elisabeth Schumann (Sophie), Maria Olszewska (Octavian), Richard Mayr (Ochs); Vienna State Opera Chorus; Vienna Philharmonic, Heger, cond. Angel GRB 4001, Two LP. —Scenes from Acts I and III. Tiana Lemnitz (Feldmarschallin), Elfride Trötschel (Sophie), Georgine von Milinkovic (Octavian); Württemberg State Orchestra, Leitner, cond. Decca DL 9606, LP.

Ariadne auf Naxos, Op. 60 (1916)

The second (and final) version of *Ariadne* is for me the most inventive and moving of Strauss's delicately woven "neo-classical" operas. Angel's recording, released some six years ago, introduced most of us to this bewitching work, and it remains unsurpassed, although no longer unrivaled, as a perfect re-creation of Strauss's score.

Comparison of the Angel version with the more recent RCA leads to an appreciation of the dedicated artistry which

has gone into both. The combination of Schwarzkopf and Rysanek and of Jurinac and Seefried is, each in its own way, so effective that a choice of either version would be difficult to make on the basis of these contributions. Choice can likewise not be predicated on either recording's casting of the secondary singing roles; all are handled with consummate skill in both. I do prefer the icy imperiousness of Angel's Neugebauer to the peevishness of Preger in the delightful speaking role of the Majordomo, though.

From this point on, the balance begins to swing decidedly in Angel's favor. The latter is clearly ahead in the Bacchus department, with Schock projecting a vitality and youthfulness unmatched by the more precise but oldish-sounding Peerce. Peters delivers Zerbinetta's excruciatingly taxing music with great technical facility. Streich is even more effortlessly agile, and her characterization reveals a sly humor and coquettish charm which to some extent eludes Peters. It is Karajan's conducting, however, which accounts for the greatest share of Angel's superiority. He permits the music to unfold at its leisure, thereby enabling each delicate orchestral strand (only thirty-five players are called for) to emerge for our examination and delectation. Without being a slave to his singers, Karajan does not make life more difficult for them via fast tempos and occasionally clipped phrases, two aspects of Leinsdorf's otherwise persuasive leadership which I find rather unappealing. Greater relaxation on this conductor's part and more frequent evidence of consultation with his singers in matters of tempo and phrasing would have contributed to the opera's atmosphere of fantasy and languid grace which is so successfully realized by Karajan.

Stereo matters little in this dramatically static opera. Angel's mono is still effective, although RCA's stereo is better able to reproduce the ethereal orchestral effects in the final Bacchus-Ariadne scene. Withal, it is the performance that counts; and in this respect Angel is still Number One. If you own both versions, consider yourself that much more fortunate.

—Elisabeth Schwarzkopf (Ariadne). Irgard Seefried (The Composer), Rita Streich (Zerbinetta), Rudolf Schock (Bacchus), Hermann Prey (Arlecchino), Karl Dönch (The Music Master), Alfred Neugebauer (Majordomo); Philharmonia Orchestra, Karajan, cond. Angel 3532, Three LP.

—Leonie Rysanek (Ariadne), Sena Jurinac (The Composer), Roberta Peters (Zerbinetta), Jan Peerce (Bacchus), Walter Berry (The Music Master & Arlecchino), Kurt Preger (Majordomo); Vienna Philharmonic, Leinsdorf, cond. RCA Victor LD 6152, Three LP; LDS 6152, Three SD.

Die Frau ohne Schatten, Op. 65 (1917)

This opera was, in the words of the composer, "a child of sorrow . . . completed in the midst of trouble and worries dur-

Continued on next page

HERE'S **PROOF** YOU ALWAYS GET Rock-Bottom Prices AT **RABSONS**

- Unless you're a millionaire with money to burn get our quote, like these shrewd buyers did!
- These excerpts from letters in our files are **proof positive** that **RABSONS' PRICES ARE ROCK BOTTOM!** Your purchase backed by our reputation for 56 years of **RELIABILITY!** PLUS our six (6) months guarantee, instead of the usual 90 days. **STANDARD LINES.** (Originals of these letters available for inspection by any prospective customer, Better Business Bureau or Governmental Agency.)
- **From "B.M." North Carolina—**
- "I was pleased with your quotation on my proposed Hi-Fi set, as it was \$30.00 less than the next lowest bid of over ten."
- **From "W.W.B." California—**
- "Your package quote was the best I've received."
- **From "J.K.B." New York State—**
- "I am pleased to inform you that yours was the lowest of six quotations."
- **From "G.E.M." Ohio—**
- "Your quotation was prompt and I was influenced by the six months warranty offer."
- **YOU TOO WILL SAVE PLENTY — WRITE NOW FOR OUR ROCK-BOTTOM QUOTE!**
- **FREE** — With our quote on the equipment or system of your choice we will include a \$1 genuine Miracle Record Cleaning Cloth.

Rabsons-57 ST., Inc. Dept. R
119 West 57 St., New York 19, N. Y.

••••• (Diagonally opposite Carnegie Hall)
CIRCLE 70 ON READER-SERVICE CARD

TOP ALLOWANCE FOR YOUR USED COMPONENTS AT **audio exchange**

WHEN YOU PURCHASE The Fisher FM-100-B FM—Multiplex Wide-Band Tuner with Exclusive Stereo Beacon

Features 0.6 microvolt sensitivity, Micro Ray Tuning Indicator, Automatic switching between mono and stereo, MPX noise filter.



TRADE 4 WAYS

- TRADE Hi-fi for hi-fi
- TRADE Amateur radio* for hi-fi
- TRADE Hi-fi for amateur radio
- TRADE Amateur radio* for amateur radio*

*Includes HAM; SWL; Citizen's Band; Test Equipment

AUDIO EXCHANGE EXCLUSIVES:
Trade-Back Plan • New Equipment from over 100 manufacturers • Used Equipment sold on 10-day unconditional money-back guarantee . . . plus 90-day service warranty • Special GE credit plan • Custom installation for stereo and monaural equipment. • Hi Fi service laboratory.

Get more! Pay less when you trade at

audio exchange

For Trading info, write dept. HM
PLEASE MAIL ALL ORDERS AND INQUIRIES TO JAMAICA
153-21 Hillside Ave., Jamaica 32, N. Y. • Axtel 7-7577
WHITE PLAINS, N. Y. BROOKLYN, N. Y. MANHASSET, N. Y.
203 Mamaroneck Ave. 1065 Flatbush Ave. 451 Plandome Rd.

CIRCLE 16 ON READER-SERVICE CARD

STRAUSS ON MICROGROOVE

Continued from preceding page

ing the war." Its style is closer to that of *Elektra* than that of *Ariadne*. I am unable to muster much enthusiasm for *Die Frau* (among other things, the Hofmannsthal libretto is among the most confused, confusing, and verbally bombastic I have ever encountered), but I must confess to having been impressed by its sheer physical enormity as a stage piece when I attended the 1955 Vienna performances on which the London recording is based. The music has its rewards, particularly in several scenes devoted to Barak and his wife; and the orchestration recaptures, to a degree, some of Strauss's earlier Wagner-inspired lushness.

London has presented the opera, virtually uncut, with its usual conscientiousness. Outstanding, indeed overwhelming—vocally and dramatically—in the huge cast are Schoeffler and Rysanek. Goltz gives a penetrating characterization in the central role of the Dyer's Wife, although she and the equally comprehending Höngen often approximate their notes. Böhm conducts his resplendent orchestra with strength and conviction.

London's sound is good, without achieving the full measure of clarity demanded by Strauss's orchestration.

I would like to add, in conclusion, that *Die Frau* stands little chance of achieving the kind of popular success envisioned for it by Strauss and Hofmannsthal. Both men attempted here to exceed the limits of opera's ability to examine profound philosophical and moral truths; and since the music fails to sustain a consistently inspired level, we remain conscious of the failure on the purely verbal level.—Leonie Rysanek (Empress), Elisabeth Höngen (Nurse), Christel Goltz (Dyer's Wife), Hans Hopf (Emperor), Paul Schoeffler (Barak), Kurt Böhme (Spirit Messenger); Vienna Philharmonic, Böhm, cond. London A 4505, Five LP.

Arabella, Op. 79 (1932)

Although *Arabella* has been given adequate exposure on American stages, audiences have been slow to respond to its charms. The critical cliché about Strauss always imitating his *Rosenkavalier* has been applied with frequency to this opera. Strauss and Hofmannsthal never denied that they were attempting to revive some of the atmosphere of their earlier masterpiece. The similarities are, however, superficial. *Arabella* is an original creation, and a very beautiful one; it may one day be fully appreciated.

In his discussion of the complete recording, HIGH FIDELITY's reviewer David Johnson referred to the opera's "many *longueurs*" between "the great moments." I can discover no *longueurs* whatever; to me every moment of *Arabella* is to be relished. As for this performance, whatever shortcomings may be evident in George London's singing, he presents a superb realization of Mandryka's pride, impetuosity, and burly forthrightness. An alarming wobble does intrude several times, but one must never lose sight of the enormous technical problems created by the role. London's singing is unquestionably of a high order; no Mandryka could sound completely at ease.

Della Casa and Gueden have been so widely acclaimed for their angelically sung and captivatingly acted *Arabella* and Zdenka that any further superlatives would merely amount to tiresome repetition. The supporting cast, led by Edelmänn and Dermota, could not be improved upon.

Solti can be accused of an occasionally rushed tempo, e.g., the sudden and excessive speed-up in Mandryka's first monologue ("Bedenken: dieser Brief kommt an") and the hectic concluding measures of Act I. Yet even when he is attempting to break some imaginary speed record, Solti manages to expose every lovely melodic detail, and the singers are more than sufficiently equipped to keep up with his pace. In the reflective portions, particularly that scene of "heavenly length" between *Arabella* and Mandryka in Act II ("Ich habe eine Frau geliebt"), Solti's conducting is all leisure and melting tenderness.

I detected some severe tape hiss in two stereo copies sampled; the mono version is flawless and includes the estimable bonus of Della Casa's *Four Last Songs*.

—Lisa Della Casa (*Arabella*), Hilde Gueden (*Zdenka*), Ira Malaniuk (*Ade-laide*), Anton Dermota (*Matteo*), Waldemar Kmentt (*Elemer*), George London (*Mandryka*), Otto Edelmann (*Waldner*); Vienna Philharmonic, Solti, cond. (with,

in LP only, *Four Last Songs*). London A 4412. Four LP; OSA 1404, SD.

Capriccio, Op. 85 (1941)

After several years of attempting to persuade myself that *Capriccio* is a quintessential masterpiece of Strauss's last years, I have decided to give up. I find Strauss's last opera a bit of a bore. The famous final scene, particularly as sung by Schwarzkopf (in the complete version as well as on the single disc), is certainly among the composer's most beautiful inspirations; and there are minor delights strewn about in other corners of the opera. But there is too little musical substance—and I say this as an ardent Straussian. The total impression that I gain from the whole is one of a rather dreary preciousness.

The "profound aesthetic conversation" which is at the heart of Clemens Krauss's shabby libretto seems to me as obvious as, say, the plot of *La Bohème*, although *Capriccio* unquestionably treats a theme which could hardly be considered standard operatic fare. "Which is of greater importance in opera, words or music?" is the central problem posed in the libretto. The question is adequately, and justly, answered in the dramatic situations of *Capriccio* itself. Strauss and Krauss opt for the music, as all of us would. It is childishly obvious that if we were to consider words of primal importance in this form, we would have precious few operas to like.

Angel's recording is a powerful inducement to familiarizing oneself with the opera. Schwarzkopf and Hotter are outstanding in the generally excellent performance.

—Elisabeth Schwarzkopf (Countess), Christa Ludwig (Clairon), Nicolai Gedda (Flamand), Dietrich Fischer-Dieskau (Olivier), Eberhard Wächter (Count), Hans Hotter (La Roche); Philharmonia Orchestra, Sawallisch, cond. Angel 3580, Three LP.

—Final scene only. Schwarzkopf; Philharmonia Orchestra. Ackermann, cond. (with *Four Last Songs*). Angel 35084, LP.

ARIZONA

WESTERN HI FI FANS
ARE YOU INTERESTED IN PRICES?
WRITE FOR QUOTATION
AUTHORIZED DISTRIBUTORS
SCOTT-JENSEN and OTHERS MAJOR LINES
Hi-Fi Sales Company
735 West Main Street
Phone 969-3191 Mesa, Arizona

CIRCLE 99 ON READER-SERVICE CARD

CALIFORNIA



QUICK-SEE ALBUM FILE

Eliminates bottom jacket wear. Rolls forward for front-view, flip-through selection. 9 models fit any cabinet, closet or shelf. \$7.95 up. Also available with cabinet shown. Dealers, inquire.

KERSTING MANUFACTURING COMPANY
504 S. Date Street, Alhambra, California

CIRCLE 55 ON READER-SERVICE CARD

DISTRICT OF COLUMBIA

Save 30%, 4-Track Stereo Music on Tape
Empty 3" Plastic Reels, 7c ea.
Bargain Prices! Send for our Recorder / blank / pre-recorded tape catalog. H-1



NORELCO SPEAKER
Famous AD3800M, twin cone 8" (75-19,000 cycles) discontinued model, former list 16.00, usual net 9.90 going at 4.99 plus postage (2 for 9.00). Other Norelco speaker sizes at bargain prices—SEND FOR SPEAKER SPECIFICATION SHEET.

SAXITONE TAPE SALES
(Div. of Commissioned Electronics, Inc.)

1776 Columbia Rd., Wash., D. C.

CIRCLE 31 ON READER-SERVICE CARD

RENT stereo tapes

- Over 2000 different albums All Labels
- 2-track and 4-track
- No deposit on tapes rented
- Postpaid to and from your home

FREE BROCHURE

stereo-parti



811-A CENTINELA AVE., INGLEWOOD, CALIF.

CIRCLE 85 ON READER-SERVICE CARD

IN WASHINGTON, D. C.
Nearly Everyone Buys At...
Myer's EMCO
MAIN STORE:
509 11TH ST., N.W., WASH., D. C.

CIRCLE 66 ON READER-SERVICE CARD

ILLINOIS

record index

recocards

Designed for collections of 150 up. Send for brochure, sample record index cards, sample index guides by composer.

Recocards

(H 2) 503 Hyde Park Bank Building
1525 East 53rd St., Chicago 15, Illinois

CIRCLE 71 ON READER-SERVICE CARD

MARYLAND

DIXIE

HIGH FIDELITY WHOLESALERS

Largest discount High Fidelity component distributors in the South. Wholesale prices on package or individual components. Latest models in factory sealed cartons.

Are prices too high?—Write:

DIXIE HI-FI

12402 Connecticut Ave., Silver Spring, Md.

CIRCLE 36 ON READER-SERVICE CARD

NEW JERSEY

WRITE FOR QUOTATION ON HI-FI COMPONENTS SOUND REPRODUCTION, INC.

34 New Street, Newark 2, N. J.
Mitchell 2-6816

CIRCLE 83 ON READER-SERVICE CARD

NEW YORK

FOR THE TOPS IN VALUE AND THE BEST TRADE-IN ON HIGH FIDELITY EQUIPMENT

Check with Arrow!

ARROW ELECTRONICS, INC.

65 Cortlandt St., New York 7, N. Y.
Dlgbly 9-4730
525 Jericho Turnpike, Mineola, N. Y.
Pioneer 6-8686

CIRCLE 11 ON READER-SERVICE CARD

AUDIO unlimited

Specializes in SAVING YOU MONEY

- ✓ FACTORY FRESH COMPONENTS
- ✓ LOWEST POSSIBLE QUOTATIONS
- ✓ FAST DELIVERY

We are FRANCHISED DEALERS for most Hi-Fi lines. Most orders SHIPPED PROMPTLY from stock. RECORDING TAPE at LOWEST PRICES. FREE—95-PAGE STEREO CATALOG.

190-F Lex. Ave., Cor. 32
St., New York 16, N. Y.

Visit Our Showroom

CIRCLE 19 ON READER-SERVICE CARD

OUT OF SPACE?



You bet we'd be....
If we were to tell you
All about AUDION'S
"Out of this World"
Hi Fi Values.

Write for free catalog.

audion

25-HF Oxford Road
Massapequa, New York

CIRCLE 20 ON READER-SERVICE CARD

NEW YORK

PROMPT DELIVERIES

LOWER PRICES

AMPLIFIERS, TAPE
RECORDERS, TUNERS, ETC.
NO CATALOG. INDIVIDUAL QUOTES. COMPARE
L. M. BROWN SALES CORP.

Dept. F-239, East 24 St., New York 10, N. Y.

CIRCLE 23 ON READER-SERVICE CARD

MAIL ORDER HI-FI

Recorders Components Tapes

at wholesale prices

Reliable, Prompt Delivery

(Free Catalogue)

We'll Air-Mail

low quotes on your packaged hi-fi

CARSTON

125-D, E. 88 St. New York 28, N. Y.

CIRCLE 27 ON READER-SERVICE CARD

RECORDS AT COST...

Through Our Special Membership Plan
Regular High Fidelity and Stereo

Classical—Popular—Jazz—Show Hits—Folk etc.

A unique kind of record club — no "agree to purchase" obligations — no "selected" record list to choose from — no "list price" purchases — no "division" requirements.

Simply, Citadel club members can purchase virtually any record or album, by any artist, on any label for cost price. Yearly membership \$3.00. Write for free details...

CITADEL RECORD CLUB

545 Fifth Ave. Dept. H. New York 17, N. Y.

CIRCLE 28 ON READER-SERVICE CARD

TAPE RECORDERS



HI-FI
Components
SLEEP LEARN
KITS
Unusual
Values
FREE
1962 Catalog

DRESSNER 1523 FA Jericho Turnpike,
New Hyde Park, New York

CIRCLE 37 ON READER-SERVICE CARD

STEREO TAPES AT FANTASTIC SAVINGS

From one of America's largest libraries. If it was professionally recorded on tape we have it or can get it for you • HI-FI COMPONENTS • KITS • TAPE RECORDERS—all standard brands—at guaranteed "We will not be undersold" prices. Quotations by return mail. EASY-PAY-PLAN — 10% DOWN—up to 24 months to pay.

Write for free catalogs.

HI-FIDELITY CENTER

220-HP East 23rd St., N. Y. 10, N. Y.

CIRCLE 52 ON READER-SERVICE CARD

HI-FI RECORDING TAPE 7" REELS

1200'	—1.5	mil Plastic	\$1.09
1200'	—1.5	mil Mylar	1.49
1800'	—1	mil Plastic	1.75
1800'	—1	mil Mylar	1.95
2400'	— .5	mil Mylar	2.49

Write for FREE quotations and catalogs for your Best Buy in Hi-Fi and Stereo Equipment.

Serving all your needs in electronics

LION ELECTRONICS

215 Fulton St., New York 7, N. Y.
Rector 2-6714, Dept. LE

CIRCLE 60 ON READER-SERVICE CARD

NEW YORK

NATIONWIDE DELIVERY...

on all your Stereo needs. Recorders, Tuners, Amplifiers, Turntables, etc.

LET US PROVE that we can supply your requirements PROMPTLY AT LOWEST COST. FREE CATALOG.

STEREO COMPONENT Supply Co., Dept. F
148-25 — 12th AVE., FLUSHING 57, N. Y.

CIRCLE 84 ON READER-SERVICE CARD

FINEST RECORDING TAPE AVAILABLE

buy ONE at \$1.29

SATISFACTION GUARANTEED

SPLICE FREE • SILICONE LUBRICATED
ENGINEERED TO THE HIGHEST FIDELITY

7" SPOOLS FOR POSTAGE ADD
1200' ACETATE \$1.29 1 SPOOL 30'
1800' ACETATE 1.79 2 SPOOLS 40'
1800' MYLAR 2.09 3 OR MORE 15' ea.

SUPERIOR MAGNETIC TAPE CO.
BOX 779 BROOKLYN 1, N. Y.

CIRCLE 87 ON READER-SERVICE CARD

TRADE-INS ACCEPTED

SAVE MONEY

on
High Fidelity Equipment

Check our prices first on all Hi-Fi and Stereo Equipment. New, fully guaranteed. Prompt service on all inquiries. Write to Arthur Knight

TERMINAL-HUDSON ELECTRONICS, Inc.
236 West 17th St., N. Y. 11, N. Y. Dept HF

CIRCLE 90 ON READER-SERVICE CARD

PENNSYLVANIA

"FRED MILES PRESENTS"

Records For Jazz Fans



CIRCLE 65 ON READER-SERVICE CARD

WASHINGTON

LEARN WHILE YOU SLEEP

Experiment in this fascinating, educational new field. Use your phonograph, recorder or amazing new "Electronic Educator" endless tape recorder. We carry a full line of endless tapes for standard recorders, plus timers, pillow speakers and complete outfits. Also 200 unusual educational and self-help courses on tape and record for sleep-learning and self-hypnosis experimenters. Write for free 300-item catalog and full details.

Sleep-Learning Research Association
P. O. Box 24-F, Olympia, Washington

CIRCLE 81 ON READER-SERVICE CARD

ENGLAND

TOPS IN HI-FI!

BRITISH EQUIPMENT from the United Kingdom Hi-Fi Mail Order Specialists. Send us details of your needs!

- AMPLIFIERS
- MOTORS
- TUNERS
- SPEAKERS
- PICK-UPS

All goods carefully packed, insured and shipped promptly at minimum cost. (Dept. H)
C. C. GOODWIN (Sales) LTD.
7, The Broadway, Wood Green
London, N. 22, England

CIRCLE 47 ON READER-SERVICE CARD

ADVERTISING INDEX

THE NEW LAFAYETTE



LT-200 UNIVERSAL MULTIPLEX ADAPTER

achieves the finest stereo performance from your tuner.

54⁵⁰

NO MONEY DOWN
Made In U.S.A.

- 35 db Stereo Separation (at 400 cps)
- Matches With Virtually All Recent Model Wide-Band Tuners Equipped With MPX Output Jacks
- Less Than 1% Harmonic Distortion From 50 to 15,000 CPS
- Hum Level Better Than 60 db At 60 cps For 1 Volt Signal Input
- Self Powered
- As Easy To Connect As Were Your Original Components
- Features Include: Notch Filter For 38KC; Low Impedance Plate Follower Output; Matched Diodes For Optimum Separation
- Complete With Enclosure & All Necessary Connecting Cables



Keep Your Components Operating AT Peak Performance with the **LAFAYETTE**

TE-15 TUBE TESTER

19.95

COMPLETELY WIRED — NOT A KIT

- Accurately Checks Over 1000 Different Tubes
- Tests for Cathode Emission, Leakage and Shorts plus Filament Continuity
- Completely Portable—Weighs Only 6 lbs. and Measures 9³/₄Wx8¹/₂Dx2³/₄H

NEW! FREE 340-page 1962 Catalog 620

LAFAYETTE RADIO ELECTRONICS
Dept. WC2-2, P.O. Box 10,
Syosset, L.I., N.Y.

LT-200 Multiplex Adapter TE-15 Tube Tester

\$ enclosed

NAME

ADDRESS

CITY ZONE STATE

CIRCLE 57 ON READER-SERVICE CARD

Key No.	Page	Key No.	Page
1	Acoustic Research, Inc.	42	
2	Airex Radio Corp.	120	
3	Allied Radio	35-37	
4	Altec Lansing	43	
5	American Concertone	87	
7	Angel Record Club	5	
6	Angel Records	73	
8	Archive Production	22	
9	Argo Records	101	
11	Arrow Electronics	123	
13	Aspen Music	116	
14	Audax	33	
15	Audio Devices	102	
10	Audio Dynamics	20, 21	
16	Audio Exchange	121	
17	Audio Fidelity	68	
18	Audio Originals	97	
19	Audio Unlimited	123	
20	Audion	123	
21	Benjamin Electronic Sound Corp.	112	
22	British Industries Corp.	44	
100	British Industries Corp.	76, 77	
23	Brown, L. M., Sales Corp.	123	
24	Cabinart Acoustical Dev. Corp.	109	
25	Cambridge Records	100	
26	Capitol Records	83, 105	
27	Carston	123	
28	Citadel Record Club	123	
29	Columbia Records	66	
30	Command Records	1	
31	Commissioned Electronics	118, 122	
32	Concord Electronics	104	
33	Deutsche Grammophon Gesellschaft	32	
34	DeWald Radio	119	
35	Dexter Chemical	100	
36	Dixie Hi-Fi	123	
37	Dressner	123	
38	Dual	12	
39	Dynaco, Inc.	86	
40	Dynaco, Inc.	111	
41	EICO	106	
42	Electro-Sonic Labs., Inc.	80	
43	Electro-Voice, Inc.	24, 25	
44	EMPIRE	40, 41	
45	Fairchild Recording Equip.	108	
46	Fisher Radio Corp.	6, 7, 9, 11	
22	Garrard Sales	44	
47	Goodwin, C. C.	123	
48	Grado Labs., Inc.	38	
49	Granco	96	
50	Harman-Kardon, Inc.	13, 15	
51	Heath Co.	30, 31	
52	Hi-Fidelity Center	120, 123	
99	Hi-Fi Sales	122	
53	KLH Research & Development Corp.	93	
54	Kapp Records	75	
55	Kersting Mfg. Co.	122	
56	Key Electronics	118	
57	Lafayette Radio	4, 124	
58	Lectronics of City Line Center, Inc.	96	
59	Library of Recorded Masterpieces	88	
60	Lion Electronics	123	
61	London Records	81	
62	Magnecord	8	
63	Marantz Co.	90	
64	McIntosh Laboratory, Inc.	85	
65	Miles, Fred	123	
66	Myer's Emco	122	
67	PACO	28	
12	Parliament Records	88	
68	Pickering & Co.	2	
69	Pilot Radio		
	Inside Front Cover		
	Professional Directory	122, 123	
70	Rabson's—57th, Inc.	121	
71	Recorcards	123	
72	Record Hunter	89	
73	Reeves Soundcraft	27	
74	Rek-O-Kut	23, 29	
75	Roberts Electronics	39	
76	Rockford Furniture Co.	14	
31	Saxitone	118, 122	
77	Scope Electronics	34	
78	Scott, H. H., Inc.	17-19	
79	Sherwood Electronics	Back Cover	
80	Shure Bros.	94	
81	Sleep Learning Research Association	123	
82	Sony Corporation	10	
83	Sound Reproduction	123	
84	Stereo Component Supply Co.	123	
85	Stereo-Parti	122	
87	Superior Magnetic Tape	123	
86	Superscope	95	
88	Tandberg	82	
89	Tannoy (America) Ltd.	110	
90	Terminal-Hudson	123	
91	Thorens	26	
	Trader's Marketplace	114	
92	Transvision	117	
93	United Artists	97	
38	United Audio	12	
94	University Loudspeakers, Inc.	Inside Back Cover	
95	Vanguard Recording	89	
96	Viking of Minneapolis	113	
97	Warner Bros.	98	
98	Westminster	79	
100	Wharfedale	76, 77	



HOW TO BUY YOUR FIRST (OR YOUR LAST) SPEAKER SYSTEM

If you demand magnificent sound . . . undistorted bass to beyond the limits of audibility—if you demand superb cabinetry and decor flexibility (with five interchangeable grille frames that snap on and off to match *any* decor) . . . then consider the unique University Medallion XII 12" Three-Way Speaker System. Medallion owners *stay* Medallion owners. Let's look inside the Medallion and see why.



Integrated within its precisely-matched cabinet are three superlative speaker components: the 12" high compliance woofer that delivers bass frequencies down to the very threshold of feeling; a newly-engineered 8" speaker to assure you of all-important mid-range *impact*; and the Sphericon super tweeter for highs unlimited. Result: virtually uniform response

compare
UNIVERSITY
 (in every price category)
 against all other brands

—smooth and rich—from 28 to 40,000 cps (± 2 db at 22,000 cps). And at your fingertips, network controls to balance the Medallion sound to match the acoustics of your room—*any* room.

Amplifier requirements? Any amplifier capable of delivering a modest ten clean watts. Medallion dimensions? Only 24" x 17" x 11 $\frac{1}{4}$ " deep. Available with or without base—for use as highboy or low-boy. Finishes? Walnut, oiled walnut,

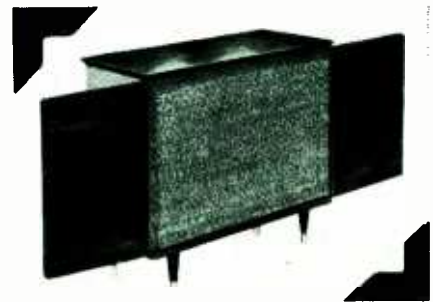

For a solution to a *really* difficult space problem, investigate the TMS-2 single cabinet stereo speaker system.

fruitwood, mahogany *and* unfinished for custom installations. And the Medallion is the world's *only* system with "select-a-style" snap-on grilles. Want to change your decor at some later date? The Medallion stays where it is—all you change is the grille! In Contemporary, Italian or French Provincial, Colonial and Swedish Modern. Medallion prices start at \$139.95, without grille. Grilles from \$9.95. Base, \$14.95.

Write for University's "Informal Guide to Component High Fidelity," Desk P-3, University Loudspeakers, Inc., White Plains, New York.

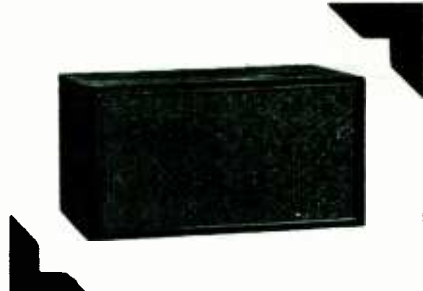

For bookshelf speaker systems with astounding 'big system' sound, look into University's RRL speaker systems.



A Division of Ling-Temco-Vought, Inc.
 TIMELESS BEAUTY AND THE SOUND OF TRUTH

SHERWOOD

only for those who want the ultimate in

FM STEREO BROADCAST RECEPTION AND STEREO RECORD REPRODUCTION



S-8000 FM/MX 64 Watt Stereo Receiver \$299.50
16 1/4" x 4" x 14" deep



S-3000 FM/MX Stereo Tuner \$160.00
14" x 4" x 10 1/4" deep



S-5000 II 80 Watt Stereo Amplifier \$199.50
14" x 4" x 12 1/2" deep



Ravinia Model S-33 3-way Speaker System \$139.50
26" x 15" x 13 1/4" deep

Correlaire Walnut Hi Fi Furniture



With FM Stereo broadcasting (multiplex) an established reality, Sherwood proudly offers the S-8000 Receiver—a brilliant combination of Sherwood's "high-rated" FM tuner design, two 32-watt amplifiers, two phono/tape pre-amplifiers, and all circuitry necessary to receive the new FM stereocasts.

The S-3000 FM Stereo Tuner features the identical tuner design found in the S-8000 including built-in circuitry for stereocast reception ... or your present FM tuner can be easily converted for stereocast reception with Sherwood FM Multiplex Adapters (\$49.50 and \$69.50).

The S-5000 II Amplifier provides the ultimate in stereo amplification. Also available—the excellent S-5500 II Amplifier, with 64 watts music power at \$164.50.

Sherwood's newest contribution—the exciting Ravinia Model S-33 3-speaker system consisting of 12" high-compliance woofer, 8" mid-range, and 2 1/2" ring-radiator tweeter. The Ravinia features extremely low intermodulation distortion and unusualy flat frequency response ($\pm 2\frac{1}{2}$ db) to 17 KC. Cabinet is hand-rubbed Walnut.

The perfect setting for hi fi components is Sherwood's Correlaire contemporary furniture modules—in hand-rubbed Walnut and Pecan. Sherwood Electronic Laboratories, Inc., 4300 N. California Ave., Chicago 18, Illinois.

For complete technical details, write Dept. H-3

