

HIGH FIDELITY®

JULY 1973 75¢
08398

Bernstein's Carmen Sondheim's A Little Night Music



Thorens TD-125 Mk. II
turntable



Shure V-15 Type III phono pickup



Yamaha TB-700
cassette deck

10 Lab Test Reports



Sherwood S-8900A receiver



Dynaco A-10
loudspeaker

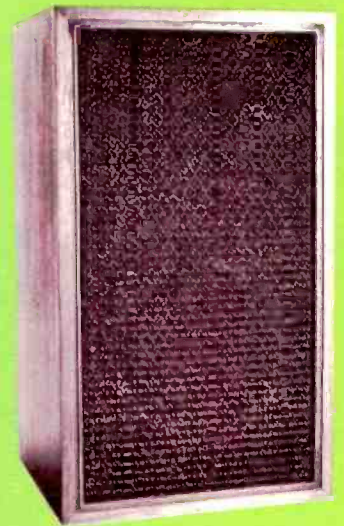

Audioanalyst A-100 loudspeaker



Pioneer SA-9100 integrated amp



Scotch ER
cassette



TDK Krom-O₂
cassette



Rebins R-47002 "enhancer"

Mimir owitz ears of rdings

HEDBUCHHAZGREDZT G FEB 74
MR DAVID BUCHANAN
HAZEL GREEN ACADEMY
HAZEL GREEN KY 41332



Sony STC-7000 tuner/preamp

2



4



PHONES ONLY

MAIN

REMOTE

MAIN
RE

MAIN

REMOTE

MAIN +
REMOTE

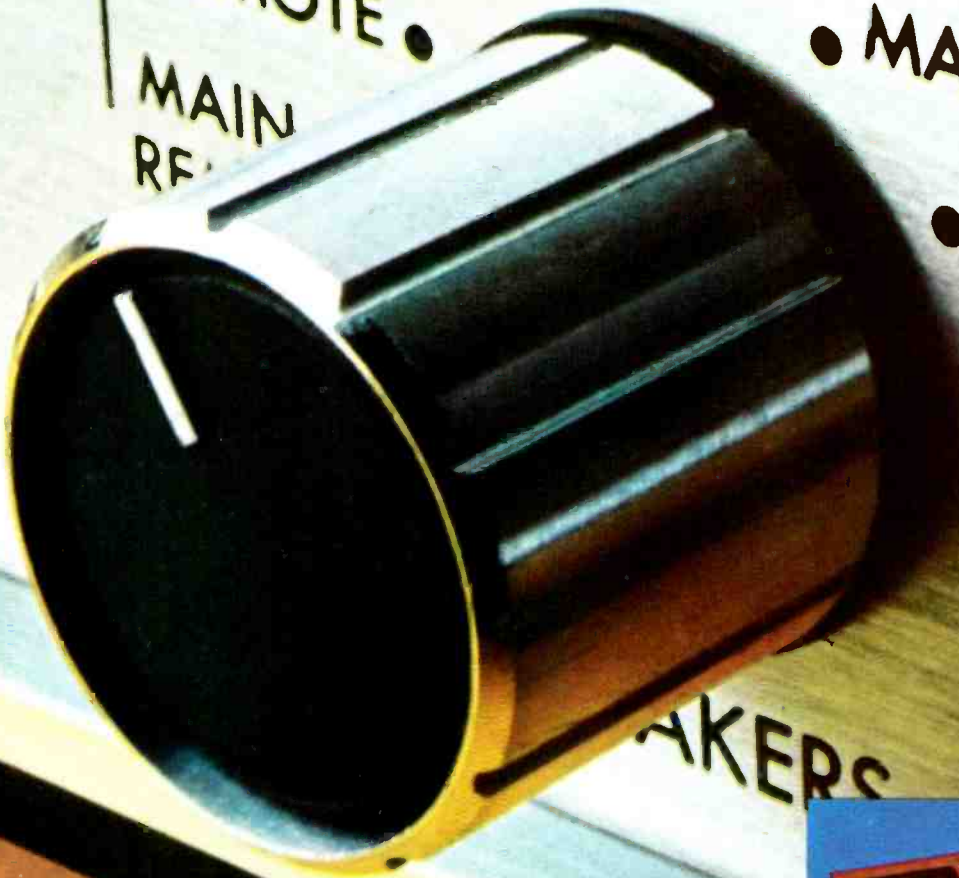

MAKERS



NO MORE UNEMPLOYED WATTS.

Until now, 4-channel receivers could deliver their full power only into four speakers.

Playing regular stereo through two speakers meant leaving two channels idle. Half of those expensive watts were unemployed.

Fisher has changed all that with the new Studio-Standard 4-channel receivers. Each has a 2/4-channel front-panel switch, like the one shown here.

In the "2" position, the four amplifiers are "strapped" together in pairs to drive two speakers with their *combined* power. No unemployed watts! In the "4" position, the four amplifiers are separated for 4-channel operation with four speakers.

The Fisher 504, at \$599.95*, is the most advanced of the Studio-Standard receivers. (See specifications.) Two others are available for considerably less, with minimal changes in features and performance.

Write us for detailed literature. The "strapping" feature is just the beginning of the Studio-Standard story.

Fisher Radio, Dept. HF-7, 11-40 45th Road, Long Island City, N.Y. 11101.

Fisher 504 Studio-Standard 4-Channel Receiver

Continuous sine-wave power, 20 Hz to 20 kHz (not just IHF music power!)	40/40/40/40 watts at 4 ohms 32/32/32/32 watts at 8 ohms
4-channel matrix decoder	SQ
FM sensitivity (IHF standard)	1.8 μ V
Capture ratio (IHF at 1 mV)	1.2 dB
FM front end	Dual-gate MOSFET with AGC
FM input	Up to 3,000,000 μ V (3 V)
MPX decoder	PLL (phase-locked loop)

*Fair trade prices where applicable.
Prices slightly higher in the Far West and Southwest.

FISHER
Studio-Standard

The right Pickering cartridge for your equipment is the best cartridge money can buy.

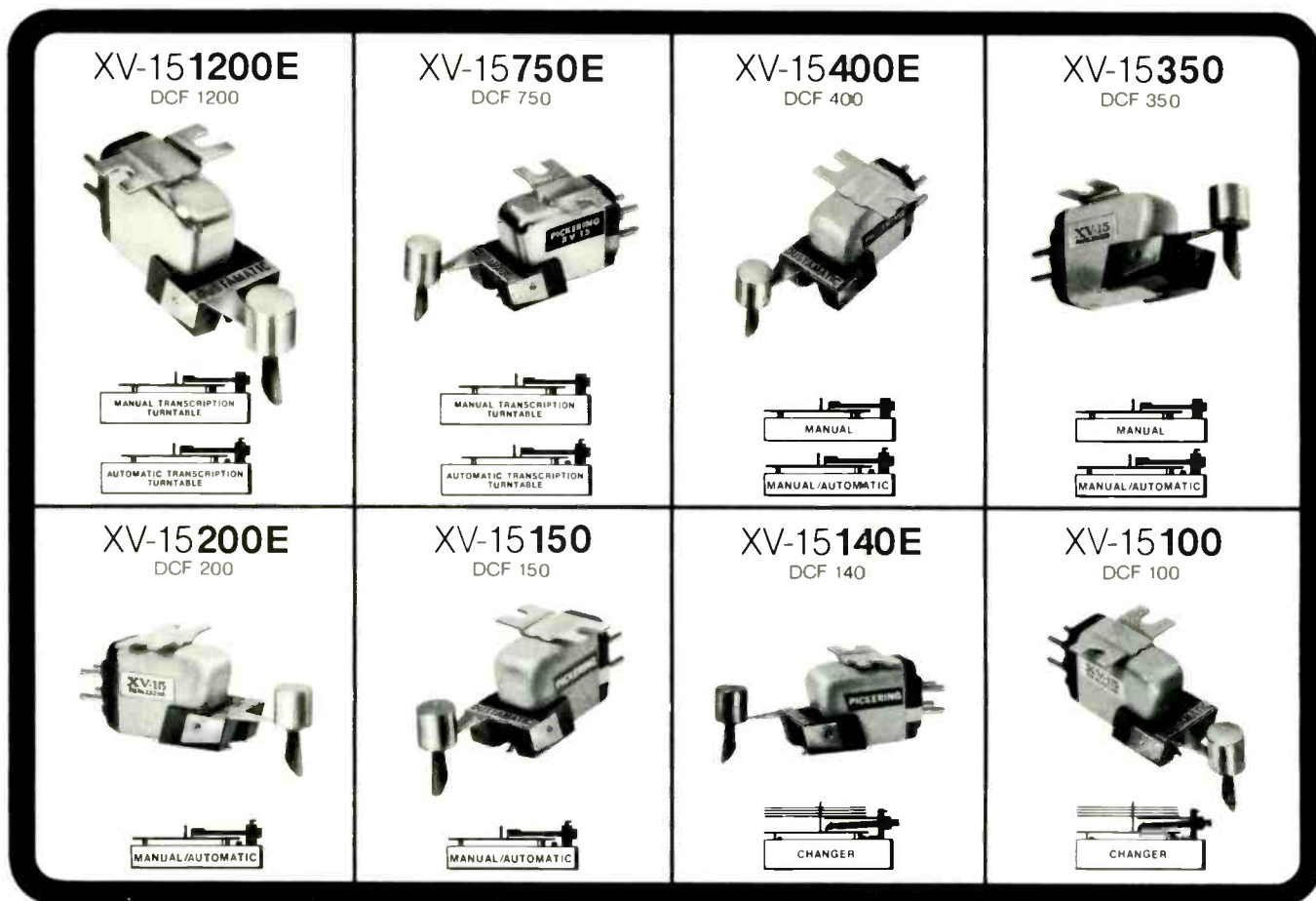

There's a "right" Pickering cartridge for every record player, and only Pickering has developed a way for you to be absolutely certain you select the "right" cartridge for your high fidelity music system.

It is a simple way for you to precisely match one of our XV-15 (100% Music Power) cartridges to whatever kind of record player you have or plan to buy. It's called Dynamic Coupling Factor — DCF for short.

We have taken virtually every record player and pre-analyzed the vital variables affecting cartridge design and those related to the engineering features of the various turntables and changers. So, no matter what

equipment you own or plan to purchase, there is a Pickering XV-15 cartridge exactly "right" for it. The DCF number enables you to select the proper Pickering XV-15 cartridge in relation to a particular type of playback equipment to achieve maximum performance.

If you're ready to buy your next cartridge, be certain you end up with the Pickering XV-15 cartridge that's best for your system. *Have your Pickering high fidelity dealer show you our DCF Chart, or write Pickering & Co., Inc., Dept. G, 101 Sunnyside Boulevard, Plainview, N. Y. 11803.*



"for those who can hear the difference"

The 100% Music Power Cartridges

All Pickering cartridges are designed for use with all two and four-channel matrix derived compatible systems.

CIRCLE 42 ON READER-SERVICE CARD

HIGH FIDELITY

July 1973

VOL. 23 NO. 7

music and musicians

- Leonard Marcus, Edward Greenfield
HOROWITZ'S COLUMBIA FAREWELL . . . PFITZNER'S PALESTRINA 12
Behind the Scenes in New York, Munich, and London
- Gene Lees **YOU WANT U.S. JAZZ RECORDINGS? TRY TORONTO** 20
The jazz revival is alive and doing business north of the border
- Caine Alder **THE RECORDINGS OF VLADIMIR HOROWITZ** 48
Including all his commercial albums from piano rolls to still unreleased tapes
- Winthrop Sargeant **DON'T SPEAK ILL OF THE GREAT CLASSICS** 61
Some perspectives on music criticism from the New Yorker's Critic Emeritus
- Royal S. Brown **A LITTLE NIGHT MUSIC IN THE STUDIO** 72
Behind the Scenes at a smash Broadway show recording

audio and video

- TOO HOT TO HANDLE** 22
- NEWS AND VIEWS** 24
Sony's cost-cutting ICs . . . A stylus for 78s
- EQUIPMENT IN THE NEWS** 26
- EQUIPMENT REPORTS** 31
Sony STC-7000 tuner . . . Shure V-15 Type III cartridge
Audioanalyst A-100 speaker system . . . Yamaha TB-700 cassette deck
Sherwood S-8900A receiver . . . Thorens TD-125 Mk. II turntable
Dynaco A-10 speaker system . . . Pioneer SA-9100 amplifier
Robins R47002 enhancer . . . Scotch Extended Range cassette tape
TDK Krom-O₂ cassette tape

record reviews

- David Hamilton **THE MET'S CARMEN UNDER BERNSTEIN** 67
Horne, McCracken, et al. re-create last season's big hit
- Royal S. Brown **A LITTLE NIGHT MUSIC ON RECORDS** 70
The original cast album captures musical theater at its finest
- Paul Henry Lang **PURCELL'S FAIRY QUEEN** 73
Clifford F. Gilmore **PURCELL'S CEREMONIAL MUSIC** 74
Two fine recordings show the baroque master's genius
- CLASSICAL** 76
Bruckner from Barenboim and Haitink . . . Crawford Seeger's string quartet
- Abram Chipman **BRAHMS SYMPHONIES BY FOUR** 78
Fine interpretations from Haitink, Ormandy, Sanderling, and Sawallisch
- IN BRIEF** 102
- Robert Long **FOUR-CHANNEL DISCS AND TAPES** 104
Playing Vanguard's Dolbyized open reels—how and which
- LIGHTER SIDE** 106
Chet Atkins . . . Bill Quateman . . . Sha Na Na
- JAZZ** 109
Art Tatum . . . New England Conservatory Ragtime Ensemble
- R. D. Darrell **THE TAPE DECK** 114
Some not-very-daring adventures outside the standard repertory
etc.
- LETTERS** 6
Spinning with the rock groups . . . Shreveport bites back
- PRODUCT INFORMATION** 18
An "at home" shopping service 99
- ADVERTISING INDEX** 98

10 Lab Test Reports

See page 31.



All of Horowitz on record. See page 48.

Lpmi High Fidelity is published monthly by Billboard Publications, Inc. at 1 Astor Plaza, New York, New York 10036. Copyright © 1973 by Billboard Publications, Inc. The design and contents are fully protected by copyright and must not be reproduced in any manner. Second class postage paid at New York, New York and at additional mailing offices. Authorized as second class mail by the Post Office Department, Ottawa and for payment of postage in cash. Yearly subscription in U.S.A., Possessions, and Canada \$7.95; in Pan-American Union \$8.95; elsewhere \$9.95. Single copies 75¢. Indexed in Reader's Guide to Periodical Literature. Change of address notices and undelivered copies (from 3579) should be sent to High Fidelity, Subscription Department, P.O. Box 14156, Cincinnati, Ohio 45214. Please state both old and new addresses when requesting change.

Current and back copies of High Fidelity and High Fidelity and Musical America are available on microfilm from University Microfilms, Ann Arbor, Michigan 48106. Microfiche copies of these magazines (1973 forward) are available through Bell & Howell Micro Photo Division, Old Mansfield Road, Wooster, Ohio 44691.

Maxell is happy to announce that the little pad that takes all the pressure has finally gotten a grip on itself.

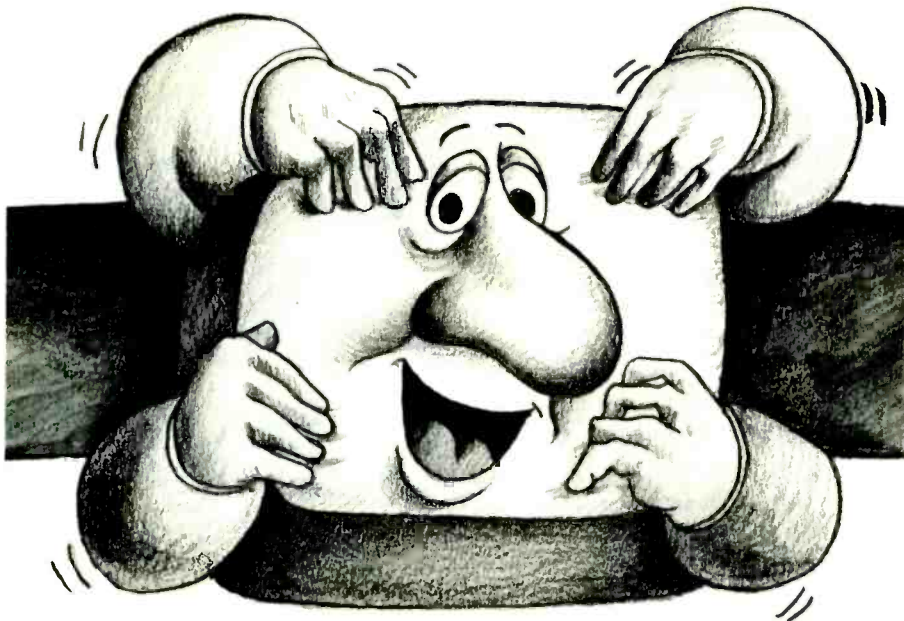

We wanted to make some really big improvements to our Ultra Dynamic cassette. But there just weren't any big improvements left to make. So we made a lot of little improvements.

Our little pad won't come unstuck.

Other cassettes keep their pressure pads in place with glue—or rather don't keep their pressure pads in place with glue. So we've designed a little metal frame that holds the pad in a grip of steel. With the result that you don't need to worry about signal fluctuations or loss of response any more.

More hertz.

We've also improved our tape. We've increased the frequency response to 22,000 Hz so you get even higher highs. The signal-to-noise ratio's now 8dB more than ordinary cassettes—which means you get less noise and cleaner sound. And the dynamic range is wider so you can turn the sound up loud enough to disturb the neighbors without worrying about distortion.

An improvement you can see but can't hear.

The first five seconds of our new UD cassette is a timing leader. And we've marked the place where it starts with three little arrows so you'll always know exactly where you are.

Amazing new miracle ingredient fights dirt fast!!!

But the leader's also a head-cleaner and what's amazing, new and miraculous about it is that it doesn't rub as it scrubs as it cleans. Because it's nonabrasive. So it keeps your tape heads clean without wearing them down.

Our new long-playing cassette is shorter.

Our new UDC-46 is twenty-three minutes per side. Which very conveniently just happens to be the approximate playing time of your average long-playing record. (Our other cassettes are 60, 90 and 120.)

And that's our new improved Ultra Dynamic cassette.

And its ultra dynamic new improvements.



maxell.

The answer to all your tape needs.

Maxell Corporation of America, 130 West Commercial Avenue, Moonachie, N.J. 07074
CIRCLE 64 ON READER-SERVICE CARD

LEONARD MARCUS
Editor

NORMAN EISENBERG
Executive Editor

WAYNE ARMENTROUT
Managing Editor

KENNETH FURIE
Music Editor

ROBERT LONG
Audio-Video Editor

SHIRLEY FLEMING
Editor, Musical America Section

EDITH CARTER
Associate Editor

VIOLA MATSON
Assistant Editor

WILLIAM TYNAN
Special Projects Editor

ROY LINDSTROM
Art Director

ROBERT MADDOCKS
Associate Art Director

MORGAN AMES
ROYAL S. BROWN
R. D. DARRELL
PETER G. DAVIS
HENRY EDWARDS
ALFRED FRANKENSTEIN
HARRIS GOLDSMITH
DAVID HAMILTON
DALE HARRIS
MIKE JAHN
MILES KREUGER
PAUL HENRY LANG
GENE LEES
ROBERT C. MARSH
H. C. ROBBINS LONDON
Contributing Editors

STANLEY BINDER
Circulation Manager

CLAIRE N. EDDINGS
Associate Publisher and
Director of Advertising Sales

WARREN B. SYER
Publisher

ADVERTISING

Main Office: Claire N. Eddings, The Publishing House, Great Barrington, Mass. 01230. Telephone: 413-528-1300
New York: 1515 Broadway (1 Astor Plaza), New York, N. Y. 10036. Telephone: 212-764-7385 Seymour Resnick, Eastern Adv. Mgr.

New England: The Publishing House, Great Barrington, Mass. 01230. Telephone: 413-528-1300. Russell Gilchrist
Chicago: Billboard Publications, Inc., 150 North Wacker Dr., Chicago, Ill. 60606. Telephone: 312-236-9818. Leonard Levine.

Los Angeles: Billboard Publications, Inc., 9000 Sunset Blvd., Los Angeles, Calif. 90069. Telephone: 213-273-7040. Andrew Spanberger.

Nashville: Billboard Publications, Inc., 1719 West End Ave., Nashville, Tenn. 37203. Telephone: 615-329-3925. Robert Kendall.

London: 7 Carnaby St., London W.1, England. Telephone: (01) 437-8090. Andre de Vekey.

Frankfurt/Main: Eschersheimer Landstrasse 69, Frankfurt/Main, West Germany. Telephone: (0611) 590805-6. Walter B. Rios.

Milan: Piazzale Loreto 9, Milan 20131, Italy. Telephone: 28.29.158. Germano Ruscitto.

Tokyo: Japan Advertising Communications, Inc., New Ginza Bldg., 7-3-13 Ginza, Chuo-ku, Tokyo 104, Japan. Telephone: (03) 571-8748. Shigeru Kobayashi, president



Never before has this little noise accompanied this much music.

If you're sophisticated enough to be reading this magazine, you're probably familiar with the two main characteristics of cassette decks: hiss and nonlinear frequency response.

Which should make you thoroughly unfamiliar with the performance capabilities of our new HK-1000. As the charts indicate, it behaves more like reel-to-reel than a cassette deck:

Signal-to-noise (unweighted) is -58 dB with Dolby and -70 dB in the audible hiss level above 4,000 Hz. The frequency response curve is essentially flat from less than 30 to beyond 15 kHz, ± 1.5 dB, with CrO₂ tape. (This curve is due largely to the way we drive our heads. Instead of the conventional constant *voltage* drive to the head, the HK-1000 is designed for constant *current* drive. Many studio model reel-to-reel decks are designed the same way.)

Because of a new low in noise and a new wide in frequency, the HK-1000 brings you a new clarity in music.

Ours is the first cassette deck designed for maximum phase linearity. Square wave response is better than every other cassette deck and even some expensive reel-to-reel decks. And the better the square waves, the cleaner and more transparent the music.

Discriminating audiophiles will also appreciate the wide selection of controls to take control of. There are two "peak-reading" VU meters; automatic shut-off in all transport modes; separate controls for recording playback and microphone levels; a "memory" rewind feature that lets you key a selection to the exact start location; a Dolby test oscillator; both record and Dolby playback calibration adjustments on the top panel; and so on.

The HK-1000 is also designed so you can use it often

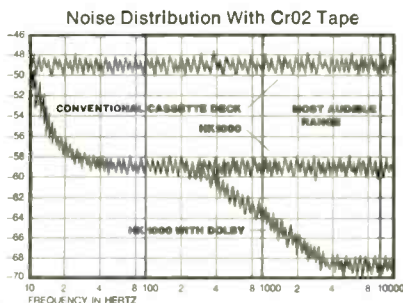

Noise.

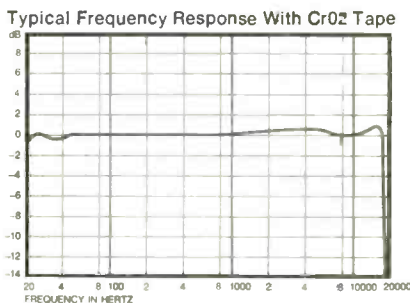

Music.

without endangering it. Plug-in printed circuit boards are used for simplicity and reliability of operation. Heads are easy to reach and clean. And the transport is the most reliable we've ever tested; it even closes with the sort of reassuring "thunk" you normally hear only by

closing the doors of expensive hand-built cars.

The price is \$300.

Never before has that small a price tag accompanied this much cassette deck.

For complete details and specs, write Harman/Kardon Incorporated, 55 Ames Court, Plainview, N.Y. 11803*.

harman/kardon
the music company



*Distributed in Canada by Harman/Kardon of Canada, Ltd., 9429 Core de Liesse Rd., Montreal 760, Quebec.
CIRCLE 23 ON READER-SERVICE CARD

letters

Supergroups

You are probably receiving scores of letters correcting Henry Edwards' mistake ["The Rock Group Spinoff," April 1973] in renaming Jim Messina "Dan," though you did get it right in the discography.

More irritating is a factual error: Of the four Buffalo Springfield albums listed, Jim Messina performed on only two—"Last Time Around" and "Retrospective." Since "Retrospective" is just a collection of previously released cuts, and Messina performs on only the three from "Last Time Around," his contribution to the Buffalo was relatively small. He replaced Bruce Palmer (the bass player on "Buffalo Springfield" and "Again") shortly before the group's demise.

—*Joe Gallagher*
Elwood, Nebr.

"The Rock Group Spinoff" was a good background piece for getting to know several of the current big-name musical combinations, at least for nonrock buffs, but the Jim Messina discography omits an amusing and historically interesting album: "The Dragsters, Jim Messina and His Jesters" (Audio Fidelity DFS 7037, 1964—still available). The cover shows Messina and crew, properly short-haired, dressed in matching blazers and ties, posing with their white Fender guitars amidst sports cars. The contents are c. 1964 surf/drag-racing music. Good nostalgia.

—*Richard P. Bell*
Syracuse, N.Y.

I felt that the comments about Poco were unfair. Citing Rusty Young's steel-guitar antics as proof of a deficiency in the group's music is somewhat like saying that Jimi Hendrix played his guitar in many positions because he couldn't play it standing still. While I can understand that technically it may be true that such dramatics do not necessarily make for better music, it is unfair to cite them as proof that nothing else is really going on.

—*Sharon McCarrell*
Westminster, Calif.

Mr. Edwards implies that the work of Poco is inferior to that of Loggins and Messina, and suggests that Messina "must certainly be glad he left Poco." Poco's music is not inferior, and Messina has stated that he left Poco because he was getting married and did not want to be separated from his wife, as touring with Poco would have required.

Poco did not try to capture the sound of the Buffalo Springfield, as Mr. Edwards claims. Richie Furay played down the ties to Springfield, wanting Poco to succeed on its own musical merits (which it has done). Nor was Poco side-tracked into Latin rock. Just because the group made the song Mr. Edwards mentioned, it does not mean that they ever left the music they do best, country-rock. I have seen Poco live, and it does not "rely on cheap theatrics to fill musical gaps." All of the band members are excellent musicians and they

really give a good show—the audience gets its money's worth.

—*Stephen Downing*
Hempstead, N.Y.

Classical Music in Shreveport

It came as quite a shock to me when I read Peter G. Davis' description ["The Classical Uprising," April 1973] of our operation ("If you walk into Stan's Music Shop . . . you will not find one classical disc—not even a 'greatest hits' assemblage. . .").

Stan's carries a *complete* line of classical music. New-release mailers go out weekly to each account we service over a twelve-state area, so that all accounts are constantly aware of what we have to offer in all types of music. If Mr. Davis visited our downtown location, it is quite possible that he could not find a classical album in our shelf stock. But our Shreve City and Southfield locations offer a complete classical line. In each of our six shops, we carry the line or lines of music people in that area prefer. All a customer has to do is place an order for the record of his choice and it will be waiting for him at the store in his vicinity the next day. We heavily advertise the locations that carry a classical line so that the buying public is aware of its availability.

If Mr. Davis is in our area again, I hope he will drop by and let us show him the vastness and variety of our operation.

—*Stanley J. Lewis*
President, Stan's Record Service
Shreveport, La.

As a member of the board of the Shreveport



Jim Messina—his spin corrected.

Symphony I can attest to the fact that we enjoy approximately a twelve-per-cent oversell for our entire concert season plus individual ticket sales. Our 1972-73 season, for example, consists of nine pairs of concerts plus six National Endowment concerts, a thriving junior symphony orchestra, and a comprehensive program for children in our public schools. Featured artists this season include Jose Ferrer, Radu Lupu, Stan Kenton, and Van Cliburn. Roberta Peters will appear here soon with the Civic Opera Association. Combine this with the Community Concerts series, Civic Opera Association, Gilbert and Sullivan Society—all providing live performances—and you will find that we have a rather healthy cultural atmosphere in Shreveport. Throw in five amateur drama groups and some outstanding art galleries, notably the R. W. Norton Gallery, and you get an entirely different picture from that drawn by Mr. Davis.

I am proud of my city and the cultural activities available here.

—*Joe Miot*
Shreveport, La.

Mr. Davis replies: My apologies to Mr. Lewis for misrepresenting Stan's Record Service. My visit was indeed to the downtown store, where I was told that classical records were not to be had. Since no information was forthcoming regarding shops in the outlying suburbs, I withdrew, nursing the obvious conclusion. Frankly, the depressing vista of Shreveport's downtown area, like so many smaller American cities today, gives every indication of advanced urban decay. Clearly the town's thriving cultural activities are now located in more prosperous surrounding communities, which I unfortunately did not see. And although I did not comment on Shreveport's live cultural events, it is encouraging to hear from Mr. Miot that they are prospering.

Columbia and the BSO

I enjoyed Robert Long's interesting account ["Behind the Scenes," April 1973] of Leonard Bernstein's recording of *Oedipus Rex* with the Boston Symphony. There are, however, a couple of inaccurate statements:

"Columbia had never before recorded the Boston Symphony Orchestra." Early in 1934 Columbia recorded Koussevitzky and the BSO on the stage of Carnegie Hall in a performance of the *Symphony 1933* by Roy Harris. (This was during the period 1931-35, when the BSO's recording contract with Victor had been allowed to lapse.) This recording, backed with the Ormandy/Philadelphia Orchestra recording of Harris' Seventh Symphony, is available from Columbia Special Products (CML 5095).

Columbia "had recorded in Symphony Hall only once." In addition to the Bernstein/New York Philharmonic Shostakovich Fifth, Columbia also made the mono Ormandy version of the Saint-Saëns *Organ* Symphony (with Biggs and the Philadelphia) in Symphony Hall. And during the 1950s Columbia re-

Does your favorite music blow your mind or just mess it up?

Koss Stereophones put your favorite music where it belongs. In your head. Not lost forever in the walls of your living room.

After all, who should hear your favorite music? You or the walls of your living room? Not to mention your family or neighbors who'd rather hear something else. Like hearing themselves think. Or their favorite television show.

World all your own

Put on Koss PRO-4AA Stereophones and you're in a world all your own. Immersed in Brahms' First or Beethoven's Fifth . . . or turned on to the Moody Blues. Patented fluid-filled ear cushions seal in the sound and seal out the unwelcome noise. So nobody disturbs you . . . and you don't disturb anybody else.

You hear more with Koss

You'll hear more of Brahms' First the first time you put on Koss Stereophones than you've ever heard with speakers. Because Koss mixes the sound in your head instead of scrambling it on your walls. The unique Koss acoustical seal around your ears produces a rich, deep bass without boominess or distortion. Yet highs are always brilliantly clear and uniform because



they're focused only on your ears . . . not on the walls of your room.

Worth hearing

Why should the Koss PRO-4AA Stereophone be so superior? Because it contains the first driver designed exclusively for Stereophones. A unique diaphragm with 4 square inches of radiating area. And an extra large 1-inch voice coil that's virtually "blow out" proof. In other words, the Koss PRO-4AA was designed from the start to provide the finest sound ever achieved in a dynamic headphone. And it does . . . with a clean, uncolored response 2-full octaves beyond the range of other dynamic headphones on the market. And with a typical frequency range of 10-20,000 Hz. In fact, High Fidelity Magazine rated the PRO-4AA a "superb" headphone. But then, everyone who has heard the Sound of Koss rates it superb.

Enjoy a new music library

Take your favorite tape or record to your Hi-Fi Dealer and listen to it thru a pair of Koss PRO-4AA Stereophones. The extra sound you get in the Sound of Koss will amaze you. In fact, you'll hear so much more from your music that buying a Koss PRO-4AA Stereophone is like getting a whole new music library.



Hearing is believing

Hear the Sound of Koss at your local Hi-Fi Dealer or Department store. Or write for our 16-page color catalog, c/o Virginia Lamm, Dept. HF-272. Once you've heard the Sound of Koss, you'll never want to mess around with anything else. From \$15.95 to \$150.



KOSS STEREOPHONES
from the people who invented Stereophones

KOSS CORPORATION

4129 N. Port Washington Ave., Milwaukee, Wis. 53212
Koss S.r.l., Via dei Valtorta, 21 20127, Milan, Italy
CIRCLE 39 ON READER-SERVICE CARD

The Sound of Excellence

Tri-Planer, a line of speaker systems that produces the live, present, and tight sound of true percussion; with a true, smooth bass; clean, crisp, yet not harsh highs; and the smooth voice of fine orchestration.

Tri-Planer II \$175



Tri-Planer III \$75



Tri-Planer I \$250

TREAT YOURSELF TO THE INNERMEDIA EXPERIENCE OF FULL DIMENSIONALITY



INNERMEDIA
ELECTRONICS

4503 E. RAILROAD AVENUE
SACRAMENTO, CA 95826
(916) 452-3341

DEALER INQUIRIES WELCOME

CIRCLE 28 ON READER-SERVICE CARD

Dokorder 9100
A MINIATURE RECORDING STUDIO

Unique in its electronic/solenoid operation. Unique in its design.
Unique in its professional features. Appealingly priced.
For information write . . .

Dokorder Inc.® 11264 Playa Court, Culver City, Calif. 90230

CIRCLE 13 ON READER-SERVICE CARD

corded a whole series of Biggs discs in Symphony Hall, with Richard Burgin conducting members of the BSO. Included in the series was a marvelous mono recording of the Poulenc Organ Concerto and some fine discs of music for organ and brass by—among others—Bach and Gabrieli.

Martin Bookspan
New York, N.Y.

Our thanks to all the readers who caught these slips.

Song O' My Heart

Conrad L. Osborne, Miles Kreuger, and the John McCormack Association of Greater Kansas City will be interested to know that the Fox studio prints of the film *Song O' My Heart* are now on deposit in the UCLA Film Archive.

The Archive has not only the "minus-dialogue" version referred to in Mr. Osborne's review of the soundtrack disc [February 1973], it also has the full-dialogue version in 35mm. The 70mm Grandeur version is not in the Archive's possession, but it is doubtful that it would have had better sound quality than the extant 35mm versions, because the track dimensions and playing speed were exactly the same as those of 35mm film. Today's 70mm processes run at a higher linear speed than the Grandeur process did (and use magnetic sound vs. Grandeur's optical), which is probably where the misconception originated.

Garry Margolis
Los Angeles, Calif.

Rachmaninoff, Please

1973 is the centenary year of Rachmaninoff. This is a plea for recordings of many works not available at the moment: most of the songs; the *Trio élégiaque*, Op. 9; the six choral songs, Op. 15; the six *Moments musicaux*, Op. 16; the Chopin Variations, Op. 22; the opera *Franческа da Rimini*, Op. 25; the *Liturgy of St. John Chrysostom*, Op. 31; the Vesper Mass, Op. 37.

I also hope that RCA will reissue its Rachmaninoff archives, and perhaps Horowitz could be persuaded to record another Rachmaninoff album. Finally I ask Angel to keep an eye on Russian Melodiya records, on which there will no doubt be more Rachmaninoff releases. The best available versions of many Rachmaninoff items are on Melodiya/Angel.

Alberto D. Fajardo
Washington, D.C.

RCA has announced plans to issue five three-disc sets containing all of Rachmaninoff's recordings including "at least thirteen items" never before released.

Inspired Travesty?

What an inspired idea to have Jan Meyerowitz do a satire on all the third-rate critical drivel about the basic validity of Puccini's music based on Puccini's character. "The Objectionable Appeal of Giacomo Puccini" [May 1973] was a masterpiece of travesty; he hit all the high points of the usual critical arsenal, bringing in each one with the skill of a master contrapuntalist, weaving them into a hilarious whole. It will be a long time before anyone dares to raise these subjects again seriously, for fear of another blast of parody from Mr. Meyerowitz. It did seem to me though that it may still be too close to World War II for us to

CIRCLE 58 ON READER-SERVICE CARD →

Every Pioneer turntable offers an exceptionally high degree of precision. Our PL-12D does it for \$99.95

Despite its simplified operation (only two controls), this versatile performer incorporates a high degree of sophistication. No other turntable in its price range has all of its features: 4-pole, belt-driven synchronous motor . . . static-balanced S-shaped tonearm . . . ultra-light tracking . . . oil damped cueing control . . . 12-inch dynamically balanced die-cast platter . . . anti-skating control . . . oil lined walnut base . . . ringed dust cover . . . 33 $\frac{1}{3}$ & 45 rpm speeds, and much more.

Hear the top performing PL-12D at your Pioneer dealer. Discover how highly satisfying a low price can be.

U.S. Pioneer Electronics Corp.
178 Commerce Rd., Carlstadt,
New Jersey 07072
West: 15300 S. Estrella, Los Angeles
90248/Midwest: 1500 Greenleaf
Elk Grove Village, IL 60007
Canada: S. H. Parker Co., Ont.

PIONEER
when you want something better

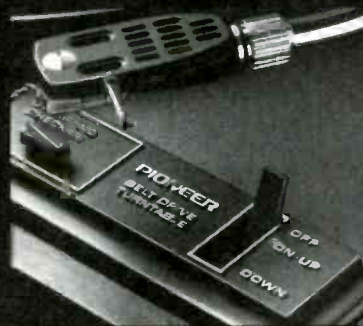

Gentle 2-way oil damped cueing control

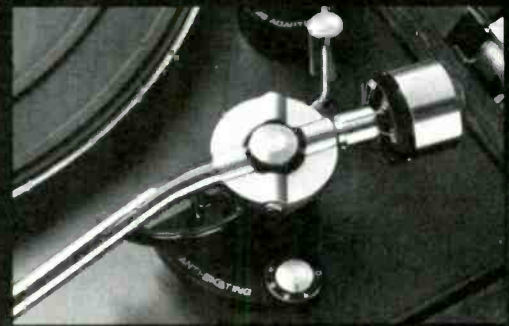

Anti-skating control minimizes distortion



When you make a better cartridge the world beats a path to your door.

From the U.S.

"Separation was tops... square wave response outstanding. We tracked it as low as 1/4 gram." **Audio Magazine**

"Among the very best. Frequency response was flat with ± 1 dB from 20-20,000Hz. Compliance measured 35 x 10⁻⁶ cm/dyne." **High Fidelity**

"The I.M. distortion at high velocities ranks among the lowest we have measured. A true non-fatiguing cartridge." **Stereo Review**

From Great Britain

"A real hi fi masterpiece. A remarkable cartridge unlikely to wear out discs any more rapidly than a feather held lightly against the spinning groove." **Hi-Fi Sound**

"A design that encourages the hi-fi purist to clap his hands with joy." **Records and Recording Magazine**

From Canada

"One of the world's greatest cartridges. Dealer's Choice. Scotty's Stereo." **Sound Magazine**

From Japan

Grand Prize for cartridges in first all Japan Stereo Component competition.

Radio Gijutsu Magazine

Write for your free "Empire Guide to Sound Design."

EMPIRE Scientific Corp. Mfd. U.S.A. Garden City, New York 11530



CIRCLE 22 ON READER-SERVICE CARD

RA-1210

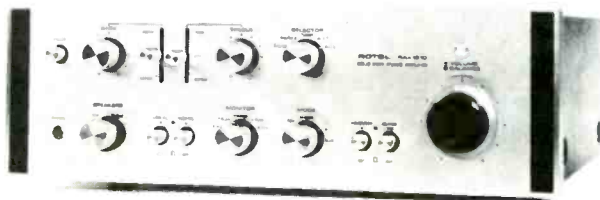

THE STEREO AMPLIFIER: RMS power, 60W/channel with both channels driven into an 8 ohm load. Two separate power supplies each with its own power transformer. Power Bandwidth of from 5-50KHz and a THD of below 0.3% from 20-20KHz. Add to this 2dB step controls, 3 stage differential pre-amplifier, adjustable input sensitivity/impedance on phono 2, plus tape monitoring and dubbing for two sets of tape recorders.

READ THE APRIL '73 STEREO REVIEW FOR A DEFINITIVE CRITIQUE ON THE RA-1210

ROTEL
 THE ALTERNATIVE



THE EVERYTHING LINE FROM ROTEL
 ROTEL of America, Inc., 2642 Central Ave., Yonkers, N.Y. 10710

CIRCLE 49 ON READER-SERVICE CARD

accept Mr Meyerowitz' experiences in Germany in a comic article like this.

Perhaps next we can ask for a satire on the usual tripe about "Meaning in Mozart's Operas"?

Edward Foreman
 General Editor, Pro Musica Press
 Minneapolis, Minn.

A Tip for Radio Stations

Classical-music radio stations could make a significant contribution to the classical-recording market (apropos of the excellent pieces by Leonard Marcus and Peter Davis in your April issue) by taking a cue from WUHY-FM, a listener-supported station in Philadelphia. Along with the identification of selection and performers following each work, WUHY announcers usually (I wish I could say always) mention the label and catalogue number of the recording.

The practice takes no more than a few seconds of air time per hour, but I believe it would boost record sales. I am certainly more inclined to buy records I have heard on the air and liked, and this would save me the bother of searching out the record title and number.

David Hoekema
 Princeton, N.J.

Beverly Wolff on Records

John Yeager ["Letters," March 1973] can hear the magnificent voice of Beverly Wolff on at least three readily available recordings: *Roberto Devereux* (Audio Treasury), *Julius Caesar* (RCA), and the Rossini *Stabat Mater* (Columbia). She also sang in Bernstein's *Trouble in Tahiti*, last available on Heliodor. I've been fortunate enough to hear Miss Wolff in *Devereux* and *Caesar* here in Los Angeles. A treat indeed!

Brian D. Mellis
 Glendale, Calif.

Correction

In the article "Warranties," which appeared in our May issue, the warranty term for free labor on KLH turntables was listed incorrectly. KLH offers three months' free labor on its turntables.

High Fidelity. July 1973. Vol. 23, No. 7. Published monthly by Billboard Publications, Inc., publisher of Stereo, Stereo International, Modern Photography, American Artist, Billboard, Vend, Amusement Business, Merchandising Week, Music Labo, Photo Weekly, Gift & Tableware Reporter, Record & Tape Retailer, Record Mirror, Discografia Internazionale, World Radio TV Handbook.

High Fidelity/Musical America. Edition published monthly. Member Audit Bureau of Circulations.

Editorial correspondence should be addressed to The Editor, High Fidelity, Great Barrington, Mass. 01230. Editorial contributions will be welcomed. Payment for articles accepted will be arranged prior to publication. Unsolicited manuscripts should be accompanied by return postage.

Subscriptions should be addressed to High Fidelity, 2160 Patterson St., Cincinnati, Ohio 45214. Subscription rates: High Fidelity/Musical America: In the U.S.A. and its Possessions, 1 year \$14; elsewhere, 1 year \$15. National and other editions published monthly. In the U.S.A. and its Possessions, 1 year \$7.95. Subscription rates for all other countries available on request.

Change of address notices and undelivered copies (Form 3579) should be addressed to High Fidelity, Subscription Fulfillment Dept., P.O. Box 14156, Cincinnati, Ohio 45214.

CIRCLE 18 ON READER-SERVICE CARD →

IF OUR \$1000 SPEAKER DOESN'T GET YOU, MAYBE OUR \$55 ONE WILL.

People who hear about the Linear Sound of EPI invariably ask, "How much?"

To which we respond: "It depends."

If money is no object, we're only too happy to recommend our Model 1000. "The Tower," we call it.

This is a \$1000 item (each), and it is the absolute epitome of EPI's Linear Sound. (The Tower is *The Stereophile's* most recent addition to its select list of five Class A speakers.)

On a frequency response graph, the Tower will record a virtually straight line from the lowest bass to the highest treble. Meaning that what you hear is a pure, uncolored, natural sound from bottom to top. With no artificial boosting of the bass to impress the innocent. And all the nuances and overtones at the treble end that, on ordinary speakers, just fade away.

In short, what you hear is something rather sensational. (At \$1000 a crack, you might say it *ought* to be sensational. It is.)

But since, for most people, money is an object, you'll be happy to know our

Model 1000 is just one of eight Linear Sound speakers from EPI.

In the middle of the line, for example, you'll find our Model 400, "The Mini Tower," at \$389. Of this speaker, *Stereo Review* said, "The airy, open quality... in our view earns it a place in the select group of superb speaker systems."

Then, for the budget-minded, is our Model 50 at an attractive \$55 each.

Don't let the price fool you.

The EPI Model 50 produces a true linear sound. It has the same 1" air spring tweeter you'll find in the Tower and the same 6" long-throw woofer you'll find in the Mini Tower.

When *Audio Magazine* reviewed the Model 50, it recorded a response that "extended from 45 to 16,000 Hz ± 3 db, and dispersion was excellent." When *Audio* tested 14 small speakers for dispersion, our Model 50 beat the pack of them.

So, getting back to the question of the cost of EPI's Linear Sound:

How much did you want to spend?

(You can reach us at Epicure Products Inc., Newburyport, Mass. 01950.)

**THE LINEAR SOUND
OF EPI.** 



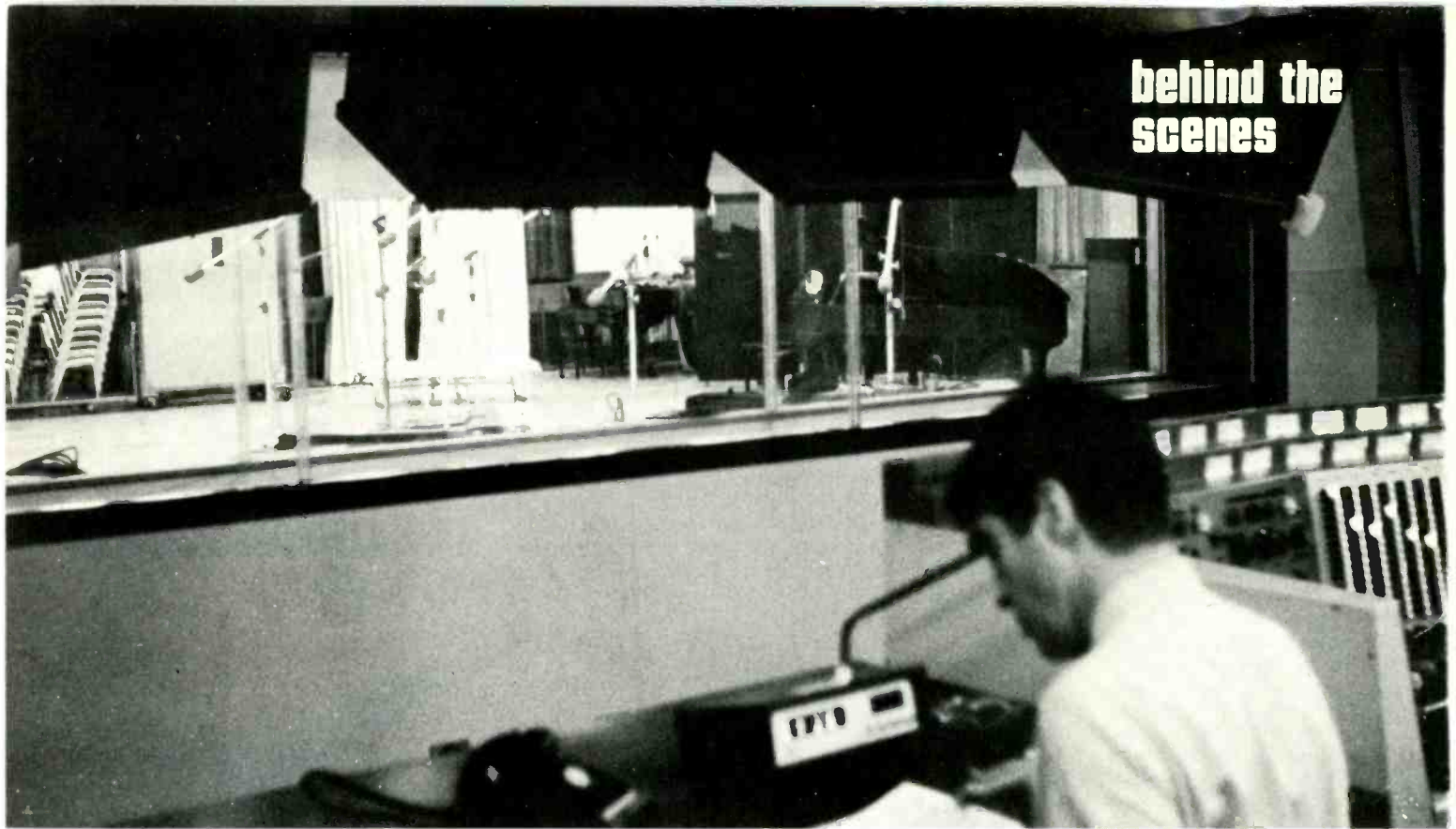

In a corner of the recording room, Horowitz is picked up by two banks of microphones and monitored over four speakers in the control room.

Horowitz Finishes Up His Columbia Contract

NEW YORK

"For me the most important thing is dynamics and color," Vladimir Horowitz explained at Columbia's East 30th Street studio. "This piano has better dynamics—more *piano*, more *forte*." He was letting me know why he was retaping material I had heard him record two Wednesdays earlier, on January 10, a session that had been plagued by a troublesome piano. (Columbia had been reserving the studio every late Wednesday afternoon for Horowitz's final sessions under his Columbia contract—which he was not planning to renew.)

On the previous occasion I had entered the control room about fifteen minutes after the session had gotten underway. Producer Dick Killough was sitting next to the control board presided over by engineer Ray Moore. Neither, frankly, seemed to have much to do. Through the control room window, far into a corner of the huge recording room, I could make out the distant figure of the pianist. He was playing excerpts from Beethoven's *Waldstein* Sonata, patching up spots that apparently hadn't gone exactly to his liking on a mid-December Wednesday three weeks earlier, when the sonata had been recorded.

My original invitation had been to

that December taping, but at the last moment Dick had phoned me to ask whether I could please make a subsequent session. Horowitz's piano—Steinway No. 186, which he had been using since 1965—was no longer playable and the pianist would rather initiate a new instrument without any curious listeners observing his midwifery.

After about five minutes more of *Waldstein*-patching, Horowitz got down to the music scheduled for the day: four Schubert Impromptus. First came the Op. 142, No. 2. It started off beautifully, as though the performer were making it up as he went along—that incredible improvisatory quality that few musicians are able to bring off. Then, suddenly, a note failed to sound. Horowitz, unfazed, without even breaking the metric pulse, repeated the offending measure. A few minutes later, during the fiendish Op. 90, No. 4 Impromptu, it happened again. The tape just kept rolling; a razor blade, I figured, would do the appropriate excising in an editing cubicle at some later date. In general the virtuoso's jackhammer fingers were performing their usual wizardry, but after a few more rapid passages that needed repeating I became uneasy. Horowitz missing notes? The last time I had heard him, at his East Side town house, was a year earlier, and he had been magnificent, tossing off the

most fiery passages—from the composer who for some time had captured his passion, Muzio Clementi—as easily as though they were the C major scale. (Yes, Virginia, Clementi was a great composer of passionate Romantic piano music, not just the writer of your student piano pieces.)

To be sure, he was not now really missing notes, or hitting wrong keys; it was just that some notes in the faster passages weren't sounding. And then a new problem arose: When Horowitz used the soft pedal, the A above middle C went out of tune. He would have to repeat the entire work. But first, the piano would have to be retuned.

Standing by, to anticipate any such contingency, was a representative from Steinway. While he fixed the instrument I entered the barnlike recording room and got a chance to greet the musician. He sat down on a cot that had been placed near the piano.

"You know," he said, "this is such a big room—look how high the ceiling is—that I keep feeling the sound isn't getting through. But in the control room they tell me it's fine."

I assured him that the sound in the control room was indeed powerful.

"That's what they keep telling me. In here you don't hear the same thing. And the piano is stiff. It was fine for the

IMPROVE YOUR HEARING FOR \$200.

Sometimes high fidelity people lose sight of what it's all about: Sound.

The ultimate test of any piece of high fidelity equipment is what you hear.

That's why, of all the statements made by equipment reviewers about our Garrard Zero 100, the most significant were these:

"Using identical virgin records, and virgin styli in identical good cartridges, the Zero 100 on occasion sounded markedly 'crisper' than other turntables." *Rolling Stone*.

"A listening test proves to bring new life to many records, noticeably reducing distortion on the inner grooves." *Radio Electronics*.

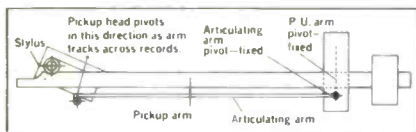

"From about 7 in. diameter to runout, the Zero 100 delivers considerably less distortion and greater definition than with the same pickup mounted in a standard arm. The improvement in sound quality is notably impressive."

Elementary Electronics.

"The articulated arm of the Zero 100 produced less distortion, and therefore greater definition, on high-level, musically complex passages, from the inner grooves."

Hi-Fi Stereo Buyers' Guide.

That's what reviewers actually

heard when they tested the first automatic turntable with Zero Tracking Error. This is, to our knowledge, the first time a turntable has been given credit for making records sound better.

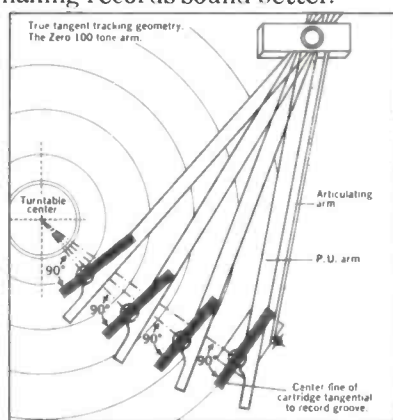

Cartridges and other components, yes. But never a turntable — until the Zero 100.

By this time you probably know how we achieve Zero Tracking Error. The principle of the articulating arm, continually adjusting the angle of the cartridge so it is always at a 90° tangent to the grooves, is a simple one. But the ingenious engineering and the development of the precision pivots to make the principle work, took several years.

But enough from us. Let's go back to what the reviewers say about the Zero 100.

"It probably is the best arm yet

offered as an integral part of an automatic player." *High Fidelity*.

"All of these features combined into one automatic turntable make news, even though some are found on other units. Only in the Zero 100 are they all put together." *Audio*.

When *Audio* talks about "all of these features" they're referring to such things as our magnetic anti-skating, variable speed control, illuminated strobe, viscous-damped cueing, 15° vertical tracking adjustment, patented Garrard Synchro-Lab synchronous motor and our exclusive two-point record support in automatic play.

But all of this gets back to our original point. It is the sound that makes the difference. After all, a \$200 record player should give you a really meaningful difference. And the high fidelity experts agree that people who own a Zero 100 will hear better than people who don't.

If you'd like to read the reviews in full detail, we'll send them to you along with a complete brochure on the Zero 100 and the Garrard line. Write to: British Industries Company, Dept. G-23, Westbury, N.Y. 11590.

GARRARD ZERO 100

The only automatic turntable with Zero Tracking Error.

Mfg. by Plessey Ltd. Dist. by British Industries Company, division of Avnet, Inc.





Photos by Leonard Marcus

From his cot Horowitz discusses his recalcitrant piano with producer Dick Killough as a Steinway representative tries to fix it. Right, Mrs. Horowitz on her own self-assembled cot.



Waldstein. But they just kept it here for nearly a month without anybody playing it, and it simply gets stiff this way. You know my old piano, 186." He was talking of it as of an intimate, personal friend. "It simply went berserk. They tried to fix it up last summer but it died. That was a beautiful piano. So now I don't have one. Oh, I have a piano in my house. That's also a beautiful piano. And there's my other beauty in Connecticut. (The Horowitzes have a house in New Milford.) But I don't have one to play professionally. Next week Steinway will sit me in front of five or six pianos and I'll just play them and choose one. This one, the notes don't come up fast enough."

I mentioned the muffled passages.

"The piece is not difficult," he explained. (Op. 90, No. 4 not difficult!?) "It's just that the notes don't come up." He rose from the cot, walked over to the piano, and played a single note in rapid machine-gun fashion. Some of the notes misfired. "Look! You see? But I'll have to do it over anyway because the piano was out of tune."

As the tuner continued his work, Horowitz turned to Dick Killough. "Are you sure it's coming out strong enough? I keep feeling that I have to push more."

"No, it's fine," Dick replied. "Just play it as you feel it."

"It's amazing what they can do in the control room," the pianist said to me. I didn't bother explaining that they didn't seem to be doing anything in the control room except listening to the great man play. There was nothing to do: he was doing it all himself.

When the session continued it was with the *Impromptus* Op. 142, No. 1 and Op. 90, No. 2.

I don't know whether Steinway ever sat Horowitz in front of a battery of pianos or not, but when I attended the Jan-

uary 24 session two weeks later the different instrument in the studio was not from Steinway's basement. Horowitz was re-recording the entire quartet of *Impromptus* on his own piano, which Columbia had brought in from his Connecticut house. The previous session's tapes would be scrapped. Hearing him now, on his "beauty," I could only think of *New York Times* critic Harold Schonberg's phrase for Horowitz: "still the champ." For this session Mrs. Horowitz, the daughter of Arturo Toscanini, was in the control room. She was leaning back in one chair, eyes closed, feet on another chair, listening to her husband record. Pinned to her dress was a name tag that read "Exhibitor—Wanda Horowitz." She opened her eyes as she heard me enter and beckoned me to sit next to her.

"I'm a working girl today," she whispered with a smile, pointing to her badge. "A friend of mine from Connecticut has an antique shop and is exhibiting in the Antique Show over at the Armory. I'm helping her out." The smile broadened. "A funny thing happened at the exhibit today. A woman came up to me, looked at my badge, which could be the badge of any suburban Jewish housewife, and said, 'Wanda—that's an unusual name. A cousin of mine had that name—Wanda Landowska.'"

A different engineer, Buddy Graham, was at the control board this time, and Dick Killough was nowhere to be seen. He was in fact running around the building turning off the air-conditioning system, which had developed a buzz that had ruined takes of Op. 142, both No. 1 and No. 2. When Dick returned, Horowitz, far from being the temperamental, easily annoyed artist that legend mistakenly has it, simply replayed the works like the consummate professional that he is.

"How do you like this piano?" Dick asked me. "You know, before we brought it here, we delivered it to Carnegie Hall so that he could try it out there. Now word has gotten around that he was playing privately in Carnegie Hall and everybody is asking when he's going to return to the concert stage." Horowitz has not given a concert since October 1969.

"I've been trying to get him to return to the stage," added Mrs. Horowitz. "And now he really is thinking about it again."

I noticed that there were two banks of microphones by the piano. Dick explained: "We're set up for two different perspectives. In one, we use the four front mikes alone. In the other, we mix the four front mikes into two channels and use the two back mikes for the other two channels. Which perspective we choose depends on the piece. This is just for stereo, although the second setup will work for quad as well. The back mikes really aren't back too far but they're as far as we can put them without picking up too much reverberation from this big room."

The session went beautifully and at its conclusion Horowitz was in an extraordinarily buoyant mood.

"It was good today. Now we can go home. Home is a nice place. Home is a nice place for all of us." We all laughed in agreement.

As he greeted me, I asked him about his plans for a concert. He had been telling me about his hopes for it for over a year and how, of course, "when I give my concert, I'll put in some Clementi. Ah, what a composer." The plans were still not settled.

Why hadn't he been recording any of Clementi's music? "That will have to come a little later. Columbia wants bet-

ter sellers. And with what they're paying me. I generally let them have their way on the type of repertoire they can sell. I've just finished the *Moonlight* and *Appassionata*—and of course the *Waldstein*. But now, after the Schubert, I have just one other side to make for them before my contract is over. I have some Chopin in the icebox and will finish up a Chopin album." He would record six mazurkas in February. (See story and discography starting on page 48.) "Then I can record for anybody. I'll be a free-lancer. And then, maybe Clementi. But in my concert I'll certainly play some Clementi."

"Why not a whole Clementi concert?"

"Oh, nobody would come to hear a whole evening of Clementi."

Actually, of course, "they" hardly come to hear a whole evening of piano playing any more. What they'd come for is to hear an evening of Horowitz—even if he just played *Chopsticks*.

LEONARD MARCUS

MUNICH

Pfitzner's Metaphysical Palestrina

Deutsche Grammophon's recording schedule listed no fewer than twenty-five sessions for a 195-minute (four-disc) opera, Hans Pfitzner's *Palestrina*. If anyone wonders why such a lavish production should be undertaken just when the fabled 1964 Vienna broadcast featuring Fritz Wunderlich is to be issued commercially, he need only look at the correspondence columns of the German record magazines. Where British readers, for example, constantly urge recordings of the lesser works of Delius, Arnold Bax, or even Granville Bantock, for German record collectors *Palestrina* has become the operatic rarity most asked for.

In my two days of sessions, I managed to hear most of the first act, and I can certainly confirm the attractions of the music: constant and strong echoes of *Meistersinger* and *Rosenkavalier* (often together, strangely enough) but with markedly less striking melodic inspiration. As usual for its sessions with the Bavarian Radio Symphony Orchestra, DG was using the Herkulesaal in the atmospheric Residenz palace. On stage when I arrived were no fewer than ten soloists—not only Palestrina himself (recognizable as that most versatile of tenors, Nicolai Gedda) but nine Masters, the spiritual dignitaries who listen to Palestrina's arguments on polyphony and religious dogma and make their comments. With such a situation it is perhaps surprising that Pfitzner managed to avoid copying Wagner's Masters as much as he did. There is no Beckmesser, but at one point the nine old men utter a series of "Hms" that is one of the most original vocal sounds in opera.

At first, recording manager Hans Weber and the engineers under Heinz Wildhagen thought they would "disembody" the Masters' comments, recording them in a separate studio. But the technical problems were too great, and with a few transparent screens to prevent excessive overtones from such powerful singers as Karl Ridderbusch and Gerd Nienstedt the final recording layout *in situ* worked very well in spite of the crowding on stage—Gedda on the conductor's right, the others in three trios, each to a music stand, on his left.

Until the last minute, conductor Rafael Kubelik had been suffering acute pain in the arm from rheumatism; you never would have known it from his equable manner throughout the two grueling days I witnessed. Though Kubelik has never conducted *Palestrina* in the theater, it is an opera he has long been fond of. Where else, he asks rhetorically, do you find an opera that deals with metaphysics? Resisting the temptation to ask what other composer would have wanted to put metaphysics on the stage (Pfitzner wrote his own libretto), I would just observe that this is plainly an opera that will work better on disc than in the house, though it *has* remained in the repertory in Vienna, Berlin, and Munich (scene of its 1917 world premiere).

Gedda has never sung Palestrina on stage, but he had recently sung the big Act I scene in concert in New York. It was an extra challenge to him that he finally recorded almost half his music in a single day. His scene before the Masters took up the first two of the three sessions in the day. I saw Kubelik analyzing a full take before his ten soloists, directing them like the most efficient of committee chairmen. In the Residenz, the DG engineers and artists have the advantage of a room of their own (a luxury virtually unknown to British engineers), and very comfortable it is—though with typical German thoroughness the central heating is so intense that even in winter the windows are usually wide open (until some singer worried about his throat surreptitiously closes them). The control panel is raised on a stage, and the two main loudspeakers were placed very precisely on lines of yellow tape stuck to the carpet. No one seemed to take much notice of two speakers behind the panel, but I cannot believe that quadraphony was being forgotten. On the playback, with all ears alert, we came to the place where Palestrina asks starrily: "When will the time come . . ." "At half past six," Karl Ridderbusch answered, eyes on the clock.

In fact the Masters were free well before then, and they departed like Wagner's Nurembergers rather than priests of Rome, shaking hands amiably with one another.

Gedda Outdoes Himself. Gedda was left on stage for the final hour's recording of the day, and there followed one of those occasions I love in the studio when impossible demands prompt artists to rise to their highest peak. Already Gedda had been the focus of the day's work, showing no signs of tiredness, but at this point he was asked to try his big meditation aria from Act I. His first attempt was more than creditable, but the second time through—with just seconds to spare before 6:30—had all the depth of concentration, a genuine sense of a master in meditation that had one hanging on the notes from whispered half-tone to full-throated fortissimo. Gedda was as delighted as Kubelik.

That left the following day for recording the opening scene of the opera, between Palestrina's son Ighino (soprano Helen Donath) and his favorite pupil Silla (mezzo Brigitte Fassbaender). It was uncanny in this long dialogue how often the women seemed to be echoing the music of Sophie and Octavian in *Rosenkavalier*. For all the difference of subject matter and Pfitzner's metaphysical preoccupation, the actual idiom of *Palestrina* could hardly be more secular, with only an occasional hint of polyphony.

Once again Kubelik's method was to rehearse in detail for the longest possible time and then do a complete take of an extended passage. In this instance it was a full eighty minutes before the recording light went on for the first time, but then, with the briefest pause in the middle, the take lasted well over twenty minutes. It was a tribute to everyone concerned that music so tricky in its rhythm and ensemble was played and sung so confidently at once. Fassbaender had one passage that in rehearsal kept worrying her, but with her superbly strong mezzo she finally polished it off.

And if anyone is wondering how Polydor can afford so expensive a set of sessions for such an opera (Fischer-Dieskau among others in the cast), the answer is that once again the Bavarian Radio has provided some of the money—a fruitful partnership. EDWARD GREENFIELD

LONDON

Margaret Price Takes Up Mozart's Gauntlet

It was good fortune that RCA's recording sessions with the young Welsh soprano Margaret Price came just before Covent Garden called her in at the last minute to take over as Fiordiligi in Mozart's *Così fan tutte*. In fact, though, she had already recorded the part complete (with Klemperer for EMI, reviewed in May 1973). But here RCA was challenging her still further, with the widest pos-

sible range of Mozart arias: three from *Figaro* (one each of the Countess, Susanna, and Cherubino), Constanze's "Martern aller Arten" from *Die Entführung*, Elettra's "Idol mio" from *Idomeneo*, Anna's "Non mi dir" from *Don Giovanni*, as well as arias from *Il Re pastore*, *Mitridate*, and *La Clemenza di Tito*.

Price—whom I have long considered one of the clear candidates among British singers for international acclaim—is the opposite of temperamental. Listening to her playbacks, she studied her achievement each time with the coolness of a practiced recording artist, happily taking surprisingly sharp criticism from conductor James Lockhart, who has

played an important part in her success so far. They would discuss in detail what pointing should be given to a particular ornament, judging the result each time with clinical care.

I went to the EMI studio on the third of three days of intensive work, but Price was still as fresh as ever, completely undaunted by the terrors of "Non mi dir." Shoulders back, hands on hips—the look was stalwart to say the least—she ran through her final take, and only when at one point she came perilously near to running out of breath (or so she told us afterward) did her expression lose its phlegm and acquire the agonized look one knows so well with other singers. At

the end, the appreciative players of the English Chamber Orchestra rattled their bows enthusiastically on their stands in acknowledgment.

Previn's Shostakovich Cycle. For EMI, the most active conductor of recent months has been André Previn—with British music to the fore. Sir William Walton was in England (his home is in Ischia) and he attended the sessions of his Second Symphony, a work that—as Previn appreciates all too well—was played supremely well on record by George Szell's Cleveland Orchestra. The coupling will be Walton's *Scapino Overture* and Constant Lambert's colorful jazz-inspired *Rio Grande*, a work that Walton has been urging on Previn for some time.

Previn and his wife, Mia Farrow, have also been recording together. The actress came to the studio to narrate Prokofiev's *Peter and the Wolf*. The coupling will be the usual: Britten's *Young Person's Guide to the Orchestra*. But this time the speaker—in a narrative slightly amended, with the composer's approval—is Previn himself. He recorded the narration not only in English but in French and German too. Being born in Berlin and passing through Paris on his way to an American education obviously proved useful.

Of all the new Previn recordings the most important is Shostakovich's Eighth Symphony—still absurdly neglected, even though in London it has now become a repertory favorite with a specialized audience. Immediately before the EMI studio sessions Previn had directed the LSO in a dedicated performance at the Royal Festival Hall. There were slight but conscious differences: For example, Previn attempted a tempo for the scherzo which, as he said, he would never have dared in a live concert. Howard Snell, the orchestra's virtuoso first trumpet (and the self-governing orchestra's chairman) was lip-perfect, announcing afterward, "It wasn't too difficult." Ultimately those who faced the worst problems were not the musicians but the engineers, who had to cope with the brutal fortissimos, which Previn wanted to make as cutting as possible in contrast with the "gray ice" of the Passacaglia. The transfer engineers may have even worse problems fitting the tape on two LP sides, what with a first movement lasting twenty-five minutes, a second movement lasting six, and the last three (continuous) movements totting up to more than half an hour—with fortissimos in all the most difficult places. But they are confident of squeezing the result in the most sensible way onto two sides. This incidentally is planned as the first installment of a complete Shostakovich symphony cycle from Previn and the LSO. E.G.

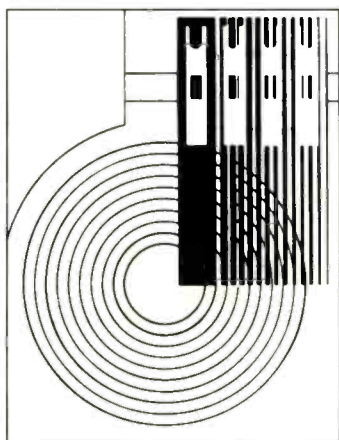

We've got the best anti-skating device ever... none at all

Master records are made by machines that drive the cutting head *in a straight line* across the record. But when you play *your* disc with a conventional pivoted arm system, the revolving groove pulls the stylus towards the center. This is called, "skating force."

Skating force causes wear on the inner wall of the groove and the stylus, and results in a loss of separation as well as distortion levels simply not acceptable to the serious listener.

Most good pivoted arm systems *do* have anti-skating devices. But they can only be set for "average" skating force... and an anti-skating device that remains *constant* cannot fully compensate for all of the *varying* forces exerted during the playing of a record. Even the *total* elimination of tracking error does not eliminate the *inherent* problem of the pivoted arm — skating force.

The RABCO pickup moves in a straight line. The record is played precisely as it was originally cut. There is no anti-skating device for one simple reason: The RABCO system eliminates skating force.

We want to tell you more about how we eliminate both skating force *and* tracking error. Drop us a note and we'll send full information straight away.



The RABCO SL-8E
A straight tracking tone arm for your turntable



The RABCO ST-4...
A professional turntable with the RABCO tone arm system

RABCO

A division of Jervis Corporation

DEPT H
55 Ames Court
Plainview, New York 11803

CIRCLE 44 ON READER-SERVICE CARD

Here's your **FREE**

HIGH FIDELITY

“at home” shopping service!



It's easy! All you do is use the Reader Service card at right . . .

HIGH FIDELITY's Reader Service Department will take it from there. It's as simple as 1, 2, 3!

1 Just circle the number on the card that matches the number below the ad or editorial mention that interests you.

You'll also find the key numbers for advertised products in the Advertiser's Index.

2 Then type or print your name and address. Don't forget your zip code, it's important!

3 Drop the card into the mail. No postage is needed if mailed in the United States.

You'll receive literature, colorful brochures and specifications about the products that interest you . . . free and without obligation!

Subscribe today by filling out the subscription order card on the reverse side of this page.

First Class
Permit No. 111
Cincinnati, Ohio

BUSINESS REPLY MAIL

No postage stamp necessary if mailed in the United States

Postage will be paid by —

HIGH FIDELITY

Subscription Dept. 73
P.O. Box 14156
Cincinnati, Ohio 45214



1	2	3	4	5	6	7	8	9	10	11	12	13	14	15
16	17	18	19	20	21	22	23	24	25	26	27	28	29	30
31	32	33	34	35	36	37	38	39	40	41	42	43	44	45
46	47	48	49	50	51	52	53	54	55	56	57	58	59	60
61	62	63	64	65	66	67	68	69	70	71	72	73	74	75
76	77	78	79	80	81	82	83	84	85	86	87	88	89	90
91	92	93	94	95	96	97	98	99	100	101	102	103	104	105
106	107	108	109	110	111	112	113	114	115	116	117	118	119	120
121	122	123	124	125	126	127	128	129	130	131	132	133	134	135
136	137	138	139	140	141	142	143	144	145	146	147	148	149	150
151	152	153	154	155	156	157	158	159	160	161	162	163	164	165

Please circle # 165 for information about the High Fidelity Annuals.

NAME _____

ADDRESS _____

CITY _____ STATE _____ ZIP _____

I am a subscriber I am not a subscriber

7 8

USE THIS POSTAGE-FREE CARD TO

DOUBLE

**YOUR LISTENING
AND READING ENJOYMENT**

Now you can enjoy
the best in both musical
worlds — in one colorful magazine:
HIGH FIDELITY/MUSICAL AMERICA.

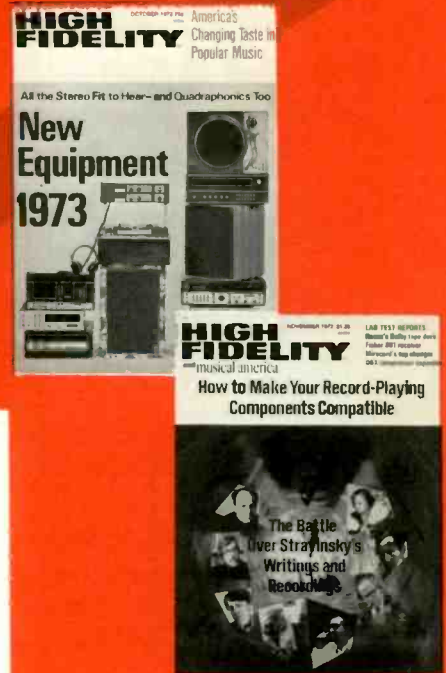

SUBSCRIPTION ORDER FORM

- Please enter a one year subscription to HIGH FIDELITY/MUSICAL AMERICA in my name. I'll receive 12 issues of HIGH FIDELITY, plus about 32 pages per issue of news and reviews of important musical happenings throughout the world — concert, opera, etc. — for only \$14.
- Please enter my subscription to HIGH FIDELITY only. I want to take advantage of your special offer of 15 issues for only \$9.47.
 - New Subscription Payment enclosed
 - Renewal Bill me

Name _____

Address _____

City _____ State _____ Zip Code _____

For postage outside U.S.A., Possessions: Add \$1.00 for HIGH FIDELITY/MUSICAL AMERICA subscription (12 months); add \$2.00 for HIGH FIDELITY subscription (15 months).



First Class
Permit No. 111
Cincinnati, Ohio

BUSINESS REPLY MAIL
No postage stamp necessary if mailed in the United States

Postage will be paid by —

HIGH FIDELITY

Reader Service 73
P.O. Box 14306
Annex Station
Cincinnati, Ohio 45214



For the full story of music and music makers today, be sure to include MUSICAL AMERICA as part of your HIGH FIDELITY subscription.

In 32 sparkling pages, MUSICAL AMERICA covers the live musical scene *completely*. You'll get news, reviews and reports of important musical events all over the world — written by critics who know the score and how to write about it with wit as well as authority. You'll meet today's outstanding conductors, composers and performers... learn how they work and live... what they think and say about music — and about each other.

MUSICAL AMERICA adds a new dimension to HIGH FIDELITY — and to your enjoyment of music. Use the postage-free card to start copies coming your way regularly.

(MUSICAL AMERICA is available only by subscription... and only with HIGH FIDELITY. It is not sold on newsstands. Another important reason for you to use the subscription card now.)

Your records represent a major investment. Does your record player protect it?

According to surveys by the major music magazines, the average music lover owns more than 200 records.

If you're typical, a little math will tell you that your record collection has already cost you over a thousand dollars. And will cost even more as you continue to buy records.

With that much money involved, it's certainly worth your while to consider how to protect that investment. Especially since the soft vinyl record is so vulnerable to permanent damage from the unyielding hardness of the diamond-tipped stylus.

What can do the damage.

As soon as the stylus touches down in the groove, a running battle begins. The rapidly changing contours of the record groove force the stylus to move up, down and sideways at great speeds. To reproduce a piccolo, for example, the stylus must vibrate about fifteen thousand times a second.

The battle is a very uneven one. If the stylus can't respond easily and accurately, there's trouble. Especially with the sharp and fragile curves which produce the high frequencies. Instead of going around these peaks, the stylus will simply lop them off. The record looks unchanged, but with those little bits of vinyl go the lovely high notes.

It's all up to the tonearm.

Actually, no damage need occur. Your records can continue to sound new every time you play them.

It all depends on the tonearm, which is to the stylus as the surgeon's hand is to the scalpel.

Basically the tonearm has just three jobs to perform. It must apply just the right amount of pressure to the stylus, keep this pressure equal on both walls of the groove, and follow the stylus without resistance as the groove spirals inward.

Today's finest cartridges are designed to track optimally at very low pressures (one gram or less). So you can appreciate how important it is for the tonearm settings to be accurate and dependable. And for the friction in the bearings to be extremely low.

Yet the difference in cost between a turntable with a precision-balanced tonearm and one with a less refined tonearm can be as little as \$50. (The cost of only a dozen records.)

Dual: The choice of serious record collectors.

For these reasons and others, Dual automatic turntables have long been the choice of serious music lovers.

And for years, readers of the leading music magazines have bought more Duals than any other make of quality turntable.

We think these are impressive endorsements of Dual quality. But if you

would like to know what independent test labs say about Dual, we'll send you complete reprints of their reports. Plus an article on what you should look for in record playing equipment.

Or, if you feel ready to invest in a Dual, just visit your franchised United Audio dealer for a demonstration. The dividends will start immediately.

How Dual protects your records.



The tonearms of the Dual 1218 and 1229 are mounted in gyroscopic gimbals, the best known scientific means for balancing a precision instrument that must remain balanced in all planes of motion.

Unlike conventional tonearms, the 1218 and 1229 track records at the original cutting angle. The 1229 tonearm parallels single records; moves up to parallel charger stack. In the 1218, a similar adjustment is provided in the cartridge housing.

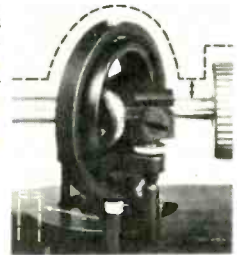

In all Dual models, stylus pressure is applied around the pivot, maintaining perfect dynamic balance of the tonearm.

For perfect tracking balance in each wall of the stereo groove, separate anti-skating calibrations for conical and elliptical styli are provided on all Duals.



United Audio Products, Inc., 120 So. Columbus Ave., Mt. Vernon, N.Y. 10553

Exclusive U.S. Distribution Agency for Dual
CIRCLE 14 ON READER-SERVICE CARD

the lees side

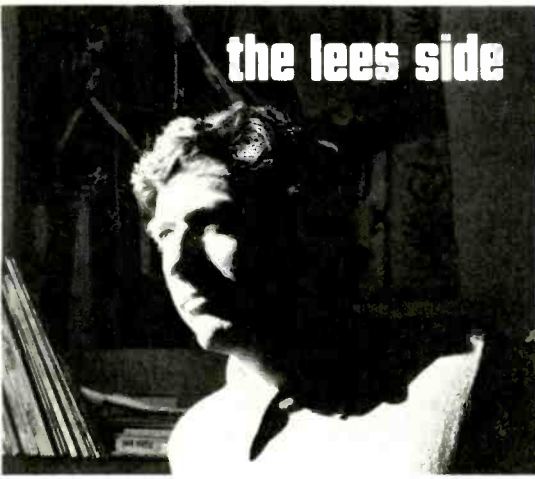

You Want U.S. Jazz Records? Try Toronto

THE ADDRESS—893 Yonge St., Toronto 5, Canada—has become known to jazz fans all over the world.

It is famous for three things: It is the home of the Sackville record label; it is the address of the Jazz and Blues Record Center; and it is the home of *Coda* magazine, a small publication (present circulation: 2,800) whose influence is out of all proportion to its size. Perhaps one should say it is famous for four things: It's also the business address of John Norris, instigator and proprietor of the aforesaid three enterprises. For jazz fans and many musicians, Norris has emerged in recent years as some sort of saint. Yet few of them know anything about him.

Norris, a six-foot, youthful thirty-nine-year-old Englishman with reddish brown hair, persisted in believing in the music even during the 1960s—"the dark time," as Oscar Peterson calls it. And now *Coda*, his nonprofit (it solicits no advertising) labor of love, is picking up about another 100 readers a month as people discover it in hotbeds of jazz like Japan. His record store—his only real source of income—is handling mail orders from all over North America and Europe; and the Sackville label, which recently issued the Jay McShann *Man from Muskogee* album that so impressed John S. Wilson in the May issue of this magazine, is starting to thrive.

"More and more people are coming to our store from the States," Norris says, taking a breath after returning from a trip to Canadian Customs, where he had extricated several boxes of American jazz albums from the toils of the bureaucrats. Ironically, many of them will promptly be mailed back south to jazz fans who can't find them in their local shops. "That's a total reversal of the situation when I came to Canada in 1956. I

used to go to New York to shop at the Jazz Record Center.

"When you have people in New York spending \$100 a month—one man spends about \$150—to buy jazz records from us in Toronto, you can see what the situation is in the American record industry.

"Besides our mail-order business, we have more and more people who make detours on their vacations to come into the shop."

Norris is disgusted by the way American record companies have treated major American artists. When Norris' little company has to bring the legendary Jay McShann to Toronto from Kansas City to make his first album in years, the industry's irresponsibility toward American music leaps into sharp relief. Nor is the Norris example the only one: Many American jazz artists, unable to get contracts at home, record for the MPS label in Germany. (The Jay McShann album, by the way, was made in four-and-a-half hours, and is every bit as good as John Wilson said it is.)

"There is definitely a jazz revival," Norris continues. "But right now, it's a revival only in the sense that we're selling a lot of jazz records and an incredible number of young people want to know about and understand jazz. It is *not* a revival in the sense that there's more work for musicians. There aren't enough jazz nightclubs, and the big labels haven't caught on to what's happening.

"When Stan Getz was here a few weeks ago, it was mostly young people who went to hear him. More than half the people who come into our store are under thirty, and many are under twenty.

"But it's hard to translate this into something that's going to benefit everybody, because radio, television, and the record industry are still ignoring it. Most of the people I know in the business privately like jazz, but they say 'Jazz doesn't sell.' Well it *does*, when it gets the chance.

"When television occasionally does try to present jazz, they screw it up. There have been two classic examples in the last year. One of them was the "Lionel Hampton and Friends" special, which was done here in Toronto. It was a diabolical disaster. They booked so many people, nobody got a chance to play. The other was that recent Duke Ellington special which, as far as I was concerned, was a black Ed Sullivan show. All that saved it was the quality of the singers and the fact that they sang Duke Ellington songs."

What is the answer? Norris doesn't know. But he knows what isn't the answer. So far, he has resisted offers from American labels to distribute Sackville. "We tried that once and it didn't work. We find we're better off shipping directly to independent distributors, and working through mail order.

"Look at this Jay McShann record. It has the potential to be a monster album, if it's handled right. But the big corporations don't have the foggiest idea what jazz is. The problem in the States is getting the music to the people who want to buy it."

Norris got hooked on jazz when he was a teenager, first by hearing imitation jazz on the radio, and then by seeing the movie *New Orleans*, with Louis Armstrong and Billie Holiday. "The next day I went out and bought my first jazz record. I was seventeen."

Norris eventually went to work for the Shell Oil Company in London. "I got bored. I couldn't see myself getting to be forty and living like all those people in Croydon, henpecked and phoning their wives every day to talk about the groceries. I had a chance to go to work in the colonies for Shell, but I couldn't see myself as the pukka sahib, either. So I thought about emigrating to Canada or Australia. I chose Canada because, if I hated it, it would be cheaper to get home than from Australia, and because Canada was right next to the United States and all that great jazz." He reached Canada with his record collection and \$300—which he promptly spent on a record player. Now, seventeen years later, he has lost most of his English accent but none of his passion for jazz.

Does it cause problems with his wife? A slow smile. "Well, it's all right. It's more than my business, it's my avocation. It's more than my living, it's my life. As soon as I come home, I put a record on."

Norris worked for the government for a while, then for Sam Sneiderman's Sam-the-Record-Man shop, one of the world's biggest record retailers—Sneiderman claims it's *the* biggest. Norris stayed there eight years. "It was an invaluable apprenticeship," he says. "I don't think most jazz fans could run a record shop." Again a smile: "They'd order all the wrong things."

Somehow he survived the '60s, subsidizing *Coda* from his own pocket, running his little record shop, building up his mail-order business in the U.S. and Europe, writing an occasional article for American musical publications, pushing for jazz, inspiring the love of older and neglected jazzmen whom he recorded (again, it was usually at a loss) on Sackville to the annoyance of the big labels he kept bugging to put out more jazz. For the heavyweight record executives in New York, he was just that nut in Toronto who doesn't *understand* this business, man.

Well he did, and he does, and another cycle of history has turned, and if there's a quiet arrogance in the eyes of John Norris, he has a right to it. He's one of the people who never sold out, and now it's paying off. GENE LEES

The 400 millisecond miracle.



Most people seem to take for granted the smooth, effortless way in which a Revox works.

And that is as it should be.

For a great deal of time, effort and sophisticated engineering have gone into translating extremely complex function into lightning quick, responsive operation.

For example, when you press the play button of a Revox, you set in motion a sequence of events that take place with the precision of a rocket launching.

It begins with a gold plated contact strip that moves to close two sections of the transport control circuit board.

Instantaneously, the logic is checked for permissibility. If acceptable, a relay is activated.

Within 15 milliseconds, power is supplied to the pinch roller solenoid, the brake solenoid, the back tension motor, a second relay and, at the same time, the photocell is checked for the presence of tape. If present, Relay One self-holds.

Elapsed time, 25 milliseconds.

At 30 milliseconds, Relay Two closes and puts accelerating tension

on the take-up motor.

The logic checks are now complete and power is available to actuate all necessary functions.

From 30 milliseconds to 300 milliseconds, mechanical inertia is being overcome and the motors and solenoids are settling down.

By 300 milliseconds, the brakes have been released, the pinch roller is in contact with the capstan shaft, the tape lifter retracted, the playback muting removed and the motors have come up to operating speed.

At 350 milliseconds power is cut off from Relay Two, which changes over to another set of contacts, releasing the accelerating tension on the take-up motor and completing a circuit through Relay One that, in turn, restores normal tension to the take-up motor.

Total elapsed time, 400 milliseconds. The Revox is now in the play mode.

And it's all happened in a fraction of the time it takes to read this sentence.

The 400 millisecond miracle. **More proof that Revox delivers what all the rest only promise.**



Revox Corporation 155 Michael Drive, Syosset, N.Y. 11791. Calif.: 3637 Cahuenga Blvd. West, Hollywood 90068
England: C.E. Hammond & Co., Ltd., Lamb House, Chiswick, London W4 2PB. Available in Canada.

CIRCLE 47 ON READER-SERVICE CARD



too hot to handle

It's a shock to see old 3M copying upstart Memorex's plastic boxes for open-reel tapes. They look nice, but do they offer any practical advantages?—F. E. Lowell, Milwaukee, Wis.

Let's put it this way. Originally 3M had a cardboard box with lots of writing space that would take a pencil (and could be erased cleanly), a ballpoint, or whatever. Inside was a length of tape on a sturdy plastic reel. Later on 3M added shrinkwrap to the outside. Then Memorex came along with a plastic box that offered little writing space, even if you could find a writing implement that would take on the silver paper. (Memorex's new silver paper will accept a variety of implements, though erasures smudge.) Inside, wrapped in a plastic bag that simply had to be thrown out, was a handsome, sturdy reel filled with tape that had leader already attached to protect tape ends. Outside was a fancy printed (including tape-type designation) plastic wrap that you had to discard to get at the tape. Now 3M has a plastic box that offers little writing space (though it does specify the tape type) and smudges when you erase. Inside, wrapped in a plastic bag that simply has to be thrown out, is a handsome, sturdy reel filled with tape that has leader already attached to protect the tape ends. Outside is a fancy printed plastic wrap that you have to discard to get at the tape. We find we fumbled a bit less in opening the 3M box because it has an obvious finger hole at the top of the hinged edge; the sides of this finger hole tend to break off in shipping, however, unless the reel is carefully packed. Neither plastic box will get mashed or split at the hinge the way the cardboard boxes did in heavy wear. The leader certainly is a plus. Outside of that we're hard put to find ways in which the new can unequivocally be called improved.

A letter from a Mr. Simpson [THTH, April 1973] complained of a chronic output transistor failure in his Sansui 5000 receiver. My own is in the shop for the same problem. Two reputable Minneapolis dealers tell me this is a common failure in this receiver and that to solve it Sansui has replaced the driver amplifier boards (F-1040-1A in the original model) with new ones (marked F-6013). The first dealer said he would not warranty his repair unless he were to replace the board in question plus the output transistors in that channel at an additional \$27.50. He also recommended that I replace the board in the other channel before it caused a similar failure. The

second dealer—from whom I bought the receiver in June 1971—said my unit was still within its two-year warranty and replaced both circuit boards plus the blown transistors free.—Paul Schelin, Minneapolis, Minn.

As you pointed out, Sansui has a good track record on reliability. But the problem with the 5000 is not due to excessive heat alone; the output driver boards are unstable under temperature and load (impedance) variations. Mr. Simpson's problem will keep recurring unless both driver boards are replaced with the Improved version, which is available to owners of the 5000 through authorized Sansui service stations at \$13.66 each plus labor. I know of several 5000s whose output transistors failed, and the new boards always have taken care of the problem.—R. E. Bulkeley, Columbus, Ohio.

Our thanks to readers Schelin and Bulkeley (and several others) for their interest in Mr. Simpson's woes.

Your report on the Sony PS-5520 turntable [January 1973] is very accurate. However the unit does have some human-engineering flaws that your readers should have been told about. The dust cover is hinged and requires about 15 inches of clearance above the baseplate for full opening, and scarcely less if it is to be opened far enough to stay up by itself. And there is no locking device to secure the arm and prevent stylus damage during dusting, tracking-force adjustment, stylus cleaning, and similar operations. For similar reasons I must complain of your report on the Rus-sound SWB-2 Multi-Play speaker selector [December 1972]. The screw terminals on the back are so close that one has to be extremely careful to keep leads from touching and shorting, even in using spade lugs.—Paul Seydor, Iowa City, Iowa.

The back panel of the SWB-2 is useless because the terminals are unidentified.—Ralph A. Sindler, Corpus Christi, Tex.

Mr. Sindler, meet Mr. Seydor. You both have worked with the same unit, but have different objections to it. All the objections cited strike us as valid, and we do make mention of such things in our reports if we feel they are significant and unexpected. The speaker terminals on much of the equipment we see can be shorted by sloppy wiring; we felt the SWB-2 required no more than normal care in this respect. Similarly it seemed obvious to us how the leads were to be attached, even though the terminals are unmarked, since the lineup

mirrors the front-panel switching. Arm locks have become increasingly common in recent years, and perhaps it is time that we began to consider the omission—rather than the provision—as requiring comment. And large minimum vertical clearance is to be expected with hinged dust covers. It's true that there are alternatives—dust covers that can be slid forward, for example—but we have found them to present their own problems (the need for space to set down a removable cover, for example) that give them no clear advantage over the common hinged type. But we thank both gentlemen for their comments, since they help us know what specifics interest our readers. As a matter of fact we're now making it a policy to state what sort of leads are best suited to the screw terminals, binding posts, and spring clips on the equipment we test. For the SWB-2 we'd suggest bare wires or *small* spade lugs.

Your cassette tape reports [March 1973] don't make it clear whether there is any difference between brands of tape in minimizing speed variations. Does Scotch's Posi-Trak backing help at all?—Donald S. Deitch, New York, N.Y.

Cassette design most certainly does contribute to motional stability, but the difference in results depends not only on the cassette but on the recorder as well. For this reason every tape plant we visit these days shows us tests being run on its cassettes with a wide variety of commercially available equipment. So while Posi-Trak's contributions to motional stability can be demonstrated in the laboratory, there's no guarantee that its advantages will be audible (or even measurable) with the particular equipment you happen to use with it.

I'm very much impressed with four-channel sound. For my money (about \$500) which system is the best to buy? I want a receiver with AM and FM, a turntable, and the four speakers. A tape deck could be purchased later. Please don't give me a negative answer.—James Ryba, Chicago, Ill.

We're tempted to give you a rude one, as a matter of fact. While understandable, the desire for a nice pat answer to such a question is utterly unrealistic. For one thing it would require a long list of specifics about your listening room, your tastes, your listening habits, your sophistication in audio matters, and—most important—the way quadrasonics will shape up over the next few years. Since quadrasonics is so young and volatile we don't believe the time has yet come when you can buy a single quadrasonic system and expect it to remain appropriate indefinitely. You probably would be better off if you planned to convert to quadrasonics over a period of years, counting some of your purchases as interim units that probably will be retired before too long. (Figure, for example, that a \$50 decoder you use for two years will have cost you about \$2.00 per month.) Our recommendation is that you look for low price in the "temporary" units and versatility and adaptability in the more expensive ones.

Can you live without a 400 watt amplifier?

Maybe. If you're content to listen to music at a less than realistic level. Or if you don't mind the loss of quality caused by clipping during the more dramatic passages in your favorite records. On the other hand, if you want to listen at a real-life level without distortion, you need at least 400 watts of amplifier power. Other things being equal, the more power you have to drive those fine speakers, the more faithful the sound. Julian Hirsch put it this way: "Anyone using a low-efficiency speaker . . . with an amplifier in the 30 to 50 watt class cannot approach realistic listening levels without severe clipping." And *Audio*, after listening to the Phase Linear 400, said, ". . . many people do not realize just how much power is necessary to handle peaks without clipping . . ."

Stereo Review summed up: "A superb amplifier, furnishing the essential qualities of the (Phase Linear) Model 700 at a much lower price (almost a bargain in today's market)."



Advanced design heat sink provides protective cooling.

At \$499.00 why live with anything less than the Phase Linear 400? Ask your dealer for an audition.

Phase Linear 400

THE POWERFUL DIFFERENCE

PHASE LINEAR CORPORATION
P.O. BOX 549
EDMONDS, WASHINGTON 98020

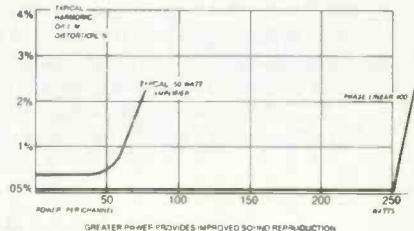

Phase Linear 400

400 watts RMS direct coupled solid state stereo power amplifier.

POWER: Greater than 200 watts/channel RMS both channels driven into 8 ohms. Power at clipping typically 250 watts/channel into 8 ohms and 400 watts/channel RMS into 4 ohms. **HARMONIC OR I.M. DISTORTION:** Less than .25%; typically less than .05%.

PROTECTION: Patented protection circuit monitors energy, shuts down amplifier if safe operating levels are exceeded. **HUM AND NOISE:** Better than 100 db below 200 watts.

STABILITY: Absolutely stable with all speaker loads including electrostatic units. **WARRANTY:** Three years, parts and labor.

PRICE: \$499.00

WALNUT CABINET: \$37.00.

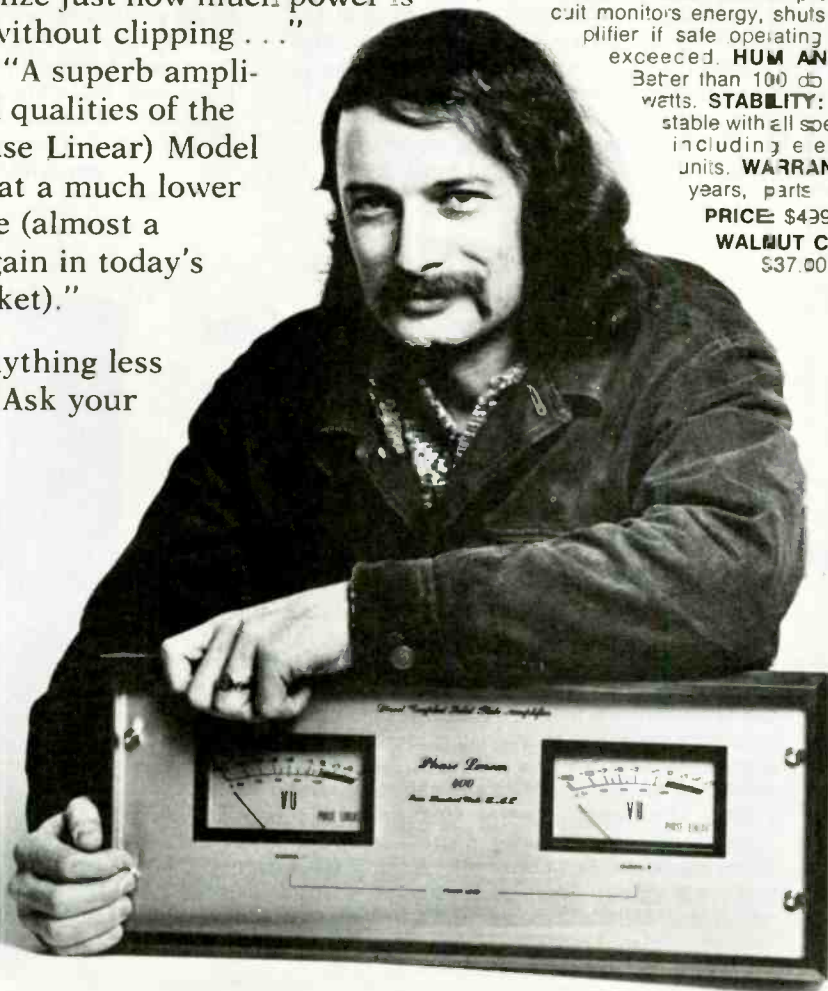

State of the Art—for 78s Too

While the April issue—which featured an article on playing 78s with modern stereo equipment—was on its way to newsstands and subscribers, we were on our way to visit Shure Bros. in Illinois. Readers of that article may remember that we mentioned (not without a certain astonishment) that International Observatory Instruments was preparing an *elliptical* stylus (to be used in the Shure M-44 cartridge) for optimum playback of the wide-range signals to be found in late 78s such as DG's Variable Micrograde and London/Decca's frr's. We didn't expect more news on this front so soon.

But in a press conference called by Shure to introduce the V-15 Type III (see test report in this issue) we

were told that some time this spring—namely, by the time you read this—the company expects to have available the \$28 VN78E biradial replacement stylus for the Type III, with tip radii of 0.5 and 2.5 mils, for playing 78s. The stylus mount includes a weight that automatically converts tracking force from the normal range (0.75) to 1.25 grams) to the one (1.5 to 3.0 grams) required for tracking 78s.

The news of elliptical diamond tips being readied for the playing of discs that are, technically speaking, some twenty years out of date is striking enough. But word of a tip for a brand new state-of-the-art cartridge—a class of cartridge for which we seldom have been able to buy any type of 78 stylus in recent years—is close to incredible.

CIRCLE 151 ON READER-SERVICE CARD

Sony's New SQ ICs—Cutting the Cost of Full Logic

Sony Corp. has introduced three integrated circuits it says will result in lower production costs, simplified adjustments, and increased reliability for SQ four-channel equipment. The chips have resulted in reduction by at least 80 per cent in the size of the SQ decoder section and from fourteen to two in the number of adjustment points.

The SQ ICs (which are manufactured by Sony in Japan, rather than imported from the U.S. as has been common among Japanese equipment manufacturers) comprise the CX-050 basic decoder, the CX-049 full-logic chip, and the CX-718 gain-logic chip. Sony says the CX-050 also functions as an RM decoder and recommends the use of one CX-049 and two CX-718s in

professional full-logic SQ decoders. About 100,000 chips will be produced each month, with marketing to SQ hardware licensees beginning this fall.

Most important is the projected cost of the ICs—about \$10 per set of three—which could reduce the cost of SQ equipment by an equal amount. This in turn could bring full-logic SQ capability in range for receiver manufacturers who have chosen to maintain their price points by omitting logic. In addition the reduction in SQ chip price, coupled with the scheduled introduction of CD-4 chips, may mean that receivers with full quadraphonic capability will be available at little increase over current cost sooner than expected.

CIRCLE 150 ON READER-SERVICE CARD

TV with Stereo, of a Sort

The developing field of video tapes, cartridges, and cassettes has generally slighted sound as such. But now Videosonics of Milwaukee is offering a \$500 stereo console for tape equipment users as an alternative to the marginal audio resulting from the inexpensive amplifiers and speakers used in most TV sets.

The console is designed to hold a television receiver on its top shelf and a video tape player (whatever the format) up to 21 inches wide on its lower shelf. A combination amplifier/speaker unit is in the middle. Videosonics says the 6-by-9-inch speaker for each channel is driven by an amplifier section rated at 15 watts per channel continuous power. Both speaker and amplifier are rated for response to 18 kHz. (Audio bandwidth on videotape normally is restricted to about 12 kHz.) An auxiliary input is provided. As the speakers are less than 2½ feet apart, we would expect stereo separation to be limited at normal listening distances. Videosonics hardly seems to be thinking in terms of the current state of the stereo art. But it does offer a significant advancement in television audio by contrast to a typical TV set with 1 to 2 watts total power and a frequency response of some 100 to 3,500 Hz.

CIRCLE 152 ON READER-SERVICE CARD

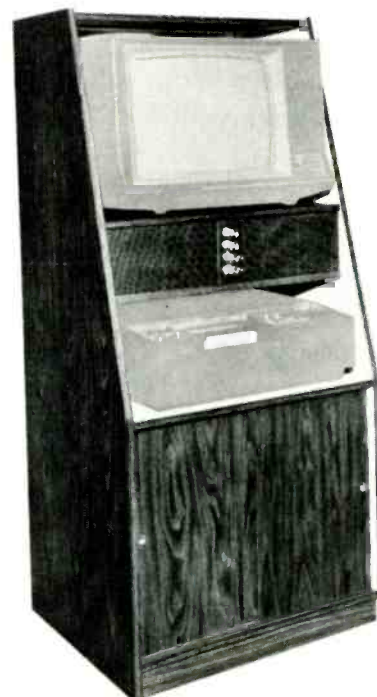

video topics

It shouldn't matter where a receiver is made. Especially one that has been as highly acclaimed as the Sherwood S-7900A, (AM/FM) and Sherwood S-8900A (FM only).

Except that with the dollar devaluation and the fluctuations of foreign currencies, you will notice that our competitors are increasing their prices. Making these receivers even better values.

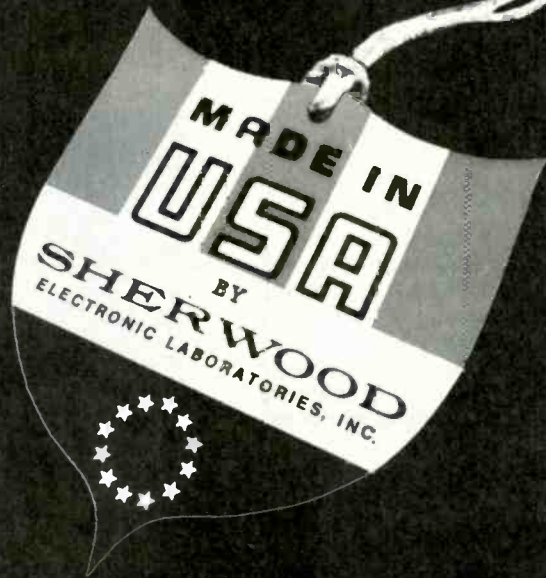

The S8900A
still \$429.95.

The S7900A
still \$459.95.



Direct coupled output circuitry with electronic relay protection.

Front panel four channel provision, (doubles as a second tape monitor).

Four gang tuning capacitor.

Solid state Ceramic FM IF Filtering.

Exclusive FM Inter-channel/side-band hush.

Built-in Dynaquad 4 channel matrix circuit.

Power Output (IHF): 280 watts total. RMS, (both channels driven) 60 watts x 2 @ 8 ohms, 20-20,000 Hz. @ 0.3% T.H.D.

FM Sensitivity (IHF) 1.7 uv (-30db noise & d.st.)

Capture Ratio: 1.9 db.

Alternate-Channel Selectivity 65 db.

Stereo Separation: 40 db. @ 1KHz

Sherwood

The word is getting around.

Sherwood Electronic Laboratories,
4300 North California Avenue,
Chicago, Illinois 60618

Video on an Audio Cassette?

Since it first came to this country, Panasonic has repeatedly demonstrated intriguing equipment prototypes, some of which eventually have reached production. (Remember the wait for the RF-60 FM headset?) The latest is a color video cassette player that utilizes a standard audio cassette.

The device, which looks like a quality cassette deck, displays a sequence of still pictures over a standard TV receiver. As many as 1,000 pictures may be recorded on a C-60 audio cassette. The video tracks (one per direction of tape travel) are between the stereo audio tracks for optimal audio/video synchronization. Pana-

sonic says it has designed the unit initially for educational use, though it might be adapted for home use.

In its current configuration, the unit will record and play audio, but will only play back video. Panasonic says it anticipates that recorded video cassettes for the unit would be available commercially. The still pictures are recorded in multiples of 3.6 seconds and are played back on the unit by a rotary head. Data on video signal-to-noise and horizontal resolution are not currently available. Panasonic also has no word on the cost or availability of the unit, although it "hopes to make a decision shortly."

equipment in the news

Nakamichi to announce second cassette deck

Although the new 700 cassette deck from Nakamichi Research Inc. has somewhat fewer features than the company's 1000 model (see "News and Views," May 1973), it still provides just about everything a user could want. Among its many features are a dual-motor drive system, solenoid-action feather-touch controls that include a timing-logic system, three heads (erase, recording, playback/monitor), an azimuth alignment system for the record head, peak-reading meters, and Dolby-B noise reduction system. The unit accommodates ferric oxide or chromium dioxide tapes and is priced at about \$700.

CIRCLE 153 ON READER-SERVICE CARD



A speaker kit from Radio Shack

If you have a screwdriver, pliers, and a soldering iron, you have what it takes to build the Archerkit speaker system kit from Radio Shack. The unit is a three-way system with a 10-inch woofer, a 6-inch cone midrange, a 3/4-inch tweeter, and electrical crossover in a bass-reflex type enclosure made of 3/4-inch hardwood. Rated impedance is 8 ohms, response is given as 40 Hz to 18 kHz, and power capacity is said to be 40 watts peak. The kit costs \$49.95 including walnut finishing oil.

CIRCLE 154 ON READER-SERVICE CARD



United Audio offers its lowest-priced changer

At \$109.50, the Dual 1214 from United Audio Products, Inc., is that company's lowest-priced model, but it still offers many attractive features: high-torque constant-speed motor, 6% (nominal $\pm 3\%$) pitch-control, silicone-damped cue-control, and elevator-action changer spindle. The low mass counterbalanced tone arm with low friction pivot bearings can track as low as 1 1/4 grams. A built-in adjustable antiskating system is preset at the factory for use with the most popular cartridges. Dust covers and bases are optional.

CIRCLE 155 ON READER-SERVICE CARD



There really is a difference

If you think that *most* cassette decks look alike... you're right.

If you think that *most* cassette decks are alike... you're right again.

But there is one so different that it defies comparison. And you can own one for no more than the "look-alikes."

There are a lot of technical similarities, but *only* AKAI gives you the incredible GX (glass and crystal ferrite) head. A head so remarkable that it is virtually wear free... Its low-noise single crystal and glass coated surface make it dust-free too. And its high frequency response is completely superior to any other head on the market today.

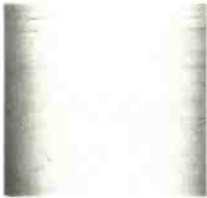
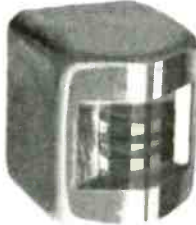

AKAI GX head after 500 hrs.

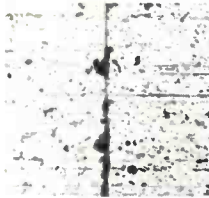

Pressed-Ferrite head after 500 hrs.

Low frequency noise and high frequency distortion are characteristic of the low tape speed of cassette players (1-7/8 ips). That's why professional reel-to-reel recordings are usually made at 15 inches per second. The Dolby® system provided the answer to low frequency noise. (Of course, we use Dolby too.) But *only* AKAI's exclusive ADRS system provides the means to eliminate *almost all* high frequency distortion over 8 KHz.



Without ADRS

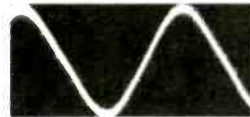

With ADRS

It all adds up to the *real* difference in fine tape equipment... GX heads, ADRS and Dolby. No one else gives you all three. Why settle for less than the best?

Listen to the AKAI GXC-46D. It may *look* similar... but you get so much more.

"Dolby" Is a Trade Mark of Dolby Laboratories, Inc.

And you don't have to be an engineer to understand it

From

AKAI™

The Innovators

AKAI America, Ltd./P.O. Box 55055,
Los Angeles, California 90055



CIRCLE 3 ON READER-SERVICE CARD

equipment in the news

Continued from page 26.

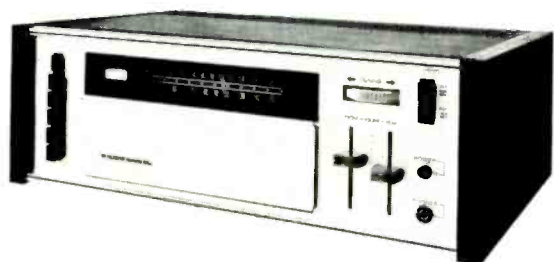

The Oratorio four-channel receiver

Teledyne Packard Bell has a new unit for the quadraphonic era—the Oratorio R30402 receiver. The company rates the unit's power at 30 continuous or "RMS" watts per channel into 8-ohm loads. The Oratorio also has a BTL switch which Teledyne says provides extra two-channel stereo power (better than 60 watts each into 8 ohms with two channels driven). Other features include pushbutton program selectors, blackout slide-rule dial, and a tilt-out panel housing tone, filter balance loudness, and output muting controls. The unit is priced at \$499.95.

CIRCLE 156 ON READER-SERVICE CARD

A timer for tapers

Timekeeper, of Great Neck, N.Y., calls its tape timer the T-1 Electronic StopClock—a good name. It's intended to rival the elaborate (and expensive) timing equipment that is used in professional studios, but at a price that may appeal to the amateur tape enthusiast. At \$185 it isn't cheap, but it has a handsome wood-grained case and reads—digitally—in minutes (up to 60), seconds, and tenths of seconds. The light-up controls, on a 15-foot extension, are for go, stop, and reset.

CIRCLE 157 ON READER-SERVICE CARD

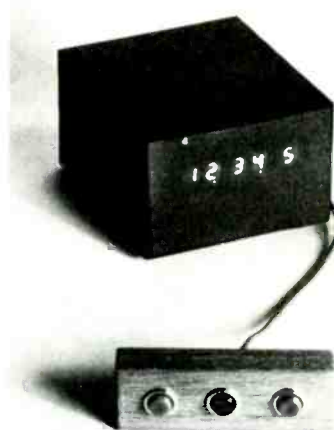

BSR deluxes its 8-track player

With the addition of an output level control so that tape volume can be matched to other inputs in a stereo system and a walnut-grained cabinet with brushed metal front panel, BSR has created the TD8SW, a deluxe version of its TD8S 8-track cartridge player. The TD8SW is designed with the tape head mounted on a stepping cam, a system said to minimize crosstalk from adjacent tracks. The price is \$59.95.

CIRCLE 158 ON READER-SERVICE CARD

Looks like a mirror, sounds like stereo

The eight-sided TT-8 from Backstrom, Inc., contains two chambers that reproduce separate stereo channels. Each chamber contains, according to the company, four rubber-edged speaker elements that deliver bass, midrange, and treble up to 8 kHz. Also included (behind the mirrorlike, chrome-plated dome on the front of the speaker) are four tweeters. When the speaker is mounted on the wall or ceiling, the chambers project the sound in opposite directions so that it can be reflected from other walls and furniture. The price is about \$400.

CIRCLE 159 ON READER-SERVICE CARD



We can warranty our components for five years. Because we know what's inside them.

Dependable stereo performance depends in great part on the parts that make up each component.

In order to give you the longest warranty* in the stereo industry Yamaha engineers had to feel confident in the reliability of all the various parts that go into our many audio products.

They had good reason to feel confident.

Because we make more of our own parts than other stereo companies. We mill our own trees for the cabinet-wood.

We actually make the machinery that forms our chassis and other metalwork.

We make the magnets for our speakers. We make these under stringent conditions, in our own facilities.

The result is stereo that can be warranted for five years on parts, three on labor.

And some very clear, natural sounding reproduction from our receivers, amplifiers, tuners, speakers, turntables and tape decks.

Come hear them at your nearest Yamaha stereo dealer.

YAMAHA

We know what's inside.

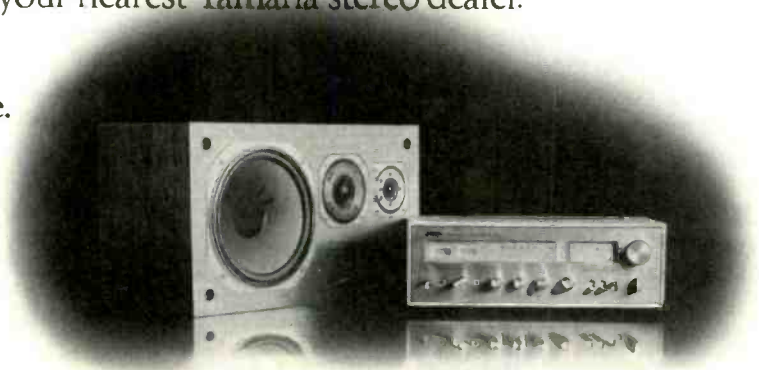
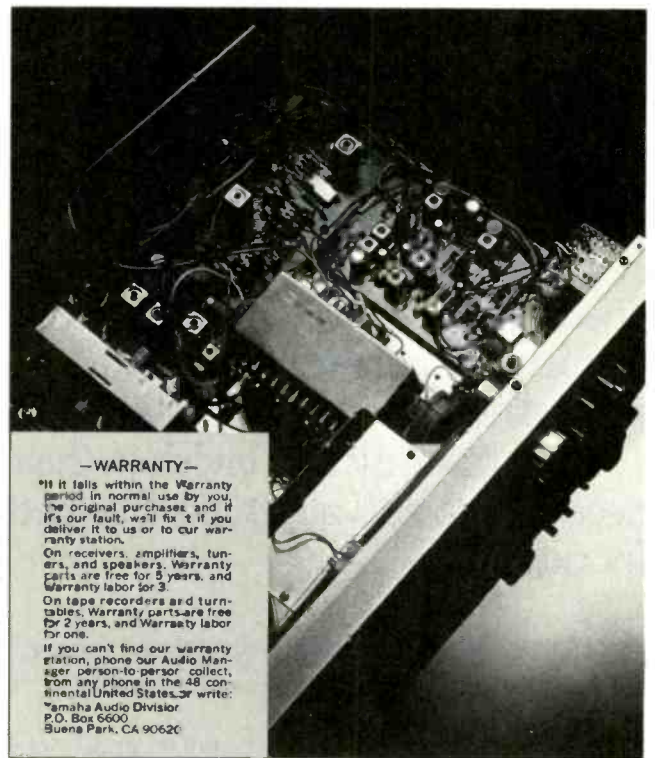

CIRCLE 60 ON READER-SERVICE CARD

The ADC-XLM "...in a class by itself."



That's the way Stereo Review described our XLM. High Fidelity headlined their review, "Superb new pickup from ADC" and went on to say, "...must be counted among the state of the art contenders." And Audio echoed them with, "The ADC-XLM appears to be state of the art."

With the critics so lavish in their praise of the XLM, there's hardly any necessity to add anything. Far better to let the experts continue to speak for us.

Frequency response The CBS STR-100 test record showed less than ± 1.5 dB variation up to 20,000Hz. *Stereo Review*
...response is within ± 2 dB over the entire range. *Audio*
Frequency response is exceptionally flat. *High Fidelity*

Tracking This is the only cartridge we have seen that is really capable of tracking almost all stereo discs at 0.4 grams. *Stereo Review*
The XLM went through the usual torture test at 0.4 grams (some top models require more than a gram). *High Fidelity*
The XLM is capable of reproducing anything found on a phonograph record. *Audio*

Distortion Distortion readings... are almost without exception better than those for any other model we've tested. *High Fidelity*

The XLM has remarkably low distortion in comparison with others. *Audio*
At 0.6 grams the distortion was low (under 1.5 per cent). *Stereo Review*

Hum and noise The XLM could be instrumental in lowering the input noise from the first stage of a modern transistor amplifier. *Audio*
The cartridge had very good shielding against induced hum. *Stereo Review*

Price This would be a very hard cartridge to surpass at any price. *Stereo Review*
We found it impossible to attribute superior sound to costlier competing models. *High Fidelity*
Priced as it is, it is a real bargain in cartridges. *Audio*

**The Pritchard High Definition
ADC-XLM \$50.**



Sony Breathes New Life into an Old Format

The Equipment: Sony STC-7000, a stereo FM and AM tuner combined with a stereo preamp-control section (no power amplifier section). Dimensions in metal case supplied: Front escutcheon, 18 $\frac{1}{8}$ by 5 9/16 inches; chassis depth behind panel, 13 9/16 inches. Price: \$589.50. Manufacturer: Sony Corp. of America, 47-47 Van Dam St., Long Island City, N.Y. 11101.

Comment: With the model STC-7000, Sony has reintroduced in modern, high-quality stereo terms a home-audio product format that enjoyed some vogue in pre-stereo days. Sony calls it an "integrated tuner." Actually, it is a tuner combined with a system preamplifier but without a power amplifier—a "semi-receiver" if you will. In offering this type of component at this time, and with the superior performance and versatility that characterize the STC-7000, Sony is making available a unit that should appeal to the home-music system planner who wants to have his audio cake and eat it too. That is to say, the STC-7000 offers the convenience of radio reception and system control facilities in one handsome, high-performing unit while at the same time permitting you to use a power amplifier of your own choice, including any of the new superheavyweights. Since these latter models are aimed at the perfectionist market, and since the Sony tuner-preamp has the kind of performance a perfectionist would seek, the design approach makes good sense. Without an ultrahigh-powered amplifier on the same chassis, the tuner-preamp can be installed wherever convenient and with only normal regard for ventilation. The heavier power amp then can be located for best ventilation, rather than accessibility. For the serious tape recordist, the STC-7000 offers many options, including a front-panel microphone level control that may be used for fading or mixing in conjunction with another input signal to a recorder and a very versatile tape duplication facility.

The STC-7000, in short, has been designed as both a hobbyist's tool and a serious listener's delight. Dominating the front panel is a generously proportioned sta-

tion tuning dial with illuminated indicators for FM, AM, stereo, plus a meter showing maximum signal (operates on both FM and AM) and another meter showing center-of-channel (for FM only). To its left is the volume control mounted concentrically around a channel balance lever. The power off/on switch is at the lower left. Next comes a stereo headphone jack, and separate bass and treble tone controls for each channel (friction-coupled). Then there's a "hi-blend" switch (for use only on noisy stereo FM programs), and an interstation muting switch. The large tuning knob itself is at the center. To its right are three more switches for low filter, loudness contour, and high filter. Next comes a channel mode knob with positions for "check L" (both channel inputs are combined and fed to the left-channel output), "check R" (both channel inputs are combined and fed to the right-channel output), reverse, stereo, L plus R (both channels are combined and fed to both channel outputs), left (left inputs are fed to both channel outputs), and right (right inputs are fed to both channel outputs). The microphone level-and-mixing control follows. The right-hand portion of the panel is given over to the elaborate signal selector and monitor facility, worked out between a knob and two slide switches. The knob has positions for AM, FM, mic, phono 2, aux 2, "1 to 2," and "2 to 1" (the last two positions for tape duplication work). The slide switch just to the left of this knob has positions for aux 1 (this cuts out the knob), a center spot that returns control to the knob, and phono 1 (which also cuts out the knob). The monitor control below these two has positions for tape 2, source, and tape 1. A stereo input phone receptacle, next to the monitor switch, is controlled by the aux 2 position of the selector knob.

Everything is logically arranged and clearly marked in exemplary fashion that combines a genuine functionalism with a neat, even pleasing, appearance. Similarly, the back panel of the set is also quite "busy" but carefully planned and laid out. Inputs include stereo pairs for microphone, phono 1, phono 2, and aux 1. The mike jacks are phone types; the others are phono jacks (pin-plug types). The aux 1 jacks are controlled by a level ad-

REPORT POLICY

Equipment reports are based on laboratory measurements and controlled listening tests. Unless otherwise noted, test data and measurements are obtained by CBS Laboratories, Stamford, Connecticut, a division of Columbia Broadcasting System, Inc., one of the nation's leading research organizations. The choice of equipment to be tested rests with the editors of HIGH FIDELITY. Manufacturers are not permitted to read reports in advance of publication, and no report, or portion thereof, may be reproduced for any purpose or in any form without written permission of the publisher. All reports should be construed as applying to the specific samples tested; neither HIGH FIDELITY nor CBS Laboratories assumes responsibility for product performance or quality.

justment. Under this group of connectors is a system-grounding terminal (the easiest to use and most secure one we've yet seen). Antenna terminals are provided for AM, and 300-ohm (twinlead) FM. There's also a true coaxial connector for 75-ohm cable, and a loopstick AM antenna. Stereo pairs of jacks are provided for feeding signals to, and playing signals from, two tape recorders. The tape 1 connectors may be alternated with a DIN connector just above them, and the tape 1 playback jacks are controlled by their own level adjustment. For main signal output (to power amplifiers) there are two stereo pairs plus a "center channel" (mono, or left plus right, signal) output jack. Special "display" outputs permit feeding signals from the STC-7000 into "scopes" to observe FM reception patterns (from the FM multipath jacks) or a graphic display of audio (via the "audio-scope" jacks). Finally, the rear apron contains four AC convenience outlets, three of them controlled by the front-panel power switch, the fourth "hot" as long as the set's power cord is plugged into an AC source.

Performance of the STC-7000 is as impressive as its many features and controls. The tuner achieves the very high sensitivity of only 1.4 microvolts and the sensitivity curve levels off to a superb quieting value of -59 dB for a mere 25 microvolts of RF input signal. The stereo sensitivity curve parallels this performance quite closely, remaining well below the -50 dB quieting level for signal strengths of 21 microvolts or more. In fact, the FM performance of this set is fairly astonishing since it is superior on all (not just some) counts: distortion, audio response, signal-to-noise, selectivity, channel separation—the works.

No less remarkable is the audio section of the STC-7000, which shapes up as a first-rate preamp-control unit. It is capable of furnishing up to 8 volts of signal per channel at no more than about 0.2% THD. At normal (rated) output of 2 volts per channel, distortion is literally one hundred times lower than that—in fact the lab measured values that were significantly better than those specified. All other tested parameters were generally better than typically found in receivers.

Listening tests of the Sony STC-7000 depend largely on what power amplifier and loudspeakers are connected to it. This is not only true in terms of how the unit is connected in a system, but also in terms of its performance, which is so good that one could say it is limited virtually only by what program sources are fed to it, and what external equipment it drives. This impression is further reinforced by listening to the STC-7000 on its own, i.e., via headphones. The set obviously supplies an ultraclean, wide-range signal. The unit can be recommended without reservation to anyone who appreciates better-than-average sound and the better-than-average apparatus for reproducing it.

CIRCLE 149 ON READER-SERVICE CARD

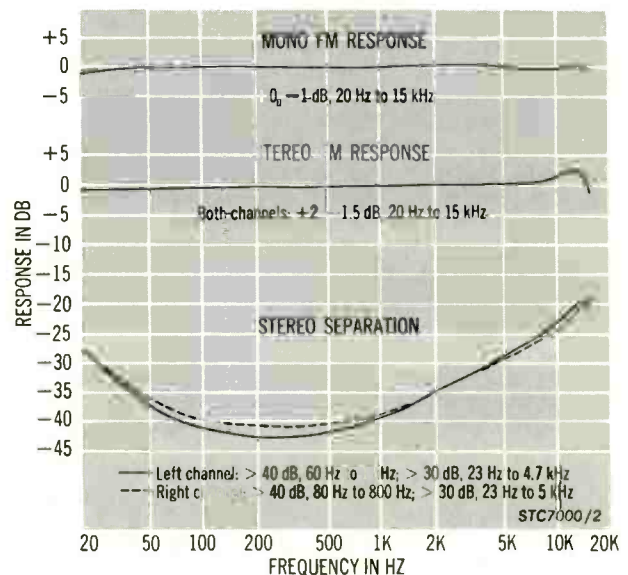
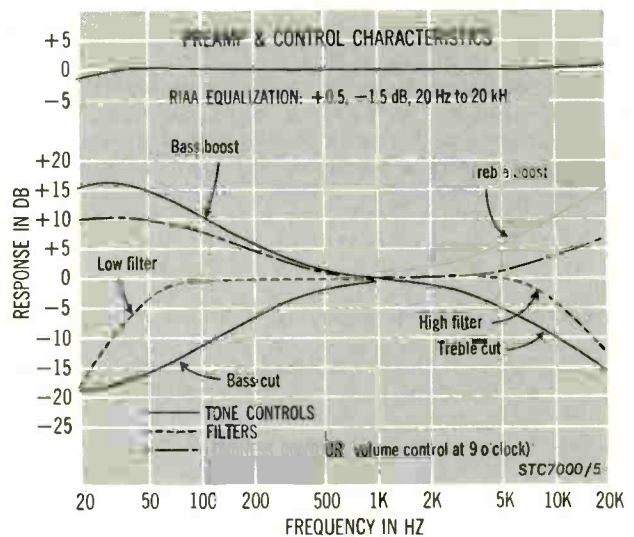
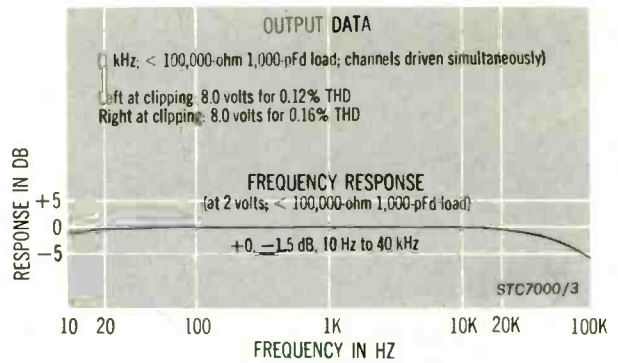
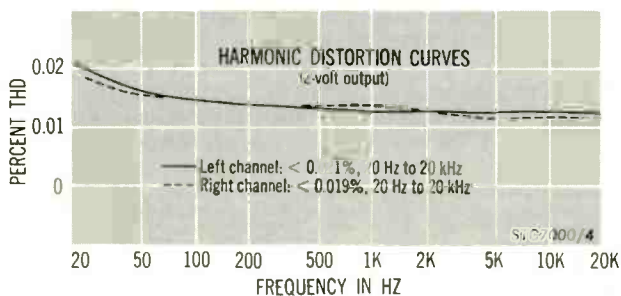

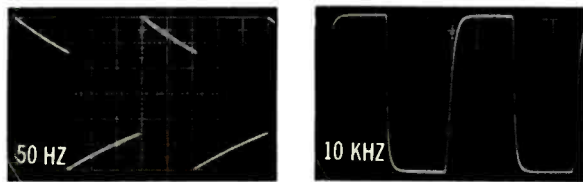
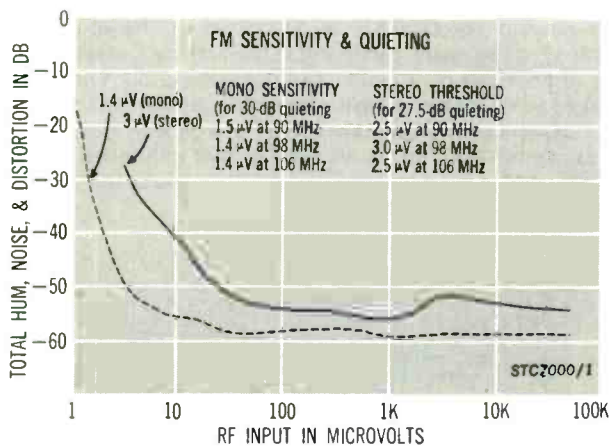

Square-wave response



The Equipment: Shure V-15 Type III, a stereo pickup cartridge with elliptical diamond stylus. Price: \$72.50. Manufacturer: Shure Brothers, Inc., 222 Hartrey Ave., Evanston, Ill. 60204.

Comment: Shure has gone through several versions of the top-of-the-line V-15. The V-15 Type II was considered a state-of-the-art model when it appeared some seven years ago. Then, three years later, the stylus assembly was redesigned. The Type II with the new stylus was called the Type II Improved—and it was, though not dramatically. Now Shure has redesigned the entire cartridge, the most striking innovation in the Type III model being the use of laminated—as opposed to solid—pole pieces in its electromagnetic structure.

The V-15 Type III bears a strong family resemblance to its predecessors in all respects, though it exhibits marked improvements in many. Both on the test bench and in the living room its behavior refines and surpasses that of the Type II Improved without changing the V-15's basic identity—which has, since the beginning, been very attractive indeed. All models have been, for their respective eras, wide-range, uncolored, un-

Sony STC-7000 Tuner/Preamp Additional Data

Tuner Section			
Capture ratio	0.75 dB		
Alternate-channel selectivity	100 dB		
S/N ratio	70 dB		
THD	Mono	L ch	R ch
80 Hz	0.13%	0.34%	0.35%
1 kHz	0.13%	0.15%	0.15%
10 kHz	0.38%	0.35%	0.45%
IM distortion	0.5%		
19-kHz pilot	-64 dB		
38-kHz subcarrier	-65 dB		
Preamp Section			
Input characteristics (for 2 V output, input controls at max.)			
	Sensitivity	S/N ratio	
phono 1 & 2	2.1 mV	68 dB	
mike	0.6 mV	51 dB	
tape 1 & 2	200 mV	82.5 dB	
aux 1	200 mV	82.5 dB	
aux 2	200 mV	83.5 dB	

Shure Improves Its Improved V-15

usually high in channel separation, and at least as low in distortion as other top models.

The specific means employed by Shure in designing the Type III have involved a careful reassessment of resonance factors with a view both to extending and flattening high-frequency response, and to providing optimum values, when used in an appropriate arm, to cope with the problems of warped records—which, as readers keep reminding us, are at least as much of a problem today as they ever have been. The frequency response in our graph shows some rise at high frequencies, but not the Type II's tendency to peak—particularly noticeable unless input capacitance was carefully matched to design values. Low-frequency resonance in the SME arm occurs at 6.5 Hz with the Type III—somewhat lower than in earlier versions.

Separation is the best the lab has measured so far and, as the graph shows, went below the limits (-30 dB) of the chart recorder over virtually all of the midrange. Intermodulation distortion (at 0.4% in the lateral plane, 1.6% vertically) is among the very lowest the lab has measured; harmonic distortion is about par for the better cartridges in the midrange (say 3% or better up to 3

kHz) and better than par above that (a maximum of 5% in one channel at 10 kHz, as opposed to almost double that in some measurements for other top models). Static compliance measures 35×10^{-6} cm/dyne in the lateral plane, 17 vertically—very close to the measurements for the Type II Improved, average or lower for other top models. The lab measured vertical tracking angle as 20 degrees and stylus-tip geometry as good, with a 0.22-mil radius in contact with the groove wall.

The audible net gain in the Type III consists less in these considerations than in what Shure calls "trackability"—the cartridge's ability to track a high velocity at low tracking force. In the standard torture test the Type III came through at 0.6 grams as opposed to 0.7 grams for Type II Improved and 0.75 grams for the earlier Type II. This information is more important, however, when stated conversely: The Type III can be expected to track higher groove velocities than its predecessors at normal tracking forces. We used 1.0 grams in listening to it and the lab made all other measurements at that tracking force.

Output from our standard groove (modulated at 1 kHz for a peak velocity of 5 cm/sec) was measured at 3.9 mV in the left channel, 3.8 mV in the right. This is higher than the Type II's output, a little higher and better balanced than that of our Type II Improved sample, and perhaps a little higher than average among today's better cartridges.

Along with the cartridge you get a certificate that can be exchanged for a free test record ("Audio Obstacle Course—Era III") that will allow you to compare cartridges in terms of "trackability." The Type III can be bought (as the V-15 Type III-G) with the VN3-G 0.6-mil spherical diamond stylus. An accessory elliptical stylus

for playing 78s (VN78E) is described in "News and Views" in this issue. Since this is the first such stylus to be announced by a major manufacturer to our knowledge (and considering the interest readers have shown in our April article on playing old records with modern equipment), the 78-rpm elliptical further enhances the attractions of what must be reckoned as one of the very finest cartridges on the market.

CIRCLE 147 ON READER-SERVICE CARD

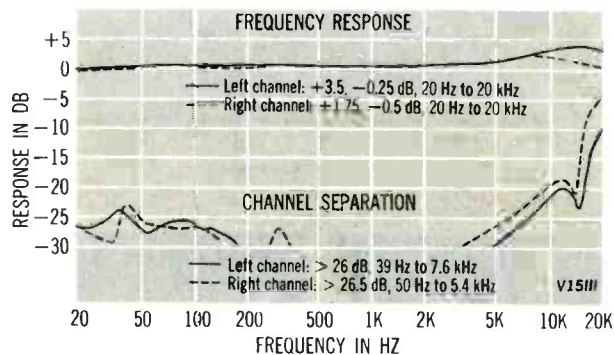

Square-wave response

Audioanalyst's

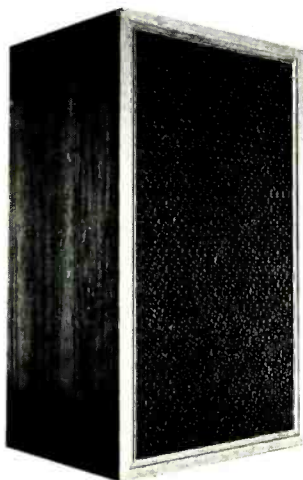

First Speaker

The Equipment: Audioanalyst A-100, a compact speaker system in wood enclosure. Dimensions: 24 $\frac{3}{8}$ by 13 $\frac{3}{4}$ by 12 inches. Price: \$129 (\$136 in western U.S.). Manufacturer: Audioanalyst, Inc., P.O. Box 262, Brookfield, Conn. 06804.

Comment: The Audioanalyst is, according to its manufacturer, a conventional acoustic suspension system that, as the first product from this company, is intended to offer good value in a highly competitive market.

Its handsome oiled walnut case has the connection terminals (thumbscrews that accept bare wires or

spade lugs) on a panel recessed into the back. The terminals are marked with a big "+" or "-" for polarity coding. Above them are two toggle switches for minor adjustments of treble (a boost of about 2 dB or less from 10 kHz up) and midrange (a similar boost between 1.2 kHz and approximately 8 kHz). We found that though the difference is slight, we often changed our minds about the "preferred" positions of these switches when we moved the speaker from one position to another in the room. The graph was made with both controls in the low position as suggested by Audioanalyst.

Behind the tweedy black-and-brown grille cloth are a 10-inch woofer, a 3-inch cone midrange driver, and a 2-inch tweeter. Crossovers are at nominal values of 2 and 7.5 kHz. Since the A-100 can be used either vertically or horizontally, Audioanalyst gives you a stick-on insignia so that you can position it as you choose (or leave it off altogether).

The manufacturer's impedance rating of 8 ohms characterizes the general value of the curve, but the lab found the actual rating point (the minimum level following the bass-resonance rise) to be 5.5 ohms. So though impedance rises to above 16 ohms in the midrange

around 1 kHz, it might be safer to treat the A-100s as 4-ohm models if you're contemplating multiple-speaker hookups.

In our standard sensitivity test (driving the speaker to an output of 94 dB at 1 meter) the lab found that the A-100 needed 10 watts. The speaker handled steady tones of up to 100 watts power before distorting excessively, and it handled pulses of up to 227.3 watts average power. In the light of these figures, Audioanalyst's recommendation that the model be used with amplifiers rated at 10 to 60 watts of music power per channel seems eminently sensible.

One of the avowed design aims of the A-100 is linear response rather than what might be called "pleasing sound" where that phrase implies a compromise with accuracy of reproduction. It's no surprise then to note that the response curve has no midrange "presence" bump and also is unusually flat toward the top for a bookshelf system in this price category. By contrast to the common, less-flat speaker characteristics, the sound is slightly bright—though not aggressively so. In terms of balance and clarity it is good with any sort of program material, though—again predictably, in the light of the design intent—not particularly (or unnaturally) spectacular. Highs are well dispersed and clearly audible off axis—with music, test tones, or white noise—right up to about 14 kHz, where rolloff begins. In the bass, and driving the speakers to moderate listening levels, there is little doubling down to 40 Hz; below that frequency response audibly falls off, and at 30 Hz it becomes mostly doubling. At higher power levels, doubling increases, as indicated by the second-harmonic distortion figures for 80 Hz in the distortion chart. Definition is good without the unnatural (and random) prominence that can be afforded some musical sounds by a speaker with a peaky midrange response.

We think Audioanalyst has been successful in producing a good value in this popular price class, and we're not surprised to learn that in the relatively short time the company has been in business it already has

found dealers in many parts of the country. So perhaps the A-100 is not only a welcome newcomer in its own right, but a harbinger of good things to come as well.

CIRCLE 148 ON READER-SERVICE CARD

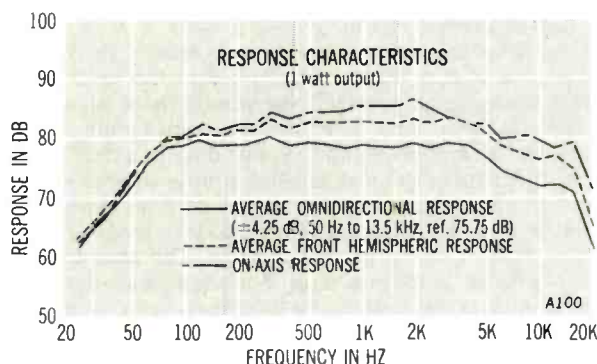

Audioanalyst A-100 Speaker Harmonic Distortion*

Output Level (dB)	Frequency			
	80 Hz		300 Hz	
	% 2nd	% 3rd	% 2nd	% 3rd
70	.90	.30	.22	.29
75	1.5	.25	.20	.21
80	2.6	.32	.19	.25
85	4.8	.40	.21	.27
90	9.5	.70	.35	.38
95			.68	.55
100			1.3	.75
102			1.7	.82

*Distortion data are taken on all tested speakers until distortion exceeds the 10 per cent level or the speaker produces the spurious output known as buzzing, whichever occurs first.



Yamaha Cassette Deck Allows Speed Adjustment

The Equipment: Yamaha TB-700, a cassette deck with built-in Dolby noise-reduction circuitry, in case with wood trim. Dimensions: 15½ by 4½ by 10 inches. Price: \$289. Manufacturer: Nippon Gakki Co., Ltd. of Japan; U.S. distributor; Yamaha International Corp., P.O. Box 6600, Buena Park, Calif. 90620.

Comment: Yamaha has been offering a variety of products in this country for some years. In audio it has been best known for its "ear-shaped" loudspeakers, though it has displayed some electronic components as well.

Last year it announced plans to offer a comprehensive line of stereo components; the TB-700 appears to be one of the first of these to go into production and is the first we've been able to examine in detail.

Toward the back of the top plate and tilted slightly upward are the VU meters. Between them are indicator lights for recording (red) and Dolby action (amber). Immediately in front of the meters are the turns counter and a series of switches. The first is a button for either "standard" or high-performance tapes; it is used in conjunction with the switch next to it, which chooses

either low-noise ferric or chromium dioxide as the tape to which the unit is adjusted in the high-performance position of the first switch. All the lab tests were run with Scotch High Energy and the low-noise position or, where indicated, Sony CRO and the chromium dioxide position. The remaining switches are for Dolby (on/off), a built-in limiter (on/off), and AC power.

In front of the switches is a series of sliders. The right-hand pair controls line input levels to the recording amp; the next pair controls mike inputs. These separate controls permit mixing of line and mike inputs. Next come the output-level controls, with detents at the "normal" position in the middle. And at the extreme left of this group is a speed vernier, which controls the servo system that regulates the unit's DC drive motor. It too has a detent at the normal position. The speed data shown in the "additional data" box were measured with the control in this position; perfect speed can of course be obtained by using this vernier, but you would need a test tape and a frequency counter unless the speed is audibly off pitch. The total range of this system is approximately a half tone either way from normal (± 5 per cent, according to Yamaha).

Though the transport keys look familiar, their operation is somewhat unconventional. You can go directly from recording or playback to the fast-wind modes, and from them back to play without activating the stop button. This makes for fast operation, and although many current decks intentionally prevent such abrupt changes in transport motion, we could detect no uneven winding of the tape as a result—let alone any suggestion of snarling or damage in the tape. During playback or fast winding the record key can be depressed, but it only stops the transport without putting it into the recording mode unless the play key is pressed simultaneously. We found the action of the pause key to be rather sluggish. When you press it, approximately a second elapses before the tape comes to a stop. When you release it there is a similar delay before sound returns to the monitor connections, though the tape gets back to speed sooner and the recording amp cuts in immediately. As a result you must time your use of the pause carefully during recording if the tapes are not to contain sounds that wow in or out. (Most LPs allow you about four seconds of silence between cuts, if that's what you're excerpting from.) At the end of the cassette the drive system automatically returns to stop.

Phone jacks for the two mike inputs and a stereo headphone jack are built into the dark trim stripe across the front. On the back panel are a DIN input/output jack, standard pin-jack pairs for line input and line output, and a two-position input sensitivity switch. The less sensitive of these positions is appropriate for the levels delivered by most stereo components. No Dolby alignment controls are accessible to the user.

The lab data show the unit to be average or better in all respects—and in some particulars well above average. Crosstalk figures are about 10 dB better than those we're used to seeing in a cassette deck and, among the units we've tested, are matched or bettered only by the Advent 201. Harmonic distortion curves are excellent—particularly at the high end, where many decks can't handle the high (-10 VU) level at which these curves are made, preventing meaningful measurements for them at 10 kHz. (Normal signal levels at this frequency are well below -10 VU, of course; that level is chosen for THD tests in order to give the midrange an adequate workout.) If the record/playback response curves are not quite as flat as most for comparable equipment, they

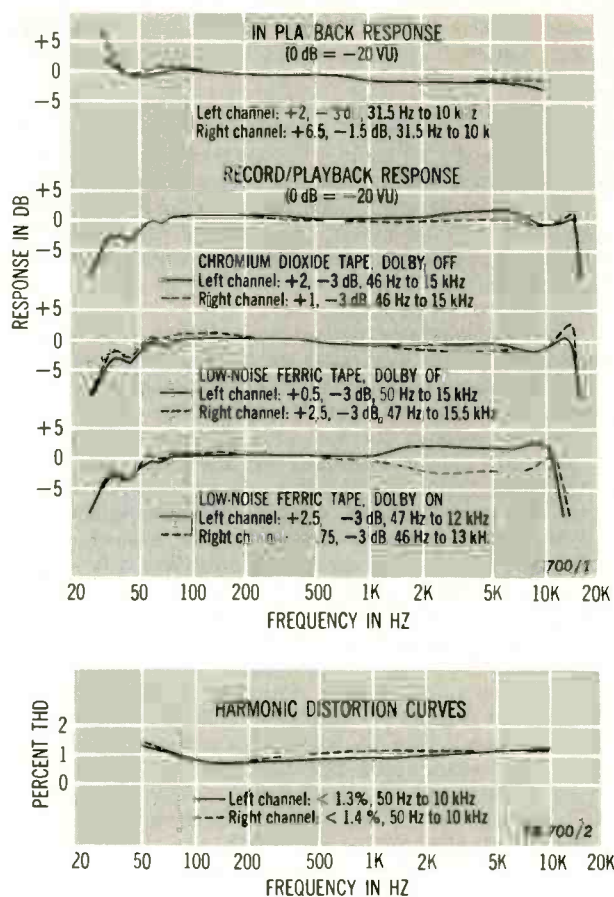

Yamaha TB-700 Cassette Deck Additional Data

Speed accuracy (vernier at "0")	105 VAC: 0.93% fast 120 VAC: 1.2% fast 127 VAC: 1.2% fast
Wow and flutter	playback: 0.10% record/playback: 0.18%
Rewind time, C-60 cassette	1 min. 36 sec.
Fast-forward time, same cassette	1 min. 36 sec.
S/N ratio (ref. DIN 0 VU, Dolby off)	playback L ch: 55.5 dB R ch: 51 dB record/playback L ch: 53 dB R ch: 50 dB
Erase (400 Hz at normal level)	52 dB
Crosstalk (at 400 Hz)	record left, playback right: 51 dB record right, playback left: 50 dB
Sensitivity (for 0-VU recording level)	line input (high) L ch: 55 mV R ch: 55 mV line input (low) L ch: 11.3 mV R ch: 11.3 mV mike input L ch: 0.40 mV R ch: 0.42 mV
Meter action (ref. DIN 0 VU)	L ch: 1 dB high R ch: 1 dB high
IM distortion (record/play, -10 VU)	L ch: 6% R ch: 6.5%
Maximum output (preamp or line, 0 VU)	L ch: 1.1 V R ch: 0.95 V

do represent better than average bandwidth. With the Dolby circuit in use they drop back to average at the high end—apparently because of the low-pass filter used to prevent any leakage of the 19-kHz FM pilot from interfering with Dolby action. There is some discrepancy in high-frequency level between channels in Dolby operation, but it is not severe and presumably has been improved in later samples; Yamaha says it has improved its production technique for setting Dolby levels, and this discrepancy (such as it is) falls just within the region where Dolby B operates.

Three features of the TB-700 require special mention. First is the thirteen-page owner's manual, which is unusually complete. Some statements in our copy are a little curious or even confusing, but Yamaha says the text has been rewritten and the booklet restyled to make it more attractive to American buyers. We trust this entails no suppression of content, since the original version is well above average in usefulness. Second is the speed vernier. Since a number of readers have complained that cassettes made on off-speed battery-portable equipment defy optimum playback on good home

equipment, we're delighted to see that some new decks (the Harman-Kardon HK-1000 and Nakamichi 1000 are among the others) allow for speed adjustment. A half tone either way should solve most problems of this sort. Third is the limiter. While it will be a help to the novice recorder in tackling subjects with extreme dynamic range (plain old living-room chit-chat can be a recordist's nightmare for example), it should not be overworked. When driven too hard by grossly and consistently high input levels the resultant distortion in the signal is clearly audible. Fortunately—considering the unit's inherent dynamic range, plus the Dolby feature to further extend it—we see no reason why the limiter should be used for anything but taming occasional unexpected peaks.

All told the TB-700 is a worthy first product in an expanded Yamaha component line. In terms of performance it can hold its own against other decks in its class, and its special features (the speed vernier and input mixing) should attract particular attention because of their comparative rarity in competing decks.

CIRCLE 145 ON READER-SERVICE CARD



Sherwood's Elegant and Versatile Receiver—With Dynaquad

The Equipment: Sherwood Model S-8900A, a stereo FM receiver with built-in Dynaquad circuitry for recovering quasi-quadraphonic "ambience" effects from stereo program material, in wood case. Dimensions: 16¼ by 5¼ by 14 inches. Price: \$429.95. Manufacturer: Sherwood Electronic Laboratories, Inc., 4300 N. California Ave., Chicago, Ill. 60618.

Comment: If Sherwood set out to prove that Dynaquad is more than a device for "faking" four channels and that it can live comfortably in a high-performance receiver with a luxurious "feel," the S-8900A must be reckoned a success. The Dynaquad circuit for deriving four signals from a two-channel amplifier has been widely adapted—sometimes in a shoddy attempt to palm off a run-of-the-mill mass-market product as the latest in quadraphonics. Sherwood will have none of that; it uses Dynaquad as a logical adjunct to stereo, in a receiver that is well adapted to eventual use as the central element in a true quadraphonic system.

The tuning dial is flanked by a center-tuning meter on the left and, on the right, by two large knobs: one for tuning, one for loudness/volume with the main AC power switch at its minimum position. This knob is marked "loudness," since Sherwood traditionally has considered that mode of operation as standard, and it is calibrated (in dB) with respect to loudness action: +8 at maximum rotation, 0 at the point (2:30 o'clock rotation) for the reference level at which no compensation is deemed necessary, -20 (10:30 o'clock), and -60 (at 7:30 o'clock). In the S-8900A loudness compensation is introduced in the bass only.

At the left along the bottom of the front panel are five knobs: mode (right, left, stereo, stereo reverse, left-plus-right mono), selector (phono, FM, aux), bass, treble, and balance. Next are two stereo phone jacks, one for connections to an outboard tape recorder, the other for stereo headphones (and live no matter how the speakers are switched). Then come seven on/off pushbutton switches: four-channel mode (about which more in a moment), tape monitor, high filter, FM "hush" (interstation muting), loudness compensation, main speakers, and remote speakers.

On the back panel are pin-jack pairs for phono input, aux input, tape-recording output, tape-monitor input, output to a quadraphonic adapter, and front-channel input from a quadraphonic adapter. Near these connections is a single, red-coded pin jack for use with a discrete-quadraphonic FM adapter when one becomes available. Nearby are a thumbscrew grounding terminal, a three-position phono-input sensitivity switch (for tailoring the pickup's output both to the dynamic range of the S-8900A's preamp and to its loudness-control action), and a Dynaquad/stereo switch. Following the fuse and line cord, plus two convenience outlets (one of which is unswitched), there are screwdriver antenna (300-ohm and 75-ohm) connections, and a special mono speaker output. This last is for use with a center-fill speaker or as a mono extension; it is, in fact, connected into the remote-speaker switching and therefore cannot be used independently of speakers attached to the remote terminals, which—with those for the main speakers—are at the upper left of the back panel and are knurled screws that will accept spade lugs or bare

wires. (The mono output will accept similar wiring, but has regular screws.)

When you switch into the Dynaquad mode, the output to the main speakers is unaffected, but the hookup configuration of the remote speakers is altered so that they are differentially driven. When these speakers are placed at the back of your listening room they therefore reproduce ambience information implicit in the original stereo signal. Sherwood says that for this purpose all four speakers should be of "reasonably similar efficiencies and sonic characteristics" and that you should "sit in a centered position in the rear one-third of the room." The implied relatively low output from the back is partly because of the padding used (presumably to prevent excessively low impedances as seen by the amplifier when all four speakers are connected) in the remote-speaker circuit, and if there is a dissimilarity in efficiency between your front and back pairs, we'd suggest that the more efficient speakers go at the back.

After all that has been written on the subject, no more need be said of Dynaquad except that it is widely used and that it does work for its intended purpose. It does not produce true quadraphonics, of course, but the S-8900A allows for that too. The connections and switching for a quadraphonic adapter can be used in conjunction with the sort of all-in-one unit that includes matrix decoder and back-channel amplifier, or these functions can be borne by separate units. When discrete quadraphonic FM broadcasting becomes a reality (assuming that it will) the special FM-signal output would be used to feed a separate adapter for that purpose—which would, in turn, feed its output to the quadraphonic additions you're using. They, in turn, would return the front-channel signals to the Sherwood via the aforementioned jack pair.

In terms of circuit configuration this feature can be described as a simple "circuit interrupt" and is identical to the wiring of a tape-monitor switch. In fact if you are not planning to go quadraphonic right away the S-8900A might best be described as a stereo receiver (with the Dynaquad option) having complete switching for two tape decks plus tape-copying options in using a third via the front-panel jack—which can function as either an input jack or an output jack, depending on the way the related switches are treated. The instruction manual spells out the possibilities for tape copying, which may be summarized as follows: from the outboard deck to the regular back-connected deck and/or one attached to the four-channel jacks; or from the regular back-connected deck to the outboard unit and/or one connected to the four-channel jacks. The manual suggests that the receiver be left off in dubbing via the front-panel jack to prevent any noise pickup from related circuitry. But we found that if you leave the receiver on it can be used as a sort of make-do mixer to combine signals from a new source (disc, for instance) with those previously recorded on tape and being played back via a deck with its own output controls.

Obviously this receiver has versatility to spare. But how does it perform? Excellently. Sensitivity figures are superb; and though raw sensitivity numbers have little meaning in themselves, they are here matched by excellent quieting curves. In this respect the stereo curve is particularly striking and is over-all one of the best the lab has measured so far. Stereo quieting reaches 50 dB before input has reached 50 microvolts and remains better than 55 dB over the entire normal operating range from 100 microvolts upwards. Distortion is very low, as are noise factors. The consistent excellence of

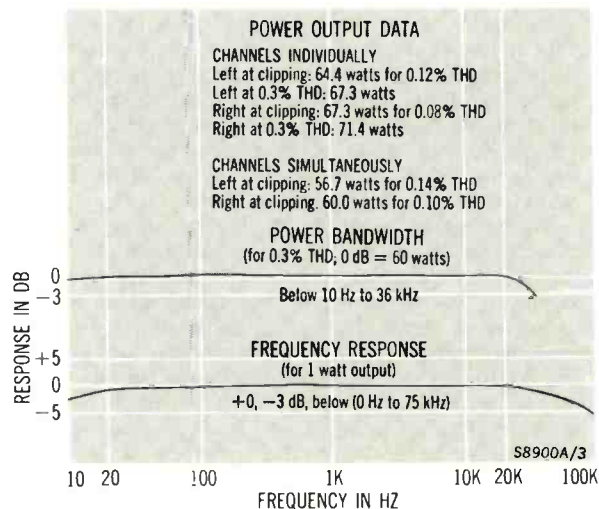
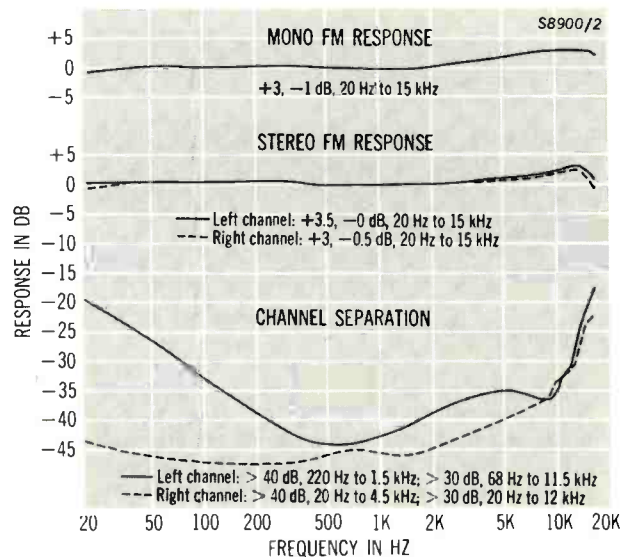
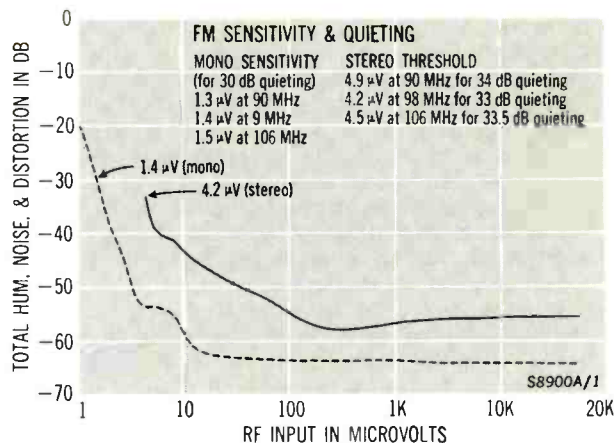

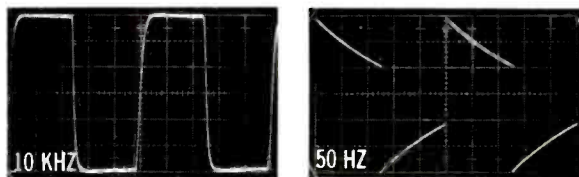
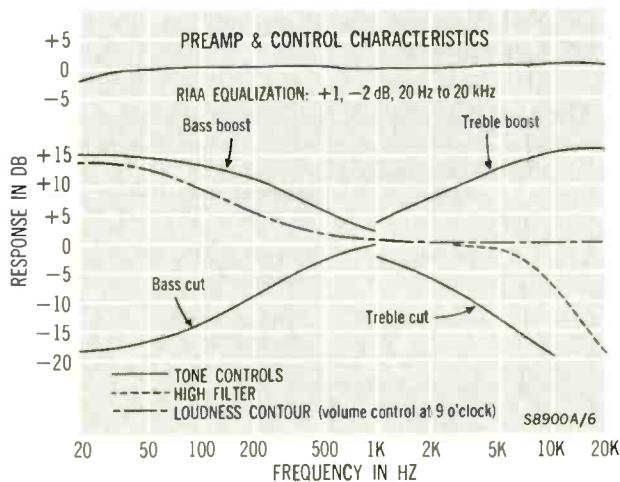
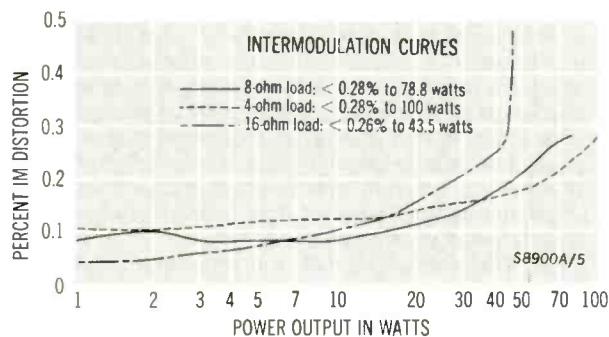
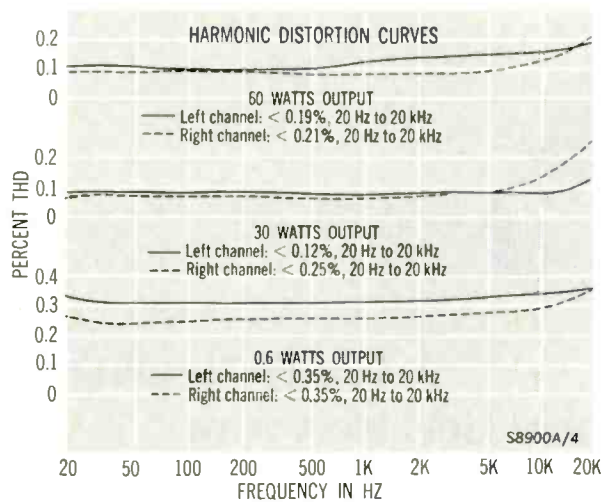

Square-wave response

these figures is a joy to behold—and the sound is a joy to hear even with signals that would provide only borderline reception with most good receivers. The FM response curves, with their upward tilt at the high end, lend a slight added brightness to the results. Whether this is good or bad will depend on your speakers and your room; it is neither excessive nor uncommon.

The amplifier section also is excellent. Sherwood's THD rating of 0.3 per cent is slightly more stringent than most today (many manufacturers choose 0.5 per cent as the rating point in better receivers), but the S-8900A comes through better than most. Only at extremely low outputs (0.6 watts) did the lab find the amp hard put to make its rating point, though it clears the 0.5-per-cent point handily. IM too stays below 0.3 per cent over the normal measurement range—except at 16 ohms, where reduced effective output power is to be expected in solid-state equipment.

The word for the S-8900A is "silky." The feel of the controls and the performance—on FM in particular—all contribute to this impression. But there is a subtler elegance to the design: that of achieving significant purpose by simple means. The Dynaquad circuit for example adds materially to the enjoyment available to the user, yet it involves only one slider switch and one resistor by comparison to a comparable stereo receiver equipped with the usual two pairs of speaker outputs. Sherwood's secret ingredient, then, appears to be care in thinking the product through in terms of user needs. It shows in the versatility of the monitor/quadrasonic/outboard-tape connections and in the consistency of FM performance—even in the normally-unmeasured stereo quieting curve. In these days of almost baroque elaboration, often to very little purpose, this is a welcome approach indeed.

CIRCLE 146 ON READER-SERVICE CARD

Sherwood S-8900A Additional Data

Tuner Section			
Capture ratio	20 dB		
Alternate-channel selectivity	60 dB		
S/N ratio	74.5 dB		
THD	Mono	L ch	R ch
80 Hz	0.07%	0.10%	0.12%
1 kHz	0.07%	0.11%	0.11%
10 kHz	0.14%	0.55%	0.60%
IM distortion	0.2%		
19-kHz pilot	-67.5 dB		
38-kHz subcarrier	-65.5 dB		
Amplifier Section			
Damping factor	43		
Input characteristics (for 60 watts output)			
	Sensitivity	S/N ratio	
phono (max)	1.2 mV	60 dB	
phono (mid)	2.7 mV	60 dB	
phono (min)	6.0 mV	60 dB	
aux	125 mV	70 dB	
tape monitor	260 mV	80 dB	



A Top Performing Turntable Gets New Arm

The Equipment: Thorens TD-125 Mk. II, a three-speed (16, 33, and 45 rpm) manual turntable supplied on walnut base and with tone arm. Dimensions: 18 $\frac{5}{16}$ inches wide, 14 $\frac{1}{4}$ inches deep, 6 $\frac{3}{4}$ inches high. Price: \$310. Optional TX-44 dust cover, \$15; TX-25 cover with hinge, \$30. Manufacturer: Thorens, S.A. (of Switzerland and West Germany); U.S. distributor: Elpa Marketing Industries, Inc., New Hyde Park, N.Y. 11040.

Comment: The Thorens TD-125 Mk. II is an updated and improved version of a well-known manual, single-play turntable. Its most obvious new feature is the Thorens arm, but there are other improvements too. A new motor, new electronic circuitry, and a redesigned pulley reduce start-up time from the former 4 seconds (at 33 rpm) to only 1.5 seconds. The redesigned drive system also is credited with reducing any stray magnetic field and consequently the chance of hum.

Styling of the Thorens combines a modern look with generously sized controls. Topside of the chassis and at the front left is the three-position speed selector. To its right is a fine speed adjustment and a built-in illuminated strobe. Next is the power off/on switch and finally the arm lift (cueing) control, another new feature of the Mk. II. As in previous Thorens models, the arm fits onto a removable board that facilitates installation (should you want to use an arm of your own choice), or substitution of other arms for experimental purposes or special applications.

The new arm itself (model TP-16) is a gimbal-suspended metal tubular type of low mass with removable pickup shell and all the requisite adjustments, including stylus overhang, vertical tracking force, and magnetically applied antiskating. It comes with a damped cueing device, an arm rest, and a prewired signal cable harness.

At an ARLL rumble level of -63 dB, as measured in the lab, the Thorens TD-125 Mk. II is one of the quietest

turntables we have yet tested. The platter itself weighs 5 pounds; its average flutter at 33 rpm was clocked at 0.08 per cent (not as low as its predecessor's but still inaudible). Arm resonance was negligible, showing only a 4-dB rise at 8 Hz with a Shure V-15 Type II Improved pickup. Arm friction similarly was negligible both laterally and vertically, too low to measure accurately. The built-in gauge for setting vertical tracking force was accurate to within 0.1 gram up to forces of 3 grams. Exact measurements are shown in the accompanying table. The unit has inherent speed accuracy plus the feature of variable speed if desired. The cueing device worked smoothly and gently with no side drift.

As in the former TD-125, the two-piece nonferrous platter is covered with a ridged rubber mat that is held in place by a center piece that may be inserted upside down to accommodate large-hole 45s. Finish and workmanship are exemplary throughout, and the handsome wooden base not only dresses up the ensemble but also serves as an excellent shock-mount for it. All told, if any turntable merits the title of "professional," the TD-125 Mk. II surely does.

Thorens TD-125 Mk. II Additional Data

Vernier speed accuracy					
33 rpm	set exact at 120 VAC; no error at 105 or 127 VAC				
45 rpm	no error at 105, 120, or 127 VAC				
16 rpm	0.8% fast at 105, 120, and 127 VAC				
VTF gauge accuracy (grams)					
gauge setting	0.5	1.0	2.0	3.0	4.0
VTF measured	0.6	1.0	1.9	3.1	3.8

Big Sound from Dynaco's Small Speaker

The Equipment: Dynaco A-10, a compact full-range speaker system in enclosure. Dimensions: 8 $\frac{1}{2}$ by 7 $\frac{7}{8}$ by 15 inches. Price, sold only as a pair, \$104. Manufacturer: Dynaco Div., Tyco, 3060 Jefferson St., Philadelphia, Pa. 19121.

Comment: Dynaco has entered the "\$50-speaker market" with a worthy competitor for this burgeoning product area. A two-way direct-radiating system, the A-10 consists of a 6 $\frac{1}{2}$ -inch extended-range woofer crossed over at 2,500 Hz to a soft-dome tweeter. Both drivers are

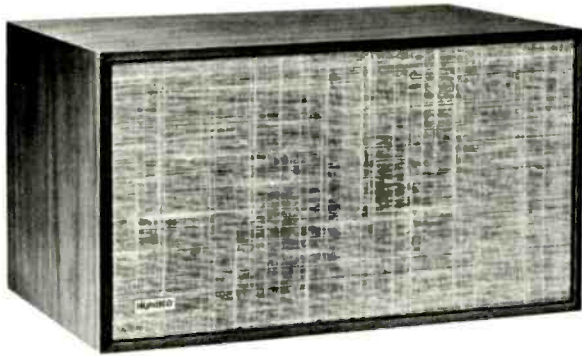

mounted on the front baffle (behind the decorative grille) where there also is a vent that helps load the system to the listening room at low frequencies. The cabinet is a neatly styled walnut enclosure that may be positioned vertically or horizontally and also is lightweight enough to hang on a wall (brackets for this purpose are fastened to the rear). Input is via color-coded screw terminals that will accept large or small spade lugs or bare wires. No level controls are provided.

In contrast to bass-reflex design, which relies on cabinet resonance for bass enhancement, the A-10 employs what Dynaco calls an "aperiodic" or nonresonant design in which the vent opening is treated with special material to add acoustic resistance to smooth the woofer's response and aid in the transfer of low-frequency energy from the speaker to the room.

Our tests confirm that the design works. The A-10, to our ears, furnishes a level and quality of sound at all frequencies that are hard to believe for the size and cost of the unit. The lab measurements show response within plus or minus 6 dB from 57 Hz to 14 kHz. On test tones of audible response we found the bass holding up cleanly to just below 50 Hz, with a gradual rolloff below this frequency, but with a surprising freedom from doubling. The middles and highs sounded well rounded and balanced, with very good dispersion, to beyond audibility. Rated for 8 ohms, the A-10's lowest impedance was measured as 6.5 ohms at the usual bass dip above bass resonance. From this area it rises rapidly and never falls below 8 ohms out to its response limits. Efficiency is moderate; the A-10 needed 6.3 watts to produce the standard test output of 94 dB at 1 meter on axis. It could

The Equipment: Pioneer Model SA-9100, an integrated amplifier (preamp and power amp) in wood case. Dimensions: 17 by 5¼ by 12½ inches (not including clearance for knobs and back-panel connections). Price: \$399.95. Manufacturer: Pioneer Electronics Corp., Japan; U.S. distributor: U.S. Pioneer Electronics Corp., 178 Commerce Rd., Carlstadt, N.J. 07072.

Comment: Whether you admire fine audio products for their specifications, for their sound, for their versatility, or even for their looks, you've got to count this a whiz-bang of a product. Pioneer has long been known for the great "feel" and excellent styling of its electronics—and for matching these qualities with sound internal design. The SA-9100 has all these elements but its performance is so exceptional and the many extras in the way of

take up to 72 watts of steady-state power (producing an output of 100 dB) before distorting significantly. Its maximum capability for handling power pulses was 69 watts average or 138 watts peak. These figures indicate ample dynamic range but within obvious design limits. That is to say, the A-10 should not be driven with any of the recent super-powerhouse amplifiers but it will do nicely when coupled with a unit that can deliver up to and even a bit more than 50 watts average sine-wave (or "rms" power) per channel. By the same token, don't look to the A-10s to cover a ballroom-size area with sound—but you can expect it to furnish a surprising and pleasant impression of "big sound" in a room of normal size or slightly larger. In such a room, its sound is quite natural on both voice and instruments, and a pair projects a good, firm stereo image.

CIRCLE 141 ON READER-SERVICE CARD

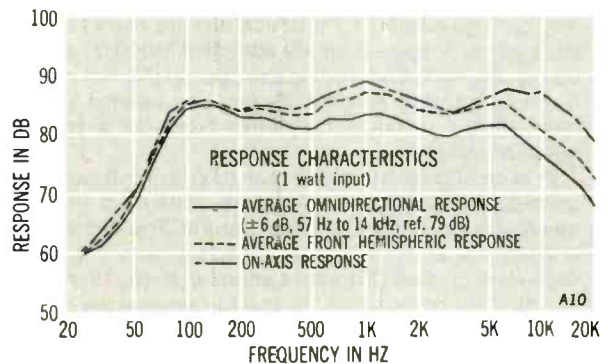

Dynaco A-10 Speaker Harmonic Distortion*

Output Level (dB)	Frequency			
	80 Hz		300 Hz	
	% 2nd	% 3rd	% 2nd	% 3rd
70	0.55	0.55	0.22	0.28
75	0.85	0.60	0.20	0.35
80	1.6	0.75	0.22	0.40
85	2.5	1.0	0.28	0.33
90	4.0	1.4	0.35	0.33
95			0.42	0.28
100			0.45	1.1

*Distortion data are taken on all tested speakers until distortion exceeds the 10 per cent level or the speaker produces the spurious output known as buzzing, whichever occurs first.

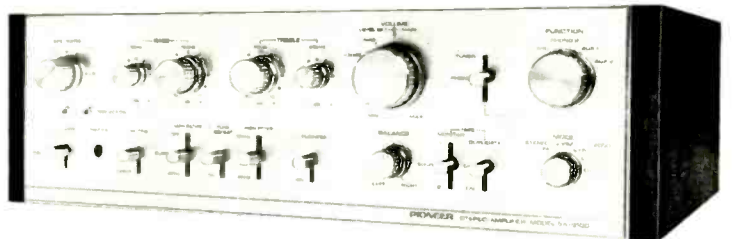

A Superb Integrated Amp from Pioneer

switching options and so on so eminently useful that we find it perhaps the most exciting piece of audio hardware we've yet tested from this company.

It all begins when you open the packing and find that muslin snood in which Pioneer lovingly packs its more deluxe items. That's impressive—but the front panel is far more so. Following a speaker selector (which allows you to use any one of three speaker pairs, any two of these pairs simultaneously, or none) at the upper left you come immediately to one unusual feature: the four tone-control knobs. The two larger ones are conventional in effect and operation except that they are stepped—and as lab tests proved, are extremely accurate in their calibration (so many dB of cut or boost at 100 Hz in the bass and 10 kHz in the treble). The smaller knobs affect only the frequency extremes; hence their calibration points are, respectively, at 50 Hz and 20 kHz and their effect is cumulative with the standard controls. You can, for example, introduce a slight rise in the upper bass only by turning the standard (100-Hz) control up by, say, 4 dB and turning the special (50-Hz) control down by a similar amount. Or you can use the special bass control to boost only deep bass—as a speaker equalizer might.

Proceeding to the right, the next control also has some special—and useful—features. The main knob is a standard volume (or loudness) control. The ring around it limits output. It is calibrated (again, with fine accuracy—within ½ dB) for attenuations of 0 dB, 15 dB, and 30 dB. This control can be used in several ways. You may turn it down to prevent speaker overload; you may use it to compensate for altered power requirements depending on the speakers in use; it helps in tailoring loudness-control action (which is, of course, keyed to the position of the volume control) to actual listening levels.

At the far right in this upper rank are the selectors. A lever switch chooses tuner, phono 1, or the main function knob's setting. That knob, at the extreme right, has positions for microphone, phono 2, and two aux inputs.

The bottom rank begins with the AC power switch and a stereo headphone output jack, which is live at all times. Next come switches for muting (a 20-dB level cut—again accurately calibrated), low filter (off, subsonic—below 8 Hz and 30 Hz), tone defeat (on/off), high filter (12 kHz/off/8 kHz), and loudness/volume. The 30-Hz filter is a standard rumble filter; the subsonic filter produces virtually no effect in the audible range, as the lab data show, and Pioneer recommends that it be left on in normal use to prevent feedback disturbances, woofer damage, and such potential problems, which can be occasioned by a poorly isolated turntable, excessive arm resonance, or warped records—among other phenomena.

Next comes the balance control. At its right are two tape switches. The first selects tape monitor 1, source, or tape monitor 2. The second is marked "duplicate" (on/off) and is so wired that it permits copying either from tape deck 1 to tape deck 2 or vice versa. The last knob is for mode selection: stereo, reverse stereo, left-plus-right mono, left-only mono, and right-only mono.

Across the top of the back panel are a series of input and output jacks, most of them in the standard pin-jack pairs. They are for phono 1, phono 2, tuner, aux 1, aux 2, tape monitor 1, tape recording 1, tape monitor 2 (or input from a quadraphonic adapter unit), tape recording 2 (or output to a quadraphonic adapter unit), tape 2 record/playback (a 5-pin DIN socket), preamp out, and power amp in. Whew! Next to the phono-2 inputs is a

three-position impedance switch: 25k, 50k, and 100k ohms. (The 50k position is normal for magnetic cartridges spec'd at 47k.) Though the tape 2 connections are marked for use with a quadraphonic adapter, such a unit might also be connected to the pre-out/main-in jacks. Or those jacks might be used for an equalizer or electronic crossover unit. Next to them is a switch for normal (internal feed directly from preamp to power amp), separated, and separated with automatic inclusion of a subsonic filter.

Across the bottom are phone jacks for left and right mike inputs, two thumbscrew terminals for grounding ancillary equipment (particularly turntables, the audio inputs for which are just above), input level controls for phono 2 and aux 2, an output level control for speaker pair B, color-coded spring-clip connections (intended for bared wires) for all three speaker pairs, and three AC convenience outlets, one of which is switched.

How does all this perform? In a word, superbly. We've indicated some of the major options open to the user, but there are many more—for example, in the use of the phono and aux input level controls to balance a variety of widely differing units so that all work together efficiently in the resulting system. And for an integrated unit the performance data are exceptional. All distortion measurements are below 0.1 per cent except at extremely low outputs. There is room to spare above the amplifier's 60-watt output rating. (Note, for example, that output to a 4-ohm load goes beyond 100 watts before intermodulation distortion zooms; at 113.8 watts IM still is only 0.08 per cent.) And not only is calibration of the various frequency-selective controls unusually accurate, but the "flat" curves are just that; the RIAA equalization curve is at least as perfect as any we have ever seen.

A product for the elite? Perhaps. But there is not a switch or a knob on it for which we cannot find good (as opposed to marginal) use. And it is a joy to use: luxurious, refined, and exceptionally well thought out. Along with the amplifier, Pioneer sent us data about its use of differential amplifiers and direct coupling in both preamp and power sections, full of terms like OCL and NFB and SEPP. While such information doubtless will fascinate design engineers, we always have been more interested in the proof of the pudding—which in this case turns out to be a feast.

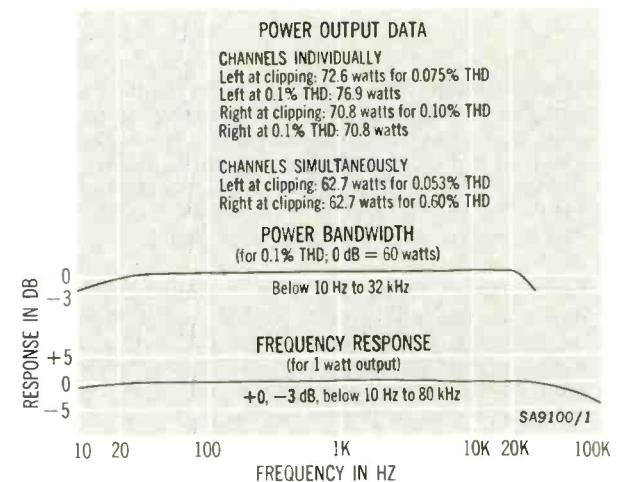

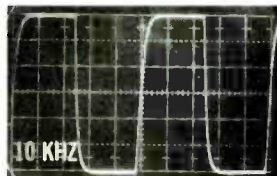
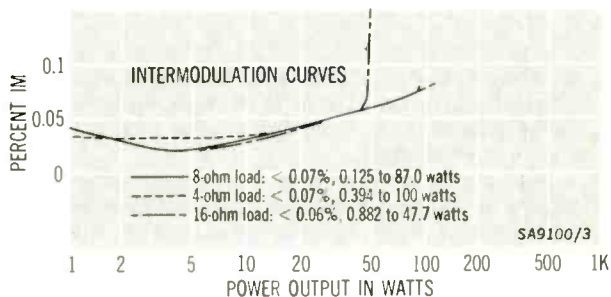
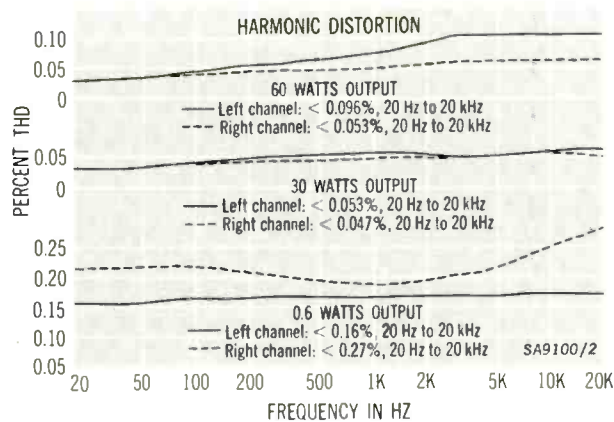

Square-wave response



A Gismo From Robins

The Equipment: Robins R47002 Dynamic Sound Enhancer, an accessory for expanding the effective dynamic range of sound heard through a stereo system, in plastic case. Dimensions: 4 by 3 by approximately 2 inches, including control knobs. Price: \$30. Manufacturer: Robins Industries Corp., 75 Austin Blvd., Com-mack, N.Y. 11725.

Comment: Robins Industries never seems to be at a loss for new accessories to titillate the high fidelity buff,

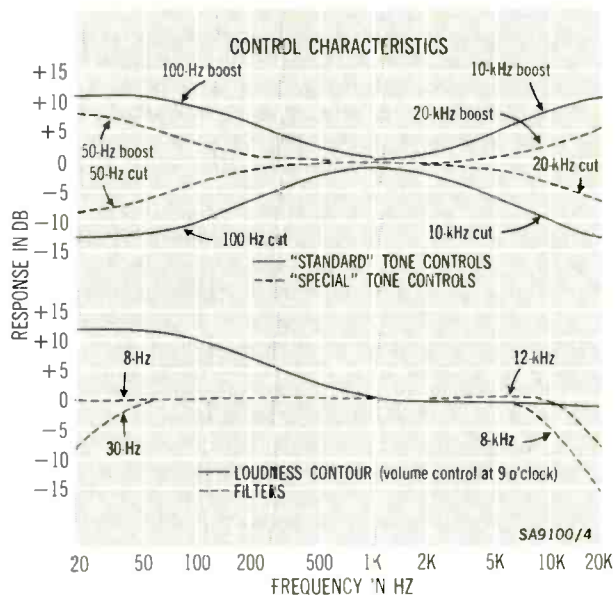

Pioneer SA-9100 Amplifier Additional Data

Damping factor	72
Input characteristics (for 60 watts output)	
Sensitivity	
mike	2 mV
phono 1	2.5 mV
phono 2	2.5-10 mV
tuner	155 mV
aux 1	155 mV
aux 2	155-1,450 mV
tape monitor 1	155 mV
tape monitor 2	155 mV
S/N ratio	60 dB
	81 dB
	65-72 dB
	80 dB
	80 dB
	80 dB
	86 dB
	85 dB
RIAA equalization accuracy ± 0 dB, 20 Hz to 20 kHz	

and over the years no company has offered such a wealth of little gadgets to gladden the souls of hi-fi put-terers. The present model—one of Robins' more recent—takes signals from the speaker connections and feeds them back to the inputs of the amplifier or receiver, where they can be used to reduce signal levels during quiet passages and thus enhance the dynamic range of the music.

On the top panel are two pairs of standard pin jacks, one for each channel. One jack of each pair is marked "in" and the other "ampl." Next to each pair is a sensitivity control knob that is uncalibrated except for "min" and "max" at the respective extreme positions. (Since the knobs have no pointers it is impossible to tell where they are set except by giving them a twist to feel for the extreme positions.) At the right are four screw terminals (for bare wires or small spade lugs) for the wires from your system's speaker connections.

If you have but one set of speaker connections, these wires would be connected in parallel with your speakers. Robins claims that this will introduce no impedance problems; this appears to be so since the unit is essentially voltage-sensitive only and exhibited only negligible speaker loading in lab tests. But since we were using a receiver equipped with main and remote speaker connections, we preferred to attach our speakers to the main terminals and the Enhancer to the remote terminals. By turning on the main speakers only we could cut

the Enhancer action out of the circuit; and by switching the remote speaker outputs in and out we could A/B the normal sound with the effect of the Enhancer.

Several possible options are available at the input end. If there is only one signal source whose dynamic range you want to expand, you could place the Enhancer between that source and the input to your amplifier or receiver. If you want to enhance all signals at will, the logical spot for it is in the tape-monitor connections—making the monitor switch in effect an on/off switch for the Enhancer except in playing tapes—though this setup would require switching on your tape unit (if you're using one at the monitor connections) allowing signals from the main system to play straight through even when you're not recording.

The graph suggests what happens. With the Enhancer's controls set at minimum the unit has virtually no effect on the signal except that all levels are reduced by about 8 dB in passing through the Enhancer. The lab could measure no appreciable distortion through the circuit, and frequency response proved to be ruler-flat from 20 Hz to 20 kHz. Actual input and output values (normally expressed in volts) are immaterial to the Enhancer's action. If you switch from a high-level source to one that delivers less signal through the Enhancer, the natural tendency will be to turn up your volume control in compensation. If your compensation is precise, the Enhancer's action will remain exactly the same, since it is the voltages at the speaker terminals that determine its behavior. Therefore we have arbitrarily defined a speaker output of 1 watt as our 0-dB point, so a 0-dB input to the amplifier is one that will produce a 1-watt output at the speaker terminals. The two scales are calibrated accordingly. The output scale also is calibrated (at the top) in terms of the power output to be expected at the speaker terminals for other signal values.

As the Enhancer's controls are rotated toward maximum a knee occurs in the curve at progressively lower input and output values. For "correct" use of the Enhancer, this knee should be adjusted to somewhere near the middle of the dynamic range of compressed program material (or perhaps near the top of the range for material that has been subject to limiting, which affects the peaks only). All signals below the knee will be attenuated; those rising above the knee area will not be. Adjusted this way, the unit meets Robins' claim of an 8-dB increase in dynamic range within quite close tolerances. Incidentally the expander action is relatively in-

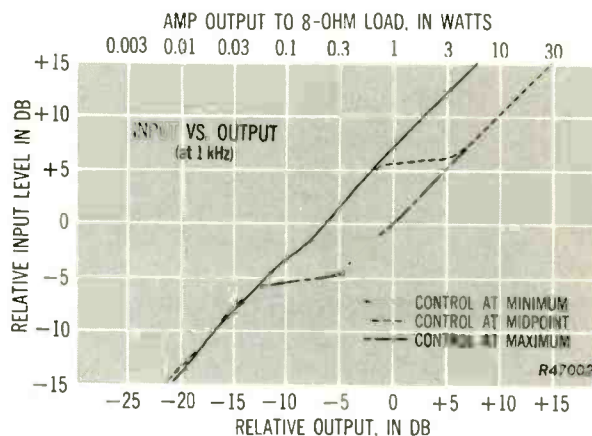

sensitive to low frequencies, so that high levels at low frequencies (tympni beats for example) are not likely to cause pulsating high-frequency noise where it is not masked by the signal.

The action is not precisely that of a professional expander of course. (At \$30 you could hardly expect it to be.) An ideal transfer-function curve would not have this knee, but remain a straight line that rotates clockwise as expansion is increased. In some program material we found the audible effect of the Enhancer to be similar to that of a true expander. Sometimes, however, it was not. One example of this involved a 1911 vocal recording (acoustic discs being textbook examples of signal sources with limited dynamic range). As the singer (Battistini) opens up from a *piano* to a good strong *forte* the swell eventually reaches the knee area, at which point the rate of swell rapidly increases until it gets beyond the knee, belying the vocal control for which the singer was so famous.

The unit is undeniably fun to work with, but it should not be taken as a substitute for the professional expanders that cost many times the price. (Even the DBX-117, a consumer version of a professional unit, costs some five times the price of the Enhancer.) We would count it, then, as an interesting innovation for the listener who loves to experiment with audio but doesn't have a bundle to spend on his predilections.

CIRCLE 144 ON READER-SERVICE CARD

Reports on Two Cassette Tapes

A detailed description of the test method, criteria, and terms used in testing cassette tapes appeared (together with reports on ten other tapes) in our March 1972 issue. The key terms may be summarized as:

Relative Sensitivity. The curve shown represents sensitivity across the frequency spectrum relative to a reference cassette on a machine adjusted for that cassette. If your deck is optimized for tape with a "hotter" high end, it would be best matched by tapes showing a rising high-frequency characteristic in this test; conversely if it is adjusted for tapes that are less sensitive at high frequencies, the "hotter" tapes will produce brighter than normal sound. The numerical sensitivity rating indicates output level with respect to the refer-

ence cassette for a given recording level at 400 Hz.

Maximum Recorded Level. The curve indicates the levels at which the tape is driven to 3 per cent total harmonic distortion or into self-erasure, whichever occurs first, and indicates the headroom or overload margin across the frequency spectrum.

S/N Ratio. The figure shown is frequency-weighted on the basis of audibility factors and is measured with respect to the DIN 0-VU level.

Dropout Count. Two samples of tape are measured for 15 minutes apiece on automatic equipment that distinguishes between major (audible in almost any type of music), medium (audible in fairly continuous music), and minor (barely perceptible) dropouts.

Scotch Extended Range

The Equipment: Scotch Extended Range, a low-noise ferric oxide tape cassette. C-60 price: \$2.50 in Philips-style box; also available in C-30, C-90, and C-120; some sizes may be found in mailer rather than Philips box. Manufacturer: 3M Company, Magnetic Products Div., 3M Center, St. Paul, Minn. 55101.

Comment: This is a report on a vanishing breed. Shortly after the lab tests were completed 3M announced that it would be withdrawing Extended Range in favor of its new Low Noise/High Density formula, an improved version of ER. The difference is easily spotted since the new formula also gets 3M's restyled packaging with a photographic illustration on the paper insert in the Philips box. (The similarly restyled High Energy package does not imply a change in tape formulation however.) Large quantities of Extended Range still are available at this writing, it appears, and are only being replaced by Low Noise/High Density as dealers' stocks of ER become exhausted.

ER's high-end sensitivity is characteristic of the Dynarange type—the original Scotch low-noise formulation. The sensitivity curve is quite similar to that for Scotch High Energy, confirming 3M's contention that the two may be used interchangeably, though the HE curve for maximum recorded level is predictably better than that for the less expensive ER. The sensitivity rating for ER (-0.5 dB) also is poorer than that for HE (+2.25 dB), but its NAB S/N ratio (58 dB) is somewhat better. All told, then, ER can be taken as a sort of archetypal low-noise tape: not as "hot" at the high end as some of the newer high-performance tapes (which may, for that reason, produce excessively bright sound on some equipment) and slightly lower in output than present low-noise/high-output types (including, apparently, its own successor—LN/HD).

The ER cassette has a larger-than-average window, which is molded right into the welded shell. Metal-clad studs serve as "idlers." The gold paper cassette label accepts ballpoint and pencil and erases fairly well. (The silver paper on the LN/HD cassette does not erase as neatly.) Labeling space on the paper insert of the Philips box is better than average for both ER and LN/HD.

CIRCLE 143 ON READER-SERVICE CARD

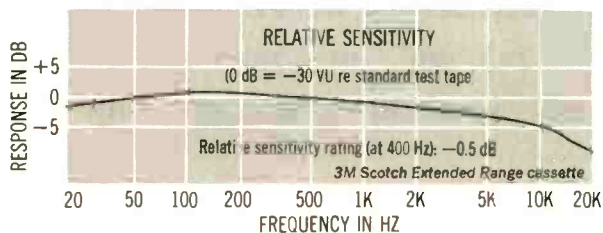
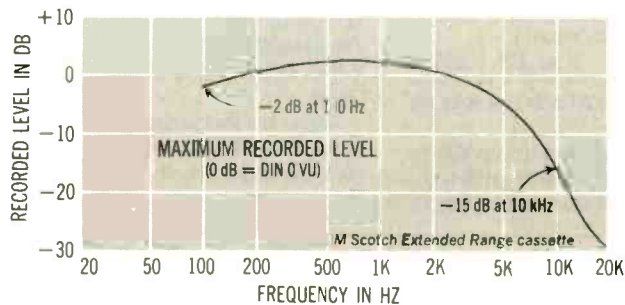

Scotch Extended Range Additional Data

S/N ratio (NAB)	58 dB		
Dropout count	Major	Medium	Minor
sample 1	0	0	1
sample 2	0	1	2

TDK Krom-O₂ Cassette

The Equipment: TDK Krom-O₂, a chromium dioxide tape cassette. C-60 price: \$3.00; also available in C-90. Manufacturer: TDK, Japan; U.S. distributor: TDK Electronics Corp., 23-73 48th St., Long Island City, N.Y. 11103.

Comment: The difference between chromium dioxide cassettes we've tested so far have been exceedingly minor (as one might expect when much of the tape—or at least the oxide—has been manufactured by a single plant: Du Pont's), and TDK's entry is approximately centered within that narrowly defined ball park. Headroom (represented in the maximum recorded level curve) is average for chromium dioxides—meaning that it is slightly less generous than typical low-noise ferric oxides in the midrange, considerably more generous at high frequencies. The one striking measurement for Krom-O₂ is the dropout count: just one notch below perfect and matched by the reading for only one other tape (Maxell UD) we have tested to date.

Both the Philips box and the cassette case have better than average labeling areas. The finely made case is held together with screws and has metal idler pins. Its windows and spring-mounted pressure pad are of standard design.

CIRCLE 142 ON READER-SERVICE CARD.

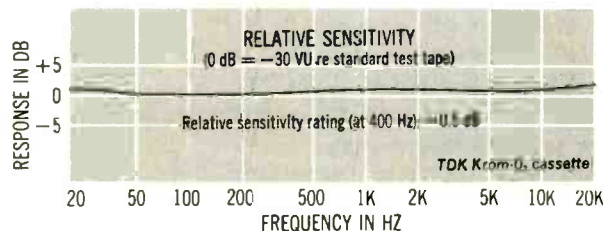
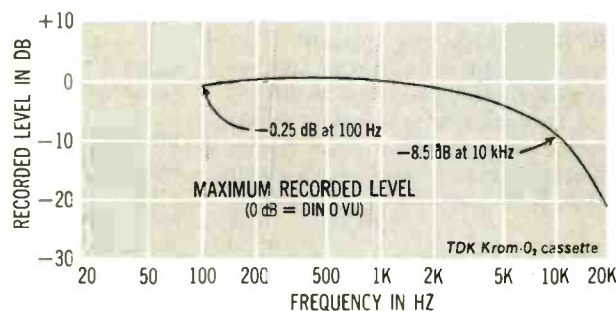

TDK Krom-O₂ Additional Data

S/N ratio (NAB)	59.5 dB		
Dropout count	Major	Medium	Minor
sample 1	0	0	1
sample 2	0	0	0



Music Listener's Book Service

A new and simple way to get those books you want, carefully selected from available lists. Circle the number(s) you want, send the coupon with your remittance. We do the rest.

THE MUSIC OF BERLIOZ. A.E.F. Dickinson. Illus. Musical examples.

Against the literary and social background of Berlioz's times, Dickinson examines the music with technical thoroughness. Both the broad aspects of style and the more minute details of tonal analysis come into play. The author draws on many sources not available in English. **No. 353 . . . \$23.50**

THE GLORY OF THE VIOLIN. Joseph Wechsberg. Illus.

Famed New Yorker author Wechsberg writes of his great love, the violin, and touches many bases. The great makers, the secrets of wood and varnish, the business of buying, selling (and cheating), the mysterious matter of tone, the noted virtuosos—all are dealt with in lively style. A fiddle fancier's delight. **No. 341 . . . \$8.95**

RECORDS IN REVIEW. 1972 EDITION.

The 17th annual edition of this "bible for record collectors." Hundreds of the authoritative, detailed reviews which appeared in *High Fidelity* in 1971 are arranged alphabetically by composer, sub-divided by category of music when releases of his music were considerable. A section on Recitals and Miscellany too, and an Artists' Index to all performers reviewed during the year, as well as those mentioned only in the text. **No. 285 . . . \$9.95**

CHOPIN. Collected Letters.

Beautifully produced reprint of the translation of three hundred letters, from the original Polish and French (collected by Henryk Opieński), first published in 1931—an almost indispensable guide to Chopin's life, his friends and his music. **No. 331 . . . \$12.00**

CARUSO. Stanley Jackson, Illus. Index. Bibl.

A popular biography of the legendary singer revealing episodes and relationships in his life, romanticized or almost completely ignored in previous biographies. Jackson separates the man from the camouflage which he encouraged. The great artist is here, also the many faceted character and personality. **No. 2114 . . . \$7.95**

DIVAS. Winthrop Sargeant, Illus.

The veteran music critic writes with liveliness and often intimate knowledge about six great singers: Sutherland, Horne, Sills, Nilsson, Price, and Farrell. The profiles, five of which appeared in *The New Yorker*, are part interview, part career-sketch, part canny observation. An assortment of photographs with each subject. **No. 352 . . . \$7.95**

JOLSON. Michael Freedland. Illus. Index.

An unvarnished story of Jolson's life and career. The boy sneaked into his first Broadway theater at 12, lived in a Catholic Boys Home (with Babe Ruth and Bojangles Robinson), worked in burlesque at 14; the man became a legend as one of the greatest entertainers in Broadway history. **No. 332 . . . \$8.95**

FACING THE MUSIC: An Irreverent Close-up of the Real Concert World. Henri Temianka. Introduction by Yehudi Menuhin. Illus.

The American-based violinist and conductor, founder of the California Chamber Symphony, casts an experienced and sometimes caustic eye on famous colleagues in the music world. A lighthearted autobiography rich in anecdotes. **No. 361 . . . \$6.95**

ENCOUNTERS WITH STRAVINSKY. A Personal Record. Paul Horgan. Illus. Photos. Index

For anyone who has felt the impact of Stravinsky's music on his own aesthetic responses, this is a book to treasure. As Horgan writes in his foreword, it is an "act of homage to a transcendent artist who for almost four decades indirectly and impersonally brought aesthetic fulfillment to my life and learning—an experience which then for another decade and a half was crowned by personal friendship with him and his wife." It is not intended as a work of musicology or complete biography, rather a sketchbook, rich in detail and anecdote, by a loving friend with the novelist's eye and ear for character and scene. **No. 2910 . . . \$7.95**

BRAHMS: A CRITICAL STUDY. Burnett James.

"Burnett James, moreover, has not written the usual dates-and-places biography, but rather a loosely biographical exegesis on Brahms's life and music . . . The book is highly discursive, for James likes to make analogies and to conjure up ideas: we range from the composer to such figures as Freud, Hemingway, Sibelius, and back."—Patrick Smith, *HIGH FIDELITY/MUSICAL AMERICA* **No. 333 . . . \$10.00**

DANCING ON THE SEATS. Andrew H. Meyer.

A wise and even witty book on the ins and outs of producing concerts on a college campus, covering such matters as choosing and negotiating with artists, their agents, and their managers; promoting the concert; setting up the hall properly on the night of the concert. The author, former president of a college concert promotional firm, deals primarily with rock concerts, but his information applies to other types as well. A valuable handbook for every new college concert chairman. **No. 342 . . . \$6.95**

THE DANCE BAND ERA: The Dancing Decades from Ragtime to Swing, 1910-1950. Albert McCarthy.

Four decades of bands and bandleaders examined both in musical terms and in their social and economic context. Unlike previous histories, this includes the great English and European bands. Lists of selected recordings with each chapter. **No. 299 . . . \$10.00**

THE RECORDINGS OF BEETHOVEN. As viewed by the Critics of High Fidelity.

To celebrate the Beethoven Bicentenary *High Fidelity* published the most immense critical discography ever undertaken by any magazine. apprais-

ing every available recording of the composer's works. At the end of the year these separate discographies were completely revised and updated and are here collected into one convenient book. It is hard to imagine any record collection without it on an adjacent shelf. Index to performers. **No. 2616 . . . \$6.95**

THIS BUSINESS OF MUSIC. Revised & Enlarged Edition, Dec. '71. Sidney Shemel & M. William Krasilovsky. Edited by Paul Ackerman.

Anyone involved or just interested in the music-record-tape industry needs this unique and indispensable reference book. No other single volume contains comparable information, arranged for easy reference and readability, on the complex legal, practical, and procedural problems.

Eight new chapters and one third more material in this new edition. 544 pages. 180 pages of appendices (Federal and International laws, statutes, contracts, applications, agreements, etc.) **No. 287 . . . \$15.00**

TARZAN OF THE APES. Drawings by Burne Hogarth. (122 pages full color). Text by Edgar Rice Burroughs. Introduction by Maurice Horn.

In the past decade, the international art world has discovered the comic strip as a significant contemporary art form. Horn documents in his learned introduction the worldwide influence of Hogarth, named by French critics the "Michelangelo of the comic strip."

Now Hogarth presents a new pictorial version of the novel that inspired the original comic strip—completely redrawn for this handsome volume. A fascinating book and a marvelous gift for any generation. **No. 2104 . . . \$9.95**

SCHUBERT: THE FINAL YEARS. John Reed.

For the more-than-casual Schubert fancier, this book explores, in readable manner, the stylistic development of the composer's work during the last three years of his life. The author's startling case for dating the Great C Major Symphony in 1826 rather than in the last year of Schubert's life is provocative and convincing. **No. 351 . . . \$15.00**

LETTERS OF RICHARD WAGNER:

THE BAYREUTH LETTERS. Trans. & Edit. by Caroline V. Kerr. Reprint of 1912 ed. with new index prep. for '72 ed.

Wagner laid the foundation stone of the Bayreuth festival theater in 1872. In this centennial edition are the deeds, words, and persons involved in its realization. **No. 2116 . . . \$10.50**

Music Listeners' Book Service, Dept. HW
HIGH FIDELITY, 2160 Patterson Street, Cincinnati, Ohio 45214

7-73

I enclose check or money order for \$ _____ Please send me, postpaid, the books indicated by the circled numbers below. (No cash, No C.O.D.'s, please).

353 341 285 331 2114 352 332 361 2910

333 342 299 2616 287 2104 351 2116

NAME _____

ADDRESS _____

CITY, STATE & ZIP _____



Meet the music savers.

Click! Another scratch in Sgt. Pepper that wasn't there before. Pop! Another one right in the middle of the Moody Blues. Crackle! Even with plastic jackets and cleaning gadgets and static removers, a few new noises seem to appear every time you put one of your records on the turntable.

If you'd like to end all that, take a look at the music savers—TEAC professional quality stereo cassette decks with built-in Dolby.* These skillfully engineered and carefully crafted TEAC Tape Decks enable you to permanently record your valued albums on convenient cassettes. Capture all of their sound purity for years to come, no matter how often you listen to them. And they'll always be reproduced with the accuracy and full-range fidelity that have made TEAC professional quality stereo cassette decks the best-selling music savers in America.

Stop the clicks, crackles and pops. Add the easy-handling convenience of cassettes and the professional performance of TEAC to your sound system, all backed by TEAC's exclusive two-year Warranty of Confidence.**

It could be the nicest thing you'll ever do for your music.



TEAC

The leader. Always has been.

*Dolby is a trademark of Dolby Laboratories, Inc.

**For two full years from date of purchase, any TEAC TAPEDECK returned with warranty card and freight prepaid by the original registered purchaser to TEAC or its nearest authorized service station will be repaired free of charge for defects in workmanship or material. This warranty applies only to TEAC products purchased in the United States.

TEAC Corporation of America • Headquarters: 733 Telegraph Rd., Montebello, California 90640 • TEAC offices in principal cities in the United States, Canada, Europe, Mexico and Japan.

CIRCLE 67 ON READER-SERVICE CARD

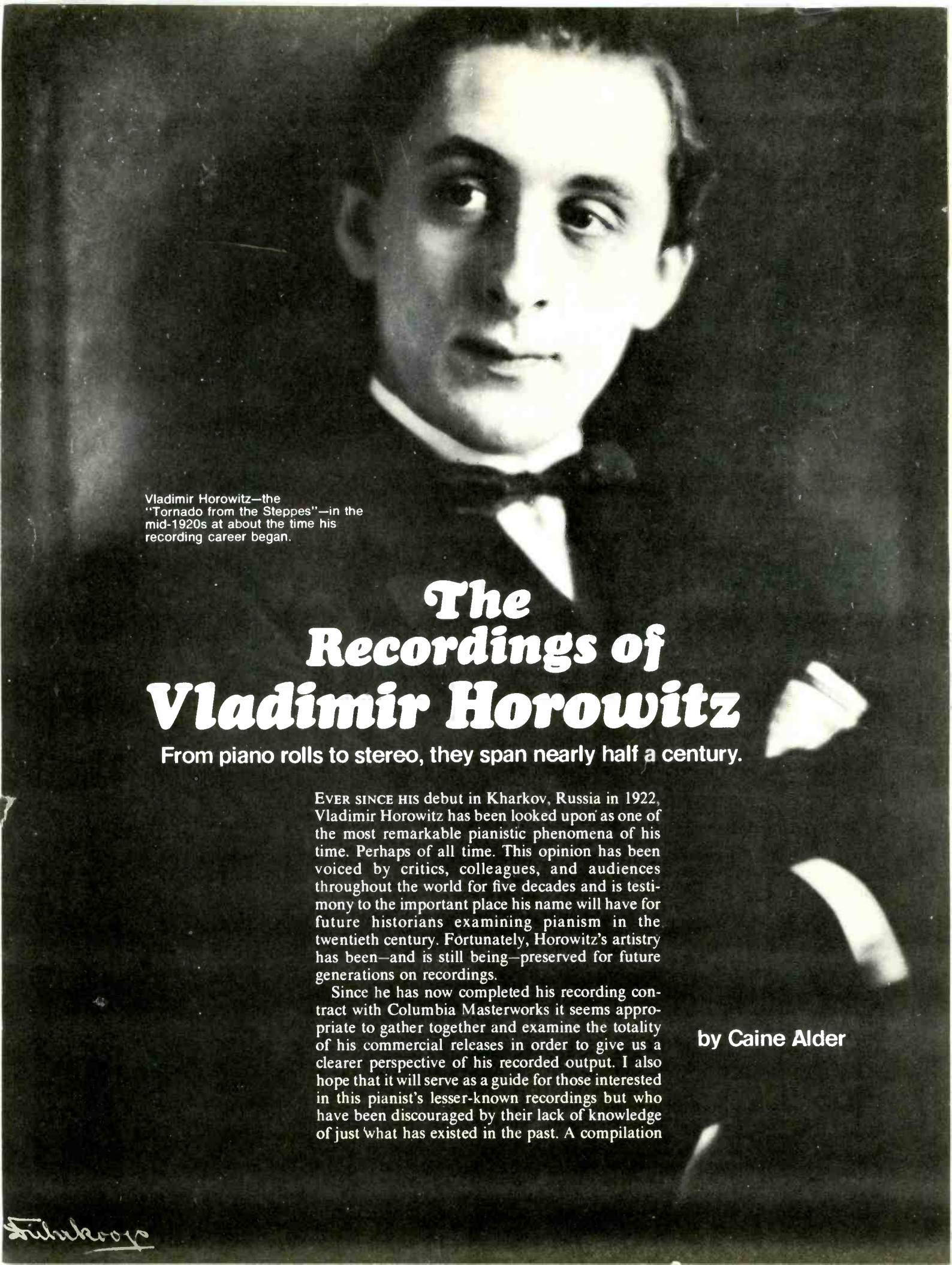

Vladimir Horowitz—the
"Tornado from the Steppes"—in the
mid-1920s at about the time his
recording career began.

The Recordings of Vladimir Horowitz

From piano rolls to stereo, they span nearly half a century.

EVER SINCE HIS debut in Kharkov, Russia in 1922, Vladimir Horowitz has been looked upon as one of the most remarkable pianistic phenomena of his time. Perhaps of all time. This opinion has been voiced by critics, colleagues, and audiences throughout the world for five decades and is testimony to the important place his name will have for future historians examining pianism in the twentieth century. Fortunately, Horowitz's artistry has been—and is still being—preserved for future generations on recordings.

Since he has now completed his recording contract with Columbia Masterworks it seems appropriate to gather together and examine the totality of his commercial releases in order to give us a clearer perspective of his recorded output. I also hope that it will serve as a guide for those interested in this pianist's lesser-known recordings but who have been discouraged by their lack of knowledge of just what has existed in the past. A compilation

by Caine Alder

at this time on Horowitz carries with it added interest since it is still in the process of creation with some of this pianist's finest achievements on recordings appearing in recent years.

Vladimir Horowitz was twenty-two years old when he made his first recorded performances for Welte during the season of 1926-27. The location was a rented castle on the Rhine, and even though the young "Tornado from the Steppes" was still more than a year away from his spectacular debut in America his fame in Russia and most of the countries of Europe was well secured. He recorded only five works for Welte utilizing a mechanical system of reproduction that many, including Horowitz, feel leaves much to be desired, particularly so far as authentic interpretation is concerned; still we should be grateful for their having been made since they are all we have of the young Russian's artistry before he came to this country.

The Horowitz debut in Carnegie Hall must surely remain one of the greatest of all time, and even now when some new star of the keyboard arrives on our shores critics often compare his debut with the first appearance of Horowitz over forty-five years ago. After the initial performance of Tchaikovsky's First Piano Concerto on January 12, 1928, with Sir Thomas Beecham and the New York Philharmonic Orchestra, the pianist made sixteen appearances in eastern cities before returning to Carnegie Hall on February 20 for his first New York solo recital. No doubt there were many (recording scouts among them), who must have felt that it simply wouldn't be possible for the young pianist to sustain the success and excitement of his first appearance and that after the newness had worn off he would be just another pianist who would visit America from time to time. The audience attending this second appearance was one of awesome distinction and included all the major pianists of the day from Josef Hofmann and Sergei Rachmaninoff on down. The program was Bach's C major Organ Toccata, arranged by Busoni, two Scarlatti sonatas, the Liszt B minor Sonata and a Chopin group ending with the A flat Polonaise, and Horowitz if anything created even more of a furor than that of the orchestral appearance six weeks earlier. Encore followed encore and still the capacity audience refused to leave the hall. Only when the houselights were turned on and the piano's lid was closed did people reluctantly begin to move toward the exits. This scene was to become a familiar one for Horowitz appearances, and the demand for his concerts became all but unprecedented.

Vladimir Horowitz was now the talk of the town. Recording executives rushed in with contracts in hand hoping to capitalize on the sensation that he was creating, and the young pianist suddenly found himself making paper player rolls for Duo Art in New York, and shellac phonograph recordings—

utilizing the new electronic process—for the Victor Company in Camden, New Jersey. Horowitz recorded only seven compositions for Duo Art; with the decline in the popularity of the player piano, recording on paper rolls soon gave way completely to phonograph reproduction. What makes the piano rolls important (even though Horowitz again feels that they are not valid reproductions of his art) is that of the total of twelve compositions he recorded for Welte and Duo Art, eight have never subsequently been recorded by him and apparently have not been in the Horowitz repertory for many years.

The contract with Victor proved to be much more lasting, and between the studios in Camden and those of Victor's affiliate in London (HMV) the association lasted until 1962, a period of thirty-four years. Horowitz made his first recording before the Victor microphones on March 26, 1928, and played one of the blockbusters he'd given as one of many encores at his New York recital appearance just five weeks before: the pianist's own arrangement of themes from Bizet's *Carmen*, which subsequently became almost inseparably linked with Horowitz's name and fame. To date he has recorded it three times in differing versions each separated by a twenty-year interval.

The Crash of 1929 notwithstanding, Horowitz continued to record for Victor through the late 1920s and early '30s, but thereafter all recordings were made in the HMV studios in London. Fortunately there was a good deal of recording activity (for those days) on the part of the pianist for HMV, particularly the year 1932 when nine works were preserved for posterity, including his now famous interpretation of Liszt's B minor Sonata. As we look back toward the first half of the 1930s it seems all the more important now than it did then that these stampers were cut, no one at the time foreseeing that complications following an appendectomy would usher in the pianist's first period of retirement. The last record he made before his illness was of Chopin's Fourth Scherzo, recorded on March 9, 1936, in London. So far as recordings were concerned, the retirement would span the next four years.

As the fall of 1939 approached and war enveloped Europe, Horowitz, largely as the result of constant urgings by Rachmaninoff and Arturo Toscanini, his father-in-law, returned to the concert stage and resumed his career in Switzerland, Paris, and London. In what would be his last concert in Europe for another twelve years Horowitz appeared with Toscanini at the Lucerne Festival on August 29, 1939, the very eve of World War II. He was thirty-five and he seemed in many ways a more settled individual, having had over three years to

Caine Alder teaches piano in Salt Lake City and is an avid collector and scholar of piano recordings.

Horowitz's thirty-four-year association with RCA resulted in landmark recordings of works by, among others, Beethoven, Liszt, Prokofiev, and his own transcriptions.



rest and simply think about music without combating the rigors of a schedule that had become so horrendous as to include nearly 100 appearances in 1935.

A greater surety and repose was evident in Horowitz's playing in his 1940 recording of Brahms's Second Piano Concerto with Toscanini and the NBC Symphony Orchestra. It was the first recording he had made in America in ten years, and its appearance was greeted with a great deal of warmth and enthusiasm on the part of public and critics alike. Its success paved the way for the second release made almost exactly a year later in May 1941, and again involved the talents of son-and father-in-law in a famous item of the Horowitz repertoire, the Tchaikovsky Concerto No. 1, in B flat minor. Its performance put an end to speculation that the pianist may have lost some of his fire and excitement during his sabbatical from the concert platform.

With the onset of the war and the great shortage of materials most recording activity came to an abrupt halt, and from 1941 to 1945 the pianist recorded only four works, one a public performance he had given in Carnegie Hall.

But it didn't take long after the end of the war for the resumption of record making, and from 1945 through the first years of the 1950s the Horowitz discography showed marked increases. One must remember that this was still the pre-LP era, and it was much more risky and expensive to record the more lengthy items of the piano repertoire. Nonetheless we have such works as Prokofiev's Seventh Sonata, Kabalevsky's Third, Beethoven's *Moonlight* and Mussorgsky's *Pictures at an Exhibition* coming out in sets containing as many as four 78 rpm records. For a brief period in the beginning of the 1950s RCA Victor manufactured three kinds of recordings: 78 rpm shellacs, the smaller doughnut-shaped 45 rpm discs made of unbreakable vinyl,

and the 12-inch LPs. The 45s offered a transition from the heavy and breakable 78s, which by that time had been in existence for nearly half a century. Horowitz recorded a half dozen or so short works for these 45 rpm releases while the larger works, such as the sonatas by Chopin (No. 2) and Barber, came out on the long-play discs.

The year 1953 marked the twenty-fifth anniversary of Horowitz's debut in this country, and appearances in New York on January 12 and February 25 were booked to commemorate the occasion. But the pianist had been touring constantly now for thirteen seasons and the rigors of travel as well as the nervous strain of always having to be "King of Pianists" was beginning to take its toll. It was fortunate that there was some historical significance to these appearances and that Victor saw to it that they were recorded, since the recitals would prove to be his last public appearances for another twelve years. February 1953 then begins his second retirement period, a time which would bring about not only a halt to his public appearances but also a change in the direction of his recorded repertoire.

From 1940 on there had been increasing demands on Horowitz the virtuoso, and in 1941 he made his second transcription, his arrangement of Saint-Saëns's *Danse macabre*. Four years later, in 1945, there was his piano version of Sousa's *Stars and Stripes Forever*, to celebrate the ending of the Second World War, and as audiences and managers demanded more and more there appeared his *Wedding March* Variations in 1947, the *Rakóczy* March in 1949, and finally his elaboration of Liszt's already overworked and famous *Second Hungarian Rhapsody* in 1952. At this time he was also introducing a large amount of modern literature to American audiences with performances and recordings of the smaller works as well as sonatas by Prokofiev, Kabalevsky, and Barber. Now even though the public rushed to his concerts—and it was



In 1962, Horowitz, here with Goddard Lieberson, then president of Columbia Records, switched his unabated recording activities to the Columbia label.

a rare house that wasn't sold out—some critics were beginning to look at him as merely a juggler or stunt man who had abandoned the musical, lyrical side of his art. Horowitz for some time had been having these thoughts himself but seemed to feel trapped in a situation that had crept up on him gradually and which had apparently gotten beyond his control; thus once again a complete break with the past was deemed a necessary solution that would remedy a number of problems at the same time. Horowitz would once again take to the stage in 1965, but 1953 marked the end to a rather large portion of his repertoire that consisted primarily of contemporary works as well as his transcendental arrangements. For the first nine or ten months of his retirement he saw virtually no one and even refused to leave his home. There was little musical activity of any kind at first as he attempted to recover physically and psychologically from the strains he had been subjecting himself to for over thirteen consecutive seasons. But as the spring of 1954 approached, Horowitz began to explore the sonatas of Clementi in editions that his wife, Wanda, had just brought back from Italy. At this point the pianist felt that he had to retrace his journey to the classics and Clementi would be a good place to begin. With the pianist still refusing to leave his home it was necessary for RCA engineers to go to him, and consequently he recorded the three Clementi works in his own living room on a concert grand Steinway that the famous piano firm had given him as a wedding present in 1933.

Having completed his first album, during what was originally intended to be a year's vacation from the stage, plans were now set in motion for an all-Scriabin album to be made later that fall, again at the Horowitz household. There would be one more disc made in this fashion the following year in 1955, but this time it was of more popular repertoire: Beethoven's *Waldstein* and a re-recording of the

Moonlight. Horowitz had been away from his public for over three seasons, and Victor seems to have wanted to make up for any momentum lost by at least recording music more familiar to the public, especially since there was now only one record per year coming from the Horowitz piano.

The pianist was a little disappointed in the sound of these recordings made in his home, and in 1956 the recording sessions for his all-Chopin disc were moved to the stage of Carnegie Hall. For the next two years there was no recording activity of any kind, and as the Horowitz sabbatical moved into its sixth year, there appeared little interest in the making of recordings, on the part of either the company or the pianist.

Finally, sometime in 1959 the first Horowitz stereo album was produced with performances of Beethoven's Op. 10, No. 3 and *Appassionata* Sonatas in what proved to be the last disc he made for RCA Victor. Horowitz seemed displeased with the kind of repertoire he was being requested to record, and Victor seemed equally discontent that their former star was no longer bolstering record sales as a traveling virtuoso who conquered large audiences in many cities. Again something had to give, and it did in 1962 when the pianist's contract with Victor was up for renewal and he decided to switch to Columbia Masterworks.

For three years now there had been no new recordings, and a virtual blackout existed on any publicity concerning his activities. With the change in companies there suddenly appeared stories headlined "Horowitz to Play Again," "Master's Return," "The Return of Vladimir Horowitz." A great deal of interest was generated by speculation about not only the pianist's present capabilities but also about what he would be programming for his initial Columbia release. The sessions with the new company took place in April and May of 1962 with a release date scheduled for later that fall. For rep-



Horowitz's record of *Kreisleriana* won, among other honors, a 1971 HIGH FIDELITY/Montreux International Record Award, presented here by HF editor Leonard Marcus.

ertoire Horowitz selected works by Chopin, Schumann, and Rachmaninoff as well as an anxiously awaited new transcription, that of Liszt's Nineteenth *Hungarian Rhapsody*. The disc was highly acclaimed and appeared on the best-seller lists for many months.

As it turned out, three more studio-made recordings would be released before Horowitz's historic return to public performances in 1965; on these discs would be works by Schumann, Scriabin, Scarlatti, Chopin, Debussy, and others that not only offered a wide variety of interest but seemed to have a great compatibility with Horowitz's own musical interests and emotional temperament.

The pianist's return to the stage in 1965 initiated four years in which his sole record releases would be from his public appearances, primarily in New York. This resulted largely from one of the things that Horowitz says most prompted him to go before the public again: He was tired of playing only for lifeless microphones in recording studios. So for four years he successfully combined the two, making records while playing in public, resulting in live performances of works from Bach-Busoni to Liszt to Scriabin. The sound is not always perfect, and the listener can easily detect audience noises in the background (not to mention the applause), but the performances remain very important documents of a great pianist playing before an obviously mesmerized group of followers. Present also is the spontaneity and excitement that have become characteristic of his appearances since the inception of his career.

In the fall of 1969 Horowitz again abandoned public appearances in favor of the recording studio, and since that time Columbia has released his multi-prize-winning performance of Schumann's *Kreisleriana* and an all-Chopin recording—which

won the most recent Grammy Award—that features among others a work new to the Horowitz Chopin discography: the Introduction and Rondo, Op. 16. In fact during the eleven years that Horowitz has been with Columbia all but two of his albums have won Grammys, and one of the two, *Kreisleriana*, won three Japanese awards as well as the HIGH FIDELITY/Montreux International Record Award. Still to be released by Columbia are recordings of works by Beethoven, Schubert, and Chopin as noted in the discography. [See also "Behind the Scenes," page 12.]

The most recent Horowitz recording to be released is the all-Scriabin disc which features a variety of the smaller works, the *Vers la flamme*, and a repressing of the Tenth Sonata taken from a recital played before a few friends in Carnegie Hall on November 9, 1965 (it was the evening of the Big Blackout along the eastern seaboard and the pianist had to complete the concert with the help of a flashlight held by an usher), which was first released in 1967.

At age sixty-nine there is one thing still certain: Horowitz remains in top form musically and technically. It is to be hoped that he will continue to enrich the recorded piano repertoire with even more frequency since there are still many works he has performed throughout his career that remain to find their way onto recordings: Bach's C minor Toccata and the F minor Prelude and Fugue from Book II of the WTC; Brahms's E flat Rhapsody and *Paganini Variations*; Chopin's Second Ballade, *Fantasie*, Op. 49, and about seven of the études (especially Op. 25, Nos. 6, 10, and 11); five études by Debussy; *Islamey* by Balakirev; Liszt's *St. Francis Walking on the Water* and the Scherzo and March (both in Horowitz arrangements); Rachmaninoff's Prelude in E minor, Op. 32, No. 4, and *Variations on a Theme of Chopin*; Scriabin's Sixth Sonata and *Fantasie*, Op. 28 (either of which could have replaced the all-Scriabin disc's reissued Tenth Sonata that, notwithstanding the great performance, is still available on the "In Concert" album); and so on.

In the discography that follows I have made no attempt to get into the intricacies of serial and matrix numbers or specific dates for record takes. All too often these items almost become ends in themselves, and I most gratefully leave them for future historians of recording encyclopedias. The problem of recording dates was difficult enough in the days of 78-rpm recordings, but with the advent of long-playing records, tape-recorded masters, and ingenious splicing engineers, the problem of assigning exact dates for recorded performances becomes all but insurmountable. And, I might add, no less so for the "live" performances of Horowitz that were released by Columbia in the last half of the '60s.

Due to the limitations of space I have listed only the presently available record number or, in the case of out-of-print items, the last available record number of a particular performance. ■

Horowitz on Records



The Works and Their Albums

The principles of this listing are outlined in the text. Only commercial recordings are included; it would be impossible to track down all the unauthorized recordings of Horowitz performances, although such "private" issues as the 1936 Brahms D minor Concerto with the Concertgebouw Orchestra under Bruno Walter or the 1953 Tchaikovsky B minor Concerto with the New York Philharmonic under George Szell have become treasures of the underground.

Each listing contains the date of recording, followed by the label (RCA = RCA Victor, now RCA Red Seal; VICTR = RCA Victrola; ANG = Angel; SERA = Seraphim; COL = Columbia) and number of the most recent album on which the selection appeared; then, in parentheses, the format of that issue (78 = 78-rpm disc, never transferred to LP; 45 = 45-rpm disc, never transferred to LP; LP-M = mono LP; LP-S = stereo LP; LP-E = electronically rechanneled LP). An asterisk indicates that the record listed is out of print. Recordings still in print are numbered. These numbers provide a guide to the contents of each in-print recording listed in "The Albums and Their Contents," page 56.

PIANO ROLLS

(The Superscopes are of course disc transfers.)

BACH-BUSONI

(1) Toccata and Fugue, in D minor, S. 565. 1926-27: SUPERSCOPE KBI 4-A068 (LP-S).

BIZET

Carmen Variations (arr. Horowitz). 1928: DUO ART 7250-4*.

CHOPIN

Etude in E flat minor, Op. 10, No. 6. 1928: DUO ART 7287-4*.

Etude in C minor, Op. 25, No. 12. 1928: DUO ART 7287-4*.

(2) Mazurka No. 21, in C sharp minor, Op. 30, No. 4. 1926-27: SUPERSCOPE KBI 4-A068 (LP-S).

HOROWITZ

Waltz in F minor. 1928: DUO ART 7360-3*.

LISZT

Fantasia on Two Motives from Mozart's Marriage of Figaro (arr. Busoni). 1926-27: WELTE-MIGNON 4128*.

RACHMANINOFF

(3) Prelude in G, Op. 32, No. 5. 1926-27: SUPERSCOPE KBI 4-A068 (LP-S).

(4) Prelude in G sharp minor, Op. 32, No. 12. 1926-27: SUPERSCOPE KBI 4-A068 (LP-S).

SAINT-SAËNS

Danse macabre, Op. 40 (arr. Liszt). 1928: DUO ART A 108*.

SCHUBERT

Liebesbotschaft (arr. Liszt). 1928: DUO ART 7282-3*.

TCHAIKOVSKY

Dumka, Op. 59, No. 1. 1928: DUO ART 7281-4*.

DISCS AND TAPES

BACH-BUSONI

- Nun freut euch, lieben Christen, S. 734. 1934 (May 6): ANG COLH 300 (LP-M)*.
 Nun komm' der Heiden Heiland, S. 599. 1947: RCA LM 1171 (LP-M)*.
 (5) Toccata and Fugue, in C, S. 564. 1965: COL M2S 728 (LP-S).

BARBER

- Sonata, Op. 26. 1950 (May 15): RCA LD 7021 (LP-M)*.

BEETHOVEN

- (6) Concerto No. 5, in E flat, Op. 73 (Emperor). 1952—RCA Victor Symphony Orchestra, Fritz Reiner, cond.: VICTR VICS 1636 (LP-E).
 (7) Sonata No. 7, in D, Op. 10, No. 3. 1959: RCA LSC 2366 (LP-S).
 (8) Sonata No. 8, in C minor, Op. 13 (Pathétique). 1963 (Sept.—Nov.): COL MS 6541 (LP-S).
 (9) Sonata No. 14, in C sharp minor, Op. 27, No. 2 (Moonlight). 1947: RCA LM 1027 (LP-M)*. 1955: RCA LM 2009 (LP-M). 1972 (fall): COL (LP-S—not yet released).
 (10) Sonata No. 21, in C, Op. 53 (Waldstein). 1955: RCA LM 2009 (LP-M). 1972 (Dec.): COL (LP-S—not yet released).
 (11) Sonata No. 23, in F minor, Op. 57 (Appassionata). 1959: RCA LSC 2366 (LP-S). 1972 (fall): COL (LP-S—not yet released).
 Variations (32) in C minor, G. 191. 1934 (May 6): ANG COLH 300 (LP-M)*.

BIZET

- (12) Carmen Variations (arr. Horowitz). 1928 (Mar. 26): RCA LM 6074 (LP-M)*. 1947: RCA LM 1171 (LP-M)*. 1968: COL MS 7106 (LP-S).

BRAHMS

- Concerto No. 2, in B flat, Op. 83. 1940 (May 9)—NBC Symphony Orchestra, Arturo Toscanini, cond.: RCA LCT 1025 (LP-M)*.
 (13) Intermezzo in B flat minor, Op. 117, No. 2. 1951 (Apr. 23): VICTR VICS 1649 (LP-E).
 Sonata for Violin and Piano, No. 3, in D minor, Op. 108. 1950 (June 22)—Nathan Milstein, violin: RCA LM 106 (LP-M)*.
 (14) Waltz in A flat, Op. 39, No. 15. 1950 (Oct. 10): VICTR VICS 1649 (LP-E).

CHOPIN

- (15) Andante Spianato and Grande Polonaise brillante, Op. 22. 1945: VICTR VIC 1605 (LP-M).
 (16) Ballade No. 1, in G minor, Op. 23. 1947: VICTR VIC 1605 (LP-M). 1965: COL M2S 728 (LP-S). 1968: COL MS 7106 (LP-S).
 Ballade No. 3, in A flat, Op. 47. 1951: RCA LM 1707 (LP-M)*.
 Ballade No. 4, in F minor, Op. 52. 1951: RCA LM 1707 (LP-M)*.
 Barcarolle in F sharp minor, Op. 60. 1956: RCA LM 2137 (LP-M)*.
 Etude in E, Op. 10, No. 3. 1951: RCA LM 1707 (LP-M)*. 1972 (Dec.): COL (LP-S—not yet released).
 (17) Etude in C sharp minor, Op. 10, No. 4. 1935 (June 2): ANG COLH 300 (LP-M)*. 1951: VICTR VIC 1605 (LP-M). 1973 (Feb. 15): COL (LP-S—not yet released).
 (18) Etude in G flat, Op. 10, No. 5. 1935

(June 2): ANG COLH 300 (LP-M)*. 1971 (spring): COL M 30643 (LP-S).

- (19) Etude in F, Op. 10, No. 8. 1932 (Nov. 15): ANG COLH 300 (LP-M)*. 1965: COL M2S 728 (LP-S).
 (20) Etude in C minor, Op. 10, No. 12 (Revolutionary). 1963 (Sept.—Nov.): COL MS 6541 (LP-S). 1972 (Dec.): COL (LP-S—not yet released).
 Etude in F, Op. 25, No. 3. 1935 (June): PATHÉ C061-01902 (LP-M, import; first released in 1972, not issued in U.S.).
 (21) Etude in C sharp minor, Op. 25, No. 7. 1963 (Sept.—Nov.): COL MS 6541 (LP-S).
 (22) Impromptu No. 1, in A flat, Op. 29. 1951: VICTR VIC 1605 (LP-M). 1972-73: COL (LP-S—not yet released).
 (23) Introduction and Rondo, in E flat, Op. 16. 1971 (Apr. 7): COL M 30643 (LP-S).
 (24) Mazurka No. 7, in F minor, Op. 7, No. 3. 1932 (Nov. 15): ANG COLH 300 (LP-M)*. 1947 (Dec. 22): VICTR VICS 1649 (LP-E). 1973 (Feb. 15): COL (LP-S—not yet released).
 (25) Mazurka No. 13, in A minor, Op. 17, No. 4. 1971 (May 4): COL M 30643 (LP-S).
 Mazurka No. 17, in B flat minor, Op. 24, No. 4. 1951 (Mar. 5): RCA LM 1957 (LP-M)*. 1973 (Feb. 8): COL (LP-S—not yet released).
 Mazurka No. 20, in D flat, Op. 30, No. 3. 1950: RCA LM 1109 (LP-M)*. 1973 (Feb. 8): COL (LP-S—not yet released).
 (26) Mazurka No. 21, in C sharp minor, Op. 30, No. 4. 1928 (Mar. 26): RCA LM 2993 (LP-M). 1950: RCA LM 1109 (LP-M)*. 1965: COL M2S 728 (LP-S).
 Mazurka No. 23, in D, Op. 33, No. 2. 1973 (Feb. 15): COL (LP-S—not yet released).
 (27) Mazurka No. 25, in B minor, Op. 33, No. 4. 1966: COL M2S 757 (LP-S).
 Mazurka No. 26, in C sharp minor, Op. 41, No. 1. 1950: RCA LM 1109 (LP-M)*.
 Mazurka No. 27, in E minor, Op. 41, No. 2. 1933 (May 29): ANG COLH 300 (LP-M)*. 1973 (Feb. 15): COL (LP-S—not yet released).
 (28) Mazurka No. 32, in C sharp minor, Op. 50, No. 3. 1935 (June 2): SERA 60207 (LP-M). 1950: VICTR VIC 1605 (LP-M). 1973 (Feb. 15): COL (LP-S—not yet released).
 Mazurka No. 38, in F sharp minor, Op. 59, No. 3. 1950: RCA LM 1109 (LP-M)*. 1973 (Feb. 15): COL (LP-S—not yet released).
 Mazurka No. 40, in F minor, Op. 63, No. 2. 1950: RCA LM 1109 (LP-M)*.
 Mazurka No. 41, in C sharp minor, Op. 63, No. 3. 1950: RCA LM 1109 (LP-M)*. 1971 (Apr. 14): COL (LP-S—not yet released).
 (29) Nocturne No. 2, in E flat, Op. 9, No. 2. 1956: VICTR VIC 1605 (LP-M).
 Nocturne No. 3, in B, Op. 9, No. 3. 1956: RCA LM 2137 (LP-M)*.
 Nocturne No. 4, in F, Op. 15, No. 1. 1956: RCA LM 2137 (LP-M)*.
 (30) Nocturne No. 5, in F sharp, Op. 15, No. 2. 1947 (May 19): VICTR VICS 1649 (LP-E).
 Nocturne No. 7, in C sharp minor, Op. 27, No. 1. 1956: RCA LM 2137 (LP-M)*.
 (31) Nocturne No. 15, in F minor, Op. 55, No. 1. 1951: RCA LM 1707 (LP-M)*. 1968: COL MS 7106 (LP-S).
 (32) Nocturne No. 19, in E minor, Op. 72, No. 1. 1951: RCA LM 1707 (LP-M)*. 1953 (Feb. 25): VICTR VICS 1649 (LP-E). 1966: COL M2S 757 (LP-S).
 Polonaise No. 3, in A, Op. 40, No. 1 (Mili-



- taire). 1972 (late): COL (LP-S—not yet released).
 (33) Polonaise No. 5, in F sharp minor, Op. 44. 1968: COL MS 7106 (LP-S).
 (34) Polonaise No. 6, in A flat, Op. 53. 1945: RCA LM 1137 (LP-M)*. 1971 (spring): COL M 30643 (LP-S).
 (35) Polonaise No. 7, in A flat, Op. 61 (Polonaise-Fantaisie). 1951 (Apr. 23): RCA LM 1957 (LP-M)*. 1966: COL M 30643 (LP-S).
 Prélude in B minor, Op. 28, No. 6. 1972 (May 4): COL (LP-S—not yet released).
 (36) Scherzo No. 1, in B minor, Op. 20. 1951: VICTR VIC 1605 (LP-M). 1953 (Feb. 25): RCA LM 6014 (LP-M). 1963 (Sept.—Nov.): COL MS 6541 (LP-S).
 Scherzo No. 2, in B flat minor, Op. 31. 1956: RCA LM 2137 (LP-M)*.
 Scherzo No. 3, in C sharp minor, Op. 39. 1956: RCA LM 2137 (LP-M)*.
 Scherzo No. 4, in E, Op. 54. 1936 (Mar. 9): ANG COLH 300 (LP-M)*.
 (37) Sonata No. 2, in B flat minor, Op. 35. 1950 (May 13): RCA LM 1235 (LP-M). 1962 (Apr.—May): COL KS 6371 (LP-S).
 (38) Waltz No. 3, in A minor, Op. 34, No. 2 (Grande Valse brillante). 1945: RCA LM 1137 (LP-M)*. 1953 (Feb. 25): RCA LM 6014 (LP-M). 1971 (spring): COL M 30643 (LP-S).
 (39) Waltz No. 7, in C sharp minor, Op. 64 No. 2. 1946 (Nov. 29): VICTR VIC 1605 (LP-M). 1972 (late): COL (LP-S—not yet released).
CLEMENTI
 (40) Sonata in F minor, Op. 14, No. 3. 1954 (spring): RCA LM 1902 (LP-M).
 (41) Sonata in F sharp minor, Op. 26, No. 2. 1954 (spring): RCA LM 1902 (LP-M).
 (42) Sonata in G minor, Op. 34, No. 2. 1954 (spring): RCA LM 1902 (LP-M).
 Sonata in B flat, Op. 47, No. 2: Rondo only. 1950 (May 17): RCA LD 7021 (LP-M)*.

CZERNY

Variations on La Ricordanza, Op. 33. 1944: RCA LD 7021 (LP-M)*

DEBUSSY

- (43) Children's Corner: No. 3, Serenade for the Doll. 1928 (Mar. 26): RCA LM 2993 (LP-M). 1947: RCA LM 1171 (LP-M)*. 1953 (Feb. 25): RCA LM 6014 (LP-M). 1965: COL M2S 728 (LP-S).
- Etude No. 11, Pour les arpèges composés. 1934 (May 6): ANG COLH 300 (LP-M)*.
- (44) L'Isle joyeuse. 1966: COL M2S 757 (LP-S).
- (45) Préludes, Book II: No. 4, Les Fées sont d'exquises danseuses. 1963 (Sept.-Nov.): COL MS 6541 (LP-S).
- (46) Préludes, Book II: No. 5, Bruyères. 1963 (Sept.-Nov.): COL MS 6541 (LP-S).
- (47) Préludes, Book II: No. 6, General Lavine. 1963 (Sept.-Nov.): COL MS 6541 (LP-S).

DOHNÁNYI

(48) Etude No. 6, in F minor (Capriccio). 1928 (Dec. 4): RCA LM 2993 (LP-M).

HAYDN

- (49) Sonata No. 23, in F. 1966: COL M2S 757 (LP-S).
- (50) Sonata No. 52, in E flat. 1934-35: SERA 60063 (LP-M). 1951 (Apr. 23): RCA LM 1957 (LP-M)*.

HOROWITZ

(51) Danse eccentricque. 1930 (Mar. 4): RCA LM 2993 (LP-M).

KABALEVSKY

(52) Sonata No. 3, in F, Op. 46. 1947 (Dec. 22): RCA LM 2993 (LP-M).

LISZT

- (53) Années de pèlerinage, Switzerland (I): No. 4, Au bord d'une source. 1947: RCA LM 1235 (LP-M) or LM 2584 (LP-M).
- (54) Années de pèlerinage, Switzerland (I): No. 6, Vallée d'Obermann. 1966: COL M2S 757 (LP-S).
- (55) Années de pèlerinage, Italy (II): No. 5, Sonetto del Petrarca No. 104. 1949: RCA LM 2584 (LP-M).
- (56) Harmonies poétiques et religieuses: No. 7, Funérailles. 1932 (Nov.): SERA 60114 (LP-M). 1950 (Dec. 29): RCA LM 2584 (LP-M) or VICTR VICS 1649 (LP-E).
- (57) Hungarian Rhapsody No. 2 (arr. Horowitz). 1953 (Feb. 25): RCA LM 6014 (LP-M) or LM 2584 (LP-M).
- (58) Hungarian Rhapsody No. 6. 1947: RCA LM 1235 (LP-M) or LM 2584 (LP-M).
- (59) Hungarian Rhapsody No. 15 (Rakóczy March; arr. Horowitz). 1949: RCA LM 2584 (LP-M).
- (60) Hungarian Rhapsody No. 19 (arr. Horowitz). 1962 (Apr.-May): COL KS 6371 (LP-S).
- (61) Paganini Etude No. 2, in E flat (arr. Busoni). 1930 (Mar. 4): RCA LM 2993 (LP-M).
- (62) Sonata in B minor. 1932 (Nov.): SERA 60114 (LP-M).
- (63) Valse oubliée, No. 1. 1928 (Dec. 4): RCA 1455 (78)*. 1950 (Dec. 29): RCA LM 2584 (LP-M) or VICTR VICS 1649 (LP-E).

MENDELSSOHN

Songs Without Words: No. 25, May

Breezes, Op. 62, No. 1. 1947: RCA ERA 59 (45)*.

- (64) Songs Without Words: No. 30, Spring Song, Op. 62, No. 6. 1946 (Oct. 29): VICTR VICS 1649 (LP-E).
- (65) Songs Without Words: No. 35, Shepherd's Complaint, Op. 67, No. 5. 1946 (Oct. 29): VICTR VICS 1649 (LP-E).
- (66) Songs Without Words: No. 40, Elegy, Op. 85, No. 4. 1946 (Oct. 29): VICTR VICS 1649 (LP-E).
- Variations sérieuses, in D minor, Op. 54. 1946: RCA LVT 1043 (LP-M)*.
- Wedding March (arr. Liszt and Horowitz). 1946: RCA LVT 1043 (LP-M)*.

MOSZKOWSKI

- Etincelles, Op. 36, No. 6. 1951 (Apr. 23): RCA LM 1957 (LP-M)*.
- Etude in F, Op. 72, No. 6. 1950: RCA ERA 59 (45)*.
- (67) Etude in A flat, Op. 72, No. 11. 1950: RCA LD 7021 (LP-M; first released in 1963)*. 1965: COL M2S (LP-S).

MOZART

- (68) Sonata No. 11, in A, K. 331. 1947—Rondo alla turca only: RCA LM 1171 (LP-M)*. 1966: COL M2S 757 (LP-S).
- Sonata No. 12, in F, K. 332. 1947: RCA LD 7021 (LP-M)*.

MUSSORGSKY-HOROWITZ

By the water. 1947: RCA LM 1171 (LP-M)*.

(69) Pictures at an Exhibition. 1947: RCA LM 1014 (LP-M)*. 1951 (Apr. 23): RCA LM 2357 (LP-M) or LSC 3278 (LP-E).

POULENC

- Pastourelle. 1932 (Nov. 11): ANG COLH 300 (LP-M)*.
- Presto in B flat. 1947: RCA 12-0428 (78)*.
- Toccata. 1932 (Nov. 11): ANG COLH 300 (LP-M)*.

PROKOFIEV

- (70) Sonata No. 7, in B flat, Op. 83. 1945 (Sept. 22): RCA LD 7021 (LP-M)*. 1953 (Feb. 25)—third movement only: RCA LM 6014 (LP-M).
- Toccata, Op. 11. 1947 (Nov. 1): RCA LM 1171 (LP-M)*.

RACHMANINOFF

- (71) Concerto No. 3, in D minor, Op. 30. 1930—London Symphony Orchestra, Albert Coates, cond.: SERA 60063 (LP-M). 1951 (May 10)—RCA Victor Symphony Orchestra, Fritz Reiner, cond.: RCA LM 1178 (LP-M)*.
- (72) Etude Tableau in C, Op. 33, No. 2. 1962 (Apr.-May): COL KS 6371 (LP-S). 1967: COL M 30464 (LP-S).
- (73) Etude Tableau in C sharp minor, Op. 33, No. 6. 1967: COL M 30464 (LP-S).
- (74) Etude Tableau in E flat minor, Op. 39, No. 5. 1962 (Apr.-May): COL KS 6371 (LP-S).
- (75) Etude Tableau in D, Op. 39, No. 9. 1967: COL M 30464 (LP-S).
- (76) Moment musical, in B minor, Op. 16, No. 3. 1968: COL M 30464 (LP-S).
- Prelude in G minor, Op. 23, No. 5. 1930: RCA M 117 (78)*.
- (77) Prelude in G sharp minor, Op. 32, No. 12. 1968: COL M 30464 (LP-S).
- (78) Sonata No. 2, in B flat minor, Op. 36. 1968: COL M 30464 (LP-S).

RIMSKY-KORSAKOV

Flight of the Bumblebee (arr. Rachmaninoff). 1932 (Nov.): PATHÉ C061-01902 (LP-M, import; first released in 1972, never issued in U.S.).

SAINT-SAËNS

Danse macabre, Op. 40 (arr. Liszt and Horowitz). 1942: RCA LD 7021 (LP-M)*.

SCARLATTI, D.

- (79) Capriccio, L. 375 (arr. Tausig). 1928 (Apr. 2): RCA LM 2993 (LP-M).
- (80) Sonata in E, L. 21. 1964: COL MS 6658 (LP-S).
- (81) Sonata in E minor, L. 22. 1964: COL MS 6658 (LP-S).
- (82) Sonata in E, L. 23. 1948: RCA MO 1262 (78)*. 1951 (Apr. 23): RCA LM 1957 (LP-M)*. 1968: COL MS 7106 (LP-S).
- Sonata in E, L. 25. 1948: RCA MO 1262 (78)*.
- Sonata in B minor, L. 33. 1935 (June 2): ANG COLH 300 (LP-M)*. 1948: RCA MO 1262 (78)*.
- (83) Sonata in F minor, L. 118. 1964: COL MS 6658 (LP-S).
- (84) Sonata in D, L. 164. 1964: COL MS 6658 (LP-S).
- (85) Sonata in F minor, L. 187. 1964: COL MS 6658 (LP-S).
- (86) Sonata in F, L. 188. 1964: COL MS 6658 (LP-S).
- (87) Sonata in E flat, L. 203. 1964: COL MS 6658 (LP-S).
- (88) Sonata in G, L. 209. 1948: RCA MO 1262 (78)*. 1962 (Nov.-Dec.): COL MS 6411 (LP-S).
- (89) Sonata in A minor, L. 241. 1964: COL MS 6658 (LP-S).
- (90) Sonata in G, L. 335. 1968: COL MS 7106 (LP-S).
- (91) Sonata in G, L. 349. 1964: COL MS 6658 (LP-S).
- (92) Sonata in A, L. 391. 1964: COL MS 6658 (LP-S).
- (93) Sonata in D, L. 424. 1964: COL MS 6658 (LP-S).
- (94) Sonata in E, L. 430. 1948: RCA MO 1262 (78)*. 1962 (Nov.-Dec.): COL MS 6411 (LP-S).
- (95) Sonata in D, L. 465. 1964: COL MS 6658 (LP-S).
- (96) Sonata in A, L. 483. 1948: RCA MO 1262 (78)*. 1962 (Nov.-Dec.): COL MS 6411 (LP-S).
- Sonata in G, L. 487. 1935 (June 2): ANG COLH 300 (LP-M)*.

SCHUBERT

- Impromptu in E flat, Op. 90, No. 2. 1973 (Jan.): COL (LP-S—not yet released).
- (97) Impromptu in G, Op. 90, No. 3. 1953 (Jan. 4): VICTR VICS 1649 (LP-E; first released in 1972). 1962 (Nov.-Dec.): COL MS 6411 (LP-S).
- Impromptu in A flat, Op. 90, No. 4. 1973 (Jan.): COL (LP-S—not yet released).
- Impromptu in F minor, Op. 142, No. 1. 1973 (Jan.): COL (LP-S—not yet released).
- Impromptu in A flat, Op. 142, No. 2. 1973 (Jan.): COL (LP-S—not yet released).
- (98) Sonata in B flat, D. 960. 1953 (Feb. 25): RCA LM 6014 (LP-M).

SCHUMANN

(99) Arabeske, Op. 18. 1933 (May): SERA 60114 (LP-M). 1962 (Apr.-May): COL KS 6371 (LP-S). 1968: COL MS 7106 (LP-S).

- (100) Blumenstück, Op. 19. 1966: COL M2S 757 (LP-S).
- (101) Fantasiestücke, Op. 12: No. 7, Träumswirren. 1932 (Nov.): SERA 60114 (LP-M).
- (102) Fantasy in C, Op. 17. 1965: COL M2S 728 (LP-S).
- (103) Kinderszenen, Op. 15. 1950: RCA LM 1109 (LP-M)*. 1962 (Nov.-Dec.): COL MS 6411 (LP-S).
- (104) Kinderszenen, Op. 15: No. 7, Träumerei. 1947: RCA LM 1171 (LP-M)*. 1950: VICTR VICS 1649 (LP-E; from 1950 complete set). 1965: COL M2S 728 (LP-S). 1968: COL MS 7106 (LP-S).
- (105) Kreisleriana, Op. 16. 1969: COL MS 7264 (LP-S).
- (106) Presto passionata. 1932 (Nov.): SERA 60114 (LP-M).
- (107) Toccata in C, Op. 7. 1934 (May): SERA 60114 (LP-M; first released in 1963). 1962 (Nov.-Dec.): COL MS 6411 (LP-S).
- (108) Variations on a Theme by Clara Wieck, Op. 14. 1951 (Mar. 5): RCA LM 1957 (LP-M)*. 1969: COL MS 7264 (LP-S).
- SCRIABIN**
- (109) Etude in C sharp minor, Op. 2, No. 1. 1950 (May 17): RCA 49-3303 (45)*. 1962 (Nov.-Dec.): COL MS 6411 (LP-S). 1965: COL M2S 728 (LP-S).
- (110) Etude in F sharp minor, Op. 8, No. 2. 1972 (spring): COL M 31620 (LP-S).
- (111) Etude in B flat minor, Op. 8, No. 7. 1953 (Feb. 25): RCA LM 6014 (LP-M).
- (112) Etude in A flat, Op. 8, No. 8. 1972 (spring): COL M 31620 (LP-S).
- (113) Etude in D flat, Op. 8, No. 10. 1972 (spring): COL M 31620 (LP-S).
- (114) Etude in B flat minor, Op. 8, No. 11. 1972 (spring): COL M 31620 (LP-S).
- (115) Etude in D sharp minor, Op. 8, No. 12. 1962 (Nov.-Dec.): COL MS 6411 (LP-S). 1968: COL MS 7106 (LP-S).
- (116) Etude in F sharp, Op. 42, No. 3. 1972 (spring): COL M 31620 (LP-S).
- (117) Etude in F sharp, Op. 42, No. 4. 1972 (spring): COL M 31620 (LP-S).
- (118) Etude in C sharp minor, Op. 42, No. 5. 1953 (Feb. 25): RCA LM 6014 (LP-M). 1972 (spring): COL M 31620 (LP-S).
- (119) Feuillet d'album, in E flat, Op. 45, No. 1. 1972 (spring): COL M 31620 (LP-S).
- (120) Poem in F sharp, Op. 32, No. 1. 1962 (Nov.-Dec.): COL MS 6411 (LP-S). 1965: COL M2S 728 (LP-S).
- (121) Poems, Op. 69 (2). 1972 (spring): COL M 31620 (LP-S).
- (122) Prelude in C, Op. 11, No. 1. 1954 (fall): RCA LM 2005 (LP-M).
- (123) Prelude in G, Op. 11, No. 3. 1954 (fall): RCA LM 2005 (LP-M).
- Prelude in D, Op. 11, No. 5. 1954 (fall): RCA LM 1957 (LP-M)*.
- (124) Prelude in E, Op. 11, No. 9. 1954 (fall): RCA LM 2005 (LP-M).
- (125) Prelude in C sharp minor, Op. 11, No. 10. 1954 (fall): RCA LM 2005 (LP-M).
- (126) Prelude in G flat, Op. 11, No. 13. 1954 (fall): RCA LM 2005 (LP-M).
- (127) Prelude in E flat minor, Op. 11, No. 14. 1954 (fall): RCA LM 2005 (LP-M).
- (128) Prelude in B flat minor, Op. 11, No. 16. 1954 (fall): RCA LM 2005 (LP-M).
- (129) Prelude in B minor, Op. 13, No. 6. 1954 (fall): RCA LM 2005 (LP-M).
- (130) Prelude in F sharp minor, Op. 15, No. 2. 1954 (fall): RCA LM 2005 (LP-M).
- (131) Prelude in B, Op. 16, No. 1. 1954 (fall): RCA LM 2005 (LP-M).
- (132) Prelude in E flat minor, Op. 16, No. 4. 1954 (fall): RCA LM 2005 (LP-M).
- Prelude in G sharp minor, Op. 22, No. 1. 1954 (fall): RCA LM 1957 (LP-M)*.
- (133) Prelude in G minor, Op. 27, No. 1. 1954 (fall): RCA LM 2005 (LP-M).
- (134) Prelude in D flat, Op. 48, No. 3. 1954 (fall): RCA LM 2005 (LP-M).
- (135) Prelude in A minor, Op. 51, No. 2. 1954 (fall): RCA LM 2005 (LP-M).
- (136) Prelude, Op. 59, No. 2. 1954 (fall): RCA LM 2005 (LP-M).
- (137) Prelude, Op. 67, No. 1. 1954 (fall): RCA LM 2005 (LP-M).
- (138) Sonata No. 3, in F sharp minor, Op. 23. 1954 (fall): RCA LM 2005 (LP-M).
- (139) Sonata No. 9, in F, Op. 68 (Black Mass). 1953 (Feb. 25): RCA LM 6014 (LP-M). 1965: COL M2S 728 (LP-S).
- (140) Sonata No. 10, in C, Op. 70. 1966: COL M2S 757 or M 31620 (LP-S).
- (141) Vers la flamme, Op. 72. 1972 (spring): COL M 31620 (LP-S).
- SOUSA-HOROWITZ**
- Stars and Stripes Forever. 1950: RCA 49-3424 (45)*. 1951 (Apr. 23): RCA LM 1957 (LP-M)*.
- STRAVINSKY**
- Petrushka: Danse russe. 1932 (Nov.): PATHÉ C061-01902 (LP-M, import; first released in 1972, never issued in U.S.).
- TCHAIKOVSKY**
- (142) Concerto No. 1, in B flat minor, Op. 23. 1941 (May 6)—NBC Symphony Orchestra, Arturo Toscanini, cond.: VICTR VIC 1554 (LP-M). 1943 (Apr. 25)—NBC Symphony Orchestra, Arturo Toscanini, cond.: RCA LM 2319 (LP-M).
- (143) Dumka, Op. 59, No. 1. 1942 (Aug. 27): RCA LM 2993 (LP-M).

The Available Albums and Their Contents

Following is a list of all Horowitz recordings currently in print in the U.S. Tape editions where available are indicated (●● = open-reel tape; ● = 8-track cartridge; ●● = cassette). The numbers following each listing mean that a performance of the correspondingly numbered composition in the above discography is included in that recording.

COLUMBIA

- KS 6371: Columbia Records Presents Vladimir Horowitz (37, 60, 72, 74, 99).
- MS 6411: The Sound of Horowitz (88, 94, 96, 97, 103, 107, 109, 115, 120).
- MS 6541: Beethoven (8). Debussy (45, 46, 47). Chopin (20, 21, 36).
- MS 6658: Horowitz Plays Scarlatti (80, 81, 83, 84, 85, 86, 87, 89, 91, 92, 93, 95).
- MS 7106: Horowitz on Television (12, 16, 31, 33, 82, 90, 99, 104, 115). Tape: ●● MQ 988; ● 18-11-0086; ●● 16-11-0086.
- MS 7264: Horowitz Plays Schumann (105, 108). Tape: ●● 16-11-0214.
- M 30464: Horowitz Plays Rachmaninoff (72, 73, 75, 76, 77, 78). Tape: ● MA 30464; ●● MT 30464.
- M 30643: Horowitz Plays Chopin (18, 23, 25, 34, 35, 38). Tape: ●● MR 30643; ● MA 30643; ●● MT 30643.

- M 31620: Horowitz Plays Scriabin (110, 112, 113, 114, 116, 117, 118, 119, 121, 140, 141). Tape: ● MA 31620; ●● MT 31620. Quadraphonic: MQ 31620 (SQ-encoded disc).
- M2S 728: Horowitz at Carnegie Hall (1, 16, 19, 26, 43, 67, 100, 104, 109, 120, 139). Tape: ●● M2Q 745.
- M2S 757: Horowitz in Concert (27, 32, 44, 49, 54, 68, 100, 140). Tape: ●● M2Q 899.
- NOT YET RELEASED: Beethoven: Waldstein and Appassionata Sonatas.
- NOT YET RELEASED: Beethoven: Moonlight Sonata. Schubert: Four Impromptus.
- NOT YET RELEASED: Chopin: Etudes, Op. 10: No. 3, No. 4, No. 12 (Revolutionary); Mazurkas: No. 7, No. 20, No. 23, No. 27, No. 32, No. 38; Polonaise No. 3 (Militaire); Prélude, Op. 28, No. 6; Waltz No. 7.
- RCA RED SEAL**
- LM 1235: Chopin (37). Liszt (53, 58).
- LM 1902: Horowitz Plays Clementi (40, 41, 42).
- LM 2005: Horowitz Plays Scriabin (122, 123, 124, 125, 126, 127, 128, 129, 130, 131, 132, 133, 134, 135, 136, 137, 138).

- LM 2319: Tchaikovsky (142).
- LM 2357: Mussorgsky (69). (Coupled with Toscanini performance on LSC 3278).
- LM 2584: Homage to Liszt (53, 55, 56, 57, 58, 59, 63).
- LM 2993: The Young Horowitz (26, 43, 48, 51, 52, 61, 79, 143).
- LM 6014: Twenty-Fifth Anniversary (36, 38, 43, 57, 70, 98, 111, 118, 139).
- LSC 2366: Beethoven (7, 11). Tape: ● R8S 1040.

RCA VICTROLA

- VIC 1554: Tchaikovsky (142).
- VIC 1605: Favorite Chopin (15, 16, 17, 21, 28, 29, 36, 37).
- VICS 1636: Beethoven (6).
- VICS 1649: Romantic Piano Favorites (13, 14, 24, 30, 63, 64, 65, 66, 104).

SERAPHIM

- 60063: Rachmaninoff (71). Haydn (50).
- 60114: Liszt (56, 62). Schumann (99, 101, 106, 107).
- 60207: Great Pianists Play Chopin (28).

SUPERSCOPE

- KB14-A068: Horowitz and Rubinstein Play Again (1, 2, 3, 4).

I bought a Marantz 4 channel receiver because I refuse to be stuck with an electronic antique.



Not one to tolerate obsolescence (planned or unplanned), I considered the stereo vs. 4-channel question carefully, then purchased a Marantz receiver for three compelling reasons.

One. Marantz has Dual Power. This means you get full power of four discrete amplifiers working all the time. When you're listening to regular 2-channel tapes and records you can combine the power of all four channels into the front speakers. This means even if you're not ready to commit yourself to a complete 4-channel system, you can buy Marantz now and when you get the other two speakers just flip a switch. You have 4-channel. Meanwhile, you're not compromising 2-channel because you're getting more than twice the power for super stereo.

Reason number two. Marantz receivers feature the exclusive snap-in snap-out adaptability to any 4-channel matrix decoder. This means that your Marantz stereo will never be made obsolete by any future 4-channel technology because the Marantz snap-in SQ* module is designed to keep up with the changing state of the art. What's more, Marantz receivers have Vari-Matrix—a built-in circuit that will synthesize 4-channel sound from any stereo source (including your stereo records and tapes) and will also decode any matrix encoded 4-channel disc or FM broadcast.

Reason number three. Marantz receivers, from the Model 4230 up, feature built-in Dolby** noise reduction to bring you the quietest FM reception ever. And you can switch the built-in Dolby into your tape deck for noise-free, no-niss recording from any source. A real Marantz exclusive.

I chose the Marantz Model 4270 because it suits my needs perfectly. It delivers 140 watts continuous power with under 0.3% distortion. And it's literally loaded with features. However, your requirements may be more modest than mine. In which case you can own the Marantz Model 4220 which delivers 40 watts with Dual Power. Or you can go all the way and get the Marantz Model 4300 with 200 watts. It is the very best. Choose from five Marantz 4-channel receivers from \$299 to \$799.95.

The point to remember is this—whichever model Marantz 4-channel receiver you do buy, you can buy it today without worrying about its being obsolete tomorrow. Look over the Marantz line of superb quality receivers, components and speaker systems at your Marantz dealer. You'll find him listed in the Yellow Pages. Think forward. Think Marantz.

marantz.
We sound better.

*SQ is a trademark of CBS Labs, Inc.
**TM Dolby Labs, Inc.



©1973 Marantz Co., Inc., a subsidiary of Superscope Inc., P.O. Box 99A, Sun Valley, Calif. 91352. In Europe: Superscope Europe, S.A., Brussels, Belgium. Available in Canada. Prices and models subject to change without notice. Consult the Yellow Pages for your nearest Marantz dealer. Send for free catalog.

CIRCLE 43 ON READER-SERVICE CARD

Introducing a new word in the Hi-Fi vocabulary:

Technics (tek·neeks') *n.* a new concept
in components.

*Design team lead
has an initial say*

*Some parts have been
designed by us, some by others
of our staff*

*Design team members
are often from the same place*

*Design team members
are often from the same place*

*Design team members
are often from the same place*

*Design team members
are often from the same place*

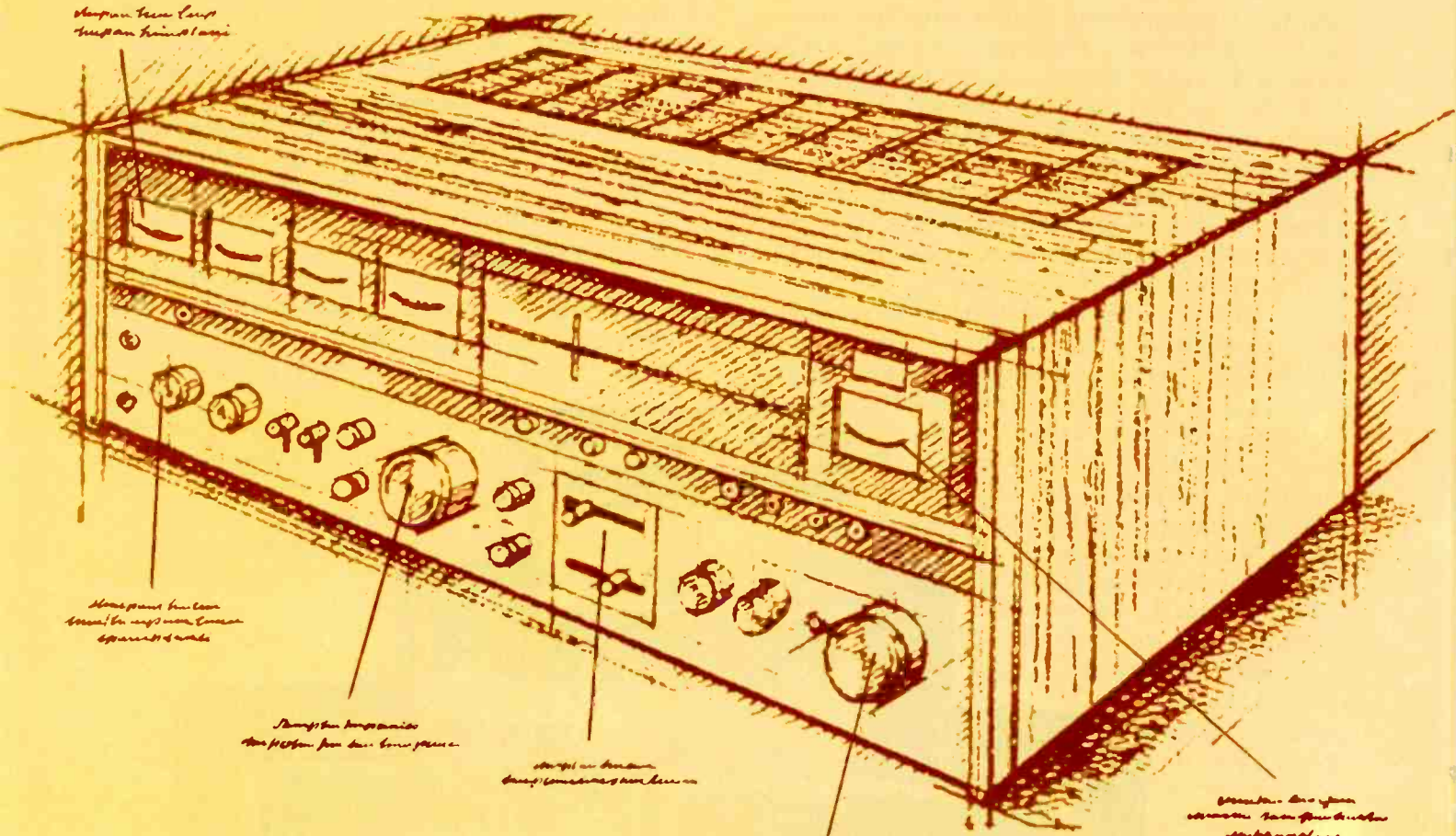

A concept that focuses the research, experience and skill of an electronics giant on the creation, design and production of components. A total commitment to audio componentry without peer.

The research has already produced over 23,000 patents. Firsts like: direct drive motors, Hot Pressed Ferrite heads, HiZNR resistors, automatic reversing micromotors, Exicon X-Ray television and new kinds of miniature fiber optics.

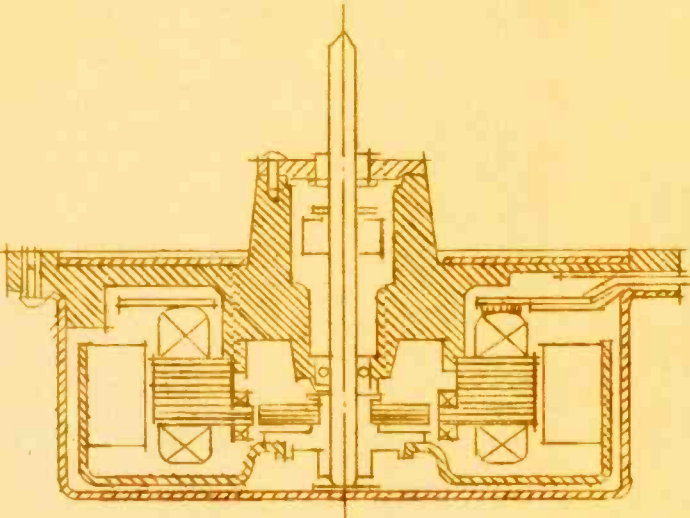

CROSS SECTION OF DIRECT DRIVE MOTOR



Experience has taught us to be extra finicky about the parts we use. So we design and make virtually every part of every component ourselves. From the newest type of monolithic I.C.'s to our own exclusive four-pole MOS FET. From the epoxy resin coils in our multiplex sections. To the precision controls on the front panel.

We have learned the virtue of being totally unmerciful in test procedures. All designs are put through tortures like baking, freezing, drenching, shock, extreme stresses and prolonged humidity. Because any unit that can survive that kind of

punishment is capable of years of faithful service under normal conditions.

We also know that there is no substitute for all-out quality control. Each subassembly is checked visually and electronically as it is put

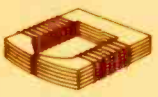
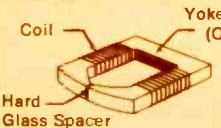
COMPARISON OF PERMALLOY AND HPF HEAD

	Permalloy Head	HPF Head
Material	Alloy of Ni, Mo and Fe	Powder of MnO, ZnO and Fe ₂ O ₃
Manufacturing Method	Punching by a press	Sintering at a high temperature under high pressure
Core	Piles of metals	Precision made block, produced by cutting, grinding and polishing.
Shape		
Finished Gap	 Gap Spacer (BeCu) Thickness of Spacer < Effective Gap Effective Gap	 Gap Spacer (Hard Glass) Thickness of Spacer = Effective Gap Effective Gap
Electric Loss	Big	Small (1/3 of the permalloy)
Hardness	130 ~ 140 HV	530 ~ 700 HV (5 times harder)
Life	about 1,000 hours	about 200,000 hours

together. And checked again as it joins the main assembly. Every complete unit undergoes 50 performance checks, involving 170 different test points and measuring things like IHF sensitivity and power output. Sixty additional tests assure perfect appearance and proper operation.

All our units have earned the coveted listing for safety of Underwriters Laboratories®.

The Technics concept has already taken shape. In a line of discrete 4-channel receivers. Direct drive turntables. Dolbyized™ cassette decks. And reel-to-reel recorders. That are ready for delivery today.

So, now that we've been formally introduced, why don't we get to know each other.

™Dolby is a trademark of Dolby Laboratories Inc.

Technics

by Panasonic

CIRCLE 40 ON READER-SERVICE CARD

control
your
own
four
channel
destiny

Now you can create your own 4-channel world with the incomparable Sansui vario matrix QRX series of 4-channel receivers.* Sansui's sound controls enable you to mix your own 4-channel sound according to your own musical preference in ways you have never experienced before.

Dollar for dollar, ear for ear, the vario matrix QRX series gives you greater power, better separation and superior, truly musical 4-channel reproduction from all sound sources: records, tapes, FM, 8-track cartridges or cassettes. The unique Sansui QS vario matrix gives you richer, fuller 4-channel sound from QS (Regular Matrix) as well as SQ (Phase Matrix) sources, plus CD-4 discrete demodulated sources. And with its superior QS synthesizing section, it creates thrilling 4-channel sound from conventional stereo. Get a demonstration today from a franchised Sansui dealer—anywhere.

* Sansui QRX Vario Matrix Series: QRX-6500, QRX-3500, QRX-3000

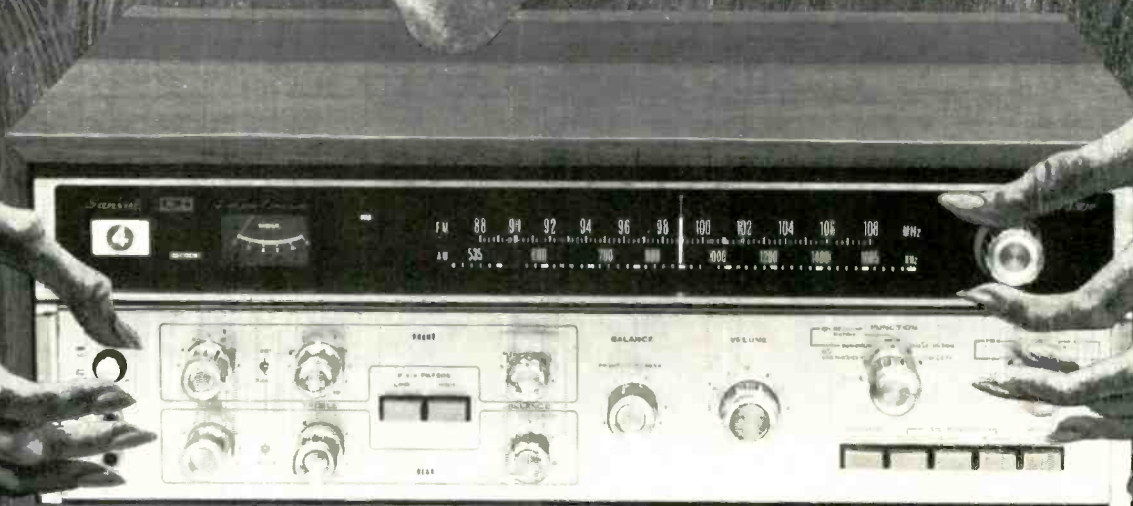

QS
REGULAR MATRIX

Sansui

SANSUI ELECTRONICS CORP.

Woodside, New York 11377 • Gardena, California 90247

ELECTRONIC DISTRIBUTORS (Canada), Vancouver 9, B.C.

SANSUI ELECTRIC CO., LTD., Tokyo, Japan • Sansui Audio Europe S.A., Antwerp, Belgium

by Winthrop Sargeant

Don't

Speak Ill of the Great Classics

If you can't say something nice about them,
you shouldn't say anything at all, claims a noted critic.

I HAVE RECENTLY come across an article by Deryck Cooke in the Music Critic's Association's little magazine, *Critic's Criteria*, entitled "The Futility of Music Criticism." In it Mr. Cooke presents an intelligent basis for controversy: that we should give up criticism of the dead masters altogether. I quite agree. Writers like Joseph Kerman and Elliott Zuckermann, who find weaknesses in Beethoven and Wagner, are silly fellows who are trying to stand on the shoulders of the great while feebly kicking them in the neck. And a year or so ago I came across a report from the Kennedy Center's poll of five hundred music critics, which asked such questions as "What do you consider the most important work of the past twenty-five years?" and "Who do you think is the most influential composer?" The answers to this poll also incline me to Mr. Cooke's position on futility. The composers named ranged from Britten and Prokofiev to Stockhausen and Milton Babbitt, and certainly indicated a vast confusion in the minds of American critics—a sort of confusion that can be found elsewhere today only among minor critics of painting and sculpture.

Mr. Cooke confesses that he, like all of us, has sometimes been guilty of negative criticism of great masterpieces, and he apologizes abjectly for running down Stravinsky's *The Rake's Progress*. My own sins in this direction have included the description of the last movement of Beethoven's Ninth Symphony as "a lot of banging and shouting," and a dislike of his *Missa solennis*. I still feel this way about both works, but it is foolish for any critic to condemn a work that has received the acclaim of a vast public over several generations, and I confess to having been a fool when I expressed hostility to these works. As Mr. Cooke says, performers and

Winthrop Sargeant, the New Yorker's Critic Emeritus, played the violin under such conductors as Toscanini and Mengelberg. His most recent book is Divas, published by Coward-McCann & Geoghegan.

the musical public are the only real judges of a work. All that a critic expresses is an opinion. There are no objective standards of music criticism.

But what surprises me about Mr. Cooke's piece is his preliminary assumption that music criticism is something of great importance. At one point he quotes Sibelius as having said that nobody has ever built a statue to commemorate a music critic. Why on earth should anybody build such a statue? It would put a critic on a par with great composers, and that would be ridiculous. Most famous music critics are famous among other things for their glaring mistakes—Hanslick for his opposition to Wagner, Shaw for his opposition to Brahms, etc., etc. But that does not mean that they were not honest critics, and honesty, in my opinion, is the first requisite of a music critic. Music criticism is not an art, or even a profound intellectual endeavor. It is a branch of journalism, useful to the extent that people like to read it and that it stimulates controversy for or against the critic's position. Again, I am somewhat astonished at Mr. Cooke's reverence for the craft. As he says, music criticism is merely a matter of opinion—and one man's opinion at that. It does not represent judgment, or a statement of eternal validity. The reader is free to agree or disagree, and if a reader is faithful enough to encounter a critic's work more or less consistently, and form an opinion himself as to the critic's more dependable prejudices, he can use the critic as a weather vane—sometimes even concluding that whatever the critic likes he would probably dislike, as well as vice versa. There is nothing sacred about the opinions of any music critic. On the other hand, I believe that it is absolutely requisite that a critic *have* an opinion about any given work, and that he be able to formulate this opinion on short notice. These are necessities of the profession. Nothing angers me more than a critic who, faced with a new composition, says things like, "This work did not

**I have crusaded for the wrong composer
a couple of times. One example is Carl Nielsen.
I have since found him not very interesting.**

impress me much, but then I may be wrong. Future generations may think highly of it." Such a critic is abdicating his principal function.

I have lived long enough to gauge the public reaction to many composers, and to see my opinions of them either confirmed or denied. I have always been more or less against the Schoenberg school (with the exception of a few inspired composers like Ginastera, Berg, and Dallapiccola), and I think that public reaction, at least in Schoenberg's case, has confirmed my impressions. On the other hand, I was promoting Mahler more than forty years ago, when the critic of the *New York Times* had no use for him, and I began promoting Bruckner nearly twenty years ago, and have probably had some influence on the current Bruckner vogue. I take no credit for special clairvoyance with regard to either composer. The fact is that I was a student of composition in Vienna in the mid-Twenties, and heard both composers frequently performed. I was simply better acquainted with their work than most people outside Austria. Conversely, I have crusaded for the wrong composer a couple of times. One example is Carl Nielsen, whom I boosted long ago simply because he was not being performed. I have since found him to be a not very interesting composer.

What all this boils down to is that a critic can be useful in bringing to public attention great composers who are being neglected. This, I should say, is one of a critic's most important and satisfying functions.

Then there is a field that Mr. Cooke does not mention at all—the evaluation and promotion of performing artists, especially young ones who can be helped by a good word. At times this kind of work seems almost an exact science. A violinist either plays in tune or out of tune. A pianist either has a fluent technique or does not have it. These are facts, not opinions. But there are more important questions too—questions of style, of whether an artist phrases well, of whether a singer enunciates well or handles the breaks between his registers well, of whether an artist accents correctly, and so on. And beyond these things is an area with no well-defined standards—personality as expressed in performance, ability to impress an audience with a new vision of a given work, etc., etc. In the evaluation of

performers, I think music criticism can serve an important function, even though now and then it drifts over into the field of the public relations man. I think it is a pity that the evaluation of young performers is left largely in the hands of assistants rather than to the chief critics of newspapers. Here of course, except in the area of exact science, the music critic is again merely expressing an opinion. But if he is widely read the opinion carries weight.

Today I think that the music critic has to function to a certain extent as a historian of contemporary style. He may dislike most contemporary music. I do. I think that I can detect a decline in the composer's art over the past sixty years, and a degeneracy of composition into mere mannerism, or what the Russians call formalism—the preoccupation with technique to the exclusion of everything else. But he ought to be able to identify and describe the idiom of a composition, to discriminate between atonality and tonality, aleatory music and written-down music, impressionism and expressionism, eclecticism and true originality, and he ought to be able to point out precedents and influences in a given composition. These powers of discrimination should be part of every critic's equipment, and he should describe the type of music he is dealing with whether he likes it or not. As to Mr. Cooke's apology for not liking Stravinsky's *The Rake's Progress*, perhaps he has reached a deep understanding of the work that has not been vouchsafed to me. I have always considered it to be a terrible bore, and frequent rehearsals of it, both on records and as staged by various people, have not altered my opinion. Of course any critic who expresses himself strongly and unequivocally is bound to be wrong occasionally. Every critic *should* express himself strongly and unequivocally, and if he is wrong, let the chips fall where they may. He may perhaps go down in history, if history notices him at all, as one of the critics who were mistaken about something—a quite honorable brotherhood. Please note that here I am discussing a fairly recent work, not one on which the public and performers have long ago bestowed their verdict. I have never noticed any overwhelming demonstrations of enthusiasm over *The Rake's Progress*. Perhaps Mr. Cooke has.

I believe that music criticism is a craft of passing value, perhaps comparable to the work of a daily

A music critic may dislike most contemporary music. I do. I have always considered Stravinsky's *The Rake's Progress* a terrible bore.

political columnist. I do not believe that any critic who is reasonably intelligent will make a practice of attacking the great classics, though most critics have sinned in this matter once or twice in their lives. I believe that a critic is more or less in the position of a lawyer, making a case before the tribunal of public judgment, and that it is his duty simply to express an opinion, which may turn out to be right or wrong. I believe that one of a critic's most important functions is to promote the work of neglected composers if he thinks that these composers are really great ones. His other most important function is to act as a judge of performing artists, operatic productions, and other passing phenomena.

Of course, the mere statement of thumbs up or thumbs down does not make for very interesting reading, and nearly every critic goes into other matters, describing, generalizing, discussing aesthetics or history or any other of the deeper phenomena that are ancillary to music. Provided his discussion of these things represents a fresh point of view, or a fresh contribution to thought, I think he is entitled to them, and they certainly give his public something to read about. But nothing disgusts me so much as a self-indulgent turning over of second-hand information, that is to say, extensive writing about things that can be found by any of the critic's readers in the musical reference books. This sort of thing is the province of the program annotator, not the critic. And exhibitionistic scholarship is as rude, self-important, and boring in relation to music as it is in ordinary conversation. Of course, there are exceptions to this rule. A critic in a smaller city, where the public is not very well informed, may feel an obligation to act as an educator. But for metropolitan critics, exhibitions of knowledge gained from standard reference works should be taboo.

I also think that all critics should write in the first person. This does not imply egotism, as many believe. On the contrary, it is the anonymous critic, or the one who makes godlike pronouncements as if they were facts, who is the egotist. First-person writing indicates that what is said is merely a personal opinion. The conventions of the old days, when a critic was expected to make bald statements like "Toscanini's performance lacked inspiration in spite of its vigor," or something of the sort, were based on the newspaper conception of the critic as

reporter—as if he were saying "crime in the 38th precinct has diminished during the past month." This is fine for reporters who are dealing with facts. But for the critic—who is dealing with opinions and not with facts, or at least not very often with facts—the old approach confers an unwarranted degree of authority. It is much better for him to preface his statements with "I think" or "in my opinion" or "it seems to me that." And I am happy to report that this approach is gaining in popularity even in newspapers.

The record critic's duties are generally the same as those of the critic of live music. But there are a few differences. Perhaps the most important of these is that, as a rule, a record—with all the help of modern recording techniques—is apt to present an ideal performance, a much superior one to the average performance that takes place in the opera house or the symphony or chamber music hall. The combining of different takes, using the best part of each, the opportunity for the singer or instrumentalist to appear at his best without the ups and downs that are hazards of live performance, makes a good recording a near perfect experience. (Of course there are exceptions, especially with regard to reissues of old recordings made under less than ideal conditions and with comparatively primitive technology, or with regard to recordings made from actual performances done in the opera house or from the concert platform, but these do not constitute the bulk of what the record reviewer considers.) Consequently, the reviewer of records should, if anything, be more severe and exacting than the reviewer of live music. There are some who believe that recorded sound is necessarily inferior to the sound in a concert hall or an opera house. I am not among them. I agree that as between the record and the live performance the sound is different, but to me this difference does not interfere in the least with the quality of performance. There are recordings where the overintimacy of reproduction demands that the result be heard in a very large room or a concert hall. They do not work in a small room, and this point should be commented on by the critic so that his readers may be aware of it. The record critic should also comment on whether the recording is a reissue, or whether rival versions of the work are better, and so on, but these are things

With the decentralization of modern cities the work of the record critic will become more important than that of the critic who is on the spot.

that record critics commonly do, and they hardly need pointing out by me. The quality of the surface sound of a record is often included in today's record reviews, and often rightly so. However, the surface qualities of most modern recordings are almost invariably good—so good that commenting on them is hardly necessary unless a particularly bad example presents itself.

One of the main differences between the record critic and his colleague of the opera house and concert hall is that the former is dealing with an article of merchandise, an object of personal property. And since this is the case, he is honor bound to act as a consumer advocate, distinguishing sharply between records that are worth the money and those that are not. It is probable, I think, that with the decentralization of modern cities—the movement of large groups to the suburbs and the country—the work of the record critic will become more important than that of the critic who is on the spot. But it is idle to make sociological prophesies in a period like ours, when vast changes are taking place. It may well be that the symphony orchestra and the opera house will eventually become obsolete. Certainly the present-day composer is writing less and less for them, and they cannot survive on the basis of an eighteenth- and nineteenth-century repertoire—or can they? In any case, the answers to such questions are outside the field of the music critic.

Is music criticism futile then, as Mr. Cooke maintains? Well, a good deal of it is burned up with the rubbish the following day, and rightly so. But in my opinion there are areas in which it can be very useful. A good critic never writes for the benefit of the composer or even for the benefit of the performing artist. Those jobs are for the teachers of various musical disciplines. The critic writes to and for the audience. In fact he is nothing more than a specially qualified member of the audience or of the record-buying public. Consequently, he should avoid the use of technical terms unless they are absolutely necessary, and he should entertain as well as try to cajole his readers to his point of view. He should remember that not all his readers have heard the events he is writing about, and so he should be as graphic as possible about the scene of the production or recital, describing the given event from an outsider's point of view, telling what it

looked like as well as what it sounded like, and in the case of an unfamiliar opera, giving a full account of the story and its highlights, from a literary as well as a musical point of view. In a case like this some second-hand scholarship is forgivable.

If he does these things, he will receive letters of comment from people who have never been near the place where the event occurred, and who merely find him an interesting or amusing writer. A little humor helps, though not when it is at the expense of the artist. Scholarly obfuscation merely confuses the reader. A good critic never indulges in it. Clarity of thought and writing are mandatory in the profession. If a critic is faced with the apparent necessity to explain the unexplainable, it is better for him to let it drop. There are large areas of music that contain unexplainable factors. The whole field of what music is ordinarily said to “express” is unexplainable, and there are reputable psychologists who have said that the apprehension of music is a mystical experience. Here the critic can walk up to the problem and indulge himself in an aesthetic generalization or two, but he will finally confess that he is unable to solve it. Music is a curious language of symbols, and great music certainly does “express” something. But what that something is, is really not reducible to the written word. Sometimes approximations and the description of intuitive “feelings” help the reader. More often they do not.

The description of techniques, on the other hand, is simple enough for those critics who know something about the processes of musical composition, and in dealing with modern music, much of which exists only to exploit the field of techniques—acoustical effects, atonal systems, and so on—he can describe away to his heart's content, and should. But what the reader really wants to know is “Would I like what he is writing about?” or “Is such and such a singer really so good that I should buy a ticket, or a recording of his work?” or “Am I obliged to applaud the work of so and so in order to be considered sophisticated and up to date?” or “Is this record really worth the money I could spend on it?” The limits of a critic's usefulness are pretty well defined by the foregoing questions. Anything that he wants to add that is fresh and clear is useful too, but not as useful as what he says between these limits. ■

The classics from KLH. Four bookshelf loudspeakers of such extraordinary quality that each has set the standard of excellence in its price range. Pictured to the far left, our popular little Thirty-Two (\$55.00†). Next, one of the best selling loudspeakers in the country, the Seventeen (\$79.95†). Up front, everybody's favorite, the Six (\$139.95†). And finally, our most spectacular bookshelf model, the Five (\$199.95†). If you really

want to know what KLH is all about, we suggest you listen to any one or all of these fine loudspeakers. And when you do, we're sure you'll agree that KLH is about the best thing to happen to bookshelves since books.

For more information, visit your KLH dealer or write to KLH Research and Development Corp., 30 Cross Street, Cambridge, Mass. 02139.

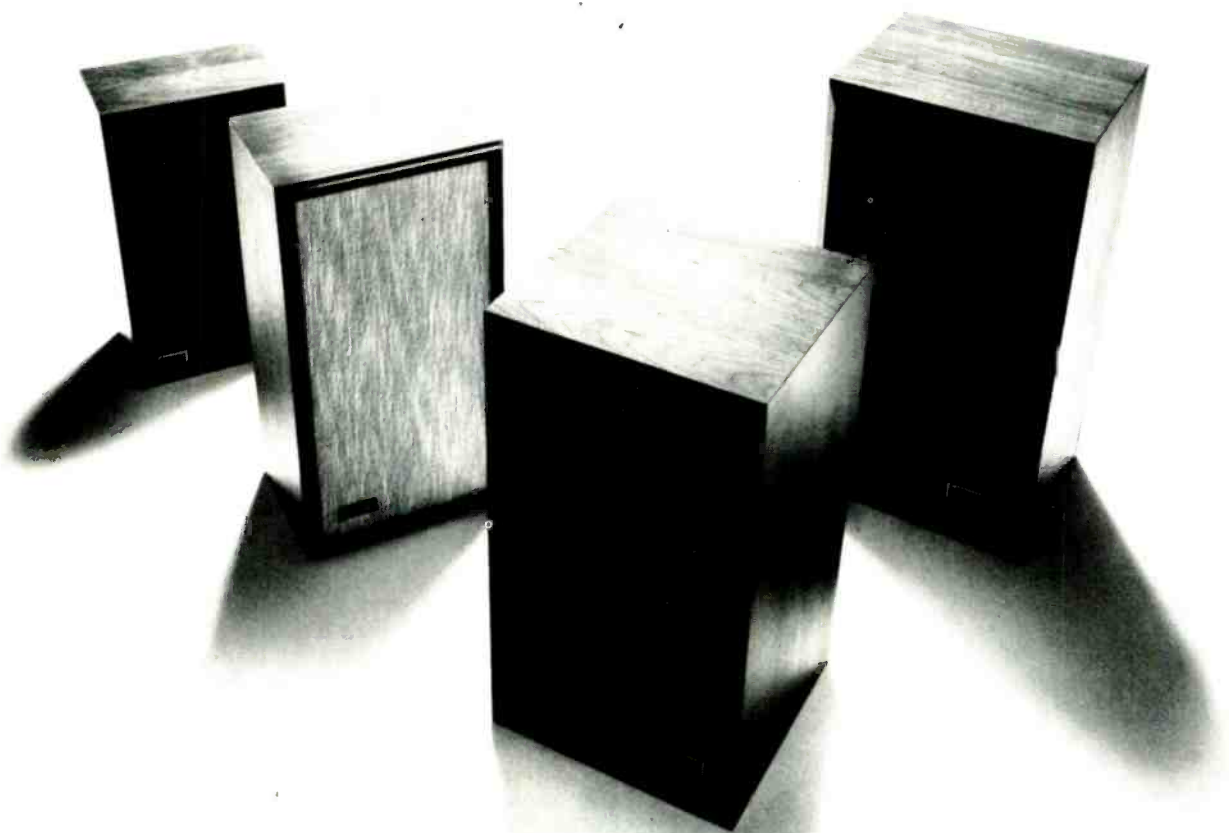

What's a bookshelf without the classics?

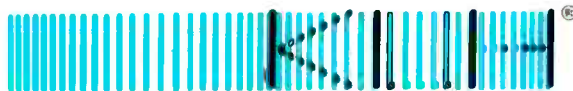

KLH RESEARCH AND DEVELOPMENT CORP.
30 Cross St., Cambridge, Mass. 02139

†Suggested retail prices—slightly higher in the South and West.

CIRCLE 31 ON READER-SERVICE CARD

For 20 years, Angel has shared opera's favorite leading lady with the entire world.

Her roles are legend. Her talents, legendary.

Maria Callas established the expectations an entire generation takes to the opera house. She brought her personal authority to the whole range of Italian repertoire, to the heroines of Verdi, Bellini, Puccini, Donizetti, and Cherubini.

She is, in Winthrop Sargeant's words (*The New Yorker*), "one of those electrifying fusions of music, theatre and personality that operagoers are only occasionally privileged to witness, and are seldom able to forget."

We have been privileged to record Maria Callas since 1953, including 24 complete operas, and countless collections of arias. Of her *Tosca*, *High Fidelity* affirmed, "A *Tosca* for history!"

Her *Carmen* set sales records, and sent critics searching for new superlatives. *Stereo Review* concluded, "Callas is *Carmen*!"



Complete: SBL-3655
Hits: S-36326



Complete: SCLX-3650
Hits: S-36312

From her 18 complete La Scala recordings, Callas has chosen her favorite arias. Volume 1 has just been issued, and a second album will appear soon.

Nine of the La Scala productions starred the inspired collaboration of Callas and tenor Giuseppe di Stefano. Five of the choice duet scenes are featured in yet another spectacular new album.



S-36929



S-36940

Maria Callas. Our favorite leading lady—and opera's—for 20 years. And sharing her with the world is one of our great pleasures.



CIRCLE 4 ON READER-SERVICE CARD

the new
releases



Don José (James McCracken) struggles with Carmen (Marilyn Horne) as Zuniga (Donald Gramm) watches in the 1972-73 Met production.

The Met's *Carmen* under Bernstein

Marilyn Horne, James McCracken, et al. re-create last season's big hit in a controversial edition.

by David Hamilton

NOT SINCE 1959, when RCA recorded the new production of Verdi's *Macbeth*, have the forces of the Metropolitan Opera taken part in a complete studio recording. However, Deutsche Grammophon's increasing activity on the American scene, and their particular interest in the Met, as witness last season's gingerly nobble (the Bing Gala's "Greatest Hits"), found a logical continuation in a complete *Carmen*—one of the most salable of popular operas, in a newsworthy and freshly studied version under the very salable baton of Leonard Bernstein. Recording sessions took place during the initial run last fall, and here, within months of the event, is its audible aspect, preserved for posterity on three sleek-surfaced discs.

That phrase "audible aspect" is important, for the production conceived by the late Goeran Gentele, staged by Bodo Igesz, designed by Josef Svoboda, and conducted by Bernstein, was clearly thought out as a theatrical to-

tality. Both visually and musically, it broke new ground for the Met, in the stark simplicity of Svoboda's geometric forms and natural colors, in the relatively unfussy direction, and—as we shall see—the musical treatment.

A purposeful gesture, then, proclaiming a new era. In the theater, not all of this lived up to its own best intentions, but the evidence of sights being set higher than before, of an unwillingness to accept *idées reçues*, was palpable and invigorating, the level of actual achievement pretty remarkable. On record, we naturally cannot share the visual excitement that filled the Met's vast stage, but I am happy to report that a considerable amount of theatrical conviction does come through the speakers. Unlike so many of our present-day operatic recordings, put together from scratch on the studio floor, this one breathes the air of a real experience, mirroring the dramatic as well as the musical qualities of its parent production.

It is, among other things, a "big" performance. Bern-



Leonard Bernstein during the *Carmen* recording sessions.

stein generally (although not always) opts for broad, spacious tempos, with lots of emphasis. The upbeats before the ritornello theme in the Prelude are given extra heavy thwacks on the cymbals and bass drum, and sometimes a *Lustpause* for further stress. The chorus of the cigarette girls is steamy and langorous. All the dotted rhythms and similar subtleties, as in the Toreador Song, the *Habanera*, and the *Seguidilla*, are enunciated with an enlivening precision, so that the tempos never seem to drag. The climaxes are given great weight, and they are carefully gauged. In terms of these particular protagonists, all this makes good sense, for Horne and McCracken have big, dramatic voices, hardly the stuff from which a petit-point reading could be made.

At the same time, there is a pull in another direction, for this "monumentalizing" approach is espoused in the context of the Met's first-ever presentation of the *opéra-comique* version of *Carmen*—i.e., with spoken dialogue instead of the familiar Guiraud recitatives and their Conservatoire formulas. Bizet conceived his opera in terms of this genre, and hardly seems to have felt it a massive, glowering tragedy: "I have written a work that is all clarity and vivacity, full of color and melody. It will be amusing." The speed and spontaneity of dialogue opens up a special range of possibilities, and Bizet knew about these, also knowing all the while that he could extend the dramatic range of the genre. He certainly did not settle for *opéra-comique* as a second choice to writing a grand opera; we have only to look at his mastery of speech-song transitions, the way the music often creeps in unobtrusively (the cigarette chorus, the *Seguidilla*, the Quintet, the Card Trio) or is theatrically motivated (the changing of the guard, Carmen's taunting of Zuniga, the processions in the final scene), to see that the opera is specifically conceived for these conventions. The removal of the recitatives shows this clearly, but I can't

help feeling that Bernstein's approach, with its big "grand opera" emphases, sacrifices some of the speed and concision that Bizet was after. One was not as conscious of this in the theater, for the Met is a big, big house, requiring big, emphatic gestures—but on records, and in comparison with Frühbeck's Angel set, the difference is very real.

Another contributing factor to this impression is the Met's decision to use *not* the version of *Carmen* played at the premiere in 1875, but rather the Fritz Oeser edition, which purports to reconstruct the prerehearsal form of the opera. I have discussed Oeser's edition, and Winton Dean's criticism of it, at some length in connection with Maazel's less complete and much less satisfactory Eurodisc recording [*HIGH FIDELITY*, January 1972]; it uncovers some substantial "new" material and a number of extended treatments of familiar material, but also introduces countless inferior readings that Bizet later rejected, and tampers unconscionably with the final episodes of the last two acts.

Oeser's greatest dereliction, in practical terms, is the failure to distinguish, in his published score, among the various sources he has muddled together; only by wading through many pages of *Kritischer Bericht* (in German) can a conductor hope to ascertain whether a "new" reading in this edition embodies Bizet's first, second, or final thought, or merely Fritz Oeser's conjectural reconstruction of what Bizet ought to have thought—and even then the evidence is not always presented completely or fairly. It is good to have the additional material available, but it would have been vastly better had the main score shown *Carmen* as Bizet left it and as it was performed in 1875, with the unused material and earlier versions in an appendix.

The bulk of the reinstated material comes in Act I, which runs fifty-five minutes in this recording—in effect, some eight minutes longer than the Frühbeck version (allowing for the latter's inclusion of the *Moralès* pantomime, which Bernstein omits). This makes a very long act, particularly since the bulk of the first twenty minutes, up to the *Habanera*, is sheer atmosphere, not really concerned with the principals. The extensions here include a charming canonic episode for solo strings between the two parts of the changing of the guard, and an intriguing second section for the cigarette chorus: both of these are first-rate, but one sees why Bizet felt that something had to go, that the main business of the opera was being delayed. Later on in this act we hear an earlier version of the post-*Habanera* episode (with a full statement of the "Fate" material, as in the Prelude), a much longer version of the quarrel chorus, and a more elaborate version of Carmen's "Tra-la-la-la" teasing of Zuniga. Combined with Bernstein's approach, all this stretches out the act, undermining the concision that Bizet clearly sought in his revisions. One can't point to any single passage and say, "This is too much," but all of it together, in this performance, is too much. (Conceivably, in a swifter reading, the first two passages mentioned above could fit in; they are first-rate stuff. But I would skip the others, especially the "Fate" bit, which merely repeats what we've already heard in the Prelude, and calls for a difficult pantomime on stage.)

None of the other acts is so greatly changed or extended, and happily Bernstein rejects the inferior earlier

version of the Act III finale that Oeser prints, in favor of the composer's familiar final solution. I wish he had done the same with our editor's disastrously flat and quite unfounded concoction at the point where Carmen is stabbed, instead of merely tampering with it, to no ameliorating effect. In this final duet, too, we can see the ill effects of editorial malfeasance with regard to tempo directions. Briefly: After Carmen affirms that she loves Escamillo, the off-stage chorus enters. *Allegro giocoso* (metronome marking 116 to the quarter); then the pit proclaims the "Fate" motive several times, punctuating José's "*Ainsi, le salut de mon âme.*" This latter segment was first marked "same tempo," but Bizet changed it (in the first-edition vocal score, which he is known to have proofread) to *moderato* (metronome 84), obviously realizing that a broader tempo was needed for this, both to contrast with the rejoicing in the bullring and to give greater weight to José's anguish. Oeser restores the first reading (blaming the change on Guiraud, although there is no evidence for such a supposition), and Bernstein plays it that way—proving, I think, that second thoughts are often better than first ones.

A few other textual points: The dialogue is severely abridged, much more so than in Frühbeck's recording (paradoxically, this does not speed things up, for now the spoken material has less opportunity to establish itself as a foil to the singing). The José/Escamillo duet is much shortened, although not in the traditional way (this is complete in Frühbeck's set, and nowhere else); one of the omitted passages, where Escamillo spares José because "my business is killing bulls, not putting holes in men's hearts," is a nice bit of characterization and a shame to lose, although in general this duet is the weakest number in the score. Micaëla arrives in the mountains most mysteriously, for her dialogue with the guide—and, indeed, the guide himself—has vanished entirely, so that she floats into the scene on a flute note held over from the preceding number. Another mystery: Why is Remendado's line announcing the discovery of Micaëla transferred to Carmen?

I've covered this ground in some detail because the essays in DG's libretto booklet are not terribly helpful. The English author obviously hasn't been told which edition is being used, while the quite different articles in French and German respectively espouse and ignore Oeser. We're better off with regard to translation, for Lionel Salter's English version is admirably literal: German listeners will have to make do with Walter Felsenstein's rather free singing translation.

Obviously, considerations of the "best" *Carmen* recording now have to deal with three categories: (1) the "old" Guiraud edition with recitatives, which, even in Beecham's elegant presentation, seems sluggish to me now that I have lived with several performances of the *opéra-comique* form; (2) the 1875 version, performed by Frühbeck with less finesse but a nice flair for pacing, staged for records with fine rippling dialogue; and (3) the Oeser edition, in which contest Bernstein easily outpoints Maazel. Not simply because it is historically the most correct form, but because it "plays" with such directness, speed, and dramatic contrast, the second of these is my choice—it is the most theatrically (and musically) convincing form of *Carmen*, performances aside.

But we can hardly ignore performances, and despite

its (I think) unwise textual decisions, the Bernstein performance bulks large. The orchestral execution is often breathtaking; the winds of the Met orchestra really surpass all competition in the *Chanson Bohème* and the *Intermezzo* before Act III. Furthermore, these soloists sing with a precision that refreshes every phrase. Marilyn Horne made a fascinating and surprising Carmen on-stage, despite her lack of obvious native endowment for the part, and on records she is even stronger, singing truly and purely, with all the little ornaments and graces that color the lines (and the character) effortlessly floated into place. Those truck-driver chest tones that sometimes vulgarize her singing are hardly in evidence here, and they are not missed. She sets forth an intriguing and temperamental woman, and does it entirely with the voice. McCracken is less smooth, coming into his own mainly in the later part of the opera, when his power and his fairly strenuous production can be brought to bear on appropriate situations—although earlier on he does some nice soft singing, whether by fair means or foul. His French is the least convincing of anyone's, although it should be added that hardly anyone is perfect, and the spoken French is less idiomatic than the sung (no substitute actors are used for the dialogue).

Given the sharp focus of this production on the heavy drama of Carmen and José, the other principals count for less than usual. Adriana Maliponte's true but not overly sweet tone gives a welcome freshness to Micaëla's utterances; she is an impeccable musician and an endearing singer. Escamillo is ever a problem, not solved by Tom Krause's fuzzy tones; he is the one principal here who came off far better to the eye than to the ear. Definitely on the credit side, however, is Donald Gramm's Zuniga, a masterpiece of characterization through diction and phrasing. The minor parts are reasonably managed, the boys' chorus is lively if rough, and the adult chorus—not, be it noted, that of the Met, which failed to come to terms on a contract in time for the recording, but a freelance group—seems a bit vague at times.

DG has given us one of the better recording jobs here: The bass is fairly clear, the resonance lively but under control. A few details are lost (I had a hard time detecting the triangle during the choral strains of the *Habanera*), but it's a good sound, appropriate to the performance.

One of the characteristics of great masterpieces is their ability to sustain varied interpretations. *Carmen* is such a masterpiece, and this is, in many ways, a fresh interpretation, carefully thought out and vibrantly executed.

BIZET: Carmen (Oeser edition).

Carmen	Marilyn Horne (ms)
Micaëla	Adriana Maliponte (s)
Frasquita	Colette Boky (s)
Mercédès	Marcia Baldwin (ms)
Don José	James McCracken (t)
Escamillo	Tom Krause (b)
Remendado	Andrea Velis (t)
Dancaire	Russell Christopher (b)
Zuniga	Donald Gramm (bs)
Morales	Raymond Gibbs (b)

Manhattan Opera Chorus; Metropolitan Opera Children's Chorus; Metropolitan Opera Orchestra, Leonard Bernstein, cond. Deutsche Grammophon 2709 043, \$20.94 (three discs).

Selected comparisons:

Maazel (Oeser edition)	Euro. 80489 XR
Frühbeck de Burgos (1875 version)	Ang. 3767
Beecham (Guiraud edition)	Ang. 3613

by Royal S. Brown

A Little Night Music—Musical Theater at

Columbia issues the original-cast album of Stephen Sondheim's

EACH OF Stephen Sondheim's recent musicals—*Company*, *Follies*, and *A Little Night Music*—has moved progressively back in time. *Company* is as modern as the New York City and the kooky marriages it portrays. *Follies* returns to the distinctive atmosphere of the 1930s. *A Little Night Music*, which has just won six Tony awards including best musical, takes place at the turn of the century . . . and in Sweden. Why Sweden? First of all because *Night Music* is based on Ingmar Bergman's 1955 film, *Smiles of a Summer Night*, a delightful, bittersweet comedy that *Night Music* has followed rather closely, even to resemblances in the casting of some of the actors. Secondly, however, because the aristocratic elegance and sheen evoked by both the story and the music could not be anything but European, and certain Protestant attitudes limit the locale even further. The Sweden recreated by Bergman offered, in fact, a perfect setting for the waltz musical Sondheim has wanted to do for some years. And thus every number in the show has been written in some sort of triple meter.

But for all its waltzes, *Night Music* is hardly a fluffy operetta whose protagonists' hearts beat in three-quarter time, and if any Strauss comes to mind, it is not Johann Jr. but Richard—a motive from *Der Rosenkavalier* is even quoted toward the end of the ensemble number *A Weekend in the Country*. As usual, Sondheim's music and lyrics not only support but actually create the diverse nuances of emotions and memory, whose decidedly human ambiguity represents one of the constant themes in Sondheim's recent work. As in *Follies*, the equivocal glow and glimmer of past loves and liaisons is one of the show's basic elements, and this is expressed not only in the haunting *Night Waltz*, whose nostalgia is that of the haunted ballroom of Ravel's *La Valse*, but also by a quintet of five excellent vocalists who function not as an operatic chorus but rather more like a Greek one. And the songs they sing (*Remember?* and *The Sun Won't Set*) as they weave in and out of the musical's action are filled with typical Sondheim hesitations: "Yellow gingham on the bed/Remember, darling?/And the canopy in red/—or was it blue?" A different kind of nostalgia is expressed by old Mme. Armfeldt as she reminisces herself to sleep thinking out loud of the regal *Liaisons* that are, alas, lacking in the life of her actress/daughter, Desirée. In this song, Hermione Gingold's distinctive voice and verbal affectations perfectly complement the subtle, dreamy textures and harmonies of the accompaniment.

But wistfulness can be found at the other end of the scale as well. One of *Night Music*'s most beautiful pieces, *The Miller's Son*, is sung by the young maid Petra (played by D. Jamin-Bartlett, whose excellent voice has an appropriate sensuality to it), who in a poignant ballad expresses her hopes for the future, and in an alternating, typically Sondheim patter-song, her *carpe diem* philosophy on love and life. But Sondheim reaches a pinnacle in his ability to delineate both character and situation with song in the *Now/Later/Soon* trio that comes toward the beginning of the show. In *Now*, Fredrik Egerman, a middle-aged former widower, contemplates how he is going to take his young virgin bride of eleven months. *Later*, on the other hand, is the lament of Fredrik's grown son, Henrik, a divinity student nobody takes seriously. Here Sondheim, perhaps remembering another Bergman film in which a mournful Bach cello suite is used as the musical background, has Henrik play a rather well-known elegy on the cello (in *Smiles of a Summer Night*, Henrik plays the piano), over which the *Later* song is sung as a countermelody. In *Soon*, Anne, the child-wife, promises that *soon* she won't shy away. Anne is then joined by Henrik, singing *Later*, and then by Fredrik, singing *Now*, creating a remarkable trio in which the dramatic tensions are inherent to the very musical structure, a phenomenon that rarely occurs with such effect even in the best of operas, and it represents musical theater at its finest.

As if all this were not enough, *Night Music*, which one critic gratefully called "an adult musical," also offers a subtle and often ironic wit and humor that one rarely finds on the Broadway stage. If much of this is due to the Bergman original, a great deal of credit must again be given to Sondheim, who possesses the rare talent of writing droll verse whose unexpected rhymes (who since Ogden Nash would dare to rhyme "cigar butt" with "bizarre, but"?) add immeasurably to the comic effect. Some of the sharpest barbs come in the duet *You Must Meet My Wife*, in which Desirée Armfeldt shows remarkable, if bemused, restraint as she listens to Fredrik, her former and renewed lover, dote on his wife—restrained, that is, until she learns that Anne is "unfortunately still a virgin," a fact the likes of Desirée simply cannot stomach. But the duet between Fredrik and his rival, Carl-Magnus, *It Would Have Been Wonderful*, with its spare, acerbic orchestral accompaniment, is also a masterpiece of caustic understatement.

Continued on page 73.

Its Finest
all-waltz show.



The *Rosenkavalier*-reminiscent song, *A Weekend in the Country*, performed by the *Night Music* cast as the Act I finale, underlines the show's waltz mood.



Glynis Johns (above center) as Desiree Armfeldt makes her entrance by telling daughter Judy Kahan, left, and maid Despo about *The Glamorous Life*. Right, Miss Kahan receives more advice from her stage grandmother, Mme. Armfeldt, played by Hermione Gingold, who explains another of the show's themes—that "a summer night smiles three times."



behind the scenes

A Little Night Music in the Studio



Glynis Johns, Judy Kahan, Hermione Gingold, Stephen Sondheim, and Goddard Lieberson enjoy a break between recording takes of *A Little Night Music*.

Broadway shows being Monday-through-Saturday affairs, recordings must be made on a single Sunday—barring catastrophe. Putting a show on disc can therefore be a harrowing experience, as Elaine Stritch—whose forty-odd takes of *The Ladies Who Lunch* from Stephen Sondheim's *Company* were immortalized in a TV documentary—will doubtless never forget. Dark memories of that ordeal were never far from the minds of the company of Sondheim's *A Little Night Music*, recorded from 10:00 a.m. on March 18 to 1:00 a.m. the following morning (just as the union officials were beginning to bring out their stop-watches) at Columbia's Studio C on East Thirtieth Street in New York, formerly a Greek Orthodox Church and the site of such memorable original-cast recordings as *West Side Story*, *My Fair Lady*, and *Company*. But *Night Music* flowed along with remarkable smoothness.

Added importance was lent by the presence of Goddard Lieberson—composer, veteran record-producer, and now senior vice-president of CBS. Lieberson had broken a three-year abstinence from album production to help get *Night Music* onto disc. "He's the highest-placed executive in the entertainment world to take on the chore of producing a show disc," Columbia's PR man Bob Altshuler told me. Lieberson had seen *Night Music*, and from that point Columbia had to record the show. "It seems like a traditional show, but it isn't," Lieberson said. This set the tone for the entire session, for the producer often directed the numbers as if he were staging an opera. "Espressivo!" said the control room voice. Or "subito!" At one point, Lieberson's "more parlando" elicited a confused "Huh?!" Everybody broke up. Lieberson concentrated on the dramatic aspects as well. "Get more quizzicality in your voice," he told the "Huh?" singer a

bit later. Assisting Lieberson were Thomas Z. Shepard, responsible for the highly successful *Company* album (among many others), and Sondheim himself, a perfectionist who was given the final word on changes and matters of interpretation. For the ensemble number *A Weekend in the Country*, a particularly difficult piece (none of Sondheim's music is easy) that had to be recorded in seven separate segments, the composer/lyricist was able to restore certain sections that had had to be eliminated from the show because of the staging.

Heads could be seen bobbing to the rhythms of Sondheim's catchy, bitter-sweet waltzes; and as the various performers stood before the mikes, their singing was accompanied by the facial expressions and even some of the gestures called for by the roles. All were delighted to be so close to the orchestra, which was beefed up with ten additional violins and an extra horn. "When you're on the stage," one cast member told me, "the orchestra's in the pit and you don't really hear them that well. This is great!" But if the orchestra was right there, so were all the other performers, and for some cast members who had never recorded before this was unnerving. "Usually they're either acting with you or else they're off stage and not watching." I was told by D. (as in Doris—"but nobody calls me Doris unless it's serious") Jamin-Bartlett, who plays the maid Petra, a last-minute replacement in Boston for a girl whose voice was not solid enough. "And then there's the microphone. I mean, it isn't like in a nightclub when the mike becomes a part of your body. It's just . . . there! But I've always thought there were two things you could do that would be really great. One is making a movie and the other is making a recording." In spite of her sound-stage fright, D.'s excellent take of her solo. *The*

Miller's Son, was warmly applauded by her fellow actors.

There were hitches of course. A ruptured blood vessel in Glynis Johns's throat (she plays the central role of Désirée Armfeldt) had almost postponed the opening of *Night Music* three weeks earlier; and the lyric sheets, which had been badly typed up for the recording session, had to be redone by Sondheim at the eleventh hour. During the session, there were moments when either Sondheim or Lieberson complained that a certain number was coming across with the spirit of a funeral march. Hermione Gingold, who plays Mme. Armfeldt, arrived at 3:30 but did not get to her solo, *Liaisons*, until three and a half hours later. During this time, however, she kept everybody entertained by playing the role of Hermione Gingold, occasionally slipping on "my famous caps" and smiling for a photographer. When Miss Gingold finally recorded her number, the very first take inspired a "terrific!" from Lieberson, and only the second half of the song was redone—to let Mme. Armfeldt doze off more convincingly. After that, even the accidental popping of bubble gum by Judy Kahan (the cast clown, I was told) in the middle of a take went unnoticed. Miss Johns, who was suffering from a sinus infection, also had to wait several hours before getting in front of the mikes. But when around 8:00 p.m. she and Len Cariou, in the role of her former and renewed lover, recorded the reprise of *Send in the Clowns*, which leads back into the final waltz, excitement mounted. By the time the solo piano sounded the last notes, it was as if the opening-night curtain had just closed on a sure hit. "What an emotional group!" somebody said.

That's the way it had been all day.

R.B.S.

Besides Sondheim's efforts, one thing that is particularly effective on this recording is the appropriateness and diversity of character as communicated by the various voices. Broadway has been tending more and more these days to abuse the privilege of using actors who can't sing, and the results have often been painful, to put it mildly. But the two nonsingers in *Night Music*, Hermione Gingold and Glynis Johns, both bring such a distinctive style to their roles that it would be difficult to imagine their songs performed by genuine "singers." Besides Miss Gingold, whom I have already mentioned, Glynis Johns—who plays Desirée and won a Tony for her efforts—moves easily and convincingly from the flightiness of *The Glamorous Life* to the sad, warm glow she creates for *Send in the Clowns*. But the other actors likewise seem to possess voices particularly well suited to their roles, from Mark Lambert's (Henrik) appropriately frenetic tenor to Laurence Guittard's (Carl-Magnus) pompous baritone; and Victoria Mallory's sweet soprano is perfect for the role of Anne. Both Len Cariou (Fredrik) and Patricia Elliott (Charlotte, Carl-Magnus' wife) do some of the best acting in the show, and it is a shame that at least some of the dialogue has not been re-

corded, since the purely musical numbers they sing here do not completely communicate the breadth of their performances. Special mention should also be made of Jonathan Tunick, whose sumptuous orchestrations (the harp and celesta are used to particularly good effect) create an essential part of *Night Music's* extraordinary atmosphere.

Fortunately, this recording, which even includes a libretto, has splendidly captured the spirit of the show—the sound is rich and realistic, although I would have preferred a bit more sound from the orchestra, and the stereo effect has been put to good use (a quadraphonic version is forthcoming). Like almost all original-cast albums, this one will have its greatest effect once you have seen the show. But that is a pleasure that nobody who is interested in the musical theater should pass up.

A LITTLE NIGHT MUSIC. Original Broadway Cast Recording. Music and lyrics by Stephen Sondheim. Glynis Johns, Len Cariou, Hermione Gingold, Victoria Mallory, Laurence Guittard, Patricia Elliott, Mark Lambert, et al.; Harold Hastings, cond. Columbia KS 32265, \$6.98. Tape: SA 32265, \$6.98; ST 32265, \$6.98. Quadraphonic: SQ 32265 (SQ-encoded disc), \$6.98; SAQ 32265 (Q-3 cartridge), \$7.98.

The Dramatic Genius of Henry Purcell



The problematic Fairy Queen:
gloriously salvaged by Britten



by Paul Henry Lang

The Fairy Queen is an example of the endless difficulties we face when dealing with the old lyric theater. In this particular case the trouble begins with the genre itself, even before we hear a sound, for *Fairy Queen* (based on Shakespeare, not Spenser) is a "semi-opera," a compromise in favor of the spoken theater. Now imagine a five-act anonymous adaptation of *A Midsummer Night's Dream*, add to it music enough for a full-fledged opera, and you get something that outlasts *Parsifal* by a good margin. Obviously, this won't do—we haven't the stamina of our seventeenth-century ancestors—so if the great score is to be salvaged, rather ruthless pruning is in order. In addition, the original score, most of it not in Purcell's hand and written in haste, is incomplete and at times ambiguous; like the play, it requires editing. This performance follows the excellent arrangement made for the 1967 Aldeburgh Festival. The play was ingeniously revised by Peter Pears; it is now manageable, has a nice continuity, the songs are well placed and come off naturally. The music was edited by Imogen Holst and

Benjamin Britten. I don't know who is responsible for what in this intelligent, tactful, and on the whole pious restoration, but that an experienced opera hand was at work is unquestionable. The redistribution of the songs (remember, this is not a through-composed opera but incidental music) is excellent, key relations are scrupulously observed (there is but one transposition), the orchestration delicately touched up, and the missing measures completed where the score is ambiguous; nowhere is there an anachronistic accent.

Was such a major restoration worthwhile? Even a few minutes of listening will convince us that it was. Every characteristic trait of Purcell's greatness is present in *Fairy Queen*. This music has no frills, it never hesitates, it is compact, and this graceful compactness, force, and sublimity raise Purcell to a place among the greatest masters of the baroque. His musical world is neither decorative nor abstract, and while he learned much from the Italians and the French, his art, which made so deep a mark on Handel, has its own climate, air, fragrance, and

rhythm. In his lyric stylization a new standard is set in the relationship between words and music; no one has ever surpassed Purcell in the musical setting of the English language. His settings are free of the rust of the mechanism; music approaches the words with reverence, but it also appropriates them completely. Purcell is really a "modern" composer—bold, chromatic, and dramatic, with an exquisite balance of irony and tenderness. Some of the ensembles sound like the chorus of birds after a storm, the airs are strung out like a necklace, and the instrumental numbers—here vigorous, there dreamy—are a sheer joy.

Britten, who conducts the performance, has a clear concept of this music and manages to convey it to all concerned, with a resultant remarkable stylistic unity. He is particularly successful with the arresting genre scenes, but his accompaniments are also impeccable: light but not evanescent. He is well seconded by the excellent continuo, which has just the right strength. Philip Ledger's improvised ornaments and runs on the harpsichord are exemplary, and Kenneth Heath's cello is discreet, with no resemblance to the dragging mournful bass we usually hear. The always first-class English Chamber Orchestra needs no new encomiums; among the fine solo winds, the trumpets especially excel here.

Peter Pears is an accomplished stylist who knows his limits and has absolute command within them; every word he sings is crystal clear. Listen to the poise, pace, and articulation of his very first air, "When a cruel long winter has frozen the earth"; this is English singing at its best. The other tenor, Ian Partridge, while not so smooth

and flexible as Pears, still does admirably, while John Shirley-Quirk, singing even the tricky chromatic lines mellifluously, projects the histrionic element with remarkable skill. Owen Brannigan contributes a second sturdy and well-modulated bass. The two countertenors, James Bowman and Charles Brett, sing their roles with the delicacy of a mezzotint, and, since these are not dramatic roles, their neutral voices are not out of place. Both Mary Wells and Jennifer Vyvyan sing well, though in the higher register their voices—especially Vyvyan's—are at times a bit out of focus, and their enunciation is not outstanding. Alfreda Hodgson's mezzo, a little heavy for the part, still blends with the others most of the time. Though her role is small, Norma Burrowes does the best singing on the distaff side. The chorus is admirable, though slightly thickened by the engineers in the fortes, but when singing quietly it is fine-grained and phosphorescent. Listen to those enchanting trebles in "I press her hand gently." The engineers are also responsible for the occasional slight rumble, especially when the close-miked timpani are in action. These minor flaws aside, this beguiling music comes through gloriously—there is not one dull moment in it.

PURCELL: *The Fairy Queen* (ed. Britten and I. Holst). Jennifer Vyvyan, Mary Wells, and Norma Burrowes, sopranos; Alfreda Hodgson, mezzo; James Bowman and Charles Brett, countertenors; Peter Pears and Ian Partridge, tenors; Owen Brannigan and John Shirley-Quirk, basses; Philip Ledger, harpsichord; Ambrosian Opera Chorus; English Chamber Orchestra, Benjamin Britten, cond. London OSA 1290, \$11.96 (two discs).

Purcell's ceremonial music: dressing an occasion with the unmatched royal pomp of the English

by Clifford F. Gilmore

THIS IS NO ordinary record of early music: For the special splendors of the repertory and the performances, this is an item to insert near the top of your "must buy" list.

The English have always had a particular and unique ability to dress up a ceremonious occasion with a higher degree of royal pomp and majesty than anyone else, and no one ever surpassed Purcell and Handel in supplying ceremonial music for those occasions. Side 1 presents Purcell's English settings of the *Te Deum* and *Jubilate Deo*, written for the celebration of St. Cecilia's day in 1694 in his most grand and festal style, in which antiphonal brass, strings, and choir alternate with choral and solo passages of an intimately expressive character. Purcell's contemporary, Thomas Tudway, wrote: "I dare challenge all the Orators, Poets, Painters &c of any Age whatsoever, to form so lively an Idea of Choirs of Angels singing, & paying their Adorations." I can only echo Tudway's innocent enthusiasm.

Purcell's "complete" funeral music on Side 2 is just as regal in its ethereal serenity as the St. Cecilia music is in its jubilation. This side contains two early works: the *Funeral Sentences*, a vividly and chromatically expressive work for four-part chorus (solo and tutti) with continuo, and the five-part anthem *Remember not, Lord, our of-*

fences. Then follow the solemn instrumental *March* and *Canzona* for brass and muffled kettledrums, and the anthem *Thou knowest, Lord*, all of which were written for the lavish state funeral of Queen Mary in Westminster Abbey in 1695. Barely eight months later Purcell too was buried in Westminster Abbey, at a ceremony whose solemnity was enriched by the very instrumental music and anthem that he had provided for the Queen's funeral.

The performances are superb in every detail; not only because each and every one is a highly skilled performer and because they have been so thoroughly rehearsed, but also because they are Englishmen performing music with which they obviously identify deeply. The recorded sound is magnificently cathedralesque, but unfortunately no texts are provided, and in spite of excellent diction not all the words are intelligible.

PURCELL: *Ceremonial Music*. James Bowman and Charles Brett, countertenors; Ian Partridge, tenor; Forbes Robinson, bass; Choir of St. John's College, Cambridge; English Chamber Orchestra (in the *Te Deum* and *Jubilate Deo*); *Symphoniae Sacrae* (in the *Funeral Music*), George Guest, cond. Argo ZRG 724, \$5.98.

Te Deum Laudamus. *Jubilate Deo* in D. *Complete Funeral Music*: *Funeral Sentences*; *Remember not, Lord, our offences*; *March*; *Canzona*; *Thou knowest, Lord* (1695).

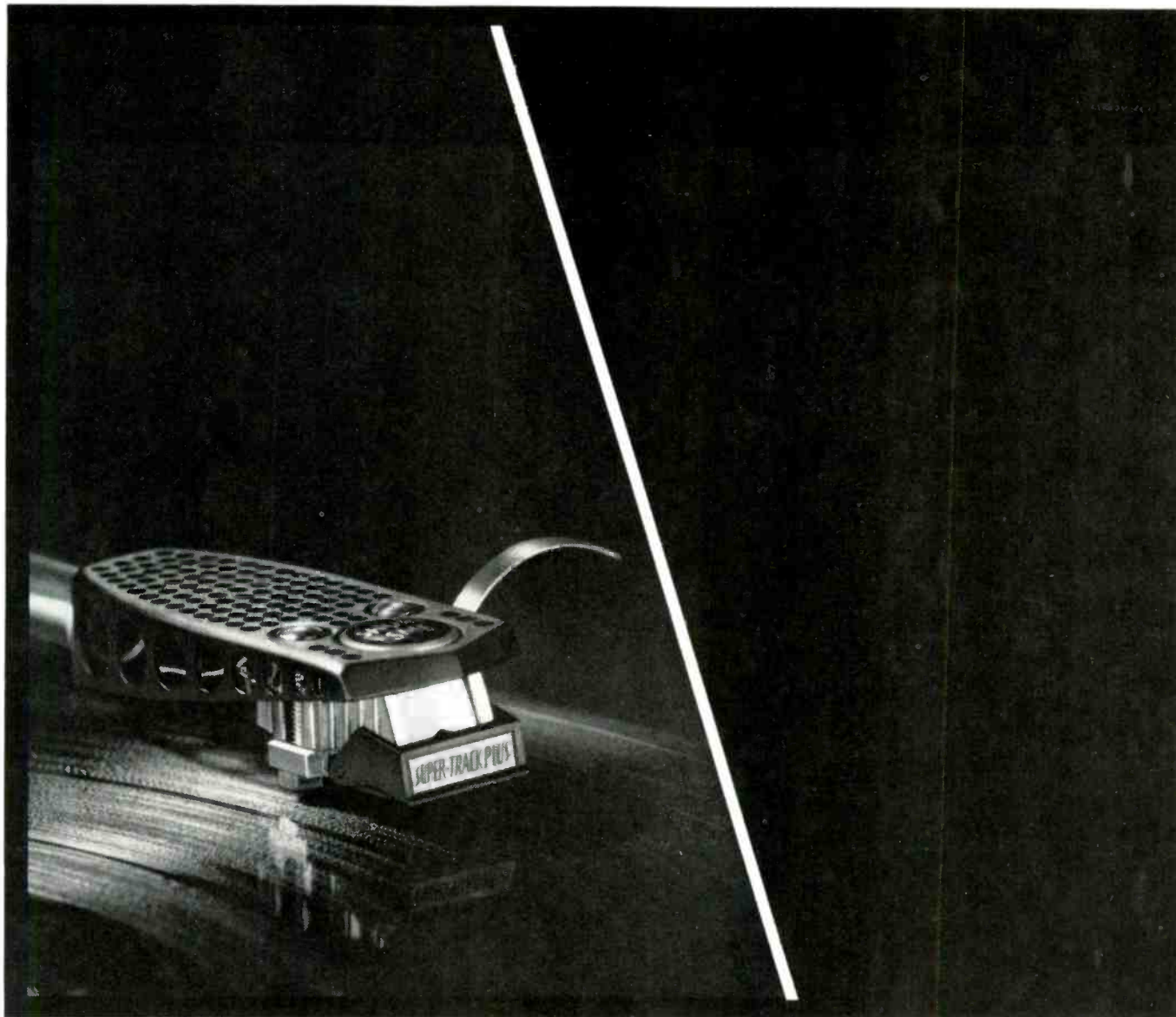

anything II could do III can do better!

Several years ago, we decided that our next challenge would be to go beyond the best there was. Our computers told us we had taken the existing cartridge structure and stylus assembly of the V-15 Type II Improved as far as we could, and that hereafter, any improvement in one performance parameter would be at the expense of performance in some other parameter.

Therefore, over the past several years, a wholly new *laminated* cartridge structure has been developed, as was an entirely new stylus assembly with a 25% reduction in effective

stylus mass! These developments have resulted in optimum trackability at light tracking forces ($3/4$ - $1/4$ grams), a truly flat, unaccented frequency response, and more extended dynamic range than was possible even with the Type II Improved, without sacrificing output level!

If you like its sound today, you will like it even more as time goes on. In fact, to go back to any other cartridge after living with the Type III for a short while is simply unthinkable, so notable is its neutral, uncolored sound. You must hear it. \$72.50.

INTRODUCING THE NEW

SHURE V-15 TYPE III Super-Track "Plus" Phono Cartridge

Shure Brothers Inc. • 222 Hartrey Ave. • Evanston, Ill. 60204

In Canada: A. C. Simmonds & Sons Ltd.,

CIRCLE 53 ON READER-SERVICE CARD

classical

reviewed by

ROYAL S. BROWN
 ABRAM CHIPMAN
 R. D. DARRELL
 PETER G. DAVIS
 SHIRLEY FLEMING
 ALFRED FRANKENSTEIN
 KENNETH FURIE
 CLIFFORD F. GILMORE
 HARRIS GOLDSMITH
 DAVID HAMILTON
 DALE S. HARRIS
 PHILIP HART
 DONAL J. HENAHAN
 PAUL HENRY LANG
 ANDREA MCMAHON
 ROBERT C. MARSH
 ROBERT P. MORGAN
 ANDREW PORTER
 H. C. ROBBINS LANDON
 JOHN ROCKWELL
 SUSAN THIEMANN SOMMER

B **BABBITT:** Quartet for Strings, No. 2. **CRAWFORD SEEGER:** Quartet for Strings. **PERLE:** Quartet for Strings, No. 5. Composers Quartet. Nonesuch H 71280, \$2.98.

The prize here is Ruth Crawford Seeger's quartet. Mrs. Seeger was the wife of musicologist Charles Seeger and the stepmother of folksinger Pete Seeger. From a conservative compositional style honed during her studies at the American Conservatory in Chicago, she evolved a strikingly modernistic idiom expressed primarily in a cluster of works written around 1930. Her string quartet, composed in 1931 in Berlin where she was living on a Guggenheim Fellowship, is her best-known work—partially because of her string-orchestra arrangement of its slow movement, which has enjoyed some popularity apart from the work as a whole.

The quartet lasts about ten minutes and is in all ways a masterpiece. To our ears what might seem most immediately striking is the uncanny anticipation of later developments, particularly Carter's independent part-writing and metrical explorations. But strictly on its own terms the quartet makes extraordinary expressive sense. The slow movement, with its eerie pulses attained through rigorously counterpointed dynamics, is perhaps the most impressive. But the first two movements, nervous and energetic, sound equally unusual on continued hearings, and the last movement, the most precisely formalistic of the four, appeals for its very sternness of structure.

The other two items on this disc are well worth hearing as well. It is always good to have more of Milton Babbitt's music at hand in performances as fine as this, to bring it off the page and into our ears in a fully tangible way. Admittedly, some other pieces by this composer—his Third Quartet, for instance, recently released on Turnabout (reviewed by Robert P. Morgan in May)—make a more direct appeal to an unprepared listener. But Babbitt doesn't compose for such a listener, and his Second Quartet is full of fascination for its dryly ingenious intellectuality. What Babbitt has done is construct a row that embraces a variety of intervals, and then constructed his quartet so that it breaks into clearly defined sections in which various intervallic possibilities are expounded and developed. Eventually the row is revealed, linearly, at the end.

George Perle is both a composer and the author of a book called *Serial Composition and Atonality*, which matches the seriousness of its quasi-scientific subject with a quasi-scientific seriousness all its own. Curiously enough, Perle's Quartet No. 5 is an apparently accessible piece, full of reasonably grateful triadic consonances and an easy lyricism. But the notes reassure us that this is, in fact, just as hard-line as Babbitt, since Perle has built his score strictly in accordance with his own "twelve-tone modal" system in which rows are developed intervallically. It just so happens that the interval in question for the Fifth Quartet is the third.

The performances, production, annotation, and packaging of this record deserve the highest praise. The Composers String Quartet has been one of our finest ensembles for some years. With the sort of performances heard here, simultaneously passionate and exact, it is easy to see why. J.R.



Ruth Crawford Seeger
 A quartet in all ways a masterpiece.

BACH: Cantatas, Vol. 6. Walter Gampert, soprano (in No. 23); Paul Esswood, countertenor; Kurt Equiluz, tenor; Marius van Altena, tenor (in No. 23); Walker Wyatt, bass (in No. 21); Max van Egmond, bass; Vienna Boys Choir and Chorus Viennensis; Vienna Concentus Musicus, Nikolaus Harnoncourt, cond. (in No. 21); King's College Choir Cambridge; Leonhardt Consort, Gustav Leonhardt, cond. (in Nos. 22 and 23). Telefunken SKW 6, \$11.96 (two discs).

Cantatas: No. 21, Ich hatte viel Bekümmernis; No. 22, Jesus nahm zu sich die Zwölfe; No. 23, Du wahrer Gott und Davids Sohn.

Selected comparison (No. 21):
 Richter

Arch. 2533 049

It's impossible to exaggerate the excellence of Telefunken's series of the complete Bach cantatas. I find myself more excited by each new release: by the technical perfection of the performers, the ever fresh vitality they bring to the music, and of course the great amount of scholarly work that has gone into each performance. Without exception, the recordings contained in these first six boxes are equal to the best competitive versions and in most cases are superior to them all.

Cantata No. 21 is a special case: It is a larger, more elaborate work than average (filling two record sides), and is deservedly one of Bach's most popular cantatas. Bach was apparently fond of it, too, since he performed

Explanation of symbols

Recorded:

B Budget
H Historical
R Reissue

Recorded tape:

●● Open Reel
 ● 8-Track Cartridge
 ●● Cassette

it several times during his years in Weimar, Köthen, and Leipzig. At each performance he made alterations and additions to suit the particular occasion, so there are knotty problems for the performer today in collating the different versions—especially with regard to the key, which was changed because of different organ pitches. Harnoncourt has chosen the D minor version, in spite of the fact that the old Bach-Gesellschaft (and therefore most performances of the work) is in C minor. His reasons for this and all the other “corrections” he has made in the score are carefully explained (as in the earlier volumes) in the booklets and full scores accompanying the records. In addition, the booklets contain a great deal of fascinating information about the history and the special problems of each work, written by several highly respected “Bach experts.” In every detail Harnoncourt’s performance is superb, but Richter’s Archive recording is among the best cantata performances on record. Richter manages to pack even more drama and excitement into his reading, but misses a few stylistic details that Harnoncourt corrects. Clearly both recordings are essential to the complete collector.

Cantata No. 22 has never been recorded before, and No. 23 only once: by Kurt Thomas for the Cantata label (now available also on Musical Heritage Society MHS 1242). Both cantatas were written for the same Sunday, February 7, 1723, and perhaps even performed in the same service as a quasi two-part work. February 7, 1723, is also the date Bach “auditioned” for the job of cantor in Leipzig by performing Cantata No. 22. It is possible that he had already written No. 23 for that date and that when he was asked to perform in Leipzig he wrote another cantata which he felt would be more suitable to the occasion. Leonhardt’s performances of these two works, with the King’s College Choir, adhere to the same high standards. I had only some vague misgivings about the choir’s overly fussy manner in the final chorale of No. 22. C.F.G.

BEETHOVEN: Sonatas for Piano: No. 17, in D minor, Op. 31, No. 2 (*Tempest*); No. 18, in E flat, Op. 31, No. 3. Stephen Bishop, piano. Philips 6500 392, \$6.98.

Here is further evidence of Bishop’s newly emerging commitment and authority. No. 18 fares particularly well in this taut, robust, well regulated pianism. All the problematical dynamic markings get their due, every accent is in place, and the whole abounds with driving momentum, vigorous brilliance, and a fair modicum of sardonic humor. My only quibble is with Bishop’s rather fast, perfunctory view of the Menuetto (but better this than dawdling sentimentality). The D minor Sonata too has many of the right qualities—including breadth, angularity of phrase, and proper heed of Beethoven’s long pedal indications for the first-movement *recitativo*. Bishop is careful to delineate the inner voices of the third section, and he also gets the *subito* pianos and against-the-melodic-grain inflections of the Adagio right. Nevertheless, he sometimes mistakes inwardness for plasticity and understatement for shapelessness. There are also curious misreadings—E and A for A and C—at bar 37 of the first movement and an elided measure (bar 160) in the Allegretto. The last-cited may be a tape-editing error. Otherwise

Bishop seems to be using a reliable *Urtext* edition.

The sound is impactful rather than soft and mellow—a good Beethovenian sonority. And apart from a bit of grinding noise in the slow movement of Op. 31, No. 2, my copy was up to the exceedingly high standards expected of Philips’ imported pressings. H.G.

BEETHOVEN: Symphonies: No. 8, in F, Op. 93; No. 9, in D minor, Op. 125 (*Choral*). Sheila Armstrong, soprano; Anna Reynolds, mezzo; Robert Tear, tenor; John Shirley-Quirk, bass-baritone; London Symphony Orchestra Chorus (in Op. 125); London Symphony Orchestra, Carlo Maria Giulini, cond. Angel SB 3795, \$11.98 (two discs).

Selected comparisons (Op. 125):
Solti/Chicago Sym. Lon. CSP 8
Toscanini/NBC Sym. Victrol 1607

When Giulini was last in Chicago, shortly before he made these recordings, we spent an hour one day discussing the problem of maintaining in the modern world the conditions traditionally regarded as essential for a spiritual life. Unlike many other musicians, whose primary interest is talking about themselves and their career plans, Giulini is the sort of man with whom such a conversation is possible. And this seems to me the sort of Beethoven Ninth one might expect from a man deeply concerned with things of the spirit. The result is one of those performances that seem a perfect mirror of the performer. Certainly I know of no other recording that represents with such consistency all the qualities in Giulini’s musicianship which I most admire. No conductor in the Italian tradition since Toscanini, I think, could reflect that musical lineage in this music more successfully than Giulini has done, although in many things, great and small, his performance is very different from that of his older colleague.

It is perfectly natural that different critics will place varying degrees of emphasis on the purely technical side of recordings. My colleague Harris Goldsmith (who reviewed the Solti Ninth in May) compares historical and contemporary material directly; to him the performance is everything, and the variation in sound really doesn’t matter. I am inclined to regard any recording more than five years old as obsolete technically. This doesn’t mean that it is not to be played or admired, but it ceases to be competitive with contemporary work. The listener should be told you are talking about the sonic counterpart of a 1968 car. (Incidentally, in most cases I scrap my record-reviewing equipment after *three* years.)

In that light, the Toscanini recording of the Beethoven Ninth is historical material of prime importance, but as a recording it is twenty-one years old and sounds every year of its maturity. For a very long time it was the Ninth everyone bought, and I assume any serious Beethoven collector has a copy around. If he doesn’t, he should. But I seriously wonder how often he is going to want to play it. And he may well want a second performance in up-to-date sound. In the early stereo era, Reiner (RCA) and Szell (now on Columbia) both offered editions that fit that need well, and now, in a still later period, Solti and Giulini have provided a pair of new albums that are worthy companions to Toscanini on any shelf.

Solti has finer players, stronger vocal soloists, and the finest chorus affiliated with



Nikolaus Harnoncourt
Essential Bach for the complete collector.

any American orchestra today—thanks to the remarkable Margaret Hillis. Solti’s performance is slower than Toscanini’s, but I don’t take that as a fault, since I have come increasingly to regard the Toscanini tempos as too fast. Once, by means of an ingenious machine that allowed one to alter the speed of a taped performance without changing the pitch of the music, I slowed down the Toscanini and found it a lot more to my liking, but my plans to broadcast the results (suitably identified, of course) were thwarted by nit-picking bureaucrats at the BBC.

The performance times of the Giulini and Solti sets are not comparable in a useful way because of their different treatment of repeats in the scherzo. Basically both are slower than the Toscanini, with Giulini tending to be slower at times than Solti, but all of these matters are deeply influenced by the differences between real and apparent motion which are provided by accents, rhythmic support, and a sense of thrust.

Giulini plays this music like a man in a true state of grace. The effect is beatific. Solti’s performance is lyric drama, charged with the high-voltage quality that he generates in action, and strongly accented. The hard-driving effect he brings to many passages is emphasized by the hall and the microphone placement; so this is a recording with the sort of polished chromium surface frequently associated with London’s firr engineering.

After proceeding through both sets contrasting roughly six-minute segments of music, I find myself admiring what each man has achieved but feeling far more deeply touched by Giulini’s results. This is, I think, the root of any choice between these performances, the distinction between pathos and reverence, which Giulini stresses, and the Promethean quality Solti finds in this music. Those who want a big, exciting performance in wildly brilliant sound with a ferocious dynamic range (and eventually, I hope, four-channel as well) will find Solti is the man.

Giulini asks for an appreciation of other things. His goal is a true quality of *melos*, a sense of glorious song that by its very simplic-

Continued on page 79.



by Abram Chipman

Brahms by Four—A Feast of Orchestral Performances

THIS LATEST BRAHMSIAN bonanza contains the second installment in Haitink's cycle of the symphonies plus three "new" complete sets.

The Sawallisch records originally appeared around a decade ago on European Philips. Turnabout has taken over the rights and at a list price of \$9 offers more of this repertory for less money than anyone else listing in Schwann-1. (It is hardly "The Complete Orchestral Music," though, in view of the absence of four concertos, two serenades, the *Hungarian Dances*, and the choral music.)

Ormandy recorded these symphonies in Philadelphia's Town Hall some five or six seasons ago (including the First, of which his prior stereo edition is still in print). Condensed onto six sides, in automatic sequence, it becomes inconvenient to play individual symphonies here, particularly Nos. 3 and 4, which start on inner bands. But the price is attractive.

The imported Sanderling set was made during 1971-72. The *Academic Festival* Overture is omitted, and Eurodisc, like Turnabout and Columbia, has not issued the symphonies individually. However, British RCA is starting to release these as singles.

These four conductors have similar points of view about the music, and basically I like their interpretations, one and all. Tempos are rarely excessive in either direction, nor modified between theme groups in the old manner of Max Fiedler and Mengelberg. The three albums under review eschew exposition repeats in the first three symphonies. Conveniently—in view of the "bulk packaging"—the interpretive differences are consistent from one work to the next.

Sawallisch is easy-going, unemphatic, almost casual in his approach. If you find Brahms heavy and overbearing, this is your antidote. Tempos are moderate but loosely controlled; hence the scores do not hold together as firmly and purposefully as they do elsewhere. The Vienna Symphony plays sweetly, in a somewhat *laissez-faire* spirit. Countless imprecisions of articulation, blending, and intonation pass muster. The oboes are sour; the horns resemble acoustically recorded trombones. The flutes, however, are limpidly expressive. All are recorded at a low level, in a dry, smallish ambience. Turnabout's pressings are happily free of the occasional pre-echo that mars the Columbia and Eurodisc discs, and the high hiss level on Philips. Since the shortcomings are not grossly objectionable, the bargain-conscious need not fear Sawallisch.

Ormandy also maintains a fair degree of rhythmic flexibility, but with a conscious sense of Romantic shaping (note the sliding cellos in the slow movement of No. 2, the violins in the third movement of No. 3). Brahms has always brought out the best in Ormandy, and his extroverted and ruddy treatment is perfectly apropos. His paces minimize sharp contrasts: Slow sections are a little faster, fast ones a little slower than the competition (cf. the switch from *un poco sostenuto* to allegro in the opening movement of No. 1). The "Fabulous Philadelphia Sound" is massive, uniform, and well-drilled. A kind of homogeneous blending is the rule, with focus on glittering strings from top to bottom. There's a modicum of reverb (mostly in Nos. 1 and 3), and dynamic range is subject to some compression. Like a "zoom lens," mikes keep swooping in at strategic moments to pick up wind details. The pressings are subject to vertical warpage.

Sanderling's beat is steady as the proverbial rock, yet he bends when needed (e.g., the transitions between sections of the scherzo of No. 2, the crests of the exposition and development of the finale of No. 1). Phrases, dynamics, and the dovetailing of inner voices are molded with the utmost plasticity. This is Brahms conducting of vast authority and calm inner strength. The Dresden Staatskapelle has a deeply glowing tonal solidity, with a sense of defined balance between and within choirs—despite the Eastern European horn and oboe vibrato. Attacks and releases are impeccably alert. Strings articulate neatly and precisely. Whether Sanderling, the ensemble itself, or the acoustical setting (Dresden's Lucaskirche) is responsible, I cannot praise too highly the clarity with which wind doublings of string parts come across, or the constant audibility of the viola line, or even the tonal differentiation of cellos and basses. The reproduction, in its depth, impact, smoothness, and transparency, is nothing short of state-of-the-art. The Eurodisc set (imported by German News Company) is easily worth the extra effort and cost of purchase.

Haitink's Fourth is solidly traditional, without extremes of either intellectual asperity or sensuous indulgence. It is warm, flowing, decently played and recorded. One of the best of early stereo Brahms Fourth was Van Beinum's from this same ensemble and company. Long unavailable, it is in many respects regenerated here.

As for the shorter works: Sawallisch and Sanderling share a view of the *Tragic* Overture which smooths down the contrast between its

two main speeds. The Variations are pleasant but not too vividly characterized. The *Academic Festival* gets from Sawallisch and his orchestra the fastest and zippiest reading I've heard in many a year.

Three of the previous symphony sets seem to me worthy of consideration (along with Steinberg's deleted Command set if—as appears likely—it reappears on Westminster Gold). Szell's—like Ormandy's, a Columbia three-discs-for-the-price-of-two package—is marked by rigorous concentration, intensity, and virtuosic elegance. Though No. 2 is overly antiseptic and deliberate, No. 4 is utterly enthralling. The separate disc of shorter works contains majestic statements in particular of the *Tragic* Overture and the St. Anthony Chorale Variations. Klemperer can be purchased separately or boxed, and the stereo recording boasts left-right separation of the violin sections. The sound otherwise shows its age, but the music-making is of iron determination, proud individuality, and wry humor (cf. the *Academic Festival*). Barbirolli has the Vienna Philharmonic, gorgeously reproduced, responding expansively to noble, unhurried, old-world conceptions from "the last of the great poet conductors." The C minor Symphony is the special gem, but you have to buy the whole package.

BRAHMS: Symphony No. 4, in E minor, Op. 98. Concertgebouw Orchestra of Amsterdam, Bernard Haitink, cond. Philips 6500 389, \$6.98.

B **BRAHMS:** Symphonies; Variations on a Theme by Haydn, Op. 56a; *Academic Festival* Overture, Op. 80; *Tragic* Overture, Op. 81. Vienna Symphony Orchestra, Wolfgang Sawallisch, cond. Turnabout TV-S 34453/6, \$9.00 (four discs).

B **BRAHMS:** Symphonies. Philadelphia Orchestra, Eugene Ormandy, cond. Columbia D3M 31636, \$11.98 (three discs).

BRAHMS: Symphonies; Variations on a Theme by Haydn, Op. 56a; *Tragic* Overture, Op. 81. Staatskapelle Dresden, Kurt Sanderling, cond. Eurodisc 85782 XHK, \$27.92 (four discs).

Symphonies: No. 1, in C minor, Op. 68; No. 2, in D, Op. 73; No. 3, in F, Op. 90; No. 4, in E minor, Op. 98.

Selected comparisons:

Barbirolli (Syms., Var., Overs.)
Klemperer (Syms., Overs.)
Szell (Syms.)
Szell (Var., Overs.)

Ang. 3732
Ang. 3614
Col. D3S 758
Col. 6965

Continued from page 77.

ity and purity makes its effect with minimal interpretation. Every time one shifts from Solti to Giulini, the intensity of Solti's driving force becomes conspicuous by omission, and after a moment or two you may wonder why it was necessary. This is going to be controversial. Some, I am sure, will say that Giulini should give more support to the line of the work, that he permits it to go a little slack at times, that more push and drive are needed to sustain the phrases. I don't agree. On the contrary I think he proves that a lot of that pushing is a gratuitous intrusion on the natural melodic contour of Beethoven's themes.

Few conductors do as much with the mysterious opening of the first movement with its deliberately ambiguous harmonies from which the rising theme leaps to capture and hold the ear. The pace is slow, but it is beautifully sustained and the movement really seems to build toward the final pages as each successive phrase unfolds in a long singing line to carry the work a step higher and higher toward that mountain top.

The scherzo is wonderfully achieved—light, firmly rhythmic, filled with a sense of laughter and delight. Giulini does not make the second repeat in the movement, feeling the proportions are better without it, and I agree.

The slow movement is the purest reflection of Giulini's artistry, an almost seamless progression in pure and noble song from start to finish. Here the comparison is especially vivid. Solti is more dramatic, and the climactic moments are more forcefully recorded, but the effect is, I think, less. Giulini conveys a sense of ecstasy and exaltation that Solti lacks.

In the final movement, Giulini is not so much involved with scaling the stars to find the Unknown enthroned (as Schiller's text suggests) but probing into the human heart to find what lies there. In the liner notes he observes that the singers are not of primary importance but must be regarded in terms of the work as a whole. This is the effect of his performance, with soloists and chorus kept very much in scale with the orchestra and not allowed to dominate important instrumental lines. It is not the effect one normally hears, but it is valid. The London Symphony Chorus does not sing German with particular sensitivity (the British aren't especially good at that sort of thing), but it is entirely acceptable, and the soloists are good if not great. (Those who want thirteen bars of undimmed high A from the sopranos at 717-729 in the finale must turn to the Solti version.) On the other hand some vocal details—the notorious third stanza of the ode, for instance—are better achieved in the Giulini performance.

It is commonplace for Angel recordings to offer less dynamic range than one might desire, and this is no exception, but the sound is very warm, exceedingly pleasant to the ear, and in the long run the most welcome to hear repeatedly. (The intrusive hi-fi quality of the Solti starts to get on my nerves in time.)

Because of the shorter scherzo, Giulini can offer on the fourth side a recording of the Symphony No. 8 in which the final three movements are done with great charm—light, zestful performances filled with a nice Italianate sense of motion. The opening movement has the important repeat and sings all the way to the close, but the tempo is rather slow. It takes some getting used to, as the British say. On rehearing I liked it more than the first time around, but the Szell performance (of a num-

ber of possible choices) remains somewhat closer to my idea of the work.

Do we perhaps have in this set a Ninth that both the Toscanini and Furtwängler camps may accept as reflecting many of the things they most appreciate in their respective heroes? Is Giulini, in the best Hegelian manner, the artistic synthesis between that thesis and antithesis? There is no doubt that he here reveals himself as a man exalted in his art.

R.C.M.

BERLIOZ: Benvenuto Cellini: Overture—See Chausson: Symphony.

BERNSTEIN: Symphonic Dances from West Side Story—See Recitals and Miscellany: Romeo and Juliet.

BIZET: Carmen. For a feature review of a recording of this work, see page 67.

BIZET: Nocturne No. 1, in F; Variations chromatiques. **GRIEG:** Sonata for Piano, in E minor, Op. 7. Glenn Gould, piano. Columbia M 32040, \$5.98.

You're not apt to hear a stranger piece from a Romantic composer than Bizet's *Variations chromatiques*, composed in 1868. Instead of the lush, chromatic progressions à la Franck or Wagner that one might expect, Bizet has taken a weird, chromatic melodic line that he presents in completely unharmonized unisons. He then goes on to develop the theme in a set of variations in which a rather straightforward Romantic piano style à la Liszt or Schumann seems to be doing battle with the chromatic theme. The results are as fascinating as they are unusual, and Glenn Gould performs the work in a manner that one has come to associate with him—beautiful, extraordinarily clear passagework, an exceptional ability to sustain dramatic momentum, and lots of unwelcome humming. He likewise brings out with great effect the crystalline brilliance of the wistful and more Lisztian nocturne.

Gould can also be counted on to come up with at least one outrageous tempo per recording: here he has chosen the third of the four movements of Grieg's 1865 sonata as his victim. In his liner notes, Gould claims kinship to Grieg, and perhaps Uncle Edward has passed down some deep, dark secret that justifies Gould's turning this section into a second slow movement, even though Grieg indicates that the third movement is to be played only a little bit more slowly than a minuet. Outside of this tempo quirk, however, Gould offers a spirited and dynamic interpretation of this episodic sonata, with its many rich and typically Griegian chordal progressions. I personally prefer Grieg as a miniaturist, and I would hope that Gould would one day record some of the *Lyric Pieces*. But the sonata offers enough attractive sections to sustain interest. The recorded sound is much better for the Bizet than for the Grieg, in which the upper registers are all but swallowed by the lower and middle ones.

R.S.B.

BLOCH: Quartet for Strings, No. 5; Concerto Grosso No. 1, for String Orchestra and Pi-

Dreaming about a pair of \$300 condenser microphones?

Think seriously about these: \$39.75* each!



Model 1710 Electret Condenser
Omnidirectional Microphone

All of the great condenser advantages are here without compromise. Flat, extended range, excellent transient response, high output, low noise, and ultra-clean sound. But the new E-V electret condenser microphones need no high voltage power supply. Just an AA penlite battery to operate the built-in FET impedance converter. The result is studio performance without complications and at a dramatically lower price.

There are 4 new E-V electret microphones, including cardioid models, from \$39.75 to just \$75.00, audiophile net. Second-generation designs with unusually high resistance to heat and humidity. Hear them today at your nearby Electro-Voice soundroom. Or write for details.

More U. S. recording studios use Electro-Voice microphones than any other brand.

*Suggested retail price. Microphones shown on Model 421 Desk Stand, \$12.00 each.

Electro-Voice®

ELECTRO-VOICE, INC., Dept. 732H,
619 Cecil Street, Buchanan, Michigan 49107
In Europe: Electro-Voice, S. A., Römerstrasse 49,
2560 Nidau, Switzerland

a **Gulton**
COMPANY

CIRCLE 19 ON READER-SERVICE CARD

the sound is great! by Jupiter...

Geared to modern living, Empire's Jupiter 6500 speaker will fit any decor or blend with any setting. The virtually indestructible enclosure is made of Uniroyal Rubicast, a new space-age acoustic material that can withstand wind, rain, and sun.

Jupiter's perfect three-way system, completely weatherproofed for indoor or outdoor use, uses Empire's heavy 12-inch downward facing woofer for bass you can feel as well as hear, a powerful mid-range for crisp, clear alto and voice tones, and a lightweight ultrasonic tweeter with wide angle dispersion.

The power of the Jupiter 6500 speaker is awesome either indoors or out — it can deliver a full 75 watts of music power without overload, burnout, or strain.

Empire's new Jupiter 6500 speaker. Available at better hi-fi dealers for \$139.95.

EMPIRE Scientific Corp.
World Famous Speaker Systems Mfd. U.S.A.
Garden City, New York 11537



EMPIRE

CIRCLE 21 ON READER-SERVICE CARD

FREE McIntosh CATALOG and FM DIRECTORY

Get all the newest and latest information on the new McIntosh Solid State equipment in the McIntosh catalog. In addition you will receive an FM station directory that covers all of North America.



MX 113

FM/FM STEREO - AM TUNER AND PREAMPLIFIER

SEND TODAY!

McIntosh Laboratory, Inc.
East Side Station P.O. Box 96
Binghamton, N.Y. 13904

NAME _____
ADDRESS _____
CITY _____ STATE _____ ZIP _____

If you are in a hurry for your catalog please send the coupon to McIntosh. For non rush service send the Reader Service Card to the magazine.

CIRCLE 35 ON READER-SERVICE CARD

ano. Fine Arts Quartet (in the quartet); Czech Radio Orchestra, David Epstein, cond. (in the concerto grosso). Everest 3328, \$4.98.

Selected comparison (Concerto Grosso): Hanson/Eastman-Rochester Sym.

Mer. 90223

Granted that Ernest Bloch blazed no paths in the string-quartet writing of our century. His five works in that form, however, are splendidly written for the ensemble and contain, particularly in the earlier ones, impressively articulate savagery, tenderness, and tragic gloom. It is therefore high time for an integral modern recording.

Meanwhile, collectors owning the deleted mono set of Bloch's first four by the Griller Quartet (London LLA 23) may count themselves fortunate indeed. The Fifth Quartet makes an obvious supplement to that album in the sturdy and polished performance of the Fine Arts Quartet. The music isn't the composer's best (the ideas are getting tired, the working out of them routinized), but the new convert to Bloch will only too gladly grab what little is available. Parenthetically, is it not shocking that the Second Piano Quintet remains to be recorded more than a decade after the composer's death?

Everest has put us in a dilemma by this coupling. The same performance of the quartet can still be had on Concert Disc (CS 225), where it is paired with the only current edition of Hindemith's powerful Third Quartet. The reissue combines the chamber work with a blazingly vital masterpiece from three decades earlier in Bloch's creative career. The concerto grosso serves to introduce record buyers to David Epstein, a gifted young American who and in recent years has made the MIT Symphony (Cambridge, Mass.) his base of operations. In the Czech Radio Orchestra, whose piano obbligato player is unfortunately unidentified, he has a competent group clearly revved up to peak form. The reading goes far beyond any past or present rivals on at least two counts: laying bare the harmonic texture, and appreciating the importance of pianissimos and other hairpin dynamic effects.

How sad, then, that the present artists didn't record Bloch's Second Concerto Grosso while they were at it, which would have made this record directly competitive with the richer-sounding Hanson coupling on Mercury. As it is, Everest's sound for the orchestral side is a bit scrawny, but is worth putting up with for Epstein's exemplary interpretation.

A final point for collectors of Everest bloopers: The printed timings for the Fifth Quartet total upwards of thirty-eight minutes, which would be a very generous LP side indeed. In fact, the third movement (6:17) was counted twice. A.C.

BRUCKNER: Symphony No. 1, in C minor (Linz version). Concertgebouw Orchestra of Amsterdam, Bernard Haitink, cond. Philips 6500 439, \$6.98.

Selected comparison: Abbado/Vienna Phil.

Lon. 6706

Unless he is planning to record the F minor Schul-Symphonie (the composer's actual first work in the form, preceding the Symphony No. 0 in the cañon, Haitink has now completed his edition of the ten Bruckner sym-

THE LAFAYETTE LR-4000



Don't just take our words for it, take someone else's...

"... Lafayette's wave-matching logic circuit . . . represents the state of the SQ art. . . ."

—*Modern Hi-Fi & Stereo Guide*, Feb. '73

"The LR-4000 epitomizes the art of matrixed 4-channel sound."

"Enough power there to give you all the decibels of hi-fi sound you could conceivably crave."

—MARTIN CLIFFORD, *FM Guide*, Nov. '72 & March '73

"... the decoding is essentially the ultimate that can be expected of a matrix system limited to a 20- to 20,000-Hz bandwidth. . . . The listening effect is almost that of discrete surround-sound."

—HERBERT FRIEDMAN, *Hi-Fi Stereo Buyers' Guide*, Spring '73

"It causes [SQ encoded] discs to sound as real four-channel should. . . . This unit, in fact, takes the SQ system as far as it can go—and proves that it is capable of good four-channel."

—*Stereo & Hi-Fi Times*, Spring '73

"Featuring all modes 4-channel operation, this receiver delivered excellent performance. Amplifier distortion is unusually low."

"FM Tuner: The sensitivity measured 1.6 μ V IHF."

—*4-CHANNEL Quadraphonic Buyers Guide 1973*

"A superb four-channel receiver. . . ."

—ROBERT ANGUS, *Modern Hi-Fi & Stereo Guide*, June '73

"... It is evident that the designers of the LR-4000 have done a remarkable job of producing the "most" SQ receiver for the money we have yet seen. . . . We were impressed also with its human-engineering aspects: the controls are laid out in a simple and functional manner, without sacrifice of flexibility. Its quadraphonic performance . . . was outstanding, as was its overall sound quality and general ease of operation. All in all, the LR-4000 is a most impressive achievement—especially so considering its price [499.95]."

—*Stereo Review*, April '73

CBS, the developer of the SQ system, uses the LR-4000 when monitoring 4-channel program material. As do thousands of people to whom sound really matters. But, listen to one for yourself. Then you won't have to take anybody's word for it!

Lafayette: If sound matters to you, listen to us.

Lafayette Radio Electronics P.O. Box 10, Dept. 19073, Syosset, N.Y. 11791



FREE

The World's Largest
Consumer Electronics Catalog

Your One Complete Buying Guide
For "Everything In Electronics"

Send my FREE LAFAYETTE 1973 Catalog to:

19073

Name _____

Address _____

City _____ State _____ Zip _____

The first NEW amplifier design since



the ORIGINAL Super Amp

You remember the first super power amplifier - the Crown DC300. Well, most of its competitors are still using those six year old circuit designs pioneered by Crown. Most every amp but Crown's new **DC300A** - a totally redesigned amplifier inside and out. Frankly, the DC300A is not created for the hi fi mass market, but for demanding commercial and professional applications. However, we know there are discerning audiophiles, perhaps like yourself, who can appreciate the difference.

The new DC300A has double the number of output transistors, effectively twice the muscle of the old DC300 for driving multi-speaker systems. Each channel has eight 150-watt devices for 1200 watts of transistor dissipation per channel. Advanced electronic output protection permits the DC300A to drive the toughest speaker loads at higher outputs before going into protection, and even then there are no annoying flyback pulse noises or DC fuses to blow.

The new DC300A has unprecedented signal purity. IM and harmonic distortion ratings are .05%, although typically below .025%. Hum and noise rating is 110dB below 150 watts, while typically -122dB. The difference in increased listening comfort is impressive.

Although totally new, the DC300A has inherited some important traits from its predecessor:

PRICE — still under \$700

WARRANTY — three years on all parts, labor and round-trip shipping

POWER RATING — 150 w/ch continuous at 8 ohms; power at clip-point typically 190 w/ch at 8 ohms, 340 w/ch at 4 ohms, 500 w/ch at 2.5 ohms, or plug in two parts for 600 watts continuous mono power at 8 ohms.

There are many new super-power amplifiers. But when you buy a Crown DC300A, you're buying more than just an amp. You're buying the Crown company — a professional audio equipment manufacturer with a 26-year reputation for solid quality and lasting value. There are thousands of Crown amps in the field still working to their original specifications, and still outperforming most new amps. Visit your Crown dealer to hear the difference. For detailed product data, write Crown International, Box 1000, Elkhart, Indiana, 46514.



CROWN

CIRCLE 10 ON READER-SERVICE CARD



Bernard Haitink—a distinguished edition of Bruckner's symphonies now complete.

phonies in the international repertory. It is an edition distinguished by its consistent high level of musical achievement and the choice of first-quality texts of the performing material, so that Bruckner's ideas are consistently set forth in the most effective manner. In this case the record is drawn from the Haas version of the symphony in its original text, the Linz version of 1866. Bruckner's ill-advised revisions of 1877-91 are wisely ignored.

It has long been my theory that the best way to move into the rather special musical world of the late Bruckner symphonies is to follow Bruckner himself, to begin at the beginning and hear for oneself how the composer's style and manner were defined and developed. The First Symphony is a work that a number of conductors (Otto Klemperer is a conspicuous example) have used over the years as a personal vehicle with great success. In the right hands it is a very powerful score, undeservedly cast into the shadows by the majesty of Nos. 7, 8, and 9.

Although Abbado's recent recording on London remains a musically effective statement based on a good text, it must now yield to the Haitink. In terms of engineering the Philips disc offers a higher volume level, a more intimate orchestral quality, that extra *soupeçon* of realism that you can't help noticing. More important, Haitink always appears to be just a little farther into the score. It's not a matter of big things but little ones: the right intuition for the flow of accents in a phrase, the second sight that always seems to put the proper pulse into a beat, the ear that can balance a page of Bruckner orchestration with all the voices firmly registered in what seems to be the optimum relationship.

Even in this early a score Bruckner is a composer with a highly individual style, a distinctive artistic profile, and Haitink plays his music with a sense of intimate knowledge and affectionate regard that few other conductors can match. The effect is total conviction. As the performance unfolds I find myself saying, "Of course, that is how it must be . . . naturally. . . ." When you have a recording that so

utterly disarms the critical faculties, it has to be good. R.C.M.

BRUCKNER: Symphony No. 4, in E flat (*Romantic*). Chicago Symphony Orchestra, Daniel Barenboim, cond. Deutsche Grammophon 2530 336, \$6.98.

Selected comparisons:
Haitink/Concertgebouw
Klemperer/Philharmonia
Mehta/L. A. Phil.

Phi. 835 385
Ang. 36245
Lon. 6695

With nine stereo editions presently available, the Bruckner Fourth has definitely come into its own as a popular symphony. No other work of the composer is equally well represented on discs at this time, although the Symphony No. 7 (for obvious reasons) is nearly as strong. Of those nine versions, this one and the three listed above are of greater than average interest. All four discs are thoroughly acceptable, offering consistently valid accounts of the composer's score well realized in terms of recorded sound. (Abram Chipman surveyed the field in his May review of the Ormandy version.)

There is a tendency to think of showpiece records in terms of *Scheherazade* or Wagner or, perhaps today, Mahler, but it has become increasingly obvious that much of the appeal of Bruckner is based on the wonderfully distinctive sound of Bruckner orchestration, particularly his masterful writing for brass. Since the Chicago Symphony has the best brass section in the business (I'm prejudiced, but it's still true!), it can play this music with superb effect—and does.

For the sessions ["Behind the Scenes," March 1973], DG took the orchestra to Chicago's Medinah Temple—a large, resonant hall—and arrayed the brass across the back of a wide stage. I heard the original four-channel tape in playback, and it is really sensational, but the stereo mixdown is impressive as well, with the effect of a brass choir filling your wall from left to right and setting the room ringing with brazen tones. In terms of sheer decibels, no other version can touch this one.

But more than decibels are involved. This is

Whatever your world of sound, find it in our world of tapes.



You're particular about sound. You want the very best reproduction you can get.

But you know different types of recording require different types of tape.

There's music you have on while you're working, and there's the music you really sit down and listen to. Very closely and critically.

Recording voices calls for a different kind of tape. And recording sounds may call for yet another.

But no matter what you're recording, "Scotch" makes a tape for it that's unsurpassed.

Consider our 206 and 207 *High Output/Low Noise*, for example. These are our best reel-to-reel tapes. They provide an improvement of 3 db in signal-to-noise over standard tapes, resulting in an actual 50% increase



in output. Or consider "Scotch" *High Energy*, our finest cassette tape. It's designed for your most important cassette recording needs.

Remember, "Scotch" tapes are the overwhelming choice of professional studios for master recording.

So no matter what kind of recording you're doing, and no matter whether it's reel-to-reel, 8-track cartridge or cassette, there's only one name you need to remember: "Scotch."

You're particular about sound. But no more than we.



"SCOTCH" IS A REGISTERED TRADEMARK OF 3M CO.

"Scotch" Brand Tapes.
Better tapes you just can't buy.

are you enjoying your outdoor music?



ASK FOR BARD AT YOUR BOZAK DEALER

Or write for full details. Bozak, Box 1166, Darien, Conn. 06820

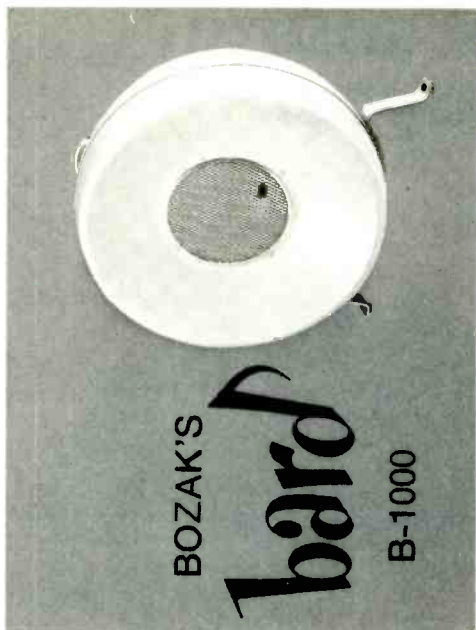

clearly one of the finest orchestral recordings Barenboim has made. His approach is direct, consistent, and largely free of the mannerisms I have found troublesome in the past. The sense of fantasy and poetry, which has such an important role in his piano playing, is here conveyed in orchestral terms with much greater effect than ever before, and he responds to the lyric and dramatic qualities of the music in a direct, forceful manner that conveys them to the listener with equal intensity. Seldom have I heard him establish and sustain a long line of musical development with greater sensitivity and skill. In this performance, not only is there a strong sense of unity in each movement, but the over-all architecture of the score is well realized—with the work building steadily to a glorious sense of resolution and fulfillment in the final pages.

However, with fine performances at hand from Mehta, Klemperer, and Haitink, the engineering factor becomes a decisive issue. In this DG set the brass is dominant, as compared to the Haitink (where it is—if anything—subdued) and the Mehta, where orchestral balances are more orthodox. If you want a Bruckner Fourth in exhilarating stereo fidelity with spectacular brass playing given a prominent role, this is the obvious choice—the Bruckner record that will be turning up at the sound shows. If you want something a little more conservative—I for my part still love the old Bruno Walter set (momentarily out of print)—I suggest the alternatives cited above.

It should be added that when the brass is silent, or playing quietly, the DG balances are excellent. And if you feel, as Barenboim apparently does, that the big climactic moments really belong to the brass, you can't help but feel shivers of pure animal response as that sound gets to you.

The text, incidentally, is the Haas edition with a few emendations and supplemental markings by (I presume) the conductor.

R.C.M.



CHAUSSON: Symphony in B flat. **BERLIOZ:** Benvenuto Cellini; Overture. Paris Conservatory Orchestra (in the Chausson); Orchestre de la Suisse Romande (in the Berlioz), Robert Denzler, cond. Stereo Treasury STS 15145, \$2.98 (from London LL 1505, 1957, and CS 6119, 1960).

Astonishingly there is no other recording of the Chausson currently listed in Schwann. So this third appearance of Denzler's Chausson/Berlioz coupling is welcome despite a few interpretive and technical flaws. The sound in the symphony is generally clear and bright, marred only by some surface noise. In the Berlioz, however, the level has been cranked up unpleasantly so that tape hiss is always apparent and forte passages exist just this side of distortion. Both works are too bottom-heavy for my taste, but this can be adjusted.

Denzler plays the Chausson very broadly and expressively, injecting a peculiarly German heartiness that may be considered out of place in this music. The climaxes, especially in the slow movement, sometimes sound more like Strauss than like his Gallic contemporary. Denzler's other major failure is being unable to shape the slow introduction to the first movement so that it is properly integrated into the whole. Munch (RCA) and Paray (Mer-

cury) offered more idiomatically French readings. (The Munch was reissued last year on English Victrola.)

The Berlioz starts off with a bang that would send any VU meter up to the pin, but the rest is fortunately more subdued. The playing is rich, dynamic, and robust, with the Suisse Romande woodwinds at their excellent best. Probably the overenthusiastic engineering accounts for the muddiness of the low strings.

A.M.

CHOPIN: Piano Works. Vladimir Ashkenazy, piano. London CS 6794, \$5.98.

Sonata No. 2, in B flat minor, Op. 35. Mazurka in A flat, Op. 59, No. 2. Nocturnes, Op. 15: No. 1, in F; No. 2, in F sharp. Valse brillante, in E flat. Op. 18.

This album—recorded on location at the University of Essex, May 10, 1972—begins and ends with bursts of applause. The audience is miraculously attentive, with only an isolated cough or two. The only thing in the playing itself to indicate that these aren't studio-made performances is the special intensity and excitement—certainly one has to look far and wide for any technical lapses in these brilliant renditions. If I had not heard Ashkenazy consistently give live recitals on this amazingly high level, I would indeed be suspicious. He plays the sonata in a thoroughly modern manner—full of powerhouse thrust but basically reserved and intense, eschewing grandiose rhetorical gestures. The scherzo, in Ashkenazy's remarkably headlong reading, gets its most brilliant statement on records since Rachmaninoff's 1930 account (RCA Victrola VIC 1534). This must be heard to be believed. The first movement is done with exposition repeat (an increasingly common practice these days), while the sobriety of the Marcia funebre and finale has its own tight-lipped eloquence. The E flat Waltz is a bit more mercurial than Lipatti's celebrated interpretation, but similar in its swinging momentum. The two nocturnes are rather slow and measured (even the stormy middle section of the F major seems deliberate rather than frantic). Best of all is Ashkenazy's treasurable account of the elusive late mazurka, done with unusual freshness and a perfect synthesis of gaiety and nostalgia. In all of this Chopin playing, there is considerable rubato leeway but never any of the usual disturbing disruptions of basic rhythm.

The sound is leaner than on many of Ashkenazy's recent records and, I think, more appropriate and realistic. One quibble: Side 2 offers less than fifteen minutes of music. When the performances are of this caliber, however, I'm inclined to look the other way. H.G.

COPLAND: Symphonic Ode; Preamble for a Solemn Occasion; Orchestral Variations. London Symphony Orchestra, Aaron Copland, cond. Columbia M 31714, \$5.98.

The first recording of Aaron Copland's *Symphonic Ode* fills a significant gap in our knowledge of his music. In 1927, aware of the ultimate limitations of the symphonic jazz idiom he had been working with, Copland began a large orchestral score in a different vein. Completed two years later (although not performed until 1932), the *Symphonic Ode* thus stands at the beginning of a new phase in Copland's development, one that we know

best from subsequent works: *Vitebsk*, the Piano Variations, the *Short Symphony*, and *Statements*. The original score was later withdrawn from circulation, and a revision prepared in 1955; according to the composer, the changes were "not very extensive"—reduced orchestral requirements, rebarring, and other modifications to facilitate performance.

The *Ode* is a "major" piece—indeed, it seems almost self-consciously so. It moves with a measured pace; even in the fast sections, where the jazzy accents of earlier works recur, harmonic motion is not rapid, and the delirium of the proclamatory opening paragraph, with its characteristic up-thrusting phrases, stays with one as the predominant tone of the piece. The transitions from this opening mood to subsequent contrasting joyous and lyrical materials and back are impressively made, and all three strands are woven into the final peroration. As played and recorded here, the tutti passages seem occasionally even more abrasive than they were intended to be—everybody gets a real workout at such points, and intonation in the upper reaches is not as precise as it might be. Despite this flaw, and some imprecisions of ensemble, the LSO delivers for Copland a spirited, authoritative reading of this imposing and unusual work.

The 1930 Piano Variations are a landmark work in concision, instrumental aptness, and incisive profile; the stark four-measure theme and its jagged rhythms are pursued with a terrific single-mindedness, generating what may very well be the most intense eleven minutes in the contemporary literature. Perhaps because I so love the original form—where the pressure on the limits of piano and pianist is such a palpable element of the total experience—the orchestral transcription, made in 1957, has never satisfied me. The piano version is a masterful cumulation of short episodes, tightly and economically built up from the minimal initial gesture, and this sense of narrow, very sharp focus is already comprised at the start by the vastly bigger scope that the orchestrated theme implies. Even the score's undoubted structural cohesion has less impact when spread around the full orchestral complement of timbres—although there is no question about the skill of the actual instrumentation. Just as there are black-and-white photographs that derive their force specifically from their monochromaticism, so too the Piano Variations are better without color. If you don't have a recording of the original version—or, better still, if you want to make the comparison for yourself—rush right out and get the superb Masselos recording on Odyssey 32 16 0040. Let it be noted that the new Columbia disc is, at any rate, a vast improvement over the previous Louisville version of the Orchestral Variations.

Preamble for a Solemn Occasion was commissioned by NBC for a 1949 concert honoring the adoption of the United Nations Declaration of Human Rights. In its original form, there is provision for a speaker, reciting portions of the preamble to the UN Charter, but this recording utilizes the alternative (only slightly different) version for orchestra alone. A stately piece for a stately purpose, it speaks with an accent familiar from other Copland scores (including the *Symphonic Ode*), setting an oratorical mood leavened with touches of lyricism, avoiding the tendentious quality that can easily invade such pieces. It is well performed and recorded here—a first recording, incidentally, that was put on tape as far back

*The great new vocal records
are as always on*

LONDON
RECORDS [®]

THRILLING NEW RELEASES:

Puccini

LA BOHEME

with

LUCIANO PAVAROTTI

MIRELLA FRENÍ

NICOLAI GHIAUROV

THE BERLIN PHILHARMONIC ORCHESTRA

conducted by

HERBERT VON KARAJAN

OSA-1299

**RICHARD TUCKER
AND ROBERT MERRILL
AT CARNEGIE HALL
January 7, 1973**

**The historic occasion of their great
Carnegie Hall appearance preserved by
London as a special bonus pack**

BP-26351/2

CIRCLE 34 ON READER-SERVICE CARD

as 1964. One hopes that Columbia will not so long delay other important Copland record premieres—*Dance Panels* and the *Nonet for Strings*, for example, which have been sitting around the storage vaults for five years already! D.H.

CRAWFORD SEEGER: Quartet for Strings—See Babbitt: Quartet for Strings.

DONIZETTI: *Anna Bolena*.

Anna Bolena	Beverly Sills (s)
Giovanna Seymour	Shirley Verrett (ms)
Enrico VIII	Paul Plishka (bs)
Percy	Stuart Burrows (t)
Rochelort	Robert Lloyd (bs)
Smeton	Patricia Kern (ms)

John Alldis Chrous; London Symphony Orchestra, Julius Rudel, cond. ABC Audio Treasury ATS 20015/4, \$23.92 (four discs). *Selected comparison:* Soultlots/Horne/Varviso Lon. 1436

With *Anna Bolena* Beverly Sills completes on record—as next season at the New York State Theater she will complete in stage performance—her “Tudor triptych” of Donizetti operas (the other two being *Roberto Devereux* and *Maria Stuarda*; and there is still *Il Castello di Kenilworth*, should Miss Sills decide that a fourth panel is needed). *Anna Bolena* (1830) was the first of Donizetti’s operas to be heard in London, and in Paris. It established his international reputation. And in our day it has loomed large in the Donizetti revival—ever since the famous La Scala production in 1957, with Maria Callas in the title role. It is one of

Donizetti’s best works—rich in ensembles, rich in color and character, carefully composed, and with few perfunctory passages. Donizetti shows great resource in preserving dramatic progress through a flow of impassioned dialogue and formal numbers. He varies the accompaniment in passages of a kind where composers of the time often merely instructed the copyist to repeat the orchestral parts “from A to B.” In successive strophes he develops his melodies instead of merely repeating them. He binds numbers into unified scenes by picking up material from one section to use in another. The recitatives include long lyrical phrases, while the arias are sometimes declamatory. The orchestral scene-painting and mood-painting are unfailingly picturesque. And the final scene—consisting of introductory chorus, three arias for the heroine, and moving episodes between them—is among Donizetti’s finest and most sustained inspirations. *Anna Bolena* is an excellent opera—and yet this new recording is not strictly “necessary.” While other excellent operas by Donizetti, such as *Poliuto*, *Belisario*, *Pia de’ Tolomei*, and *Il Furioso*, remain unrepresented in the regular catalogues, this is the second *Anna Bolena* to appear. That earlier version, on London, with Elena Souliotis as its heroine, was admittedly not all that one hoped for. If the new version were markedly superior, it could be welcomed with no more reservation than a slight regret that a trodden path was being preferred to new exploration. On balance, however, the set does not strike me as superior to its predecessor.

So far as the title role goes, the choice is be-

tween a soprano who has a very intelligent idea of what is needed—agility, and delicacy—but a voice too thin, peaky, and monotonous in color to bring off a very dramatic part; and a soprano whose voice has far more power, more tone and body to it, but is too unwieldy to bring off all the fine detail. Souliotis can be strident, and clumsy in passages, but she has great spirit, and her recorded performance of *Anna Bolena* was in fact far more deftly sung than one might have expected. Sills can also become strident, when she strives (in, for example, the final “*Coppia iniqua*”) to put more weight on the voice than it will bear; but the real trouble is that she simply does not have the vocal grandeur to fill the big phrases and to deliver the dramatic utterances at their full strength. With soft, quiet things she can enchant us. “*Cielo, a’ miei lunghi spasimi*,” Donizetti’s variation of *Home Sweet Home* in the last act, is touchingly done.

Shirley Verrett sings Jane Seymour in a vigorous, almost violent manner. Too often, nowadays, she seems intent on “energizing” whatever she does, pushing charges of vitality into every phrase. The results can be very exciting—but in this performance she seems too bumpy. Some notes and syllables are clipped, while others are banged out. Relax a bit, one wants to say, and just *sing* the music in the smooth, lustrous tones we know you have. Marilyn Horne, on London, can be faulted for trying so hard to make an effect that what should register as intimate dialogue sounds like oratory. “Mr. Gladstone.” Queen Victoria once remarked, “speaks to Me as if I was a public meeting”; King Henry VIII might



TD-160C It's new. It's integrated.

Here's the Thorens precision turntable you've always wanted at a price you can afford. Introduced right on the heels of the new, highly sophisticated TD-125 Mark II series, the Thorens TD-160C shares many of its advanced engineering features, including: Magnetic anti-skating control with the new TP-16 gimbal suspension tonearm . . . Faster start

up with a newly designed high torque belt-driven 16-pole synchronous motor . . . Front panel precision cueing control . . . Dynamically balanced 7 lb., 12-inch non-ferrous die cast platter with a new resonance-muffling rubber mat . . . Unified suspension system to minimize rumble, acoustic feedback and vibrations.

Don't settle for less than the best.

The precision TD-160C comes complete with the new Thorens TP-16 tonearm, walnut base, and even a tinted dust cover, for only \$200. Visit your Thorens dealer today.

Elpa Marketing Industries, Inc.,
New Hyde Park, N.Y. 11040 &
Scottsdale, Ariz. 85253
Available in Canada through
Tri-Tel Associates

It's a **THORENS**

CIRCLE 20 ON READER-SERVICE CARD

When you want the very best stereo without paying the highest price

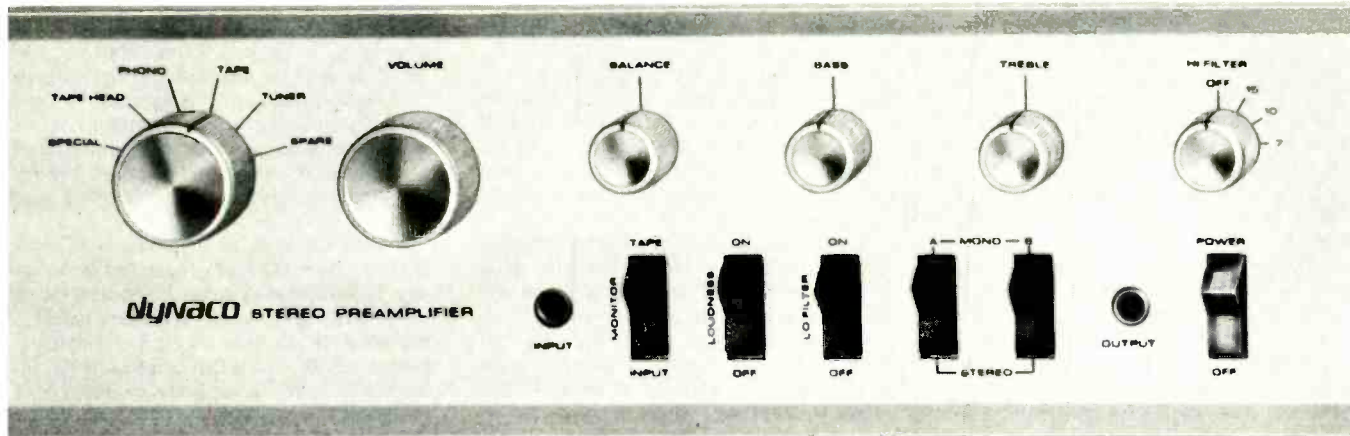

PAT-4 Preamplifier

BUILD A DYNAKIT

The experts agree that Dynakits deliver pure performance that matches the most costly components. A few evenings of your time bring you substantial savings with unparalleled listening satisfaction. It's easy, fun and educational. Advanced engineering, with functional simplicity which is a hallmark of Dynaco's designs, adds a special satisfaction for you who appreciate excellence.

It's much easier to build a Dynakit. Thoroughly proven circuits, supplied preassembled and tested on fiberglass etched circuit boards, leave only the mechanical assembly and interconnection to you. Detailed step-by-step instructions with easy-to-follow pictorial diagrams clearly show every connection. In high fidelity stereo or 4-channel sound there is no match for Dynakit **value**.



A-25 Loudspeakers



SCA-80Q Amplifier



AF-6 AM-FM Tuner

dynaco inc. Division Tyco
3060 Jefferson St., Phila., Pa. 19121
Also available in Canada
from Dynaco of Canada, Ltd.

DYNACO INC.
3060 Jefferson St., Philadelphia, Pa. 19121

HF

Gentlemen:

Please send me your new 1973 full color Dynaco catalog.

Name _____

Address _____

City _____ State _____ Zip _____



The records you buy are not an afterthought... and the turntable you play them on shouldn't be either!

The **Connoisseur BD/2** offers a range of features and capabilities that one would expect on units costing much, much more... features and capabilities which directly reflect true British pride in engineering, design and workmanship. And, each BD/2 is "backed" with the quality and reliability that only 50 years of engineering experience can bring.



The performance abilities of the BD/2 exceed normal broadcast specifications for hum (-80 dB), rumble (-60 dB), wow & flutter (less than 0.1%). The unit is an integrated turntable with a sleek yet strong pick-up arm (Type SAU2) which was expressly designed to complement and complete the sound quality excellence of the BD/2. The damped hydraulic lifting and lowering device insures maximum protection to both stylus and record, while the Bias Compensator (an integral part of the arm) corrects for any possible "skating" effect. The BD/2 also features a 16-pole hysteresis synchronous motor.

With so many turntables to choose from... you really owe it to yourself (and your valuable record collection) to find out about the **Connoisseur BD/2**. Don't let our modest price fool you! Write for full information today. HerVIC Electronics, Inc., 1508 Cotner Avenue, Los Angeles, California 90025.

HerVIC
ELECTRONICS INC

...for hifi components to change your whole world of music

CIRCLE 25 ON READER-SERVICE CARD

make the same complaint about this Jane Seymour. Stuart Burrows, on ABC, is a tasteful, reliable Percy; so is John Alexander on London. Not much to choose between them. Neither of them has much ardor in his tones. Mr. Burrows is perhaps in general smoother and more shapely, and Mr. Alexander more expressive in "Vivitu." Paul Plishka's Henry is a decent, unremarkable performance, satisfactory so far as it goes, but without the brightness and keenness that—particularly after his Pagano in the Carnegie Hall *Lombardi*—one hoped for. On London, Nicolai Ghiurov makes a slightly more formidable Henry. Patricia Kern sings Mark Smeaton's two arias ably, if with rather noisy breaths between phrases. Janet Closter, on London, brings a touch more vividness to the character of the young musician. Robert Lloyd, the most promising of England's young *bassi cantanti*, makes an admirable Rochford.

Julius Rudel, conducting, is not a very convincing Donizettian. He handles the score neatly. He plainly feels the merit of the orchestral writing and aims to make something of the instrumental passages (generally, they are rather slower than in Silvio Varviso's version for London). But triplets that should roll out at a slightly eased tempo tend to get skimmed; expressive woodwind phrases are sometimes flicked. What should be atmospheric (for example, the music before Smeaton's furtive entry into the Queen's apartments) sounds merely dapper. Naturalness is missing, and as a result the music sometimes takes the wrong color: The first finale, which Anne launches with the words "Ah, my fate is sealed," becomes a jolly affair. Orchestra and chorus are competent, not inspired.

The recording, made in EMI's London studios, needs handling with care, for it easily becomes edgy, especially in the treatment of Miss Verrett's voice. (Miss Sills does not sound so full and ample of tone as in those sets made in All Saints, Tooting.) The *suon festivo* of the final scene, the sounds of street band, cannons, and cheers that recall Anne to her surroundings, is very skillfully managed, a first-rate piece of dramatic recording. The opera is done complete (the four cuts in the London version are tiny and of no significance). There is a thorough album note by William Ashbrook—though I regret that, in correcting the old conventional assessment of Donizetti, he repeats the old conventional assessment of Bellini and does not give him credit for originating (in *Il Pirata* and *La Sraniera*) a dramatic manner we now deem characteristically Donizettian. The album libretto—in which lines are often printed as they are sung; the same phrase may appear five or six times—has not been checked against the performance, and its words sometimes differ from those used by the singers.

A.P.

GRIEG: Sonata for Piano—See Bizet: Nocturne.



HAYDN: Symphonies, Vol. 6. Philharmonia Hungarica, Antal Dorati, cond. Stereo Treasury STS 15249/54, \$17.88 (six discs).

No. 36, in E flat; No. 37, in C; No. 38, in C (*Echo*); No. 39, in

G minor; No. 40, in F; No. 41, in C; No. 42, in D; No. 43, in E flat (*Mercury*); No. 44, in E minor (*Trauer*); No. 45, in F sharp minor (*Farewell*); No. 46, in B; No. 47, in G; No. 48, in C (*Maria Theresia*).

With the arrival of this volume, Dorati's edition of the Haydn symphonies is complete from No. 36 through No. 92, which covers a lot of ground (and a lot of very important Haydn). Actually the recording sessions for this monumental project ended late in 1972 [see "Behind the Scenes," May 1973], and all that is involved now is editing tapes and disc production. Vol. 7, containing Nos. 20-35, is already out in England. Presumably one volume will cover the final dozen symphonies of the London period, and—depending on album size, performance times, and coupling—one or two volumes will provide the unnumbered Symphonies A and B, and Nos. 1-19. The entire collection may be in our hands by a year from now—perhaps sooner.

For this listener there is nothing more exciting going on in the field of recorded music today. To say that each successive volume seems better than its predecessor is perhaps unfair to the initial releases, which were and remain excellent, and the fact is that Dorati and his colleagues are now so completely into the style of this music that you have the same sense of authenticity in a performance tradition that comes from the Preservation Hall band in traditional jazz or Stravinsky's finest early recordings of his own music. Haydn never had it so good—not even, I suspect, at Esterház.

The symphonies in this album date from between 1757 and 1772. The numbers are suspect: No. 37 is really better designated No. 13 or thereabouts, and No. 47 is really better thought of as No. 54. The names are equally misleading. No. 39 is often called *The Fist*, although the reason is a mystery. No. 38, on the other hand, is called *Echo*, and the reason is delightfully clear. No. 48 is, by historical association, called *Maria Theresia*, but H. C. Robbins Landon finds this erroneous and believes the designation properly belongs to the Symphony No. 50 (in Dorati's Vol. 3).

These are transitional works. The early part of the series calls for keyboard and bassoon continuo (both of them well achieved) and are written in a preclassical style with lingering baroque influences. The later symphonies are much more complex—true classical symphonies in the *Sturm und Drang* manner.

Several of the symphonies are among the most popular in the Haydn canon—the *Trauer* and *Farewell*, for example—and these scores are played with the consistent skill that makes these the most desirable recordings of those presently available. But the popularity of Haydn symphonies frequently is capricious. The superb brass writing in No. 41, the incredible finale of No. 46, for instance, are exactly the sort of things to make these works popular as well—were they generally known. (Neither, for example, has ever been heard at a subscription concert of the Chicago Symphony, and I doubt if the situation is much better in other American cities.)

As Robbins Landon points out in his notes (and his annotation of this edition is one of its further distinctions), the Austrian symphony around 1770 came in two forms: the festive type (for which Haydn preferred the key of C with high C alto horns, trumpets, and drums),

Realistic 4-Channel with the Luxury of Wireless Remote Control!

"Leave it to Radio Shack to make a 4-channel receiver with a remote control that's really useful! Pre-set your 6 favorite stations, control tuning and volume from your easy chair. And it's wireless, too!"

Arthur Fiedler
Conductor of the Boston Pops



Introducing the Realistic QTA-790 280-Watt AM/FM 4-Channel Receiver



Palm Size Remote Control. Selects 6 Pre-Set FM Stations and Adjusts Volume

The most powerful, most innovative receiver in our 50-year history. Accepts every kind of source, reproduces every kind of sound. Has the power and outputs for eight speakers—enough for 4-channel anywhere you want it. Accu-Balance™ sliding controls balance left, right, front and rear just the way you like. Perfect Loudness™ adds the right amount of bass at any volume. Jacks for stereo or 4-channel headphones. Bass, treble and midrange controls, hi and lo filters, FM muting, more. Our wireless remote controller is a "miracle" you can put in your pocket. Try it out at any of our 2000 stores in all 50 states.

598⁰⁰

- Plays SQ Matrixed Records, FM and Tapes
- Synthesizes 4-Channel from 2-Channel
- Has Separate Input with Volume Control For Q-8 Discrete 4-Channel Tapes
- Complete 2-Channel Tape Facilities Including Monitoring and Dubbing
- Plays Two Separate Stereo Programs In Two Different Rooms At Once

FREE CATALOG

215

Values in Home Entertainment, Audio, Parts, Kits, Communications, More!

At your nearby store or mail to address at right.

Name _____ Apt. # _____

Street _____

City _____ State _____ Zip _____

REALISTIC[®]
by
Radio Shack[®]

and ALLIED RADIO STORES

A TANDY CORPORATION COMPANY

2617 W. 7th St., Fort Worth, Texas 76107

and the chamber symphony (which has less sonority and makes its musical points by different means). Some Haydn scores are clearly influenced by both genres, and this album provides welcome contrasts between the two approaches. Dorati and his players not only see this distinction well, but they respond with complete consistency in viewpoint to both types of score—an achievement not to be undervalued if you have reviewed a large number of Haydn recordings over the years.

Just to go through the thirteen works in this album briefly, here are some capsule comments:

No. 36 is a fresh, lively work in Haydn's early style that repays discovery. No. 37 is a

chamber symphony with possible influences from Vivaldi. No. 38 is a festive score, but a more mature and developed work that produces even grander effects. The distinctive feature of No. 39 is the minor key that, as one might expect, reflects an introspective work. No. 40 presents the more familiar Haydn wit and verve. In No. 41 the festive mood returns, and the music is, as H.C.R.L. puts it, "packed with nervous excitement." No. 42 is another happy, extroverted score filled with the usual Haydn humor. In No. 43 the chamber style returns, but in a highly sophisticated manner. The symphony of mourning, No. 44, was to have supplied music for Haydn's own funeral, but the Mozart Requiem was played instead.

No. 44 was always one of his favorite works. No. 45, in a highly unorthodox key, is the *Farewell* Symphony, by which the Esterházy orchestra suggested to their noble employer that they wanted to go back to Vienna. In No. 46 Haydn is working in another unusual key with that fabulous *Presto e scherzando* finale. No. 47 is a serious work in the chamber manner, while No. 48 (even if improperly associated with the Austrian Empress) is a very grand score in the festive style.

Even if you do not plan to buy all the Dorati volumes, this is one I think you would fully enjoy. R.C.M.

HODDINOTT: Roman Dream, Op. 54; Trio for Violin, Cello, and Piano, Op. 77. **TATE:** Apparitions, for Tenor, Harmonica, String Quartet, and Piano; Three Gaelic Ballads. Margaret Price, soprano (in *Roman Dream* and *Gaelic Ballads*); Gerald English, tenor (in *Apparitions*); Cardiff Chamber Players, James Lockhart, dir. Argo ZRG 691, \$5.98.

Alun Hoddinott and Phyllis Tate are solid and respected members of what might be called the older (not yet really old) school of British composers: Hoddinott, a Welshman, was born in 1929, and Tate, who is identified somewhat pejoratively on the record jacket as "one of the most prominent of English women composers," in 1911.

Hoddinott's music reminds one immediately that modern composers tend to be international: *Roman Dream* sounds like a lot of post-Webern works turned out all over the world in the Fifties, particularly in American universities. Margaret Price sings the angular line with all the precision one could ask, but it remains difficult to get involved with the piece, whose text is an Emyr Humphreys poem about a man serving a dictator and trying to survive as a moral individual. The idiom is Schoenbergian expressionism, passed through the prism of sonority that one associates with *Pierrot Lunaire* and its heirs. The crashing percussion of Messiaen and Boulez come to mind as influences, as well as the Bartók of *Music for Strings, Percussion, and Celesta*. The Hoddinott trio, though later than *Roman Dream*, goes even more directly back to Schoenberg, especially in an *Erwartung* mood in the Andante and its generally anguished and nervous atmosphere throughout. The twelve-note theme is diligently worked out, but in spite of some striking moments, the effect is that of prosaically skillful work.

In the Tate pieces, we hear more going on, musically and perhaps intellectually. *Apparitions*, with a watery-toned harmonica providing ghostly comments and veils of sound, has genuine power to stir the imagination. Tate, like any accomplished composer in any period, has the craft of her trade at her fingertips: *Apparitions* is full of inversions and retrogrades and diminutions and augmentations. But one needn't be aware of them to admire this little cycle of four songs, which Gerald English sings in a beautifully clear and bright tenor. The vocal style, reminiscent of Walton's *Façade* or Stravinsky's Shakespeare songs, is sometimes too mannered, with its wrong-note chanting in a kind of *Sprechstimme* that is more song-speech than speech-song in its emphasis. But the nice weirdness achieved by the canonical conversations between voice and harmonica in the second song, *The Suffolk*



Next time you plan a trip to Europe, make sure you visit the unique country.

Where can you find: Europe's largest waterfalls?
Europe's blondest blondes?
Europe's highest geysers?
Europe's greatest glaciers?

And where can you find moonlike craters where the astronauts trained? More volcanos than anywhere else on earth? Historic landmarks of the world's oldest continuous parliament? Celebrations marking Europe's youngest republic?

The answer to all of these questions is—ICELAND. Next time you plan a trip to Europe, make sure you visit Iceland.

The only thing it may cost you is time well spent. Because you'll save enough money on Icelandic's lowest jet fares from New York to Luxembourg to pay for your stopover in Iceland. Or, you can hop over from New York on a deluxe weekend package tour for \$190 this winter.

Next time you plan a trip to Europe, ask your travel agent about Icelandic Airlines. Or phone Icelandic Airlines, for folders about Iceland and lowest jet fares to Europe. In New York State, phone (212) 757-8585. Elsewhere in U.S., phone toll free (800) 221-9760.

CIRCLE 26 ON READER-SERVICE CARD

Miracle, shows a composer's gift. Tate is that valuable artist, the modest talent that does small things exquisitely. The Three Gaelic Ballads, sung by Margaret Price, are further illustration: traditional tunes set in a disturbingly dry and unfolksy harmonic language that throws such things as *The Lake of Coolfin* into an askew perspective. One is forced to hear its tragic old lines with an immediacy and sense of reality that the quaintness of a conventional ballad arrangement might succeed only in denaturing. D.J.H.

B **LULLY:** *Thésée*: excerpts. Anne Ayer, mezzo-soprano; Mimi Mattei, soprano; Hugues Cuénod, baritone; Vienna Volksoper Orchestra, Willard Straight, cond. RCA Victrola VICS 1686, \$2.98.

It is about time that someone should come around to revive the czar of French opera of the seventeenth century, so powerful and influential that the whole of Europe listened to him with awe. Unfortunately, we really know little about Lully, despite his fame. The timorous editors of his operas in the late nineteenth century were shocked by his "audacities" and bleached them out of his scores, as their contemporaries, the English music professors, did with Purcell. All we have readily available are these faulty piano-vocal scores from the 1880s. Willard Straight commendably worked from the original full score of *Thésée*, which, much less commendably, he "edited and reconstructed," though without telling us in what way.

But even if we assume that Straight did not pull a Leppard on us, his recording is unacceptable as a specimen of Lully's art. The plot of this opera is complicated, and the way the "highlights" are imbedded in the action is confusing; and when the eight roles are distributed among three singers (Anne Ayer holds down four!), the recording resolves itself into a meaningless vocal concert. But the gravest offense, one that destroys even the meaning "highlights," is the omission of the chorus, the most distinctive feature of the *tragédie lyrique*. Furthermore, the unrelieved melancholy of the singers' delivery, which must be the result of a mistaken concept of the nature of the *style galant*, becomes boring by the middle of the first side. Everything is carefully sung and played but thin in frame and flesh; the respectful dignity gets on one's nerves. Hugues Cuénod's voice (now a "baritone") still has a certain ring when he sings out, but in the quiet passages it is largely his fine musical intelligence that saves the day. Anne Ayer has a somewhat hollow voice and only moderate skill in inflecting a melodic line; Mimi Mattei does better. But the instrumental numbers are spirited and the continuo quite good. This sort of thing illustrates the danger that abridgment, if carried too far, removes just those touches that give a skeleton life. P.H.L.

PERLE: Quartet for Strings, No. 5—See Bablitt: Quartet for Strings.

PURCELL: The Fairy Queen; Ceremonial Music. For a feature review of recordings of these works, see page 73.

RACHMANINOFF: Concerto for Piano and Orchestra, No. 3, in D Minor, Op. 30. Yevgeny Mogilevsky, piano; Moscow Philharmonic Orchestra, Kiril Kondrashin, cond. Melodiya/Angel SR 40226, \$5.98.

Selected comparisons:
Ashkenazy/Fistoulari/London Sym. Lon. 6359
Weissenberg/Prêtre/Chicago Sym. RCA 3040

A remarkably successful Rachmaninoff Third from the young Soviet virtuoso (now twenty-eight) who took first place at the 1964 Queen Elisabeth International Competition in Brussels. Mogilevsky is a blockbuster who commands huge mountains of sonority and yet never forces his sound to ugliness. In the main, he strikes an ideal middle ground between the

whimsical fleetness of Ashkenazy's earlier (and better) recording with Fistoulari and the laconic detachment and sardonic distortions of the more fiercely demonic Weissenberg/Prêtre version. His tempos are moderately expansive, yet move along succinctly; he surmounts the technical hurdles with poise and excitement and still finds ample room for brooding Slavic poetry. The cadenza played, for better or worse, is the thick-sounding alternative one also favored by Cliburn, Gieseking, Watts, and Ashkenazy (the latter in his later version with Previn). Mogilevsky, on the other hand, does *not* play the more difficult octave variant at the very end. Kondrashin's support is superbly authoritative: You will recall



The new LDL 749A.

Is it the world's best reflector speaker system?

Thanks to an improved, more linear transducer design, the new LDL 749A has the smoothest, most extended response of any reflector speaker on the market. Yielding crisp, clearer highs. And richer, fuller lows. It's an audible superiority you hear at once.

Or the world's best speaker system?

Hearing our new 749A for the first time, some people claim it's the best speaker they've ever heard, of any type. With its smooth overall response. Superior power-handling capabilities. And a precise combination of frontal and panoramically-reflected sound that duplicates the concert hall.

You decide.

While our 749A has raised a lot of eyebrows, only your ears can decide which speaker's best for you. With that in mind, we invite you to audition a pair at your LDL dealer. Could be you'll make our new speakers, your new speakers.

LD
Linear
Design
Labs Inc.

20 Willett Avenue, Port Chester, N.Y. 10573

he recorded the same piece twice with Van Cliburn (Van Cliburn's faster, fresher Soviet version, never released domestically, is, incidentally, far superior to the dry on-location RCA recording made with the Symphony of the Air upon his return home.) And for a change the orchestral texture counts for something in this excellently balanced reproduction.

Unquestionably one of the great recorded performances of this flawed but ever-so-popular concerto. H.G.

ROSSINI: Operatic Scenes. Marilyn Horne, mezzo-soprano; Ambrosian Opera Chorus; Royal Philharmonic Orchestra, Henry Lewis,

cond. London OS 26305, \$5.98.

L'Assedio di Corinto: Avanziam... Non temer d'un basso affetto... Sei tu che stendi, o Dio: L'ora fatal s'appressa... Giusto cie! La Donna del lago: Mura felice; Tanti affetti.

Selected comparison (soprano arias): Caballe

RCA 3015

This is an exhilarating, delightful record—Marilyn Horne at her best, in a recital that displays all her astonishing abilities. There's a sort of "anything you can do, I can do better/faster/higher/lower/louder/softer/longer" quality about it, which is perfectly winning because Miss Horne realizes that these Rossini arias are at once display pieces and dramatic *scenas* of Rossini's maturity, in which virtuosity must serve an expressive purpose as well as

being astounding in its own right. So we can enjoy her power, her fleetness, her tremendous range, her sense of scampering fun which recalls Conchita Supervia, and her long-held notes that go on and on like Sigrd Onegin's—and also think what enjoyable music it all is. And the singing is not spoiled by any excessive banging down on the trombone tones.

The sleeve note rather skates over exactly what the pieces from *The Siege of Corinth* are: and, being at present far from my scores, I can only do the same. But in brief: Rossini composed *Maometto II* in Naples with a contralto hero, in 1820, and then in Paris, six years later, he recast it as *Le Siège de Corinthe* with a tenor hero, the great Nourrit. In 1969 the work was revived for Beverly Sills's debut at La Scala. Thomas Schippers, who conducted, also prepared the edition, and since his hero was to be Marilyn Horne, he conflated the more sober Parisian score with the more florid Neapolitan original—and gave Miss Horne, so to speak, the best of both worlds. The big *scena*, nearly twenty-five minutes of it, that fills the first side of this record sounds to me like two pieces joined together. First there is a full-scale, three-section grand aria in the manner of Isabella's "*Pensa alla patria*" in *L'Italiana in Algeri*. An orchestral prelude includes virtuoso melodies for the oboe and for the clarinet—splendidly played by the Royal Philharmonic wind soloists—and then Neocles breaks directly into this prelude with his first utterances, joining in it along with the instruments for a while until more conventional recitative appears. Then comes a heroic air, "*Non temer d'un basso affetto*," in which Miss Horne displays her command of decorated cantabile—of spinning fioriture that nevertheless do not obscure the basic lyrical shapes. Then a very energetic cabaletta. But that is not the end; things start up once again as Corinthian maidens begin to lament, offstage, and to sing a hymn rather like "*La Vergine degli Angeli*" in *La Forza del destino*, while onstage, Neocles comments, and then embarks on another aria. Miss Horne runs fleetly through a range closer to three octaves than to two, hops, skips, and jumps with aplomb, is now vigorous, now delicate, and altogether astonishing. Marilyn Horne in this *scena* was one of the highlights of the *Scala Assedio di Corinto*; another was Beverly Sills, tall and beautiful, standing on the prow of Mahomet's ship and ravishing her hearers with the long, flexible, melancholy line of Pamira's *preghiera* in Act III: one of those Rossini inventions that is very simple and very beautiful. Miss Horne's recital includes this soprano number too. She does it very well—though not quite so well as Montserrat Caballé does on her RCA recital of "Rossini Rarities"; more of that comparison below.

La Donna del lago was composed the year before *Maometto II*: it is an ambitious, very "romantic" opera. Rossini gives the orchestra a good deal to do, and in his vocal writing he seeks for unconventional expressive effects. Malcolm's "*Mura felice*" opens with a depiction of rapt, almost reverent joy more deeply and inwardly expressed than Arsace's in the similar situation of *Semiramide*, or Tancredi's when he returns home. If I hear rightly, the aria is called "*O tu che chiamo*," and the cabaletta "*O quante lagrime*" (there is no text with the disc—a black mark against London, since text and translation are essential to a full ap-

3 of the World's Best Sellers!



AS-2A 8" 2-WAY
\$49.95 NET

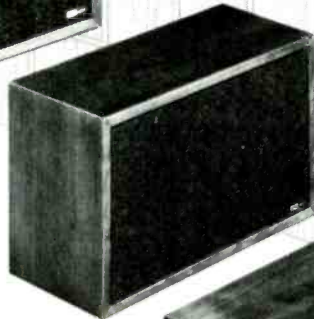

WD-90-12" 3-WAY
\$89.95 NET



HSI-C-12" 3-WAY
\$99.95 NET

Utah
sells more
speaker systems
than anyone else

Chances are very good that you have heard our sound. In fact, if you listen to many great speaker systems, you couldn't miss us. We haven't promoted the name too much, since engineering, sound technology and manufacturing techniques are our real forte. All this means to you is **incomparable** sound for astonishingly low prices. IT'S NO WONDER, WE ARE NUMBER 1! Here are three examples of quality systems that sell by the thousands.

FINISH: (ALL MODELS) Genuine Walnut Veneer, handsome hand-rubbed, oil finish.

Please write to UTAH ELECTRONICS for detailed information on Model or Models of your choice.



HUNTINGTON, INDIANA

UTAH SPECIFICATIONS

AS-2A: 8" 2-WAY ACOUSTIC SUSPENSION SYSTEM—\$49.95 NET (8" Woofer, 3½" Tweeter, Weight—22 pounds, Size—11" x 18" x 9")
WD-90: 12" 3-WAY ACOUSTIC SUSPENSION SYSTEM — \$89.95 NET (12" High Compliance Woofer, 8" Midrange, 3½" Tweeter, Weight—33 pounds, Size—14" x 23" x 10")
HSI-C: 12" 3-WAY SPEAKER SYSTEM—\$99.95 NET (12" Heavy Duty Woofer, Midrange Compression Horn, 5" Tweeter, Weight—46 pounds, Size—15" x 25¾" x 14")

CIRCLE 59 ON READER-SERVICE CARD

When you build the Heathkit deck with Dolby circuit, you get pride of accomplishment plus features you won't find on others

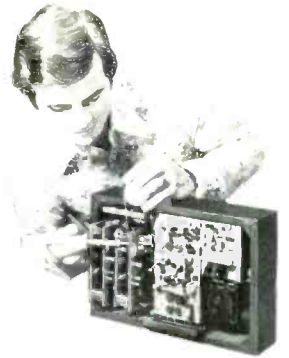

If you have built a kit, you know the kind of pride we are talking about. Now imagine the satisfaction of assembling a stereo cassette deck with Dolby circuitry. One that is equal, or superior, to the finest components on the market today.

Moreover, you can't miss on this kit. Ask the man who has built a Heathkit component. He can tell you how service outlets in every major metropolitan area, plus a technical correspondence group at the Heath Headquarters, simply won't let you fail.

Actually, the fact that it is a kit gives the Heathkit AD-1530 two of its completely unique features. The built-in test circuit, using VU meters, 2-tone audio oscillator and test cassette supplied, allows you to set up bias and Dolby level for the cassettes you will be using, also permits you to do your own periodic recalibration or reset the levels for any new types of tape in the future. Secondly, the assembly manual contains all the troubleshooting and maintenance information you should ever need for self-service. These two items alone make the AD-1530 one of the most economical cassette decks you can buy. The AD-1530 also has switch

selection of either high-level or mike inputs. That lets you record the family band the same way you record Blood, Sweat & Tears — without an additional microphone amplifier.

Other features include automatic shutoff; lever switches for stereo or mono input, Dolby on/off and tape type (conventional tape or CrO₂ tape); two record level controls with separate VU meters; large three-digit resettable counter. You can build the Heathkit AD-1530 in about five spare evenings. The tape transport mechanism comes pre-assembled to make the job even easier.

Kit AD-1530, 20 lbs. 249.95*
ADA-1530-1, dust cover, 1 lb. 4.95*

AD-1530 SPECIFICATIONS: **Frequency Response:** Regular (iron oxide) tape; ±3 dB from 40 Hz to 12 kHz typical. CrO₂ (chromium dioxide) tape; ±3 dB from 40 Hz to 14 kHz typical. **Distortion:** Tape dependent; electronics less than 0.2%. **Hum and Noise:** Dolby Switch OFF. —48 dB. Dolby Switch ON—Provides Additional Noise Reduction as Follows: —10 cB @ 4000 Hz and up. —9 dB @ 2400 Hz. —6 dB @ 1200 Hz. —3 dB @ 600 Hz. **Wow and Flutter:** Less than 0.25% RMS. **Inputs: Microphone:** Lo-Z, 0.2 mV to 10 mV. Auxiliary: Hi-Z, 50 mV to 10V. **Bias Oscillator Frequency:** Approximately 100 kHz. **Tape:** Any good quality iron oxide or chromium dioxide tape cassette may be used. **Tape Speed:** 1 7/8 in/s or 4.76 cm/s. **Fast Forward/Rewind Time:** Approximately 45 sec. for C-60 cassette. **Solid State Devices:** 37 transistors and 2 JFET's. **Output:** Greater than 0.5 volts from low impedance source. **Dimensions:** 5 1/2" H x 9 1/2" D x 14" W. **Power Requirements:** 120 volts, 60 Hz, 15 W.

HEATHKIT ELECTRONIC CENTERS — ARIZ.: Phoenix; CALIF.: Anaheim, El Cerrito, Los Angeles, Pomona, Redwood City, San Diego (La Mesa), Woodland Hills; COLO.: Denver; CONN.: Hartford (Avon); FLA.: Miami (Hialeah); GA.: Atlanta; ILL.: Chicago, Downers Grove; IND.: Indianapolis; KANSAS: Kansas City (Mission); MD.: Baltimore, Rockville; MASS.: Boston (Wellesley); MICH.: Detroit; MINN.: Minneapolis (Hopkins); MO.: St. Louis; N.J.: Fair Lawn; N.Y.: Buffalo (Amherst), New York City, Jericho; L.I.: Rochester; OHIO: Cincinnati (Woodlawn), Cleveland; PA.: Philadelphia, Pittsburgh; R.I.: Providence (Warwick); TEXAS: Dallas, Houston; WASH.: Seattle; WIS.: Milwaukee.



World's largest selection of electronic kits SEND FOR FREE CATALOG

HEATH
Schlumberger

HEATH COMPANY, Dept. 8-7
Benton Harbor, Michigan 49022

Please send FREE Heathkit Catalog.
 Enclosed is \$_____, plus shipping.
 Please send model AD-1530.

Name _____
 Address _____
 City _____ State _____ Zip _____

*Mail order prices; F.O.B. factory. HF-274

CIRCLE 24 ON READER-SERVICE CARD

THE MIND CHANGER

ELAC/MIRACORD
50H MARK II

The Elac/Miracord 50H Mark II, with hysteresis synchronous motor, is certain to change your way of thinking about automatic changers. Featherweight pushbutton controls start, stop, even replay a record without dropping the next. A gentle flick of the cueing lever floats the viscous damped arm up from the record and floats it down again in the same groove or anywhere on the record. Also, effective anti-skate, precise tracking below 1/2 gram, variable speed control, built-in illuminated strobe, and a simple, exclusive leadscrew with built-in guidepost gauge for proper and critical stylus overhang adjustment! And lots more! The Elac/Miracord 50H Mark II! There is a difference in record players. See it. Hear it. Today.

ELAC DIVISION, BENJAMIN ELECTRONIC
SOUND CO., FARMINGDALE, N.Y. 11735



ELAC

DIVISION OF

BENJAMIN

We put more engineering in...
so you get more music out.

CIRCLE 16 ON READER-SERVICE CARD

preciation of Miss Horne's performances). The recital closes with Ellen's rondo-finale: again a soprano piece that Montserrat Caballé has recorded, and again a piece in which florid decoration delicately enhances but does not overwhelm a lyrical melody. Caballé is lighter, brighter, and bouncier in her treatment, and her tone is more beautiful. She makes more effect with those delightful little "stops" before the word "*felicità*"—as if just for a moment all the mingled happy emotions whirling within in her had left her speechless. The accompaniments from the Royal Philharmonic under Henry Lewis are bright and poised. The recording is excellent. A.P.

RUSO: Three Pieces for Blues Band and Symphony Orchestra—See Recitals and Miscellany: Romeo and Juliet.

B **STRAVINSKY:** *Petrushka*; *Firebird* Suite (1919 version). Paris Conservatoire Orchestra, Pierre Monteux, cond. Stereo Treasury STS 15197, \$2.98 (from RCA Victor LM 2113, 1957; *Firebird* also on RCA Victrola VICS 1027, 1963).

Selected comparison (*Petrushka*):
Monteux/Boston Sym.

RCA 2376

The closest thing on records to an ideal Monteux *Petrushka* is his version on RCA with the Boston Symphony. The performance that appears here, while good to have at last in stereo, is only a pale reflection.

The difference, of course, lies in the orchestras: the Paris Conservatoire cannot match the virtuosity of the BSO. The *Petrushka* the latter gives Monteux is crisp, strongly rhythmic, and sassy in all the right places. The Conservatoire's playing is far less sharply defined, heavy, and sometimes imprecise. Add to this the bright, live sound provided by RCA against the distant and less resonant sound London presents in this reprocessing.

The *Firebird* sounds subdued and reticent—unlike its earlier Victrola incarnation. London's new Stereo Treasury transfer minimizes the highs and thus loses much-needed brilliance and color. A.M.

SZYMANOWSKI: Concerto for Violin and Orchestra, No. 2—See Wieniawski: Concertos for Violin and Orchestra.

B **TCHAIKOVSKY:** Works for Piano and Orchestra. Michael Ponti, piano; Luxemburg Radio Orchestra, Louis de Froment, cond. (in Concerto No. 3); Prague Symphony Orchestra, Richard Kapp, cond. (in the remaining works). Vox SVBX 5460, \$9.95 (three discs).

Concertos: No. 1, in B flat minor, Op. 23; No. 2, in G, Op. 44; No. 3, in E flat (three-movement version), Op. 75/79. Concert Fantasy, Op. 56.

Selected comparisons (Opp. 44 and 75):

Graffman Col. 6755
Zhukov Mel./Ang. 40097 and 40188

With this set Ponti and Vox complete their traversal of Tchaikovsky's piano music (two three-record Vox Boxes of the solo piano music came out in 1971: SVBX 5455 and 5459). All of these performances are new except the Third Concerto, which was released last year on Candide CE 31056, backed with the Rimsky-Korsakov Concerto.

The most unusual item here—again apart from the Third, of which Ponti's is the only recording currently available in America of the "complete" three-movement version, using Taneyev's reconstruction of the two movements of Op. 79 after the more familiar Allegro brillante of Op. 75—is the Concert Fantasy, Op. 56. This is Tchaikovsky in a playful, unpretentious mood, and the result is a Lisztian, exuberant delight, full of pleasing melodies and sweet, uncomplicated good spirits. The Second Concerto is also a relative rarity, but it would seem high time to overcome popular prejudice in favor of the First: The Second is fully characteristic of Tchaikovsky in his grander moods, and the second movement—which suffered especially in the stripped-down Siloti version that seems finally to be disappearing in favor of the composer's original—sounds almost Brahmsian in its luxurious writing for piano, solo violin, and solo cello.

Froment's accompaniment in No. 3 is only just adequate. Kapp's accompaniments are rather more forceful and sympathetic, if still without optimal orchestral finesse. The pianist's own work is typical of his previous efforts: fleet, strong-fingered, often exciting, often superficial, and just a bit heartless. The recorded sound seems unduly shallow, although that may have something to do with the kind of tone both Ponti and his cohorts produce.

As far as the competition is concerned, it should be noted that a Philips set with Werner Haas (including the three-movement Third Concerto and the Concert Fantasy) is available in Europe, and Angel has a Gilels/Maazel set (presumably including Nos. 1 and 2 and the one-movement Third) in the works. On the domestic scene, however, Ponti has no current competition in the Concert Fantasy or the complete Third. For the one-movement Third and the Second, the alternatives are Gary Graffman with Ormandy and the Philadelphia Orchestra on Columbia and Igor Zhukov with Rozhdestvensky and the Moscow Radio Symphony on two Melodiya/Angel discs. The Graffman might seem the better buy, but it's not. Graffman plays less fluently than Ponti with hardly more in the way of sensuous feeling, and he makes use of the Siloti edition for the slow movement of the Second, which hacks it almost in half. Zhukov tends sometimes toward clangorousness, and the Moscow orchestra is hardly the equal of the Philadelphia. But the performances are convincingly idiomatic ones nonetheless, alternately full-blooded and poetic. As for the First and its nineteen other currently competing versions, one need only say that several surpass Ponti's otherwise worthy effort. J.R.

TATE: Apparitions; Three Gaelic Ballads—See Hoddinott: Roman Dream

VIVALDI: The Four Seasons. Pinchas Zukerman, violin; Philip Ledger, harpsichord; Eng-

For information on Annuals published by High Fidelity, please circle = 165 on the Reader-Service Card.

Stereo Review EQUIPMENT TEST REPORTS

By Hirsch-Houck Laboratories

Pioneer SX-626 AM/Stereo FM Receiver



● PIONEER's new stereo receivers share many design and operating features as well as common styling. Although the SX-626 is one of the lower priced units, it is a fully flexible and high-performance receiver. The FM tuner of the SX-626 has an FET r.f. amplifier, followed by an i.f. section employing three IC stages and three permanently aligned ceramic filters. An IC performs most of the multiplex-demodulation functions, and an unusually effective interstation-noise muting circuit is included. The AM tuner, a simple and basic design, includes two ceramic filters as well as tuned transformers in its i.f. section. A relative-signal-strength tuning meter is used for both AM and FM reception.

The continuous-power output of the audio amplifier is conservatively rated at 20 watts per channel (both channels driven into 8-ohm loads) from 20 to 20,000 Hz with less than 1 per cent distortion. The preamplifier has inputs for two magnetic-phono cartridges, a microphone (mono, driving both channels), and a high-level AUX input, as well as the AM and FM tuner sources. There are two sets of tape-recording inputs and outputs, with separate monitoring pushbutton switches that make it possible to copy tapes from one machine to the other. If desired, one of the sets of connections can be used to drive an external four-channel decoder-synthesizer and rear-speaker amplifier. This still leaves a set of inputs and outputs available for use with a tape recorder.

Other pushbutton controls provide for stereo/mono switching, FM muting, loudness compensation, and low- and high-frequency audio filters. Both the bass and treble controls have eleven detented positions; the balance and volume controls are conventional. The speaker selector (which also controls the a.c. power to the receiver) can activate any of three pairs of speakers or two combinations of two pairs at a time. An OFF position is included for headphone listening via the front-panel jack.

In the rear of the receiver, in addition to the signal inputs and outputs, there are separate preamplifier outputs and main amplifier inputs (with jumper plugs to interconnect them), a DIN connector for one of the tape-recorder circuits, line and speaker fuses, and two a.c. outlets, one of which is switched. The speaker connections are made with Pioneer's foolproof, easy-to-use plugs and jacks. The Pioneer SX-626 is supplied complete with a walnut cabinet. Price: \$329.95.

● **Laboratory Measurements.** The power output at signal clipping with 8-ohm loads was 27.8 watts per channel at 1,000 Hz. Into 4 ohms it was 36 watts, and into 16 ohms the output was 16.5 watts. The harmonic distortion

for a 1,000-Hz test signal was between 0.03 and 0.09 per cent from 0.1 watt to about 23 watts per channel. Intermodulation (IM) distortion was about 0.1 per cent up to 5 watts, increasing to 0.5 per cent at 25 watts.

At the rated power of 20 watts per channel, the harmonic distortion was about 0.1 per cent from below 100 to above 10,000 Hz, and reached a maximum of about 0.2 per cent at 20 and 20,000 Hz. Distortion was lower at all reduced power levels—typically a low 0.05 per cent or less over most of the audio-frequency range.

The magnetic-phono sensitivity (for 10 watts output) was 1.35 millivolts, with an overload point of 68 millivolts and an excellent signal-to-noise ratio of 73 dB. The microphone input sensitivity was 1.15 millivolts with a noise level of -75.5 dB. The AUX input sensitivity was 0.11 volt, with an 81-dB signal-to-noise ratio. All of these measurements indicate very fine performance.

The tone controls had excellent characteristics, with a sliding turnover frequency for the bass, and high-frequency control action effective principally above 3,000 Hz. The RIAA phono equalization was within ± 2 dB from about 100 to beyond 15,000 Hz, with a slight rise of about 4 dB in the 50- to 70-Hz region. Microphone response was quite flat over most of the range, tapering off to -2.5 dB at 15,000 Hz.

The FM tuner's IHF sensitivity was 2.1 microvolts, and a 50-dB signal-to-noise ratio was reached at only 2.6 microvolts. The ultimate quieting was exceptionally good: -76 dB for all signal levels above about 70 microvolts. Distortion (including the 0.5 per cent residual of our signal generator) totaled about 0.7 per cent at 100 per cent modulation. The capture ratio was 1.7 dB. Image rejection was notably good at 95.5 dB, as was the alternate-channel selectivity of 84.5 dB. The AM rejection was 55 dB, typical of most good tuners.

The muting threshold of 4 microvolts insured fully quieted, low-distortion reception of any station that "un-muted" the receiver. The muting action was positive, with a slight "click." We noted that the un-muting occurred only when the receiver was tuned within about 50 kHz of the channel center. When you hear a station, it has to be tuned correctly!

● **Comment.** The FM tuner of the SX-626 compares favorably with many separate tuners selling for more than the price of the entire receiver. It has enough sensitivity and selectivity for practically any receiving situation, plus exceptionally easy and noncritical tuning.

From a user's viewpoint, we were especially impressed by the solidity and precise "feel" of the SX-626's controls. Clearly, nothing has been skimped in the mechanical design and construction of this receiver. It is a joy to use, a very good value in every respect.

U.S. Pioneer Electronics Corp., 178 Commerce Rd., Carlstadt, N.J. 07072. Midwest: 1500 Greenleaf, Elk Grove Village, Ill. 60007 • West: 13300 S. Estrella, Los Angeles, Cal. 90248 • Canada: S. H. Parker Co., 67 Lesmill Rd., Don Mills, Ont.

PIONEER
when you want something better

From across the wide Pacific comes the new Shibata stylus and Dual Magnet™ design for better 4-channel and stereo sound.

Model AT14S,
\$75.00 suggested retail

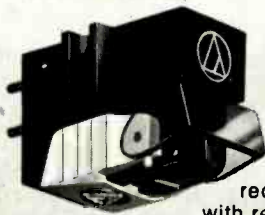

For the past 10 years, Audio-Technica phono cartridges have been sold primarily in the Orient and Europe.

Now they are here. Eight models in all. Including three designed to meet the rigorous demands of discrete 4-channel records while actually *improving* performance with regular and matrix stereo.

Response of these three extends to 45,000 Hz and beyond. It's a direct result of the unique Shibata stylus plus the exclusive Audio-Technica Dual Magnet* cartridge construction.

Even the least expensive Audio-Technica cartridge offers unusually flat response and excellent tracking. Read the entire story in our free brochure, available for the asking. Or better yet, hear Audio-Technica products today at leading high fidelity specialists. It's worth the trip.

*Patents pending

audio-technica.



AUDIO-TECHNICA U.S., INC., Dept. 73H, 1655 W. Market St., Fairlawn, Ohio 44313

CIRCLE 6 ON READER-SERVICE CARD

astounding sounding

The new AR-7 will, quite simply, astound you. Never before has it been possible to get so much sound—and such accurate reproduction—from such a small speaker system.

Although the AR-7 measures only 9¾" x 15¾" x 6¼", and sells for \$65, professional audio critics and knowledgeable consumers have consistently compared it favorably with other speakers 4 times its size and 10 times its price.

The AR-7 was originally developed to fill the needs of 4-channel stereo where space is at a premium, but its high dispersion tweeter and new woofer—both with unusually high power handling capacity—provide such wide, even frequency response that the AR-7 is an excellent choice for any high quality music system.

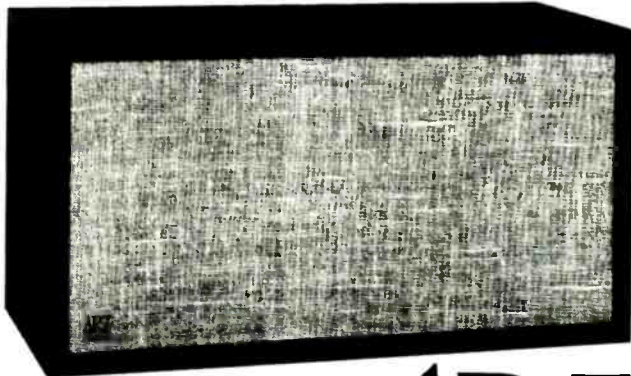

AR-7



Acoustic Research, Inc., 10 American Drive, Norwood, Mass. 02062

CIRCLE 1 ON READER-SERVICE CARD

lish Chamber Orchestra, Pinchas Zukerman, cond. Columbia M 31798, \$5.98. Tape: ● MA 31798, \$6.98; ●● MT 31798, \$6.98. Quadraphonic: MQ 31798 (SQ-encoded disc), \$6.98; MAQ 31798 (Q-8 cartridge), \$7.98.

VIVALDI: The Four Seasons. Michel Schwalbé, violin; Horst Göbel, harpsichord; Berlin Philharmonic Orchestra, Herbert von Karajan, cond. Deutsche Grammophon 2530 296, \$6.98.

B VIVALDI: The Four Seasons. Jan Tomasow, violin; Anton Heiller, harpsichord; I Solisti di Zagreb, Antonio Janigro, cond. Bach Guild HM 15 SD, \$2.98 (from Vanguard BG 564, 1957, and BGS 5001, 1959).

It's the season for *Seasons* once again, and in they pour—the reissued Janigro/Solisti version just in time to stand up and be counted with two formidable new arrivals. A quick summary of their relative attitudes toward the work is easy enough to make, for each takes its own stance quite obviously. The Berlin group is smooth, urbane, and just about flawless; the Solisti is fresh, spontaneous, unstudied, youthful; the English Chamber Orchestra is self-conscious, markedly individual, and tends to make an *Othello* performance out of music that is closer to *A Midsummer Night's Dream*.

Neither the Berlin nor the Solisti—each beautiful and captivating in its respective way—need much commentary beyond this, except the observation that the Solisti reissue is slightly edgy in tone but quickly becomes acceptable to the ear. (The Berlin's smooth and rounded sonic ambience is in keeping with the performance, and emphasizes the surface sheen of the ensemble's tone.)

But Zukerman and the ECO pose a special dilemma. They adopt a quite modern attitude toward the score, and apparently vowed to take it apart and dig below the surface for a new look at its internals. Your response will depend on how much you think Vivaldi was concerned with those internals—and that's the rub. Maybe the continuo *should* be pushed to the fore; maybe the bass line, when something special is happening there, *should* hit us head-on; maybe the realization of the harpsichord part *should* be fancied up to include little linking passages and brief echoes of the solo violin (most apparent in the Fourth Concerto). Maybe I will get used to these things and come to like them in time. But right now, at least, they seem distracting and—to use my earlier adjective—self-conscious. It goes without saying that Zukerman's violin playing is superb; for better or for worse, the generally slower tempos taken in this recording encourage him to magnify what the Berlin and Solisti soloists do more casually: The detached howling in the third movement of *La Primavera*, for instance, is far more emphatic in Zukerman's hands than with Schwalbé or Tomasow. Once again, very self-aware. Well, try it. You may like it.

S.F.

WIENIAWSKI: Concertos for Violin and Orchestra: No. 1, in F sharp minor, Op. 14; No. 2, in D minor, Op. 22. Itzhak Perlman, violin; London Philharmonic Orchestra, Seiji Ozawa, cond. Angel S 36903, \$5.98.

WIENIAWSKI: Concerto for Violin and Orchestra, No. 2, in D minor, Op. 22. SZYMA-

NOWSKI: Concerto for Violin and Orchestra, No. 2, Op. 61. Henryk Szeryng, violin; Bamberg Symphony Orchestra, Jan Krenz, cond. Philips 6500 421, \$6.98.

It's hard to believe that there is no other pairing of the two Wieniawski violin concertos in the catalogue; and hard to believe that only one version of each was available before the arrival of this really stunning disc by Itzhak Perlman and the London Philharmonic, strongly seconded by Henryk Szeryng's overlapping appearance with No. 2.

Wieniawski as a violinist seems, from contemporary accounts, to have had everything—elegance, passion, a faultless technique, a fascinating quality of tone. One can't help wondering how he could be any better than Itzhak Perlman, whose infallible intonation and equally infallible technique, coupled with a wide resource in tone color and a simply irresistible rhythmic punch, enable him to bring out in these two concertos everything they've got. And they've got a lot, not only in terms of violinistic display (especially No. 1) but in the realm of melody and imaginative touches of scoring. No. 1 is usually snubbed as derivative and structurally weak, but all I can say is—who cares? From the moment the soloist enters, in an electric passage of double-stopping, the red-blooded romanticism is unabashed and all-encompassing, and I don't see how anyone who enjoys violin playing can resist it. There are grand rhetorical sweeps, melting moments of lyricism, incredible spurts of derring-do, quick shifts of coloration from low and husky to high and silky. Without compiling a catalogue of Perlman's virtues in exploiting all these things, let's just say that he does indeed do so. He generates the virtuoso passages like a dynamo at Grand Coulee and never sounds as if his teeth are clenched while doing it, and he shifts with utter finesse from the rich, luxuriant tone demanded in the slow movement into the bright-as-mercury legato line of the finale.

The Concerto No. 2 is a less spectacular work, more subtly conceived. A pure, singing tone counts for much in the first movement, and a melancholy gentleness in the second. The finale, of course, summons forth the expected flashes of lightning, and a dancing verve in rhythm. Perlman—supported with virtuosic flair by Ozawa and the London Philharmonic—is with it all the way.

So is Henryk Szeryng, whose lyric warmth and purity of tone are perfect for such music. His playing is somewhat more "old school" than Perlman's—by which I mean that it is a little more highly inflected, creates a little more light and shadow in dynamics. Szeryng is more distantly miked than Perlman, and as a result his performance does not stand forward quite so boldly. At times he is almost obscured by the orchestra, and we regret missing even a couple of measures.

The Szymanowski No. 2, the composer's last major work (written in 1933), is a very different proposition from the Wieniawski—rhapsodic, impressionistic, requiring an ongoing propulsion of singing line that must be free and cohesive at the same time. Szeryng invests it with great life and vitality, and even though the violin must contend with a welter of surrounding orchestral sound at times, on this side of the disc we never lose the thread for a moment.

Szymanowski was of course much in-

fluenced by his Polish heritage, and suggestions of that fact prevail in the concerto in about equal measure to the suggestions of Debussyian influence. There is at least one very folksy melody here, and doubtless Szeryng's own Polish heritage allows him his special sympathy for it.

Without any suggestion of pinpoint miking, conductor Krenz still manages to bring forth the individual instruments that converse with the soloist enough so that we are aware of the interworkings of the score. It is a good collaboration. S.F.

recitals and miscellany

E. POWER BIGGS: Famous Organs of Holland and North Germany. E. Power Biggs, organ. Columbia M 31961, \$5.98. Tape:  MT 31961, \$6.98.

BACH: Allein Gott in der Hoh sei Ehr! **SCRONK:** Fantasias in Echo Style; in G; in F. **TELEMANN:** Aria in C minor. **SWEELINCK:** Fantasias; in A minor; in the Dorian Mode; in A minor. **BUXTEHUDE:** Cantata, Ihr lieben Christen, freut euch nun; Sinfonia; Lobt Gott, ihr Christen, allzugleich. **PAUMANN:** Fundamentum Organandi; Mit ganzem Willen. **CORNET:** Courante met Varieties. **KOETSIER:** Partita for English Horn and Organ, Op. 41, No. 1 (with Leo van der Lek. English horn).

This collection of miscellany is related in format to Biggs's "Historic Organs of..." series; but here Biggs concentrates on a geographical area with artistic—not political—boundaries. Holland and North Germany have a common tradition of organ building, and that tradition includes the culmination and highest flowering of the organ-building art, since it is here that Arp Schnitger worked at the turn of the eighteenth century.

The record includes recordings of the two greatest organs of all time: the magnificent Schnitgers in Zwolle and Alkmaar. On the Zwolle instrument we hear three Sweelink Fantasias and on the Alkmaar instrument a set of variations by Pieter Cornet (1562–1626). A Bach harmonization of the chorale *Allein Gott* with interludes is played on the equally splendid and sparkingly brilliant Niehoff organ at the Johanniskirche in Lüneburg, built in the 1550s (Bach surely knew this instrument from his student days in that town). There are also works played on the Schnitger organs at Uithuzen, Lüdingworth, and Dedesdorf.

Side 2 ends with a surprise and a real treat: a new work for organ and English horn by the Dutch conductor/composer, Jan Koetsier (born 1911), played on the new Flentrop organ at the Church of the Holy Sacrament in Breda (not to be confused with the Flentrop "restoration" and extension in the Church of Our Lady in Breda). The ten-minute piece, written in a conservative and lyrical vein, culminates in an English horn statement of the chorale "How brightly shines the morning star," and is really quite beautiful. Leo van der Lek plays the English horn superbly.

The record, however, will be of primary interest for the clear, clean recordings of the Zwolle, Alkmaar, and Lüneburg organs. Biggs gives his usual attractively enthusiastic performances. Unfortunately no specifications or registrations are given, with only brief notes about each instrument and piece. C.F.G.

VISIT NEW YORK'S FREE PERMANENT HI-FI EXHIBIT.

Free Audio Primer to all visitors.

The first place to visit when starting or upgrading a hi-fi system is the International Hi-Fi Expo. See and hear the finest and largest selection of hi-fi equipment from the world's leading manufacturers.

- You operate the components yourself.
- Bring your favorite records. Compare their sound on different equipment.
- No pressure to buy. Sell yourself and buy from your favorite audio dealer.
- Hear the latest 4-channel equipment at your leisure.
- Exhibitors: Altec, Bose, Bozak, Benjamin, Concord, Dual, Elac, Electro-Voice, Garrard, Dynaco, Kenwood, JVC, Jensen, Koss, Lee, Martin, Miracord, Onkyo, Ortofon, Marantz, Pioneer, Rectilinear, Sansui, Sony Superscope, Superex, Tandberg, TEAC, Toujay, Reibach, Wharfedale, Barzilay.
- Headquarters for SAC/Society Audio Consultants.

Looking for a career in audio?

SAC/Society of Audio Consultants' professional hi-fi course is available to audio salesmen and audiophiles. Successful completion with one year minimum practical experience leads to certification. The SAC Certification Board comprises internationally recognized authorities whose articles appear in leading hi-fi publications. N.Y. residents: Visit your audio dealer for Hi-Fi course applications to Saturday sessions at HI-FI EXPO. Others, send for details on Home Study course. \$1.00 covers mailing and handling for Audio Primer.

INTERNATIONAL
**HI-FI
EXPO**

443 Park Ave. So., N.Y. 10016 (at 30th St.)
Hours: Tues. thru Fri.—11-5; Sat. 11-4

CIRCLE 30 ON READER-SERVICE CARD

ADVERTISING INDEX

Key No.	Page No.
1	Acoustic Research, Inc. 96
2	A.D.R. Audio 113
3	Akai Electric Co. 27
4	Angel Records 66
	Audio Dynamics Corp. 30
6	Audio-Technica U.S. Inc. 96
62	Audio Warehouse 111
7	Baltimore Stereo Wholesalers 111
103	British Industries Co. 13
8	Bozak 84
9	Carston Studios 113
	Classified Ads 112
10	Crown International 82
11	District Sound, Inc. 110
12	Dixie Hi Fidelity Wholesalers 108
13	Dokorder, Inc. 8
14	Dual 19
15	Dynaco Inc. 87
16	Elac Division, Benjamin Electronic Sound Co. 94
19	Electro-Voice, Inc. 79
20	Elpa Marketing Industries, Inc. 86
21	Empire Scientific Corp. 80
22	Empire Scientific Corp. 10
18	Epicure Products 11
	Fisher Radio Cover II, 1
103	Garrard 13
23	Harman-Kardon, Inc. 5
24	Heath Co. 93
25	Hervic Electronics, Inc. 88
26	Icelandic Airlines 90
27	Illinois Audio 111
28	Innermedia 8
29	International Hi Fi Distributors 110
30	International Hi Fi Expo. 97
36	Kenwood Cover IV
31	KLH Research and Development 65
39	Koss 7
33	Lafayette Radio Electronics Corp. 81
	Linear Design 91
34	London Records 85
43	Marantz 57
64	Maxell Corp. 4
35	McIntosh 80
37	Midwest Hi Fi Wholesalers 110
	Music Listeners Book Service 46
38	Nova Audio 108
32	Onkyo 105
40	Panasonic 58, 59
41	Phase Linear Corp. 23
42	Pickering & Co. 2
44	Rabco 16
45	Rabsons-57 St., Inc. 111
46	Radio Shack 89
47	Revox Corp. 21
48	Rose Records 108
49	Rotel of America 10
50	RTR Industries 101
51	Sansui Electronic Corp. 60
52	Sherwood Electronic Laboratories, Inc. 25
53	Shure Brothers, Inc. 75
54	Sony Corp. of America 115
63	Sony/Superscope, Inc. 116, Cover III
55	Stereo Corp. of America 110
56	Superex 103
67	Teac Corp. of America 47
20	Thorens 86
	3M Co. 83
57	Tokyo Shapiro 113
14	United Audio Products, Inc. 19
58	U.S. Pioneer Electronics Corp. 9
61	U.S. Pioneer Electronics Corp. 95
59	Utah Electronics 92
60	Yamaha Audio Products 29

B **PETER KATIN:** Piano Recital. Peter Katin, piano. Stereo Treasury STS 15124, \$2.98 (from London CS 6085, 1960).

R **BACH:** Chromatic Fantasia and Fugue, S. 903. **BRAMHS:** Intermezzo in B flat minor, Op. 117, No. 2. **Rhapsody In G minor, Op. 79, No. 2.** **CHOPIN:** Berceuse in D flat, Op. 57; Waltz in C sharp minor, Op. 64, No. 2. **RACHMANINOFF:** Melodie in E, Op. 3, No. 3. **SCARLATTI:** Sonatas in E, L. 23; in D minor, L. 413. **SCHUMANN:** Novelette in E, Op. 21 No. 7; Romance No. 2, in F sharp, Op. 28, No. 2.

Peter Katin's artistry—impeccably poised and civilized—has always been a trifle too British to appeal to American tastes. In the big, flamboyant virtuoso concertos of Rachmaninoff and Tchaikovsky, his low-keyed sobriety misses some of the requisite abandon. In the present situation, though, very different qualities are called for, and it is difficult to find any shortcomings. This is a perfectly lovely record, played with musicianship, patrician finesse, sincerity, and—when appropriate—decided warmth of spirit. Katin's liquid trills are a source of sensuous delight in the Scarlatti E major Sonata, and its companion piece in D minor has altogether touching simplicity (though how subtle the playing is!).

Adroit use of the sustaining pedal gives an attractive wash of color to the romantically prescient Bach Chromatic Fantasia and Fugue, but this too for all its pianistic splendor is kept strictly within stylistic bounds: The atmosphere in no way detracts from the *sec* linearity and stylized, severe phrasing. In the nineteenth-century repertory, Katin opens up appropriately: His Chopin Berceuse, Op. 57 has a shimmering repose and drifting, gentle momentum (it reminds me of Solomon's celebrated recording); the Schumann *Novelette* is very robust both in sound and in contouring. I also like Katin's chiseled, slightly reticent way with the Schumann romance and Brahms intermezzo, though I find his account of the Brahms rhapsody too angular and unflowing for my taste. The early Rachmaninoff trifle, on the other hand, sings with beguiling succinctness.

The piano reproduction has exemplary clarity and a marvelously rounded, clinging warmth. A bargain offering from a woefully underestimated artist. H.G.

THE PERILOUS NIGHT AND OTHER NEW SOUNDS IN AMERICAN MUSIC. Richard Bunker, piano. Avant AV 1008, \$6 (Avant Records, 6331 Quebec Dr., Hollywood, Calif. 90068).

CAGE: *The Perilous Night*, Suite for Prepared Piano; TV Köln. **SUBOTNICK:** Prelude for Piano and Electronic Tape, No. 4. **LAZAROF:** Cadence IV. **CHILDS:** 37 Songs. **IVES:** Chorale for Quarter-Tone Piano.

Selected comparison (The Perilous Night): Kirstein Col. M2S 819

This record should be of great interest both to enthusiasts of the prepared piano and to anybody who likes the more accessible, coloristically ingenious kinds of modern American music. (The prepared-piano buffs are also directed to Bunker's manual for the instrument. *The Well-Prepared Piano*, published in 1973 by the Colorado College Music Press in Colorado Springs.) The fare here has its ups and downs, but more ups. The Cage pieces are rather different from each other. *The Perilous Night* (1943-44) is one of his most fascinating explorations of the prepared piano, and noteworthy here for Bunker's care in the preparation of the instrument. *TV Köln* (1958) is a thirty-two-second joke, played twice—or more

accurately a *Scherz*, since this gently inconclusive bit of graphic notation was produced, as the title tells us, for Cologne television. Barney Childs's *37 Songs* (1971) is a moving, effective, idiosyncratic juxtaposition of short, simple, leitmotiviclike ideas, ritualistic and mystical. The Ives (played here on two pianos tuned a quarter-tone apart, rather than on the two-manual quarter-tone piano Ives envisaged) is characteristically witty and disturbing. Subotnick's Prelude No. 4 (1966) has its striking moments and demonstrates a good deal of sensitivity in blending piano and synthesized sound, even if it does lapse periodically into the composer's characteristic cuteness. The Lazarof (1970) is by far the most conservative effort here, a virtuosic but faceless exercise.

Bunger himself was born in Pennsylvania, educated at Oberlin, and now teaches and lives in Los Angeles. The performances here all sound excellent, and make it easy to understand why he seems to be enjoying a burgeoning career as a new-music piano recitalist. All of the pieces here, except for the Subotnick, were recorded live in concert at Oberlin, complete with applause—an odd choice, one might think, especially since it diminishes the impact of the recorded sound (Jeanne Kirstein's version of *The Perilous Night* on Columbia, for instance, is recorded with far greater immediacy). Still, it's fun to hear laughter during the Ives. J.R.

ROMEO AND JULIET. San Francisco Symphony Orchestra, Seiji Ozawa, cond. Deutsche Grammophon 2530 308, \$6.98.

TCHAIKOVSKY: *Romeo and Juliet*. **PROKOFIEV:** *Romeo and Juliet: Excerpts*. **BERLIOZ:** *Romeo et Juliette: Love Scene*.

BERNSTEIN: *Symphonic Dances from West Side Story*. **RUSSO:** *Three Pieces for Blues Band and Symphony Orchestra*, Op. 50. Siegel-Schwall Band (in the Russo); San Francisco Symphony Orchestra, Seiji Ozawa, cond. Deutsche Grammophon 2530 309, \$6.98.

The recording companies were interested in the San Francisco Symphony as long as Monteux was its conductor, but when he departed their interest departed too, and these are the first records the orchestra has made in many years. They are typical of the Ozawa regime in that the sound of the ensemble is magnificent, rich, colorful, and accurate, and the interpretations are full of drama and life. But the cultural imperatives involved in bringing a major orchestra back into the recording lists have been flouted, and that too, alas, is typical of the Ozawa regime.

The gimmicky "Romeo and Juliet" album is typical of the slick packaging of the young Japanese conductor: Everything is geared to selling, as if a symphony orchestra were some brand of cornflakes. That there are more than twenty competing versions of the Tchaikovsky currently in Schwann, that the excerpting of one movement from a symphony by Berlioz is as provincial as it is antediluvian, and that the Prokofiev amounts to very little doesn't seem to enter into the calculations of the retailers and advertising executives behind this enterprise. But matters really hit the fan with the Bernstein/Russo record.

As Peter Davis put it in this magazine not long ago, if you throw enough garbage against the wall, some of it will stick. Garbage-throwing may perhaps be excused when private entrepreneurs indulge in it, but there is no justification whatsoever for such activity on the part

Here's your **FREE**

HIGH FIDELITY

“at home” shopping service!



It's easy! All you do is use one of the Reader Service cards at right... HIGH FIDELITY's Reader Service Department will take it from there. It's as simple as 1, 2, 3!

1 Just circle the number on the card that matches the number below the ad or editorial mention that interests you.

You'll also find the key numbers for advertised products in the Advertiser's Index.

2 Then type or print your name and address. Don't forget your zip code, it's important!

3 Drop the card into the mail. No postage is needed if mailed in the United States.

You'll receive literature, colorful brochures and specifications about the products that interest you... free and without obligation!

Use HIGH FIDELITY's "at home" shopping service today!

1	2	3	4	5	6	7	8	9	10	11	12	13	14	15
16	17	18	19	20	21	22	23	24	25	26	27	28	29	30
31	32	33	34	35	36	37	38	39	40	41	42	43	44	45
46	47	48	49	50	51	52	53	54	55	56	57	58	59	60
61	62	63	64	65	66	67	68	69	70	71	72	73	74	75
76	77	78	79	80	81	82	83	84	85	86	87	88	89	90
91	92	93	94	95	96	97	98	99	100	101	102	103	104	105
106	107	108	109	110	111	112	113	114	115	116	117	118	119	120
121	122	123	124	125	126	127	128	129	130	131	132	133	134	135
136	137	138	139	140	141	142	143	144	145	146	147	148	149	150
151	152	153	154	155	156	157	158	159	160	161	162	163	164	165

Please circle # 165 for information about the High Fidelity Annuals.

NAME _____

ADDRESS _____

CITY _____ STATE _____ ZIP _____

I am a subscriber I am not a subscriber

7 8

1	2	3	4	5	6	7	8	9	10	11	12	13	14	15
16	17	18	19	20	21	22	23	24	25	26	27	28	29	30
31	32	33	34	35	36	37	38	39	40	41	42	43	44	45
46	47	48	49	50	51	52	53	54	55	56	57	58	59	60
61	62	63	64	65	66	67	68	69	70	71	72	73	74	75
76	77	78	79	80	81	82	83	84	85	86	87	88	89	90
91	92	93	94	95	96	97	98	99	100	101	102	103	104	105
106	107	108	109	110	111	112	113	114	115	116	117	118	119	120
121	122	123	124	125	126	127	128	129	130	131	132	133	134	135
136	137	138	139	140	141	142	143	144	145	146	147	148	149	150
151	152	153	154	155	156	157	158	159	160	161	162	163	164	165

Please circle # 165 for information about the High Fidelity Annuals.

NAME _____

ADDRESS _____

CITY _____ STATE _____ ZIP _____

I am a subscriber I am not a subscriber

7 8

NOVEMBER 1972 \$1.25
08396

LAB TEST REPORTS
Revox's Dolby tape deck
Fisher 801 receiver
Miracord's top changer
DBX compressor expander

HIGH FIDELITY

and musical america

How to Make Your Record-Playing Components Compatible

See Reverse Side for
FREE "at Home" shopping service!

There's more pleasure
in store for you every
month with HIGH FIDELITY...

The Battle
Over Stravinsky's
and

First Class
Permit No. 111
Cincinnati, Ohio

BUSINESS REPLY MAIL

No postage stamp necessary if mailed in the United States

Postage will be paid by—

HIGH FIDELITY

Reader Service 73
P.O. Box 14306
Annex Station
Cincinnati, Ohio 45214



... AND EQUIP
YOURSELF
WITH
HIGH FIDELITY'S
ANNUALS!



First Class
Permit No. 111
Cincinnati, Ohio

BUSINESS REPLY MAIL

No postage stamp necessary if mailed in the United States

Postage will be paid by—

HIGH FIDELITY

Reader Service 73
P.O. Box 14306
Annex Station
Cincinnati, Ohio 45214



Circle #165 on the reverse side for information
on the Annuals published by High Fidelity.
Descriptions and price information will be
sent as soon as we receive your request.

of an organization subsidized by its local community and by the National Endowment for the Arts so that it does not have to sell out but may maintain the highest cultural standards in its special field.

They all know perfectly well that these works are stale, old-fashioned, worn-out, ninth-rate stuff. Putting the San Francisco back into the discographic running with these shoddy goods is typical of the managerial mentality that tries to work both sides of the cultural street: The orchestra is a commercial institution when there is money to be made, or they think there is money to be made, but it is strictly an idealistic cultural institution when the money must be asked for. The sad thing about all this is that it never works; even sadder, however, is the fact that people like Seiji Ozawa, who pretend to be artists, go along with it. A.F.

TEBALDI IN CONCERT. Renata Tebaldi, soprano; Richard Bonyngue, piano. London OS 26303, \$5.98.

DONIZETTI: Me voglio fa 'na casa. **MASCAGNI:** La tua stella; Serenata. **TOSTI:** Sogno. **ROSSINI:** L'invito. **ZANONAI:** L'assuolo. **CIMARA:** Stornello. **PONCHIELLI:** Non leggiamo insieme. **PERGOLES:** Se tu m'ami, se sospiri. **PARADISI:** M'ha presa alla sua ragna. **A. SCARLATTI:** Il Pompeo; O cessate di piagarmi. **GLUCK:** Paride ed Elena; O del mio dolce ardor. **F. RICCI:** Il carrettiere del Vomero. **MERCADANTE:** La sposa del marinaro. **BELLINI:** Malinconia, ninfa gentile. **PUCCINI:** E l'uccellino.

Renata Tebaldi is not a very accomplished recitalist—not, at least, on the evidence of this disc. For one thing, she appears to lack the necessary sense of scale. During the last twenty-five years she has concentrated on the *lyrico spinto* repertoire, devoting herself principally to roles like Maddalena in *Andrea Chénier*, Adriana Lecouvreur, Tosca, and Desdemona—all of them impassioned creatures, larger than life, extravagantly conceived. Such specialization seems to have left Tebaldi unprepared to cope with less expansive musical modes. In the present collection of mainly amorous trifles she sounds quite out of phase—oppressive, grand, and unsmiling, where she should be intimate, light, and charming. These songs are all miniatures and Tebaldi's approach is broad, even distended. To hear her hearing down in full cry on such inconsequential material as the Donizetti, Rossini, and Ricci items is awesome—like witnessing, helpless to interfere, the Slaughter of the Innocents. In the more reflective songs, too, her manner is excessively ponderous. Caught in her overstrung embrace Ponchielli's *Non leggiamo insieme* suffocates. At the same time, a dramatic or at least pictorial song like *L'assuolo* fails to respond properly to her efforts. Zandonai's evocation of a stormy night and the ominous sound of the owl draws from her little more than generalized melancholy. The text is not vividly enunciated; the music is unimaginatively phrased; the terrors remain unplumbed.

A lot of the trouble is vocal. Tebaldi, though wise enough to confine herself to a fairly narrow compass (she hardly goes above or below the staff), nevertheless sounds mostly clumsy, ill at ease, rhythmically slack. She finds a lot of upward intervals hard to negotiate. The sustained E flat that concludes the Ponchielli song is badly supported. The leap to high F at the end of the Donizetti is very ugly. Worst of all, perhaps, the bloom has quite gone from her voice, even in the middle register, and what remains is hard-driven, inelastic, and dead in

quality. There is little here to show why Tebaldi was once so extravagantly admired as a vocalist. Only a few phrases sung in a head tone testify to the former mellifluousness; parts of the first verse of Cimara's *Stornello*, parts of the opening of Bellini's *Malinconia, ninfa gentile*. Otherwise the voice is unattractive and, one is forced to conclude, burnt out.

Though the early pieces (Scarlatti, Pergolesi, Gluck, Paradisi) are remote from Tebaldi's stylistic understanding (or technical skill—faced with a cadential trill, all she can summon up is indecisiveness), the rest of the program is not without intrinsic interest. To be sure, these songs are slight, yet they are gratifyingly vocal: A long tradition of lyricism lies behind them. Richard Bonyngue, who helped to select them, is the discreet, sensitive accompanist. The miking, however, is close and tends to favor the singer unduly. Disgracefully, there are neither texts nor translations.

D.S.H.

THE TEN-STRING GUITAR INTERPRETS CLASSICS. Vincent Macaluso, guitar. Klavier KS 508, \$5.98.

BACH: French Suite No. 5; Well-Tempered Clavier, Book II: Prelude No. 17. **PAGANINI:** Moto perpetuo, Op. 11. **SATIE:** Gymnopédies Nos. 2 and 3. **MACALUSO:** Song for Rayanne. **SOR:** Variations on a Theme of Mozart, Op. 9. **BLOCH:** Suite for Violin, No. 2: Andante and Molto allegro.

Vincent Macaluso, a jazz and classic guitarist who makes his solo recording debut with this program, plays the ten-string instrument familiar to classic-guitar enthusiasts through the many live recitals and appearances on disc of

Narciso Yepes. Yepes has been proselytizing for the laudarra, as it is sometimes called, for at least a decade, but Macaluso is the only ten-string recruit this listener is aware of. Unfortunately he is not as polished a musician as Yepes, who for all his tendency to approach some music stolidly and coldly does play consummately. As here recorded, at least, Macaluso is one of the hard-finger boys, and his metallic-toned, rattling reading of Paganini's *Moto perpetuo* makes difficult listening. Satie is trivialized at once by a statement of the theme of No. 2 in artificial harmonics, and the guitarist's way of socking at the strings is particularly inapt for these gentle little pieces. His own *Song for Rayanne* is thin pop stuff; the Sor variations are played doggedly, as exercises; and the Bloch transcription emerges all jangle and punch, with too little attempt to color or shade in the ways so beautifully possible on the guitar. The Bach items are prosaically done in transposed versions (the French Suite in G goes up to A; the Prelude in A flat comes out in E flat). Throughout the recording, Macaluso takes the usual Segovian liberties, adding basses and so on, without persuading one of their inevitability, as the best transcribers sometimes can do, even with Bach.

The assets and potential of the ten-string guitar, unquestionably real and not yet fully exploited, seldom become apparent on this disc, partly because the extra four strings are chiefly valuable in adding resonance on certain weak notes of the standard six. Macaluso does not play well enough to make such subtleties apparent. D.J.H.

THE NEW COLUMNS



The RTR columns are a new concept in transducer application which by design exhibit a broad band of preferred loudspeaker characteristics. Each elegant walnut enclosure houses multiple ultralinear butyl edge suspension woofers; one of which is planar resistive loaded. This technique, is accomplished by floor loading a woofer through a predetermined planar slot, which yields maximum acoustic low frequency coupling, increased damping, and a smooth rolloff above 100 Hz. This powerful low frequency concept is the cornerstone of the new RTR column speaker system.

Write for complete information and specifications for:
MODELS 180D and 280 DR (COLUMNS)
MODEL ESR 6 and HPR 12

*PATENT APPLIED FOR



RTR INDUSTRIES, INC.
 8116 DEERING AVE., CANOGA PARK, CA 91304
 (213) 883-0116

CURRENT DEALERS

WEST:

Acoustics Unlimited, Hollywood, CA
 Audio Arts, Livermore, CA
 Audio Vision, Ventura, CA
 California Hi Fi, Van Nuys, CA
 California Hi Fi, Commerce, CA
 Garehime's Music Co., Las Vegas, NV
 Henry's Radio & Electronics, Anaheim, CA
 Shelley's Audio Inc., Los Angeles, CA
 Sound Co., San Diego, CA
 Stereo City, Eureka, CA
 Mal Sykes TV HiFi, Sacramento, CA
 Woodland Stereo, Woodland Hills, CA
 International Sound, Modesto, CA
 Kustom Hi Fi, Burlingame, CA

MID-WEST:

Audio King, Minneapolis, Minn.
 George Filip Music, Aurora, Ill.
 Fray's Electronics, Aberdeen, So. Dakota
 Gill Custom House, Palos Hills, Ill.
 Jensen's Stereo, Stillwater, Minn.
 Lloyd E. Dissmore, Kenosha, Wisc.
 Roman's Audio Classics, Minneapolis, Minn.
 Stereoland, Fargo, No. Dakota

SOUTH:

Arnold & Morgan Music Co., Garland, Texas
 Audio Concepts Unlimited, Denton, Texas
 Gibson Audio of New Orleans, Shreveport, La
 Quail Creed Stereo, Inc., Shreveport, La
 Sounds Unlimited, Corpus Christi, Texas
 Toby Corp., Fort Worth, Texas

EAST:

Paul Heath, Rochester, N.Y.
 Ullica Audio, Ullica, N.Y.
 Sago World Wide Electronics, New York, N.Y.

DEALER INQUIRIES INVITED

in brief

B
R **DELIUS: Florida Suite; Dance Rhapsody No. 2; Over the Hills and far away** (ed. Beecham). Royal Philharmonic Orchestra, Sir Thomas Beecham, cond. Seraphim S 60212, \$2.98 (from Capitol SG 7193, 1960).

This is Seraphim's "Music of Delius, Album 2"; there will be no Album 3. Sir Thomas' second stereo program devoted to the composer, whose magic he unlocked for the world, was to be his last. It is an important record also in that none of these works may currently be purchased elsewhere. If *Florida* and the Second Dance Rhapsody are not the ultimate realizations of Delius' extraordinary fantasy life, *Over the Hills and far away* surely is one with its mist-colored orchestral canvas and a melodic outpouring as prolific as Schubert's. This—Beecham's third recording of it—grows on rehearing, though there are still unique things to savor in his multi-coupled mono LP, to say nothing of the 78s with the London Philharmonic in Vol. II of the Delius Society sets. Seraphim's sound strikes me as a shade more subdued on the high end than the earlier Capitol issue. A.C.

MOZART: Quartets for Strings: No. 17, in B flat, K. 458 (Hunt); No. 19, in C, K. 465 (Dissonant). Collegium Aureum Quartet. BASF KHB 20344, \$5.98.

Few Mozart chamber works rival these two quartets from the set of six dedicated to Haydn. They are played here by a group of first quality, which follows orthodox interpretive lines and offers a "standard reading" that is nonetheless vigorous, communicative, and attractive. Technically, the quartet seems to be excellent, but it is difficult to say because of the recording. The sound is very hard, metallic, and assertive—for me quite inappropriate to music of this character. (I further protest the omission of separating hands.) With a more natural string tone this would have been a most welcome disc. R.C.M.

B
R **SAINT-SAENS: Symphony No. 3, in C minor, Op. 78**. Pierre Segon, organ; Orchestre de la Suisse Romande, Ernest Ansermet, cond. Stereo Treasury STS 15154, \$2.98 (from London CS 6331, 1963).

When this recording first appeared as a full-priced release it was so outclassed in the sonic-spectacular sweepstakes (especially by the Munch and Paray versions) that probably relatively few discophiles even bothered to give it a hearing, much less evaluate it on its own terms as an attempt to stress the music's poetic and ceremonial rather than melodramatic and grandiloquent qualities. I hope it will receive better justice now. At any rate, the present low-cost reissue proffers what still must rank as exceptionally beautiful, transparent, and floating sound, as well as an illuminatingly different approach to the familiar warhorse itself. R.D.D.

B
R **STRAUSS, R.: Ein Heldenleben, Op. 40**. Anshel Brusilow, violin; Philadelphia Orchestra, Eugene Ormandy, cond. Odyssey Y 31922, \$2.98 (from Columbia MS 6249, 1961).

Ormandy fans will welcome this reissue, but Strauss fans may want something more sensitively handled. Between hero Ormandy's bombast and the engineers' extremely high levels, even mezzo forte passages are shouted out. In climaxes like the battle scene, only turning the volume well below normal can save the ears. Whoever wins this battle, it won't be the listener. The hero's enemies are not only carping but confused; the Philadelphia woodwinds here create more of a bewildered scramble than an organized attack. Brusilow's solo is not especially distinguished, although in other respects this section is the best played. At budget prices you can get the more scrupulous readings of Reiner (Victrola VICS 1042) or Beecham (Seraphim S 60041). At full price, Haitink's recent recording (Philips 6500 048) gives a lean, transparent performance with excellent work from all sections of the orchestra and clean, spacious sound. A.M.

TCHAIKOVSKY: 1812 Overture, Op. 49; Marche slave, Op. 31; Romeo and Juliet. London Symphony Orchestra, André Previn, cond. Angel S 36890, \$6.98. Tape: ●8XS 36890; \$7.98; ●●4XS 36890, \$7.98.

Despite the snappy title, "A Tchaikovsky Spectacular," this record contains musically solid and superbly articulated performances of these Tchaikovsky staples. It will satisfy anyone seeking first-class performances of this coupling (though hearing the *Marche slave* immediately after the *1812 Overture* is a pretty thick dose of bombast). Previn's *Romeo and Juliet* is extremely expansive, his phrasing expressive without lapsing into sentimental overindulgence, his control of both tonal and dynamic balance extremely firm. The less substantial overture and march receive the same conscientious effort. The cannon and carillons in the *1812 Overture* are handled in good perspective without detracting from the musical flow. P.H.

TRIMBLE: In Praise of Diplomacy and Common Sense. OVERTON: Pulsations. Richard Frisch, baritone (in the Trimble); The Ensemble, Dennis Russell Davies, cond. Composers Recordings SD 298, \$5.95.

Lester Trimble's piece is a choral setting of news items dealing with human idiocy, greed, cruelty, stupidity, and blockheadedness, all of them published during 1965. The voices are accompanied by a large percussion ensemble with which some interesting things are done; the vocal setting, unfortunately, makes the whole thing sound like the track for a Grade Z movie about Adolf. Hall Overton's *Pulsations*, on the other side, is another unsuccessful effort to combine jazz with symphonic writing. Its recording does the memory of its composer a disservice. A.F.

WEBER: Overtures to Der Freischütz, Der Beherrscher der Geister, Oberon, Euryanthe, Abu Hassan, and Peter Schmoll. Berlin Philharmonic Orchestra, Herbert von Karajan, cond. Deutsche Grammophon 2530 315, \$6.98. Tape: ●89 462, \$6.98; ●●3300 294, \$6.98.

It is difficult for me to imagine anyone wanting to listen for the better part of an hour to a series of Weber overtures; I want an overture to be something more than a preface to another overture. But for those not bothered by this, here is a superbly played and recorded disc. Karajan lavishes his familiar depth and warmth of texture (to my taste the ideal of how an orchestra should sound on records) on these six pieces as if all were symphonic masterpieces. Three of them (*Freischütz*, *Oberon*, *Euryanthe*) are of course just that, and they enjoy deserved popularity in the concert hall. But of the others only *Abu Hassan*—a Germanic version of Rossinian wit—makes much of an impression. P.H.

B
R **RUDOLF SERKIN: Romantic Showpieces for Piano and Orchestra. MENDELSSOHN: Concertos: No. 1, in G minor, Op. 25; No. 2, in D minor, Op. 40; Capriccio brillante, Op. 22; SCHUMANN: Concerto in A minor, Op. 54; Introduction and Allegro, in D minor, Op. 134**. Rudolf Serkin, piano; Philadelphia Orchestra; Columbia Symphony Orchestra (in Mendelssohn Op. 40), Eugene Ormandy, cond. Columbia MG 32042, \$6.98 (two discs; from various Columbia originals).

All these performances are distinctive and unique, even if many will take violent exception to Serkin's fiery, high-strung accents and biting tone in the two Mendelssohn concertos. Schumann's music seems to absorb the vehemence and passion more comfortably. At the cut-rate price this is a decidedly worthwhile album though, frankly, I personally would advise the earlier incarnations, which include Serkin's incomparable readings of the Richard Strauss *Burleske* (with the Mendelssohn Op. 22 and Schumann Op. 134 on MS 7423) and Schumann's Op. 92 *Konzertstück* (with the Schumann concerto on MS 6688). The two Mendelssohn concertos in these same accounts are, of course, also issued as a full-priced single (MS 6128). Save for a pronounced background hiss on the pre-Dolby Mendelssohn concertos, Columbia's reproduction is faultless. H.G.

Feel what you hear on Superex Stereophones

Ready to feel Beethoven run right through your body? Ready for physical sensations you can't get from the best seat in Philharmonic Hall? For \$120.00, you can buy the Superex PEP-77D Electrostatic Stereophone System. The audiophile dream.

It's all based on an advanced engineering principle which creates the flattest frequency response and purest sound you can get. Instead of the usual conventional cone working in a magnetic field, there's a wafer thin diaphragm controlled by an electrostatic field. You've got to feel the difference!

Begin by placing just twelve ounces of stereophones on your head. Feel what a 10-22,000 Hz frequency response can mean. Then feel the comfort of replaceable Con-Form ear cushions and a completely adjustable headband. Feel the new

freedom of 15 generous feet of coil cord.

Now connect all this to the Superex Electrostatic Console. It's compact and it's real walnut. And works off any amplifier. 4-16 Ohm impedance. With automatic protection for stereophones and amplifier. And a Speaker/Phones switch. Plus outlets for two sets of stereophones, in case you and a friend decide to feel the music together.

You can finally hear what your amplifier can really put out. Records, the way they were recorded. Music, the way you were meant to feel it. For \$120.00, you can have the ultimate Superex Electrostatic Stereophone System. For \$85.00, you can have the same system, minus a few features. Each fine system is guaranteed for one year. And are the two best sound investments around.

PEP-77D Electrostatic Stereophones System
Sugg. Retail Price \$120.00

PEP-79 Electrostatic Stereophone System
Sugg. Retail Price \$85.00



Superex Stereophones

Feel what you hear

See us at Booth 514

Superex Electronics Corp., 151 Ludlow St., Yonkers, N.Y. 10705, In Canada, Superior Electronics Inc.

CIRCLE 56 ON READER-SERVICE CARD

4-channel discs/tapes BY ROBERT LONG

Vanguard's Dolby ORs. At last the promised Dolby-B processed open-reels from Vanguard have arrived, and I've had a chance to sample them. They contained no surprises, really—outside of the basic surprise that even a company as enterprising as Vanguard would issue quadrasonic recordings in a format that seems so formidably esoteric.

The catch is that for "correct" playback you need four channels of Dolby processing. I used a pair of Advent 100A noise-reduction units (driven by a Sony/Superscope TC-854-4S deck, and driving a Heathkit AA-2004 quadrasonic amp and Onkyo Model 20 speakers). This is a logical approach if you want to go four channel from a present stereo Dolby system. If you want to start from scratch, Teac has a nifty stereo/quadrasonic Dolby B unit: the AN-300, which can be used as a recording/monitor unit (comparable in that respect to the 100A) or as a quadrasonic playback unit (for which purpose the two erstwhile recording Dolby circuits are converted to use as a second playback pair). Of course you also can do what music lovers without Dolby equipment are doing to hear Dolby-processed cassettes and broadcasts: cut back on your treble controls to get a fairly convincing approximation of the intended sound.

The program material all has been issued (and reviewed in this column) in other formats: SQ discs and, in some cases, Q-8 cartridges. Instrumental placements are more unequivocal than in the SQ issues; noise is less noticeable than in the cartridges. But it isn't much less in some recordings—and particularly in the spoken instructions for speaker setup that you'll find at the head of each tape. Those instructions will become an awful bore once you've got your system tuned; I'd suggest you chop them off and splice leader in ahead of the music—or at least put leader between instructions and music so that you can easily skip the preliminaries except when you want to re-check the system.

Most impressive of the tapes I've heard is the first volume of the Joan Baez "Blessed Are . . ." album (Vanguard VSS 12, \$14.98). I can't find any suggestion of master-tape hiss, and the quadrasonics are crisper than in the SQ release. A close second—for a different reason—is the Stokowski recording of the Tchai-

kovsky Fourth (VSS 15, \$14.98). I had previously heard it only in the cartridge version, which seemed excessively hissy on wide-range equipment. The superiority of the open-reel version is particularly noticeable in the back channels, which are used for ambience and therefore contain relatively low signal levels.

The *Messiah* highlights (VSS 16, \$14.98) also have ambience information in the back channels, but at fairly high levels, as it might be in a church. The relatively blurred perspective of the SQ release provides the pleasant sensation of wallowing in Handel—and of plenty of space around you to wallow in. The greater definition of the open-reel version results in an unpleasantly echoey quality at times. I'm afraid that as quadrasonics this recording already is beginning to show its age—which demonstrates just how far and how fast things have moved.

Fun and Games? When a reworking of the classics *works*, we have something like the "Switched-On Bach." When it doesn't, we get musical low-jinks, which soon becomes a crashing bore. RCA subtitled its "Stolen Goods" Quadradisc (Red Seal ARD1 0015, \$5.98) "The Outrageous Dr. Teleny's Incredible Plugged-in Orchestra." A further idea of what an overworked put-on this disc is suggested by the cut titles: *Wild Turkey* (Mozart's *Rondo alla turca*), *Rhapsody from Hunger* (Liszt's *Hungarian Rhapsody* No. 2), and so on. The few good things in the album are ruined by non-pertinent (if not downright impertinent) intrusions. *King of Kings* (the "Hallelujah" chorus), for example, opens with a quiet and eminently musical passage for front-center "harpsichord" and "double-bass"—actually, as you must have guessed, their synthesized counterparts—and just as the interplay gets absorbing the back right channel takes up some wiggled-out jews-harp sounds that bear no musical relationship I can discover to the other two "instruments." Similarly, the end of this cut discards the climax of the Handel original without substituting anything of comparable interest.

And what is one to make of an SQ disc billed as "Quadrasonic Spectacular . . . 10 Pianos/16 Pianists . . . Monster Concert . . . Members of the Eastman School of Music Piano Faculty, and Eastman

School Graduates, Samuel Adler, Conductor . . . Featuring Eugene List, Frank Glazer, Barry Snyder, and Maria Luisa Faini" (Columbia MQ 31726, \$6.98)? The record contains multipiano arrangements of everything from the *William Tell* overture to *The Stars and Stripes Forever* by way of Johann Strauss, Carl Czerny, Louis Moreau Gottschalk, and Scott Joplin. Again there are some interesting passages, and perhaps these clangorous bagatelles will attract a following as highbrow camp; but since the sixteen pianists make their presences felt less through the marvels of quadrasonic sound than through their want of unanimous rhythmic impulse. I'll take the original scorings, thank you.

The Remixes Are Coming. As this column is being readied for the printer there has appeared on my desk a gaggle of SQ "Greatest Hits" discs from Columbia (MQ 32054/59: Bach Vol. 1, Tchaikovsky, Beethoven, Mozart, Chopin, and Johann Strauss respectively; \$6.98 each). I say gaggle because this sort of repackaging is something I gag at. Does the sharing of a single composer really justify mixing Pablo Casals ("*Air for the G String*") with Walter Carlos (finale of the Third *Brandenburg*)? And is there really any excuse for dismembering masterpieces to present individual movements as the "*Ode to Joy*" or the "Theme from *Elvira Madigan*"—or for sampling music as pianistic as Chopin's mostly in orchestral transcriptions? If there is, it escapes me.

Columbia has been honest about its intentions at any rate. All the discs have clear credits for Arthur Keady, quadrasonic remix engineer, and Jay David Saks, quadrasonic sound supervision. (RCA's innumerable early Q-8 cartridge remixes left the impression in the labeling that all the recordings were spanking fresh and engineered from the outset for quadrasonics.) But if I were a purchaser instead of a reviewer I would resent deeply being asked to pay full price for the patchwork samplers (to mix stitchery metaphors) by which the recording companies seek to stretch the profits in their properties.

If you can stomach the hodgepodge presentation, however, Columbia has at least demonstrated its ingenuity in quadrasonic remixing. ■

Onkyo designed the TX-666 to be a genuinely fine, total quality audio instrument with unmatched features. Now the verdict is in. Two highly respected evaluating experts — Hirsch-Houk Laboratories for Stereo Review (March '73) and High Fidelity (in its May '73 issue) agree that the TX-666 is a winner!

Said Hirsch-Houk: "... A first-rate tuner and powerful, low distortion amplifier — a well-designed, well-constructed receiver... (with many) often overlooked details of design and operating 'feel'. Everything works smoothly and positively... FM Interstation muting is flawless, free from noise or 'thumps'. Dial Calibration is unusually accurate... FM Frequency Response and Stereo Separation are exceptionally uniform... Alternate Channel Selectivity is excellent... (and it's) as sensitive as any on the market... Amplifier ratings are quite conservative... at any output up to the rated 53W (RMS) per channel... Phono-overload

We're Not Just Another Pretty Face. Onkyo TX-666.

capability is extraordinary... The TX-666 is an auspicious entry for Onkyo..."

High Fidelity Magazine's test experts made these comments; "The TX-666... is a solidly built, generally well-planned unit... distortion readings at frequency extremes are exceptionally good... excellent in terms of harmonic distortion... it stayed well under 0.2% (THD) to the test limit. The amplifier section proved a hard act to follow... (In FM) its thump-free behavior across the dial is an attractive plus... The TX-666 is a worthy introduction for Onkyo."

Prove it to yourself and audition this fine instrument. As for its "pretty face", you'll discover a smartly styled, walnut cabinet with a brushed black gold panel. The price for this superior receiver is only \$469.95. The TX-555 with 43W (RMS) per channel is available at a lower price.

ONKYO
Artistry in Sound

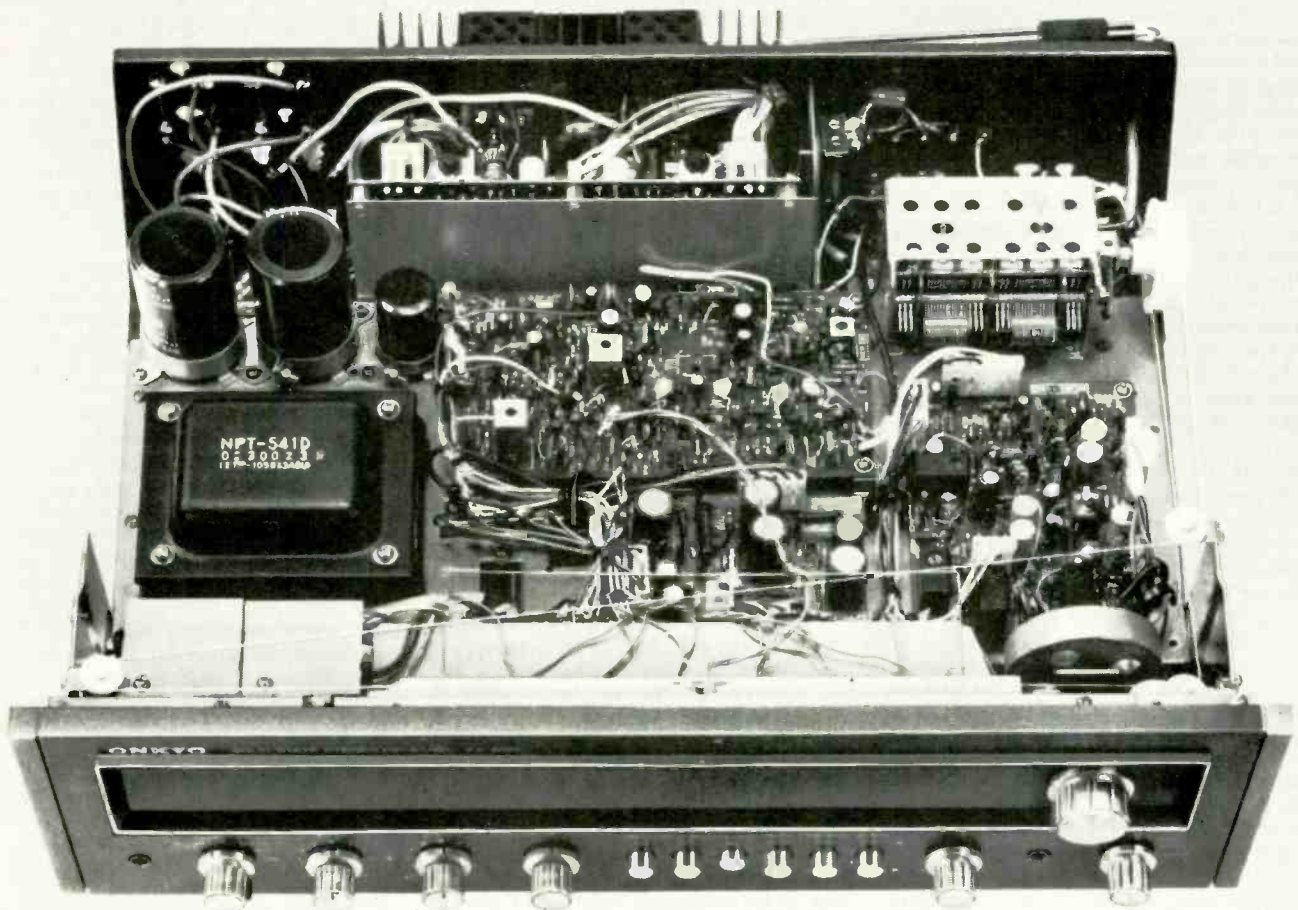

Onkyo Sales Section / Mitsubishi International Corp.
25-19 43rd Avenue, Long Island City, N.Y. 11101 / (212) 729-2323

CIRCLE 32 ON READER-SERVICE CARD

the lighter side

reviewed by

MORGAN AMES

ROYAL S. BROWN

R. D. DARRELL

HENRY EDWARDS

MIKE TAIN

JOHN S. WILSON



Bill Quateman—immediately discernible supermusical talent.

*** BILL QUATEMAN.** Bill Quateman, song, vocals, guitar, piano; Tom Radtke, drums; Sid Sims, bass; Ken Ascher, arr. *Circles; Get It Right On Out There; Too Many Mornings*; six more. Columbia KC 31761, \$5.98. Tape: ● CA 31761, \$6.98; ●● CT 31761, \$6.98.

It is no great trick for a producer or an artist to recognize a great new song when he hears it. Both Carly Simon and producer Richard Perry must have known early in her last project that the first single would be *You're So Vain*. It was a natural. No, the great trick is to recognize an ordinary song when you hear it—and to avoid it. That is how so many mediocre songs get on so many albums. What happens, in the absence of really good material or artists, is that the producer (or record company or promo department or disc jockey or you-name-it) talks himself into believing in the next best thing, or less. A contract is signed; a lot of time, money, skill, and effort go into a project; and then it is presented to the public. The public has an unthinking, uncanny, nearly unerring way of informing the producer whether he was right or wrong. *You're So Vain* was a hit about ten minutes after it hit AM radio. When a record flops the producer is back where he started, back when he knew it wasn't a hit anyway.

This philosophizing comes out of hearing the first five bars of this new album by Bill Quateman. Not the first five minutes but the first five bars. That's how long it takes to stop fooling around, stop listening passively as the piles of passively competent, IBM-card pop albums go by the record player. Reviewers, like producers, do the best they can with what is available.

I do not say that this album by Bill Quateman, whom I've never heard of, is a hit. I do say that it is of hit quality—ninety per cent above most albums released.

Quateman's sensitive, strong, supermusical talent is immediately discernible. He reminds me just a bit of David Crosby. He writes his own material, sings beautifully if you like rough real voices, and plays guitars and keyboards well. The album takes off like a glider (the new ones with the engines) and soars through several moods, styles, and stories. The nucleus of the music comes from Quateman, drummer Tom Radtke, and bass player Sid Sims.

The album has been sweetened in the choicest way by Ken Ascher, who also co-produced with Robin Geoffery Cable. Ascher,

whom I first heard of five or six years ago when he was the youngest member of Woody Herman's band, has written some lovely string arrangements, plus percussion, rhythm, and one flute. The charts are carefully wed to the soloist, unobtrusive but supportive. They are also mixed in with clarity and a sense of space. The engineer was Michael Stone. There is another credit I don't understand: "Sound—Robin Geoffery Cable." I wish I knew what Cable did (besides producing with Ascher), because the sound is very good indeed.

If Quateman has a weakness, it is his lyric writing, which moves from clarity to vagueness and then back. Some songs are quite together: *My Music* and a charming look backwards in *Only the Bears Are the Same*. *Keep Dreaming* gets lost, lyrically. Musically, Quateman is steady as a rock, with melodies swaying hypnotically (*Only Love*). His voice is easy and his feelings are out front. *What Are You Looking For* is performed with piano only, that is, nearly naked. Quateman's emotional level reminds me of Bette Midler's on *Superstar*.

In all, this is a splendid debut album, and it really cheers my day. M.A.

*** SHA NA NA:** The Golden Age of Rock 'n' Roll. Vinnie Taylor, guitar; Lennie B., sax; Screamin' Scott Simon, piano; Gino, guitar; Zoroaster Clarke, bass; Jocko, drums; Bowzer, Frederick Dennis Greene, Johnny Contardo, Donny, Joff, and Capt. Outrageous, vocalists. *A Lover's Question; His Latest Flame; Chantilly Lace; Heartbreak Hotel; Wild Weekend; Rock Around the Clock*; twenty-four more. Kama Sutra KSBS 2073-2, \$11.96 (two discs).

For four years, Sha Na Na has been the most appealing and the most creative group in the rock 'n' roll revival. Their versions of the old rock 'n' roll songs range from excellent to not bad, with only a few shoddy performances. And their choreography more than makes up for any flaws in their performances. But on record, where one can't see them combing their hair and wiggling their pelvises, Sha Na Na has come off less than the spectacle it is. With the issuance of this new, two-disc album,

the group has changed that situation. I am annoyed, however, that Sha Na Na still insists on performing many of the up-tempo songs faster than the originals. But on the whole this is a great album, especially the studio-recorded side. Scott (Capt. Outrageous) Powell's Elvis Presley imitations remain the wonder of the rock 'n' roll revival. The best of the three "in concert" sides is the medium-tempo material such as *Rock Around the Clock*. M.J.

KAMARINSKAYA! Popular Russian Folk Music Played on Authentic Instruments. Various soloists and ensembles. *The Birch Tree; A Guelder Rose on the Hill; Polka; Three Bylorussian Round Dances*; nine more. Melodiya/Angel SR 40223, \$5.98.

You may know a balalaika when you hear one (or a whole orchestra of various-sized examples) and you'll probably dig a bayan as a concertina or accordion with a Russian accent. But how about a gusli (a kind of Russian dulcimer/psaltery)? A domra (Russian lute)? And above all a double zhaleika (unidentified here but sounding like some extremely primitive double-reed instrument)? You'll meet 'em all here in this mostly high-voltage program of performances presumably anthologized from earlier Melodiya recordings by a dozen or more virtuoso soloists and a wide variety of groups including the Beryozka, Pyatnitsky, and Soviet Army Ensembles; Andreyev Folk Instrument and Osipov Balalaika Orchestra, etc. Some—perhaps most—of the pieces are probably more truly traditional and pop than folk, and among those credited to specific composers there are the Fair Scene from *The Gadfly* film score by Shostakovich and the Russian Quadrille from Shchedrin's ballet

Explanation of symbols

exceptional recording

Recorded tape:

- Open Reel
- 8-Track Cartridge
- Cassette

The Humpbacked Horse. But what's most genuinely exciting here is the dazzling bravura of the playing, the toe-tickling stimulation of the dance rhythms, and perhaps most of all the vividly vibrant recording of a whole new world of exotic tone colors. It's well worth visiting. R.D.D.

GENESIS: Foxtrot. Tony Banks, organ, mellotron, piano, electric piano, twelve-string guitar, and back-up vocals; Steve Hackett, electric guitar, twelve-string and six-string solo; Phil Collins, drums, back-up vocals, and rhythm accompaniment; Peter Gabriel, lead vocals, flute, bass drum, and tambourine oboe; Michael Rutherford, bass, bass pedals, twelve-string guitar, and cello. *Watcher of the Skies*; *Time Table*; *Get 'Em Out by Friday*; three more. Charisma CAS 1058, \$5.98. Tape: ● M81058, \$6.95; ●● M51058, \$6.95.

When Genesis' lead singer, Peter Gabriel, appears on stage he dons a number of disguises. He emerges from the wings dressed as a fox, a nun, a bat, a flower, a woman. Even with these unusual theatrical touches, Gabriel is not just another disciple of the Alice Cooper-David Bowie "freak-rock"-"glitter-rock" syndrome. Gabriel views himself as an actor; Genesis views itself as a spinner of tales. The band is devoted to bringing drama to rock-and-roll, and "Foxtrot" presents Genesis' latest collection of dramatic narratives with Gabriel enacting a number of roles, highlighted by Tony Banks's sweeping use of the mellotron to underline Gabriel's vocal effects. The music and the performances shine with intelligence, but Genesis is still a frustrating listening experience. The stories lack coherence and maturity, and while one marvels at the effects one wishes they served a better purpose. *Get 'Em Out by Friday*, for example, tells the story of a government that wishes to evict its population and replace it with people half their size, in order to increase its profits. It's a whimsical notion, but whimsy cannot co-exist with either obscure lyrics or complicated instrumentation. Nevertheless, I do not wish to downgrade Genesis. Rock should be lifted from its present almost primitive theatrical form. When Genesis brings its concepts to life with some degree of depth, this mission may very well be accomplished. H.E.

FANNY: Mother's Pride. Jean Millington, June Millington, Alice de Buhr, and Nickey Barclay, vocals and instrumentals. *Long Road Home*; *Old Hat*; *I Need You Need Me*; ten more. Reprise MS 2137, \$5.98.

As far as I know, Fanny is the only all-lady rock group to survive beyond an exploitative one-shot album. This is Fanny's fourth album, not counting its major contribution to Barbra Streisand's pop-market records.

Fanny has even survived its name. The fact is that, in spite of the har-hars, it's a good group. But though this album has its moments, it is not Fanny's best. It is not the group's fault, but more of that later.

Most of the good stuff is on Side 1, including Randy Newman's *Last Night I Had a Dream*. *Long Road Home* is sung by June Millington, who wrote it. This lady could be an effective solo singer with a little well-placed direction, which should have come from the

producer. As it is, she just sings into the mike without using it. With voices such as June Millington's, the vocal mike can be a particularly good friend if you ask it to be. She also sings shy and scared, as if she needs permission. A foxy producer would have given it to her.

Solid Gold is a cute song about a hit record, written by pianist Nickey Barclay and sung by drummer Alice de Buhr. Miss De Buhr gives it just the irreverent, comical treatment it needs. *Is It Really You* is by Nickey Barclay, who sings lead. She is the group's strongest solo singer, though all perform well as background voices. *All Mine*, by June and Jean Millington, is one of the better tunes and benefits from a little sweetening—a couple of instruments and the singing "Fannets." One track, *Summer Song*, was recorded and mixed in London by Glyn and Andy Johns. Its presence is noticeably different from the rest—crisper, more energetic, and truer to the group. The other tracks are mostly phone-ins, substandard tunes, nondirectional vocals, sparse and unaided instrumentals.

My quarrel is with Todd Rundgren. Talented as he is, he took on far too much here, functioning as producer/engineer/mixer. A great many engineers will not produce at the same time (and vice versa), and albums such as this explain why. Because Todd Rundgren took all this upon himself, a great deal was inevitably missed. (It is amazing that he got as much as he did. That and a quarter will get you half a pack of cigarettes.) Among the problems: the faulty vocal mentioned earlier on *Long Road Home*; the inconsistent mix on *Solid Gold*, leaving the words on the bridge unintelligible; the boomy bottom-heavy sound on *Polecat Blues*. Indeed, Side 2 is barely "produced" at all. It just happened, and it sounds like it.

It's difficult to understand why a man deliberately dilutes his own effectiveness, ties his own hands, but peace and love, love and peace. The album could have been far more exciting if its primary chores had been spread out more sanely. Live and maybe learn. M.A.



CHET ATKINS: Alone. Chet Atkins, guitar. *Take Five*; *Smile*; *Me and Bobby McGee*; nine more. RCA APL 1-0159, \$5.98.

Chet Atkins has for years produced recordings of great taste, both with and without accom-



Chet Atkins—another legendary album?

paniment. His several recordings of duets with guitarist Jerry Reed have in just a few years become legendary in country music. This solo LP may be destined for the same honor. It is a great recording, a simple and honest one. Atkins has given to his music the kind of talent and dignity that makes it easy to suggest to followers of more serious guitar music. Best is *Take Five*. M.J.

THE MOVE: Split Ends. Jeff Lynne, vocals; Bev Bevan, drums; Ray Wood, guitar. *Do Ya*; *Message from the Country*; *Chinatown*; nine more. United Artists UAS 5666, \$5.98.

The jacket sleeve of this album contains ten columns of Move history by Ben Edmunds. The notes could earn Edmunds a doctorate in history. The author traces the English group from its birth in the mid-Sixties through its bubble-gum, psychedelic, and post-psychedelic symphonic reincarnation as the Electric Light Orchestra. As intriguing and complex as the plans for the invasion of Normandy, these liner notes are packed with details as Edmunds eagerly displays his knowledge of such obscure English bands as Carl Wayne and the Vikings, Mike and the Nightraiders, the Ace Kefford Stand, Sight and Sound, the Uglys, and Balls. They are far more fascinating than the disc itself.

"Split Ends" consists of eight cuts from Move's 1971 album, "Message from the Country," released on the Capitol label (the third of the four American companies for whom the Move has recorded). The set is rounded out by recent Move singles including *Do Ya* which has received plenty of attention in the United States.

The music is perfectly competent, but none of it is very exciting. Indeed, at its best the Move only conjures up memories of other English bands and occasionally even suggests derivative Beatles and Bee Gees. Reaching its lowest ebb on *California Man*, in which the style of American Fifties rock clashes head on with a heavy-handed English approach, "Split Ends" offers rewards only for those who are not discriminating. H.E.

PROCOL HARUM: Grand Hotel. Gary Brooker, piano and vocals; Alan Cartwright, bass; B. J. Wilson, drums, percussion, and mandolin; Mick Grabham, guitar; Chris Copping, organ; Keith Reid, lyrics; vocal and instrumental accompaniment. *Grand Hotel*; *Toujours L'Amour*; seven more. Chrysalis CHR 1037, \$5.98.

Ever since 1967's *A Whiter Shade of Pale* faded away, Keith Reid has been one of the most consistently lame lyricists in rock. But what's interesting is not that he's lame, but that despite his infirmity he manages to limp to the bank with regularity. The other members of Procol Harum must hear something in him, for they use him exclusively. Perhaps, as with certain whistles, only dogs can hear it. The combination of Reid's elusive, say-nothing lyrics with Procol Harum's rich, melodramatic, and, more often than not, overblown rock is amusing now and then, but usually it is just pathetic. I thought that, with the departure from the band of Matthew Fisher and his omnipresent liturgical organ, some needed understatement might enter the

NOVA AUDIO

The Brightest Super Star
In Stereo Today

At Last!

- MAIL ORDER
- Plus —
- SERVICE
- Plus —
- FINANCING
- Plus —
- TOP MAJOR BRANDS

Nationwide Financing

Also Bank Americard & Mastercharge

We carry all the Fair Trade Brands

Whenever Possible these makes are quoted 'In Systems'

We quote on ALL Major Brands

Large complete inventory on everything we sell

We provide our own Factory Authorized Service on everything we sell

YOU CAN TRUST US!

Write for our price and quotations on complete systems or individual items. Whatever your needs, we'll fill them and SAVE you money, time and worry!

2940 A Prosperity Ave.
Merrifield, Va. 22116
703) 280-4500

CIRCLE 38 ON READER-SERVICE CARD



RECORD CLUB DROP OUTS

Lend Us Your Ears

Let us show you how the mail order SERVICE of the world's largest record store can offer the greatest selection, speediest service, and competitive prices for records and tapes. No membership fee or obligation to purchase. Specialists in classical music, shows, Jazz, nostalgia, and imports. Send for free catalog.

ROSE
DISCOUNT RECORDS
214 S. Wabash Ave.
Chicago, Ill. 60604

CIRCLE 48 ON READER-SERVICE CARD

music. I thought that if he pounded the typewriter long enough Keith Reid might find something to say. I was wrong. M.J.

GENTLE GIANT: Octopus. Gentle Giant, vocals and instrumentals. *The Boys in the Band*; *Dog's Life*; *River*; five more. Columbia KC 32022, \$5.98. Tape: ● CA 32022, \$6.98; ●● CT 32022, \$6.98.

This is a curious album. Members of Gentle Giant are Kerry Minnear, Raymond Shulman, Gary Green, Derek Shulman, Philip Shulman, and John Weathers. If things got any more British we wouldn't be able to hear them at all.

Gentle Giant strikes me as the British rock equivalent of the West Coast cool school of jazz of the late Fifties and Sixties, with guys like Lee Konitz, Warne Marsh, and Paul Desmond. Emotionally the stance is the same: be cool, be clever. This group makes no mistakes whatever. Surgical instruments could be sterilized in this music. The players are excellent and the singers the most precise since the Hi Lo's, where the resemblance ends.

So what is this music? It falls somewhere between Elizabethan balladry and rock. I realize that is like saying Kansas lies somewhere between the Atlantic and Pacific oceans. It's all I can do.

The first track is called *The Advent of Panurge*, followed by *Raconteur Troubadour*. The lyrics mean as little as the titles. Each one bears a note that reads as though it were writ-

ten with a quill while leaning on an upholstered couch in the library at Eton. It does not give me much to relate to. There is an extraordinary track called *Knots*, dedicated to R. D. Laing, vastly complex musically, spotlessly performed. Its lyric is one of those pompous riddle affairs: "... It hurts him to think that she is hurting her by him being hurt to think."

When the level of musicianship is as high as this, one is obliged to listen closely. The longer you do it, the harder it is. For all their incredible fluidity, Gentle Giant says nothing. What's worse, it seems to feel nothing. It is an exercise group, a test-tube truth, an endless study class. *Think of Me with Kindness* is nearly warm and then apologizes in the notes: "A personal song. It has been kept simple to retain the essentially intimate mood of the piece." Presumably cleverness and facility are more comfortable than feeling. This track is the only break from it.

This is a splendid album in a science-fictionish way, all slick and tubular. The longer I listen the madder it gets me. So cool and self-contained and organized. So unlike life. M.A.

ROBERT KLEIN: Child of the Fifties. All material and songs written and performed by Robert Klein. *Civil Defense (No Talking)*; *Public School*; *School Lunch*; twenty-one more. Brut 6001, \$5.98.

CHRIS RUSH: First Rush. All material written and performed by Chris Rush. *Even Nice People Get TV*; *Ca-ca-ah-ah-doody-poo-poo*; *Grass*; eight more. Atlantic SD 7257, \$5.98.

These two comedy albums present an established young comedian, Robert Klein, and an underground favorite, Chris Rush. Klein has appeared many times on television; he has hosted late-night talk shows and he has played major nightclub dates. His material is hip enough to appeal to young people and yet is general enough to engage other audiences. The comedian is preoccupied with memories of his youth and can regale his listeners with stories of his attempts to sneak into the best seats at ball games. He also applies his energies to TV commercials, making mincemeat of such epics as Kraft's Velveta cheese. Klein believes in the hard sell, and his style can best be described as bombastic. Along the way he does deliver many sharply etched lines and he does employ considerable wit. But his comic intelligence should be mated to more significant material. Klein has the potential; he could become an authentic satirist.

On his debut disc Chris Rush deals with such topics as female-hygiene sprays, euphemistic language, nostalgia, Howdy Doody, the generation gap, marijuana, Jesus freaks, children's toys, science fiction, the Fifties, and growing up Catholic. It seems that the successful underground comedian is one who is pro-dope, pro-sex, and pro-four-letter words. The underground audience seems to hunger for a reinforcement of its values (or alleged values), and Rush eagerly plays patty-cake with his fans. It's the kind of obsequiousness that Lenny Bruce would have destroyed. Both Chris Rush and his audience are advised to take a refresher course in the works of Lenny Bruce in order to observe what a real comedian achieved when he applied his talents to contemporary material. H.E.

DIXIE SAVES YOU MORE BY MAIL!

ON NATIONALLY ADVERTISED BRANDS • HI-FI COMPONENTS!

 Master Charge / BankAmericard Honored on Mail Orders			
	FISHER		SHURE
	SONY		GARRARD
	DYNACO		

Write Today for Our FREE Wholesale Audio Catalog

*DIXIE, one of the largest stereo wholesalers, fills all your orders promptly. At prices actually LOWER than "Discounters". See our exciting new Wholesale Price Catalog, or write for quotes. Choose the famous brand stereo equipment and accessories you desire. Everything shipped factory-sealed.

DIXIE HI-FI WHOLESALERS
10140 Bacon Drive • Beltsville, Md. 20705

DIXIE HI-FI WHOLESALERS
10140 Bacon Drive • Beltsville, Md. 20705

Please rush me your FREE Wholesale Audio Catalog and complete information. I understand there is no obligation.

Name _____
Address _____
City _____ State _____ Zip _____

HF-7

CIRCLE 12 ON READER-SERVICE CARD



The New England Conservatory Ragtime Ensemble—foot-pounding ragtime.

JOHNNY WINTER: Still Alive and Well. Johnny Winter, vocals, guitar, and mandolin; Randy Jo Hobbs, bass; Richard Hughes, drums; Rick Derringer, guitar; Jeremy Steig, flute; Todd Rundgren, mellotron; Mark Klingman, piano. *Rock Me Baby; Rock & Roll; Too Much Seconal; Let It Bleed*; six more. Columbia KC 32188, \$5.98.

For two years after his major concert debut early in 1969, Johnny Winter was considered by many the leading white blues guitarist. He was, at any rate, certainly the most popular. Then a long hospitalization and convalescence intervened, and as a result this new LP is Winter's first since 1971. It is, unfortunately, little more than a sign that he is still alive. It contains all of the flaws that have hurt Winter in the past: flashiness, aggression rather than taste, and poor choice of material. Though there is an undeniable excitement in some of the tracks, it's an excitement that can be found in many heavy-handed British bash-away-at-it rock bands. Winter's potential as a blues master is wasted here. He has done much better in the past. And now that it's established he's still alive, perhaps he will do better in the future. M.J.

FOCUS: Focus 3. Thijs van Leer, vocals, organ, piano, alto flute, piccolo, and harpsichord; Jan Akkerman, solo and acoustic guitar; Bert Ruiter, bass guitar; Pierre van der Linden, drums. *Round Goes the Gossip; Love Remembered; Sylvia*; seven more. Sire SAS 3901, \$5.98.

Focus. Holland's premier jazz-rock band, has taken all of the continent by storm. *Focus*, their hit American single, with its throbbing repetitions, yodels, and unearthly scat singing, allowed the band to build an American beachhead. "Focus 3" will enable this band to capitalize on its gains.

In concert, this band presents its audience with a "wall of sound." Extremely musical, the band uses a ferociously high level of volume and bombards its fans with the Focus sound. On record, one need not be subjected to this assault in order to appreciate the talents of this ensemble; there's talent to spare on "Focus 3." Destined for immediate popularity are the gay, carefree *Sylvia* and *Focus III*, a romantic instrumental composed for two pulsating guitar lines. *The Happy House of King*, Focus' first Dutch hit, is also included, as is *Elisabeth of Nottingham*, which features a lute and recorder line. Over and over again, Focus presents a brilliant melody and then repeats it

with increasing intensity until the listener is drenched in sound. This technique works perfectly on short numbers. On longer cuts, however, focus seems to lose its inspiration; the improvisations are not imaginative enough, and the band's melodic invention falters. *Anonymous II*, a twenty-seven minute instrumental spread across two sides of the disc, points up these faults. When Focus finds a way to deal with an expanded format, it will have truly made major innovations in the rock form. H.E.

theater and film

A LITTLE NIGHT MUSIC. For a feature review of the original-cast recording, see page 70.

ORIGINAL MOTION PICTURE SOUNDTRACK: The History of MGM Movie Music, Vol. 1. *Lara's Theme; Love Theme of Ben Hur; Themes from Brigadoon; Overture from Gigi; Slaughter on Tenth Avenue; An American in Paris Ballet*; ten more. MGM 2-SES-15-ST, \$6.98 (two discs).

This selection from the history of the musical soundtracks to MGM motion pictures varies, as do the films, from the heavy and ponderous to the light and lively. The films honored range from *Gone with the Wind* (1939) to *The Unsinkable Molly Brown* (1964). There have been better recorded versions of *Lara's Theme*, for example, and certainly of *An American in Paris*. But these are the movie originals, and valuable on that basis alone. MGM, both movie and record divisions, has seen better times. The record division lately has been doing a lot of looking back and reissuing. This is the best reissue from MGM yet. M.J.

jazz

*** NEW ENGLAND CONSERVATORY RAGTIME ENSEMBLE:** Scott Joplin: The Red Back Book. New England Conservatory Ragtime Ensemble, Gunther

Schuller, cond. *The Entertainer; Sun Flower Slow Drag; Maple Leaf Rag*; seven more. Angel S 36060, \$5.98. Tape: **8XS** 36060, \$7.98; **4XS** 36060, \$7.98.

Gunther Schuller, who not only seems to be able to find the time to do everything in the musical world that there is to do but to do it all unusually well, has now turned his attention to the ragtime revival. Along with composing, conducting (in the classical field), serving as president of the New England Conservatory, and—possibly—even writing the much-postponed second half of the history of jazz he began so well with *Early Jazz*, Schuller is now conducting the New England Conservatory Ragtime Ensemble and going on the road with it to Washington and New York, among other outposts. On this disc the Ensemble plays the arrangements of Scott Joplin pieces that appeared in that basic New Orleans source book, *Fifteen Standard High Class Rags*, better known as *The Red Back Book*. This is some of the same material that has been recorded recently by the New Orleans Ragtime Orchestra, so comparisons are inevitable. The NORO has been improving steadily, performance by performance, but nothing it has yet recorded can match the ensemble attack and the solo verve of the Conservatory Ensemble. There are high spirits at work in the Ensemble (note the exuberant foot-pounding passages on *The Ragtime Dance*) that give Joplin's pieces the sense of joy, combined with graceful beauty, that one hears in the playing of the better ragtime pianists. And the Ensemble includes pianist Myron Romanul, who not only rollicks through the Ensemble performances but has a pair of solo pieces which he carries off with a commendable mixture of stately propriety and happy rhythm. J.S.W.

*** ART TATUM:** God Is in the House. Art Tatum, piano, vocals; Frankie Newton, trumpet; Chocolate Williams and Ebenezer Paul, bass; Reuben Harris, whistler; Ollie Potter, vocal. *Georgia on My Mind; Sweet Lorraine; Sweet Georgia Brown*; ten more. Onyx 205, \$5.98.

52ND ST., VOL. 1. Groups led by Tony Scott, Slam Stewart, Don Byas, and Sid Catlett. *All Too Soon; Three Blind Mice; Melody in Swing*; twelve more. Onyx 203, \$5.98.

THE FOREMOST! Groups led by Teddy Edwards, Dexter Gordon, Leo Parker, and Wardell Gray. *The Duel; Rollin' with Leo; Blues in the Closet*; ten more. Onyx 201, \$5.98.

RED RODNEY: The Arrow. Red Rodney, trumpet; Ira Sullivan, tenor saxophone and trumpet; Tommy Flanagan, piano; Oscar Pettiford, bass; Philly Joe Jones and Elvin Jones, drums. *Star Eyes. Stella by Starlight; Red Arrow*; three more. Onyx 204, \$5.98.

BIG BANDS! Mills Blue Rhythm Band, led by Van Alexander; Louis Bellson's Band. *Blue Rhythm Jam; Blue Rhythm Blues; Blue Lou*; ten more. Onyx 202, \$5.98.

The role that Arnold Caplin's Biograph Records has carried out so successfully in reissuing jazz and blues from the smaller and often quite obscure labels of the 1920s is apparently being undertaken in the fallow field of small labels of the Forties and Fifties

BIG DISCOUNTS

STEREO COMPONENTS

Largest selection of top name brands... try us and see...

It's worth a call
(301) 488-9600



6330 Frankford Ave.
Baltimore, Md. 21206

All mail answered within 24 hours
Phone Daily 9 AM to 9 PM
Saturday 9 AM to 4 PM
Phone (301) 488-9600

CIRCLE 29 ON READER-SERVICE CARD

DISCOUNTS

WASH. D.C.
HAS NO FAIR
TRADE
LAWS!

ON STEREO COMPONENTS

PLEASE REQUEST
Prices for your choice of
Changers, Receivers, Tape
Recorders, Speakers, etc.

PROMPT DELIVERY
IN FACTORY
SEALED
CARTONS.

DISTRICT SOUND INC.

2316 Rhode Island Ave. N.E.
Washington, D.C. 20018
202-832-1900

CIRCLE 11 ON READER-SERVICE CARD

SAVE MONEY ON DYNACO

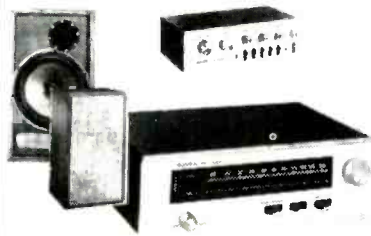

Shamelessly Low Prices.

As one of America's largest wholesale distributors, we're guilty of shamelessly low prices. Our buying volume has made our prices the lowest. We seriously doubt you can find one lower... and that we're proud of. What's more, at S.C.A. you can select from hundreds of NEW, Factory Sealed, Full Warrantee, Brand name, Hi-Fi Stereo components. If its in the Hi-Fi, Audio field we have it!

Write for a lowest of the low quote... or even better come down and see for yourself... we're not ashamed.

STEREO CORPORATION OF AMERICA

Dept. H.F. 2122 UTICA AVENUE,
BROOKLYN, NEW YORK 11234
(212) 338-8555

In L.I. 1180 HEMPSTEAD TPK, UNIONDALE

CIRCLE 55 ON READER-SERVICE CARD

Why pay retail for hifi?

Buy direct from us, and you save money with our high-volume prices on more than 100 name brands. Order from the branch nearest you to save time and money on freight.

Midwest Hifi

WHOLESALE & MAIL ORDER DIVISION

Send for our free catalog!
2455b Wisconsin Ave.
Downers Grove, Ill 60515
(Attn: Hugh Findley)

3309 E. J W Carpenter Frwy.
Irving, Tex 75062
(Attn: Henry Fox)

CIRCLE 37 ON READER-SERVICE CARD

by Don Schlitten's new Onyx label. Schlitten—who produced jazz records for Prestige for many years and more recently for MPS/BASF and Cobblestone—has launched Onyx with a group of releases that are bound to bring back nostalgic memories to those who knew New York's Fifty-second Street when it was still "The Street" to all musicians. It was a block between Fifth and Sixth Avenues lined with small, dark clubs (including the Onyx, for which the label is named), through which drifted most of the great jazzmen of the Thirties and Forties. Many of the young musicians who were on The Street when the sound of jazz was changing in the Forties are on these Onyx discs—Tony Scott, Dizzy Gillespie (as "B. Bopstein"), Ben Webster, Sarah Vaughan, Slam Stewart, Erroll Garner, Don Byas, Coleman Hawkins, and Sid Catlett turn up on "52nd St., Vol. 1," garnered from records originally issued by Gotham, Manor, and Super Disc. Records made for Dial in 1947 by Dexter Gordon and Teddy Edwards, for Gotham in 1950 by Leo Parker, and a Chicago session by Wardell Gray in 1955 make up "The Foremost!" Red Rodney's Signal session of 1957 with Ira Sullivan is dusted off as "The Red Arrow." And a pair of big-band sessions that have scarcely seen the light of day are collected on "Big Bands"—the Mills Blue Rhythm Band organized by Van Alexander in 1947 and a Louis Bellson band recorded in 1964.

These discs, however, are just the routine fare on this first Onyx release. The real event is the appearance of "God Is in the House," a collection of Art Tatum after-hours solos recorded in Harlem clubs in 1940 and 1941 by Jerry Newman on his portable disc recorder. It was Newman, using the same machine, who made the celebrated records at Minton's Playhouse in those same years that gave us the only recordings of Charlie Christian stretching out, away from the studio situations with Benny Goodman's septet (now on Counterpoint 5548). These Tatum performances are equally valuable because, although he was recorded at tremendous length in studios by Norman Granz, Tatum was at his best in the relaxation and challenge of after-hours sessions. This is the only collection of Tatum playing in such circumstances. And what a ball Tatum has! He fills his performances with all the traditional Tatum filigree, performing fantastic musical balancing acts as he throws out lines with abandon and pulls them all together, romping and rollicking through everything from *Sweet Georgia Brown* (with the added touch of Frankie Newton's muted trumpet) to *Mighty Lak a Rose!* He sings, too, with a dark, chuckling mumble and plays so buoyantly behind a singer named Ollie Potter that he makes her seem good.

Newman often played his acetate discs of these Tatum performances for friends and on radio programs and, over the years, they inevitably became worn. As a result some of the sound is not all that it might be. But now that these performances have finally been issued, they automatically become an essential part of the Tatum discography. There's nothing else that shows off the full Tatum brilliance quite as well.

J.S.W.



JIMMY RANEY: Strings and Swings. Jimmy Raney, guitar; Gene Orloff, violin; Walter Trampler, viola; Charles

McCracken, cello; Jack Brengle and Peter Ind, bass; John Roy and Nick Stabulas, drums (in Suite for Guitar Quintet); Bobby Jones, tenor saxophone; Bob Lam, piano. *'Round Midnight; Stella by Starlight*; two more. Muse 5004, \$5.98.

Jimmy Raney, who was one of the most distinctive jazz guitarists in the Fifties, when the jazz world seemed to be crawling with guitarists, has been staying close to home (Louisville, Kentucky) in recent years. But a visit to New York in 1972 got him back into the Gotham jazz swing, and this record—made up of two belatedly issued sessions—should remind the rest of the world that a major jazz talent has been going unrecorded and largely unheard for too long. The more fascinating of these two sides is the one devoted to Raney's Suite for Guitar Quintet—by which is meant guitar, string quartet, and drums. Recorded in 1957, after Raney had been studying with the late Hall Overton, the Suite uses the string quartet brilliantly in a jazz context. Raney derived from Bela Bartók and Alban Berg a classical string approach that actually enlivens the jazz element instead of deadening it. The Bartók influence is quite overt (one of the Suite's five sections is called "Homage to Bartók") as Raney shifts back and forth between sections that place his guitar within the body of the string ensemble and those in which it is used in the more traditional jazz solo style with the strings as support. The second side, recorded at a concert in Louisville in 1969, puts Raney back in a situation somewhat similar to his days with Stan Getz. With Bobby Jones on tenor saxophone taking the Getz role, the two create music that moves with a remarkably light and airy swing on *Bernie's Tune* (which sounds delightfully fresh after all these years). Raney's solo work, beautifully realized, is featured on two ballads. J.S.W.

MOACIR SANTOS: Maestro. *Nana; Bluishmen; Luanne*, five more. Blue Note LA007-F, \$5.98.

Moacir Santos is, according to the liner notes on this disc (remarkably informative for a Blue Note record but printed, as is all information on Blue Note records, in such obscure fashion that it is very difficult to decipher), a highly successful Brazilian musician from Pernambuco whose career has built up steadily from bands playing in northern Brazilian villages and towns to Radio Recife and to the full music scene of Rio de Janeiro. Now, in his maturity, he has come to California and made his American recording debut with this disc, which combines suggestions of bossa nova with straightforward American jazz. Santos sings, plays baritone saxophone, and is the composer of most of the pieces. The collection has a generally exotic quality, but the most viable parts of the record come from the American musicians Santos brought to the session—Don Menza on tenor saxophone and flute, Frank Rosolino on trombone, Ray Pizzion soprano and alto saxophones, Oscar Brashear on trumpet, and Clair Fischer on organ. The set moves up and down, depending on how much formal arrangement is involved—the less the better. It all comes together in its best form on *Mother Tracema*, which is driven by the searing solos of Pizzi, Fischer, and guitarist Joe Pass. J.S.W.



Yes, it does! We're one of the country's largest Mail Order Houses of Stereo Equipment and components. We pass our volume buying power right along to you.

BALTIMORE
Stereo Wholesalers

*WRITE FOR QUOTATIONS AND OUR LATEST FREE CATALOG!

7A Aylesbury Road

Timonium, Md. 21093 • 301,252-6880

CIRCLE 7 ON READER-SERVICE CARD

THIS

OVER **67** YEARS
OF RELIABILITY

IS WHY STEREO & HI-FI
BUYERS CAN BE SURE OF
SAVINGS
AT RABSONS

At Rabsons Competitive Prices, Reliability and Personal Service have been bywords for over 67 years.

It's so EASY and SAFE to deal with Rabsons. As close as your telephone — as near as your mailbox • Fast Air Mail Response on Quotation Requests • Franchised Distributor for Hi Fi Lines • All merchandise brand new in factory sealed cartons, shipped double-packed, fully insured promptly from our warehouse • Greater savings on complete systems • Export packing • 220 Volts, 50 Cycle merchandising a speciality • Free list of monthly specials.

BEFORE YOU BUY GET A RABSONS QUOTE... YOU'LL BE GLAD YOU DID!

RABSONS 57 ST. INC.
119 West 57th Street, New York, N. Y. 10019
Tel. Area Code 212-338-8546

CIRCLE 45 ON READER-SERVICE CARD

SAVE!

MONEY • TIME • FREIGHT

- ♪ QUALITY STEREO EQUIPMENT AT LOWEST PRICES.
- ♪ YOUR REQUEST FOR QUOTATION RETURNED SAME DAY.
- ♪ FACTORY SEALED CARTONS—GUARANTEED AND INSURED.
- ♪ SAVE ON NAME BRANDS LIKE:

A.D.C.	KLH
A.R.	SHURE
DYNACO	KOSS
FISHER	SONY

AND MORE THAN 50 OTHERS.

BUY THE MODERN WAY

BY MAIL—FROM

ia
Illinois audio

Department 217H

12 E. Delaware Place

Chicago, Illinois 60611

312-664-0020

CIRCLE 27 ON READER-SERVICE CARD

HUGE SAVINGS ON FAMOUS BRAND STEREO COMPONENTS

DISCOUNTS

ON NATIONALLY ADVERTISED
TURNTABLES • CARTRIDGES

COMPACTS • RECEIVERS
AMPLIFIERS • TAPE RECORDERS

Wholesale Prices! Audio Warehouse Sales, one of the Capitol's largest stereo wholesalers will fill and deliver all your mail orders promptly in factory sealed cartons, at prices that will amaze you.

Write for quote on Famous Brand, Stereo Components. We guarantee satisfaction.

AUDIO
WAREHOUSE SALES
3310 NEW YORK AVE. N.E.
WASHINGTON, D.C. 20002
(202) 832-1616

CIRCLE 62 ON READER-SERVICE CARD

HIGH FIDELITY CLASSIFIED

1515 Broadway, New York, N. Y. 10036 · Phone: (212) 764-7300

Rates: \$1.00 per word. Minimum \$10.00.
Words in caps at 10¢ extra each.

Display Classified

1 inch by 1 column—\$200.
2 inch by 1 column— 400.
3 inch by 1 column— 600.

5% discount for 6 consecutive issues;
10% discount for 12 consecutive issues.

Full Payment Must Accompany All Copy for
Classified Ads except those placed by
accredited advertising agencies.

Name _____

Address _____

City _____ State _____ Zip _____

Telephone _____

My classified ad copy is attached.

for sale

RARE ROMANTIC PIANO SCORES—Moscheles, Henselt, Herz, Liszt, Scharwenka, Scriabin, etc. Free catalog. MUSIC TREASURE PUBLICATIONS, Box 127, Highbridge Station, Bronx, New York 10452.

A full octave of new bass from your AR, KLH, Advent, Dyanco, ADC, Rectilinear bookshelf speakers, using low cost electronic equalization. Three test reports, comprehensive literature, from Norman Laboratories, 520 Highland Parkway, Norman, Oklahoma 73069.

TEST FREE COMPARISONS

Comparisons by Pittsburgh's Audio experts of over 100 speakers, receivers, changers, and cartridges included in the most informative catalog of its kind. Complete with lowest wholesale prices.

Wholesale Audio Inc
3916 SAW MILL RUN BLVD., D-1
PITTS., PA. 25527 (412) 884-8797

SAVE MONEY BY THE BUSHEL WHERE THE CORN GROWS... Fantastic Savings on Name Brand Stereo Equipment... WRITE FOR QUOTE, MIDWEST AUDIO WHOLESALE, P.O. BOX 1132, WATERLOO, IOWA 50704.

miscellaneous

SLEEP-LEARNING—HYPNOTISM! TAPES, RECORDS, books, equipment. Also Alpha Brainwave Feedback devices. Free catalog. Autosuggestion, Box 24-F, Olympia, Washington 98501.

DIAMOND NEEDLES and Stereo Cartridges at Discount prices for Shure, Pickering, Stanton, Empire, Grado and ADC. Send for free catalog. All merchandise brand new and factory sealed. LYLE CARTRIDGES, Dept. H, Box 69, Kensington Station, Brooklyn, New York 11218.

Stereo Components, Appliances, low quotes, \$1.00 for catalog. Defa Electronics, 2209 B'Way, N.Y., N.Y. 10024. (212) 874-0900.

INTEGRATED CIRCUIT KITS—Free catalog. FRAZIER & ASSOCIATES, 3809 Surfwood Road, Malibu, California 90265.

Protect your records Poly sleeves for jackets 5¢ Roundbottom Inner sleeves 5¢ Poly lined paper sleeves 11¢ White jackets 25¢ Postage \$1.00. Record Supply House, Hillburn, New York 10931.

HIGH FIDELITY'S TEST REPORTS—Over 175 currently available audio products. Tests, analyses, prices. Send \$2.25, includes 30¢ postage & handling, to High Fidelity's Test Reports, Box HF, 2160 Patterson St., Cincinnati, Ohio 45214.

Earned Bible Degrees—Correspondence and Residence—Fundamental Bible Seminary & College, P.O. Box 942-CM-F-Elk City, Okla. 73644.

Thorens 125 B, Dual 1229; ADC 25; Citation Eleven (217) 485-5518.

Lowest prices on Stereo components—National Brands—Electronic Centers, 5323 Westlayan, Houston, Texas 77005.

AUDIO REVIEW. EXCITING NEW REPORTS OFFERING FULL EXPOSURE TO AUDIO/STEREO NEWS. FEATURE ARTICLES, EQUIPMENT PROFILES/REVIEWS/RATINGS, ADVISORY/ANSWER SERVICE, MORE FREE COPY. AUDIO REVIEW, BOX 175-H, NORTH BRANFORD, CONN. 06473.

HIGH FIDELITY IS ON MICROFILM: Back copies of HIGH FIDELITY are available on microfilm dating from APRIL 1951 to DECEMBER 1971. Microfilm copies of articles from any of these issues may be obtained from Billboard Publications at a cost of \$1.00 per page. For further information contact: Constance Bewen, Corporate Research Division, Billboard Publications, 1515 Broadway, New York, N.Y. 10036.

This Was Your Hit Parade



Has all the weekly song listings from the program's inception in 1935 to the last program in 1958 — plus various compilations of the top songs. \$6.95 plus 25¢ for shipping and handling. Order from: JOHN R. WILLIAMS, 24 Union St., Camden, Maine 04843. Maine residents add 5% sales tax.

services

RENT 4-TRACK OPEN REEL TAPES—ALL MAJOR labels—3,000 different—free brochure. Stereo-Parti, 57 St. James Drive, Santa Rosa, Cal. 95401.

RENT STEREO TAPES \$1.50 week, Postpaid—new Catalog 25¢. Tape Library, Box 8126, Washington, D.C. 20024.

new equipment for sale

DON'T PAY THE HIGH MAIL ORDER PRICES. THIEVES WAREHOUSE IS COMING TO YOUR AREA. FRANCHISES AVAILABLE. THIEVES WAREHOUSE, P.O. BOX 8057, PENSACOLA, FLORIDA 32505.

BUY DIRECT FROM ENGLAND. Save money! Decca, SME, Transclaptors, Tandberg, Revox, Cambridge, KEF, Godl Speakers, Ortofon, Leak, Goldring, B.O. Price list free. For catalog send \$2.00 bill (\$4.00 airpost). Credited on \$100.00 purchase. Goodwins, 7 Broadway, Woodgreen, London N22. Visitors welcome.

Protect your valuable equipment with a professional security system. Low prices. No wires. Easy installation. Write: Electrodyn, P.O. Box 230, Brooklyn, N.Y. 11223.

tapes & records

"HARD TO GET" RECORDS—ALL SPEEDS, RECORD Exchange, 842 Seventh Avenue, New York, N.Y. 10019.

SCOTCH RECORDING TAPE, LOWEST PRICES. TAPE CENTER, Box 4305C, Washington, D.C. 20012.

"LIVE" OPERA, CONCERTO, SYMPHONIC, TAPE BARGAINS—\$3.50—(REELS & CASSETTES). BOX 1101, WOODHAVEN, NEW YORK 11421.

OPERA RECORDS—rare live performances now available for the first time on top quality LP recordings. Ed Rosen, Box 97, Freeport, N.Y. 11520.

Records—soundtracks, shows, cut-outs. Send wants—we'll quote. Lesco, 2205 Marylane, Broomall, Pa. 19008.

Basf, Memorex, Scotch, TDK, Reels, Cassette, 8-tracks, Lowest Prices. S & S Audio, P.O. Box 523, Skokie, Ill. 60076.

Live opera tapes from capitals of the world. Top quality copies. Extensive catalogue free. A. Fischer, Box 83, Fordham Station, Bronx, N.Y. 10458.

FILM-STAGE SOUNDTRACKS. Large free list. A. Lutsky, Box 7342 Miami, Fla. 33155.

Soundtracks—O.C.—Personalities & Jazz Want lists to: Theo's Records, P.O. Box 4994, Panaroma City, Ca. 91412.

"LIVE OPERA PERFORMANCES ON REEL-TO-REEL TAPES. Incredible performances dating back 40 years, from PONSSELLE-CALLAS. Catalog; MR. TAPE, Box 138, Murray Hill Station, N.Y.C. 10016."

BASF—MEMOREX—Audio and Video Recording Tape. BSC Inc., Box 1181 (HF), Melrose Park, IL 60161.

OPERA TAPES—GREAT PERFORMANCES OF PAST 35 years. Free catalog. Ed Rosen, P.O. Box #97, Freeport, N.Y. 11520.

Soundtrack album's from films. Whalon, 2321-U Hill, Redondo Beach, Calif. 90278.

Kennedy/Tippitt/Oswald murders! Actual episodes + police recordings! Reels-cassettes! \$10. Majestic, 9651 Foxbury, Pico-Rivera, California 90660.

SOUNDTRACKS. Large free catalog. Star 26, Rt. 2, Box 1944R, Escondido, Calif. 92025.

WHOLESALE OLD RADIO PROGRAMS on CASSETTES. \$2.00, HOUR!! Send 2 stamps, AM Treasures, Box 192, Babylon, N.Y. 11702.

RARE CLASSIC MOVIE SOUNDTRACK ALBUMS—Wilson, 823 Timberlane, Galion, Ohio 44833.

AMERICA'S LARGEST SOUNDTRACK SPECIALISTS! FREE CATALOGUE. "RTSH" 1111 S. Benito, Suite F, Alhambra, California 91803.

RARE SOUNDTRACKS—SHOWS. Extraordinary list. Write to Film Music, Box 1195, Beverly Hills, California 90213.

RARE KORNGOLD! Cello Concerto, string Serenade. Mint lp's \$10.25 to Box 24420, Los Angeles, California 90024.

STEREO EIGHT-TRACK TAPES \$1.80 EACH. OVER 500 SELECTIONS FROM ROCK-CLASSICAL. Send long stamped self-addressed envelope for complete list. S. Scanlon, Box 127, Hazelcrest, Ill. 60429.

SCOTCH BRAND CASSETTES	1-9	10	48
SC-45 Low Noise, 45 Min.	1.35	1.21	1.15
SC-45 High Energy, 45 Min.	1.65	1.48	1.40
SC-60 1-Hr. Low Noise	1.50	1.35	1.21
SC-60 1-Hr. High Energy	1.80	1.62	1.54
SC-90 1-1/2 Hr. Low Noise	2.25	2.02	1.92
SC-90 1-1/2 Hr. High Energy	2.70	2.43	2.31
SC-120 2 Hrs. Low Noise	3.30	2.70	2.56
Shipping-Handling + 10% (+ 5% Over \$80.00)			

*Above May Be Assorted For Best Quantity Price

**TAPE RECORDERS
5% ABOVE
DEALER
COST!**

SCOTCH MAGNETIC TAPE (USED)

± 150, 1800 Ft. 7 inch reel, 1 mil polyester, recorded once, bulk erased (no box), 99¢, plus 10% shipping & handling (min. order \$10.00); slightly used 10-1/2 inch fiberglass reels, 3/4" hole, 50¢ each, plus shipping by weight and zone.

SAXITONE TAPE SALES
1776 Columbia Rd.,
NW, Washington, D.C. 20009



in brief

*** WILSON PICKETT:** Mr. Magic Man. RCA LSP 4858, \$5.98. Tape: P8S 2142, \$6.95.

For his debut disc on the RCA label, Wilson Pickett provides another collection of soulfulness: he is a musical master, in his prime. H.E.

RICK WAKEMAN: The Six Wives of Henry VIII. A&M SP 4361, \$5.98.

Yes's rock keyboardist Wakeman combines rock, jazz, and classical modes to create these six instrumentals. Yes, it is a musical conceit, a musical conceit that Wakeman pulls off. Don't be surprised if *Catherine of Aragon* becomes a hit single. H.E.

BERT JANSCH: Moonshine. Reprise MS 2129, \$5.98.

The latest recording of slightly modernized medieval ballads and medieval-sounding modern songs by the noted British musician. Predictably, it's a good one. M.J.

GLADYS KNIGHT & THE PIPS: Neither One of Us. Soul S 737L, \$5.98.

As always, this truly soulful group delivers the goods. Though nothing on this disc matches the fervor of Gladys Knight and the Pips's biggest hit, *I Heard It Through the Grapevine*, the title tune is invigorating and the entire album is filled with exuberance framed by a sterling sense of discipline and tastefulness. H.E.

KEN MUNSON: Super Flute. Paramount PAS 6049, \$5.98.

Even though Munson's flute performances on such current hits as *I Can See Clearly Now*, *Brandy*, and *Me and Mrs. Jones* eventually begin to pall, this disc still makes for a pleasant diversion. H.E.

*** MICK GREENWOOD:** To Friends. MCA 307, \$5.98.

This young singer/songwriter writes evocatively and sings with suitable intensity. He will inevitably be a superstar, a fitting reward for someone with so much talent. H.E.

HANK SNOW: Hank Snow Sings Grand Ole Opry Favorites. RCA APL 1-0162, \$5.98.

It's easy to appreciate the honesty of country music when it's done by someone who's been a master of it for more than twenty years. The tunes on this excellent recording are not the best-known country songs, but they are among the best. M.J.

DANA COOPER. Elektra 75052, \$5.98.

Here they are again, the best sidemen in town ripping off another group of tracks for another new singer. Dana Cooper. He's okay, he's fine, with a high tenor that is popular now. He wrote the songs. Nothing new. If there were it would be hard to tell, since the backup group has appeared on hundreds of albums. They all sound alike somehow. A singer has to be damned strong to outshine the stars in the band, such as Jim Gordon, Leland Sklar, etc. Some singers are, most aren't. M.A.

TRACY NELSON: Mother Earth. Columbia KC 31759, \$5.98.

Fine, earthy performances recorded in Nashville, but much more into blues and boogie than into country. Happy music. M.A.

TOKYO SHAPIRO

WORLD WIDE
STEREO WHOLESALERS
THE BEST OF BOTH
WORLDS... DIRECTLY
TO YOU

WHO ARE THESE GUYS?

We're a group of young people that are well informed about the Hi-Fi world. We're no ripoff. We give you the best value for your money, plus honest practical advice. Every major brand is in our line, we have stock for immediate delivery and you get factory sealed cartons with full warranty. Write your needs to us today and if it's an entire system, we'll save you even more. Send for free catalog, current mfg. specials and price list.

WE'RE OFFERING YOU ALL
THE FAMOUS NAMES IN
STEREO COMPONENTS
BELOW
NORMAL DISTRIBUTORS' PRICES

TOKYO SHAPIRO

26050 Richmond Road
Bedford Heights, Ohio 44146
Phone (216) 292-5832

ATTENTION:
Midwest Residents: Buy from us,
save excessive freight charges.

CIRCLE 57 ON READER-SERVICE CARD

DISCOUNTS

HI-FI SYSTEMS COMPONENTS

KITS • COMPACTS
TUNERS • AMPLIFIERS
RECEIVERS • TURNTABLES
SPEAKERS • TAPE RECORDERS

- Franchised Distributors for over 70 mfrs.
- Largest selection in the country
- Full manufacturers warranty protection
- Only brand new, factory sealed components
- Fast, fully insured shipments
- Double-boxed cartons where possible
- Same day reply to your inquiry
- Extra savings on complete systems
- Lowest possible prices

WRITE FOR OUR QUOTE AND SPECIALS BULLETIN
VISIT OUR NEW MODERN WAREHOUSE
FREE AMPLE PARKING AT PREMISES

ARSTON Stereo

146 OLD BROOKFIELD RD. (NORTH)
DANBURY, CT. 06810
DANBURY, CT. (203) 744-6421
N. Y. CITY (212) 369-6212

CIRCLE 5 ON READER-SERVICE CARD

HIGH FIDELITY CLASSIFIED

employment opportunities

EPIURE PRODUCTS, INC. is seeking quality applicants to meet expansion needs. Applicants must be willing to travel extensively four or five days per week; be knowledgeable of, or willing to learn, all aspects of the hi fi industry—products, policies, and future developments. Position requires a professional approach to sales, and a person interested in rapid advancement into a growing management team. Base salary and monthly incentive. Epicure Products, Inc. Call: Robert Fuller, Personnel, Newburyport, Mass. 01950. (617) 462-8191.

wanted to buy

CASH FOR UNWANTED STEREO LPS AND PRERECORDED TAPES. Reder. 81 Forshay Road, Monsey, New York 10952.

business opportunities

GET IN ON THE MONEY to be had in the booming song and music world as a lyric writer. Go-write with me on a 50-50 basis. Publishers contract guaranteed. Recording promotion. Send lyrics with stamp: Paul Jackson, Rt. 9, Box 292-cr, Athens, Ala. 35611.

used equipment for sale

For Sale: McIntosh Tuner MR73 FM/AM \$400 w/walnut case and Sony ECM22P Mic. \$75. Box 2002 High Fidelity, One Astor Plaza, New York, N.Y. 10036.

RECEIVERS
TUNERS
AMPLIFIERS

TAPE
RECORDERS
DECKS

LOW PRICES

ON FAMOUS BRAND
NATIONALLY ADVERTISED
STEREO COMPONENTS

FAST DELIVERY
FACTORY SEALED CARTONS
WRITE TODAY FOR OUR QUOTE

A. D. R. AUDIO

6200 CHILLUM PLACE N.W.
WASH., D.C. 20011
(202)
723-6060

SEND FOR
OUR FREE
CATALOG

SPEAKERS
CARTRIDGES
COMPACTS

ALL
STEREO
SYSTEMS

CIRCLE 2 ON READER-SERVICE CARD

the tape deck

BY R.D. DARRELL

"Safe Adventures" may strike you, at first glance, as an obviously self-contradictory category for any kind of listening experience—unless you have already encountered some entirely unfamiliar music that unexpectedly lacks the unknown's usual strangeness, sometimes even evoking an eerie feeling of *déjà entendu* or of running across a childhood friend you'd inexplicably forgotten. Such works are most often found just off the repertory beaten paths yet still well within the domains of composers well known and loved for their major—or at least more frequently heard—masterpieces. And it's in the search and discovery of such Safe Adventures that one's musical horizons can be significantly expanded without serious risk of running into stone walls—or, less metaphorically, of investing in recordings one will never want to play a second time.

An apt current example is the first complete taping of Handel's Op. 3 Concerti Grossi: a set of six quintessentially Handelian masterpieces long overshadowed by the *Water Music*, *Fireworks Music*, the twelve Op. 12 Concerti Grossi for strings only, etc. Yet Op. 3 is triply fascinating: first of course for its inexhaustible outpouring of sheer musical vitality (often jauntily swaggering as well as poignantly lyrical or grandly ceremonial); but also for a variety of form and instrumentation techniques—clearly experimental, yet always paradoxically assured; and not least for its composer's many self-borrowings and rescorings. Listening to the present ineffably exhilarating, vividly recorded performances by the Munich Bach Orchestra under Karl Richter (Archive/Ampex L 3116, 7½-ips reel, \$7.95), what I personally relish is the piquantly differentiated tonal coloring featuring oboe and bassoon timbres in particular—colors that are aural equivalents of the transparent purity and freshness that make true fresco painting so distinctively different from painting in oils. And to think that not so many years ago Handel's orchestral music always had to be "arranged" before it was considered fit for concert or recorded performance! Transcribers like Beecham and Harty certainly weren't bad orchestrators, but the Old Master must have forgotten more tonal ingenuities than they ever dreamed of!

Except for the great Requiem, K. 626, Mozart's nineteen Masses (most of which date from his unhappy service in Salzburg) aren't too well known or often recorded. Only K. 626 is currently avail-

able in both reel and cassette formats and K. 427 in cassette only. Hence a general need for what I think is the first taping of the *Credo* Mass in C, K. 257, and a replacement for a couple of now out of print tapings of the *Coronation* Mass in C, K. 317 (Philips/Ampex L 5034, 7½-ips reel, \$7.95; Latin-text and notes included). But these works also are highly pertinent to our present Safe Adventures notion (in particular the more relaxed and less solemnly ceremonial K. 317), not least because they are part of the distinguished British Mozartean series directed by Colin Davis which gave us the best recorded *Requiem* just a year ago and which has since grown to include a number of other church works not yet transferred from discs to tapes.

Segovian Reminiscences. *El Supremo's* long and celebrated recording career for American Decca has been brutally terminated in what may be a conglomerate's economic gain but is surely the classical repertory's profound loss. This means that Segovia's projected long autobiographical series combining spoken memoirs with guitar-technique tips and exemplary music will have to be continued, if at all, in Spain. The first two "Guitar and I" programs were made here, however, and were recently released on tape in cassette and 8-track cartridge formats (Decca 73/6 10179 and 10182, \$7.98 each). I haven't received review copies of them, but Vol. 2 (oddly out of sequence) is included in the second release list of Magtec/Stereotape 7½-ips reel processings (DST 710182, \$7.95). And it proves to be as much of a must for every guitar aficionado as one can imagine just from reading the contents. On the first side Segovia talks, in characteristically old-fashioned and accented but perfectly intelligible fashion, about his first exposure to classical music, early concerts in Granada and Seville, and first concert guitar; and then plays a few technical-formula exercises. Overside, he plays, without spoken comment, fifteen short studies by such guitar-specialist composers as Giuliani, Sor, Coste, and Tárrega. Both voice and instrument are captured with admirably intimate clarity, and only uninitiates in this particular recording world will object to, or even worry about, the finger-lifting string-snapping noises seemingly inseparable from close guitar miking.

More Magtec/Stereotape Reelizations. My earlier concentration (May and June columns) on RCA Red Seal releases in the first batches of Magtec/Stereotape tapings has unfairly obscured the fact that many other labels are being represented, if mostly by pop musical materials outside this column's province. The only non-RCA classical releases, apart from the Segovia reel above, are two Vir-

gil Fox live Bach Organ Recitals (Decca/Magtec DST 75263 C and 75323 C, 7½-ips reels, \$7.95 each); Stokowski's Respighi/Early Italian program; and the Villa Lobos *Forest of the Amazon* (United Artists/Magtec UST 8001 C and 8007 C). I haven't heard any of these as yet, but remembering the 1960 tape versions of the exotic Brazilian tone poem, especially for its inclusion of Bidú Sayão's legendary vocal magic, I don't hesitate to commend the new *Forest of the Amazon* reel unheard.

I have heard, however, a considerable number of RCA/Magtec reels, especially by Ormandy and the Philadelphians, on which at least some brief comment is called for. Most of them strike me as satisfactorily comparable with their earlier disc and cassette/cartridge editions, but even the best reprocessing technology can't erase the interpretative objections I have to some of the performances themselves—particularly the Scriabin *The Poem of Ecstasy/Prometheus* coupling (ERPA 3214 C); the Falla *Nights in the Gardens of Spain* coupled with a more successful Saint-Saëns Second Piano Concerto, both starring Rubinstein (3165 C); and an insufficiently dramatic "Ride of the Valkyries" Wagner Ring-excerpts program (3264 C); also, but with more lukewarm responses, to "Greensleeves: Lush Favorites in a Romantic Mood" (3284 C) and the 1968 Tchaikovsky *Pathétique* (3058 C).

On the other hand, what I did like originally and now admire more than ever before are the warmly expansive Brahms Second Piano Concerto with Rubinstein (3253 C); that sound-system demonstrators' delight, the stereo-spectacular coupling of Beethoven's *Battle Symphony* (Wellington's Victory at Victoria) with Tchaikovsky's *1812 Overture* (3204 C); and the welcome return to the reel repertory of the somber but impressively eloquent Shostakovich Thirteenth Symphony (*Babi Yar*), with Tom Krause and chorus (3162 C, now of course in a 7½-ips taping, in contrast with the 3¼-ips reel version of 1970).

Then, for those musical travelers who shrink from embarking on even the safest adventures and insist on guided tours being prescribed for them, here are several "World's Favorite" thisses-and-thats anthologies drawn from earlier (sometimes a good many years earlier) releases. Of them I've heard only the "World's Favorite Showpieces" (RCA/Magtec ERPA 3302 C, 7½-ips reel, \$7.95). It strikes me as mainly valuable for its resurrection of Kondrashin's fine Rimsky-Korsakov *Capriccio espagnol*; less so for a more obviously aged Munch Ravel *Bolero*, and the more sonically up-to-date Ormandy Sibelius *Finlandia* and Smetana *Moldau*. For the rest, you're on your own! ●



SONY PS 2251: a declaration of independence.

Independence of belts, pulleys, idler wheels and all the other paraphernalia that can cause wow, flutter and rumble. Independence from fluctuations in power line voltage that can effect the precise speed of the turntable. And independence of acoustic feedback. The new, direct-drive Sony PS-2251 has declared itself independent of all these potential intruders upon the enjoyment of your records.

Most turntables use belts, pulleys, idler wheels to make their turntables spin at the record's speed, instead of the motor's. Look underneath Sony's new PS-2251 and all you'll see is the motor. We don't need all those extras, because our motor's speed is precisely the same as the record's.

Eliminating all those parts also eliminates the wow and flutter and rumble they can cause. So, our rumble figure is a remarkable -58dB (NAB).

And because our motor turns so much slower than conventional ones, the rumble frequency is lowered too, making the rumble even less audible than that -58dB figure indicates.

To maintain precise speed accuracy at slow speeds, we use an AC servo system (superior to a DC servo system because of its uniform magnetic field strength). Its precise speed is not affected by variations in line voltage or in line frequency. But its speed can be varied $\pm 4\%$ by the built-in pitch control and returned to a precise $33\text{-}1/3$ or 45 rpm , with the built-in self-illuminated strobe.

Then we matched it with a statically-balanced tonearm that tracks records as precisely and faithfully as our turntable turns them. We added viscous-damped cueing and effective anti-skating. And we mounted the PS-2251 on a handsome wood base using an independent spring suspension system to completely isolate

it from externally caused vibrations. At $\$349.50$ (suggested retail) including arm, wood base and hinged dust cover, the PS-2251 is today's most advanced turntable.

We also offer a moderately priced, single-play component turntable with the convenience of automatic operation, the PS-5520. The complete system: turntable, arm, walnut base and hinged dust cover, $\$159.50$ (suggested retail) Sony Corporation of America, 47-47 Van Dam St., Long Island City, N.Y. 11101.



CIRCLE 54 ON READER-SERVICE CARD

first came the word...



And then there was music.
And then came Sony tape recorders
to capture the words and music
with perfect fidelity. Right from the
start, Sony has always been first with
the best, the newest and the broadest

selection of tape recording equip-
ment in the world. Sony tape
recorders, Sony accessories, Sony
microphones, Sony recording tape.
We could go on and on and on.
We are.

SONY. Ask anyone.

A Product from SUPERSCOPE.





 **KENWOOD**

...has more of what you're looking for
when you're looking for the best in stereo

Better performance, greater dependability, and a wider selection of stereo components with extra features . . . sophisticated engineering, tough new long-life materials, and stringent standards of quality control . . . magnificent stereo reproduction, superb FM quality, and sophisticated controls for an expansive stereo system . . . that's what you can expect from KENWOOD.

For complete information on KENWOOD's fine Receivers, Amplifiers, Tuners, Cassette Decks, 4-Channel Units, and Accessories . . . visit your nearest KENWOOD Dealer, or write . . .

The sound approach to quality



KENWOOD

15777 So. Broadway, Gardena, Calif. 90248 ■ 72-02 Fifty-first Ave., Woodside, N.Y. 11377

CIRCLE 36 ON READER-SERVICE CARD