

HIGH FIDELITY

RECEIVED
APR 1981
Hartwick College Library

How to Find a Quality Receiver for \$250

Here Comes Stereo AM - Look Out FM!



Best Car Stereo Gear Yet!

vo-Way Disc - ds-On ort

HARTWICK COLLEGE LIBRARY
CANTON, N.Y.
12020



A red kazoo is positioned on the left side of the image, tilted upwards. A black speaker cone is on the right side, showing its concentric rings. A thin black line points from the text above to the opening of the kazoo.

Conventional kazoo
has paper cone.

WHAT'S GOOD FOR A KAZOO IS BAD FOR A SPEAKER.

Blow into a kazoo and what do you hear? A buzzing noise you'd expect from a toy that costs about fifty cents. But just as the paper cone in a conventional kazoo creates a buzzing noise, the paper cone in most conventional speakers creates distortion.

The reason? Paper cones flex. As they alter their shape, they alter

your music.

Pioneer's HPM speakers have cones made of Polymer Graphite instead of paper. This amazing material reduces speaker distortion up to three-fold. Which means instead of listening to your speakers you can listen to a lot more of your music.

What's more Polymer Graphite



Conventional speaker has paper cone.

Pioneer's speaker has polymer graphite cone.

is lightweight and non-resonant. So it doesn't add any of its own sound to your music.

So why buy a conventional paper speaker and limit your system's high fidelity, when you can buy a Pioneer HPM Polymer Graphite speaker and improve it.

 **PIONEER**
We bring it back alive.



Pioneer HPM Polymer Graphite™

MASTERPIECE

a brilliant new level of achievement
in cartridge development

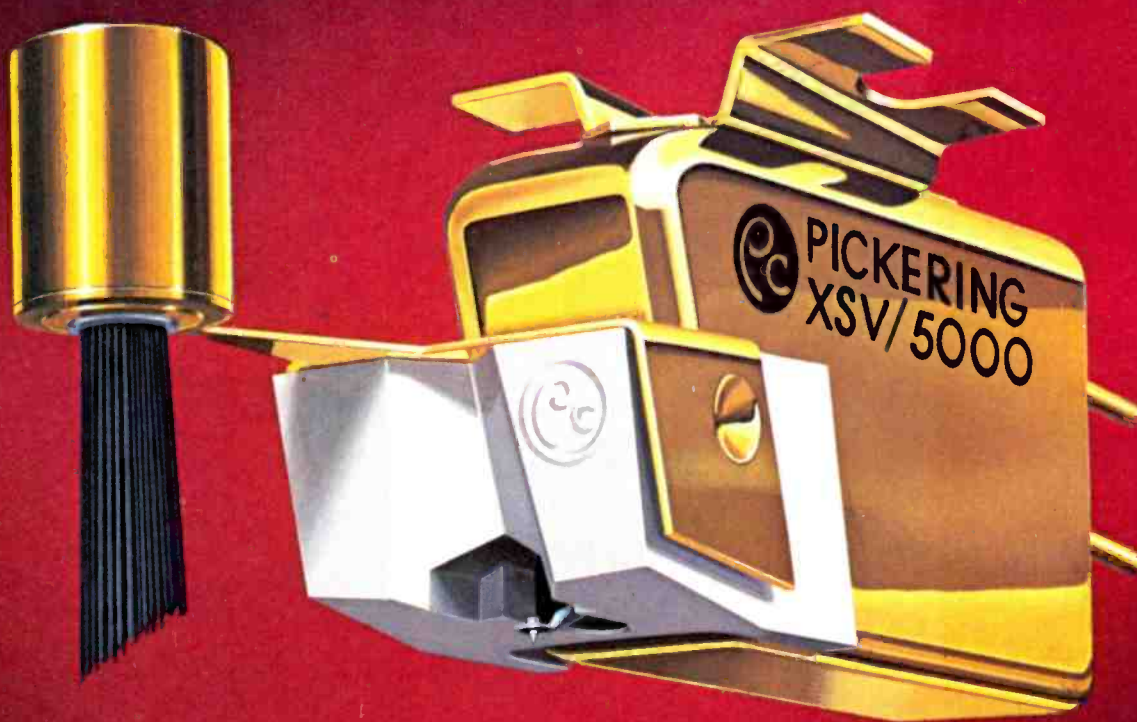

Now Pickering, the company with the world's finest background in cartridge development, introduces a new level of engineering brilliance in the XSV/5000. Starting with a sleek, improved cantilever tube that adds an incredible dimension of traceAbility, the XSV/5000 offers an improved Stereohedron™ stylus design that brings out all of the audio information, particularly in direct-disc recordings, and a new internal configuration that offers a frequency response out to 50,000 Hz.

Over three years in development, backed by 30 years of experience and carefully handcrafted to the highest standards, the XSV/5000 is the one cartridge that not only meets the most demanding technical specifications, but delivers a smooth and faithful reproduction of sound that must be heard...truly "The Source of Perfection" —hear it at your Pickering dealer today!

For further information write to: Pickering & Co., Inc.
101 Sunnyside Blvd., Plainview, N.Y. 11803

 **PICKERING**

"for those who can hear the difference"

HIGH FIDELITY

**MUSICAL AMERICA
EDITION**

**Special Bonus
Supplement**
VIDEO TODAY
& TOMORROW
begins after page 50

William Tynan
Editor

Shirley Fleming
Editor, Musical America

James R. Oestreich
Classical Music Editor

Susan Elliott
Editor, Backbeat

Robert Long
Audio-Video Editor

Peter Dobbin
Associate
Audio-Video Editor

Michael Riggs
Assistant
Audio-Video Editor

Sarina Bromberg
Art Director

Rebecca Abbott
Associate Editor

**Lynda Carlotta
Brenda Everett
Susan Galardi
Isabel Parker**
Assistant Editors

Patricia Vogt
Assistant to the Editor

Diane Albano
Editorial Assistant

Edward J. Foster
Consulting Audio Editor

Robert S. Clark
Editorial Director
High Fidelity Group

**Crispin Cloe
R. D. Darrell
Harris Goldsmith
Edward Greenfield
David Hamilton**

**Dale Harris
Don Heckman
Stephen Holden
Nicholas Kenyon
Paul Henry Lang
Irving Lowens
Robert C. Marsh
Fred Miller
Andrew Porter
Susan Thiemann Sommer
John S. Wilson**
Contributing Editors

Kathleen Davis
Production Supervisor

Susan M. Alyn
Circulation Director
Subscription Sales

Dominic Mustello
Circulation Director
Newsstand Sales

William P. Johnson
Circulation Service Manager

Suzanne Hochman
Direct Mail Manager

Steven I. Rosenbaum
Publisher

HIGH FIDELITY and **Musical America** are published monthly at The Publishing House, Great Barrington, Mass. 01230 by ABC Leisure Magazines, Inc., a subsidiary of American Broadcasting Companies, Inc. Copyright © 1981 by ABC Leisure Magazines, Inc. The design and contents of **High Fidelity** and **Musical America** are fully protected by copyright and must not be reproduced in any manner. Second-class postage paid at New York, New York, and at additional mailing offices. Yearly subscription in the U.S.A. and Possessions \$24, elsewhere \$29. Subscription including international Directory of the Performing Arts \$49 in U.S.A. and Possessions, elsewhere \$64. Single copies \$1.95. Subscribers: Send subscriptions, inquiries, and address changes to **High Fidelity**, 1 Sound Ave., Marion, Ohio 43302. Change of address: Give old and new addresses, including ZIP Code. Enclose address label from last issue and allow five weeks for change to become effective. **Postmaster: Send Form 3579 to High Fidelity, 1 Sound Ave., Marion, Ohio 43302. Postal Identification Number 964300.**



Audio

- 10 CrossTalk**
- 12 High Fidelity News**
Surveying the audio marketplace
- 21 Equipment Reports**
Sony TC-K81 cassette deck
Epicure 3.0 Series II speaker
Micro-Acoustics 630 phono cartridge
Aiwa AD-R500U cassette deck
Celestion Ditton 130 speaker
Advanced Audio Systems DNR-450 dynamic noise filter
- 35 Shopper's Guide to Budget Receivers**
Getting the facts before you buy
by Michael Riggs

- 38 AM Stereo**
The prospects are improving
by Robin Lanier
- 40 Car Stereo '81**
WCES offerings deal with the real world
by Robert Angus

Music/Musicians

- 46 Bartók Recordings, Part II**
The vocal, chamber, and orchestral works
by Jeremy Noble
- 51 Schubert's Successor**
A "complete" edition of Poulenc's songs
by Patrick J. Smith
- 53 The Tape Deck**
by R. D. Darrell
- 54 Classical Records**
Celibidache, composer and conductor
Dennis Brain in recital
- 56 Critics' Choice**

Backbeat

- 74 Superior Superdiscs**
by Crispin Cloe
- 76 Input Output**
Winter NAMM report
by Fred Miller
- 77 Pop Records**
Phoebe Snow
Ian Gomm
The Isley Brothers
- 86 Jazz Records**
Don Byas
Bobby Jasper
The Big Sky Mudflaps
- 88 Bill Haley, 1925-81**
by Mitchell Cohen

Et Cetera

- 6 Letters**
- 71 Reader-Service Cards**
- 88 Advertising Index**

Musical America begins after page 72

ART CREDITS

Cover photograph by Bob Brody;

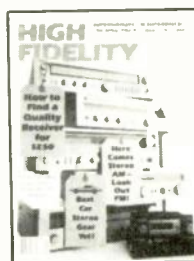

- page**
- 35** Photograph by Bob Brody.
- 42-43** Collage by Randy Brozen.
- 51** Photograph from Bettmann Archive.
- 74** Photo by David Gahr.
- 75** Tom Scholz photo by Ebet Roberts.
- 76** Pocket Fuzz photo by Harold H. Brown.
- 77** Brian Eno photo by Deborah Feingold.
- 77** Rosanne Cash photo by Beverly Parker
- 79** Photo by Ebet Roberts.
- 80** Photos by Deborah Feingold.
- 82** Photo by Ebet Roberts.
- 88** Photo courtesy of BMI Archives.

ADVERTISING

Main Office: The Publishing House, Great Barrington, Mass. 01230. Telephone: 413-528-1300. Robert Maddocks, Advertising Promotion Manager; Ruth Martin, Advertising Production Director; Rita Ganci, Advertising Assistant.

New York: ABC Leisure Magazines, Inc., 825 7th Avenue, 6th Floor, New York, N.Y. 10019. Telephone: 212-265-8360. Seymour Resnick, Advertising Director; George Dickey, Record Advertising Manager; Ozzie Bruno, Eastern Advertising Manager; Janet Cermak, Administrative Assistant; Yetta Peltzman, Classified Advertising Department.

Midwest: ABC Leisure Magazines, Inc., 190 N. State St., Room 632, Chicago, Ill. 60601. Telephone: 312-782-1173. William P. Gordon, Midwest Advertising Manager.

Los Angeles: ABC Leisure Magazines, Inc., 2020 Avenue of the Stars, Suite 245, Century City, Calif. 90067. Telephone: 213-557-6481. Andrew Spanberger, National Advertising Manager; Janet Endrijonas, Western Advertising Manager.

Tokyo: Japan Advertising Communications, Inc., New Ginza Bldg., 7-3-13 Ginza, Chuo-ku, Tokyo 104, Japan. Telephone: (03) 571-8748. Shigeru Kobayashi, President.

HIGH FIDELITY and HIGH FIDELITY/MUSICAL AMERICA are published monthly by ABC Leisure Magazines, Inc., a subsidiary of American Broadcasting Companies, Inc. Robert G. Burton, President; Leonard Levine, Vice President; Herbert Keppler, Senior Vice President, Photographic Publishing Division; Ernest G. Scarfone, Vice President, Graphics and Production; Steven L. Rosenbaum, Vice President, High Fidelity Group; Ronald Stuart, Vice President, Finance; Member Audit Bureau of Circulation. Indexed in Reader's Guide to Periodical Literature. Current and back copies of High Fidelity and High Fidelity/Musical America are available on microfilm from University Microfilms, Ann Arbor, Mich. 48106. Microfiche copies of these magazines (1973 forward) are available through Bell & Howell Micro Photo & Old Mansfield Road, Wooster, O. 44691.

Editorial correspondence should be addressed to The Editor, High Fidelity, Great Barrington, Mass. 01230. Editorial contributions will be welcomed, and payment for articles accepted will be arranged prior to publication. Unsolicited manuscripts should be accompanied by return postage.



PRECIOUS METAL IS A SOUND INVESTMENT.

Scotch[®] introduced the original metal tape, Metafine[®]. The same dedication to technological achievement that created Metafine goes into every Scotch cassette. So invest in precious metal. Get Scotch.

To find out more about recording on Metafine, write to: Metafine, Home Entertainment Products Department, 3M Center, St. Paul, MN 55144.

SCOTCH CASSETTES. THE TRUTH COMES OUT.



Circle 35 on Reader-Service Card

FREE McIntosh STEREO CATALOG and FM DIRECTORY

Get all the newest and latest information on the new McIntosh catalog. In addition you will receive an FM station directory that covers all of North America.

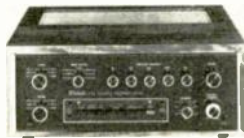
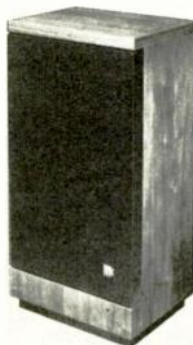

SEND TODAY!

McIntosh Laboratory, Inc.
East Side Station P.O. Box 96
Binghamton, N.Y. 13904

HF

NAME _____
ADDRESS _____
CITY _____ STATE _____ ZIP _____

If you are in a hurry for your catalog please send the coupon to McIntosh. For non rush service send the Reader Service Card to the magazine.

Circle 21 on Reader-Service Card

The tonearm that isn't.



The traditional tone arm has been replaced. By Linatrack. A revolutionary tracking system developed by Revox.

This sophisticated and highly refined electronic servo-system ensures that your records are played just the way they were cut, with perfect tangential tracking.

We've eliminated the causes of distortion inherent in conventional tone arm design. There's no need for an anti-skating device because there is no skating force. Our unique LED/photo diode array monitors the stylus angle and makes instant corrections to keep the tip absolutely perpendicular.

Pivot friction has also been dramatically reduced by our unique single-point jewelled pivot/magnetic support and suspension system.

With Linatrack, tracking error is reduced to a phenomenal 0.5° or less, virtually eliminating distortion and protecting your records from excessive wear.

The high torque direct drive motor of the Revox B790 uses Hall-Effect magnetic sensors tied to a quartz crystal to constantly read and instantly correct rotational speed. This eliminates the moment-to-moment deviations

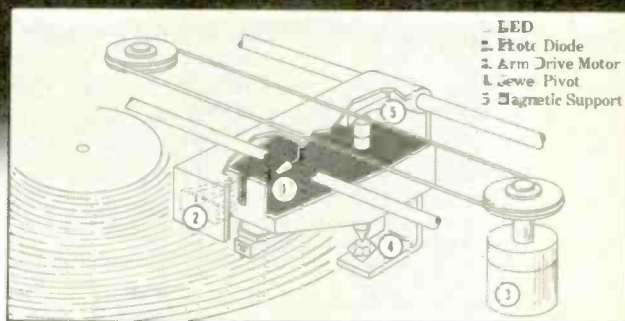

- 1 LED
- 2 Photo Diode
- 3 Arm Drive Motor
- 4 Jewel Pivot
- 5 Magnetic Support

found on even the most expensive conventional direct drive motors. You can verify speed accuracy with the fast responding LED digital readouts. The readouts also provide an accurate log of manual speed adjustments.

Even with its advanced features, the Revox B790 is a pleasure to operate with safe and convenient automation. It works with virtually every cartridge and is ruggedly built to stand up to years of daily operation.

For more good reasons to play your records without a tone arm, experience the B790 at your Revox dealer.

STUDER REVOX

Studer Revox America, Inc.
 1425 Elm Hill Pike, Nashville, TN 37210, (615) 254-5651
 Offices: Los Angeles (213) 780-4234 / New York (212) 255-4462
 In Canada: Studer Revox Canada, Ltd.

International Record and Tape Club

35% SPRING DISCOUNT SALE

LOWEST PRICES IN USA
SAVE TIME, SAVE GAS,
SAVE MONEY, ORDER NOW
All Records And Tapes
 Classical, Opera, Pop, Rock,
 Folk, Jazz, Shows, Int'l,
 Country.

List Per LP	Sale Price Per LP
\$3.98	\$2.59
4.98	3.24
5.98	3.89
6.98	4.54
7.98	5.19
8.98	5.84
9.98	6.49
10.98	7.14

For multiple sets, multiply sale price per LP by number of LP's in set. All other List Prices, your discount is 40%.

To compute the cost of your order, take total of list prices and deduct 35% (except for Specials of the month).

NEED CATALOG? Send \$1.25 for Schwann (plus 50c for postage and handling). If you order catalog, we extend sale ending date to give you more time to order.

SPECIALS OF THE MONTH

All Angel \$9.98 List (LP, Tape)	\$6.19
All Seraphim (LP, Tape)	3.59
All RCA \$9.98 (LP, Tape)	6.19
All Vox Box \$8.99 (LP, Tape)	9.99

TOLL FREE NUMBER OPEN 24 HRS.
 800-331-1750
 ASK FOR OPERATOR 394

Audiophile, Direct-to-Disk, Digital, Superdisc
 15% Discount
GUARANTEE

Orders shipped within 3-15 days. Record or tape replaced at no charge after one play if defective.

ORDER NOW
SALE ENDS JUNE 10, 1981

List items wanted on separate sheet of paper. State whether LP or Tape. Add 95¢ for first LP or Tape, 25¢ each additional LP or Tape, plus 50¢ for insurance for entire order.

Maximum charge for shipping, handling and insurance is \$3.95.

UPS Shipments if desired, add \$1.75
 VISA, Master Charge, accepted.

INTERNATIONAL RECORD AND TAPE CLUB
 DEPT. HF 394, 315 W. 36th St.,
 New York, N.Y. 10018

Circle 14 on Reader-Service Card

Letters

A Meaty Issue

It is a delight to be able to put down the February HIGH FIDELITY, half-read, to sing your praises on my chattering typewriter. Four lead articles, which is as far as I've had time to get, have grabbed my attention and made it hard to remember that I'm in the middle of a monthly consumer magazine.



Bob Angus' delightful and intentionally worrying piece on counterfeit cassettes wanted doing and couldn't have been more nicely gauged and carried off. The message is all too clear: Uphold standards and buy the good stuff, or be swamped by the no-good stuff. Robert Long and cohorts dove (aligned) headlong into a dozen off-the-shelf cassette decks and turned up a strong bias in favor of the good manufacturers, though their caveats made their mark, too.

The story of Tchaikovsky's unnatural death had been rattling around in one or another direction, insubstantial and hazy, until the responsible and low-key report by Joel Spiegelman offered a plausible indictment of the Soviet Union's habitual tight-lipped husbanding of the facts. I didn't see the word "alleged" peppered three times through each sentence, but I do apply my own "zerno sol" (as the man who died would have said) to this version until corroborated by further angles on the tragic mystery.

My greatest enjoyment, though, came from Patrick J. Smith's detailed and fair look at the "New Grove Dictionary of Music and Musicians." As owner of three of the earlier ones, including the frustrating but useful fifth edition, I look forward to the doubled depth of Stanley Sadie's "97% new" opus. I will not be put off by such piffing hindrances as the need to rob a bank to be able to pay for it. The review helped allay the

fears many of us had about the tone and scope of the new monster edition. Mr. Smith's assessment of future incarnations in smaller format of selected portions of "Grove" is sound—and intriguing. HIGH FIDELITY is wise to devote five columns to this necessary adjunct to the corner of the music world the magazine so thoughtfully serves.

Christopher Greenleaf
 Brooklyn Heights, N.Y.

Postscripts on "Grove"

At the time I wrote the article on the "New Grove Dictionary of Music and Musicians" [February], I had seen only the first few volumes. I have since seen all twenty volumes and, more important, have had a chance to use them in my writings on music. I would therefore like to add to what I had to say then. The "New Grove" is indeed in every way far more valuable and informative than its predecessors and is even more indispensable than I had thought.

Patrick J. Smith
 New York, N.Y.

While busy writing reviews on the "New Grove," I much appreciated the article by Patrick Smith.

In such a monumental work, omissions are inevitable, but one omission for which I am grateful—and which Mr. Smith calls "inexcusable"—is that of B. H. Haggin. To many of us familiar with Haggin and other critics, the editors of the "New Grove" can be commended for omitting him. Not even Harold Schonberg and Martin Bernheimer are included, and these gentlemen are noted for their scholarship: Haggin is not.

Dr. Hans A. Illing
 Los Angeles, Calif.

Overstepping Her Bounds?

In the February issue of BACKBEAT, Elise Bretton reviews the folio of "A Day in Hollywood, A Night in the Ukraine" ["Music in Print"] and mentions parenthetically that "the original-cast album is poorly recorded." As engineer and assistant producer of that recording, I object to her statement on two counts.

First, I don't feel it is within the purview of a folio reviewer to discuss recordings with respect to either performance or quality. HIGH FIDELITY has a

Circle 34 on Reader-Service Card ▶

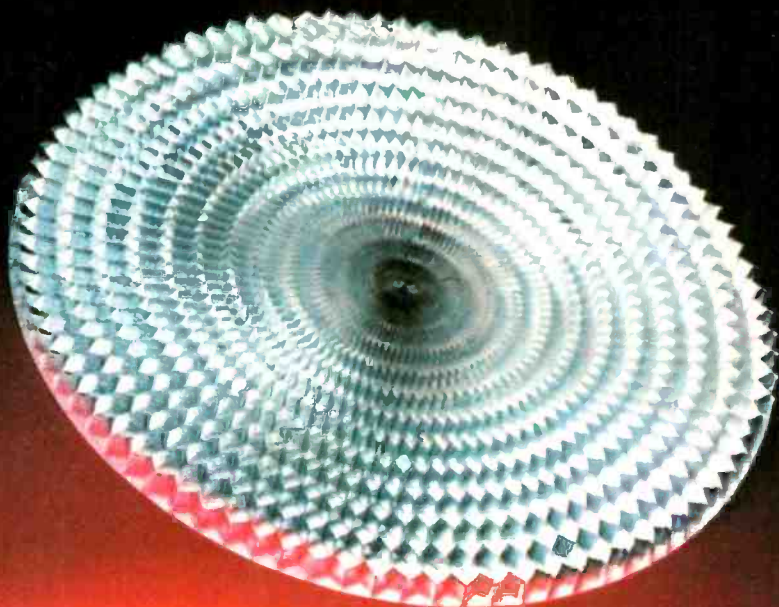
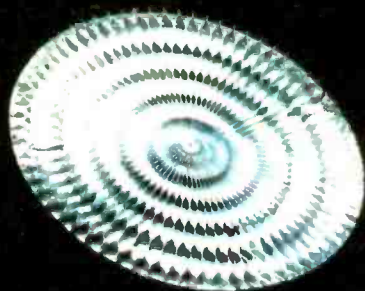

The anatomy of a breakthrough in sound reproduction. Technics Honeycomb Disc speaker system.

You're looking at the heart of a revolutionary new speaker system—the flat honeycomb drivers of Technics new Honeycomb Disc speakers. A new shape that takes sound beyond the range of traditional cone-shaped speakers to capture the full energy and dynamic range of today's new recording technologies. It's the essence of a true sonic breakthrough.

All conventional cone-shaped drivers have inherent distortion problems due to uneven sound dispersion in the cone cavity. But Technics new axially symmetric Honeycomb drivers are flat. So "cavity effect" is automatically eliminated. And just as important, phase linearity occurs naturally in Honeycomb Disc speakers because the acoustic centers are

now perfectly aligned across the flat driver surfaces.

Technics also added a unique nodal drive system designed to vibrate the speakers in more accurate piston-like motion to reduce distortion even further. The result is an incredibly wide, flat frequency response, broad dynamic range, and amazingly low distortion.

To complete the system, Technics Honeycomb Disc tweeter with special front-mounted acoustic equalizer extends frequency response to a remarkable 35 kHz.

Technics offers a complete new line of Honeycomb Disc speakers, all enclosed in a rich rosewood-grain cabinet.

Now that you've seen what a sonic breakthrough looks like, listen to Technics—and hear what one sounds like.

Technics
The science of sound

Special! Full Color Sound for your walls as well as your ears.

Our posters are collector's items! Now they're available when you buy any Sony Metallic, FeCr, EHF, SHE, HFX, LNX cassette tape. Send 3 complete cellophane cassette wrappers with proof of purchase plus \$2 for one poster or \$5 for all three.

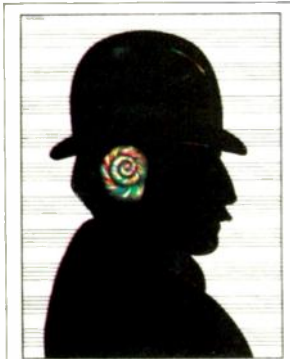

SONY TAPE
FULL COLOR SOUND

The Shell by Milton Glaser, 24" x 36"



Violinist by R.O. Blechman, 24" x 36"

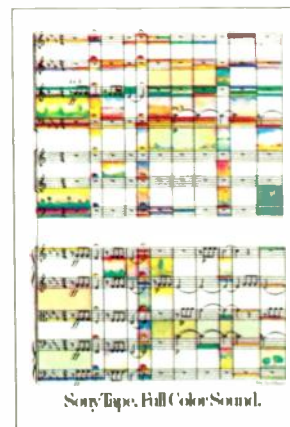

Music Score by Milton Glaser, 24" x 36"

Return order form complete cellophane cassette wrappers, proof of purchase and check or money order to Sony Distribution Center, P.O. Box CN03150, Trenton, N.J. 08650.

SONY

One poster All three posters HF5
The Shell Violinist Music Score

Name _____

Address _____

City _____ State _____ Zip _____

Valid only in U.S. Please allow 4 weeks for delivery. Offer expires Dec. 31, 1981.
© 1980 Sony Corporation of America, Tape Div. Sony is a trademark of Sony Corp.

battery of record reviewers who are far more qualified to do so. Second, to indict something so briefly with no supporting evidence strikes me as completely irresponsible. Does "poorly recorded" refer to bad mike-placement technique? inferior equipment? unsuitable location? poor musicianship? sloppy edits? a noisy pressing? Or perhaps the problem is an inadequate playback system.

For those of us who spent dozens of hours, many thousands of dollars, and a great deal of personal care in the preparation of that album, it hurts to be dismissed so casually—not to mention carelessly. How would Ms. Bretton feel if a critic reviewed "Music in Print" and simply said, "The section is poorly written"?

Fred Miller
Brooklyn, N.Y.

Ms. Bretton replies: Perhaps my brevity in referring to "A Day" as being "poorly recorded" was unjustified. I am not the only BACKBEAT writer whose space is limited. And you're right—record reviews are not my province. But as a musical theater aficionado, a session singer, vocal contractor, and professional transcriber of musical sound to notation, I have a good deal of experience and expertise in listening to and sorting out recorded sounds. I stand by my opinion and add two suggestions to your list of possible causes of the problem: faulty mixing and/or mastering.

Requiem for Tchaikovsky

I was deeply saddened by—and am deeply grateful for—Joel Spiegelman's article "The Trial, Condemnation, and Death of Tchaikovsky" in the February issue. The frankness and dignity of the article honor the memory of Tchaikovsky and advance the cause of freedom and acceptance for gay people.

Barry Frauman
Chicago, Ill.

That was a sad slur on Tchaikovsky's character in the February issue. I spent several years doing research in New York, Paris, Switzerland, and Los Angeles among St. Petersburg émigrés. Some of these people knew the composer as well as his sister, brother, and nephews. I recall particularly some discussions of the last days of Tchaikovsky with the families of Rachmaninoff and Rimsky-Korsakov and with Dr. Sergei

Bertenson. It is very odd that there was no shadow, hint, suspicion, memory, or implication along the lines of your story from any of these émigrés.

Tchaikovsky's sexual habits are not at issue here. His noncholera death is a moot point, and suicide is highly questionable at this juncture. The con-fabulation here is similar to the forged Chopin-Potocka correspondence, only worse. I can only say again, with La-roche: Peter Ilytch, "let the weight of your fame crush this scum."

Noel Farrand
President, Friends of American Music, Inc.
The New Mexico Music Festival Taos, N.M.

I am writing in reference to the article on Tchaikovsky. Even if this new evidence, or whatever you want to call it, is true—which I doubt very much—can't people stop digging up garbage on someone like Tchaikovsky, who has been dead since 1893, and leave his soul to rest in peace? I would think the genius of his music is enough.

Francesco Watson
San Francisco, Calif.

Is Video Taking Over?

The January issue, announcing a change of editor and sporting sixteen pages of VIDEO TODAY, is without "Behind the Scenes" and "The Tape Deck," both of high interest to the audio reader. I mention this because audio is the reason I buy the magazine, and I don't think that the introduction and gradual expansion of a new subject should crowd out coverage of the subject I had supposed to be the reason for the magazine's existence. I think it is time for you to discuss the issue with your readers, via a thoughtfully composed questionnaire.

No more "HiFi-Croistics" either? I miss them.

A. Robert Nelson
Provincetown, Mass.

Mr. Nelson's concern has been expressed by several readers. In fact, the introduction of our special video section was in response to reader requests for additional video coverage, and it has not been at the expense of audio or music coverage. And, likewise, a lack of reader interest is the reason "HiFi-Croistic" no longer appears.—Ed.

WHY ONLY SONY WINDS UP WITH FULL COLOR SOUND.

Strangely enough, some of the things that make Sony Full Color Sound sound so terrific are things you can't hear.

Such as Sony's unique experience and technical achievement. Sony makes both tape and the equipment that plays it. So Sony's experience with tape recording is unique among major tape manufacturers. After all, you'd better know all there is to know about tape decks before you make a tape. Sony does.

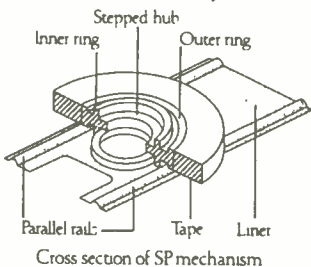

Then there's unique Sony balance. The fine-tuning of all the elements that go into making a tape, so that each synergistically complements the other and delivers the finest recording humanly and technically possible to achieve.

You also can't hear Sony's unique SP mechanism, one of the carefully balanced elements in every Sony tape. It's a perfect example of Sony technical achievement. The SP mechanism is what makes the tape run so smoothly inside the cassette. And smoothly running tape is critical for total, perfect tape performance.

Smooth running means less friction. So some of the most popular tape makers give the tape as much clearance inside the cassette as possible. (We used to do the same thing.) But this method results in uneven or too tight winding and actually increases friction as you wind and rewind the tape. Jamming and even a stopping of the tape in its tracks can result.

It was clear to Sony that even, uniform winding was the key. So Sony reversed the basic thinking about friction completely and invented the SP mechanism, the first positive guidance system on the market. Instead of giving the tape lots of room, it gently guides the tape smoothly and precisely through the cassette, and onto the reels, with a maximum of positive precision support, yet with an absolute minimum of friction. This is a perfect example of Sony

pioneering and how the Sony balance system works.

Some of the unique patented Sony innovations are the stepped hub wheel, which suppresses wobble; parallel "rails" of the liner which guide the tape and hub and keep the tape winding flat and even. Even the surface which touches the tape is special graphite-coated polyester, for the least possible friction.

Our Sony SP mechanism is actually 10 times more trouble-free in lab tests than our old conventional mechanism. And the increase of friction after 200 "torture-test" windings and rewindings has been reduced by nearly 2/3!

The fact is, the more sophisticated your equipment, the more you'll appreciate Full Color Sound. Listen to Sony SHF (our best normal bias tape), EHF (high bias), FeCr or Metallic tape. Listen to the perfect balance of its perfect components. It's the secret of Full Color Sound. **SONY.**



Precision guide roller

Tape

Pressure pad

Shielding plate

CrossTalk

Q. Although I am scrupulous in setting the bias and equalization switches correctly when making recordings on my Realistic cassette deck, the correct 70-microsecond equalization for chrome or ferrichrome tape always results in muffled recordings. By contrast, switching to 120-microsecond equalization in playback, which should give me too much highs, yields a noticeable improvement in frequency response and much clearer sound. Is this normal, and if not, what should I do to correct it?—Gray Brown, Selma, N.C.

A. Assuming that you've cleaned the tape heads and carefully compared the source with the playback to be sure that the more "muffled" of the two settings isn't actually the more accurate (extra brightness can sound mighty attractive sometimes), the most likely explanation is that your deck's bias and Dolby tracking levels aren't set properly for the brand of tape you're using. If the owner's manual makes specific tape recommendations, stick to them; if not, check with Radio Shack to find out what brands of tape will yield the best response with the high-bias/70-microsecond settings. If you still have trouble, you might ask the manufacturer to readjust the deck to meet its published specifications. Finally, you might want to select a good chrome or chrome-equivalent formulation and have a competent technician tweak the deck's bias and recording sensitivity ("Dolby tracking") for optimum performance. Of course, from then on you will get best results only with that brand and type of tape.

Q. I am using a Shure V-15 Type III cartridge with a Dual 1229 turntable and a Sansui 8080 receiver. The cartridge requires 450 picofarads of capacitance, but the Dual supplies only 155 pF; to make matters worse, I am using special low-capacitance phono cables, which I am reluctant to give up because they seem to reduce the noise level. It would seem, then, that I need to add at least 300 pF to the system. But will that offset the noise reduction provided by the low-capacitance cables?—Paul Thiel, Covington, Ky.

A. The type of cables you use should have no effect on hiss, though the amount of hum or RFI might change. But it is the quality of the shield,

rather than the capacitance, that makes the difference. (If anything, adding capacitance might tend to improve RFI rejection.) Apparently you are not using the cables supplied with the turntable, so Dual's 155-pF specification no longer applies. To find out whether additional capacitance is necessary (and if so, how much), you must determine the capacitances of the cables you are now using, of the Dual's internal tonearm wiring (exclusive of the supplied connecting cables), and of the Sansui's phono-input capacitance. This information should be available from the manufacturers. If the sum of these capacitances is less than the 450 pF Shure specifies for the V-15 Type III, you can make up the difference with an external shunt capacitor. DB Systems of Jaffrey, New Hampshire, has a small kit that makes this task easy for anyone to perform without tools in just a few minutes.

Q. I have been using my Nakamichi 582 to build a very nice cassette library, mostly on metal tape. If I get a cassette player for my car, will I be able to use it to play these tapes, or will all the heavy road vibration damage them?—Henry I. Gonzalez, Greensboro, N.C.

A. Vibration won't hurt cassettes, but there are other environmental hazards you should be alert to. Shells and tape can be deformed by excessive heat, so don't leave cassettes on your dashboard or store them in a closed car during the summer. And dirt, grit, cigarette ashes, and the like, if they find their way into a cassette housing, can harm not only the tape, but also the decks on which it is played. Keep your cassettes in their cases when you're not playing them. If you take reasonable precautions, there's no reason why you shouldn't be able to enjoy your tapes on the road as well as at home—provided, of course, that you choose a car deck with the 70-microsecond playback-EQ option necessary for correct response with metal or chrome tapes.

Q. I have begun assembling a new stereo system, the heart of which will be a Harman Kardon Citation 17 preamp and Citation 19 power amp, which—like many others—has provision for only one pair of speakers and does not operate safely into loads of less than 4 ohms. My speakers are rated at 5

ohms, so if I buy an ambience-enhancement unit without a built-in power amplifier, how can I connect my Citation amp to drive both the front and back channels without making the load impedance too low?—Kurt Potain, Woodland, Calif.

A. You can't, and you wouldn't want to even if you could. There are now two kinds of ambience-enhancement devices on the market. Some, such as the Carver C-9 and the Sound Concepts IR-2100, require only one pair of speakers and a single amp, and they work mainly to improve the depth and solidity of the front stereo image. Others, including models from Audio Pulse, ADS, Koss, Sound Concepts, Advent, Phase Linear, Nikko, SAE, and Audionics, require another pair of speakers and a second amplifier to drive them; they work mainly to give a sense of acoustic space. The back-channel output from such a system is quite different from the front-channel output, so it cannot be run through the same amplifier. If you buy an ambience device that does not have a built-in amplifier, you will have to get a separate power amp.

Q. I have the drivers and crossovers for a pair of ESS AMT-10b loudspeakers whose cabinets were destroyed by vandals. I am going to have new cabinets made for them and have been told that, because the system uses a passive radiator, its bass response can be extended simply by increasing the volume of the enclosure. Is this so, and can it be done without otherwise impairing the speaker's performance?—William Shannon, Portsmouth, Ohio.

A. A properly designed loudspeaker is a balance of many interrelating factors, including enclosure volume, woofer mass and compliance, and the mass and compliance of the passive radiator (if any). If one of these is altered unilaterally, the almost certain result is degraded performance—as long as the system was well designed to begin with. So unless your cabinet builder has the savvy to avoid the pitfalls, ask him to copy the originals as closely as possible.

We regret that, due to the volume of reader mail we get, we cannot give individual answers to all questions.

IMMORTAL MUSIC SHOULDN'T BE KEPT ON MORTAL TAPE.



Good music never dies. Unfortunately, a lot of cassette tapes do.

At Maxell, we've designed our cassettes to be as enduring as your music. Unlike ordinary cassettes, they're made with special anti-jamming ribs that help prevent tape from sticking, stretching and tearing.

And our cassette shells are built to standards that are as much as 60% higher than the industry calls for.

So if you'd like to preserve your old favorites for the years to come, keep them in a safe place. On one of our cassettes.



IT'S WORTH IT.

High Fidelity News



Sennheiser goes for isolation

Sennheiser, a name that has become almost synonymous with open-air headphones, is offering a sealed-cup design. The Model HD-222 is said to exert very little pressure against the head yet maintains a tight seal around the ears with extremely soft and compliant cushions. The dynamic transducers employ samarium-cobalt magnets for high field intensity and low weight. Price of the HD-222 is \$120.

Circle 139 on Reader-Service Card

Nakamichi's latest glamor deck

With its calibration processor that automatically sets azimuth, bias, Dolby tracking level, and equalization prior to recording, the three-head Model 700ZXL cassette deck from Nakamichi promises a frequency response of 20 Hz to 20 kHz, $+1\frac{1}{2}$ dB (at -20 dB) from any quality ferric, "chrome," or metal tape. During recording, each of up to fifteen programs per side is infrasonically encoded with a digital address and information about the correct playback equalization and noise-reduction settings. As many as thirty commands can be programmed into the random-access music memory (RAMM) to recall programs in any sequence and repeat them as many times as desired.

Also included are defeatable multiplex and infrasonic filters to prevent an FM stereo pilot signal or the 700ZXL's own control encoding signal from causing mistracking of the noise-reduction system. The deck's LED recording-level display is of the peak-reading type. It has a self-resetting peak-hold feature and covers an unusually wide range, from -40 to $+10$ dB. Nakamichi's asymmetrical, diffused-resonance, dual-capstan drive system uses four servo motors to control capstans, reels, the cam-positioning assembly (which replaces more conventional solenoids for smoother operation), and the azimuth-alignment mechanism. A key aspect of the transport is its use of rotating parts with different masses and rotational speeds, which is said to prevent common resonance modes and thereby to reduce wow and flutter.

An outboard Dolby C device, the NR-100, is equipped with four noise-reduction circuits to facilitate accurate off-the-tape monitoring during recording. The NR-100 is designed for use only with the 700ZXL and its big brother, the 1000ZXL, and it is powered via the deck's remote-control socket, which is replicated on the optional full-function RM-300 remote-control device. The 700ZXL costs \$3,000; the NR-100 noise-reduction unit, \$230; and the RM-300, \$190.

Circle 136 on Reader-Service Card

A Fried for mid-budget moderns



Recognizing that modern programming, requiring wider dynamic range, makes ever greater demands on loudspeakers, Fried Products Company has introduced the A/2 to reproduce such sources accurately at moderate cost. The system uses an 8-inch polypropylene driver loaded with the Fried Line Tunnel—a highly damped slot port (visible at the bottom of the enclosure) whose cross-section equals the driver area—and a dome tweeter. Fried claims accuracy comparable to that of its own monitor speakers, but at a price of \$500 per pair.

Circle 143 on Reader-Service Card

TDK CREATES SA-X.

Now you can explore the far reaches of high bias.

TDK has added a new dimension to high bias recording. It's called SA-X.

SA-X emerges from the Super Avilyn technology that has set the reference standard for high bias cassettes. Beyond that, TDK engineers saw new worlds of high bias to explore. By taking two layers of Super Avilyn with different coercivities and optimally matching them, TDK creates a formulation that raises high bias to a higher level. One that approaches the sound quality of metal.

You will hear rock and jazz soar to new heights. Classical, with more of its wide dynamic range. A clarity that even the best bias couldn't give you before. With every kind of music, SA-X brings you closer to the richness of a live performance. And it will keep you there, with its flawless mechanical construction. TDK has given SA-X the Laboratory Standard Mechanism for optimal interfacing with cassette deck heads. You'll hear its consistently superior performance for years to come.

SA-X performs like no other cassette. Expect it to cost a bit more. You can also expect it to take you further into high bias than you've ever been.



TDK

The Amazing Music Machine



Sharp makes a double play

Sharp Electronics says that by August you will be able to buy its ultraconvenient VZ-3000 compact music system, featuring a vertical turntable with dual tangent-tracking arms, so that you can play both sides of the record without turning it over. The arm drive mecha-

nism includes manual positioning and cueing controls, as well as automatic programming for continuous play of both sides or for repeating one side. The system's cassette deck has a random-access feature in its Auto Program Search System. The VZ-3000 includes an AM/FM tuner and a pair of speakers in addition to the necessary switching and amplification functions. It is expected to sell for less than \$1,000.

Circle 142 on Reader-Service Card

Soundcraftsmen THE EQUALIZATION LEADER...

WHY? Because WE CARE about HOW an equalizer does its job BEST! That's the reason for Our 10-POINT "TOTAL-SYSTEM EQUALIZATION"

YOU NEED MORE THAN JUST AN EQUALIZER... FOR OPTIMUM EQUALIZATION BENEFITS, HERE ARE THE TEN ESSENTIAL ELEMENTS YOU NEED:

- 1 YOU NEED VISUAL ZERO-GAIN LEVEL INDICATION. SOUND-CRAFTSMEN combination zero-gain controls with LIGHT EMITTING DIODE indicators to show when exact zero-gain is accomplished. Adjusting zero-gain controls for equal L/R channels assures you of input to output level matching.
- 2 YOU NEED FULL-SPECTRUM BOOST OR CUT CONTROLLABILITY. SOUND-CRAFTSMEN zero-gain circuit provides an additional 18 dB control range over the full spectrum 20 to 20,000 Hz on each channel for instantaneous input/output zero-distortion signal matching.

- 3 YOU NEED AUTOMATIC CONTINUOUS OUTPUT OVERLOAD WARNING SIGNAL. SOUND-CRAFTSMEN'S 2 top L/R D's glow brightly (bottom L/R D's off) if output voltage is boosted excessively, thus eliminating the danger of distortion and/or damage to related equipment resulting from the high voltage that can be generated by any fine equalizer.
- 4 YOU NEED A POSITIVE METHOD OF READING dB SETTINGS. YOU NEED AT LEAST 30 dB TOTAL CONTROL OF EACH OCTAVE...
- 5 YOU NEED A UNIT THAT WILL ADD ZERO NOISE AND DISTORTION. SOUND-CRAFTSMEN'S signal-to-noise and distortion performance figures are far superior to most high-fidelity components. SOUND-CRAFTSMEN products are used in professional broadcast and recording systems, assuring you of completely noise-free and distortion-free operation with any system.
- 6 YOU NEED TO BE ABLE TO LOOK AT YOUR ACTUAL "EQ" CURVES.
- 7 YOU NEED THE ABILITY TO EQUALIZE TAPE RECORDINGS...



9 YOU NEED A REAL-TIME FREQUENCY SPECTRUM ANALYZER TEST RECORD. Using your own ears to read out. Every Soundcraftsmen equalizer includes a Test Record recorded and designed exclusively for Soundcraftsmen equalizers. Without any expensive test equipment or technical knowledge you can quickly tune the acoustics of your room to ±2dB, just by following the announcer's Step by Step directions.

10 YOU NEED A MEMORY SYSTEM FOR "EQ SET-RESET REFERENCING." SOUND-CRAFTSMEN provides you with a quantity of "COMPUTONE CHARTS" for recording the exact setting of each octave control for future reference and resetting. Automatic Instant Memory Programming is readily available by cutting off the Computone Chart, holding against front panel, and moving up knobs into position.

The Equalizer you buy should have all 10 of these features:

- Real-Time Frequency Analyzer Test Record
- Computone-Chart Memory System
- Two Zero-Gain controls
- EQ Tape Record • Tape Monitor
- EQ defeat • ±16/12dB octave gain
- S/N-105dB • THD 0.01%
- Cabinet included

\$249



FREE! 16-page Full-Color Brochure

Includes TEST REPORTS, complete specifications, Class "H" amplifier REPORT, EQ COMPARISON CHART, and the "WHYS & HOWS" of equalization—an easy-to-understand explanation of the relationship of acoustics to your environment. Also contains many unique IDEAS on "How the Soundcraftsmen Equalizer can measurably enhance your listening pleasures." "How typical room problems can be eliminated by Equalization." And a 10-POINT "DO-IT-YOURSELF" EQ evaluation checklist so you can FIND OUT FOR YOURSELF WHAT EQ CAN DO FOR YOU!

SEND \$6.00 FOR EQUALIZER-EVALUATION KIT: 1-12" LP TEST RECORD, 1 SET OF COMPUTONE CHARTS, 1 COMPARISON CONNECTOR CABLE, AND 1 INSTRUCTION FOLDER.



SOUND-CRAFTSMEN INC., 2200 So. Ritchey, Santa Ana, CA 92705 • CANADA: E.S. Gould Marketing, Montreal H4T 1E5

Circle 29 on Reader-Service Card



Super-quiet reception from Sony

The ST-J75 tuner, which employs what Sony calls Direct Comparator circuitry, is rated for astonishingly high signal-to-noise ratios: 87 dB in stereo and 92 in mono. The digital tuning circuitry incorporates quartz-crystal locking of synthesized frequencies. A programming system allows you to choose the order in which the eight station memories will be selected and will retain the instructions with the power off; timed automatic recording from multiple stations thus is possible while you are away from home. The tuner sells for \$450.

Circle 144 on Reader-Service Card

Matsushita adopts Philips/Sony disc

Having suffered once already in the furor over competing quadriphonic disc technologies, Matsushita Electric Industries—parent company of JVC and Panasonic—is attempting to forestall potential confusion in the developing digital audio disc field by redirecting its thrust away from its JVC-developed Audio High Density disc and toward the Philips/Sony laser-based Compact Disc system. A spokesman told us Matsushita believes that the Japan Digital Audio Disc Council will soon recommend the Philips/Sony approach as an industry standard and that it "has to be prepared." The company's digital players are expected to be introduced some time in late 1982.

Some confusion remains, however, as to the future of the Audio High Density disc. JVC adamantly maintains that AHD will eventually come to market.



mounted multiradial diamond tip and has a recommended vertical tracking force range of 0.8 to 1.6 grams.

Circle 141 on Reader-Service Card

Rugged power from Bipolar

The Model 850 from Bipolar Electronic Systems is a wideband, low-feedback power amp rated at 85 watts (19%

d8W) per channel into 8 ohms. Each four-transistor output stage is engineered to dissipate up to 1,000 watts; extruded aluminum heat sinks with 400 square inches of surface area keep these transistors within safe operating temperatures. The net effect of such rugged design, claims Bipolar, is the ability to drive extremely complex and demanding speaker loads without current limiting. The Model 850 costs \$1,600.

Circle 138 on Reader-Service Card

Cramolin combats gremlins



Caig Laboratories has an electrical-contact care package it calls the Cramolin Audio Kit, containing two vials of fluid for use on plugs, jacks, switches, or pots. CR-10 is essentially a remedial cleaner

formulated to remove oxidation products that introduce noise and demodulated radio signals (RFI) into your audio. CR-20, primarily a preventive, is intended to seal contact surfaces against air and moisture so that corrosion doesn't form. The kit sells for less than \$10.

Circle 147 on Reader-Service Card

Plug-in pickups for Technics



Audio-Technica now has three pickups designed specifically to mate with the tonearm on Technics' family of compact linear-tracking turntables: the SL-15, SL-10, and SL-7. The top of the new pickup line, the \$200 Model AT-152LP, has a claimed frequency response of 5 Hz to 35 kHz, with a channel separation of greater than 30 dB. It features a nude-

the best value in hi-fi

Three V15 Type IV Technological Breakthroughs

Dynamic Stabilizer Suspended from two viscous-damped bearings, acts like a shock absorber to maintain constant cartridge-to-record distance and uniform tracking force; eliminates record groove skipping caused by warp; cushions the stylus from accidental damage.

Electrostatic Neutralizer 10,000 conductive graphite fibers discharge static electricity from the record during play. Eliminates attraction of dust and tracking force variations caused by static charges.

Telescoped Shank Greatly improves trackability at the critical middle and high frequencies. Lowest effective mass, with no sacrifice of necessary stiffness or strength.

Plus a Studio Cartridge Innovation

SIDE-GUARD Stylus Deflector A unique lateral deflection assembly developed by Shure for its professional studio cartridge—prevents the most common cause of stylus damage by withdrawing the *entire* stylus shank and tip safely into the stylus housing before it can be bent by sideways thrusts.

In 6 Models to Match Any Turntable, Any Budget All these features are incorporated into six moderately-priced cartridges—with tracking forces ranging from 3/4 to 3 grams, and three different stylus configurations—including the revolutionary distortion-reducing Hyperelliptical stylus. Headlining the M97 Series is the M97HE-AH, featuring a precision aligned cartridge-headshell and adjustable overhang.

For all the facts see the February 1981 Issue of High Fidelity or circle 50 on Reader Service Card



THE HEADLINER™
Model M97HE-AH
with adjustable integrated headshell

M97 SERIES phono cartridges



Shure Brothers Inc., 222 Hartrey Ave.
Evanston, IL 60204
In Canada: A. C. Simmonds & Sons Limited
Manufacturers of high fidelity components,
microphones, sound systems and related circuitry.



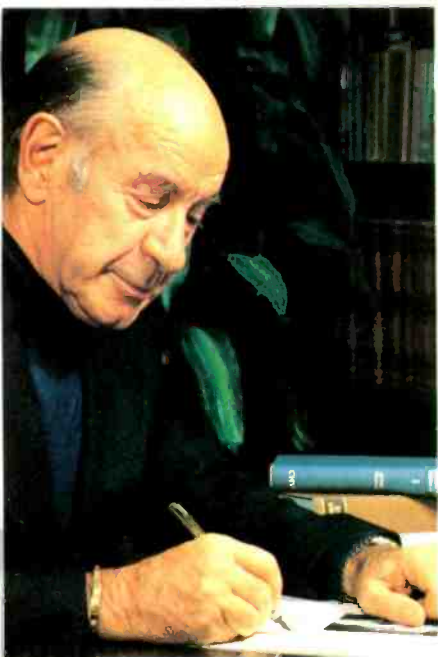

ERICH LEINSDORF



EUGENE ORMANDY



SEIJI OZAWA



CARLO MARIA GIULINI

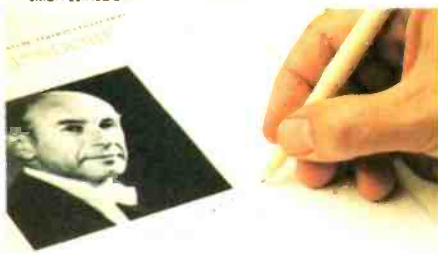

SIR GEORG SOLTI



SIR COLIN DAVIS

An unprecedented opportunity in record collecting from The Franklin Mint Record Society

THE GREATEST RECORDINGS OF THE WORLD'S GREAT CONDUCTORS

PERSONALLY HAND-SIGNED BY EACH CONDUCTOR.

Special Signature Edition permanently limited to 5,000.

Each one of these great conductors will personally sign a special edition of their finest recordings for you. Zubin Mehta, Eugene Ormandy, Seiji Ozawa, Sir Georg Solti, André Previn, Erich Leinsdorf, Sir Colin Davis, Claudio Abbado, Carlo Maria Giulini, Lorin Maazel, Neville Marriner, Daniel Barenboim, Antal Dorati, Bernard Haitink, Rafael Kubelik.

maestro brings his own unique style, his own special magic to the performance of the world's most glorious and immortal works of music.

Over the years, today's great conductors have recorded virtually all of the masterpieces of the world's great composers. And now the very finest of all these recordings have been selected with the approval of the individual conductors themselves—and these superb works will comprise "The Great Conductors Collection." The first edition of this collection will be a special Signature Edition. It will be strictly limited by number. And every album in this limited edition will be personally signed by one of the fifteen conductors represented.

It is rare that a major conductor autographs his record albums. And it would be virtually impossible to acquire a col-

lection of the greatest recordings signed by leading conductors of our day if you attempted to obtain them individually. But now you can own a complete collection of the greatest recordings ever made by the world's foremost conductors—signed personally for you.

A collection that will make recording history

These conductors are among the most distinguished figures in the world of music. Internationally acclaimed maestros whose achievements are known on every continent. In this collection, their greatest recordings are brought together for the first time. The collection has been assembled by The Franklin Mint Record Society in cooperation with all of the world's leading record companies.

The recordings feature: Zubin Mehta

IN THE WORLD OF MUSIC, the great conductors reign supreme. Brilliantly interpreting the music of the masters. Providing their creative genius to musicians and performers. And offering untold joy and inspiration to their audiences. Each



PH. MÉHIS



PH. PRÉVIN



conducting the New York Philharmonic, with Isaac Stern as soloist, in a landmark performance of the Brahms Violin Concerto. Seiji Ozawa and the Boston Symphony Orchestra in a performance of Ravel's masterpiece "Daphnis et Chloé". Sir Georg Solti's masterful reading of Beethoven's Ninth Symphony with the Chicago Symphony Orchestra. Lorin Maazel conducting and appearing as the violin soloist in Mozart's A Major and G Major Violin Concertos. And other performances that feature artists like Pinchas Zukerman, Vladimir Ashkenazy, Rudolf Serkin and Sviatoslav Richter.

A private library of monumental recordings—autographed by each conductor. To be enjoyed by every member of the family and kept permanently as the cornerstone of your music library.

Superior records of unique proof-quality

The records are exceptional for both their clarity and tonal quality. A superior vinyl material, containing its own anti-static element, is used in the production of these records. This exclusive vinyl material, together with the process by which the pressing is made, results in a record that is more rigid, durable and resistant to dust. A record that has true fidelity, clearer sound quality and a long life.

To further assure their quality, the Franklin Mint records are pressed in a dust-free, atmosphere-controlled "clean room," where careful methods of produc-

tion and inspection assure the high quality of these great recordings. The result is a collection of proof-quality records—attested to by the mintmark of The Franklin Mint on each record.

Luxurious library albums

There will be a separate library album for each conductor, and each album will contain 5 long-playing records. These custom-designed, hardbound library albums will make an impressive addition to your home as well as affording permanent protection for the records.

A specially-written biography and commentary will be bound into each album, and the title page will be hand-signed by the conductor represented.

Limited Signature Edition

The Signature Edition of "The Great Conductors Collection" will not be sold in record stores. It can be obtained only by subscription. Furthermore, each conductor will sign only 5,000 of his albums—so the edition will be permanently limited.

The fifteen library albums (each containing 5 records) will be sent to you conveniently at the rate of one every other month, and the price per record is just \$9.75—*guaranteed* for every record in the collection in spite of strong inflationary pressures in the record industry.

To take advantage of this unprecedented opportunity, mail the application at right to The Franklin Mint Record Society, Franklin Center, PA, by May 31, 1981.

© 1981 FMRS
SUBSCRIPTION APPLICATION

THE GREAT CONDUCTORS COLLECTION

Signature Edition

Limit: 5,000 • Please mail by May 31, 1981

The Franklin Mint Record Society
Franklin Center, Pennsylvania 19091

Please enter my subscription for the *Signature Edition* of "The Great Conductors Collection," consisting of 15 library albums, each containing 5 proof-quality records—personally hand-signed by the conductor represented. The issue price for each record is \$9.75* plus \$1.25 for packaging, shipping and handling.

I need send no money now. Please bill me for each album in two equal monthly amounts of \$27.50* each (including handling), the first payment due in advance of shipment.

Signature _____

ALL APPLICATIONS ARE SUBJECT TO ACCEPTANCE

Mr. _____

Mrs. _____

Miss _____

PLEASE PRINT CLEARLY

Address _____

City _____

State, Zip _____

NOTE: Each conductor will sign only 5,000 of his own album. Thus, the Signature Edition is strictly limited. If the limit is reached by the time your application is received, it must be refused.

- 1939...FIRST DIRECT-DRIVE TURNTABLE SYSTEM.
- 1951...FIRST MOVING-COIL CARTRIDGE.
- 1972...FIRST DIGITAL (PCM) RECORDING.

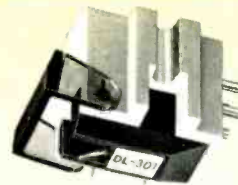

DL-301 To control resonances, the cantilever fulcrum of all Denon MC cartridges is independent of the damping rings. The DL-301 uses two damping rings, each optimized for its portion of the frequency range.

In addition a special magnetic structure eliminates pole pieces, reducing both weight and cost for the best sonic value in MC cartridges today.

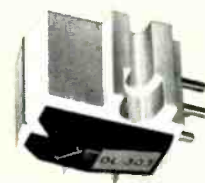

DL-303 The first of the DL-300 Series, the DL-303 has repeatedly been judged "best of its class." It features Denon's cross-shaped coil and dual cantilever design and a special tensioning device that maintains ultra-high performance for extended periods.



DL-305 The ultimate Denon cartridge for 1981. It combines the cross-shaped coil, dual-section cantilever, double damping, special tensioning device, advanced stylus shape and amorphous boron cantilever (for the greatest rigidity-to-mass ratio known to man). The DL-305 is the top of the Denon line and, therefore, the finest cartridge available today.

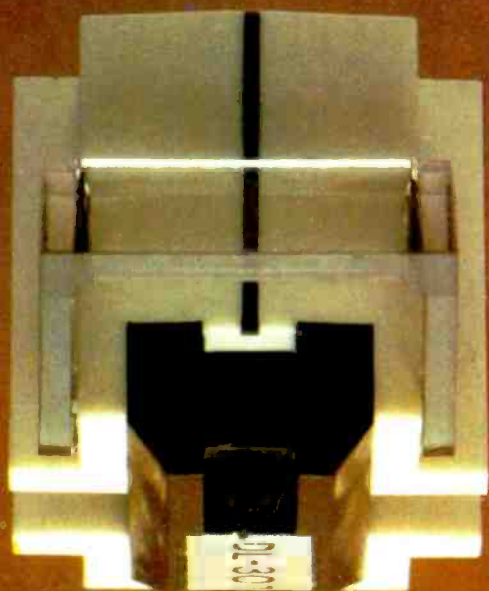

1981...DENON DL-300 SERIES ULTRA-LOW MASS MOVING COIL PHONO CARTRIDGES.

While many manufacturers tout Moving-Coil cartridges as their latest technological advance, the truth is that Denon developed its first moving-coil cartridge over 30 years ago. This design became the basis of the famed DL-103 Series, a medium-mass moving-coil cartridge line that even today is a reference standard among high quality phono pickups.

Denon's new DL-300 Series, 30 years later, represents an equally significant introduction. With the lowest stylus tip masses of any stereo cartridges in history, achieved through the use of a dual-section cantilever and cross-shaped coil (both developed by Denon), they depict nuance and depth in music with unsurpassed sonic accuracy.

Denon's DL-300 Series Cartridges for 1981: Three new musical instruments from the company where innovation is a tradition.

DENON
Imagine
what we'll
do next.

Denon America, Inc.
27 Law Drive, Fairfield, N.J. 07006

New Equipment Reports

Preparation supervised by Robert Long, Peter Dobbin, Michael Riggs, and Edward J. Foster. Laboratory data (unless otherwise noted) supplied by CBS Technology Center or Diversified Science Laboratories.

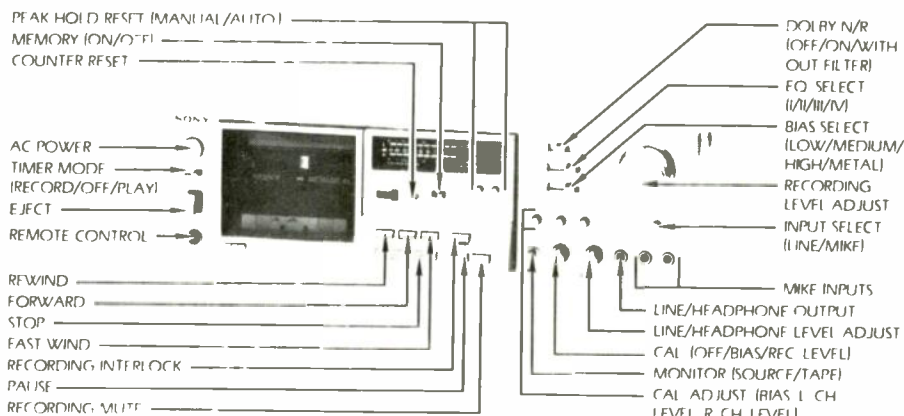

Sony Concocts A Super Deck

Sony TC-K81 cassette deck

PLAYBACK RESPONSE (TDK test tape, -20 dB DIN)

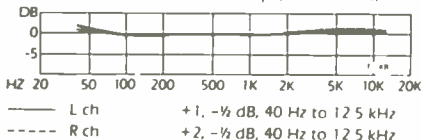

RECORD/PLAY RESPONSE, TYPE 2 TAPE (-20 dB)

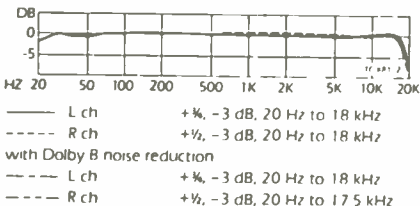

RECORD/PLAY RESPONSE, TYPE 4 TAPE (-20 dB)

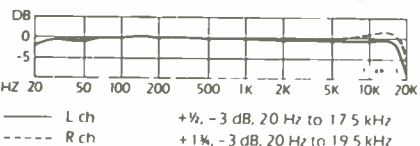

RECORD/PLAY RESPONSE, TYPE 1 TAPE (-20 dB)

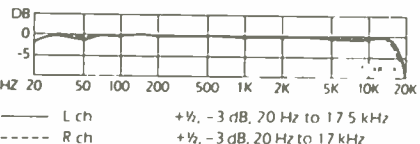

S/N RATIO (re DIN 0 dB, R/P, A-weighted)

	Type 2 tape	Type 4 tape	Type 1 tape
without noise reduction	57½ dB	56½ dB	54 dB
with Dolby B	64½ dB	63½ dB	62½ dB

METER READING FOR DIN 0 DB +2 dB

METER READING FOR 3% DISTORTION (at 333 Hz)

Type 2 tape	+4 dB
Type 4 tape	+5½ dB
Type 1 tape	+2 dB

Sony TC-K81 cassette deck, in metal case. Dimensions: 17 by 5 inches (front panel), 10½ inches deep plus clearance for controls and connections. AC convenience outlet: one unswitched (300 watts max.). Price: \$550; optional RM-50 remote control, \$50. Warranty: "limited," two years parts and labor. Manufacturer: Sony Corp., Japan; U.S. distributor: Sony Corp. of America, 9 W. 57th St., New York, N.Y. 10019.

To a large extent, Sony wrote the book on the modern consumer tape recorder. It wasn't the only company setting the pace during the years of rapid growth both before and after the introduction of the compact cassette, but it's one of the few brand names that stayed in the forefront throughout the period, almost without exception outlasting its early rivals and predated its present-day competitors. And the message of the TC-K81—a tough-minded contender that makes a strong bid for the role of pacesetter among monitoring-head cassette decks in the \$500-600 range—is that the Sony name means today much what it did a generation ago.

The measurements from the Diversified Science Laboratories test bench show the deck at its best and at its worst. The response curves not only are very extended, but also are exceptionally flat, at almost 2% fast, the transport speed is well beyond the "magic" 1% that, rule of thumb says, speed error should not exceed. This "fault" is a benign one in a consumer deck and is more than balanced by the solid performance elsewhere—capped by those excellent response curves.

They were made in conformance with the instruction manual, which implies that you should tweak the bias and sensitivity controls individually for each tape you use—always a good idea for best possible results. DSL used Sony's own tapes: FHF "chrome" for Type 2, Metallic for Type 4, and HFX for the Type 1 ferric. The deck was, in theory, preadjusted for these tapes, and DSL did find that only slight adjustment away from the detents was called for in each case. (Since absolute consistency is more than the present state of the tape-manufacturing art can manage, some slight tweaking for optimum results is to be expected.)

The markings on the main bias selector switch are LOW (with no further identification), MEDIUM (for IEC Type I ferric and Type III ferrichrome), HIGH (for Type II chrome/ferricobalt), and METAL (Type IV). The LOW range obviously corresponds to what we have been calling Type 0—the "old-fashioned" ferrics—and proves to be an excellent performer with tapes in this group. Since it gets the best, which is really quite good, out of these moderate-price tapes, we consider the feature very welcome. If, like us, you resent being left with the choice of either paying a premium or getting muffled, overbiased recordings, this could be the feature that clinches the choice, since few competing decks offer it.

The adjustment process is unlike that on any deck we've worked with before. Once you've chosen the basic switch positions for the tape you're using, you go into the recording mode and turn the calibration knob away from OFF. Output from the deck ceases. There are no test-tone outcries to threaten your tweeters or disturb your neighbors. At the same time, the top end of the meters (above the 0-dB indication) converts to ½-dB steps. When you set the calibration knob to REC LEVEL (adjusting for tape sensitivity), the output of each channel shows on its allotted



Comprehensive bias and EQ options feature two-tone bias adjustment using both channels of display.

DISTORTION (third harmonic, at -10 dB DIN)

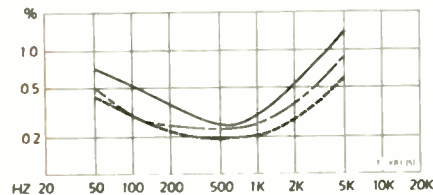

— Type 2 tape	≤ 1.4%, 50 Hz to 5 kHz
- - - Type 4 tape	≤ 0.60%, 50 Hz to 5 kHz
- · - Type 1 tape	≤ 0.87%, 50 Hz to 5 kHz

ERASURE (333 Hz, re DIN 0 dB)

Type 2 tape	75 dB
Type 4 tape	69 dB

CHANNEL SEPARATION

49 dB

SPEED ACCURACY

1.7% fast, 105 to 127 VAC

WOW & FLUTTER (ANSI/IEEF weighted peak)

	average	maximum
playback	± 0.08%	± 0.10%
record/play	± 0.09%	± 0.11%

SENSITIVITY (re DIN 0 dB, 333 Hz)

line input	110 mV
mike input	0.40 mV

MIKE INPUT OVERLOAD (clipping)

44 mV

OUTPUT (from DIN 0 dB)

0.81 V

Report Policy: Equipment reports are based on laboratory measurements and controlled listening tests. Unless otherwise noted, test data and measurements are obtained by CBS Technology Center, a division of Columbia Broadcasting System, Inc., and Diversified Science Laboratories. The choice of equipment to be tested rests with the editors of HIGH FIDELITY. Samples normally are supplied on loan from the manufacturer. Manufacturers are not permitted to read reports in advance of publication, and no report, or portion thereof, may be reproduced for any purpose or in any form without written permission of the publisher. All reports should be construed as applying to the specific samples tested. HIGH FIDELITY, CBS Technology Center, and Diversified Science Laboratories assume no responsibility for product performance or quality.



Level display's peak-hold cursors (here between +2 and +4 in both channels) retain maxima for a moment in AUTO mode to aid reading values. In MANUAL, readings remain until higher level occurs or display is reset, permitting unattended monitoring of maximum source levels.

portion of the meter and is individually adjustable; when you choose BIAS, one display element shows a 400-Hz tone and one an 8-kHz tone, making it easy to tell when both tones are at the same output level—which they are when the bias is correctly adjusted. If you later rewind the tape and play the test tones, you will find that the levels are far below the apparent 0-dB level (doubtless to avoid any hint of compression in the 8-kHz tone, which would compromise the adjustment), meaning that the sensitivity of the metering alters, as do the calibration steps, during adjustment.

The metering is equally well conceived for normal recording, though the fact that the display segments don't correspond to unequivocally marked calibration points in most of the range may be off-putting at first if you're used to a neater arrangement—or, at least, one that appears so. Calibration is from -40 to +8 on the main scale, with marked 2-dB increments in the critical range and a relatively high 0 dB, reflecting the display's ultrafast peak-reading response. This very good scheme, combined with manual instructions that make unusually thorough allowance for both program demands and tape capabilities, constitutes an excellent metering system, in our view. Add to this an exceptionally good peak-hold system, which gives you the option of either an automatic reset (the cursor representing the last maximum disappears after a second or so) or manual (the cursor remains until you again press the MANUAL button), and you have one of the finest consumer metering systems around and a very strong argument in favor of the TC-K81.

The solenoid transport controls work well, with a PAUSE that is relatively quick for such controls. It leaves a blank that lasts, at most, about 1/2 second—an intrusive hiatus if you're trying to create the impression of continuous sound but of no practical consequence in most consumer applications. It also leaves behind a "pop" loud enough to be heard in surrounding silence but dull enough to disappear altogether in some situations.

The back panel gives you two line outputs, one of them controlled by the front-panel output-level knob. This control also adjusts the headphone output, which could be used as yet a third line output for temporary lashups if you choose. We figure many owners will use the fixed-level back-panel output for normal line connections and save the variability for their headphones. (DSL measured accordingly, through the fixed output.) Also on the back panel is an accessory AC outlet, which not only is a convenience, but once was considered an obligatory feature of all decks that (like this one) offer timer start. The idea is that you can plug your tuner or receiver into this outlet so that it, too, will fire up when the timer delivers the juice to the deck.

The TC-K81 is not an "everything" deck, by any means (there is no line/mike mixing, for example); that's part of its strength, because the quality of what's included is not compromised. It's a really tough job making decisions about which features to include and which to exclude: Marketing reputations hang on the results, and a career can be destroyed by one wrong guess. That's one reason we

often see over-featured models. Sony has had the intestinal fortitude to go for a format that would neither elaborate needlessly nor shirk nice details. (Note, for example, that, if you press REWIND and FORWARD simultaneously, the MEMORY feature converts from MEMORY STOP to MEMORY PLAY without making you switch modes.) We don't see how they could have done a better job of achieving that objective

Circle 131 on Reader-Service Card

A Quick Guide to Tape Types

Our classifications, Types 0 through 4, are based largely on those embodied in the measurement standards now in the process of ratification by the International Electrotechnical Commission. The higher the type number, the higher the tape price generally is in any given brand. Similarly, the higher type numbers imply superior performance, though—depending in part on the deck in which the tape is used—they do not guarantee it.

Type 0 tapes represent "ground zero" in that they follow the original Philips-based DIN spec. They are

ferric tapes, called LN (low-noise) by some manufacturers, requiring minimum (nominal 100%) bias and the original, "standard" 120-microsecond playback equalization. Though they include the "garden variety" formulations, the best are capable of excellent performance at moderate cost in decks that are well matched to them.

Type 1 (IEC Type I) tapes are ferrics requiring the same 120-microsecond playback EQ but somewhat higher bias. They sometimes are styled LH (low-noise, high output) formulations or "premium ferrics."

Type 2 (IEC Type II) tapes are intended for use

with 70-microsecond playback EQ and higher recording bias still (nominal 150%). The first formulations of this sort used chromium dioxide, today they also include chrome-compatible coatings such as the ferricobalts.

Type 3 (IEC Type III) tapes are dual-layered ferrichromes, implying the 70-microsecond ("chrome") playback EQ. Approaches to their biasing and recording EQ vary somewhat from one deck manufacturer to another.

Type 4 (IEC Type IV) are the metal-particle, or "alloy" tapes, requiring the highest bias of all and retaining the 70-microsecond EQ of Type 2.

An Epicure for Epicures

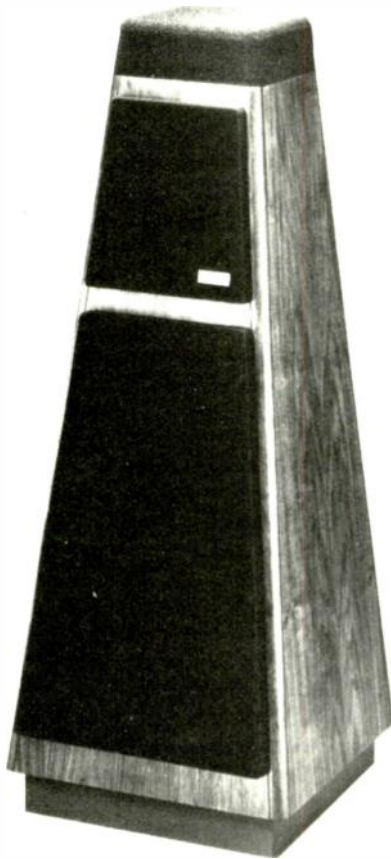

Epicure 3.0 Series II loudspeaker

ANECHOIC RESPONSE CHARACTERISTICS (0-dBW input)

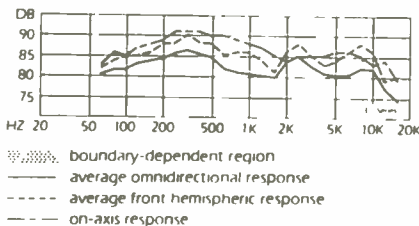

Epicure 3.0 Series II loudspeaker system, in wood cabinet with walnut veneer finish. Dimensions: 16½ by 16½ inches (base), 41½ inches high. Price: \$475. Warranty: "limited," ten years parts and labor. Manufacturer: Epicure Products, Inc., 1 Charles St., Newburyport, Mass. 01950.

Though opinions are bound to be divided on the visual appeal of the top-of-the-line Epicure 3.0 Series II loudspeaker, its design is certainly one of the most interesting—and, in our opinion, arresting—manifestations of form following function. The tall truncated pyramid, with sharply sloping sides and rounded corners, enables each driver in this three-way acoustic suspension system to be mounted for minimum interference from effects induced by the room and enclosure.

Starting from the bottom, the 10-inch woofer is approximately 1½ feet above the floor, curtailing the influence of that boundary on bass response. The cabinet narrows rapidly above the woofer and, at the point where the midrange driver is mounted, is only about 2 inches wider than that driver's nominal 6-inch diameter. The narrow baffle combines with the cabinet's rounded edges to diminish the possibility of diffraction effects. The 1-inch inverted-dome tweeter is mounted in its own spherical enclosure atop the cabinet, above a foam pad to absorb spurious reflections. Epicure claims that loading the tweeter in its own sealed enclosure not only further reduces diffraction, but helps to increase high-frequency output. The low-frequency and midrange cones are concealed by separate removable foam grilles, while the tweeter is shrouded in a black foam hood.

Other elements of note include the use of ferrofluid in the voice-coil gaps of both the tweeter and midrange drivers to increase power-handling capacity and to damp their motion. A special lead and asphalt compound is said to line the interior walls of the enclosure to damp cabinet vibrations and thus reduce still another possible source of coloration. Finally, the tweeter has a three-position level control recessed into the foam pad behind it. Connection to the amplifier is via screwdown posts on the underside of the enclosure.

According to the data from CBS Technology Center, the 3.0 Series II can handle prodigious amounts of power with nary a complaint. It breezed through the 20-dBW (100-watt) continuous-tone test and exceeded distortion limits in the pulsed-power tests only when input reached the equivalent of 3 kilowatts—producing a thunderous sound pressure level of 126 dB in the process. Frequency-response measurements depict remarkably extended bass response, with lots of output down to 30 Hz. A glitch in the response curves at 1.6 kHz with the "standard" microphone placement (which takes the center of the front surface as the on-axis position) disappeared when CBS raised the microphone to the tweeter's axis. The tweeter level control shows admirably regular response, matching the -3 and -6 dB detent positions with just about that much cut from 2 kHz up.

Impedance values remain relatively consistent for a system of this complexity. The nominal impedance of 4.4 ohms occurs at 200 Hz. Aside from a minimum of 3.6 ohms at 1.1 kHz, where there are few musical fundamentals, the impedance curve stays between 5 and 8 ohms. This and the system's moderately high efficiency make it an "easy" load for most amplifiers.

At moderate listening levels, both second and third harmonic distortion products remain well below ½% over most of the speaker's range. At loud levels

AVERAGE OMNIDIRECTIONAL OUTPUT
[250 Hz to 6 kHz]
83 dB SPL for 0 dBW (1 watt) input

CONTINUOUS ON-AXIS OUTPUT (at 300 Hz)
111 dB SPL for 20 dBW (100 watts) input

PULSED OUTPUT (at 300 Hz)
126 dB SPL for 34% dBW (3,000 watts) peak

"NOMINAL" IMPEDANCE 4.4 ohms

APPROX. TWEETER CONTROL RANGE (re "flat")
-3, -6 dB above 2 kHz

(100 dB), third harmonics show only the smallest rise, but second harmonics rise appreciably, averaging a bit more than 1% from 200 Hz to 1 kHz. Scope photos of tone-burst response show virtually perfect reproduction of 300-Hz pulses but some evidence of overhang with 3-kHz bursts.

In the listening room, auditioners were unanimous on the 3.0 Series II's remarkable imaging qualities. Assuming well-recorded material, these speakers can reproduce marvelously detailed sound fields, with extraordinary depth and width. One panelist commented that the apparent width of the stereo range reminded him of the effects possible with a stereo image enhancer! Our listeners also were enthusiastic about the reproduction of instrumental timbres, though most preferred to set the tweeter level control to -3 dB. High-frequency transients—the slap of a wire brush on a cymbal or staccato piano notes—emerged with clarity. Likewise, upper bass and midrange frequencies sounded distinctly uncolored. Some auditioners, however, did point to a slight heaviness in the deep bass.

Considered in toto, the 3.0 Series II is a fine loudspeaker. Though we admire it for both its sonic character and its striking physical appearance, there are doubtless some who will dismiss it on the latter ground. We never claimed to be interior decorators, but we'd consider it a shame if you missed an opportunity to audition such an extraordinary loudspeaker simply because of its shape. In our view, it's Epicure's best yet.

Top Pickup from Micro-Acoustics



Micro-Acoustics 630 phono pickup

FREQUENCY RESPONSE & CHANNEL SEPARATION
(test record: STR-170)

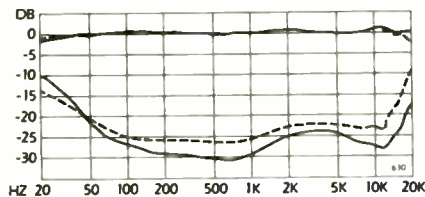

Frequency response
—— L ch $\pm 1\frac{1}{2}$ dB, 20 Hz to 20 kHz
----- R ch +1, -3 dB, 20 Hz to 20 kHz
Channel separation ≥ 25 dB, 100 Hz to 1.2 kHz;
 ≥ 15 dB, 30 Hz to 17 kHz

SENSITIVITY (at 1 kHz) 0.87 mV/cm/sec

CHANNEL BALANCE (at 1 kHz) $\pm < \frac{1}{4}$ dB

VERTICAL TRACKING ANGLE
16-20° (see text)

LOW-FREQUENCY RESONANCE (in SME 3009)
vertical 8.6 Hz, 12 dB rise
lateral 8.1 Hz, 5 dB rise

Micro-Acoustics 630 electret phono pickup, with Micro Point multiradial diamond stylus (approx. 5 by 18 micrometers). Price: \$250; R-630 replacement stylus, \$115. Warranty: "limited," three years parts and labor, excluding stylus wear. Manufacturer: Micro-Acoustics Corp., 8 Westchester Plaza, Elmsford, N.Y. 10523.

If you are still debating the relative virtues of moving-coil and fixed-coil pickups, you should be aware of still another type: the no-coil pickup. In fact, Micro-Acoustics eschews both coils and magnets in favor of an electret transduction element in its top-of-the-line Model 630 and its other three System II cartridges. Micro-Acoustics, which has made this type of pickup for several years, claims electrets have many advantages over coil/magnet generating systems, including a superior ability to reproduce transient musical waveforms. In addition, the element's inherently low inductance (in combination with a built-in passive microcircuit) is said to make each System II pickup remarkably insensitive to preamp/cable loading conditions. The Model 630, for instance, is claimed to deliver essentially the same frequency response when operating into capacitive loads of 25 to 1,500 picofarads and resistive loads of 5,000 to 100,000 ohms.

Removing the magnets, coils, and pole pieces from a cartridge, and housing it in a carbon-fiber case instead of metal, also substantially reduces its mass. On the scales at Diversified Science Laboratories, the 630 weighed in at a scant 4.2 grams; if your arm requires even lower mass for optimum performance, you can remove one or more of the three $\frac{1}{2}$ -gram slugs from a snap-open compartment on the pickup body. Conversely, should more mass be needed to achieve correct arm balance, a 1-gram slug can be mounted in the headshell along with the pickup. The cantilever is formed of high-purity beryllium for sufficient stiffness at reduced mass. Special iridium-platinum material is used in one of the unit's multiple damping devices. Twenty-four-carat gold wire was chosen for all internal connections because of its high conductivity. And the Micro Point diamond stylus is said to be the smallest tip ever developed for playback.

On the test bench, the 630 acquitted itself with uniformly high marks. With vertical tracking force set at 1.0 gram, the mean of the manufacturer's recommended range, sensitivity came in at a generous 0.87 millivolt with $\frac{1}{4}$ dB of difference between channels. The cartridge's tracking ability is superb; in the 300-Hz test, it easily negotiated the highest velocity band available on the CBS test record. Separation through the critical midrange area is outstanding, well in excess of 25 dB.

To determine vertical tracking angle, DSL is using a special test record cut by Telefunken in Germany according to DIN specification No. 45,542. The record contains two sets of intermodulation bands for IM products of, respectively, 1 and 5 kHz. Each set is divided into separate bands, cut at VTAs ranging from 6 to 30 degrees. Theoretically, when the VTA of the pickup matches the VTA of the test band, second-order IM distortion should show the same null point in both the 1-kHz and 5-kHz tests. DSL's tests, however, resulted in different VTAs for each IM set: 20 degrees in the 1-kHz bands, and 16 degrees in the 5-kHz bands. Both figures are closer to European and American standards than we have seen in pickup tests using the FM method reported

(Continued on page 29)

Circle 5 on Reader-Service Card ▶

The Tape Guide

Professional-I.
The one tape that stands up when you crank it up.



Premium ferric oxide tapes have more headroom which allows higher maximum recording levels (MRL). Among all premium ferric oxides PRO I has the best MRL for loud recordings. Uniform maghemite particles provide increased headroom for very accurate and loud recordings with virtually no distortion. In the fundamental music range (20Hz-5kHz) PRO I can be recorded louder and driven harder than even high bias tapes. PRO I is the internationally accepted reference tape, whose bias point is specifically matched to the Type I/normal/ferric position on today's high quality cassette decks.

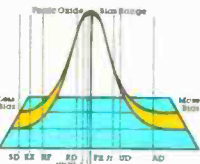
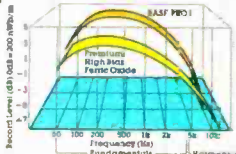

PRO I is designed to be compatible with the normal bias setting of most cassette decks than any other ferric tape.

Greater headroom allows more distortion-free recording.

Professional-II.
The world's quietest tape puts nothing between you and your music.



High bias tapes consistently provide wider frequency response and less tape noise (hiss or background noise) than any other tape type. Among premium high bias tapes PRO II is in a class by itself. It is the second generation chromium dioxide tape with superb frequency response and outstanding sensitivity in the critical (10kHz-20kHz) high frequency range. It also has the lowest background noise of any other competitive tape available today. PRO II will capture the many subtle harmonics of the most demanding recordings and play them back with the reality and presence of a live performance. PRO II is the tape for the Type II/chrome/high bias position that comes closest to Metal tape performance for half the price.



The pure chromium dioxide particles in the PRO II unlike ferric oxide particles, are homogeneously shaped and uniaxially used to give this tape superior performance.

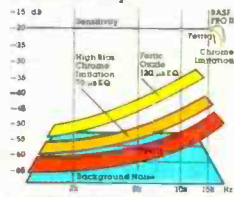

PRO II has the best high-frequency sensitivity and the least background noise of any high bias tape.

Professional-III.
The only car tape that eliminates the car.



Ferrichrome tapes combine the benefits of chromium dioxide and ferric oxide tapes for superior performance in car stereos. The top layer is pure chromium dioxide for unsurpassed highs and low background noise. The bottom layer is ferric oxide for superior lows and great middle frequencies. And it also gives you higher recording levels, so you get clearer, louder playback without cranking up your volume control to compensate. PRO III is the ideal tape for car stereo systems and performs just as well in the home on the Type III/ferrichrome position.

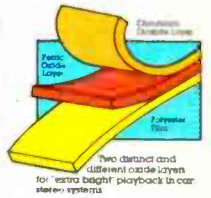

Two distinct and different oxide layers for "extra bright" playback in car stereo systems.

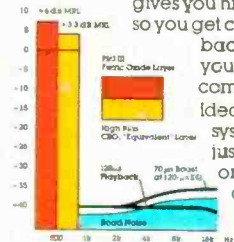

PRO III provides a higher maximum recording level (MRL) than high bias tapes, and effectively boosts the highs to overcome road and car noise.

GUARANTEE OF A LIFETIME

"The guarantee of a lifetime." All BASF tape cassettes come with a lifetime guarantee. Should any BASF cassette ever fail—except for abuse or mishandling—simply return it to BASF for a free replacement.



Patented "Jam-Proof" Security Mechanism (SM).™ All BASF tape cassettes come with our exclusive SM—Security Mechanism. Two precision arms actually "guide" the tape in a smooth, exact and consistent track, so that winding is always even, no matter how often the cassette is played. SM puts an end to tape jamming.



BASF

Crosby Drive, Bedford, Massachusetts 01730

Now with the new BASF cassette shell. Greater precision for greater performance.

Sansui "Z" Receivers give you a spectrum worth analyzing.

What frequency range does your favorite singer's voice most commonly fall into? What about your favorite instrument?

How accurately does your cartridge handle those frequencies? How about your tape deck?

The newest Sansui "Z" Receivers all have an ingenious spectrum analyzer that answers these and other questions by letting you see exactly what you hear.

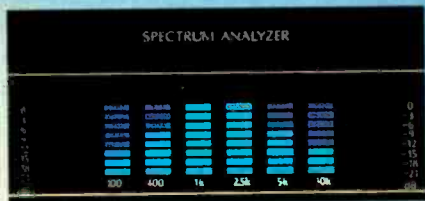

And it's what you hear that makes Sansui so special.

SANSUI—THE LEADER IN DC TECHNOLOGY. The DC-Servo Amp brings you coloration-free, superbly defined reproduction with the healthy, realistic bass response that only a DC configuration can provide. Gone are unwanted ultra-low frequencies—like record warps and tonearm resonance. What you hear is a clean, tight, transparent sound that sets a new standard for receiver performance.

SYNTHESIZED DIGITAL TUNING. You can't mistune a Sansui synthesized digital receiver. Not even a little. Press the up/down tuning buttons.

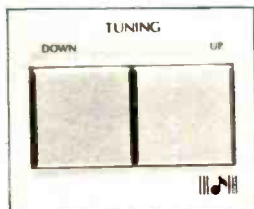

The digital circuitry ensures that every station received is automatically locked in for lowest possible distortion, with its frequency indicated both on a digital readout and by a LED indicator along an analog type dial.

12 PRESET STATIONS. To make FM and AM tuning still easier, up to 12 user-selected stations may be "stored" in all "Z" Receiver memory circuits for instant recall. The last station received will be remembered when the tuner is turned on again; and memories are kept "live" even during a power outage.

TOUCH VOLUME CONTROL & LED PEAK POWER LEVEL INDICATOR. The Sansui "Z" Receivers use a pair of touch-buttons to adjust the listening level. Relative volume control setting is indicated on a fluorescent display. On most models actual peak power amplifier output is shown by 14- or 18-segment LED indicators.

And there's more. Instead of up/down tuning buttons, both the 9900Z and the 8900ZDB have tun-

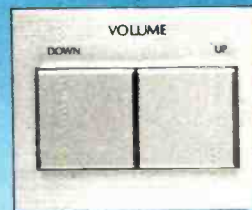

ing knobs linked to a rotary "encoder" disc. As you turn the knob, the encoded disc works with an LED and a photo transistor to generate electronic pulses to raise or lower the tuned frequency. In addition, the 9900Z, 8900ZDB, and 7900Z have ceramic buzzers which signal unobtrusively while you tune in a station. There are three speaker select switches on the 9900Z for driving any two of three connected speaker pairs and two switches on all the other "Z" receivers. Included are LED's for every important function. Two Muting Modes. Two tape deck connections with dubbing. And much more.

The full line of Sansui "Z" Receivers are at your Sansui dealer now. Visit him for a complete demonstration soon. He has just the right model for your pocketbook and power requirements.





SANSUI "Z" RECEIVERS

9900Z

160 watts/chan., min. RMS, both channels into 8 ohms, from 20-20kHz, with no more than 0.015% THD.

8900ZDB

125 watts/chan., min. RMS, both channels into 8 ohms, from 20-20kHz, with no more than 0.02% THD.

7900Z

100 watts/chan., min. RMS, both channels into 8 ohms, from 20-20kHz, with no more than 0.02% THD.

5900Z

75 watts/chan., min. RMS, both channels into 8 ohms, from 20-20kHz, with no more than 0.03% THD.

4900Z

55 watts/chan., min. RMS, both channels into 8 ohms, from 20-20kHz, with no more than 0.03% THD.

3900Z

40 watts/chan., min. RMS, both channels into 8 ohms, from 20-20kHz, with no more than 0.03% THD.

Cabinet of simulated wood grain.

Sansui

SANSUI ELECTRONICS CORP.

Lyndhurst, New Jersey 07071 • Gardena, Ca. 90247
SANSUI ELECTRIC CO., LTD., Tokyo, Japan
In Canada: Electronic Distributors



“Curious. Now that I have the 2 acoustically optimized cylinders of a Jensen J-2000, I don't feel the need for the 8 high compression cylinders of a Ferrari GTB-308.”

The Jensen J-2000 mini speaker system.

Sleek, bronze and beautiful, the design of the J-2000 is like no other car stereo speaker you've ever seen. And, more importantly, it sounds like those fine mini-speaker systems you used to hear only at home.

Housed in an acoustically optimized cylinder is a 4½" long throw woofer, a ¾" high frequency dome radiator tweeter, and a totally unique 4½" passive radiator. It's a planar sheet of compressed hollow glass spheres, so lightweight and compliant it effectively doubles the bass response of the J-2000.

With a 20 oz. Barrium Ferrite magnet and Nomex® high temperature voice coil, the J-2000 can handle a substantial 55 watts of power. It has a sensitivity level of 93dB SPL, and brings in a truly accurate frequency response of 40-16kHz.

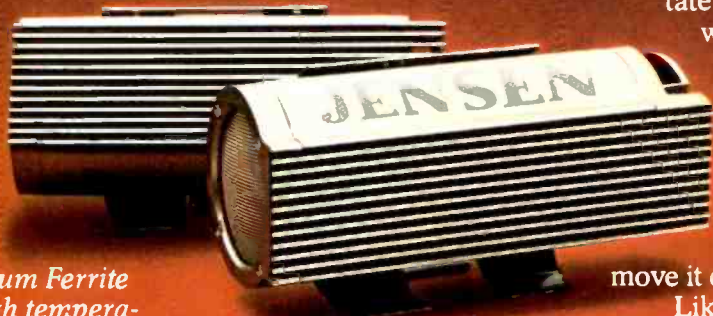

The J-2000 extruded aluminum housing is elegance with a purpose. The solid extrusion is not only durable, but guarantees a perfect acoustic seal. And the grille of injected Noryl® serves not only as a striking design element, but as protection for the high frequency driver.

And the J-2000 has a swivel mount that can rotate ± 30° to direct the sound where you want it. From the rear deck of a car, the wall of a van, or a shelf in a living room. Because the J-2000 has spring loaded connections for speaker leads and large knurled mounting knobs, you can move it quickly and easily.

Like all Jensen car speaker systems, the J-2000 was innovated with one purpose: Sound performance. So if that's what moves you, come hear it soon.

JENSEN
SOUND LABORATORIES
AN ESMARK COMPANY

When it's the sound that moves you.

© 1980, Jensen Sound Laboratories, Schiller Park, Illinois 60176.

MAXIMUM TRACKING LEVEL (re RIAA 0 VU, 1.0 gram) at 300 Hz +18 dB

WEIGHT 4.2 grams (see text)

SQUARE-WAVE RESPONSE (1 kHz)

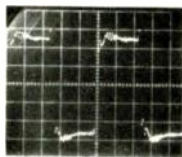

in these pages for the last two years. The disparity between the two DIN measurements is consistent with the findings of Jon Risch and his colleagues at Discwasher, who cite tip rake angle as contributing to this apparent contradiction. (See "A New Angle in Record Playing," HF, March.)

Finally, frequency response of the 630 presents no marked anomalies. The curves depict relatively flat response across the audible band, with minor (and quite acceptable) aberrations at the extreme top and a slight rise in the lower treble. When mounted in our "standard" medium-mass SME arm, the important vertical resonance occurred safely above the warp frequency range. By comparison to past reports, the 12-dB rise may seem to indicate the need for more damping, but (as we commented last month) our recent change in lab for these measurements makes head-on comparison with past numbers somewhat risky. The lateral resonance, however, is much closer to the values we're used to seeing.

In the listening room, we were quite eager to test the 630's claimed insensitivity to preamp loading conditions. Our reference preamp allows us to vary both capacitive and resistive loads, and we were delighted at the pickup's uniformity of response despite the varying conditions we presented to it. In fact, we were delighted with the pickup in general. No auditioner could single out any marked flaw in its sonic behavior, so neutral and effortless was its response to a wide variety of musical material. Though the top-of-the-line Model 630 might represent a rather steep investment for the novice audiophile, we can only point out that there are several more expensive cartridges available that do not match it in overall performance.

Circle 135 on Reader-Service Card

Quick on the Draw—in Both Directions

Aiwa AD-R500U cassette deck

PLAYBACK RESPONSE (TDC test tape, -20 dB DIN)

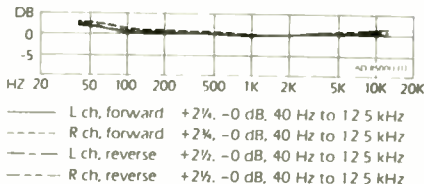

RECORD/PLAY RESPONSE, TYPE 2 TAPE (-20 dB)

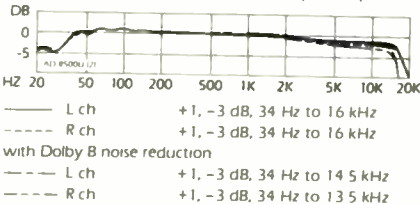

RECORD/PLAY RESPONSE, TYPE 4 TAPE (-20 dB)

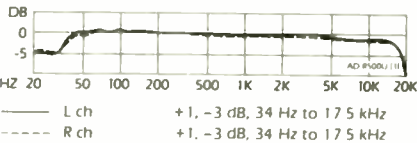

RECORD/PLAY RESPONSE, TYPE 1 TAPE (-20 dB)

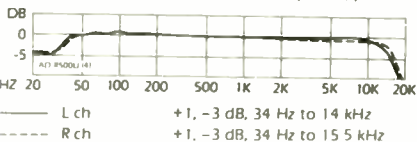

Aiwa AD-R500U bidirectional cassette deck, in metal case with wood ends. Dimensions: 18 1/2 by 4 1/2 inches (front panel), 11 inches deep plus clearance for connections. Price: \$450; optional RC-11Y remote control, \$40. Warranty: "limited," two years parts and labor. Manufacturer: Aiwa Co., Ltd., Japan; U.S. distributor: Aiwa America, Inc., 35 Oxford Dr., Moonachie, N.J. 07074.

This deck establishes that bidirectionality doesn't have to entail a grave sacrifice in performance, though past experience sometimes has made it seem that the two necessarily go hand in hand. That some degree of performance sacrifice is involved—or, conversely put, that bidirectionality adds to a deck's price—is axiomatic. So reviewing a reversing deck is largely a question of addressing tradeoffs and comparing them against the criteria we would expect readers to apply. We think Aiwa has been very successful in this respect with the AD-R500U; but since it ultimately is your criteria against which the tradeoffs must be judged, read on and make your own assessment.

In the first place, this deck will record in both directions. Models that will play in both but record in only one strike us as background-music equipment; we value reversibility, in particular, because it can record long works with a minimum break when the Side 1 tape runs out. In this respect the AD-R500U is at least the match of any reversible we've ever used. When manually triggered, the reverse is completed in less than 1/2 second. (Aiwa's spec says 0.4 second, which we'd judge conservative.) That's extremely good, but far more impressive is the ability to do the same thing automatically. Aiwa has a photoelectric sensor that, when activated (QUICK REVERSE), will trigger at any leader transparent enough to allow passage of its light beam. The resulting "hole" in the music is no more obtrusive than that occasioned by a single, severe dropout. Aiwa warns that damaged tapes may "look" like leader to the sensor (that's why the QUICK REVERSE is defeatable), but we were unable to find any that would cause misbehavior. If you use leaderless tapes, the photo sensor won't work, but the mechanical reverse system that operates at the end of the leader without the QUICK REVERSE will give you an almost instantaneous direction change. We found this portion of the system an unalloyed delight.

The controls themselves present some minor problems. In the interests of visual simplicity, Aiwa has added a door to hide the buttons and knobs below the transport controls. That's fine (though the door-latch button seems an unnecessary complication), and it does leave a very sleek front panel when the door is closed. Maybe too sleek: The graphic identification on the seven transport buttons is recessed so that it becomes invisible unless the deck is reasonably close to eye level. Viewed from more than about 45 degrees above the horizontal, they require that you remember the button sequence—no easy feat—if you're to push the right one.

At the extreme right of this area there are LEDs for the transport modes (unidirectional, out-and-back, and repeat—the last operating in playback only, of

Circle 15 on Reader-Service Card

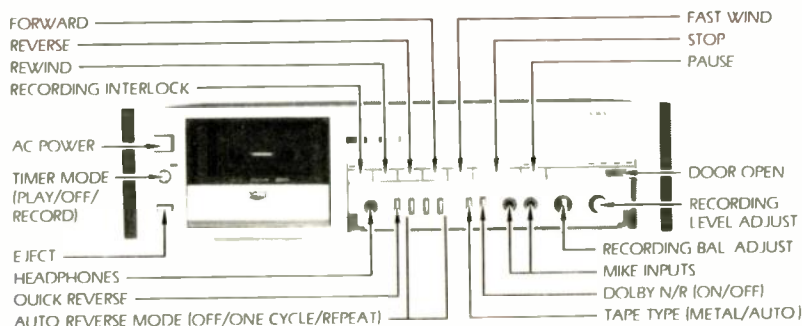

S/N RATIO (re DIN 0 dB, R/P, A-weighted)

	Type 2 tape	Type 4 tape	Type 1 tape
without noise reduction	5B dB	58% dB	54% dB
with Dolby B	63% dB	63% dB	62 dB

METER READING FOR DIN 0 DB +6 dB

METER READING FOR 3% DISTORTION (at 333 Hz)

Type 2 tape	+5 dB
Type 4 tape	+6 dB
Type 1 tape	+6% dB

DISTORTION (3rd harmonic, at -10 dB DIN)

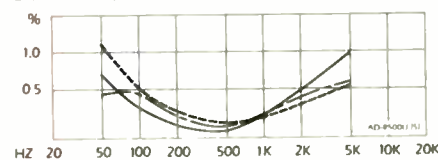

— Type 2 tape	< 0.99%, 50 Hz to 5 kHz
- - - Type 4 tape	< 1.2%, 50 Hz to 5 kHz
- · - Type 1 tape	< 0.8%, 50 Hz to 5 kHz

ERASURE (333 Hz, re DIN 0 dB)

Type 2 tape	70% dB
Type 4 tape	73% dB

CHANNEL SEPARATION 52 dB

SPEED ACCURACY 1.8% fast, 105 to 127 VAC

WOW & FLUTTER (ANSI/IEEC weighted peak)

	average	maximum
forward playback	± 0.06%	± 0.07%
reverse playback	± 0.06%	± 0.08%
forward record/play	± 0.05%	± 0.07%
reverse record/play	± 0.05%	± 0.06%

SENSITIVITY (re DIN 0 dB, 333 Hz)

line input	97 mV
mike input	0.64 mV

MIKE INPUT OVERLOAD (clipping) 34 mV

OUTPUT (from DIN 0 dB) 0.81 V

course—plus the QUICK REVERSE), but there are no LEDs on the transport controls. When you press FORWARD or REVERSE, you must look at indicators built into the transport to double-check the direction of play. As a result, we found ourselves slightly less surefooted in using these controls than a more self-evident scheme might have made us. Most surefooted is the PAUSE, which not only is very quick and pop-free, but leaves a virtually seamless joint when you use it in the middle of a sustained sound—in a word, a paragon.

The meters certainly are handsome, with their slender pointers and their calibration, which lights up green below 0 dB and red above. But that is all the illumination Aiwa provides, so legibility—already somewhat compromised by the tightly packed calibration points and the slender, fast-moving pointer—depends largely on ambient light. In dim, flat room lighting, the meters cannot be read at all on typical music signals. That statement sounds more damning than it is; Aiwa also provides a series of peak-responding LEDs and instructions on their interpretation for different tape types. We tended to ride gain by these LEDs and use the meters only as a double-check on signal balance or for signals too low to fire the LEDs.

The tape choices are relatively limited. In the interest of simplicity, Aiwa uses automatic switching—which, of course, depends on the extra key well at the back of Type 2 cassettes for the sensing/bias/EO system to work. Since metal cassettes have no consistent key well coding, a manual switch behind the door accommodates them. There is no provision for Type 3 ferrichromes or for Type 0 ferrics, both of which will be treated as Type 1 ferrics by the automatic switching; you may luck out with listenable recordings if you try them, but accuracy of reproduction is very unlikely with any formulation in either group.

Aiwa suggested that Diversified Science Laboratories test with TDK SA for Type 2 and OD for Type 1, with Scotch Metafine for Type 4. The results are shown in our data. The response curves are acceptable, meaning that they are unusually good for a reversing deck, and are particularly notable for their consistency in the two directions of tape travel. (As a result, we show only the forward direction in the record/play response curves.) Aiwa uses a single head, repositioning it for the change in transport direction. This system promotes the aforementioned consistency—vis-à-vis extra head gaps or head assemblies, which pose their own problems—but it suggests that head seating should be checked by a service technician at least once a year, since only slight wear could alter head azimuth and therefore might entail high-frequency response losses. Transport speed exceeds nominal by a margin (almost 2%) big enough to raise eyebrows in a unidirectional deck at this price, but not in a reversing model.

Again, our value judgments must be weighted by your needs. If continuous playback is the prime desideratum, for example, you obviously must ignore our disparagement of "background music" and, therefore, our dictum that bidirectional recording is a key capability. In terms of our priorities, the AD-R500U is possibly the best deck of its type we've ever encountered: to coin a phrase, an exceptional bidirectional.

Circle 132 on Reader-Service Card

Celestion's Small Wonder

Celestion Ditton 130 loudspeaker system, in wood cabinet with vinyl finish. Dimensions: 9 1/2 by 19 inches (front), 9 1/2 inches deep. Price: \$200. Warranty: "limited," five years parts and labor. Manufacturer: Rola Celestion, Ltd., England; U.S. distributor: Celestion Industries, Inc., Kuniholm Dr., Holliston, Mass. 01746.

Though never what you would call a household name in the U.S.,

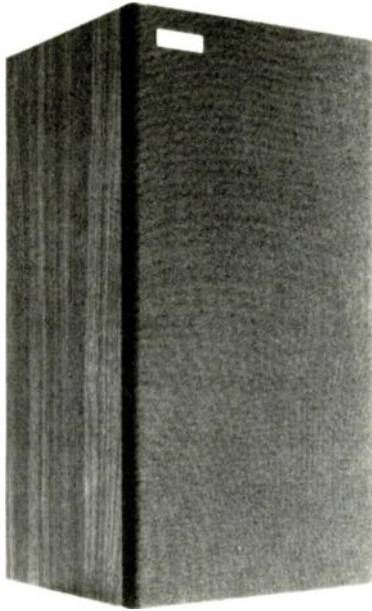

Celestion Ditton 130 loudspeaker

ANECHOIC RESPONSE CHARACTERISTICS (0-dBW input)

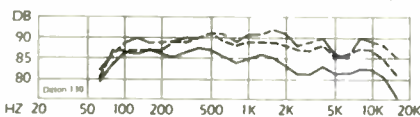

..... boundary-dependent region
 — average omnidirectional response
 - - - - average front hemispheric response
 - · - · on-axis response

AVERAGE OMNIDIRECTIONAL OUTPUT
 (250 Hz to 6 kHz)
 84½ dB SPL for 0 dBW (1 watt) input

CONTINUOUS ON-AXIS OUTPUT (at 300 Hz)
 109½ dB SPL for 20 dBW (100 watts) input

PULSED OUTPUT (at 300 Hz)
 118½ dB SPL for 29½ dBW (850 watts) peak

"NOMINAL" IMPEDANCE 7.5 ohms

Celestion has long been known in Britain both for its excellent loudspeaker systems and for its drivers, which a number of other manufacturers have used in their own speakers. When we last reviewed a Celestion product, the floor-standing Ditton 662 (September 1979), we were much taken by the sheer beauty of its sound, though we wondered whether its "accuracy"—long considered an important (if exceedingly elusive) loudspeaker criterion among the British—was as great as its comeliness. The company's latest, the Ditton 130, has suffered no loss of beauty while making a significant gain in accuracy, we are happy to report.

The 130's two drivers—an 8-inch cone woofer and a 1-inch dome tweeter—are vertically aligned and mounted flush on the front baffle. The tweeter itself is new, designed with the aid of Celestion's laser interferometry techniques for observing diaphragm motion. It is said to be more efficient and to have higher power-handling capacity than its predecessors and is protected from accidental damage by a wire screen. A removable black grille cloth hides the drivers, while attractively setting off the cabinet's vinyl walnut finish. Amplifier connections are via color-coded binding posts recessed into the back of the enclosure. The instruction sheet supplied with the speaker gives basic installation information and useful suggestions on placement for best response in your listening room.

Lab tests show the Ditton 130 to be moderately efficient, with an impedance curve that varies from maxima of about 30 ohms at 75 Hz and 1.8 kHz to a minimum of 5½ ohms at about 9 kHz. In the frequency range where most musical energy is concentrated, however, impedance never dips below 7½ ohms, making the speaker an easy load for almost any amplifier to drive.

Power handling is also quite good—particularly for such a small speaker. The 130 sailed unperturbed through the 20-dBW (100-watt) continuous-tone test and accommodated pulses up to 29½ dBW (850 watts) before exceeding distortion limits. At low listening levels, both second and third harmonic distortion products average less than ½%. The second harmonic is especially well controlled through the midrange and lower treble, staying below ¼% or so from 200 Hz to 4 kHz. Distortion rises at loud levels (100 dB), but it rarely exceeds 1% and poses no particular surprises at any frequency.

In the listening room, the Ditton 130 is notably self-effacing: No specific quality of the speaker calls undue attention to itself. Imaging is good, even from off-center listening positions, and frequency response is as wide and smooth as the graph suggests. Highs are all present without being shrill or hard. In short, it is very easy to forget that the little Celestions are there, an illusion that is not hurt by their compact dimensions and demure styling. Bass response is necessarily limited by the small acoustic suspension enclosure, but on most music this is likely to go unnoticed except in direct comparison to a speaker with more gusto in the bottom end.

Most audiophiles will find little to fault in the Ditton 130. Its low price, smart looks, and clear, accurate sound should win it a warm spot in the hearts of listeners whose gold is all in their ears.

Circle 133 on Reader-Service Card

A "Best Buy" Denoiser

Advanced Audio Systems Model DNR-450 dynamic filter, in metal case with wood ends. Dimensions: 12½ x 2½ inches (front panel), 6½ inches deep plus clearance for controls and connections. Price: \$200. Warranty: "limited," one year parts and labor. Manufacturer: Advanced Audio Systems, International, 4040 Moorpark Ave., Suite 200, San Jose, Calif. 95117.

DNR—for Dynamic Noise Reduction—is a coinage of National Semiconductor, which makes the IC "chip" on which this product is based. Like the Philips DNL (Dynamic Noise Limiter) circuit, it is a dynamic low-pass filter that "removes" existing noise on a moment-by-moment basis—not an encode/decode system like Dolby B or DBX. Unlike DNL, which was engineered specifically to make cassette-tape hiss less objectionable, DNR is intended as a multiple-application system, though National Semiconductor sees it as particularly useful in such applications as VCR and video-disc audio. Equipment manufacturers offering a broad range of consumer goods have been approached on DNR's behalf, and Delco already plans to use it in 1982 auto radios.

But the ideas it embodies are not altogether new. National Semiconductor tells us that the IC is made under license from Burwen, whose own denoising equipment it resembles. Advanced Audio is the first company we know of to employ National's IC version, beginning with a kit model that, the company says, was electrically identical to the wired DNR-450. For our tests we did not have



Advanced Audio Systems DNR-450 dynamic filter

FREQUENCY RESPONSE (bypass mode)
 +0, -1 dB, · 10 Hz to 12.4 kHz,
 -3 dB at 23.8 kHz

S/N RATIO (re 0.5 volt, A-weighted)
 ≥ 80% dB at all control settings

CLIPPING POINT (at 1 kHz, sensitivity at max.)
 2.3 V

DISTORTION (THD at 0.5 volt with sensitivity at
 midpoint, 20 Hz to 20 kHz) ≤ 0.13%

access to the final 450 case design, but we're assured that the innards were what you will get in the 450.

The basic idea of any such filter system is that it should pass the full audio bandwidth at maximum signal levels but progressively introduce a low-pass filter (here, a slope of 6 dB per octave) as levels drop toward some preset threshold. (The 450's bandwidth, at -3 dB, is reduced to 800 Hz.) So far, so good—or bad, according to your experience with consumer dynamic filters, all of which have been designed along these lines since the Scott Dynaural circuit of 1947. The problem is in letting the filter "know" when and how much to close down: that is, how signal levels are sensed and what sort of time constants are employed in applying the sensed information to the filtering.

Let's say, for example, that we have a sensing circuit that passes the entire signal bandwidth. At first glance, that would seem a logical approach. But consider what happens during a drumbeat: The signal causes the filter to open, allowing a burst of noise through along with the drum sound. If it's a snaredrum, with a lot of high-frequency energy, the sound may mask the noise very nicely—making you believe that the dynamic range has, indeed, been improved—but the success of the effect will depend on the time constants. Obviously, the filter should open as rapidly as possible to let the snare sound through immediately, but how fast should it close back down? If it follows the decaying level of the original drum sound, the snare components can be prematurely muffled. The standard solution is to inhibit return to the no-signal filtering for an instant; but if the instant is too long and/or the recording too unreverberant, the delay will leave a little noise "tail" after the drum sound has faded. Either way, poor choice of constants can compromise the naturalness of the effect, and the ideal decay time will vary with the reverberance of the recordings you play.

Switch from a snaredrum to a bass drum, and the problems increase. Now there are no snares to lend brightness that must be preserved until it fades naturally, but there also is no brightness to mask high-frequency noise. The resulting burst of hiss often sounds like a steam radiator venting in perfect sync with the drum beat. Ideally, the filter should open only at frequencies where there is signal to mask the noise, which implies an immensely complex (and expensive) multiband control system. The standard solution, therefore, is to use a simple (usually, single-band) system and carefully choose the frequency shaping of the control band and the time constants for its response—plus the slope of the filtering and the cutoff-frequency/sensitivity relationship—for the most subjective noise suppression consistent with minimal side effects, based on most music and typical noisy-signal conditions. It's a neat trick, if you can do it.

When we tested the progenitor of the National Semiconductor/Advanced Audio circuit, we thought it solved the riddle fairly handily, though we considered it really superior only with very moderate noise levels. The DNR circuit in this incarnation—which, be it noted, offers fewer control options—seems considerably better. (We no longer have the original for comparison, however.) Even some FM broadcasts on stations too weak to be really listenable without processing emerge much improved; though the DNR leaves clearly audible "puffs" of noise in each burst of sound, particularly on speech, the total effect impresses us as much less intrusive than we would have expected. In general—and taking cassettes and discs, as well as FM, as our source material—we find the 450 one of the most satisfactory general-application denoisers we've worked with. Close listening plus canny choice of program signal can usually isolate some perceptible side effects, but in normal use we are consistently struck by their unnagging ways. Bandwidth is not unrestricted, nor is response within it perfectly flat, even in the bypass mode, yet the "restrictions" are minor. Distortion in the active mode is only moderate and essentially is confined to second-order products as long as the circuit is not driven too hard, particularly at high frequencies. Distortion exceeds 1% above about 20 kHz at 1 volt and 10 kHz at 2 volts. More important in terms of audible results, midband (400-Hz) THD reaches almost ½% at 2 volts. Normally signal levels will not go much higher, but if your system delivers nonstandard levels, you could get noticeable distortion.

Admittedly, the key evaluation is a subjective one. Noise perception is itself a subjective phenomenon, and its banishment therefore no less so. One objective fact stands out: The price of the Advanced Audio denoiser is half that of its predecessor. So even if your subjective reaction is not as positive as ours, the value offered by the DNR-450 is hard to beat.

Circle 134 on Reader-Service Card

"I gave my kid brother
my turntable.
I gave him my tuner.
I gave him my tape deck.
But I kept my AR's."

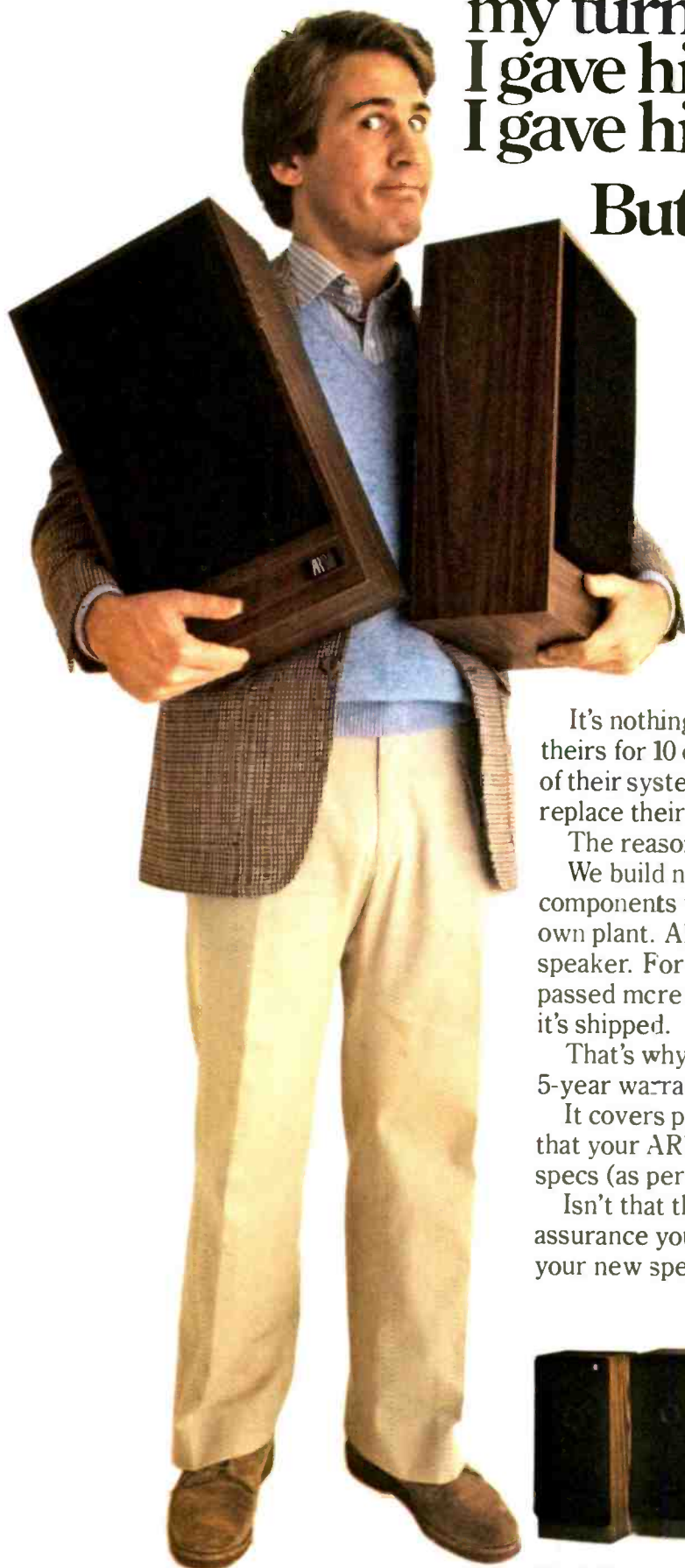

Most good speakers sound fine when they're new.

But what about next year?

And the year after?

Will they start to sound tired and send you looking for something better?

Not if they're AR's.

We build accurate speakers.

Because no matter what kind of music you like, accuracy is the standard.

It's the way a speaker *should* sound.

So we build AR's to stay accurate.

It's nothing for us to hear from owners who've had theirs for 10 or 15 years. They've upgraded the rest of their system, but they still can't find an excuse to replace their AR's.

The reason AR's sound so good for so long is basic.

We build nothing but speakers. We design all the components that go into them and build them in our own plant. All our effort goes into making the perfect speaker. For example, every AR, yours included, has passed more than 70 quality control tests before it's shipped.

That's why AR can cover you with a full (not limited) 5-year warranty.

It covers parts. It covers labor. And it also promises that your AR's will perform to within 1 dB of design specs (as per AR warranty statement).

Isn't that the kind of quality assurance you want with your new speakers?



"Truth in Listening"



TELEDYNE ACOUSTIC RESEARCH

10 AMERICAN DRIVE, NORWOOD, MA 02062 USA © 1981. IN CANADA BY A. C. SIMMONDS AND SONS LTD. AND IN AUSTRALIA BY W. C. WEDDERSPOON PTY. LTD.

NEW HEAVYWEIGHT TECHNOLOGY IN LIGHTWEIGHT HEADPHONES. BY BEYER.

Imagine headphones so light you hardly know they're there. Imagine these same headphones with a frequency range so wide you never miss a note. And imagine what it took to create such headphones -



Heavyweight technology that distinguishes Beyer from the rest.

The DT 880 coil is made of copper that is .9 millimeter thick and 1/3 the weight of those found in conventional headphones. The polycarbonate plastic diaphragm is so light, rigid and rare that it is found only in the best mics made in the world. It is viscous damped like the finest loudspeaker cones and statistically embossed so that its surface will be absolutely perfect for transmitting sound. Imagine using rare earth samarium cobalt magnets, the strongest magnet material known to man. And imagine headphones that will simply overwhelm you with bass response and a transparency of sound unheard of except in the finest, most expensive electrostatic transducers.

But you don't have to imagine. Just visit your Beyer dealer and see and hear our new heavyweight line of lightweight headphones. Try them on. We guarantee that you've never worn more comfortable headphones regardless of size! They feel great. They sound great. They look great. And they are priced just right. Come see for yourself. There is something better from Beyer.

Beyer 
Dynamic

BEYER DYNAMIC, INC.

5-05 Burns Avenue, Hicksville, NY 11801 • (516) 935-8000 In Canada, H. Roy Gray, Ltd.

How to Buy the Best Budget Receiver

by Michael Riggs



Answers to the basic questions every shopper should ask



If you're looking to buy a "budget" receiver—by which we mean one with a list price of about \$250 or less—you're probably shopping for your first real high fidelity system. And chances are you're a little bewildered by some of the choices facing you. The flexibility of modern receivers, which finds expression in a profusion of knobs, switches, input and output jacks, and multicolored indicator lamps, is in considerable measure a by-product of the technological developments that have made low-priced, high-performance stereo components possible. But fear not: The fundamentals you need to know to make a good buying decision are not impenetrably technical. Armed with the answers to a few simple but important questions and an understanding of some of the essential specifications (see "Psyching Out the Specs"), you'll be ready to pick the best receiver for your needs and budget.

● What are the basic functions of a receiver?

A receiver is really three components in one package: a preamplifier, a tuner, and a power amplifier. The

preamp section's most important job is to amplify the minute signal from a magnetic phono cartridge to a level high enough to drive the power amp section. At the same time, it must provide the correct electrical termination for the cartridge (a 47,000-ohm resistance in parallel with a small capacitance, usually about 100 to 200 picofarads) and accurate RIAA equalization, to undo the treble lift and bass rolloff that are cut into every LP to increase playing time and reduce noise. If these conditions are not met, records will not sound properly balanced.

The preamplifier also performs a variety of control functions. It has switches for selecting the source to be listened to, normally providing for one turntable, the tuner section (FM and, ordinarily, AM), a tape deck, and usually one other (aux). It also has volume and balance controls to alter the overall sound level and the relative levels of the two channels; bass and treble controls, to change the frequency balance of program material to suit your tastes; a tape monitor switch; a headphone jack; and often a loudness switch, which usually introduces a bass and treble boost to compensate for the subjective requirements of low listening levels. Modern research indicates the need for just bass

boost at low volume levels, but only a handful of manufacturers have arranged their loudness compensation controls accordingly. In any event, don't be too concerned about it; often the tone controls do a more precise and flexible job of loudness compensation.

Beyond these basics, you may find any of a variety of other controls: switches for selecting two—sometimes three—pairs of loudspeakers; a switch to convert the receiver to monophonic operation for improved reception of weak FM stations or for cancellation of rumble on mono records; a muting switch (sometimes combined with the mono switch) to cancel the receiver's FM interstation muting for reception of weak stations; high-frequency scratch filters; and low-frequency rumble filters. Although useful, these are icing on the cake.

The tuner section is, simply put, a radio designed to pick up mono and stereo FM and, in most cases, AM as well. The power amplifier is the part of the receiver that actually drives the loudspeakers. To do this, it must be able to supply large amounts of both voltage and current to the speakers in proportion to the relatively small voltages coming from the signal source through the preamplifier.

(More)

● Aren't separate components capable of better performance than receivers?

Separates—i.e., an integrated amp and a tuner or a preamp, power amp, and tuner—have no inherent performance advantage over receivers. This is not to say that they are not, in some cases, better in practice. Separates are usually designed with perfectionists in mind and with somewhat less concern for selling price, so there often is less temptation for the manufacturer to cut corners to hit a specific price point. But audible differences, when they exist at all, are certainly not large enough for the budget-conscious shopper to worry about.

The main benefit of having separates is flexibility. You can get just the functions you want with just the amount of power you want. The overwhelming advantage of a receiver is that it requires only one chassis and only one power supply, which make up much of the expense of any electronic component. On a strict price/performance basis, receivers are clearly the way to go.

● What portion of a system budget should be allocated to the receiver?

There's no hard-and-fast answer to this question. A good rule of thumb is to put a third of your money on the receiver, another third on the turntable and cartridge, and the remaining third on speakers. This assumes that you intend to lay out about \$600 for the entire system, with about \$200 going for the receiver, and that you will not be paying list price. (Almost all systems are sold at some discount, so you should shop with that in mind.) Unfortunately, at the \$600 price level for an "entire" system, you probably won't be able to afford a cassette deck. Some people, however, will forgo the turntable for a tape deck, and our advice as to the allocation of funds still holds; don't expect to pay less than \$200 for a decent quality cassette deck.

As the total system budget goes up, you probably will want to put slightly increasing emphasis on the head and the tail of the dog: the record-play-

ing equipment and the speakers. And as you get out on the street and get a feel for what specific features you want and what discounts are available, you will almost certainly want to bend our rule of thirds.

● Can you get good sound without a lot of power?

Yes. With fairly efficient loudspeakers playing in a moderate-size living room, you will normally be asking your receiver's amplifier section to provide less than a watt of power. There will be peak demands well above that base level, but so long as these remain within the power limits of your receiver, all will be well. When they don't, the amplifier will "clip": It will shear off the tops of the offending waveforms, compressing the music's natural dynamics and generating lots of harmonic distortion. A little of this can pass unnoticed, but taken to excess, it will make the reproduced sound mushy and gritty.

The louder you play your music and the wider its dynamic range (i.e., the volume range between the loudest and the softest passages in the music), the more often you will clip your receiver. Other factors affecting the amount of power you will want are the size and liveness of your listening room (a large well-cushioned room will soak up more sound, and therefore more power, than a small bare one) and the efficiency of your speakers. The latter can make a significant difference, because just a 3-dB increase in loudness (1 dB being generally accepted as the smallest perceivable increase in loudness) requires a doubling of wattage from the amp. Consequently, a speaker that is 3 dB more efficient than another will require only half as much power to produce the same volume.

It makes sense, then, to shop for speaker efficiency instead of amplifier power. You'll have to pay about 50% more for a 40-watt receiver than for a 20-watt model, yet you will be getting just 3 dB more output. But two loudspeakers that differ only in their efficiencies will not necessarily differ in price. HIGH FIDELITY'S test reports are a good source of information on speaker efficiency.

Also pay attention to the receiver manufacturer's dynamic headroom rat-

ing. This figure, expressed in decibels (dB), tells you how much extra power the amplifier section will kick out in response to demanding musical transients. All else being equal, a 20-watt receiver with 3 dB of dynamic headroom will perform very much like a 40-watt receiver with no dynamic headroom: It, too, will be able to pump out the equivalent of 40 watts of power, though only in momentary doses.

● What tape-monitoring and dubbing capabilities are necessary?

That depends entirely on how you intend to use the receiver. If you have several tape decks and like to record and to dub from, say, open reel to cassette, you could use two or more tape-monitor loops and a dubbing circuit that enables you to make transfers from one deck to another while you listen to another source. That kind of sophistication costs money, however. Budget receivers usually have a single tape-monitor loop, which allows recording from records, FM broadcasts, or any other source connected to the receiver and switching between the source being recorded and the playback signal from the tape deck without interruption of the recording process.

● Is a manufacturer's least expensive receiver always his best value?

There is no unequivocal answer to this question. It depends to a great degree on your listening habits and on what features are important to you. A little more money usually buys an added measure of refinement—of freedom from the kind of corner-cutting that can leave a component's performance a little wobbly in one or two areas. And it usually brings more power and more than the bare minimum of features. On that basis, we would be inclined to say that most manufacturers' best buys are in the \$300 to \$500 price range. Above that, you tend to pay a lot more money for what is, in effect, only slightly more power and for elaborate features that most people will hardly use. **HF**

A Renaissance for AM Radio



The decision on a stereo broadcast system is likely to bring better quality in both studio and receiving equipment—and possibly even better programming—to “the other” tuning band.

by Robin Lanier

Not too long after this magazine is distributed, music lovers may get an invitation to something brand-new: “Buy our receiver (or tuner), and hear fine music *in stereo* from AM stations!”

Should the invitation be accepted? Will stereo AM, talked about endlessly within the broadcasting industry, really deliver music of satisfying quality? This report will explore stereo AM’s strengths and weaknesses and discuss the forces behind it and how to make the most of the new service it will bring. You will find the outlook positive, with a few qualifications and some important precautions that must be noted.

FM broadcasting has had stereo for a long time but has no exclusive right to it, though its stereo technique essentially has been beyond the reach of AM stations, with their much more restricted radio-frequency bandwidth. In fact, proposals for stereo AM go back more than twenty years, predating the move to stereo FM. But until fairly recently, the pressure for stereo AM was not strong; the AM broadcaster was doing very well, thank you, without the added cost and the turmoil that a changeover would have entailed.

Several forces changed that in recent years. First, FM radio—with big help from stereo—has climbed from its lowly spot as the upstart minority service to become mightily competitive with AM and has even outdone it commercially in some areas. The AM broadcasters have been forced to consider their options for getting back into the game. Going to

stereo has become a central item in that agenda. A second factor, closely related to the first, is the widening realization that the American listening public becomes more fidelity-conscious every year. To get listeners back, AM broadcasters must make significant improvements in the technical quality of their signals. The \$8.99 drugstore special, AM radio’s main link with large masses of listeners for a couple of decades, is losing its power, and many broadcasters know that. Millions of people will no longer accept the double-digit distortion and the truncated frequency range of the old standard AM receiver. Even fairly expensive AM receivers have been little better than the bottom-rung models: High-frequency response typically fell off rapidly above about 3.5 kHz, and bass was less than solid.

Moreover, many AM stations, in order to seem as “loud” as possible on the dial, drastically reduced the dynamic range of their music and broadcast the resulting “homogenized” sound at the highest level that would not overload the transmitter. By actual measurement, a successful New York AM rock station a few years back was putting out music with a dynamic range—the spread from loudest to softest—of 5 to 6 dB! That compares with 40 to 50 dB for moderately good records, 80 to 90 dB for digital tape masters, and some 100 dB for a live symphony. Well-run FM stations manage at least 50 dB on the air.

Further spurring AM broadcasting (and FM, too) to sharpen the quality of the signal has been the appearance of high fidelity systems for taking network signals around the country. The old standard Bell System long-distance tele-

phone lines, which served network radio for decades, generally cut off at around 5 kHz and often were very noisy. But satellites have brought top fidelity to network program distribution. Earth terminals are going in by the hundreds across the country, and stations so equipped will have access to a wealth of high fidelity music, in stereo, from many sources—and for broadcast on AM as well as FM.

The satellite revolution and the general upsurge in the public’s quality consciousness have pushed the Bell System into upgrading the connecting links (so-called land lines) it rents to broadcast networks and individual stations. There is a new class of service—reaching about fifty cities by early this year—with low distortion, 15-kHz frequency range, and stereo capability. These developments are vital not only for technical signal quality, but also for the availability of high-grade programming.

Partly as a result of these developments, there was a surge of interest in stereo AM, and experimental systems for achieving it began to take shape about five years ago. Five companies actually built stereo AM systems for trial: Kahn Communications, RCA-Belar (a joint effort), Magnavox, Motorola, and the Harris Corporation. All had persuasive design characteristics and in laboratory trials seemed to do the job well. But which did it best?

Enter here the Federal Communications Commission, which has the legal responsibility for regulating the broadcast industry. On technical matters of such weight, it moves with a deliberation bordering on the catatonic. The standard operating procedure is to issue a Notice of Inquiry, asking for industry com-

Robin Lanier, a longtime HF contributor, is presently on the staff of Broadcast Management/Engineering magazine.

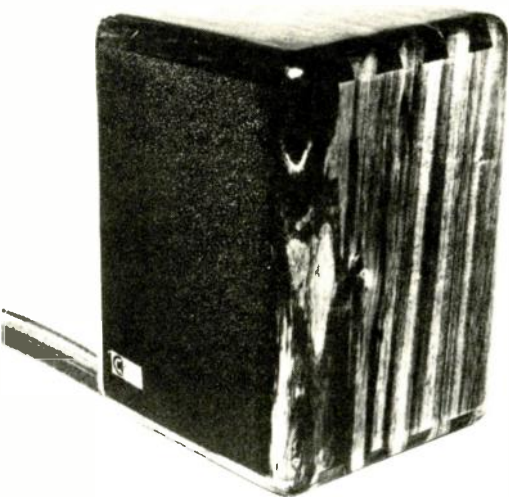

ments and suggestions. When these have been digested (after one to two years), the FCC may issue a Notice of Proposed Rule-Making, which means it has chosen a system and seeks comment on that.

Pressed by the industry, the commission brought out a Notice of Inquiry on stereo AM in July 1977. There was a tidal wave of response from interested parties inside and outside the industry, a large part of it to the general effect that stereo AM is highly desirable and should be instituted as quickly as possible. The resulting dialog with the FCC has had nearly endless ramifications; to make a long story short, the Notice of Proposed Rule-Making did not appear until April 1980. It named the Magnavox system as the anointed one.

There were bellows of outrage from some (but not all) of the rival developers. Many in the industry criticized both the weight the FCC gave to certain tests and the logic of its "scoring" of the various systems. Result: The FCC retreated, asked again for information, got a flood of comment, and retired to digest it.

Early this year, the word from the FCC was that one of the developers had asked for, and been granted, an extension of the period for comment to March but that there would be no further extensions. We can hope, in other words, that the final final decision will be made early this summer.

Has the enthusiasm of AM broadcasters been transmuted into disgust by the interminable wait for the FCC decision? Some trade journals have said that broadcasters are shifting their hopes to "all-talk" programming—news, discus-

sions, interviews—which do not need stereo. I find reason for a very different view: Though the talk format has succeeded for a few stations in large cities, it cannot hold onto enough listeners in small and medium markets for commercial radio success. Everyone in station management I've recently interviewed has been dispirited by the long wait for stereo AM, but they still want it.

The best evidence of that is the considerable investment that has been put on the line by AM stations to upgrade their studios and install stereo tape machines, control boards, and signal paths. I have reported elsewhere on a score or more of such upgradings, and in every single case, the whole studio has been converted to stereo operation, so that the station—right up to the transmitter itself—will be ready when stereo AM comes. In several instances, whatever programming a station records itself is being done in stereo.

The final element of a broadcast plant is the transmitter, and this is where a change to stereo must wait for the FCC's selection. The rest of the radio plant is, in effect, a very elaborate high fidelity system—perhaps even a stereo system; at the transmitter, the signals must now be combined to mono for transmission over the air. When a stereo method is approved, certain changes will be made in the transmitter to convert it to two-channel operation.

We also will need new receivers, of course, designed to match the chosen stereo system. Here, again, confidence is in order because most of the leading receiver makers have said they see stereo AM as an excellent spur for the market. In fact, both Motorola and Magnavox have frankly attributed their interest in the change to hopes for a revitalized receiver market. The stereo AM capability will surely appear in a flood of component-grade tuners and receivers.

How good will it be?

Finally, we come to two questions that are paramount. What about the overall fidelity of stereo AM? And what about the quality and quantity of the music it is likely to bring?

At the transmitting end, the fidelity undoubtedly will be good. In fact, the very same gear could now be used for both FM and AM—and sometimes is already. The only possible difficulty would come from some older AM trans-

mitters whose fidelity is too low for use in stereo at all. But competitive pressures are going to force upgrading of transmitters whenever that is needed to satisfy the new demands for quality.

At the receiving end, there is a stickier problem. The new receivers will be far, far better than typical AM models of the past, in part because the manufacturers can charge more for them as a "specialty" product; they will escape the old economic stranglehold on the cheap AM receiver. But extending the frequency response to the FM limit of 15 kHz would make the reception vulnerable to noise and interstation interference on the AM band, where stations are slotted only 10 kHz apart. In some areas, particularly at night, a receiver with strong response beyond 10 kHz may bring in disturbing interstation whistles, noise, and even signals from the wrong station.

One key approach to this problem is being discussed: an IF section that can be switched, at the front panel, from narrow to wide response. The narrow would cut off sharply above, say, 8 kHz, lopping off the noise and whistles. Turning it to wide would open response all the way for full-fidelity AM when the air is "free." And though it's not "true high fidelity," a response of 50 to 8,000 Hz can give much musical satisfaction. Stereo AM will do at least this well nearly all of the time. The lesson is that, when shopping for a stereo AM receiver, the music lover should look for adjustable IF response, with very sharp filters in the narrow mode.

What kind of music are we going to get? Technology and economics are working for us again. As already noted, the revolution of satellite distribution is opening up many new programming operations for radio. There will be a lot of networks, both old and new, competing for the radio broadcaster's affiliation and satellite earth terminal. Stereo music will be an important element in their programming: The technology is simple, and the fare demonstrably popular. It will range from rock to symphony, and the classical extreme will receive more than token treatment. The software producers have decided that enough Americans want "culture" to make this programming profitable.

So, after a buildup period, stereo AM will bring us a reasonable amount of fine music. All we need now is final action from the FCC. **MF**

Car Stereo '81: Coping with Reality

Our resident autophile sees lots of real-world refinements in this spring's gear.

by Robert Angus



New to Panasonic's Cockpit line, the \$1,400 RM-710 includes a cassette deck, AM/FM tuner, power amp, preamp, and five-band graphic equalizer.

After years of ever bigger, ever more powerful car stereo amplifiers, a plethora of pushbuttons, and multiple speaker systems, the car stereo industry is finally coping with the realities of driving in the 1980s: smaller cars, higher-priced gasoline, and problems caused by some of the auto sound improvements of the past two years. For example, engineers seeking to improve FM reception by increasing the sensitivity of tuning circuits didn't seem to realize that some noise comes from the car's own electrical system. Now some models have gone for improved noise suppression and greater selectivity. And many manufacturers are quietly advising their installers of the need to take greater care to mount components and wiring properly.

Head-end units designed for the X- and K-body cars—and other small models not specifically intended for use in those cars, but almost as small—are available from virtually every manufacturer. Except for raw power and number of pushbuttons, they seem to provide the performance and nearly all the features of the larger models of a few years back, but in lighter packages that are easier to install. A growing number of systems this season—particularly the expensive ones—have digital readouts, if not true digital tuning. Many have the equalization necessary for correct playback of chrome and metal tapes. And some form of noise reduction is almost taken for granted in high-quality gear.

In fact, the biggest news may be the introduction of DBX noise reduction by a reborn Fosgate Electronics, now called Rockford-Fosgate. A switchable DBX decoder is built into the RX-5 and RX-1 power amps, rated at 200 and 100 watts per channel, respectively. Also included in each model is an integral electronic crossover and five-band equalizer.

Sanyo has extended the technical

benefits of its Plus Series home components to car stereo equipment in five cassette/radio combinations, two power amps, and a pair of speakers. The FT-30 head-end unit (\$250) boasts an automatic music selector system, pushbutton tuning, sendust alloy heads, and switchable tape equalization. The PA-6110 power amplifier (\$200) is rated at 50 watts per channel into 4 ohms with a slew rate of 70 volts per microsecond and a THD of 0.05%.

Most other manufacturers also have launched several products offering consumers a wider range of pricing, features, and combinations thereof, although few represent innovative features and technology. Three of Pioneer's ten models have Supertuner II circuitry to suppress noise on FM. The KE-5100 (\$300) is an in-dash AM/FM/cassette unit with electronic tuning and a digital time and station-frequency display, plus fifteen station presets. Among the company's speakers are the TS-108 (\$65 per pair), a two-way, 4-inch system designed to fit very thin doors, and the three-way TS-X11 (\$300 per pair), with a 3¼-inch woofer. Intended primarily for use in recreational vehicles, the two-way TS-Z80 (\$400 per pair) houses a 6½-inch woofer and a 1-inch tweeter in a die-cast aluminum enclosure.

Panasonic, which staked out the area overhead a couple of years ago with its roof-mount Cockpit systems, has a new one: the RM-710 (\$1,400). Besides all the usual ingredients (AM/FM tuner, cassette deck, power amp, and preamp), the 710 includes a five-band graphic equalizer. Also from Panasonic is an 8-inch coaxial speaker, the EAB-080 (\$180 per pair), which can handle as much as 100 watts of power. Typical of Autotek's three offerings is the CSR-2300 in-dash cassette deck (\$270) with manual auto reverse, Dolby noise reduction, sendust

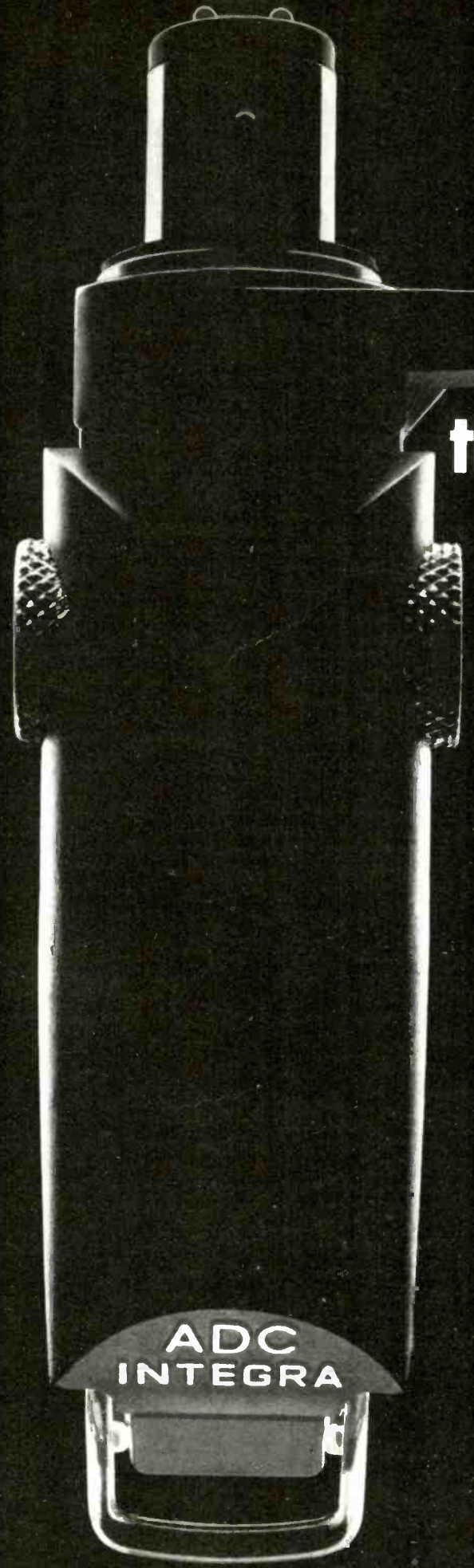

The advantages of owning an ADC Integra

VS

the disadvantages of owning anything less

Keep count. There are quite a few. First, the Integra is a totally integrated headshell/cartridge. It upgrades your tonearm by lowering its effective mass by as much as 50%! That's a big advantage. No matter what turntable you own. So is Integra's unique vertical tracking angle adjustment. Without it, you're compromising at best. With it, the Integra gives you the optimum match for the vertical tracking angle record companies use to cut their masters. There's also Integra's overhang dimension adjustment. It's simple. To set the optimum offset angle all you do is release the adjustment lock. Adjust. Then re-lock. No more nuts. No more bolts. No more hassles. But there are more Integra advantages. Like Integra's precision molded carbon fibre (versus our competitors molded plastic) body. It not only reduces mass dramatically, it virtually eliminates low frequency signal loss and flexing. But the biggest advantage of all has to be the fact that all those other advantages are available in three different ADC Integra models. One for every kind of budget. All for one kind of sound... devastating. If you'd like to hear more, call Audio Dynamics Corp. toll-free (800) 243-9544 or your ADC dealer.

ADC INTEGRA

heads, and adjustable voltage output.

Not to be outdone, Clarion has added four in-dash AM/FM/cassette ensembles, an AM/FM radio, an equalizer and power booster combination, and a loudspeaker series. Starting at the top, the PE-962A receiver/cassette deck has pushbutton presets for five AM and five FM stations, a local/distance switch, and Dolby noise reduction. The PE-751C, the latest version of the company's best-selling audiophile model, has sensust heads, equalization for chrome and metal tapes, Dolby noise reduction, auto reverse, and an output of 24 watts per channel. And the PE-572A, with DIN nose and short chassis, is a lower-cost solution for the foreign-car owner. The Hi-Way Fidelity modular speaker system includes 6-by-9 and 6½-inch woofers and a midrange/tweeter module. The three speakers can be used as separates or in a three-way configuration.

Visonik of America introduces the D-5000 (\$200 per pair) and the D-3200 (\$150 per pair) to the speaker market. The first is a two-way system consisting of a 1-inch soft-dome tweeter and a 4-inch long-excursion woofer in a die-cast aluminum enclosure, while the second is a door-mount speaker with the same components. Pyle Industries, too, has a new 4-inch system, along with a pair of 6-by-9 coaxials. Designed to fit most subcompacts, the small unit is said to have a power-handling capacity of 35 watts. The larger model incorporates a new compression-driver tweeter and a long-excursion woofer with a half-roll polyurethane suspension. An unbelievable twenty-one speakers have tumbled out of the Craig cornucopia, including several flush-mount designs: two 6½-inch (\$35), two 3½-inch (\$25), and two 4-inch models (\$37), plus a pair of 5½-inchers designed for limited-depth installations (\$35). Also part of the line are two 6½-inch coaxials (\$55), a 1-inch soft-dome tweeter with ferrofluid (\$40), another at the same price with a phenolic ring dome radiator, and two midrange systems priced at \$50 and \$60.

More modest in number are the introductions from Kraco and Fujitsu Ten, with two each in the AM/FM/cassette category. Kraco's both are rated at 12 watts per channel, have auto reverse, Dolby noise reduction, and a distortion spec below 1%. Price for the HP-1085 is \$320; the pushbutton HP-108 sells for \$375. Fujitsu's CR-1130 (\$280), rated at



Clarion's Hi-Way Fidelity modular speaker system contains 6-by-9 and 6½-inch woofers and a midrange/tweeter module.



The KE-5100 in-dash cassette model from Pioneer includes a digital tuner with Supertuner II circuitry and fifteen station presets.

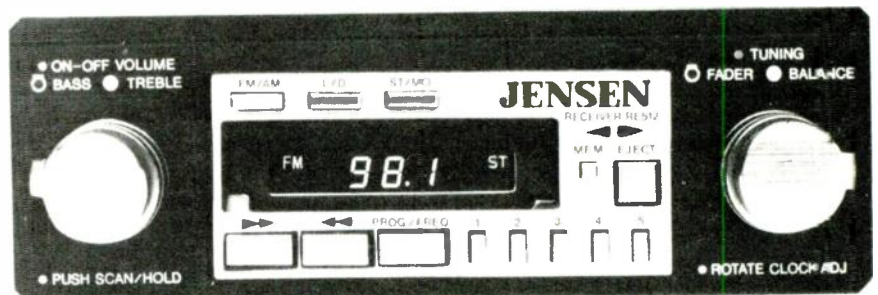

Jensen's RE-512 AM/FM/cassette unit is the first model from that company to incorporate electronic tuning. Note five station presets and scanning mode.

16 watts, and CR-1030 (\$240), 4 watts, are designed to fit in most compacts and subcompacts.

Jensen's offerings include four new AM/FM/cassette units: the \$350

RE-512, the company's first electronically tuned model; the \$260 R-401; the \$150 R-200 for X-body autos; and the \$200 R-210, designed for Japanese imports but sized to fit many X-body cars

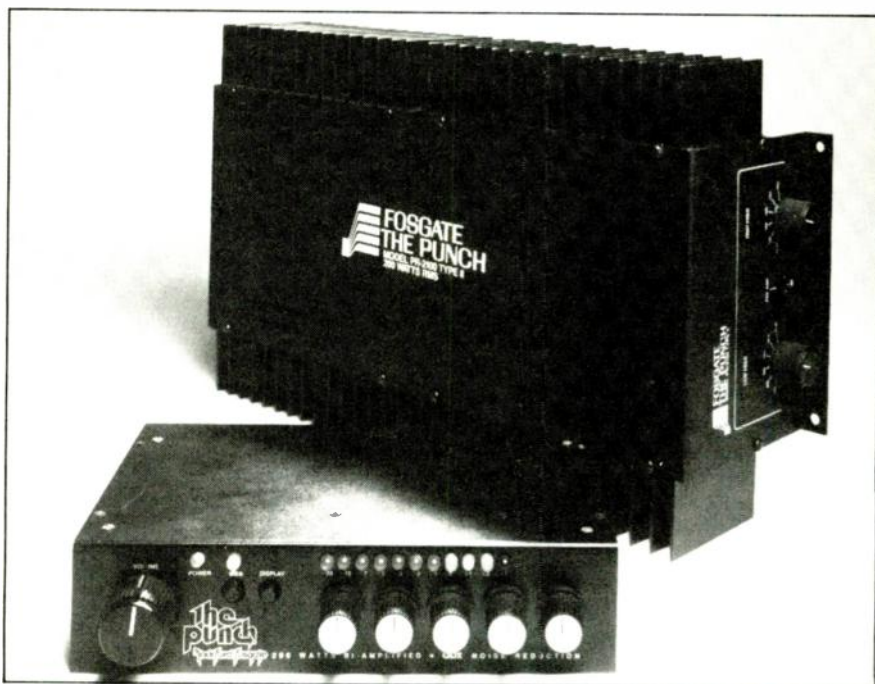

Bi-amplification is the theme in many of Rockford-Fosgate's new amplifiers, including the RX-5 with built-in DBX noise reduction.



Blaupunkt's CR-3001 in-dash auto-reverse cassette deck with AM/FM tuner features electronic tuning, pushbutton station selection, and digital display.

as well. The A-30 power amp (\$100), rated at 12 watts per side, and a 4-inch thin-mount speaker (\$45) join the line.

Image enhancement comes to car stereo with the Omnisonic 801A, a \$150 device said to create an apparent increase in the height, width, and depth of the reproduced sound. Unlike similar home devices, the 801A is reported to be relatively noncritical of listener position.

A tuner/cassette in-dash combination and a high-end digitally synthesized tuner are Sony's contributions to the season's products. The XR-70 (\$375), intended for use with an external power amplifier, has an automatic music sensor in the tape deck, Dolby noise reduction, digital frequency readout, and five station presets. The XT-1 tuner (\$330) provides four means of station selection: ten-station pushbutton memory, auto

seek and auto scanning, direct-access frequency selection, and electronic manual tuning. In somewhat the same category is the Blaupunkt CR-3001 (\$630), an AM/FM/cassette unit with four 15-watt amplifiers, electronic scanning, twelve-station memory, and a large digital program display.

Audiovox has a high-end series called Hi-Comp Phase II. It encompasses eleven AM/FM/cassette ensembles, ranging in price from \$145 to \$650; an amplifier rated at 15 watts per channel with five bands of equalization for \$100; a five-band graphic equalizer/booster (no price available); and a 4-by-6 coaxial with a DIN basket for imported cars or an adapter for General Motors cars. Among Sparkomatic's offerings for 1981 is the surface-mount SK-550 system, incorporating a 5-by-7 woofer, a 2-inch

midrange, and two 1¼-inch tweeters in an aluminum acoustic suspension enclosure. Its SR-304 AM/FM/cassette unit, with an amplifier capable of 10 watts per channel, is small enough to fit Japanese and European imports and the new General Motors cars.

As you may have gleaned from our descriptions of this spring's wave of new equipment, the power race is over. Most models have modest ratings compared to the excesses of the recent past. Similarly, tuner sensitivity isn't the hot issue it was a season or two back. And digital readout is taken for granted in the upper price echelons. Manufacturers not only are concentrating on scaling down size, but are concerned with value, offering convenience features such as push-button tuning, auto reverse, noise reduction, and tape-EQ switching, but with less power, lower tuner sensitivity, or fewer nonessentials than last year.

There are no breakthroughs in speakers, either—just a bewildering array of configurations, prices, sizes, and potential combinations to fit almost anywhere in virtually any vehicle ever conceived. Not that there are no product improvements; it's just that, for the most part, they don't sound very sexy in product literature: fluid-cooled voice coils, longer-lasting yet more flexible speaker surrounds, cast baskets instead of stamped metal, new kinds of coaxial speaker mountings for better treble dissemination, and the like. As in other auto components, the stress is on more value for the dollar in the form of better-made speakers with higher performance.

If that amounts to austerity, it's a trend that extends to preamps, amps, power boosters, and equalizers as well. Some of the exotic features of previous years—such as microphone and electronic-instrument inputs, faders for multiple speakers, and multiband equalization—are nowhere to be found in most of the new models. Instead, manufacturers have reduced physical size and distortion and have simplified operation and installation, frequently without adding to the selling price. With less emphasis on high power output, engineers have had more time to think about overall sound quality, about how motorists actually use their equipment (and what that means to front-panel design), and about the interiors of the new cars. Is this marking time? I prefer to think of it as fine tuning. **HF**



WE DARE YOU TO COMPARE.

**Compare the new Jensen System Series Speakers
to AR, Bose, Infinity, JBL, Pioneer, and Advent
and you'll hear what we're talking about.**

Just for a minute, forget the specs, the response curves, the graphs and acoustic theories. Let's get back to the ultimate test of a speaker. It's music, pure and simple.

At Jensen, we're so sure of our new line of System Series Speakers that we urge you to compare them. Match any of our speakers against comparable models of any other top brand speakers.

Listen to your favorite, most familiar recording. Listen at all levels and from all areas of the room. And see if you don't choose the Jensen for better sound.

When it comes to choosing home audio speakers, it's really quite simple. Compare them all. We know you'll like the Jensen System Series Speakers.

For additional information or for your nearest Jensen Dealer write to Jensen Home Audio, 4136 North United Parkway, Schiller Park, Illinois, 60176. Or better yet, call, 800-323-0707.

**JENSEN
HOME AUDIO**

Music... pure and simple.

Bartók Recordings

Part II: Vocal, chamber, and orchestral works

This is the second and final installment of a discography begun in our March issue as part of a Bartók centenary tribute. Here again, "Sz." numbers refer to András Szöllösy's work list, which can be found in the New Grove Dictionary. Detailed lists of the recordings referred to appear near the end of each section.

Vocal works

It's odd, at first sight, that a composer who spent as much time listening to people sing as Béla Bartók did (and you have only to look at his scholarly publications to see how intently he listened) should have put relatively little of his creative energy into composing vocal music. But perhaps it is not so strange after all. At least in his earlier period the folksong was for Bartók a self-sufficient entity; even to give it an accompaniment was a compromise, a matter of presenting it to the "cultivated" musical public.

This is certainly true of the earliest set of arrangements, the ten *Hungarian Folksongs* of 1906 (Sz. 33), originally published with a corresponding set by Kodály. In the *Eight Hungarian Folksongs* (1907-17) (Sz. 64), which combine five settings from the same period with three from the war years, the piano contributes a more independent commentary, though the melody is still the main thing. Eszter Kovács sings these songs warmly but with some appreciation of their essential impersonality on Hungaroton SLPX 11603; Leslie Chabay's account of them on Bartók 904 seems sentimental by comparison.

Kovács's cultivated style and slightly languid production are even more appropriate in the two sets of art songs, Opp. 15 and 16, where the folk influence is barely present. These were Bartók's only essays in this genre, both composed early in 1916 under the impact of an infatuation with a talented young girl named Klára Gombossy, about which László Somfai's sleeve note gives much new information. Some of the texts of Op. 15 are apparently by Klára; those of Op. 16 are by the poet Endre Ady. It was a critical period in Bartók's personal and creative life, and this is reflected both in the general gloom of the songs and in the almost expressionist

by Jeremy Noble



"Seesaw" from Bartók's *Seven Sketches* for piano.

complexity of their harmonic idiom (more dissonant than either *Bluebeard*, which preceded them, or *The Wooden Prince*, which came immediately after). Kovács and her accompanist Adám Fellegi do full justice to their pervading melancholy (though I think Magda László got even more intensity into her performance of Op. 16 on an old Westminster disc, XWN 18665).

The new stylistic synthesis that Bartók worked out for himself after the war was achieved primarily in instrumental terms, but its effects can be felt in his next vocal composition, the *Village Scenes* of 1924 (Sz. 78), dedicated to his second wife, Ditta Pásztor. Here his abiding fascination with folksong is subjected to a treatment at once freer and more consciously constructivist than before. Erika Sziklay is something of a specialist in modern music, and she sings both the *Village Scenes* and the 1929 set of *Twenty Hungarian Folksongs* (Sz. 92) with accuracy and charm on Hungaroton SLPX 11610. It is only when one turns to an older Hungarian record (Qualiton LPX 1253) of the former by Erzsébet Török that one realizes how much they gain from a voice with more earth in it; Sziklay's light soprano begins to seem both too refined and too monochromatic.

In 1926, on a commission from the New York League of Composers, Bartók

reworked the last three of the five *Village Scenes* for women's chorus and a colorful little chamber group that both reflects the influence of Stravinsky's *Renard* and brings out the music's links with *Les Noces* (first heard in 1923, though it had been essentially composed during the war). The very attractive and rarely heard *Three Village Scenes* (Sz. 79) are on another Hungaroton record (SLPX 11510) together with other music for voices and orchestra, including orchestrations of five of the *Twenty Hungarian Folksongs* of 1929, beautifully sung by Julia Hamari, and of seven of the *Twenty-seven Choruses* of 1935. These all receive enchanting performances from various Hungarian forces under András Kórody and Antal Dorati. Unfortunately, the main work on the disc, and one of the most significant in Bartók's entire oeuvre, the great *Cantata profana* of 1930, is far less well done. In this work he applied his by now profoundly folk-impregnated idiom to the legend of the woodsman's seven sons who, in the heat of the chase, are magically turned into stags and thus exiled forever from their father's home. The concept of exile held meaning for Bartók on many different levels—political, artistic, personal; for all its compression (the piece should last little more than a quarter of an hour), the music it drew from him was startlingly vivid.

János Ferencsik is one of the best-known names among contemporary Hungarian conductors still based in that country; perhaps that, rather than any particular sympathy for Bartók's idiom, was why he was chosen for this important task. Here he plays slow and loose with Bartók's detailed indications of tempo in a way that few other performers in the Hungaroton series do. Of course one cannot expect the same degree of accuracy from a large chorus and orchestra as from a string quartet, let alone a solo pianist, but one can expect something better than Ferencsik offers; the version of *Cantata profana* once available from Deutsche Grammophon (SLPM 138 873) with the same soloists under György Lehel, though not ideal, was far more scrupulous and so more vital. József Réti still copes manfully with

the frantically high tessitura of the tenor who represents the eldest son, the spokesman for the enchanted stags, but András Faragó, as the father, is even more ill focused on the new recording than on the old. He, in particular, is easily outsung by Marko Rothmüller on Bartók 312, but this elderly monaural recording suffers from an unusually artificial balance, presumably intended to make a rather small pickup chorus, singing in English translation, sound larger than it really is. Truth to tell, this important but tricky work has never yet been given the recorded performance it deserves. I can think of few better ways for London Records to celebrate the Bartók centenary than to commission a new one from Sir Georg Solti and his Chicago forces.

Two more Hungaroton records complete the repertory of Bartók's choral music. On SLPX 1290 the girls' chorus of the Győr High School of Music, under its director Miklós Szabó, sings the Twenty-seven Choruses for two- and three-part unaccompanied voices (1935), music of astonishing variety and technical invention within very closely defined technical limitations;

[In the lists that follow, performing groups are indicated with appropriate combinations of St (State), P (Philharmonic), R (Radio), S (Symphony), C (Chamber), O (Orchestra), and Ch (Chorus). Where a set includes more than one disc, the number is given parenthetically following the record number.]

- HUNGAROTON SLPX 11603—*Hungarian Folksongs* (Sz. 33); *Five Songs, Op. 15* (Sz. 61); *Five Songs, Op. 16* (Sz. 63); *Eight Hungarian Folksongs* (Sz. 64). E. Kovács, Fellegi.
- BARTÓK 904—*Hungarian Folksongs* (Sz. 33), Nos. 1, 2; *Eight Hungarian Folksongs* (Sz. 64); *Twenty Hungarian Folksongs* (Sz. 92), Nos. 1, 3, 19, 20. Chabay, Kozma. (Also two arrangements by Kodály.)
- WESTMINSTER XWN 18665—*Five Songs, Op. 16* (Sz. 63); *Eight Hungarian Folksongs* (Sz. 64), Nos. 1–5; *Twenty Hungarian Folksongs* (Sz. 92), Nos. 16–20; *Folksongs* (4). László, Holetschek.
- HUNGAROTON SLPX 11610—*Twenty Hungarian Folksongs* (Sz. 92); *Village Scenes* (Sz. 78); *Mikrokosmos* (Sz. 107): *Four Songs* (Nos. 65, 74, 95, 127). Sziklay, Lantos.
- QUALITON LPX 1253—*Eight Hungarian Folksongs* (Sz. 64); *Hungarian Folksongs* (Sz. 33). Csajbok, Tusa. *Village Scenes* (Sz. 78); *Mikrokosmos* (Sz. 107): *Four Songs* (Nos. 65, 74, 95, 127). Török, Tusa.
- HUNGAROTON SLPX 11510—*Cantata profana* (Sz. 94). Réti, A. Faragó; Budapest Ch&SO, Ferencsik. *Five Hungarian Folksongs* (Sz.

four of these are also vividly performed by the Kodály Girls' Choir on a rather overreverberant Angel disc (S 36334) mainly given to that group's eponymous composer. While there is a sense in which these pieces are written at least as much for the performers as for an audience, the choral cycles on the remaining record were conceived as concert works—particularly the two magnificent late ones, both for unaccompanied male voices. The six *Székely Songs* (Sz. 99) tax the singers to the utmost in a six-part polyphonic texture of great complexity and tonal fluidity, but the triptych *From Olden Times* (or *From Bygone Days* in some sources) is perhaps even more important. Here Bartók places all the technical devices of the Twenty-seven Choruses at the service of an overtly political statement in praise of the peasants whose sturdy, self-sufficient way of life he had come to know and admire during his many years of song gathering: "They do not learn their songs from books, they need no rubbish from the town." Does this sound like sentimental back-to-naturalism? There is not a trace of sentimentality in the music; Bartók had earned the right to pay this tribute to a

101). Hamari; Hungarian StO, Kórody. *Three Village Scenes* (Sz. 79). L. Faragó, Adam; Győr Girls' Ch, Budapest C Ensemble, Dorati. *Twenty-seven Two- and Three-Part Choruses* (Sz. 103): *Choruses with Orchestral Accompaniment* (7). Liszt Academy CCh, Budapest SO, Dorati.

DEUTSCHE GRAMMOPHON SLPM 138 873—*The Miraculous Mandarin* (Sz. 73). Hungarian R and Television Ch, Budapest PO, Ferencsik. *Cantata profana* (Sz. 94). Réti, A. Faragó; Hungarian R and Television Ch&O, Lehel.

BARTÓK 312—*Cantata profana* (Sz. 94). Lewis, Rothmüller; New SO&Ch, Susskind. *Four Slovak Folksongs* (Sz. 70); *Twenty-seven Two- and Three-Part Choruses* (Sz. 103): *Songs* (8). Concert Choir, Hillis.

HUNGAROTON SLPX 1290—*Twenty-seven Two- and Three-Part Choruses* (Sz. 103). Győr Girls' Ch, Szabó.

ANGEL S 36334—*Twenty-seven Two- and Three-Part Choruses* (Sz. 103): *Four Songs* (4). Kodály Girls' Choir, Andor. (Also works by Kodály.)

HUNGAROTON SLPX 11519—*Four Old Hungarian Folksongs* (Sz. 50); *Slovak Folksongs* (Sz. 69); *Székely Songs* (Sz. 99); *From Olden Times* (Sz. 104). Hungarian People's Army Male Choir, Vásárhelyi. *Four Slovak Folksongs* (Sz. 70); *Hungarian Folksongs* (Sz. 93). Slovak P Choir, Szabó.

culture that had given him so much. The music on this record (SLPX 11519) is superbly sung by the Hungarian Army Choir and, in the mixed-chorus pieces, by the Slovak Philharmonic Choir. For me it is one of the most valuable of the whole Hungaroton series, because it presents, in performances of absolute conviction and authority, music that few of us are likely to know. I hope it will inspire choirs outside Hungary to tackle the challenge of these pieces, particularly the male-voice ones; perhaps if enough do, Bartók's publishers will make them more readily available.

Chamber works

Bartók turned to vocal music only occasionally during his career, but his involvement with chamber music was constantly self-renewing. The string quartets, of course, present the classic example. Spanning almost the whole of his maturity, from 1908 (an early quartet from his teens has remained unpublished) to the last months before he left Europe for America, they cover every aspect of his stylistic development.

No. 1 was composed soon after his discovery with Kodály of "true" Hungarian folksong, yet the idiom of the quartet as a whole is still a fascinating amalgam of German late-Romanticism with traces of something French—Ravel rather than Debussy at this time. It is as if Bartók were looking for a way out of the fin-de-siècle maze and had caught a glimpse of it in the Hungarian folksong style, conjured up in the typical pentatonic phrase that he twice highlights in the finale—or is this only a glance back at a lost age of innocence? No. 2, composed almost ten years later, is at once more individual and more homogeneous in style; but it is a homogeneity that can contain the widest possible range of expression, from the lyricism of the first movement through the ferocity of the central scherzo to the encircling gloom in which the work ends (like so many others of this period). Another ten years bring us to the Third and Fourth Quartets, written in almost immediate succession in 1927 and 1928. (Only the violin rhapsodies written for Sziget and Hungarian Székely, occasional music for all their skill, come between.) Yet in spite of their proximity, these two quartets are astonishingly dissimilar: Where the former is expressionistic, instinctive in its organic development, the latter is

consciously controlled, almost geometrical in the symmetries it observes at every level of composition; where one is like drama, the other is more like architecture. But the works have their similarities, too; above all, the now familiar range of expression, carried to its farthest extremes, gives rise in both to a new exploitation of every possibility of string color and technique. These are still found in the Fifth Quartet, composed within a single month in 1934, though by now the tension of extremes has begun to relax, and this relaxation makes itself felt in a withdrawal both from the dissonant harmonic idiom and from the extremes of performance technique. There may be some loss in nervous excitement but also a gain in lucidity and immediate communication—carried still farther in the valedictory Sixth Quartet of 1939, which looks back on the contradictions of the earlier works, frames them, and resolves them in a serenity beyond grief.

For all their differences, reflecting the psychological and technical development of a composer driven to constant self-exploration, the quartets betray a fundamental allegiance to the ideals, sometimes even the methods, of Beethoven. Like Beethoven's, they pose an immense range of challenges to the performers; a definitive performance of either cycle is almost unimaginable. Yet at the same time no quartet is likely to put the necessarily huge investment of intellectual and physical energy into a complete recording of Bartók's six unless its members are profoundly aware of their quality, and one cannot dismiss any of the currently available complete versions out of hand. Instead, one can only choose from among them by a process of whittling away those that, for all their virtues, contain features with which one would not wish to live. Thus the Tátrai Quartet's account on Hungaroton SLPX 1294/6 is put out of court by a generally thin and topky quality of sound (it was among the earliest of the Hungaroton series) and a lack of dynamic contrast that may be the fault of the recording but could also come from some lack of commitment in the players. The Guarneri version (RCA ARL 3-2412) is unsatisfying for rather different reasons—not a lack of commitment, but an unripeness that shows itself in overemphasis of details, particularly in the leader's tendency to exaggerate what should be the merest nuances of his line.



It is as if Bartók were looking for a way out of the fin-de-siècle maze and had caught a glimpse of it in the Hungarian folksong style.



RCA's small, clear, distinctly roomlike quality of sound makes a refreshing contrast with some of the overresonant versions, though the best *sound* on any of the sets recently available is that with which Telefunken has provided the Végh Quartet (36.35023). That recording—deleted last November but still available in a Musical Heritage Society pressing (1501/3)—combines clarity (you get the leader's every sniff) with a luminosity that comes from careful microphone placement in a sympathetic hall. Yet in spite of this immediately attractive sound and in spite of some beautiful interpretive touches (perfectly judged tempo changes in the finale of No. 1, a superbly impassioned cadenza in the middle of the Sixth's second movement—all the solo recitative passages are excellent), Sándor Végh himself here shows some loss of control in bowing and intonation. I should want this set to fall back on, for its moments of true insight, but not perhaps as a completely reliable "standard edition."

For that, it seems to me, there are three plausible candidates. The Hungarian Quartet, led by Zoltán Székely, whose association with Bartók goes back to the early 1920s, made its complete recording for Deutsche Grammophon in 1962 (Privilege 2728 011). Its sound is perhaps just a shade constricted, by today's best standards, but it is beautifully clear and well balanced for all that, and the players themselves are incomparable in the more inward movements, with an excellent sense of the music's ebb and flow of feeling (and a most idiomatic use of portamento) that never puts its fundamental classicism at risk. The Juilliard recording (CBS D35 717) is at once more extrovert and more virtuosic, with a power and accuracy in the most hair-raising moments that none of the other groups can quite match. Yet there are

dangers in the constant intensity of the playing, and these are compounded by a very close sound that can become a little glassy at climaxes. The New Hungarians on Vox (SVBX 593) are recorded at a level that allows surface noise to be more audible than with some of their full-priced rivals, but the actual balance of sound is excellent, and their interpretations must rank among the best; the only fault I can find is that they occasionally sacrifice verve to absolute rhythmic accuracy.

One small yet profoundly symptomatic point that gains importance in retrospect: The New Hungarians, like the various European quartets mentioned above, take the end of No. 6, where the pizzicato cello brings back the initial phrase of the work's generating melody beneath a bare fifth on the violins, absolutely straight. The Juilliard cellist introduces a slight ritard, the Tokyo player (in a record intended as the first of a complete set, DG 2530 658) makes an enormous one. Why does this seem so offensive? Surely because it contradicts the fundamental symbolic significance of the passage (and hence of the quartet itself), which is none the less powerful for being implicit: The cycle begins again, the song continues, even unheard, and so a heavily signaled "dying fall" is a solecism.

No other genre of chamber music occupied Bartók over so long a period as the string quartet, but he tackled many at different times. After various juvenilia, he made no attempt to combine piano and strings until the two extraordinary violin sonatas of 1921–22, in which he makes a virtue of *not* combining them, or at least not allowing them to share material. Both were dedicated to the brilliant young violinist Jelly d'Aranyi and intended for performance by her and the composer (though the first performances were in fact given by other violinists), but Bartók paid her the compliment of making no compromise with preconceived notions of femininity: These are among the toughest of all his works, radical in their approach to form, texture, and tonality, and making huge demands on listener and players alike.

It is obviously convenient for the collector to have both on a single disc, but between the two distinguished records that present them in this form, I find it difficult to choose. The young Russian artists Gidon Kremer and Yuri Smirnov, who play them on Hungaroton

(Continued on page 65)

A CHALLENGE TO YOUR STEREO SYSTEM FROM THE ORIGINAL MASTERS

SHAKESPEARE'S masterpieces challenge the standards of literary perfection. An Original Master Recording™ Lp or cassette, challenges the sonic potential of your stereo system and markedly improves its performance.

Original Master Recordings™ are hand-crafted from the original recording studio or concert hall master tapes of the most acclaimed musicians and vocalists of our time. Each is a Limited Edition, reproduced for extraordinary quality... not quantity.

For the first time, you will be able to hear music the way the artist originally performed it... every incredible note and nuance.

Each Original Master Recording™ Lp utilizes our *exclusive* half-speed mastering process for total sonic accuracy. They are pressed on Super Vinyl to give you unparalleled clarity, quiet surfaces and extended playing life. Custom packaging is provided for absolute protection against warpage.

Our Original Master Recording™ High Fidelity Cassettes are custom duplicated in real time (one-to-one) from the original stereo master tape. Nothing is lost in the translation. Maximum frequency response and negligible background noise levels are achieved through high bias Chromium Dioxide tape. The ultra-protective cassette shell prevents jamming and significantly reduces headwear, wow and flutter. You will not believe that pre-recorded cassettes can sound this spectacular.

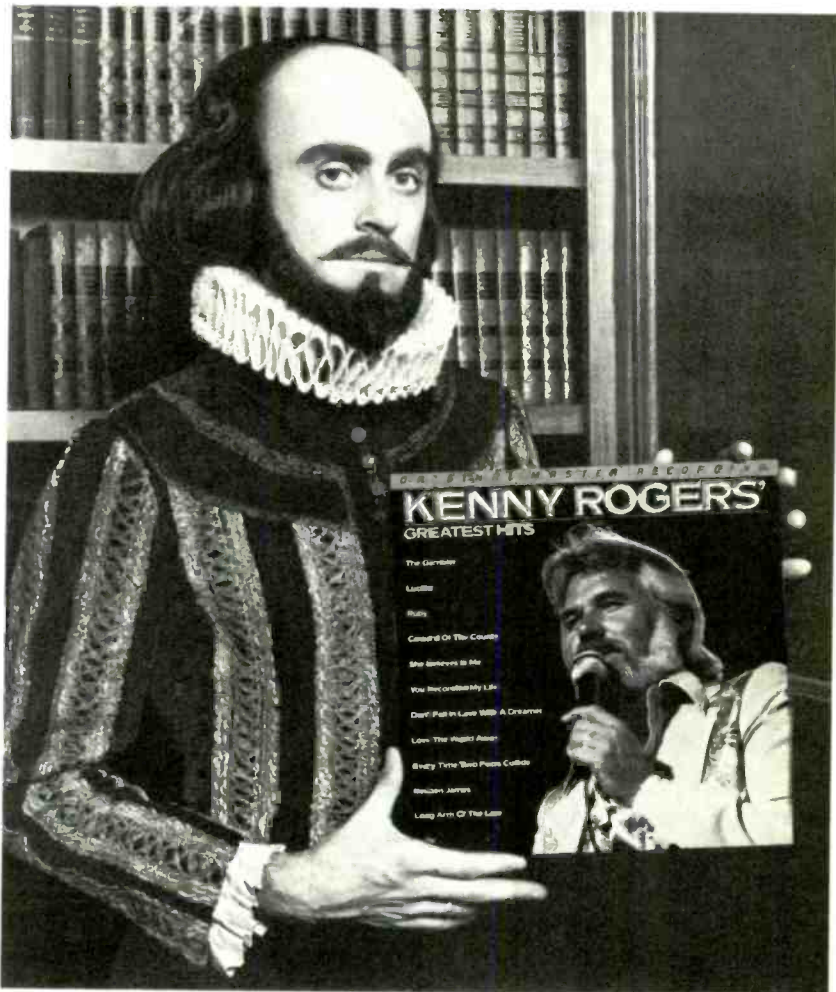

Free color catalogue. Write: Mobile Fidelity Sound Lab, (Dept. HF) P.O. Box 919, Chatsworth, California 91311.

Available at discriminating audio, record and automobile sound stores.



New Limited Editions From The Original Masters

O R I G I N A L M A S T E R R E C O R D I N G S™

Circle 22 on Reader-Service Card

Take Control of your Television

Video discs. Video cassettes. Cable television. Pay T.V. Home computers. Over-the-air information. Video games. Direct satellite-to-home reception.

Five years ago, nobody even considered having any of this in their homes. Today, people are clamoring to get in on the action. Tomorrow, the whole video field will have grown to the point where video technology will be the single most important aspect of our daily lives.

T.V. is more than just entertainment. Medical information, daily food cost comparisons, computer checking and bank transactions right to your television screen, newspapers over the air, updated constantly ... today's video world is more than motion pictures.

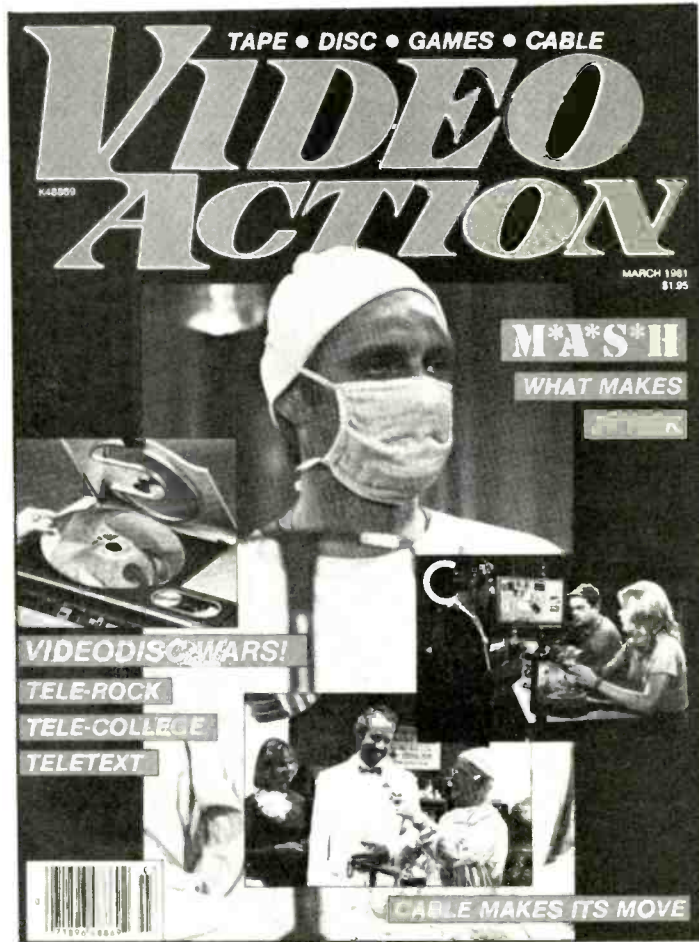

VIDEO ACTION is the first magazine that helps you take control of your television set. We will keep you abreast of all the latest in this, the fastest growing communications medium.

Written so you don't have to be a T.V. repairman or electronics genius to understand it, VIDEO ACTION covers every aspect of the field. We keep you on top of the latest in broadcast and cable television, in video discs, cassettes and games. We keep you informed of all the changes in the field—what's new, what's being replaced, what's changed ... and how all this will effect you.

VIDEO ACTION. Every month, at your nearest magazine rack or by subscription.

VIDEO ACTION. Take control of your T.V.

SPECIAL CHARTER OFFER

Please send all orders to: Video Action, P.O. Box 255 Mt. Morris, IL 61054

PLEASE BILL ME FOR:

\$17.00 ONE YEAR \$28.00 TWO YEARS \$40.00 THREE YEARS

SAVE EVEN MORE! Enclose payment and get 12 issues for \$15 savings of over 30% off newsstand rate!

Name _____

Address _____

City, State, Zip _____

Enclosed is my check, money order, bill me or charge to my Visa,

Master Charge

Interbank No. _____ Exp. Date _____

Signature, Date _____

OR CALL TOLL FREE:

1-800-435-0715

(In Illinois call 1-800-892-0753)

TO CHARGE IT OR HAVE YOUR
SUBSCRIPTION BILLED TO YOU

**SPECIAL BONUS
SUPPLEMENT**

VIDEO TODAY

CONTENTS/MAY 1981

& TOMORROW

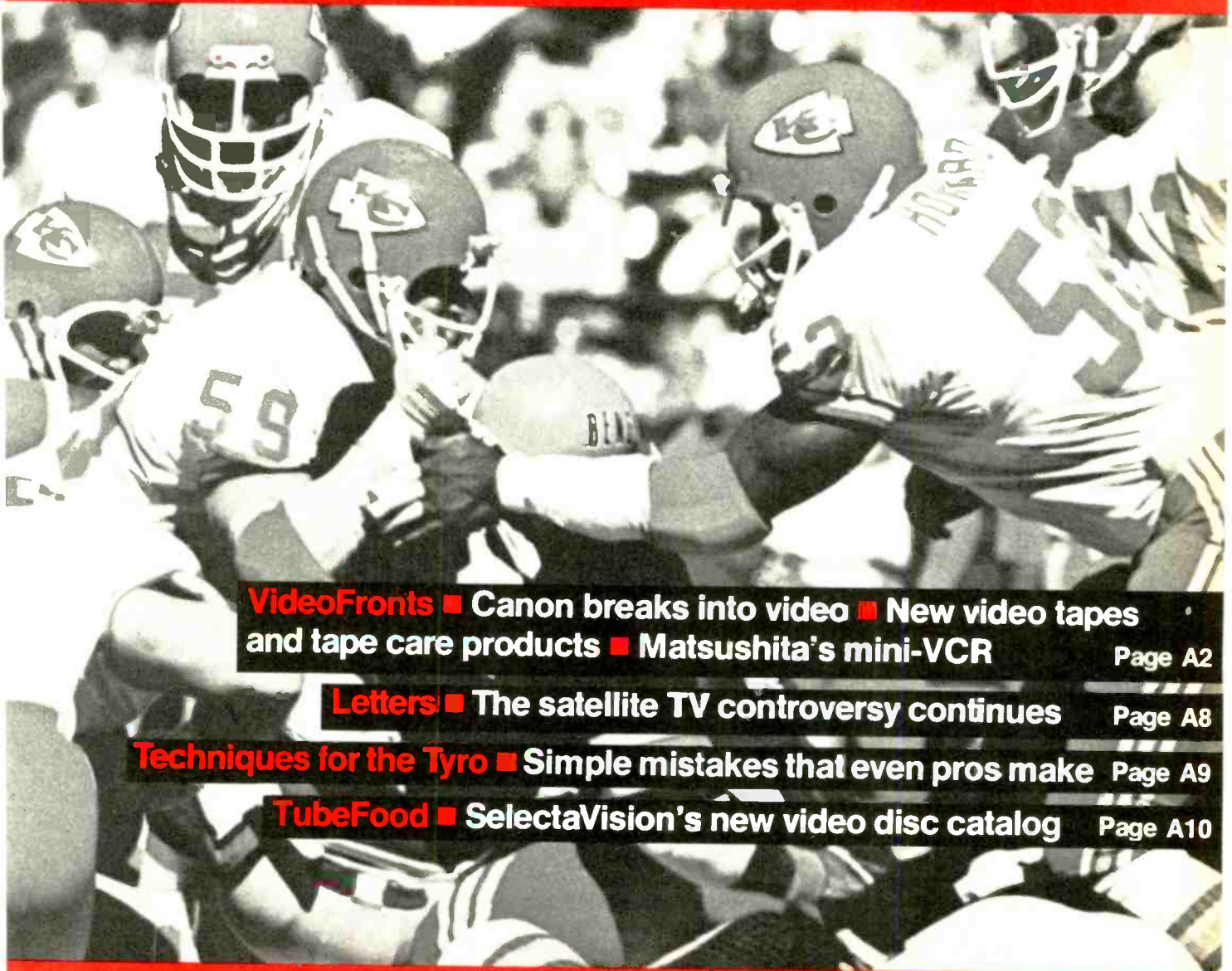

VideoFronts ■ Canon breaks into video ■ New video tapes and tape care products ■ Matsushita's mini-VCR Page A2

Letters ■ The satellite TV controversy continues Page A8

Techniques for the Tyro ■ Simple mistakes that even pros make Page A9

TubeFood ■ SelectaVision's new video disc catalog Page A10

Hands-On Report ■ A two-way conversation with the first "interactive" video disc—*How to Watch Pro Football*. Page A6

VideoFronts

Latest Video News and Products

Matsushita's Mini Video

Matsushita joins in the mini video revolution—along with Sony and Hitachi—with its Micro Video combination camera/VCR. Only in prototype form at this stage, the Micro Video uses a half-inch Cosvicon tube as imager and quarter-inch tape cassette that slips into the recorder portion of this all-in-one unit. Similar to the Hitachi version, it is capable of recording up to 2 hours.

Matsushita claims a horizontal resolution of about 250 lines using a video head drum 4 inches in diameter. Weight is said to be 5 or 6 pounds. The company also will offer an adapter to transfer recordings to half-inch formats or to play back original recordings on your TV set.

—Tony Galluzzo

Beta Format VCR Due from Aiwa

By the end of this year, the Aiwa Company plans to introduce its first video cassette recorder in the U.S. It's hardly surprising that the machine will be in the Beta format: Aiwa is an affiliate of Sony Corporation, the originator and chief proponent of Beta recorders. Aiwa plans to complete its production facilities in Japan sometime in June and will initially sell its production run to Sony. It plans to produce portables under its own label later. The company is also said to be investigating

the use of quarter-inch cassette tapes; currently, the majority of VCRs (including the Betas) use half-inch tape.

A sophisticated electronic viewfinder is one attribute of JVC's Vidstar GX-88U camera (price not available). By looking into the viewfinder—a 1½-inch black-and-white CRT—you can determine if a scene is overexposed, underexposed, or correctly exposed; the remaining battery power; and white balance. Other features include low power drain, automatic backlight compensation, a switchable daylight filter, a vidicon shutter switch, and a fold-away hand grip. The f/1.4 six-to-one (12-to-72mm) auto zoom lens has an automatic iris control. The color camera weighs 4 pounds, 4 ounces.

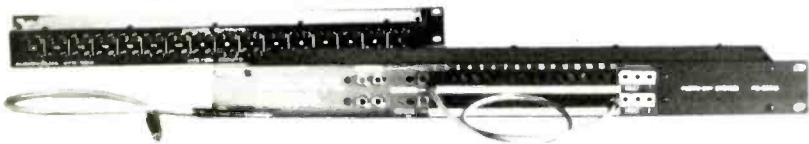

If you have a sophisticated home video system, the programmable audio/video patch bay from Audiovisual Systems may be of interest. The PB-289G allows you to link a number of VCRs, image enhancers, monitors, etc., and the

programmable circuit enables the device to operate in most cases without patchcords or pushbuttons. Gold-plated contacts are used throughout for low signal loss. The device has seventeen two-channel inputs and outputs. It costs \$650.

A compact satellite TV antenna is available from Downlink, Inc. The Skyview I comes in either an 8-foot or a 12-foot spherical design, both of which use an aluminum screen reflector surface for low wind resistance. The antenna can receive signals from up to seven satellites without reorientation. The company says this model is aimed at making a home satellite receiver system practical and affordable for more con-

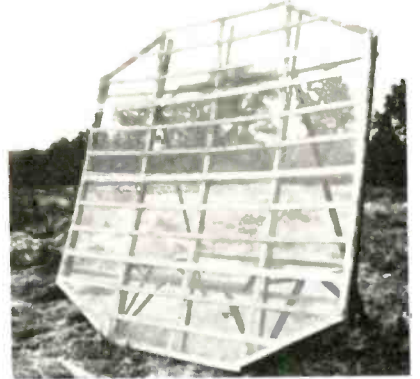

Canon Breaks into Video with Portable System

Canon may be the first photographic company to offer video hardware in this country. It has started the ball rolling with the recent introduction of a relatively compact video cassette recorder and color video camera. The system, we're told, should already be available to Japanese consumers as you read this.

What system are we talking about? The Canon VR-100 VCR weighs little more than 7 pounds, including its rechargeable nicad battery, and it accepts a video cassette that's hardly larger than standard audio cassettes. Instead of using half-inch tape, such as that found in VHS and Beta cassettes, this one uses quarter-inch tape with a maximum recording time of 30 minutes.

Since Canon is primarily known as a maker of fine optics, still and movie cameras, and—more recently—office copiers and calculators, how has it suddenly made its way toward such lightweight, innovative video gear? Canon has aligned itself with a large Japanese electronics company specializing in video technology. And judging from the look and workings of the VR-100 recorder, we made an educated guess that that electronics company

sumers to use. Cost of the Skyview system, depending upon installation, ranges from \$5,000 to \$7,500.



Expanding its extensive video tape line, TDK has introduced a new Super Avilyn Beta video cassette. The L-750, capable of a maximum of 4½ hours of recording and playback, uses the same particle technology as do the L-500 and L-250 cassettes. The L-750 is said to have an improved particle binding system, utilizing a newly developed thin-film polyester base. Cost is \$24.

A video head cleaner utilizing Freon TF cleaning formula is available from Robins Industries. The kit (# 29-500), which sells for \$11, includes five specially designed applicators and a 1-ounce bottle of the Freon formula. Applicators and solution may also be bought separately.



For the person with an extensive video cassette library, the VCR Tape Library 2460 from Gusdorf Corporation may be just the thing. Designed with double doors that swing outward from the main unit, this storage cabinet holds 168 VHS or Beta video cassettes; a VCR fits easily on top of it, if desired. The cabinet has walnut vinyl veneer, casters, and brass door handles. Cost is \$150.

(continued on page A12)

is Funai Electric. Why Funai? Because Funai makes the Technicolor 212 VCR, introduced last fall, and that piece of hardware has a striking resemblance to Canon's.

What sets Canon apart is its superiority in the optical field, having had experience designing some of the best zoom lenses for video, 16mm, and the critical super 8 format. The manufacturer places its stamp and its designing acumen on the 13-65mm f/1.8 zoom lens that fronts the companion VC-100 color video camera.

The camera employs a ⅔-inch vidicon as imager and provides a standard horizontal resolution of 240 lines with signal-to-noise of 45 dB, according to the company. Focusing is through an SLR-type optical finder with a split-image center, but an accessory electronic finder can be attached.

Exposure is fully automatic via through-lens iris control. If prevailing lighting conditions are dimly low, the automatic peak control will help to brighten the image.

Specs on the VR-100 recorder are about as impressive as those on any half-inch portable VCR. Pushbutton controls offer fast forward, rewind, record, play, and stop/eject. At the side of the recorder, where camera and power cables plug in, you can engage a button for sound dubbing and turn a dial for picture tracking or

still mode. There's a three-digit tape counter with memory and automatic shutoff should moisture build up on the head drum or battery power become insufficient. The 12-volt nicad battery fully recharges in one hour, by the way, to provide 40 minutes of power with the camera, 80 without. If you're out in the field, it's possible to charge the system through your car battery; at home, the AC power adapter/charger is used.

Canon claims 220 lines of horizontal resolution from the recorder, somewhat less than the camera is capable of delivering and just a bit less than half-inch systems. But, when viewing a demonstration of the system in Japan, we were quite impressed by the overall color and image quality possible.

Even after adding the weight of the camera, about 3 pounds, the total system still weighs less than any half-inch VCR alone. Price of the recorder, roughly converted from the yen value as of this writing, is about \$850; ditto for the camera. The AC adapter/charger, however, will cost an additional \$150, the battery \$50, and blank quarter-inch cassette tapes about \$10. But, thus far, there's no word on Stateside delivery.

—Tony Galluzzo



New Canon VCR employs small helical scan video head drum, microelectronics, and quarter-inch tape to reduce weight to 7 pounds. Canon zoom is featured on VC-100 color video camera.

Capture a million save \$100 RCA's best color

There's never been a better time to videotape your little girl's



birthday, New Year's Eve, a beautiful woman, or any of the once-in-a-lifetime events you live.



RCA's new CC010 video camera lets you capture them live, in color, and at a savings of \$100!

**Introducing the new
RCA CC010.
The state of the art in
home video cameras.**

A versatile 8:1 lens is standard. So you can videotape your daughter's birthday smile (as close as 4 inches). And two-speed zoom lets you switch to wide angle party shots at the



touch of a button.

Whether you're right or left-handed, a reversible electronic viewfinder lets you see what the camera sees as it records New Year's Eve.

An automatic white balance switch adjusts a beautiful girl's beautiful color levels without a TV monitor. And, an



memories and with video camera.



automatic iris adjusts the proper lens setting. You can even record sound with a *built-in microphone*. And monitor it through an *earphone jack*.



And, no matter what events you shoot on videotape, an *automatic fade button* gives you smooth, professional-looking transitions between scenes.

**The camera for
most VHS systems. Including
RCA's best.**

The CC010 is lightweight, portable and comes with a *compatibility switch* that lets you use it with RCA's Convertible SelectaVision Video Recorder—or most any other VHS system. So you can shoot almost anywhere, anytime or anything.

**Save \$100
when you
buy now.**

We've made the CC010 our best camera yet. And now we've made it more affordable.

During RCA's Save 'N Shoot Spectacular you can save \$100 on the CC010—in a check directly from RCA. And you can save \$75 on the CC007 model camera, and \$50 on the CC005, too.

It's all going on now through June 7, at your participating RCA Dealer. Save now during RCA's Video Camera Save 'N Shoot Spectacular. And save a million memories for years to come.



For the complete line of SelectaVision VCR models and color video cameras, write to:
RCA Consumer Electronics, Department 32-312X
600 North Sherman Drive,
Indianapolis, Indiana 46201



HANDS-ON REPORT

Interactive Action

Hands-on appraisal of the first optical video disc with programming you can manipulate.

by Myron Berger

In a very real sense, the era of the video disc was ushered in recently with the arrival of the interactive disc. Until now, the only programs available for the U.S. Pioneer and Magnavox optical laser players have been films of various subjects pressed onto disc. Now Magnavox and Pioneer have joined with MCA to form Optical Programming Associates, and its initial release is *How to Watch Pro Football*. This interactive disc is the first made expressly to take advantage of all the capabilities of this unique new medium.

"Interactive" is a term that slipped into public usage several years ago, when Warner Communications installed the Qube two-way cable television system in Columbus, Ohio. Using a hand-held keyboard controller, Qube subscribers are able to engage in a two-way electronic dialogue with many of the programs they watch. In the case of the interactive optical video disc, viewers use the transport controls on the player to manipulate the program and customize its presentation of information.

The stated aim of the pro football disc is to help viewers understand and enjoy the game more than they do now—essentially an educational mission with a strong measure of appreciation thrown in. The presentation presumes that you have at least a passing familiarity with the subject and, preferably, an interest in it that may border on passion. It is most definitely not for beginners. Although my own interest in football falls considerably short of passion, I found it entertaining and the potentials of interaction—which this disc only hints at—to be exciting.

This program goes about its mission in a fairly straightforward manner: A number of professional coaches each present a lesson on a different aspect of the game. Dallas Cowboys coach Tom Landry, for example, discusses passing strategy in one section, and Miami coach Don Shula offers his thoughts on goal-line defense in another.

The lectures (and that is, after all, what they are) include heavy doses of explaining football jargon—a language only slightly more comprehensible than Middle High German. Both strategy and terminology are almost invariably demonstrated in footage from pro games.

Since the optical disc player is eminently controllable, the viewer can use the freeze-frame, SLO-MO, scan, and frame-step features or search out a particular frame or chapter. Most of these functions, incidentally, are not available on the CED player developed by RCA and will likely be offered only as options on the VHD players due out late this year from JVC, Panasonic, Quasar, and General Electric.



Scene from first video disc with viewer-manipulated program.



Designed for laser-optical players, the disc's primary purpose is to educate viewers about pro football. A second disc—for children—is due soon and requires greater viewer participation.



Among the many viewer-operated controls is SEARCH FRAME, which lets you locate a particular frame almost instantly. A total of 54,000 individual frames are contained on the disc.

Another exclusive feature of the optical players—discrete two-channel audio—is used in three chapters on this disc to convey different information. In two cases, the viewer is quizzed on the material he has just watched. By silencing Channel 2, he sees a play and hears the question. He then backtracks to the beginning of the question, silences Channel 1, and activates Channel 2, which contains the answer.

In the third example of two-channel audio, Kansas City coach Marv Levy presents his thoughts on offensive moves at the goal line on Channel 1 while coach Shula discusses goal-line defense on the other channel. The visual material in both cases, obviously, is identical. This application of the feature is interactive in the sense that the disc asks what you would like to hear, and you respond by pushing a button and get what you selected.

Another interactive function afforded by the optical disc drive controls is the presentation of an NFL play book. The 361 pages of the volume (containing terminology and standard formations and plays) are reproduced at the rate of one page per disc frame. If the machine is in the play mode, all 361 pages will flash by in a matter of 15 seconds. If you care to read the material, you use the STILL/STEP-FRAME button to advance one page at a time at your own pace.

What is essentially the first video disc game, entitled Freeze When, is contained in Chapter 6, Side 2. You punch up the frame number display on your screen, watch footage of a play, and hit the STILL/STEP-FRAME button as soon as you can tell whether the quarterback will pass or run. By deducting the number of the frame when the play started from the number of the frame when you reached your decision, you arrive at your score.

The video disc has been programmed to activate the transport functions of the player so that freeze frame occurs automatically at the conclusion of each play and the score rating chart is displayed. By hitting the STILL/STEP-FRAME button, you move to the next frame for instructions for the next play. Move one more frame to note the number, hit PLAY, and you're off.

All the interactive features on my disc worked perfectly, although the play book sequence is only marginally useful since most of the print is too small to read (regardless of screen size). Still, the diagrams are quite clear, and they make up perhaps 75% of the material in the book.

Image quality throughout the disc is good, though not spectacular. Optical video disc manufacturers claim an image at least as good as the best broadcast picture, and color saturation, contrast, and clarity are indeed comparable. But the disc is marred by a high noise level. Another minor problem is the fact that all the material was originally shot on film stock rather than video tape. The result is a graininess that is occasionally disturbing, though never disruptive.

While my enthusiasm for the subject was distinctly limited, I felt almost as if I were in the presence of a historically important device. Assuming that video discs will prove to be as significant a medium of communication, information, and entertainment as its proponents suggest, this first interactive disc is, in fact, a milestone.

The second such disc from OPA, due out soon, is a children's program that is said to be far more interactive than the football release. If this is only the beginning, I can't wait to see what follows!



Questions and answers are on separate audio channels. With Channel 2 off and 1 on, you hear a question. Backtrack to the beginning, switch audio channels, and get the answer.

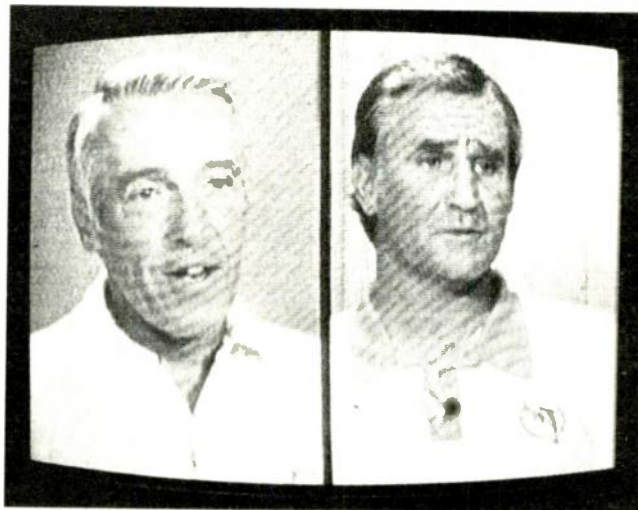

Offensive goal-line strategy is discussed by Kansas City coach Marv Levy (left) on one audio channel, while Miami coach Don Shula fills you in on goal-line defense on the other channel.

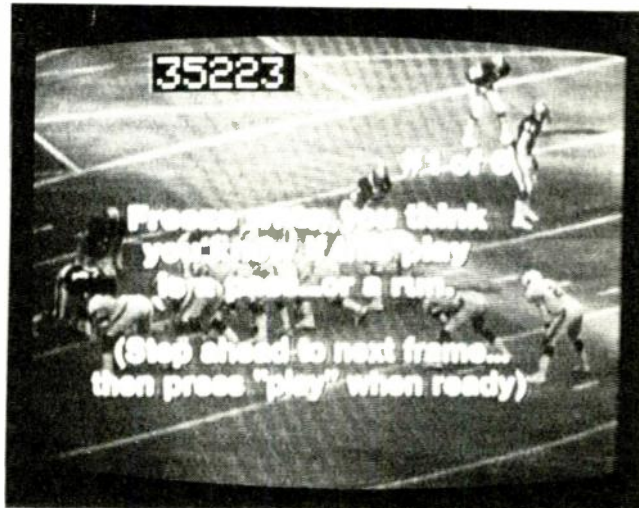

A video disc game called Freeze When tests how quickly you can guess if the quarterback will pass or run. Scoring is based on the number of elapsed frames from the beginning of the play.

Letters



The Satellite TV Controversy

I recently read your article on satellite television ["Are You a Signal-Napper?," February], which discussed the pros and cons of owning your own earth station. I have my own system and have contacted all the programmers at one time or another to negotiate payment of their wholesale programming fees. Most flatly refuse to sell any service to private terminal owners.

Since all the stations with religious programming actively encourage you to pick them up, it is very hard, as you pass through the channels (HBO, Showtime, ESPN, Warner, etc.), not to stop and enjoy. I am not by any means advocating piracy. But, when a responsible citizen wants to pay the fees and programmers refuse to discuss the use of programs that are on public airways, we have a problem. The irony is that, once you have the written approval of the religious stations to use their programming, there is no way anyone can come into your house and enforce any laws that prohibit you from watching pay programming.

I actively support SPACE and Richard Brown in their efforts to fill the gap between user and programmer. Keep up the good work.

Richard P. Lee
Redondo Beach, Calif.

An open letter to Jack Valenti, president of the Motion Picture Association of America, Inc. [See "Letters," February].

To protect myself and my family against the continued willful and wanton broadcast of microwave radiation by communication satellites, it has been necessary to erect (at great expense!) a saucer-shaped metallic shield over the roof of my home. This shield is attached to our television, where the intensity and duration of the radiation can be monitored both visually and aurally. In fact, my children regularly spend several hours each evening ab-

sorbed in vigilant monitoring. Your vituperative outburst, suggesting that I and similar health-minded individuals have no right to protect ourselves from electromagnetic effluents, is in itself "astonishing and evil."

I believe that you should know, too, that I have taken the precaution of recording on video tape many hours of this electronic litter, should it become necessary to take legal steps to stem this flow of broadcast pollution from the skies.

Creighton Scott
San Mateo, Calif.

P.S.: The kids want me to ask if you'll see to it that they get to monitor the movie *Popeye* soon. Thanks.

Technology has made it possible to have the choice of hundreds of TV channels, all with the clearest possible signals and available just about anywhere on this planet. With the problems associated with ground-wave transmission, this has to be the future of quality TV.

I am confident that technology will continue to improve this system and provide the movie industry with protection for its investments. I am sick to death of the movie industry crying about the risk of piracy and whatever else it fears. I think it is time the consumer was considered in all of this. Give us a way and something worth paying for, and we will do it. Don't expect us to sacrifice progress because you can't adapt to the new technology.

I fully intend to have an earth station when I can afford it. The movie industry says I am a thief. (The FCC says not.) I classify this attitude with a lot of the other trash I have seen



coming out of Hollywood.

Richard Green
Cassopolis, Mich.

I have begun to enjoy the parasitic VIDEO TODAY section; there is definitely a need for a professional forum in which to discuss developments in the fast-moving field of video entertainment.

Thanks for publishing Jack Valenti's letter in the February issue. His megalomania is unbelievable: Does he believe that the RF spectrum is private property? The movie and pay-TV companies have an excessive dependence on the concept of exclusive access to satellite transmission media, which rests solely on the rapidly diminishing economic and technical barriers to widespread availability of satellite receiving equipment. Rather than rant and rave about thievery and piracy, Mr. Valenti and his cohorts would be better advised to concentrate on developing techniques to prevent backyard receivers from receiving intelligible signals. It is counterproductive and ultimately futile to attempt to stem the advance of technology through legal action, especially when the precedents in favor of private use of RF signals are so strong.

Vade Forrester Jr.
San Antonio, Tex.

In the article on signal-nappers, you referred to an organization called SPACE (Society for Private and Commercial Earth Stations). I would like the mailing address of the organization, as I am interested in purchasing a home antenna and would like more information.

Larry N. Frey
Downey, Calif.

The address of SPACE is 1521 O St., N.W., Washington, D.C. 20005.—Ed.

In regard to the letter sent by Jack Valenti: The only thing evil about taking these radio waves is the cost of the antenna. Now that's evil.

Ralph C. Burr
Roanoke, Va.

VIDEO TODAY & TOMORROW is published monthly by ABC Leisure Magazines as a supplement to HIGH FIDELITY and MODERN PHOTOGRAPHY magazines. Editorial correspondence should be addressed to VIDEO TODAY & TOMORROW, P.O. Box 550, Dept. VT, Great Barrington, Mass. 01230.

Techniques for the Tyro

mistakes too stupid to be included in your VCR instruction book. by Herbert Keppler

Anyone who purchases a video cassette recorder for the first time and manages to get it hooked up properly will soon find various puzzles that don't seem to be covered in the instruction book. Some are there if you look hard enough, and others are just so basic that the manual writer never dreamed they should be included. They should, however. I'll let you in on three of my boners in the hope that you can avoid them with your system.

The mystery of the switching channel. I was really looking forward to viewing *A Funeral in Berlin*, which I had recorded at some crazy, early-morning hour using the automatic timer. I invited in a few special friends, started the tape, and got—*The Alamo* with John Wayne!

Had the station substituted the movie? That seemed most logical, until I came to a commercial and station break. I had set the machine to



So you want to record Channel 7? Make sure you don't switch off the recorder momentarily, or the tuner is liable to revert to another channel!

record Channel 7. What did I get? Channel 2. How could this have happened? Perhaps I had simply set the tuner to the wrong channel. Then the same darned thing happened two days later, with a program I wanted on Channel 4, turning again into a program on Channel 2.

What my instruction manual had not told me was that, whenever you set the tuner on my VCR to a specific

channel and turn it off, it automatically switches to Channel 2 when it is turned back on again. I had been blithely assuming that, every time the unit was switched on (whether by me or by the timer), it would pick up at the station at which it had been set the last time I used it. The result was chaos. So a word of warning: If you are recording with the timer, always make sure that checking your channel selection on the tuner is the last thing you do. More to the point (since VCRs vary in their programming procedures), develop a routine to run through when you set your VCR for unattended recording, to assure that everything is correctly set.

The case of the nonfitting cassette. The VCR had been working nicely. My wife asked to see a certain tape I had recorded a few days previously but not viewed. I slipped the cassette out of its case and attempted to push it into the cassette compartment. It wouldn't go. I struggled, trying not to force anything. I selected another cassette. It fit fine. Why wouldn't the first cassette fit? I had recorded it on the same machine.

Then the dawn broke. I had fastened the new spine label to the cas-



Why won't this cassette fit into the recorder? The label is right side up, but the cassette is upside down! Exposed spools are the giveaway.

sette upside down and was trying to load the cassette with the label right side up. Ergo, the cassette was upside down. I should have noticed the two naked spool cores on top; they must go at the bottom.

The peculiar blurry picture edge. I never realized how much I enjoyed some home movies but hated getting out the super 8 projector, screen, and all the mess. Then I transferred a few choice films to video cassette. Throw the cassette into the VCR and—presto—home movies and sound with no fuss and

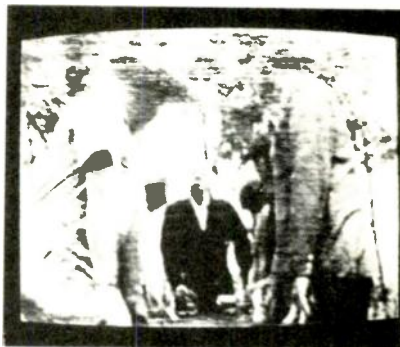

Have a fuzzy picture section on only one cassette and only when played on one specific VCR? Try altering the tracking.



bother. I showed one of these on a friend's machine at his home. It was fine. I took it home, slipped it into my machine, and the upper third of the picture was blurry and continued to break up. I put it on another neighbor's VCR. Fine again. I tried other cassettes on my own machine. Just dandy. What was wrong?

In desperation, I tried every control on both the TV set and the recorder. Eventually, I moved the tracking control ring on the VCR. A slight turn to the left, and the blurred, broken up third of my picture cleared. Lesson: Each cassette has (or can have) its own quirks that may show up on only one VCR, so adjust each separately if need be.

Those are my boners for the month. Now we'd like to hear about yours.

TubeFood

by Peter Dobbin

A monthly roundup and review of new (and sometimes original) video tape and video disc releases.

SelectaVision Discs Arrive

Considering the scope and content of RCA's first SelectaVision video disc catalog—and the enormous sums the company plans to spend on promoting its CED grooved-disc system—I don't think there's much question anymore as to the "winner" of the war between the competing video disc formats. If the discs perform properly (MCA DiscoVision's optical discs still have a weakness in this respect) and RCA can produce enough discs and play-

ers to support its vast dealer network, it's difficult to imagine what could stop the CED onslaught.

The first thing that strikes you while thumbing through the catalog—released just prior to RCA's nationwide launch of its disc player in March—is pricing. Early reports had indicated that CED discs, with an hour of playing time per side and compatibility with existing pressing technology, would be far less expensive than optical discs, but they are in fact competitively priced. For example, a collection of children's cartoons will cost \$14.98, and most feature films, \$19.98. Special discs are somewhat higher; Zeffirelli's *Jesus of Nazareth* (on four discs) goes for \$99.98.

Movie offerings are broken down

into categories of adventure, science fiction, musical, comedy, mystery, and drama. I feel that RCA's programmers showed a great deal of thought in the choices for this first catalog. Classics like *Citizen Kane* and *Casablanca* mingle nicely with such modern features as *The Boys from Brazil*, *Heaven Can Wait*, and *Starting Over*. I am especially pleased to see that a number of music programs are included. Though *The Grateful Dead in Concert* and *Gimme Shelter* will certainly lose something when reproduced monaurally, perhaps the corporate moguls will get cracking on second-generation stereo players and discs if sufficient interest is shown in video music. (The technology for CED stereo playback is already established, thanks to RCA's alliance with CBS Technology Center.)

But enough nitpicking. I, for one, can't wait to get my hands on a SelectaVision player and an assortment of discs. There are exactly 100 programs to choose from, with 45 more waiting in the wings. Stay tuned for a full report in a subsequent issue.



Hard Sell for Soft Core

Though the industry gulps in embarrassment at the memory, until quite recently it seemed that pornography would dominate the market for prerecorded video cassettes. In fact, some industry pundits privately foretold the doom of video discs simply because the limited number of disc pressing plants and their control by Establishment companies would preclude the availability of hard-core programs in that medium. Interestingly enough, legitimate movie companies and communications conglomerates saw the potential for profits in prerecorded video versions of classic theatrical productions and recent feature films.

Hard-core features persist, but the bulk of that market seems to be heading toward soft-core, R-rated programs. Still, it is often difficult to detect this change from the advertising and merchandising being employed. For instance, Visual Concepts is offering *The Stewardesses*—reportedly having the highest gross earnings of any 3-D color feature film ever released—in the Beta and VHS formats for \$80 (including two pairs of viewing glasses). Though I haven't personally assessed the impact of the film's 3-D effect when translated onto a home television screen, I did have the misfortune of seeing the original version in its commercial release back in 1970. As a rather overeager undergraduate at a small New England college, I clearly recall sneaking downtown to the less-than-savory movie house. Though our expectations of a sexy movie were certainly less "advanced" eleven years ago, I remember feeling disappointed by *The Stewardesses*. The scenes of simulated sex between fully clothed "airline captains" and bare-chested ladies—along with an occasional breast popping out at you, thanks to the miracle of 3-D—are hardly more explicit than an episode of TV's *Dallas*.

Another disappointment is MCA DiscoVision's optical video disc program entitled *The Touch of Love: Massage*. Though it appears under "Self-Improvement" in the DiscoVision catalog, its \$25 list price seems rather steep, especially when you note that the other two programs in that category sell for just \$6.00. But that's part of the appeal:

(continued on page A12)

Editor	William Tynan
Senior Editors	Peter Dobbin Tony Galluzzo Robert Long Michael Riggs
Technical Editor	Edward J. Foster
Video Music Editor	Susan Elliott
Copy Editor	Rebecca Abbott
Assistant Editor	Lynda Carlotta
Editorial Production	Kathleen Davis Jean M. Whitehead
Graphics	Tony Palagonia
Editorial Consultants	Robert S. Clark Herbert Keppler
Assistant to the Editor	Patricia Vogt
Credits: 51, 56, 57, John Payne; 58, Robert Curtis; 59, Herbert Keppler.	

Coming in June's VIDEO TODAY & Tomorrow

Video Camera Lenses

Everything you need to know to get top picture definition from your video imaging system.

A TV for "Time-Shifters"

Hands-on report on a three-screen television.

ICELAND

You haven't seen it all until you've seen this unspoiled land.

WHAT'S ALL THIS TALK ABOUT ICE?

You don't hear it from people who've been here. Just from those who haven't.

Fact is, you'd have to deliberately search for it to find ice in Iceland. Most of our geography consists of picturesque villages and natural wonders. Volcanic craterlakes. Huge rock formations. And thundering waterfalls. The largest in Europe.

All of which makes for breathtaking views. And some of the most awesome colors this side of the solar system.

COLORFUL AS MARS. AND A HECK OF A LOT CLOSER.

Much of Iceland is as it was centuries ago. Clean, natural, colorful. We have over 230 varieties of birdlife. A rare, native breed of pony. And lots of other things that make bringing your camera almost mandatory.

Start planning today to visit us soon. Your travel agent can plan your itinerary and brief you on our wondrous sights.

And Icelandair will get you here in non-stop comfort from New York in 5 hours.

ICELANDAIR

For the Icelandic toll free number in your area call 800-555-1212. Or for full details write Icelandair, P.O. Box 105, West Hempstead, N.Y. 11552



VIDEOFRONTS (continued)



A Beta format VCR cleaner system called the Allsop 3 is available from Allsop, Inc. It comprises two elements—a cassettelike cleaning device and a container of liquid cleaner. You moisten the exposed cleaning strip on the cassette, insert the cassette into the deck, and push the button. The chamoislike strip then cleans the recorder playback heads while a separate felt pad cleans the capstan and pinch roller, all in about five seconds. The cleaning strips are replaceable. The system sells for \$30.

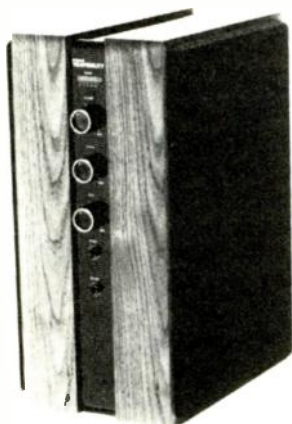

A pseudo-stereo effect is possible with the Telefidelity TV sound converter from Petrous Electronics. The device has a built-in 15-watt (11 1/4-dBW) amplifier and allows you to adjust volume, bass, and treble. It connects to the (monaural) audio output on a television with a quarter-inch phone plug. The walnut grain cabinet, 18 inches high, contains an 8-inch woofer and 3-inch tweeter for wide-range response. The cost is \$100 for the standard model (shown); \$130 for the deluxe model.

At 11 1/4 pounds, the HR-2200U is JVC's lightest portable VHS recorder. It is equipped with microprocessor-based transport controls and an edit/start control that automatically aligns the beginning of a segment being recorded with the end of the previous recording. Other features include a shuttle search function that allows visual cue or review at 10 times normal speed, variable slow motion, freeze frame, and two-speed recording (2 and 6 hours). Price of the HR-2200U is \$1,050.

A lockable video cassette storage cabinet, which can hold up to twelve VHS or Beta tapes, is offered by Video Specialties. The Stack-Rak, 10 inches high and a little more than 17 inches wide, can also be used to store video game cartridges. It sells for \$35.



Latest addition to Fuji's video tape line is the L-750 Beta cassette, which permits up to 4 1/2 hours of recording in the Beta III (long-playing) mode. The cassette features Fuji's Beridox particles that, together with an improved binder system, are said to yield sharper, more saturated color recordings after a large number of plays. Two-way tensile strength has also been upgraded, according to Fuji. Price for the L-750 is \$27.

Want More Information?

If you'd like further information about any of the equipment or companies mentioned in the pages of VIDEO TODAY, write us at P.O. Box 550, Dept. VT, Great Barrington, Mass. 01230.

TUBEFOOD (continued)

Porn can be good (read dirty) only if it sells for a premium price. The net effect of viewing this 27-minute program is nothing more than boredom. A man and a woman give massages to each other while the viewer has the choice of either a music soundtrack on Channel 1 or an instructional "how-to" dialogue on Channel 2. Though both actors are nude, the disc hardly warrants the catalog's admonition "for adults only."

For Your Video Library

I am delighted with Magnetic Video's latest releases in its Video Playhouse series. The catalog talks about these productions as additions to "your video entertainment library," and welcome additions they are, indeed. First presented by the American Film Theater, all fourteen tapes feature top-name performers in critically acclaimed films.

Standouts include *The Man in the Glass Booth* with Maximilian Schell playing the role of Arthur Goldman, a survivor of the Nazi concentration camps who later is accused of being Col. Adolf Dorff, a former S.S. leader involved in the "final solution." Though he freely confesses his guilt from the bulletproof glass booth built to protect him in the courtroom, doubt about his real identity soon emerges, making for a chilling and thought-provoking conclusion. Among the other offerings are Ionesco's *Rhinoceros*, with Zero Mostel and Gene Wilder; Edward Albee's *A Delicate Balance*, with Katharine Hepburn, Paul Scofield, and



Lee Remick; and Alan Bates playing the much-confused Butley in Simon Gray's play of the same name directed by Harold Pinter. Each is available in VHS and Beta formats.

Record Reviews

Schubert's Successor

A remarkable range of songs, surprising even to a Poulenc fancier, gives genuine stature to the "house-zany" of *Les Six*.

by Patrick J. Smith

The *New Grove Dictionary* entry on Francis Poulenc, written by Roger Nichols, ends emphatically: "And if Poulenc was not quite a Schubert, he is so far the twentieth century's most eligible candidate for the succession." Well, indeed! However much one agrees or disagrees with this statement, when applied to Poulenc's songs vis-à-vis Schubert's, the analogy becomes very strong. For his 140-odd songs make up the finest such group by any French composer, Debussy and Fauré included.

This edition from Pathé Marconi purports to be "intégrale," and indeed, it is near complete. The only omission I note is the waltz "Les Chemins de l'amour" (1940), which Poulenc wrote for a Jean Anouilh play. The collection, of course, does not include songs for chorus or those with orchestral settings, such as *Le Bal masqué* or *La Dame de Monte Carlo*, but it compensates by including various songs not found in Pierre Bernac's invaluable book *Francis Poulenc: The Man and His Songs* (Norton, 1977)—notably the Polish cycle (sung in that language by Nicolai Gedda), some lighter songs, and a vocal duet.

Two generalizations are usually made about Poulenc's songs: that they are narrow in range and most effective when keeping to the Satie-drenched flippancy of Poulenc the house-zany of *Les Six*; and that they are quintessentially French and thus, to a large extent, closed off from a wider audience in a way that Schubert's songs, for instance, are not. The first is false, the second only partly true.

What has surprised me, a Poulenc lover, in listening to these five records, is the range, not the limitations, of his talents. His songs, unlike those of some composers, can stand up to extended listening without inducing a feeling of weighted repetitiousness. If his music betrays a homogeneity that defines his stature as a *petit-maître* rather than a musical genius, it nonetheless encompasses more than a small world of experience. And that world is explored and brought to life with a vividness and a melodic grace that are refreshing in the work



Francis Poulenc: A world of experience explored with vividness and melodic grace

of a twentieth-century composer but in no way nostalgic musically.

Poulenc's childlike innocence and wonder, and his infectious and roguish gaiety, are well represented in the songs that have always been popular—the folkish ones of the country, such as the *Chansons villageoises*, and the many songs in celebration of his beloved Paris. These latter exert a tremendous emotional pull on anyone suffering from francophilia (which perhaps is not a transmittable disease): I want to head for the next plane to Paris.

But if half of Poulenc's heart lies in his lighter songs, the other lies in the more serious ones—the songs of love and loss. The term that has been used to characterize these songs, "gentle melancholy," is too limiting. Quite often the melancholy is only a surface response to something deeper, which is depicted in the musical setting. The great cycle *Tel jour, telle nuit*, to poems of Paul Eluard, is typical of this depth of feeling. Its final song, "Nous avons fait la nuit"—one of the most powerful love songs written—represents an exact counterpart to the "Leiermann" from Schubert's *Winterreise*: a summing-up yet a transcendence of what came before. But the Poulenc song accomplishes this in a way wholly dif-

ferent from Schubert's close. The piano postlude encapsulates what Bernac says of the song: that its lyricism is scarcely equaled in the vocal literature of the twentieth century.

We come now to the difficulties Poulenc presents to his audience. One is his own compositional reticence and abhorrence of undisguised sentiment. The heart-on-sleeve openness of Schubert is here unknown, and the listener must penetrate the curtain Poulenc raises between the emotion and its experience. He gives some help in the always melodious contours of his musical speech (which may become banal but are never ugly); yet for full enjoyment the listener must be prepared to go another step.

Typical of his style is a compression of gesture in one quick glimpse that throws the rest into relief. The note that ends the poignant setting of Guillaume Apollinaire's war poem *Bleuet*—a supertonic left hanging in the air—gives the song a sudden uncertainty. But that sounding note also evokes in an instant the quietude reached by the text "O sweetness of former days/slow moving beyond all memory." The "immémoriale" is thus indicated by the unresolved note and made more nostalgic to those reading the score by the date underneath it: October 1939. Or take the setting of the climactic "O ma France, ô ma délaissée" in Aragon's war poem "C": a welling-up of intensity for the first five words and then (a Poulenc trademark) the sudden piano for the first two syllables of the word "forsaken," going up to a pianissimo high A flat—an emotion too strong to express.

The settings of two poems by Robert Desnos, moreover, must be heard with a knowledge of their background. The first, "Le Disparu," talks of someone who disappeared, but nowhere do we discover that it refers to someone abducted by the Gestapo. The second, "Dernier Poème," is a setting of some fine verses, but not especially memorable, until we learn that the words were the last to be written by the poet in a concentration camp and smuggled out to his wife.

Poulenc was never a portrayer of character in his song settings. In this he was closer to his French compatriots than to Schubert, Schumann, and of course, Hugo Wolf. His settings tend to be impressionistic and generalized, a sort of amalgam of piano and voice to conjure up the images. These images can be varied and dazzling, as in Apollinaire's "Dans le jardin d'Anna," but they are finally external, for the composer is

standing back and observing rather than entering the skin of the singer. The lack of characterizational focus, moreover, does lead to certain limitations of effect. As Bernac correctly observes, Poulenc cannot portray hate or rage in his songs—those that try are hollow—and therefore those emotions are best conveyed by being severely repressed, in irony or deliberate understatement.

The final difficulty is the one that runs through almost all French songs, a feature that defines them: the French language. The hoary commonplace about the importance of enunciation and pronunciation in French will now be waved about once again—only because it is so important. A person can, I imagine, “understand” the *Schöne Müllerin* cycle without grasping the words, for the emotions are clearly set out in the music. I suppose the same person could “understand” *Tel Jour* in the same way, but the level of comprehension will be far lower. Since the poems of Louise de Vilmorin and, to a lesser extent, those of Apollinaire—two poets who contribute mightily to Poulenc’s output—rely on wordplay and assonance, a certain amount of onomatopoeic imagery will come across, apart from meaning. But the listener does need to know the texts, and this to a greater extent than in the German Lied.

This fact is accentuated in the poems of Eluard, which provide texts for thirty-four Poulenc songs. Eluard, who began as a surrealist poet and ended as a “liquid impressionist,” wrote verse of notoriously elusive content—even for Frenchmen. To try to pin down the exact nature of one of his poems is to try to write on water, but for this very reason they are susceptible to the musical envelope Poulenc provides. The cycle *Le Travail du peintre*, for instance, seeks to evoke word-portraits of certain painters, and Poulenc provides musical equivalents.

The composer liked to say that his piano did not accompany, but that piano and voice were one. The songs that best illustrate this unity are the Eluard settings, which have an expressive power because of their seamlessness.

If Poulenc’s songs, despite their lyricism, pose special problems (and offer commensurate rewards!) for the listener, they also pose them for the performers. As Bernac says over and over, these are not easy works; they must be thoroughly rehearsed to make their effects. The pianist must be able to maintain what Poulenc calls an “implacable” tempo, using rubato only when called for. This is again a feature of the antisenimental in Poulenc. Yet the pianist must also be able to cloud the line with pedal. (Poulenc often asks for the line

to be “bathed” or “washed,” or for “a fog.”) It is almost as if Fauré had been superimposed upon Stravinsky, an effect central to Poulenc’s music-making. The implacable tempo, in turn, is allied to another of his standard devices: the ongoing musical line repeated almost like an ostinato, a feature of many of his songs that can be extremely powerful, as evidenced in the moving final scene of his opera *Dialogues des Carmélites*.

The singer must have a similarly implacable rhythmic sense, plus a command of articulation, legato (and more legato), and the ability, rare among singers today, to sing at pianissimo at the very top of the voice for several bars at a time. One can easily understand why only the most outward or Satie-like of Poulenc’s songs will ever be widely programmed in recitals.

The merited strength of this collection lies in the unifying force of the single accompanist, Dalton Baldwin. He knows these songs intimately; he has worked with Bernac and thus presents what could be termed the Poulenc party line—absolutely just for an “intégrale.” Of course, he shows a certain inflexibility when compared to Poulenc himself, but this is entirely understandable. His is a formidable achievement.

(But withal, I will for a moment become devil’s advocate. Poulenc’s insistence on the strict avoidance of the sentimental was a product of his time that perhaps should be rethought in the coming decades. Régine Crespin’s recordings of his songs notably transgress by interpreting them with a tempo freedom I doubt Poulenc would have liked, but the songs are not sentimentalized or trivialized by the treatment; they are strong enough to survive more than one interpretive approach. For this edition, however, Baldwin was correct to stick to the text.)

If Baldwin never dominates his five singers, he establishes the framework for the collaboration, and the differences among the five make for a variety that is most welcome in a survey of this size. Gérard Souzay, of course, has the greatest knowledge of the songs and their style, but his voice has now passed its prime and has sufficiently darkened so that he transposes some of them down a step or two. Some Poulenc lovers will therefore prefer earlier recordings of his. Nicolai Gedda’s voice also is not what it once was, and he lacks the legato that the *Tel Jour* cycle should ideally possess; still, his singing is never less than accomplished. Gedda is a master of enunciation, but he has learned it in the traditional way, as an adjunct of the vocal production; it is instructive to compare his way with words to that of Michel Sénéchal, who has been taught in the French manner—the

words clearly to the fore and dominating. Sénéchal’s light tenor has hardened over years of use in the opera house so that he cannot project anything quieter than mezzo-forte; his rendition of the five Ronsard songs needs more variety and color. But his work elsewhere (“*Dans le jardin d’Anna*,” “*Allons plus vite*,” and the children’s songs) more than compensates: These performances throb with life and zest and bring in strongly the music-hall ambience that hovers in the wings of many Poulenc songs. Elly Ameling and William Parker have the freshest voices, and though neither is French, both have excellent diction, with Ameling’s a bit more soft-grained and, in some songs, a bit undersexed.

The recordings, made between 1974 and 1977, are excellently produced, with a proper balance between voice and piano so that both are clear yet combined. The record surfaces are absolutely silent, and a bilingual booklet is included, with English articles by Baldwin and Bernac and the texts of all the songs.

But enough! As Poulenc said: “Above all, do not analyze my music—love it.” That’s easy to do, thanks to this set, which brings Poulenc into stellar conjunction with Schubert.

POULENC: Songs (complete).

Elly Ameling, soprano*; Nicolai Gedda* and Michel Sénéchal**, tenors; Gérard Souzay* and William Parker**, baritones; Dalton Baldwin, piano. EMI FRANCE 2C 165-16231/5, \$69.90 (five discs, manual sequence) (distributed by International Book and Record Distributors, 40-11 24th St., Long Island City, N.Y. 11101).

Le Bestiaire*; Cocardes**; Poèmes de Ronsard (5)**; Chansons gaillardes*; Airs chantés*; Epitaphe*; Trois Poèmes de Louis Lalanne*; Quatre Poèmes (Apollinaire)!; Cinq Poèmes (Jacob)*; Huit Chansons polonaises*; Cinq Poèmes (Eluard)!; A sa Guitare*; Tel Jour, telle nuit*; Trois Poèmes (De Vilmorin)*; Deux Poèmes (Apollinaire)**; Miroirs brûlants!; Le Portrait!; La Grenouillère!; Priez pour Paix!; Ce doux petit Visage*; Bleuets*; Fiançailles pour rire*; Banalités!; Chansons villageoises!; Métamorphoses!; Deux Poèmes (Aragon)**; Montparnasse*; Hyde Park*; Deux Mélodies (Apollinaire)**; Paul et Virginie!; ...Mais mourir!; Hymne!; Trois Chansons!; Le Disparu!; Main dominée par le cœur!; Calligrammes!; Mazurka!; La Fraîcheur et le feu!; Parisiana!; Rosemonde!; Le Travail du peintre!; Deux Mélodies (Apollinaire; De Beylie)!; Dernier Poème!; Une Chanson de porcelaine**; La courte Paille*; Toréador**; Quatre Chansons pour enfants**; Fancy*; Colloque**.

The Tape Deck

by R. D. Darrell

New hi-tech fronts

Vanguard long has been a front-running connoisseur-oriented record company. So if it's late in launching a wholehearted musicassette program, it now does so appropriately with superchrome (BASF) Dolby-B tapings in slow-speed duplications that (Glory be!) are not premium-priced (\$8.98 each) yet include at least brief musical notes. Not the least promising aspect of this project is the active involvement of Janet Shapiro, former manager of the Advent Corporation's pioneering chromium-cassette series.

Pending its full-fledged "audiophile" specials, featuring brand-new digital as well as analog recordings, Vanguard's first superchromes bring back a dozen outstanding earlier programs, among them several I've long treasured in old (and, in some cases, new) open-reel editions. One of the late Alfred Deller's triumphs, as both countertenor and conductor, the famous 1962 recording of Purcell's *Come ye sons of art* and two anthems, sounds even more vivid with less surface noise in its chromium metamorphosis (CA 405047) than in its non-Dolby ferric-reel taping, out of print. So do three other favorites: the milestone 1962 "Virtuoso Trumpet" concertos starring Helmut Wobisch (CA 405041) and two powerfully dramatic Charles Mackerras programs, the 1974 Mussorgsky *Pictures* (orch. Ravel) and *Khovanshchina* Prelude (CA 471188) and the 1973 *Petrushka* (1911 ed.; CA 471177). Moreover, these all are very close matches for the recent Barclay-Crocker Dolby-reel editions (D 5041, 71188, and 10113).

The only other debut release I've heard so far is the Handel *Messiah* conducted by Johannes Somary in its first taping (Prestige Box CA 410090/2, two cassettes, \$17.96), one of the most rewarding versions of those following authentic Handelian size and style traditions. The thirty-two-voice Amor Artis Chorale and the English Chamber Orchestra perform and are recorded with exemplary lucidity and relish, while at least two soloists—soprano Margaret Price and bass Justino Díaz—rank among the very best in the whole *Messiah* discography.

Deutsche Grammophon's initial digitally recorded cassette release, Herbert von Karajan's *Zauberflöte* (Prestige Box 3382 001, three cassettes, \$32.94), lacks the disc edition's 45-rpm bonus—Karajan's 1938 *Zau-*

berflöte Overture—but has a better bonus of its own: chromium tape (brand unspecified). Since DG has waited to go digital until some of the early problems have been partially solved, it avoids harsh highs and excessively dry ambiances while retaining the characteristic sonic clarity and rock-solid lows. The performance, however, is far more Karajanian than Mozartean. And its ultravirtuoso orchestral playing cannot compensate for the vocal and dramatic colorlessness of the soloists—at least for anyone who has ever heard truly great Mozart singing.

The Old Reliables

Musicassette Vox Boxes have quickly come to share the disc equivalents' reputation for a maximum of music at a minimum price (\$13.98 per three-cassette box), substantial yet adventuresome repertory, and generally satisfactory performances by skilled, if not necessarily big-name, artists. Typical in every respect are the latest releases: Liszt's nineteen Hungarian Rhapsodies in specialist Louis Kentner's authoritative 1969 pianism (CBX 5452); the most recent (1979) integral set of Rachmaninoff's three symphonies, by an impressively matured Leonard Slatkin and St. Louis Symphony (CBX 5152); and the 1976 authentically Gallic traversal of Saint-Saëns' piano-orchestral works by Gabriel Tacchino and the Luxemburg Radio Orchestra under Louis de Froment (CBX 5143).

Today's musicologists may not consider Sir Thomas Beecham "reliable," but his uninhibited, highly idiosyncratic Romanticism long enraptured countless listeners. It still can—in the latest reincarnation of his unique 1958 mono version of Haydn's *Salomon* Symphonies, Vol. 1, Nos. 93-98 (Arabesque 9024-3, \$20.94, which also includes his No. 40 of 1948). No longer electronically "stereoized," the Royal Philharmonic's playing is still an aural delight, nonpurist as it may be.

And with the Old (and I hope Reliable) in mind, I've just remembered that this is the twenty-fifth anniversary of the very first appearance of the "Tape Deck" (May 1956). Even those of us who have lived with recorded-tape developments for that full quarter-century find it hard to realize just how immeasurably far they—and we—have come! **HF**

Now you can add
the three-dimensional
impact of
Sonic Holography
to your system
three different ways.



The C-4000 Control Console includes Sonic Hologram Generator, full-function stereo pre-amplifier, time-delay system with built-in 40 watt (total) power amplifier, Autocorrelator System that reduces noise up to 8 dB, a peak limiter/downward expander that nearly doubles dynamic range.

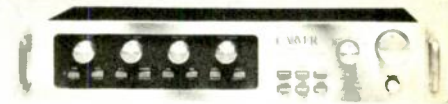

The C-1 combines the Sonic Hologram Generator with a full-function preamplifier.



The C-9 Sonic Hologram Generator allows you to add Sonic Holography to any system including one with a receiver.

And when you do, you'll hear what these audio experts heard in their systems:

Hal Rodgers, Senior Editor of Popular Electronics: "When the lights were turned out we could almost have sworn that we were in the presence of a real live orchestra."

Julian Hirsch of Hirsch-Houck Labs: "The effect strains credibility—had I not experienced it, I probably would not believe it... the 'miracle' is that it uses only the two normal front speakers."

Larry Klein, Technical Director of Stereo Review: "... it brings the listener substantially closer to that elusive sonic illusion of being in the presence of a live performance."

High Fidelity put it this way: "... seems to open a curtain and reveal a deployment of musical forces extending behind, between and beyond the speakers... terrific."

And now, whatever components you own, you can hear what all the audio experts have heard and acclaimed: Sonic Holography by Carver.

For literature, test reports and nearest Carver dealer, circle number below. For faster response, write directly to Carver.

CARVER
CORPORATION

P.O. Box 664, 14304 N.E. 193rd Place
Woodinville, Washington 98072

Circle 6 on Reader-Service Card

Classical Reviews

reviewed by

John Canarina	Allan Kozinn
Scott Cantrell	Paul Henry Lang
Kenneth Cooper	Irving Lowens
R. D. Darrell	Robert C. Marsh
Kenneth Furie	Karen Monson
Harris Goldsmith	Robert P. Morgan
David Hamilton	Conrad L. Osborne
Dale S. Harris	Andrew Porter
R. Derrick Henry	Patrick J. Smith
Nicholas Kenyon	Paul A. Snook
	Susan Thiemann Sommer

BEETHOVEN: Concerto for Piano and Orchestra, No. 5, in E flat (*Emperor*)—See Clementi: Sonatas for Piano (3).

BELLINI: *I Puritani*.

CAST:

Elvira	Montserrat Caballé (s)
Enrichetta	Julia Hamari (ms)
Arturo	Alfredo Kraus (t)
Bruno	Dennis O'Neill (t)
Riccardo	Matteo Manuguerra (b)
Giorgio	Agostino Ferrin (bs)
Walton	Stefan Elenkov (bs)

Ambrosian Opera Chorus, Philharmonia Orchestra, Riccardo Muti, cond. [John Mordler, prod.] ANGEL SZCX 3881, \$30.94 (three discs, automatic sequence).

COMPARISONS:

Callas, Di Stefano/Serafin	Ang. CL 3502
Sills, Gedda/Rudel	MCA ATS 20016
Sutherland, Pavarotti/Bonyngé	
	Lon. OSA 13111

Bellini's *I Puritani* is a record-opera par excellence—a work that comes to life more on discs than in the opera house. It has not lacked for recording, from the classic Callas set to the two others now in the catalog, those of sopranos Sills and Sutherland. I have discussed their qualities in earlier reviews: Briefly, the Callas stands alone but is cut and not perfect, and the available Sutherland (with Pavarotti) is preferable to the Sills.

Strangely, the consideration here (except for diehard Caballé fans) does not revolve around the soprano. This is the only recording of *I Puritani* that is focally a conductor's show, and one's reaction to Riccardo Muti's view of the opera will determine purchase.

B	Budget
H	Historical
R	Reissue
A	Audiophile
	(digital, direct-to-disc, etc.)

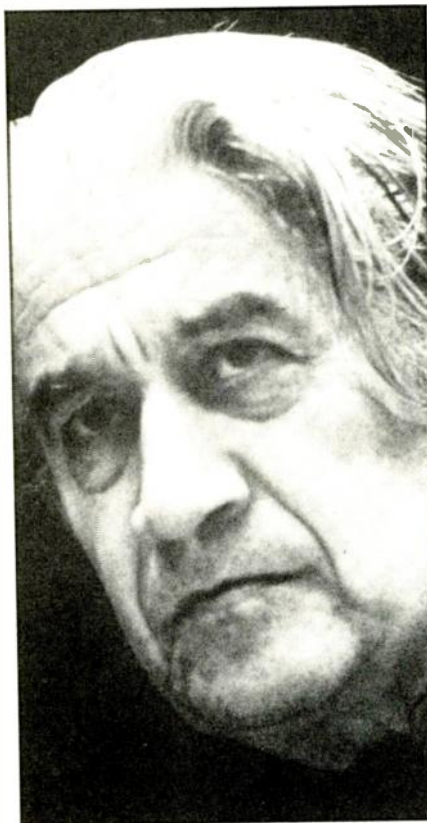

Sergiu Celibidache, who hates to record, conducting his *Taschengarten*

Muti takes a Toscaninian approach; he has definite ideas about all of the music, and he controls. He uses the standard Ricordi edition (unheard on records since Callas), without the Palermo cabaletta at the end, and refuses to allow his singers either embellishment or unwritten high notes at the end of ensembles. His orchestra sets the tempos, provides the fluctuations within the line, and the singers are expected to follow. This is at odds with current thought about bel canto and the centrality of the singer as opposed to the "accompaniment"; it will offend some. Certainly, a measure of a floating ease of the dominating voice is missing, as well as a sense of repose within the music that Bellini does ask for.

If the general feeling of the performance is that of a thoroughbred under bare control, Muti avoids monotony. He inflects the line throughout with breaths and hesitations, rhythmic pulsating energy, and individuality; everywhere his ideas about Bellini's music give the opera shape and power. A fine dramatic moment such as the

entrance of Arturo in Act I has an urgency and force no one else provides; contrariwise, the opening lamentation chorus of Act II is taken at a deliberate pace, with strengthened accents, and the contrasting middle section is treated as a funeral march. Too much? Well, this conception does place Bellini into a context less of middle Verdi than of his contemporary Meyerbeer, with perhaps some Strauss-waltz adhesions. It may be stylistically curious, if not flatly "wrong," yet Bellini's music can and does take this treatment extremely well. As someone who believes that the composer produced much more than pretty tunes with rum-tum accompaniments, I like this questing spirit, although I might wish for more vocal freedom; I especially like the idea that Bellini's music matters—which it also does, in a very different way, for Richard Bonyngé.

Caballé is her usual self in a lyric reading closer to that of Sutherland (though with less firm vocalism and more pianissimo shadings) than to the more dramatic one of Sills—not to mention Callas. There is much affecting singing qua singing here and a strong musical line but little personality; where Bellini asks for maximum expression of sadness in Act II, Caballé delivers a placid singability. The mad qualities of the character are therefore undercut, with too little difference between Elvira sane and Elvira mad. In the context of a Muti-dominated performance, she recedes.

Alfredo Kraus is, of course, the leading exemplar of the long musical line among today's tenors, and his singing is polished and elegant. The character of the role is always revealed within and not outside of the musical line, and if he does not project the romantic ardor of Di Stefano or the plummy *slancio* of Pavarotti—his voice simply is not as gorgeous as either of theirs—he gives much pleasure. He does not, however, take advantage of the many messa di voce opportunities in the score (because of inability or because of Muti?), and he wisely avoids the two high Fs in the last act.

Matteo Manuguerra's Riccardo, the best of the current crop, offers some really lovely singing, and if Agostino Ferrin is a bit querulous and dry-voiced as Giorgio, he does project the requisite humanity and compassion. Predictably, the ensembles are excellent, and—in contrast to too many recorded operas—there is a constant sense of purpose to the proceedings, owing to

Muti's advocacy. The orchestral and choral sound, however, is dull; in some ensembles, not a word can be made out in the aural swamp.

All in all, if you believe that Toscanini rather than Tullio Serafin had the right approach to opera, you will probably like this *Puritani*. P.J.S.

BYRD: Motets (10).

William Byrd Choir, Gavin Turner, cond. PHILIPS 9502 030, \$9.98.

Gaudeamus omnes; Beati mundo corde; Iustorum animae; Non vos relinquam orphanos; Beata es, Virgo Maria; Visita quaesumus, Domine; Salve, sancta parens; Confirma hoc, Deus; Senex puerum portabat; Tribulationes civitatum.

The motets of William Byrd represent one of the high-water marks of English music; yet they are all too little performed outside his native land. An ambitious series on BBC Radio placed the motets he wrote for feast days in the church's year (published in his *Gradualia*) in their liturgical context, with Mass ordinaries by Continental composers, plainsong, and the chant of the liturgy. It would be good to have these reconstructions available on record.

Meanwhile, here is a splendid sampler of Byrd's art: ten motets, nine of them from the *Gradualia*, sung by the small London choir that has made a speciality of his music. The style of singing is, alas, unfamiliar in this country: bright, clear, clean, and absolutely precise. The expressively interweaving lines of Byrd's writing are controlled with sensitivity and a real feeling for the weight of choral sound by the choir's conductor, Gavin Turner. Byrd's impassioned response to the liturgical texts is sometimes treated a little coolly. His humble declaration that "as one meditates on the sacred words ... the right notes somehow suggest themselves" should not mean that singers take the word setting for granted. His choice of textures and phrases is miraculously appropriate, from the high fluting sounds of *Visita quaesumus, Domine* to the serenity and peace of *Iustorum animae*.

It is a little ironic that the music of this Renaissance master, the equal of Palestrina and Victoria, should be issued in a series called—with an appropriateness only a record company could devise—"Living Baroque." N.K.

CELIBIDACHE: Der Taschengarten.

Stuttgart Radio Symphony Orchestra, Sergiu Celibidache, cond. [Hugo Herold, prod.] INTERCORD INT 160.832, \$10.98 (distributed by Brillly Imports, 155

The New Standard of Excellence on Angel

HOLST · THE PLANETS

RATTLE

Philharmonia Orchestra

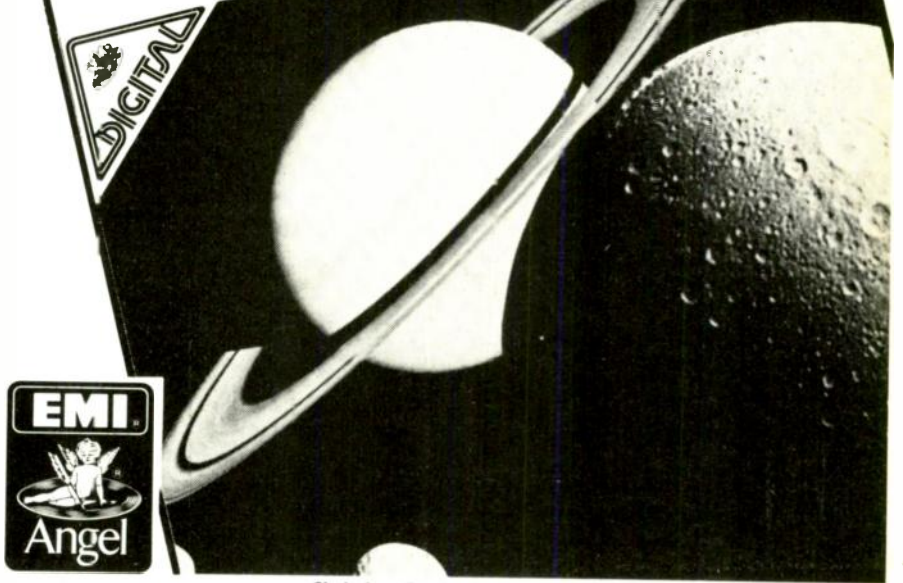

Circle 1 on Reader-Service Card

CALL FOR PRICE.

Congratulations! You've just discovered a source for stereo and video equipment. Our prices are better than retail — and we're much easier to deal with.

Just pick up the phone, dial our toll-free number, and ask for P.R.I.C.E. quotes (Or ask us to mail you this month's P.R.I.C.E. list.) P.R.I.C.E. is what you want.

800-343-1078

- Pioneer KP-1500 AM/FM cassette in-dash \$82.53
- Pioneer KP-4500 AM/FM cassette in-dash \$112.95
- Jensen R-200 AM/FM cassette in-dash \$99.95
- Jensen R-406 AM/FM cassette in-dash \$195.95
- Pioneer TS-695 3-way, 6x9-inch car speakers (pr.) \$79.95
- Jensen J-1130 3-way, 4x10-inch car speakers (pr.) \$74.95
- Technics SL-B2 belt-drive, automatic shutoff turntable \$85
- Teac CX-310 cassette deck \$124.95
- Kenwood KR-710 28 watt/channel receiver \$157.50
- Sony Walkman® TPSL-2 stereo cassette player with headphones \$147.50

P.R.I.C.E.™

27 Teed Drive, HF1
Randolph, MA 02368



Circle 33 on Reader-Service Card

Critics' Choice

The most noteworthy releases reviewed recently

BACH: English and French Suites, S. 806-17. Curtis. TELEFUNKEN 46.35452 (4), Jan.

BARTÓK: Bluebeard's Castle, Op. 11. Sass, Kováts, Solti. LONDON OSA 1174, Jan.

BEETHOVEN, MOZART: Keyboard Works. Bilson. NONESUCH H 71377, N 78004, Feb.

BEETHOVEN: Symphony No. 6, Op. 68. Stuttgart Klassische Philharmonie, Münchinger. INTERCORD INT 160.828, March.

BEETHOVEN: Violin Concerto, Op. 61. Mutter, Karajan. DG 2531 250, Feb.

BRAHMS, BEETHOVEN: Clarinet Trios. Pieterse, Greenhouse, Pressler. PHILIPS 9500 670, Feb.

BRAHMS: Orchestral Works and Concertos. Furtwängler. EMI ELECTROLA 1C 149-53420/6M (7), April.

BRAHMS: Piano Trios Nos. 1, 2. Schneiderhan, Mainardi, Fischer. BRUNO WALTER SOCIETY BWS 739, Feb.

BRAHMS, SCHUMANN: String Quartets. Guarneri. RCA ARL 3-3834 (3), April.

CORIGLIANO: Clarinet Concerto. BARBER: Essay No. 3. Drucker, Mehta. NEW WORLD NW 309, April.

GOLDMARK: Die Königin von Saba. Takács, Jerusalem, Fischer. HUNGAROTON SLPX 12179/82 (4), April.

GRIEG: Works for String Orchestra. Norwegian Chamber Orchestra, Tønnesen. BIS LP 147, Nov.

HAYDN: Great Organ Mass. Academy of Ancient Music, Preston. OISEAU-LYRE DSLO 563, March.

HAYDN: L'Incontro improvviso. Zoghby, Ahnsjö, Dorati. PHILIPS 6769 040 (3), Feb.

HOLST: The Planets, Op. 32. Scottish National, Gibson. CHANDOS ABRD 1010, Feb.

LISZT: Hungarian Rhapsodies (7). Various. ARABESQUE 8011, Dec.

MAHLER: Symphony No. 6. Chicago Symphony, Abbado. DG 2707 117 (2), April.

MASSENET: Le Roi de Lahore. Sutherland, Lima, Milnes, Bonyngé. LONDON 3LDR 10025 (3), Jan.

STRAVINSKY: Le Sacre du printemps (arr.). Atamian. RCA ARC 1-3636, April.

TAKEMITSU: Instrumental Works. Tashi, Boston, Ozawa. DG 2531 210, March.

FERNANDO DE LUCIA: The Gramophone Company Recordings, 1902-9. RUBINI RS 305 (5), Dec.

EZIO PINZA: The Golden Years. PEARL GEMM 162/3 (2), Feb.

MAURIZIO POLLINI: Piano Music of the Twentieth Century. DG 2740 229 (5), March.

RÓZSA, WAXMAN, WEBB: Film Music. ENTR'ACTE ERM 6002, March.

N. San Vicente Blvd., Beverly Hills, Calif. 90211).

FRENCH SUITE.

R Berlin Radio Symphony Orchestra, Sergiu Celibidache, cond.*; Paris Opera Orchestra, Georges Sébastian, cond.*; Leipzig Gewandhaus Orchestra, Werner Egk, cond.*. [Tom Null and Chris Kuchler, prod.] VARÈSE SARABANDE VC 81110, \$8.98 (mono) [from URANIA UR 5006*/8013*/7022†, 1950-56].

ROUSSEL: Petite Suite.* DEBUSSY: Petite Suite (orch. Busser).* MASSENET: Espada.* EGK: French Suite after Rameau.*

Since gaining prominence shortly after World War II, Sergiu Celibidache has become something of a cult figure among musicians and record collectors alike. He is famous for his refusal to make records (would that some other conductors felt the same!) and for demanding twelve rehearsals for each concert he conducts. The better an orchestra, he feels, the more it must rehearse, for it then offers a wider range of tone colors and dynamic gradations than a mediocre one can. (To Celibidache, the Vienna Philharmonic is a mediocre orchestra.) Many normally hard-boiled musicians admit to having been mesmerized by him.

The Intercord disc is an obvious exception to his policy, a recording of one of his own compositions done for a special purpose, as the profits from its sales benefit UNICEF. Celibidache the composer is new to me, as he must be to most listeners. *Der Taschengarten* (*The Pocket Garden*) is a set of thirteen pieces for children (actually twelve, the first and last being identical) with such fanciful titles as "Come on in, kids!," "Mister Wind lets the tulips sing," "The Duck's Sermon," and "Hedgehog, where are you?" The premise of the set is, in part: "Unfortunately there are many kids who have no garden, but they all certainly have a drawer. We, the children who didn't have to cry so much, have hidden for the others a couple of true stories, very funny, guaranteed new, and of course tiny little. If you let this round disc turn always in the same way, it could, all by itself, allow you to find in your drawer what the grownups were always looking for in their garden."

The pieces are perfectly charming, with a poignant atmosphere in the slower numbers that leads me to suspect there may be a deeper meaning to the music than that given by the titles or by the descriptive poems included. Like all good children's music, this imaginatively orchestrated work can be enjoyed unashamedly by adults. While its idiom is only mildly contemporary, its originality is such that I was not reminded of any other composer. My only quibble is that the forty-five-minute

length of the complete work, with a preponderance of slow pieces, might cause the young people for whom it is intended to grow a bit restless. One could always play excerpts from it, yet Celibidache repeats the opening piece at the end, indicating that he regards the work as a unified whole. Still, this is a thoroughly enjoyable and worthwhile release, one that makes me curious to hear other works by this composer.

The Varèse Sarabande disc is part of that company's series of reissues from the old Urania catalog. The Celibidache-led *Petite Suites* date from about 1949, before his self-imposed recording ban. They do little to enhance his reputation, the Rousset, especially, being slow and heavy-handed, lacking in the Gallic high spirits so characteristic of that composer. If one is not already familiar with the work, little can be learned about it from this performance and its murky recording. The Debussy fares better in a sensitive and lively reading, but it, too, is defeated by the poor recording quality.

The non-Celibidache side offers a little-known ballet score by Massenet, *Espada*. Those who enjoy the ballet music from *Le Cid* will certainly respond to this equally agreeable piece in the Spanish idiom. This is an excellent mono recording from 1956. Werner Egk's *French Suite after Rameau*, once available in a Ferenc Fricsay version, is bright, witty, and sophisticated, somewhat reminiscent of the neoclassical Stravinsky. Played with great verve under the composer's direction, it nevertheless deserves to be heard in a modern recording. J.C.

CHOPIN: Concerto for Piano and Orchestra, No. 1, in E minor, Op. 11.

Murray Perahia, piano; New York Philharmonic, Zubin Mehta, cond. [Andrew Kazdin, prod.] CBS MASTERWORKS M 35893, \$9.98. Tape: MT 35893, \$9.98 (cassette).

CHOPIN: Concerto for Piano and Orchestra, No. 2, in F minor, Op. 21; Andante spianato and Grande polonaise brillante, Op. 22.

Krystian Zimerman, piano; Los Angeles Philharmonic Orchestra, Carlo Maria Giulini, cond. [Hans Weber and Hanno Rinke, prod.] DEUTSCHE GRAMMOPHON 2531 126, \$9.98. Tape: 3301 126, \$9.98 (cassette).

Perahia and Mehta work together like the professionals they are, and certain details bespeak a civilized meeting of minds and—on a superficial level, at least—adequate preparation. Appoggiaturas are played long and on the beat by both soloist and orchestra, and the dovetailing is mostly punctilious (The orchestra, for once, is

dead on in that problematical place in the third movement where, at the end of a scale passage, the piano unexpectedly and deceptively states the principal rondo theme a semitone lower.) The New York Philharmonic, moreover, is on good behavior, playing with a modicum of vigor and attentiveness, and CBS supplies clear, judiciously balanced sound.

Yet somehow the chemistry seems wrong. On a higher aesthetic plateau, Perahia's poetic style and crystalline sound, innately patrician, are mismatched with Mehta's gruffer, plebeian manner. String accompaniments sound swarthy rather than luminous; woodwind solos are never properly shimmering and seductive; and the tutti texture is unpleasantly dominated by heavy, opaque brass and timpani. Although Mehta's pacing is for the most part brisk and straightforward, in a couple of places he applies the brakes in an ungainly manner. Almost intangibly, Perahia seems influenced by the extroverted accompaniment: His pianism, finely chiseled and rhythmically well sprung as usual, sounds drier in tone, more externalized than his norm. The performance, by no means objectionable, sounds distinctly perfunctory alongside the richly inflected, memorably lyrical 1973 Perahia/Muti/Philadelphia broadcast tape.

The Zimerman/Giulini F minor represents a marked advance over their E minor (DG 2531 125, September 1979). For one thing, the piano sounds warmer, with none of the brittleness of the earlier record (though the sound there was an improvement over that of Zimerman's still earlier releases). Some listeners used to a warmer sound and more generous sweep in Chopin (Rubinstein, for example, but even Lipatti and Perahia) might feel that Zimerman glides over the surface, but there is something innately appealing in the long-spun line and pristine freshness. Chopin, it is worth remembering, was only nineteen when he wrote the F minor Concerto—and only twenty-four at the time of the *Andante spianato* and *Grande polonaise*, here performed in its orchestral form, again more warmly engineered than was Zimerman's solo account, DG 2530 826, October 1977. H.G.

CLEMENTI: Sonatas for Piano: in F minor, Op. 14, No. 3; in F sharp minor, Op. 26, No. 2; in G minor, Op. 34, No. 2.

R Vladimir Horowitz, piano. RCA RED SEAL ARM 1-3689, \$9.98 (mono). Tape: ARK 1-3689, \$9.98 (cassette). [From RCA LM 1902, 1955.]

BEETHOVEN Concerto for Piano and Orchestra, No. 5, in E flat (*Emperor*).

R Vladimir Horowitz, piano; RCA Symphony Orchestra, Fritz Reiner, cond. RCA RED SEAL ARM 1-3690, \$9.98 (mono). Tape: ARK 1-3690, \$9.98. [From RCA LM 1718, c. 1953.]

RCA's systematic restoration of its older Horowitz recordings continues. The more significant of the two latest installations contains the three Clementi sonatas taped in the pianist's living room early in his period of self-imposed seclusion

(1953-65). The 1954 sound, never particularly alluring, has been given greater body and amplitude by judicious equalizing, but the twanginess evidently inherent in the original master is beyond remedy. That irritant can, of course, be tolerated in view of the musical and historical values preserved here, and the secco immediacy of the acoustic is actually appropriate to the music, written for the period fortepiano. Unfortunately, RCA's processing does not live up to its mastering: A burst of hissing inter-

Incredible Sound/Affordable Price "Our advice is not to buy speakers until you've heard the Polks." Musician Magazine

Reviewers and Critics Agree

Polk speakers will give you the highest sound quality and the most listening pleasure for your money. They will deliver amazingly life-like, boxless, three dimensional sound with breathtaking clarity and detail in your listening room from your hifi system.

"Polk Speakers (are) so vastly superior to the competition... a remarkably well integrated and coherent sound that adapts itself ideally to all kinds of music...the kind of open, uncolored, perfectly imaged sound we thought began at twice the price...

Sound quite magnificent with a good mid-powered popular brand receiver... They make the popular speakers in their price range seem dim, colored, boxy and just plain insufficient." Musician Magazine

Better sound in your home — Polk Audio loudspeakers will give you more listening pleasure and greater long term satisfaction from your music, your records and your hifi system. They offer the best sound for the money available on the market and are affordably priced from less than \$125 each to less than \$400 each. **Simply use the free reader service card** to receive detailed information, copies of the expert's rave reviews and the location nearest you for auditioning the incredible, affordable Polks. Polk Audio, Inc. 1205 S. Carey St., Balto., Md. 21230

polkaudio
Monitor Series Loudspeakers

Incredible Sound / Affordable Price

ference disrupts the first movement of Op. 34, No. 2, and sundry pops and crackles occur throughout both sides (some continuing in the "silent" grooves at the end). Horowitz feels these unjustly neglected near-masterpieces intensely, and his beautifully honed performances project bite, character, and enlivening rhythm. This is a must for all connoisseurs of superb pianism.

The *Emperor* disc is intrinsically less important, since there are many alternative versions of at least equal merit. But it remains one of Horowitz' most straightforward Beethoven interpretations, with lean, incisive orchestral support from Reiner and his pickup ensemble (probably mostly New York Philharmonic and NBC Symphony musicians). The latest reincarnation once again attempts to broaden the thinnish sound with more support at the bottom and offers a transfer of perhaps even greater impact than the fine one in CRM 4-0914 (a set that also contains the 1940 Brahms Second, the 1943 Tchaikovsky First, and the 1951 Rachmaninoff Third). Both of these straightforward mono editions are immeasurably superior to the muffled, waterlogged pseudo-stereo Victrola transfer (VICS 1636). Here RCA's pressing is just fine. H.G.

DEBUSSY: Petite Suite—See Celibidache: *Der Taschengarten*.

DESTOUCHES: Les Eléments—See Rebel: *Les Eléments*.

EGK: French Suite after Rameau—See Celibidache: *Der Taschengarten*.

ELGAR: Sea Pictures, Op. 37*; *In the South, Op. 50*.

Yvonne Minton, mezzo-soprano*; London Philharmonic Orchestra, Daniel Barenboim, cond. [Paul Myers, prod.] CBS MASTERWORKS M 35880, \$9.98. Tape: MT 35880, \$9.98 (cassette).

ELGAR: Falstaff, Op. 68; In the South, Op. 50.

London Philharmonic Orchestra, Georg Solti, cond. [Andrew Cornell, prod.] LONDON CS 7193, \$9.98.

Same orchestra, same composer, even one of the same pieces on both discs—but different conductors with radically different approaches. Somewhere between Sir Georg Solti's hard-driving brilliance and Daniel Barenboim's episodic languidness, there rests a better Elgar solution.

The five orchestral songs that make up *Sea Pictures* come across as the most colorful and successful music on these records; their Wagnerian cast seems to have spurred



The Starving Woman from Musgrave's *Christmas Carol*—page 60.

Barenboim to give structure its due. One is supposed to comment on the insignificant nature of the poetry Elgar chose for these songs (even CBS's notes apologize for his lapses of literary taste), but more to the point, the words obviously fit the composer's intentions. If the poems might have drowned, left to their own devices, who cares?

More important are the specific lapses of this recording. Barenboim distinguishes himself and the London Philharmonic Orchestra, bringing out the *Meistersinger* in *Sea Pictures* without losing touch with the music's British origins. But the engineering is thick, the sonic elements oddly separated, and mezzo Yvonne Minton (called a soprano in the credits) creeps around the solo lines as if she were intimidated by them—which she surely needn't have been.

There's no creeping to be heard in Solti's *Falstaff*; this performance of Elgar's most Straussian tone poem is crammed with virtuosity—so much so, in fact, that one completely misses "the undercurrent of our failings and sorrow" that Elgar himself attributed to this score. The London Philharmonic's playing is impressive, but Barenboim's *Falstaff*, with the same orchestra (CBS, deleted), is better.

For direct comparison, both of these discs include *In the South*, the overture (more like another tone poem) Elgar wrote in response to his first visit to Italy, where, near Alassio, he could walk and marvel at snow-capped mountains to his left and the blue Mediterranean to his right. Solti seems

to have given all his attention to the craggy cliffs, while Barenboim stared out to sea. Or to put it more pragmatically, the Hungarian conductor evidently looked on *In the South* as a peremptory filler for this disc, while the Israeli wanted to linger over the music, make it prettier than it really is.

Write off the Solti version; it makes the *South* seem particularly unattractive. Barenboim's interpretation has more merit, but it is so disjointed, and sometimes so lethargic, that it ultimately fails to make its point. Neither recording proves the merits of *In the South*, which is not otherwise available in stereo. But if nothing else, the London Philharmonic is coming to be the world's most chameleonlike orchestra, completely changing its color with the flick of a baton. K.M.

HAYDN: The Seven Last Words of Christ (choral version)*; Salve Regina in G minor*.

Veronika Kincses, soprano; Klára Takács, alto; György Korondy, tenor; József Gregor, bass; István Lantos, organ*; Budapest Chorus*, Hungarian State Orchestra, János Ferencsik, cond. [János Mátyás, prod.] HUNGAROTON SLPX 12199/200, \$19.96 (two discs, manual sequence).

The Seven Last Words of Christ, which Haydn considered among his best works, has a curious history. It was commissioned in 1787 for the Good Friday three hours' observance at the cathedral in Cadiz, Spain; the service consisted of the reading of the seven "Words," each with a meditation delivered by the bishop followed by a period of silent prayer. Haydn, asked to compose suitable music to be played during the prayers, delivered seven slow pieces plus a prelude and postlude. He scored the work for full orchestra and made an arrangement for string quartet; subsequently it was also made into an oratorio by a provincial church musician. When Haydn saw that score, he decided he could do a better job—as indeed he did—and it is this setting that Hungaroton offers.

Given the composition's specific purpose, the difficulty of absorbing its steady slow pace and solemnity without the church service to justify them, and its hybrid and much patched-up physiognomy (Haydn proceeded from the ungainly "oratorio" of Kapellmeister Friebert), a recording or concert performance becomes a bit of a trial. Yet taken in smaller doses, this music is interesting enough—particularly the formal construction, as each of the choral numbers presents a different application of the sonata principle. The *Intermezzo*, a later addition, is a good piece for large wind band, demonstrating Haydn's extraordi-

nary knowledge of the large orchestra even though he seldom wrote for it. The final—and only fast—piece, "The Earthquake," represents typical *Sturm und Drang*.

The recording suffers from a very long echo; large portions of the score are hurt by harmonies that bleed like Madras cloth. Conductor János Ferencsik does a workmanlike job, but not much more; surely the *Largos*, *Adagios*, and *Lentos* could have been more differentiated. The singing and playing are good—when not blanketed by the lingering echo.

Salve Regina fares better—understandably, since it is not an arrangement, but an original work composed in 1771 for solo quartet, chorus, strings, and organ. It is coeval with the *Sturm und Drang* Symphonies Nos. 45 and 46 and is indeed full of sighs and tears, altered chords and Neapolitan sixths, rather unusual modulations and dissonances. This is not one of Haydn's masterpieces but is worth hearing. The sound is better here; the solo quartet is excellent, orchestra and chorus ditto, and even Ferencsik's pulse goes up a few points. Curious how unconvincing the organ solos are when the instrument is used as part of the orchestra; one soon wishes that some honest flute or oboe or clarinet would take over. The organ is a world by itself, and so is the orchestra; they just don't mix well. P.H.L.

HINDEMITH: *In einer Nacht*, Op. 15; *Tanzstücke*, Op. 19; 1922, Op. 26.

Hans Petermandl, piano. [Jaroslav Rybář, prod.] SUPRAPHON 1111 2476, \$9.98.

HINDEMITH: *Sonatas for Organ* (3).

A Elisabeth Ullmann, organ. TELEFUNKEN 6.42575, \$11.98 (digital recording).

The three Hindemith piano works on the Supraphon disc were written between 1919 and 1922, critical years in the young composer's development when he was just beginning to find his own musical voice. The earliest piece, *In einer Nacht*, is rarely played and has never even been published but is a fascinating document in which one can hear Hindemith moving cautiously away from the late-Romantic character that had dominated his earlier music. There are traces of the old style in the relatively lush chromaticism still based on a triadic harmonic foundation, yet flashes of that rough and sardonic humor that was to become so characteristic of him in the later 1920s also appear, especially in the two movements that irreverently parody music from *Rigoletto* and *Hänsel und Gretel*. (At this time Hindemith was concertmaster of the Frankfurt Opera Orchestra.)

This parodistic tendency is even

more evident in the *Tanzstücke*, Op. 19, and the suite for piano entitled 1922, for the year of its composition. Both works consist entirely of dancelike movements conceived in a leaner, more linear style featuring sharp dissonances and a highly flexible approach to tonality far removed from that of the nineteenth century. 1922 is especially effective, amply revealing the composer's fascination just then with jazz and popular music.

These piano works, not yet vintage Hindemith—the style, a kind of experi-

mental eclecticism, had not completely coalesced—nevertheless exude youthful enthusiasms: a rough yet appealing charm and a sense of fun and delight in musical high jinks. These are qualities largely missing from the three organ sonatas, also written within a relatively restricted period—1937–40. By this time Hindemith had become much more self-conscious about his work and, indeed, had codified his entire compositional approach into an elaborate and explicitly defined theoretical system. Thus, these sonatas, all conforming to the

Do your records sound like thisssssssss?

When you're listening to your favorite albums, nothing can spoil your enjoyment as much as hiss, clicks, pops and static. It's dissssturbing. It's disssstracting. And it's unnecessary.

Because with proper handling and regular Sound Guard care, your records can maintain their like-new clarity and fidelity. Even old records sound

better after one treatment with Sound Guard.

Sound Guard makes products respected around the world, to clean, preserve, protect and enhance the quality of records.

So, depend on Sound Guard to keep the hiss away from Stravinsky, Streisand, Kiss and any other record that gives you sheer satisfaction.

The best way
to prove
how much you
love music.



**sound
guard**

Facilities:
Pompano Beach, Florida;
Cincinnati, Ohio; Tokyo,
Japan; Brussels, Belgium

STEREO CORPORATION OF AMERICA

TRY & BEAT OUR PRICES!

OR CALL TOLL-FREE
800-221-0974
AND LET US BEAT ANY PRICE YOU CAN FIND!

RECEIVERS



PIONEER SX-3000 ... \$199
HARMAN KARDON HK-670 ... \$329
SONY STR-V35 ... \$212
TECHNICS SA-203 ... \$169

CASSETTE DECKS



TEAC CX-400 ... \$214
TECHNICS RS-M205 ... \$109
HARMAN KARDON HK-3500 ... \$299

BLANK CASSETTE TAPE

TDK SA-C90 box of 10 \$24
TDK SA-C90 box of 10 \$31
MAXELL UD-XL2-C90 box of 12 \$41

VIDEO

J.V.C. HR-6700 ... \$825
PANA. PV-3200 ... \$1070
SONY SL-5400 ... \$849

TURNTABLES



SONY PS-X45 ... \$134
SANSUI FR-D55 C ... \$254
TECHNICS SL-D2 ... \$96

CARTRIDGES

SHURE V15-4 ... \$91
SHURE M9SHE ... \$30
SHURE M97HE ... \$45
STANTON 681S ... \$79

AIWA MICRO SYSTEM

SA-A22 AMP
SD-L22 CASSETTE
ST-R22 TUNER

COMPLETE SYSTEM

ONLY! **\$399**

ACCESSORIES

ADC SOUNDShAPER 2 MK3 ... \$210
BIC FM-10 BEAM BOX \$59

Call Toll-Free! **800-221-0974**

(except N.Y., Alaska, Hawaii)
Mon.-Fri. 9Am - 5:30Pm

Thurs. til 9Pm Sat. 9Am - 5Pm E.S.T.
or call (212) 253-8888

Write or call for FREE catalog!

AMERICA'S #1 SOUND CHOICE!

STEREO CORPORATION OF AMERICA

Dept. 205

1629 Flatbush Avenue
Brooklyn, New York 11210
MASTERCARD & VISA ACCEPTED

Circle 31 on Reader-Service Card

composer's newly self-imposed restrictions, seem much tamer in outlook and more restricted in design and character.

Perhaps their most interesting feature is Hindemith's attempt to revitalize the baroque organ, recognizable in both the music itself and the instrument for which it was conceived: a mechanical-action organ with relatively simple registrational possibilities. The sonatas are linearly conceived, with motivic material developed through a process of repeating short figures that is clearly derived from Bach. These are solid works, written with thought and musicality. Yet they seem overly predictable; one misses the sudden, unexpected moment.

Both pianist Hans Petermandl and organist Elisabeth Ullmann provide excellent readings, although Petermandl seems a bit reserved for some of the music he plays. In the score of 1922, for example, the performer is told to play the last movement in a "wild" manner, to treat the piano like a percussion instrument, and to play it rhythmically, "like a machine." One hears little of this from Petermandl. R.P.M.

MASSNET: Espada—See Celibidache: Der Tschengarten.

MUSGRAVE: A Christmas Carol.

CAST:

Fan/Starving Woman/Caroler/Liza Fezziwig/Belinda Cratchit/Lucy Claudette Peterson (s)
Belle Fezziwig/Laundress/Martha Cratchit/Rosie Kathryn Montgomery (s)
Mrs. Cratchit/Charwoman/Caroler/Mrs. Fezziwig/Aunt Louise Carolyne James (ms)
Bob Cratchit/Man with Snuffbox/Mr. Dorrit Jerold Norman (t)
Ebenezer Scrooge Frederick Burchinal (b)
Fred/Man with Red Face/Ben Howard Bender (b)
Portly Gentleman/Fat Man/Mr. Fezziwig/Topper Robert Randolph (b)
Marley's Ghost/Joe/Gabriel Grub/Great-Aunt Ermintrude Howard Scammon (spkr)

Virginia Opera Association Orchestra, Peter Mark, cond. MMG 302, \$24.98 (three discs, manual sequence) [recorded in performance, Dec. 16, 1979].

I don't know whether schoolchildren still read Dickens' *A Christmas Carol*, but certainly, in this media-dominated age, the old Alastair Sim film version has become a late-night television classic, rivaled during the holiday season only by *It's a Wonderful Life* and—for reasons beyond me—*Miracle on 34th Street*. In addition, Dickens' charming tale of spiritual rebirth

has been put forth in every guise from cartoons to stage adaptations. It was one of the latter, combined with a commission for a Christmas opera, that inspired Thea Musgrave's treatment.

The libretto, Musgrave's own, makes several changes in detail, in sequence, and most important, in emphasis and characterization. Most of those in the first two categories reflect a carefully planned and wisely economical approach to staging. For instance, rather than transport Scrooge from his warehouse to his home, and then out his bedroom window with the Spirit of Christmas Past (the Spirits here are danced, not sung), she places all but the final scene of the opera in Scrooge's house: The upstairs serves as his dwelling, the lower floor as his office (the composer thereby providing a tax deduction Scrooge would have appreciated), and all the ghostly voyages are presented as dream sequences that take place downstairs.

Among the more significant differences between the Dickens and Musgrave conceptions is the relative importance of Belle, young Scrooge's fiancée. Dickens' soft-spoken Belle is seen only in passing as she breaks off the relationship, leaving Scrooge to his more consuming financial concerns, and then briefly in a scene with her husband and a brood of children. Scrooge reacts to these scenes with remorse at having lost both Belle and the possibility of family life. In the opera, though, she is headstrong and demanding. She insists that Scrooge either pay her some attention immediately or lose her forever. Whereas Dickens' Scrooge protests mildly, then acquiesces, Musgrave's is more animated and agitated, pragmatic and paranoid. He insists they defer their plans until they are financially stable and tries desperately to stop her from leaving. For Musgrave, this scene is pivotal, and it leads to an extended outburst of self-recrimination, underpinned by turbulent and percussive music.

If Belle's importance is heightened, that of the Cratchit family is diminished. The opening scene and the Cratchit Christmas dinner are intact. But the Spirit of Christmas Future shows us a side of Bob Cratchit far removed from the simple soul Dickens created—out of work, destitute, and embittered. Musgrave must have found the book's ending unstageable; rather than end the work with Scrooge taking the Cratchits under his wing—and with Tiny Tim's famous line—she sets the finale at Scrooge's nephew's house. There the repentant ex-miser makes his peace with his sole family connection, and a resounding New Year's greeting is raised by the full cast. As a representation of the Dickens tale, the film version (even with its spurious

additions) is more faithful.

Nevertheless, Musgrave has created a workable stage piece (four ghosts in two acts), and her fine score brings her characterizations to life. Unspoken reactions and momentary changes of mood find expression in the orchestral music, which, naturally, alternates between the ominous (Marley and Christmas Future) and the downright humorous (the party scenes). The parties also retain some of the story's early-Victorian flavor with period-style dance music at Fezziwig's and round-singing at Scrooge's nephew's house. And there are some nice, if facile, touches, such as the familiar child's tune in the orchestral backdrop to the scene in which Scrooge sees his sister Fan. Fan's own music, well sung by Claudette Peterson, is the prettiest, most freely soaring melody in the opera.

The work lasts nearly two hours, with remarkably little wasted motion. There are a few minor flaws: Jacob Marley's chains sound too tinkly to be much of a burden; Belle, in her first emphatic farewell, sounds more like a gum-chewing high-school truant than a well-bred English lady; and the boy who sings young Ebenezer sounds quite listless. But only a Scrooge would suggest that these things detract much from this first-rate performance. The Virginia Opera Association's small orchestra (twenty-eight players) plays solidly throughout, and the action moves quickly under the baton of Peter Mark, the company's director (and the composer's husband). Frederick Burchinal is a hefty, if not always ideally colorful, Scrooge. The other singers also acquit themselves honorably, most of them in multiple roles (as many as six).

Considering that this is a live recording made at the work's premiere, evidently without patches from rehearsals or other performances, the full, well-balanced sound is all the more commendable. There is some foot-shuffling on-stage, and all the applause and tittering of the audience has been left in, occasionally covering the end of a phrase. Perhaps it's the spirit of the work, but I don't find these intrusions very bothersome. A.K.

POULENC: Songs (complete). For a review, see page 51.

REBEL: Les Eléments. **DES-TOUCHES:** Les Eléments.

Academy of Ancient Music, Christopher Hogwood, harpsichord and dir. [Peter Wadland, prod.] OISEAU-LYRE DSLO 562, \$9.98.

Jean-Féry Rebel (1666-1747) opens his *Les Eléments* with one of the most astonishing chords in all eighteenth-century

UP TO 10X FASTER THAN MAGNETIC CARTRIDGES.

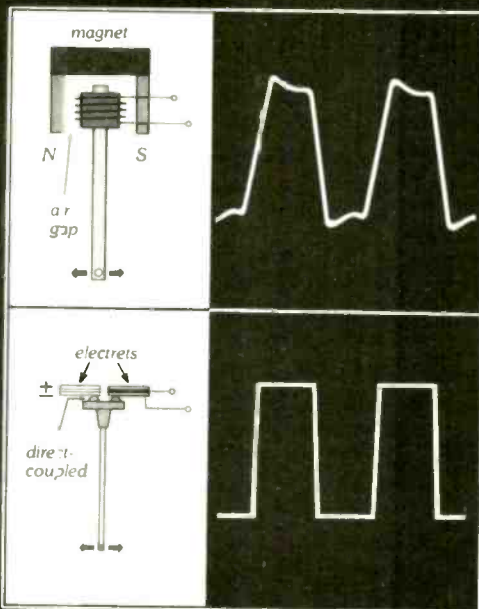

Micro-Acoustics System II phono cartridges. More than a new design—a completely new technology. The first phono cartridges to eliminate the magnetic air gap that delays musical transients by *direct-coupling* the stylus to an electret transducer. For virtually instant response from below 5Hz to above 50kHz. And that's only the beginning of what we've accomplished. In the fastest, lightest, most accurate phono cartridges ever. Hear them yourself at your Micro-Acoustics dealer.

Micro-Acoustics Corp.
8 Westchester Plaza, Elmsford, NY 10523.

ma
Micro-Acoustics
System II

The Stereo Cartridge Reinvented.

© 1981 Micro-Acoustics Corp.

COMPARE PRICES !

<p>Jensen Tri Axials \$59 pr. 6 x 9 J-1065</p>	<p>Clarion Equalizer EGB-100 \$62</p>	<p>Craig Auto Reverse T-690 \$217</p>
<p>\$297 Marantz Computuner 427</p>	<p>Akai Computerized \$765 GX-F95 Cassette</p>	<p>Sony's Best Call for our price PS-X75</p>

TOLL FREE 800-356-9514 Weekdays 9-9
Saturdays 9-5

Over 100 Brands like:

- | | | | | |
|----------|----------|------|----------|---------|
| Technics | Maxell | Sony | Cerwin | Acutex |
| Pioneer | Empire | Teac | Vega | Craig |
| Marantz | Altec | Akai | JBL | Scotch |
| Kenwood | Sharp | Dual | Audio | B.I.C. |
| Sansui | Phillips | Koss | Technica | Stanton |
| Jensen | Shure | TDK | Clarion | Picking |

WDS

WISCONSIN DISCOUNT STEREO
2417 w. badger rd. madison, wi 53713

music: the eight notes of the scale, piled on top of each other. This is Rebel's representation of Chaos, and the movement includes seven repeats of that chord as order establishes itself around it. Rebel's ballet, first performed in 1737, was a lavish affair that portrayed Earth, Air, Fire, and Water, each with its own musical characteristics, each with its special dance. So in the remaining movements of this inventive suite, Fire has a chaconne, Earth and Water share a loure, and Air has a "ramage." The music is lively, colorful, and quite intricate. This performance shows the Academy of Ancient Music attempting to run before it can walk: Without any previous experience in the idiom of the French high baroque, it sounds less than fully confident with ornamentation and rhythmic niceties.

It is much more at home in the companion ballet, also called *Les Eléments*, composed by André Cardinal Destouches (1672-1749) in 1721. The idiom is clearer, less exciting, but there is a magnificent overture, a delightful "Air pour les heures et les zéphirs," and a final chaconne that elicits the best performance on the disc, full of grace and crisp elegance; I've listened to this movement many times, and it loses none of its attractiveness and poise. N.K.

ROSSINI: Guillaume Tell (in Italian).

CAST:

Mathilde	Mirella Freni (s)
Jemmy	Della Jones (s)
Hedwige	Elizabeth Connell (ms)
Arnold	Luciano Pavarotti (t)
Ruodi	Cesar-Antonio Suarez (t)
Rodolphe	Piero de Palma (t)
Tell	Sherrill Milnes (b)
A Huntsman	John Noble (b)
Gesler	Ferruccio Mazzoli (bs)
Walter	Nicolai Ghiaurov (bs)
Melcthal	John Tomlinson (bs)
Leuthold	Richard van Allan (bs)

Ambrosian Opera Chorus, National Philharmonic Orchestra, Riccardo Chailly, cond. [James Mallinson, prod.] LONDON OSA 1446, \$39.92 (four discs, automatic sequence). Tape: OSA5 1446, \$39.92 (four cassettes).

COMPARISON:

Caballé, Gedda, Bacquier/Gardelli
Ang. SEL 3793

ROSSINI: Overtures (5).

Czech Philharmonic Orchestra, Gaetano Delogu, cond. [Libor Mathauser, prod.] SUPRAPHON 1110 2637, \$9.98.

Guillaume Tell; Semiramide; Il Barbiere di Siviglia; La Gazza ladra; L'Italiana in Algeri.

ROSSINI: Overtures (6).

London Symphony Orchestra, Claudio Abbado, cond. [Charles Gerhardt,

prod.] RCA RED SEAL ARL 1-3634, \$9.98. Tape: ARK 1-3634, \$9.98 (cassette).

Guillaume Tell; Semiramide; Il Barbiere di Siviglia; La Scala di seta; Il Turco in Italia; Tancredi.

ROSSINI: Overtures (6).

Philharmonia Orchestra, Riccardo Muti, cond. [John Mordler, prod.] ANGEL SZ 37750, \$9.98.

Guillaume Tell; Semiramide; Il Barbiere di Siviglia; La Scala di seta; Le Siège de Corinthe; Il Viaggio a Reims.

Guillaume Tell (like Verdi's *Vêpres siciliennes* and *Don Carlos*) is far more frequently heard in Italian translation than in the French to which it was composed. As a result, the work is known to the public in a form that too often annihilates the original close relationship between music and text, and thus betrays Rossini's musico-dramatic intentions. In doing so, moreover, it undercuts the expressive force of the opera. For example, in the ecstatic hymn to freedom that brings *Guillaume Tell* to so powerful a conclusion, the melodic emphasis with perfect appropriateness, falls repeatedly on the key line "Liberté, redescends des cieux" ("Liberty, come down again from the skies"). In the Italian version the line becomes the very much blander and less dramatically apt "Non può l'anima spiegar" ("My soul can find no words"), thus robbing the finale of a crucial part of its inherent eloquence. Because such instances appear throughout the opera—at the climax of the tenor's aria "Asile héréditaire," to take another egregious example—one can only regret that London chose to record it in Italian.

Yet even when disguised as *Guglielmo Tell*, the opera still makes a strong impression. Act II, in particular, is full of masterstrokes that the Italian text can only impair, not obliterate: the sweetly melancholic aria for Mathilde, the rousing patriotic trio for Arnold, Tell, and Walter, and the tremendous finale, in which the men of three Swiss cantons assemble in the cause of liberty. And the closing scene of Act IV, whether undercut by translation or not, remains a thrilling and moving climax to the work as a whole.

In any case, London's performance has much to recommend it. Riccardo Chailly, a young conductor of promise, offers a lively account of the score's many heroic episodes, which he handles with commendable vigor and rhythmic skill. In the more lyrical sections, he seems less certain of purpose. Both of the Mathilde/Arnold

Correction: In a review last month, Derrick Henry incorrectly suggested that Telarc might release analog versions of its digital recordings; Telarc has no such plans.

duets (in Acts II and III) are somewhat slack and pedestrian, and even "Sois immobile," the famous aria sung by Tell before shooting the apple from his son's head, sounds more mawkish than noble.

To this piece and to the title role as a whole, Sherrill Milnes brings a brash and blustery manner that is monotonous and unilluminating. When he does attempt to sing softly, his tone becomes unfocused. In addition, his habit of attacking upward intervals by means of a small yowl soon grows wearisome; it also robs the music of all beauty. Luciano Pavarotti is in excellent voice. The abnormally high tessitura of Arnold's music evidently suits him—in the recording studio, at any rate—though not all his forays above the staff are equally successful: The high C sharp that crowns the finale of Act IV, Scene 1, for example, is hardly more than a strangled cry. Nevertheless, in the more extrovert sections of the role, he is at his thrilling best. In the duets with Mathilde and in "Asile héréditaire" he shows little musical imagination, even a certain perfunctoriness.

Best of the principals is Mirella Freni, also in excellent voice, and a more naturally musical performer than either Milnes or Pavarotti. While her singing can sometimes be faulted in matters of detail, she deserves praise for her fully realized characterization of Mathilde. Nicolai Ghiaurov, though increasingly rusty of tone, is a sympathetic Walter. The small roles are mostly competent, but the villainous Gesler sounds far too infirm to be much of a threat to the virile Swiss. Less than ideal, too, is Cesar-Antonio Suarez, whose account of the fisherman's song in Act I lacks charm and polish.

The Ambrosian Opera Chorus, if not quite as alert as it was eight years previously for the Angel recording of *Guillaume Tell*, remains highly capable. The National Philharmonic Orchestra plays very well. The sound, despite some annoying pre-echo, is excellent, and the pressings are virtually flawless. The set contains notes and an Italian/English libretto. There is no real competition here for the Angel set; the latter, though on balance no better performed, is sung in French and is thus necessarily closer to what the composer had in mind.

As the case of *Guillaume Tell* demonstrates, Rossini's overtures usually make a greater appeal to the public than the operas they serve to introduce. Certainly, his powers of invention, his virtuosity and feeling for musical drama are seen at their unflagging best in the overtures. There is a certain amount of overlapping among these anthologies. The Delogu performances are highly proficient but pale beside those of Abbado and Muti. Yet I find it hard to



HELP KEEP THIS MAN IN TEARS.

Canio, the tragic figure in Pagliacci, has brought tears of joy to millions.

Yet these tears of joy could easily turn to sorrow.

The Metropolitan Opera's task of maintaining its standard of excellence is becoming more costly. And that's where you can play an important role.

Pioneer will double the

amount of whatever you can give. Your gift will help the Metropolitan Opera match its grants from the National Endowment for the Arts. That way the Met can put more into each performance and you can get more out of it.

So help us help the Metropolitan Opera. Or people who enjoy a great tragedy will really have something to cry about.

Enclosed is my contribution of \$. Checks should be made payable to: The Metropolitan Opera/Pioneer Fund. Mail the coupon with your contribution to: The Met, c/o U.S. Pioneer Electronics Corp., 85 Oxford Dr., Moonachie, N.J. 07074. HI

NAME

ADDRESS

CITY STATE ZIP

 PIONEER

We all owe a lot to music.

make a clear-cut choice between the latter and am glad to have both discs. Muti is the more vibrant and brilliant Rossinian, Abbado the more sensitive and graceful—equally legitimate approaches. Abbado's London Symphony, however, plays with greater finesse than Muti's Philharmonia, and I suspect that in the long run it is to Abbado's elegant performances that I will want to return more often. All three discs are well recorded. Angel's surfaces, it is good to note, are excellent. D.S.H.

Recitals and Miscellany

DENNIS BRAIN: Unreleased Performances.

Dennis Brain, horn*; Wilfrid Parry, piano*; Dennis Brain Wind Ensemble*. [Sylvia Cartner, prod.] **ARABESQUE** 8071, \$6.98 (mono). Tape: 9071, \$6.98 (cassette). [Recorded in concert, Aug. 24, 1957; includes interviews and tributes.]

BEETHOVEN: Quintet for Piano and Winds, in E flat, Op. 16.** **DUKAS:** Villanelle.** **MALPIERO:** Dialogue No. 4.* **MARAIS:** La Basque.**

DENNIS BRAIN: Horn Recital.

Dennis Brain, horn*; Conrad Hansen* and Benjamin Britten*, piano; Dennis Brain Wind Quintet*. I **GRANDI INTERPRETI IGI** 370, \$7.00 (mono) (includes postage; Discocorp, Inc., P.O. Box 771, Berkeley, Calif. 94701) [recorded in concert, 1955, except sonata, date unknown].

BEETHOVEN: Sonata for Horn and Piano, in F, Op. 17*; Quintet for Piano and

Winds, in E flat, Op. 16*†. **MILHAUD:** Le Cheminée du roi René.† **MOZART:** Divertimento No. 14, in B flat, K. 270 (arr. Baines).†

Among the precious legacies left us by the great artists of the past, there are some we treasure with a special affection intensified by a keenly poignant sense of unfulfillment: the abbreviated discographies of musicians tragically silenced in the very prime of their incalculably promising careers. One thinks first perhaps of conductor Guido Cantelli, contralto Kathleen Ferrier, pianist William Kapell, violinist Ginette Neveu, tenor Fritz Wunderlich, and others, but also of the still-living yet incapacitated cellist Jacqueline du Pré and pianist Leon Fleisher. And not least of all these, notable even among them for his meteoric rise to fame and for the unanimity of international acclaim for his matchless artistry, was Dennis Brain. Unfortunately, the incomparable horn player's affinity for his instrument, its history, and its music was accompanied by a fascination with cars and fast driving that led to his fatal crash of September 1, 1957, at the age of only thirty-six.

The scant Brain repertory still in the catalog remains one of the most persuasive and rewarding introductions to what is perhaps the noblest of orchestral instruments—the four Mozart concertos above all (Angel 35092), but also the two Richard Strauss concertos (Angel 35496), the collection "The Art of Dennis Brain" (Seraphim 60040), and the sole stereo example, Hindemith's horn concerto with the composer conducting (Angel S 35491). Arabesque's BBC memorial program will appeal more to

specialists, particularly to confirmed Brain devotees, for its main attractions are not so much the performances themselves, engaging but indifferently recorded, as the excerpts from a 1955 lecture-recital and a 1956 interview, even less well recorded yet quite intelligible. There are also several brief spoken reminiscences and tributes by such colleagues as conductor Norman del Mar, flutist Gareth Morris, and critic Felix Aprahamian. Like Arabesque's moving earlier memorials to Maggie Teyte (8069) and Kathleen Ferrier (8070), this one is absolutely essential for every aficionado's most treasured memorabilia.

The IGI recital disc may have slightly more general appeal, since it includes no spoken materials or audience applause—nor, indeed, any annotations. In contrast to the admirable Arabesque documentation, there is inexcusably no detailed information on exactly when and where the (broadcast?) duo performance and the three 1955 live-concert quintet performances took place, or who recorded them. Yet while the larger ensemble pieces are recorded rather coarsely and closely, the lively Mozart divertimento and the piquant (if here hardly Gallic) Milhaud suite are welcome additions to the Brain discography; and this reading of the Beethoven quintet has the added attraction of Benjamin Britten's surprisingly deft pianistic participation—markedly more distinctive than Wilfrid Parry's playing in the Arabesque version. Even more magnetically attractive is the more brightly recorded Beethoven sonata, in which Brain's own authoritative virtuosity is fully matched by that of the fine German pianist Conrad Hansen. R.D.D.

Our Invisible Shield!

MuMetal Shield
between independent
magnetic systems.

Model AT155LC
illustrated.

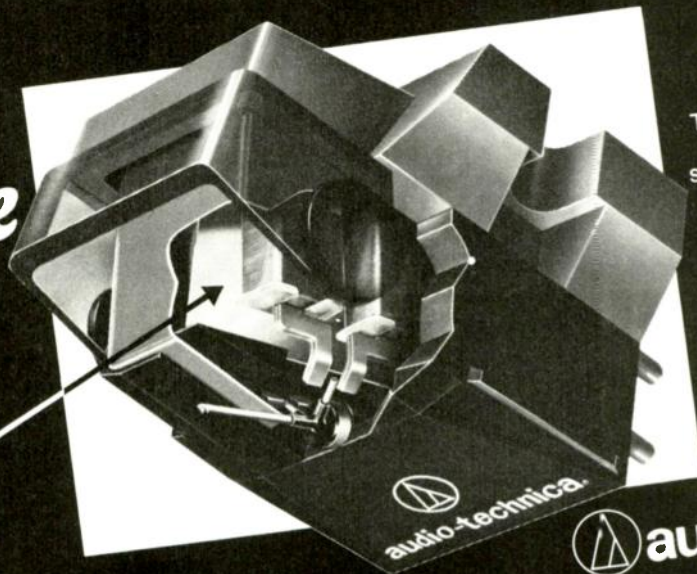

Deep within each new Audio-Technica Dual Magnet™ cartridge are TWO separate, completely independent magnetic systems. Separate magnet, pole pieces, and coils for each stereo channel. Now, to insure the ultimate in stereo separation, we've installed a magnetic barrier between the two systems. It's the thoughtful, innovative extra step typical of every Audio-Technica design. Hear the Audio-Technica difference today.

 audio-technica.

(Continued from page 48)

SLPX 11655, have the advantage of excellent recording (with a firmer bass to the piano tone) yet seem to me to exaggerate the music's rhapsodic character. Isaac Stern and Alexander Zakin (CBS M 30944) take a more classical line with the music, though Stern's tone, at least as recorded, is sandy, and in spreading many of the wide chords that are such a feature of Bartók's piano writing, Zakin tends to diffuse some of the rhythmic impact.

Denes Zsigmondy puts one of these sonatas on each of his two records (Klavier KS 535, 542) devoted to Bartók's violin music. His performances are as Romantic as Kremer's, but the musical partnership between himself and his wife, Anneliese Nissen, is not so evenly matched; moreover there are some slight oddities about the recording—a curiously off-mike quality to the violin in much of the First Sonata and a tendency to rather unnatural channel separation. (But don't be alarmed by the superfluous scroll inserted into a rest in No. 2—the music is unaffected.) The most completely convincing renditions of these sonatas that I know are both a little hard to find yet worth looking for: Robert Mann (the leader of the Juilliard Quartet) and Leonid Hambro in No. 1 on Bartók 922 (monaural; no other work on the disc), and for No. 2, André Gertler and Diane Andersen on Supraphon SUAST 50481, coupled with the solo violin sonata (Sz. 117).

Whereas the two violin sonatas are in Bartók's most advanced "serious" idiom, the two Rhapsodies (Sz. 86, 89—originally for violin and piano but soon orchestrated, Sz. 87, 90) are frankly relaxed crowd-pleasers composed in 1928 for his friends Szigeti and Székely, with a quite unsnobbish return to the old *verbunkos* style that he never ceased to relish, even though he and Kodály had long ago shown that it was not the most authentic Hungarian folk music. Székely plays both rhapsodies in the original violin-piano version on Hungaroton SLPX 11357, and although his intonation may not be quite what it was, his interpretations have an unimpeachable authenticity; the same record also offers the only currently available version (rather dimly recorded) of the cello arrangement of the First Rhapsody and a performance of *Contrasts* for violin, clarinet, and piano by a young Hungarian group.

Contrasts, composed in 1938 in response to a commission from Benny

Goodman but making a good deal more use of *verbunkos* style than of Goodman's own, is more idiomatically played by the team of Mann, Stanley Drucker, and Hambro on Bartók 916 (monaural); there is a mature authority to their performance, a vividness of character, that the young Hungarians cannot quite match, for all their nationality. On the reverse side, moreover, appears Mann's account of the solo violin sonata, one of the best available. An attractive disc, then, in terms of both playing time and performance, provided you are willing to accept less than up-to-date tone quality.

Coming back to the rhapsodies, we find Vincent P. Skowronski, on a record entitled "Gentlema. Gypsy" (Eb-

Sko ES 1004), playing the First a great deal better than he writes in his liner notes and excellently recorded; but by taking the *friss* section too slow he quite misses the music's tongue-in-cheek humor. The Zsigmondys catch this better, I think, on the first of their two discs mentioned above (which likewise include only the more popular First Rhapsody). For the colorful orchestral versions, you will want to turn either to Stern and Leonard Bernstein, who use them as a filler to their recording of the Berg violin concerto (CBS MS 6373), or to Dénes Kovács on the Hungaroton recording of Bartók's own violin concerto, discussed below (SLPX 11350); either account is more than acceptable. (more)

- HUNGAROTON SLPX 1294/6(3)—String Quartets Nos. 1–6 (Sz. 40, 67, 85, 91, 102, 114). Tátrai Qt.
- RCA ARL 3-2412(3)—String Quartets Nos. 1–6. Guarneri Qt.
- TELEFUNKEN 36.35023(3)—String Quartets Nos. 1–6. Végh Qt. (Also on MUSICAL HERITAGE SOCIETY 1501/3.)
- DG PRIVILEGE 2728 011(3)—String Quartets Nos. 1–6. Hungarian String Qt.
- CBS D35 717(3)—String Quartets Nos. 1–6. Juilliard String Qt.
- Vox SVBX 593(3)—String Quartets Nos. 1–6. New Hungarian Qt.
- DEUTSCHE GRAMMOPHON 2530 658—String Quartets Nos. 2 (Sz. 67), 6 (Sz. 114). Tokyo Qt.
- HUNGAROTON SLPX 11655—Sonatas for Violin and Piano, Nos. 1 (Sz. 75), 2 (Sz. 76). Kremer, Smirnov.
- CBS M 30944—Sonatas for Violin and Piano, Nos. 1 (Sz. 75), 2 (Sz. 76). Stern, Zakin.
- KLAVIER KS 535—Sonata for Violin and Piano, No. 1 (Sz. 75); Rhapsody for Violin and Piano, No. 1 (Sz. 86); *Two Romanian Dances* (Sz. 43). Zsigmondy, Nissen.
- KLAVIER KS 542—Sonata for Solo Violin (Sz. 117); Sonata for Violin and Piano, No. 2 (Sz. 76) (with Nissen). Zsigmondy.
- BARTÓK 922—Sonata for Violin and Piano, No. 1 (Sz. 75). Mann, Hambro.
- SUPRAPHON SUAST 50481—Sonata for Violin and Piano, No. 2 (Sz. 76) (with Andersen); Sonata for Solo Violin (Sz. 117). Gertler.
- HUNGAROTON SLPX 11357—Rhapsodies for Violin and Piano, Nos. 1 (Sz. 86), 2 (Sz. 89). Székely, Moore. Rhapsody No. 1 for Cello and Piano (Sz. 88). Mezö, Tusa. *Contrasts* (Sz. 111). Szenthelyi, Berkes, Kocsis. *For Chiláren* (Sz. 42): Hungarian Folksongs (9). Szücs, Tusa.
- BARTÓK 916—*Contrasts* (Sz. 111) (with Drucker, Hambro); Sonata for Solo Violin (Sz. 117). Mann.
- EB-SKO ES 1004—Rhapsody for Violin and Piano, No. 1 (Sz. 86); *Romanian Folk Dances* (Sz. 56)(arr.). Skowronski, Isaak. (Also works by Ravel, Szymanowski.)
- CBS MS 6373—Rhapsodies for Violin and Orchestra, Nos. 1 (Sz. 87), 2 (Sz. 90). Stern; New York P. Bernstein. (Also BERG: Violin Concerto.)
- HUNGAROTON SLPX 11350—Rhapsodies for Violin and Orchestra, Nos. 1 (Sz. 87), 2 (Sz. 90) (with Ferencsik); Violin Concerto No. 2 (Sz. 112) (with Lukács). D. Kovács; Budapest SO.
- LONDON TREASURY STS 15153—Sonata for Solo Violin (Sz. 117). Ricci. (Also works by Hindemith, Prokofiev, Stravinsky.)
- HUNGAROTON SLPX 11479—Sonata for Two Pianos and Percussion (Sz. 110). Ránki, Kocsis, Petz, Marton. Sonata for Solo Violin (Sz. 117). D. Kovács.
- PHILIPS 9500 434—Sonata for Two Pianos and Percussion (Sz. 110). Argerich, Bishop-Kovacevich, Goudswaard, De Roo. (Also works by Debussy, Mozart.)
- DEUTSCHE GRAMMOPHON 2530 964—Sonata for Two Pianos and Percussion (Sz. 110). A.&A. Kontarsky, Caskei, König. (Also works by Stravinsky.)
- TURNABOUT TVS 34465—Sonata for Two Pianos and Percussion (Sz. 110). Brendel, Zelka. (Also STRAVINSKY: Concerto for Two Solo Pianos.)
- TURNABOUT TVS 34036—Sonata for Two Pianos and Percussion (Sz. 110). G. Sándor, Reinhardt, Schad, Sohm. Piano Concerto No. 2 (Sz. 95). G. Sándor; Vienna SO, Gielen.
- HUNGAROTON SLPX 11398—Concerto for Two Pianos, Percussion, and Orchestra (Sz. 115). Pásztory Bartók, Tusa; Budapest SO, J. Sándor. Suite for Two Pianos (Sz. 115a). Pásztory Bartók, Comensoli.
- CBS MS 6956—Concerto for Two Pianos, Percussion, and Orchestra (Sz. 115) (with Gold, Fildale); *Music for Strings, Percussion, and Celesta* (Sz. 106). New York P, Bernstein.

PARK ROW

CAMERA and ELECTRONICS, Corp.

We beat
any
Price

For Visa or Master Charge order
Dial TOLL FREE For Orders Only

800-221-8464

(except New York, Hawaii & Alaska)

CAR STEREO

FTC 4	63.95	Sanyo 1495	119.90
FTC 6	71.50	Blaupunkt CR 2001	237.95
FTC8	99.95	CR 3001	428.00
		CR 4000	244.95
		Sanyo 1496	174.95
		New MRX 3 C90	217.95

TAPE

SCOTCH			
Master I, II or III C90	3.19	Sony LNX C-60	1.25
Metal Tape 60	4.99	Sony LNX C-90	1.59
Metal Tape 90	5.99	MEMOREX	
TDK			
DC 60	1.19	New High Bias 60	1.99
DC 90	1.55	New High Bias 90	2.49
SAC 90	2.95	New MRX 3 C60	1.59
Metal MA60	5.99	New MRX 3 C90	2.00
Metal MA90	7.99	MAXELL SERIES	
New TDK SAX C60	3.99	Grand Master C90	2.99
New TDK SAX C90	4.99	New Ampex T120	14.95
Mar C60	10.49	Ampex 20 + 20 C-90	2.49
Mar C90	14.95	Maxell UD C-90	2.79
Fax C90	4.85	Maxell UDXL 1 or 11 C-60	2.45
REEL TO REEL			
Ampex Grand Master		Maxell UDXL 1 or 11 C-90	3.35
# 1800 ft	6.99	Scotch Low Noise	
Ampex 3600 10 1/2"	19.95	C 90 13 pk	4.99 for 3
Maxell UD 35-90 1800 ft	5.99	VHS FORMAT	
Maxell UDXL 35-90 1800 ft	6.99	Scotch T-120 (Rebate)	29.50
MAXELL UD 35-180 3600 ft		2 Tapes	14.95
(10 1/2")	19.95	TDK T-120	14.95
Scotch 212 1800 ft	6.25	Maxell T-120	14.95
Scotch 207 1800 ft	5.99	Ampex T-120	14.95
TDK S-1800 ft	4.32	VIDEO TAPES	
		BETA FORMAT	
		Sony L-750 (3 Hour)	13.75
		Sony L-500 (2 Hour)	10.95
		Sony L-830	16.95
		Videohead Cleaner	19.95

VIDEO MART

Video Color Camera		Panasonic	
Panasonic		New 1210	659.00
PK 700	725.00	PV-1750	1099.00
PK 750	765.00	PV 3100 Port	835.00
New PK 800	899.00	PV-3200 Port w/Timer & Tuner	995.00
RCA C007	849.00	JVC 6700 HR	799.00
JVC New 71P	1299.00	JVC 2200 w/Timer & Tuner	1075.00
We also carry full line of Toshiba, Magnavox, Zenith, Sanyo, Akai. We also carry full line of Video equip. for Pal systems for overseas use. Write or call.		Sony New 5800	1095.00
		RCA VDT 650 (VHS)	1049.00
		RCA New VET 180	675.00
		RCA VET 450 (14 day prog.)	839.00

ELECTRONIC GAMES

Panasonic RF 2500	219.95
Sony Walkman	147.95
Mattel Intellivision	218.95
Atari CX 2600	139.95
All ELECTRONIC GAMES IN STOCK	CALL

CARTRIDGES

SHURE	
V15 Type IV	96.99
V15 Type III	79.50
M95 HE	33.95
M95 ED	29.95
M97 HE	49.50
M97 ED	19.95
All Stylus for Shure in Stock	

TV

Sony Walkman	147.95
Panasonic RF 2900	219.95
All Sony TV's in Stock Call for Price	

CASSETTE DECKS

JVC NEW KD-A11	119.95
JVC KD-A66	329.95
JVC KD A8	489.95
SHARP RT 4488 Metal	269.95

VIDEO MOVIES

All Video Movies In Stock

STEREO, AUDIO, TV, VIDEO

CATALOG SEND \$2.50

Prices Subject to change without notice on tapes. Minimum Shipping and Handling Charge \$3.50.

1 Park Row • New York, N.Y. 10038

(212) 233-8862

Outside N.Y. 800-221-8486

Daily 9-6 Sunday 10-4

Circle 23 on Reader-Service Card

If, like me, you regard the solo violin sonata written for Yehudi Menuhin in 1944 as an essentially classical work, for all its virtuoso demands on the player's technique, Zsigmond's version on the previously mentioned Klavier recording will probably seem too consistently intense and extrovert; Ruggiero Ricci's, part of an interesting recital of twentieth-century solo violin music available until recently (London Treasury STS 15153), suffers a little from the same old-style virtuoso mannerisms. For my taste, the other completely satisfying performance—apart from Mann's already mentioned—is that of Dénes Kovács on Hungaroton SLPX 11479, where it is coupled with a very good account of the Sonata for Two Pianos and Percussion (1937) (Sz. 110) by the young Hungarian pianists Dezső Ránki and Zoltán Kocsis. This, unfortunately, is marred by a reversal of the stereo channels and a slight imbalance between them; there is also a slightly higher level of tape hiss than on the two most competitive of its rivals, disturbing in a work as concerned with sonorities as this one.

Ideally the choice for this great work must rest, I think, between Stephen Bishop-Kovacevich and Martha Argerich on Philips 9500 434 (slightly romanticized in terms both of tempos and of recorded sound) and the unbelievably accurate and spotlessly clear recording by the Kontarsky brothers on DG 2530 964—a supremely successful demonstration that Bartók's music needs no putting over if the players can only do fully and precisely what he asks for. With its coupling of Stravinsky two-piano works, the concerto and the sonata, the Kontarsky disc is a must in any collection of twentieth-century music on record; whether you invest in any other performance of the Bartók sonata is up to you. As for the cheaper versions on Turnabout, the Alfred Brendel/Charlotte Zelka (TVS 34465) doesn't sound like real stereo and is in any case so dim as to be out of the running. That of György Sándor and Rolf Reinhardt (TVS 34036), though not terribly well recorded, is still—just—competitive; this pressing is less noisy than that contained in Vol. 2 of Sándor's Vox Box series of Bartók's piano music.

The orchestral version of this work, made in 1940 (Sz. 115), seems to me one of Bartók's rare miscalculations, blurring the music's lines and obscuring its taut contrapuntal argument. There is

a rather sluggish and imprecise reading on Hungaroton SLPX 11398, with the composer's widow and Erzsébet Tusa as soloists and the Suite, Op. 4B (Sz. 115a), as coupling (for which, see Early works, March). The altogether more brilliant performance by Arthur Gold and Robert Fisdale with the New York Philharmonic under Bernstein (CBS MS 6956) is unfortunately coupled with a version of the *Music for Strings, Percussion, and Celesta* (Sz. 106) that demonstrates some of the worst failings of the Romantic approach to Bartók—but more of that below.

Orchestral works

In point of time, Bartók's first orchestral venture after *The Miraculous Mandarin* was the *Dance Suite* of 1923, in which many of the ballet's ferocious gestures are humanized into surprising (yet welcome) joviality. It is a delightful work, still too little known, but because of the company it usually keeps on records, I shall postpone consideration of the recorded versions until I have looked at the three piano concertos, which evidently belong together.

The first two were written, No. 1 in 1926, No. 2 in 1930-31, for the composer himself to play on his concert tours. Both represent his particular interpretation of the neoclassical urge common to all the best composers of the 1920s, including Schoenberg as well as Stravinsky. An athletic, percussive, almost brusquely motoric counterpoint characterizes the outer movements; only in the slow central movements, particularly that of the deliberately more accessible No. 2, is there much in the way of lyricism. In keeping with the character of the music, the orchestra is treated in blocks of color, with woodwinds, brasses, strings, and even percussion functioning equally and independently: Thus, no strings at all are used in the first movement of No. 2 (cf. Stravinsky's Piano Concerto of 1924). This means that recording engineers must be prepared to shed some of their preconceptions about orchestral balance when dealing with these two works in particular. (The Third Piano Concerto, composed in 1945 for the composer's wife, is rather more conventional in its treatment of both piano and orchestra and thus poses fewer problems.)

I had heard such high praise of the recent DG recording (2530 901) of the First and Second Concertos with Mau-

rizio Pollini and the Chicago Symphony under Claudio Abbado that I thought it would be an easy winner. Not a bit of it. The performance is magnificent, the sound astonishingly free of distortion, but the balance, to my ears, intolerable. We are forced to listen to the work as if from inside the piano, or at best from the piano bench, and however much we may admire Pollini's playing, this is a grotesque distortion of the music's texture and sense: Many details, especially in strings and woodwinds, are virtually inaudible, though I am quite sure (given the quality of the rest of the playing) that they were there.

So we turn to the Philips recordings, packaged either individually (9500 043, 839 761) or as a set together with the Sonata for Two Pianos and Percussion (6768 053), by Bishop-Kovacevich, partnered by two different English orchestras under Colin Davis. Here we at once find a more natural balance between piano and orchestra, but it is compromised, alas, by an excess of hall resonance, which sets up a kind of aural blur between the listener and the music. (Listen to the end of No. 1's first movement.) Someone may have thought that this was a way of making these rather astringent works more palatable; I find it merely exasperating not to be able to hear clearly what my eye tells me is going on. In addition, this soloist and conductor are rather prone to exaggerate the slowness of Bartók's slow tempos. Admittedly his metronome markings can seem a shade too fast for the slow movements of both these concertos, but Bishop-Kovacevich slows them down quite a bit more than most other pianists, in favor of what seems to me a rather specious mystery. (The same thing happens in his account of the two-piano sonata with Argerich, so perhaps it's fair to attribute this quirk to him rather than to Davis.) On the other hand, his handling of the quicker movements is so splendidly athletic and assured that, if it were not for the smudged orchestral sound, I could recommend this set above its competitors. As it is, we must fare farther in hope of finding better.

Kocsis plays the first two concertos on Hungaroton SLPX 11516, accompanied by the Budapest Symphony Orchestra under Lehel. Lehel strikes me as one of the most scrupulous of the conductors involved in the Hungaroton series, and it is interesting to find him and Kocsis taking the slow movements

at Bartók's marked speeds with no apparent loss of meaning and a considerable improvement in linear continuity. But here the recorded balance is the absolute reverse of Pollini's; instead of a forward, all-obliterating piano, it is treated merely as a part of a rather too distant orchestra; since the overall sound has too much reverberation, the result, for all its good intentions, is still not ideal. To my ears, Géza Anda's recordings made with Ferenc Fricsay for DG in the early 1960s (Privilege 2535 262/333) still come closer to presenting what Bartók meant us to hear than most of their more modern rivals—even though no one could claim that the Berlin Radio Symphony Orchestra was in the same league as the Chicago Symphony. I should perhaps add that Daniel Barenboim's Angel recordings of Nos. 1 and 3 did not reach me and that they may be the answer to my prayer; if they are not, I would recommend that anyone get to know Bartók's piano concertos (particularly the first two) from Anda's recordings, then supplement that experience by listening to Kocsis, Bishop-Kovacevich, and Pollini, in that order. Each adds something vital to the total picture.

Of separate versions of individual concertos I should single out Rudolf Serkin's of No. 1 (CBS MS 6405), which is generally on the slow side but impressively clearheaded and purposeful, and Julius Katchen's of No. 3 (London Treasury STS 15494), subtly phrased but more accurate and less mannered than Anda's. Ránki's Hungaroton recording of No. 3 (SLPX 11421) is refreshingly virile and better balanced than Kocsis' of Nos. 1 and 2. György Sándor, however, is let down both by his orchestra and by the recorded sound in Nos. 2 and 3 (Turnabout TVS 34036, 34483). None of the other available separate versions offers serious competition to the sets.

When we turn to the purely orchestral music, without soloists, choices at once become simpler. For the *Dance Suite*, Solti's performance with the London Symphony Orchestra, a generous filler to their *Concerto for Orchestra* on London CS 6784, is a fairly clear winner, with a recorded sound that combines clarity with warmth and an instinctive rapport between conductor and orchestra that permits the most fluid changes of tempo to sound completely natural. (The same recording appears on Turnabout TVS 34163, coupled with Solti's 1955 reading of the *Music for Strings, Percus-*

illinois audio



SAVE • money
• time
• freight
on name brands

CASSETTE TAPES

SONY METALIC C-90 METAL TAPE	\$75.00/10
SONY EHF-90 HIGH BIAS TAPE	28.00/10
SONY FER-90 HIGH BIAS PREMIUM	28.00/10
TDK MA-C90 METAL CASSETTE TAPE	\$64.00/10
TDK SA-C90 SUPER AVALIN TAPE	29.50/10
TDK SA-C90 SUPER AVALIN TAPE	22.50/10
TDK C-90AD NEW AUDIA TAPE	22.00/10
BASF C-90 PROFESSIONAL TYPE I	\$26.50/10
BASF C-90 PROFESSIONAL TYPE II	27.00/10
BASF C-90 PROFESSIONAL TYPE III	30.00/10
MAXELL C-90 LN LOW NOISE TAPE	\$23.50/12
MAXELL C-60UD ULTRA DYNAMIC	23.00/12
MAXELL C-90UD ULTRA DYNAMIC	29.50/12
MAXELL UD-XL-C90 TYPE I OR II	29.50/12
MAXELL UD-XL C-90 TYPE I OR II	39.50/12
SCOTCH C-90 MASTER TYPE 2 OR 3	31.50/10

REEL TO REEL TAPE

TDK LX-35-90M NEW 7IN.	\$60.00/10
TDK LX-35-180M NEW 10 1/2 IN	170.00/10
MAXELL UD-35-90 ULTRA DYNAMIC 7"	57.50/10
MAXELL UD-35-180 SAME ON 10 1/2"	153.00/10
MAXELL UD-XL-35-90B BACKCOATED XL	69.50/10
MAXELL UD-XL-180B SAME ON 10 1/2	198.50/10
SCOTCH 207R-90 POLY-POSITRAC	55.00/10
SCOTCH 207 R-180 10 1/2 IN	170.00/10

VIDEO TAPE

SCOTCH L-500 BETA TAPE	\$110.00/10
SCOTCH L-750 BETA TAPE	130.00/10
SCOTCH T-120 VHS TAPE	140.00/10

NOTE: FUJI NOW IN STOCK AT LOW PRICES !!!!!

<u>AUDIO TECHNICA CARTS.</u>		<u>STANTON CARTRIDGES</u>
MODEL 155-LC \$105.00		MODEL 881-S \$82.50
MODEL 140-LC 60.00		681-EES 60.50
		681-EEE 52.00

<u>SHURE CARTRIDGES</u>		<u>FLICKER CARTRDGS.</u>
V-15 TYPE 4 \$95.00		XSV-3000 \$55.00
V-15 TYPE 3HE 70.00		XSV-4000 77.00
M-97 HE 49.50		XSV-5000 99.00

SHURE 9095ED \$17 WITH TURNTABLE PURCHASE !!!

AUTOMOTIVE STEREO

PIONEER KE-2100 ELECTRONIK READOUT	\$175.00
PIONEER KP-8500 AM-FM CASSETTE	140.00
WHITE FOR ALL PIONEER AUTOMOTIVE PRICES !!!!!	
JENSEN J-1065 6x9 TRIAXIAL® PAIR	82.00
JENSEN J-1069 6x9 COAXIAL® PAIR	40.00
JENSEN J-1077 5 1/4 COAXIAL® PAIR	38.00
JENSEN J-1093 4 1/2 COAXIAL® PAIR	34.00

HEADPHONES

KOSS MODEL HV-X STEREO HEADPHONES	\$41.50
KOSS MODEL HV-XLC "	"	49.50
KOSS PRO-4 AAA "	"	47.50
SENNHEISER HD-414 HEADPHONES	\$45.00

NEW SONY LIGHTWEIGHTS IN STOCK !!!!!

— send for free catalog —

Name _____
 Address _____
 City _____
 State _____ Zip _____

illinois audio

12 East Delaware Place
 Chicago 60611

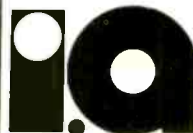

Phone Now
 (312)
 664-0020
 TOLL FREE
 (800)
 621-8042



"RATED NO. 1 FOR SERVICE & RELIABILITY"

NOW THERE'S A BETTER WAY TO BUY RECORDS & TAPES!

J&R Music World Mail Order Service

Incredible! That's the only way to describe J&R Music World's 5-FLOOR RECORD & TAPE WAREHOUSE, brimming with thousands of recordings from every musical category. We're **NOT A CLUB**—you buy what you want, when you want with absolutely no obligation. *Playboy Guide* said: "J&R is chock-full of nutty bargains on major-brand records and tapes, components and audio sound. Exhaustive!"

TREMENDOUS SAVINGS

We buy in such huge quantities that we're able to knock down prices dramatically. One look at our everyday price list will convince you of the dramatic savings we offer. EVERYDAY.

EVERY ARTIST, EVERY LABEL

Vladimir Horowitz, Zubin Mehta, Billy Joel, Paul Simon, George Benson, Fleetwood Mac, Frank Sinatra, Barbra Streisand, Tony Bennett, Bob James, Eric Gale...we've got it all, from Rock to Bach and everything in-between.

SUPER-FAST SERVICE

We provide same-day shipping on most orders by U.P.S.—you never have to sweat out long delays. And everything's guaranteed factory-fresh and free of defects.

J&R's 200-PAGE CATALOG

It's yours free, and it contains our entire record and tape inventory, plus exciting buys on famous-name audio and video equipment.

WITH J&R's SUPER-LOW EVERYDAY PRICES, IT'S LIKE YOU'RE GETTING A SALE 365 DAYS A YEAR!

LOWEST EVERYDAY PRICES

List Price 4.99	2 ⁹⁹ LP	List Price 11.99	7 ⁹⁹ LP
List Price 5.99	3 ⁹⁹ LP	List Price 12.99	8 ⁹⁹ LP
List Price 7.99	4 ⁹⁹ LP	List Price 14.99	9 ⁹⁹ LP
List Price 8.99	5 ⁹⁹ LP	List Price 15.99	9 ⁹⁹ LP
List Price 9.99	6 ⁹⁹ LP		

Case & Truck Same Price as LP
Minimum Order: 3 Records or Tapes

If you want a Schwann Catalog to help you with your selections, send \$1.25 and we will gladly send it to you.

WE ALSO CARRY A COMPLETE STOCK OF AUDIOPHILE DIGITAL AND DIRECT-TO-DISC RECORDINGS, ALL AT SEN- SATIONAL DISCOUNTS!

HOW TO ORDER BY MAIL: For prompt shipment, send money order, certified check, cashier's check, MasterCard or Visa (include card number, expiration date and signature). Shipping insurance charge is 5% of total or \$3.95 minimum (\$5 additional for orders outside of Continental U.S.). N.Y.S. residents add tax. No C.O.D. All merchandise 100% guaranteed brand new and factory fresh 3 weeks delay on personal checks.

Please use a separate piece of paper to order and indicate whether you want LP or tape. If any items are not available or temporarily out of stock, we'll send you an immediate refund. When ordering multiple sets, please multiply price per LP by number of LP's ordered.

ORDER TOLL FREE (800) 221-8180



23 PARK ROW, NEW YORK, N.Y. 10038 DEPT. HF

SEND FOR OUR 200 PAGE FREE CATALOG

Circle 17 on Reader-Service Card

sion, and *Celesta*, but this version is less well pressed.) In the mid-1960s, when this recording was made, the London Symphony was at the height of its powers, a virtuoso orchestra that combined discipline with individual sensitivity, particularly in its first-desk winds, and we are fortunate that Solti recorded so much Bartók with them at that time.

The two runners-up are Stanislaw Skrowaczewski on Candide QCE 31100, marred only by a rather sentimental treatment of the ritornello tune and the fourth (Arabian) dance and by the slightly undernourished tone of the Minnesota strings; and Dorati (Philips 6500 931), with excellent tempos but an orchestra not quite in the virtuoso class and a blurred sound quality. Of the remainder, all more or less lack swagger and panache—none more so than Pierre Boulez, with the New York Philharmonic on CBS M 31368, where the suite is coupled (intelligently, it must be said) with *The Miraculous Mandarin*.

Apart from the piano concertos and miscellaneous transcriptions, Bartók did not return to purely orchestral composition until the *Music for Strings, Percussion, and Celesta* of 1936 (Sz. 106), which can more easily be considered extended chamber music than a work for reduced symphony orchestra. In saying so, I at once betray my preference for performances with the kind of chamber orchestra for which the work was originally conceived; even the best-disciplined full-size symphonic string groups seem to me to blur the details of, for example, the opening viola melody of the nocturnal third movement. This alone would be almost enough to ensure my vote for Neville Marriner's excellent account, with the Academy of St. Martin-in-the-Fields, on Argo ZRG 657, but it is most sensitive yet strongly structured into the bargain—and coupled with an equally fine performance of the *Divertimento*.

But that is not to say that a performance by a symphony orchestra's full string section cannot be thrilling, too, in its broader way, and of these my choice would go to Solti and the London Symphony (in a coupling with a stunning *Miraculous Mandarin Suite*, to which I drew attention in its place, on London CS 6783); to the older but still exciting Fritz Reiner/Chicago version on RCA Victrola VIC5 1620, whose fire blazes through the slightly foggy sound; or to Boulez (CBS MS 7206), who is in altogether more vital form with the BBC



One of the rewards of making this survey was the belated discovery of Reiner's Bartók performances, which I had somehow managed to miss before.



Symphony Orchestra than with the New York Philharmonic. The rest are well played but a little faceless (Ormandy, Angel SZ 37608), more or less over-romanticized (Bernstein, CBS MS 6956—positively lachrymose in the first movement—and Karajan's newer recording, DG 2530 065), too comfortable in tempo to convey the hurtling energy of the last movement, whatever good things may have gone before (Dorati, Philips 6500 931; Lehel, Hungaroton SLPX 1301; Ozawa, DG 2530 887), or marred by out-dated recording (the older Karajan on Angel S 35949, with its hopelessly dim percussion; the older Solti on Turnabout TV5 34613; Wand on Everest).

It is sad to have to reject the last, since Günter Wand's performance of the *Divertimento* on the reverse side is better in every way and perhaps worth the price of the record by itself. The *Divertimento* (1939) (Sz. 113) is a considerably slighter work, though it was written for the same group, Paul Sacher's Basel Chamber Orchestra. Its central slow movement can seem disproportionately intense for the breezy outer ones, but I wonder whether this is not due to a bad performance tradition of taking it slower than Bartók intended. Of the two Dorati recordings, the one with the BBC Symphony Orchestra (Mercury SRI 75118) has a really big sound, rich yet well defined; that with the Hungarians (Hungaroton SLPX 11437) is more refined but less buoyant. But the Marriner, already mentioned, is best of all, and this disc is surely essential to any Bartók collection.

The Violin Concerto (Sz. 112) written for Székely in the preceding year is an altogether more substantial work. Here for once we have the evidence of a recording of the first performance, by

the work's dedicatee, to help us set our critical sights. Székely's reading, with Willem Mengelberg and the Concertgebouw Orchestra (on Hungaroton LPX 11573), is not likely to be anyone's first choice today, since the sound, transferred from acetates of a broadcast, is inevitably pretty limited. But what do come over, and very clearly, are the intimacy and subtlety of the performance; this is first and foremost ensemble playing, and only incidentally a display of virtuosity. Kovács on Hungaroton SLPX 11350 perhaps comes closest to the character of Székely's interpretation, but the Budapest Symphony Orchestra is no Concertgebouw. Kovács offers both the rhapsodies as a filler; Henryk Szeryng, partnered by the Concertgebouw under Bernard Haitink, gives the first one only (Philips 6500 021); all the other available versions present the concerto alone. Szeryng, a player whom I much admire, in this instance gives a rather undervalued performance; moreover the engineers have given him too much spotlight, so that the ensemble aspects of the piece fail to come across as they should.

A similar failing afflicts Kyung-Wha Chung's eloquent if occasionally rather mannered version with the London Philharmonic under Solti (London CS 7023)—a recording that with more natural balance one might well want to recommend as the best available. In Stern's recording with Bernstein and the New York Philharmonic (CBS MS 6002), the balance is not so bad, but there is a great deal of unwanted reverberation cluttering up the orchestral detail, and the soloist's persistent tension puts an edge on his tone that becomes positively painful at times—inappropriate for this of all Bartók's works. Pinchas Zukerman's rendition with the Los Angeles Philharmonic under Zubin Mehta (CBS M 35156) is more attractive in sound, though distanced overall, and a little lacking in nervous vitality.

Of all the currently available versions, only Itzhak Perlman's with the

London Symphony under André Previn (Angel S 37014) offers the kind of natural balance and clarity that we should surely be able to take for granted. But this is not the only reason I prefer it. Perlman and Previn do not give the same kind of performance as Székely; theirs is a thoroughly Romantic interpretation of the concerto, impassioned and extrovert where the original was intimate, almost aloof. Yet for me it carries conviction through its consistency and its constant alertness to the interplay between soloist and orchestra.

About the Viola Concerto (Sz. 120) I can say little, because I have so little confidence that I know what Bartók wanted this work (completed after his death by Tibor Serly) to sound like. Simply on the basis of the score, I would be inclined to recommend Dariel Benyamini's performance on DG 2531 249, with Raphael Hillyer, the ex-violist of the Juilliard Quartet (Nonesuch H 71239) and Géza Németh (Hungaroton SLPX 11421) as runners-up.

With the *Concerto for Orchestra* we are all, engineers and listeners alike, on safer ground; Bartók wrote it as a display piece for full symphony orchestra, so that the familiar sound and disposition of the music to a greater extent than is usual with him. Since there are so many at least decent versions available, it will probably be best to begin by paring away those that for one reason or another seem to me not very desirable, leaving readers to make their own choice from among the several that are.

Ernest Ansermet was a fine interpreter of much music of Bartók's generation, and he repeatedly worked wonders with his Suisse Romande Orchestra; this virtuoso work was not really for them, though, and the quality of sound (on London Treasury STS 151 10) now seems inadequate. Leopold Stokowski's very different performance, on Everest 3069, obtrusively over-phrased, is also poorly recorded by modern standards. George Szell's superbly disciplined rendition with the Cleveland Orchestra on CBS MS 6815, is marred by a perversely, almost artificially slow account of the fugue in the finale. Boulez (CBS M 32132), perhaps put off by the unaccustomed demands of quadriphonic recording, gets a surprisingly undisciplined performance from the New York Philharmonic; there is just a touch of bogus rhetoric about some of

J&R "RATED NO. 1 FOR SERVICE & RELIABILITY"

THIS MONTH'S SUPER SPECIALS!

Audio & Video

VIDEO		AUDIO	
SONY SL 5400 Betamax	\$790	TECHNICS RS-M45 Cass Deck	\$225
VHS-UB-0700 Video Rec	\$490	B I C 172 Cassette Deck	\$150
ZENITH VR-9000 Beta Vid Rec	\$609	DUAL 606-55 T. A/Cart	\$219
RCA VE1 250 Video Rec	\$775	TECHNICS SA-202 Receiver	\$165
RCA VLP 150 Port Vid Rec	\$729	PIONEER SK-3700 Receiver	\$259
SONY KV-1914 19" Color TV	\$439	TECHNICS SL 02 Turntable	\$190
PANASONIC CT 9010 19" Col TV	\$359	AKAI LCL212 Micro Int Amp	\$150
PANASONIC CT 288 17" Col TV	\$279	TECHNICS ST12 Tuner	\$155

CAR STEREO

PIONEER		JENSEN	
CASSETTE IN-DASH W/RADIO		CASSETTE IN-DASH W/RADIO	
KP-1500	\$4 90	R-412 Receiver	174 90
KP-2500	90 00	R-406 Receiver	210 00
KP-4500	114 00	R-410 Receiver	200 00
KP-5500	124 00	R-405 Receiver	259 00
KP-6500	141 90	SPEAKERS	
KE-2100	174 90	J-1001 6 x 9 Separates	94 90
KE-3200	209 00	J-1006 6 x 9 In-Dash	52 50
KE-X 20	214 90	J-1033 6 x 9 In-Dash	70 50
KP-1500 (Foreign Cars)	129 00	J-1201 6 x 9 (Car & Min)	59 90
KP-4502 (Foreign Cars)	144 90	J-1101 4 x 10 In-Dash	52 50
KP-8000	154 90	J-1130 4 x 10 In-Dash	70 90
KP-9000 (Stereo Amp)	154 90	J-1174 5 1/4 In-Dash	78 50
KP-9500 (Stereo Amp)	175 90	J-1101 4 x 10 In-Dash	52 50
J-1186 6 x 9 (Car & Min)	42 95	J-1009 6 x 9 (Car)	40 50
J-1037 6 x 9 (Car & Min)	52 50	J-1041 5 1/4 (Car & Min)	49 50
CASSETTE UNDER DASH		SANYO	
KP-173	\$4 90	IN-DASH CASSETTES	
KP-75	129 90	FI-1406	179 95
KP-100	129 90	FI-1408	219 90
KP-460 (req. amp)	175 50	FI-1409	119 95
KP-750 (req. amp)	104 90	FI-2400	224 90
KP-460 (req. amp)	99 00	FI-C2	54 90
KP-707G	118 90	FI-C4	54 90
KP-707G	146 00	FI-C6	71 90
POWER AMPS/EQUALIZERS		FI-C8	90 90
BP-320	49 90	FI-C10	106 90
AD-30	89 90	FI-C16	147 90
AD-50	141 90	BLAUPUNKT	
GM-40	49 90	CB-2001	238 90
GM-120	106 90	CR-3001	432 90
CD-5	89 90	CR-4001	256 90
CAR SPEAKERS		CR-5001	331 90
TS-4A2	32 90 PAIR	BE-100	107 90
TS-83	32 90 PAIR	BE-200	174 90
TS-07	37 00 PAIR	BE-50	74 95
TS-107	44 90 PAIR	CLARION	
TS-148	82 90 PAIR	PE-900 (req. amp)	569 90
TS-695	82 90 PAIR	PE-950B	319 90
TS-760	89 90 PAIR	PE-758B	172 90
TS-X9	129 90 PAIR	PE-544	94 90
WE ALSO CARRY THE FULL LINE OF CAR STEREO BY PANASONIC, SAUNDERS, MITSUBISHI, CONCORD, SONY, HILBEY AND CRANE		100EGB3	77 90
		300EGB7	137 90

BLANK CASSETTES

AUDIO		VIDEO	
AMPEL GRAND MASTER II OR III C90	2 90	WE CARRY VIDEO TAPES BY AMPEL	
BASF PRO II OR III C90	2 90	BASF FUR JVC MATRELL PARAGON	
FI-FI 1 OR II C90	2 90	NEWMAN FOR SCOTCH SONY RCA	
SCOTCH HIGHLANDER C-90 3-PK	2 90	AMPS	
MEMOREX HI-BIAS C90	2 90	ALL BETA I 500	10 95
SCOTCH MASTER II OR III C90	3 25	ALL BETA L 750	13 95
SONY FE-CR C90	3 25	ALL VHS-T90 (EXCEPT HGI)	14 95
SONY LNF C90	1 54	MATEL INTELLIVISION	219 90
DK-HD BY BERGHEITZER	1 19	ATAF VIDEO GAME CX 2600	148 00
DK-D C90	1 68	SPACE INVADERS CONTINUED	23 90
DK-AD-C90	1 68	PANA PV-1400 Video Rec	849 00
DK-SAC-C90	2 45	ZENITH VR 9750	1020 00
DK-SAC-C90	2 15	WE STOCK B&W AND CORDON TV'S VHS AND BETA VIDEO RECORDERS AND HOME MOVIE FILMS FROM ALL MAJOR HOLLYWOOD STUDIOS. SEND FOR CATALOG.	
DK-MA-C90 (RETAIL)	6 20	MINIMUM ORDER 12 TAPES 100% GUARANTEED	
DK-MA-C90 (RETAIL)	6 20		
MATEL UNIBREW ISBLR	100 (UP TO)		
CALL OR WRITE FOR PRICES	ADVERTISE		
LANSBUR AUD 58 Int Amp	274 00		
TECHNICS SA-303 Receiver	109 00		

ACCESSORIES

CAR ACCESSORIES		HEADPHONES	
FUZZBUSTER ELITE	134 95	ROSS PRO 4 AAA	46 50
FOX XR RADAR DETECTOR	99 50	ROSS TECH VFR	46 50
FOX XBRN (remote)	109 50	ROSS HYX LC	46 90
SUPERFOX	224 90	SENNHEISER HD-420	52 50
PAGE ALERT 4000	114 95	SENNHEISER HD-430	72 50
BELL 810 (Supermini)	154 95	AUDIO TECHNICA ATH 7	94 90
H&R FA 80 (Anti-1)	33 95	PIONEER SE 205	22 95
MISCELLANEOUS		SONY MDR 3	34 50
BIC FM-6 BEAM BOX	24 90	SONY MDR 7	54 95
BIC FM-8 BEAM BOX	34 90	CARTRIDGES	
BIC FM-10 BEAM BOX	44 90	SHURE MP6E	19 95
CASIO C-80 Cal Watch	44 90	SHURE MP6D	29 95
CASIO MR-8 CALCULATOR	31 95	SHURE V15V	69 95
CHESS CHALLENGER K7	87 90	PICKERING 35V 3000	53 95
BACKGAMMON CHALLENGER 7	85 90	WE ALSO STOCK	
ISSD X10 (KIT)	68 95	AUDIO TECHNICA, EMPIRE	
ISSD X10211 (Timer)	59 95	STANTON, ADC, AT LOWEST PRICES	
BIC B-1	19 95		
BONE PHONE PADIO	63 95		
SONY TPSL2 PORT STEREO	179 95		

RECORDS

ALL ROCK, JAZZ & CLASSICAL

As 7 98 List As 8 98 List As 9 98 List **499 599 699** Cass & 8-Track Same Price as LP. Minimum Order: 5 Records or Tapes

PRICES MAY VARY ON IMPORTED RECORDS. We Stock all Major Labels

HOW TO ORDER BY MAIL: For prompt shipment send money order, certified check, cashiers check, Master Charge or Visa (include card number, expiration date and signature). Shipping insurance charge is 5% of total or \$3.95 minimum (\$5 additional for orders outside of Continental U.S.). N.Y.S. residents add tax. No C.O.D. All merchandise 100% guaranteed brand new and factory fresh. 3 weeks delay on personal checks.

ORDER TOLL FREE (800) 221-8180 Customer Service Hotline (212) 233-0857

For more information call: 732-8500



23 PARK ROW, NEW YORK, N.Y. 10038 DEPT. HF
SEND FOR OUR 200 PAGE FREE CATALOG

Circle 18 on Reader-Service Card

Bartók's music is many-sided enough to be looked at from different viewpoints.

The Simple Solution

LAST

PRESERVATION

TWO YEARS of research and testing have perfected LAST, the acclaimed and elegantly SIMPLE SOLUTION to the most serious record wear problem facing today's collector. Groove damage caused by the stylus shock wave can now be ELIMINATED. A single 30 second TREATMENT (less than a MINIMUM of 200 PLAYS.

The LAST Factory
P. O. Box 41
Livermore, CA 94550
(415) 449-9449

Circle 19 on Reader-Service Card

FREE details A DIFFERENT KIND OF RECORD CLUB

TREMENDOUS SAVINGS
on every record and tape in print — no "agree-to-purchase" obligations of any kind
DISCOUNTS OF 43% TO 73%
off mfg suggested list special catalog features hundreds of titles and artists

ALL LABELS AVAILABLE
including most imports through special custom ordering service — guarantees satisfaction

SCHWANN CATALOG
lists thousands of titles, classical, pop, jazz, country, etc

DISCOUNT DIVIDEND CERTIFICATES
Dividend Gifts — certificates redeemable immediately for extra discounts

NEWSLETTERS
informational news and happenings in the world of music special super sale listings

DISCOUNT ACCESSORY GUIDE
Diamond needles, cloths, tape cleaners, etc

QUICK SERVICE

same day shipping on many orders rarely later than the next several days

100% IRON-CLAD GUARANTEES
on all products and services — your total satisfaction is unconditionally guaranteed

Discount Music Club is a no-obligation membership club that guarantees tremendous discounts on all stereo records and tapes and lets you buy what you want...when you want...or not at all if you choose.

These are just a few of the money-saving reasons to write for free details. You can't lose so why not fill out and mail the coupon below for immediate information.

DMC DISCOUNT MUSIC CLUB, INC. IDEPT. 8-0581
650 Main Street, New Rochelle, N.Y. 10801

Name _____
Address _____
City _____
State _____ Zip _____

Circle 8 on Reader-Service Card

his slow tempos, too. Angel has given Seiji Ozawa and the Chicago Symphony a distant perspective, providing weight but little detail (SFO 36035); either this or the performance itself leaves a rather impersonal impression. Bernstein, on the other hand, is given almost excessively clear detail in the quieter passages of his recording with the New York Philharmonic (CBS MS 6140); here the fuller sections sound constricted. There is a bit of untidiness in the fugue, but no one could say the performance as a whole lacked commitment, and in this it seems preferable to Eugene Ormandy's on RCA ARC 1-3421, since the Philadelphia woodwinds phrase with so little individuality. Yet Ormandy has the advantage of much more naturally balanced sound than Bernstein, even though the full orchestral passages are a little overreverberant for my taste.

With these last two versions, though, we are already among the group whose good points outweigh their bad. Of Dorati's three recordings, I am inclined to prefer the second, with the London Symphony Orchestra (Mercury SRI 75105); Mercury's seventeen-year-old sound has stood up excellently to transfer and is even clearer than that provided by Hungaroton on SLPX 11437; the performance, too, is more agile and firmly characterized. Agility is not the most obvious characteristic of Herbert von Karajan's reading on Angel S 37059. At times it even gets a little gluey, but I very much like his weighty treatment of the deliberately vulgar "Shostakovich" tune in the fourth movement; taken faster, as most conductors except Ormandy do it, it becomes perky and loses some of its horrifying banality.

Reiner (RCA AGL 1-2909) misses this point and is in general less concerned with the letter of the score (lazy trumpet rhythms in the first movement, a surprising side-drum flub at the beginning of the second) than its spirit—but how well he catches that! One of the rewards of making this survey was the belated discovery of Reiner's Bartók performances, which I had somehow managed to miss before; I only wish that RCA had provided this reissue with a filler and so made it even more of a bargain. Both Skrowaczewski's (Candide QCE 31100) and Mehta's (London CS 6949) versions, with the Minnesota and Israel Philharmonic Orchestras, respectively, are good value, the one with the *Dance Suite* as a filler, the other with the

HIGH FIDELITY'S Free Armchair Shopping Service

On the card opposite, circle the number indicated at the bottom of the ad or at the end of the editorial mention of the product you're interested in. (Key numbers for advertised products also appear in the Advertising Index.)

Type or print your name, address, and zip code on the card. Postage is prepaid.

Mail the card today. You'll soon receive free product literature and specifications from manufacturers.

MAIL ORDER BUYER'S SERVICE

Three Great Buyer's Guides From HIGH FIDELITY Order Now!



1981
HIGH
FIDELITY'S
Test
Reports
\$3.95
Circle
161

1981
Buying
Guide to
Stereo
Components
\$3.95
Circle
162

1981
Buying
Guide to
Speakers
\$1.95
Circle
165

To order, circle the number on the attached card that matches the number of the Buyer's Guide you want. Enclose payment plus \$1.00 for postage with your order and mail to:

HIGH FIDELITY
One Sound Avenue
Marion, Ohio 43302

(Enclose payment. No credit orders.)

MUSICAL AMERICA

THE JOURNAL OF CLASSICAL MUSIC

MAY 1981

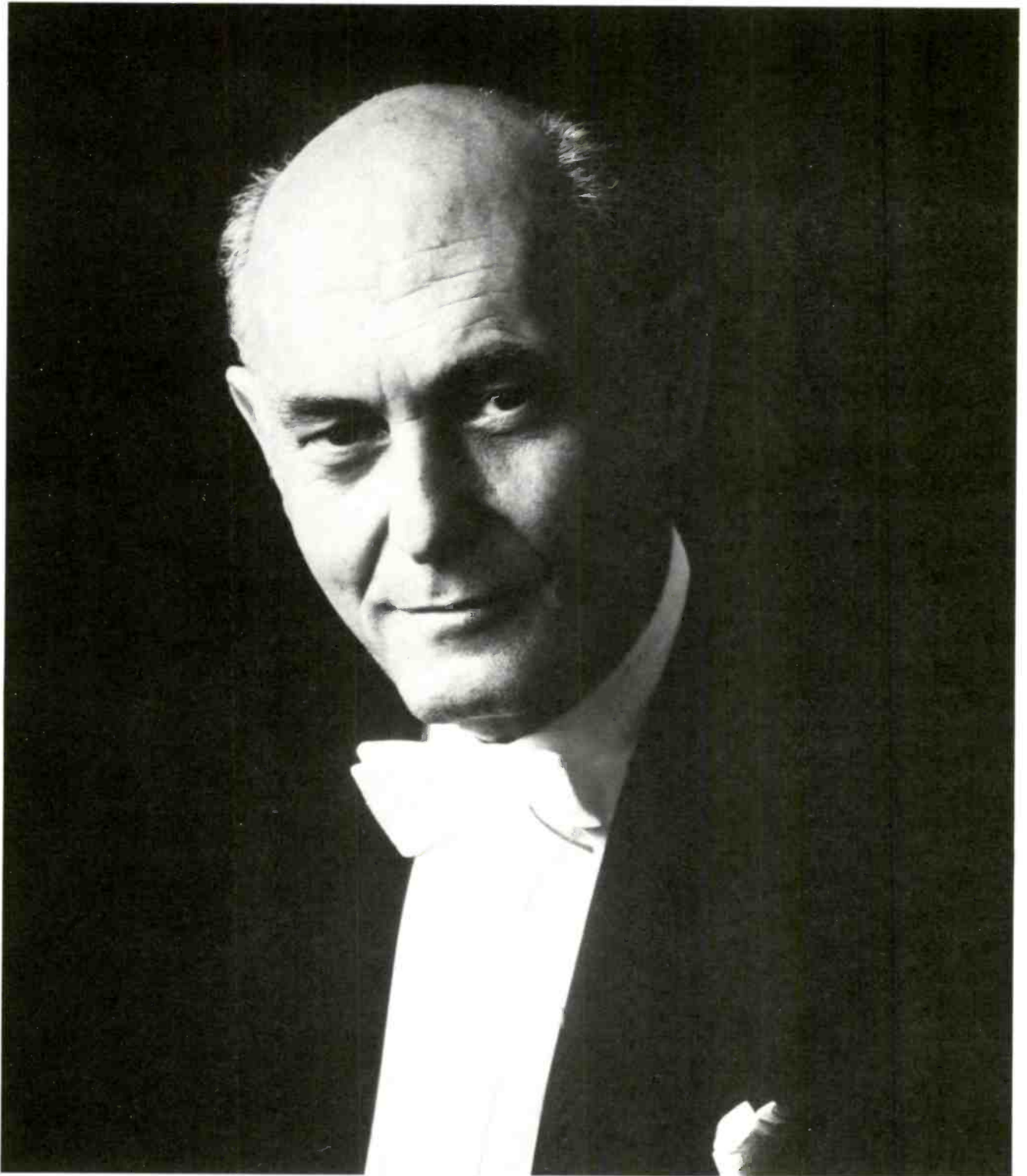

GEORG SOLTI

The Bell System is giving American orchestras a hand.

The Bell System American Orchestras on Tour program is taking 30 major symphony orchestras to over 240 cities across the United States.

It's our way of helping orchestras reach places and people they might not have reached before —not merely an extension of our business, but a part of it.

Simply put, communication is much more than phone calls. It's anything that can stir a person's heart.



Bell System





Shirley Fleming
Editor

Susan Galardi
Assistant Editor

George Dickey
Adv. Sales Manager

Susan Allyn
Circulation Manager

Leonard Levine
Publisher

Contributing editors:

Charles B. Fowler, education

Jack Hiemenz, television

Joan La Barbara, new music

Jacqueline Maskey, dance

Patrick J. Smith, book reviews

Dorle J. Soria, personalities

MUSICAL AMERICA

FEATURES

MAY 1981

- 6 Sir Georg Solti / Musician of the Month**
Phillip Huscher
- 22 Carnegie Hall is 90**
Dorle J. Soria
- 30 Metropolitan Opera**
- 39 Summer Festivals / Part II**

DEPARTMENTS

- 4 Letters**
- 10 The Dance**
Jacqueline Maskey
- 12 On Education**
Charles B. Fowler
- 16 New Music**
Joan La Barbara
- 32 Debuts & Reappearances**

HIGHLIGHTS OF MAY

- Thursday 7** Florida State University at Tallahassee opens a three-day Festival of New Music, featuring guest composers Karel Husa and Ellen Taaffe Zwillich.
- Friday 8** The Pittsburgh Symphony under André Previn performs the U.S. premiere of John Williams' Flute Concerto; Bernard Goldberg is the soloist.
- Saturday 9** Eugene Ormandy and the Philadelphia Orchestra give the premiere of David del Tredici's *All in the Golden Afternoon*—completing the composer's "Alice" opus.
- Sunday 10** The Saint Louis Symphony under Leonard Slatkin presents the U.S. premiere of Szymanowski's opera *King Roger*.
- Thursday 14** Morton Gould's *Burchfield Gallery*, commissioned by the Cleveland Orchestra, is given its premiere under the direction of Lorin Maazel.
- Saturday 16** Brooklyn College commemorates its 50th anniversary with a concert featuring the premiere of faculty-member Robert Starer's *Voices of Brooklyn*, for narrator, soloists, chorus, and symphonic band.

Advertising Sales Office, 825 Seventh Avenue, New York, N.Y. 10019, Telephone (212) 265-8360.

High Fidelity/Musical America (ISSN 0018-1463) is published at Great Barrington, Mass. 01230 by ABC Leisure Magazines, Inc., a subsidiary of American Broadcasting Companies, Inc. Copyright © 1980 Musical America edition published monthly. Yearly subscription in the USA and Possessions \$24; elsewhere \$29. Subscription including International Directory of the Performing Arts \$49 in USA and Possessions; elsewhere \$64. Subscriptions and change of address: write Musical America subscription department, 1 Sound Ave., Marion, O. 43302. Postal identification number 964300.

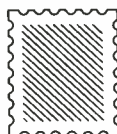

A rebuttal

I read the letter of Mr. William Kirkness in the September 1980 issue of *MUSICAL AMERICA* [concerning Zubin Mehta] and I was shocked by his style and expression! In all due respect, I reject with contempt this outrageous attack on a great man; I am confident that I speak for the majority of musicians and music lovers around the world. The senseless opinions expressed by Mr. Kirkness reveal a total ignorance of the music profession.

As a professional orchestra musician who throughout twenty-four years has worked with countless conductors—Monteaux, Bernstein, Metropolitan, Barbaroli, Krips, Solti, to mention only a few in the great list of Israel Philharmonic Orchestra music directors and guest conductors—I must say that everyone can be analyzed according to his musical approach, knowledge, musical imagination, and professional attitude. But one thing must be understood: Maestro Mehta is one of the few on my great list of artists of over two decades who succeeds in radiating his personality to the orchestra and kindling the public simultaneously.

The opinion of Mr. Kirkness of Zubin Mehta reveals a complete lack of understanding for conducting in particular and of music in general.

May I congratulate *MUSICAL AMERICA* on its choice of Musician of the Year 1980 and wish for Zubin Mehta many more honors—also from the State of Israel.

Zvi Litvak

Management Board
Israel Philharmonic Orchestra
Tel-Aviv, Israel

Union gripes

In his February Television column, Jack Hiemenz writes, "What really griped me about the union bozos . . ." The paragraph in which this sentence appears was a condemnation of the union strike. Mr. Hiemenz was perturbed that some TV operas had to be canceled and he could not see them. As an opera fan I too was disappointed that I could not see them and could not attend the Met.

What is very disturbing about the condemnation of the union is that Mr. Hiemenz clearly holds the union responsible for the labor dispute. He does not, at least, hold the Met management responsible for the strike, he does not refer to the Met management as bozos. I suggest that if he is to place blame on anybody, he substantiate his case. The *New York Times* published a long article on the strike after it was over. The Met management did not come off very clean, and in many ways was responsible for the strike. I suggest Mr. Hiemenz read it. I think he is the bozo for his anti-union prejudices.

Anthony Ficco
New York, NY

Milwaukee choice

Congratulations to Lukas Foss first on gaining the conductorship of a wonderful orchestra in Milwaukee, and for being named your Musician of the Month for January.

For shame, however, on the trustees of the Milwaukee Symphony for passing up their resident conductor, James Paul, for the position. Foss, a composer more than conductor, will split his time. Paul could have

given one hundred percent.

William Allin Storrer
Columbia, SC

Beethoven quote

In the December 1980 issue, page 22, there was a review of my "String Quartet and Tape" by Frank Merkling. In his review he says, "His quartet was patched in one place with common practice harmony . . ." That short section of my quartet was not "common practice harmony," and it was not patched. It is an exact quote, carefully prepared and labeled in the score, of the Beethoven String Quartet No. 15, Opus 132 in A minor. By not recognizing such an illustrious Beethoven Quartet your magazine has misrepresented my work.

In all fairness I think you owe me a printed explanation that this Beethoven quote was misunderstood by the reviewer.

Elias Tanenbaum
New Rochelle, NY

Frank Merkling replies:

It seems to me Mr. Tanenbaum protests too much.

The verb "patch" is not necessarily pejorative. One definition I find in my dictionary is "to provide with a piece of cloth sewn on as an ornament or insignia," which comes close to what I intended in my article. Nor is it any denigration of Beethoven to refer to his harmony—even in the late quartets—as "common practice." This itself is universal practice.

I enjoyed Mr. Tanenbaum's music, as did everybody else, and I reserved the climax of my article for it. If I chose not to specify the source of his quote, perhaps it was to avoid making him sound like a mere imitator of George Rochberg.

ON THE USE OF ORIGINAL INSTRUMENTS & OTHER EXPECTATIONS: THE BIRTH OF A RECORD COMPANY NAMED PRO-ARTE.

“If a musician is convincing, what he offers will leave an authentic impression. But if he strives to be authentic, his performance will never be convincing.” GUSTAV LEONHARDT

PRO-ARTE is a new American Record Company. What it plans to offer is authentic: a major classical catalogue – the first in more than a quarter of a century – which will stress unusual repertoire and first rate performances on high quality pressings.

PRO-ARTE

The
Unexpected,
The
Unusual,
The
Unexplored.

VIVALDI Six Flute Concerti, Op. 10 Frans Brueggen Orchestra of the 18th Century	J. S. BACH Brandenburg Concerti, Nos. 1-6 Gustav Leonhardt, Cond.	DIGITAL Works for Trumpet & Organ Basch/Fubsam German Bach Soloists
DIGITAL Virtuosi Trumpet Concerti of the Baroque German Bach Soloists Basch, Trumpet	DIGITAL Tchaikovsky: Symphony No. 5 Gary Bertini, Cond. Bamberg Symphony	DIGITAL Digital Spectaculars Yuri Ahronovitch, Cond. Vienna Symphony

Here are some recordings to look for:

Frans Brueggen's new *Orchestra of the 18th Century*:

- Brueggen conducts & performs Vivaldi's "Six Flute Concerti, Op. 10" (on original instruments)

Gustav Leonhardt's definitive recordings of:

- Bach: "The Art of the Fugue"; "The Musical Offering"; "The Six Brandenburg Concerti"; Two Suites for Harpischord/Chromatic Fantasy"

State of the Art digital recordings that are musical joys, not excuses to raise prices:

- "Works for Trumpet & Organ" – Basch/Rubsam German Bach Soloists
- "Virtuoso Trumpet Concerti of the Baroque" – Basch/German Bach Soloists
- Gary Bertini, newly appointed director of the Detroit Symphony, leads a stunning performance of Tchaikovsky's Fifth, with the Bamberg Symphony; "Digital Spectaculars" with the Vienna Symphony.

PRO-ARTE: A record company for the arts.

Available at record stores throughout the United States



Give the gift
of music.

Sir Georg Solti

The Chicago Symphony,
at 90, celebrates the
glories of his era

Phillip Huscher

*"When I first came I said this
was a provincial orchestra. . . .
Now no matter where you go
everybody is talking about the
Chicago Symphony"*

This, the Chicago Symphony Orchestra's ninetieth anniversary season, has been a celebration of the glories of the Solti era, and with good reason. Since Sir Georg Solti came to Chicago in 1969 the CSO has risen to a fame unrivaled even during the brilliant Reiner years. The Solti-CSO "marriage"—to use Sir Georg's metaphor—is still going strong, and in January the Hungarian-born music director renewed his contract through the 1984-85 season. This month Sir Georg rounds out his twelfth season with two Carnegie Hall performances of Berlioz's *Damnation du Faust*, and more concerts, recording sessions, and a masterclass awaiting him back in Chicago. Last January I visited with Solti in the Drake Hotel suite where he, his wife Valerie, and their two daughters Claudi and Gabrielle make themselves at home in Chicago for a few weeks each year.

"You know, I was very misunderstood by somebody locally," Solti remembers, "because when I first came to Chicago I said this was a provincial orchestra. This was a *wonderful* orchestra, but it was not *known*—that's what I meant. Now no matter where you go—Europe, Japan—everybody is talking about the Chicago Symphony. That's the sort of reputation we have now, and this pleases me enormously, because that wasn't there twelve years ago."

Solti did put Chicago in the international spotlight, but he also likes to think he has made this a better orchestra. With evident pride, he mentions a recent conversation with Eugene Ormandy, who had just conducted the CSO for the first time in a decade. "So," Solti says with a smile, "I asked him 'How did you like our orchestra?' And he said 'What a question! What you did is a miracle—this orchestra is an absolute miracle.'"

Despite all the acclaim the last twelve years have brought, the man now universally called Sir Georg still wrestles with a reputation formed long before his Chicago days. "People like to make one a cliché, and mine is that I'm a *dramatic* conductor, and that's the cliché that goes on with me. But it doesn't suit me anymore today—I am a *different* person. When I was a younger conductor my major talent was a dramatic talent, an operatic talent, and many people today don't want to see that that's changed *very* much. I am developing much more of a lyrical talent—which is also part of my nature—and I am getting much more interested now in details."

Much of this reputation is, of course, based on the historic London *Ring* cycle which Solti recorded in the late Fifties and early Sixties when, as he admits today, he was "too young as a Wagner conductor," and before he had ever performed *Siegfried* or *Götterdämmerung* in the opera house. Ironically, the most famous *Ring* conductor of our day has had little luck with staged productions of the cycle since. His last attempt, in Paris, was "a total fiasco in visual terms," and Solti bowed out after conducting *Rheingold* and *Walküre* in 1976. "I hated every minute of it, and after that I wanted to do only concert versions." Now, finally, Sir Georg hopes to get the *Ring* of his dreams. In the summer of 1983, the centenary of Wagner's death, Solti will conduct the new *Ring* at Bayreuth, and return the following two summers to repeat the entire cycle. This will mark Solti's first appearance at Bayreuth, and he does not disguise his delight: "This is practically a childhood wish of mine, to conduct in this place which is Mecca to Wagner lovers." The only question was to find

"To play the Bösendorfer is a labor of love."

Victor Borge, Musician

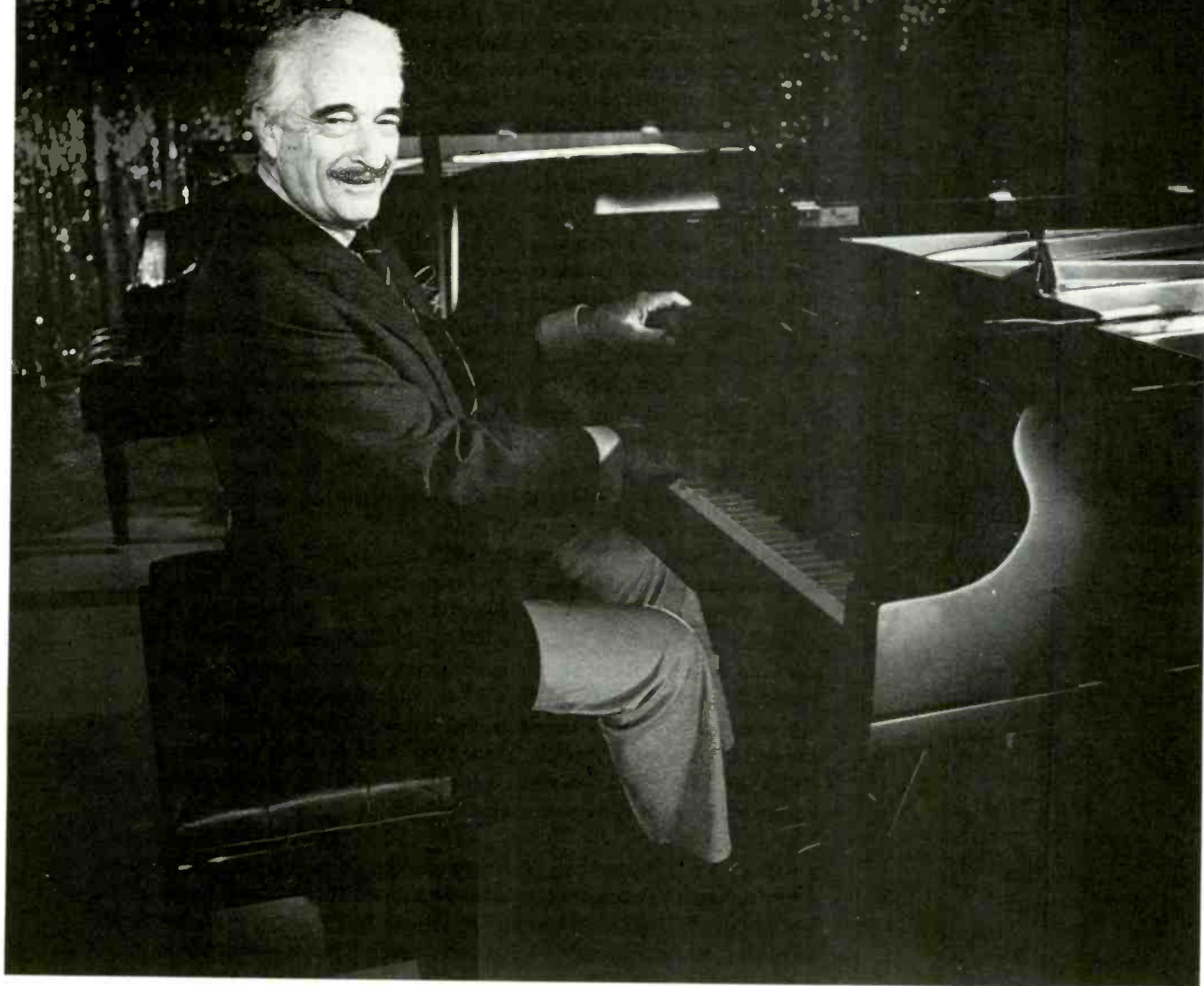

For over a century and a half musical giants like Liszt, Wagner, Brahms and Strauss applauded the incomparable Bösendorfer. Today musical giants like Victor Borge still do. Because Bösendorfer is still the only totally handcrafted piano built anywhere.

In their quest for excellence, Bösendorfer's piano masters spare neither time nor expense. Every piece of wood used in the Bösendorfer is seasoned outdoors from three to four years. Each

mechanism takes more than a year to complete. Every bushing incorporates noiseless felt.

The result is a genuine masterpiece. Worthy of the world's most magnificent concert halls, and of the world's greatest pianists. Like Victor Borge. And perhaps like you. If you'd like to learn more about the Bösendorfer contact Sally J. Silberman, Kimball, 1549 Royal Street, Jasper, Indiana 47546.

Bösendorfer
PIANOS
of Vienna

The piano that sets the standard of the world.

A Division of Kimball International, Inc.
1549 Royal St. Jasper, IN 47546 812/482-1600



Solti: there's a *Ring* in his future

a director who shares Solti's conception of the *Ring*. Sir Georg is highly optimistic about the choice of Peter Hall, who worked with the conductor before at Covent Garden, and now, of course, has a huge success in Peter Shaffer's play *Amadeus*. Decca/London is considering a live recording of the Bayreuth *Ring*, and this too pleases Solti, because he no longer identifies with the earlier effort that catapulted him to fame.

In this country, Solti's operatic appearances have become a thing of the past. Aside from occasional concert versions in Chicago, he has done nothing here since *Figaro* and *Otello* with the Paris Opéra during its 1976 visit. Solti once remarked that, in his blood, he was really an opera conductor, a man of the theater. But today, even with the projected Bayreuth *Ring*, he has to admit that "this distinction—how shall I say it—the blood test is getting a little bit different, because now I do so much symphony and so little opera." Solti turns pensive, suddenly: "I think if I had to do only one," and here he pauses, genuinely puzzled—"I would be *sad*."

Solti, of course, isn't making a choice, although to accommodate the new *Ring* he will limit himself exclusively to Bayreuth and Chicago, leaving the London Philharmonic when his contract expires in 1982. He will return once again to Covent Garden in 1984 to do a new *Rosenkavalier*, twenty-five years after he first appeared there, conducting the same opera. "So this will be a sort of nostalgic journey home."

Solti, who took another trip home in 1978, when he returned to Budapest for the first time in thirty-nine years, knows how memory can play tricks. A few years ago, someone gave him a tape of the legendary 1937 Toscanini *Zauberflöte*, in which the young Solti played Papageno's glockenspiel. Solti listened, in shock: "In my memory it was the most beautiful, the most magical *Magic Flute*—and unfortunately it isn't. I imagined it gentle and rather slow-paced, and of course it is so tremendously fast. So I always laugh when people say 'I heard Mr. X twenty-five years ago and he did it that way.' Nobody knows that. Everybody is changing constantly, and when you are not changing, you are—*dead*."

In August and September, Sir Georg and the Chicago Symphony make a fourth European tour. "Now we have a very difficult tour because we are fighting our '78 legend. When we first arrived in 1971 it was easy; we took them by surprise. Then, in '74, the underlining tenor was neutral—as if everyone said 'That's alright, but they're still not the Berlin Philharmonic, not the Vienna Philharmonic.' And then came the '78 tour, when suddenly we are on *that* level. They're still talking about us, and that is a sign for you that it was very successful. But this is very difficult to repeat; I know this will be our most difficult tour."

Solti has always been sensitive to the musical public, both here and abroad. "There are certain audiences in America which are tremendously good and there are very bad ones. In Europe you won't find the *very* bad ones but, you see, one shouldn't make unfair comparisons. Here we have a giant subscription system, but when we go to Europe there's no subscription: everyone buys his or her ticket and wants to come to this single concert. The psychology of subscription is *so* different. If you have a subscription you

Continued on page 43

UNIVERSITY OF SOUTHERN CALIFORNIA SCHOOL OF MUSIC SUMMER SESSION '81

SPECIAL PROGRAMS

- PIATIGORSKY SEMINAR FOR CELLISTS**, June 13 to June 20, with Raya Garbousova, Lynn Harrell, Mischa Maisky and William Pleeth
- PIANISM: THE ARTIST AND THE INSTRUMENT**, A Symposium, July 12 to July 24, at Strawberry Hill, Richmond-upon-Thames, Twickenham, England, with James Bonn, Richard Burnett, Carola Grindea, Sidney Harrison, G. Maurice Hinson, John Perry, Daniel Pollack, Marianne Uszler and Fanny Waterman
- SPECIAL STUDIES IN THE MUSIC OF THE 19TH CENTURY: WAGNER'S RING CYCLE**, July 20 to August 1. Lectures on the life and work of Richard Wagner and attendance in Seattle at the Seattle Opera Company's production of the Ring Cycle, with William Robinson
- ORFF SCHULWERK, LEVELS I, II & III**, June 29 to July 10, with Jos Wuytack, Mi-lie Burnett, Susan Cambique, Mary Ann Cummins and Mary Shamrock
- SPECIAL EDUCATION and MAINSTREAMING**, June 22 to June 26, with Claus Bang
(With the exception of the Piatigorsky Seminar, all of the above Programs are offered in cooperation with the University of Southern California College of Continuing Education)

SIX FULL WEEKS - JUNE 22 to AUGUST 1 -
OF STUDIES IN

- CHURCH and CHORAL MUSIC**: Choral Development, Choral Literature, The Practice of Church Music, and Choral Conducting, with James Vali, Sally Etcheto and Tom Somerville
- CONDUCTING**: Instrumental Conducting, with Hans Beer and William Schaefer
- MUSIC EDUCATION**: Literature for Choirs, Grades 7 through 12, and Introduction to Research in Music Education, with William Triplett
- MUSIC HISTORY and LITERATURE**: Music History Review, Music of the Renaissance, Music of the Baroque Era, Music of the 20th Century: Music since 1945, seminars in Performance Practice, Musicology and Music History, with Gilbert Bount, Bryan Sims, and Richard Wingell
- VOCAL ARTS**: Class Voice, with Sally Etcheto
- ELECTRONIC MUSIC and RECORDING ARTS**: Electronic Synthesizer Techniques and Recording Arts Workshop, with Ted Arcona, William Biersach and Richard McIlvrey
- JAZZ**: Techniques of Jazz Improvisation and Jazz, Ragtime and Blues, with Thom Mason
- MUSIC THEORY and COMPOSITION**: Theory Review, Aural Skills: Elementary Orchestration and Tonal Counterpoint, with Robert Moore, Marty O'Donnell and Leroy Southers
- BEGINNING GUITAR**: With Richard McIlvrey
- BEGINNING PIANO**: With Marcia Cook-Wozniak
- PRIVATE INSTRUMENTAL and VOCAL INSTRUCTION**

For full information, write Stan Young, Assistant Director, School of Music,
University of Southern California, Los Angeles, CA or call (213) 743-6935

USC MUSIC

Clevelanders Come to Brooklyn

At New York City Ballet, Martins choreographs Stravinsky

•Jacqueline Maskey



The Cleveland Ballet is the third company—after the San Francisco and Los Angeles Ballets—to appear in the Brooklyn Academy of Music's Ballet America series (January 20-25) and the most up-front about its reasons for its first out-of-state tour. This is an ambitious bunch which clearly is not content to be a big fish in a small pond. Swimming in a big pond means national rather than exclusively regional exposure, and towards that end the Cleveland Ballet's board in an overwhelming gesture of support guaranteed \$250,000 to underwrite the BAM visit and a three-city Florida tour.

John Clifford's Los Angeles company looked as if it could have fit everything into a footlocker and, for all I know, the dancers may have even pressed their own costumes, but the Clevelanders traveled in style: costumes, sets (including a 650-lb. rainbow), special lighting equipment for the Florida part of the tour, and that nearly extinct animal, an orchestra (the Ohio Chamber Orchestra led by Stanley Sussman and Dwight Oltman). The company's directors, Dennis Nahat and Ian Horvath, prominent performers with American Ballet Theatre a few years back, have done a terrific selling job at home; but the quality of the product they're pushing is less impressive than one might have hoped.

The image of Nahat

The Cleveland Ballet seems cast largely in the image of Dennis Nahat, who choreographed most of the ballets seen in New York, with the exception of Kurt Jooss's *The Green Table* (given a surprisingly forceless presentation). Billed as associate di-



Bruce Falco in "Celebrations"

Michael Edwards



Darci Kistler: joie de danse

Steven Carras

rector beneath Horvath's artistic directorship, Nahat dominated the two programs as choreographer and principal male dancer. Horvath, due to illness, made no appearances and his impact on the company is thus more difficult to assess. Nahat, however, is remembered for his distinct qualities as a performer: an ease and facility in the classical repertoire, a pronounced gift for *demi-caractère* work which, when unchecked, became distinctly campy. In his first work for ABT, *Brahms Quintet*, he made no secret of a fondness for a swooning sort of lyric dance, and it is this vein that he continues to work in Cleveland, with such ballets as *Quicksilver* (Mendelssohn's Piano Concerto No. 1) and *Celebrations* (Beethoven's Symphony No. 7). Unfortunately both these pieces are verbose examples of ballet-making—the opening section of *Quicksilver* was crammed with so many steps that I feared there would

be none left for the rest of the evening. Nahat's ballets have, at first glance, a full-fledged look which is initially pleasing; unfortunately, they are deficient in the requisite structure of bone which ensures both shape and longevity.

The chief surprise of the program was Nahat's honest attempt to overcome his own limiting predilections by attempting more variety in subject matter as in *Things Our Fathers Loved*, a series of back-looking vignettes set to some Charles Ives songs, and in *U.S.* However, given Nahat's proven talents in outrageous parody I rather expected something more flavorful in the latter's parade of American dance styles spanning the eras from decorous to disco. Perhaps this was Horvath's too-restraining influence; he was, with Nahat, listed as choreographer.

The company of thirty-eight is a very pleasant-looking one—hand-

some youngsters groomed to the nines, with enough variety in physiques to avoid the cookie-cutter look, although their creamy way of moving is sometimes achieved through technical shortcuts. Aside from Nahat himself, however, the only performer of real presence is Nanette Glushak who may, with the Cleveland company, develop the dramatic potential she seemed to promise but did not fully produce during her ABT days.

Martins at NYCB

It is a mark of *premier danseur* Peter Martins' status in the New York City Ballet—he is spoken of as heir to the company directorship when Balanchine ceases to be—that Lincoln Kirstein now writes his program notes. Except for dead masters like Fokine, I can't recall Kirstein performing this chore for anyone other than Balanchine. In this case the notes, aside from their historical interest and information, were gratuitous; there was little need to be told that Martins in this piece eschewed "... linkages of word, music and pantomime ..." in favor of "... chains of steps ... governed by the intrinsic metric and spirit of the musical notation." The curtain went up on a chaste and economical setting—four off-white "legs" stage left and right, Stravinsky's spikey and flavorful score rose from the pit, and a couple of kids gamboled on, followed in one's and two's by a number of other kids. Playfulness rather than ponderousness was thus announced right off, smoothly followed by some pretty supported adagio for Darci Kistler and Ib Andersen, fleet aerial work for Jean-Pierre Frohlich and Kyra Nichols, and a good-natured tango for Heather Watts and a male trio comprised of Victor Castellini, Bart Cook, and Daniel Duell.

Had not *Parade* been opted already for the Massine-Satie ballet, it would have been an apt title for this one instead of the cumbersome *Suite from Histoire du Soldat*. The marching
Continued on page 21

Virtuotissimo: Study With The Best

BROOKLYN COLLEGE *Department of Music*

FACULTY

PIANO: Agustin Anievas, John Challener, Paul Jacobs, Michael Rogers **HARPSICHORD:** Paul Jacobs, Stoddard Lincoln **ORGAN:** Károly Köpe **STRINGS:** Albert Blain, *guitar* • Leonard Davis, *viola* • Marion Feldman, *cello* • Jules Hirsh, *bass viol* • Burton Kaplan, *violin* • Lewis Kaplan, *violin* • Stephen Kates, *cello* • Masao Kawasaki, *violin* • Julius Levine, *bass viol* • Edna Michell, *violin* • Itzhak Perlman, *violin* • Ora Shiran, *violin* • Michael Smith, *guitar* **HARP:** Bernice Horowitz **VOICE:** Jean Hakes, Sidney Johnson, Brian McGovern, Eleanor Steber **WOODWINDS:** Vincent Abato, *clarinets, saxophone* • Joseph Allard, *clarinet, saxophones* • Leonard Hindell, *bassoon* • Harold Jones, *flute* • Karl Kraber, *flute* • Charles Kuskin, *oboe* • Eleanor Lawrence, *flute* • Bert Lucarelli, *oboe* • Leon Russianoff, *clarinet* • Paul Shelden, *clarinet* • Jane Taylor, *bassoon* • Stephen Taylor, *oboe* • Eugenia Zukerman, *flute* **BRASS:** John Aley*, *trumpet* • Jerome Ashby, *French horn* • Robert Biddlecome*, *trombone* • Ronald Borrer*, *trombone* • David Braynard, *tuba* • Jerry Kuhl, *trombone and baritone* • Raymond Mase*, *trumpet* • David Wakefield*, *French horn* **TIMPANI AND PERCUSSION:** Morris Lang **ORCHESTRA AND SYMPHONIC BAND:** Dorothy Klotzman **CHORUS:** Harry Saltzman **OPERA THEATER:** Sidney Johnson **PERCUSSION ENSEMBLE:** Morris Lang **CONTEMPORARY MUSIC ENSEMBLE:** Joel Sachs **COMPOSITION:** William Boswell, Noah Creshevsky, Charles Dodge, Dorothy Klotzman, Robert Starer **THEORY AND ANALYSIS:** William Boswell, Noah Creshevsky, Charles Dodge, Walter Gerboth, Nancy Hager, Dorothy Klotzman, Károly Köpe, Sherman Van Solkema **MUSICOLOGY:** Allan Atlas, Walter Gerboth, Nancy Hager, H. Wiley Hitchcock, Siegmund Levarie, Stoddard Lincoln, Joel Sachs, Judith Tick, Sherman Van Solkema **MUSIC EDUCATION:** Lucille Goodman, Ernest McClain, Emile H. Serpos **CENTER FOR COMPUTER MUSIC:** Charles Dodge, Director • Paul Grassie **INSTITUTE FOR STUDIES IN AMERICAN MUSIC:** H. Wiley Hitchcock, Director • Rita H. Mead, Research Associate **MUSIC LIBRARY:** Diette Baily

*Member, American Brass Quintet in residence at Brooklyn College

B.A., B.S., M.A. Degree Programs

For further information contact:

Professor Dorothy Klotzman, Chairman
Department of Music, Brooklyn College
Brooklyn, N.Y. 11210 • (212) 780-5286

The Met Says: "Let's Make An Opera"

Student productions explore life as well as art

Charles B. Fowler



A scene from "Sibling Rivalry": meeting the challenges of creativity



PR directors at work



The time, 7:30 p.m. The place, the auditorium of P.S. 183 in Manhattan. The event, a performance of *In the Balance We're Just Small People*, an original musical theater piece written and produced by fourth, fifth, and sixth grade students. The stage manager gives the cue and thirteen performers dash on stage singing, "Give Me a Break." This launches a dialogue between two "kids," one who follows the rules and one who breaks them, that climaxes in the song, "Bein' Good Means Not Bein' Bad."

The next scene explores the rivalry of a sister and her little brother. They sing:

"Me and my sister are very good friends.

But when it comes to certain things, well then it depends . . ."

Later, the young actors and singers give their own view of divorce, with one child explaining how he's a three-

time loser: "First, my mother and father (or A and B) got divorced. Then they married other people (C and D). My mother (A) got custody of me. But my father (B) got my brother. Now, my mother (A) and my step-father (C) had two kids, little brother (a) and little sister (b). My father (B) and his new wife (D) had two kids, little (c) and (d). Now then, finally. Whew. My mother (A) and step-father (C) got divorced. Couldn't stand each other. And my step-father (C) got married to my step-step-mother (E) and they had little (e) my step-step-sister. So there it is, My Family—the Alphabet!"

Then one of the youngsters sings:

"Divorce is a crummy, rotten thing.

When your mom takes off her wedding ring.

Everything feels gloomy and sad.

I hate divorce where ev'ryone's

mad . . ."

In the finale, the cast joins in singing their thoughts about adults:

"They're not really bad; we're partly to blame.

Generations from now; we'll be the same."

Obviously, this is no ordinary musical production. And "The Great, Terrific, Wonderful, Super, Fantastic Company," as the students named it, is obviously no ordinary company, either. For their first original production, these students invented their own dialogue, lyrics, music, acting, singing, lighting, costumes, and scenery—all the accouterments of the musical stage—to express their own experiences and to communicate their own viewpoint. By becoming personally involved, they learned something about the dynamics of the combined art forms of theater and music. They experienced the challenges of creative self-expression and its satisfactions. And, perhaps, they

came closer to understanding and appreciating the underlying substance of opera.

Education via the Met

The students performed their "opera" for fellow students, for their parents, and then took it on tour to other schools. These performances brought to a culmination a special five-week program sponsored by the Metropolitan Opera Association. Developed by the Education Department of the Metropolitan Opera Guild, this In-School Project represents a new approach to bringing the world of the musical stage into education. JoAnn Menache, director of education for the Guild, along with her associate, Bruce Taylor, a professional opera production/stage manager, go into the schools and work directly with the students and teachers.

In each school where the project is replicated, the results are refreshingly different. Another school formed the "Don't Think We're Corny Company" and produced a comedy based on Aesop's fables.

Menache and Taylor get students to create an original musical by setting up the same structure that professionals use. Under their guidance, a "company" is formed consisting of writers, performers, and a production staff, the last comprising a production manager, stage manager, assistant stage manager, set, costume, and make-up designers, electricians, carpenters, and public relations directors. The students determine the subject of the show, write the script and song lyrics, design and build the sets, lights, and costumes, execute publicity, and rehearse and manage

J. J. JOHANNESSEN
Founder / Director

10th ANNIVERSARY



FORMERLY NAMED SHAWNIGAN SUMMER SCHOOL OF THE ARTS

Financially assisted by the Federal Government of Canada and the
Provincial Government of British Columbia, Foundations and Corporations

JULY 14 to AUGUST 25 INTERNATIONAL SUMMER SCHOOL AND OPERA CENTRE

Highly specialized program of strings, keyboard instruments, winds, voice and composition. Enrollment limited to 200 students per session, 16 years of age minimum. All programs designed for advanced students only, professionals wishing to advance their careers, and teachers enrolling as participants or auditors.

- DAILY MASTER CLASSES AND SOME PRIVATE SESSIONS
- DAILY CHAMBER MUSIC PROGRAMS WITH INTERACTION BETWEEN STUDENTS AND FACULTY
- OVER 30 CONCERTS FEATURED IN THE SIX-WEEK PROGRAM

FACULTY WILL INCLUDE:

Violin

DANIEL HEIFETZ
VACLAV HUDECK
DANA POMERANTS-MAZURKEVICH
YURI MAZURKEVICH

Viola

EBERHARD KLEMMSTEIN
WILLIAM PRIMROSE
GERALD STANICK

Cello

HARVEY SHAPIRO
PHILIPPE MULLER
TSUYOSHI TSUTSUMI

Chamber Music

DUO MAZUREKEVICH
PACIFIC WIND QUINTET
QUARTET CANADA
THE NEW BUDAPEST QUARTET

Double Bass

JAMES VANDERMARK

Flute

SAMUEL BARON
KATHRYN CERNAUSKAS

Oboe

BERT LUCARELLI

Clarinet

MICHAEL WEBSTER

Keyboard

MICHELL ANDREWS, piano
RUTH LAREDO, piano
ROBIN McCABE, piano
JOHN OGDON, piano
BELA SIKI, piano
RONALD TURINI, piano

Opera Centre

(Producer of CANADA OPERA PICCOLA
—A Touring Company)
PIERRETTE ALARIE, Artistic and
State Director
LEOPOLD SIMONEAU, Master Classes

Enquire now for 1981 faculty list and application forms . . .

REGISTRAR,
JOHANNESSEN INTERNATIONAL SCHOOL OF THE ARTS
3737 OAK STREET, VANCOUVER, B.C.
CANADA V6H 2M4

TELEPHONE: (604) 736-1611

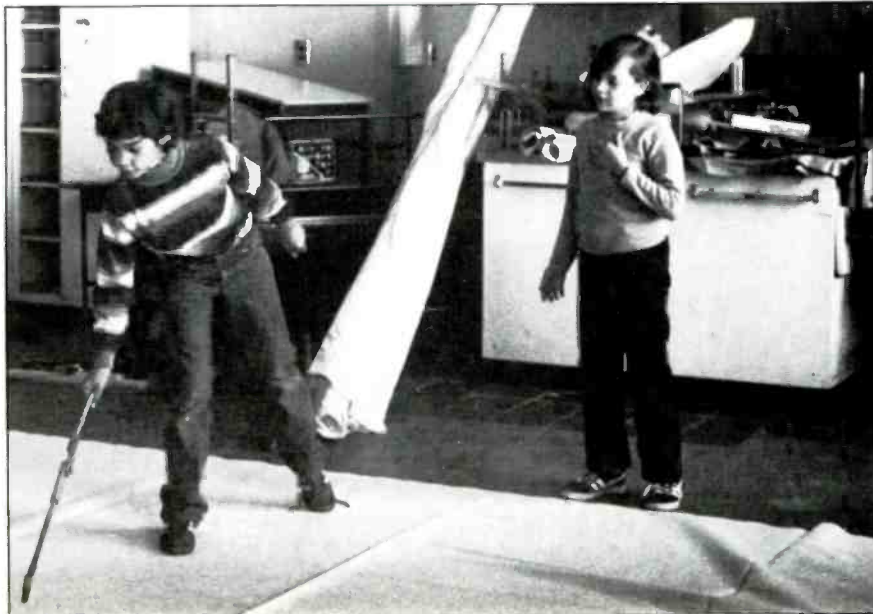

Carpenter and set designer: career education at its best



Lighting designer and electrician: children "apply" for jobs

the production

The music for the production at P.S. 183—the overture, songs, and interludes—was composed by Frank Oteri, a senior in New York's High School of Music and Art. Oteri served as the production accompanist as well. Every aspect of the production

is implemented by the students themselves with the advisers providing only the procedures and guidelines.

Understanding the process

Menache and Taylor meet with the parents before the project begins to inform them about objec-

tives and procedures. They work with the school administrators to coordinate schedules. And they meet with all the teachers in the school, giving them an hour-and-a-half workshop each week that provides information about opera as an art form, and a detailed understanding of the score-to-stage process that the students are going through. The project is a learning experience all the way around.

Job descriptions and responsibilities are carefully explained to all the students and posted before auditions. In the screening process, students "apply" for a position and are asked what they think the position entails and why they want it. Children interested in building sets, for example, are asked, "Why do you like to build things? What have you built before?" In this way the students become familiar with the various jobs associated with the stage and the necessity for collaboration and coordination—career education at its best.

But Menache takes a very realistic view: "Participation does not mean that children will automatically 'love' opera or wish to become professionals in the field. It will, however, enable them to make informed choices about careers and personal tastes in the arts."

Doing something big

Students who participated held their own lecture-demonstration on the project before about 250 classroom teachers and music specialists who were participating in an in-service course at Lincoln Center. One of the teachers asked Rollyn if she wanted to be a writer now that she had served as one. Her reply: "No, not really. But I am kind of interested more in poetry, and I also read more stories now because I know what the writer did to make them up."

Alexander, one of the electricians, was asked why he liked the project. "Everybody said I was shy

before," he said, "and in this project, well, I couldn't be shy. I had to work with the company."

But perhaps April, the public relations director, got to the real heart of the matter. She said she felt that the purpose of the project was "to show people that us kids can do something big and that we are responsible."

The In-School Project is just one thrust of the Metropolitan's revitalized educational program. Each year the Guild produces two "Opera Boxes"—multi-media educational tools designed to help classroom teachers bring the excitement of various operas to their students. This year's boxes are on *Carmen* and *La Traviata*, and schools are invited to subscribe to the series.

"In the past," Menache says, "our education programs have focused on teachers and students and have used live performances and other activities at the Opera House as vehicles for the development of opera appreciation in young people." But she recognizes that such education programs "should not be limited to the young or to people in the New York area who happen to have easy access to the Met."

Accordingly, the Guild has expanded their educational programs in two ways: first, by enhancing existing school programs to reach more students and teachers more effectively; and second, by developing new programs that provide continuing education for adults, address the needs of special constituency groups such as the handicapped, and involve families in the arts education of their children.

Anthony Bliss, general manager of the Metropolitan Opera, acknowledges the importance of these educational efforts: "Naturally, we are concerned with building audiences to assure our future, but the reason for having an opera education

program is much deeper. As a major form of human expression, opera is an important part of our culture. All people should have access to understanding and enjoying this medium of communication as part of their education as maturing members of

this society. We want to do our part to assure that accessibility."

For further information about these programs, write the Education Department, Metropolitan Opera Guild, 1865 Broadway, New York, New York 10023. **MA**

Stockhausen SCORES

can now be ordered directly from the Stockhausen-Verlag
by MAIL ORDER

Prepay with personal check or money order, made out to:

Stockhausen-Verlag
(Music publishing co.)
2832 Maple Lane
Fairfax, Virginia 22031

POLE for 2 and EXPO for 3 players/singers in one volume	\$14.00
MANTRA for 2 pianists (printed on one side for performances)	\$35.00
MANTRA (printed on both sides)	\$25.00
FOR TIMES TO COME 17 texts for intuitive music (small ensembles)	\$16.00
STERNKLANG (Star Sound) Park music for 5 groups (21 performers)	\$38.50
TRANS for orchestra	\$52.00
"In the sky I am walking . . ." (12 American Indian songs for 2 singers)	\$31.00
YLEM for 19 players/singers	\$21.00
"Lecture on HU" musical analysis of INORI with 224 photographs (for 1 performer) in one volume with the Prayer Part (for 1 or 2 dancers/mimes)	\$52.00
"Breathing gives life . . ." Choir-Opera with orchestra or tape	\$41.00
HERBSTMUSIK (Autumn music) for 4 players	\$38.50
MUSIK IM BAUCH (Music in the Belly) for 6 percussionists and 3 music boxes.	\$46.00
TIERKREIS (Zodiac) for a melody and/or keyboard instrument	\$14.00
for high soprano or high tenor	\$21.00
for soprano or tenor	\$21.00
for mezzo soprano or alto or low tenor	\$21.00
for baritone	\$21.00
for bass	\$21.00
for chamber orchestra	\$18.00
HARLEKIN (Harlequin) for clarinet	\$36.00
THE LITTLE HARLEQUIN for clarinet	\$19.50
AMOUR 5 pieces for clarinet	\$14.00
IN FRIENDSHIP for clarinet	\$10.00
for flute	\$10.00
for oboe	\$10.00

Prices include postage and handling.

The complete list of Stockhausen's works and records is available free of charge, upon request.

Multi-media: the Fusion Is Fragile

"Thoughts in Stone" is a union that works

Joan La Barbara

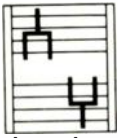

In searching for a wide range of musical experiences, one often finds oneself in locations other than the concert hall and enjoying a variety of additional media, often mixing visual with aural. Collaboration and cooperation are fragile fusions but when they work, the amplification of experience makes the effort well worth the struggle for both audience and artists.

"Thoughts in Stone"

At the Japanese American Cultural Center in downtown Los Angeles I attended the opening of "Thoughts in Stone," a collaboration of visual and sound sculpture. This was not sculpture which made sound or sound which tried to sculpt the aural space but separate visual and audio elements by individuals whose work perfectly complemented each other.

Pieces by two sculptors working with stone as the focal element was presented with Carl Stone's sound environment. (Stone's name was merely a curious coincidence.) Kunishima placed stones in other stones, framing them three dimensionally, setting them as special objects. Naraha's intricate, one-stone sculptures give the impression that two stones are juxtaposed, like puzzles. The visual works were elegant, as were the gentle sounds of Stone's tape music.

There was an unobtrusive yet very present quality to the music, as long tones, some created by blowing air through pipes or tubes of different lengths and materials, floated over a mild, pulsing bass produced by a plucked string, recorded and rerecorded to effect timbral shifts. Though the feeling was continuous, there were subtle changes in the ac-

tivity, just enough to draw one's attention from the visual to the aural and then feel it directed back again. The music focused the mind and the sculpture attracted the eye and spirit.

Oskar Schlemmer costumes

As part of the city of Berlin's continuing birthday gift to its sister city, Los Angeles, the fantastic costumes created by Oskar Schlemmer were presented in two different performances with separate musical settings. Only the costumes had a legitimate claim to authenticity; the dances, with one or two exceptions put together from Schlemmer's notes and letters, were new, and so was the music, in each case created for this production.

In the first instances, the No-Set Ensemble—Eberhard Blum, Jolyon Brettingham-Smith, and Roland Pfrengle—did lively improvisations on synthesizers and a variety of amplified acoustic instruments, including flutes, horns, voices, and percussion. Their music was clear and connected and worked well with the short ballets. In one dance, the "music" was made entirely by the costume—straight wooden sticks that clicked together and magically made varying geometric shapes as the dancer/choreographer Gerhard Bohner shifted shoulders, arms, and legs in an impressively skilled feat of coordination and grace. This performance, at California Institute of the Arts in Valencia, consisted of short sketches of dances for costumes not included in the major work, *Triadische Ballet*, which was presented on the UCLA campus.

The mostly electronic, free jazz, and *concrete* score, commissioned from composer Hans-Joachim Hespos for

the *Triadic Ballet* was scattered, a smattering of styles with no definable concept. It unfortunately detracted from the dance presentation by annoying, serving to make one uneasy in one's seat, wanting to move about instead of more passively watch and listen.

Blending of East and West

Movement was also an element in the performance by Tona Scherchen-Hsiao at the Monday Evening Concert series last November 24, but in this case it was the composer who was moving. The composer knelt on the stage to the right of the trio of musicians (clarinet, harpsichord, and cello) and spoke very quietly, not quite audibly. The clarinet concentrated on multiphonics against sparse, single notes from the harpsichord and long cello tones interspersed with a fluttering of the hand on the body of the instrument.

Scherchen-Hsiao often speaks of the blending of East and West in her cultural and personal background, and this mixture is clearly reflected in her music. The mood shifted from Zen-like simplicity to jazzy moments, but stayed within a small, controlled dynamic range, mostly moderate.

Her movements were slow, simple, and sincere, suggesting a soft, poetic drunkenness, reflecting the words of the poem on which the composition was based. The harpsichord often sounded like an oriental guitar-like instrument, delicate and quiet, sometimes using the upper keyboard on a very dry stop to emphasize the plucked-string sound. The clarinet had the most "extended" techniques and showed excellent, graceful com-

Continued on page 21

AN INTRODUCTION TO MUSIC PUBLISHING

\$3.50
Order #P33

A TOUR THROUGH THE MUSIC PUBLISHING OPERATIONS INVOLVED IN
TRANSFORMING THE COMPOSER'S MANUSCRIPT INTO A PRINTED PUBLICATION
AND ITS DISSEMINATION TO THE STUDENT AND THE PERFORMER

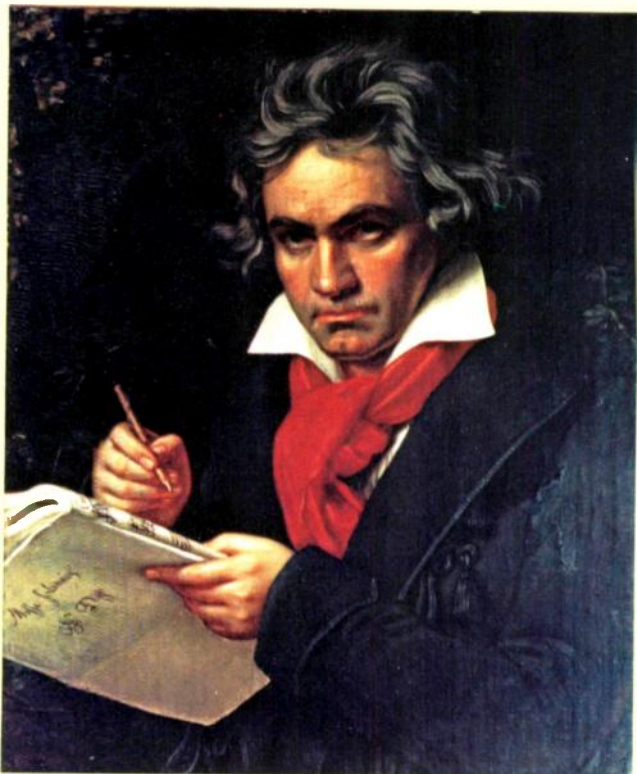

INCLUDING ARTICLES ON CONTEMPORARY MUSIC,
MUSIC PUBLISHING AND RELATED AREAS BY

Arnold Broido	William Lichtenwanger
Lance Brunner	Otto Luening
Gilbert Chase	Fritz Oberdoeffler
Aaron Copland	James G. Roy, Jr.
Leonard Feist	Carolyn Sachs
Charles Gary	Teresa Sterne
Pia Gilbert	Ruth Watanabe
H. Wiley Hitchcock	Arthur Weisberg
Margaret Jory	Grove's Dictionary

PREFACE BY JOSEPH MACHLIS



FEATURING

COLOR PORTRAITS OF MASTER COMPOSERS
IN A REMOVABLE CENTERFOLD POSTER

A CLOSER, HISTORICAL LOOK AT
A MAJOR REPRESENTATIVE PUBLISHER:



PREFACE

At a time when it is increasingly important for young people to be able to investigate all the possibilities of a life in music, **An Introduction to Music Publishing** performs a real service to music education. The articles in the book introduce the reader to various aspects of a subject that not only is interesting in its own right but also is not touched upon in the usual music curriculum. Coming at a moment when the paths to career opportunities are becoming more and more crowded, this book will open up new perspectives to young musicians.

The chapters are by authorities in their respective fields. They are written in an accessible manner that is down-to-earth without ever being condescending, and range from esthetic-stylistic discussion—for example, Aaron Copland's essay *A Modernist Defends Modern Music*—to such practical matters as Fritz Oberdoerffer's *Editing the Composer's Manuscript* or *The Copyright Law* by Charles Gary. Several, such as *The Economic Nature of Music Publishing* by Leonard Feist or *Recording Contemporary Music* by Teresa Sterne, raise questions that I have personally encountered in the classroom—questions for which I previously did not have an answer. I am therefore convinced that everyone concerned with guiding young people to careers in music will more than welcome the appearance of this book.

JOSEPH MACHLIS

Professor of Music, Queens College of the City University of New York, and author of The Enjoyment of Music

SPECIAL INTRODUCTORY OFFERS

These offers valid only when submitted on one of the coupons below.

Free Review Copy or
(enclose \$1.00 to cover shipping & handling)

FREE BONUS COPIES on Quantity Orders
(1 free copy will be sent for every 4 copies ordered and paid for)

MAIL TODAY

MAIL TODAY

MAIL TODAY

C. F. PETERS CORPORATION
373 PARK AVENUE SOUTH NEW YORK, NEW YORK 10016
(please print or type—this is your shipping label)

SHIP TO: Special Fourth Class Printed Music

name: _____

address: _____
city: _____
state: _____ zip: _____

AN INTRODUCTION TO MUSIC PUBLISHING
Please indicate your choice:
 Free Review Copy.
I enclose \$1.00 (dollar bill, stamps, check) to cover shipping and handling.
 Bill me for _____ copies @ \$3.50 each.
(I understand that additionally 1 free copy will be sent for every 4 copies ordered and paid for). Enclosed find my check or money order (for total order amount + \$2.00 shipping & handling + local New York tax if resident), or official school purchase order.

C. F. PETERS CORPORATION
373 PARK AVENUE SOUTH NEW YORK, NEW YORK 10016
(please print or type—this is your shipping label)

SHIP TO: Special Fourth Class Printed Music

name: _____

address: _____
city: _____
state: _____ zip: _____

AN INTRODUCTION TO MUSIC PUBLISHING
Please indicate your choice:
 Free Review Copy.
I enclose \$1.00 (dollar bill, stamps, check) to cover shipping and handling.
 Bill me for _____ copies @ \$3.50 each.
(I understand that additionally 1 free copy will be sent for every 4 copies ordered and paid for). Enclosed find my check or money order (for total order amount + \$2.00 shipping & handling + local New York tax if resident), or official school purchase order.

C. F. PETERS CORPORATION
373 PARK AVENUE SOUTH NEW YORK, NEW YORK 10016
(please print or type—this is your shipping label)

SHIP TO: Special Fourth Class Printed Music

name: _____

address: _____
city: _____
state: _____ zip: _____

AN INTRODUCTION TO MUSIC PUBLISHING
Please indicate your choice:
 Free Review Copy.
I enclose \$1.00 (dollar bill, stamps, check) to cover shipping and handling.
 Bill me for _____ copies @ \$3.50 each.
(I understand that additionally 1 free copy will be sent for every 4 copies ordered and paid for). Enclosed find my check or money order (for total order amount + \$2.00 shipping & handling + local New York tax if resident), or official school purchase order.

CONTENTS

I. MUSIC PUBLISHING – AN OVERVIEW

The process of bringing printed music to the public depends on an interlocking network of a wide variety of artistic, economic, technological and legal considerations.

1. How Music Publishing Works	2
by Carolyn Sachs	
2. American Music Publishers and Their Services to American Composers ..	4
by James G. Roy, Jr.	
3. Questions and Answers Concerning Music Publishing	6
by Arnold Broido	
4. The Economic Nature of Music Publishing	6
by Leonard Feist	
5. Editing the Composer's Manuscript	7
by Fritz Oberdoerffer	
6. Copyright Information	7
by Charles L. Gary	

II. CONTEMPORARY MUSIC AND THE PUBLISHER

Publishing the music of the present day involves a special set of challenges and problems. A music publisher's concerns are closely related to those of contemporary composers, performing ensembles, choreographers, recording companies, music libraries and music educators.

1. A Modernist Defends Modern Music	8
by Aaron Copland	
2. New Directions in Music in the Twentieth Century	9
by Gilbert Chase	
3. The Function of the Music Library	12
by Ruth Watanabe	
4. The Composer and the Dance	12
by Pia Gilbert	
5. The Contemporary Chamber Ensemble	13
by Arthur Weisberg	
6. Recording Contemporary Music	13
by Teresa Sterne	
7. How to Survive as a Composer	14
by Margaret Jory	
8. Publishing Contemporary Music: A Current Problem and an Innovative Solution	14
by Lance W. Brunner	

III. C. F. PETERS – A PUBLISHING TRADITION

A look at the development and growth of a representative music publishing firm over the course of almost two centuries shows a history of composer and publisher working together to realize common goals.

1. C. F. Peters Corporation and Twentieth-Century American Music	15
by H. Wiley Hitchcock	
2. The History of C. F. Peters – Music Publishers	16
from Grove's Dictionary	
3. Portraits of Master Composers	Centerfold
The Original Publication of Works by Master Composers	16
4. A Selection of Edition Peters Editors	16
5. Walter Hinrichsen and the Establishment of C. F. Peters in America	17
by William Lichtenwanger	
6. Statements by John Cage and George Crumb	17
7. The C. F. Peters Family of Contemporary Composers	18
8. The Relationship between Composers and C. F. Peters	20
by Otto Luening	

MEET THE AUTHORS



ARNOLD BROIDO

Arnold Broido, the current President of the Music Publishers' Association of America, has 35 years of experience in editorial and executive capacities in music publishing firms. He has been President of the Theodore Presser Company, music publishers, in Bryn Mawr, Pennsylvania, since 1969, and also serves as Chairman of Elkan-Vogel, Inc. A former Director of the Music Educators National Conference (1966-68) and President of the Music Industry Council (1966-68), Broido is a member of the Board of Directors of the National Music Council.



LANCE W. BRUNNER

Lance W. Brunner is a musicologist who has been on the faculty of the University of Kentucky since 1976. Educated at Brown University and the University of North Carolina at Chapel Hill, his primary research interests have focused on liturgical chant of the Middle Ages, for which he has received a number of grants to work in European libraries. Professor Brunner also has an active interest in new music. He is the director of the annual University Contemporary Music Festival and teaches courses and conducts seminars on twentieth-century music at the University.



GILBERT CHASE

Gilbert Chase has been involved with music primarily as critic, historian and teacher. His books include *The Music of Spain*, *A Guide to the Music of Latin America*, *America's Music: From the Pilgrims to the Present*, and *The American Composer Speaks*. He founded and edited the *Yearbook for Inter-American Music Research* (1964-77). He has taught courses on American music at Tulane University, the State University of New York at Buffalo, and the University of Texas at Austin.



AARON COPLAND

Born in Brooklyn, New York, in 1900, Aaron Copland has been a major shaping force in twentieth-century music, not only as one of the world's foremost composers, but also as a writer, lecturer, pianist, conductor and organizer of musical societies. After early studies with Rubin Goldmark in New York, he spent three years in Paris as a student of Nadia Boulanger. Copland then returned to America where his career received the strong support of Serge Koussevitzky. For many years a member of the Board of Directors of the League of Composers, he was also a founder of the American Composers Alliance. He has served as Head of the Composition Department and Chairman of the Faculty at the Berkshire Music Center at Tanglewood. In addition to numerous honorary doctoral degrees, Copland has received such varied awards as the first Guggenheim Fellowship to be awarded to a composer (1925-27), the Pulitzer Prize (1945), the Oscar Award (1950) and the Presidential Medal of Freedom (1964). His books include *What to Listen for in Music*, *Music and Imagination*, *Copland on Music* and *The New Music*.



LEONARD FEIST

Leonard Feist, a second-generation music publisher active in the music industry for over four decades, has served as head of the National Music Publishers' Association since 1966. As President and Board Chairman of the National Music Council and Vice President of the Copyright Society of the United States, he has participated in a wide range of activities in domestic and international music and copyright. In 1976, Feist received the honorary degree of Doctor of Music from the Peabody Institute.



CHARLES L. GARY

Dr. Charles L. Gary, a former chief executive of the Music Educators National Conference, has represented music educators on the Ad Hoc Committee of Educational Organizations on Copyright since 1965. Currently on the faculty of George Mason University, he has taught at American and Purdue Universities, as well as Austin Peay State, where he served as department head. His books include *The New Copyright Law and Education*. He conducts a Copyright Information Project for the National Music Publishers' Association, the Music Publishers' Association and the MENC.



PIA GILBERT

Pia Gilbert is Professor of Dance and Resident Composer at U.C.L.A. She has written music for numerous dance and theater productions, both on and off campus, including scores for Gordon Davidson's productions of *The Deputy*, *The Devils* and *Murderous Angels*. Within the past few years, Pia Gilbert has received several commissions to compose independent musical scores, two examples of which have just been released by Protone records: *Transmissions* for organ and percussion, and *Interrupted Suite* for clarinet and 3 pianos.



H. WILEY HITCHCOCK

H. Wiley Hitchcock is Distinguished Professor of Music at Brooklyn College of the City University of New York and Founding Director of its Institute for Studies in American Music. He has held Guggenheim and Fulbright Senior Research Fellowships and is President of the Charles Ives Society, Inc. The author of *Music in the United States and Ives*, he is also series editor of the *Prentice-Hall History of Music Series*, *Earlier American Music* (Da Capo Press), and *Recent Researches in American Music* (A-R Editions).



MARGARET JORY

Margaret Jory is Executive Director of the American Music Center, Inc. Born in Chicago, Illinois, and graduated from Radcliffe College, she has served as Director of the Hunter College Concert Bureau and the Lincoln Center Student Program at the Juilliard School of Music, and as Arts Administrator at the Institute of International Education. A consultant to performing ensembles, performers and creative artists, she has also worked as an opera stage director and stage manager with, among other companies, the San Francisco Opera, the Cincinnati Summer Opera and the Metropolitan Opera National Company.



WILLIAM LICHTENWANGER

Born in Asheville, North Carolina in 1915, music librarian William Lichtenwanger served as Head of the Reference Section of the Library of Congress' Music Division from 1960-74. From 1960-63 he was Editor-in-Chief of *Notes*, the quarterly journal of the Music Library Association. A music editor and contributor to such works as *Collier's Encyclopedia*, *The Dictionary of American Biography*, and *Notable American Women*, he was also Chairman of the MLA committee compiling the *Directory of Musical Instrumental Collections in the U. S. and Canada* (1974).

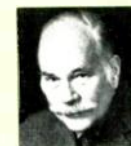

OTTO LUENING

The career of composer, conductor, performer, and educator Otto Luening gives a remarkably vivid and full picture of 20th-century musical life. Born in 1906 in Milwaukee, he has lived in Zurich, Munich, Chicago and New York, while working with such major figures in the arts as Ferruccio Busoni, Richard Strauss, James Joyce and Martha Graham. Luening has composed over 250 pieces of music, ranging from choral music to opera to electronic music, a field which he pioneered during the 1950's. A founder of CRI (a recording company for American composers), Luening has just completed writing his autobiography, *The Odyssey of an American Composer* (Scribner's, 1980).



JOSEPH MACHLIS

Joseph Machlis is the author of *The Enjoyment of Music*, the most widely read college text on music, which has sold almost a million copies. Among his other works are *Introduction to Contemporary Music*, *American Composers of Our Time*, and *Adventures in Music*. Professor of Music at Queens College of the City University of New York, Machlis has also been active as a translator of opera. Among his well-known English adaptations (singing versions) of operas are *Dialogue of the Carmelites* and *La Voix Humaine* by Francis Poulenc, *La Traviata*, *Rigoleto*, *La Boheme*, *Fidelio*, *Cavalleria rusticana*, and Prokofiev's *War and Peace* and *The Flaming Angel*. He is also the author of several novels.



FRITZ OBERDOERFFER

Musicologist and editor Fritz Oberdoerffer was born in Hamburg, Germany, in 1895, and died in Austin, Texas, in 1979. A specialist in the area of thorough-bass realization and in the music of C. P. E. Bach, Dr. Oberdoerffer contributed articles to scholarly publications (including *Acta Musicologica*) and prepared meticulous editions of baroque works for various European publishers. After a distinguished teaching career in Germany, he joined the faculty of the University of Texas and became Senior Editor for C. F. Peters Corporation, New York, a position he held for over 25 years.



JAMES G. ROY, JR.

James G. Roy, Jr., is Assistant Vice-President, Concert Administration, of Broadcast Music, Inc., in New York City. A graduate of the University of Alabama, he pursued advanced studies at Cornell University and the Eastman School of Music. Since coming to BMI in 1968, Roy has been identified with a variety of company and cultural projects, including the BMI U.S.A. Bicentennial Exhibits to 90 cities in the United States and Europe. Also active as a pianist, critic and composer, he is a contributing editor for the forthcoming revised edition of *Grove's Dictionary*.



CAROLYN SACHS

Carolyn Sachs (born 1952, New York City) is a composer, editor and writer on musical subjects. She holds a B.A. from Harvard University and an M.A. in music composition from Columbia University, where she is currently a doctoral candidate. Her vocal, instrumental and electronic works include scores and arrangements for film and theater. During a 6-year association with C. F. Peters, she has been an editor of *Peters Notes*, and is working on Edition Peters' forthcoming series of books on contemporary American composers.



TERESA STERNE

Born in Brooklyn, New York, into a family of musicians, Teresa Sterne had an early performance career as a pianist, including many orchestral appearances—three of them with the new New York Philharmonic. While still active in music-making, she went to work for the Sol Hurok organization and then for record companies: Columbia, Vanguard, and finally Nonesuch, where she produced over 400 records between 1965 and 1979. Her work at Nonesuch covered a broad spectrum of musical repertory, ranging from early music to avant-garde compositions, some newly created for the label.



RUTH WATANABE

Ruth Watanabe currently serves as President of the Music Library Association. Born in Los Angeles, California, she earned her B.Mus., A.B. (English), N.A. and M.Mus. degrees from the University of Southern California and her Ph.D. from the University of Rochester. She is Librarian of the Sibley Music Library at the Eastman School of Music, University of Rochester, and is also Professor of Music Bibliography. A frequent contributor to scholarly journals, Ruth Watanabe is the author of *Introduction to Music Research*, a standard text for graduate students.



ARTHUR WEISBERG

Arthur Weisberg travels throughout the world as conductor and director of the Contemporary Chamber Ensemble, a group which he founded in 1960, devoted to the performance of new music. He is also Founder and Director of the Orchestra of the 20th Century. Born in New York in 1931, Weisberg studied bassoon and conducting at the Juilliard School of Music, and has played bassoon with the Houston, Baltimore and Cleveland Orchestras and with the New York Woodwind Quintet. He has held teaching posts at the Juilliard School of Music, the State University of New York and Yale University.

New Music

Continued from page 16

mand of the special sounds required. The musicians spoke, occasionally with some embarrassment but mostly with ease, and the overall effect was dreamlike and a bit strange.

I learned after the performance that Scherchen-Hsiao had only recently decided to add the element of "performance" to the piece, inspired by many performance events she had seen and wanting to try her hand at it. The newness of the decision may have lent a tentative quality to the work, but its floating, slightly off-balance effect was definitely achieved.

The blending of media has been tried in various forms throughout time and it is often pleasant to experience creative people moving from one format to another in a constant effort to find a satisfying means to express ideas.

Arts support

One urgent political note for artists of all persuasions. Congressman Fred Richmond has a bill before the House regarding voluntary tax support for the arts. His bill suggests that polls and studies show many Americans would be willing to add up to \$25 to their tax payment, earmarked specifically for the arts. The money would be returned by the Federal government to the local state arts councils to enhance cultural activities nationwide. Richmond and his bill need your support. I urge you to write for further information: Fred Richmond, 1707 Longworth House Office Building, Washington, D.C. 20515. In the face of across-the-board cuts in Federal spending, including appropriations for the National Endowment for the Arts, new legislation to benefit the arts is sorely needed. Studies show that this bill could result in an additional two billion dollars to be spent only on cultural projects. It could mean a continuation and expansion of the American arts, instead of a desperate cutback. **MA**

The Dance

Continued from page 11

rhythms in the score seem a major influence on Martins' choreography; there is a lot of formation-making and the final movement assembles the *corps de ballet* in rows, joined in succession by the soloists. There are some shifts—still in discernible formation—before the *corps* springs off, leaving only the principal female dancers and two handmaidens (Helene Alexopoulos and Maria Calegari) alone for a quick blackout.

The influence of parades and parading is not the only visible one: the breeziness of the men's passages recalls Balanchine's *Symphony in Three Movements* (also by Stravinsky), the flexed-foot grace notes those legitimized by the choreographer in *The Four Temperaments*. What gives more than passing interest to Martins' work is his more than average musical knowledge—whether acquired by study, observation, or intuition I can't say; but among the choreographers creating Balanchine ballets, nobody is doing it better than Martins.

Darci Kistler

The chief interest of the post-*Nutcracker* NYCB season lay not in its new ballets but in the rapid arrival front and center of Darci Kistler, a sixteen-year-old product of the company's school who, a year ago, was just one of the bunch at the barre in the studios across the plaza. In the expected Balanchine mold—long and leggy—and with an attractive half-fledged gosling quality, what really distinguishes Miss Kistler at this point is her spectacular confidence as a performer. I've lost count of the number of her new roles—they include the Swan Queen—but none seem to faze her. It's a pleasure to see such uncomplicated *joie de danse* (Miss Kistler actually seems to chortle during her curtain calls) which I trust will be even more amply displayed in the company's Tchaikovsky Festival, scheduled for June 4-14 at the State Theater. **MA**



44TH
CARMEL BACH FESTIVAL
MAESTRO SANDOR SALGO
 MUSIC DIRECTOR
 AND CONDUCTOR
 P.O. BOX 575
 CARMEL, CALIFORNIA 93921
 408-624-1521



Ravinia Festival

International Festival of the Arts
 on Chicago's North Shore

46th Season

June 26-August 29, 1981

James Levine, Music Director
 Edward Gordon, Executive Director

World-renowned
 Chicago Symphony Orchestra
 Conductors and Soloists
 Recitals and Chamber Music
 Opera Programs
 Ravinia Pops Programs
 Pop/Jazz/Folk Concerts
 Musical Theatre
 Master Classes
 Young People's Programs
 Outdoor Sculpture Exhibit

Inquire about a Festival visit.
 Nearby accommodations available.
 Groups welcome.

Ravinia Festival, 22 West Monroe Street
 Chicago, Illinois 60603, 312/782-9696

Carnegie Hall Is 90

A landmark institution is very much alive

Dorle J. Soria

It seems inevitable, looking back, that the architect of Carnegie Hall should have been a musician. William B. Tuthill, who designed it, played the cello and had a good tenor voice and, though acoustical science was then in its infancy, he had studied the acoustics of all of Europe's great concert halls. He was chosen as the architect primarily because he was Secretary of the Oratorio Society for which the hall was basically built and of which Andrew Carnegie was president. The Scottish-born philanthropist had promised Walter Damrosch two million dollars to build the hall although he himself preferred pipe organs, Scottish folk-songs, and bagpipe music to symphonies and choral works. However, young Damrosch had won him over when he visited Carnegie's castle near Perth.

There, during long walks on the moors and trout fishing and playing and explaining excerpts from Wagner's *Ring* at night, he planted the seed in Carnegie's mind, the need of New York for a beautiful new large hall. When its cornerstone was laid on May 11, 1890, Carnegie said: "It is built to stand for ages, and during these ages it is probable that this hall will intertwine itself with the history of our country."

"Ages" is a big word but it is certainly true that the first nine decades of Carnegie Hall have justified Andrew Carnegie's belief. Culturally, at least, Carnegie Hall has intertwined itself with the history of the country. This May 5 it will celebrate that fact when the New York Philhar-

EDITOR'S NOTE: To allow space for this special tribute to Carnegie Hall, we are holding Dorle J. Soria's regular column, Artist Life, until next month.



The grand opening as viewed by *Harper's Weekly*

monic under Zubin Mehta, together with the Oratorio Society, will recreate the opening concert of May 5, 1891, when Walter Damrosch began a five-day inaugural festival with the Oratorio and the Symphony Society from which the Philharmonic is partially descended; the Philharmonic itself resided at Carnegie seventy years, from 1892 until it left for Lin-

coln Center. For the occasion Damrosch had invited a distinguished guest from abroad, Peter Ilyich Tchaikovsky, who at the first program conducted his *Marche Solennelle*.

Queen Victoria reigned

From that day to this, Carnegie Hall has been the home of great music, the Mecca to which every art-



The façade in 1891—there was no marquee to protect patrons

ist is drawn. Once, twenty years ago, its existence was threatened. The owners had contracted to sell and demolish the hall, and a large commercial building was to rise on the site. At the last minute it was dramatically saved by a group of public-spirited citizens led by do-or-die idealist-violinist Isaac Stern. The miracle happened. The destruction was halted.

New York City was permitted to buy Carnegie Hall and a nonprofit organization called the Carnegie Hall Corporation was chartered with Isaac Stern as president. On November 6, 1964, the U.S. Government designated the hall a national landmark, as the plaque outside the building attests.

In 1891 Queen Victoria was

still on the British throne. Less glamorous figures ruled this country. Benjamin Harrison, a Republican, was President; his Secretary of State was, however, James G. Blaine, Damosch's father-in-law. Someone called Hugh S. Grant was Mayor of New York City. But Brahms and Verdi were still alive and Dvořák was about to come to New York to head the National Conservatory.

And in New York, where music was very much alive, the opening of the new hall was definitely an event. The *New York Herald*: "There was a line of carriages leading from the entrance to the hall a full quarter of a mile away. The audience was most interesting as a study of music lovers not under the pressure of mandates of fashion. The women in the boxes were in evening dresses and many were the same who nightly ornamented the *loges* at the Metropolitan Opera House, yet there was a decided change in demeanor. There was no chatter or conversation. Half the house held *partitions* of the Berlioz *Te Deum* in their hands and turned the leaves as carefully as the choruses. There was no coming and going of dandies and mouthpieces. All was quiet, dignified, soft, slow and noiseless, as became the dedication of a great temple of music."

The *New York Post* predicted: "May 5 will always be a memorial day in the annals of music in America as being the date on which a new Hall was dedicated which will doubtless be the center of our musical life for a century to come." Tchaikovsky, who had been bored and bewildered by "a clergyman's long and wearisome speech" at the start, and who had had "some painful hours" when "before my appearance I had to speak to several strangers," was happy with his



Roosevelt campaigning in 1900



Early program cover strikes a pensive note

reception. "I made a sensation—according to the day's papers." Tchaikovsky had not been at ease in New York. "The houses are simply colossal. I cannot understand how anyone can live on the 13th floor." However he liked Andrew Carnegie. "Dining with him, he expressed his liking for me in a very marked manner. He embraced me (without kissing me; men do not kiss over here), got on tiptoe and stretched his hand up to indicate my greatness." Tchaikovsky died a year and a half later. Otherwise he would probably have returned, as did so many of the famous European conductors, com-

posers, and virtuosi who followed.

Paderewski the first

It would take pages to name them all. Paderewski was the first official recitalist in November 1891. In 1892 Busoni made his first appearance under Damrosch, as did Sarah Bernhardt. In 1897 Peary lectured on his Arctic experiences. In 1893 Dvořák gave the premiere of his *New World Symphony* with the Philharmonic. Casals came in 1894, as did Ysaÿe. 1906 brought Camille Saint-Saëns in a piano recital and sixteen-year-old Artur Schnabel in his New York debut with the Philadelphia

Orchestra. In 1908 Mischa Elman came and there were Fritz Kreisler and Josef Hofmann in joint recital; a year later Rachmaninoff arrived. In 1911 Isadora Duncan danced with the New York Symphony in a Bach-Wagner program. That year Tetrazzini and Mary Garden also sang at Carnegie Hall. 1917 brought the historic debut of Jascha Heifetz. Ten years later the boy Yehudi Menuhin made both his recital and orchestral debuts in the hall within a few days of each other. In 1925 there was the first performance of George Gershwin's *Concerto in F*, with the composer at the piano. 1928 marked the dramatic

double debut of Vladimir Horowitz and Sir Thomas Beecham. There followed a series of great artists, Iturbi and Casadesu and Serkin, Milstein and Francescatti and Piatigorsky. . . . But the list is too long.

And there were the famous in other fields, including Presidents of the United States. Theodore Roosevelt delivered a stirring campaign speech from the platform of Carnegie Hall in 1900. President Wilson, in July 1919, came to talk to the American people on the Peace Treaty. And back in 1901, a hero of the Boer War, Winston Churchill M.P., gave a lecture on the subject "illustrated by lantern slides." In 1906 humorist Mark Twain, whose daughter was to marry conductor-pianist Ossip Gabrilowich, came to speak on behalf of a drive to raise money for Booker T. Washington's Tuskegee Institute.

And of course, Carnegie Hall was the New York home of the titans of the symphony orchestra, from Gustav Mahler to Toscanini, from Bruno Walter to Fritz Reiner and George Szell, to Leonard Bernstein who, one Sunday afternoon in November 1945, was called on at the last minute to conduct the Philharmonic, made front-page news, and began the kind of career dreams are made of—the first American-born musician to be engaged as head of the venerable orchestra.

Opera, too, played its part at Carnegie Hall, a continuing practice. We remember the excitement when Mitropoulos with the Philharmonic presented *Wozzeck* and *Elektra* and Halasch's *Murder in the Cathedral*. Ground-breaking were the adventurous American Opera Society evenings which, under Allen Sven Oxenburgh, pioneered a long and lovely series of unfamiliar bel canto operas, introducing such singers as Monserrat Caballé, starring such artists as Schwarzkopf, Sutherland, and Calas.

Yes, if walls have ears, the walls of Carnegie have absorbed treasures of sound. Recently Carlo Maria Giul-

ini wrote in tribute: "I believe in tradition. That is another reason Carnegie Hall beckons me back again and again. Even before I raise my baton I listen to the beautiful silence of the place. In that silence I can hear faint but vivid reverberations from the performances of other men, other orchestras, long-ago friends like Arturo Toscanini, Bruno Walter, Otto

Klemperer, idols like Furtwängler, Kleiber, Mengelberg, who were my exemplars, my teachers."

Warkow's passion

We talked of Carnegie Hall with its executive director, Stewart Warkow. For him Carnegie is not a job; it is his consuming passion, his life. He spends his time there from

Orchestras in the 80's

American Symphony Orchestra League National Conference

DALLAS

June 15-19, 1981

Join the managers, presidents, and board members, volunteers, publicity and development directors, and conductors of all of America's symphony orchestras, as well as publishers, composers, artist managers, and critics as they discuss important issues facing orchestras in the 80's.

- Keynote Luncheon Speaker, Isaac Stern
- Sessions on programming, fundraising, ticket sales, promotion and press, marketing, and more . . .
- Rodeo and Barbeque at the original Southfork Ranch from the television show "DALLAS"
- Special concerts by the Dallas Symphony Orchestra and the Texas Little Symphony with the winner of the Van Cliburn competition.

For further information, please fill out the form below and return to:

American Symphony Orchestra League
Conference 1981
Box 669
Vienna, VA 22180

Yes! Rush me information and a registration form for the American Symphony Orchestra League National Conference in Dallas, June 15-19, 1981.

Name _____
(please print)

Address _____

City/State _____ Zip _____

Phone () _____
(daytime)



Andrew Carnegie:
he preferred bagpipes

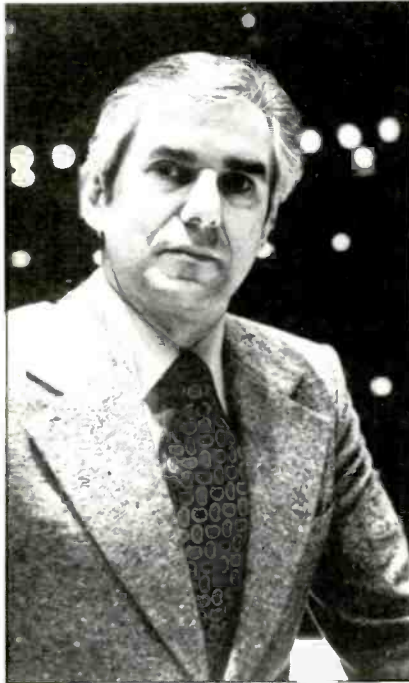

Stewart Warkow:
"You're always close to the magic"



Artur Schnabel: among the great performers

early morning to late night. Fortunately, he is a bachelor. He is supported in this dedication by a board whose chairman, Australian-born investment banker James D. Wolfensohn, who once studied cello with Jacqueline Du Pré and who plays

chamber music at home with his three small children. He also has the friendship and confidence of Isaac Stern, whose personal enthusiasm, far-reaching ideas, and wide circles of influence are another source of strength in program-planning, in en-

couraging young artists, and in guaranteeing a secure future.

The ninetieth birthday season was coming to an end when we saw Stewart Warkow. He spoke of it with justified pride. In addition to the Philharmonic, the Philadelphia Orchestra, the Cleveland Orchestra and the Boston Symphony had recreated their Carnegie Hall debut programs. There had been a "one-time only" series marking both Isaac Stern's sixtieth birthday year and his twentieth as president of Carnegie. There had been an International Festival of Orchestras including the Czech Philharmonic playing works of Dvořák. There had been a Salute to New York State featuring four orchestras of the state, each playing a work of a New York State composer. There was a series of recitals by great singers and programs by four of the top string quartets. There was a "Celebration of Chamber Ensembles" and the annual series of the American Symphony Orchestra which continued to promote young performers and composers; a special event was a concert for Aaron Copland's eightieth birthday, conducted by the composer and his friend Leonard Bernstein. The centenary of three great composers was marked. Antal Dorati and the Detroit Symphony presented two all-Bartók programs. Yehudi Menuhin devoted an entire concert to the music of Enesco, Bloch, and Bartók. And Isaac Stern appeared one night in a favorite role, presiding over and participating in a concert with five young artists, "acting as first-violin pater-familias." And jazz, which has always found a home at Carnegie, was represented by three historic concerts, among them "A Joyous Salute to W.C. Handy," re-creating the first Carnegie concert of W.C. Handy's Orchestra and Jubilee Singers back in April 1928. As for Carnegie Recital Hall, it also played its part in the anniversary season by providing the ideal background for young talent, debuts, unusual and contemporary music.

Looking ahead

Now Stewart Warkow is looking ahead. "There is a three-sided master plan: renovation, rehabilitation, restoration. We have made an architectural survey of the building to see which things need attention. By the centenary we hope we will have taken care of all the problems which plague us. We are now concentrating on the performing areas, on the foyers, entrances, lighting. And we must constantly repair and repaint. There is always in a house like this old plumbing and electric wiring to be replaced. And we must do something for the handicapped. Now we have—it was Itzhak Perlman's suggestion—a chair lift from stage to dressing room for the artist. But we must take care of the physically handicapped in the audience. We must provide easier access to the hall, public elevator service from ground floor to every level.

Dressing rooms should be expanded and facilities for loading and delivery, the air-conditioning upgraded for heavy all-summer activity. Now we close between mid-July and Labor Day. We own the parking property south of the building which brings income, but we must find a better way to develop the area. And the outside of the building must be restored. In the course of years there have been many changes. For instance, street stores were carved out of the ground floor masonry. We would like to restore it to the way it once was. The coffee shop on the corner, for instance, must go."

Stewart Warkow has known the house since he was about sixteen, when he came there to study organ on the eighth floor where Amelia Del Terzo, who taught piano and organ, reigned over a suite of studios. "The studio had a beautiful pipe organ

which had belonged to Miss Del Terzo's teacher Pietro Yon, who had been organist at St. Patrick's Cathedral and who designed the original organ at Carnegie Hall. I had studied piano and violin but I loved the organ. One of my first studies was a book of Yon on pedal technique. My problem was to transfer what I had learned on the piano to the organ."

In 1954, when he was nineteen, he found a way to work at Carnegie Hall, though only as a volunteer for the Symphony of the Air, the cooperative orchestra consisting of former members of the NBC Symphony, organized after that orchestra, with the departure of Toscanini, had been disbanded. All day long young Warkow worked as a clerk in the accounting department of NBC; at night he slaved for the orchestra. "I did everything. I ran errands, stamped letters,

"A STERLING TRADITION"

Music Academy OF THE WEST Summer Festival

Theo Alcantara, Artistic Director



SANTA BARBARA, CALIFORNIA
JUNE 30 - AUGUST 22, 1981

Fourteen Performances, including chamber music,
symphony concerts and opera, PLUS a special benefit by
ITZHAK PERLMAN and JEROME LOWENTHAL!

Faculty and Guest
Artists include:

JUDITH BECKMANN
KEITH BROWN
CLEVELAND QUARTET
GARY GRAFFMAN
MITCHELL LURIE
RAINER MIEDEL
JAMES PELLERITE
GABOR REJTO
MILTON THOMAS
BENITA VALENTE
ZVI ZEITLIN

For ticket information write:
Music Academy of the West
P. O. Box 5737
Santa Barbara, CA 93108
(805) 969-4726

three concerts at Carnegie, three at Avery Fisher Hall, jointly presented and promoted." Which reminded him: "Next year will be the centenary of Stokowski's birth and the American Symphony will commemorate it at Carnegie with a concert on his birthday, April 18, 1982."

A public obligation

Carnegie Hall feels itself a catalyst. Situated right in the middle of New York, it feels an obligation to help and change and develop the people of the city. Stewart Warkow says: "We are a public institution with public support and we owe much to the public." Carnegie Hall responds in many ways. It works with senior citizens, the hospitalized and infirm, the young. "We give regular free concerts in the schools and at senior citizen centers. We give daytime concerts when the ill and the old and

the children can come. We present every kind of program, depending on the audience for which it is intended—jazz, dance and mime, chamber music. We seek out young talent and encourage contemporary music. With our work in the schools we hope we may spawn the next generation of virtuosi or composers—certainly we develop the love of music."

Recently Carnegie Hall received from the Rockefeller Foundation a \$489,400 two-year administrative grant to co-sponsor the next International American Music Competitions, formerly based at Kennedy Center. The competitions are for pianists, vocalists, and violinists in annual rotation. Howard Klein, director of arts at the Foundation, said he was so impressed by Carnegie's enthusiasm for the project that he felt the corporation might eventually take over the perpetuation of the con-

test. Isaac Stern responded that "Carnegie Hall will bring to the contest all its performance standards and expertise."

Other plans are in the offing. It had been reported that Isaac Stern was close to establishing a post-graduate study foundation for young musicians under the aegis of Carnegie Hall but he refused to confirm this, or other happy rumors. The time had not yet come.

But it is not hard to persuade Isaac Stern to talk of Carnegie. It is hard to stop him. It is a subject close to his heart. "I know how the hall lives and breathes. Every artist has left a piece of his soul there. There is not an artist I know to whom Carnegie Hall is not mother, father, brother, lover."

"Dich, teure Halle" . . . dear precious Hall, we greet you and wish you a very happy birthday. **MA**

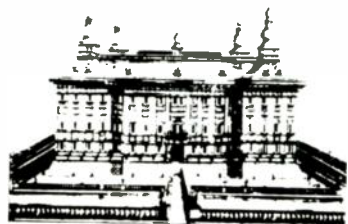

CLASSICAL MUSIC SEMINAR 1981

Sixth Annual CLASSICAL MUSIC SEMINAR

Don V Moses
Music Director

Eisenstadt, Austria
August 4-18, 1981

- Resident chorus and orchestra
- Emphasis on style and performance practice of eighteenth-century music
- Lectures on interpretation and literature
- Internationally renowned faculty
- Concerts, recitals, lectures
- Tours of east Austria, Vienna, and Hungary
- University credit available
- Tax deductible

For complete details,
please write or call:

CLASSICAL MUSIC
SEMINAR
200G Jefferson Building
The University of Iowa
Iowa City, Iowa 52242
1-319-353-7395

The Bösendorfer is the official piano of the CLASSICAL MUSIC SEMINAR

Metropolitan Opera

"Lulu"

In the Met program George Perle, who has proselytized so tirelessly on behalf of the complete, three-act *Lulu*, calls Berg's opera "the supreme masterpiece of the lyric theater." While so absolute a judgment can only be regarded as quirky, there is no doubt in my mind after seeing the Met production that *Lulu* is indeed a great operatic masterpiece: powerful, moving and, despite the squalor and even silliness of its dramatic materials, extraordinarily beautiful.

Under James Levine the Met orchestra, playing as well as I have ever heard it, did full justice to Berg's transparent textures and sensuous scoring. At the same time Levine, slower and more full-bloodedly romantic than Pierre Boulez at the Paris Opéra two years ago, infused the music as a whole with a passionate weightiness that lent the drama tremendous force.

The Met's cast was fully worthy of this auspicious occasion. Teresa Stratas, though disadvantaged by the heroine's flights into altissimo, was a fascinating, utterly convincing Lulu. Franz Mazura, a singing actor of considerable stature (blessed, incidentally, with wonderfully clear diction) brought to Schön the right mixture of vulnerability and authority and to Jack the Ripper a chilling intensity of purpose. Effective, too, if less sheerly notable, were Evelyn Lear's Gräfin Geschwitz, Kenneth Riegel's Alwa, and Lenus Carlson's Animal Tamer and Acrobat. Andrew Foldi's Schigolch was memorably seedy.

John Dexter's straightforward production served the opera well. That the Met could mount so difficult a work with such success so soon after its recent labor troubles is surely a sign of the organization's fundamental strength.

DALE HARRIS



J. Heffernan

Stratas: utterly convincing

"Die Zauberflöte"

The good news about this year's version of Mozart's *Magic Flute* at the Met (which I heard January 15) is that the Chagall sets and costumes and animals are in apple pie order, as beautiful, appropriate, and moving as ever. Also that Lucia Popp, though still a touch lightweight for Pamina, can carry the artistry of her lovely Susanna and Marzelline—striking memories from the 1979 visit of the Vienna Opera to Washington—up to the higher emotional plane this dignified role demands. And that Dale Duesing is a perfect Papageno—sonorous and totally lighthearted, with delightful interpolations and gestures (like begging the horns to stop with that Masonic music after he has flunked the test of the First Temptation).

The bad news, alas, is just

about everything else. Not since Kurt Adler walked ponderously through it in a Vassar College benefit nearly thirty years ago have I heard a performance of this miraculous work so devoid of rhythmic tension and musical coherence. On half a dozen occasions (one of them, excruciatingly, in a passage of echoed coloratura), the singers were unable to slow down as far as debut conductor Lawrence Foster wanted, and the stage got out of synch with the pit. Orchestral entries were sloppy, too, and one could see why, watching a beat that began numbers well ahead of the music but often wound up a tad behind it.

Under these circumstances, it was hard to blame David Randell, who made pretty tenor sounds, for his failure to phrase Mozart; though one cannot entirely forgive a "*Dies Bildnis*" that is meandering rather than rhapsodic. Making another Met debut, the Polish coloratura Zidzislawa Donat was hopelessly overmatched by the house when she had to sing "*O zitt're nicht*" from the back of the stage, but did somewhat better with a clockwork "*Der Hölle Rache*" up front. At best, though, she lacked force, and Queen of the Night is a forceful role or nothing.

For the rest, John Macurdy had pitch problems as Sarastro and James Atherton was all but inaudible as Monastatos. On the plus side, the invaluable Betsy Norden was bright and pretty as Papagena (she is having a super season in the comprimario cast, having triumphed also as the cheerful novice in *Dialogues* and the vicious boy in *Lulu*). The three ladies—Shirley Love, Patricia Craig, and Isola Jones—testified to the inherent strength of the company, Miss Love being a joy to hear as always and Miss Jones displaying a startling, rich alto of individual timbre. They could

not always overcome the flaccidity of the conducting, but they were tonally handsome. The boys were . . . boys, in a house too large for children's voices—but I thought the most effective moment musically all night long was their little quartet with Miss Popp.

The chorus backslid to its bad old habits—not surprisingly, perhaps, as it seemed to be drawn almost entirely from the company's geriatric ward. Fifty-two voices is in fact a little light for *Magic Flute* in a 4,000-seat theater, but you'd think they could make more noise than *that*. Perhaps not all of them were singing.

So much of the stage "action" is dominated by the Chagall sets that the direction of this production, even when Gunther Rennert had it personally in hand, has always seemed a little perfunctory. Still, in the old days people knew what they were supposed to do and where they were supposed to be. For this revival, Bodo Igesz seems to have left the cast essentially to its own devices, and except for the little duet of Papageno and Pamina, which Duesing and Miss Popp brought to life all by themselves, the characters seemed not to relate to each other at all.

Yes, I know there was a strike, but except for Randell (who replaced the projected Eric Tappy), this cast was as originally chosen, and the result was below any acceptable floor, especially at these prices. Perhaps the time has come to remind the Music Director, in whose debt we all stand, that the Met cannot ask to be judged, by critics or customers, only on the performances he conducts. The evening was also disfigured, incidentally, by the presence of a small, ludicrous clique, which greeted the conductor with a little volley of bravos and later tried to rouse enthusiasm for Miss Donat's disastrous "*O zitt're nicht.*" Whoever is now the *chef* of this operation should remember the first rule of claquery: if it's really bust, don't try to fix it.

MARTIN MAYER

"Tristan und Isolde"

In a frigid week of its crippled season the Metropolitan Opera brought back Wagner's *Tristan und Isolde*, in what may have been the first uncut performance of the 325 times it has been given here; with a cast and conductor who have not previously done the work in this house. When the production was new in 1971 many reviewers were enthusiastic about its quality—"achingly beautiful" was my own phrase then—and were moved by a distinctive touch of imagery developed by August Everding, the producer, and his designer Gunther Schneider-Siemssen: an instantaneous transformation, once in each act, from the mundane "day-time" world to the exalted realm of night and love. There were many other glories. In the climax of the Act II duet the lovers are raised, physically, as though to the top of the world. The staging seemed no less impressive in the 1976 revival when, on one memorable night, Birgit Nilsson found a worthy partner in Jon Vickers.

And so to January 1981, of which it can be reported that the visual elements still work as well as they ever did: it is *we* who have changed. We have all been exposed in this decade to many forms of multi-media magic and are a little less apt to fall under the spell of atmospheric projections. The lighting was subtly and effectively done—Gil Wechsler gets the credit—but some of the effects might be described as coy or precious, like that moment when only the hands of the two lovers can be seen.

The stage pictures were just fine. The thing that wasn't, to get at once to the core of the beastly business, was the singing of Gwyneth Jones as Isolde. Miss Jones has had her ups and downs over the years and this role (which she first sang in San Francisco a few months ago) is decidedly one of the downs. The sound was squally and hooty, with jarring tonal

Continued on page 37

The Cincinnati Opera

James de Blasis,
General Director

1981 Summer Festival

AIDA

Giuseppe Verdi

June 18 & 20 (in Italian)

June 19 (in English)

8:00 p.m.—Music Hall

starring Johanna Mejer, Mignon Dunn, John Alexander, Andrew Smith, Justino Diaz
Cond. Anton Guadagno Dir. James de Blasis

DAS RHEINGOLD

Richard Wagner

June 25 & 27 (in German)

8:00 p.m.—Music Hall

starring Eleanor Bergquist, Gwynn Cornell, Jess Thomas, Leif Roar, Andrew Foldi
Cond. Christopher Keene
Sets by David Mitchell

DON PASQUALE

Gaetano Donizetti

July 2 at 8:00 p.m.

July 5 at 2:30 p.m.

(in Italian)

Music Hall

starring Nancy Hermiston, Michael Cousins, Vernon Hartman, Italo Jari, Cond. Byron Dean Ryan Dir. James Lucas

TOSCA

Giacomo Puccini

July 9 & 11 (in Italian)

8:00 p.m.—Music Hall

starring Carol Neblett, Harry Theyard, Ryan Edwards, Tom Fox, Cond. Anton Coppola
Dir. James de Blasis

H.M.S. PINAFORE

Gilbert & Sullivan

July 16, 17 & 18

8:00 p.m.—Music Hall

starring Margaret Cusack, John Fowler, Jack Eddleman, Cond. Byron Dean Ryan
Dir. David Morelock Sets by Jay Deppenbrock

SOUTH PACIFIC

Rodgers & Hammerstein

July 28, 31, August 1 & 2

at 8:00 p.m.

August 2 at 2:00 p.m.

Music Hall

Cond. Anton Coppola
Sets by Paul Shortt

The Cincinnati Opera

James de Blasis,
General Director

Debuts & Reappearances

Baltimore

Baltimore Symphony: Lewis "Moto" [premiere]

The Baltimore Symphony Orchestra is playing less new music this year than it has in recent seasons. Apart from short works by Copland and Krenek, music director Sergiu Comissiona slated only three pieces by living composers—two of them local—for the orchestra's twenty-four subscription programs during 1980-81. One of those pieces, Robert Hall Lewis' *Moto*, received its first performance December 17, with Lewis, a Goucher College and Peabody Conservatory faculty composer, on the podium.

The six-part essay for large orchestra moves diffusely through fif-

teen minutes of rhythmically active atonality. Technical features are clearer than formal ones: contrasts of timbre, simultaneous tempos and musics, and varied instrumental textures, the most effective of which deploy percussion and brass in diverse combinations. A tonal counter-melody which appears four times, twice early on, twice near the end, constitutes the clearest structural landmark. Enunciated first by offstage brass, then by tubular bells as part of a percussion quartet, the melody turns up later in the prepared piano and in a wind quartet. At the end, percussionists chant "mo - to," "mo - to" softly, and the piece closes with visual motion, but no sound, from the strings. *Moto* impressed this listener as moderately inventive, but lacking a strong structural or coloristic vision.

After it, Comissiona took the

podium for Ravel's Piano Concerto for the Left Hand, with Leon Fleisher as soloist, and Dvořák's Eighth Symphony.

Hearing Fleisher play is a poignant experience. Fifteen years ago, the pianist's right hand became incapacitated due to a mysterious ailment—physical, psychosomatic, nobody seems sure—which proved to be chronic. When he plays in public now, the handful of works for left hand alone are his vehicles. Since his disability, conducting and teaching have come to occupy more of the fifty-two-year-old musician's time. Most of his current podium activity is with the Annapolis Symphony, a community orchestra he serves as music director, and the Theatre Chamber Players of the Kennedy Center, of which he is artistic director. He also holds the Andrew Mellon

INTERLOCHEN. ARTS FOR ALL SEASONS.

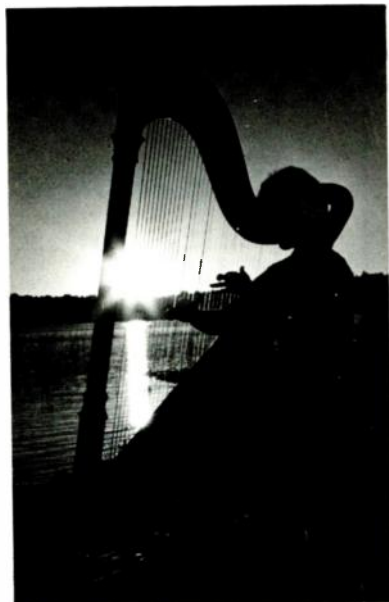

School Year— Interlochen Arts Academy.

America's foremost fine arts boarding high school. Offering pre-professional training in music, dance, drama, the visual arts, and creative writing. Complete college preparatory curriculum for grades 9-12. Fully accredited. Co-educational.

Summer— National Music Camp.

An eight-week adventure in art, dance, drama, and music. Junior, intermediate, high school, and university divisions. Sports and recreation programs. 54th season begins June 28, 1981. Affiliated with the University of Michigan.

Write Dept. MA, ICA, Interlochen, Michigan 49643.
Or call (616) 276-9221.

Interlochen
Center For The Arts

Interlochen admits students of any race, color, and national or ethnic origin.



Fleisher: power & lyricism

Chair in Piano at Peabody.

The Ravel Left-Hand Concerto has become Fleisher's warhorse, and on this occasion he played it with power and lyricism, rhythmic incisiveness, and subtle control of tone color. Comissiona and the orchestra gave their soloist a tautly synchronized, detailed orchestral backdrop.

The conductor's interpretation of the Dvořák symphony revealed distinctive ideas about phrasing, color, dynamics, and tempo relations. The opening Allegro con brio moved briskly, the orchestral playing exceptionally spirited if not infallibly accurate, while the Adagio had suppleness and character. Only in the third movement did Comissiona become fussy, toying with the rhythm and swooning unnaturally instead of letting the music speak unaffectedly, both in the main waltz section and in the two Trios. In the freely organized theme and variations finale, he imparted immense personality to each section within a flexible tempo framework while preserving overall continuity.

STEPHEN CERA

The Hon. George Rallis, Prime Minister, and the Government of Greece
announce

THE CORFU INTERNATIONAL FESTIVAL

Thursday, June 18 – Wednesday, July 8, 1981

Dino Yannopoulos, Artistic Director

Featuring THE AVA OPERA THEATRE

THE RAPE OF LUCRETIA – Britten

June 20 & 22

Evelyn Lear as Lucretia

LA SONNAMBULA – Bellini

June 19 & 21

Gwendolyn Bradley as Amina

plus orchestral & oratorio concerts by the *Symphony of Moravia*
dance by the *Ballet of Gyor*

Medieval Greek drama by the *Amphi-Theatre Company*

Italian folk music by *La Nuova Campania del Canto Popolare*

Festival Tour Packages & Tickets:

MASTERS OF TRAVEL
1700 Sansom Street
Philadelphia, PA 19103
(215) 563-9300

The Academy of Vocal Arts
1920 Spruce Street
Philadelphia, PA 19103
(215) 735-1387

The Saint Paul Chamber Orchestra, Pinchas Zukerman, Music Director, Announces Its Annual Composers Competition

American composers are invited to enter a competition for a new work written for chamber orchestra, to be premiered May 13, 1982.

GUIDELINES

- The Competition is open to American citizens born after December 31, 1945.
- Registration deadline: June 30, 1981.
- Deadline for submission of scores: December 31, 1981.

- One award of \$2,500, plus copying costs to the winning composer, for an unpublished, unperformed work.

- The judging panel will select a winning score from four finalists, at a score reading on May 1, 1982.

- Premiere performance of the work: May 13, 1982, in Minneapolis. The Orchestra retains the right to this performance as the world premiere of the work.

- The work should be written for nothing larger than the following instrumentation and should not include soloists: 1 flute, 2 oboes, 1 clarinet, 2 bassoons, 2 French horns, 1 trumpet, percussion (1 player), keybord, and strings (6 6 4 4 2).

- Length of the work: 10-15 minutes.

For further information, contact:

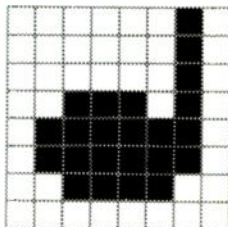

The Saint Paul Chamber Orchestra

Annual Composers Competition

315 Landmark Center • 75 West Fifth Street
St. Paul, MN 55102
612/292-3242



THIS MONTH ON
NATIONAL PUBLIC RADIO

The following programs will be broadcast in May over many of the NPR member stations throughout the country via a new satellite distribution system that insures the highest transmission quality.

Check local listings for date of broadcast. This information is published by Musical America as a public service.

INTERNATIONAL CONCERT HALL

Adrian Sunshine conducts the London Chamber Players: Elgar's Serenade for Strings, Op. 20; Mozart's Flute Concerto No. 2. (Jean-Pierre Rampal). Bach Brandenburg Concerto No. 4 in G. (Rampal, Edward Beckett, flutes; Rodney Friend, violin), and Haydn's Symphony No. 52 (Taped Oct. 7, 1980, Ascona Festival.)

Gunther Herbig conducts the Berlin Symphony Orchestra: Ruth Zechlin's Briefe für Orchester; Konzertstück for Flute & Orchestra (Richard Waage); premiere of "Hyperion-Fragmente" by Siegfried Matthus (Theo Adam, bass-baritone); and the premiere of Symphony No. 2 "Explosionen und Cantus" by Wilfried Kratzschmar. (Taped Feb. 23, 1980, E. Germany.)

Gilbert Varga conducts the Philharmonia Hungarica: Overture to Verdi's "La forza del destino"; Jean Balissat's "Ruckblick" (Liwu-Mirceau Casleanu, violin). Violin Concerto in D by Tchaikovsky (Alexander Barantschik); and Cello Concerto in B minor, by Dvorak (Henrich Schiff). (Taped Aug. 7 and 8, "Festival Tibor Varga 1980.")

Philippe Entremont conducts the Vienna Chamber Orchestra: Divertimento in D and Piano Concerto No. 14, by Mozart (Philippe Entremont); and Piano Concerto in D and Symphony No. 42 by Haydn (Philippe Entremont). (Taped Aug. 11, 1980, Ascona Festival.)

LOS ANGELES PHILHARMONIC

Myung-Whun Chung, conductor: Works by Beethoven, Ravel, and Bartók, plus the Piano Concerto No. 4 in G by Beethoven. (Murray Perahia). (Taped March 15, 1981.)

Myung-Whun Chung, conductor: Works by Rachmaninoff, Bartók, and the Piano Concerto No. 2 in F minor by Chopin (Martha Agerich). (Taped March 22, 1981.)

Giuseppe Sinopoli, conductor: Webern's Symphony, opus 21; and Mahler's Symphony No. 9. (Taped April 5, 1981.)

Herbert Blomstedt, conductor: Piano Concerto No. 2 in B-flat (Maurizio Pollini) and Brahms's Symphony No. 4 in E minor. (Taped April 12, 1981.)

NPR RECITAL HALL

The King's Singers: Songs from the Auvergne by Goff Richards (arr.); and works by Thomas Weelkes, Paul Patterson, John Dowland, John Ward, and William Byrd. (Taped Nov. 16, 1980, Yale U.)

Eugene Moye, cello, and Mary Louise Vetrano, piano: Sonatas by François Francoeur, Beethoven; Debussy, and Chopin. (Taped Nov. 14, 1979 at the U. of Miami.)

Wolfgang Ribusam, organ: Works by Joseph Rheinberger, Cesar Franck, Max Reger and J. S. Bach. (Taped July 18, 1980, Magadino Organ Festival.)

National College All-Star Tuba-Euphonium Ensemble; and R. Winston Morris, conductor: Works by Frank Bennet; G. P. Telemann; Simone Vazzana; E. Boccalari; Wagner; R. Strauss; Thomas Rodgers; John Cheetham; Fisher Tull, and James Garrett. (Taped in Aug. 1980.)

SAINT LOUIS SYMPHONY ORCHESTRA

Max Rudolf, conductor: Haydn's Symphony No. 97; Horn Concerto No. 1 in E-flat; Antonio Vivaldi's Concerto for Two Horns (Barry Tuckwell and Roland Pandolfi); and Mendelssohn's "Reformation" Symphony. (Taped Nov. 1, 1980.)

Leonard Slatkin, conductor: Works by C. M. von Weber, Carl Nielsen, and Beethoven's Piano Concerto No. 1 (Malcolm Frager). (Taped Oct. 2, 1980.)

Leonard Slatkin, conductor: Mozart's "Prague" Symphony; and the premiere of "In Memory of a Summer Day" by David Del Tredici (Taped Feb. 23, 1980.)

Erich Bergel, conductor: Olivier Messiaen's "L'Ascension" (orchestra and organ versions); Symphony No. 7. (Taped Nov. 21, 1980.)

Reynald Giovaninetti, conductor: Works by Ernest Chaussons, Emmanuel Chabrier, and a Rachmaninoff Piano Concerto. (Ted Joselson) (Taped Nov. 29, 1980.)

WINDWORKS

Frank Battisti conducts the New England Wind Ensemble in Dvorak's Serenade in D minor; **Robert A. Winslow conducts the M. Texas State U. Symphonic Wind Ensemble** in Karel Husa's Saxophone Concerto (Dennis Diemond).

Craig Kirchoff conducts the Ohio State U. Wind Ensemble in Stravinsky's Dctet; **H. Robert Reynolds conducts the U. of Michigan Wind Ensemble** in Symphonies for Wind Instruments by Stravinsky; and **Robert Wojciak conducts the U. of Southern California Wind Ensemble** in Circus Polka, also by Stravinsky.

Dr. Harry Begian conducts the University of Illinois Symphonic Band in Schoenberg's Theme and Variations, opus 43a; and **Robert Wojciak conducts the University of Southern California Wind Ensemble** in "Emblems" by Aaron Copland.

John C. Stansberry conducts the North Texas State U. Chamber Wind Ensemble in "Dixtuor" for Wind Instruments by Milhaud; **Dwight Oltman conducts the Baldwin-Wallace College Conservatory of Music/Symphonic Wind Ensemble** in Petite Symphonie by Gounod; and **Gene Young conducts the Oberlin Wind Ensemble** in Messiaen's "Oiseaux exotiques" (1955-56). (Peter Takács, piano; Stephen Fitch, xylophone; Charles Wood, glockenspiel.)

SAINT PAUL SUNDAY MORNING

Members of the Saint Paul Chamber Orchestra under the direction of Bill McGlaughlin. Works by J.C. Bach, Handel, Hindemith, Dvorak, and Haydn.

Violinist Pinchas Zukerman with pianist Marc Neikrug. Violin sonatas of Mozart, Brahms, and Schubert.

The New World String Quartet. Works by Dvorak, Stravinsky, and Haydn.

Members of the Saint Paul Chamber Orchestra under the direction of Bill McGlaughlin. Music by Monteverdi, Albinoni, Boccherini, and Tchaikovsky.

New York

American Composers Orchestra

The American Composers Orchestra gave a diverse survey of twentieth-century American music in a brief but ambitious program at Tully Hall on November 24. In a mere hour and forty minutes the concert covered such areas as 1920s experimentalism in Frederick Converse's *Flivver Ten Million* (1927), rugged individualism in Aaron Copland's *Orchestral Variations* (1930 and 1957), neoclassicism in Walter Piston's *The Incredible Flutist Suite* (1940), and chance music in Richard Felciano's *Galactic Rounds* (1972). There was also the premiere of Erik Lundborg's Piano Concerto.

Jorge Mester, who was conducting the orchestra for the first time, came well equipped to handle these multiple challenges. Having recently finished eleven years as director of the Louisville Orchestra, Mester has developed an insight into the idiosyncrasies of modern music which few of his peers can match. Time and again he showed the knack of navigating right to the heart of a work and revealing its most striking features. Add to this his genial and self-effacing manner on the podium, and he must be counted a definite asset to any musical enterprise he belongs to.

The older works on the program proved the more rewarding. Converse's *Flivver Ten Million* is a musical biography of the life of a Model T Ford from assembly line to highway collision. It seems a bit quaint today, but the good-natured cacophony with which it depicts the operation of a Detroit auto plant may have jolted some of its first listeners. Unlike many, I am not a great admirer of the Copland *Variations*. For me it lacks the lyrical warmth which adds such distinction to the composer's ballet music. Nevertheless, there is a case to be made for its flinty determination, as was proved by the

fine performance it received here. As for the Piston Suite, it is always worth hearing, especially for the boisterous Circus March which delights audiences. But the score also contains moments of real poignancy, and it has surely earned the right to be regarded as a twentieth-century classic.

The new Piano Concerto by Erik Lundborg was an enthusiastic effort with a lot to say, most of it said incoherently. The composer, a Montanan who now lives and teaches in New York, seems to have had difficulty reconciling the use of serial techniques with the apparatus of a concerto. Solo and orchestra each seem unaware that the other exists, the one exception occurring briefly at the end of the slow movement when the two do literally come together. Otherwise most of the writing is a rampage for brass and percussion with the other instruments, including piano, left behind in a cloud of noise. It is no surprise, then, that the work leaves a sprawling impression although it lasts only fifteen minutes. Ursula Oppens is as dedicated and talented an advocate of this repertory as any pianist today, and she stoically defied the risks of the solo part.

Whatever his deficiencies, however, Lundborg still offered something more substantial than did Richard Felciano in *Galactic Rounds*, an entertaining but dated aleatory exercise.

ANDREW DERHEN

New York

Voices of Change: Rodriguez Trio, Erb Trio [N.Y. premieres]

New music is alive and well in the Southwest thanks to the Voices of Change, the ensemble in residence at Southern Methodist University in Dallas. On their New York debut December 18 at the Abraham Goodman House they presented two New York premieres, Robert Rodriguez's Trio No. 1 for violin, cello, and piano, and Donald Erb's Trio, as well as Olivier Messiaen's *Quartet for the End of Time*.

Rodriguez's Trio, performed by pianist Jo Boatright, violinist Ronald Neal, and cellist Craig Weaver, was a strong work that generated considerable volume and a variety of emotional levels.

Donald Erb made an unannounced appearance as conductor of his own Trio for keyboards (celeste, piano), violin, and a large percussion battery that included a harmonica and water jug. Erb's interest in sound for its own sake was the guiding principle of the five-movement work. The audience was delighted when the second movement dissolved briefly into Mozart's *Marriage of Figaro* overture. Nevertheless, one went away remembering not tunes but the exotic colors.

The second half of the program was devoted to Messiaen's masterpiece. The eight-movement, fifty-minute quartet catalogues Messiaen's compositional enthusiasms: modes, palindromic rhythms, color symbolism, birdsongs, and theological meaning. The composer's discourse here is not only about the announcement (in Revelations) of the end of time, but also about musical time itself, where for Messiaen durations rather than divisions of beats rule, and time elapses extremely slowly. Each musician must strain the far reaches of his technique in order to be able to perform, for example, long solo clarinet lines, held harmonics (in each string instrument, which demands considerable control of the bow arm), and endlessly repeated notes (on the piano, requiring superb control of dynamics). If chamber musicians can sustain the tension over a Mahlerian timescale, the effect is transcendental. Voices of Change successfully met the challenge.

ANDREA OLMSTEAD

New York

Frederick Zlotkin, cello

"When in doubt, start trilling," was one wag's word of advice to

10th ANNIVERSARY

Victoria INTERNATIONAL Festival

J. J. JOHANNESSEN
FOUNDER/DIRECTOR

JULY-AUGUST
1981

British Columbia,
Canada

Over 26 concerts
featuring international
soloists, ensembles,
symphony orchestra
and opera

Tickets available from:
**McPHERSON PLAYHOUSE
BOX OFFICE**
3 Centennial Square,
Victoria V8W 1P5
Telephone 386-6121

Further information:
**VICTORIA INTERNATIONAL
FESTIVAL**
3737 Oak Street, Vancouver, B.C.
Canada V6H 2M4
Telephone: (604) 736-1811

would-be Bach stylists, and in recent seasons, with everyone trilling as a matter of course, instrumentalists striving for even greater authenticity have turned to more elaborate forms of notational embellishment.

The cellist Frederick Zlotkin has—please forgive a rather crude pun—opened a “Pandora’s Bach.” A year ago, this New York-based musician performed all six of the Suites for Unaccompanied Cello in copiously embroidered texts (and made a recording of them, which has still to be issued). He repeated his version of the Third Suite at his recital at Kaufman Concert Hall on January 3, a program which also included four movements of Francoeur’s E major Sonata, Schumann’s Op. 73 *Fantasiestücke*, Shostakovich’s early Sonata, and Chopin’s *Introduction and Polonaise Brillante*.

Historically speaking, Zlotkin’s way with the Bach had logic on its side: his procedure was, basically, to play the music more or less “as is” the first time around and to rev it up on the repetition. So far, so good. And it should be added that Zlotkin is a musician of sensibility; his phrasing has a good basis in harmonic structure, and his low-keyed temperament tended to add a certain poignancy to his expressiveness.

Admittedly, embellishment is largely a question of taste, but I cannot help instinctively distrusting Zlotkin’s inclinations here: it seemed to me that his roulades went much too far—that his ornate excursions were less suited to Bach’s sturdy outlines and to the cello’s physical properties than to rococo French music (Couperin or Rameau) and the clavacin. The simple eloquence of the Sarabande (where the filling out was kept discreet) emerged intact, but elsewhere the music’s back was broken under the dubious burden.

The Schumann pieces provided the evening’s high point. Zlotkin and his capable supporting pianist, Margo Garrett, presented a shapely, flowing account of this triptych. After lamenting the hoardes of pianists

who foolishly play uneven rhythms in the second piece because Schumann—in attaching melodic duplets to the first and third of accompaniment triplets—unwittingly asked for the unplayable, I happily commend Miss Garrett for showing how that passage should be done. The coda to the third piece, with its accumulating acceleration, also flowed more smoothly than usual.

I was less happy with some other aspects of Zlotkin’s playing on this occasion. In the Francoeur Gavotte, the dance rhythm was distorted by some cute pauses and unflowing ritards. And a recurrent lack of the highest order of virtuosity took its toll in various ways: the player’s imperfect spiccato bowing made the Allegro of the Francoeur and the finale of the Shostakovich sound rather grim, stringy, and unduly pressured. The Chopin was marred by a few ungainly shifts, and by a general deficiency of aristocratic grace and requisite tonal color. Perhaps Zlotkin should concentrate on music demanding seriousness rather than bravura.

HARRIS GOLDSMITH

Philadelphia

Philadelphia Orchestra: Laderman Violin Concerto [premiere]

Ezra Laderman’s Violin Concerto, a showpiece that recalls the days of the super-virtuoso, was premiered in December by violinist Elmar Oliveira with the Philadelphia Orchestra playing under the baton of the composer. Although this is Laderman’s second violin concerto, it is the first using large orchestra, and that raised an immediate problem. The density of the orchestration forced Laderman to make substantial changes, almost up to performance time, to lighten the texture. The performances were of a work in progress.

Laderman’s concerto style vividly evoked that of nineteenth-century virtuosos, for it made the soloist a dashing figure whose bravura carries

him over all hazards. The violin plays Don Juan to an orchestra that dances, strolls, and often calls seductively to the solo line and draws a hauntingly songful response. The form is traditional. A romantic slow movement floats between two highly energetic sections built on shifting meters and tonal thematic ideas that evolve from a rising pattern in the opening bars. The solo line demands such feverish technical skill that the work has a visual aspect like opera. The violinist plays the demonic virtuoso while playing the music. That portrayal is lodged in the notation. The soloist has to manage wide stretches between fingers, mountainous upward intervals bridged by gliding portamento, supercharged rapid articulation that makes the bow bounce and, in the last movement, a section for plucked strings almost unique in the literature.

The first movement is built from rising broken chords that fly by. The pace never relents until the sudden final hushed note—a point of repose that startles.

The second movement sends the soloist on a long melodic route. He plays on the lower strings as the line drops in a long graceful curve, turns upward and closes with an ornamented flourish. Long falling intervals are a motto of the movement. The cadenza midway is an expansive melodic invention that asks derring-do to create a mood of sweetness.

The timpani roll that launches the finale sends the soloist in a perpetual motion rush across shifting meters. The extended section for pizzicato—played against the orchestral strings’ trill—provides another view of the first idea, always with high energy. The huge solo sweep from bottom to top of the instrument’s range finishes it off with the panache worthy of a Paganini.

Whether this was a final version is doubtful. Oliveira had problems projecting through the orchestra’s clamor. Laderman is probably not the best conductor of his own work,

Continued on page 38

Continued from page 31

transitions. One had the feeling that all the notes were somehow within her command but that control had gone, at least for the time being. She did well in the Act I narration and curse, then Act II began dismally and offered only momentary excursions into the kind of quality that is needed. The pity is that she looks and moves like a perfect story-book Isolde, blonde and comely; and that intellectually (if not mechanically) she has the music within her.

Spas Wenkoff, a Bulgarian tenor in his Met debut, made a favorable impression. Not a giant voice, by any means, but firm, musical, and under very intelligent control. If he has not the heroic dimension, he does not lack the staying power for a thoroughly acceptable traverse of the part, including that stretch of delirium in the third act, in the closing stages of which (even in abbreviated performances) your average Tristan will often gasp and bark voicelessly. Here the new man showed sensible planning and much stamina, even though the orchestral dynamics covered him occasionally.

Tatiana Troyanos, a singer of uncommon quality, possessor of a rich, warm mezzo sound and mistress of "the long line," would seem ideally cast as Brangaene; but it did not quite work out. She was at her best in Act I, during the long exchange with Isolde. The extended phrases of the warning (in the next act) did not sound as clear and as firmly on pitch as they should. Donald McIntyre was a gruff and effective Kurwenal and Timothy Jenkins a massive, threatening figure as Malot.

"Uncut" means that you get the full untrimmed dimension of King Mark's monologue, a slow strophic plaint that lasts more than a quarter-hour—and an item whose condensation would worry none but the most ardent Wagnerite. Yet on this occasion the full measure was a decided boon, for the part was played, in a notable debut appear-

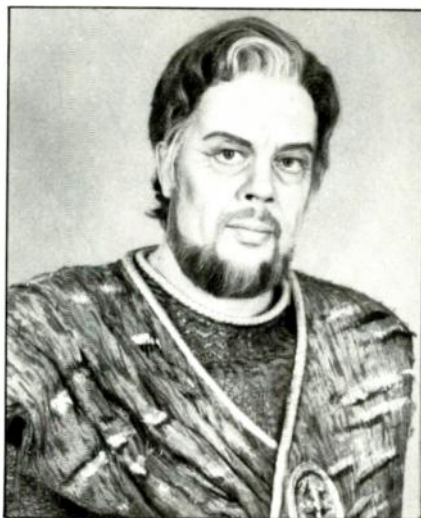

Salminen: a notable debut

ance, by the Finnish basso Matti Salminen. He has a splendid, sonorous, and plangent voice, no question; but he also has an uncommon sensitivity on the acting side. At the climax of his narration he laid a hand on Tristan's shoulder, then knelt weeping beside the man who had betrayed him. It was an overwhelming moment.

We come at last to the dominant performance of the night, the vast tapestry of sound that it is the conductor's duty to weave for us. James Levine, here doing his first performance of this work, used a wide loom and many colors. Some things were knotty, others rough. The balance of voices and instruments was often awry. But, no mistake about it, we have a grand design underneath it all which will one day yield a performance of immortal quality. Levine knows what this score is about and I can think of nobody alive who is more likely to succeed with it. The Met orchestra, perhaps refreshed by the extra day of rest won so bitterly in the recent strike, played like a world-class ensemble. The chorus, to the contrary—it only appears for a minute at the end of Act I—was dismayingly threadbare. Richard Nass took the *cor anglais* solo in Act III with full command and plaintive tone.

GEORGE MOVSHON

DA CAPO PRESS

•KEYBOARD•

THE PHYSIOLOGICAL MECHANICS OF PIANO TECHNIQUE

Otto Ortmann
ISBN: 76059/ \$39.50

THE PRACTICAL HARMONIST AT THE KEYBOARD

Francesco Gasparini
ISBN: 76017/ \$16.50

GRADUS AD PARNASSUM

Muzio Clementi
ISBN: 79570/ \$42.50

CLAVIERBÜCHLEIN VOR WILHELM FRIEDEMANN BACH

J.S. Bach
ISBN: 79558/ \$17.50

•VOICE•

TRAINING THE SINGING VOICE

Victor Alexander Fields
ISBN: 79510/ \$27.50

THE ART OF SINGING/ HOW TO SING

Enrico Caruso/
Luisa Tetrazzini
ISBN: 70674/ \$19.50

SINGING

Herbert Witherspoon
ISBN: 76001/ \$15.00

ACTING IN OPERA

George E. Shea
ISBN: 76004/ \$14.50

•WOMEN• COMPOSERS SERIES

Write for information on works by Amy Beach, Louise Farrenc, Clara Schumann, Rebecca Clarke, Fanny Hensel, Ethel Smyth, and others.

Da Capo Press, 233 Spring St.,
New York, N.Y. 10013

Continued from page 36

either, but provided a serviceable guide to entrances and meters. The resolution to these problems is probably some way off. Nonetheless, the piece is a theatrical one for violin which views the player as a Douglas Fairbanks with a Tourte instead of a sword.

DANIEL WEBSTER

St. Louis

St. Louis Symphony: Williams Violin Concerto [premiere]

In a pre-performance interview, composer John Williams described his Concerto for Violin and Orchestra—written in 1974 as a memorial to his late wife but unheard until the St. Louis Symphony Orchestra gave it its world premiere performances on January 29 and 31—as “basically romantic in contour.” Indeed, for all its quasi-serial melodic development, the concerto glances backward to a time when composers viewed expression and construction as equally important elements of their work. Were its contents more profound, future historians might find reason to mention it in a chapter on the concertos of Berg and Stravinsky. As it stands, Williams’ music is more reminiscent of the concertos of Walton and Elgar—more up-to-date in the specifics of its style, to be sure, but otherwise just as heartfelt and heartwarming.

On the surface, there’s not much about it to link it to the tuneful and rhythmically simple sound tracks of *Star Wars*, *Superman*, *Jaws*, and the countless other motion pictures Williams has scored. On a more abstract level, though, the similarities are clear enough. Like the film scores, the concerto uses an attractive kernel of melody—in this case, a sigh-like downward moving interval—for its energy source and develops it resolutely for its entire twenty-nine-minute duration. Like the film scores, the concerto is craftily paced and seductively orchestrated, so much so that



Williams: wholly palatable

even a moderately willing listener has little choice but to give in to its emotive power. And like the film scores, the concerto, for all its angularity and sprinkles of dissonance, seems wholly palatable to the so-called “average” listener of the 1980s.

The St. Louis Symphony Orchestra’s music director Leonard Slatkin was the conductor. Mark Peskanov, a twenty-two-year-old Russian emigre who’s fast on his way to a major international career, was the soloist for the St. Louis premiere and the subsequent performance in Carnegie Hall. Both Slatkin and Peskanov treated the work with the respect it deserved—John Williams’ Concerto for Violin and Orchestra doesn’t lend itself to blazing displays of virtuosity, but it does demand a certain low-keyed interpretive intensity, and that’s exactly what Peskanov gave it.

JAMES WIERZBICKI

Syracuse

Society for New Music: Israel, Wilkinson [premieres]

The splashiest offering on the SFNM’s January 18 concert was

Brian Israel’s new *In Praise of Practically Nothing* (1980) for tenor and ensemble. A zany display of compositional fluency, the cycle emphasized broad parody: the fourth song, for instance, buffeted about a cousin of the *Carousel Waltz*. But *In Praise* reached its high point in its one moment of seriousness. Reminiscent of Shostakovich at his iciest, the fifth song—about Death—suggested, in its understatement, a more deeply felt musical vision than the rest of the set.

The other premiere, Jane Wilkinson’s *Sky Stones* (1980) for soprano, flute, and harp, was less flamboyant, although no less mercurial. Its overall structure—for instance, its arch form—was tight and clear. But on the level of detail, it offered a prismatic swirl of rhythm and timbre that attested (e.g., in the play of articulation that mirrored the “spikes” of quartz against snow) to a sensitive appreciation of Neruda’s texts.

The remaining works contrasted admirably. Harris Lindenberg’s powerful piano trio, *From the Grotte of the Combarelles* (1978), provided the concert’s greatest intensity, especially in its rich opening section. At the opposite pole, repose was offered by Christopher Rouse’s slow, spare *Dream of Christophene* (1977) for soprano and ensemble. As its musical ideas (occasionally quotations) drifted by, and as dissonances subtly clotted its harmonies, it suggested sounds not quite heard, effectively evoking a sensuous dreamscape. The only disappointment was Marta Ptaszynska’s *Un grand sommeil noir* (1977) for soprano, flute, and harp, where intricate wordplay (Verlaine’s French text is intertwined with an English translation run backward) made it difficult to concentrate on the music.

The performers included soprano Neva Pilgrim, tenor James Schults, flutist Linda Greene, pianist Brian Israel, conductor Charles Schneider, and half a dozen more; all met the Society’s usual high standards.

PETER J. RABINOWITZ

Festivals: Part 2

ARIZONA

THE FLAGSTAFF FESTIVAL OF THE ARTS. Flagstaff, June 20-July 26. Denis de Coteau, music director and conductor. Recital and orchestral artists include Cho Liang Lin, Liona Boyd, Steven de Groote, Nathaniel Rosen, Francine Reed, Susan Restin St. John, and others. Also the Phoenix Masterworks Chorus, the Oakland Ballet, the Arizona Theatre Company, special attractions and a film classics series. All events on the campus of Northern Arizona U.

CALIFORNIA

CARMEL BACH FESTIVAL. Carmel, July 17-August 2. Sandor Salgo, music director and conductor. Highlights will include Bach's *Passion According to St. Matthew*, the Magnificat, Concerto for Four Harpsichords; Mozart's *Don Giovanni* in concert form, Symphony No. 36 ("Linz") and Piano Concerto K.451. Soloists will include Sara Ganz, Pamela Myers, Carol Vaness, Gregory Wait, William Fleck, Douglas Lawrence, Thomas Paul, Peter Rejto, Michael Hensch, Hans Pischner, and Gerhard Puchelt. Seventeen concerts, twelve recitals, lectures, and symposia.

REDLANDS BOWL SUMMER MUSIC FESTIVAL. Redlands, every Tuesday and Friday evening through July and August. 1981 is the fifty-eighth year of free concerts including four nights of symphony (Harry Farbman, conductor), ballets, operas, recitals, one musical comedy, folk dances and songs.

SAN FRANCISCO OPERA SUMMER FESTIVAL. San Francisco, June 12-July 19. Kurt Herbert Adler, general director. Highlighting the festival is the American premiere of Aribert Reimann's

Lear, with Thomas Stewart in the title role. Also appearing are Helga Dernesch, Rita Shane, Emily Rawlins, David Knutson, and Jacque Trussel. Performances as June 12, 15, 18, 21, 23. *Don Giovanni* with Cesare Siepi, Giuseppe Taddei, Carol Vaness, and Kathryn Montgomery, will be given June 16, 19, 24, 28, and July 4. *Die Meistersinger von Nürnberg* with Karl Ridderbusch, William Johns, Hannelore Bode and Kurt Rydl is presented June 27, 30, July 3, 9, 13, 19. Piero Cappuccilli sings the title role of *Rigoletto* with Krisztina Laki on July 1, 5, 8, 11, 14, and 17. *L'incoronazione di Poppea* with Tatiana Troyanos, Eric Tappy and Maureen Forrester is given July 7, 10, 12, 15, 18.

SAN LUIS OBISPO MOZART FESTIVAL. San Luis Obispo, August 3-9. Week of 14 concerts includes two orchestral concerts with Mozart Festival Orchestra and chamber concerts and recitals featuring such soloists and groups as Russell Sherman, Jerome Lowenthal, the Primavera String Quartet, American Early Music Consort, and Ko Ke-la. Weekend Mission concerts in Mission San Luis Obispo de Tolosa feature orchestra and Festival Chorus in a performance of Mozart's *Requiem*.

Concurrent with the Festival is a Hubbard Keyboard Instrument Symposium sponsored by California Polytechnic University Music Dept. Symposium lectures will be open to the public. Tours of Hearst Castle will be offered as part of the Festival goes ticket package.

COLORADO

COLORADO MUSIC FESTIVAL. Boulder, June 19-July 24. Giora Bernstein, music director. Featured guest artists will include Leonard Rose, Shlomo

17th ANNUAL NEW COLLEGE MUSIC FESTIVAL 1981

FACULTY ARTIST
CONCERTS
VAN WEZEL
PERFORMING ARTS
HALL
JUNE 5-6, 12-13, 19-20

Featuring
distinguished
solo and ensemble
artists of world-wide
renown with the
Festival Chamber
and Symphony
Orchestra,
Paul Wolfe conducting.

For Information
Call or Write
(813) 355-2116

New College Music Festival
5700 N. Tamiami Trail
Sarasota, Florida 33580



Music at Gretna

with

The Audubon Quartet
Guest Artists

"One of the best small
classical music festivals in
the country" — TIME

Under the chestnut roof of an 85-year-old hall, nestled in the Appalachian foothills near Lancaster, Pennsylvania, 1½ hours from Philadelphia.

(717) 964-3836

Music at Gretna
Box 519

Mt. Gretna, PA 17064



Mintz, Misha Dichter, Zehava Gal, Erie Mills, and Larry Graham. A special project, "Between the World Wars", will chronicle artistic, social, and political developments from 1919-1940. Joining visiting artists and scholars will be concert performances featuring works of Copland, Schuller, Weill, Gershwin, Hindemith, Ravel, and Stravinsky.

CONNECTICUT

YALE IN NORFOLK CHAMBER MUSIC. Norfolk. June 19-July 31. This season's performers include: The Tokyo String Quartet, Syoko Aki, Szymon Goldberg, Masuko Ushioda, Raphael Hillyer, Martha Strongin Katz, Aldo Parisot, Laurence Lesser, Thomas Nyfenger, Ronald Roseman, Keith Wilson, Arthur Weisberg, Robert Nagel, Paul Ingraham, Ward Davenny, and Joan Panetti. The festival's forty-first season will feature chamber music, orchestral works, and one choral concert by the Litchfield County Choral Union July 26 at 3:30 p.m. All other concerts are on Friday and Saturday evenings at 8:30 p.m. in the Music Shed.

FLORIDA

NEW COLLEGE MUSIC FESTIVAL. Sarasota, May 31-June 20. Paul Wolf, music director. Millicent Fleming, administrative director. Three weeks of intensive study, rehearsal and performance under the direction and guidance of distinguished visiting faculty artists including Joseph Silverstein, Robert Bloom, Samuel Baron, and Robert Nagel. Six major concerts by faculty artists.

ILLINOIS

GRANT PARK CONCERTS. Chicago, June 27-August 30, 1981. Steven A. Ovitsky, general manager. Conductors for 1981 include David Zinman, Leonard Slatkin, George Cleve, Gaetano Delogu, Mitch Miller, Norman Leyden, and Thomas Peck. Soloists include Tedd Joselson, Walter Klien, Robert Levin, Sheldon Shkolnik,

Mark Kaplan, Sergiu Luca, Hermann Baumann, Jorma Hynninen, Arnold Voketaitis, Manuel Barrueco, and the New Swingle Singers.

Highlights are the world premier of Jan Bach's Piano Concerto, Ravel's "L'Enfant et les Sortilèges," concerts devoted to music of Dvorak and Sibelius; and performances by the Grant Park Symphony Chorus of Beethoven's Ninth Symphony, Haydn's Harmoniemesse, Walton's "Belshazzar's Feast" and the German Requiem by Brahms.

The Grant Park Symphony Orchestra performs at all concerts which include pops and ballet performances.

RAVINIA FESTIVAL. Highland Park, June 26-August 30. James Levine, music director. Entering its forty-sixth season, the festival plans programs of symphonic concerts, recitals, chamber music, orchestral pops concerts, pop/jazz/folk attractions, master classes and children's concerts. The season opens with the first Ravinia/Chicago Symphony performance of Verdi's "Macbeth," with Sherrill Milnes and Renata Scotto in the leading roles. French music will be the emphasis during the eight weeks of concerts by the Chicago Symphony Orchestra and chamber music events in the Murray Theatre. James Levine will conduct the first Chicago performance of Zemlinsky's Lyric Symphony on July 11, with soloists Johanna Meier and Tom Krause. Judith Blegen, Philip Creech, and Donald Gramm will be the soloists for Haydn's "The Seasons" by the Chicago Symphony and Chorus on July 12, with Levine conducting. Guest conductors will be Neville Marriner, James Conlon, Jesus Lopez-Cobos, Edo de Waart and Kurt Masur. Franz Allers and Erich Kunzel will conduct seven orchestral pops concerts, and Zubin Mehta will conduct the New York Philharmonic in two performances on August 24 and 25. Teaching master classes will be Lynn Harrell, Donald Gramm, Horacio Gutierrez and Jean-Pierre Rampal, all soloists at Ravinia con-

certs. Pop/jazz/folk attractions include Preservation Hall Jazz Band, Harry Chapin, Gordon Lightfoot, Kris Kristofferson, Melissa Manchester, Emmylou Harris, and the Summer of '42 show. Also among this year's soloists: Yuri Egorov, André Watts, Alicia de Larrocha, Kenneth Noda, Misha Dichter, Emanuel Ax, Garrick Ohlsson, Giuliano Ciannella, Timothy Jenkins, New World String Quartet, Michael Ouzounian, Christian Altenburger, Shlomo Mintz, James Galway, Cho-Liang Lin, Kyung-Wha Chung, Mark Kaplan, Kun-Woo Paik, Doc Severinsen, Dave Brubeck and the Brubeck Quartet, and Robert Merrill.

INDIANA

FESTIVAL MUSIC SOCIETY. Indianapolis, July 6-27. Programs include performances by the Indianapolis Brass Quintet, the Smithsonian Chamber Orchestra, and the Cincinnati Early Music Consort. Igor Kipnis, harpsichordist, will give a solo recital, a duo recital with John Solum, flute, and a duo recital with James Weaver, forte-piano.

MAINE

BAR HARBOR FESTIVAL. Bar Harbor, July 3-August 14. Francis Fortier, artistic director. The performers for the fifteenth anniversary season include: violinists Francis Fortier, Paul Childs; violist Liane Marston; cellist Jeanne LeBlanc; pianists Tana Bawden, Judith Olson, Steven Mayer, and Diana Kacso; mezzo-soprano Mary Anne Hart. The Acadia String Quartet and the Acadia Trio are the ensembles in residence. The Bar Harbor Festival String Orchestra, directed by Francis Fortier, will also perform. The Singing Boys of Pennsylvania, directed by Bernard Schade, will make a guest appearance. Highlight of the 1981 Festival include free outdoor chamber music: concerts by the Acadia String quartet in Blackwoods and Seawall Campground Amphitheatres of Acadia Na-

tional Park; recitals and chamber music concerts in the Bar Harbor Congregational Church; and pops concert series at the historic Bar Harbor Club. Major works to be performed include Beethoven's Trio No. 7 (Archduke), the Schumann Quintet for Piano and Strings in E flat, Op. 44; the world premiere of James Park's String Quartet (1980); and a concert of American music featuring works by Barber, Douglas Moore, and Piston.

MASSACHUSETTS

ASTON MAGNA FESTIVAL. Great Barrington, June 28-July 18. Albert Fuller, artistic director. This season's performers include Fortunato Arico, Albert Fuller, Stephen Hammer, John Hsu, Judith Nelson, Lionel Party, Elizabeth Pruett, Charles Bressler, Jan Opalach, Linda Quan, Stanley Ritchie, Jaap Schroder, and John Solum. Featured are works by Monteverdi, Cavalli, Vivaldi, Telemann, and Mozart. A seminar will be held entitled "Venice in the Age of Monteverdi: 1575-1650." Concerts each weekend at 6 pm at St. James Church on July 3, 4, 10, 11, 17, 18.

CAPE & ISLANDS CHAMBER MUSIC FESTIVAL. Cape Cod, Martha's Vineyard, Yarmouth Port, Wellfleet, Falmouth, August 1-17. Evelyn Velleman, administrative director, Samuel Sanders artistic director and pianist. Featuring Kathleen Lenski, violin; Myra Kestenbaum, viola; Robert Sylvester, cello. Guest artists include Carol Wincenc, flute; James Van De Mark, double bass; Robert White, tenor; and Joanna Simon, mezzo-soprano. One program will feature works by Cape area composers and works with particular relevance to the region, such as Crumb's *Voice of the Whale*.

SOUTH MOUNTAIN CONCERTS. Pittsfield, August 1-November 7. Mrs. Willem Willeke, music director. This season's performers include the Beaux Arts Trio, the Clark/Schul-

man Duo with Robert J. Lurtsema, the American String Quartet, and Boris Goldovsky and his Mostly Mozart Quartet of singers. Most concerts are given in the Coolidge Auditorium.

MICHIGAN

ANN ARBOR MAY FESTIVAL. Ann Arbor, April 29-May 2. Programs feature the Philadelphia Orchestra conducted by Eugene Ormandy, with soloists Judith Blegen, soprano; and Gyorgy Sandor, piano. Aldo Ceccato will conduct the Rossini's *Stabat Mater* with soloists Faye Robinson, soprano; John Gilmore, tenor; Katherine Ciesinski, mezzo-soprano; and John Cheek, bass-baritone. Ceccato will also conduct the Bruch Violin Concerto with Ani Kavafian, violin. All concerts are at 8:30 pm in the Hill Auditorium.

INTERLOCHEN ARTS FESTIVAL. Interlochen, June 28-August 24. Edward J. Downing, director. Planned performances for this season include appearances by the Pittsburgh Symphony Orchestra, the Fred Waring Show, the Glen Miller Orchestra, Roger Wagner, the Coast Guard Band, Pete Fountain, the U.S. Army Band, and Bob James. In addition, more than 300 other events will feature faculty, staff, and campers in a wide range of fine arts performances. Conductor in residence will be Henry C. Smith, who will share duties with guest conductors Glenn Block, Donald Johanos, and Robert Marcellus. Also highlighting the summer will be productions of *Kiss Me Kate* and *H.M.S. Pinafore*.

MATRIX: MIDLAND CELEBRATION OF THE ARTS AND SCIENCES. Midland, June 5-21. Presented this season are Robert Merrill and Anna Moffo in an "Italian Opera Night" in Dow Gardens; *St. Mark's Gospel*, starring Eric Booth; a writer's conference, featuring author James Heller; an outdoor production of *A Funny Thing Happened on the Way to the Forum*, the

new music for Carnegie Hall Corporation presents

young ensembles, inc.

George Rochberg:
Duo for Bassoon and Oboe

Phillip Ramey:
"La Citadelle," Rhapsody for
Oboe & Piano (rev. 1980)
(World Premiere)

Francis Poulenc:
Trio for Oboe, Keyboard & Bassoon

William James Ross:
Diverimento for Flute, Clarinet,
Bassoon, Trumpet and Percussion
(1980 Co-winner—World Premiere)

William Walton:
Facade # 2

Bert Lucarelli, Oboe
Janet Bookspan, Narrator
Ainslee Cox, Conductor
Donald MacCourt, Bassoon
Thomas Hryniv, Piano
Bernard Yannotta, Clarinet
Sue Ann Kahn, Flute
David Aks, Cello
Lewis Wyatt, Saxophone
Richard Brown, Percussion
John Aley, Trumpet

Carnegie Recital Hall
Thursday, May 14, 1981
at 8 p.m.

Summer Voice Institute June 29 — July 17, 1981

An interdisciplinary approach to the study of the Voice in Singing, Acting and Speech. Designed for singers, actors, choral and stage directors, voice therapists, teachers of vocal music and speech pathologists.

- Voice lessons
- Vocal Coaching in Repertoire and Style
- Voice and Body Movement for the stage
- Analysis of Vocal Problems in Speech and Song
- Speech Therapy and Vocal Rehabilitation

Resident and Guest Faculty
Undergraduate — Graduate credit
enrollment or non-credit participation

Write: Dr. Frank Pullano
State University College
Fredonia, N.Y. 14063

FREDONIA
STATE UNIVERSITY COLLEGE

Northwood Symphonette, leading brain theorists Solomon Snyder and Karl Pribram, and psychic Karrell Fox.

MEADOW BROOK MUSIC FESTIVAL. Rochester, June 25-September 6. Neville Marriner, artistic director. Summer home of the Detroit Symphony Orchestra. Conductors include: Neville Marriner, Michael Tilson-Thomas, Sixten Ehrling, Semyon Bychkov, Paavo Berglund and Gaetano Delogu. Guest artists include: Ruth Laredo, Ida Haendel, Joseph Suk, Jessye Norman, Misha Dichter, Heinz Holliger and Ivan Moravec. Sunday Pops Concerts include the following conductors, artists, and attractions: Richard Hayman, Jack Jones, The Detroit Concert Band, Barbershop Quartet Champions, Kingston Trio, Margaret Whiting, Preservation Hall Jazz Band, Thomas Michalak, The New England Conservatory Ragtime Ensemble, Miklos Rozsa, Flavio Varani, and Neville Marriner. Popular concerts will feature Cleo Laine and James Galway, Lettermen and Four Freshmen, Chrystal Gayle, Rodney Dangerfield, Harry Belafonte, Kris Kristofferson, Lionel Hampton, and Count Basie.

NEW MEXICO

THE JUNE MUSIC FESTIVAL. Albuquerque, June 1-11. The fortieth anniversary features an appearance by the Guarnari String Quartet. The concerts will be held at Woodward Hall at the University of New Mexico in Albuquerque. Single and season tickets are available.

NEW MEXICO FESTIVAL. Taos, July 17-August 16. Mark Camphouse, music director. Symphonic and chamber music performances by young musicians who work closely with orchestral faculty, and present two symphonic concerts weekly, plus ensemble programs and recitals. Highlights are the Barber Violin Concerto, Henze Symphony No. 5,

Hendemith's "Mathis de Maler," plus works by Bacon, Bartók, Elgar, and Schuller.

NEW YORK

CARAMOOR MUSIC FESTIVAL. Katonah, June 27-August 23. Featured is the Caramoor Festival Orchestra with conductors including James Conlon, Michael Feldman, Julius Rudel, John Nelson; and soloists Misha Dichter and Ivo Pogorelic. Concerts will be given by the St. Luke's Chamber Ensemble, The Waverly Consort, Beaux Arts Trio, Tokyo String Quartet, and the New York Chamber Soloists. Recital artists include Emmanuel Ax, Young Vok Kim, Yo Yo Ma, Paula Robison, Ruth Laredo, Pinchas and Eugenia Zukerman, Rudolf Firkusny, and Richard Stolzman. Other events include two children's programs, a dance program for children, and two performances of *The Ballad of the Bremen Band*, a Caramoor commissioned opera.

MOSTLY MOZART FESTIVAL. New York City, July 13-August 29. Mostly Mozart Festival Orchestra with guest conductors Alexander Schneider, James Conlon, Christopher Eschenbach, Michael Tilson-Thomas, Leonard Slatkin, and Pinchas Zuckerman. Soloists Jean-Pierre Rampal with Russell Sherman, Emanuel Ax, Misha Dichter, Jessye Norman, Alicia de Laroccha, and Lynn Harrell. Chamber music by the Cleveland Quartet with Rudolf Firkusny, the Tokyo Quartet with Richard Goode and Paula Robison, the Beaux Arts Trio, the Kalichstein-Laredo-Robinson Trio, the Aspen Chamber Symphony, and the Marlboro Winds.

NEW YORK PHILHARMONIC SPRING FESTIVAL. New York City, May 27-June 19. Guest conductors include James Conlon, Kiril Kondrashin, James Levine, Kurt Masur, and Christoph Von Dohnanyi. Guest soloists are John Aler, tenor; Emanuel Ax and Bella Davidovich, piano; Julius

Baker, James Galway, flute; Kathleen Battle and Roberta Knie, sopranos; Itzhak Perlman, Rosa Fain, and Glen Dicterow, violin. All concerts at 8 pm at Avery Fisher Hall.

PINE ORCHARD ARTISTS FESTIVAL. Pakenville, July 25-August 7. Featured are performances of Menotti's "The Consul" with soprano Alexandra Hunt, on July 25, 31 and August 7, and Mozart's "Così fan tutte" with soprano Carolyn Heafner on July 26, August 1 and 5. Musical director for both operas is Terence Frazor, stage director Jay Pouhe, designer Irving Milton Duke. Other events include plays for children and films.

SARATOGA PERFORMING ARTS CENTER. Saratoga Springs, July 7-25: New York City Ballet, George Balanchine, Jerome Robbins, and John Taras, Ballet Masters. August 5-22: the Philadelphia Orchestra, Riccardo Muti, music director, Eugene Ormandy, conductor laureate, and guest conductors. Also appearing will be the Saratoga Potsdam Chorus, Brock McElheran, director. John Houseman Summer Theater—July 26-Aug. 8: The Empire State Youth Theater Institute; Aug. 9-22: The Acting Company. July 4 & 5: The Newport Jazz Festival. The Center also features SPAC Specials presenting rock groups, folk singers, country-western artists and the top entertainers in show business from mid June to August.

OHIO

BLOSSOM MUSIC CENTER. Akron, June 15-September 13. Lorin Maazel, music director. Summer home of The Cleveland Orchestra. Festival Concerts, Pops Concerts, Sunday Series, Ballet, and Special Attractions. The Festival Concerts, led by such conductors as Lorin Maazel, Sir Colin Davis, Michael Gielen, Jesus Lopez-Cobos, Eduardo Mata, and Andrew Davis, run from July 10 through August 30. While embracing a broad

Continued on page 44

Sir Georg Solti*Continued from page 8*

already know now that on September 14 you have to go to a concert, and you *hate* it. Maybe you have a headache or a stomachache, or want to play bridge or go to the cinema. But you go to the concert because you have a ticket. That's what we are fighting here."

Solti made no secret of his displeasure with certain audiences when he first came to Chicago, but he recognizes that the Chicago musical public has improved. "I must say that if I think back over the last twelve years, there is a tremendous change. We have certain audiences now which are as good as any major European audiences.

"I've been thinking for years of a major campaign to improve listening capacity, because that's what we are talking about. It's not a question of politeness. Nobody wants to insult me or the orchestra. They are very proud of us. But they never had a chance to realize *why* you listen, or *how* you listen. The trouble is that this has to be learned, how to listen. Look, the ideal would be if I could take every subscription audience to a rehearsal, to show them what we work on. Then they will see what is important in listening to music." Solti's face glows with inspiration: "Maybe once I will have to take all my subscribers to the sports stadium and lecture!"

The day after we talked, Sir Georg and the Orchestra made their first record together in Orchestra Hall, a lovely, seventy-six-year-old building scheduled for minor surgery over the summer. The Decca/London team was delighted with the sound of Bartók's *Concerto for Orchestra*, and immediately scrapped plans to move back to Medinah Temple for the next week's sessions. Solti was doubly pleased, because this was the first time that he had recorded music of his fellow-Hungarian and former teacher with the Chicagoans.

This month, after taping the *Damnation du Faust*, Solti looks forward to a rare masterclass. "Oh, I enjoy it more than the people around me!" he says with a grin. "It's so enjoyable to pass something on, and see how it works."

Solti looks to these next years in Chicago as his greatest challenge. He repeated a colleague's words: "The most difficult is beyond the peak where the air is so thin." "Now," Solti said, "this is our task—to stay on the peak."

In January, Solti announced that Claudio Abbado will become principal guest conductor in 1982, a position vacated by Carlo Maria Giulini in 1972. Chicagoans are quick to interpret this as the first step in grooming Abbado for Solti's job, although Abbado has expressed no interest in taking on such responsibility in America. In any event, Sir Georg has every hope to stay with his orchestra until its centenary in 1990-91. "But that," he says with a smile and a sly glance heavenward, "is not in my hands." **MA**

MAESTRO EDOARDO DE FALCE

Teaches the Art of Bel Canto
25 years singing and teaching in Italy
Italian, French and German spoken
Tel. (212) 874-5000, Ext. 158

DALCROZE INTERNATIONAL SCHOOL OF MUSIC

Combining the
best features of
European and
American Music
Education



Complete Music
Curriculum—Artist
Faculty—Dalcroze
Teacher's Certificate
Program

Only Authorized Dalcroze Teachers'
Training School in the Americas
DR. HILDA M. SCHUSTER DIRECTOR
161 E. 73rd St., New York, N.Y. 10021 TR 9-0316

THE CLEVELAND INSTITUTE OF MUSIC

11021 East Blvd. • Cleveland, Ohio 44106
BM, MM, DMA, Diploma, Artist Diploma

**DIRECT FROM THE CLEVELAND
INSTITUTE OF MUSIC TO THE
DETROIT SYMPHONY**

Paul Silver was chosen first out of 58 who auditioned for the Detroit Symphony. He had a brand new masters degree from The Cleveland Institute of Music and a plan. Plans for a music career should include an internationally acclaimed conservatory with a stellar faculty. Like The Cleveland Institute of Music. Go for it. Auditions for The Institute of Music held in New York, Boston, Atlanta, Dallas, San Francisco, Seattle, Chicago and major U.S. cities. Phone Dean Rhoda Payne for admissions information.

216-791-5165 Grant Johannesen, President

Aston Magna

Albert Fuller, Artistic Director

9th Summer Season of Festival Concerts

Friday and Saturday evenings
July 3rd, 4th, 10th, 11th, 17th and 18th, 1981
St. James' Church

Great Barrington, Massachusetts
in conjunction with the

NEH-Sponsored 4th Aston Magna Academy

Raymond Erickson, Director

For ticket & public lecture information:

Aston Magna
65 West 83rd Street
New York, NY 10024
(212) 595-1651



SEWANEE SUMMER MUSIC CENTER June 20—July 26

Chamber music, orchestras, private instruction, theory, composition, and conducting—for intermediate and advanced students. Exceptional repertoire and performing opportunities. Artist faculty. College credit. Weekend chamber music and orchestra concerts begin June 21. The Annual Festival, July 23-26.

M. McCrory, Director
Sewanee, Summer Music Center
Sewanee, Tenn. 37375



Continued from page 42
range of repertoire, the Festival Concerts will spotlight the music of Beethoven, whose Symphonies nos. 3, 5, 8 and 9, Piano Concerto no. 2, and Violin Concerto which will be performed over the eight week period. The Cleveland Orchestra will also assist the Houston Ballet in four performances, (August 13-16). Soloists scheduled for the Blossom season include Leonard Rose, cellist; Elmar Oliveira, violinist; James Galway, flutist; Horacio Gutierrez, pianist; Clive Lythgoe, pianist; Dylana Jensen, violinist; and Heinrich Schiff, cellist.

OREGON

OREGON SUMMER FESTIVAL. Eugene, June 22-July 5. Helmuth Rilling, music director. Major works to be performed include eight cantatas and the G minor Mass of J.S. Bach, the Haydn *Lord Nelson* Mass, and Mendelssohn's *Elijah* with soloists Delcina Stefenson, Alyce Rogers, Douglas Lawrence, and John Humphrey. Also featured are recitals by Ingo Goritsky, oboe; Douglas Lawrence, baritone; and Guy Bovet, organ; plus two concerts of chamber music by the Los Angeles String Quartet. Free noon concerts will be given daily by members of the Festival Orchestra. Two lectures will be given by New York Times critic Harold Schonberg on the topics "Pianists—past and present" and "Singers—past and present."

RHODE ISLAND

NEWPORT MUSIC FESTIVAL. Newport, July 15-26. Three concerts will be given daily by internationally-known guest artists, and will include chamber music concerts and solo recitals. Roster has not been finalized.

TEXAS

HOUSTON SYMPHONY SUMMER FESTIVAL. Houston, July 15-25. Sergiu Comissiona, artistic advisor. All-

Tchaikovsky programs featuring the complete symphonies and piano concerti, as well as ballet music. Guest artists include Oxana Yablonskaya, David Bar-Illan, and Michael Ponti, pianists; Ruben Gonzalez and Eugene Fodor, violinists; Nathaniel Rosen and Shirley Trepel, cellists. Prior to each concert there will be a 45-minute program featuring chamber music of the composer.

WISCONSIN

MORAVIAN MUSIC FESTIVAL AND SEMINAR. Waukesha, June 17-21. Barbara Strauss, general chairman; Dr. James Boeringer, music director. Performances by the Festival chorus, directed by David Crosby and accompanied by the Wisconsin Chamber Orchestra; band concerts, ensembles, and trombone choirs directed by Jeffrey Reynolds, trombonist of the L.A. Philharmonic; recitals by the Wisconsin Brass Quintet. The Seminar, "Moravians in the Midwest: The Second Generation," coordinated by Mary Tipton, will include a field trip to Old World Wisconsin, an outdoor ethnic museum, a visit to restored German and Norwegian farmsteads.

WYOMING

GRAND TETON MUSIC FESTIVAL. Teton Village, Jackson Hole, July 15-August 22. Twentieth anniversary season. Ling Tung, music director and conductor. Congregation of one hundred resident artists performing five-to-six concerts a week in Festival Hall, on the lower slope of the Teton Mountains. Symphony concerts, chamber music, baroque, recitals, and "Music in the Present Tense." Roger Ruggeri, director of this weekly program devoted to 20th century music. Karel Husa, composer-in-residence. Roster includes Steven DeGroot (piano), Hidetaro Suzuki (violin), Sharon Isbin (guitar), the Chester Quartet, Lionel Party (harp-sichord), and Gregory Fulkerson (violinist & winner of the 1980 Rockefeller Competition).

CANADA

FESTIVAL OTTAWA, OPERA PLUS. July 4-29. National Arts Center. Mario Bernardi, artistic director. Featured operas are *Idomeneo* with George Shirley, Pauline Tinsley, and Benita Valente, conducted by Mario Bernardi, designed by Josef Svoboda; *Rigoletto* with Louis Quilico, Ruth Welting, Neil Shicoff, conducted by Paolo Peleso, directed by Jean Herbiet, designed by Pier Luigi Pizzi; Britten's *Midsummer Night's Dream* with Norma Burrowes, John York Skinner, and John Stewart, conducted by Mario Bernardi, directed by Brian MacDonald; *Bastien and Bastienne* and *The Impresario* will be in concertized form with Constanza Cuccaro and Claude Corbeil, conducted by Franz Paul Decker. The chamber music series features the Prague, Orford, New Budapest, Emerson, and Tokyo String Quartets, plus pianists Jean-Philippe Collard and Michel Beroff. The festival is planning a tribute to Bartók and will include lectures by Bela Bartók Jr. and Bartók scholars plus a folkloric musical group.

GUELPH SPRING FESTIVAL. Guelph, April 30-May 17. Featured will be the Canadian premieres of Dominick Argento's opera *Postcard from Morocco* with Glyn Evans, Henry Ingram, Giulio Kukurugya, Mark Pedrotti, Roxolana Roslak, Janet Smith, and Janet Stubbs, conducted by Nicholas Goldschmidt; and Leoncavallo's *La Bohème* with Theodore Baerg, Janet Coates, Carrol Anne Curry, and Roeffel Oostwoud, directed by Stuart Hamilton. Also featured are recitals by Teresa Stratas, Norbert Kraft with Bonnie Silver, Ronald and Avis Romm, Joan Morris with William Bolcom, and Woody Herman; plus performances by Les Grands Ballets Canadiens, the Scottish Baroque Ensemble, Lutnia Choir of Poland, Nuovo Compagnia di Canto Popolare di Napoli of Italy, Canadian Brass, Coop/Dodington/Robbin Trio, Israel Piano Quartet, and Toronto Symphony Youth Orchestra.

exquisitely orchestrated miniatures of the *Hungarian Sketches* (or *Pictures*), which are also to be found on Reiner's fine record of the *Music for Strings, Percussion, and Celesta*. Skrowaczewski scores in his treatment of the vulgar tune, but Mehta's handling of the finale is more firmly structured.

In view of my comments about Solti's recordings with the London Symphony, it will surprise no one that I find their version of the *Concerto for Orchestra* (London CS 6784) to be one of the very best—alertly performed (does anyone

else kick into the finale's fugue with more delicious high spirits?), clearly and cleanly recorded, and provided with a generous filler in the shape of the *Dance Suite*. But the Solti of fifteen years ago was perhaps more completely in tune with the earlier, more nervous Bartók than with this relatively serene work of his last years; tempos tend to be on the fast side, tempo changes are a little steep, and although the work's brilliance could hardly be better presented, some of its inwardness, its poetry, fails to come across. For this, I think I should

turn to a conductor who has not so far appeared in this survey, Rafael Kubelik. His performance with the Boston Symphony Orchestra on DG 2530 479 has all the power and discipline of a great American orchestra (in fact the one for which Bartók wrote the work), though tempered by a humane and cultivated sensibility. I would not claim that Kubelik's was a complete view of the *Concerto for Orchestra*, but it makes an excellent complement to Solti's, and Bartók's music is many-sided enough to be looked at from different viewpoints. **MF**

- DEUTSCHE GRAMMOPHON 2530 901—Piano Concertos Nos. 1 (Sz. 83), 2 (Sz. 95). Pollini; Chicago SO, Abbado.
- PHILIPS 9500 043—Piano Concertos Nos. 1 (Sz. 83), 3 (Sz. 119). Bishop-Kovacevich; London SO, Davis.
- PHILIPS 839 761—Piano Concerto No. 2 (Sz. 95). Bishop-Kovacevich; BBC SO, Davis. (Also STRAVINSKY: Concerto for Piano and Winds.)
- HUNGAROTON SLPX 11516—Piano Concertos Nos. 1 (Sz. 83), 2 (Sz. 95). Kocsis; Budapest SO, Lehel.
- DG PRIVILEGE—2535 333—Piano Concerto No. 1 (Sz. 83); Rhapsody for Piano and Orchestra (Sz. 27). Anda; Berlin RSO, Fricsay.
- DG PRIVILEGE 2535 262—Piano Concertos Nos. 2 (Sz. 95), 3 (Sz. 119). Anda; Berlin RSO, Fricsay.
- CBS MS 6405—Piano Concerto No. 1 (Sz. 83). R. Serkin; Columbia SO, Szell. (Also PROKOFIEV: Piano Concerto No. 4, with Philadelphia O, Ormandy.)
- LONDON TREASURY STS 15494—Piano Concerto No. 3 (Sz. 119). Katchen; London SO, Kertész. (Also RAVEL: Piano Concerto in G.)
- HUNGAROTON SLPX 11421—Piano Concerto No. 3 (Sz. 119). Ránki; Hungarian StO, Ferencsik. Viola Concerto (Sz. 120). Németh; Budapest PO, Kórody.
- TURNABOUT TVS 34036—See Chamber Works.
- TURNABOUT TVS 34483—Piano Concerto No. 3 (Sz. 119). G. Sándor; Pro Musica O, Gielen. Viola Concerto (Sz. 120). Koch; Luxembourg RO, Springer.
- LONDON CS 6784—*Dance Suite* (Sz. 77); *Concerto for Orchestra* (Sz. 116). London SO, Solti.
- CANDIDE QCE 31100—*Dance Suite* (Sz. 77); *Concerto for Orchestra* (Sz. 116). Minnesota O, Skrowaczewski.
- PHILIPS 6500 931—*Dance Suite* (Sz. 77); *Music for Strings, Percussion, and Celesta* (Sz. 106). Philharmonia Hungarica, Dorati.
- CBS M 31368—*Dance Suite* (Sz. 77); *The Miraculous Mandarin* (Sz. 73) (with Schola Cantorum of New York). New York P, Boulez.
- ARGO ZRG 657—*Music for Strings, Percussion, and Celesta* (Sz. 106); *Divertimento* (Sz. 113). St. Martin's Academy, Marriner.
- LONDON CS 6783—*Music for Strings, Percussion, and Celesta* (Sz. 106); *The Miraculous Mandarin* (Sz. 73). London SO, Solti.
- RCA VICTROLA VICS 1620—*Music for Strings, Percussion, and Celesta* (Sz. 106); *Hungarian Sketches* (Sz. 97). Chicago SO, Reiner.
- CBS MS 7206—*Music for Strings, Percussion, and Celesta* (Sz. 106). BBC SO, Boulez. (Also STRAVINSKY: *Firebird*; Suite.)
- ANGEL SZ 37608—*Music for Strings, Percussion, and Celesta* (Sz. 106); *The Miraculous Mandarin* (Sz. 73); Suite. Philadelphia O, Ormandy.
- CBS MS 6956—See Chamber Works.
- DEUTSCHE GRAMMOPHON 2530 065—*Music for Strings, Percussion, and Celesta* (Sz. 106). Berlin PO, Karajan. (Also STRAVINSKY: *Apollo*.)
- HUNGAROTON SLPX 1301—*Music for Strings, Percussion, and Celesta* (Sz. 106); *The Miraculous Mandarin* (Sz. 73); Suite. Budapest SO, Lehel.
- DEUTSCHE GRAMMOPHON 2530 887—*Music for Strings, Percussion, and Celesta* (Sz. 106); *The Miraculous Mandarin* (Sz. 73); Suite. Boston SO, Ozawa.
- ANGEL S 35949—*Music for Strings, Percussion, and Celesta* (Sz. 106). Berlin PO, Karajan. (Also HINDEMITH: *Mathis der Maler*.)
- TURNABOUT TVS 34613—*Music for Strings, Percussion, and Celesta* (Sz. 106) (with London PO); *Dance Suite* (Sz. 77) (with London SO). Solti.
- EVEREST 3355—*Music for Strings, Percussion, and Celesta* (Sz. 106); *Divertimento* (Sz. 113). Cologne PO, Wand.
- MERCURY SRI 75118—*Divertimento* (Sz. 113). BBC SO, Dorati. (Also CORIGLIANO: Piano Concerto, with Somer; San Antonio SO, Alessandro.)
- HUNGAROTON SLPX 11437—*Divertimento* (Sz. 113); *Concerto for Orchestra* (Sz. 116). Hungarian StO, Dorati.
- HUNGAROTON LPX 11573—Violin Concerto No. 2 (Sz. 112). Székely; Concertgebouw O, Mengelberg.
- HUNGAROTON SLPX 11350—See Chamber Works.
- PHILIPS 6500 021—Violin Concerto No. 2 (Sz. 112); Rhapsody for Violin and Orchestra, No. 1 (Sz. 87). Szeryng; Concertgebouw O, Haitink.
- LONDON CS 7023—Violin Concerto No. 2 (Sz. 112). Chung; London PO, Solti.
- CBS MS 6002—Violin Concerto No. 2 (Sz. 112). Stern; New York P, Bernstein.
- CBS M 35156—Violin Concerto No. 2 (Sz. 112). Zukerman; Los Angeles PO, Mehta.
- ANGEL S 37014—Violin Concerto No. 2 (Sz. 112). Perlman; London SO, Previn.
- DEUTSCHE GRAMMOPHON 2531 249—Viola Concerto (Sz. 120). Benyamini; O de Paris, Barenboim. (Also HINDEMITH: *Der Schwanendreher*.)
- NONESUCH H 71239—Viola Concerto (Sz. 120). Hillyer; Japan PO, Watanabe. (Also HINDEMITH: *Der Schwanendreher*.)
- HUNGAROTON SLPX 11421—See above.
- LONDON TREASURY STS 15110—*Concerto for Orchestra* (Sz. 116). O de la Suisse Romande, Ansermet.
- EVEREST 3069—*Concerto for Orchestra* (Sz. 116). Houston SO, Stokowski.
- CBS MS 6815—*Concerto for Orchestra* (Sz. 116). Cleveland O, Szell. (Also JANÁČEK: *Sinfonietta*.)
- CBS M 32132—*Concerto for Orchestra* (Sz. 116). New York P, Boulez.
- ANGEL SFO 36035—*Concerto for Orchestra* (Sz. 116). Chicago SO, Ozawa. (Also KODÁLY: *Dances of Galánta*.)
- CBS MS 6140—*Concerto for Orchestra* (Sz. 116). New York P, Bernstein.
- RCA ARC 1-3421—*Concerto for Orchestra* (Sz. 116). Philadelphia O, Ormandy.
- MERCURY SRI 75105—*Concerto for Orchestra* (Sz. 116) (with London SO); *Romanian Folk Dances* (Sz. 68) (with Minneapolis SO). Dorati.
- ANGEL S 37059—*Concerto for Orchestra* (Sz. 116). Berlin PO, Karajan.
- RCA AGL 1-2909—*Concerto for Orchestra* (Sz. 116). Chicago SO, Reiner.
- CANDIDE QCE 31100—See above.
- LONDON CS 6949—*Concerto for Orchestra* (Sz. 116); *Hungarian Sketches* (Sz. 97). Israel PO, Mehta.
- LONDON CS 6784—See above.
- DEUTSCHE GRAMMOPHON 2530 479—*Concerto for Orchestra* (Sz. 116). Boston SO, Kubelik.

BACKBEAT

Superior Superdiscs

by Crispin Cioe

The Bee Gees: *Spirits Having Flown*

*The Bee Gees, Karl Richardson,
& Albhy Galuten, producers*
Half-speed remastered
Nautilus NR 17

In a characteristic Bee Gees production, rhythmic textures waft around in aural space without calling attention to any particular instrument. In this case remastering's extended dynamic range hasn't altered the instrumental balance, but it has brought out the trio's trademark falsetto harmonies on virtually every track. Other treats include an extremely crisp drum and cymbal sound on funkier numbers like *Love You Inside Out* and Alan Kendall's guitar on the title track. This is one of Nautilus' best offerings yet.

Boston

John Boylan & Tom Scholz, producers
Half-speed remastered
CBS Mastersound HE 34188

Boston's 1976 debut featured guitar overdubs in extremis with lots of doubling and fattening. The fact that the guitars were recorded so fastidiously to start with makes the album a fitting choice for an audiophile reissue. Add in Brad Delp's sweet lead vocals and you get unique, captivating American rock & roll that Boston itself has yet to equal.

The Cars

Roy Thomas Baker, producer
Half-speed remastered
Nautilus NR 14

Interesting dynamics and impressive imaging become quite apparent on the audiophile incarnation of the Cars' 1978 album debut. Greg Hawkes's keyboards and synthesizers detachedly hover around the relatively conventional yet precise crashing guitars. The group's sound is deceptively refined and well-suited for Ric Ocasek's songs of modern angst and anomie, and the ironies of a song like *Good Times Roll* are all the more notice-



Barry, Maurice, & Robin Gibb

able here. Roy Thomas Baker knew just how to contrast the Cars' inborn guttural American rock instincts with an ironic, British-sounding production coating.

Neil Diamond: *His 12 Greatest Hits*

Tom Catalano, executive producer
Half-speed remastered. DBX encoded
Direct-Disk Labs SD 16622

Neil Diamond first made his mark during the heyday of pop 45s, and his productions were among the most sweeping and grandiose ever designed for Top-40 radio. It was a style that might contrast—as on *Stones* and *Cracklin' Rosie*—an ultrapresent, ersatz flamenco guitar part with deeply reverberant bass and strings. Audiophile technology has beautifully illuminated what were, in retrospect, extremely meticulous and well-recorded productions. Worth the ticket.

The Best of Earth, Wind & Fire, Vol. 1

Maurice White, producer
Half-speed remastered
CBS Mastersound HC 45647

Earth, Wind & Fire's mixes are so

masterfully balanced and equalized that an audiophile set of their best cuts can't help but be impressive. Thick, pungent brass parts on *Got to Get You Into My Life*, deeply plunging bass lines underpinning the perfect vocal vibratos on *Fantasy*, crackling rhythm guitar parts on *Shining Star*—the list of aurally enhanced already-great sounds goes on and on. For pop/r&b mavens, this one's a must.

Dan Fogelberg & Tim Weisberg: *Twin Sons of Different Mothers*

Dan Fogelberg & Tim Weisberg, producers. Half-speed remastered
CBS Mastersound HE 45339

"Twin Sons of Different Mothers" yielded the hit single *The Power of Gold* and was well recorded on the first ground in '78. Here, Tim Weisberg's flute is consistently full and rich, but the most noticeable improvement is in the midrange: Fogelberg's acoustic guitar overlays sound wonderfully vibrant and lush throughout, especially on the classically flavored bossa nova *Guitar Etude No. 3*. The thoughtful sequencing of vocals and instrumentals is a refreshing change for a pop LP.

Dave Grusin: *Mountain Dance*

Dave Grusin & Larry Rosen, producers. Digitally recorded
Arista/GRP 5010

This is the best digital disc I've heard yet. Recorded live in the studio, the lightly funky pop/instrumental set features high-caliber musicianship throughout, with such players as drummer Harvey Mason and guitarist Jeff Mironov turning in assured and lively performances. Both the outside material and pianist Dave Grusin's originals are arranged with a good deal of popping rhythmic panache, especially *Friends and Strangers*, which Ronnie Laws popularized a couple of years ago. Most significantly, the sounds on this conventionally-priced LP are so stunningly alive and sensual that the al-



Townshend & Roger Daltrey

bum makes a completely convincing case for digital recording's continued rapid growth. When the aural, aesthetic, and technological elements are as compatible as they are on "Mountain Dance," the results are staggering.

Kansas: Point of Know Return

Jeff Glixman, producer
Half-speed remastered
CBS Mastersound HZ 44929

As America's answer to Yes, Kansas' hard-edged rock/classical fusion has always had a down-home earnestness that

distinguished the band from its European art-rock counterparts. Shifting rhythm patterns, exhaustive violin/guitar arpeggio battles, and heartland American rock vocals are the earmarks of its sound. Sometimes the playing sounds a tad contrived and wooden, especially in the rhythm section. But this is the kind of cleanly metallic rock that half-speed remastering greatly enhances, since the instruments have been recorded well and separated carefully in the mix. This album is certainly the definitive Kansas in all its Great Plains glory.

Willie Nelson: Stardust

Booker T. Jones, producer
Half-speed remastered
CBS Mastersound HC 45305

The album's concept alone should be a clue that it's a classic: Willie Nelson's emotive voice wrapped around ten ageless American popular standards, supported by his own band's elegantly understated playing and Booker T. Jones's diaphanous production. Nelson's soulful voice is like pricelessly hand-tooled, well-worn leather on tunes like *Georgia on My Mind* and *Blue Skies*, with every subtle nuance and irony clearly captured via great engineering and exemplary remastering.

Cal Tjader: La Onda Va Bien

Carl E. Jefferson, producer
DBX encoded
Concord Jazz Picante CJP 113

This mainstream analog recording, DBX encoded, features the acknowledged master of Latin jazz vibraphone playing supported by a bevy of sensitive and swinging San Francisco Bay Area musicians. The level of surface noise is low, while expanded dynamic range is especially apparent on an evocative Latinized *Star Eyes* that shifts from quiet ballad to uptempo cooker during solos. Roger Glenn's flute sound is warm and rhythmically propulsive, contrasting nicely with Cal Tjader's more laidback playing. Percussionist Poncho Sanchez gets plenty of room to step out on congas, and all his varied inflections are captured beautifully.

The Who: Who Are You?

Glyn Johns & Jon Astley, producers
Half-speed remastered
DBX encoded. Direct-Disk Labs
SD 16610



Boston's Tom Scholz

The Who may be the most sophisticated purveyors of traditional "natural-sounding" rock where drums, bass, guitars, and vocals all sound as if they were recorded live. A certain amount of room sound and leakage between tracks was part of Glyn Johns and Jon Astley's production strategy on this powerful '78 release, and the newly reduced surface noise renders that natural finish more cutting and present than ever. Remastering lends added bite to Pete Townshend's already-stinging guitar leads, especially on 3.905. This edition extends and clarifies the entire, glorious Who attack.

Input Output: Instruments and Accessories

Winter NAMM Report: Business Not as Usual

by Fred Miller

For those who want to know what's new in the world of musical instruments and accessories, the National Association of Music Merchants (NAMM) holds two conventions a year at which member manufacturers display their latest wares. NAMM shows are usually part high-tech, part hype, and part Elk convention, complete with free beer, demonstration bands, and smiling young ladies in tight clothing handing out product literature. Most attendees are buyers for or owners of musical instrument retail stores throughout the U.S.

This year's show, held early in February near Los Angeles, was markedly different from those of the past. Rather than free goodies and drunken bashes, potential buyers were given the total, undivided attention of some three-hundred-plus manufacturers large and small, all trying to get a solid footing in a not-so-solid marketplace.

What with the integration of digital technology, there was little at the show that could be called revolutionary, and the this-month's-model syndrome seems to have come to a grinding halt. Fender, Yamaha, Roland, Teac, and the other giants still had extensive displays and large staffs of employees, but everyone seems to have curbed new product development. No more supergizmos or digital distortion devastators—the emphasis instead seemed to be quality and versatility.

Some of the more interesting items came from very small companies. The HiLo Dolly Corporation's namesake and sole product is a combination hand truck/PA speaker platform. Helpinstill's Road-Master is based on a similar principle: an electric piano built into its own road case, suitable for shipping as is. D&M percussion introduced its Add-A-Tone percussion kit, a small acoustic chamber that fits under the drum head and enables you to get two different tones from any drum. In the good things in small packages depart-

ment was the Metrina Quartz pocket size metronome. It's battery operated, comes complete with a flashing I.F.D. earphone, and a built in speaker that will keep you in time and in tune, since the unit can generate its own 440 Hz tone. Barcus Berry has a new Insider guitar pickup that fits inside the guitar. Pocket Fuzz from Zoler Systems is a 2 by 3 by 1 inch guitar amplifier for backstage warmup, street performances, or any occasion to which you don't feel like lugging your regular amp. All of these products are representative of practical yet innovative thinking—a new trend that comes straight out of old fashioned Yankee ingenuity. It was nice to see manufacturers using their heads instead of their publicists.

Moving on to the Big Boys, Altec Lansing has announced a new line of speakers from subwoofers to stage monitors called Stanley Screammers. I didn't stay for the demonstration, but I heard them loud and clear in the next aisle, so I'm sure they live up to their name. ARP introduced its Arpiano, an electronic keyboard with settings for acoustic and electric piano, vibes, and harpsichord. Audio Technica has a new remote powered electret condenser microphone. Also present and accounted for were such old faithfuls as Moog, Ludwig Industries, Ampeg, Peavey, Gretsch, Crown International, Nady, Electro Voice, Morley, Ibanez, MXR, Guild, Baldwin, Senn, and Steinway. Publishers such as Warner, Big 3, and Cherry Lane were also on hand, as were *Guitar Player*, *Modern Recording*, *Musician Player and Listener*, and several other magazines.

Seminars at the convention covered such topics as Creative Financing for the Professional Audio Equipment Dealer and Everything You've Always Wanted to Know About Harmonicas but Were Afraid to Ask(!). The show lasted three days, and for all the talk of a depressed economy, it was the largest winter NAMM convention to date with over 13,000 attendees. ☛

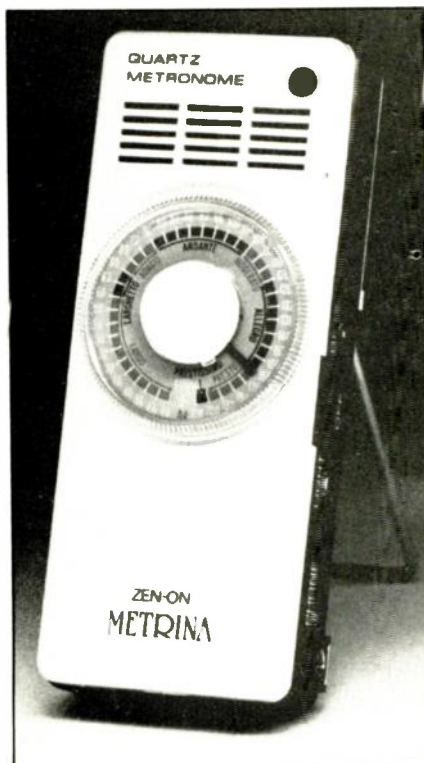

Pocket-size metronome



A 2" by 3" by 1" guitar amp

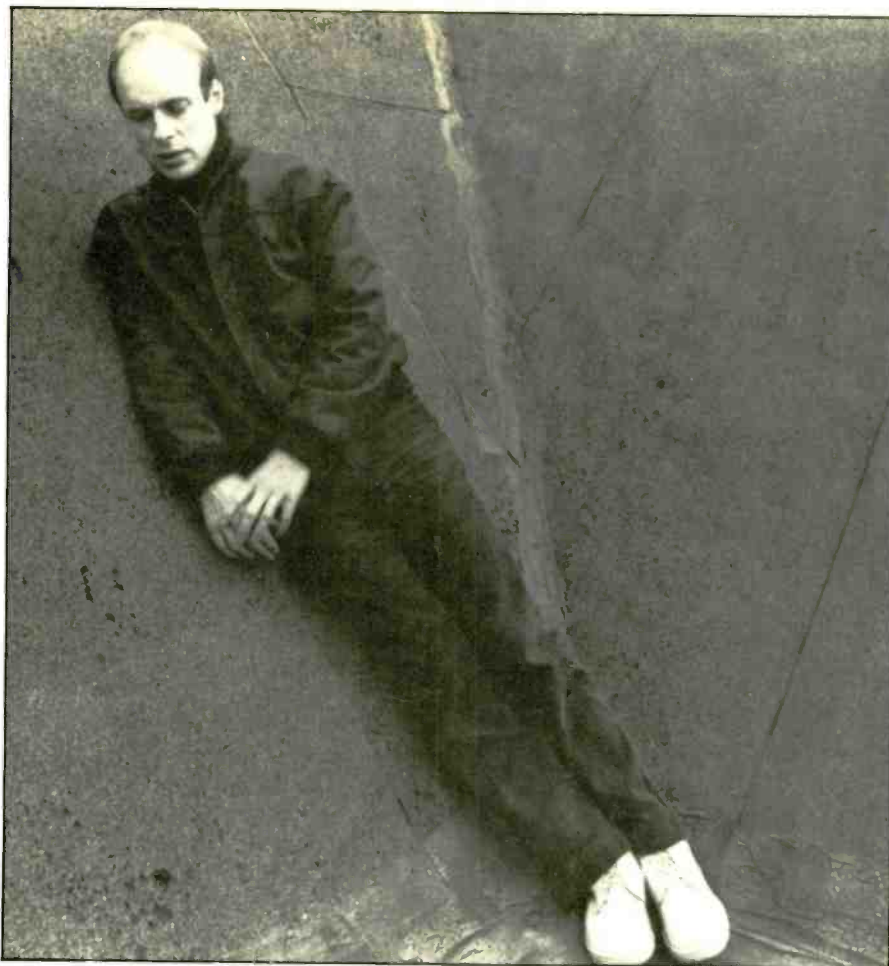

Eno: an excursion into musical anthropology and montage

Cash: earthy and forthright

David Byrne—Brian Eno:
My Life in the Bush of Ghosts

David Byrne & Brian Eno,
producers. Sire SRK 6039
by Mitchell Cohen

On no other album in 1981 will you hear a group of Algerian Muslims, a Lebanese mountain singer, an exorcist, and the head Talking Head engaged in an exercise in musical anthropology and montage. David Byrne and Brian Eno, layering percussive patterns and swatches of electronic music over voices taken from radio programs and existing LPs like "The Human Voice in the World of Islam," have made a record of fascinating eccentricity. As a global aesthetic experiment that challenges notions of what constitutes pop music, "My Life in the Bush of Ghosts" has numerous points of interest. As a listening experience, it is half compelling, half maddening.

The album combines elements of Eno's ambient LPs and the incandescent

"Remain in Light" (by Byrne's Talking Heads) with the kind of music usually available on Elektra/Nonesuch's Explorer label. Side 1, in particular, has a few striking tracks—the rhythmic *The Jezebel Spirit* and *America Is Waiting*, on which Byrne and Eno whip up a funk background behind an enraged radio announcer from San Francisco. *Regiment's* rhythmic section is composed of two current Heads (Busta Jones and Chris Frantz) and *Help Me Somebody*, which is based on the preaching of Reverend Paul Morton, builds up an intense fervor similar to *The Great Curve* from "Remain in Light."

Side 2 is more esoteric and more problematic. It just becomes too much, and some of the juxtapositions are unintentionally humorous. On *Come with Us*, an evangelist is accompanied by pops and bleeps reminiscent of a computer game in a Broadway amusement arcade. The opening music of *Qu'ran* sounds like swarming insects, and when the Muslims

come in it's as if they're chanting to rid themselves of a locust plague. These detours, and pieces that could be a soundtrack to a Tibetan Army training film, aren't damaging enough to write off "My Life in the Bush of Ghosts" completely. When musicians are as talented and as eager to test boundaries as Byrne and Eno, even a failed effort such as this one offers moments of idiomatic illumination.

Rosanne Cash: Seven Year Ache

Rodney Crowell, producer
Columbia JC 36965
by Steven X. Rea

It isn't the subject matter that distinguishes Rosanne Cash from her female country counterparts; country music has always been a wellspring for songs about the deliriums of new love, love gone sour, jealousy, infidelity, true love, etc. No, what sets Johnny Cash's daughter apart from the crowd is her impeccable taste—in material, musicians, and producer/hus-

bands. Rodney Crowell has been responsible for giving her confidence in her own considerable talents, the foremost of which is her remarkable, instinctive voice. Over the year or so that's lapsed between her excellent debut "Right or Wrong" and "Seven Year Ache," Cash's singing has acquired new strength and nuance. Her earthy, forthright timbre chimes true and sure.

Flanked by sundry members of the Emmylou Harris/Brian Ahern/Hot Band axis, Rosanne rarely falters here. Two self-penned pieces, the title track and *Blue Moon with Heartache*, are uncommonly eloquent. The former glides over some rough emotional terrain (buoyed by Glen D. Hardin's ardent rhythm piano), ascending to a near-hypnotic chorus with Rosemary Butler and Rosanne murmuring in unison. "The boys say when is he gonna give us some room/The girls say God I hope he comes back soon." *Blue Moon* . . . sounds like its title: slow, sad and lonesome. Emory Gordy, Jr.'s string arrangements lend a lush commerciality that marks this song for the country charts.

Crowell and Cash have both previously recorded Keith Sykes's work, and "Seven Year Ache" is no exception, sporting two of the Memphis-based singer/songwriter's tunes. *Rainin'* is an upbeat, bluesy rocker aswirl in Booker T. Jones's organ and Albert Lee's per usual dazzling guitar. The other Sykes entry, *Only Human*, fares less successfully; two further disappointments are the raucous but ultimately vacuous reading of Steve Forbert's *What Kinda Girl?* (transposed from *What Kinda Guy?*) and Tom Petty's *Hometown Blues*.

On the other hand, there's Leroy Preston's *My Baby Thinks He's a Train*, on which Rosemary, Emmylou, and Rosanne jump octaves, mimicking the wail of a train whistle; Larrie London's drumming chugs along locomotive-style and Lee is just plain ridiculous, with the notes pouring from his guitar faster than humanly possible. Crowell—whose only song contribution is *I Can't Resist*, written with guitarist Hank DeVito—has become quite adept at realizing his musical notions in the studio. His production is precise, subtle, and occasionally adventurous. "Seven Year Ache" confirms the promise of Cash's first effort, and marks her emergence as a truly important modern country artist.



Foley: broadened scope

Perry Como: Live on Tour

Mike Berniker, producer
RCA AQL 1-3826
by John S. Wilson

When one considers how many records Perry Como has made in his forty-five-year career, it is extraordinary to think that this one—recorded at the age of sixty-eight—may be his best yet. Como's manner has always been laidback and easygoing; and when he has opened up and reached out a bit, as on his early hit *Temptation*, he hasn't had to go very far to impress a listener.

On "Live and on Tour" (taken from three successive nights at the Mill Run Theater in Niles, Ill.), he retains the effortless quality that has been his hallmark, a quality that a young Bing Crosby shared but lost control of in middle age. Como has it down better now than ever (listen to *Where or When*), his voice sounding richer, fuller, and more controlled than it did thirty years ago. His projection, particularly on *Temptation*, does not just come from a good microphone. Experience is a wonderful thing when the instrument stays in shape.

In addition, this record is a model

of live performance and recording. The sound is vital and completely rounded, and the orchestra's superb renderings of Nick Perito's arrangements give the show a marvelous sense of presence.

There are things one can quibble about. Como's exchanges with the audience may have worked in the theater, but they are not something one wants to hear every time you play the record. And toward the end some huskiness begins to cloud his voice. But Sinatra is three years younger and sounds that way when he begins a show. Como never quite achieved the adulation of Crosby or Sinatra—perhaps he has found a way to grow older more gracefully than they.

**Ellen Foley:
The Spirit of St. Louis**

Mick Jones, producer
Epic NJE 36984
by Crispin Cioe

Two years ago, when record companies were rediscovering female rock singers, Ellen Foley's debut revealed an emotional, theatrically tinged voice and attitude, surrounded by a wash of blazing guitars. As before, "The Spirit of St. Louis" finds her covering outside material, but the big surprise is that she has found an attractive and provocative new musical direction.

Foley's boyfriend/producer Mick Jones (of the Clash) has cast her in the kind of proto-European setting that the Rolling Stones favored in the mid-'60s circa *Ruby Tuesday* and "Flowers." The LP uses unusual song forms, modes, and instruments (marimba, mandolin, harmonium, concertina, castanets) to present a very cosmopolitan viewpoint. Material ranges from *The Shuttered Palace*, a story about a Parisian girl of the streets, to the purely surreal (*The Death of the Psychoanalyst of Salvador Dali*), to a torchy, strictly continental version of the '60s Dusty Springfield hit, *How Glad I Am*. Jones's production is spacious, sometimes excessively so in his use of reverb. But drummer Topper Headon always anchors the rhythmic grooves solidly, while multi-reedman Davey Payne (of Ian Dury and the Blockheads) contributes wonderfully lyrical solos that weave soulfully around the singer's vocals.

Foley first attracted attention singing on Meat Loaf's first (and only) album, and there's still more than a trace of the

Midwestern rock & roll belt left in her voice that contrasts the artful dreaminess the rest of the album projects. But despite its sometimes-uneven experimental tone, "The Spirit of St. Louis" is a most auspicious second album that greatly broadens Foley's scope as an artist.

Ian Gomm: What a Blow

Martin Rushent, producer

Stiff-Epic JE 36433

by Steven X. Rea

Listening to Ian Gomm is like eating chocolate-covered ants: all sugar and sweetness on the outside, strange and dark on the inside. Like his former Brinsley Schwarz band colleague Nick Lowe, Gomm is a masterful pop purveyor. Hooks ricochet around his songs with a frenzied charm, mellifluous harmonies abound, and not an extraneous note is struck—the tunes consistently clock in at a little under three minutes. But lurking beneath this diminutive Welshman's artfully crafted compositions—a breezy amalgam of British Invasion-ese, pub rock, country, rockabilly, and soul—there's a pervasive melancholy that suggests that Gomm is living on the edge of doom.

"What a Blow" opens with *Man on a Mountain*, a thundering rocker framed in a whirlwind of guitars, propelled by drums that sound like nothing so much as someone getting socked in the gut. But through this spirited, rousing music the story emerges of a man without a cause, taking a stand just so he'll be noticed. Likewise, *It Don't Help*, a roots-rock number punctuated with echoing handclaps, is really a declaration of world-weary ennui. The sprightly tempo of *Here It Comes Again (That Feeling)* contrasts sharply with the lyrics' stark portrait of a man alone and lonely. And *Nobody's Fool*, with its *Theme from Batman*-like groove, takes to task the lifeless grind of meaningless, nine-to-five work.

Throughout "What a Blow," Gomm's vocals are vigorous, emotive, and fused with wit and grace. Martin Rushent's production is a resounding success: Tough, teeming guitars (courtesy of Gomm and Taff Williams), ebullient keyboards, and a galloping rhythm section are all recorded with sharp, keen clarity. Amidst the eleven Gomm originals (including one Lowe collaboration from the vintage Brinsley days) lies a curious cover selection: Johnny Rivers' m.o.r. '77 smash



Gomm: melancholy with humor

(*Swayin' to the Music*) *Slow Dancin'*. Here Gomm's penchant for romantic, schmaltzy pop rears its lush head, but the singer's sense of humor is never far behind. At the close of the chorus ("Slow dancin' / just me and my girl"), weird little sounds like cooing pigeons emerge from the mix.

"What a Blow" is a captivating piece of vinyl. Cool, danceable, and indelibly stamped with an often sullen, yet ultimately upbeat sensibility.

The Isley Brothers: Grand Slam

The Isley Brothers, producers

T-Neck FZ 37080

by Tom Vickers

There are two keys to the Isley Brothers' consistent success: One is total artistic freedom, as afforded by their own production company, T-Neck. The other is their ability to draw both young and old listeners due to the range of ages within the group. The three original Isleys who first hit in the late Fifties with *Shout*—Ronald, Rudolph, and Kelly—teamed up with their two younger brothers, Ernie and Marvin, and cousin Chris Jasper in the late Sixties. The younger members not

only made the group more self-contained instrumentally, but they brought a more contemporary feel to the proceedings. The result was a band that could sing ballads to the older members of the audience and rock/funk tunes to the kids, and not offend either.

Since arriving at the current lineup there has been a certain sameness in material and sequence to each record and "Grand Slam" is no exception. The slower songs are concentrated on Side 1, which opens with a patented Isley ballad, *Tonight Is the Night*. The combination of Ronald's emotionally charged vocal, a chantlike chorus, and understated instrumentation makes it the standout on the album, and one of the Isley's best ever. The tempo increases on *I Once Had Your Love* but the instruments are still muted, creating a dreamy, late-night mood. *Hurry Up and Wait* is a midtempo funk tune propelled by Marvin's bass and Ronald's gruff tenor.

Side 2 contains the harder-edged material. The Isley's own brand of black rock is spotlighted on *Young Girls*. Ernie's Hendrix-influenced psychedelic guitar floats over a heavy bass line while Ronald sings about those nubile teens in their designer jeans. *Party Night* follows in the group's standard funk groove, but without the fire. An aimless instrumental break lacks the rhythmic heat of their best dance tracks, while the lyrics about what a good time you should be having pound you over the head. *Don't Let Up* brings back the flame with its chant vocals and keyboard effects, but the overall groove is pretty standard. The album closes with *Who Said?*, another funk track that wears out quickly. Ronald's vocal is strong, but the lyrics about cheating and shacking up at the Holiday Inn border on ridiculous.

Usually it's the hotter side of the Isleys that garners the hits, but on "Grand Slam" the real standouts are the ballads.

Garland Jeffreys: Escape Artist

Garland Jeffreys & Bob Clearmountain, producers. Epic JE 36983

by Mitchell Cohen

Garland Jeffreys writes about the mystery kids out on the street with "no future, no hope, no dreams." He writes about the rioting cops and blacks in sunbaked Miami Beach and about mismatched lovers who don't stand a ghost of a chance. But though "Escape Artist" paints

a predominantly dark picture, it's put across with such unerring detail, sensitivity, and sharp-edged musicianship that the album is an explosion of life. For Jeffreys—who has been touted as a major rock figure since his neglected *Wild in the Streets* single and 1977 "Ghost Writer" LP—this new album and a half (it comes with a four-song, eighteen-minute EP) is a vindication. "Escape Artist" is urban rock & roll at its brittle best.

Assembled for the occasion are the rhythm section from the Rumour, the keyboard players from the E Street Band, both Brecker Brothers, Lou Reed and two of his band members, reggae singer Big Youth, lead guitarist G. E. Smith, and numerous other fine musicians. Usually, an amalgam like this results in defused chaos, but "Escape Artist" is a rare instance of handpicked all-stars bringing out the finest qualities in an artist. The band handles rigorous, authoritative reggae (*Graveyard Rock*), expansive cityscape dynamics (*Mystery Kids*), taut romantic pop (*Modern Lovers*, *Christine*), basement-blasting rock (a searing *96 Tears*), and never overshadows Jeffreys' vocals.

There's a terse urgency to everything on "Escape Artist," an acknowledgment that things are collapsing all around. Romance goes awry on *True Confessions* and *Ghost of a Chance*; on *Mystery Kids*, Jeffreys walks us up six floors on a blacked-out, urine-stenched, rat-infested stairwell; *Graveyard Rock* talks about "the crash of '80-'81." Confusion and complexity dominate. Only rarely does Jeffreys allow himself an expression of optimism, and twice he literally spells out his objects of hope. The opening track, *Modern Lovers*, is an irresistible rocker that celebrates romance in tough times and ends with him singing "L-o-v-e-r-s." The second side's first cut, *R.O.C.K.*, deals with the force that rescued him "from a fate that's worse than death." "Escape Artist" is that rare exception, an album that snaps back, jumps with alertness and street-smarts, and re-establishes its author as one of rock's most accurate marksmen.

B. B. King: *There Must Be a Better World Somewhere*

Stewart Levine, producer
MCA 5162

Lonnie Brooks Band:

Turn on the Night

Bruce Iglauer & Lonnie Brooks, producers. Alligator AL 4721
by Sam Sutherland

Both B. B. King and Lonnie Brooks can easily pass muster as classic blues guitarists, being deft players and gutsy singers. But their current albums showcase broader, more sophisticated contexts that pay homage to brassy, big city blues roots. Although different in mood and execution, King's "There Must Be a Better World Somewhere" and Brooks's "Turn on the Night" both boast crack horn sections that are given greater prominence than on most recent blues releases, and both men let their underlying grasp of other musical idioms shine through.

For King, the new set is a return to form after an uneven decade that saw him shifting from classic small-group outings to ill-advised hybrids. Though a titan of the genre, he had evinced a healthy reluctance to let purism overshadow showmanship. Yet it is also possible that his various producers emphasized commercial factors in designing studio lineups.

His new set isn't an exercise in scholarship either, since it draws from new material written by veteran rock and r&b writers Doc Pomus and Dr. John. What makes this collection work is King's reunion with some of the players that helped him reach beyond an already vast black audience to a new rock-informed constituency during the late '60s. Hank Crawford, David "Fathead" Newman, and Ronnie Cuber (on alto, tenor, and baritone saxes respectively) all have portfolios reaching back to an era when blues and r&b were really just semantic distinctions. Here, they marry impressive technique with soul-deep feeling. They also draw from King some of his most convincing vocal performances in some time.

Chicago's Brooks may not have King's celebrity status, but like King he embodies the urban bluesman whose personal tastes reach well beyond the genre. On first listen, Brooks's new Alligator LP offers all the classic moves and plenty of the blues' welcome humor. (Check out *Inflation*, an example of the genre's time-honored way with monetary hassles.) But there are also convincing allusions to '50s r&b (*Something You Got*), rock (in Brooks's guitar technique, which often plumbs the stripped-down architecture of



Jeffreys: explosion of life



King: back in good form

hard rock motifs), and New Orleans' Cajun heritage (the rollicking *Zydeco*).

Brooks' album focuses on briefer, uptempo tunes to convey an overall boisterousness, while King's prime suit is the genre's darker side of resignation and remorse. Both albums, however, provide fresh evidence that the blues remains a vital and evolving tradition, especially when entrusted to artists this good.

Willie Nelson:
Somewhere over the Rainbow
Willie Nelson, Paul Buskirk, & Freddie Powers, producers
Columbia FC 36883
by Mitchell Cohen

"Somewhere over the Rainbow" is Willie Nelson's third and most graceful archeological dig into the American pop past. The material on the first album, "Stardust" (Ellington, Gershwin, Carmichael), and on the second of the two-disc "One for the Road" was of higher quality than the selections here, but Nelson has grown as an interpreter to the point where he effortlessly inhabits whatever he sings and gives it emotional resonance. Like a country Crosby, he has made an art of casualness; like Billie Holiday, he phrases in a way that is always unexpectedly right and always undeniably his own. As enjoyable as "Stardust" is, it doesn't contain performances as assured as *I'm Confessin' (That I Love You)*, *I'm Gonna Sit Right Down and Write Myself a Letter*, or *Mona Lisa* from "Rainbow."

There is treacle on the album—the appeal of the title song is one of the century's great mysteries: *My Mother's Eyes* is uninspired sentimentality. But the disc is never less than charming, and often a good deal more. The sprightlier numbers, where Nelson shares the vocals with co-producer Fred Powers, have a first-take, after-hours energy. Familiar tunes like *Who's Sorry Now?* and *Exactly like You* (both over fifty years old) sound remarkably fresh. A dark-horse highlight is *Won't You Ride in My Little Red Wagon*: Nelson's vocal evokes pre-World War II innocence while Powers' hipper counter-singing suggests the more sexual metaphorical possibilities in the lyric.

The LP was recorded in Texas on the day after Willie's 1980 Fourth of July picnic, and the musical spirits are high. The style is a move away from the lush ar-

rangements of the two prior Tin Pan Alley albums. Dispensing with such Nelson band cornerstones as harmonica, drums, keyboards, and electric guitars, "Rainbow" adapts the acoustic guitar-violin combination pioneered by Django Reinhardt and Stéphane Grappelli in France in the 1930s. This jazz-inflected instrumental interplay (the final track, a loose rendition of *Twinkle, Twinkle Little Star*, is entirely instrumental) is a perfect cushion for these vintage melodies and Nelson's relaxed vocals. Only one complaint: at a playing time of under a half-hour, "Somewhere over the Rainbow" is over too quickly. Couldn't Nelson and his small combo have whipped up an impromptu version of, say, *Honeysuckle Rose*?

Smokey Robinson: Being with You
George Tobin, producer
Motown T8 375M1
by Tom Vickers

While his contemporaries play to half-filled houses and struggle for record deals, Smokey Robinson remains at the top of the charts because of his unique ability to sing about teenage love from a nostalgic adult perspective. When he attempted to compete with the teen hit-makers on previous LPs, his career floundered. But once he found a way to his breathless falsetto to reawaken the past without wallowing in it, his voice and vibration took on new meaning.

Robinson's two hits of last year, *Cruisin'* and *Let Me Be the Clock* centered on adolescent romance. "Being with You" shares that theme and brings it into sharper focus. The title track's soft, catchy tune is destined for hit singledom. *Food for Thought* features a reggae groove set off by steel drums that dominate the mix. Unfortunately, Robinson sings in a bogus Jamaican accent that dilutes the political message of the lyric. The midtempo ballad *If You Wanna Make Love (Come 'Round Here)* is reminiscent of Smokey's work with the early Miracles. A breakup love song, *Who's Sad*, closes Side 1 with a haunting chorus that perfectly captures the feeling an adolescent's feeling of emptiness and helplessness.

Side 2 is less successful. The opening *Can't Fight Love* is a total, embarrassing steal from the Jackson's *Shake Your Body (Down to the Ground)*. Next is *You*

Audiomatic Electronics
HOME ENTERTAINMENT SPECIALS

1 sec CX350 special 189.99	Technic SL02 134.99
Koss K4DS Delay 349.99/pr	Atari CX2600 Video Game 149.99

BLANK TAPES

Maxell	
C-90 UOX-I or II (Cr.)	3.39
C-60 UOX-I or II (Cr.)	2.49
C-90 UD	2.79
*TDK	
C-90 SA (Cr.)	2.99
C-60 SA (Cr.)	2.19
C-90 AD	2.49

PHONO CARTRIDGES

Shure V15 Type IV	105.99
Shure V15 Type III HE	86.99
Shure M97 HE	56.99
Audio-Technica AT155LC	109.99
Audio-Technica AT148LC	64.99
Audio-Technica AT125LC	39.99
Stanton 681S	82.99
Stanton 681 EES	62.99
Stanton 681 EEE	56.99
Empire 2006Z	54.99
Empire 400TC	22.99
Pickering XSV4000	68.99
Pickering XSV5000	87.99
Pickering XSV7500	33.99

HI-8 PHONES

Koss Pro 4AAA Special	49.99
Koss MVXLC	48.99
Koss MVX	42.99
Sennheiser HD-430	75.99
Sennheiser HD-222 New	73.99
Sennheiser HD-420	52.99
Audio Technica ATH-7	99.99

VIDEO RECORDERS

RCA VET-650	1099.99	JVC HR-6700	899.99
Panasonic PV3750	1099.99	Sony SL500	1099.00

ENTIRE SCHWANN CATALOG
ROCK JAZZ-R&B-CLASSICAL
(minimum order -4 Records)

All 7.99 List	Only 4.99
All 8.99 List	Only 5.99
All 9.99 List	Only 6.39

JENSEN Car Stereo
Call for prices on Car Stereos

SPEAKERS

J1033 (8Ω) Triax II	84.99/pr
J1037 (8Ω) Coax II	64.99/pr
J1041 (5Ω) Coax II	54.99/pr
J1126 (4Ω) Coax II	54.99/pr
J1065 (8Ω) Triax II	62.99/pr
J1069 (8Ω) Coax II	40.99/pr

BLAUPUNKT Car Stereo

CR-2001 in-dash	256.99
New York	299.99
CR-3001	469.99
CR-5001	349.99
BEA-200	169.99

WRITE FOR FREE CATALOG

ORDERING INSTRUCTIONS

All merchandise is Factory Fresh with manufacturer's warranty. Send MONEY ORDER or CASHIER'S CHECK for Quick Shipment within 24 Hours. Add Shipping Charges \$4.25. Canada and Puerto Rico add 10% of order. Personal Checks held for 3 weeks.
Customer Service HOT-LINE (212) 683-9088
We carry full lines of SHERWOOD, HARMON-KARDON, NIKKO, SONUS, as well as SONY, MITSUBISHI, CRAIG, and CONCORD car stereos.

Audiomatic Electronics
CALL TOLL-FREE 800-223-2706
In N. Y., Hawaii, Alaska, & Canada Call (212) 686-5500
1263 Broadway New York, N.Y. 10001

Circle 3 on Reader-Service Card

Big Savings

CALL NOW
(301) 488-9600

HERE ARE SOME IMPORTANT REASONS YOU'LL ENJOY DEALING WITH International Hi Fi...

- ★ You pay the same price many dealers pay.
- ★ More than 120,000 customers coast to coast. You save on our big-volume discounts.
- ★ No risk. No-deposit phone orders shipped the same day you call - COD or credit card.
- ★ Over 70 top name brands - equipment most mail order and discount dealers can't supply.
- ★ 2 to 3 day delivery on most orders.
- ★ Shipments fully insured-full manufacturer's warranty up to 5 years.
- ★ Exclusive "no-lemon" guarantee. Fully staffed customer service department.
- ★ Seven audio advisors to assist the inexperienced buyer.

WRITE FOR: BROCHURE WITH PRICES AND TIPS ON BUYING BY MAIL

INTERNATIONAL HI-FI DISTRIBUTORS
Moravia Center
Industrial Park, Dept. H
Baltimore, Maryland
21206

Circle 13 on Reader-Service Card



Snow: needing focus

Are Forever, in which Smokey delivers a teenage statement of undying devotion. The tension slackens with *As You Do*, a lackluster love song that goes nowhere lyrically or vocally. The album closes on an up note with *I Hear the Children Singing*, a song that captures the manchild essence of Smokey.

If his radio hits have captivated you, "Being with You" is the best match of material with voice since Smokey left the Miracles.

Sister Sledge: All American Girls

Narada Michael Walden, producer
Cotillion SD 16027
by Crispin Cioe

Sister Sledge, the female r&b vocal quartet from Philadelphia, has left the production fold of Chic's certified hit-makers Nile Rodgers and Bernard Edwards to work with Narada Michael Walden, the former jazz fusion drummer turned successful r&b singer/producer. Rodgers & Edwards' pared-down funk is a hard act to follow, but once past the obviously Chic-derived title track, "All American Girls" reveals a different, and for the most part, successful approach. Walden's songs and arrangements effectively frame

the Sisters in a latter-day Supremes context.

This is very much a dance record, with Randy Jackson's fat bass playing bouncing amiably off Walden's solid backbeat and expressive cymbal work. But against this contemporary rhythm scheme, the songs convey an unabashed pop earnestness, much the way those of the '60s girl groups did. *He's Just a Runaway* masterfully blends a high chorus of sighing "oohs" with a Motown-esque chord progression and a sad story about a boy with "honest eyes and a lonely face," but as the song later reveals, his "innocence lies . . . he'll run and break your heart." The equally danceable *Ooh You Caught My Heart* and *Make a Move* follow similar strategies, combining finger-popping, backbeat-heavy rhythms with snatches of riffs from soul music's rich past. A breathy, streetwise sexiness hovers about these elements, which collectively create a big production sound. "All American Girls" effectively positions the Sisters in the pure pop pantheon, where they belong.

Phoebe Snow: Rock Away

Greg Ladanyi & Richie Cannata, producers. Mirage WTG 19297
by Crispin Cioe

The musicians, producers, and record label have changed, but Phoebe Snow's strengths and weaknesses as a recording artist have not. "Rock Away" sports a band of highly touted pop/rock players: David Brown, Liberty Devitto, Doug Stegmeyer, and Richie Cannata from the Billy Joel band, and Warren Zevon's lead guitarist/musical director, David Landau. At first glance it would seem that Snow had dropped the ultra-slick production style that first brought her to prominence in the '70s. Such rockers as *Gasoline Alley* by Rod Stewart, Carolyn Mas's *Baby Please*, and Snow's own *Down in the Basement* (which features Billy Squier's excellent drummer, Bobby Chouinard) contribute a new-found rough edge and punchiness to Snow's lovely vibrato and unique vocal timbre.

But for all the hand-picked musicians and good sounds supplied by producers Greg Ladanyi (of Jackson Browne fame) and Cannata, the album ultimately lacks focus. It wanders from rock to slick L.A.-style production on the single-oriented *Games* (which uses a completely



Winchester: slighter than usual

different lineup of Ronstadt/Browne sidemen) and finally back to such usual Snow fare as Don Covay's *Mercy, Mercy, Mercy* and Allen Toussaint's *Shoo-Rah, Shoo-Rah*.

To her credit, Snow sings with graceful precision throughout and, on *Games*, even a touch of wild abandon. And her midtempo original, *Something Good*, is a memorably melodic love song. "Rock Away" has the basic ingredients: good songs, unobtrusive production, fine distinctive voice. But the ultimate Phoebe Snow album will not become a possibility until she finds an appropriate style and sticks with it.

Jesse Winchester: Talk Memphis

Willie Mitchell, producer
Bearsville BRK 6989
by Sam Sutherland

News that Jesse Winchester was returning to the studio with producer Willie Mitchell after a lengthy hiatus was both surprising and provocative. The songwriter's earliest recordings—culled from material written in exile in Canada as a conscientious objector—had sketched an imposing aggregate style that combined the hushed spareness of folk balladry with

undercurrents of black blues and economical rock. But as the artist became better known, and a changing political climate freed him to play his first U.S. shows in years, Winchester's studio work seemed to lose its potency in a pronounced swing toward more bucolic country arrangements and less distinguished topical conventions.

"Talk Memphis" does make a much stronger case for his range as a singer, allowing Winchester to flex the funkier vocal nuances acquired in his first teenage bands in Memphis (and solidified during his early performances as a Montreal resident), Mitchell, whose work with Al Green and Ann Peebles earmarked him as inheritor of Memphis' streamlined r&b tradition, infuses the tracks with a clipped rhythmic vitality. At the same time he has adapted the players' attack to Winchester's gentler vocal character, creating a kind of funky folk middle ground.

What's still missing, though, is the deeper poetic richness that was the singer's original strength, and that is squarely his own responsibility. Uptempo performances like *Say What, Sure Enough* and the title tune are undeniably infectious, boasting the kind of light-hearted charm that made Winchester's mid-'70s sleeper *Rhumba Man* a concert standout and a popular cover song for singers like Nicolette Larson and Dolly Parton.

Yet the effect is merely charming. That might be acceptable from a mere entertainer but it's a bit frustrating for those of us who've played Winchester's first three LPs until the grooves were smooth. Only on *Leslie*, an affecting love song inspired by his wife, and *I Love You No End* does he recapture the contemplative mood and verbal purity of his earliest and best writing. Nowhere does he reach for the broader philosophical statements that gave albums like "Jesse Winchester." "Third Down 110 to Go," and "Love It or Leave It" a luminous poetic weight.

"Talk Memphis" is thus a minor step forward for a major talent, its music heartening in its renewed affection for the songwriter's earliest roots but disappointing in its comparatively slight content. Perhaps Winchester has found the emotional and spiritual peace that too often eluded the protagonists of his early '70s creations. But that personal gain has cost him a tension in his writing that was once a compelling trademark.

IMPOSSIBLE!

They said it couldn't be done. Create a "closed-ear" headphone that compares with our legendary Open-Aire® models for clarity, definition, wide-range response and dynamic range.

And they were right, until now. Now, there's the HD 222. Its novel 8.8-oz. design gives you maximum performance and privacy with minimum weight. Plus the kind of forget-you're-wearing-it comfort that's uniquely Sennheiser.

For professional monitoring—or total involvement—audition our HD 222. And hear the impossible for yourself.



SENNHEISER

ELECTRONIC CORPORATION
10 West 37th Street, New York 10018 (212) 239-0190
Manufacturing Plant: Bissendorf/Hannover, West Germany
© 1981 Sennheiser Electronic Corp.

47st. photo

Cameras • Electronics • Audio • Video

NEW!

RCA SelectaVision VFP-170

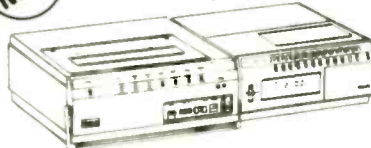

- Lightweight
- 6 Hr VHS
- 14 Day Program
- Full Function Remote Control
- Fast & Slow Motion
- High Speed Search
- AC/DC Operation

ON SALE CALL FOR LOW PRICE
OTHER GREAT VIDEO BUYS

PANASONIC PV-1210 RECORDER	\$649
SONY SL 5400 BETAMAX	\$769
RCA SELECTAVISION 450	\$849
JVC HR-6700U RECORDER	\$829
PANASONIC PORTABLE COLOR CAMERA	\$719
TOSHIBA AUTO FOCUS COLOR CAMERA	\$929

VIDEO TAPE SPECIALS

VHS T-120 (6HR)	12.95	BETA-L 500	9.25
RCA VK-250	13.95	BETA-L 750	12.25
PANA T-120	13.95	BETA-L 830	15.50



SONY WALKMAN, TP5-L2

STEREO CASSETTE PLAYER
with Stereo Headphones



PRICES SUBJECT TO CHANGE **139.95**

47th Street Photo Inc.

67 West 47th St, New York, N.Y. 10036

212-260-4410

OPEN SUNDAYS TOLL FREE OUT OF STATE

800-221-7774



Circle 10 on Reader-Service Card



FREE!

1981 Pro-Line Guide

- A comprehensive 64 pg. color guide to all Carvin Pro-Line equipment including illustrations, technical information and specifications with Special Direct Prices.
- Carvin's new products for the 80's include: double neck guitars, modular power amps up to 700w RMS, Recording and road mixing boards, JBL Pro speakers, bi-channel tube guitar amps, Parts, plus much, much more.
- As we introduce you to the finest Pro Equipment available, you'll appreciate Carvin's policy of selling Direct for exceptional values.

Write: CARVIN Dept. HF80, 155 Industrial Ave., Escondido, CA 92025 • Phone: (714)747-1710

CARVIN FREE CATALOG

Name _____
Address _____
City _____
State _____ Zip _____ HF80

HIGH FIDELITY CLASSIFIED

MAIL TO: 825 7th Ave., 6th Floor, New York, N.Y. 10019. Phone: 212-265-8360

GENERAL: All copy subject to publisher approval. First line caps. Users of P.O. Box MUST supply permanent address and telephone number before ad can run.

CLOSING DATE: 1st of second month preceding cover date.

CLASSIFIED RATES: Regular type, per word: 1x-\$2.10; 3x-\$2.05; 6x-\$1.90; 12x-\$1.85. Words in caps—10¢ extra each. **IMPERIAL type, per word:** 1x-\$2.80; 3x-\$2.70; 6x-\$2.60; 12x-\$2.50. Words in caps—15¢ extra each. Minimum 15 words. Box numbers: \$2.50 additional per insertion to cover cost of handling and postage. Display, per inch: 1x-\$335; 3x-\$325; 6x-\$320; 12x-\$270.

PAYMENT WITH ORDER: Send check, M.O., MASTERCHARGE or VISA No. and expiration date to: Classified Dept., HIGH FIDELITY, 825 7th Ave., 6th Floor, New York, NY 10019.

FOR SALE

STEREO REPRESENTATIVES NEEDED!!! LOWEST POSSIBLE PRICES!!! OVER 100 BRANDS!!! KRASCO Rep. HF, 99B Orange Ave., West Haven, Conn. 06516.



NEW TECHNOLOGY RAW SPEAKERS.

Leaf tweeters, the Wave Aperture™ system, the Nestorovic woofer™ system, polypropylene drivers, and more from

Speakerlab, the highly acclaimed speaker design/manufacturing company. Send today for your free catalog of speaker systems, raw speakers and design guidelines.

Speakerlab®
Dept. HF14, P.O. Box C-30325
Wallingford Station-Seattle, WA 98103

ATTENTION: "FOREIGN" AUDIOPHILES AND DEALERS! Western World Audio Exporters can supply virtually ALL brands of hi-fi components, speakers, cartridges, etc. (including esoteric lines) at very attractive prices. Quotes, terms and availability furnished upon request. Write to WESTERN WORLD AUDIO, 373 Fifth Avenue, suite 1556, New York, N.Y. 10016. TELEX-423826 SAKI UR.

SAVE 50% BUILD YOUR OWN SPEAKER SYSTEM Write McGee Radio Electronics 1901 McGee Street, Kansas City, Missouri 61408

ONLY 189 COPIES LEFT! High Fidelity's Silver Anniversary Treasury will soon be out of print. Don't miss this opportunity to get your copy of this 348-page hardcover compilation of the best writing to appear in the magazine over the past three decades. Send \$9.95 to Wyeth Press, 1 Wyeth Street, Marion, Ohio 43302.

FREE

THE GREAT ELECTRONIC THINGS & IDEAS BOOK!

HUNDREDS OF UNUSUAL PARTS GADGETS & IDEA ITEMS. UNAVAILABLE IN STORES OR CATALOGS ANYWHERE! Bargain prices on everything! New items in every issue! Rush postcard for your copy!

ETCO
ELECTRONICS
Dept 318
Plattsburgh, N.Y. 12901

A SINGER'S DREAM!

TVE

REMOVES VOCAL FROM MOST STEREO DISCS

The Thompson Vocal Eliminator can actually remove most or virtually all of a solo vocalist from a standard stereo record and yet leave most of the background music untouched! Not an equalizer! We can prove it works over the phone. Write for a brochure and demo record below. **COST: \$249.00**

YOU SHOULD SEE US

For:

- Time Delay/Ambience
- Studio Echo/Reverb
- Tape Noise Reduction
- Parametric Equalization
- Electronic Crossovers
- Compressor/Expanders
- Mic Preamp/Mixers

We manufacture a full line of high quality audio and recording equipment. You will probably have to pay twice as much elsewhere to obtain comparable quality. Only Direct Sales make our prices and quality possible. Send \$1 for a 20 page brochure and 20 minute demonstration record.

Write to: **LT Sound, Dept. HF, P.O. Box 338, Stone Mountain, GA 30086, Phone (404) 493-1258**

HAFLER IN STOCK TRADES ACCEPTED.

Morel Electronics, 57 Park Place, New York, N.Y. 10007 212-964-4570.

ACCURATE, QUALITY AUDIO. Reasonable Prices! Car/Home. Send stamp:

Denco Audio, P.O. Box 6104-H, El Monte, CA 91734 [213] 961-6158. Evenings, weekends. MONTHLY SPECIALS

QUALITY AUDIO COMPONENTS, MULTI-TRACK EQUIPMENT, PROGRAMMABLE CALCULATORS, ACCESSORIES. Competitive Pricing! Prompt Delivery! Knowledgeable Staff! Service Facility! Credit Cards Accepted. FREE Catalog. SOUND IDEAS, Dept. HF, P.O. Box 340, Cary, N.C. 27511. 1-800-334-2483 (NC 919-467-8462).

Call Us Last!!

FOR THE LOWEST PRICES ON THESE TOP BRANDS!

- Maxell • Technics • Panasonic
- TDK • Sony • Altec/Lansing
- AKAI • Sansui • JBL • Dual
- JVC • Empire & More!

AUDIO • VIDEO
ATTIC INC.

Call Toll Free: (800) 221-0118

In N.Y. State Call Collect: (212) 544-0101
99-10 Metropolitan Ave., Forest Hills, N.Y. 11375

LOWEST PRICES ON STEREO-ESOTERIC COMPONENTS, cartridges, tonearms, tapes, car. Free catalog. Audio Unlimited, 1798 Technology Drive, San Jose, CA 95110, 408/279-0122. 1-6M-Th.

TO RECEIVE FREE unedited movies sports, shows; Send \$29.95 for complete ready to install AMATEUR MICRO-WAVE T.V. ANTENNA, or \$9.95 for complete plans, refundable on purchase of antenna. PHILLIPS-TECH ELECTRONICS, Dept. Sp-6, 5025 North 68th Street, Scottsdale, Arizona 85253.

COLLEGE DEALERS—WRITE for details on college program. Fast shipments, low prices, specify college. Sound Reproduction, 7 Industrial Road, Fairfield, N.J. 07006.

CHICAGO SPEAKERWORKS DESIGNS & Manufactures a complete line of quality speaker kits & finished systems at huge factory direct savings. Fried systems, transmission lines for KEF drivers, subwoofers, satellites, horn loaded systems, raw components & much, much more. Send \$1.00 for catalog to: Chicago Speakerworks Inc., Dept. HF, 5125 N. Damen, Chicago, IL 60625. Factory showroom open Mon.-Sat. (312) 769-5640.

CARTRIDGES AT WHOLESALE—PLUS HUGE DISCOUNTS ON NAME-BRAND EQUIPMENT. FREE PRICE LIST AUDIO COMPONENTS SYSTEMS, 2313H BRENTWOOD PLACE, OLYMPIA, WA 98532

CONSUMERS CO.
TAPES — DISCOUNTS — STEREO
Minimum Order 10 Tapes

	SAC-90 2.99	DC-60 1.15
SAC-60 2.20	DC-90 1.67	
ADC-60 1.66	Demag 14.50	
ADC-90 2.39	VIDEO	
ODC-90 3.69	VT-120 14.79	
SAXC-90 4.79	VT-90 13.95	

SONY

Metal C-60 5.95	EHF C-60 2.65	
Metal C-90 7.49	EHF C-60 1.89	
FECR C-90 2.89	LNK C-90 1.62	
FECR C-60 2.49	LNK C-60 1.10	

VIDEO — BETA L-500 10.50 — L-750 13.25 — L-830 15.95
MAXELL UDXL I or II C-90 3.30

SANYO CAR STEREO	SHURE CARTRIDGES
FT-2400 222.95	M 97 HE 53.99
FTC-6 75.50	M 95 HE 34.99
FTC-8 99.90	V15-III HE 83.99

All merchandise fresh, manufacturer guaranteed.

Phone Orders Call Toll Free
(800) 431-2932
In N.Y.S. Call
(914) 664-2909

CONSUMERS CO.
P.O. Box 550 Dept. HF581 Mt. Vernon, N.Y. 10551

TOP-NAME AUDIO AT LOW PRICES !!! We carry all of the finest brands of audio and video equipment at the best possible pricing. Our audio consultants are available for phone quotes and additional information Monday thru Saturday from 10 AM-7 PM (EST) at 212-254-3125. Or send \$2.00 for our informative brochure to DIRECT DISCOUNTS LTD., P.O. Box 841-H, Cooper Station, New York 10276. We accept M/C and VISA, will ship C.O.D., and DON'T charge sales tax to out-of-state customers.

SPEAKER BUILDERS: JBL, ELECTROVOICE, AUDAX & more, including tested computer designed plans. GOLD SOUND, P.O. Box 141 HF, ENGLEWOOD, CO 80151.

WOOFERS-MIDS-TWEETERS-CROSSOVERS AT TREMENDOUS SAVINGS. EV, BECKER, SEAS, POLYDAX, PEERLESS, PHILIPS, EMILAR, GAI AND MANY OTHERS IN STOCK FOR IMMEDIATE DELIVERY. SPEAKERS FOR HI-FI, CUSTOM AUTO, REPAIRS, PRO-SOUND AND MUSICIANS. LARGEST SELECTION OF PARTS AND ACCESSORIES IN THE U.S. FOR SPEAKER BUILDERS AND HOBBYISTS. SEND \$2.00 FOR THE ALL NEW '81 CATALOG (REFUNDABLE WITH FIRST PURCHASE) TO SRC AUDIO, DEPT HF3, 3238 TOWERWOOD DR., DALLAS, TEXAS 75234.



We're #1 all across America!

Recording Begins With The Leader!

It's here! Our FREE 32 page catalog is the easy way to find out why Saxitone is the leader in sales & service with America's recording tape needs. Choose from our wide tape selection of audio & video tape, cassette recorders & decks, and recording accessories from such industry leaders as Maxell, TDK, Scotch, Sony, BASF, B+C, Aiwa, Technics, Superscope, Audio Technica, EV and more! Master Charge & Visa honored for 24-hour shipping. Join the thousands of satisfied customers who know why Saxitone is #1 All Across America!

(202) 462-0800

SAXITONE TAPE SALES

1776 Columbia Rd. NW, Washington, DC 20009 (202) 462-0800

MISCELLANEOUS

DIAMOND NEEDLES and Stereo Cartridges at Discount prices for Shure, Pickering, Stanton, Empire, Grado, Audio Technica and ADC. Write for free catalog. **LYLE CARTRIDGES**, Dept. H, Box 69, Brooklyn, New York 11218. For Fast Service, call TOLL FREE 800-221-0906.

PROTECT YOUR ALBUMS. WHITE CARDBOARD REPLACEMENT JACKETS 35c. PLASTIC LINED INNER SLEEVES 15c. POSTAGE \$1.25. OPERA BOXES, 78 SLEEVES AVAILABLE. FREE CATALOG. CABCO 301-3, BOX 8212, COLUMBUS, OHIO 43201.

The best New Stereo Systems Deserve The Best New Stereo Records (Tapes too)! You need the Monthly **SCHWANN RECORD CATALOG** available from record shops everywhere or, for a sample copy PP, Send \$2.50 to ABC-SCHWANN Single Copy Sales, Dept. 2160 Patterson St., Cincinnati, Ohio 45214.

SLIPCASES for HIGH FIDELITY Magazine. Simulated blue leather, Holds 6 High Fidelity issues. \$4.95 single case, \$14 for 3 cases, \$24 for 6 cases. USA orders only. Allow 6 weeks for delivery. **HIGH FIDELITY Library Cases**, Box 5120, Philadelphia, PA 19141.

Free Promotional Albums, Concert Tickets, Stereo, Etc. Information. **Barry Publications**, 477 82nd Street, Brooklyn, NY 11209.

COLLEGE STUDENTS!—Improve your grades!—Temp paper catalog—306 pages—10,278 titles—Rush \$1.00 (refundable!)—Research, Box 25916R, Los Angeles, 90025 (213) 477-8226.

NEW YORK PHILHARMONIC GUIDE TO THE SYMPHONY by Edward Downes. This 1,100-page book is a composer-by-composer, A to Z compendium of program notes from the Philharmonic. Send \$25.00 plus \$1.00 for shipping to High Fidelity's Music Listener's Book Service, 1 Wyeth Street, Marion, Ohio 43302.

NEW EQUIPMENT FOR SALE

BUY DIRECT and save. British and European Hi-Fi. Attractive prices. Send Reply Coupon for Quote, \$3 bills for brochures. Goodwins, 7 The Broadway, Wood Green, London N22. Phone 888-0077. VISA/Master Charge. Visitors welcome.

TOP-RATED CARTRIDGES UP TO 70% OFF! We offer Acutex, ADC, Dynavector, Grado, Nagatron, Ortofon, Shure, Sonus and many more at the lowest possible prices. Just call 212-254-3125 for more information, or write to **DIRECT DISCOUNTS LTD.** P.O. Box 841, Cooper Station, N.Y. 10276.

TAPES & RECORDS

RARE OPERA, SYMPHONIC MUSIC ON OPEN REEL TAPE. Historic performances. **EUROPEAN, DOMESTIC**. Free Catalogue. Underhill, Box "U," Bellport, NY 11713.

"**SOUNDTRACKS, SHOW, NOSTALGIA & JAZZ—FREE** Catalog & Offering List—A-1 Record Finders, P.O. Box 75071-H, L.A. CAL 90075."

SCOTCH RECORDING TAPE, LOWEST PRICES. TAPE CENTER Box 4305C, Washington, D.C. 20012.

"**LIVE OPERA TAPES** Reels—Cassettes. Unbelievable treasures since 1926. Over 5,000 selections. Free DELUX Catalog. MR TAPE, Box 138, Murray Hill Station, NYC 10016."

SHOW ALBUMS—Rare, out-of-print lps, 64-page list \$1.00. King of Hearts—original cast LP \$9.95. Broadway-Hollywood Recording\$, Georgetown, CT 06829.

1930-1962 RADIO PROGRAMS, \$1.00 HOUR! Professional 200 page catalog, \$1.25. AM Treasures, Box 192HF, Babylon, NY 11702.

VIENNESE LIGHT MUSIC SOCIETY—Strauss, Lanner, etc. on Dolby Cassettes, KC Company, Box 793, Augusta, Maine 04330.

OPEN REEL TAPES. Top Quality. 100% money-back guarantee. Major labels. Classical, pop, rock, quad—direct disk & video. Bank cards accepted. Catalog/order information, \$1. No other fees, obligations. **THE REEL SOCIETY**, P.O. Box 55099-H, Valencia, CA 91355.

LIVE OPERA ON REEL/CASSETTE. THOUSANDS OF PERFORMANCES, WORLDWIDE SINCE 1930's. The ONLY service that provides the personal attention demanded by the Vocal Art. Free Gifts, Magnificent Free Catalogue. **LIVE OPERA**, Box 3141, Steinway Station, L.I.C., N.Y. 11103.

SCHUBERT/DYER-BENNET. The splendid Tully Hall performance of "the Dyer-Bennet translation of "Schone Mullerin" (Characterized by Andrew Porter as "A 'Schone Mullerin' which came to life") now available in a meticulously produced studio recording (stereo—two discs) directly from Dyer-Bennet records, Monterey Stage, Great Barrington, MA 01230. \$17.50 postpaid.

VIENNESE OPERETTA RECORDS, INC. Extensive range, superb vocal performances, on currently available LP's. Free list. P.O. Box 50-B, Dover, Mass. 02030.

OPERA VIDEO—Magnificent performances from Europe. Beta, VHS Formats. Free catalog. **HRE**, Box 12, Kew Gardens, N.Y. 11415.

SCHWANN RECORD AND TAPE GUIDE now available by subscription. Includes 12 monthly issues of Schwann-1, 2 semi-annual issues of Schwann-2, plus Annual Children's Catalog. Annual subscription \$25.00, add \$10.00 for addresses outside of U.S. Order from Schwann Record & Tape Guide, P.O. Box 2131, Radnor, PA 19089.

SOUNDTRACKS—New and out-of-print film music recordings. Free listings and info. **CINE MONDE RECORDS**, 1488 Valjeo St., San Francisco, CA 94109.

RARE RECORD/TAPE COLLECTOR'S DIRECTORY. New enlarged treasury of over 250 addresses. Annotated. All categories. Send \$4.95. **DIRECTORY**, Dept. H.550, East Rustic Road, Santa Monica, Calif. 90402.

GOLDEN AGE RADIO—your best source for radio tapes. Free catalog. Box 25215-J, Portland, Oregon 97225.

PROBLEM. THE HIGH COST OF PREMIUM CASSETTES. "The Audiophile's Choice" has the solution with its guaranteed 20 to 20 cassette. Send \$2.00 for a C-60. Box 888, Kingsport, TN 37660.

OPEN REEL TAPES from studio masters. Philips, Argo, Telefunken, Vanguard, Unicorn. Catalogue \$1.00. Barclay-Crocker, Room 1470-H, 11 Broadway, NYC 10004.

OVER 3,000 RECORDINGS. **SOUNDTRACKS, JAZZ, Rock**, and many more! Catalog \$1.00 (refundable) \$2.00 outside U.S. Cuches, 23 N. Henry St., Brooklyn, NY 11222.

QUALITY TAPES AT WHOLESALE PRICES

MAXELL UD1 (1 or, C 90)	\$ 3.19	TDI T 120 (Video)	14.49
MAXELL UD C 90	2.43	SONY L 750 (Video)	12.99
TDI SA C 90 (New)	2.85	SONY L 500 (Video)	10.49
TDI SA C 60 (New)	2.13	MAXELL UD35 90/800	5.38
TDI SA C 90 (New)	4.59	MAXELL UD4135 90B 1800	6.58
TDI CDC 90 (New)	3.39	TDI LX 35 90	5.39
TDI MC 90 (New)	2.32	TDI LX 35 90B	5.89
TDI MC 90 (New)	1.42	TDI CASS HEAD D-MAG HD 01	15.99
TDI MA C 90 (New)	6.95	DISCWASHER COMPLETE SYSTEM	10.50
TDI MAR C 90 (New)	11.75	DISCWASHER D 416 DZ REFILL	10.50

Order from U.S. add \$1.50 or 4% shipping whichever is more. Others add \$3 more send ch. m. visa or mc. No COD. Cards add 2% handling. Call 212 339 9085.

QUALITY TAPES, 2085 E. 8th St., Dept. MM, Brooklyn, NY 11223

RECORD HOUND, BOX 88H, Eagleville, PA 19408. Fills wants lists? Doggone right!!! 33 1/3 specialist. Fast friendly service.

SEARCHING FOR OUT-OF-PRINTS? Try for Discontinued Records, 444 South Victory, Burbank, California 91502 (213) 849 4791.

Bravo Beethoven. Sampler. LP \$1.98, Cassette \$2.49. Free catalog: Musical Concepts, Box 53HF 5, Cedarhurst, N.Y. 11516.

ALL-STAR OLDTIME RADIO TAPES EXCEPTIONAL Selection, Value! Unconditionally Guaranteed FREE Catalog. Heri age-HA, 412 Redbud, Oxford, MS 38655.

S's FOR OLD RECORDS DIRECTORY OF BUYERS. SEND \$5.00 TO "IMPRESSIONS" BOX H, 15086, HONOLULU, HI, 96815.

SUPER SOUND RECORD SERVICE Half-speeds, digitals, Japanese imports, more. P.O. Box 411237, Chicago, ILL 60641.

ELVIS PRESLEY ENTHUSIASTS, Collector's Item "Tell Me Pretty Baby" 45 RPM Recording in original package. A Dallas Country jury said "It's not by Presley." Opinion of voice identification expert from Mich State Univ., "it is." Not represented to be Presley. Send \$4.95 check or money order to C/WC Sales, P.O. Box 501075, Dallas, TX 75250. Add \$1 postage and handling.

CLASSIFIED CAN WORK FOR YOU

CHARGE IT ON MASTER CHARGE OR VISA

USE POST CARD ORDER FORM IN THIS ISSUE OR CALL CLASSIFIED AD DEPT., (212) 265-8360

CLASSICAL RECORDINGS FOR COLLECTORS List, send \$1.50 ARS MUSICA, 29 Knox Road, Brewster, N.Y. 10509

WANTED: CLASSICAL RECORDS AND TAPES. Any size collection. All speeds, all sizes bought. Also selling. Send want list. R & S MUSIC P.O. DRAWER J, HICKSVILLE, NEW YORK 11802 (516) 731-3224.

BLANK RECORDING TAPE BARGAINS!
Cassettes. Cartridges. Reels. Audio. Video. Catalog 25¢. Tower, 213F, Dunkirk, Md. 20754.

D.J.s 90 min. Cassette available covering Mixings and related Skills. "Listen and Learn" \$6.00 ppd. to J.A.M. Enterprises 3021 Heath Ave., Bronx, N.Y. 10463

BUSINESS OPPORTUNITIES

MAKE MONEY IN COLLEGE SELL BRAND NAME AUDIO components no investment required unbelievable pricing... Call Mr. Kay toll free (800) 241-6270.

WANT YOUR OWN RADIO STATION?
Investment/experience unnecessary. Home operation possible. Free information. "Broadcasting," Box 130-D5, Paradise, Calif. 95969.

PUBLICATIONS

THE BLIND AND OTHER PHYSICALLY HANDICAPPED can know the joy of reading memorable selections chosen from over 50 outstanding periodicals, completely free of charge. Write CHOICE MAGAZINE LISTENING, Dept. HFC, Box 10, Port Washington, NY 11050 or call 516-883-8280

HIGH FIDELITY'S TEST REPORTS 1981, 334 fact-filled pages of information on amplifiers, turntables, speakers, tape decks, receivers and other components, \$3.95 plus \$1.00 for postage and handling. Order from: High Fidelity's Test Reports 1981, 1 Sound Avenue, Marion, Ohio 43302

GUIDE TO BASIC CLASSICAL RECORD LIBRARY. Up-to-date; authoritative, 500 works considered. 125 pp. \$10.95 postpaid, Box 22116, Cleveland, Ohio 44122.

Furtwaengler Society, 6112 West 77 Street, Los Angeles, California 90045. \$10.00 yearly dues. Newsletter quarterly

ELECTRONICS

ELECTRONIC BARGAINS, CLOSEOUTS, SURPLUS! Parts, equipment, stereo, industrial, educational. Amazing values! Fascinating items unavailable in stores or catalogs anywhere! Unusual FREE catalog. ETCO-017, Box 762, Plattsburgh, N.Y. 12901.

RECEIVE "SECRET" TV CHANNELS with inexpensive kit. Details: \$1.00 (refundable). NDS, Box 12652-H, Dallas, 75225.

SLEEP-LEARNING

SLEEP-LEARNING EQUIPMENT, tapes, books. Strange catalog free. Autosuggestion, Box 24-F, Olympia, Washington 98507.

INVENTIONS WANTED

INVENTIONS WANTED. FREE CONSULTATION NO IDEA TOO SMALL. Disclosure registration. Potential cash of royalties from manufacturers seeking new ideas. For free information on how to register your ideas, call or write AMERICAN INVENTORS CORP., 59 Interstate Dr., Dept. HF, West Springfield, MA 01089, (413) 737-5376. A Fee Based Marketing Company.

PERSONAL

SINGLES! Meet new friends—nationwide introductions—many who travel. Write Club More, Box 405-HF, Wilmette, IL 60091. Or call (312) 262-9800



Bug Alley: a tight group of singing instrumentalists

○○○○○○ JAZZ ○○○○○○

The Big Sky Mudflaps:
Armchair Cabaret
Randy Rand & the Big Sky Mudflaps, producers. Helios HR 4402 (Helios Records, P.O. Box 8665, Missoula, MT. 59807)

Bug Alley
Gene Perla, Son Soleil & Bug Alley, producers PMR019 (PM Records, 20 Martha St., Woodcliff Lake, N.J. 07675)
by John S. Wilson

Many of today's young jazz ensembles are finding inspiration in singing groups of the '20s through the '50s. One of the most popular sources for them is the Boswell Sisters, who, according to Maxene Andrews, inspired the Andrews Sisters. New York's Manhattan Rhythm Kings draw on the Boswells, as do the groups represented on these two discs: Bug Alley, apparently based in Montreal, and the Big Sky Mudflaps from Missoula, Montana.

Once past the Boswells, the two groups spread out in a variety of direc-

tions. The Mudflaps, a seven-piece ensemble that includes an alto saxophone and a violin, draw on Louis Jordan, contribute their own lyrics to Charlie Parker's *Yardbird Suite*, throw in Helen Humes's *Flippity Flop Flop* and Duke Ellington's *Do Nothin' till You Hear from Me*, and cover some originals as well. Bug Alley, basically five singing instrumentalists supplemented by saxophone and trumpet, comes out of Lambert, Hendricks and Ross and uses that trio's lyrics for Basie's *Down for the Count* and the Bill Harris and Woody Herman specialty, *Bijou*. The group has written its own lyrics to Miles Davis' *Milestone*.

Musically, Bug Alley is the more accomplished of the two. It's a very crisp performing unit and has a remarkable lead singer in Karen Young. The Mudflaps' voices occasionally lack authority, but their instrumental work is good. Strangely, Bug Alley's Boswell medley misses the Sisters' style entirely, while the Mudflaps rendering of their *Sentimental Gentleman from Georgia* is superb. The Mudflaps' calling card is their jovial amateurism: Even when the singers are hanging on by their teeth, their winning enthusiasm pulls them through.

Don Byas
Inner City IC 7018
 by John S. Wilson

Though Don Byas spent most of his career in Europe, he is frequently cited as one of our major tenor saxophonists, along with Coleman Hawkins, Ben Webster, and Lester Young. This collection, better than any that I know of, explains why he has been so highly regarded. On Side 1, he plays with pianist Mary Lou Williams, bassist Buddy Banks, and drummer Dave Pochonet. He and Williams are superb together, both on her four exceptional originals and on two standards. This side alone would make "Don Byas" an exceptional disc, but parts of Side 2 are equally rewarding. Here, Byas plays with pianist Beryl Booker's all-woman trio (Bonnie Wetzel on bass, Elaine Leighton on drums) and in a quintet with vibraphonist Fats Sadi. Booker is a strong, swinging player (*Booker's Byas-ed Blues*) and her performance of *I Should Care* shows her to be a fine vocalist as well. Though the remaining quintet selections are less interesting, the caliber of playing is unusually high, as it is throughout.



Jasper: affecting solos

Merle Koch and Eddie Miller
Audiophile AP 135
 by John S. Wilson

Eddie Miller should have been one of the stars of the Swing era. But since his idiomatic style on tenor saxophone did not fit in with either the Coleman Hawkins or Lester Young school, he seemed out of fashion at the time. If his smooth, soft, mellow singing tone and attack was related to anyone's, it was to another also-ran's of the time, Bud Freeman.

Miller played with the Bob Crosby band from 1936 to '42 (and gave it its most distinctive sound), with various Dixieland bands on the West Coast in the '50s and '60s, and then spent more than a decade with Pete Fountain's group in New Orleans, his birthplace. This record finds him at a club called Michele's Silver Stope in Virginia City, Nevada, with pianist Merle Koch's quartet. (Koch, pronounced "Cook," was also with the Fountain band.) Miller's warm tone—which relates to that of classic New Orleans clarinetists Barney Bigard, Albert Nicholas, and Sidney Bechet—hasn't changed at all, and he sounds as easy, smooth, and melodic here as he did with the Crosby band.

Despite the fact that Koch developed in California and spent a long time in New Orleans, his playing here suggests Chicagoans Jess Stacy, Joe Sullivan, and even Art Hodes. But Miller is the star of this set, and if ever there was a summation of his talents on disc, "Merle Koch and Eddie Miller" is it.

Bobby Jasper: Revisited
Inner City IC 7013
 by John S. Wilson

Belgian saxophonist Bobby Jasper built such a strong reputation among American jazz musicians in Europe in the '50s that when he came to the U.S. he found immediate acceptance. Though his playing usually wavered between Lester Young and Stan Getz, on these four sessions (recorded in 1953 and '54, ten years before he died), he frequently sounds like another Young follower, Brew Moore.

Jasper was also a most provocative arranger for seven- and nine-piece groups, working in the style of the Miles Davis nonet of 1948 and '49. On "Revisited," his rich, tight voicings reach their apex in his arrangement of *So Easy to Love*, in which a darkly singing ensemble paves the way for his affecting, warm, reflective solo. His contrapuntal nonet arrangement of *Jeux de Quartes* is adventurous, even by contemporary standards. So is the inclusion of Andre Hodiér's *Paradoxe* (1954), a twelve-tone affair in which Nat Peck's trombone and Jasper's sax wrap around each other in a swinging ferment. The disc also includes some pieces for sextet and quintet.

HENRY'S HI-FI-VIDEO CAMERAS MAIL ORDER DEPT. Big Discounts

HI-FI-VIDEO-CAMERA CHECK OUR PRICES FIRST!

Hi-Fi: Akai • AR • Bose • Dual • ESS • HK • Kenwood • JBL • JVC • Marantz • Phase linear • Pioneer • SAE • Sony • Technics • Panasonic • Tandberg

Video: Hitachi • JVC • Panasonic • RCA • Sanyo • Sony • Zenith • TDK • Fuji • Scotch

Camera: Nikon • Konica • Olympus • Minolta • Pentax • Polaroid • Rollei • Leica • Minox • Hasselblad • Canon • Chinon • Bronca • B&H • Elmo • Fujica • Mamiya • Eumig • Yashica • Beaulieu • Besseler • Durst • Omega • Paterson • Vivitar

CAR STEREO		REEL TO REEL	
N (New), U (Used), D (Demo)		AKAI 255	\$520.00
ABS P100 AMP (U)	\$239.00	AKAI 4000	\$329.00
ABS L300 (U)	Pair \$219.00	Pioneer RT 707	\$459.00
Magnum CR 7000	\$179.00	Pioneer RT 909	\$595.00
Magnum CR 2001	\$239.00	Sony TC 399	\$340.00
Magnum CR 9000	\$239.00	Sony TC 765	\$799.00
Magnum CR 5001	\$299.00	Sony TC 766-2	\$860.00
Magnum CR 3001	\$429.00	Tandberg 20A	\$1145.00
Magnum New York	CALL	Technica Pro 1500 US	\$1055.00
Magnum Berlin 8000	CALL	Technica Pro 1506 US	\$1055.00
Concord All Models In Stock	CALL	Technica Pro 1520 US	\$1395.00
Marantz Car 302	\$199.00	Teac X-3	\$349.00
MARANTZ CAR		Teac X-7	\$475.00
Pioneer KP 1500	\$ 85.00	Teac X-7B	\$525.00
Pioneer KP 2500	\$ 90.00	Teac X-10	\$660.00
Pioneer KP 3500	\$125.00	Teac X-10R	\$765.00
Pioneer KP 4500	\$115.00	Teac 2340 SX	\$835.00
Pioneer KP 5500	\$135.00	Teac 3440 SX	\$1255.00
Pioneer KP 6500	\$165.00	Teac 3300 SX 2T	\$835.00
Pioneer KP 7500	\$185.00		
Pioneer FP 8500	\$155.00		
Pioneer KP 9500	\$179.00		
Pioneer KEK 20	\$219.00		
Pioneer KE 100	\$255.00		

WE CARRY FULL LINE PRO MICS, MIXERS AND ACCESSORIES

Call toll free (800)421-8537

Out of state except Alaska & Hawaii

Henry's CAMERA HI-FI-VIDEO

316 W. 8th St. Downtown L.A., Ca. 90004 Tel. (213) 488-0341
 Hours: Mon & Fri 9:30-7:30 Tu, Wed, Thur, Sat 9:30-6 PM

Circle 11 on Reader-Service Card

Moving?

Be sure and send us your new address 8 weeks before you move so you won't miss any copies of HIGH FIDELITY.

And please include an old mailing label from our magazine when writing us about your subscription.

Write to:
HIGH FIDELITY,
 1 Sound Avenue, Marion, Ohio 43302

- Change of address.
- Enter new subscription. 1 yr. \$13.95
- payment enclosed bill me

AFFIX LABEL

name _____

address _____

city _____

state _____

zip code _____

If you have no label handy, print OLD address here

name _____

address _____

city _____

state _____

zip code _____

New Address

please print

Add'l postage: \$3 per year outside U.S., its poss.



Key No.		Page No.
	Acoustic Research	33
1	Angel Records	55
2	Audio Dynamics Corp.	41
3	Audio-Matic Electronics	81
4	Audio Technica, U.S. Inc.	64
5	BASF	25
	Beyer Dynamics	34
	Bose Corp.	Cover III
6	Carver Corp.	53
	Carvin Mfg Co.	83
	Classified Ads	84-86
7	Denon America Inc.	20
8	Discount Music Club	70
9	Discwasher, Inc.	Cover IV
10	47th Street Photo	83
	Franklin Mint	
	Record Society	16-19
11	Henry's Camera	87
	Icelandair	A11
12	Illinois Audio	67
13	International Hi Fi	81
14	International Record & Tape Club	6
16	Jensen Home Audio	44, 45
15	Jensen Sound Laboratories	28
17	J & R Music World	68
18	J & R Music World	69
19	Last Factory	70
20	Maxell Corp.	11
21	McIntosh Laboratory	4
	Metropolitan Opera/Pioneer Fund	63
	Micro-Acoustics Corp.	61
22	Mobile Fidelity Records	49
23	Park Row Electronics	66
24	Pickering & Co.	2
25	Pioneer High Fidelity	Cover II, 1
26	Polk Audio	57
33	P.R.I.C.E.	55
	RCA Consumer Electronics	A4, A5
	Revox	5
27	Sansui Electronic Corp.	26, 27
	Sennheiser Electronics Corp.	83
50	Shure Brothers, Inc.	15
	Sony Industries	8
28	Sony Industries	9
29	Soundcraftsmen	14
30	Sound Guard	59
31	Stereo Corp. of America	60
	Studer Revox America, Inc.	5
32	TDK Electronics Corp.	13
34	Technics by Panasonic	7
35	3M Co.	4
	Video Action	50
36	Wisconsin Discount Stereo	61

Bill Haley, 1925-81

by Mitchell Cohen



Haley (top) & the Comets

“Rock & roll’s first phenomenon and first victim”

You see this on rock documentaries from time to time: silent footage of Bill Haley and the Comets on stage in Europe, causing riots, broken chairs, rushing crowds. A quarter of a century later, that reaction seems amazing. A plain-looking, even doughy man with a silly spit-curl became a pop hero by playing music derived from both kinds of Swing—big band and country—and bowdlerized r&b. With the simplistic *Rock Around the Clock* blurring on the soundtrack of *Blackboard Jungle*, Bill Haley entered rock history.

Crazy Man Crazy hit the pop charts in 1953, a cleaned-up version of Joe Turner’s *Shake, Rattle and Roll* a year later. *Rock Around the Clock* in ’55, then *See You Later Alligator*, and that, aside from a brief chart reentry with *Skinny Minnie*, was just about it. Bill Haley was rock & roll’s first phenomenon and first victim. He was a casualty of the pop audience’s

need for newer thrills. Once Elvis—more visceral, more mysterious, more carnal—came along, Haley was close to obsolete.

Certainly he was significant. His novelty-oriented brand of hep cat jive had a jaunty air of rebellion that caught the adolescent mood of the moment. Slangy and fun, the music of Haley’s Comets was an ice-breaker. *Rock Around the Clock*—said to have sold over 22 million copies—represented perpetual energy, and has lasted as a symbol of a break with the past. (People as diverse as George Lucas in *American Graffiti* and Sid Vicious have appropriated it in the cause of art.) But it was hardly enough. Doomsayers’ predictions for the quick demise of rock & roll might have come true had Haley’s perky style remained the standard, had Elvis not raised the stakes, had radio not opened up to black music.

Except for a reissue of *Rock Around the Clock*, Haley never had a pop hit after 1960. He remained something of a star overseas, and was a mainstay on the oldies circuit. As a middle-aged man, he saw his contribution reduced to Pavlovian nostalgia for what were perceived as happier days. He will not be remembered for the quality of his music, and only slightly for his prescient blending of country, blues, and bop into a catalytic white pop sound. Unlike rock’s other pioneers, he left behind no song or group of songs to which one can point and say, without that record, the story of rock & roll would be greatly diminished.

Best to remember Bill Haley as an opening act for the wildest show on earth, a genial entertainer, a musical innovator on a moderate scale, a man who was there early enough to make an impact. One hears of stages being stormed, cinemas being wrecked to the beat of Haley’s group, and it doesn’t make any sense when you listen to the music. But of course it does make sense. Rock & roll was beginning, and anything would be possible from that point on. ●

1 The First Fundamental Difference

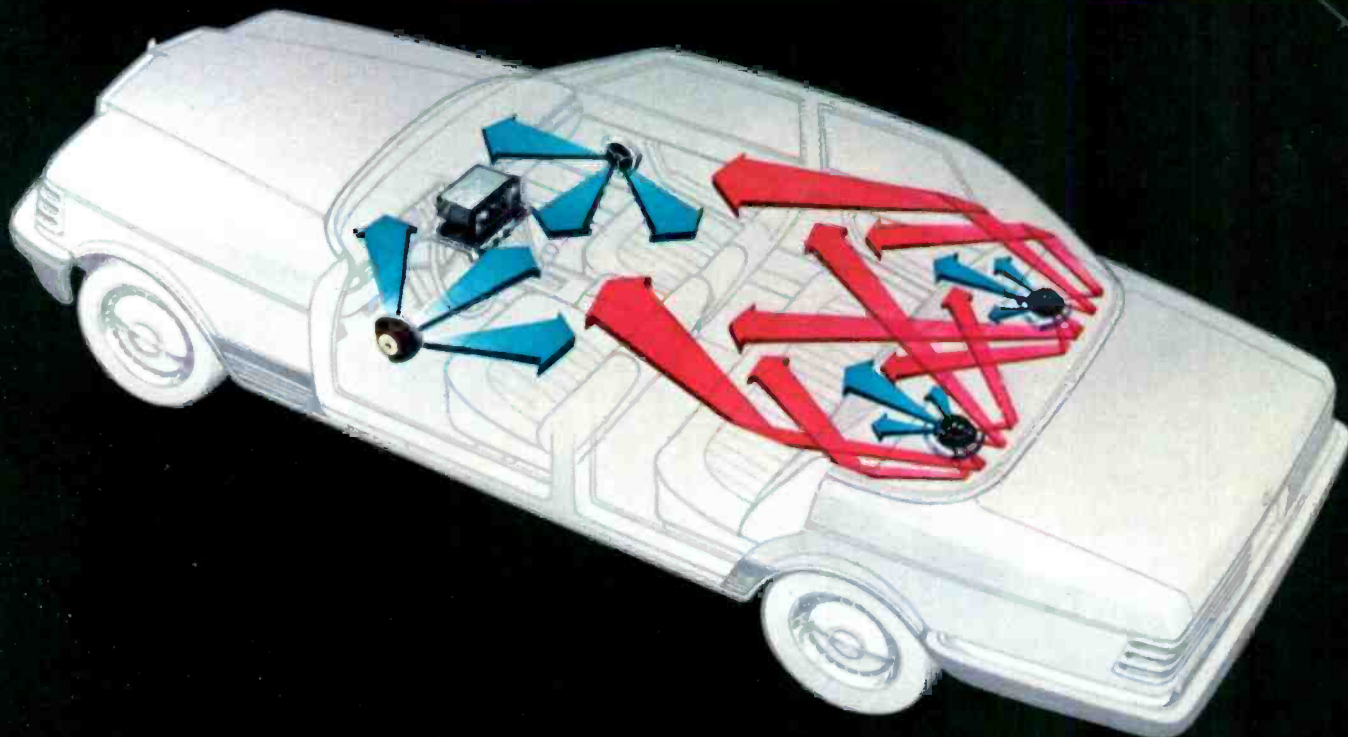

Direct/Reflecting® Speakers in the Bose® Car Stereo System.

The Bose Car Stereo System is fundamentally different from conventional car stereo components. It is designed as an integrated system. It is tested to withstand the demanding requirements of the automotive environment. And it is engineered to include innovations like Active Electronic Equalization and Direct/Reflecting® Speakers.

This is the first in a series examining each of the fundamental differences more closely.

Most of the sound you hear at a live performance is *reflected* off the walls, floor and ceiling of the



concert hall. Very little sound comes directly from the source. This natural combination of reflected and direct sound is what makes live music sound "live."

Unlike conventional direct-radiating speakers, the Direct/Reflecting® speakers in the Bose

Car Stereo System are specifically designed to recreate a natural-sounding balance of reflected and direct sound energy. Adjustable speaker grilles reflect music off the windows and walls of your car for lifelike spaciousness and clarity that can only be compared to a live performance—even individual instruments in an ensemble can be distinguished one from another!

To hear the difference yourself, ask your authorized Bose dealer to compare the Bose Car Stereo System with any other car stereo. The difference is fundamental.

For more information and the name of your local dealer, dial toll-free 1-800-528-6050, ext. 1401. In Arizona, 1-800-352-0458, ext. 1401.

DISC WASHER® AUDIO SCIENCE™ SERIES

Record Care, Part 2: A Record Life Study

How long will your phonograph records last?

How many times can you safely play records without degrading sound quality?

Using quality playback equipment, the factors of Record Longevity are twofold and closely interrelated: the record must be kept free of contamination, and the stylus must be kept clean during playback.

Scanning electron microscopy clearly shows the need and contribution of both record cleaning and stylus care.

Exhaustive research shows that with proper record/stylus care, an entire "life span" of 200 play events will not damage record surface quality or fidelity. (Most albums are played a total of 50 times or less.)

200 Plays Without Record Cleaning

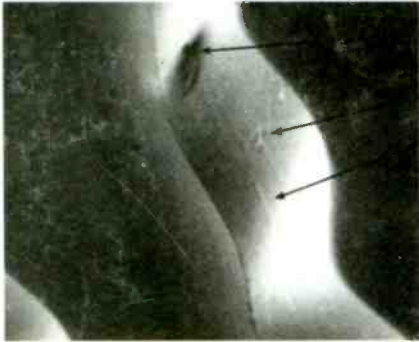

Pit from dust abrasion.
Ground-in microdust.
Prominent dust abrasion.
Prominent stylus path from abrasive-coated diamond face.
Vinyl particles welded by contaminated upper area of stylus.

200 Plays Without Stylus Care

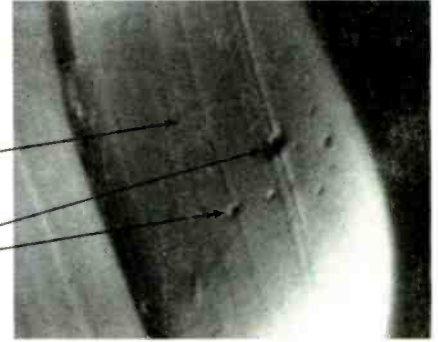

200 Plays With Record and Stylus Care

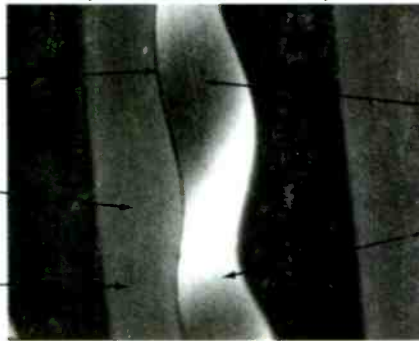

Results of D4 Record Care:
Clean central radius due to capillary attraction of D4 Fluid into D4 pad fabric.
Microdust-free stylus path due to exclusive D4 "spiral fiber" particle holding.
No wall-slurry of "lubricant" products.

Results of SC-2 Stylus Care:

Reduced wall abrasion due to uncontaminated diamond face.
Cleaned stylus leaves no welded-in particles.



There is no substitute for the valid research you get with Discwasher products. Ask for them where better dealers take interest in a longer "life span" for you.

discwasher®
PRODUCTS TO CARE FOR YOUR MUSIC

Discwasher, Inc., 1407 N. Providence Rd., Columbia, MO 65201