

High Fidelity™

THE MAGAZINE OF AUDIO, VIDEO, CLASSICAL MUSIC, AND POPULAR MUSIC

How To Pinpoint and Solve Stereo-System Problems Fast!!!

Want Better Video Sound? Best Ways To Get It!

Folkie Bonnie Raitt Turns Hard-Rocker! She Tells Why!

High-Performance Chic and Sleek Loudspeakers!!!

• \$150 to \$1,600

• New Designs, Trends
• Lab Tests

28CH5 12605 C0098 02816 JAN84
DAVID S BUCHANAN 1 HIF
2605 COUNTRY CLUB CRT
ASHLAND KY 41101 DIR

**PLUS: Speaker
Roundup —
90 Brand-New
Models**



**PRODUCT
INFORMATION
FREE!**
See Page 65



AT PIONEER, WE CARE ABOUT THE WAY YOU LISTEN

Nobody listens to audio equipment.
They listen to music.

receiver from a receiver. A Pioneer car
stereo from a car stereo. A Pioneer



A small distinction to make, but the
very thing that distinguishes a Pioneer

portable from a portable. And so on.
Because at Pioneer, we're convinced



WE ONLY CARE ABOUT THINGS.

What matters isn't that what really matters can't be measured in watts per channel, or total harmonic distortion, or wow, or flutter.

What matters isn't just cassette decks with three direct-drive motors, linear tracking turntables or quartz-lock tuning.

What matters isn't that we make more audio equipment than the next

guy. Or, for that matter, that we've sold more in the last five years than any other audio manufacturer.

When all is said and done, plugged in and switched on, what matters, is the music.

 **PIONEER**[®]
Because the music matters.

Circle 1 on Reader-Service Card

DESIGN INTEGRITY:



The Tape Tension Servo technology on our 24-track recorders...

...can be found on our \$1350. DH-510 Open-Reel, Half-Track High Speed Tape Deck...



...and our \$500. DR-F7 Three-Head, Discrete Dolby-C Cassette Deck.



Many cassette manufacturers compare their sound quality to open reel. Rather than making such inflated claims, Denon chose to incorporate the transport technology developed for our studio and 1/4" mastering machines into our cassette decks.

Proper tape-to-head contact, absolutely critical for the highest quality tape recording and playback, is controlled by outboard tension sensing arms on studio machines. On the DR-F Series cassette decks, this is accomplished by Denon's Tape Tension Servo Sensor system. Working in concert with the DR-F Series' Non-Slip Reel Drive Motors, which eliminate belts and clutches (the principal source of maintenance problems on conventional cassette decks), Denon's decks offer a literal miniaturization of a studio-type transport.

An equally important example of Denon's design approach for the DR-F Series is the use of DC (capacitorless) electronics throughout, a principle developed for Denon's Advanced Engineering Series.

Denon products share more than name alone.

DENON

Imagine what we'll do next.

Denon America, Inc., 27 Law Drive, Fairfield, N.J. 07006

High Fidelity

AUDIO

High Fidelity News *by the Audio Editors*
New tape recorder standards; Sota's sapphire-bearing turntable; Denon amp 9

CrossTalk *by Robert Long*
Is "washing" records OK? Can signal processors be connected in series? 14

Basically Speaking *by Michael Riggs*
Separation, tracking, and distortion in phono cartridges 16

***New Equipment Reports**

DCM Macrophone speaker	19	KEF 203 speaker	24
Linn Sara speaker	20	Speakerlab SX speaker	26
Cizek Sound Window speaker system	23	Boston Acoustics A-40 speaker	29

***Loudspeakers: The Untamed Component** *by Michael Riggs*
Striking new models and traditional designs in our summer speaker roundup 30

***Retsoff's Remedies** *by Alexander N. Retsoff*
Quick tips for troubleshooting your stereo system's problems 36

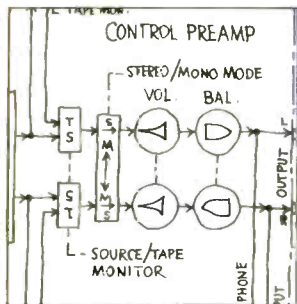

36 Mapping It Out

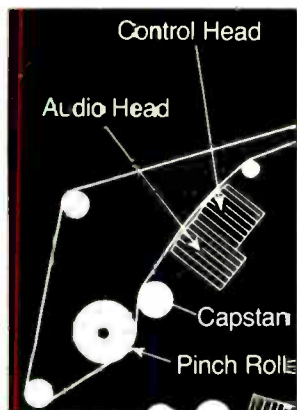

39 Overcoming the Odds



45 Stravinsky's 100th



72 Green Light for Raitt

VIDEO TODAY & TOMORROW

***VideoFronts** *by the Editors*
Toshiba's front-loading Beta cassette deck; JVC's eight-hour VHS tape 38

Quality Video Sound *by Edward J. Foster*
Improving audio performance is key to the future success of video 39

TubeFood *by Susan Elliott*
Home video and pay cable highlights 41

Video Q. & A. *by Edward J. Foster*
Beta-format camera? 42

CLASSICAL MUSIC

Behind the Scenes *by James R. Oestreich*
Stravinsky's 100th; More Hamilton; Still more Stokie 44

Three Cheers for Stravinsky *by Jeremy Noble*
But why don't the record companies give us more of his music? 45

The Masters' Voices *by David Hamilton*
Stravinsky and Bartók centenary albums: Are composers' recordings definitive? 47

The Glories of the French Baroque *Reviewed by Nicholas Kenyon*
Even questionable performances can't diminish the greatness of Rameau and Charpentier 52

Sylvia Marlowe: Wit, Warmth, and Wisdom *Reviewed by Kenneth Cooper*
Her last recording—Haydn sonatas—and a discography of her career 55

Reviews: Goldsmith on the "legendary" Hollywood Quartet; Stenhammar symphony; Dvořák's *Devil and Kate* 58

Critics' Choice 60

More Tchaikovsky, Ho . . . Huh? *Reviewed by John Canarina*
The original *Romeo* and other first (!) recordings 63

The Tape Deck *by R. D. Darrell*
Transcriptions and aberrangements; Anachronistic new, authentic old 71

BACKBEAT/Popular Music

***Bonnie Raitt Lightens Up** *by Steven X. Rea*
Onetime folkie rocks out, but maintains her musical and political integrity 72

Input Output *by Fred Miller*
Tascam eight-track mixer; Tusc tube amplifier; Dynafex noise reduction unit 75

Pop Reviews: Wendy Waldman; Squeeze; Fingerprintz; Talking Heads 76

Jazz Reviews: Ornette Coleman; Charlie Parker; Bobby Short 80

DEPARTMENTS

*Cover Stories	Letters	7	Advertising Index	86
	*Reader-Service Cards for FREE Product Information			65



This 16-page book of reviews from High Fidelity, Stereo Review and Stereo is available at your local audio dealer... or write to: Pickering & Co., 101 Sunnyside Blvd., Plainview, NY 11803

THE SOURCE OF PERFECTION



"for those who can hear the difference"

Circle 2 on Reader-Service Card

Music in the round. With BES speakers, center stage is everywhere.

No matter where you sit, no matter where the speakers are placed, the musical image remains 3-dimensional and lifelike.

That's because BES speakers radiate the sound in all directions, not in a narrow beam like ordinary box speakers that limit the stereo image to one point in the room. BES projects the spacious quality of live music everywhere.

BES Speakers—suddenly center stage is wherever you are.

 **BES speakers.**
Music in the round.



© 1982 by BES, 345 Fischer Street, Costa Mesa, Ca. 92626 • (714) 549-3833

Circle 46 on Reader-Service Card

William Tynan,
Editor-in-Chief
Shirley Fleming,
Editor, Musical America
Susan Elliott,
Managing Editor
Editor, Backbeat
James R. Oestreich,
Classical Music Editor
Robert Long,
Audio-Video Editor
Robert Maddocks,
Director of Graphics
Michael Riggs,
Associate Audio-Video Editor
Peter Hemingson,
Copy Editor
Susan E. Fingerhut,
Assistant Music Editor
Janet Wolf,
Mildred Comacho-Castillo,
Editorial Assistants
Edward J. Foster,
Consulting Audio-Video Editor

Contributing Editors: Crispin Cioe, R. D. Darrell, Harris Goldsmith, Edward Greenfield, David Hamilton, Dale Harris, Don Heckman, Stephen Holden, Nicholas Kenyon, Allan Kozinn, Paul Henry Lang, Irving Lowens, Robert C. Marsh, Fred Miller, Andrew Porter, Steven X. Rea, Susan Thiemann Sommer, John S. Wilson.

Kathleen Davis,
Director of Production
Randy Brozen,
Audio-Video Production Editor
Lida A. Silverman,
Music Production Editor
Susan M. Allyn,
Circulation Director, Subscription Sales
Dominic Mustello,
Circulation Director, Newsstand Sales
William P. Johnson,
Circulation Service Manager
Suzanne Hochman,
Direct Mail Manager
Steven I. Rosenbaum,
Publisher

Cover photo: George Menda

ADVERTISING

New York: ABC Leisure Magazines, Inc., 825 7th Ave., 8th Floor, New York, N.Y. 10019. Telephone: (212) 265-8360. Seymour Resnick, Advertising Director. Raymond Foster, Associate Advertising Director. George Dickey, Record Advertising Manager. Yetta Peltzman, Classified Advertising Manager. Robert Maddocks, Director of Graphics. Kathleen Davis, Director of Production. Janet Cermak, Advertising Production Manager. Cecelia Giunta, Administrative Assistant.

Midwest: ABC Leisure Magazines, Inc., 415 South Ioka Avenue, Mt. Prospect, Ill. 60056. Telephone: (312) 398-7580. William P. Gordon, Midwest Advertising Manager.

Los Angeles: ABC Leisure Magazines, Inc., 2020 Avenue of the Stars, Suite 245, Century City, Calif. 90067. Telephone: (213) 557-6481. Andrew Spanberger, National Advertising Manager. Janet Endrignas, Western Advertising Manager.

Tokyo: Japan Advertising Communications, Inc., New Ginza Bldg., 7-3-13 Ginza, Chuo-ku, Tokyo 104, Japan. Telephone: (03) 571-8748. Shigeru Kobayashi, President.

HIGH FIDELITY and **HIGH FIDELITY/MUSICAL AMERICA** are published monthly by ABC Leisure Magazines, Inc., a division of ABC Publishing, Inc., and a subsidiary of American Broadcasting Companies, Inc. ABC Publishing, Inc. Robert G. Burton, President. Ronald Stuart, Vice President. Finance: ABC Leisure Magazines, Inc. Herbert Kepler, Senior Vice President. Photographic Publishing Division: Anthony F. Morgano, Vice President. Finance: Ernest G. Scarfone, Vice President. Graphics and Production: Steven I. Rosenbaum, Vice President. High Fidelity Group Member Audit Bureau of Circulation, Indexed in Reader's Guide to Periodical Literature. Current and back copies of HIGH FIDELITY and HIGH FIDELITY/MUSICAL AMERICA are available on microfilm from University Microfilms, Ann Arbor, Mich. 48106. Microfiche copies of these magazines (1973 forward) are available through Bell & Howell Micro Photo Division, Old Mansfield Road, Wooster, Ohio 44691.

Editorial correspondence should be addressed to The Editor, HIGH FIDELITY, 825 7th Ave., New York, N.Y. 10019. Editorial contributions will be welcomed, and payment for articles accepted will be arranged prior to publication. Submissions must be accompanied by return postage and will be handled with reasonable care; however, the publisher assumes no responsibility for return of unsolicited photographs or manuscripts.

HIGH FIDELITY is published monthly at 825 7th Ave., New York, N.Y. 10019, by ABC Leisure Magazines, Inc., a subsidiary of American Broadcasting Companies, Inc. Copyright © 1982 by ABC Leisure Magazines, Inc. The design and contents are fully protected by copyright and must not be reproduced in any manner. Second-class postage paid at New York, New York, and at additional mailing offices. Authorized as second-class mail by the Post Office Department, Ottawa, and for payment of postage in cash. Yearly subscription in U.S.A. and Possessions \$13.95, elsewhere \$19.95. Single copies \$1.50. Subscribers: Send subscriptions, inquiries, and address changes to HIGH FIDELITY, P.O. Box 10759, Des Moines, Iowa 50340. Change of address: Give old and new addresses, including ZIP Code. Enclose address label from last issue and allow five weeks for change to become effective. **Postmaster: send Form 3579 to HIGH FIDELITY, P.O. Box 10759, Des Moines, Iowa 50340. Postal Identification Number 243820.**



Now Technics lets you hear nothing but the sound of the source. Introducing the SV-P100 Digital Cassette Recorder.

No tape hiss. No wow and flutter. Not even head contact distortion. With Technics new SV-P100, they no longer exist. The result—now you listen to the actual music... the source, not the tape or the tape player.

Utilizing the Pulse Code Modulation (PCM) digital process, the SV-P100 instantaneously translates musical notes into an exact numerical code, stores them on any standard VHS cassette, then "translates" them back into music on playback. Duplicate tapes are exactly the same as the original. Thus, every recording and every copy is a "master."

The revolutionary size of the new Technics SV-P100 recorder (17"x11"x10") is the result of state-of-the-art semiconductor technology. The built-in videotape transport mechanism brings the convenience normally associated with conventional front-loading cassette

decks to a digital application. Tape loading is now fully automatic. And, frequently used controls are grouped together on a slanted panel with LED's to confirm operating status.

Despite its compact size, the SV-P100 recorder offers performance beyond even professional open reel decks. Since the digital signal is recorded on the video track, the space usually available for audio can therefore be used for editing "jump" and "search" marks. The unit employs the EIAJ standard for PCM recording. And, in addition, editing and purely digital dubbing are easily accomplished with any videotape deck employing the NTSC format.

Technics new SV-P100 is available at selected audio dealers. To say that it must be heard to be appreciated is an incredible understatement.

Technics
The science of sound.



Because Sony redesigned the car stereo, the auto makers don't have to redesign the car.

The interior of an automobile is designed with a lot of purposes in mind. Unfortunately, great stereo sound reproduction isn't one of them.

Fortunately, Sony did more than just tackle this problem. They actually solved it. By designing a stereo system that meets the acoustical challenges inherent in a car.

INTRODUCING THE SONY SOUNDFIELD™ SYSTEM.

As the very name of our system indicates, we started with the acoustical sound field itself by treating the entire front of the car as a stage. The very directional high-end and mid-range frequencies emanate from this stage in an accurate stereo image.

Two Super Woofers in the rear create deep, dramatic bass.

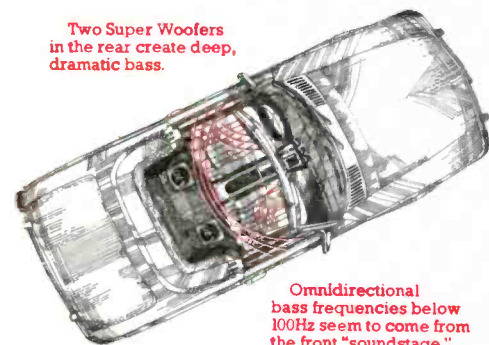

Omnidirectional bass frequencies below 100Hz seem to come from the front "soundstage."

So the highs come across clear and soaring. The midrange, natural and accurate.

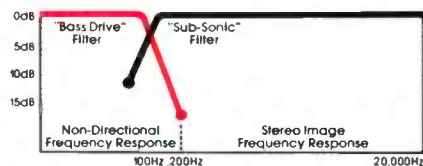

The bass frequencies below 100Hz actually are directed from the rear of the car, where the Super Woofers are placed. However, since these frequencies are omnidirectional, they seem to be coming from the proper "stage" location.

The result is richer, fuller, and more dramatic bass.

CONVERT WITH COMPONENTS.

The optimum SoundField System consists of a powerful amplifier (XM-120) driving a pair of 8" Super Woofers (XS-L20), along with a medium-powered amplifier driving the front speakers. This means full-range speakers can be used without risk of modulation distortion.

But you can begin to enjoy the

SoundField System simply by adding one of our lower powered amplifiers and the Super Woofers to the car stereo you already have. Then you can slowly build up your system, adding a higher powered amplifier, more speakers, and an equalizer.

A SOUND THAT TAKES A BACKSEAT TO NONE.

Although the technology of the Sony SoundField System is complex, the reason for it is simple.

It will give you high dB levels with very low distortion, extremely precise stereo imaging, and an amazingly broad frequency response. In addition, you'll be pleasantly surprised at just how easily a SoundField System can be installed in your car.

So come into your local Sony dealer and ask to hear the next generation in autostereo systems.

One listen and you'll know why the auto makers don't have to redesign the car.

SONY
THE ONE AND ONLY



Letters

X-Rea Ayes

I usually take Steven X. Rea's reviews with a grain of salt; I've been burned on some of the records he reviewed enthusiastically. I'll definitely make an exception with the new Chubby



Checker record, though [BACKBEAT, April]. The first time I put it on my turntable, it nearly blew my doors off! For once, X. Rea was right.

George P. Fries
Marquette, Mich.

Fused Whumps

In your "CrossTalk" answer to the fellow who kept blowing speaker fuses when he used his equalizer [February], you neglected to mention another possible cause. It is characteristic of certain filter designs that when the turnover, or notch, frequency is changed rapidly, the unit emits a pulse of DC bias. This is particularly a problem with low-frequency filters, as they are often built from components having a greater charge-storage capacity. Quickly changing the position of a bass control (or the low-frequency control on an equalizer) will often result in a loud "whump" from the speakers and might well blow a speaker fuse.

W. Olin Sibert
Arlington, Mass.

Mr. Riggs replies: An interesting comment, though nothing in the original letter confirms that the reader was given to changing the equalizer's control settings in this way.

Midwestern Blues

I enjoyed Don Heckman's review of the Akiyoshi-Tabackin Big Band album, "Tanuki's Night Out" [January]. I've called all the record stores in Des Moines, but I've been unable to find one that has the album. Can you supply the address of Jazz America Marketing?

Austin Core
Des Moines, Iowa

Jazz America Marketing is at 1737 De Sales Street, N.W., Suite 300, Washington D.C. 20036. The album is available for \$7 plus \$1.50 for postage and handling.—Ed.
(Continued on page 8)

Address letters to The Editor, HIGH FIDELITY, 825 7th Ave., New York, N.Y. 10019. All letters are subject to editing for brevity and clarity.

WE'LL LURE YOU WITH OUR PRICES... AND WIN YOU WITH OUR SERVICE

ORDER TOLL FREE (800) 221-8180
IN NEW YORK (212) 732-8600

STEFEO-TO-GO

Sony Walkman II Player
-Metal Tape Player
-2 Headphones included
-1 Headphone in Car

\$89

COMPUTERS

Commodore VIC-20 Home Computer

\$239

BLANK CASSETTES

AUDIO CASSETTES

MAXELL UDXL I or UDXL II C-60 12.49
MAXELL UDXL I or UDXL II C-90 12.49
MAXELL UD C-60 15.99
MAXELL LN-90 2-Pack 12.57
TDK SA C-60 12.37
TDK SA C-90 12.95
TDK MAC 90 (Metal) 15.29
TDK SA C-90 14.49
TDK C-60 11.25
TDK C-90 11.64
TDK A60 12.45
TDK HD 01 11.99
TDK Head Demagnetizer 116.99

VIDEO CASSETTES

MAXELL T-120 12.95
MAXELL HCT-120 High Grade 12.49
MAXELL L-120 12.25
TDK T-120 12.95
TDK HCT-120 High Grade 9.95
TDK L-500 110.49
SONY L-500 110.49
SONY L-750 112.95
SCOTCH T-120 12.95
FUJI T-120 10.49
FUJI L-500 112.49
BASF T-120 12.95
BASF L-500 9.49
AMPEX T-120 111.90

WE CARRY TAPES BY: MAXELL, TDK, SONY, SCOTCH, FUJI, MEMorex, BASF, AMPEX, JVC, PANASONIC, ZENITH

COMPUTERS

HARDWARE

ATARI 800 Home Computer 135.99
ATARI 800 Deluxe Computer 167.99
TI P/MC 004A Home Computer 132.99
SHARP PC-1500 (Port. Computer) 229.99
ATARI 810 Program Recorder 184.90
ATARI 810 (DMA Drive) 1449.90
ATARI 825 (Printer) 148.90
EPSON MX-100 (Printer) 163.99
EPSON MX-100 (Printer) 167.99
COMMODORE VIC-1510 Data Cassette 79.99
COMMODORE VIC-1515 (Printer) 135.99
TI P/MC 190C (6.5 Printer) 129.99
TI P/MC 185C (Disk Drive) 156.99
SHARP CE-150 (Printer) 117.99

SOFTWARE

ATARI CIL-4011 Star Raiders 159.90
ATARI CIL-4022 (Pac Man) 156.90
ATARI CIL-4008 (Space Invaders) 156.90
ATARI CIL-4006 (Super Breakout) 156.90
COMMODORE VIC-1904 Super Star 126.90
COMMODORE VIC-1211A (Super Star) 126.90
COMMODORE VIC-1211A (Espace Invaders) 159.90
TI P/MC-4023 (Mull. The Wumpus) 121.90
TI P/MC-4031 (The Attack) 132.90
TI P/MC-4036 (Zero-Zax) 117.90

TELEPHONES

GTE FLIPPHONE II 168
FREEDOM PHONE 5500 (Mini Cordless) 1225
COBRA CP-300 Wireless 600 Range 1159
DEMON DIALER MODEL 176-T (Memory Dialer) 1149.95
PHONE CONTROLLER (Memory Dialer) 184.95
EXTERNA PHONE EX-3000 (Collins Phone) 1155

CAR STEREO

CAR STEREO in Dash Cassette w/AM/FM Radio

PIONEER KE-2100 1175
PIONEER KE-1100 1210
JENSEN JE-518 (10W Auto Rev) 1279
JENSEN JE-406 (Auto Rev, 5 presets) 1198
BLAUPUNKT CB-2010 1289
BLAUPUNKT CR-3001 1449
CLARION 7500 (FM AM) 1210
SANYO FT-CB (Horn V/E Mount) 1108
PIONEER CD-761 (FM AM) 1210
MARANTZ SR-427 (Digi. AM) 1240
CRAGT-690 (Auto Rev, Dohy) 1209

CAR SPEAKERS

JENSEN J-2033 (6x9 Triax) 199.90 (PAIR)
JENSEN J-1069 (6x9 Coax) 149.90 (PAIR)
JENSEN J-1065 (6x9 Triax) 169.90 (PAIR)
JENSEN J-2176 (6x9 Coax) 159.90 (PAIR)
JENSEN J-2041 (5 1/4 Coax) 154.90 (PAIR)
PIONEER TS-15 134.90 (PAIR)
PIONEER TS-68 199.90 (PAIR)
PIONEER TS-635 189.90 (PAIR)
PIONEER TS-168 74.90 (PAIR)
PIONEER TS-10 1129.90 (PAIR)
PIONEER TS-108 149.90 (PAIR)

VIDEO ACCESSORIES

VIDEORAF Detailer II 1195
VIDEORAF Stabilizer 159
VIDEORAF Prog. Amp (New) 1234
VIDEORAF Detailer I 1105
PCRE DUBMASTER 1179.95
(Detail & Enhance)
RHODADES TELEADAPTER TE 200 127.99
RHODADES TELEADAPTER TE 100 112.95
ACME-LITE TYPHOID 154.95
MAXELL Head Cleaner VHS or Beta 17.99
TDX Head Cleaner VHS or Beta 17.99
SCOTCH Head Cleaner (VHS) 146.99
ALLTOP Head Cleaner VHS or Beta 118.99

J&R MUSIC WORLD

23 PARK ROW, DEPT. HF6, NYC NY 10038

HOW TO ORDER BY MAIL

FOR PROMPT AND COURTEOUS SHIPMENT SEND MONEY ORDER, CERTIFIED CHECK, CASHIER'S CHECK, MASTERCHARGE, VISA, include card number, international explanation date and signature. DO NOT SEND CASH, PERSONAL AND BUSINESS CHECKS. MUST CLEAR OUR BANK BEFORE PROCESSING. SHIPPING HANDLING & INSURANCE Charge is 5% of Total Order with a \$8.95 minimum charge. WE SHIP TO CONTINENTAL U.S., ALASKA, HAWAII, PUERTO RICO, AND CANADA ONLY. Canadian Orders Add 10% shipping with a \$9.95 minimum charge. For shipments by air, please double these charges. NEW YORK STATE RESIDENTS PLEASE ADD SALES TAX. ALL MERCHANDISE SHIPPED BRAND NEW, FACTORY FRESH AND 100% GUARANTEED.

SEND FOR FREE 240 PAGE AUDIO/VIDEO CATALOG

Circle 27 on Reader-Service Card

2 OZ. PRODIGY

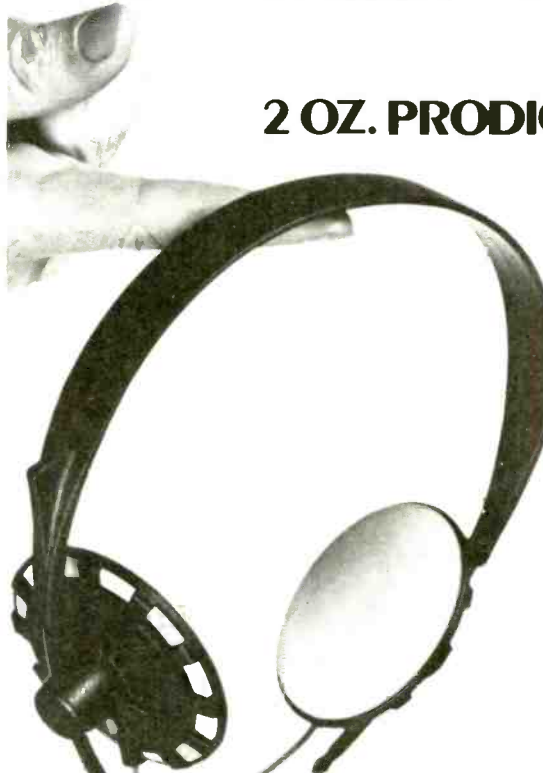

If you think lightweight headphones mean lightweight sound, prepare to be amazed.

They're the incredible new HD40, Sennheiser's latest—and lightest—Open-Aire® model. With the electrifying clarity and definition that earned their forerunners world renown. Plus the wide frequency response and natural dynamic range that are Sennheiser trademarks.

Come hear Sennheiser's latest triumph at your dealer today. The price is so modest, you won't feel anything but the music.

SENNHEISER

ELECTRONIC CORPORATION

10 West 37th Street, New York 10018 (212) 239-0190
Manufacturing Plant: Bissendorf/Hannover, West Germany

GET YOUR HEADS FANATICALLY CLEAN.



Oxide deposits on heads, pinch rollers, and capstans play havoc with your sound and mechanical performance. The Teac Cleanmatic Head Cleaner kit goes after dirt and oxide as only its unique liquid cleaning system can. Cleans any head — Erase, Play, or Record. Along with the capstan shaft and pinch rollers.

If there's no Teac dealer in your area, send for Cleanmatic direct. Write us at Teac, 7733 Telegraph Road, Montebello, CA 90640. Enclose \$7.95 per kit, plus \$1.50 for handling and postage. In California please add 6% sales tax.

TEAC MADE IN JAPAN BY FANATICS

COPYRIGHT 1982, TEAC CORPORATION OF AMERICA, 7733 TELEGRAPH ROAD, MONTEBELLO, CA 90640

Circle 8 on Reader-Service Card

WHY PAY MORE!

SONY's
Best **\$1099**

SL 2500

PORTAPAC
Portable Stereo **\$109**

PMS 3020

PIONEER
Digital Supertuner **\$193**

KE 5100

SHARP
Dolby **\$79**
Cassette Deck

RT-10

SONY FM
Walkman **\$64**

PIONEER
\$125 ea.

HPM 700

TOLL FREE 800-356-9514 Weekdays 9-9
Saturdays 9-5

Over 100 Brands like:

- | | | | | |
|----------|----------|------|----------|-----------|
| Technics | Maxell | Sony | Cerwin | Acutex |
| Pioneer | Empire | Teac | Vega | Craig |
| Marantz | Altec | Akai | Onkyo | Scotch |
| Kenwood | Sharp | Dual | Audio | B.I.C. |
| Sansui | Phillips | Koss | Technica | Stanton |
| Jensen | Shure | TDK | Clarion | Pickering |

WDS

WISCONSIN DISCOUNT STEREO
2417 w. badger rd. madison, wi 53713
608-271-6889

Circle 43 on Reader-Service Card

Letters

(Continued from page 7)

Where It's Due



We were gratified to be favorably associated with the New Pro Arte release of the Taneyev piano quartet performed by the Cantilena Chamber Players ("Muscovite Phoenix: The Taneyev Phenomenon," April). However, credit for the sonic character of this recording belongs solely to the producer, Judith Sherman. The modest virtue of our Sony PCM recorders is that their busy little digits file and recall faithfully whatever is forwarded to them.

MacDonal Moore

New York Digital Recording, Inc.
New York, N.Y.

Video Sources

I've been frustrated in attempting to order for our library several of the video cassettes you listed in the April "TubeFood." *Video Source Book* has no addresses for Electric Video, Mastervision, and Thorn/EMI. Can you please help?

James Elrod

Director of the Library
California Institute of the Arts
Valencia, Calif.

Electric Video
1116 Edgewater Ave.
Ridgefield, N.J. 07657

Mastervision
969 Park Ave.
New York, N.Y. 10028

Thorn/EMI
9th Floor
1370 Avenue of the Americas
New York, N.Y. 10019

Journey Not a Trip

I'd like to reply to the letter from Todd Cravens concerning Journey [March]. In response to a negative review of "Escape," Cravens reminds us that the album is No. 1 on most Top LP charts and that the disc contains at least four songs that are "bound to be hits."

Unfortunately, popularity has nothing whatsoever to do with artistic or musical quality. Any slop can become a hit with the right publicity and promotion. *Troglodyte (Cave Man)*, *Hold On*, and *Monster Mash* (which made the charts twice!) are just a few of the most painfully obvious examples.

My point is not to place Journey in this category (though many would), but to make a distinction between popularity and quality.

Shelley V. Sybesma
Music Director, KSBT
Encinitas, Calif.

High Fidelity News

New equipment and developments by the Editors

New Standards for Recorders

About the time this issue appears, new measurement standards for home tape equipment should be circulated by its sponsors for ratification. The committee in whose hands the writing of the standards was placed began its work under the Institute of High Fidelity about two years ago and has been chaired by Edward J. Foster of Diversified Science Laboratories, our Consulting Audio Editor. Also on the panel were our Audio-Video Editor, Robert Long, and representatives of various manufacturers, industry groups, and publications that

share an interest in tape recording equipment. Before the work of the committee was finished, the IHF was absorbed by the Electronic Industries Association, so the standard will be officially an EIA project. Some practices developed by HF and DSL are reflected in the EIA test procedures. Ed Foster will have much more to say about the tape-recorder standard and its impact in his next two "Sound Views" columns. Additional provisions of the new standard will also be applied to HF's test program in subsequent issues.



Soundcraftsmen's MOS FET Amp

The LA-2502 power amplifier from Soundcraftsmen utilizes power MOS FETs in its output stages and omits all current-limiting circuitry in order to achieve very low harmonic distortion. Dual strings of LEDs provide calibrated output metering at intervals of 1 to 3 dB up to 500 watts (27 dBW); clipping LEDs signal actual waveform distortion. The amp is rated at 125 watts (21 dBW) per channel into 8 ohms, with no more than 0.05% THD, from 20 Hz to 20 kHz. Signal-to-noise ratio is said to be at 105 dB. A/B speaker switching is provided; walnut end panels are included. The price is \$650.

Circle 89 on Reader-Service Card



Affordable Linear Tracking

Technics has expanded its line of linear-tracking turntables with the full-size SL-DL5. It incorporates a direct-drive motor

and a microprocessor control that provides such automatic features as lead-in, size and speed selection (with manual override), cue, return and stop, and repeat. The \$250 SL-DL5 can be fitted with cartridges made by Ortofon, Shure, and Audio-Technica as well as Technics.

Circle 85 on Reader-Service Card



Stylish Receiver from Sanyo

An attractive new receiver from Sanyo, the model DCR-350, incorporates digital frequency-synthesis tuning, a twelve-station memory, and a five-stage LED signal-strength meter. Other features include one-way tape dubbing, remote-speaker switching, and high and low filters. The \$300 receiver is rated at 33 watts (15 1/4 dBW) per channel into 8 ohms, with no more than 0.03% THD.

Circle 84 on Reader-Service Card

Infrared Reverse

By using a rotatable head assembly and an infrared detector that senses the tape leader, Toshiba's new PC-G6R cassette deck achieves a 2-second automatic reverse in both recording and playback modes. The head system is designed to provide (Continued on page 10)

POLK

THE CRITIC'S CHOICE

"One of the finest of all high efficiency speakers is Polk's superbly musical 10A Monitor System (\$300), which produces veritable cascades of remarkably natural sound from only 10 watts." *The New York Times*

The Experts Agree! Polk speakers will give you the highest quality sound and the most listening pleasure for your money. They will deliver amazingly life-like, boxless, three dimensional sound with breathtaking clarity and detail in your listening room from your hifi system.

Polk speakers are affordably priced from about \$100 to \$500 each. Simply use the free reader service card to receive detailed information, copies of the expert's rave reviews and the location nearest you for auditioning the **Incredible, Affordable Polks.** Polk Audio, Inc. 1915 Annapolis Rd., Baltimore, MD. 21230

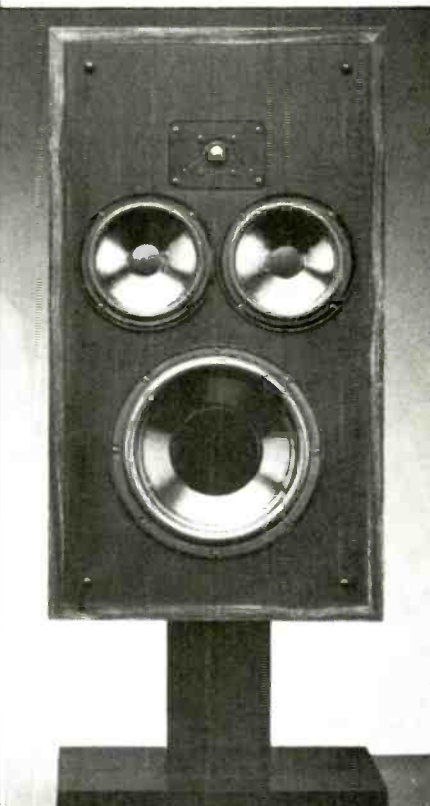

The award winning Polk Monitor 10 is less than \$300 each. Audiogram says, "It's simply a steal."

polkaudio
The Speaker Specialist's

(Continued from page 9)

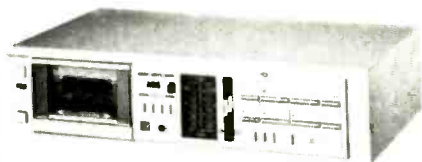

increased performance and reliability in both directions of tape travel. Also featured are metal-tape compatibility, solenoid transport controls, and Dolby B noise reduction. Frequency range is rated at 20 Hz to 18 kHz with metal tape, wow and

flutter at 0.045%, and the signal-to-noise ratio (Dolby off) at 58 dB. The PC-G6R is priced at \$300; the optional RM-20 remote control is \$40.

Circle 90 on Reader-Service Card

Multifacet Turntable

Sota's new turntable has an inverted bearing on which rests a sapphire-disc thrust plate fixed to the center of the underside of



the platter, providing rotation at the center of gravity and thus cancelling any unbalanced forces. The Sapphire Turntable incorporates a massive subassembly for inertial stability and isolation and has a balanced platter pad to control ringing and standing waves. The brushless DC servo motor and belt drive are electronically switchable for 33 or 45 rpm; both speeds are adjustable. The price, without a tone-arm, is \$695.

Circle 91 on Reader-Service Card



Add-On Audio Cabinet

The Woodmere Glasslid cabinet by Custom Woodwork and Design can be modified to accommodate different accessories. Construction is of solid wood with an oiled or waxed finish; other features are bronze tempered-glass doors, two hinged glass lids, two adjustable shelves, and chrome hardware and casters. Optional accessories include a drawer (with removable dividers) that can hold record-care products or as many as 60 cassettes, a slide-out shelf for a VCR or extra turntable, and a video cassette drawer with a capacity of twenty-four Beta or VHS tapes. The Woodmere Glasslid is available in natural oak and dark oak for about \$450; in natural walnut for about \$550.

Circle 83 on Reader-Service Card

(Continued on page 12)

For additional news on new instruments and accessories, see *Input Output*, page 75.

They'll sound as good in your home as they measure in our lab.

Although all our Norman Laboratories speakers are designed to measure well in the lab, we never forget where they have to sound best — and that's in your home.

That's why we use polypropylene woofers, ferro-fluid damped tweeters, and computer-designed cross-overs — because they sound better where it counts . . . in your home. Just as our genuine walnut and oak cabinets look better. Listen to our Norman Labs speakers. They sound, and look, more expensive than they cost.



Norman Laboratories, Inc.

2278 Industrial Boulevard, Norman OK 73069

Write for the name of your nearest dealer, or call (405) 321-3205.

Circle 34 on Reader-Service Card

Circle 10 on Reader-Service Card ▶

Introducing TDK AD-X. The normal bias tape with Super Avilyn technology.

New TDK AD-X is the first normal bias audio cassette to use TDK's Avilyn magnetic particle—based on the renowned Super Avilyn formulation that has kept TDK the leader in audio and videotape technology.

The Avilyn advantage offered in AD-X is demonstrably clear. You now can record and play back—in the normal bias/EQ position

with complete compatibility for any cassette deck over a wider dynamic range and with far less distortion. Even at higher recording levels, the increased headroom in

new AD-X can easily handle strong signal input without over-saturation.

When you hear the brilliant playback resulting from the higher

MOL and lower bias noise you won't believe that your deck can "improve" so much.

The new AD-X has truly versatile applications. Its higher sensitivity makes it ideal for all-round home entertainment use and also suitable for any cassette player.

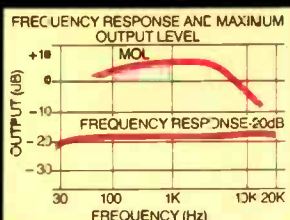

Avilyn magnetic particle achieves higher saturation and lower noise.



Record at higher levels with far less distortion.

To ensure years of reliable use, AD-X is housed in TDK's Laboratory Standard Mechanism, and protected by TDK's lifetime warranty. With its distinctive packaging, you won't miss it.

So for high quality recordings in the normal bias/EQ position, snap in the new TDK AD-X. You'll discover that the Avilyn advantage means superior overall performance for you.

TDK
THE MACHINE FOR YOUR MACHINE





WHAT TYPE ARE YOU?

Power has its price. Unfortunately, with many receivers, you usually end up paying for a lot of power you may not necessarily need in order to get the computerized features you want.

At Kenwood, we don't think that's playing fair.

Which is why every one of our new Hi-Speed™ receivers offers a host of very intelligent engineering advances.

Like Direct Coupled, Hi-Speed amplifier circuitry for absolutely brilliant musical clarity, down to 0Hz.

And microprocessor controlled Quartz PLL Synthesizer tuning to give you perfect, drift-free FM reception.

We've even included the convenience of our computerized AutoScan tuning. And instant, automatic computer-memory tuning of 6 AM and 6 of your favorite FM stations.

But best of all, we didn't restrict all this intelligence to just our new KR-850 Hi-Speed receiver.

You can also find it on our new KR-830.

And our new KR-820.

And even our new Slimline KR-90.

Examine all the possibilities at your Kenwood dealer. With all the choices we offer, you'll find the computerized receiver that's exactly your type.

At your type of price.

 **KENWOOD®**
The audio company that listens.

P.O. Box 6213, Carson, CA 90749

AUDIO High Fidelity News

(Continued from page 10)



Low-Price Sonus

For compatibility with tonearms of relatively high mass that are found on many moderate-price turntables, the SR-202 cartridge has a slightly stiffer suspension than other Sonus models. This moving-iron design has a mass of only 5.5 grams and features an elliptical stylus with a tracking range of 1½ to 2½ grams. Sonus claims a frequency response of 10 Hz to 10 kHz, ±1 dB, and channel separation of 25 dB at 1 kHz. The price is \$60.

Circle 92 on Reader-Service Card

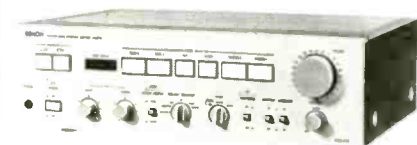

Denon's Accurate Integrated Amp

No negative feedback is used in Denon's new PMA-770 integrated amplifier. It features a localized error-detection-and-correction system designed to cancel distortion without the side effects attributed to conventional feedback arrangements. In addition, the output stages employ variable-bias circuitry said to provide Class A performance without the waste heat of true Class A configurations. Other features include what Denon calls Real Drive circuitry, which compensates for impedance variations, reducing distortion with real speaker loads, and direct coupling for improved bass performance and minimum phase shift. The PMA-770 is rated at 100 watts (20 dBW) per channel with no more than 0.005% THD. It sells for \$620.

Circle 93 on Reader-Service Card



Jensen's Car Mini

Designed for most X-body and imported cars, the JR-110 cassette/receiver unit from Jensen boasts a compact chassis and incorporates automatic loudness compensation. Other features include automatic local/distance switching, five-station preset tuning, and locking FAST FORWARD and REWIND. The \$200 JR-110 is rated at eight watts total power.

Circle 87 on Reader-Service Card

empire introduces an improvement so dramatic you can not only measure it, you can hear it.

THE NEW EMPIRE GOLDEN TOUCH SERIES.

Exclusive Anti-Static Stylii eliminates static build-up without the added mass of brushes. Using an exclusive Empire process, each cantilever and diamond tip in both our new 1000GT and 900GT Golden Touch cartridges are micro-plated with one of the most conductive materials known to man... solid gold.

Our exclusive Anti-Static Stylii act almost like miniature lightning rods, attracting static electricity then discharging it through our Micron Neutralizer™ before any build-up can cause annoying "pops" and "clicks." Amazing? You're right, but what's even more impressive is the fact that, unlike competitive solutions incorporating brush devices, both the 1000GT and 900GT achieve this incredible feat while simultaneously reducing mass by a stunning 20%. An improvement particularly noticeable on warped and uneven records.

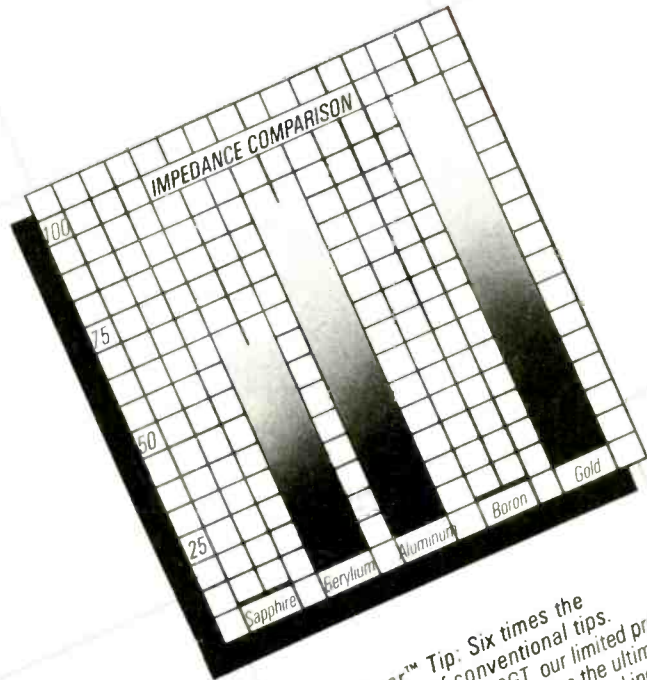

Para-Linear™ Tip: Six times the contact area of conventional tips. The Golden Touch 1000GT, our limited production model, offers listeners the ultimate in Empire tip technology—our Para-Linear™ tip. Capable of tracking musical signals way beyond the limits of audibility (6Hz to 50kHz!), this superb diamond also boasts the lowest tip mass (and that means the lowest record wear) presently available...an astonishing 0.18mg!

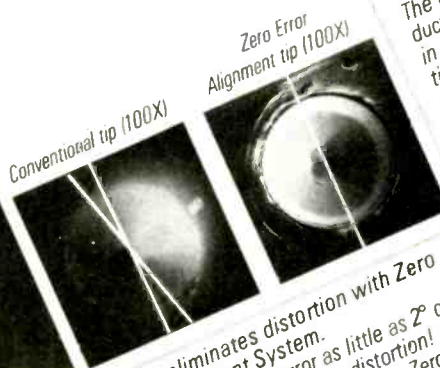

Empire eliminates distortion with Zero Error Alignment System. A lateral alignment error as little as 2° can more than double cartridge distortion! That's why Empire developed the Zero Error Alignment System for elliptical and parabolic stylii. A unique manufacturing system that allows Empire to precision cut and polish the diamond tip after it has been mounted in the cantilever. Look at the comparison.

The Zero Error Alignment System's accuracy reduces distortion, caused by lateral alignment error, to immeasurable levels. The Empire Golden Touch cartridges. A totally new concept for a totally new sound...awesome!

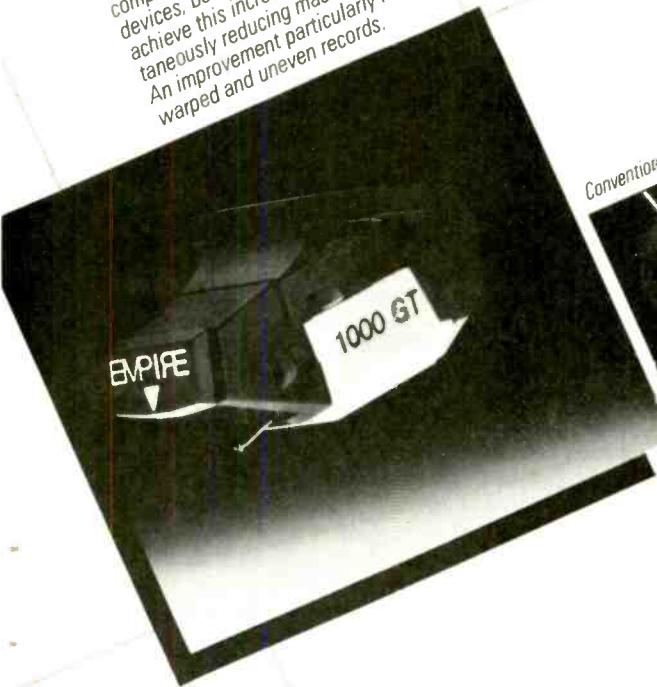

Empire Scientific 1055 Stewart Avenue, Garden City, New York 11530

EMPIRE SCIENTIFIC EMPIRE SCIENTIFIC

CrossTalk

Practical answers to your audio questions by Robert Long

Wash and Wear

Can I clean (wash) my discs with a good soap and warm water, instead of using record-cleaning kits or special liquids?—Guillermo Arturo Apolo, San Ysidro, Calif.

Yes you can, if you don't want maximum life expectancy from your records. At one time, a mild soap (Ivory Liquid was frequently mentioned) was usually taken as the cleaning method of choice. Because of the potential leaching of plasticizers from the vinyl of the discs, however, soap and water is now not considered nearly as safe as the Dishwasher fluid, in particular. Deprived of plasticizers, vinyl loses toughness, and the discs can become noisier and wear faster than would otherwise be the case.

Why Switch?

I own a Mitsubishi DA-R25 receiver, and I find that I must always remember to push in the subsonic filter switch before playing records—or, for that matter, tapes made from my records. Given the fact that this filter attenuates only inaudible signals, is there any theoretical or pragmatic reason why the switch should not always be left in the ON position? If there isn't, why don't manufacturers simply build the filter into the internal circuitry of the receiver?—Dr. Myron Drazen, Flushing, N.Y.

An infrasonic filter (technically, subsonic means "slower than the speed of sound," not "at frequencies lower than those of sound," which is what you mean), if it is sharp enough to do its job, alters phase response well up into the audible band. Whether or not this produces effects that are themselves audible is a subject for endless debate, but that possibility is one reason for making the filtering switchable. The other is to permit wideband response specs, which look much more impressive than those derived from circuits that have built-in filters.

Thick and Thin

I have been preparing my own program tapes from records and FM for more than

twenty years. Some ten years ago, I acquired two Tandberg open-reel machines and gradually adopted 25- and 35-micron Maxell as my standard tapes. At 3¼ ips, the former gives me about 2½ hours per side and the latter about 1¼ hours. But during the last year I've been unable to find any more of the 25-micron thickness. Is there any other brand I can obtain that has the necessary (high) bias specification for the Tandberg?—Dr. H. S. Friedman, Baltimore, Md.

Manufacturers generally have been backing off from the double-play (25-micron) and thinner open-reel tapes because they have several properties inconsistent with the performance demands of most open-reel users today. The worst of those properties, in my opinion, is the greater print-through that you must expect with them. And their floppiness makes them harder to handle (and to edit) without damage. I steer clear of them myself and generally prefer standard-play (50-micron, or 1½-mil, nominal thickness) to 35-micron (1-mil) formulations. So even if I knew of a good alternative extrathin tape, I couldn't in good conscience suggest you use it.

Why Y?

Help! I am moving up to separates and would buy the NAD preamp reviewed in your December 1981 issue except that I need a mono circuit, which it doesn't have. In the same issue, C. Victor Campos mentions that you can use a Y connector to provide a mono circuit. How?—Jordan Wm. Burrill, Marlborough, Conn.

It depends on what you need the mono circuit for. If you're a purist who prefers playing mono records on a mono turntable (a practice for which the tip radii in mono pickups provides some justification), or if you have a tape recorder that permits separate mono recordings on left and right tracks but won't switch to play them back independently (there are some models like that), you'd need a Y-adaptor to split the single output between the left and right preamp inputs. If you play mono records with a stereo pickup and want to listen on only one speaker for authentic mono sound (another practice for which there is some technical justification), you'd have to

reverse the Y-connector so that the two channels from the turntable are combined into either the right or left input of the preamp. If you have a tuner with no mono switch and want to combine channels for quietest possible reception on a weak station, you'd want two Y-adapters—one to unite the signals from the tuner, and the other to distribute the resulting mono signal to both inputs of the preamp.

But if these special circumstances don't apply, why bother? If, for example, you play a mono record on a stereo system with no mono switch, the music will still appear in to be in mono. The noise from dust and scratches will appear to be in stereo, but that makes it, if anything, a little easier to ignore when you're listening to mono music.

Loop the Loop

Every time I turn around, someone seems to be selling a new signal-processing device that's designed to be connected into the tape-monitor loop of a preamp, integrated amp, or receiver. Is it safe to hook several of these units—such as an equalizer, an expander, and an image enhancer—in series in a single tape-monitor circuit and to use their bypass switches to select which ones will be active at a particular time?—Rusty Buck, Alexandria, La.

Yes, although in some cases you may need to be careful of how you sequence them. For example, tick-and-pop suppressors, such as the SAE 5000A, require ultrasonic signal information to differentiate clicks from music, so it's usually best to put them first, ahead of any devices that might limit high-frequency response (this especially includes dynamic noise filters and equalizers). Dynamic-range expanders should also come ahead of equalizers; in fact, it's almost always best to put equalizers at the end of the chain, to forestall control-circuit misbehavior in any of the other processors. It is also advisable to leave all of the devices turned on any time you use your system, whether or not you are actually using them. Finally, if you have a great many signal processors, you might find an accessory switch box or a patch panel very handy.

We regret that the volume of reader mail is too great for us to answer all questions individually.

MAXELL IS PLEASED TO PRESENT AN EVEN HIGHER PERFORMANCE TAPE.



If you're familiar with Maxell UD-XL tapes you probably find it hard to believe that any tape could give you higher performance.

But hearing is believing. And while we can't play our newest tape for you right here on this page, we can replay the comments of Audio Video Magazine.

"Those who thought it was impossible to improve on Maxell's UD-XL II were mistaken. The 1981 tape of the year award goes to Maxell XL II-S."

How does high bias XL II-S and our normal bias equivalent XL I-S give you such high performance? By engineering smaller and more uniformly shaped epitaxial oxide particles we were able to pack more into a given area of tape. Resulting in a higher maximum output level, improved signal-to-noise ratio and better frequency response.

To keep the particles from rubbing off on your recording heads Maxell XL-S also has an improved binder system. And to eliminate tape deformation, XL-S comes with our unique Quin-Lok Clamp/Hub Assembly to hold the leader firmly in place.

Of course, Maxell XL II-S and XL I-S carry a little higher price tag than lesser cassettes.

We think you'll find it a small price to pay for higher performance.



IT'S WORTH IT.

Maxell Corporation of America, 60 Oxford Drive, Mahwah, N.J. 07074

Basically Speaking

Audio concepts and terms explained by Michael Riggs

Pickup Tracking, Separation, and Distortion

LAST MONTH I KICKED OFF a two-part discussion of phono-cartridge specifications with a quick look at sensitivity, channel balance, and frequency response. Among the most important of the remaining pickup performance characteristics is the ability to keep information intended for one channel from leaking into the other. This capacity for keeping the two channels separate is called, not in the least surprisingly, separation.

Stereo separation in phono cartridges is achieved by mounting the coil pole pieces for the two channels in a "V" configuration, at a 90-degree angle to each other. When everything is correctly oriented, a record groove with a signal engraved on only one wall should cause maximum output from one coil and minimum output from the other. This is because the pure 45-degree motion of the stylus generated by modulation of a single wall causes the relative motion of the magnetic field to be perpendicular to one coil and parallel to the other so that a voltage is induced only in the first. A mono signal—one that causes purely lateral stylus motion—should yield identical outputs from the two channels, because the relative motion of the magnetic field is at the same angle to both sets of coils.

In practice, such pristine behavior is impossible to achieve. Some interaction between the generator systems for the two channels is always present, which precludes total separation between channels. Separation is usually tested by measuring each channel's output in response to a signal that should, ideally, produce output from only one. The ratio of the desired output to the undesired output, normally expressed in decibels (dB), is the separation.

In our test reports on phono cartridges, we include a graph with curves for frequency response and separation for both channels. A simplified version of such a graph appears in the illustration at the center of this page. The nearly straight line across the

top is the response plot; the roughly bowl-shaped curve below indicates how much lower the unwanted output from the opposite channel is than the desired output from the driven channel. About 15 dB of separation at midband is usually sufficient for good stereo reproduction; 20 to 25 dB is excellent. Separation normally deteriorates somewhat at the frequency extremes, especially at the high end, but this is usually not audible.

Regardless of how good a pickup is in other respects, it will be worthless if its stylus can't maintain intimate contact with the record groove. The degree to which it is able to do this in the face of high groove velocities is its tracking ability. Tracking ability is a function both of a cartridge's design and of how hard its stylus is pushed down against the record. The force that

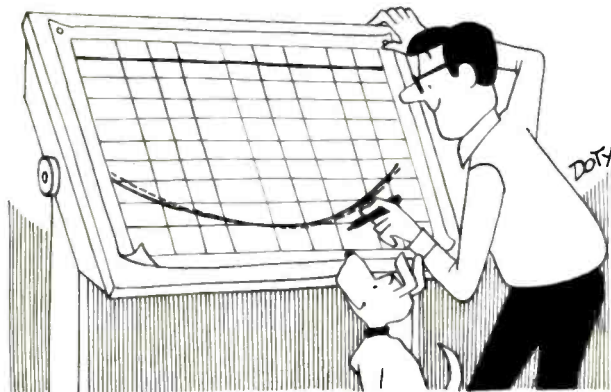

works to hold the stylus in the groove is called the tracking force; it is applied by the turntable's tonearm and usually ranges from about ¼ to 3 grams, depending on the pickup.

All else remaining equal, the higher the tracking force, the better the tracking. But there are limits. One is that too much force will collapse the cantilever suspension, making the cartridge unusable. Another, more subtle problem is that increasing the tracking force also tends to accelerate record wear. This difficulty can be mitigated somewhat by careful attention to the shape of the stylus contact areas, but not a great deal. Consequently, most manufacturers design their pickups to track at forces from 1 to 1½ grams.

Tracking ability can be measured in a number of ways. For HIGH FIDELITY's cartridge test reports, Diversified Science Laboratories measures the maximum levels at which various combinations of low- and

high-frequency tones can be tracked. We give the results in dB above a standard reference level, up to the limits of the test record: +18 dB laterally and +12 dB vertically. Most premium cartridges can take the record's maximum levels in stride, and we expect that good cartridges will track at least +15 dB laterally and +9 dB vertically.

When a cartridge's tracking ability is exceeded, the pickup mistracks. Depending on how far beyond its limits the cartridge has been pushed, the results can range from barely audible raspiness to shattering distortion to—in extreme cases—the stylus actually jumping out of the groove. But distortion can occur without the pickup mistracking. In fact, even at their best cartridges are probably the highest-distortion link in the audio playback chain. Distortion on the order of several percent routinely

occurs just because it is impossible to use a playback stylus that exactly matches the shape of a disc-cutting stylus. However, designers have worked hard to come as close as possible to that ideal shape within the realm of practicality; hence the current prevalence of various sorts of line-contact styli, especially on premium pickups.

Additional distortion arises from misalignment of the stylus to the groove. Unless you use a linear-tracking tonearm, which keeps the stylus constantly tangent to the groove, some slight lateral misalignment will almost always exist. However, correct tonearm geometry and careful installation can minimize such misalignment.

Vertical alignment, particularly as defined by the stylus rake angle and the vertical tracking angle, also affects distortion. Stylus rake angle, or SRA, is the angle between the stylus and a line perpendicular to the record surface. The vertical tracking angle, or VTA, is the angle formed by the stylus cantilever's pivot point, the point at which the stylus contacts the record, and the record's surface. Ideally, a cartridge's SRA and VTA should match the corresponding angles of the cutting stylus during disc mastering. Unfortunately, not all records are cut at the same angles, so it is nearly impossible to get everything right all the time on playback. However, the distortion caused by even fairly severe stylus misalignment (especially vertical) can often pass unnoticed. **HF**



HIGH FREQUENCY LEVEL

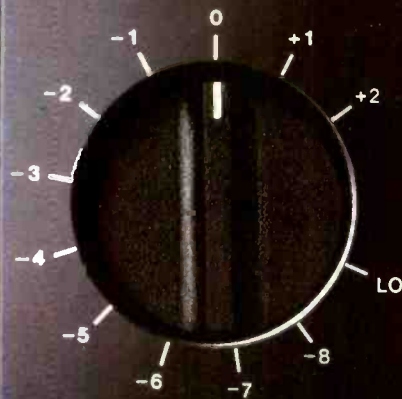

JENSEN

SYSTEM C

POWER-COMP™

POWER OVERLOAD
COMPENSATION MONITOR

MAXIMUM POWER
125 WATTS

MID FREQUENCY LEVEL

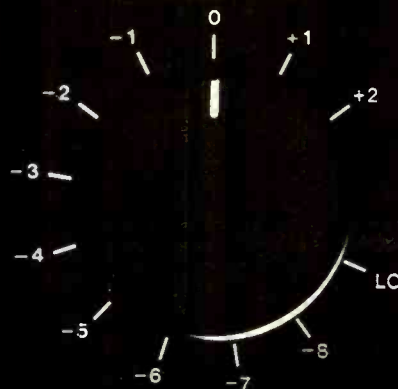

MADE IN U.S.A.

FOR CONSENTING ADULTS.

Jensen believes that sound reproduction should be based on listener preference, not on the sound coloration built into many speakers. And that makes Jensen speakers unique. With uniform power response and ultra-precise crossovers, they deliver pure, virgin sound. Jensen System Series Speakers offer a broad range of adjustment to accommodate differences in program material or room acoustics. Listen to uncensored, virgin sound at finer audio shops. For more information and dealer locations, call 800-323-0707.



JENSEN

INTRODUCING THE VI5 TYPE V

**A STEP BEYOND
EXTRAORDINARY**
No other cartridge, at
any price, offers so
many benefits.

FEATURING MICROWALL/Be[™] TECHNOLOGY

SIDE-GUARD PROTECTION SYSTEM

Protects stylus from
accidental breakage
by withdrawing shank
assembly into
stylus housing.

MASAR[™]-POLISHED HYPERELLIPTICAL STYLUS TIP

Assures accurate, distortion-free
tracking—plus reduced record and
stylus tip wear.

BERYLLIUM/Be[™] MICROWALL/ STYLUS SHANK

Unprecedented high frequency
trackability due to this revolutionary
new high stiffness, low mass
stylus shank.

DYNAMIC STABILIZER/ DESTATICIZER

Exclusive! Functions like a miniature shock
absorber to eliminate warp-related problems
such as signal wow, groove skipping, and
cartridge bottoming. Simultaneously
discharges surface static electricity and
sweeps away microdust.



PLUS!

As an extra bonus,
you get a certificate
good for a copy of the new
TTR17 Trackability Test Record
—a \$15 value—FREE!
Send for our fact-filled brochure.
Ask for AL694.

SHURE

Shure Brothers Inc., 222 Hartrey Ave., Evanston, IL 60204

New Equipment Reports

Preparation supervised by Robert Long, Michael Riggs, and Edward J. Foster.
Laboratory data (unless otherwise noted) supplied by Diversified Science Laboratories.

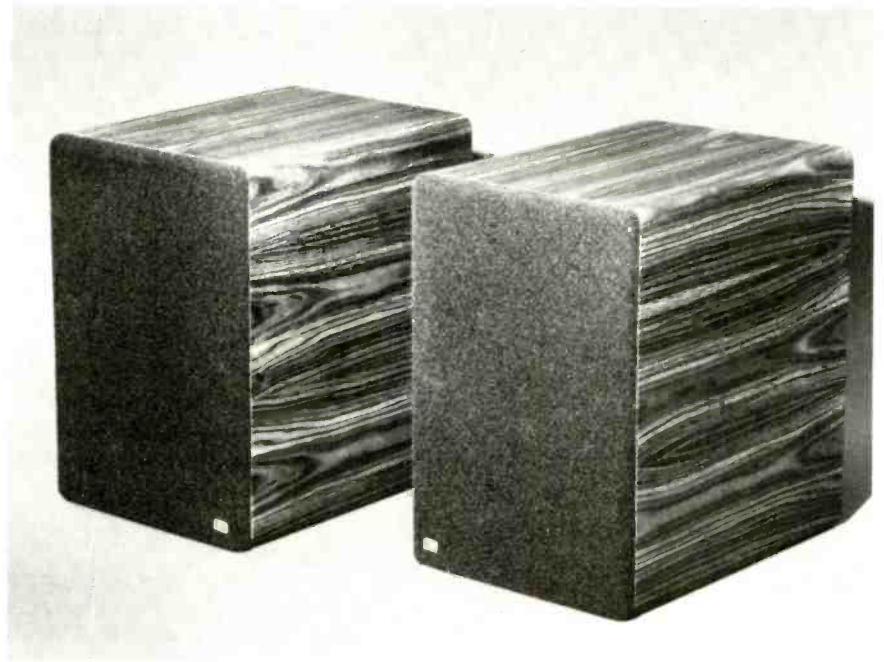

DCM Calls It a Macrophone

DCM Macrophone loudspeaker system. Dimensions: 9 by 13 inches (front), 12 inches deep plus clearance for connections. Price: \$396 per pair in walnut, \$450 per pair in rosewood (shown) or zebra. Warranty: "limited," five years parts and labor. Manufacturer: DCM Corp., 670 Airport Boulevard, Ann Arbor, Mich. 48104.

ROOM RESPONSE CHARACTERISTICS

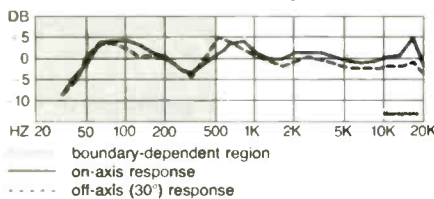

SENSITIVITY (at 1 meter; 2.8-volt pink noise, 250 Hz to 6 kHz) 84¾ dB SPL

AVERAGE IMPEDANCE (250 Hz to 6 kHz) 16.1 ohms

APPROX. TWEETER CONTROL RANGE ±1 dB above 8 kHz

LOUDSPEAKER COMPANIES generally emerge into the limelight by one of two routes. One involves marketability (price points, value, appearance, the comprehensiveness of the line, and so on) and addresses itself primarily to audio dealers; the other involves fancy technological footwork (or fancy verbiage in default of any convincing technology) and addresses itself to the end purchaser. DCM's emergence cleaves more to the latter pattern than the former, though the company is among the more reticent of its type. The Time Window, the company's premier model, has gained a following that has helped spread the word, and the line continues to grow.

For our first test of a DCM product, we've chosen its only bookshelf model, the extremely handsome Macrophone. It's a two-way system with banana-plug binding posts and a tweeter control (with an exceedingly narrow adjustment range) on the back panel. (Note that, in addition to the rosewood finish shown in the photograph, both walnut and zebra veneer finishes are available.) Whether by design or serendipity, it will fit snugly on typical record-storage shelves, taking only 9 inches of linear shelf space. Thus it potentially is a superb space saver in an apartment that has a lot of record storage but little available room atop storage units or on the floor. DCM does not specifically recommend such placement,

however. In fact, the company's instructions are quite broad, though they do suggest that you begin placement experiments with the pair set near the narrow end of your room, about 6 feet apart, and at least 1½ feet from the side walls.

Diversified Science Laboratories made its measurements, including those for our response graph, with the speakers backed up against the wall; in addition, response was measured with the Macrophones 4 feet out into the room. This placement filled in the dip at around 300 Hz (which is a function of speaker and room geometry) for a markedly smoother ($\pm 3\frac{1}{2}$ dB) overall response but with a gradual bass rolloff beginning above 100 Hz. In the listening room, we tried the DCMs in several positions, and generally found the bass adequate even with the speakers well out in the room, though with some placements and program material we opted for a little bass boost at the tone controls. With the speakers against the back wall, we naturally got more bass, though we generally preferred the sound with the speakers well out in the room. (The listening room provides no satisfactory way of trying our idea of slipping the Macrophones into record-storage units, though in theory this should result in both solid bass and smooth response. Had we been able to give it a fair test, this might have proven most satisfactory of all.)

The sensitivity of the Macrophones is on the low side and the impedance—which is unusually smooth across the frequency band—is on the high side, suggesting that you will need more than average power to drive them. DSL's tests suggest that you needn't worry about too much power, since the Macrophone accepted the full output of the test amp—28 dBW, or over 600 watts, peak—without flinching in both the continuous and the pulsed 300-Hz tests.

There's more to this than meets the eye, however. DCM is convinced from its own psychoacoustic testing that most loudspeakers are designed for optimum results at preternaturally high listening levels. Further, it believes that you should be able to listen from very nearby to a speaker like the Macrophone, which doesn't necessarily work well with speakers that test well by conventional standards or sound superb when they're booming out into a large room. Thus the company has taken care that the Macrophones should sound good when driven with 1 watt and less and believes it to be an abuse of both speakers and listener to ask, say, 110 or 115 dB SPL from them. Now—though we have had staffers who

seemed to believe that loud is, ipso facto, lovely—these ideas don't strike us as far off the mark, however seldom we may encounter them among audiophiles.

Our tests confirm that close listening is unusually pleasant with the Macrophones and that they are most comfortable in the loudness range where we are most comfortable—with peaks running about 90 dB SPL at 1 meter. At this level and below, distortion above the extreme bass averages about 1/2%; at 95 dB it rises to about 1% and is above 1% at 100 dB. DCM calls this a "thickening" of the sound as the speaker is pushed harder than its designer intended.

We have yet to find a small speaker that's really effective at filling large rooms at high listening levels, of course, despite the protestations to the contrary by manufacturers. DCM indulges itself with no such claims. It knows exactly what sort of room and listening the Macrophone is intended for and has done an excellent job of supplying a perceived need. That, combined with the Macrophone's outstanding appearance and the company's growing reputation, should win many new friends for both.

Circle 96 on Reader-Service Card

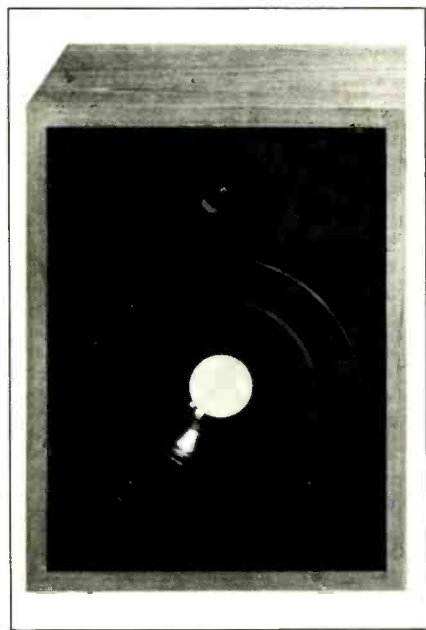

Sweet Sara from Scotland

Linn Sara loudspeaker system. Dimensions: 13 by 17 inches (front), 10 inches deep. Price: \$795. Warranty: "limited," two years parts and labor. Manufacturer: Linn Products, Ltd.; U.S. distributor: Audiophile Systems, 6842 Hawthorn Park Drive, Indianapolis, Ind. 46220.

THE STORY HAS IT that Ivor Tiefenbrun's wife was the real moving force behind the development of the Sara (Small Acoustical Reproduction Apparatus) loudspeaker. For those of you who don't know, Ivor is proprietor and chief designer at Linn Products, a Scottish company best known for its Linn Sondek turntable (it also manufactures a tonearm and a larger speaker called the DMS, and it distributes a moving-coil phono cartridge made to its specifications by Supex), as well as something of a personality on the British audio scene. His wife's role in Sara's creation was, it is said, to challenge him with something like: "If you're so smart, why don't you build a good loudspeaker that will look nice in a bookcase." And the rest is history.

The key to the design is what Linn calls Isobarik (literally, "constant-pressure") loading for the woofer, a technique originally developed for the DMS. This is achieved by placing a box within a box: A second woofer is mounted, face in, on the back panel of a sealed box located inside the main speaker enclosure. The box, in turn, encloses the rear of the main woofer. Both of the low-frequency speakers are driven in tandem.

Consequently, when the main woofer's diaphragm is driven back into the subenclosure, the secondary woofer's diaphragm pulls back by the same amount, pushing into the main enclosure. What this means is that the secondary woofer acts to keep the pressure in the inner box constant at all times. This makes the subenclosure appear much larger than it really is to the

main woofer, tricking it into having a lower resonance frequency—and therefore deeper bass response—than it would without assistance. Of course, the secondary woofer hasn't the benefit of any such trick. It sees the volume of the main enclosure just as it is and therefore has a somewhat higher resonance frequency than the main woofer. This must, in turn, limit the secondary woofer's excursion at very low frequencies—which is undoubtedly what prevents the inner box from appearing to the main woofer to be of infinite volume. At any rate, as we shall see, the scheme does seem to work.

The drivers that actually face the world are the 8-inch cone main woofer and a small dome tweeter. Both are normally hidden by a black foam grille. Amplifier connections are made via Cannon XLR sockets on the rear of the cabinet. Although these do provide an unusually secure connection (the reason Linn has adopted them), they are rare in domestic equipment, and the necessary mating plugs jut out a couple of inches from the rear of the enclosure, making it impossible to mount the speakers flush against the wall. This all adds up to a considerable nuisance, and we wish Linn would reconsider its decision on this point.

Although Linn recommends mounting the speakers against the rear wall, away from side walls, and elevated to ear level, Diversified Science Laboratories found that the smoothest response was obtained with the speakers on the floor. So placed, on-axis response is amazingly even (especially through the critical midrange), remaining

The Kyocera Series R-851 AM/FM Tuner/Amplifier... Beneath the sleek styling lurks the devastating power of an MOS/FET output

Unsurpassed technology. Uncompromising quality. From beginning to end.

"Never design solely for the sake of design, never change solely for the sake of change." This is the philosophy that has kept Cybernet at the forefront of technology in sophisticated audio components. A philosophy that led to the Kyocera Series R-851.

It utilizes Cybernet's unique MOS/FET output supported by uniform negative feedback at each frequency stage. The result...high power, a full 85 watts/channel* with low distortion. An amazing low 0.015% THD; a slew rate of 70v/ μ sec and a rise time of 0.9 μ sec. A successful Cybernet design with brilliant audible result.

Having satisfied the first goal, Cybernet advanced on the second. "Never change solely for the sake of change." The 3-band parametric equalizer proved vastly superior to conventional tone controls. Quartz locked electronic tuning provided precise station selection with the added convenience of 14 station programmable memory (7 AM and 7 FM) and automatic scanning and station seek. A direct reading LED digital fluorescent panel vividly presents you with accurate frequency and mode indications.

Both MM and MC phono inputs combined with two-way tape dubbing and monitoring produce the versatility required by today's component enthusiast. A flip-down control access panel insures that once vital controls are adjusted, they're not easily tampered with...and the refinements continued, each satisfying a specific goal...improve performance!

Please stop by your local audio retailer and see why once you get past the sleek styling, the Kyocera Series R-851 is just one of a distinguished series of devastating audio components and systems.



 **Cybernet**
A Division of Kyocera

© 1982 CYBERNET

*85 watts/channel minimum RMS
both channels driven into 8 ohms
from 20-20,000 Hz with no more than
0.015% THD.

Seven Powder Horn Drive, Warren, N.J. 07060 U.S.A. Telephone: (201) 560-0060 Telex: 642529 CYBERNET WARE.

DESIGN INTEGRITY:

The same Dynamic Servo Tracer tonearm technology found on our \$6,200. DP-100M...
Cutting Lathe Motor AC Direct Drive Turntable.

... can be found on our \$525. DP-52F...
Microprocessor-controlled Fully Automatic AC Direct Drive Turntable.

... and on our \$199. DP-11F.
Fully Automatic Flat-Twin Direct Drive Compact Turntable.

Instead of gimmicks, the Denon DP-100M uses the same cutting lathe motor that creates disc masters. Its Dynamic Servo Tracer system, working in concert with a Denon high-precision, ultra-low mass tonearm effectively suppresses resonances while providing the proper damping for the widest variety of cartridges.

The same Dynamic Servo Tracer system is incorporated on the DP-52F, making it one of the most effective playback systems ever developed for warped and hard-to-trace records. Damping, anti-skating and tonearm lift/locate are all applied through microprocessor-controlled non-contact electronics. Its AC Servo motor employs the same drive principle and magnetic speed control found on Denon's DP-100M.

The DP-11F introduces Denon design technology to a new price category. It features magnetic speed detection, a Flat-Twin Direct Drive motor and the same Microprocessor-controlled Dynamic Servo Tracer tonearm system found at the very top of our line.

Design Integrity: Denon's products share more than name alone.

DENON

Imagine what we'll do next.

AUDIO New Equipment Reports

ROOM RESPONSE CHARACTERISTICS

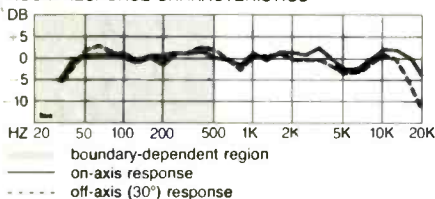

SENSITIVITY (at 1 meter, 2.8-volt pink noise;
250 Hz to 6 kHz) 88 dB SPL

AVERAGE IMPEDANCE (250 Hz to 6 kHz)
4.1 ohms

within $\pm 2\frac{1}{2}$ dB from 35 Hz to 18 kHz, and off-axis response is very nearly as good. Raising the speakers off the floor introduced a low, broad bump in the midrange and lower-treble response (which may account for a slight tendency to thinness we noted when listening to the speakers placed as recommended). One solution might be to turn the speakers on their sides, woofers out, and place their bottoms against the side walls: that would give the same loading as mounting them vertically on the floor away from the side walls. We don't want to make too much of this, however, as the actual response anomaly is not large, and the on-axis response with the recommended placement is within ± 4 dB from 35 Hz to 20 kHz. Few speakers can do as well under any circumstances.

The Sara's sensitivity is fairly high, but its average impedance is low, and there is a sharp dip in the impedance curve to a minimum of 2.5 ohms at about 4 kHz. (This will cause difficulty for many amplifiers, and, indeed, Linn warns of this. You should consult with your dealer about proper amplifying equipment before you buy.) Power-handling is excellent: The Linn accepted the full output of DSL's amplifier

on 300-Hz tone bursts. Based on the measured sensitivity, this 67-volt peak output translates into a calculated peak sound pressure level of 115½ dB at 1 meter on axis. And distortion is impressively low—most notably in the deep bass, where a more typical speaker of this size would generate much more harmonic distortion. At a moderate output of 85 dB SPL, total harmonic distortion (THD) averages less than ½% over DSL's 30 Hz to 10 kHz measurement range and reaches a maximum of barely more than 2% at 30 Hz. Even at 95 dB SPL, THD averages only about 1% and remains less than 5% above 50 Hz.

In the listening room, we find these very fine reproducers, with perhaps a touch of thinness when raised off the floor. For the most part, however, tonal balance is excellent, as is imaging. We continually find ourselves amazed at the bass response of these little beauties: They go all the way down (further down than some much larger systems)—and very cleanly, besides. If this sounds like what you're looking for, and you're prepared to foot the rather substantial expense (these are not cheap speakers), the Sara is well worth considering. **Circle 97 on Reader-Service Card**



Hang a Window On Your Wall

Cizek Sound Window loudspeaker system. Dimensions: 12 inches square, 3½ inches deep (satellites); 13½ inches square, 16 inches high (woofer). Price: \$195 per pair (satellites); \$250 (woofer). Warranty: "limited," three years parts and labor. Manufacturer: Cizek Audio Systems, Inc., 300 Canal St., Lawrence, Mass. 01840

MIX-AND-MATCH SATELLITE/SUBWOOFER combinations are hardly a rarity in today's stereo world, but there are some elements that set the Cizek Sound Window system apart. Foremost among them is certainly the abandonment of the conventional baby-shoe-box satellite format in favor of a shallow "window" speaker just a foot square and designed to hang on the wall of the listening room. If you're just interested in background music, you could stop right there—as you can with most satellites—and pass up the deeper bass afforded by the subwoofer (which Cizek has the candor to call a "woofer"). It takes over from about 100 Hz down and supplies underpinning that we would consider obligatory for high fidelity reproduction.

The system we tested had a pair of satellites and a single subwoofer. If you want, you can use a separate subwoofer in each channel; Cizek gives you wiring instructions for the necessary jumpers at the subwoofer's terminal panels, which are on the bottom. There are four terminal pairs: for left and right inputs from the driving amplifier and for left and right outputs to the satellites. The crossover between satellite and subwoofer is built into this panel. (The satellites, incidentally, are not identical: They are a mirror-image pair. On our samples, the indication of which was right and which was left was all but invisible. The tweeter is toward the *inside* edge in either case.)

The ensemble continues Cizek's round-cornered look, which is intended to prevent unwanted diffraction effects as well

as please the eye. However, our eyes weren't as pleased by the appearance of this system as they were by the dovetailed-oak look that characterized the Cizek KA-1 reviewed in our March 1980 issue. Cizek has adopted what it calls Acuthane—a plastic material with a urethane base that, it says, is useful in controlling resonances. In appearance, it is a reasonable simulation of wood, but it does look a little bleached-blond when compared to the real thing.

DSL measured the system with the satellite 31 inches above the floor. The response curves fall within about $\pm 4\frac{3}{4}$ dB from 60 Hz to 16 kHz. Except for the peak at about 600 Hz—which is partly a function of floor reflection and therefore subject to alteration by the room and the positions of the satellites—the response is quite smooth. Indeed, in listening we judged the response to sound even smoother than it looks in the data. Balance seemed a little on the bright side to some listeners, but clarity, imaging, and "musicality" were praised. And a recurring comment of our auditors was that the visible shallowness of the satellite enclosures belied the aural depth of the sound.

The individual impedance curves of the satellites and the subwoofer are notable for their dissimilarity—that of the former being fairly conventional, and that of the latter quite odd, reaching a narrow minimum of only 1.5 ohms at 250 Hz. When connected as a system, however, they deliver an astonishingly consistent load across the whole frequency spectrum, with

ROOM RESPONSE CHARACTERISTICS

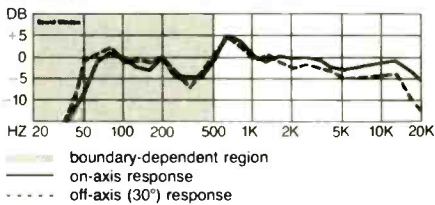

SENSITIVITY (at 1 meter, 2.8-volt pink noise, 250 Hz to 6 kHz) 93½ dB SPL

AVERAGE IMPEDANCE (250 Hz to 6 kHz) 5.1 ohms

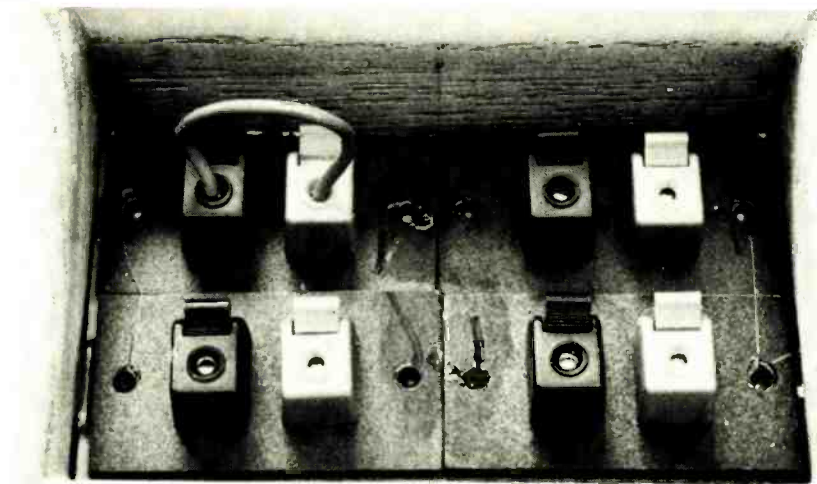

Subwoofer's bottom panel contains satellite-subwoofer crossover, enabling you to use a separate subwoofer with each satellite via jumper connections between terminals.

several minima just above 4 ohms scattered across it and no maximum greater than 7.7 ohms. This impedance is too low to encourage use of Sound Window systems in two rooms, paralleled from the same amplifier, but it will wheedle a little more power out of typical transistor amps than would an 8-ohm speaker system. Some buzzing showed up, as drive levels were increased, long before measurable distortion became a significant factor in DSL's tests. Since the system could be driven to levels of 110 dB SPL and above without difficulty, however, we don't consider the fact material unless you try to fill a very large room with a Sound Window System or drive it to mer-

ciless levels in smaller ones.

Part of the Sound Window's quality should, in our opinion, be attributed to the shallow, rounded contours of the satellites, which are acoustically more nearly part of the wall on which they are mounted than is possible with the more familiar shoe boxes. If you have a wall appropriate for this use, you should welcome the ease with which you can pick the ideal mounting height for your listening setup. (Bookshelves are not always very adaptable.) And the extreme compactness of this scheme can be a big advantage in crowded apartments. All told, we find it a very attractive design.

Circle 98 on Reader-Service Card



KEF 203: A Grand Little Loudspeaker

IT'S SMALLER THAN THE "CLASSIC" (two-cubic-foot) bookshelf speaker, but it's larger than a mini (like KEF's own 101—HF, April 1981). In fact, it's very close to the dimensions of a breadbox, a size that we've sometimes called a "compact bookshelf speaker," though it actually fits more readily on real bookshelves than its bigger predecessors did. Typical of the type, the KEF 203 is a two-way system with spring-clip connections on the back panel but no tweeter control. (Essentially, neither KEF nor HF believes in them.) Also typical of the type is the dome tweeter; typical of KEF products is the Bextrene woofer cone. A knit grille fabric and choice of walnut or teak veneer complete the picture.

The overall impression created by the 203 is just what we've come to expect from KEF. The sound is smooth and well balanced, with a sense of tight control—no floppy bass or ringing highs, for examples. In DSL's measurement room and with the back of the speaker 6 inches in front of the rear wall, the on-axis response measures within about $\pm 3\frac{1}{4}$ dB from below 50 Hz to the limit of testing at 20 kHz—which is excellent. The results were even smoother when DSL tried a position 4 feet out into the

room (KEF suggests a minimum of 50 centimeters—about 20 inches—from the back wall; the test setup is not calibrated for that particular distance), but the bass response was not as extended, of course, in that position. Like all KEF speakers, its listening window is rated as fairly tight: ± 5 degrees with respect to the tweeter's vertical axis in this case. For this reason, floor placement isn't recommended. In some rooms, bookshelf mounting, with the front of the speaker flush with the books, might prove the best choice of all, though it's not hinted at in the instructions.

The 203 is, as KEF claims, fairly efficient for a small, extended-range system and therefore doesn't require undue driving power, despite its relatively high average impedance. (The conventional nominal impedance of 7.2 ohms confirms KEF's 8-ohm rating but applies only to a limited portion of the range.) KEF suggests 100 watts (20 dBW) as a maximum, and DSL found that the 203 started breathing hard with the equivalent of about 19 dBW of continuous 300-Hz tone and 22½ dBW on tone bursts, confirming the rating. Calculated sound pressure levels for these conditions were 107½ and 110½ dB at 1 meter, which is

THE FIRST NEW METHOD OF TRANSDUCTION IN OVER TWENTY YEARS

The Moving Flux Phono Cartridge by Astatic

"The MF is a very successful design."

Red Apple
Russellville, AR 72801

"Highest on the modulus of elasticity
we have yet tested"

D.B. Audio
Berkeley, CA 94704

"Comparable to the best of the
Moving Coil."

Sound Cellar
Brea, CA 92621

"They're the best-selling cartridge
I've got and it's replacing my previous
best seller I've had for four
years."

Deete's Sound Room
Carmichael, CA 95608

"Exceptional value."

Christopher Hansen Ltd.
Los Angeles, CA 90069

"The cartridges are very dynamic."

Northridge Audio
Northridge, CA 90324

"They're a very good value."

Audible Difference
Palo Alto, CA 94301

"Incredible performance at a reason-
able price."

Systems Design Group
Redondo Beach, CA 90278

"Excellent cartridges for the price."

Audio Excellence
San Francisco, CA 94111

"They exhibit excellent transient
response and a very stable stereo
presentation."

House of Music
San Francisco, CA 94123

"Astatic Moving Flux Cartridges
gives you the excellent performance
normally found only in more
expensive Moving Coil Cartridges."

Century Music
San Jose, CA 95128

"The best of both worlds, Moving
Coil performance at Moving Magnet
prices."

Absolute Audio
Santa Ana, CA 92706
Woodland Hills, CA 91364

"Their performance rivals some of
the very best Moving Coil
Cartridges."

Music By Design
Sausalito, CA 94965

"The cartridges have an effortless
Moving Coil type of sound."

Monterey Stereo
Monterey, CA 93940

"An incredible bargain."

Gene Rubin Audio
Monterey Park, CA 91754

"Open, accurate, and musical."

Audio Com
Old Greenwich, CT 06870

"Astatic's frequency response is extraordi-
narily flat . . . Separation is also excellent, even
at very high frequencies. The sound itself is
superb — clean, well balanced, and free of
harshness or strain on even the loudest most
complex musical passages. A number of our
listening panel were especially impressed with
the transparency of the MF 100's high end."

High Fidelity Magazine

Some of the finest Audio Salons in the nation
compared the MF Cartridge to the most expen-
sive Moving Coils. These are their comments.

"The sound of the better Moving
Coils without the hassles of head
amps."

The Stereo Shop
Martinez, GA 30907

"MF bridges the gap between
Moving Magnet and Moving Coil
types."

Audio Unlimited
Honolulu, HI 96825

"We are very happy with their
performance."

Ward Audio Systems
Honolulu, HI 96814

"Astatic — The rational alternative."

Audio Reference Systems
Honolulu, HI 96822

"Very open, detailed, and amazingly
fast. Superb even with electro-
statics."

Quintessence Audio Limited
Hinsdale, IL 60521

"The Moving Flux Cartridge is
exceptionally good value."

Paul Heath
Chicago, IL 60614

"Finest high end we have ever
heard."

Sound Production
Carmel, IN 46032

"An incredible value."

Audio Specialists
South Bend, IN 46601

"Excellent separation."

Music Plus
Franklin, LA 70538

"Astatic MF Cartridges have
excellent tracking."

Three Phase Audio
Lafayette, LA 70506

"I find them very fine for the price."

Paragon of Sound
Bethesda, MD 20817

"Superior value in performance in a
unique non-moving coil design."

Goodwins
Boston, MA 02116

"One of the most accurate pickups"

Stereo Showcase, Inc.
Grand Rapids, MI 49506

"Astatic MF Cartridges are the only
cartridges we have been using!"

Perpich Music
Virginia, MN 55792

"Sounds like music"

Personalized Audio
Dunnellen, NJ 08812

"Astatic is a best buy in cartridges."

CSA Audio
Upper Montclair, NJ 07043

"Truly the new generation of phono
cartridges."

Woodbridge Stereo
Woodbridge, NJ 07095

"Exceptional Value."

Landis
Chester, NJ
Orange, NJ

"Clarity never before experienced in
a high output cartridge."

Audio Breakthrough
Manhasset, NY 11030
Huntington, NY 11746

"They are an excellent product at an
excellent price."

Paul Heath Audio
Rochester, NY 14623

"Outstanding performance and
value."

Lytic Hi-Fi
New York, NY 10028
White Plains, NY

"Reproduces the piano beautifully."

The Hi-Fi Shop
Lawton, OK 73501

"Incredibly dynamic, musically
accurate, and open."

Canlen Audio
Bethlehem, PA 18018

"Extraordinary value."

Audiolab Stereo Center
Fairless Hills, PA 19030

"Extremely clean, very detailed"

Audioworks
Harrisburg, PA 17111

"Natural and open high frequency
reproduction."

Sassafraz Records & Audio
Montgomeryville, PA 18936

"Astatic MF Cartridges of unusual
design and sound quality represent
a good value."

21st Century Audio
Philadelphia, PA 19120

"Moving Flux truly makes a
difference"

Better Sound Concepts
Pittsburgh, PA 15216

"In music speed is everything, and
that's Astatic!"

Ovation Audio
Shadyside, PA 15232

"The most transparent sound I've
heard"

Audio Outlet
Amarillo, TX 79109

"After 15 years in Audio, nothing
comes close for the money. We love
them."

Estes Home Entertainment Center
Lufkin, TX 75901

"We like them real well!"

Sound West
Pampa, TX 79065

"They sound very sweet and are a
particularly good value for the
money."

The Audio Phile
Austin, TX 48704

"Sounds incredible; great detail,
very open, and good transient
response."

Digital Sound
Virginia Beach, VA 23464

"Exceptional smoothness and clarity
throughout the audio range."

Happy Medium
Madison, WI 53703

"Very smooth through all frequencies"

Audio Phile Specialists
Oshkosh, WI 54901

"One of the very few truly dynamic
cartridges."

Salon One
Wisconsin Rapids, WI 54494

"Astatic MF Cartridges combine the
convenience, tracking ability and
price of Moving Magnets with the
sound of the finest Moving Coils."

Precision Audio, Inc.
Rio Piedras, P.R. 00927



Astatic Corporation, Audio Division, P.O. Box 120, Conneaut, Ohio 44030-0120

Circle 57 on Reader-Service Card

AUDIO New Equipment Reports

KEF Model 203 loudspeaker system. Dimensions: 11 by 18½ inches (front), 8¾ inches deep. Price: \$600 per pair in walnut or teak veneer. Warranty: "limited," five years parts and labor. Manufacturer: KEF Electronics, Ltd., England; U.S. distributor: KEF, P.O. Box 17414, Washington, D.C. 20041.

ROOM RESPONSE CHARACTERISTICS

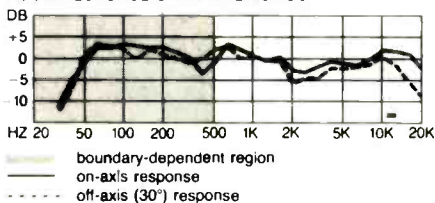

SENSITIVITY (at 1 meter; 2.8-volt pink noise, 250 Hz to 6 kHz) 88 dB SPL

AVERAGE IMPEDANCE (250 Hz to 6 kHz) 20.6 ohms

comfortably above the rating KEF implies when it says that the 203 is designed to reproduce 86 dB SLP at 1 meter in rooms of average size and to reach a maximum output of 106 dB SPL on program peaks. Distortion levels measure quite low—generally under ½%—at 85 dB SLP, creep up somewhat at 90 dB, and average around 1% across most of the band at 95 dB, further corroborating KEF's specs.

This precise definition by its designers of what the 203 is and how it should be used is, perhaps, the most spectacular thing about the speaker. We're not used to the

sober candor of these statements. And just as loudspeaker manufacturers are frequently given to extravagant verbiage, loudspeakers themselves are frequently prone to overstate elements in the signals they reproduce. We simply can find no significant overstatement in the sound of the 203s. Nor are they the biggest or the smallest or the most lavish or the most cost-efficient of the several models in KEF's line. Yet by virtue of the very fact that they represent no extreme whatever, they may well prove one of KEF's most popular models has to offer. **Circle 95 on Reader-Service Card**



Speakerlab Keeps It Good and Simple

Speakerlab SX loudspeaker system. Dimensions: 11¾ by 20¾ inches (front), 9½ inches deep. Price: \$129 each assembled (\$158 per pair in kit form). Warranty: "limited," five years parts and labor. Manufacturer: Speakerlab, Inc., 735 N. Northlake Way, Seattle, Wash. 98103.

ROOM RESPONSE CHARACTERISTICS

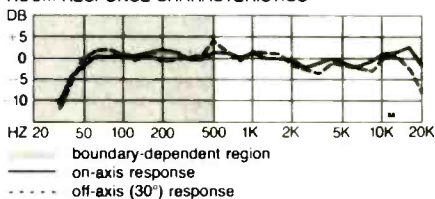

SENSITIVITY (at 1 meter; 2.8-volt pink noise, 250 Hz to 6 kHz) 89½ dB SPL

AVERAGE IMPEDANCE (250 Hz to 6 kHz) 6.4 ohms

WHEN WE LAST TESTED a Speakerlab system (the Model 30 kit, in July 1979), the company specialized in do-it-yourself speakers—either homebrew from Speakerlab parts, or from kits—and in mail-order sales. Speakerlab did offer finished speakers and had its own stores (primarily in the Pacific Northwest), but it was the kits—from a mini to a huge corner horn whose debt to the classic Klipsch design was freely acknowledged—that really caught our fancy. A lot has changed since then. The company still makes kits (though supplied without cabinets; the drivers now come mounted on a front panel), but Speakerlab's emphasis has shifted to finished systems, which it sells through a growing list of dealers. And most of the designs in the current catalog were not yet available in 1979.

Among the newcomers since our last report (though not the newest) is the SX, one of the largest in Speakerlab's line of compact speakers that are all designed to fit on real bookshelves. Like the SL, which shares the same enclosure dimensions, the SX is a two-way system. Its 6½-inch polypropylene woofer is loaded by a reflex enclosure with a 2½-inch port and is crossed over at 3.8 kHz to a leaf tweeter (the same one that's used on many of the company's fancier floor-standing models). The drivers and the port are aligned on the front panel's vertical axis; there is no tweeter level control. Thus this is an exceedingly straightforward design, which doubtlessly contributes substantially to keeping the price as attractive as it is.

As you can see from our graph, the on-axis response in the Diversified Science Laboratories measurement room is extremely flat; within ±2¼ dB from 50 Hz up. In addition to the usual high-end roll-off, the off-axis curve shows some increase in roughness. As you might expect from the bass-reflex design, sensitivity is remarkably high for so small a system with so extended a bass response. Yet the SX

accepted without serious complaint all the power DSL's test amp could provide, with peaks at the voltage equivalent of 24½ dBW (over 280 watts) into 8 ohms on a pulsed 300-Hz tone, for a calculated sound pressure level of 117 dB—more than enough for any sane need, in our view. Distortion figures run around 1% at a quite loud 95 dB SPL, increasing and decreasing only moderately with changes in input level.

Impedance varies between 4.8 and 19 ohms (a relatively modest spread, as such things go) across the band. The classic "nominal" impedance occurs fairly high, at about 250 Hz, where there is a lot of musical energy, and reads 5.3 ohms in the DSL test; the average impedance shown in the data is only slightly higher. Either way, the impedance is low enough that some amplifiers would surely react poorly to paralleled pairs of SXs.

Speakerlab suggests that the SXs be placed 3 to 10 inches out from the back wall, either on the floor or on a shelf. DSL chose the floor and set them 4 inches out from the wall. In our listening room, however, we found the bass a touch heavy with the speakers on the floor. And to avoid having to angle the SXs upward toward the listeners, we judged shelf height or something similar to be the option most users would choose. The midrange is not as smooth in this position—either in HF's listening room or in the one used for measurement by DSL—because of room reflections, and some listeners noted a slight "hollowness" in some music with the speakers at this height.

Considering the simplicity of means, the low cost, and the compact dimensions that characterize the SX, its performance must be counted as unusually good. Among its peers in budget territory, where many disreputable designs can be found, the Speakerlab SX is definitely one of the "good guys".

Circle 94 on Reader-Service Card

...and then came the SE-9.

35 years ago, to satisfy listening preferences, serious music lovers had to redesign their listening rooms. Remove the drapes. Add a rug here. Rearrange the upholstered sofa there. Get rid of that crystal chandelier!

Bass and treble tone controls came later, and they helped — but only a little. When you needed a boost in that lowest bass region, you had to accept boosted upper bass and mid-range tones as well — whether you needed them or not.

By 1958, the first equalizers appeared. They allowed you to alter specific bands of tones to suit the needs of the listening room — and the music program. With special mics, a pink noise generator, and a real-time

analyzer, you could electronically adjust your system to your listening preference. If — that is — you didn't mind spending several thousand dollars and a half hour adjusting and readjusting controls to enjoy a half hour of listening.

Then came Sansui's remarkable SE-9 Compu-Equalizer. It takes the guesswork and the frustration out of equalization. At the touch of a button, the SE-9's built-in pink noise generator feeds its signals first to one speaker, then the other. Sounds picked up by the SE-9's calibrated microphone are then analyzed by its microprocessor. Sit back and watch in amazement, as the SE-9's motorized system moves each of its

16 fader controls (8 per channel) to create the curve that yields precisely flat response at your preferred listening location.

Touch another button, and the curve is memorized for future, instant recall. Move to another location — even another room — and the SE-9 can create and store a new curve — up to four of them.

At last, after 35 years, a perfect equalization system without errors or frustration. And, at a price that makes perfect equalization affordable for all serious music lovers.

See the SE-9 and Sansui's truly complete line of high quality components and systems at your Sansui dealer today. Or write to us for details.



SANSUI ELECTRONICS CORPORATION
Lyndhurst, New Jersey 07071, Gardena, CA 90248
Sansui Electric Co., Ltd., Tokyo, Japan



YAMAHA NATURAL SOUND AM/FM STEREO TUNER T-70 Computer Servo-Lock system



YAMAHA NATURAL SOUND STEREO CONTROL AMPLIFIER C-70

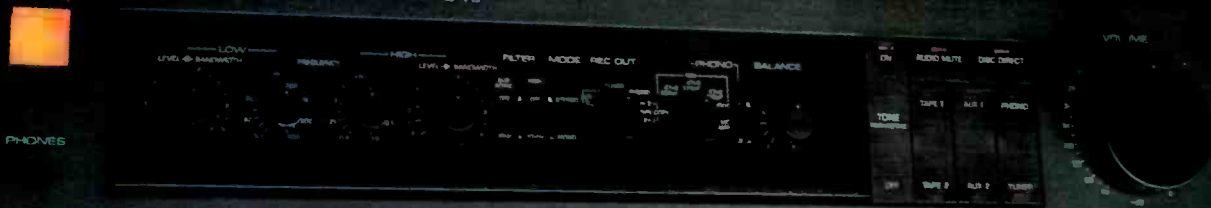

YAMAHA NATURAL SOUND STEREO POWER AMPLIFIER M-70



IMMEASURABLE.

Introducing Yamaha's newest separates—the T-70 tuner, the C-70 control amplifier, and the M-70 X-power amplifier featuring our unique Zero Distortion Rule. Zero Distortion

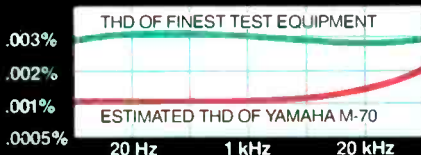

Sophisticated test equipment is incapable of measuring the M-70's THD.

Rule for distortion so low, it can't be measured. Here, in a nutshell, is how the Zero Distortion Rule circuitry works: Sophisticated circuitry measures any difference between the output signal and the input signal, and feeds back only this difference 180 degrees out of phase. This, in effect, completely cancels distortion.

How completely? Laboratory research has found that the only distortion test instruments can detect in the M-70 is the distortion generated by the instruments themselves. Which is why we have to estimate the M-70's Total Harmonic Distortion (arrived at by computer extrapolation) at no more than 0.002% at 200 Watts RMS per channel, both channels driven into 8 ohms, from 20 Hz to 20 kHz.

and the input signal, and feeds back only this difference 180 degrees out of phase. This, in effect, completely cancels distortion.

But the only test instruments you'll be using to measure the M-70's sound are your ears. So you'll hear only the most breathtakingly clear, accurate music reproduction possible.

To complement the phenomenal M-70 amplifier, we created the equally phenomenal T-70 computer servo-locked synthesizer tuner, and the C-70 control amplifier complete with two-band parametric equalization and

full-logic function switching. Nothing less would measure up.

Yamaha's new separates. Immeasurable in performance, beauty, versatility, and musical listening pleasure. Visit your



The most critical test equipment of all.

Yamaha dealer now and measure for yourself.

For more information, write to Yamaha Electronics Corporation, USA, P.O. Box 6660, Buena Park, CA 90622.

For the music in you.

YAMAHA

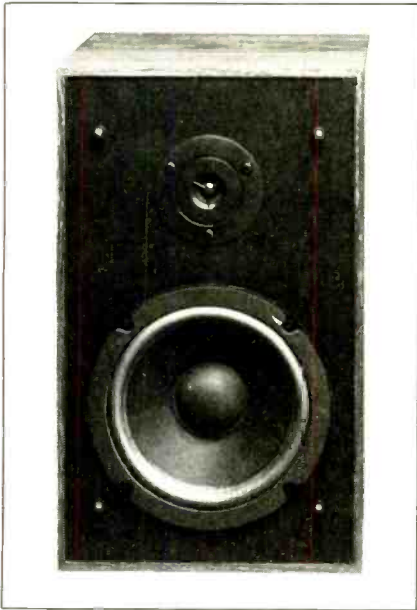

A Spunky Little Bostonian

Boston Acoustics A-40 loudspeaker system.
 Dimensions: 8¼ by 13½ inches (front), 7½ inches deep. Price: \$75. Warranty: "limited," five years parts and labor. Manufacturer: Boston Acoustics, Inc., 130 Condor St., Boston, Mass. 02128.

ROOM RESPONSE CHARACTERISTICS

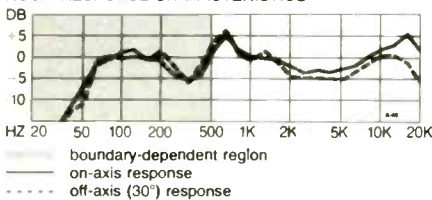

SENSITIVITY (at 1 meter; 2.8-volt pink noise; 250 Hz to 6 kHz) 89 dB SPL

AVERAGE IMPEDANCE (250 Hz to 6 kHz) 12.0 ohms

To Order Test Report Reprints, send us a letter with the following information: the type of product, the name of the product, the model number, manufacturer, and the issue in which the test appeared. Also enclose a self-addressed stamped envelope and send to Test Report Reprints, High Fidelity, 825 Seventh Ave., New York, N.Y. 10019. Requests for three or fewer reprints will be filled free-of-charge.

THE AVOWED INTENT behind Boston Acoustics' design for the A-40 loudspeaker is the realization of maximum potential in a small, inexpensive two-way system—in a word, value. It's small, though not as diminutive as some of the most popular "satellite" speakers, and it's finished in furniture style (actually, like virtually all low-priced "wood-grain" speakers today, in vinyl film over particleboard), rather than the more mechanized silver-and-black look espoused by many others of its proportions. Another distinguishing feature of the A-40 is that it is not designed to give up at about 100 Hz in the bass on the expectation that a so-called subwoofer (read, in this context, "external woofer") will bail it out for listeners who demand something more than mid-fi.

When placed against a wall and 30 inches above floor level in DSL's measurement room, the A-40 delivers good confirmation of Boston Acoustics' claimed bandwidth—with response down by 3 dB at 60 Hz in the bass and at above 20 kHz at the top end. Between these limits, on-axis response varies within ± 5 dB in DSL's measurements. The lab also tested the speaker 4 feet in front of the back wall with similar results, although the pattern of irregularities naturally shifted about somewhat in frequency. Bass can be extended—as it can with just about any speaker—by moving the A-40 close to a side wall or to the floor or ceiling. We confirmed this in our listening tests with good results, though Boston Acoustics warned us against such placements on the ground that highs tend to be lost in most rooms with the speakers placed at these extreme positions unless they can be angled toward the listener.

We'd urge buyers to experiment: The A-40s aren't exceptionally finicky about placement, but they are easy to move about, so experimentation is not unduly onerous. In our listening room, we tended to prefer positions with some floor or side wall coupling (we had no way of evaluating ceiling coupling), but midwall placement scored some points, too. Free-standing, the A-40s sound brightest—even rather bloodless with the bass thus attenuated. These experiments also verified another property claimed by Boston Acoustics for the A-40: broad directivity in the high frequencies to prevent sonic "hot spots" as you move around the room. Also in evidence was good stereo imaging.

The latter may be aided by the A-40's crossover, which is ultrasimple (partly to keep manufacturing costs low, partly to avoid phase anomalies by staying with slopes of 6 dB per octave), and by the prox-

imity of the drivers to each other. The woofer is a 6½-inch cone. The ¾-inch dome tweeter is fitted with what appears to be an acoustic lens element; its propagation is further refined by wedges that present a smooth acoustic transition between the speaker's front surface and the grille frame to reduce reflection and diffraction effects.

At moderate output (85 dB SPL), distortion over most of the frequency range is between ½% and 1%, rising higher (but still remaining essentially below 2%) only in the bass below 100 Hz. By the time sound pressure levels have reached a fairly hefty 95 dB, distortion averages above 1% across the board. Driving the speaker another 5 dB harder creates audible distress at very high frequencies (around 10 kHz), and the speaker's limit in the 300-Hz continuous-tone test appeared at a drive level equivalent to an output of 107 dB SPL. The voltage at that point was the equivalent of 18½ dBW (70 watts) into 8 ohms, indicating that the A-40 will withstand a surprising amount of power (though not without complaint or even failure if you literally drive it this hard). And it accepted the equivalent of 26¼-dBW (more than 400-watt) peaks into 8 ohms—the full output of the test amplifier—in the 300-Hz tone-burst test, which more nearly simulates music.

The actual impedance curve is relatively flat. Its nominal rating point—which occurs at about 200 Hz—is a minimum of just over 5 ohms, but the value in our rating band (250 Hz to 6 kHz, where most musical energy occurs) is 12 ohms. Because the A-40's sensitivity in that region is fairly high for so small a system and the actual current drain imposed by the impedance characteristics is moderate, paralleled pairs should not stress most amps, despite the relatively low 5-ohm "nominal" rating.

To speak frankly, no under-\$100 loudspeaker should be expected to qualify as truly uncolored, and the A-40 does nothing to rescind that rule—though it does temper it to the extent that there is astonishingly little coloration for so inexpensive a speaker. What coloration you hear will depend, in part, on the A-40's placement, of course. And—again, like many small (but not necessarily inexpensive) speakers—there is a limit to how much power the A-40 will accept gracefully. Signs of compression appear on peaks when you try to fill too large a room at too high a level. But, within the context of truly competing speakers, the A-40 is outstanding. If it proves to be the last of the good \$75 speakers, the breed is ending with anything but a whimper.

Circle 99 on Reader-Service Card

Report Policy: Equipment reports are based on laboratory measurements and controlled listening tests. Unless otherwise noted, test data and measurements are obtained by Diversified Science Laboratories. The choice of equipment to be tested rests with the editors of HIGH FIDELITY. Samples normally are supplied on loan from the manufacturer. Manufacturers are not permitted to read

reports in advance of publication, and no report or portion thereof may be reproduced for any purpose or in any form without written permission of the publisher. All reports should be construed as applying to the specific samples tested. HIGH FIDELITY and Diversified Science Laboratories assume no responsibility for product performance or quality.

Loudspeakers: The Untamed Component

A twist or two on traditional design principles has yielded some strikingly different models.

by Michael Riggs

Associate Audio-Video Editor

This article is the second in a series on the new stereo components introduced at the recent Consumer Electronics Show. Our coverage continues next month with system accessories and add-ons, including products for tape and disc care, noise reduction units, and image enhancement devices.

OF ALL AUDIO COMPONENTS, only loudspeakers remain untamed. When someone tells you he's going to show you an amplifier or a turntable, you have a pretty good idea what you're in for; if the same person offers to give you a look at a new speaker, all bets are off—there could be anything on the other side of that door.

This state of affairs indicates that designers are still far from agreement on exactly what a loudspeaker should do or how it should go about it. Although the Winter CES in Las Vegas was short on unusual drive principles (almost everything I saw was based on the old reliable moving-coil approach), it presented a fair number of interesting twists to an old theme.

Exotica

Easily the most remarkable, the Wilson Audio Modular Monitor (WAMM) incorporates a host of twists. Each channel consists of two 6½-foot towers. Of these, the full-range tower has two flat-piston woofers in a sealed cabinet; a mast jutting up from this bass enclosure supports an electrostatic tweeter array between two

conventional midrange/tweeter modules, above and below. Each of these three units is at the end of a steel shaft that can be moved fore and aft to calibrate the system's response for the positions of the speaker and the listener. The other tower on each side is a ported subwoofer with an 18-inch driver. The system includes an eleven-band equalizer with variable center frequencies and an electronic crossover for separate amplification of the subwoofers. All cabinets are constructed of Finnish birch and are available in any of an extensive range of veneers, including fisheye padauk, tropical olive, zebrawood, curly white oak, and the ever-popular burly imbuia. A complete two-channel system weighs 750 pounds and sells for approximately \$32,000, including installation and calibration by the designer, Dave Wilson. And, in case you were wondering, it sounds fabulous.

No less a maverick is Bennett Sound Corporation, whose two speaker systems, the Compusound 300 (\$6,000 a pair) and 150 (\$3,800 a pair), are designed specifically to work in conjunction with the special amplifiers and electronic crossovers that accompany them. The systems operate under the control of analog computers. The intent is to eliminate spurious output due to driver resonances, improve transient response, and eradicate the "garbled hoot" that Bennett claims is endemic to all other loudspeakers. The 300 has two 12-inch woofers, a 7-inch low-midrange driver, a 2-inch high-midrange driver, and a 1-inch tweeter; the 150 lacks the 7-inch driver and has two 10-inch (not 12-inch) woofers.

Another loudspeaker with dedicated

amplifiers is the Meridian M-10 Active Loudspeaker (\$3,950 per pair). This big brother to the M-2 (Test Report, June 1981) incorporates steep-slope, linear-phase electronic crossovers and four amplifiers to drive a 2-inch tweeter, two 5-inch midrange drivers, and four side-mounted 5-inch woofers acoustically coupled to an 8- by 12-inch passive radiator on the rear of the slender floor-standing enclosure. Claimed advantages of the design are very low coloration and exceptional imaging.

DCM, already well known for its established Time Window loudspeaker, is introducing an improved high-end version called The Time Window² (\$1,000). Advances incorporated in this enhanced model are said to include improved phase and amplitude responses, wider dispersion, and greater dynamic range. Among the most unusual looking speakers to be seen at the show was the GNP Lead Cylinder (\$425)—a 1-inch soft-dome tweeter and a 5¼-inch Bextrene midrange driver, each in its own lead-layered cylindrical enclosure and stacked one atop the other. A complete system is formed by mating the Lead Cylinder to either a W-101 (\$220) or W-100 (\$150) bass module. The SM-B1 (\$200) and SM-P1 (\$125, with a polypropylene midrange unit) use drivers similar to those of the Lead Cylinder, but in conventional nonmetallic enclosures.

The only new full-range electrostatic I saw was the Stax ELS-F81 (\$3,100)—a crossoverless design that is said to have unusually wide directivity for an electrostatic. Dennesen has a hybrid model with three electrostatic tweeters mounted in free

Once again, JVC harnesses higher tech in the pursuit of higher fidelity.

The power of higher tech, harnessed by superior engineering. Once again, it's the mark of JVC's leadership. Even in the realm of moderately priced components like these.

The intricacy of JVC turntable design.

You see it, and hear it, in attention to subtle, yet significant details. Like a straight, low-mass tonearm with *tracing hold* to stabilize tracking. And quartz control to insure virtually perfect platter rotation.

Powerful, yet musically pure receivers.

A JVC innovation called *Super-A* removes subtle forms of distortion. So

musical overtones and transients are amplified intact for a pure, musically natural sound. Add graphic equalization and quartz tuning, and you have receivers unsurpassed for performance and versatility.

The innovators in metal cassette decks.

It was JVC who first put together the technology needed to record metal tapes. Now we've added Dolby® C for ultra-quiet recordings. Plus features like Music Scan to find selections automatically. Spectro-Peak metering. Logic controls, digital indication, memory and more.

Speakers more precise than the ear itself.

Our Dyna-Flat ribbon tweeter extends to 100 kHz, higher than the ear can hear. By doing so, it helps provide correct amplitude and phase characteristics in the audible range. So music takes on the focus, detail and spatial image of live sound.

Your JVC dealer is waiting to demonstrate the full new line of higher tech components. Computerized tuners. "Thinking" tonearms. Self-optimizing cassette decks. Higher tech engineering all focused on one goal — achieving the highest fidelity possible.



JVC®

US JVC CORP.

41 Slater Drive, Elmwood Park, N.J. 07407
JVC CANADA INC., Scarborough, ONT.

*Dolby is a registered trademark of Dolby Laboratories.

Exotica

Unusual speaker design approaches are typified by models shown here. Both employ dedicated amplifiers and electronic crossovers, which in the Compusound 300's case, are controlled by analog computers.

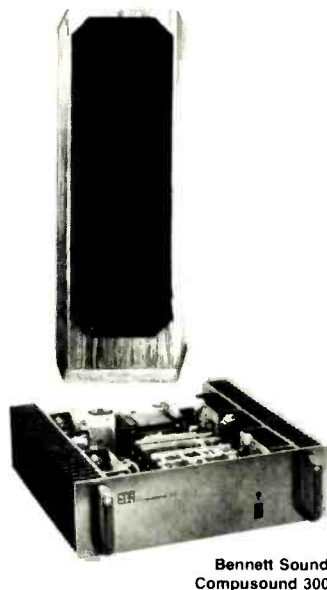

Bennett Sound
Compusound 300

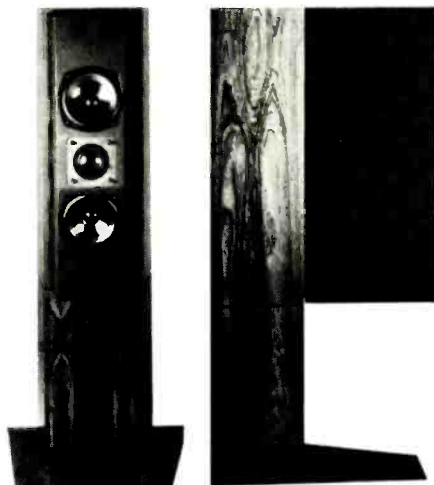

Meridian M-10 Active Loudspeaker

space, crossed over to a 5-inch midrange cone and thence to a 10-inch acoustic suspension woofer. The \$1,350 system's butcher-block cabinet is available in a variety of finishes.

A novel, but increasingly popular, type of driver is the leaf tweeter, two of which are incorporated in a vertical array on the Model 12B from Norman Laboratories (\$800). Below them is a 2-inch dome midrange driver. All three are mounted on a narrow baffle atop a much larger bass enclosure, which houses two 10-inch polypropylene woofers.

One of Phase Diametrics' two new speakers, the Fuselier Model 9 (\$3,000), comprises two cabinets: a wide, 4½-inch deep panel with eight drivers that cover the range from 55 Hz up and a separate bass unit with a single driver that handles the bottom octave. The panel is said to be a dipole radiator up to 4.5 kHz. The more affordable Fuselier Model 3 (\$400) is a three-way tower delivered in mirror-image pairs for best imaging.

Symdex, also concerned with accurate imaging, has designed its Sigma loudspeaker (\$450) for excellent phase response and low diffraction. Bass response of the Sigma, which uses a 6-inch Bextrene sandwich woofer and a 1-inch dome tweeter, can be extended by the addition of the Omega subwoofer (\$1,300) with its 10-inch Bextrene driver. Kindel Audio's floor-standing, full-range Phantom (approximately \$450) is

also designed for good phase response and low diffraction. Its driver complement consists of a planar tweeter, a ½-inch dome midrange, two 5¼-inch Bextrene woofers, and an 8-inch passive radiator.

While others try to eliminate reflections of various sorts, Uniphase is working hard to create them. The company describes the S-8000 (\$1,250) as a "point-source omnidirectional loudspeaker." Its floor-standing enclosure contains a 15-inch woofer; directly above it, a sphere houses eight dome tweeters, distributed over its surface in an array that is said to approximate (for a listener a reasonable distance away) a true point-source radiator.

My initial reaction to the O'Malley Holocustic system was, "What's that?" Full-blown, a Holocustic system includes speakers at both the front and rear of the room. (The rear speakers are fed a delayed signal for ambience enhancement, but you can start out with just the front channels.) Woofers, tweeters, and midrange drivers are housed in separate enclosures. Systems range from the Model 3015 (\$3,400), consisting of two 15-inch bass units, two midrange modules, and two tweeter modules, to the Model 2008R, with two 8-inch woofer modules and two tweeter modules.

Bread 'n Butter

Despite this listing of exotica, however, I don't want to imply that traditional

techniques cannot yield pleasing and even exceptional results. Acoustic Research—inventor of the acoustic suspension principle and the dome tweeter—has topped off its Super Value line of compact speakers with the \$325 AR-58s, a system whose basic configuration resembles that of the venerable AR-3a—a true "classic" model in its day.

And AR is making some cosmetic changes to the AR-93 and AR-94 (now the AR-93s and AR-94s), adding walnut veneer to their top panels and changing the color of their cloth-sock coverings to dark brown. A conversion kit for the originals will retail for \$70. JBL has added two new two-way models to its speaker line: the L-46 (\$165) with an 8-inch woofer and the L-56 (\$225) with a 10-inch woofer. Both have dome tweeters and bass-reflex woofer enclosures.

Newcomers from Polk include the diminutive Monitor 4 (\$100), which boasts a 6½-inch woofer and a 1-inch dome tweeter, and the LF-14/4 satellite/subwoofer system (\$500), which couples the LF-14 subwoofer to two Monitor 4s. Altec Lansing's new Series II line comprises three high-sensitivity speakers, ranging from the two-way Model 4 (\$250), with a 10-inch woofer, to the three-way Model 8 (\$450), with a 12-inch woofer and a 5-inch midrange driver; all three employ Altec's Mantaray horn tweeter. The company also has a new three-way direct-radiating speaker, the Model 312 (\$250), said to have unusually high sensitivity.

The latest and littlest in Dahlquist's Dynamic Tracking Monitor series is the DQM-5 (under \$300 in gray Nextel finish or walnut vinyl). Like the rest of the series, this bass-reflex design is said to be very sensitive. Infinity also has a new small speaker—the RS_{jr} (\$130), with a 6½-inch polypropylene woofer and an Emit tweeter—along with a successor to the Reference Standard 4.5, the \$4,000 Reference Standard 1. It consists of two 5-foot towers, one having six 8-inch servo-controlled woofers with polypropylene cones and the other with seven Emim midrange drivers and four Emit tweeters. The Reference Standard 1 must be biamplified.

Cizek's tower, the \$750 King, tops the company's new Aristocrat line. Almost 4 feet tall, it includes a 12-inch polypropylene woofer with an infrasonic filter, an 8-inch polypropylene lower-midrange driver, a 1½-inch dome upper-midrange driver, and a leaf tweeter. New in Cizek's 700 series is the three-way Model 747 (\$300), designed for high sensitivity and featuring a 15-inch woofer complemented by a piezoelectric tweeter.

Cizek's 747 is not to be confused with Mission's new 727 and 717 speakers. Both of the Mission models are two-way, high sensitivity systems. There are three speakers in Mordaunt-Short's revamped line: the Pageant 3 (\$765 a pair), with an 8-inch

Bread 'n Butter

Traditional techniques—approaches that have survived the test of time—continue to be the most popular and pervasive. Models pictured here are basically mainstream designs, tradition spiced with a new twist or two. Prices generally range between \$200 and \$600.



Realistic Mach One



Polk Audio Monitor 4



Cerwin-Vega 812T



Mission 727



Acoustic Research AR-58s



Visoric David 8000



KEF 303.3



Scott 197BII

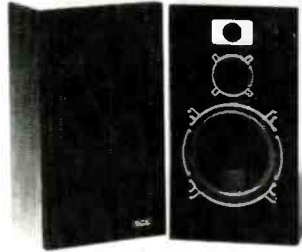

Altec Lansing 312

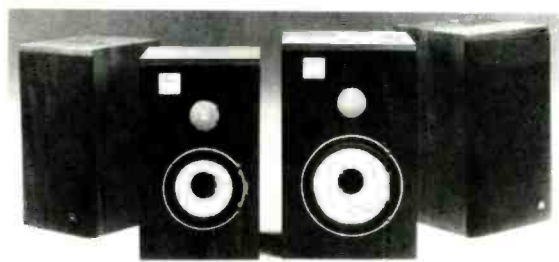

JBL L-46, L-56



Technics SB-L301



BSR 153

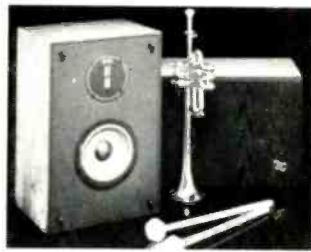

Infinity RSjr



Mordaunt-Short Festival 3, Pageant 3, Carnival 3



Electro-Voice Patrician 800



Mesa Mini-Mesa 100



Heath AS-1324

woofer, a 5-inch midrange driver, and a 1/2-inch dome tweeter; the Festival 3 (\$525 a pair), with an 8-inch woofer and a 1-inch tweeter; and the Carnival 3 (\$395 a pair), with an 8-inch woofer and a 1/2-inch dome tweeter. And KEF now has a conventional vinyl-finish version of its Model 303.2, the \$200 303.3.

Electro-Voice, on the other hand, hasn't changed a thing about its classic Patrician 800 loudspeaker (except the price, which now is \$5,000). Originally introduced in 1952, this speaker was discontinued in 1972 and then revived to satisfy the demand of a substantial cult following in Japan. The Patrician's 4 1/2-foot-tall enclosure conceals four drivers, including a 30-inch woofer, behind woven cane grilles.

The Ambassador line from Visonik consists of four three-way bookshelf speakers, ranging from the \$300 A-80, with a 7-inch woofer, to the \$465 A-150, with a 12-inch woofer. The company also has added the \$230 David 8000 to its range of minispeakers. All three of Scott's new loudspeakers are three-way systems. The most elaborate, the \$800 PRO-100BII, has a 15-inch woofer, two 4 1/2-inch midrange drivers, and three 1-inch dome tweeters, with one of the midrange units and two of the tweeters mounted on the top of the cabinet for wider directivity.

Jamo of Denmark has a completely new line designed to reduce secondary radiation caused by cabinet resonances. This CBR Series includes ten models, ranging from the \$150 Mini 80, with a 6-inch woofer, to the \$650 Model 1702, with a 13-inch woofer, a 7-inch low-midrange driver, a 2-inch dome midrange unit, and a 1-inch dome tweeter. Also from Denmark, Bang & Olufsen's new \$250 S-55 incorporates the company's proprietary "phase link" to ensure linear phase response.

Micro-Acoustics achieves wide high-frequency directivity in its 4-dx speaker (\$135) by mounting a 2-inch tweeter at the end of a rotating control shaft, so that you can aim it for best results in your listening room. Low notes are handled by an 8-inch slot-loaded woofer with a polypropylene diaphragm. Meanwhile, Heath has added a new three-way speaker module—the AS-1321 (\$290)—to its AS-1320 subwoofer (\$300) to create the four-way AS-1324 (\$570). The subwoofer consists of a 15-inch driver in a 9-cubic-foot vented enclosure. The upper-range module (which can also be used as a stand-alone system) has a 6 1/2-inch polypropylene midbass driver, a 2-inch dome midrange unit, and a planar tweeter; the AS-1321 is designed to fit into the AS-1320's cabinet. The system comes as a kit and is available by mail order.

Besides having the loudest exhibit at the show, Cerwin-Vega may also have had the largest number of new speaker introductions: ten in all. One particularly unusual model is the 812T (\$600), which the company describes as "a mid-axial time-coinci-

dent speaker." It's called "mid-axial" because a tweeter and a midrange/bass driver are mounted on the same axis; a 12-inch woofer is mounted below them on the front of the trapezoidal cabinet.

Paisley Research is introducing the \$125 Model 5, said to be the first speaker to incorporate Passive Electronic Suspension (P.E.S.) bass loading, which Paisley says yields extended low-frequency response and high efficiency from an enclosure of modest volume while reducing sensitivity to infrasonic disturbances. Sony also has only one new speaker—the \$90 SS-X150, designed mainly for use with the company's X0-5 and X0-7 cassette players.

Technics and BSR have three new speakers each. The Technics units are linear-phase designs. The smallest, the \$150 SB-L101, has a 10-inch woofer and a radial-horn tweeter; the largest is the \$250 SB-L301, with a 12-inch woofer. All of the BSR models have acoustic suspension woofers. The Model 153 is the big boy of the group, with a 15-inch woofer, a 5-inch midrange unit, and an exponential-horn tweeter. Like many other manufacturers, Radio Shack is using ferrofluid to improve power handling and linearity. The latest version of the company's Mach One speaker (\$240) uses it in both the horn midrange driver and bullet tweeter. Bass is handled by a 15-inch acoustic suspension woofer.

New Kids on the Block

At every show, a few new companies take the plunge into the crowded speaker market, and the last Las Vegas CES was no exception. Foremost among the newcomers

is Interaudio Systems of Framingham, Massachusetts. Designed for smooth response, high sensitivity, and consistent reliability, the four speakers in the line range from the two-way Alpha One (\$150), a bass-reflex bookshelf speaker with an 8-inch woofer and a 3-inch tweeter, to the floor-standing Alpha Four (\$450), which has a 10-inch woofer, a 10-inch passive radiator, a 6 1/2-inch midrange driver, and two 3-inch tweeters. The tweeters on all four models have what the company calls Omnivector lenses to improve high-frequency coverage.

Daybreak Acoustical Research makes two full-range speakers—the three-way Model 22 (\$525) and the two-way Model 11 (\$300)—and a subwoofer (\$900) that can be used with either. Connections are silver-soldered for highest possible conductivity, and the five-way binding posts are gold-plated for corrosion-free reliability.

Origin Audio is also concerned with getting even the small things right, especially those relating to transient response. Its first product, the \$275 MC-1, uses a 1 1/4-inch dome tweeter and a 10-inch woofer in a ported enclosure.

Finally, we come to a newly imported line from Morel, which first appeared in Israel in 1975. Since then, the company has grown and now makes its own drivers. Its least expensive speaker, the \$170 LA-205 II, is a two-way model with an 8-inch woofer and a dome tweeter.

And there you have it. We don't know yet which speakers are better than the others, but we'll examine some of them as the year progresses and pass the results of our tests on to you. **HF**

New Kids on the Block

A few new companies enter the crowded speaker field each year, and 1982 is no exception. New models include those from manufacturers in the U.S. (such as Interaudio) and from abroad (such as Morel).



Morel LA-205II



Interaudio Systems A-3

RECOMMENDED FOR MATURE ADULTS ONLY.

You're old enough to know better. So pull out all the stops, end all the compromising and introduce yourself to AKAI quality and performance. You'll find we've engineered all the



intimidation out of high-performance hi-fi. And put a whole lot more human engineering in. While adding 15 superbly crafted new components that give you just a little more for your money.

But if you're an adult, you're not about to settle for less.

In tune with the times.

For example, take the all-new AKAI GX-F71 cassette deck. Just for openers, you get Dolby[®] B and C noise reduction and AKAI's famous Super GX Combo Heads. Plus the convenience of a built-in microcomputer that automatically calibrates bias, equalization and sensitivity for any tape used, Auto-Fade, Instant Program Locating System and Intro-Scan that plays a 10-second preview of every program selection.

One for the records.

With the AKAI AP-L95 you can always count on a well-rounded performance. And for obvious reasons. A built-in microcomputer makes it fully

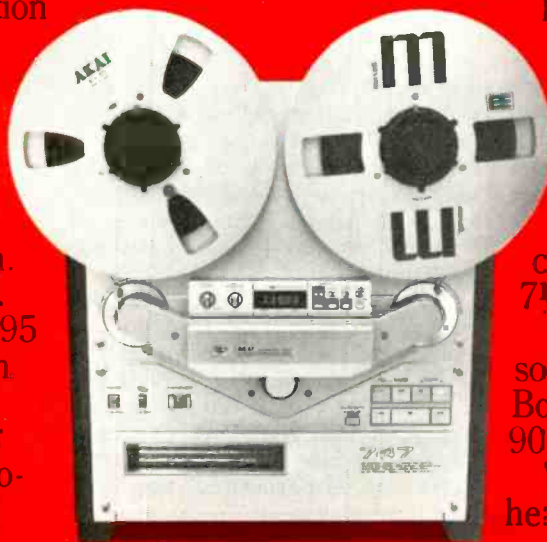

programmable. A linear-tracking tone arm virtually eliminates normal tracking error. And a superb quartz lock, direct drive motor keeps wow & flutter to an inaudible minimum.

Efficiency expert.

AKAI's magnificent GX-747 represents that latest breakthrough in open-reel technology. Because it's one of the world's first decks designed to handle the new "EE" (Extra Efficient) tapes.

And that means you get the equiva-



lent of 7½-ips performance at a much more economical speed of just 3¾ ips.

But that's not all. You also get: four Super GX Heads, two erase heads, Auto-Reverse Playback/Record, Auto-Mute and an unheard of frequency response of 25-33,000 Hz ± 3dB at 7½-ips.

So visit your AKAI dealer soon. Or write: AKAI, P.O. Box 6010, Compton, CA 90224.

With AKAI, you've never heard it so good.

AKAI

Hi-Fi & Video.

How to Isolate Trouble Spots

Simple solutions to common stereo system problems
by Alexander N. Retsoff

TROUBLESHOOTING YOUR STEREO SYSTEM is not very difficult. The basic analytic tools are simple logic and some knowledge of how the signals flow through the components. From there, it's just a matter of applying common sense.

Let's take it one step at a time, tracing the signal path from the source through the amplifier to the speakers. All signals are routed through a single switch in a preamp, integrated amp, or receiver—the input selector—but they follow different paths getting there. Phono signals follow a circuitous route that usually involves several components. First, the stylus physically traces the record grooves and the cartridge generates an electrical analog of the stylus motion. Because this signal is very weak, it is passed through a special phono-preamp section (located in the preamp, integrated amp, or receiver), which amplifies the voltage anywhere from 50 to 100 times (34 to 40 dB) at the standard test frequency of 1 kHz. The gain, or amplification factor, of the circuit varies with frequency to compensate for the RIAA recording equalization used in cutting the disc (see "Basically Speaking," March).

Moving-coil cartridges usually produce such a low-output signal that they require yet another stage of amplification ahead of the phono pickup. This is supplied by a step-up transformer or head amp (or "pre-preamplifier") that provides a voltage gain of about 20–26 dB (an amplification factor of 10 to 20 times).

After you analyze the phono signal path, it's easy to conclude that if the trouble occurs only when playing records, the problem must be in the cartridge, in the wiring from the cartridge to the preamplifier, or in the phono preamp itself. If the difficulty occurs on the moving-coil input but not on the fixed-coil one, the fault must lie in the head amp.

The output level of the phono preamp is approximately equal to that of a tuner or tape deck. Each of these "line-level" sources is fed to a multiposition input selec-

Alexander N. Retsoff was a long-time contributor to STEREO magazine. Beginning with this issue, his column will appear in HIGH FIDELITY every other month.

tor, where the signal you choose is directed through the line-amp and control stages of the preamp and on to the power amplifier. On the majority of amplifiers, this signal is also fed to the tape-recorder (tape-output) jacks.

Some amplifiers, however, have an independent recording selector switch. Signals are routed to both the input selector and the recording selector, so you can record from one source while listening to another. Thus, if you find that you can listen to a particular signal but not record it, the problem is in the amplifier's recording selector switch, the tape deck's recording electronics, or the cable between the two. If you can

RETSOFF'S REMEDIES

record from a source but not listen to it, the problem must be in the input selector or in the electronics between that switch and your speakers.

Amplifiers that have a recording-selector switch usually accommodate more than one tape deck, and certain positions of this control will enable you to dub from Deck 1 to Deck 2 or vice versa. Usually the output from each deck is fed directly to the recording selector switch and—when the appropriate position is chosen—on to the other deck. This signal path is entirely independent of the input-selector setting.

You'll sometimes find a separate dubbing switch, with either two positions (SOURCE and 1▶2, if dubbing can be done in only one direction) or three settings (SOURCE, 1▶2, and 2▶1, if two-way dubbing is possible). When Deck-1-to-Deck-2 dubbing (or vice versa) is chosen, the switch connects the amplifier's tape-in jack (which accepts the signal from the source deck) directly to the tape output jack (which sends the signal to the recording deck), isolating the tape-signal path from the input selector. Only when the dubbing switch has been set to SOURCE are the tape decks fed with the signal from the input-selector con-

trol. When you select 1▶2 or 2▶1 dubbing, you can record from deck to deck while listening to another source. You can't, however, record from anything but the source deck and still be able to listen to another signal. For example, you can't record from PHONO while listening to an FM broadcast.

From the input selector, the signal travels first through the balance and volume controls, then through the tone-control and filter circuitry, and finally to the power-amp. In most designs, the volume and balance controls and tone-control and filter circuits come *after* the tape output jacks. They therefore cannot affect tapes you record through the amp. (They do function in playback, however.) In some cases, the infra-sonic filter (if there is one) is in the phono preamp—an approach I personally prefer—to block the low-frequency garbage generated by warped records before it can foul any other part of the system, including tape decks. (Such signals can easily overload recording circuits). Certain amps also let you switch the tone controls into the circuit *ahead* of the tape output jacks, enabling you to adjust the tonal balance of a recording as you make it.

In some units, a tone-defeat switch permits the signal to bypass the tone controls entirely, thus eliminating any distortion or noise these circuits might introduce. With such a design, you can check the tone-control circuits quite simply by switching them in and out of the system. If the signal drops out or becomes noisy or distorted when the controls are activated, the problem lies in the tone-control circuitry.

The signal has now passed through the entire preamplifier. If you have separate components, this is the point at which the signal is sent via cables to the power amp. In many integrated amps and receivers, the preamp and power-amp sections are linked by removable jumpers on the back panel. This design enables you to route the signal through an image expander, a graphic equalizer, or other such devices. To determine if it is an add-on that is causing your problem, simply remove that piece of equipment from the circuit.

(Continued on page 84)

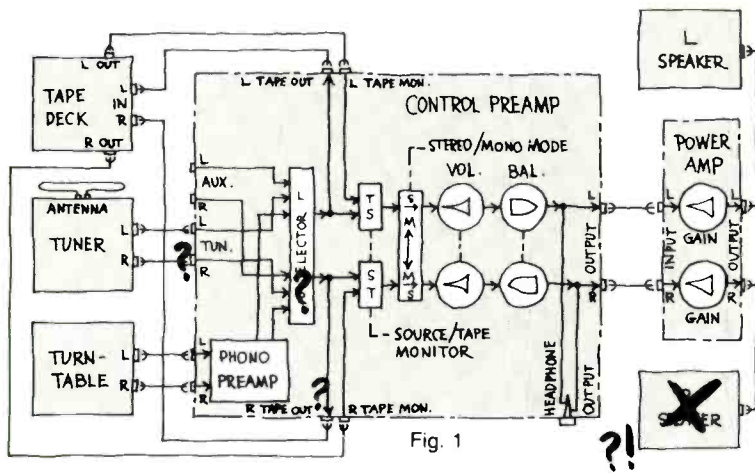

Fig. 1

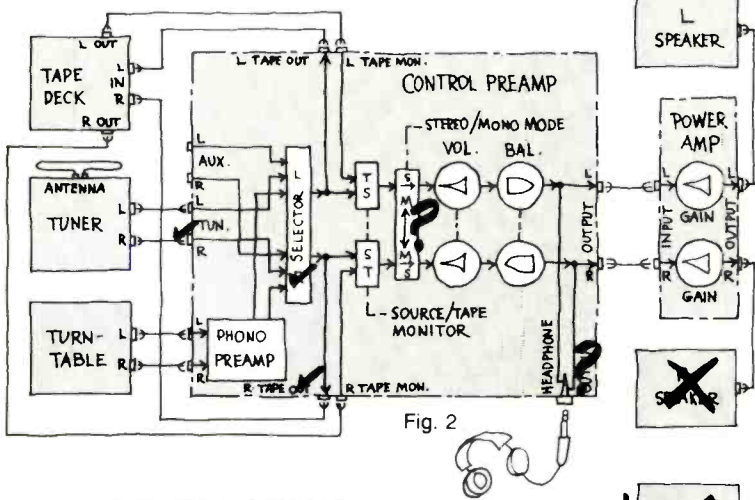

Fig. 2

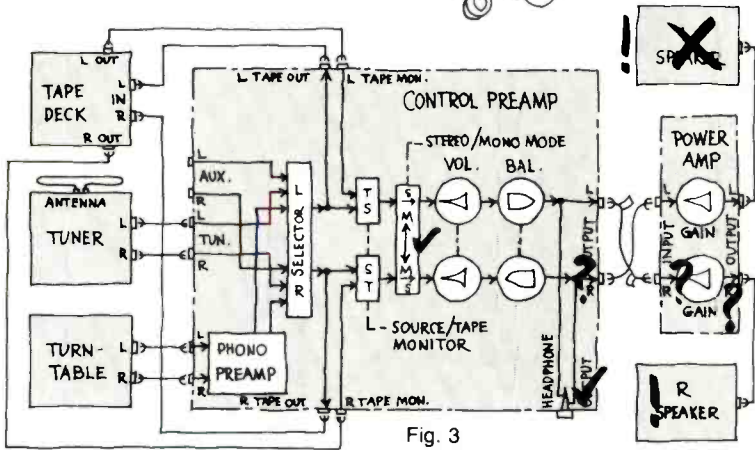

Fig. 3

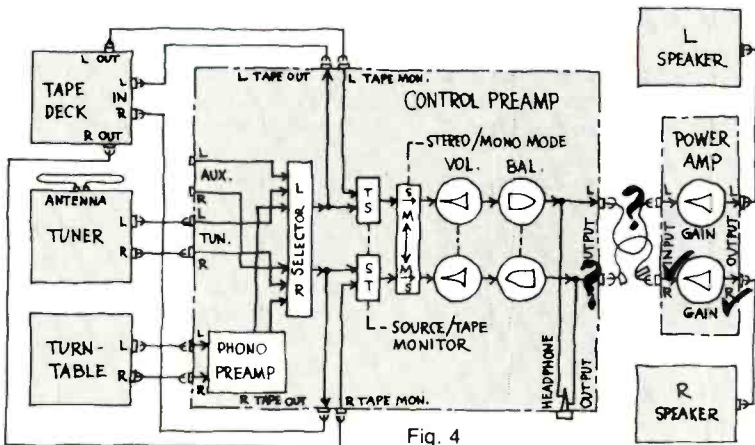

Fig. 4

Draw Your Own Troubleshooting Map

A homemade map of your stereo system can be a big help when the time comes for troubleshooting. In this diagram of a basic collection of separates we are assuming a turntable, a tuner, a tape deck, a preamp with fairly simple controls, a power amp with its own gain controls, and a pair of speakers. (A receiver is a preamp, power amp, and tuner wired together on a single chassis; an integrated amplifier combines a preamp and a power amp.) The diagram of your system should show all the elements—including any speaker controls—that might affect the signal path in ways that you can check.

To show you how to use such a diagram, let's suppose that—when you turn on the system to play FM—you find the right speaker dead. You might check the speaker first and work backward (any systematic approach will do), but let's begin at the input to the control preamp. Is the tuner not feeding it a right-channel signal, or is the preamp killing the right-channel input from any source?

Fig. 1. Put a record on the turntable and rotate the selector switch to PHONO. The right channel is dead on phono, too, so the problem is not peculiar to the tuner; it appears to occur after the selector switch. Next set the tape deck to RECORD. If you find that the meters indicate a right-channel signal for both tuner and phono, you have established that the fault happens after the tape-recording feed. Perhaps you can pinpoint the fault with the mode switch or by connecting headphones at the preamp's output.

Fig. 2. The right speaker remains dead with the MODE in either position, but sound is audible in each earpiece at both MODE settings. The fault, therefore, must be somewhere between the headphone jack and the speaker. It could be at the very output of the preamp or at the input or output of the power amp.

Fig. 3. You can narrow the field by adding masking-tape "flags" to the demonstrably faultless cable that carries left-channel information from the preamp output to the power-amp input and then interchanging it with the right-channel cable at the power-amp input. When you restore power, it is suddenly the *left* channel that has gone bad. The right channel has revived. This procedure eliminates the power amp and the speakers as possible sources of the system's trouble.

Fig. 4. The fault may then be at the output of the preamp or in the right-channel cable. Switch the preamp ends of the cables so the questionable unflagged cable now runs from the left-preamp output to the left power-amp input. If the left speaker remains dead, you can now deduce that the problem is in the cable. The cure is easy: Buy a new cable.

ROBERT LONG

Video Fronts

Latest video news and products by the Editors



Up to 8 hours of recording is now possible in the VHS extended play (EP) mode with JVC's T-160 video cassette. The new tape length, which increases maximum recording time at all VHS speeds by one-third, was made possible by the development of a thinner tape/coating and by new slitting technology, according to JVC. Price is \$35. *Circle 71 on Reader-Service Card*



Blending high performance with fine furniture is the idea behind Mitsubishi's new VS-521UD projection TV system (\$4,300). A pecan-finish cabinet houses a 105-channel random-access tuner and a 50-inch projection screen with image brightness rated at 120 foot-lamberts. Full-function wireless remote control includes volume up/down, continuous and single-step channel-change, and audio mute. The system's audio section incorporates a stereo amp rated at 10 watts per channel; separate bass, treble, and volume controls; and a "pseudostereo" enhancement circuit. Stereo speakers are built-in; outputs are also provided for an external audio hookup. *Circle 70 on Reader-Service Card*

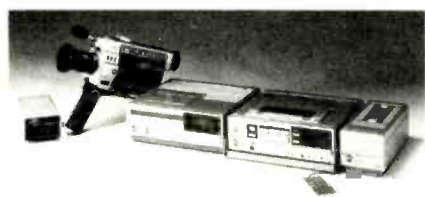

A complete Beta-format portable video recording system—comprising the VCP-

1000E VCR (\$830), TT-1000E tuner/timer (\$315), and TC-1000E color video camera (\$1,050)—is available from NEC Home Electronics. Features on the VCR include two-speed (Beta II and III) operation, Betascan (nine times normal speed in forward and reverse), wired remote control, and a quick-charge battery pack. Weight with battery is 12 pounds. The companion tuner can be programmed for five events in a two-week period; AC adapter and VCR battery charger are built-in. Completing the system is the color camera, which incorporates a two-speed 6:1 (12.5mm to 75mm) power zoom lens, a telescoping mike, remote VCR transport controls, and an electronic viewfinder. The camera weighs just under 4½ pounds; power consumption is 7 watts (12 VDC). *Circle 69 on Reader-Service Card*

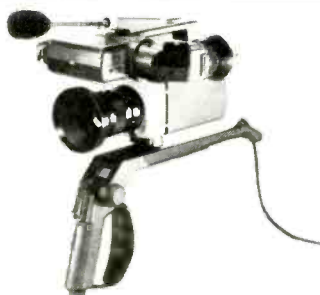

A two-speed power zoom is one of the features you will find on the VK-731TE color video camera from Quasar. The f/1.6 macro lens is equipped with an automatic iris with manual override; there's also a tally lamp. Other extras include a sidemounted electronic viewfinder, fade-in and fade-out capability, and an accessory shoe to hold a light. The VK-731TE sells for \$1,120. An optional kit (Model VF-790TE, \$126) provides a wide-angle accessory lens, a neutral-density filter, a protective lens made of clear glass, and an adapter ring to fit the 49mm lens to 58mm camera mounts. *Circle 80 on Reader-Service Card*



Intelligible audio at up to two-and-one-half times normal speed is now possible

thanks to Showtime Video Ventures' V-100 Voice Tracker, which preserves intelligibility during high-speed review. "We've taken the Donald Duck sound out of fast-moving tape," says a company spokesperson. The V-100 electronically corrects the pitch of the audio as the tape speed is accelerated. Since the brain can comprehend language at more than twice the normal speaking rate, you can watch a half-hour newscast in just fifteen minutes. The \$312 V-100 should be used in conjunction with a VCR's speed-search or fast-play modes. *Circle 82 on Reader-Service Card*



Constructed of durable vinyl, the VHS-6 Pak video tape album from Blackbourne can be used for storage at home or as a compact carrying case when you travel. The folding album holds up to six VHS cassettes in rigid vinyl trays. A Velcro flap secures the tapes. *Circle 81 on Reader-Service Card*



Automatic color-maintenance circuitry, ten-function infrared remote control, and 105-channel tuning capability are among the many features of Sanyo's new 91-C89 color television set. Also included on this 19-inch model are an LED display for time and channel, channel-lock tuning, automatic brightness control (to adjust to different room-lighting conditions), automatic degaussing, and a regulated power supply (to maintain picture quality during low line-voltage conditions). An earphone jack and 75-ohm cable connector are provided. Price is \$620. *Circle 68 on Reader-Service Card*

Quality Video Sound: Why Are We Still Waiting for It?

Improving audio performance
is key to the future success of video.

by Edward J. Foster

Consulting Audio-Video Editor

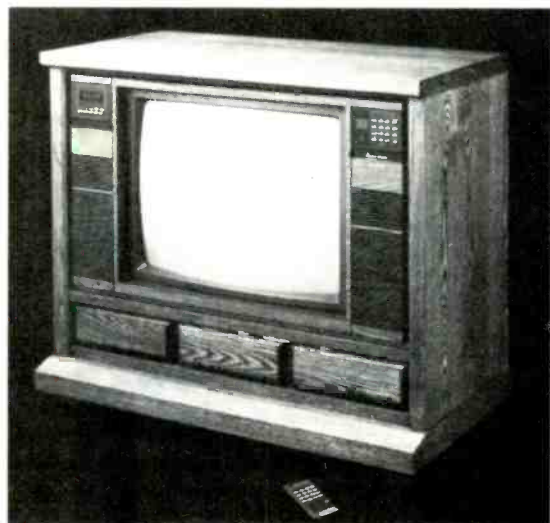

Mitsubishi TV set with stereo FM, amp, and speakers

YOU'RE UNDOUBTEDLY AWARE that digital technology is the key to tomorrow's super-fidelity audio, both in the contexts of recording and playback. What you may not know is that these advances in audio are based in part on video recording techniques. Why, then, is the sound reproduction of a home VCR so inferior to that of an ordinary audio cassette deck, particularly when you consider that a video tape's audio track is recorded in the same way as an audio cassette? The answer is simple: In order to produce a better quality picture and longer recording and playback time, numerous tradeoffs have been made—at the expense of audio.

Take bandwidth, for instance. To create an image with even modest resolution requires a frequency response of at least 2 megahertz (MHz), and that implies very high tape speed or, more precisely, a high *relative* speed between tape and head. In VCRs this speed is attained by mounting the video heads along a slit in the head drum at opposite ends of an arm. The arm rotates at high speed, bringing the heads into contact with the tape as it moves around the drum. The tape wraps part way around the drum, and the heads trace a series of parallel diagonal tracks across the width of the tape. Because the heads rotate so rapidly—1,800 rpm, or 30 revolutions per second—the *relative* head-to-tape speed is very high, even though the tape itself is moving quite slowly.

Theoretically, the audio signal could have been piggybacked onto the video signal by giving it some of the available bandwidth. Such is not the case, however. Instead audio is assigned a narrow stripe along the edge of the tape, so it must be

recorded by a stationary head. The relative tape-to-head speed for the audio track is therefore the same as the *linear* tape-transport speed for the video track. As designers have slowed the tape more and more to increase recording time on the cassette, sound quality has suffered accordingly.

Video tape itself was formulated to favor the needs of video over audio. The thin coating of high-density low-noise magnetic particles used on a quality audio cassette tape simply won't withstand the wear from high-speed VCR video heads, so more durable coatings are used.

Taking all this into consideration, the sound quality of today's VCRs is surprisingly good. For example, the linear tape speed of the Beta II format is under 0.8 inch per second (ips)—less than half that of a standard audio cassette (1.825 ips). That

makes a 10-kHz response as difficult to achieve as a 20-kHz response on an audio cassette deck. (Indeed, few audio decks can manage that.)

SP is the VHS format's fastest speed; yet, at 1.31 ips, it is still slower than an audio cassette. A good VHS recorder operated at SP is capable of a 12-kHz audio response. But when a VHS deck is switched to the LP mode, tape speed drops to 0.66 ips; in the EP mode, tape speed is 0.44 ips. Maximum possible bandwidth drops correspondingly; 5 kHz is about all you can expect in EP. The point is clear: If you want top quality sound, choose the fastest recording speed—SP for VHS and Beta II for Beta. You'll be able to record for over two hours if you use the longest tape available.

Recording at a faster speed also improves sound quality by reducing flutter. Typically, a VCR's flutter—particularly apparent on sustained notes—ranges between 0.2% and 0.5%. That high percentage is a result of the VCR's complicated tape path. The loading mechanism that withdraws the tape from the cassette and wraps it around the head drum uses a number of rotating posts to position the tape properly. Each post is a possible source of flutter, as is the drum itself. Also, there are three fixed heads along the tape path—the erase head, the control head (which supplies synchronization pulses), and the audio head. Each of these may be a source of so-called scrape flutter. In addition, the tape undergoes a constant pummeling from the rotating video heads, since they push *into* it in order to make good contact. The length of tape that is stretched along the path at any one time is over a foot, compared to the two

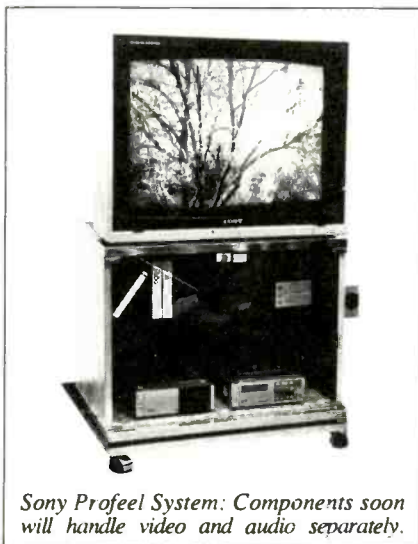

Sony Profeel System: Components soon will handle video and audio separately.

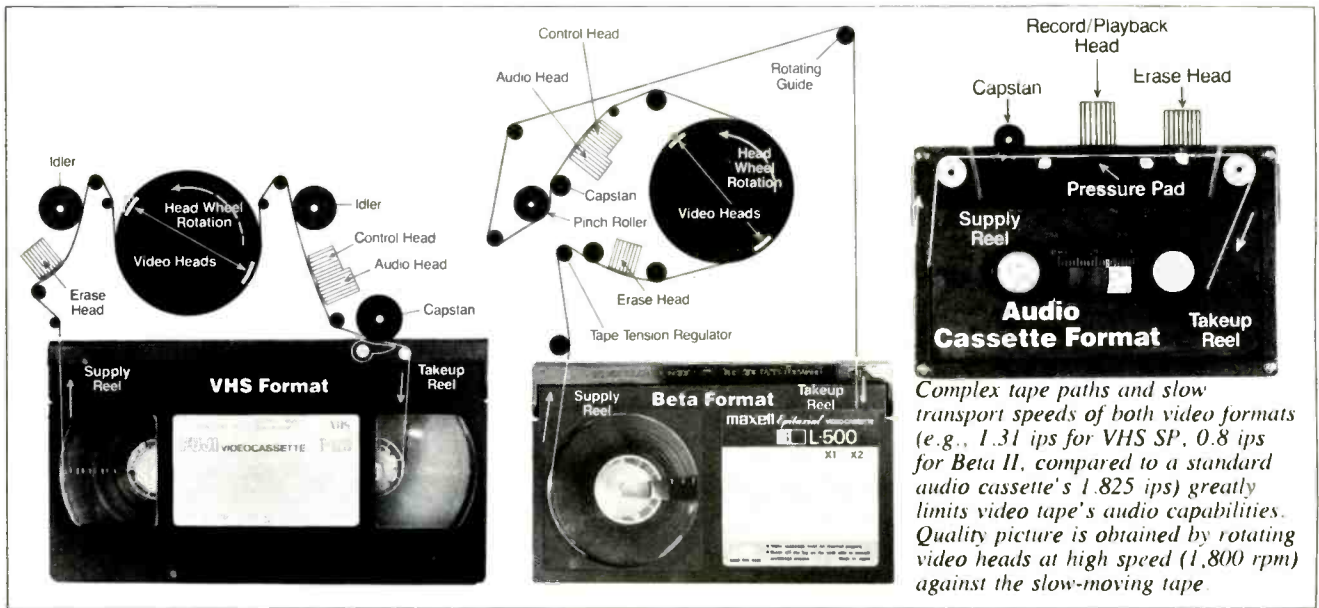

Complex tape paths and slow transport speeds of both video formats (e.g., 1.31 ips for VHS SP, 0.8 ips for Beta II, compared to a standard audio cassette's 1.825 ips) greatly limits video tape's audio capabilities. Quality picture is obtained by rotating video heads at high speed (1,800 rpm) against the slow-moving tape.

inches or so that travel through an audio cassette recorder's very simple path. The result is low tape-travel stability in a video deck, compared to an audio deck's high stability. For all of these reasons, VCR flutter can range from two to ten times that of a good audio cassette recorder.

Most audio cassette decks have manual level controls and recording-level indicators. Only very inexpensive or special purpose decks use automatic gain controls (AGCs). By contrast, VCRs—even the most costly—do use AGCs. These sense the average audio level, increase gain during quiet passages to keep the recorded level above the tape noise, and reduce gain during loud passages to prevent overload. Though excellent in theory, these circuits are less than foolproof in practice and are subject to a variety of sonic flaws depending on how the "average" signal level is chosen.

If the AGC responds too rapidly to abrupt changes in level, it tends to track low-frequency signals incorrectly, introducing substantial amounts of bass distortion. If the circuit attacks too slowly, it won't prevent tape overload on sudden transients. If it decays too slowly, a soft passage immediately following a loud one will start at too low a level (since the gain previously was reduced to prevent overload) and gradually—and very audibly—increase in level. While automatic level controls may handle voice recording reasonably well, I have yet to hear a deck with an AGC—and every VCR I'm aware of uses some type of automatic level circuit—that didn't make sonic nonsense out of music with a wide dynamic range, particularly classical.

The AGC can be most annoying when you are recording a program that contains a fair amount of residual noise. The circuit is supposed to increase gain during quiet passages without affecting perceived noise.

If you want top sound quality on your video tape, record at the highest speed.

But, if the program is hissy to begin with, the increased gain simply results in the hiss being recorded at a higher level, and the final tape is noisier than the original program. Also, the noise level surges up and down with program dynamics, lending a breathing quality to the proceedings.

The signal-to-noise level of a typical audio cassette recording is better than 60 dB below 0 VU. Most VCRs struggle to

achieve a 45 dB S/N ratio. So even with an ideal program source and a well-designed AGC, tape hiss will be very noticeable when you route a VCR's audio output through a quality stereo system for playback.

Most home audio cassette decks that cost \$100 or more have some form of noise-reduction system. Yet, to date, only two VCRs have such a circuit—Dolby B, in both cases. In fact, the audio portion of a video tape is so in need of improvement that almost anything would help. For example, an effective single-pass noise reduction system (e.g., one of the so-called dynamic noise filters) would be valuable for cleaning up television sound *before* recording (as well as for quieting video tapes recorded without any form of noise reduction). Such improvements would cost little; all the pop-
(Continued on page 42)

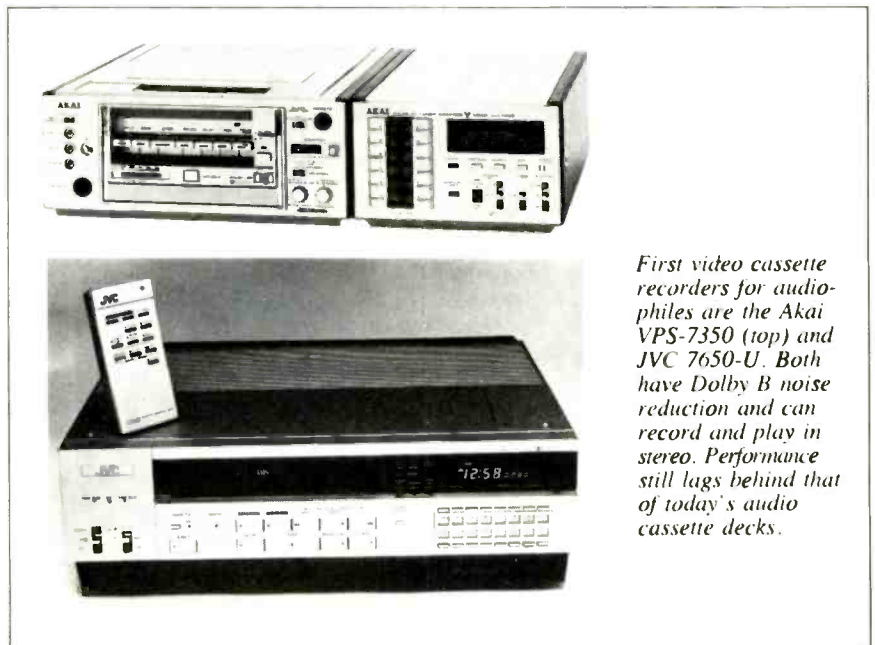

First video cassette recorders for audiophiles are the Akai VPS-7350 (top) and JVC 7650-U. Both have Dolby B noise reduction and can record and play in stereo. Performance still lags behind that of today's audio cassette decks.

TubeFood

Home Video and Pay Cable Highlights by Susan Elliott

Video Cassettes

CONTEMPORARY FILMS

- **Media Home Entertainment:** *Day of the Animals; The Dark; The Force Beyond: Kill and Kill Again.*
 - **MGM/CBS Home Video:** *Viva Las Vegas; Tarzan the Ape Man; Westworld.*
 - **MGM/CBS (rental only):** *Rich and Famous; All the Marbles; Whose Life Is It Anyway?*
 - **Paramount Home Video:** *Gallipoli; Mahogany; Time Bandits; Hud; Bang the Drum Slowly.*
 - **Thorn/EMI Video Programming:** *Time Bandits; Lord of the Rings; Times Square; Honky Tonk Freeway; King Kong (1976); The Valachi Papers; Heartland; The Mirror Crack'd; Two-Way Stretch.*
 - **Twentieth Century-Fox Video:** *French Lieutenant's Woman; On Golden Pond; Escape from New York; Lenny; Everything You Always Wanted to Know About Sex but Were Afraid to Ask; Return of the Pink Panther; Public Enemy; Juggernaut; Griffin and Phoenix; Return of a Man Called Horse.*
 - **Twentieth Century-Fox (rental only):** *Modern Problems; Taps.*
 - **Vestron Video:** *Loving Couples; Good Guys Wear Black; Joe; My Brilliant Career; The Changeling; Picnic at Hanging Rock; Madame Rosa; La Grande Bourgeoise; Tribute.*
 - **Video Communications, Inc.:** *Sacco and Vanzetti; Getting Wasted; Encounter with Disaster.*
 - **Video Gems:** *Kung-Fu Commandos.*
 - **Warner Home Video:** *The Late Show; Look Back in Anger; Agatha; The Last of Sheila; Portnoy's Complaint; McCabe and Mrs. Miller; Night Moves; Ode to Billy Joe.*
 - **Warner (rental only):** *Arthur.*
- ### FILM CLASSICS
- **MGM/CBS:** *Pride and Prejudice; The Band Wagon; Kismet; The Prisoner of Zenda; Early Days; At the Circus; The Good Earth.*
 - **Nostalgia Merchant:** *Rock, Rock, Rock (Chuck Berry and Frankie Lyman); Shall We Dance (Astaire/Rogers); Stage Door; Kitty Foyle; Black Beauty; Courage of Black Beauty; Son of Monte Cristo.*
 - **Thorn/EMI:** *Dead of Night.*
 - **Twentieth Century-Fox:** *Salute to Marilyn Monroe; Bus Stop; Some Like It Hot; The Seven-Year Itch; How to Marry a Millionaire; The Misfits; There's No Business like Show Business; Gentlemen Prefer Blondes.*
 - **Vestron Video:** *Go Tell the Spartans; And God Created Woman.*

- **VidAmerica:** *Under Capricorn.*
 - **Video Gems:** *Commandos; Who Killed Mary What's 'Er Name?*
 - **Warner:** *Splendor in the Grass.*
- ### TV CLASSICS/DOCUMENTARIES
- **MGM/CBS:** *Picasso, a Painter's Diary; Sybil.*
 - **Nostalgia Merchant:** *Laurel & Hardy Comedy Classics, No. 8; Pardon Us (Laurel & Hardy); I Remember Mama.*
 - **Thorn/EMI:** *The Death of Adolf Hitler.*
 - **Vestron Video:** *Comedy Tonight (HBO—Andy Kaufman, Robin Williams, more).*
- ### ARTS PROGRAMMING
- **Dubs Video:** *Coppelia (American Ballet Theater); Erick Friedman Plays Fritz Kreisler; The Rime of the Ancient Mariner (animated, narration by Sir Michael Redgrave).*
 - **Mastervision:** *Degas, Erté, and Chagall.*
- ### THEATER/STAGE SHOWS
- **MGM/CBS:** *Concert in Central Park (Simon and Garfunkel).*
 - **Vestron Video:** *Richard Pryor—Live in Concert.*
- ### CHILDREN'S PROGRAMMING
- **Family Home Entertainment:** *Gunby, Vols. 1 and 2; Captain Nemo, Vols. 1 and 2.*
 - **MGM/CBS:** *Miss Peach of the Kelly School.*
 - **Video Gems:** *Boy of Two Worlds.*
 - **Walt Disney Home Video (rental only):** *Watcher in the Woods.*
 - **Warner:** *The Looney, Looney Bugs Bunny Movie.*
- ### NEW ON PAY CABLE
- **The Movie Channel:** *Stripes; Blow Out; Atlantic City; Continental Divide; Zorro, the Gay Blade; The Story of Adele H; Chu Chu and the Philly Flash; Silence of the North; The Survivor; Gal Young Un; Going Ape!; Little Dragons; Loose Shoes; Darby O'Gill and the Little People; Night School; Final Cut; Last Days of Man on Earth; Dead Man's Float; Which Way Is Up?; The Other Side of the Mountain, Part 2.*
 - **Home Box Office:** *Continental Divide; Stripes; Blow Out.*
 - **Showtime:** *Atlantic City; Continental Divide; Stripes; Blow Out; Chu Chu and the Philly Flash; The Hearse; The Return of the Secaucus Seven; Graduation Day; Zorro, the Gay Blade; The Dogs of War; Skatetown, U.S.A.; The Stunt Man; The Silver Streak; I Sent a Letter to My Love; 8½; Far from the Madding Crowd. Broadway on Showtime: Footlight Frenzy.*

DIRECT HOT LINE

1-800-327-0896 Ext. 2

FOR PRICES ON SONY, JVC, PANASONIC, RCA & other famous Mfgs.

COLOR TV'S

SONY COLOR TV'S		SONY RV-1913-19 19" screen \$ 469
SONY RV-4000 20" screen \$ 449	SONY RV-1948-19 19" screen \$ 389	SONY RV-1949RS 19" screen \$ 449
SONY RV-1217 17" screen \$ 449	SONY RV-2145RS 21" screen \$ 739	SONY RV-2602 26" screen \$ 795
SONY RV-1221R-12 22" screen \$ 410	SONY RV-2647RS 26" screen \$ 995	SONY RV-2648RS 26" screen \$ 1350
SONY RV-1515 15" screen \$ 519	SONY RV-2649RS 26" screen \$ 995	
SONY RV-1744B 17" screen \$ 529		

BIG SCREEN TV'S

RCA PFR-100 100" screen \$1999	SONY KP-5020 50" screen \$2195
PANASONIC CT-4500 45" screen \$2495	SONY KP-7220 72" screen \$2595
MITSUBISHI S200 200" screen \$3395	SONY KP-5040 50" screen \$2995
MITSUBISHI S200JD 200" screen \$3895	ADVENT VB-125 125" screen \$2295
QUASAR VR-4800 48" screen \$2795	ADVENT VB-225 225" screen \$2295

We also carry the complete lines of PANASONIC, JVC, RCA, SANYO & HITACHI. Call 1-800-327-0896 for lowest prices.

HOME VIDEO RECORDERS

SONY SL-5000 Betamax \$ 649	PANASONIC PV-1770 VHS Recorder \$ 899
SONY SL-2500 Betamax \$ 1119	SANYO VT-4200 Base Recorder \$ 499
SONY SL-3600 Betamax \$ 1809	RCA VE1-200 VHS Recorder \$ 599
JVC HR-7660U VHS Recorder \$ 1119	RCA VFS-250 VHS Recorder \$ 719
JVC HR-7300 VHS Recorder \$ 1079	RCA VFS-6600 Hi-Fi VHS Recorder \$ 899
PANASONIC PV-1275 VHS Recorder \$ 589	QUASAR 5010 Hi-Fi VHS Recorder \$ 1099
PANASONIC PV-1370 VHS Recorder \$ 749	QUASAR VR-730 Color Camera \$ 799
PANASONIC PV-1470 VHS Recorder \$ 849	QUASAR 5310 VHS Recorder \$ 879
	QUASAR 5810 Hi-Fi VHS Recorder \$ 899

VIDEO CAMERAS

SONY DVC-2200 Betamax Camcorder \$ 979	HITACHI VSC-800 Auto Focus \$ 995
PANASONIC PK-751 6 1/8" lens camcorder \$ 1049	HITACHI GPD-4 Color Camera \$ 575
PANASONIC PK-801 6 1/8" lens camcorder \$ 1779	RCA C0010 Color Camera \$ 649
PANASONIC PK-700 1/2" lens camcorder \$ 975	RCA C0011 Color Camera \$ 595
JVC GR-84U Color Camcorder \$ 599	QUASAR VR-730 Color Camera \$ 649
JVC GR-16 1/2" lens camcorder \$ 675	QUASAR VR-731 Color Camera \$ 699
PANASONIC PK-802 Color Camera \$ 999	PANASONIC PK-802 Color Camera \$ 899

We also have available a complete line of industrial cameras.

PORTABLE VIDEO RECORDERS

SONY SL-2600 Betamax \$ 849	RCA VGR-170 VHS + Tuner \$ 1095
SONY TT-2000 Tuner/Timer \$ 799	RCA VFS-170 VHS + Tuner \$ 865
PANASONIC PV-5110 VHS Recorder \$ 799	ZENITH VR-8800 VHS + Tuner \$ 1049
PANASONIC PV-5200 VHS Recorder \$ 895	QUASAR VR-8410 VHS Recorder \$ 995
PANASONIC PV-5600 VHS Recorder \$ 989	QUASAR VR-530 Tuner/Timer \$ 349
HITACHI VT-6600A VHS + Tuner \$ 995	SANYO VTR + Tuner \$ 795

VIDEO TAPES

CAR STEREOS

We carry video tapes by SONY, FUJI, JVC, MAXELL, MEMOREX, RCA, PANASONIC, SCOTCH & TON.

Any L-500 \$10.50 Any L-750 \$12.95 Any L-830 \$14.95 Any T-120 \$12.95

The complete line of SONY SANYO & BLAUPUNKT are available. Call for lowest prices.

SPECIALS

ATARI CX-2600 Computer game \$45	SONY Walkman I \$69
Mini-cass. available from \$13.95	SONY SR-400 FM Walkman \$69
SONY WALKMAN II \$99	JVC PC-SJW Port. Stereo System \$325

We also carry PANASONIC, AKAI, SHARP, BLAUPUNKT, HITACHI, ATARI, SANYO, FUJI, BRAUN, JVC, ADVENT, and much more.

For more information send for a free catalog and enclose \$2.00 for postage and handling. Order by phone or by mail, send money or certified check. Two week delay on personal checks, when paying by charge include card number and expiration date. Shipping charges will be added on to credit card. Not responsible for typographical errors. Prices subject to change.

International Wholesalers

OF MIAMI, INC.

17866 IPCO ROAD • (N.E. 5th AVE.)
MIAMI, FL 33162

For FREE 192 pg. catalog send \$2.00 for postage and handling Ext. 3

Name _____

Address _____

Circle 34 on Reader-Service Card

Listen to television on your stereo.



IN SIMULATED STEREO!

TELEDAPTER® easily connects to any TV and plugs into the Aux., Tape, or Tuner input of any stereo amplifier. (TV and stereo can be any distance apart.) All TV programs will come through your stereo amplifier and speakers, even Video Tape, or Cable TV shows. Quality electronic circuitry assures correct 10 to 50,000 OHM impedance matching, for full 50 to 15,000 HZ frequency response. The matrix circuitry actually provides two channels of simulated stereo. Total chassis isolation means protection for both your stereo and TV. TELEDAPTER® is also great for using stereo headphones and taping TV programs. Complete with instructions, and TWO YEAR WARRANTY. 15 day trial or money back if dissatisfied.

The TE-200 Teledapter

--- only \$39.95 Plus \$3.00 Shipping and Handling

To order: Call toll free
1-800-251-8608 24 hours
or enclose check or

Master Card VISA

Card # _____

Expiration date _____

Name _____

Address _____

City _____ State _____ Zip _____

SEND FREE CATALOG

Circle 35 on Reader-Service Card

RHODES

NATIONAL CORPORATION
P.O. Box 1052 Dept.
Columbia, TN 38401
(615) 381-9001

VIDEO SOUND

(Continued from page 40)

ular noise reduction designs are now on integrated-circuit (IC) chips, and they require few extra components to become operational. If consumers would be more adamant in their demands for better VCR sound, manufacturers would undoubtedly respond.

The dismal picture of video audio brightens considerably when we consider the disc medium. The VCR was conceived as a video recorder. Since broadcast television with stereo sound didn't exist at the time the VCR was developed, there was little point in designing a recorder with stereo capability. The video disc, on the other hand, was conceived for playback only. So, on two of the three disc systems—the laser optical type and JVC's capacitive-sensing VHD approach—stereo sound is the rule. Only RCA's CED system lacks the second channel, a condition that will be remedied in the company's next-generation player.

Technically, the most practical way to carry any audio information on a video disc is to piggyback it on the video track. Since the video must yield some of its territory to audio, it made sense to set aside sufficient space for quality, two-channel audio. In addition, the idea of audio noise reduction came early to the video disc; both RCA and Pioneer have decided to CX-encode the audio on their software, using virtually the same system that CBS devised for conven-

tional phonograph records.

Many factors suggest that the quality of VCR audio will improve substantially. Consider the rapid progress of audio cassette decks; it was not that many years ago that they were at the performance level of today's VCRs. The Electronics Industry Association (EIA) presently is conducting tests of stereo TV sound in this country. Each of the proposed formats uses a noise reduction system—variations on Dolby, DBX, and CBS technology. Broadcast TV with stereo sound (which already exists in Japan and Europe) will soon be a reality in the U.S. At that point, the demand for—and logic of—'stereo VCRs' will be substantial. Akai was the first to introduce a stereo VCR (VPS-7350) in this country, and the unit also has Dolby B noise reduction circuitry. JVC recently introduced a similar model (7650-U). Can the others be far behind?

Finally, the move toward TV separates, or so-called component TV, bodes well for audio. The TV monitor will soon be just one part—video playback—of an entire home entertainment system. Once consumers come to understand this, once they become accustomed to playing back all audio through their stereo systems, the low power amplifier and miniature speaker will no longer be an acceptable alternative. Add programming broadcast with stereo sound, and quality audio seems just around the video bend.

HF

Moving?

Be sure and send us your new address 8 weeks before you move so you won't miss any copies of HIGH FIDELITY.

And please include an old mailing label from our magazine when writing us about your subscription.

Write to:

HIGH FIDELITY,
P.O. Box 10759, Des Moines, Iowa 50340

Change of address.

Enter new subscription. 1 yr. \$13.95

payment enclosed bill me

Add'l postage: \$3 per year outside U.S., its poss.

AFFIX LABEL

If you have no label handy, print OLD address here

name _____ please print

address _____

city _____

state _____

zip code _____

New Address

name _____

please print

address _____

city _____

state _____

zip-code _____

Video Q.&A.

by Edward J. Foster

Q. I have a Beta-format VCR, and I'm interested in getting a video camera and a portable recorder (probably without a tuner/timer) to make my own tapes. Can I use any camera, or do I have to get a Beta-format one to match the VCR?—S. Y. Chang, Napierville, Ill.

A. Such a camera does not exist! VCR formats—Beta and VHS—are defined by the particular speeds, tape paths, and track layouts used in recording; they have no relation to the camera used to make the recording. However, your portable recorder will have to be a Beta unit, and it is important that the camera's scanning pattern and color circuitry be compatible with

the recorder and television set that you use. The camera must, for example, generate a standard NTSC signal. And its cable and power connections must match (or be adaptable to) those on your portable video cassette recorder.

If you wish to operate the camera in the field, you may need a battery pack. Naturally, your portable recorder requires power, too, and rather than lugging two heavy batteries around, it's easier to power both units from a single source. For this very practical reason, you're probably better off sticking with a camera that's designed specifically to work with your portable machine.

The final point of compatibility between the camera and the recorder involves matching up audio and video signal levels and impedances. Again, you're certain of compatibility if you stay with a camera that's designed for use with your deck, which would mean that they'd both have to be from the same manufacturer. On the other hand, if you check the specs carefully enough, you can probably match a camera of one brand with a VCR of another without a problem.

In a nutshell, though it isn't essential, you're always safe if you buy the recorder and camera as a one-brand package.

Here's how we kiss the hiss goodbye.

BASF Chrome. The world's quietest tape.

With BASF Chrome, you hear only what you want to hear — because we "kissed the hiss goodbye."

In fact, among all high bias tapes on the market today, only PRO II combines the world's lowest background noise with outstanding sensitivity in the critical high frequency range for superior dynamic range (signal-to-noise ratio).

PRO II is unlike any other tape because it's made like no other tape.

While ordinary high bias tapes are

Magnified
15,000 X

Perfectly shaped and uniformly sized particles of pure chromium dioxide provide a magnetic medium like no other tape in the world.

made from modified particles of ferric oxide, only PRO II is made of pure chromium dioxide. These perfectly shaped and uniformly sized particles provide a magnetic medium that's truly superior — so superior that PRO II was chosen by Mobile Fidelity Sound Lab for their Original Master Recording™ High Fidelity Cassettes — the finest prerecorded cassettes in the world.

PRO II — a tape so superior, a cassette so reliable, that it was the one chosen by Mobile Fidelity Sound Lab for their Original Master Recording™ High Fidelity Cassettes.

For the best recordings you'll ever make.



BASF

Audio/Video Tapes

Circle 16 on Reader-Service Card

And like all BASF tapes, PRO II comes encased in our new ultra-precision cassette shell that provides perfect alignment, smooth, even

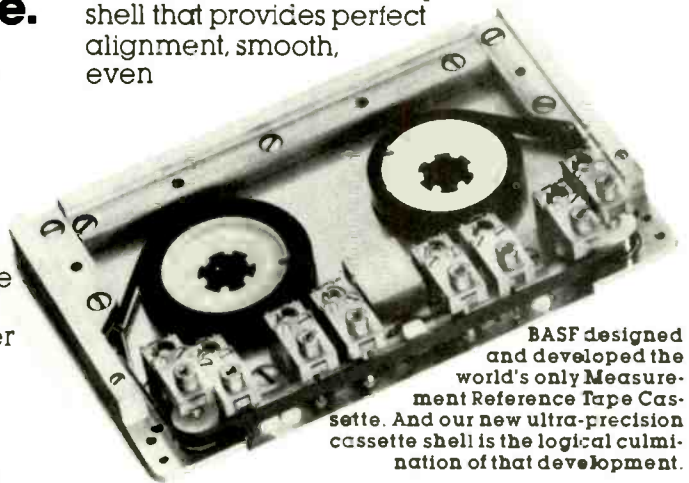

BASF designed and developed the world's only Measurement Reference Tape Cassette. And our new ultra-precision cassette shell is the logical culmination of that development.

tape movement, and consistent high fidelity reproduction.

So when you want to hear all of the music and none of the tape, turn on to BASF Chrome. It's the one tape that kissed the hiss goodbye.



Behind the Scenes

Music news and commentary by James R. Oestreich

Stravinsky's 100th



Igor Stravinsky, by Pablo Picasso

It's an editor's dream to come upon the Stravinsky centenary with writers like Jeremy Noble and David Hamilton. Any tribute I pay Noble necessarily pales alongside that of the *New Grove Dictionary*, where he was invited to contribute the entry on editor Stanley Sadie. Noble also collaborated with Eric Walter White on *Grove's* Stravinsky entry, providing the discussion of the works. There was never any question that we'd include him in our Stravinsky observance; we only wondered whether, having survived the rigors of last year's Bartók discography (March and May 1981), he would again disrupt his academic schedule. Happily, he did.

More Hamilton

Hamilton, of course, is a more regular contributor to these pages—though not nearly as regular as we'd like these days, due to the press of his various activities and the extraordinary amount of preparation that went into this month's article. One of the products of those other activities has just appeared: a volume in a "Listener's Guide" series published by Facts on File, *Great Instrumentalists* (136 + iii pp., \$11.95). It centers around twenty-five recordings (but discusses many more) dating from before and just after World War II, selected not only for the quality of their playing, but for the understanding they give of the century's earlier performance styles.

The chapter on "Strings," for example, discusses interpretations by Kreisler, Szigeti, Heifetz, Menuhin, Primrose, and Casals; there are other chapters on "Keyboards," "Winds and Brass," and "Chamber Music."

Hamilton's valuable introduction analyzes "The Art of the Instrumentalist" and, particularly in a section on composers' recordings, sounds many of the same themes developed in his article: "A sensible attitude toward composer performances would be one of respectful attention rather than abject submission; even the finest . . . represent only one of many potential ways to play a piece, not a dogmatic assertion of a 'right' way. And the same is true for recordings by performers closely associated with the composer, or those who took part in the first performance. . . . I have attended enough first performances during the last several decades to know that first is rarely best, and is sometimes worst—or so the suffering composer must devoutly hope."

Though the book is "addressed principally to beginning collectors" and will doubtless be of vast benefit to them, it also offers much to the grizzled veteran. As so often, there is more useful information in Hamilton's parenthetical asides alone than in many another entire treatise. And the analyses are particularly rewarding for their clear statement of the considerations that go into informed criticism at its best. (A gemlin has had at the index, however. The key: Subtract four, and you'll be close.)

In the same series, Christopher Headington's *Chamber Music* (138 pp., \$11.95) is, as its title implies, more wide-ranging. (But what—no Boccherini?) Not surprisingly, therefore, it is more generalized and diffuse. Yet it is also repetitious, littered with inaccuracies, and poorly edited: "The C major Quintet (K. 515) has an Andante that reminds us that Mozart himself played the viola, and owes its extra melodic richness in the alto register to the texture that the two violins [!] create"; "the Beaux Arts Trio and their associates have the same kind of unsentimental warmth [in Schumann] . . . , and the pianist Samuel Rhodes [!] does not try to hog the lime-light. . . ." And many of Headington's selections, insufficiently explained or defended, seem merely arbitrary (an evidently undead horse, though I probably flogged it adequately last month). Still, there are occasional insights and fresh slants. Balancing tragedies, for instance, Headington

notes that Beethoven faced deafness at an age Schubert never even saw.

Still More Stokie

For the 1982 WQXR radiothon, the New York Philharmonic has pulled together its second two-disc volume of historic live recordings, a splendid celebration of the Stokowski centenary. The extraordinarily interesting program features three Bach-Stokowski chorale-preludes (1947-49); Handel's Concerto, Op. 4, No. 6, with a thoroughly willful, thoroughly delightful solo performance by harpsichordist Wanda Landowska (1949); Falla's *Nights in the Gardens of Spain*, with pianist William Kapell (1949, previously released on LP); three movements from Thomson's *Mother of Us All* Suite (1950); and a gripping performance of Prokofiev's Sixth Symphony (1949). The sound is always listenable and often good, though a ghostly voice intrudes unintelligibly through much of the Thomson. Some applause is kept, and the outburst following the Prokofiev seems particularly appropriate; what does not, at least to these humorless ears, is the "encore" that follows—a 1949 rendition of Hupfeld's "When Yuba Plays the Rhumba on the Tuba Down in Cuba," sung and played by William Bell. Rhumba humbug! The set (821/2) is available for \$20 from the New York Philharmonic Society, 132 W. 65th St., New York, N.Y. 10023.

Two of the Dell'Arte Stokowski reissues discussed in April are now available in the U.S., distributed by Fonodisc International (535 E. 86th St., New York, N.Y. 10028): the Bach (DA 9001) and Mussorgsky (DA 9002). Three new Dell'Arte releases have also appeared, including two more by Stokowski, licensed from RCA: the 1954 Sibelius Second with the NBC Symphony (DA 9004) and a coupling of Stravinsky recordings recently reissued by the Philadelphia Orchestra and discussed last month, the 1927 *Firebird* Suite and 1927-29 *Sacre* (DA 9005). The first non-Stokowski disc offers 1938 performances by Toscanini and the Hague Philharmonic, licensed from Dutch Radio: Cherubini's *Anacréon* Overture, Debussy's *L'Après-midi*, Dukas's *Sorcerer's Apprentice*, and Haydn's Symphony No. 101 (DA 9007).

"From Sweden to America," an album noted last December, is now distributed by Nor-Disc, 2242 Lawton Dr., Lemon Grove, Calif. 92045. **HF**

Three Cheers for Stravinsky (One-and-a-Half for the Record Companies)

The laws of supply and demand make us all the poorer in depriving us of Stravinsky's significant lesser-known works.

by Jeremy Noble



COURTESY CBS MASTERWORKS

the fact that *The Nightingale*, begun just before *Firebird* and completed just after *The Rite of Spring*, has been recorded only twice, in French under André Cluytens in the 1950s, and by Stravinsky himself in the original Russian not until 1960? There's surely nothing in the work's own mélange of styles to frighten anyone away. On the contrary, both the limpid Debussy-esque serenity of the opening scene and the fantastical chinoiserie of the imperial court ought, one would think, to be equally attractive to audiences—as indeed they proved to be at the Met last year. Yet the fact remains that until the arrival of the huge "Legacy" package reviewed by David Hamilton elsewhere in this issue, even Stravinsky's own recording had been out of the catalog for some time (CBS having inexplicably missed the opportunity to bring it back at the time of the Met production).

One explanation that I used to hear offered for the continuing public demand for *Firebird*, *Petrushka*, and *The Rite of Spring*, and the relative unpopularity of later pieces, was that Stravinsky, poor fellow, had cut himself off from his roots when he abandoned an overtly Russian musical idiom; like Antaeus, no doubt, he was supposed to get his strength from Mother Earth. But if that were true, it would hardly explain why neither *The Wedding nor Renard*, both as Russian as they come, has ever begun to rival *Petrushka* or *The Rite of Spring* with the wider public. Too Russian, perhaps? Well, maybe—but I am inclined to think that this whole method of gauging

public demand contains an inbuilt distortion. Of course people tend to like what they are familiar with, but what they can become familiar with may in turn be dictated, or at least influenced, by what the concert-giving organizations and, following them, the record companies find it convenient to give them. Supply and demand become interlocked in a vicious circle with convenience at its center—and what is convenient, alas, is what fits the conventional norms.

So much the worse for Stravinsky. For him every new work was a specific response to a specific stimulus, one that set its own norms of structure and procedure, not least in terms of instrumentation. Even when it was a matter of writing for string orchestra, as in *Apollo*, he was not content simply to take over the standard disposition of the symphony orchestra's string section but specified insistently that there be enough cellos to allow for a continuous six-part texture, with cellos and basses reflecting the layout of violins and violas. Inflated as the orchestra may be for the early Diaghilev ballets, particularly *The Rite of Spring*, it fits the framework of conventional concert-giving a good deal more comfortably than the miscellaneous vocal forces plus four pianos and percussion of *The Wedding*, let alone the miniature ensemble (complete with cimbalom) required for *Renard*. These works are inconvenient to put on (particularly in the theater, where they belong); they're given rarely; they remain unfamiliar, and so, even when they

NAIVE AS IT MAY SEEM, I have never quite managed to stop being surprised at the enormous discrepancy in popularity between the handful of Stravinsky's works that everyone knows and others that seem no less attractive or accessible yet remain relatively little played and recorded.

The most extreme case, of course, is still that of the three early ballets. You have only to look at the listings in SCHWANN to see how disproportionately they predominate among the recordings currently available, and presumably this must reflect something about public taste, if the laws of supply and demand are working as they are supposed to. But can it be only a matter of taste? How, for instance, can one explain

become available on records, they're in relatively small demand. Or take *Persephone*, one of the most substantial and impressive of all Stravinsky's middle-period works. How many ballet companies have been put off tackling it by the fact that in addition to a corps de ballet it calls for a first-rate tenor soloist, a chorus (including both women and boys), and a diseuse who can dance or alternatively a danseuse who can dise? And all this for a work that lasts barely an hour! No wonder *Persephone* is a work that we rarely hear in theater or concert hall, and that it has, as a consequence, been recorded only three times in its near half-century of existence.

It begins to sound as though I were blaming the record companies for the public's uneven response to Stravinsky's huge and diverse output, yet this would clearly be nonsensical—as well as ungrateful—since those of us who know and love his music owe an immense debt to recordings. As with most of my generation, I suspect, my own first exposure to Stravinsky's music came in the context of Disney's *Fantasia*, but kids are tough, and although even now faint after-images of *tyrannosaurus rex* impinge on my experience of the "Glorification of the Chosen One," it seems to have done me little lasting harm. In any case, I confess that the records I bought under the immediate impact of *Fantasia* were the Bach-Stokowski Toccata and Fugue, Tchaikovsky's *Nutcracker*, and Beethoven's *Pastoral*; even at the age of ten I drew the line at the "Dance of the Hours."

Wartime England was not the best place to make the acquaintance of Stravinsky's music, either in a London whose concert life had been virtually closed down by blitz and blackout, or in the remote Lake District fastness to which my school was evacuated. Yet it was there, in a bookshop in Kendal, that I came across Edwin Evans' little "Musical Pilgrim" volume on *The Firebird* and *Petrushka*; that and Romola Nijinsky's book about her husband (somewhat hazily understood) drove me to ask for the records for my next birthday. Back in London *The Rite of Spring* soon followed when I discovered in a neighboring suburb (Stevie Smith's Palmers Green, as it happens, though I didn't know it was hers at the time) a rather down-at-heels record shop that still had a number of prewar pressings on its distinctly unglamorous shelves—things that had sat there since they were first issued, I suspect. Looking back, I can't help wondering what other treasures I might have found, if I had known what to look for; still, there was the old Paris recording of the *Symphony of Psalms*, in plain cardboard covers for all the world as if they thought it might deprave or corrupt, and that too joined my infant collection.

In later years I was to come across musicians of an older generation who rather sniffed at the idea of getting to know music

What we need is a good, cheap collected edition.

through records: The implication was that you should either play it yourself or at the very least experience a live performance first. But one has to start from where one is. Live performances of Stravinsky's later music were pretty scarce during my wartime and immediately postwar adolescence, and I couldn't have performed any very useful role in them myself, even though I spent hours hacking my way through the scores at the piano. Yet the fact that I was getting much of my knowledge of Stravinsky's music through the not very high fidelity equipment of those days did nothing to weaken its impact on me, and I had ample cause to bless the composer's determination, from the earliest years, to record his own intentions with the most advanced techniques available to him.

That debt of gratitude was more than redoubled during my first visit to the United States, in 1958–59. Suddenly there was a chance to supplement those treasured Columbia blue-label 78s with the LPs that Stravinsky had been making in America, but which had not yet been released in England (though some of them were to come out later on the Philips label during a brief alliance between that company and CBS). New York's more comprehensive record stores were my happy hunting ground for days, while I tracked down such things as the Cleveland versions of *Pulcinella*, *The Fairy's Kiss*, and the *Symphony in C*, not to mention such then new works as the *Cantata*, the *Septet*, *In Memoriam Dylan Thomas*, the *Canticum sacrum*, and *Agon*, which charted Stravinsky's annexation of serial territory. True, I had already heard most of these pieces in London by this time, but here at last was the opportunity to get to know them thoroughly, in performances as nearly definitive as individual performances can be. What a privilege, not only to be able to explore a favorite composer's past output, but to be introduced, work by work, to his newest music!

Yes, I have good reason to be grateful to the record companies for the access they gave me to Stravinsky's music—and not only CBS, though it naturally takes pride of place. Decca/London's lengthy Ansermet series, Philips' recordings with Colin Davis, Mercury's with Dorati (Dorati's *Firebird* gave me my first introduction to the complete score, as opposed to the various suites)—all of them contributed to that continuous experience of the music which, while it is no substitute for the occasional blazing live performance, is an indispens-

able preparation for it.

So why does the nagging feeling of dissatisfaction persist? Should I not be blaming the record-buying public for failing to buy as many copies of *The Wedding and Threni* as they do of *Petrushka* and the *Symphony of Psalms*? To some extent, yes. The majority of record buyers are astonishingly unadventurous and incurious, and perhaps the more so in this country because there is so little state-supported risk-taking in public performance to lead the way. But although I would certainly urge adventurousness on record buyers, I would also like to urge a bit more imagination and, yes, responsibility on the companies that are supposed to cater to their needs. If I succeed in persuading someone that he will relish the wit and lyricism of *The Fairy's Kiss* or the grave melancholy of *Orpheus* (neither of which has been in the catalogs recently), is it reasonable to expect him to invest in an immense thirty-one-record set? To me that smacks less of memorial than of tombstone, however glamorously packaged. And if I am to make a case for the less familiar works, I shall certainly want the aid of the best recorded version, which by no means always means the most recent. It is exciting to see a student's eyes light up at the vividness of one of those Cleveland performances of the early 1950s, or the Cologne recording of the *Symphonies of Wind Instruments* (the only one Stravinsky himself ever conducted), but disappointing when one has to add, "Of course, it hasn't been available in years."

So while I am glad of the opportunity to raise three cheers for Stravinsky in his centenary year, and to put on record the continuing delight his music has given me for the past four decades, I find I can muster only about one cheer and a half for the way in which the record companies most closely associated with that music have so far celebrated the occasion. What we need—and by "we" I mean the younger generation of music lovers rather than middle-aged figures like myself who have had an opportunity to amass a collection over the years—is a *cheap* collected edition, selected from the very best recorded performances from every period of Stravinsky's long life, and flexibly packaged so as to tempt each of us to acquire (or replace) just those things we need. Is that too much to expect of a free-enterprise system in which competition is supposed to stimulate imagination? I suppose it is, so the most constructive thing I can do is to urge anyone who is about to buy his nineteenth *Rite of Spring*, or even his second, to try another work first. *The Wedding* or the *Symphony in Three Movements* will give your record player almost as good a workout, if that's what you're after, and who knows, you may find that Stravinsky is worth getting to know, patiently, bit by bit, in all his moods and styles. Try it, and show the record companies they have something to gain by not underestimating you! **HF**

The Masters' Voices



How "definitive" are a composer's own performances? CBS's Stravinsky set and Hungaroton's Bartók provide partial answers, with disparate results.
by David Hamilton

EVER SINCE 1889, when Johannes Brahms played one of his *Hungarian Dances* onto a now substantially undecipherable Edison cylinder, composers have been performing their works for recordings. Despite frequent pious platitudes, the record companies have not encouraged this principally for the sake of posterity; by definition, posterity takes a generation or more to pay its bills, and even in the long-gone days of single-digit interest rates, record companies didn't plan to wait that long. No, they recorded composers because they hoped to sell records immediately, on the strength of the promise of authority implicit in the dual function.

However, posterity inevitably does come around the corner, and transforms objects of commerce into documents of historical evidence. All records document something, of course, but composers' recordings have always been regarded as a category of special interest, quite distinct from that reserved for "unforgettable performances"—though naturally some composers' recordings (e.g., Rachmaninoff's) inhabit both categories at once.

The reasons for according composers special status among interpreters are not as simple as they seem at first glance: only the

naive believe that the guy who wrote the piece necessarily plays it better than anybody else—and there is no shortage of composers who clearly do not play very well at all, period. Even when, as in the case of Rachmaninoff, a composer is clearly one of the sovereign performers of the day, he may himself make clear (as Rachmaninoff did in the case of the young Horowitz) his approval of an alternative interpretation—and if one alternative is permissible, then surely others (though not necessarily *all* others!).

But then the whole idea of a single "best" or "definitive" performance is a modern one, which would have made little sense before the introduction of the phonograph: before Edison, all performances were perforce ephemeral, including the composer's. Indeed, for music to continue in the active repertory long after its composer's death was itself a relatively new phenomenon; one wonders if the difficulties encountered by performers in coping with music of earlier times and styles may not have encouraged the tendency of composers, in the nineteenth and early twentieth centuries, to make their scores ever more precise and detailed (though there were

compositional reasons for this as well). Once performances themselves could be made durable, the idea that a composer might leave behind "touchstone" performances of his works must soon have occurred to someone—a performance that would be, by fiat, "best."

The composer who most eagerly embraced this possibility was Igor Stravinsky. In fact, before the introduction of electrical recording made reasonable facsimiles of his music possible on discs, he spent untold hours transcribing his works for pianola, hoping thus to fix for posterity "the relationships of the movements (*tempi*) and the nuances in accordance with my wishes . . . to create a lasting document which would be of service to those executants who would rather know and follow my intentions than stray into irresponsible interpretations of my musical text." (Given the importance in Stravinsky's music of instrumental articulation, inevitably altered drastically in the pianola transcriptions, one remains amazed at the importance he accorded this project, which, even financially, can hardly have justified the effort. Still, it would be fascinating to hear some of the Pleyel rolls,

which have been entirely neglected on records.)

Behind this remarkable attempt to annex territory previously occupied by performers is Stravinsky's view of the performer's role in his music, which, he often insisted, "should be transmitted and not interpreted." This was not, one imagines, an entirely egocentric insistence, for Stravinsky's new music, from *Petrushka* on, involved such novel priorities among the musical elements that the kinds of "interpretation" then espoused (and effectively, in earlier contexts) by his Western European contemporaries could have had only damaging effects. A musical discourse founded on irregular metrical grouping will not make sense unless the tempo remains quite steady, a neutral background against which the shifting metrical patterns can be perceived. Passages that develop by cumulative rotation and variation of small melodic cells will positively not benefit from the kind of subtle, freely expressive accenting that was used to enliven without obscuring the basically symmetrical melodies of an earlier period.

Furthermore, since the rhythmic complexities of Stravinsky's music required from players and conductors a variety of technical and auditory skills that were not yet taught in the conservatories, many early performances surely misrepresented the music in grosser ways as well. His descriptions (in the *Autobiography*) of the distortions to which *The Rite of Spring* was subjected vividly suggest why he might have felt the need to resist "interpretation." Although Stravinsky was tactful in the *Autobiography* about Koussevitzky's premiere of the *Symphonies of Wind Instruments* (he needed the performances and conducting engagements at the conductor's disposal), blaming its failure on physical circumstances, one can hardly imagine that the tricky relationships among the several montaged tempos in that work were even remotely realized on that occasion, or for many years later.

By now, of course, *The Rite* is a staple of conducting classes in conservatories, and is regularly performed in concert and on records with a technical perfection undreamed of even twenty-five years ago (and hardly achieved in any of the composer's recordings, fascinating though all three remain). Stravinsky's recordings of this—and many others of his works—are no longer needed to fulfill the function that he originally assigned them. Nor did he foresee the pervasive trend toward a more "objective" style of musical performance, a trend that had begun back in the nineteenth century and of which Stravinsky, like Verdi and Wagner and Richard Strauss before him, was a significant part. Nevertheless, although in his early comments the composer was pessimistic about the effectiveness of his recordings ("Unfortunately, very few conductors avail themselves of

them"), it seems likely that later generations of would-be conductors and performers grew up with the sound of those recordings in their ears—especially in the case of the neoclassic works for which there were few alternatives until relatively recently. At any rate, not many recorded performances by others, over the years, seem really to question Stravinsky's basic premise of "execution, not interpretation," though they are often more smoothly played and may well suffer from more-or-less involuntary defects of character—the kind of thing the composer referred to in speaking of the "fallen arches" of the Ansermet recordings and the "elevator shoes" of Dorati's. What really underlines the considerable agreement about the main lines of Stravinsky performance is the occasional example from left field—e.g., such Eastern-Europe-

Bartók was far from legislating, Stravinsky-fashion, about performances.

an manifestations as Mravinsky's *Apollo*, played with the top-line schmaltz that would be just right for the Tchaikovsky that the score in fact resembles only superficially.

Stravinsky's recordings served yet another function: the dissemination of his new works. He generally succeeded in getting his own version first on the market, beginning in the early 1930s with the *Capriccio* and *Symphony of Psalms*, with the result, in many cases, that no competition emerged for years; in the face of the composer's recordings, with their imprimatur of authority, few record companies thought it worthwhile to contest what was, after all, not a very lucrative market to begin with. There is, of course, a contradiction inherent in "stop press" recordings of new works: The sooner you make the record, the less likely it is to contain a really accurate, settled performance, suitable to serve as a model for others. The recordings of Stravinsky's late works illustrate this dilemma all too vividly.

Stravinsky visited the recording studios pretty regularly over a period of forty years (1928–67) as conductor and also recorded as a pianist in the Thirties and Forties. Béla Bartók's recording career began about the same time but was cut short by his death in 1945. Furthermore, Bartók lacked Stravinsky's aggressive ambition and Diaghilev-honed instinct for publicity, and he was based in Budapest, a city not much frequented by the major record companies. His recorded legacy is thus much smaller

and has, for the most part, been less accessible and thus less influential—and in any case, it is restricted to the part of his catalog involving the piano, for Bartók never conducted.

Still, Bartók attached considerable importance to his recordings: In a 1937 essay on "Mechanical Music," he discussed with remarkable prescience the potentials and drawbacks of recordings, calling particular attention to "those infinite, minute nuances which cannot be expressed notationally, yet can be immortalized in their totality on gramophone records." Bartók's acquaintance with that particular power of recordings came early, for he used Edison cylinders in his folk-music collecting—and it is precisely in such matters, stemming from the prevalence in his concert music of rhythmic and agogic usages similar to those of Hungarian folk music, that we turn to Bartók's own recorded performances with the greatest curiosity.

For all that, Bartók was far from legislating, Stravinsky-fashion, about the authority of his recordings; rather, he called attention to the fact that even a composer's performances are not invariable. "Even if one succeeded in perfectly preserving with a perfect process a composer's works according to his own ideas at a given moment, it would not be advisable to listen to these compositions perpetually like that. Because it would cover the composition with boredom. Because it is conceivable that the composer himself would have performed his compositions better or less well at some other time—but in any case, otherwise."

Among the several points implicit in that compact statement is the value, where available, of multiple composer recordings of the same work. (Stravinsky/Craft make a related point, in *Dialogues and a Diary*: "The fifty recordings of [a] Beethoven symphony are fifty different angles of distortion, but these distortions actually protect the scope of the work: The larger the variorum, the greater the guarantee that Beethoven himself will remain intact." A single recording of a contemporary work, "on the other hand, lacking comparison, fixes the music at a single angle.") One of the many merits of Hungaroton's centennial edition of Bartók's own recordings—a supplement to the complete recording of his music that has been appearing over the past decade—is its completeness. Nothing, however trivial, has been excluded on the grounds of duplication, and László Somfai's admirable essay in the booklet accompanying Vol. 1 of the edition explores some of the ways in which these duplications prove instructive.

The division into two volumes is also to be praised, reflecting as it does the nature of the contents. Vol. 1 includes "all the material of good quality," most of it studio recordings approved by the composer; in

brief, it comprises all the recordings listed in my article "Bartók at the Piano" (HF, March 1981) and adds the following: an alternate take of the Suite, Op. 14 (recorded 1929); transcriptions of the Welte-Mignon piano rolls (c. 1920; from Welte-Legacy 676), including the *Sonatina* and the six *Romanian Folk Dances*, of which no other commercial recording by Bartók is known; and the five additional pieces from *For Children* (1945) that never previously made it to LP.

The real surprise is Vol. 2: more than three hours of previously unpublished material, principally from off-the-air recordings taken down in Hungary in the later 1930s, but also ranging back to cylinders made by Bartók at home in 1912 on his Edison machine, some mysterious but apparently authentic recordings that may stem from 1922 Pleyel piano rolls, and a side of spoken material. The first thing to be said is that nearly all of this is in very poor sound (as the late William H. Seltsam used proudly to proclaim on his reissues of Mapleson cylinders, "This is *Not* a High Fidelity Record!"). and the second, that many of the recordings are fragmentary or damaged or both. Unlike Vol. 1, all of which is perfectly listenable, this stuff is only for the dedicated, but it is of the utmost significance for our knowledge of Bartók as a performer.

Of his own music, as well as several short pieces, the most important items are two concerted works, a category in which we previously have no commercial recordings of Bartók's playing at all. In five fragments of the Second Piano Concerto, the orchestra, conducted by Ansermet, is scarcely audible, but the composer's playing of the massive chords is incredibly lithe and volatile. There are only four gaps in the better-sounding Rhapsody, Op. 1, conducted by Dohnányi; Bartók plays this early, rather Lisztian work with great freedom and panache.

As I noted last year in connection with the familiar recordings of Vol. 1, it is in the music of other composers that Bartók most surprises us, and that is true of Vol. 2 as well. Some of the recordings are mere sonic potsherds—tantalizing fragments of Bach (including two-and-a-half movements of the G major Partita, the even sixteenths transformed into a forest of prickly Bartókian rhythmic variety), Mozart, Beethoven, Chopin, Liszt, and Kodály. Complete is the Brahms B minor Capriccio, Op. 76, No. 2, emerging as a rowdy country dance. Two-piano performances, with Bartók's second wife, Ditta, include fragmentary versions of the Mozart Sonata in D, K. 448, and Debussy's *En blanc et noir*, and a blessedly complete one of the Brahms Sonata in F minor (the alternative version of the piano quintet). Most fascinating of all is Liszt's *Concerto pathétique* (in the Bülow version), in which Bartók is joined by the other great Hungarian virtuoso of his day,

Ernö Dohnányi—two titans whose disparate but equally committed conceptions of their great predecessor's style makes for a spellbinding performance.

There is enough here to establish Bartók as a performer of major status—comparable to Rachmaninoff, on an interpretive and imaginative, if not a technical, plane. You will need a score to decipher some of the sounds in Vol. 2, but I can't imagine that these difficulties will deter anyone passionately interested in Bartók—or indeed, in piano-playing in general—from making the effort and finding it enormously rewarding. (Perhaps, after the complete edition has been sold out, Hungaroton might consider making a one-disc selection of the better-sounding complete pieces and movements, for those who want only a sampler.)

CBS's Stravinsky set is relatively less comprehensive than Hungaroton's Bartók.

That any of this material survived at all seems miraculous (the circumstances are narrated by János Sebestyén in the booklet accompanying Vol. 2), and we must be grateful for the countless hours of work that have been expended in making it as listenable as it is—although without any basis for comparison it is naturally impossible to judge the quality of this technical work. In Vol. 1, comparison is possible, and we are given details of the source material used. The EMI material was newly and capably transferred by Keith Hardwick—from vinyl pressings when possible, otherwise from commercial pressings. The American material, on the other hand, has been taken from master-tape copies furnished by the proprietors: CBS, Vanguard, Moss, etc. Thus, although the sound is never worse than on previous issues, recent advances in sound restoration have not been brought into play. For example, the 1940 Columbia recordings are presented in the same transfers that circulated here in the 1950s (although mercifully without the electronic "stereo" effect applied to the *Odyssey* reissue of *Contrasts* and some of the *Mikrokosmos* pieces). Hungaroton's edition of the radio recording of the *Sonata for Two Pianos and Percussion* goes back to the original Vox issue, sparing us the sonic deterioration that was evident in the later Turnabout edition. And a hum that afflicts the Turnabout pressings of the 1945 Continental recordings has been removed.

A combined "contents" booklet for the two sets gives recording and publication data, and helpfully cross-indexes multiple

recordings of the same work. Each set also has its own illustrated booklet in five languages, with thoughtful essays about the recordings and their significance. My only regret is that all this is so specifically aimed at the specialist, because I think Vol. 1 should be of great general interest; there is no background information about the music itself, and I think even the specialist would welcome texts and translations of the four sides devoted to Bartók's and Kodály's songs and folksong arrangements, so vividly and variously sung and played. (Another by-blow of the Hungaroton Bartók Edition is a single-disc selection, LPX 18069, from the original folksong cylinders recorded in the field by Bartók in 1906–14, packaged with texts, translations, and references to Bartók's use of the same melodies in concert versions as piano pieces, songs, and choruses; this enables us, in some cases, to compare Bartók's own performance of the concert version with the rural original.) By any standard, however, this is a notable achievement, exemplifying the phonograph's powers of preservation—and retrieval!—at their highest and most valuable.

For the Stravinsky centennial, CBS has come up with an even larger, though relatively less comprehensive, package. On thirty-one records, "Igor Stravinsky: The Recorded Legacy" is not (although some of the manufacturer's publicity has suggested it is) a complete collection of Stravinsky's recordings. Nor is it a complete collection of all his works (though it includes several recordings—and I don't mean those by Stravinsky's assistant Robert Craft—that, whatever their individual merits, have nothing at all to do with Stravinsky the performer of his own music). It does not include every work he recorded, and some works that he did record are included here in performances by others. In many cases where alternative composer-conducted versions are available, the best has not been chosen.

It is the last, I think, that constitutes the most serious criticism of what clearly has been designed as a consumer product, a kind of sonic coffee-table book, rather than a serious contribution to the public appreciation of Stravinsky's music and the special qualities of his own performances. Stravinsky was not a conductor of the first rank, but under the right circumstances he could produce vivid, illuminating, characterful performances of his music. Unfortunately, many of his recordings were made under something less than the best circumstances, with inadequate or uncongenial soloists selected for extramusical reasons, with pickup orchestras that had to be taught the music from scratch in the studio, under considerable time pressure. (Some even involved orchestra tracks and post-synced singers.) The contrast between many of these "Columbia Symphony Orchestra"

recordings and those made with established orchestras—especially Cleveland and Chicago—after a run of fully rehearsed concert performances, is always striking.

A few of those good recordings are present in this set: a beautiful Chicago performance of *Orpheus*, and the *Ode* and *The Card Game* (of which more anon) from Cleveland. But in his later years Stravinsky conducted such major orchestras rarely (many of them were apparently averse to accepting Craft as a co-conductor, and Stravinsky could no longer, in his late seventies and early eighties, sustain a complete program), so most of his stereo recordings were made with pickup groups or with lesser ensembles. (Several visits to Toronto produced a considerable harvest of earnest but somewhat scrawny work by the CBC Symphony.) For all their interest in detail to the scholar, these late recordings are rarely preferable to the mono versions of such scores as *Pulcinella*, *The Fairy's Kiss*, and the *Symphony in C* (all with the Cleveland Orchestra in superb form).

But like those coffee-table books in which a fuzzy photo in color is preferred to a clear one in black-and-white, CBS has, with only minor exceptions, based "The Recorded Legacy" exclusively on the stereo recordings; all of them are here, except for the 1967 recording of the *Firebird* Suite (the earlier performance of the complete ballet is included, of course), and the 1965 version of the *Pastorale*, with Israel Baker as violin soloist (the mono recording with Joseph Szigeti has been preferred, with reason—the reason being not so much the violinist as the greater security of the earlier wind ensemble). Both of these omitted items are still in print, and so is the great 1951 Cologne performance of *Oedipus Rex* (Odyssey Y 33789), which makes forgivable the preference here for the (also very good) Washington Opera version.

But many other desirable alternatives are not available, and have not been for years. At the same time as that Cologne *Oedipus*, Stravinsky recorded a first-class performance of the *Symphonies of Wind Instruments*, and the same disc contained a grand and witty *Soldier's Tale* that featured Alexander Schneider and the cream of New York's free-lance players, with a point and detail that the 1961 Hollywood remake didn't really match. I could go on and on, but will mention only one further, and baffling, mis-selection: In 1938 Stravinsky and his son Soulima recorded the *Concerto for Two Pianos*, a rare set of 78s that has never since been reissued and would have contributed valuably to this set; instead we find, inexplicably, a mono recording of a routine performance by Vronsky and Babin (not to mention their two-piano version of the *Tango*, in an arrangement that has nothing to do with Stravinsky either!); if we can't have Stravinsky, why not at least the excellent stereo version by Gold and Fildale?



Stravinsky at work; bottom photo, taken at session, shows Stravinsky aide Robert Craft, in foreground, and Columbia producer John McClure, standing directly behind Craft.

COURTESY CBS MASTERWORKS; ARNOLD NEWMAN (above, right)

On the technical front, there is better news. The recordings have been remastered, and in some cases remixed and otherwise improved, to good effect; particularly striking is the clarification of the *Canticum sacrum*, which turns out to have been out of phase in its two previous incarnations! Elsewhere, I noticed clarification of detail, elimination of low-frequency noise—and throughout, surfaces of the highest quality (pressings from Germany). The couplings have been rearranged in the interests of compactness—so intelligently, on the whole, that the single glaring error sticks out prominently: In order to accommodate Stravinsky's 1959 spoken narrative of the history of *The Rite of Spring*, the side break in that remarkable score has been placed not between the two parts, but in the middle of Part II (at the brief pause just before the "Evocation of the Ancestors"), irreparably shattering the work's tension. No other recording of *The Rite*, to my knowledge, suffers that crippling disability—and unnecessarily so, for the British CBS edition of talk and ballet placed the talk quite comfortably before Part I, with the side break at the usual place.

In addition to these miscalculations, there are a couple of mysteries. When I reviewed the Columbia Symphony *Persephone* back in 1967, I noted a passage near the beginning where a faulty take had been used, and badly spliced in at that; lat-

er, the climax of the trumpet aria was wrongly edited as well. In the new set, both those spots are corrected. (I am indebted to Sedgwick Clark, editor of *Keynote*, for calling my attention to this.) When queried, neither the executive producer of the set, the producer of the original recording, nor the remastering engineer could explain how this happened, though all agreed that no re-editing had been undertaken for the new set.

That change improved a defective recording, so we may be grateful to the unidentified hand that effected it (while still wondering how the initial flaws got into print to begin with)—but what are we to say about the curious goings-on in *The Card Game*? In his concerts, Stravinsky occasionally repeated the passage between rehearsal numbers 99 and 106, near the end of the "Second Deal," but he did not do so in either of his recordings—the 1938 Berlin Philharmonic set for Telefunken or the Cleveland version as first issued. Now, in the new set, it appears twice—and the first time in a defective take in which the conspicuous and essential oboe phrases at the end are not played! This, clearly, is *not* an improvement—and again nobody at CBS can explain how it happened. (I cannot swear that these are the only textual discrepancies between the new set and the first editions; although I did listen to all sixty-two sides, I don't know all of these record-

ings that well, and some small variants may well have slipped by.)

It's certainly worth mentioning that something like half the recordings in this set have been unavailable for some time, some of them the only current versions of major scores (*The Fairy's Kiss*, *The Nightingale*, *Mavra*, *Persephone*), some the only recordings ever (*The Flood*, *Orchestral Variations*, *Abraham and Isaac*, and *Requiem Canticles*)—though it will be small comfort to the seeker after a single work to discover that he can buy it only in a thirty-one-record set. Within the mammoth slipcase, the records are organized in two-disc "Interpacs" (except for *The Rake's Progress*, which is boxed), along with cards containing a table of contents and an index. The outsides of the Interpacs are given over to photographs, many of historical or theatrical interest. (I wonder, though, what David Hockney will think of the hand-coloring that has been applied to his famously black-and-white sets for *The Rake*?)

Inside, there are liner notes, often by Stravinsky or Craft—but since the whole geschmier has to be repeated in three languages, usually significantly abridged from their presentation on the recordings' first editions. The editing has not always been done carefully, so that a number of pieces are not adequately located chronologically, nor is there always a clear list of the movements within a work—and nowhere will you find adequate synopses of any of the story ballets. The identification of performers is less than consistent, and sometimes disagrees with the labels. The key of the Symphony in C has become "C major," that of the Violin Concerto in D "D major," and so on. This is just sloppy and/or ignorant. Texts and translations are given on insert sheets.

In her "Foreword" to the set, executive producer Vera Zorina Lieberson says that "A kind of 'legend' sprang up during Stravinsky's last years that he really did not conduct some of the recordings issued under his name. This is not true. . . . I'm sorry, but it is true: The *Danses concertantes* published on M 30516 as the work of Stravinsky was actually conducted by Robert Craft—as the present set now confirms. *The Flood* was originally issued as "conducted by Igor Stravinsky and Robert Craft," although Stravinsky apparently conducted little more than the rehearsal sequence shown as part of the original TV program; the new set doesn't help much here, for the outside of the sleeve credits only Stravinsky as conductor, while the inside, the text sheet, and the label credit only Craft! Stravinsky is no longer claimed as "supervising" the *Capriccio* (a session that he notoriously refused to attend), but he is now credited in that capacity for Craft's *Symphonies of Winds* and *Orchestral Variations*. (He was certainly in the control room for the first of these, but I

Stravinsky The CBS "Legacy"

1. *Stravinsky in rehearsal; Stravinsky in his own words. The Faun and the Shepherdess. Two Poems of Verlaine. Two Poems of Balmont. Three Japanese Lyrics. Three Little Songs. Pri-baoutki. Tihim-Bom. Berceuses du chat. Four Russian Songs. Three Songs from Shakespeare.*
2. *Pastorale (2). Duo concertant. Mavra: Russian Maiden's Song. Concerto for Two Solo Pianos. Tango. Piano-Rag Music. Three Easy Pieces. Five Easy Pieces. Sonata for Two Pianos. Sonata for Piano. Serenade in A.*
3. *Concerto for Piano and Winds. Capriccio. Movements for Piano and Orchestra. Concerto for Violin and Orchestra, in D. Concerto for String Orchestra, in D. Ode.*
4. *Scherzo fantastique. Symphony in E flat. Symphony in C. Scherzo à la russe. Symphony in Three Movements.*
5. *The Firebird. Fireworks. Petrushka. Suites for Small Orchestra (2).*
6. *Le Sacre du printemps. Apollo. Orpheus.*
7. *Le Baiser de la fée. Bluebird pas de deux. Jeu de cartes. Fanfare for a New Theater. Scènes de ballet. Circus Polka.*
8. *Danses concertantes. Four Norwegian*

- Moods. Agon. L'Histoire du soldat; Suite. Song of the Nightingale. Four Etudes.*
9. *The Nightingale. Pulcinella. Renard.*
10. *Mavra. The Wedding. Oedipus Rex.*
11. *Persephone. The Flood. Monumentum pro Gesualdo di Venosa. Dumbarton Oaks Concerto.*
- 11a. *The Rake's Progress.*
12. *Preludium. Ragtime. Tango. Ebony Concerto. Concertino for Twelve Instruments. Octet. Greeting Prelude. Double Canon. Epitaphium. Symphonies of Wind Instruments. Septet. The Star-Spangled Banner. Elegy for J.F.K. Four Russian Peasant Songs. The Owl and the Pussycat. Eight Instrumental Miniatures. Variations.*
13. *Ave Maria. Credo. Pater noster. Symphony of Psalms. Zvezdoliki. Babel. Mass. Canticum sacrum. Threni.*
14. *Anthem. A Sermon, a Narrative, and a Prayer. Introitus. Chorale Variations on Bach's "Vom Himmel hoch da komm' ich her." Abraham and Isaac. Cantata. In Memoriam Dylan Thomas. Requiem Canticles.*

(numbers refer to "Interpacs")

could not see, from the studio itself, at what point in the session he retired.) If there was—and is—any "legend" about the identity of the conductor in some of these recordings, it is a legend fostered by CBS's own prior carelessness and lack of candor in the matter.

Zorina's "Foreword" is part of the package's final element, a forty-eight-page booklet (again trilingual) full of pictures. Stravinskian *obiter dicta*, and a chronology of the composer's life and works. Here, too, editorial standards leave much to be desired. Pictures are vaguely or incompletely captioned (if the fellow at the left of the Cocteau caricature on page 11 looks familiar, I'll give you a clue: He's a Spanish painter with the initials P.P.), and the chronology, credited to François Lesure of the Bibliothèque Nationale in Paris, is something of a disaster, translated into often awkward English (references to "shortened score," for example) and filled with egregious factual errors (the early Piano Sonata in F sharp minor is described as "ms. lost," though the manuscript was found, and the piece published and recorded, some years back; the wrong date for the American premiere of *The Rake's Progress* is one of several errors picked up from the first edition of Eric Walter White's book, but the misidentification of its conductor is an original contribution from Paris—and so on ad infinitum). Do not rely on any statement in this booklet without outside corroboration.

Good marks for sound, then—and bad

marks for selection, annotation, and presentation. If the coffee-table gloss of this package should lure some new ears to Stravinsky's music, they will get precious little help from the rest of the package. Fortunately, the music remains fascinating, and can stand on its own. But for a serious study of Stravinsky's legacy as a performer, this set is less than an adequate resource. His "recorded legacy" still awaits satisfactory treatment that will make available all the evidence about his performances. **HF**

STRAVINSKY: The Recorded Legacy.

Igor Stravinsky, piano and cond.; various soloists and ensembles. [Vera Zorina Lieberson, prod.] CBS MASTERWORKS LXX 36940 (mono and stereo; thirty-one discs, manual sequence) [from various originals, 1934-69] [price at dealer's option].

CENTENARY EDITION OF BARTÓK'S RECORDINGS, VOL. 1: Bartók at the Piano, 1920-45.

Béla Bartók, piano; various artists. [László Somfai and Zoltán Kocsis, prod.] HUNGAROTON LPX 12326/33. \$79.84 (mono; eight discs, manual sequence) [from various originals (gramophone records, piano rolls, live recordings)].

CENTENARY EDITION OF BARTÓK'S RECORDINGS, VOL. 2: Bartók Plays and Talks, 1912-44.

Béla Bartók, piano; various artists. [László Somfai, János Sebestyén, and Zoltán Kocsis, prod.] HUNGAROTON LPX 12334/8. \$49.90 (mono; five discs, manual sequence) [from various originals (private and family recordings, fragments)].



BETTMAN ARCHIVE

Jean-Philippe Rameau (1683–1764)

The Glories of the French Baroque, Dimmed and Brightened

In new performances of Rameau and Charpentier, the composers' greatness shines through—but sometimes just barely. Reviewed by Nicholas Kenyon

"RAMEAU: AN INFATUATED, pedantic, and affected imitator of Lully." Thus Johann Mattheson, in 1752, dismissed the greatest composer of the late French baroque, and for almost two centuries it seemed that posterity might agree. Richard Alexander Streatfield's *The Opera* (1897) mentions his "pompous artificiality"; Cecil Gray's *History of Music* condemns his music as "unenterprising, stiff, archaic, lacking in spontaneity and charm." A few dances and some of the keyboard music remained popular, but not until very recently was it thought possible to revive his stage works. They were, it was claimed, too firmly tied to their age, to the ethos of the French court, too dependent on eighteenth-century spectacle, machinery, and above all, dance.

But the enthusiasm of a handful of scholars and performers has overcome those prejudices. Paul-Marie Masson's great study of the operas, published in French in 1930, and Cuthbert Girdlestone's enthusiastic and detailed survey in English, published in 1957, along with a few isolated revivals, helped to prepare the way for the remarkable Rameau renaissance of recent years. That can be dated, perhaps from Anthony Lewis' superb recording of *Hippolyte et Aricie*, based on a stage revival in England in the mid-1960s, with Janet Baker and John Shirley-Quirk. The cause was advanced in England by important concert performances by John Eliot Gardiner (of which only part of one, "La Danse" from *Les Fêtes d'Hébé*, reached the recording studio) and by the English Bach Festival. Nevertheless, no major opera house—except Paris, which had done *Les Indes galantes* in 1952 with purple smoke and other exotic effects—took up the challenge. Rameau has yet to be seen at the Met, the New York City Opera, Covent

Garden, or Glyndebourne (though Aix-en-Provence has a series planned for later in the decade).

Now onto the scene comes that well-known popularizer and transmogrifier of baroque opera, Raymond Leppard. Emboldened, no doubt, by a sentence from Girdlestone (who was desperate to see any of this music reach the stage) to the effect that Rameau's *tragédies* are "still alive, awaiting merely the magic wand of an arranging and transcribing Ismenor," Leppard has done a little conjuring with *Dardanus*—for another Paris production—and produced an opera that, I fear, Rameau would hardly recognize.

Dardanus, along with *Hippolyte* and *Castor et Pollux* (recorded by Harnoncourt), contains some of Rameau's greatest, most serious, and most entrancing music. However, it exists in several versions: two from 1739, the year it was first performed; two more from 1744, the year it was first revived; and several other revisions for later revivals. The fundamental change is that in 1744 the plot was completely rewritten from the middle of the opera to the end: The 1739 and 1744 principal versions are the same in outline for Acts I and II but diverge in Acts III–V. Each version is worthy of revival, but the mood and character of each—as well as its contents—are quite distinct.

Not to Leppard, though. He seizes on Girdlestone's remark that a modern version could be put together "based on that of 1744 but incorporating some of the best parts from the earlier score" and juggles with plot and music in a deft way. The prologue is cut, as in 1744, and the 1744 revisions to the start and finish of the first act are observed. The second act, however, concludes with the massive and exciting

chorus that in 1744 began Act III—presumably because Leppard wants to start the third act as in 1739. He then interleaves scenes from the two versions, including the central chorus from both. To end Act III, he uses a truncated version of the 1744 entr'acte that separated Acts IV and V—a marvelous battle piece, which in its original context is cleverly linked to the start of the scene. Leppard's Act IV starts as in 1744, with the extraordinary "*Lieux funestes*"—a dark, deep, and dissonant prison scene—and proceeds by way of a huge cut through much of that act. Then he starts again with the 1739 fourth act and its serene "*sommeil*" sequence. After a while, Dardanus exclaims "*Où suis-je?*", a remark one can only echo. The exciting scenes of monsters and tempests close the act (approximately) as in 1739.

Leppard's brief and inconsequential Act V starts as in 1739 and ends with music from 1744 but finds room in between for a few bars snipped out of the 1744 Act IV and a piece from the second version of 1744. He says that he has omitted "the final danced chaconne, which Rameau himself cut in 1744, and put in its place a chorus . . . much more suitable as the conclusion of a predominantly vocal evening." Well! Rameau left out the chaconne—one of the opera's glories—only in the first 1744 version, quickly restoring it, and he anyway substituted other dances. Leppard's evening is "predominantly vocal" only because his vast cuts (made to accommodate the two versions) involve omitting almost all the dances that are an integral part of the opera's structure.

Leppard's justification for all this, in his sleeve notes and in the published score (Faber Music, from Schirmer), is that "I have found a way to produce a version of

the opera with a dramatic structure that makes theatrical sense in terms of the ebb and flow of tension and relaxation." Sense, that is, to Leppard, not to Rameau. Of course some cuts may be necessary. But to exclude most of the dances is analogous to cutting most of the chorales from the Bach Passions; and what Leppard has done to the two versions of *Dardanus* is not so remote from splicing together the *St. John* and *St. Matthew* Passions (at least they have the same plot), cutting down the recitative, and omitting the climactic final movement.

All this might matter less if the performance were one that could be enthusiastically recommended. It has strong points: Leppard's sparkling rhythmic vitality is always in evidence, and the few rigaudons and tambourins that remain go with a swing. There is some splendidly lithe and flexible singing from Georges Gautier in the high-tenor role of Dardanus (though sometimes he is flat at the top); and José van Dam is a splendidly clear yet sonorous bass as the conjuring Ismenor. But in the central tragic role of Iphise, Frederica von Stade takes on all the weighty portentousness that served her in Leppard's account of Monteverdi's *Ulisse* (CBS M3 35910). Here it clogs the music fatally, impeding its flow and at times reducing it to a snail's pace. When she lightens the tone, she can sound most attractive, but she does so rarely. As the two bass-baritone kings, Michael Devlin and (especially) Roger Soyer are lugubrious and bumbling; their splendid first-act duet is stodgy. Christiane Eda-Pierre contributes a sweet, bright Venus, with ornaments applied like icing on a cake; Veronique Dietschy is an attractive incidental maiden.

Underneath this variable singing, the Paris Opera band plows through the orchestral writing with heavy, sustained bass lines and vibrato-laden expressiveness. The continuo is inflexible. The chorus sings acceptably but without much force. Nevertheless, something comes through: There are thrilling moments (the modulation as Dardanus rushes in to save his rival from the monster) and affecting ones (the depth of feeling between Dardanus and Iphise), and these make their impact. But as a whole, it is difficult to welcome this set as a contribution to the understanding of Rameau's art.

The recordings of *La Princesse de Navarre* and *Nais* both originated with staged revivals in London by the English Bach Festival. These revivals (of which the latest, *Castor*, was by all accounts a considerable success and has also been recorded), though often short on scenery, sophistication, and rehearsal time, have observed scrupulously the importance of the dance and have also always used original-instrument orchestras. Jean-Claude Malgoire's unsatisfactory *Hippolyte* recording owes something to his Bach Festival performances, as does his livelier account of *Les*

Leppard has done some conjuring and produced an opera Rameau would hardly recognize.

Indes (CBS M3 32973). These two new discs—both produced by Erato, but *La Princesse* presumably licensed to MHS before the welcome Erato revival here—feature the young conductor Nicolas McGegan, a flutist and keyboard player who has appeared in several Academy of Ancient Music recordings on Oiseau-Lyre and has also taught in this country at Washington University in St. Louis.

Nais is the more important and enjoyable opera; like Handel's *Fireworks Music*, it was written to celebrate the peace of Aix-la-Chapelle in 1749. Its scale is relatively small—three acts instead of the five of the *tragédies*—and its tone light. But there are some splendid scenes, and the divertissements of each act are delightful—the first based around the contests of the Isthmian games, the second pastoral, the third celebrating the water gods. The plot, though thin, is at least sustained through the opera (thus distinguishing it from the episodic form of the *opéra-ballet*) and easy to follow. The impeccably faithful edition—with just a few cuts—has been made by Graham Sadler, who comments in the booklet that "the chief glories of the opera . . . are to be found among the many *airs de ballet*." That is especially true in this performance: The instrumental playing, though sometimes tentative, makes these dances sparkle; the inventiveness of their scoring and the sensual effect of what Sadler calls the "drowsy yet wistful languor" of the pastoral pieces are intoxicating.

The singing is not on such a consistent level; there is little sense of corporate vocal style in the cast—which shows how undeveloped the art of baroque singing is, compared with that of baroque playing. Lynda Russell's *Nais* is warm, Ian Caley's Neptune rather strained; Ian Caddy's Jupiter and Telenus are very fine and well focused, as is John Tomlinson's Pluto. Brian Parsons copes well with the *haute-contre* part of Asterion, and there is a splendid small contribution from Jennifer Smith. The chorus is too small and weak; in the colorful opening tableaux, where the superb battle overture overflows into a torrent of furious activity, far more sharpness and attack are needed. The performance has been well recorded; in spite of its unevenness and occasional unwonted feebleness, it gives an excellent idea, unlike Leppard's *Dardanus*, of the precisely balanced art form that was

Rameau's opera.

La Princesse is inevitably less valuable in that respect, since it consists only of interludes inserted into Voltaire's play for the marriage of the dauphin in 1745. But these "intermezzos" have here been restored to their complete form for the first time, by Lionel Sawkins, yielding an attractive sequence of numbers, performed in a wide variety of styles: Eiddwen HARRY blasts her way excitingly through "*Vents furieux*," while Michael Goldthorpe (*haute-contre*, sung here as a high tenor, not countertenor as on the sleeve) delivers "*Dieux ennemis*" and "*Régnez en paix*" tastefully and cleanly. The instrumental playing is crisp, with some fine trumpet-and-drum work in the festive pieces; but it is even more bland than in *Nais*, lacking any phrasing in the Act III Entrée, far too slow in the Act II Sarabande. The Act III "*Prélude pour la descente de l'Amour*," however, with its eloquent bassoons, is ravishing.

If—it may reasonably be objected—I am not wholly content with the orchestral styles either of the English Bach Festival players or of Leppard's Parisian ensemble, then what exactly do I want? Happily, I can answer that promptly: The single-disc recording by La Petite Bande of dances from *Hippolyte* is an absolute paragon of Rameau playing—irresistibly exciting and stylish. I defy anyone who has not succumbed to Rameau's charms (if, indeed, any such have read this far) not to capitulate to this record. The original-instrument playing has all the clarity and flexibility missing from Leppard, all the bite, bounce, and dynamic rhythmic impetus lacking in the Bach Festival's tasteful playing. The musicians' command of their instruments is complete, and Sigiswald Kuijken, who directs from the violin, characterizes each dance firmly so that its special character emerges.

And what variety is here! There are dances from the 1733 production and from the 1742 and 1757 revivals; one can trace the development of a mid-eighteenth-century style in the way the horns are used in the later pieces to fill in harmonies, rendering the continuo superfluous. The foreboding fugal *ritournelle* for the 1742 Act III (printed in an appendix to Girdlestone's book, by the way) is magnificent, the set of *airs de furies* from Act II as vivid as anything in Handel or Gluck. In the 1757 tambourins there are rustic drones and widely spaced duets between high flutes and bassoons; throughout, the sheer coloristic skill of the composer should excite anyone who responds to the textures of Bach's *Brandenburgs* or Vivaldi's wind concertos.

This record sent me back to an old two-disc set by the Collegium Aureum of dances from *Les Indes* and *Dardanus* (BASF/German Harmonia Mundi 29334-3), with playing that is overblown but ener-

getic, to marvel again at the resourcefulness of Rameau's orchestral writing and to hear in disbelief the music that Leppard excised from his *Dardanus*.

French opera before Rameau: As Mattheson's quotation above implies, what is there except Lully? That conclusion would have pleased no one more than Lully, who maintained an iron grip on the sources of patronage and the means of performance throughout his life and schemed relentlessly to exclude his talented rivals from favor. He very largely succeeded; as James Anthony's useful book *French Baroque Music* notes, "Lully indeed created an empire, but an empire which did not provide for heirs." Though many composers tried to write *tragédies lyriques* after Lully's death—

some fifty-nine were given at the Académie Royale between Lully's last and Rameau's first—few survived.

Lully's most talented rivals chose to channel their work into other forms. But Marc-Antoine Charpentier, who devoted much of his life to church music, did stage one *tragédie lyrique* at the Académie, *Médée*, and also presented one in the year after Lully's death, 1688. This was *David et Jonathas*, an unusual opera, for it was written on a biblical subject and given at the Jesuit College interspersed with a Latin play, *Saul*, that treated the same theme. The opera was copied out by the librarian and composer Philidor for the royal library in 1690—probably the only reason it survives. The enterprising Opéra de Lyons edited and revived it a couple of years ago;

this recording is based on that revival, but with the English Bach Festival orchestra borrowed to replace the French players.

It is a fine performance. Unlike Corboz' account of Cavalli's *Ercole amante* (Erato STU 71328, May), it is excellently cast with singers experienced in the idiom. Paul Esswood sings David (a *haute-contre* part) as an alto, and Philippe Huttenlocher is a dignified and moving Saul; both singers are well-known from Telefunken's Bach cantata series. Colette Alliot-Lugaz, whom I enjoyed in a small part in the Cavalli, here sings Jonathan with real insight and feel for the shaping of the lines. Roger Soyer is a disappointing Achis, and Antoine David is rather acid in the main tenor role (though his words are admirably pointed); but several of the smaller parts are well taken—especially by the pairs of chorus singers who have frequent ensemble duets—and René Jacobs turns in an outstanding cameo as *La Pythonisse*.

The work makes a mixed impression. The recitative is sensitively written, the moments of high tension are impassioned, and bright, attractive instrumental interludes begin each act. Yet the whole does not convince on dramatic terms as Rameau's dramas do; the instrumental pieces are not especially appropriate. There are splendid highlights: David's Act I, Scene 3, soliloquy, powerfully projected by Esswood, and Saul's last-act lament with chorus. But the really affecting moments in the tragic story—Saul offering his sword to Jonathan, Jonathan's dilemma of loyalty—do not call forth any extra inspiration from Charpentier. The narration remains on the restrained level of a *historia*, and that conflicts oddly with the passions expressed in the text. The feeling of restraint is compounded by Corboz' quiet, unsensational reading of the score.

Jean Duron's edition must have involved much reconstruction of the instrumental parts; there are few indications in the score, apart from special effects like the four bass string instruments that accompany the Ghost of Samuel (Pali Marinov) in the Prologue. The result is generally tasteful, though I am not keen on the recorder parts Duron gave himself (as it happens) to play at the climactic meeting of David and Jonathan in Act V and at other moments where our attention should be focused on the vocal lines. "*Trompettes et tambours*," invoked by the text, make a sudden appearance in the last number. The booklet has copious notes and essays, and the libretto is fully annotated with political and biblical exegesis.

Charpentier has been far more recorded recently than has Lully; posterity has begun to take its revenge. Both his small-scale oratorios and his church music have been represented—the former through French Harmonia Mundi recordings by William (Continued on page 84)

RAMEAU: Dardanus.

CAST:

Venus	Christiane Eda-Pierre (s)
Iphise	Frederica von Stade (s)
Phrygian	Véronique Dietschy (s)
Dardanus	Georges Gautier (t)
Antenor	Michael Devlin (bs-b)
Teucer	Roger Soyer (bs-b)
Ismenor	José van Dam (b)

Paris Opera Chorus and Orchestra, Raymond Leppard, cond. ERATO STU 71416, \$17.96 (two discs, manual sequence) (distributed by RCA).

RAMEAU: Naïs.

CAST:

Naïs	Lynda Russell (s)
Flora/Second Shepherdess	Ann Mackay (s)
First Shepherdess	Jennifer Smith (s)
Asterion	Brian Parsons (t)
Neptune	Ian Caley (t)
Jupiter/Telenus	Ian Caddy (b)
Tiresius	Richard Jackson (b)
Palemon	Antony Ransome (b)
Pluto	John Tomlinson (bs)

English Bach Festival Chorus and Baroque Orchestra, Nicolas McGegan, cond. [John Rushby-Smith, prod.] ERATO STU 71439, \$17.96 (two discs, manual sequence).

RAMEAU: La Princesse de Navarre.

Marilyn Hill-Smith, Eiddwen Harrhy, Frances Chambers, and Judith Rees, sopranos; Michael Goldthorpe, tenor; Ian Caddy and Peter Savidge, baritones; Richard Wigmore, bass; English Bach Festival Singers and Baroque Orchestra, Nicolas McGegan, cond. MUSICAL HERITAGE SOCIETY MHS 4396, \$7.75 (\$4.95 to members) (add \$1.60 for shipping; Musical Heritage Society, 14 Park Rd., Tinton Falls, N.J. 07724).

RAMEAU: Hippolyte et Aricie: Suite.

La Petite Bande, Sigiswald Kuijken, dir. [B. Bernfeld, prod.] HARMONIA MUNDI GERMANY IC 065-99837, \$10.98 (distributed by German News Co., 220 E. 86th St., New York, N.Y. 10028).

CHARPENTIER: David et Jonathas.

CAST:

Jonathan	Colette Alliot-Lugaz (s)
First Shepherd/First Captive	Agnès de Crouzat (s)

Second Shepherd/Second Captive

Monique Pouradier-Duteil (s)

David	Paul Esswood (ct)
The Prophetess	René Jacobs (ct)
Joabel/One of the People	Antoine David (t)
Saul	Philippe Huttenlocher (b)
Achis	Roger Soyer (bs)
Samuel's Ghost	Pali Marinov (bs)
Warrior	François Le Roux (bs)

Follower of Jonathan Jean-François Gardeil (bs)
Children's chorus, chorus, English Bach Festival Orchestra, Michel Corboz, cond. ERATO STU 71435, \$26.94 (three discs, manual sequence).

CHARPENTIER: Caecilia, virgo et martyr; Filius prodigus.

Les Arts Florissants, William Christie, dir. HARMONIA MUNDI FRANCE HM 10.066, \$11.98 (distributed by Harmonia Mundi U.S.A., 2351 Westwood Blvd., Los Angeles, Calif. 90064).

CHARPENTIER: Messe pour les Trépassés; Motet pour les Trépassés; Miserere des Jésuites.

Karine Rosat and Jennifer Smith, sopranos; Hanna Schaefer, alto; John Elwes and Fernando Serafim, tenors; Philippe Huttenlocher, baritone; Michel Brodard, bass; Gulbenkian Foundation Chorus and Orchestra (Lisbon), Michel Corboz, cond. MUSICAL HERITAGE SOCIETY MHS 4098/9, \$15.50 (\$9.90 to members) (two discs, manual sequence).

CHARPENTIER: Requiems: in G minor; in D minor.

Bernadette Degelin and Anne Verkinderen, sopranos; David James, countertenor; Jan Caals, tenor; Kurt Widmer, bass; Westvlaams Vocal Ensemble, Musica Polyphonica, Louis Devos, cond. MUSICAL HERITAGE SOCIETY MHS 4350, \$7.75 (\$4.95 to members).

CHARPENTIER: Messe pour le Samedi de Pâques. DELALANDE: Psallite Domino. ANON.: Messe de Toulouse; Messe de Tournai.

Schola Cantorum of the Church of St. Mary the Virgin, McNeil Robinson, cond. [Frederick J. Bashour and Jeffrey Nissim, prod.] MUSICAL HERITAGE SOCIETY MHS 4133, \$7.95 (\$4.95 to members). Tape: MHC 6133, \$7.95 (\$4.95 to members) (cassette).

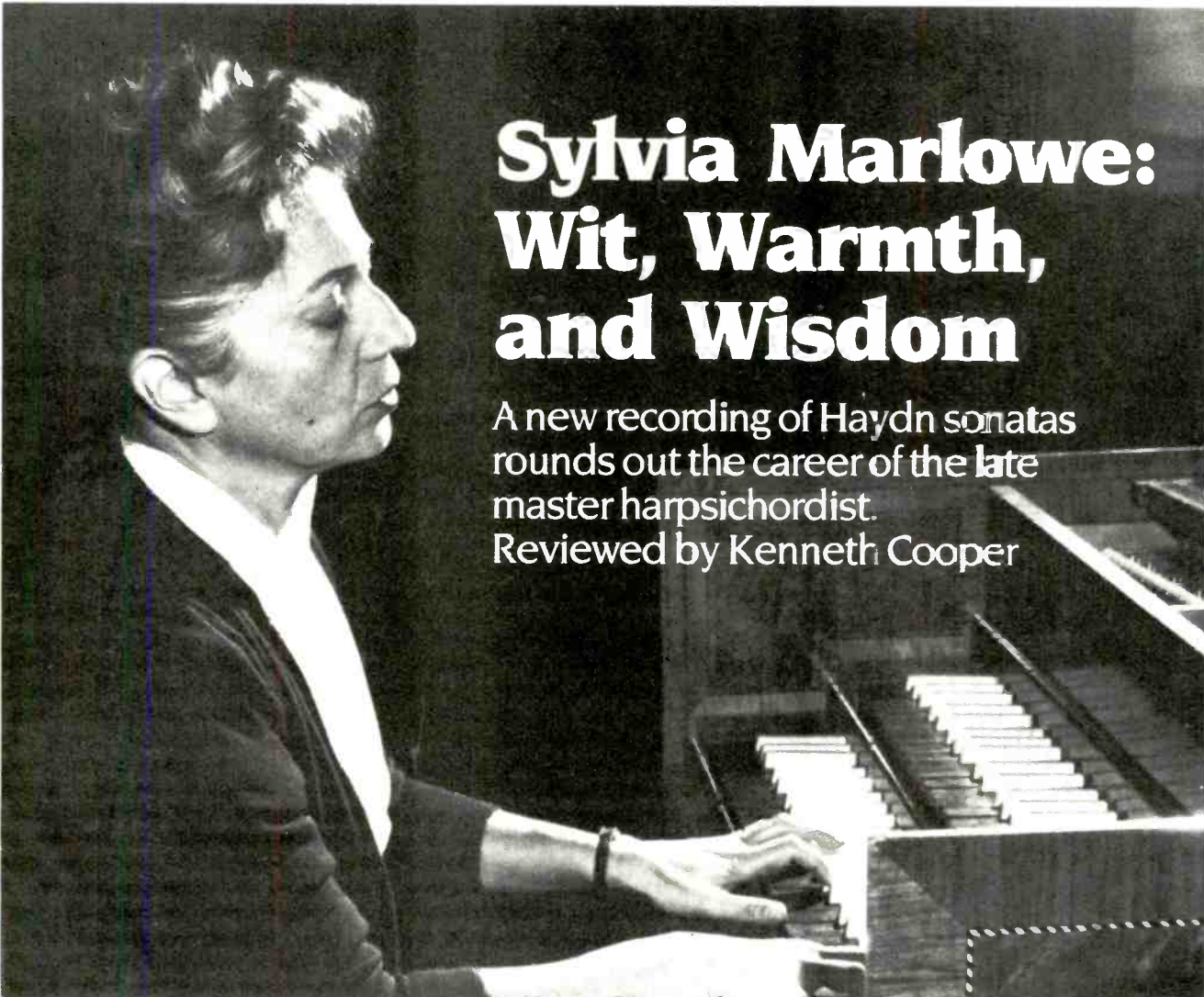
A black and white photograph of Sylvia Marlowe, a harpsichordist, shown in profile from the chest up. She is seated at a harpsichord, with her hands on the keyboard. She is wearing a dark jacket over a light-colored blouse. The background is dark, and the lighting highlights her face and the instrument.

Sylvia Marlowe: Wit, Warmth, and Wisdom

A new recording of Haydn sonatas rounds out the career of the late master harpsichordist.

Reviewed by Kenneth Cooper

IT WAS IN 1960 that I first went to the Mannes College of Music to study harpsichord with Sylvia Marlowe, a wonderful opportunity made possible by the Harpsichord Music Society. It took no more than one lesson to discover that she was a great harpsichordist. Only now, however, am I beginning to understand the depth and particular style of her musical work and personality. New thoughts were prompted, sadly, by her death, on December 10, 1981, in New York City, and by the release of her last recording of five Haydn sonatas.

Despite decades of appreciation by thousands all over the world, there seems to be little in print that clarifies her musical contribution. From a press sample we learn only that she was wonderful: "exalted occasion . . . skill and devotion . . . plays as have few in our time . . . taste and foresight . . . unfailingly distinguished music-making . . . depths of poetic and ethereal expressiveness. . . ." Those who knew her were grateful for the vagueness of that critical acclaim, grateful that critics and audience alike could see her worth through her difficulties. Her longtime friend Virgil

Thomson, never one to mince words, wrote (back in 1948) of her "not quite complete control of her own powerful temperament. That temperament is mercurial, and her exhilarating mind forms one with it. When she gets bored by a piece, as she sometimes does right in the middle of it, all her brilliance and surety leaves her; and the execution falls, for all its taste and learning, straight to earth." That he wrote of the problem is now informative though unkind. About the cause, I believe he was wrong: Marlowe suffered her whole life from acute stage fright, not boredom, and even asked me one day what she could do about it. At home, among friends, or in the recording studio, her concentration was better than most, even if she did talk, play, and smoke at the same time.

Mannes president Charles Kaufman recently described Marlowe's personality as "peppery" and "not altogether content" with the repertory, herself, or anything else. The lack of contentment was a fiery force driving her from one project to the next, always erasing the past. According to historian Arthur Schlesinger, Jr., she

blended "twentieth-century urgency with eighteenth-century elegance"; the lady who loved society, spoke French, was the "sparkling center of her salon on East 60th Street," and wished only to be allowed to pursue her beautiful work was also a dynamic pioneer of twentieth-century repertory for the harpsichord and by choice a liberated, modern, urban woman.

The harpsichord was, for her, also liberated, modern, and urban, and although she loved her summers in the quiet of the country, like Handel, she regarded summers as preparations for winters. She was concerned with giving a "contemporary identity to the harpsichord, which has for a long time been associated with the music of the past." She always craved a lively, beautiful harpsichord sound and a wide, sensuous palette of colors, activated by a mechanism that worked and stayed reasonably well in tune. When her taste for the Pleyel waned (after the Decca *Goldbergs*, c. 1962), she quite naturally fell into a long enthusiastic association with builder William Dowd.

As her student, I was impressed by her

seriousness, her passionate devotion to genuine musical experience, and her unflagging honesty and lack of tact. She said "marvelous" as often as she said "terrible." Her approach to the music she chose to play was governed largely by those traditional values (rhythm, melody, contrast) that I see now she used in an elemental way, without mitigation. From one day to the next, the tempo, dynamic, or articulation rarely changed *a little bit*; a black-or-white decision was made: staccato or legato, fast or slow, free or rhythmically steady. She asserted her ideas more impatiently, naturally, when my way was not clear or failed to convince or hadn't been sufficiently prepared. Often I went home with two interpretations: One I knew was imperfect, and one I knew I couldn't quite do. They often melded, indicating that she knew what I needed. She took special pains to deepen my experience with Couperin and Rameau, seeing that I was already immersed in the music of Bach, Handel, and Scarlatti. But she always looked out for pieces that strengthened my strengths, too—improvisation, for example.

What transpired in later years seemed to me even more remarkable. She maintained contact, even when we were both busy for long stretches, and always called when she was working on a new record or concert project asking for the same sort of honest criticism she gave so often. Nerve-racking as they were—"high-strung" hardly describes Marlowe's means of getting through the day—the times we had playing duets of Couperin (now available on Serenus SRS 12052), Bach, and Stravinsky were instructive and exciting. Her former student Doris Ornstein had the reaction, too, that Marlowe "treated a student like a colleague and not like a lower form of life." While rehearsing our recital of two-harpsichord music in 1971, I brought her the six Bach trio sonatas for two claviers and pedal; she approached them with some trepidation. (Would this be a transcription?) Months later, discovering what wonderful harpsichord duets they make, she wanted to record them all.

At her funeral in New York, four of her "progeny" played, on her harpsichord: Shirley Matthews, Hendrik Broekman, Gerald Ranck, and I. Naturally, we are four quite different artists, but the occasion struck me as a testament to Marlowe's ability to transmit to all of us a healthy, sensible, unmethodical attitude toward whatever we chose to do. I never before realized that she had made such a deep impression.

She died of emphysema, the apparent victim of the cigarette. She greeted me in St. Luke's Hospital with "Remember me, the chain-smoker?" This energetic woman spent the last years of her life debilitated, bed-ridden, and attached to an oxygen tank. She sorely missed her husband, Leonid Berman, who died in 1976. He was her opposite: a quiet, stable, unmercurial man,

Sylvia Marlowe A Chronological LP Discography

- Couperin, F.:** *Les Fastes (Ordre 11); Le Tic-toc-choc (Ordre 18)*. **Rameau:** *Gavotte et Doubles (Suite No. 4); La Poule (Suite No. 5)*. MGM E 538 (1946).
- Rieti:** *Partita* (with J. Baker, M. Miller, Kroll Qrt). Mercury 10012 (1948).
- Bach:** *Brandenburg Concerto No. 5* (with J. Baker, F. Eyle, F. Reiner, cond.). Columbia ML 4283, Harmony HL 7064 (1950).
- Haydn:** *Sonatas Nos. 1-3, 6, 8-11, 13, 14 (H. XVI: 1-10)*. Haydn Society 3037 (2) (1951).
- Loeillet, J. B. I.:** *Trio Sonata in B minor, Op. 2, No. 6*. † **Telemann:** *Musique de table, II: Trio in E minor; Quartet in D minor*. ‡ (With M. Wittgenstein, S. Baron, T. Witt, E. Brenner, M. Hubert.) Westminster 5076 18585†, 18031‡ (1951).
- Bach:** *Flute-Harpsichord Sonatas, S. 1030-35* (with J. Baker). Decca DX 113 (2) (1951).
- Handel:** *Flute-Harpsichord Sonatas, Op. 1 (7)* (with J. Baker). Decca DX 116 (2) (1952).
- Bach:** *Toccatina in D, S. 912*. **F. Couperin:** *Les Folies françaises (Ordre 13)* (C. Monteux, narrator). **D. Scarlatti:** *Sonatas, K. 107, 113, 124, 206, 446, 490, 492*. Remington 136 (1953).
- Couperin, F.:** *L'Apothéose de Corelli. Frescobaldi: Canzone (5)*. **Rosenmüller:** *Sonata No. 8*. (Harpsichord Qrt., including C. Monteux, H. Shulman, B. Greenhouse.) Esoteric ES 517, Counterpoint 5517 (1953).
- Couperin, F.:** *Ordre 26; Passacaille (Ordre 8); Les Fastes (Ordre 11)*. Remington 202 (1953).
- Hovhannes:** *Quartet, Op. 97* (Harpsichord Qrt. but H. Bennett, flute). **Lessard:** *Toccatina*. **Rieti:** *Sonata all'antica*. **Thomson:** *Sonata No. 4*. New Editions 3 (1953).
- Bach:** *Trio Sonata in C, S. 1037*. **Handel:** *Gamba-Harpsichord Sonata in C; Concerti à 4, Nos. 1, 2*. (Harpsichord Qrt.) Esoteric ES 528, Counterpoint 5528 (1954).
- Falla:** *Concerto*. **Rieti:** *Partita*. **Surinach:** *Tientos (3)*. (With Concert Arts Players, Harpsichord Qrt.) Capitol P 8309 (1955).
- Frescobaldi:** *Toccatina in G minor; Partite sopra'l Roggiere; Capriccio sopra la battaglia; Aria detto la Frescobalda*. **D. Scarlatti:** *Sonatas, K. 8, 27, 29, 32, 175, 487*. Capitol P 8336 (1956).
- Bach:** *Concertos after Vivaldi (6)*. Capitol P 8361 (1956).
- Bach:** *Concerto in D minor, S. 1052*. **Haydn:** *Concerto in D*. (With Concert Arts Orchestra.) Capitol P 8375 (1957).
- Byrd:** *Lord Willobies Welcome Home, F.*
- Couperin:** *Les Baricades mystérieuses (Ordre 6); Le Tic-toc-choc (Ordre 18)*. **Daquin:** *Le Coucou*. **Haieff:** *Bagatelles (3)*. **Handel:** *Air with Variations (Suite, Book I, No. 5)*. **Haydn:** *Sonata No. 50, in D*. **McPhee:** *Lagu delem*. **Mozart:** *Sonata in C, K. 545*. **Purcell:** *Ground in C minor*. **Rameau:** *Gavotte et Doubles (Suite No. 4); Tambourin (Suite No. 2)*. Decca 710001, Sine Qua Non 7764 (1958).
- Bach:** *Italian Concerto; French Suite No. 5; Toccatina in D, S. 912; Fantasia in C minor, S. 906; Art of Fugue; Contrapunctus No. 15*. Decca 710012, Sine Qua Non 148/3 (1959).
- Handel:** *Suites, Book I, Nos. 5, 7; Air with Variations (Suite, Book II, No. 1); Concerto in G minor, Op. 4, No. 1* (with chamber orchestra). Decca 710020, Sine Qua Non 148/3 (1959).
- Berger, A.:** *Intermezzo; Bagatelle*. **Lessard:** *Toccatina*. **Rieti:** *Sonata all'antica*. **Shapero:** *Sonata No. 1*. **Thomson:** *Cantabile; Intermezzo; Sonata No. 4*. **B. Weber:** *Serenade* (with Harpsichord Qrt.). Decca 710021 (1960).
- Bach:** *Concertos for Harpsichords, S. 1061, 1064, 1065* (with P. Cook, R. Conant, T. Saitenberg; D. Saitenberg, cond.). Decca 710028, Serenus SRS 12051* (1961).
- Bach:** *Gamba-Harpsichord Sonatas (3)* (with B. Greenhouse). Decca 710036 (1961).
- Ben Haim:** *Sweet Psalmist of Israel* (with New York Philharmonic, L. Bernstein, cond.). Columbia ML 5451, MS 6123 (1962).
- Bach:** *Goldberg Variations*. Decca 710056 (1962).
- Bach:** *Concertos, S. 1052, 1056, 1058* (with chamber orchestra). Decca 710104, Sine Qua Non 148/3 (1964).
- Carter:** *Sonata (1952)*. **Falla:** *Concerto*. **Roem:** *Lovers-Narrative*. **Sauguet:** *Suite royale*. (With S. Baron, R. Roseman, A. Kouguell, D. Glazer, M. Raimondi, H. Farberman.) Decca 710108, Serenus 12056* (1965).
- Bach:** *Concerto after Vivaldi, S. 972*. **Byrd:** *The Bells*. **L. Couperin:** *Chaconne in D minor; Pavane in F sharp minor*. **D. Scarlatti:** *Sonatas, K. 29, 107, 124, 206, 328, 487, 490, 492*. Decca 710113 (1965).
- Bach:** *Brandenburg Concerto No. 5* (with S. Baron, I. Cohen). **Haydn:** *Concerto in D*. (With chamber orchestra, D. Saitenberg, cond.) Decca 710130, Sine Qua Non 7758 (1966).
- Rieti:** *Partita; Concerto*. (With S. Baron, R. Roseman, C. Libove, A. Ajemian, H. Zaratzian, C. McCracken; chamber orchestra.) Decca 710135, CRI S 312* (1967).
- Purcell:** *Suites Nos. 1, 2, 4-7; Miscellaneous pieces*. Decca 710149, Serenus SRS 12055* (1968).
- Couperin, F.:** *Duets: La Julliet (Ordre 14); La Létiville (Ordre 16); Musétes de choisi, taverni (Ordre 15)* (with K. Cooper). *Apothéoses de Lully, Corelli* (with S. Baron, I. Cohen, R. Roseman, C. McCracken). Decca 710159, Serenus SRS 12052* (1968).
- Couperin, F.:** *Ordres 25, 26; Miscellaneous pieces*. Decca 710161, Serenus 12053* (1968).
- Couperin, F.:** *Ordres 6, 8; Les Folies françaises, L'Âme-en-peine (Ordre 13)*. Decca 710174, Serenus SRS 12054* (1969).
- "Purcell-Boogie"; "Boogie" (with bass and traps). SM 001 (limited release) (1969).
- Bach:** *Goldberg Variations*. RCA AGL 1-2447* (1977).

*currently available

a wonderful painter, and her "rock of Gibraltar."

Marlowe's recording career, which stretched almost four decades, had special meaning to her, because she loved working in the studio and performed there at her best. Her recorded legacy represents her work well and includes some of the finest of all harpsichord discs. Among them are her authoritative performances of some of the works she commissioned. Just after the war, she recorded almost five dozen 78-rpm sides, including Scarlatti, Couperin, and Rameau works for Musicroft (sets 72 and 84), Purcell's eight suites (Gramophone Shop GSC 2), a rare collection called "The Evolution of Piano Music" (Boston ES 2), some boogie-woogie, and Douglas Moore's popular children's record "Said the Piano to the Harpsichord" (Young People's Records 411), in which she plays a bit of Chopin's A flat Polonaise and Moore's *The Old Gray Mare*, surely one of Marlowe's most delightful premieres. (Neither she nor Moore could remember the name of the fine pianist in this recording. Does anyone know?) Her thirty-eight previous LPs are listed on page 56, with thanks to Serenus for keeping many of them in print.

The present recording of Haydn sonatas is a tribute to Marlowe's "wit, warmth, and wisdom," to use Schlesinger's apt words. Although she had recorded them for the Haydn Society in 1951, her more focused rhythm, more colorful registration, and very much more adventurous ornamentation make them sound like new works.

The *Divertimenti per il clavicembalo solo*, as Haydn called them, were "composed during a period of teaching and freelancing for Haydn (c. 1755-60), prior to his long residence at Esterházy," according to Marlowe's own notes; they apparently predate his earliest quartets and symphonies. Perhaps they also were among the early works Haydn later remembered as having a "tunefulness and a certain youthful fire." With brilliant sound and clear articulation, Marlowe projects these delightful pieces in a way that would have pleased old Haydn. It is an enlightened style of playing based on the rhythms and textures of the classical orchestra rather than the beginners' rules of the keyboard method-books. We sense immediately that we are in the presence of an artist who possesses convictions, not one who obeys orders.

As mentioned, there is imaginative ornamentation and variation, mostly on repeats but, yes, even on first statements, too. Ornamentation was a musical matter for this creative lady; she did what she liked, but she often consulted us, as if she needed moral support. I remember the day she was worried about the exciting little chromatic ornament in measure 12 of the Andante of Sonata No. 10 (H.1); she knew it was great, but she wanted to know whether it was OK.

She did not hesitate to tap any resource on the instrument if she felt the music was best served. The use of the harp stop, for example, in accompanying florid melodies (such as in the aforementioned Andante), while not ordinarily available on eighteenth-century harpsichords, she considered necessary simply to achieve a proper balance between elements. Not to achieve that balance, for whatever reason, was unacceptable. Her grounds, if she needed them, were rooted in the orchestration of the time; witness the pizzicato accompaniment in Haydn's Quartet, Op. 3, No. 5.

The performances on this record also display a wide and deep emotional range, convincing us that such depth is inherent in this seemingly simple music. The first Menuet of Sonata No. 10 has an energetic grace, while the trio broods in the dark colors painted by one who knew well (perhaps better than Haydn) the deeper recesses of baroque music. For the opening Moderato of Sonata No. 11 (H.2), Marlowe, in a gem of impeccable Haydn playing, becomes buoyant and witty, sporting the necessary snap in the triplets (a little late and fast), but not missing the tiny chromatic poignancies. The Largo of Sonata No. 11, with its flexible melodic line and repeating-note bass is a challenge to the harpsichord, a probing movement of the type so profoundly exploited later by Haydn. It shows his debt to the *Empfindsam* (sensitive) style of his mentor C.P.E. Bach. The Menuet and trio of Sonata No. 14 (H.3) are done with a kind of rubato I could never imitate, especially when she growled, "That's just awful; do it this way. . . ." For the opening of Sonata No. 14, Marlowe has the soft leather "*peau de buffle*" ready for the harpsichordist's dread (in classical repertory), the Alberti bass. Her articulation and timing of the tune make us forget those perpetual triplets. Sonata No. 9 (H.4) is put forth with still another captivating rhythm, and the Menuet is done slowly, with a warm, poetic atmosphere. Sonata No. 8 (H.5), the most developed of the works, is flashy, with windy effects (oboes and horns). The trio to this Menuet, however, speaks (a little prophetically for 1760) of the *Sturm und Drang*, the more public, extroverted edge of the *Empfindsam* movement. The finale gives a whiff of the opera buffa and reminds us, too, that Haydn and Scarlatti were not (yet) of different eras.

Gasparo deserves thanks for releasing this inspiring disc, and credits are due to Marlowe's faithful friend and engineer Israel Horowitz for his "Master Tape Production." HF

HAYDN: Sonatas for Keyboard (5).

Sylvia Marlowe, harpsichord. [Roy Christensen, prod.] GASPARO GS 218. \$8.98. (Gasparo Co., P.O. Box 120069, Nashville, Tenn. 37212.)

Sonatas (H. XVI: 1-5): No. 8, in A; No. 9, in D; No. 10, in C; No. 11, in B flat; No. 14, in C.

illinois audio



SAVE • money • time • freight

CASSETTE TAPES

SONY SHF-90 STANDARD BIAS TAPE	•••••	\$26.00/10
SONY FHF-90 HIGH BIAS TAPE	•••••	27.00/10
SONY FER-90 HIGH BIAS PREMIUM	•••••	28.00/10
TDK MA-C90 METAL CASSETTE TAPE	•••••	34.90/10
TDK SA-C90 OPTIMUM STEREO BIAS	•••••	36.00/10
TDK SA-C90 SUPER AVALIN TAPE	•••••	29.50/10
TDK C-90AD NEW ALDIA TAPE	•••••	22.00/10
BASF PERFORMANCE C-90 QUALITY TAPE	•••••	\$16.00/10
BASF PRO II OR III C-90 SPECIFY	•••••	26.00/10
MAXELL C-90 LN LOW NOISE TAPE	•••••	\$23.50/12
MAXELL C-60UD ULTRA DYNAMIC	•••••	23.00/12
MAXELL C-90UD ULTRA DYNAMIC	•••••	29.50/12
MAXELL UD-XL-C90 TYPE I OR II	•••••	29.50/12
MAXELL UD-XL-C90 TYPE I OR II	•••••	39.50/12
SCOTCH C-90 MASTER TYPE 2 OR 3	•••••	31.50/10

REFL TO REFL TAPE

TDK LX-35-90 NEW 7 IN.	•••••	\$60.00/10
TDK LX-35-180M NEW 10 1/2 IN.	•••••	170.00/10
MAXELL UD-35-90 ULTRA DYNAMIC 7"	•••••	57.50/10
MAXELL UD-35-180 SAME ON 10 1/2"	•••••	153.00/10
MAXELL UD-XL-35-90R BACKCOATED XL	•••••	69.50/10
MAXELL UD-XL-180R SAME ON 10 1/2"	•••••	198.50/10
SCOTCH 207R-90 POLY-POSTITRAK	•••••	55.00/10
SCOTCH 207 R-180 10 1/2 IN.	•••••	170.00/10

VIDEO TAPE

FUJI L-500 BETA TYPE	•••••	\$110.00/10
FUJI L-750 BETA TYPE	•••••	145.00/10
SCOTCH T-120 VHS TYPE	•••••	140.00/10

AUDIO TECHNICA CARTRIDGES

MODEL 155-LC	\$105.00	MODEL ARI-S	\$79.00
MODEL 140-LC	66.00	ARI-FEES	59.00
MODEL 125-LC	44.00	ARI-FEET	49.00
SHURE CARTRIDGES		EMPIRE CARTRIDGES	
V-15 TYPE 4 WRITE!	MR-3		\$110.00
V-15 TYPE SHF	LAC-600		80.00
M-97 HF	2000E-3		25.00
SHURE 9095ED \$22 WITH TURNTABLE PURCHASE !!!			

AUTOMOTIVE STEREO

PIONEER KE-2100 ELECTRONIC READOUT	WRITE!	
PIONEER KP-8500 AM-FM CASSETTE	•••••	140.00
TS-695 6x9 3-WAY SRCL. SYSTEMS	•••••	82.00
TS-696 6x9 2-WAY SRCL. SYSTEMS	•••••	64.00
WRITE FOR ALL PIONEER AUTOMOTIVE PRICES !!!		
JENSEN R-405 AM-FM IN DASH CASS.	•••••	\$168.00
JENSEN J-1033 6x9 TRIAK II SRCL.	•••••	79.00
JENSEN J-1037 6x9 CO-AX II SRCL.	•••••	60.00
WRITE OR CALL FOR OTHERS INCLUDING SONY!!!!		

HEADPHONES

ROSS MODEL HV-X STEREO PHONES	•••••	\$41.50
ROSS PRO-IX NEW 2-WAY SYSTEM	•••••	49.50
SENNHEISER HD-224 LIGHTWEIGHT	•••••	81.00
SENNHEISER HD-114 HEADPHONES	•••••	45.00
SONY MDR-50T NEW SUPER PHONES	•••••	33.00

—send for free catalog—

Name _____
Address _____
City _____
State _____ Zip _____

illinois audio

12 East Delaware Place
Chicago 60611

Phone Now
(312)
664-0020

TOLL FREE
(800)
621-8042



CLASSICAL Reviews



Enrique Bátiz' blazing Three-Cornered Hat: almost a clean sweep—See page 59.

BRAHMS: Trios for Violin, Cello, and Piano: No. 1, in B, Op. 8; No. 2, in C, Op. 87; No. 3, in C minor, Op. 101.

Les Musiciens. HARMONIA MUNDI FRANCE HM 1063/4, \$23.96 (two discs, manual sequence). Tape—Op. 8: 40.1063, \$11.98 (cassette). (Distributed by Harmonia Mundi U.S.A., 2351 Westwood Blvd., Los Angeles, Calif. 90064.)

BRAHMS: Quartet for Piano and Strings, No. 3, in C minor, Op. 60. **SCHUMANN:** Quartet for Piano and Strings, in E flat, Op. 47.

An Die Musik. [Max Wilcox, prod.] PELICAN LP 2025, \$8.98. (Pelican Records, P.O. Box 34732, Los Angeles, Calif. 90034.)

BRAHMS: Quartet for Strings, No. 3, in B flat, Op. 67. **SCHUMANN:** Quintet for Piano and Strings, in E flat, Op. 44.*

LaSalle Quartet: James Levine, piano*. [Rainer Brock, prod.] DEUTSCHE GRAMMOPHON 2531 343, \$10.98. Tape: 3301 343, \$10.98 (cassette).

BRAHMS: Quintet for Piano and Strings, in F minor, Op. 34.

Dezső Ránki, piano; Bartók String Quartet. [András Székely, prod.] HUNGAROTON SLPX 12280, \$9.98.

After the deluge of Brahms trio recordings noted here last year (February 1981), it seems almost incredible that even more are on the way. (An additional EMI version, by Peter Frankl, György Pauk, and Ralph Kirshbaum, may also appear domestically.) The French Harmonia Mundi edition by

pianist Jean-Claude Penner, violinist Régis Pasquier, and cellist Roland Pidoux offers highly intense, cultivated readings—elegantly balanced, full of linear tension, and with a touch of astringency welcome in this music, which can so easily become smug and complacent. Perhaps these readings aren't quite as distinctive and appropriate as the group's Schubert trios (HM 1047/8, September 1981), but this is certainly a distinguished set. The Bis (LP 98/9, Trio Pro Arte) and Philips (Festivo 6770 007, Beaux Arts) alternatives give somewhat better value, however, since both include the early A major Trio.

An die Musik gives a sober, competent reading of Brahms's C minor Piano Quartet and an altogether more stimulating one of the Schumann work that undoubtedly inspired it. Since the first was recorded in 1979 at an undisclosed location and the second a year later at the Abraham Goodman House in New York, one can only speculate as to what accounts for a rather astonishing metamorphosis: the players' added experience; a personnel change (violinist Alan de Veritsch, who performed in the Brahms, was replaced in the Schumann by Jesse Levine—who has since ceded his place to Barbara Hustis); the livelier Goodman acoustics; or simply a greater affinity for Schumann. In any case, the Schumann is splendidly performed and reproduced with a scintillant brilliance; by comparison, the Brahms sounds claustrophobic.

The LaSalle disc completes a DG cycle of Brahms string quartets, complementing an earlier release of Op. 51 (2531 255, April 1981). There is something very satisfying about the LaSalle's almost Prussian steadiness of tempo in this music; all the typical Brahmsian rhythmic displacements are bound together with rugged authority. I also like the gruff bass line and the general unfussiness (though details are sharply articulated).

With James Levine's vital piano playing, the Schumann quintet takes off in a shower of gravel and maintains impetus impressively. As in last year's New York concert performance by the same artists, a few of the tempos seem constricted and inflexibly accented, yet this is certainly an interpretation with a (valid) point of view. DG's sound is splendid.

The Hungarian performance of the Brahms piano quintet is also hyperkinetic: Tempos are generally brisk, the rhythmic values stated with spring and articulation, and the sonorities warm enough but with an astringent, biting edge. The noble breadth of the Serkin/Budapest account (CBS MS 6631) is lacking, yet there is plenty of

Reviewed by:

John Canarina
Scott Cantrell
Kenneth Cooper
R. D. Darrell
Peter G. Davis
Kenneth Furie
Harris Goldsmith
Matthew Gurewitsch
David Hamilton
Dale S. Harris
R. Derrick Henry
Joseph Horowitz

Nicholas Kenyon
Allan Kozinn
Paul Henry Lang
Irving Lowens
Karen Monson
Robert P. Morgan
James R. Oestreich
Conrad L. Osborne
Andrew Porter
Patrick J. Smith
Paul A. Snook
Susan T. Sommer

drive, authority, and musical intelligence—a youthful performance, attractively presented. In some ways, I prefer this account to the recent Pollini/Quartetto Italiano (DG 2531 197, April 1981). H.G.

CHARPENTIER: David et Jonathas; Choral Works—See Page 52.

DVOŘÁK: The Devil and Kate.

CAST:

Princess	Brigita Šulcová (s)
Chambermaid	Natálie Romanová (s)
Kate	Anna Barová (ms)
Kate's Mother	Daniela Suryová (ms)
Jirka	Miloš Ježil (t)
Musician	Oldřich Poláček (t)
Marbuel	Richard Novák (b)
Lucifer	Jaroslav Horáček (bs)
Gatekeeper	Jan Hladík (bs)
Guard	Aleš Stáva (bs)
Marshall	Pavel Kamas (bs)

Brno Janáček Opera Chorus and Orchestra, Jiří Pinkas, cond. [Jan Vrána, prod.] SUPRAPHON 1116 3181/3, \$29.94 (three discs, manual sequence).

Like Haydn and Schubert, Dvořák never quite got the hang of opera, although he too poured a great deal of time, effort, and good music into the form. *The Devil and Kate*, composed in 1898–99, just before his most successful stage work, *Rusalka*, is almost as popular in Czechoslovakia—this, in fact, is its second recording. The first, which dates back to 1955, circulated here on the Artia label in the 1960s, and was available until recently on Aurora pressings.

The plot of *The Devil and Kate* is based on a Czech folk tale. Kate, a homely and sharp-tongued village girl, finds that no one will dance with her on fair day, so she furiously announces that she would dance with the Devil, if he'd only ask her. Sure enough, the Devil appears—actually Marbuel, a servant of Lucifer—and he not only dances with Kate, but convinces her to accompany him to Hell. This turns out to be a mistake, since Kate's peevish garrulity is more than Lucifer and his minions can stand, and they are all more than happy when Jirka, an out-of-work shepherd, comes to fetch her back.

Meanwhile, Marbuel returns to earth

to carry off the woman Lucifer really wanted, a Princess who has been misruling the country and making everyone miserable. By the time we meet the lady in Act III, she is repentant, promising Jirka and Kate anything if they can thwart the Devil's plans. That is easily accomplished—all Marbuel needs is one sight of Kate and he is off for good. The Princess rewards Jirka by making him prime minister, while Kate gets a brand-new house and her choice of a husband.

Mild stuff, you say. Perhaps so, but the libretto draws the characters effectively, has many genuinely amusing incidents, and never wastes any time. Onstage, with a lively cast and vigorous direction, the opera could be quite enjoyable. About the best to be said for Dvořák's music is that it rarely gets in the way and makes all the appropriate gestures, but hardly a note sticks in the mind after the curtain falls. The opera is an unusual one, offering no love interest and few opportunities for lyrical expansion, surely this composer's long suit. There are some catchy dance sequences, the orchestra always has interesting points to make, and the piece is put together with Dvořák's customary polished craftsmanship, but no one will discover a neglected masterpiece.

I rather prefer the old performance, which has considerably more sparkle and character, although the new entry makes a perfectly reasonable case for the opera. If

neither recording boasts a major voice in the cast, none is really needed. Now that Supraphon has been so generous to *The Devil and Kate*, the label might be persuaded to turn its attention to Dvořák's *Dimitrij* and *Armida*, also flawed works but of far greater musical interest. P.G.D.

FALLA: The Three-Cornered Hat.

Maria Luisa Salinas, mezzo-soprano; Orquesta Sinfónica del Estado de México, Enrique Bátiz, cond. [Brian B. Culverhouse, prod.] VARÈSE SARABANDE VCDM 1000.170, \$15 (digital recording).

COMPARISONS:

Salinas, Mata/London Sym. RCA ARL 1-2387 DeGaetani, Boulez/N.Y. Phil. CBS M 33970

Veteran discophiles who remember Ansermet's 1952 mono and 1961 stereo historical milestones of sonic spectacle find it hard to understand why Falla's kaleidoscopic ballet score has been relatively neglected lately. Only now, indeed, do we get a long-overdue digitally recorded complete version. But it's well worth the wait, with even more technological power than expected applied to the most blazingly ferocious Spanish-Gypsy interpretation to date—one that makes most others seem almost staid and outdoes even the unforgettable 1960 Jorda Everest reading in uncurbed animal spirits.

My first exposure to the fast-rising Mexican conductor Enrique Bátiz (b.

1942), noted in this month's "Tape Deck," came in the form of one of his first Angel releases—a highly idiosyncratic program of Arbós orchestrations of Albéniz piano works; it scarcely prepared me for the white-hot passion he and his compatriots bring to a twentieth-century masterpiece too often underappreciated or enjoyed only in excerpted bleeding chunks. Even Mata's scarcely less idiomatic, more poetic reading with the London Symphony (HF, September 1978) pales in comparison; and its high-end sonic deficiencies compare unfavorably with the naturalness of the present Soundstream digitalism, which paradoxically offers both transparency and solidity, enhanced by first-rate half-speed disc mastering and processing. And while the 1976 Boulez sonics still remain impressively brilliant, especially in quadriphonic playback, that Franco-American performance never evokes as pungently the earthy scents of Falla's Aragonese countryside.

It's not quite a clean sweep for Bátiz: Mata's standard-price version includes Falla's complete *Amor brujo* and has the best bassoon soloist, that "satirical musical surrogate of the officious mayor" in the ballet plot. And the standard-price Boulez version stars the most attractive vocal soloist, Jan DeGaetani, and includes the outstanding recording, with Igor Kipnis, of Falla's harpsichord concerto. Moreover, Bátiz' Mexican orchestra is not the most precise or

ORIGINAL MASTER RECORDINGS™

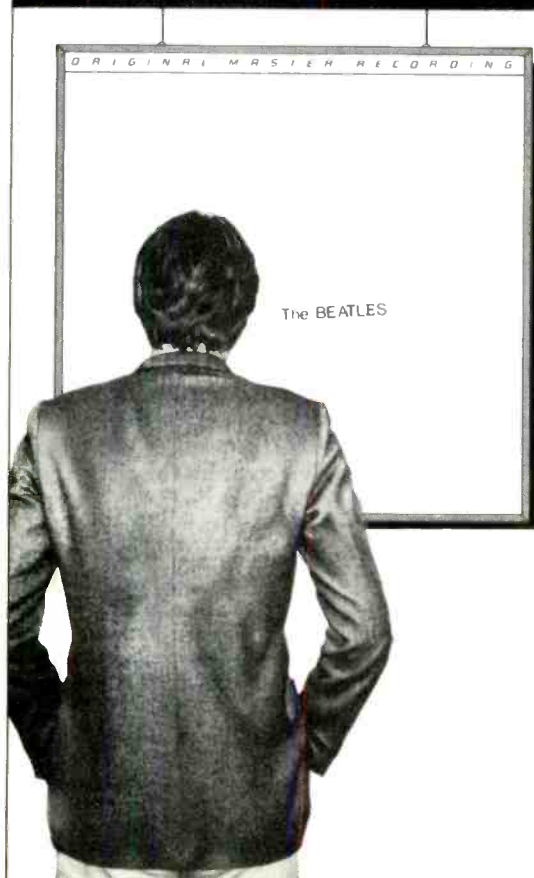

SONIC MASTERPIECES GUARANTEED TO IMPROVE THE PERFORMANCE OF YOUR STEREO SYSTEM!

Our Original Master Recordings are exclusively transferred from the original recording studio master tapes of the world's finest artists. Every note and nuance is faithfully reproduced exactly as it was first recorded. Additionally, each of our Lp's and cassettes are Limited Editions, guaranteeing you absolute quality control.

Choose from our newest Original Master Recordings, featuring such artists as Supertramp, Frank Sinatra, Hall & Oates, The London Philharmonic, Queen, Quincy Jones, Neil Diamond, Alan Parsons and more than 60 other selections. Available at fine audio salons, record stores and autosound showrooms. Only from Mobile Fidelity Sound Lab.

For a FREE copy of our newest color catalogue plus exclusive information regarding upcoming new products and releases, circle the reader response card in this magazine or write: Mobile Fidelity Sound Lab, Dept. HFS, P.O. Box 919, Chatsworth, CA 91311.



Critics' Choice

The most noteworthy releases reviewed recently

BACH: *Harpisichord Concertos (6)*. Koopman. PHILIPS 6769 075 (2), April.
BEETHOVEN: *String Quartet No. 1 (orig. version)*. Pro Arte Quartet. LAUREL LR 116, Jan.
BIRTWISTLE: *Punch and Judy*. Roberts, Wilson-Johnson. Atherton. DECCA HEADLINE HEAD 24/5 (2), Dec.
BLOCH, E.; HINDEMITH: *Viola-Piano Works*. Schotten, Collier. COMPOSERS RECORDINGS SD 450, April.
CAVALLI: *Ercole amante*. Palmer, Cold, Corboz. ERATO STU 71328 (3), May.
CHOPIN, MUSSORGSKY: *Piano Works*. Schenly. DIGITECH DIGI 108, April.
DELIUS: *The Fenby Legacy*. Royal Philharmonic, Fenby. UNICORN-KANCHANA DKP 9008/

9 (2), Feb.
DEL TREDICI: *Final Alice*. Hendricks, Soliti. LONDON LDR 71018, April.
FRANCK, SZYMANOWSKI: *Violin-Piano Works*. Danczowska, Zimerman. DG 2531 330, March.
MARTINŮ: *The Greek Passion*. Mitchinson, Tomlinson, Mackerras. SUPRAPHON 1116 3611/2 (2), April.
MOSZKOWSKI: *Piano Concerto in E, Op. 59*. Bar-Illan, Antonini. AUDIOFON 2003, May.
PUCCINI: *Tosca*. Scotto, Domingo, Bruson, Levine. ANGEL DSBX 3919 (2), March.
PURCELL: *Dido and Aeneas*. Kirkby, Thomas, Parrott. CHANDOS ABRD 1034, May.
RODRIGO: *Concierto de Aranjuez; Fantasia para un gentilhombre*. Bonell, Dutoit. LONDON LDR 71027, May.
SCHUBERT: *Lazarus; Mass, D. 167*. Armstrong, Johnson, Guschlbauer. ERATO STU 71442 (2), May.
SCHUBERT: *Piano Works*. Goode. DESMAR

SRB 6001/2 (2, tape only), May.
SCHUBERT: *Song Cycles and Songs*. Hüsck. ARABESQUE 8107-3L (3), March.
SCHUBERT, WOLF: *Songs*. Pears, Britten. BBC REGL 410, March.
SCHUBERT: *Trout Quintet*. Sawallisch, Endres Qt. EURODISC 25 567, April.
SHOSTAKOVICH: *Symphonies Nos. 1, 9*. London Philharmonic, Haitink. LONDON LDR 71017, May.
SMETANA, SUK: *String Quartets*. Bohemian Quartet. PARNASSUS 1001, Feb.
TANEYEV: *Piano Quartet*. Cantilena Chamber Players. PRO ARTE PAD 107, April.
TIPPETT: *King Priam*. Harper, Tear, Bailey, Atherton. LONDON LDR 73006 (3), March.
WEILL: *Songs*. Stratas, Weitach. NONESUCH D 79019, Feb.
BOLCOM AND MORRIS: *Rodgers and Hart Album*. RCA ARL 1-4123, March.
GERMAN CHAMBER MUSIC BEFORE BACH. Cologne Musica Antiqua, Goebel. ARCHIV 2723 078 (3), Jan.

polished in the world (but who cares about that when deliriously intoxicated by its uninhibited and inexhaustible exuberance?), and there's at least one serious engineering miscalculation: the lack of the *off-stage* presentation (as demanded by the plot) of the "cuckoo" solo of the mezzo-soprano—here the same Maria Luisa Salinas, also near ideal in the Mata version.

But enough niggling. If you can afford the premium price of this latest *Sombrero de tres picos*, you get your money's worth and more in electrifying dramatic excitement—musical and sonic bravura at their most potent. The only way to do better is to obtain the same recorded performance in its alternative DBX-encoded edition. R.D.D.

HAYDN: Sonatas for Keyboard (5)—See page 55.

HAYDN: Songs—See Mozart.

JANÁČEK: From the House of the Dead.

CAST:

Alieia	Milada Jirglová (s)
Harlot	Alena Míková (ms)
Filka	Vilém Přibyl (t)
Skuratov	Ivo Žídek (t)
Tall Prisoner	Jaroslav Stříška (t)
Old Prisoner	Beno Blachut (t)
Drunken Prisoner	Miroslav Frydlewicz (t)
Young Prisoner/Voice	Miroslav Švejda (t)
Shapkin/Kedril	Milan Karpíšek (t)
Cherevin	Viktor Kočí (t)
Guard	Jaromir Bělor (t)
Shishkov	Jaroslav Souček (b)
Goranchikov	Richard Novák (b)
Chekunov	Jindřich Jindrák (b)
Don Juan	Karel Pruša (b)

Blacksmith	Jiří Holeňa (b)
Short Prisoner	Karel Berman (bs)
Commandant	Jaroslav Horáček (bs)
Cook	Jaromir Vavruška (bs)
Clergyman	Karel Petr (bs)

Czech Philharmonic Chorus and Orchestra, Václav Neumann, cond. [Milan Slavický, prod.] SUPRAPHON 1116 2941/2. \$19.96 (two discs, manual sequence).

COMPARISON:

Mackerras/Vienna St. Op. Lon. LDR 10036

From the House of the Dead, based on Dostoevsky's depressing study of life in a Siberian prison camp, appeared in a definitive London recording two years ago (HF, July 1986), the first performance to follow the composer's autograph scrupulously in nearly every detail. The textual controversy that has surrounded the opera since its premiere in 1930, two years after Janáček's death, finally seemed to be resolved. Until the release of the London discs, *House of the Dead* had usually been performed in a heavily edited arrangement by Břetislav Bakala and Osvald Chlubna, who were convinced that the opera's austere instrumentation and numerous compositional peculiarities indicated that Janáček never actually completed the work.

In his liner notes for London, John Tyrrell convincingly argued that the composer knew exactly what he wanted, there being no evidence at all that the work was left in an unfinished state. Like all of Janáček's mature operas, *House of the Dead* was created in three progressive drafts; the final one in each previous case differed only in minor ways from what eventually became the definitive printed score, and there is no documentation to prove that the composer had changed this procedure for his last opera.

Now here is a new Supraphon recording that goes back to Bakala-Chlubna in most particulars, except that it does dispense with the now universally discredited bogus finale. In his notes for this performance, conductor Václav Neumann states that "the so-called original is an incomplete work, which, especially in its third act, is the first outline rather than a finished composition." Neumann admits, rather disarmingly, that this observation is based more on a practicing musician's instinct than on any factual proof, and that every future interpreter of *House of the Dead* will simply have to make up his own mind. For Neumann, the opera just sounds better this way.

Apparently what we have here is a twentieth-century *Boris Godunov* dilemma—purists will always take Mussorgsky's rough-hewn original as representing the composer's true vision, warts and all, while others will never be able to resist Rimsky-Korsakov's glittering recomposition. In Janáček's case, though, there is no artistic justification for such an attitude, not even time-honored tradition: one might just as well refuse to acknowledge Bach's organ Toccata and Fugue in D minor as the real thing because Stokowski's orchestration makes such an irresistible impact.

Supraphon's recording presents an analogous situation, primarily because Neumann is a superb conductor and he delivers an exceptionally powerful performance of the bowdlerized score. Many listeners might even prefer him to Mackerras for the simple reason that the thickened orchestral textures sound so seductively lush compared to the biting acerbity of the authentic version. The singers, too, give gripping accounts of their roles, the orches-

Loran™ is the cassette of the future... but it's here right now. The original and only heat resistant cassette shell and tape that withstands the oven temperatures of a car dashboard in the sun. Testing proves that even TDK or Maxell cannot take this kind of punishment.

With Loran, you'll capture a full range of sound as you've never heard it before. Tape that delivers magnificent reproduction of highs and lows, along with an exceptionally low background noise level. Super sensitive with an extremely high maximum recording level capability. That means you can record Loran at high input levels for greater clarity. As a matter of fact, we recommend it.

Because of our cassette shell, Loran

tape can stand up to being accidentally left near a source of excessive heat in your home or in your car. It is indeed the finest quality tape available today.

Loran also has exclusive features not available on any other cassette. Safety Tabs™ (patent pending) prevent accidental erasures. But unlike other cassettes, you can restore its erase and record capabilities simply by turning the Tab screw a 1/2 turn. Our Hub Lock (patent pending) secures the tape to the hub in such a way that the harder it is pulled the tighter it's held.

With all these features, it's no wonder Loran was selected as "one of the most innovative consumer electronics products..." by the Consumer Electronics Show Design and Engineering Exhibition.

Every Loran tape comes with a full lifetime warranty. Listen to Loran. The new generation of cassettes is here right now.



LORAN™
The Design of Spectacular Sound

**WHEN ALL OTHERS FAIL...LORAN CASSETTES
ARE SAFE AND SOUND SENSATIONAL.**



Actual cassettes tested in a closed car in the sun.

Loran™ is manufactured exclusively by Loranger Entertainment, 10-48 Clark Street, Warren, Pa. 16365

tra plays brilliantly, and the wide-ranging sonics show a vast improvement over many recent discs from Czechoslovakia. For anyone who wants to hear the real Janáček, though—examining the stark reality of imprisoned humanity with a compassionate, unsentimental, and piercingly truthful eye—only the London recording will do.

P.G.D.

KOTIK: Many Many Women.

SEM Ensemble, Petr Kotik, dir. [Heiner Stadler, prod.] LABOR LAB 6/10, \$44.90 (five discs, manual sequence) (Labor Records, P.O. Box 1262, Peter Stuyvesant Station, New York, N.Y. 10009).

It stands to reason that, as minimalism comes of age, the repertory it spawns will have its share of successes and failures. Petr Kotik's *Many Many Women* is among the latter. Part chance, part minimal, and part organum, the piece looks promising on paper: It contains 173 sections, each a setting of part of the Gertrude Stein text. Between two and six pairs of performers may participate (there are six here—flutists, trombonists, clarinetists, sopranos, tenor and countertenor, baritone and bass), dividing the 173 bits more or less equally. Each pair may transpose each of its sections to any pitch, but must render the music in parallel fourths, fifths, or octaves. Pairs read their parts in numerical order, pausing as long as they like between sections.

Melodically, the 173 lines vary from unwaveringly bland to rather chromatic; rhythmically, they are all square and chant-like. But the score's "directions" allow for so many possibilities that one would expect something interesting to emerge, if only by chance, as the ensemble's texture and density change and as the variously pitched pairs intermingle. Variety there is, and the work can scarcely be called static; yet the musical ideas are so paltry that organizational variety alone cannot sustain the piece for long. When an interesting idea does arrive, it turns out not to have been worth the wait.

Also, with its insistent androidlike declamation and its open fourths and fifths, *Many Many Women* becomes very very grating, and patience is guaranteed to wear thin by the end of any side. I confess that I could not bring myself to endure all ten sides (214 minutes, 30 seconds), but I at least sampled each, and I did sit through several, much of the time meditating on the relative charms of Chinese water torture. To create in any idiom a work that is both utterly boring and punishingly long seems to me a cardinal sin, but apparently I have taken the wrong approach: According to a note on the boxed set's back cover, this piece "isn't music you listen to so much as live with." Personally, I think wallpaper should be seen and not heard. The set does come with a poster.

A.K.

MOZART: Concert Arias for Soprano (35).

Time-Life's Mozart set is so handy that I wish the performances were more involving.

Kiri Te Kanawa, Edita Gruberová, Krisztina Laki, and Elfriede Höbarth, sopranos; Teresa Berganza, mezzo-soprano; Vienna Chamber Orchestra, György Fischer, cond. (With guest appearances by Joan Sutherland, soprano; National Philharmonic Orchestra, Richard Bonynge, cond.; London Symphony Orchestra, John Pritchard, cond.) [Christopher Raeburn, prod.] TIME-LIFE RECORDS M 16, \$29.95 (five discs, manual sequence). Tape: \$34.95 (five cassettes). (Add \$2.81 for shipping; Time-Life Records, 541 N. Fairbanks Ct., Chicago, Ill. 60611.)

[N.B.: The Te Kanawa material is available as London OS 26661, \$10.98.]

HAYDN: Songs (48).

Elly Ameling, soprano; Jörg Demus, piano. PHILIPS 6769 064, \$32.94 (three discs, manual sequence). Tape: 7654 064, \$21.96 (two cassettes).

As reference sources, both of these collections avoid certain pitfalls of the genre. Time-Life has sensibly split the load of Mozart's concert arias for soprano five ways, allotting each singer a sort of disc-long recital drawn from the full chronological span of the material, so that none of them is stuck with a narrow band of the spectrum, and we're not stuck with a chronological listening sequence. While Philips has made do with a single soloist for the much simpler Haydn songs, she is a singer known for stylistic and linguistic versatility, and here too the published sequence has been juggled in the interest of effective presentation.

If you're interested in having this material, you'll be glad to know that it has been so conscientiously prepared. And certainly the Mozart arias are worth having, containing as they do so much strong writing spanning his career. It's awfully handy having all of this neatly gathered in one box, so handy that I wish the performances were more involving. Whereas the Haydn songs, although quite decently performed, would seem to be material of rather limited interest.

The Mozart set, as I understand it, is the first installment to be recorded expressly for Time-Life's Mozart collection. Deca/London's Christopher Raeburn has both produced and annotated the volume, incorporating two numbers from his company's existing catalog: Teresa Berganza's "*Ch'io mi scordi di te?*," K. 505, from her 1962 Mozart recital (an obvious candidate for Jubilee reissue), and Joan Sutherland's

"*Vorrei spiegarvi, oh Dio.*," K. 418, from the Mozart program that David Hamilton received so coolly in September 1980.

Granting the good sense of Time-Life's division of labor, there remains the question of where we're going to find five singers capable of making either musical or emotional sense of these arias. Or even one.

Since these arias were generally written to show off the abilities of particular singers, we shouldn't be surprised that they tend to be fiercely difficult, what with those coloratura eruptions and the frequent stratospheric extensions. In case you're inclined to hope that the presence of unfamiliar names here indicates major vocal discoveries, forget it. Elfriede Höbarth is as shrill and picky here as she was as Fiakermilli in the recent Angel *Arabella* (reviewed below). Krisztina Laki, who is new to me, is tonally a bit more solid, but not much.

Among the more familiar singers, Gruberová is a notch above Laki, but listen to her sing Susanna's "*Giunse alfin il momento*" recitative and ask yourself whether you'd care to hear her go on to "*Deh vieni, non tardar.*" What she in fact goes on to, and the reason she sings a familiar recitative here, is an outrageously flashy replacement aria, "*Al desio di chi t'adora.*" K. 577, one of two arias written for the Susanna of the 1789 Vienna *Figaro* revival. The other, "*Un moto di gioia.*" K. 579, is a quickie that sounds more like a substitute for Cherubino's "*Non so più.*" at least as sung by Berganza, who handles her assignments like a canny old pro. Of course her material is by and large easier than the others'. Less high-flying anyway.

The most appealing vocalism, not surprisingly, comes from Te Kanawa, but she doesn't make much of her selections. And, in the end, these arias may be more daunting emotionally than vocally, considering that the performer has to create a full human context for each without the benefit of familiar operas surrounding them. (The Te Kanawa disc, incidentally, has now been issued by London itself, with bare-bones notes.)

Unlike the singers, György Fischer and the Vienna Chamber Orchestra had to learn *all* this material, and a right nice job they did. They don't display a lot of imagination, but the playing is consistently spirited and colorful, and so a good deal of richly imagined orchestral writing is well conveyed by the attractive recorded sound. The booklet of notes and texts is exemplary except for the omission of an overall contents listing to show what's where and who sings what. You'd better make your own, or you'll go crazy trying to find anything.

Perhaps the best way to approach the Mozart collection is one or two arias at a time, and this may also be the case with the Haydn songs. What the Philips set contains is the total of forty-eight songs published in the collected edition: two sets of twelve

More Tchaikovsky, Ho . . . Huh?

Reviewed by John Canarina



Geoffrey Simon secures brilliant, sensitive playing from an unbored London Symphony

SO YOU THINK YOU KNOW your Tchaikovsky, eh? I thought I did until this fascinating album arrived. It's a bit ironic that several major works by one of the world's most popular and beloved composers should only now receive their first recordings—or in the case of the *Hamlet* music, first complete recording. If you wonder how the thrice familiar *Romeo and Juliet* falls into this category, please note that this is the composer's first version, of 1869.

As is well-known, Tchaikovsky wrote *Romeo* at the instigation of Mily Balakirev, who was not satisfied with the result. Tchaikovsky then revised the score twice, incorporating Balakirev's suggestions: it's the final revision of 1880 that has become the standard version we know all too well. But since the original was not destroyed, we are able to enter the composer's workshop, as it were, to observe his first thoughts on the subject. No one hearing the beginning of this score for the first time could guess that it's *Romeo*. It opens not with a chorale, but with three minutes of music that does not appear at all in the final version, a simple, folklike melody developed to a majestic climax. Only then comes a hint of the "love theme," followed by the familiar agitated *Allegro giusto* section, common to all three versions, and the love music, intact. Most striking is the ensuing fugal development, also not heard in the final version. There are many other differences, including a shortened coda with only two loud chords over the final timpani roll. (Balakirev disapproved of all the endings; he felt the work should end quietly, an opinion shared by Leopold Stokowski, whose performances always concluded in that manner.)

One can, of course, question the propriety of resurrecting a composer's first version when the final one is such an acknowledged masterpiece. After all, a recording artist certainly wouldn't want an inferior "take" released, nor would I be happy to see the first draft of this review printed rather than the obvious masterpiece you're now reading. The 1869 *Romeo* does suffer in comparison with the 1880; structurally it is more overtly sectional, and the material is not fully developed. So why play it? Because it contains interesting material not heard elsewhere and because—while it's not apt to replace the other, nor should it—it provides a refreshing alternative. To hear it is to return to the now hackneyed standard version with fresh ears and a heightened perception of its greatness. Besides, no one minds that there are three *Leonore* Overtures.

The real find of this set is the *Festival Overture on the Danish National Hymn*, written in 1866 to commemorate the visit to Moscow of the tsarevitch and his Danish bride. It's yet another of Tchaikovsky's works incorporating the tsarist national hymn, and he came to rate it "in musical quality much better than the *1812 Overture*." While this may or may not be so, depending on your feelings about *1812*, it is in any case a rousing and effective work undeserving of its long oblivion.

The incidental music to *Hamlet*, from the late 1880s, was composed somewhat halfheartedly for a St. Petersburg performance of Shakespeare's tragedy by the French actor Lucien Guitry and his company. Some of the score reworked existing music: the Overture is a condensation of the *Hamlet Fantasy Overture*, and the Act II

Entr'acte derives from the second movement (*Alla tedesca*) of the Third Symphony. There is, however, sufficient new music of interest to make the complete score worth hearing, if not an effective concert work in toto. (Excerpts would be most welcome.) Outstanding are the Act IV Entr'acte (an "Elegy for Strings" that certainly merits an independent life of its own), the Act V Funeral March, and the Act III Melodrama, with a haunting bassoon theme over syncopated strings. Three striking vocal numbers add variety: two Scenes of Ophelia sung (and spoken) affectingly by soprano Janis Kelly and a brief Gravedigger's Song with Derek Hammond-Stroud the macabrely humorous baritone soloist. These are sung in French, in keeping with the production for which they were written. The remainder of the score consists largely of short brass fanfares and snippets of music plus complete or partial repetition of some of the other numbers. This recording is complete, with a vengeance.

The brief *Serenade for Nikolai Rubinstein's Name Day* is pleasantly unmemorable (unmemorably pleasant?). The excerpts from *Mazeppa* are vigorous and robust; the colorful Cossack Dance is already familiar from several recordings.

This is an important release not only for the new light it throws on Tchaikovsky, but also for the opportunity it affords to become acquainted with the work of the young Australian-born conductor Geoffrey Simon, currently music director of the orchestras and opera at the University of Wisconsin in Milwaukee. Unfailingly musical, his conducting projects convincingly the passion and excitement of the scores, as well as their many moments of delicacy and repose. He secures brilliant and sensitive playing from the London Symphony Orchestra, which obviously relishes *not* recording another *1812* or *Pathétique*. One looks forward to hearing from Simon again before too long.

The whole project was the happy idea of Edward Johnson, who provides the extremely informative annotations (from which I have cribbed unashamedly). An ardent Tchaikovskian, he was unable to interest any of the major companies in this repertoire; it is to Chandos' credit that it took up the cause—and with such splendid results. **HF**

TCHAIKOVSKY: *Orchestral Works*.

Janis Kelly, soprano*; Derek Hammond-Stroud, baritone*; London Symphony Orchestra. Geoffrey Simon, cond. CHANDOS DBRD 2003. \$29.98 (digital recording; two discs, manual sequence) (distributed by Sine Qua Non Productions, Ltd., One Charles St., Providence, R.I. 02904).

Festival Overture on the Danish National Hymn, Op. 15. *Hamlet* Incidental Music, Op. 67a.* *Mazeppa*: Battle of Poltava; Cossack Dance. *Romeo and Juliet* (orig. version). *Serenade for Nikolai Rubinstein's Name Day*.

German songs, published in 1781 and 1784; two sets of six English canzonettas, published in 1794 and 1795; plus a dozen miscellaneous settings, including two in Italian.

Unlike Mozart, Haydn seems to have had no special feel for the voice, nor was he much of a melodist per se—and remember that even Mozart didn't do much with the song form. This said, Haydn's songs are all well crafted, and after those first two dozen German songs, which are so simple as to be barely noticeable, there is a good deal of charm and sensibility in evidence. I wonder whether more substance mightn't be revealed by a performer—even Ameling herself—who was dealing with only a few, precisely chosen songs. In any event, we now have a convenient way of hearing what there is to choose from.

The accompaniments don't challenge Demus. The sound is okay, and there are adequate notes and texts. **K.F.**

RAMEAU: Dardanus; Nais; La Princesse de Navarre; Hippolyte et Aricie: Suite—See Page 52.

SCHUMANN: Piano Quintet, Op. 44; Piano Quartet, Op. 47—See Brahms.

STENHAMMAR: Symphony No. 2, in G minor, Op. 34.

Stockholm Philharmonic Orchestra. Stig Westerberg, cond. [Håkan Elmquist, prod.] CAPRICE CAP 1151, \$10.98 (distributed by Fonodisc International, Inc., 535 E. 86th St., New York, N.Y. 10028).

Just because you don't find the name Wilhelm Stenhammar (1871–1927) listed in SCHWANN, you should not infer that he wasn't a fine composer. To disabuse yourself of any such notion, you have only to sample one of his major works; his Second Symphony, begun in 1911 and completed in 1915, is an excellent place to start.

For reasons difficult to fathom, Swedish composers of Stenhammar's generation—contemporaries of Carl Nielsen and Jean Sibelius—are just about unknown on this side of the Atlantic. Although somewhat less prolific than his better-known Scandinavian colleagues, particularly as a creator of orchestral music, Stenhammar was no less gifted; in his own country, at least, he is accepted as one of the leading figures of his time. Certainly this Romantic, contrapuntal, and essentially modal symphony (sometimes referred to as the *Dorian*) ranks as an impressively powerful and eloquent work that can easily hold its own with any major orchestral work written during the decade.

Stenhammar himself never referred to this as his "Second" Symphony; he abandoned his first attempt, completed in 1903,

For the first time, Stenhammar's G minor Symphony gets the treatment it merits.

as unworthy of publication after having heard Sibelius' First Symphony, and considered the G minor his only successful venture in the genre. Although recognized as a concert pianist of international standing and one of Sweden's leading conductors, as well as a gifted composer of songs and chamber music, Stenhammar was essentially an autodidact and as late as 1909 felt somewhat insecure about his compositional technique. In that year he began to work through the exercises in Heinrich Beller-mann's *Der Kontrapunkt* (1862), a work that revived the theories of J.J. Fux's *Gradus ad Parnassum* (1725), and the results of his study are very evident in this symphony, especially in his magnificent treatment of fugato in the final movement.

There is much discussion in the literature on Scandinavian music about the "Swedish" character of Stenhammar's writing, and Bo Wallner's excellent notes attempt to tie the symphony to Swedish folksong. I don't hear it. True, there is an occasional reminiscence of Sibelius or Nielsen, both of whom Stenhammar conducted and greatly admired, but on the whole, the flavor of the piece is international rather than Scandinavian—much less Swedish. By the time Stenhammar took up this symphony, he had rejected the Romantic chromaticism of Wagner and Strauss and developed into something of an embryonic neoclassicist. The influence of Brahms is strong in his late works, although perhaps not quite so evident here as in other compositions.

Surprising as it may seem, this is the symphony's third recording. Its history goes back to the days of shellac; it was considered so important in the history of Swedish music that it was released on twelve sides in a recording by the Göteborg Radio Orchestra under the direction of Sixten Eckerberg on the Radiotjänst label. This was followed, in early LP days, by Tor Mann and the Stockholm Philharmonic (RCA Victor), but the performance lacked intensity and conviction. As long ago as 1973, David Hall was complaining bitterly about the need for a good recording of the work. His wish has been realized in this resplendent reading by Stig Westerberg and the Stockholm Philharmonic in a recording that makes that excellent orchestra sound like one of Europe's greatest. It would be fair to say that this is the first time Stenhammar's

G minor Symphony gets the sort of sympathetic treatment it merits, and the disc should do much to enhance the composer's reputation outside Sweden. Perhaps it will even inspire somebody to take up once again Stenhammar's D minor Piano Concerto, surely one of the most thrilling of the post-Romantic big machines for virtuoso. The now unavailable EMI recording by Janos Solyom, assisted by the Munich Philharmonic under the baton of Westerberg, is eagerly sought by cognoscenti. **I.L.**

STRAUSS, R.: Intermezzo, Op. 72.

CAST:

Christine Storch	Lucia Popp (s)
Anna	Gabriele Fuchs (s)
Notary's Wife	Gudrun Greindl-Rosner (s)
Baron Lummer	Adolf Dallapozza (t)
Kapellmeister Stroh	Martin Finke (t)
Robert Storch	Dietrich Fischer-Dieskau (b)
The Notary	Klaus Hirte (b)
Commercial Counselor	Raimund Grumbach (b)
Legal Counselor	Jörn W. Wilsing (b)
Kammersänger	Kurt Moll (bs)
Little Franzl Storch	Philipp Brammer (spkr)

Bavarian Radio Symphony Orchestra. Wolfgang Sawallisch, cond. [Theo Holzinger, Helmut Storzjohann, and Christfried Bickenbach, prod.] EMI GERMANY IC 165-30983/5. \$35.94 (three discs, manual sequence) (distributed by German News Co., 220 E. 86th St., New York, N.Y. 10028).

STRAUSS, R.: Arabella, Op. 79.

CAST:

Arabella	Julia Varady (s)
Zdenka	Helen Donath (s)
Fiakermilli	Elfriede Höbarth (s)
Adelaide Waldner	Helga Schmidt (ms)
Fortune Teller	Doris Soffel (s)
Matteo	Adolf Dallapozza (t)
Count Elemer	Hermann Winkler (t)
Mandryka	Dietrich Fischer-Dieskau (b)
Count Dominik	Klaus-Jürgen Küper (b)
Count Lamoral	Hermann Becht (bs-b)
Count Waldner	Walter Berry (bs-b)

Bavarian State Opera Chorus, Bavarian State Orchestra. Wolfgang Sawallisch, cond. [F. Axel Mehrle, Dieter Sinn, Diether G. Warneck, and Christfried Bickenbach, prod.] ANGEL DSCX 3917, \$33.94 (digital recording; three discs, manual sequence).

CAST:

Arabella	Maria Reining (s)
Zdenka	Lisa della Casa (s)
Fiakermilli	Herma Handl (s)
Adelaide Waldner	Rosette Andlay (ms)
Fortune Teller	Ruth Michaelis (ms)
Matteo	Horst Taubmann (t)
Count Elemer	Julius Patzak (t)
Mandryka	Hans Hotter (b)
Count Dominik	Josef Witt (b)
Count Lamoral	Alfred Poell (b)
Count Waldner	Georg Hann (bs-b)

Vienna State Opera Chorus, Vienna Philharmonic Orchestra. Karl Böhm, cond. DISCORP RR 525, \$24 (mono; three discs, manual sequence) [recorded in performance, August 12, 1947] (Discocorp, Inc., P.O. Box 771, Berkeley, Calif. 94701).

The opening scene of *Intermezzo* calls to mind an acting exercise in which you are called on to concoct a series of three sequential phone conversations, involving

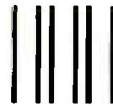

NO POSTAGE
NECESSARY
IF MAILED
IN THE
UNITED STATES

BUSINESS REPLY MAIL

FIRST CLASS PERMIT NO. 550 PITTSFIELD, MASS.

Postage will be paid by addressee

**High
Fidelity**

Reader Service 82
P.O. Box 1143
Pittsfield, Mass. 01202



HIGH FIDELITY's Reader Service Program puts you in contact with manufacturers anxious to send you free information about their merchandise and services. Simply circle the key numbers that match editorially featured or advertised products in which you have more interest.

Please be sure to complete the name and address section of our postage-paid reply card, including your zip code, to insure accurate delivery of brochures. Allow four to six weeks for processing.

You may also use the reply card to contact our editors: we are interested in you and in your opinions, so feel free to complete that section of the card in confidentiality.

Thank you.

NEW!

**READER
SERVICE
NOW INVITES
YOUR
EDITORIAL
COMMENTS!**

High Fidelity™

FREE PRODUCT DATA

Please circle the appropriate numbers:

1	2	3	4	5	6	7	8	9	10
11	12	13	14	15	16	17	18	19	20
21	22	23	24	25	26	27	28	29	30
31	32	33	34	35	36	37	38	39	40
41	42	43	44	45	46	47	48	49	50
51	52	53	54	55	56	57	58	59	60
61	62	63	64	65	66	67	68	69	70
71	72	73	74	75	76	77	78	79	80
81	82	83	84	85	86	87	88	89	90
91	92	93	94	95	96	97	98	99	100

Dear Editor:

In general, I would like more coverage of _____
and I would like less coverage of _____

In this issue I liked _____ the most and
_____ the least.

I would also like to suggest that _____

Age _____ Sex _____ Marital Status _____

Approximate annual family income:
 ___ Under \$9,999 ___ \$25,000-\$34,999
 ___ \$10,000-\$14,999 ___ \$35,000-\$49,999
 ___ \$15,000-\$19,999 ___ \$50,000-\$74,999
 ___ \$20,000-\$24,999 ___ \$75,000 or more

NAME _____
 ADDRESS _____ APT. _____
 CITY _____ STATE _____ ZIP _____

Card void if mailed after 9/1/82
 (Please remember it takes 4-6 weeks for processing and delivery of literature.)

THANK YOU FOR YOUR INTEREST IN HIGH FIDELITY 6/2/S

NEW!

READER SERVICE NOW INVITES YOUR EDITORIAL COMMENTS!

HIGH FIDELITY's Reader Service Program puts you in contact with manufacturers anxious to send you free information about their merchandise and services. Simply circle the key numbers that match editorially featured or advertised products in which you have more interest.

Please be sure to complete the name and address section of our postage-paid reply card, including your zip code, to insure accurate delivery of brochures. Allow four to six weeks for processing.

You may also use the reply card to contact our editors: we are interested in you and in your opinions, so feel free to complete that section of the card in confidentiality.

Thank you.

Please circle the appropriate number/s:

1	2	3	4	5	6	7	8	9	10
11	12	13	14	15	16	17	18	19	20
21	22	23	24	25	26	27	28	29	30
31	32	33	34	35	36	37	38	39	40
41	42	43	44	45	46	47	48	49	50
51	52	53	54	55	56	57	58	59	60
61	62	63	64	65	66	67	68	69	70
71	72	73	74	75	76	77	78	79	80
81	82	83	84	85	86	87	88	89	90
91	92	93	94	95	96	97	98	99	100

Dear Editor:

In general, I would like more coverage of _____ and I would like less coverage of _____

In this issue I liked _____ the most and _____ the least.

I would also like to suggest that _____

Age _____ Sex _____ Marital Status _____

Approximate annual family income:

_____ Under \$9,999	_____ \$25,000-\$34,999
_____ \$10,000-\$14,999	_____ \$35,000-\$49,999
_____ \$15,000-\$19,999	_____ \$50,000-\$74,999
_____ \$20,000-\$24,999	_____ \$75,000 or more

NAME _____

ADDRESS _____ APT. _____

CITY _____ STATE _____ ZIP _____

Card void if mailed after 9/1/82

(Please remember: it takes 4-6 weeks for processing and delivery of literature.)

THANK YOU FOR YOUR INTEREST IN HIGH FIDELITY

6/2S

High Fidelity™

FREE PRODUCT DATA

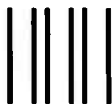

NO POSTAGE
NECESSARY
IF MAILED
IN THE
UNITED STATES

BUSINESS REPLY MAIL

FIRST CLASS PERMIT NO. 550 PITTSFIELD, MASS.

Postage will be paid by addressee

High Fidelity

Reader Service 82
P.O. Box 1143
Pittsfield, Mass. 01202



three very precise and very different relationships, the purpose being to discover how *you* change, in effect become a different person in instantaneous response to different circumstances and relationships.

In that first scene of *Intermezzo*, Christine Storch, wife of the celebrated composer-conductor Robert Storch, has to deal with a teeming household that includes: her husband (about to depart for a two-month stay in Vienna), her personal maid and confidante, two housemaids and a cook, her small son, and a telephone operator and the merchant she is phoning. With each of these people she has a different relationship and a different set of needs (which of course vary with circumstances), and Strauss found words—he wrote his own libretto—and music to characterize each of them.

For this range of dramatic needs, the composer experimented with a range of positions on the musical continuum from straight singing to straight speech—essentially the same opportunity Berg was exploring in his operas. In general, Strauss chose the more conversational modes for scenes proper, concentrating his bursts of pure lyricism in the orchestral interludes that connect the opera's fourteen scenes (in two acts), many of those scenes of cinematic brevity.

There is, for example, a magical scene in which Christine, having met and been flirted with by a dashing young baron, writes to Robert. She reads and tests the letter in straight speech, lapsing into song to comment, brood, fantasize, and free-associate. Lucia Popp has some fun with this scene in EMI's premiere recording, but she has hardly begun to explore Christine's reality. Why, for example, she reads the letter *aloud*. Why accept this as simply a stage device to clue the audience in when the scene can be made so much richer by justifying her actions? Clearly it's important to her to *hear* what she's written, perhaps as a way of anticipating her husband's response, perhaps as part of the delicate balancing act she's performing between full disclosure and discreet omission.

What we choose to disclose and withhold is at the center of *Intermezzo*, the story of a marriage thrown into crisis ostensibly by a chance misunderstanding but in reality by the years' accumulation of frustrations and resentments. This would be an ideal piece if we were ever to develop a true music-theater company that numbered among its members an outstanding lyric-soprano actress. (Glyndebourne seems to have had some success with it with Elisabeth Söderström.) Under any other performance circumstances, the prognosis would seem guarded.

The recording is most successful with the relationship between Christine and Baron Lummer. (It's the souring of this flirtation, when Christine discovers that the impecunious baron has merely marked her as a soft touch, that leaves her bruised ego



JIMMY HEFFERMAN

Lucia Popp has some fun but stops short.

so vulnerable to the apparent proof of Robert's infidelity.) As far as she goes, Popp is a lovely, direct Christine, and Dallapozza's pleasant light lyric tenor suits the baron well.

Fortunately for us, Hofkapellmeister Storch doesn't reappear, after his departure in Scene I, until Act II—fortunately because Fischer-Dieskau is frankly awful, barking, whining, and at best crooning. Otherwise the casting is adequate, with one happy inspiration: the engagement of Moll for the bass Kammersänger, one of Robert's partners in the semifamous skat scene.

Since Angel has chosen not to release *Intermezzo* domestically, it's fortunate that the German edition includes English notes and texts (a singing translation, though). It's also fortunate that the performance as a whole is good enough to suggest the piece's special qualities. At the same time, the performance's limitations are frustrating, and some of the blame has to fall on Sawallisch.

It's hard to point to anything actively wrong in the conducting. At every turn, Sawallisch could point to the score and claim that he has faithfully translated it into sound. And so he has. Certainly the orchestral interludes are lovely. But the substance of the opera is what comes between the interludes, and it tends to rattle along without more than grazing against the actions of the characters.

This complaint applies fairly generally to the new *Arabella*, even allowing for the likelihood that the problem here is built-in. For much of the opera, Strauss seems to be going through conversational motions remembered from his earlier collaborations with Hofmannsthal. (*Arabella* was their second and last opera together after resuming the partnership Strauss had interrupted, following *Die Frau ohne Schatten*, to write

Intermezzo. In between had come *Die ägyptische Helena*.)

It's significant to me that the London *Arabella* conducted by Solti, available until recently on Richmond, although objectively speaking strong in nearly all areas, still comes to life only fitfully—e.g., in the Arabella/Zdenka scene of Act I and the meetings of Arabella and Mandryka in Act II. If you applied the same level of casting and executant competence to, say, *Rosenkavalier*, you'd probably have something really special.

Maybe the moral is precisely that to make *Arabella* work you have to try that much harder. In which case we're headed in the wrong direction. DG's 1963 Bavarian State Opera live recording already represented a general step backward from the London set, but that deterioration concerned mostly the weakish supporting cast and Joseph Keilberth's prosaic conducting. Lisa della Casa remained in command of the title role; Anneliese Rothenberger was a tolerable successor to Hilde Gueden as Zdenka; and Fischer-Dieskau, although light-voiced for Mandryka, had moments of eloquence.

The casting of the new recording is, overall, weaker still, and it's further hobbled by that modern curse of passivity: As with so many opera performances of recent years, instead of making something happen on their own, the singers seem to be waiting for some outside agency (the conductor? a director? the CIA?) to goose them into . . . well, something.

Vocally speaking, there's no reason why Varady shouldn't be able to make something of Arabella, even though her warm timbre and emotional openness might sooner suggest Zdenka. Yet pleasant as much of her singing is, it's inert. Even "*Aber der Richtige*," the opera's closest approach to a surefire passage, just sort of hangs there. Part of the problem with the scene, too, is the Zdenka of Donath, which is respectably sung but represents a distinct falloff of voice and personality from Rothenberger's, not to mention Gueden's.

Fischer-Dieskau, meanwhile, is mostly embarrassing. Even in the DG recording, he was turning Mandryka into a discombobulated nincompoop by raving such admittedly problematic set pieces as the scurrying Act I account of his receipt of Waldner's letter and the Act II discovery of Arabella's "betrayal." Now there appears to be hardly anything in the role that he's up to or interested in singing. The supporting cast is also weak, though Dallapozza offers an ingratiating Matteo, if not in a class with Dermota's for London.

I'm in a bind here. It was only this past February that I wrote ["What Makes an Opera Good?"]: "I may say that, on present evidence, I believe hardly a word or note of *Violanta*. I may even doubt that any performers could make me believe. What I can't say is that the opera is, pure and sim-

ple, unbelievable." Neither, I suppose, can I call *Arabella* purely and simply unbelievable, even though I know it a good deal better than *Violanta*. But how might it be made more believable?

It's reasonable to wonder whether some light might be shed by the 1947 Salzburg Festival performance newly issued—"in splendid sound" (well, that's one opinion; I'd call it "okay sound")—by Discocorp, under license "from GEMA via AMRA" (?). The answer is a definite yes-and-no.

Böhm's conducting often seems on the verge of taking hold more specifically than Solti's, and yet I can't say that the performance involves me significantly more. There are attractions in the casting, but even these tend to duplicate those of the London set. For instance, while Reining and the young Della Casa are a very good *Arabella* and Zdenka, are they better than the older Della Casa and Gueden? Hotter's *Heldenbariton* weight and dignity are useful for Mandryka, but London's George London in fact sings the music better. London's supporting cast is also superior in nearly every role—for all the difference it makes.

Of course the London recording isn't available now. If you're buying the Angel *faute de mieux*, the Salzburg performance takes on new importance as a desirable, perhaps even necessary supplement. One thing it can't compensate for, though, is Angel's glassy, uninvolved digital sound, distinctly less satisfying than *Intermezzo's* nondigital sound. K.F.

STRAVINSKY: The Recorded Legacy—See page 47.

TCHAIKOVSKY: Orchestral Works—See page 63.

Recitals and Miscellany

CENTENARY EDITION OF BARTÓK'S RECORDINGS, VOLS. 1-2—See page 47.

EDITA GRUBEROVÁ: French and Italian Opera Arias.

Edita Gruberová, soprano; Munich Radio Orchestra. Gustav Kuhn, cond. [John Mordler and Helene Steffan, prod.] ANGEL DS 37870, \$10.98 (digital). Tape: 4XS 37870, \$10.98 (cassette).

DELIBES: Lakmé: Bell Song. DONIZETTI: Lucia di Lammermoor: Mad Scene. GOUNOD: Roméo et Juliette: Je veux vivre dans ce rêve. MEYERBEER: Les Huguenots: Nobles Seigneurs, salut! ROSSINI: Il Barbiere di Siviglia: Una voce poco fa. Semiramide: Bel raggio

Who would have expected Gruberová to emerge from her shadow of anonymity?

lusinghier. THOMAS: Hamlet: Mad Scene.

There's not only a lot of music in this program (just under an hour), but music of enormous difficulty, both vocal and dramatic. So who would have expected Gruberová suddenly to emerge from her shadow of coloratura anonymity? Considering how much she has recorded in just a few years—including not only much unfamiliar music and a number of small roles but such coloratura touchstones as Constanze, the Queen of the Night (twice!), Oscar, and Zerbinetta—she's established an awfully vague artistic profile. That she can get through all this repertoire says something about the voice's mechanical efficiency. Often, though not always, it has a measure of color in its upper half, and often, though not always, it sounds rather clumsy in its lower half. In a dozen or two recordings, I don't recall noticing any personality beyond All-Purpose Coloratura Pertness.

Actually, the coloratura fireworks as such are among the less impressive features of this recital. Oh, she gets through it all creditably enough, but the more breathless stuff is sometimes more glided-over than truly articulated. Still, Gruberová does something more important here: As you can hear from the opening "Ah!" of the Bell Song, she tries to find expressive intent in the shapes and gestures of the fioritura. This is the necessary first step toward expanding our view of such writing as merely the domain of vocal pyrotechnics, a view that leaves us no response except to keep score of the accuracy and panache of the pyrotechnics.

Instead we might consider, for example, that when Ophélie sings that "the lark, awakened before dawn, hovered in the air" and lets fly with a coloratura outburst on "l'air," her purpose may not be to show off her voice. Nor—and this is tricky—is she simply illustrating the flight of the lark. She may be doing this, but that leaves the question why. Even crazy people don't do anything without a reason (no, not even mad sopranos), however peculiar the reason may seem to us. Is Ophélie trying to gratify some internal craving, or perhaps seeking the answer to a question, however incoherent, or simply seeking some manner of relief? In the space of five bars, the vocal line incorporates two dozen or more kinds of motion, giving the singer worlds of behavioral reality to anchor in action. It's

nice to hear Gruberová, rather than simply executing the notes, exploring these phrases a bit, and finding some variety and life in them.

Which is not to say that the performances are of Callas-like specificity. But then, Callas' choices were her own. One of the nice things about Gruberová's performances is that, limited as her exploration may so far have been, she *is* exploring, and her solutions relate specifically to her own voice—what rhythmic freedom it allows, what dynamic and coloristic shapes, etc. She manages those five bars, for example, with considerably more grace and ease (not to mention having a real trill) than Callas. This same interpretive honesty goes a long way in the *Lucia* Mad Scene, presented in full except for the interruption of Enrico's return.

Even more successful are the more straightforward Bell Song, Juliet's waltz, the Page's song from *Les Huguenots*, and "Una voce poco fa." "Bel raggio" seems to me to call for a weightier voice, or at any rate some means of achieving the declamatory force of lines like "Arsace ritornò." In addition, Gruberová's Italian and especially her French need work, though I don't want to make the mistake of confusing fastidious dictionizing with precise communicative intent. If Gruberová were to try to make that intent more precise, I think she'd be led naturally to pin down the linguistic vagueness, which would sometimes help her musically too, as with all those unstressed *e's* she swallows.

The orchestral accompaniments are appealingly shaped, and plainly helpful to the singer. (Who is Gustav Kuhn anyway? The liner note is too busy gushing over the star to bother with such trivia.) Maybe these aren't great performances; at least they're *performances*. For the first time, I find myself curious about Gruberová's future work. K.F.

THE LEGENDARY HOLLYWOOD STRING QUARTET.

Hollywood String Quartet; Victor Aller, piano*; Kurt Reher, cello†. [Robert E. Meyers*‡ and Richard C. Jones†, prod.] EMI RLS 765, \$29.94 (mono; three discs, manual sequence). Tape: TC RLS 765, \$29.94 (three cassettes). [From CAPITOL originals, 1951-56.] (Distributed by Brilly Imports, 155 N. San Vicente Blvd., Beverly Hills, Calif. 90211.)

BRAHMS: Quintet for Piano and Strings, in F minor, Op. 34.* DVORÁK: Quartet for Strings, in F, Op. 96 (*American*).‡ SCHUBERT: Quintet for Strings, in C, D. 956.† SMETANA: Quartet for Strings, No. 1, in E minor (*From My Life*).‡

Yesteryear's bargains are this year's legends: I acquired many of the "legendary" Hollywood Quartet recordings (this Smetana among them) when they were being unglamorously remaindered for 99¢ a disc as unmemorable "modern" performances. The British source of this reissue is all the

more incongruous, since the ensemble's slightly slick style was precisely what chauvinistic London critics habitually derided in the *Gramophone* as machine-tooled Americana, with engineering to match.

The Hollywood members, all front-rank players in studio orchestras, included first-violinist (and sometime conductor) Felix Slatkin and cellist Eleanor Aller, parents of currently active conductor Leonard Slatkin and cellist Frederick Zlotkin, the latter of whom has reverted to the original spelling of the family name. (Victor Aller, pianist in the Brahms, is the brothers' uncle.) Established in 1948, the same year as Broadus Erle's New Music Quartet and two years after the original Juilliard foursome, the Hollywood reflected the American aesthetic of the time: Like the two other groups, it favored a lean, slashing style, with a very controlled approach to rhythm and ensemble, a satin-smooth yet ultralean linearity, and generally fast tempos. Somewhat warmer in sound and more flowing than the early Juilliard, it nevertheless lacked the enlivening musical distinction of the New Music (whose truly legendary performances of Boccherini and early Mozart, along with some slightly less distinctive Mendelssohn, were less audaciously revived a few years ago by Columbia Special Products). The Hollywooders' occasional tempo adjustments and Heifetz-oriented shifts date their playing slightly, but few if any of our current quartets play with such an unabashedly virtuoso approach. Heard in sensible dosages, the energy and brilliant attack of these performances provide a stimulating antidote to all the lugubrious "profundity" being heard today.

Certainly these selections reflect an intelligent choice: The group's virtues are abundantly evident and its shortcomings artfully—if not completely—concealed. The earliest performance here is the 1950 Schubert C major Quintet (with Kurt Reher as second cellist)—a flowing, tender account that treats the music sensitively and straightforwardly. If the approach is a bit spineless and small-scaled alongside the incomparable 1952 Prades Festival performance by Stern/Schneider/Katims/Casals/Tortelier (CBS M5 30069), with its dynamism and structural solidity, it is also notably free of the fussy tinkering that blemished the Hollywood recording of *Death and the Maiden*. (There, a faster tempo for the last movement's first theme and a slower one for the second proved awkward, for Schubert inconsiderately combines the two in his development!)

There are a few rhetorical tempo adjustments in the 1954 Brahms piano quintet, giving that performance a slightly calculated, theatrical (as opposed to "dramatic") aura akin to some of the Reiner/Chicago performances of the period. But even with its occasional fussiness, this reading is convincing. If it doesn't quite rival some of the really great readings (Bauer/Flonzaley;

Serkin/Budapest, CBS MS 6631; Richter/Borodin), it stands up well to the test of time and remains light-years ahead of the same team's miserably mincing and insipid Schumann quintet.

The Dvořák *American* and Smetana *From My Life* were taped later, after violist Alvin Dinkin (who had played with the group as second in its fine *Verklärte Nacht* recording) had replaced the original Paul Robyn. Both performances, finely inflected and tastefully nuanced, can be wholeheartedly recommended even in the face of such formidable competition as the most recent Budapest account of the Dvořák on CBS M 32792.

In the really profound literature, the Hollywood was a bit out of its depth: I recall finding its letter-perfect account of Beethoven's Op. 132 cosmetically glossy and pallid alongside the thrusting passion of the Busch Quartet's much less polished account. Yet in whole areas—Dvořák, Smetana, and Dohnányi; Tchaikovsky and Borodin; and most notably, many modern works, such as the Hindemith Third and the already cited Schoenberg—the quartet made a significant contribution to the music-making of its time. Unquestionably, this tribute is deserved.

An A/B comparison with the original Capitol pressing of the Smetana shows that the new version has a little more solidity at the bottom and slightly more presence on top, possibly at the expense of some sweetness. The basic sound—close and a bit cramped—is not at all inappropriate for chamber music, and the balance is just fine. Good surfaces, too. H.G.

Theater and Film

GHOST STORY. Music from the original film soundtrack.

Composed and produced by Philippe Sarde. MCA 5287. \$8.98. Tape: MCAC 5287. \$9.98 (cassette).

QUEST FOR FIRE. Original motion-picture soundtrack recording.

Composed by Philippe Sarde; Ambrosian Singers, London Symphony and London Philharmonic Orchestras, Peter Knight, cond. [Philippe Sarde and Michel Larmand, prod.] RCA RED SEAL ABL 1-4274. \$9.98. Tape: ABK 1-4274. \$9.98 (cassette).

Without doubt the most gifted film composer to emerge in France, if not all of Europe, since Michel Legrand is Philippe Sarde. Barely into his thirties, he has already amassed a substantial body of music in a variety of styles ranging from small-group jazz (the score for *Mort d'un pourri* was built around the improvisations of Stan Getz) to the misty, romantic tableaux of Roman Polanski's *Tess* (MCA 5193), prob-

ably the best-known of his scores in this country.

Sarde first came to prominence in France with the distinctive sonic world he created for several low-key but penetrating Claude Sautet films of the early and middle '70s (such as *Les Choses de la vie*, *Vincent, François, Paul, et les autres*, and *Une Histoire simple*): he subtly encapsulated the forlorn sense of middle-class ennui and the muted despair of midlife crisis with his unsentimentally spare and halting strains. As his Herrmann-esque score for Bertrand Tavernier's underrated philosophical thriller *Barocco* testified, however, Sarde, unlike Legrand, is not oriented primarily toward commercial pop music and performance values; rather, his is a sober, withdrawn, often severe sensibility that eschews easy formulas and meretricious glitter. Much of his work has been marked by a modest, economical, and small-scale intelligence, such as the wonderfully atmospheric, low-down *boîte-de-nuit* ambience of Bertrand Blier's *Beau-Père*.

Would that the flatly and ineptly executed film version of Peter Straub's superlative *Ghost Story* were as sharply focused and richly nuanced as Sarde's music, which—unlike the relatively monotone and fragmentary *Tess*—represents his graduation into the cosmopolitan ranks of symphonic film scoring. Instead of the expected harum-scarum effects, he offers a thoughtful, mature, and musically compelling delineation of the narrative, which takes account of the human toll and erotic undertow as well as the sheer horror of this "Love Story" manqué.

Through the dexterous deployment of four memorable, malleable, and closely related ideas—the melancholic, mesmerically lyrical, stepwise "ghost" theme; an alternating minor/major triadic motif, which gives rise to a telegraphic, xylophone-accented triplet "terror" motto; and an innocently vernal "love theme" (almost a mirror image of the "ghost" theme)—Sarde assembles a tight, fluid, and consistently fertile score, which maintains unity in diversity in several imaginative ways. By the telling but frugal use of organ pedal-points, female vocalise, and woodwinds in their low-to-middle registers, he achieves some truly fresh and unconventional tonal effects: The "Love Suite" section, for example, is comparable to the whimsical and wistful manner of Alex North in such scores as *The Rainmaker*.

The performance—presumably under Sarde's direction—seems authentic enough, and the careful selection and disposition of sequences make for a very satisfactory listening experience. MCA's engineering and pressing, though only middling, are good enough to document the rapid growth and maturation of a major new talent.

Ghost Story left me keenly looking forward to Sarde's score for a much more

SA-X. High Bias Is Richer For It.



The greatest honor a cassette can receive is to be held in higher esteem than the one now setting the high bias standard. SA-X has already gone beyond SA in frequency response, sensitivity, and resolution. It was intended to.

With its ultra refined dual layer of Super Avilyn and the Laboratory Standard Mechanism, nothing less was possible. TDK believes sound reproduction should have no set barrier. No limit.

For us, high bias was a limit to be surpassed. SA-X has won three international audio awards to date. It will doubtless win others.

But we take awards philosophically. They represent our continuing effort to create the machine for your machine. In that, we could not be happier with SA-X.



©1981 TDK Electronics Corp.

Circle 60 on Reader-Service Card

CLASSICAL Reviews

significant and original film, the science fantasy about prehistoric man, *Quest for Fire*. Since there is little dialogue, the almost continuous music plays an integral part in the panoramic odyssey this film recounts. My initial enthusiasm waned upon reflection, however; Sarde's music, like so much else in this visually and conceptually stunning, anthropologically authentic, yet dramatically trite and psychologically stillborn endeavor, seems neutral, factitious, and basically misconceived. Again, as with the film it so conspicuously adorns, one admires the scope of the score's ambitions while regretting its frequent lapses in imaginative truth.

Sarde was perhaps overwhelmed by the enormous forces at his disposal: both the London Symphony and London Philharmonic Orchestras (presumably used for different recording sessions), under the expert guidance of veteran arranger-conductor Peter Knight, plus the Ambrosian Singers, Les Percussions de Strasbourg, and two solo flutists.

After an auspicious beginning, which highlights a striking leitmotif of repeated staccato chords intoned by low strings and utilizes a choral uprush in the heart-stopping manner of Ravel's dawn music for *Daphnis et Chloé*, Side 1 soon degenerates into a series of primarily functional, atematic episodes, dominated by endless modulations and monotonous tom-tom effects intended to convey the constant peril facing the helpless protagonists. This all sounds more imposing and occasionally even more dissonant in the theater than on the disc, perhaps owing to misjudgment in the selection of sequences or inferior engineering or both. In any case, the score is decidedly less stimulating as music than as background noise.

Some tone-deaf film critics have alluded to Stravinsky and Orff in describing this music, but its real ancestry lies closer to hand, in Max Steiner's *King Kong*, though without the latter's lurid angularity and streamlined momentum. In fact, on Side 2, when the panpipe makes its appearance with a rather plaintive, primeval-sounding "love chant," the music's increasingly pseudo-Rózsa strains call up some third-rate ersatz harem escapade rather than the scientifically and philosophically elevated parable of the title. Whatever the reason, Sarde has somehow failed to solve the perhaps insurmountable problem of creating music for this unusual tale that is both appropriate on the subliminal level and compelling as a conscious listening experience. Nor has RCA helped matters any by providing a very dry and stunted acoustical ambience, in contrast to the spectacular Dolby soundtrack heard in the theater.

Ghost Story—although written for a far less successful film artistically—gives a much fairer indication of Sarde's potential as a film composer than the static, tedious, and ultimately overblown *Quest*. P.A.S.

FREE McIntosh STEREO CATALOG and FM DIRECTORY

Get all the newest and latest information on the new McIntosh stereo equipment in the McIntosh catalog. In addition you will receive an FM station directory that covers all of North America.

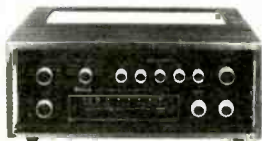
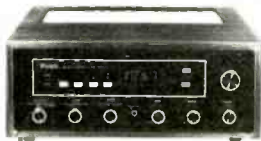

SEND TODAY!

McIntosh Laboratory, Inc.
East Side Station P.O. Box 96
Binghamton, N.Y. 13904-0096

HF

NAME _____

ADDRESS _____

CITY _____ STATE _____ ZIP _____

If you are in a hurry for your catalog please send the coupon to McIntosh.
For non rush service send the Reader Service Card to the magazine.

Circle 56 on Reader-Service Card

The Tape Deck

Critiques of new cassette and open-reel releases by R. D. Darrell

Metamorphoses

No, I don't have any new versions of Richard Strauss's late masterpiece or Hindemith's transformations of Weber themes. But some current musicassettes are arrestingly paradigmatic of various musical "changes in form or substance"—things that have been "turned into something else," if not necessarily "by enchantment or other supernatural means."

"Transcription" may involve simple substitutions of instruments, common practice in the baroque and earlier eras; but more often in later times the originals are so extensively rewritten as well as recolored that their whole character is radically altered. I've just been startled by several such extreme aberrations, which, even as they shock conservative listeners, may delight others, or at least electrifyingly stimulate them into fresh new perceptions.

Sheerly preposterous is young Kazuhiro Yamashita's solo-guitar transcription and performance of Mussorgsky's *Pictures at an Exhibition*, a piano work best-known in Ravel's kaleidoscopic orchestration. Yet ridiculous as the whole notion may be, Yamashita demonstrates that he understands these tonal portraits better than do some of the big-name conductors and pianists who have recorded them. He is, moreover, an extraordinary virtuoso and his tour de force is superbly recorded (JVC digital) and processed (chrome tape; RCA ARE 1-4203, \$15.98; no Prestige Box, but notes are included).

Indeed, I doubt that the essential character of Mussorgsky's work is as fundamentally compromised as is that of Bizet's opera excerpts in Rodion Shchedrin's percussion-dominated *Carmen* ballet, or that of the little Mozart piano pieces and motet transmogrified by Tchaikovsky in his Fourth Orchestral Suite (*Mozartiana*). Witness the latest versions: the Shchedrin *jeu d'esprit* by the Los Angeles Chamber Orchestra under Gerard Schwarz (Angel 4XS 37337, \$10.98) and the Tchaikovsky by the Philharmonia under Michael Tilson Thomas (CBS Masterworks HMT 36702, price at dealer's option). Both these digital recordings do greater justice to the ingenious reworkings than ever before. Yet Schwarz's rather mannered *Carmen* lacks the ebullience of Fiedler's on RCA. And Thomas' suites (the Second is coupled with the Fourth) may be less consistently balletic

than Dorati's in his 1967 Mercury set of all four, but they are more poetically—even lovingly—expressive, and the Second sounds quintessentially Tchaikovskian.

Much less startling are some more orthodox current transcriptions. The nature of Bach's S. 1039 Trio Sonata is affected less by substitution of Kyung-Wha Chung's violin for the second flute than by the dominance of James Galway's first flute part; the same happens in the companion S. 1038 and S. 1079 (*Musikalisches Opfer*) Trio Sonatas, originally scored for flute, violin, and continuo (RCA Red Seal ARK 1-4201, \$9.98). Romanticists will delight in the warmly expressive playing; purists will deplore the imbalances (continuo cello also prevails over harpsichord) and the overall stylistic anachronisms. Enrique Fernández Arbós' orchestrations of his contemporary Isaac Albéniz' piano works, *Navarra* and five numbers from the *Iberia* Suite, are generally admired as being both faithful and effective, so it's good to have them in their first digital recording, in strikingly individual readings by the London Symphony under Mexican conductor Enrique Bátiz (Angel 4XS 37878, \$10.98); this, along with two simultaneously released Rodrigo programs on Angel and two Chávez and Falla discs for Varèse Sarabande, marks Bátiz' recording debut. And it was Brahms himself who dropped the original vocal parts to his *Lieblieder Waltzes*, leaving the Op. 52a piano-duet versions. For me, these are preferable to the more frankly sentimental originals—especially as played by Michel Béroff and Jean-Philippe Collard, with crisp bravura. Equally spirited and no less glitteringly recorded are the coupled performances, Brahms's popular Op. 39 Waltzes and less often heard *Variations on a Theme by Schumann*, Op. 23 (Angel 4XS 37794, \$10.98).

Provocative yet illuminating are noted cellist Laszlo Varga's adaptations of the three Brahms violin sonatas for his own instrument, with the original keys and piano parts left intact. I wrote last March about No. 2, Op. 100 (coupled with Dohnányi's cello sonata in MusiCelli MC 104); now the Varga/Jenkins collaborations in No. 1, Op. 78, and No. 3, Op. 108, also seem as "Brahmsian" as the originals, if not more so! These are coupled (in MC 102 and 103, respectively) with the "real" Cello Sonatas, Opp. 38 and 99, all in fervently Romantic, sometimes overintense interpretations and clean-cut, well-balanced recordings (available only by mail from

MusiCelli, P. O. Box 31178, San Francisco, Calif. 94131; \$8.00 per cassette plus \$1.00 for shipping). There is also an unusual Varga/Jenkins Beethoven coupling (MC 101), the Cello Sonata, Op. 102, No. 1, and the composer-approved transcription of his popular Op. 3 String Trio—published as his "Sixth" Cello Sonata, Op. 64, in 1807—by one Franz Xaver Kleinheinz. Musical metamorphosis is indeed nothing new or unusual!

Anachronistic new; authentic old. Quite different transmutations are involved when old music is performed on modern instruments by non-historically-minded interpreters. Haydn and Mozart might well be astounded by the virtuosity with which their works are played today, but would they wholly approve of the slick timbres and readings? Present-day listeners surely will have no such doubts about the bravura performances of Mozart, J. C. Bach, Vanhal, and C. Stamitz oboe quartets by Ray Still (How good to have him back in chamber music!) with a new all-star ensemble of Itzhak Perlman, Pinchas Zukerman, and Lynn Harrell (Angel 4XS 37756, \$10.98); or about the dramatically gripping Melos versions of Mozart's great K. 589 and 590 *Prussian* Quartets (Deutsche Grammophon 3301 320, \$10.98); or about the Polish Varsovia Quartet's infectiously zestful, tonally bewitching readings of Haydn's *Emperor* and *Serenade* (Op. 3, No. 5) Quartets (Pro Arte digital/chrome, PCD 112, \$12.98).

Yet Mozart himself would feel more at home with the sound of the fortepiano used by Gustav Leonhardt in a fascinating 1972 program of Mozart sonatas (Nos. 4, 10, 13, 21) and three shorter pieces (Pro Arte Prestige Box 2PAC 2009, \$19.96). And he'd recognize the timbres of his favorite Anton Walter concert instrument in the Philip Belt replica used by Malcolm Bilson and Robert Levin in four-hand sonatas (K. 381 and 497), Vol. 1 of a welcome series (Nonesuch N4 78013, \$9.98).

I suspect William Byrd had in mind a smaller-toned instrument (virginals) than the R. Schultze replica of a Flemish harpsichord John Whitelaw uses for his Byrd program. Yet this is so aurally enchanting and so well recorded, without any need for Dolby B noise reduction, and the eight well-chosen pieces are so charming that even Byrd himself couldn't seriously object (Spectrum SC 239; \$4.50, plus \$1.50 for shipping; by mail only from Spectrum, Harriman, N. Y. 10926). **HF**

BACKBEAT

Bonnie Raitt Lightens Up

Her new album is straight-ahead rock & roll.
Has the California air gone to her head?
by Steven X. Rea

BONNIE RAITT IS SOMETHING of an enigma in pop music circles. A onetime folkie, she strummed her way through a succession of Cambridge coffeeshouses in the late Sixties singing songs of social protest. In the Seventies, she blossomed into a scratchy-voiced blues belter who could beat out the best r&b performers at their own game. Raised amid the glitz and glamour of the entertainment world (her father is Broadway baritone John Raitt), Raitt—who now lives in Hollywood—has eschewed show biz trappings in favor of a modest, private, quietly efficient lifestyle. A staunch feminist with deepfelt political values, she nonetheless projects a sexy mama image, cracking dirty jokes and acting like “one of the boys.” She can be serious and reflective one minute, and ready to party till the sun comes up the next.

“Green Lights,” the thirty-three-year-old singer/guitarist’s eighth album (her self-named debut was released in 1971), is rife with surprises as well. It is, simply, a rock

& roll record: Not just another pop disc featuring Raitt and a phalanx of Angeleno session wizards doing a couple of rock tracks, but an all-out, aggressive, rollicking affair: buoyant, emphatic, and charged with a Stones-like energy. Backed by the Bump band—guitarist Johnny Lee Schell, ex-Faces keyboardist Ian McLagan, bassist Ray Ohara, and drummer Ricky Fataar—Raitt sounds assured and at ease. Her rhythm- and slide-guitar work is without fault, her voice is vibrant, her mood upbeat and passionate.

Sitting at a table in the Hollywood office she shares with her business manager/booking agent, Bonnie is fairly ecstatic about her new LP, which was recorded last summer and fall at producer Rob Fraboni’s beachside Shangri-la Studios in Malibu.

Backbeat: All of a sudden you’re a rock & roll singer. What happened? It sounds like you sneaked into a Rolling Stones session and stole the rhythm tracks or something.

Raitt: I know, I love it. Johnny Lee Schell,

the guitar player, has obviously been influenced a lot by Keith Richards. But it really hasn’t been that sudden. There were inklings of the direction I was going in all along: when I started standing up at my shows about five years ago instead of sitting in a chair; when I began to play the Gibson instead of the acoustic, and then a Strat instead of the Gibson; when I moved my uptempo songs from the encore to the beginning of the set.

Backbeat: I must admit that your enthusiasm for “Green Lights” is contagious. Are you always this excited when you’ve just completed an album?

Raitt: Not necessarily. I’ve been waiting my entire career to make this record, and I finally got the right band with the right producer in the right studio. It’s the most productive experience I’ve ever had in a studio. I had a ball. The last six months have been the best in my life—less worrying and less pain. And to have a bunch of musicians that know each other and who would choose to play with each other over anybody else—it’s just been a pleasure.

Backbeat: What do you mean, “less worrying and less pain”?

Raitt: I tend to worry too much, to analyze and anguish over everything. It’s the businesswoman side of me. I manage my own affairs along with a team of people, but I pretty much make the decisions. That tends to make you look at things in a more serious framework. But then there’s the side of me that likes to let go and party all the time. It’s difficult to reconcile the two. Rob and the guys in the band helped to bring out the rebellious, crazy side of me.

Backbeat: “Green Lights” really does reflect that. You’ve even said yourself that it isn’t as “laden with messages” as some of your albums. There aren’t any Jackson Browne songs. The title track and *Me and the Boys* were both written by NRBQ, a real

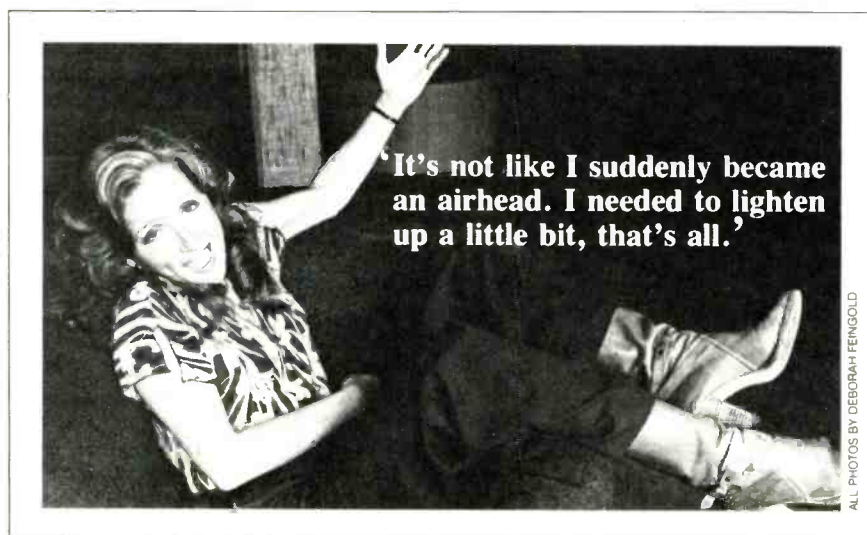

‘It’s not like I suddenly became an airhead. I needed to lighten up a little bit, that’s all.’

ALL PHOTOS BY DEBORAH FENGOLD

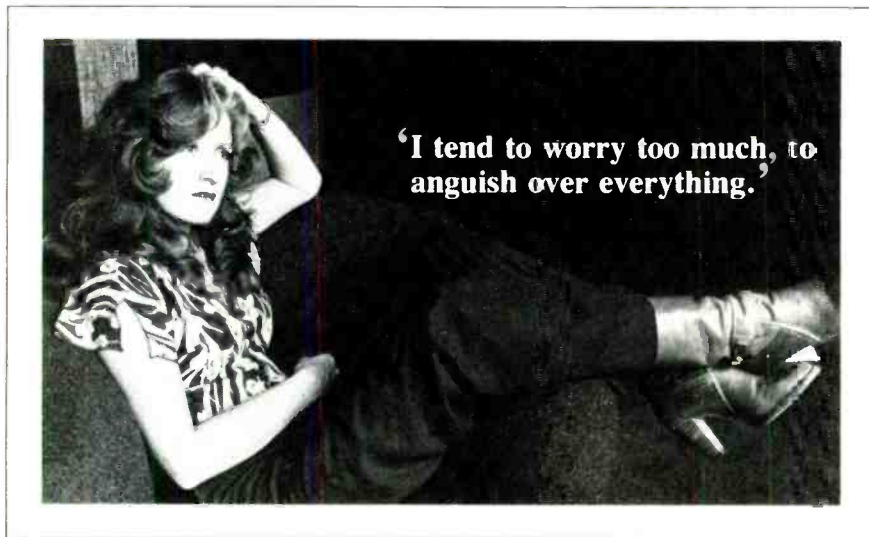

'I tend to worry too much, to anguish over everything.'

bunch of out-for-a-wild-time rockers. *Baby Come Back* was a bluebeat hit for the Equals in 1967. Even Eric Kaz's *River of Tears* rocks. Have you gotten any negative reaction from old fans who feel they've been betrayed?

Raitt: Well, a lot of my friends thought I had moved to the beach and turned into Gidget. But it's not like I suddenly became an airhead. I needed to lighten up a little bit, that's all. I was laughing all the time, having a lot of fun, hanging out at this funky old studio that had hippie blankets hanging from the ceiling. Now I'm getting some feedback from people who feel the same way that I do about rock & roll. Then there are other, more conservative friends whom I've known for years who still wish I was sitting in a chair playing acoustic guitar. So yes, the album shocked a few people.

Backbeat: Peter Asher's production on your last album, "The Glow," was ultraslick. Was your decision to rock out with Rob Fraboni a reaction to that?

Raitt: We tried not to make "The Glow" slick. I did all the vocals on the first or second take, but there must be some reason why people didn't take to it—the "vibes" or something. The combination of Peter and I looked promising, even though it was surprising, since I try hard *not* to have a polished veneer. I've always respected Peter's work, but until I read in *Rolling Stone* that he was interested in producing me, the thought had never crossed my mind. We sat down and talked and I told him I was frustrated that my records didn't sound more live and he said "Yeah, I want to make it live too. Everybody thinks I'm Mr. Slick. I want to prove to people that I know what rock & roll is." I felt that he saw what made me special to him and he tried to bring it out. I like the record, but a lot of people have told me that it seemed colder than it should have been.

I was a little stung by the lack of response to "The Glow." And I was disappointed by not being able to make a record that sounded the way I wanted it to

sound. Moving to Shangri-la, I wanted to get back to the roots and to the funkiness I had on earlier records, even though I'm not crazy about how they sound. They sound like I was having a lot more fun than I really was. "Green Lights" is the first album I actually had fun doing.

Backbeat: The very first?

Raitt: Well, where it was more fun than worry. It has never been the producer's fault. It has been my attitude—like I said, I'm a worrier.

Backbeat: Looking back over your recorded output, are there any albums that you're particularly fond of? Any that you hate?

Raitt: To an extent, I like all my records. I make sure of that or else I don't put them out. I think it's terribly irresponsible to put out something that you think is junk. "Streetlights" [1974] was the one done under the most duress. It was meant to be an "uptown" soul album, but the strings and the horns and some of the material were just not what I was into at the time. But I liked working with Jerry Ragovoy.

"Takin' My Time" [73] is one of my favorite records to listen to, although I started out with Lowell George producing it

and he and I got too close to be able to have any objectivity about it. That's a problem when you're a woman and you get involved with the people you work with—and I don't just mean romantically. It becomes too emotional. It's hard to have a strong woman telling the man her ideas when, in fact, the man wants to take over the situation. So that album had a lot of heartache in it. At the time it was a difficult one to make, but now I like it.

I feel close to "Give It Up" [72] and the first album, but it's impossible for me to listen to them for pleasure because I sound so young. I sound like a little Mickey Mouse.

Backbeat: Despite all the accusations about Gidget and becoming a mushbrain, the fact is you're still very involved with a lot of political projects. Do you find it hard to balance your career as a performer and your work as a political activist?

Raitt: The political stuff often takes precedence, but it's not just the music on one side and the politics on the other. It's the whole thing: When the music's not happening then the politics suffer too. They feed off of each other; when I'm productive in one area it usually rubs off on the other.

Backbeat: You've expressed disappointment on how the *No Nukes* movie was marketed—or not marketed. Do you regret the time you devoted to MUSE (Musicians United for Safe Energy) and to that project? Do you feel frustrated?

Raitt: Not at all. It's true that MUSE was not as successful as we had hoped because the film was promoted so badly. But in the long run it's going to make money. And I never feel frustrated about giving my time to causes I believe in. I *do* feel frustrated at the stupidity and ignorance and greed responsible for things like Three Mile Island. Last year I did six months of benefits for the Pacific Alliance and for Water for Life, which is a project to make people aware of the problems of radioactive waste, toxic wastes, and acid rain. The benefits are all tremendously successful in terms of rais-



'Yes, "Green Lights" shocked a few people.'

ing consciousness and money. But I would like to see a really *big* group that can fill a giant arena for a week running donate one night to this. Because I'm just making chicken feed, playing three-thousand-seat halls.

I've done benefits now for more than ten years. They're an imperative part of my career. Every artist should be doing them. It's insane to take that much money out of the community and not put any of it back.

Backbeat: Ever since you moved back to Los Angeles from Cambridge [Mass.], there has been a tendency among critics to lump you into the L.A. sound and compare you with singers like Linda Ronstadt. How do you feel about that? Are you striving for the megaplatinum superstardom Ronstadt enjoys?

Raitt: I moved to L.A. to be with Little Feat. I fell in love with somebody and liked the climate here better. In Cambridge I was too well known. I couldn't walk down the street without being recognized and I was drinking too much. It was just a big untogether scene for me.

I don't want to be a pop singer like Linda. I love her stuff, but people tend to lump women together. They assume, wrongly, that we're all after the same thing. I mean, everyone wants to be liked, to be successful, but that's not why I have horns playing on "Home Plate" [75]. I don't care whether I go down in history as a major performer. I don't spend that much time on it. All I ever want to do is make people have a good time. I don't care if I'm significant as long as I get to live and be happy.

Backbeat: But it must hurt when you work on something—on one of your albums—for so long and then, like "The Glow," it just doesn't sell. To date, "Sweet Forgiveness" [77], has been your only gold record, and that probably happened because its version of Del Shannon's *Runaway* was a hit single.

Raitt: Yes, it's a drag. To work on something for a year—selecting material,



'The more successful you are, the more preoccupied you become with staying successful.'

rehearsing, recording, mixing, all that—and then to have it not sell. It does hurt. And it hurts to read certain reviews.

Backbeat: So wouldn't you like it if "Green Lights" took off?

Raitt: Yes and no. The more successful you are the more preoccupied you become with staying successful. I'd be doing more political things and I'd be doing more video and I'd be producing people. Look at Jackson: All his success has allowed him to do is to spend less time doing his own records. He's producing more and involved in all sorts of other things.

Besides, I'm amazed that 200,000 or 300,000 people want to buy my record. I'm grateful that we draw as well as we do. All the people that come to see me year after year— I feel like I have a pact with them.

When I made \$100 a night singing for half an hour, that was enough. I was nineteen and I was making more money in one night than a lot of people make working two or three days all day. My lifestyle is fine. I'm comfortable, I have a nice house. . . .

Backbeat: So you feel like you have all the commercial success—all the money and

fame—you can handle?

Raitt: If I were any more famous or successful than I am now, I wouldn't be prepared for it. And I wouldn't want it. I have more money than I need. It's earned money, but we get paid ridiculous amounts in this business. Of course, I'm talking about a penny compared to the dollar bill most huge acts bring in. But if you only need a half a penny to live on, a penny's a lot of money. Having been raised by relatively well-off parents who cared more about spending money on education and travel than on material things, money doesn't mean that much to me.

In terms of fame, that brings you more influence and I would like to have more influence. I believe in the kind of music I do, and I'd like to be able to get more people to appreciate Howlin' Wolf and Sippie Wallace [she performed with Sippie in '73 on the "Ann Arbor Blues and Jazz Festival" LP] and to listen to Little Feat and Jackson Browne. I hope this new record, for example, shows people that they should have more of a sense of humor about music. That it's fun to really rock out. I mean, this stuff gets me off.

Backbeat: What happened to your songwriting? Between "Give It Up" and "The Glow" there weren't any Bonnie Raitt compositions at all, and on "Green Lights" you just cowrote two songs.

Raitt: And they were mostly written by the others—Walt Richmond on *Can't Get Enough* and Johnny Lee Schell on *I Can't Help Myself*. I guess it's a combination of laziness and lack of desire. I don't spend any time at it. I don't play guitar or piano for recreational purposes. I'm not a songwriter. I'm not a poet like Jackson. I'm just not that good at it. Maybe I'd be better if I worked at it more.

But as it is, I don't have enough time to do the things I enjoy. I don't think music should be the beginning and end of existence. I'd like to do different things: Study anthropology, take up painting or flying. I don't want to be one-dimensional. **HF**

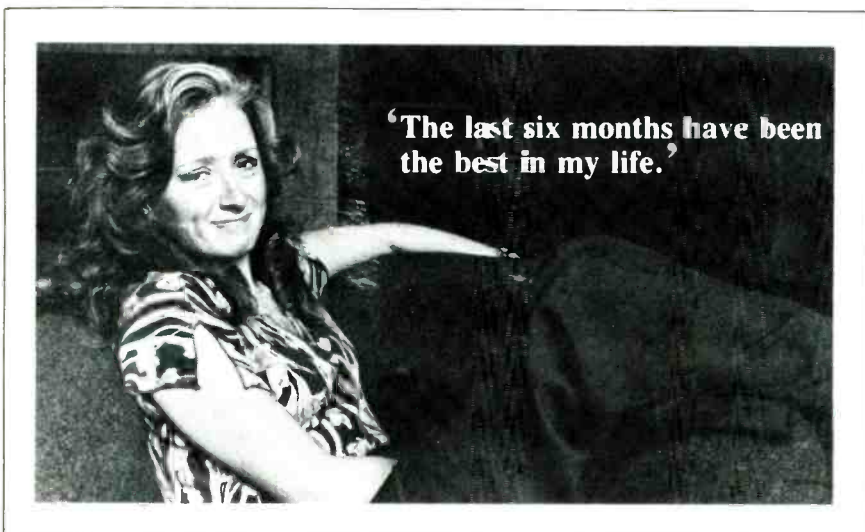

'The last six months have been the best in my life.'

Input Output

New electronic instruments and accessories by Fred Miller



Tube Amplifiers

Tusc has joined the current renaissance of tube, vs. solid state, amplifiers with its new DF and CR stage amps. Both models have several parametric equalizer settings and a memory function for their automatic recall during the course of performance. Other features include preamp line output, stereo input for guitar and keyboard, and pre- and post-reverb. The DF incorporates two 12-inch speakers and is available with outputs of 50 and 100 watts (17 and 20 dBW) for \$1,030 and \$1,100, respectively. The 100-watt (20-dBW) CR has one 15-inch speaker and costs \$1,140. Casing is 3/4-inch plywood, and both models have removable wheels.

Circle 76 on Reader-Service Card

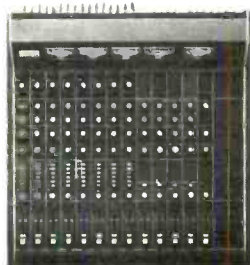

8-Track Mixer

The Tascam Model 35 audio mixer incorporates a number of features not usually found on small production boards. Its eight-in/four-out configuration can be expanded to twenty inputs; there are parametric equalizers on all inputs; an optional slate/talk-back function can record an announcement and also send it to both the cue buss and the studio speakers.

The Model 35's rather sophisticated monitoring section is designed to permit full control over both control room and headphone balances, independent of recording levels. The solo function allows you to isolate and audition any input without affecting the signal. There are six low-impedance balanced inputs with XLR connectors and two high-impedance unbalanced inputs with phone jack connectors for direct feeds. Each VU meter has an LED to indicate channel overload. Price of the Model 35 is \$2,300.

Circle 73 on Reader-Service Card



Quieter Process

The Dynafex Model D-2B is a new single-ended noise-suppression unit from Micmix that, unlike Dolby and DBX, does not require encoding and decoding. Rather, it works by sensing the input level's highs and processing them relative to the user-set reference level (nominally, +8, +4, 0, or -10 dB). If, for instance, the signal is deficient in high-frequency content, the D-2B gradually closes off its corresponding high-frequency filters automatically.

As a two-channel unit, it can be used in stereo mixdown. Micmix also stresses its consumer-playback and broadcast applications and rates its noise reduction at 30 dB. Threshold level is set via a continuously variable control pot and there is a bypass switch for each of the two channels. The front panel also includes a stereo/mono switch. Cost of the Dynafex is \$750.

Circle 75 on Reader-Service Card



Analog Delay

Analog/Digital Associates' STD-1 analog delay line, designed for instrument, studio, and sound-reinforcement applications, is capable of producing up to six delays simultaneously from a single mono input signal. Its effects include flanging, doubling, chorusing, echo, and reverb, and each of the six delay taps can be assigned to either (or both) of the two output busses to create true stereo spatial effects. Delay times range from 1.3 to 55.5 milliseconds, sweep rate from 0.1 to 25 seconds.

The OUTPUT-MIX controls enable the user to blend the processed with the dry signal. In the REGENERATION section, the outputs of selected delays are fed back to the unit's input, creating longer decays to simulate reverberation. The STD-1's high-cut filter is adjustable from 12 KHz to 800 Hz and there is an LED headroom display to monitor the signal strength at the input stage. Options include a control pedal for changing delay times and a 240-volt power supply. Connections are of the 1/4-inch phone jack type. The STD-1 is 1 3/4 inches high, fits in a standard 19-inch equipment rack, and costs \$800.

Circle 72 on Reader-Service Card

BIG SAVINGS

NOW YOU CAN OWN ALL

**TOP BRAND
STEREO COMPONENTS
AT THE SAME PRICE MANY
DEALERS PAY!**

120,000 Customers Coast-to-Coast
CALL TODAY 9 A.M. to 9 P.M.

FOR FULL COLOR BROCHURES OR
PLACE YOUR ORDER FOR

SAME-DAY DELIVERY

COD OR CHARGE CARD

ASK ABOUT OUR "NO-LEMON" GUARANTEE

CALL

1-800-638-8806

OR 1-301-488-9600

OR SEND FOR BROCHURE WITH
LINES AND PRICES AND TIPS
ON BUYING BY MAIL TO...



**INTERNATIONAL
HI-FI
DISTRIBUTORS, Inc.**

MORAVIA CENTER
INDUSTRIAL PARK
BALTIMORE, MARYLAND
21206

Circle 45 on Reader-Service Card

SUBSCRIBE NOW TO SCHWANN RECORD and TAPE GUIDES

12 Monthly Issues of Schwann-1 and
2 Semi-Annual Issues of Schwann-2

- 1 yr U.S. & Possessions **\$25.00**
- 1 yr Canada **\$35.00**
- 1 yr Foreign (surface
mail) **\$40.00**
- 1 yr Foreign (Air Printed
Matter) **\$75.00**

Payment Must Accompany Order!

Send to:

ABC Schwann Record & Tape Guides
Dept. A21123
P.O. Box 2131
Radnor, PA 19089

Name _____

Address _____

City _____

State _____ Zip _____

Reviews



Wendy Waldman: Her reemergence rocks with self-confidence—see page 78.

Alvin Fields: Special Delivery

Michael Zager, producer
A&M SP 4890

Although this is his first album, Alvin Fields's material has been covered by such artists as Dionne Warwick, the Spinners, and Robert John. During the height of late-'70s discomania, his *Let's All Chant* was a huge hit for the Michael Zager band. One might expect, then, that his solo debut would be a writer-turned-singer best-of compilation. Instead, "Special Delivery" is a surprisingly coherent affair with a musical vision that fits the singer's impassioned falsetto like a pair of fancy kid gloves.

Fields's major musical reference point is early-'70s Motown, especially Nick Ashford and Valerie Simpson, the classy songwriting team that got its start on that label. This writer's forte is mating out-front melodies and involved harmonic patterns with strong rhythmic grooves—a sort of Broadway-goes-uptown approach to r&b. His songs tend to start out sounding faintly familiar, but they eventually develop enough interesting chord changes and instrumental twists to establish their own identities. The title cut, for example, is

based on one descending four-chord sequence, but with careful layering of a progressively complex vocal arrangement, the song gathers variation and color. Fields uses an appealing combination of smoky head voice and pure falsetto, often building the instrumental charts around sophisticated vocal pyrotechnics. On *Any Way You Like It*, a laidback paean to amorous gratification, Pete Cannarozzi's keening synthesizer answers Fields's floating voice with mounting urgency. The arrangement, one of the album's best, is like a tapestry: Each instrumental part dovetails with the next, and Fields's vocal serves as another thread in the rich fabric. *All in the Name of Love*, with its contemporary Eurodisco feeling, is full of futuristic synthesizer washes that dramatically contrast the singer's pleading, romantic delivery.

Perhaps best of all, "Special Delivery" suffers from none of the excesses that mar some recent r&b releases, and credit should go to producer Zager for his restraint and taste. Even on the emotional ballad *All That I Am* (which has its roots in early Gladys Knight and the Pips weepers like *If I Were Your Woman*) Zager and Fields keep a tight rein on the proceedings, building

momentum by gradually introducing strings. Like last year's impressive r&b newcomer Luther Vandross, Fields has a firm grip not only on his songs but on their context, which can—and does—make all the difference. —CRISPIN CIOE

Fingerprintz: Beat Noir

Chris Kimsey, Jimme O'Neill,
& Chris Porter, producers
Stiff TEES 1001

Here's a British-based quartet that lolled around for a few years making competent pop/rock—and, at one point, supplying backup and material for Rachel Sweet—before finally finding its real musical calling. "Beat Noir" is that rare album that combines a strong thematic thread with a consistent musical direction without sounding forced or stagey. Its genre is dance-oriented rock, with all the reliance on synthesizers and mechanically precise rhythm tracks the style implies. Within a framework that can be restrictive and ultimately boring in the wrong hands, Fingerprintz has created an LP that's not only trendily danceable, but genuinely interesting musically.

"Beat Noir" evokes the imagery and language of the film noir period, when hard-boiled detectives and dishy dames with shady pasts inhabited the black-and-white silver screen regularly. Fingerprintz and producer Chris Kimsey have recognized that, for all its modernistic surface glare, contemporary dance-rock deals in many of the same nocturnal pursuits and dark desires as those '40s and '50s celluloid classics. On *Catwalk*, lead singer Jimme O'Neill's sulking vocals combine with a stuttering guitar ostinato and rigidly punching horns to paint the perfect picture of a woman "of shadows . . . dressed up, hungry for love." *The Chase* is a stunning crystallization of the modern dance-rock groove: A repetitive, funky bass line—derived from James Brown's long-ago hit *Give It Up or Turn It Loose*—bubbles over a ruthlessly stolid, unsyncopated drum figure. O'Neill sings, in deeply hushed tones, of "chasing action, chasing shadows, chasing you," sometimes in tandem with the wonderfully sultry Sadie the Cat. Steve King's angular synthesizers accent the vocals mysteriously, and halfway through the song saxist John Earle starts repeating Charlie Parker's bebop anthem *Ornithology*. As the elements come together over the pulsing track, the '40s and the '80s meet in an underworld of era-spanning cultural connections.

Producer Kimsey, who has engineered several Rolling Stones LPs in recent years, creates an appropriately eerie spaciousness. He also keeps O'Neill's twangy guitar high enough in the mix to establish that this is indeed a rock band and not a machine. Those very tensions between man and machine, past and present, light and shadow make Fingerprinz far more than just another trendy dance-rock aggregation.

—CRISPIN CIOE

Jools Holland and His Millionaires
Glyn Johns, producer
I.R.S. SP 70602

When keyboardist Jools Holland exited Squeeze to pursue his own musical course—taking with him his boogie woogie piano runs and cartoonish, cigar-chompin' stage persona—many thought that the British band's best days were over. As it turned out, the post-Holland quintet came up with "East Side Story," one of 1981's finest albums, and its best days had just begun. Holland, meanwhile, assembled a group of sidemen and proceeded to record his solo debut. Many thought it would be crammed full of arch, accomplished material, all delivered with wild and wacky aplomb. As it turns out, "Jools Holland and His Millionaires" is almost painful to the ears.

Who's to blame for this disastrous, muddy-sounding affair? Not lyricist Chris Difford, whose words (when one can decipher them through Holland's shrill, nasal quacking) are as wry and winsome as those he pens for Squeeze melodist Glenn Tilbrook. Not Holland's Millionaires: Bassist Pino Palladino shows a knack for tight, skirting rhythms (especially on the subdued, stop-and-start *Glad You've Gone*); drummer Martin T. Deegan keeps things running at a nice, fast clip; and saxophonist Mike Paice toots up Holland's ditties with a spirited jazzbo panache.

The fault, unfortunately, lies mostly with Holland and veteran studio man Glyn Johns. Regarding the latter, the kindest thing that can be said is that he must have slept through the entire session—the tinny, distant quality of this LP is without match in the history of modern recording.

As for Holland, vocals have never been his strongpoint, but on "Jools Holland and His Millionaires" the singing is so weak and helter-skelter that *Bumble Boogie*—the sole instrumental—stands out like a shining beacon. Only on *When I'm Through*, with its spiffy sax and circus keyboards, and the goofy *Pineapple Chunk*, wherein Holland mumbles rather than whines, is his voice anything other than annoying. Concerning his musicianship, the limits of Holland's influences (Ray Charles, Jerry Lee Lewis) are all too apparent, particularly after thirteen jivey, downtown tunes.



Holland: painful to the ears

In the suicidal *Goodbye World*, Jools mutters in mock despair, "I'd shoot myself but I can't afford a gun." One feels tempted to send him the money. —STEVEN X. REA

Rick Springfield:
Success Hasn't Spoiled Me Yet
Keith Olsen, producer
RCA AFL 1-4125

Like the guy on campus who wants to be elected class president, Rick Springfield is eager to please. He has a personality that is made to be stamped "Most Popular," and he plays centrist musical politics by tailoring different songs to meet different demands. On his new album, "Success Hasn't Spoiled Me Yet," sleek pop alternates with quasi-hard rock, with a lot of music falling neatly between those poles. One song sounds like Styx, another is reminiscent of Joe Jackson, some are in the "adult contemporary" mode of Michael McDonald, still others have the stop-and-start tension that made last year's *Jessie's Girl*—Springfield's fresh slant on sexual envy—such an exceptional single.

But it would be too simple to dismiss Springfield because of his stylistic promiscuity, or his teen-idol looks, or his role as a soap opera M.D. After all, he has been pursuing a musical career longer than he has a dramatic one (at least since 1968), and a good deal of this virtual sequel to "Working Class Dog" shows as much energy as ambition. *Calling All Girls* and *How Do You Talk to Girls* (his range of subjects is not broad) are the kind of song he does best: galloping melodies with lyrics that mix desire with frustration. He shrewdly undercuts his pretty-boy appeal, and avoids alienating half of his potential constituency, by pleading awkwardness with the opposite sex. And numbers like *I Get Excited* and his

**SEND FOR OUR NEW
FREE 40 PAGE
HI-FI DISCOUNT
CATALOG No. 61**

- Lowest prices on audio components!
- Fast service!
- Fully insured!
- In factory sealed cartons!



SOUND REPRODUCTION, INC.
(201) 227-6720

CLIP & MAIL TODAY!

Sound Reproduction, Inc.
7 Industrial Rd., Fairfield, N.J. 07006

Please rush your free Hi-Fi Discount Catalog

Name _____
Address _____
City _____
State _____ Zip _____

Circle 38 on Reader-Service Card

TEAC **SANSUI**
Cassette Deck **Reciver**



V-30

\$99.

7900-Z

\$475

OVER 100 BRANDS OF HOME AND CAR STEREO EQUIPMENT

1-800-545-5188

CALL US TOLL FREE

SANTA FE

EXPRESS

P.O. BOX 7578

ALB. N.M. 87194

Circle 48 on Reader-Service Card

remake of Los Bravos' *Black Is Black*, where guitars sound like racing heartbeats, are touched by an understanding of rock momentum.

Springfield gets brisk support from his band, and made-for-radio polish from producer Keith Olsen, but over the length of the album his limitations as a singer and writer become clear. *What Kind of Fool Am I* (not the Newley song) and *Don't Talk to Strangers* (not the Ron Elliot song) are bland midtempo rockers, *The American Girl* (not the Petty song) is condescending, and *Tonight* (not the Bernstein-Sondheim song) is one of those blue-collar romances wherein the line "breakin' backs from nine to five" inevitably leads to one about the difficulty of stayin' alive. At moments like these, Springfield's formula for success seems less diverse than derivative.

—MITCHELL COHEN

Squeeze: Sweets from Strangers
Phil McDonald & Squeeze,
producers. A&M SP 4899

The balance of economy and ingenuity in their melodies, and the deft, tongue-in-cheek slant to most of their lyrics make Squeeze songs breezy exercises in social history. But, make no mistake, lurking near the hearts and heads of writers Glenn Tilbrook and Chris Difford are as many dark images and grim conclusions as antic, satirical diversions. As a result, their hapless protagonists are constantly fighting hangovers, contemplating suicide, or grappling with blasé sirens who could qualify as modern succubi. In its very title, "Sweets from Strangers" sums up this balance of real-world menace and frothy pop classicism.

What makes the fluctuation between lampoon and lament irresistible is the warm, Merseybeat ebullience of Tilbrook's hearty voice and the mitigating tenderness of the lyrics. On *His House Her Home*, one of Difford's rare turns as lead vocalist, the detail accorded an adulterous affair reveals depth of feeling, not moralistic disapproval. The narrator realizes the awkwardness of his indiscretion and yet is hopeful at the prospect of becoming his lover's permanent mate.

If that song contains some of the most striking images, the set's most vivid music hews more to tragi-comic pop. *Out of Touch* kicks off the record with a striking rhythmic force, its nervously shuttling drum accents offset by Tilbrook's elongated vocal lines. Sinuous slide-guitar accents in turn play against sudden, staccato bursts of raw rhythm guitar. On *I Can't Hold On* and *Black Coffee in Bed*, Tilbrook and Difford's finely honed grasp of Beatle-browed '60s pop classicism meets head on with their invocations to lyrical soul.

Last year's "East Side Story" consolidated the band's verbal idiosyncrasies and melodic universality while using a broader orchestral palette. That trend continues



Springfield: a song for all reasons

here, along with a shift in keyboard style that returns somewhat to original member Jools Holland's more angular, experimental approach. Holland's replacement on keyboards, Paul Carrack, has in turn departed; Carrack's successor Don Snow (formerly of the Sinceros) incorporates both Carrack's classic Hammond organ fills and Holland's discordant brinkmanship. As a result, songs like *Stranger than the Stranger on the Shore* and *On To the Dance Floor* are fractured, abstracted collages appropriate to their nightmarish texts.

Production—which marks the band's first foray behind the console—reflects both the cinematic meticulousness of their original producer, John Wood, and the crisp immediacy Elvis Costello achieved on "East Side Story." "Sweets from Strangers" is very much a consolidation of past virtues. If there's no sense of quantum forward motion, as there was on "Argybargy" and the last album, this is still impressively savvy modern rock. —SAM SUTHERLAND

The Name of This Band Is Talking Heads
Talking Heads, producers
Sire 2SR 3590 (two discs)

What we have here is the aural equivalent of a time-lapse film: a double live set that compresses—via various concert performances—four years and four excerpted studio albums into a document of growth, change, development, and experimentation. As such, record one, which runs from 1977 through '79, is by far the most fascinating and ultimately the most listenable of the two-disc "The Name of This Band Is Talking Heads." Early songs like *New Feeling*, *Don't Worry About the Government*, the buoyant *Pulled Up*, and the heretofore unreleased track *A Clean Break* bristle with a stark, frantic urgency. David

Byrne's yelping vocals are lean and hungry, his chicken-scratch guitar playing is wiry and insidious; Jerry Harrison attacks his keyboards with a splashy, minimalist verve; drummer Chris Frantz pounds out a solid, sprightly backbeat; and Tina Weymouth propels the band forward with her simple, economical I'm-learning-as-I-go-along bass patterns. What comes across in these pre-Brian Eno, pre-*Take Me To the River* days is Talking Heads' nascent charm and the almost primal energy with which the band punches out Byrne's spookily neurotic songs about buildings and food.

As the first disc nears its end, culminating in the ethereal *Air*, *Building on Fire*, and *Memories (Can't Wait)*, things begin to change: Songs get longer and more involved; lyrics get less specific; loopy, spacey guitars are woven into the framework; Byrne sings with more confidence. By the second record, which spans the period between 1980 and '81, everything is different. The T. Heads quartet has been augmented by guitarist Adrian Belew, bassist Busta Jones, clavinet player Bernie Worrell, singers Nona Hendryx and Dolette McDonald, and percussionist Steve Scales. All of them dish out churning, repetitive (some might say hypnotic) African-influenced rhythms while Byrne waxes ethnic (the Afro encantation of *I Zimbra*) or abstract (*Crosseyed and Painless*) and delves into a kind of arty antidisco disco music (*Life During Wartime*).

The sound quality of all of these performances (recorded in places as diverse as Passaic, New Jersey, and Tokyo, Japan) is consistently excellent while the tracks are thankfully devoid of extended, cranked-up crowd noise. Byrne's singing is even wackier and more reckless than it is in the studio (it gets more so on the '80-'81 material), and the selection of tunes comprises a pretty good sampling of Talking Heads' work thus far. —STEVEN X. REA

Wendy Waldman:
Which Way to Main Street
Eddie Kramer, producer
Epic ARE 37913

By the time Wendy Waldman delivered her final album to Warner Bros. in 1978, she had become stereotyped as a quintessential southern Californian singer/songwriter. Though the LP itself marked a decisive swing away from folk/pop eclecticism toward a tougher rock stance, her self-proclaimed "gypsy" persona, underslung vowels, and mix of romantic confession and pastoral imagery had cemented her identity as fevered earth mother of L.A.'s acoustic mafia. That Waldman herself didn't recognize this typecast was indicated by her decision to leave Warner, apparently confident that other record companies were aware of her new stylistic bent and would be eager to sign her.

Instead she was greeted with indifference. So she dismantled her band, found a new publisher, and began writing a body of new work—some in collaboration with Eric Kaz—that probed many of the same themes but relied on a substantially stripped-down lyric approach. Similarly, the often-convoluted melodic framework of her earlier songs was replaced by a more classic pop song structure.

"Which Way to Main Street" demonstrates conclusively that Waldman's confidence of four years ago was well placed. Relative to her earlier works, these new songs are consistently more focused and emotionally direct. And, somewhat paradoxically, by embracing the more melodramatic dynamics of rock, she has parlayed that "youth" genre into a convincing vehicle for her most mature music. That process is helped along by her own passionate alto, which occasionally seemed overblown against the lacy piano and acoustic guitar of her mid-'70s recordings. The voice has gained new power, but more significantly, it meets a more potent match in the electric context of guitar crossfire and angular synthesizer and organ lines.

The songs move from declarations of perseverance (*Heartbeat*, *Fighting It Out in the Heart of the City*) to vulnerable intimations of romantic longing (*Does Anybody Want to Marry Me*, *Gotta Get Over You*). As such, they suggest a personality at once stronger and less judgmental than the folk/rock priestess of nine years ago. Some of the more routine rock exercises suffer from thematic slightness, but the overall consistency and quality of Waldman's writing is as strong as ever. And when she hits her stride, as she does fairly often, her new rock sensibility yields a majestic flow. On *We'll See in the End*, the message of self-definition and enduring faith builds through the quiet verses to rich choral harmonies that give the title phrase rhapsodic force. *Lovin' You Out of My Life* demonstrates how a potentially hackneyed subject, romance on the rebound, can be addressed with dignity and emotional realism.

Producer Eddie Kramer is best known for his vivid use of studio effects on late '60s albums by progressive rock titans like Jimi Hendrix and Traffic. His widescreen frame here is charged with rock urgency, and if he falls back on some of his more heavy-handed technical ploys (like rapid stereo panning), the musical marriage is still satisfying. With Waldman as his star, Kramer can rightfully lay claim to his own comeback. —SAM SUTHERLAND

Jimmy Webb: Angel Heart
Matthew McCauley & Fred Molin,
producers. Columbia FC 37695

If for no other reason, Jimmy Webb's place in pop music history is assured for having come up with *MacArthur Park*, the seven-

minute dishy piece of nonsensical melodrama recited in portentous tones by English actor Richard Harris. The 1968 smash, with its lyrics about forgotten recipes and icing that melts in the rain, was all Webb's handiwork: He wrote the words, composed the music, arranged the grandiose score, and produced Harris' stalwart vocal performance. Since then, his songs—which combine an uncanny sense of what's commercial with graceful eloquence, lush poetry, and a touch of whimsy—have been recorded by everyone from Glen Campbell to the Supremes, Art Garfunkel, and Waylon Jennings.

"Angel Heart" is Webb's sixth solo album (his first, *Words & Music*, was recorded in 1970). Like its predecessors, it's a quirky, on-again, off-again effort. He has always maintained that "no one can do a song like the person who writes it, no matter what their vocal talents are," and while that's an admirable position to take, it's not always true. Two songs here, *Scissors Cut* and *In Cars*, were recorded by Garfunkel on his most recent LP and both fared better under his silken timbre. Webb's vocals are variably breathy and bluesy, or full of a boisterous, booming strength, but his performance lacks the subtlety and nuance that a singer like Garfunkel can summon.

Nevertheless, "Angel Heart" hardly sounds like a half-baked demo session, the material benefiting in no small way from some sterling instrumental and vocal support. The former includes most of Toto, as well as bassist Lee Sklar, keyboardist David Foster (almost all the electric piano is Webb's), and guitarists Dean Parks and Fred Tackett. Background vocals are supplied by Daryl Hall, Stephen Bishop, Michael McDonald, Leah Kunkel, Valerie Carter, Kenny Loggins, and Graham Nash. The title track is the record's finest. On it, Webb's singing is so assured that it is indeed hard to imagine anyone doing it better. The midtempo marvel shimmers with his trademark orchestral flourishes and surges with Fifties-style rock & roll. Other standouts include *Our Movie*, which utilizes technical film jargon as a metaphor for love, and *Nasty Love*, an X-rated ballad.

Despite the sizable fortune he has amassed through publishing royalties, TV jingles, and film scores, Webb remains a frustrated singer/songwriter who has yet to have a certified hit of his own. Whether "Angel Heart" will change all that is anyone's guess; if it does, his success will be well deserved. —STEVEN X. REA

Kim Wilde
Ricky Wilde, producer
EMI America ST 17065

Despite its unmistakable stamp of crass calculation and its sprinkling of utter nonsense, "Kim Wilde" is an upbeat, enter-

SAVE \$ ON AUDIO & VIDEO COMPONENTS CALL TOLL-FREE 800-221-0974

RECEIVERS		TURNTABLES	
TECHNICS SA-424	\$278	TECHNICS SL-5	\$133
PIONEER SR-4	\$275	DUAL CS-DL-1	\$224
MARANTZ SR-4100	CALL	CALL	CALL
SONY STR-V85	CALL	SONY PS-X800	CALL
TECHNICS SA-203	\$168	PIONEER PL-7	\$135
SANSUI 8800Z	CALL	AKAI AP-Q310	\$114
CASSETTE DECKS		CARTRIDGES	
TECHNICS RS-8283	\$219	SHURE V15-IV	\$90
AKAI Q3-F31	\$198	SHURE M7HE	\$48
MARANTZ SD-3030	CALL	PICKERING XSV-3000	\$44
ONKYO TA-4300M	\$197	PICKERING XSV-4000	\$63
SONY TC-FX30	CALL		
TEAC V-7	\$270		
BLANK TAPE		PERSONAL STEREO	
BASF PP-011 C-90	Box/10 \$26	SONY WALKMAN II	\$99
TDK SA-K-C-90	Box/10 \$28	SONY WALKMAN I	\$77
TDK SA-C-90	Box/10 \$28	PANASONIC RX-1950	\$138
MAXELL UD-XL II C-90	Box/12 \$39	AIWA CS-J1	\$148
MAXELL UD-XL III C-90	Box/12 \$49		
VIDEO		CAR STEREO	
PANASONIC PV-5500	(VHS) CALL	JENSEN RC-518	\$284
PANASONIC PK-902	(CAMERA) CALL	JENSEN J-1033	\$69
RCA VFT-450	(VHS) CALL	SAHYO FT-590	\$247
SONY SL-2500	(BETA) CALL	PIONEER LHP-4200	\$133
		PIONEER TS-895	\$188
		PIONEER TS-168	\$73
		SONY CAR STEREO	CALL

ALL MERCHANDISE IS BRAND NEW,
FACTORY FRESH, AND FULLY GUARANTEED
Quantities limited. Prices subject to change without notice.

Write Or Call For Free Catalog!

Call Toll-Free
800-221-0974
(Ex. N.Y., AK, HI.)
Monday - Friday
9Am - 5:30Pm
Sat. 9Am - 5Pm E.S.T.
OR CALL (212) 253-8888

Use our special
Night-Owl Line!
Call Toll-Free
800-327-1531
Monday - Friday
5:30 - 10Pm E.S.T.

**STEREO CORPORATION
OF AMERICA**
Dept 206
1629 Flatbush Ave., Brooklyn, N.Y. 11210

Circle 29 on Reader-Service Card

FREE details. A DIFFERENT KIND OF RECORD CLUB

TREMENDOUS SAVINGS
on every record and tape in print—
no "agree-to-purchase" obligations of any kind
DISCOUNTS OF 43% TO 73%
off mfg. suggested list special catalog
features hundreds of titles and artists
ALL LABELS AVAILABLE
including most imports through special custom
ordering service—guarantees satisfaction.

SCHWANN CATALOG
lists thousands of titles:
classical, pop, jazz, country, etc.
DISCOUNT DIVIDEND CERTIFICATES
Dividend Gifts—certificates
redeemable immediately for extra discounts.

NEWSLETTERS
informational news and happenings in the
world of music...special super-sale listings.
DISCOUNT ACCESSORY GUIDE
Diamond needles, cloths, tape cleaners, etc.

QUICK SERVICE
same day shipping on many orders,
rarely later than the next several days
100% IRON-CLAD GUARANTEES
on all products and services—your total
satisfaction is unconditionally guaranteed.

Discount Music Club is a no-obligation membership club
that guarantees tremendous discounts on all stereo
records and tapes and lets you buy what you want...when
you want...or not at all if you choose.
These are just a few of the money-saving reasons to write
for free details. You can't lose so why not fill out and
mail the coupon below for immediate information.

DMC DISCOUNT MUSIC CLUB, INC. Dept. 8-0682
650 Main Street,
P.O. Box 2000
New Rochelle, N.Y. 10801

Name _____
Address _____
City _____
State _____ Zip _____

Circle 51 on Reader-Service Card

taining debut. You can see right through it, but it doesn't matter. All the good stuff is on the surface anyway. It's a real kitchen-sink production, complete with post-Blondie pop-with-sass modern accoutrements (such as electronic keyboards that sound like hypertense watercoolers), the instrumental perkiness of the early girl-group sound, and the "I'm cool and inscrutable" vocal poses of the mid-'60s female mods. *Water on Glass*, *Chequered Love*, and *Falling Out*—the album's strongest cuts—are so packed with activity that it's all Wilde can do to keep up her end.

In a way, the record is a throwback to the years when a girl singer was used as a vehicle, given songs and a sound by hands behind the scenes. Wilde's records are produced by her brother Ricky, and most of her material is written by him and her father, Marty. (Twenty years ago, Marty Wilde was one of England's top singers, primarily by virtue of covering hits by U.S. stars like Bobby Vee and Dion.) So Kim essentially has been cast in a role by her family, and she's quite adept at it. When she sings, just this side of shrill, "We only wanna stay young!/We only wanna be free!" (on *Young Heroes*), it's as enjoyable as a scene from Alan Freed's '50s film *Don't Knock the Rock*. This type of pandering is so archaic that it may be ready to come back in style.

Other songs, such as *Kids in America* (her first U.K. hit) and *Our Town*, are similarly self-conscious in their attempts to be youth anthems, but even these bits of exploitation have such crafty, giddy arrangements that it's difficult to object. And on the less gimmicky pop songs—the ethereal, reggae-ish *Everything We Know* and *You'll Never Be So Wrong*—Wilde's plaintive voice gets a chance to emerge from her brother's carnival of effects. The only time "Kim Wilde" truly fizzles is on *Tuning in*. *Tuning on*, a slow-paced, psychedeliatinted number about the infinite properties of sound—or some such foolishness. Otherwise, the album's light-headedness is a lot of fun.

—MITCHELL COHEN

Jazz

Ornette Coleman: Of Human Feelings

Ornette Coleman, producer
Antilles/Island AN-2001 (digital)

Ornette Coleman's recordings are so rarely in distribution these days that any new release from him assumes a very special cachet. This is particularly true since he has been credited with having major influence on the much-heralded guitarist James



Coleman: a shift towards the mainstream

"Blood" Ulmer and, more to the point, since he appears to be reaching for more accessible blues-based sounds from his own music.

There was never much doubt, even in his most avant-garde days, that Coleman was a child of the Southwest. His phrasing, the characteristic blues "cry" in his tone, and the thematic structure of his compositions (despite their occasional "missing" beats) were clearly derived from an early association with the lean, gutsy blues music of Fort Worth and its environs. But working with musicians like Paul Bley, Billy Higgins, Charles Haden, Don Cherry, as well as having a series of creative encounters with Eric Dolphy, John Lewis, George Russell, and others, provoked Coleman's already revolutionary instincts far beyond the limits of his Texas heritage. Whether one liked his early recordings or not, there could be little doubt that they opened up new landscapes for musicians of the Sixties and Seventies.

More recently, Coleman has been slowly leaning back toward his roots, first through his association with Ulmer and, in this recording, with his young group, Prime Time. To describe the results as jazz/rock or as commercial (as some observers have) is a bit misleading. Coleman is structuring his music as he always has—with stretched out, blues-tinged melodies and various kinds of collective improvisation. If one could isolate his solos from the accompaniment on "Of Human Feelings," they would follow very logically in the spontaneous style so characteristic of his work a decade or two ago.

The difference is in his intent, and in the musicians with whom he is working. That he has wider audience acceptance in mind is obvious in the three short (three or four minutes) cuts that start each side of the disc. Each represents Coleman's version of

a "jump" piece, with the two- and four-bar phrases typical of simple dance music. Nothing is allowed to intrude on the straight-ahead, dynamically unvarying character of each track. Even the slower tunes *Him and Her* and *Love Words* retain the basic energy of dance music. The style (and ability) of Prime Time compliment his intentions. The two guitarists bounce lines in and around each other, and the bassist plays accents that can be disturbingly reminiscent of a polka band. But the effect is light-hearted, blues-based, conversational dance music.

Will it work? With the recent renaissance of interest in jazz, Coleman is going to get more audience response—one way or the other. But for this listener, the departure of all the fringe benefits of his music is a serious loss. One longs to hear the stunning interaction with players who are his creative equal, the serious exploration of his compositional skills, the further development of his improvisational abilities. Only on the longer pieces (*Air Ship* and *Times Square*) do we get a whisper of the electricity he can generate. And even here, the simplistic surroundings lack the kind of energy he requires to play his best.

Any Coleman recordings are better than none. But one had hoped for more from "Of Human Feelings" than it seems designed to provide. Surely a world that can provide adequate sponsorship for the likes of Arthur Blythe, Pat Metheny, and Weather Report can provide sufficient wherewithal for Coleman not to have to worry about being "commercial." —DON HECKMAN

Mary Osborne: Now and Then

Bernard Brightman, producer
Stash ST 215 (P.O. Box 390,
Brooklyn, N.Y. 11215)

Jazz guitarist Mary Osborne arrived in New York in the 1940s playing with a polished Charlie Christian influence. From 1952 to 1960, her strongly swinging sound could be heard on a daily morning radio show. Then, in the '60s, she followed her husband to California, subordinating her career to be a suburban housewife and mother. A few years ago she became active again, performing at the Women's Jazz Festival in Kansas City and at the Newport Jazz Festival. A recent gig at Bechet's in New York revealed the same assurance and strength of phrasing that had been her earlier hallmarks.

This collection is split between the new and the old. On the newly recorded set she is backed by Steve Laspina on bass and Charli Persip on drums. The older session, originally released in 1959 on Warwick Records, features Tommy Flanagan on piano, Danny Barker on rhythm guitar, Tommy Potter on bass, and Joe Jones on drums. Though Osborne is an appealing soloist on (*Continued on page 85*)

High Fidelity Classified

MAIL TO: 825 7th Ave., 6th Floor, New York, N.Y. 10019. Phone: 212-265-8360

GENERAL: all copy subject to publisher approval. First line caps. Users of P.O. Box MUST supply permanent address and telephone number before ad can run.

CLOSING DATE: 1st of second month preceding cover date.

CLASSIFIED RATES: regular type, per word: 1x—\$2.30; 3x—\$2.25; 6x—\$2.10; 12x—\$2.00. Words in caps—10¢ extra each. IMPERIAL type, per word: 1x—\$3.10; 3x—\$2.95; 6x—\$2.85; 12x—\$2.75. Words in caps—15¢ extra each. Minimum 15 words. Box numbers: \$2.50 additional per insertion to cover cost of handling and postage. Display, per inch: 1x—\$365; 3x—\$355; 6x—\$350; 12x—\$295.

PAYMENT WITH ORDER: Send check, M.O., MASTERCARD or VISA No. and expiration date to: Classified Dept., HIGH FIDELITY, 825 7th Ave., 6th Floor, New York, NY 10019.

For Sale

STEREO REPRESENTATIVES NEEDED!!! LOWEST POSSIBLE PRICES!!! OVER 100 BRANDS!!! KRASCO Rep. HF, 998 Orange Ave., West Haven, Conn. 06516.

AUDIO REPLAY IS NEW ENGLAND'S LEADING dealer in secondhand audio. Now you don't have to come to New Haven to browse through our inventory. Two dollars will bring you our current listing, typically 100-200 items long. We recondition and warranty what we sell, so you can shop with confidence. Audio Replay, Dept. HF, 252 Park St., New Haven, Ct. 06511

SAVE 50% BUILD YOUR OWN SPEAKER SYSTEM. Write McGee Radio Electronics, 1901 McGee Street, Kansas City, Missouri 61408.

WE WILL NOT BE BEAT!! Lowest Prices Anywhere! Super Selection—Full Warranty—Fast Delivery Hi-Fi—Hi-End—Car Product and Video. Visa—Mac Call Now—(203) 934-5291 AUDIO PEOPLE, 1000 Orange Avenue, West Haven, CT 06516.

Quality Tapes

Quality Tapes at Wholesale Prices!

Maxell UDXL for II C-90	\$3.09	TDK SA C-90	\$2.69
Maxell UDXL for II C-60	2.45	TDK SA C-60	2.10
Maxell XL for II S C-90	3.89	TDK SAX C-90	3.89
Maxell UD C-90	2.39	TDK AD C-90	2.12
Maxell UD 35-90	5.39	TDK D C-90	1.55
Maxell UDXL 35-90B	6.69	TDK D C-60	1.18
Maxell Cass Demag. (HE-44)	16.49	TDK LX35-90	5.25
Discwasher Complete System	9.50	TDK LX35-90B	5.85
Discwasher D-4 16 oz. refill	10.50	TDK GK35-90B	7.89
Discwasher D-sat	32.95	TDK Cass. Demag. HD-01	14.25
Discwasher Zerostat Gun	15.00		
VIDEO			
TDK T-120	\$12.75	SONY L-750	12.65
TDK HG T-120	15.95	SONY L-500	9.95
MAXELL HG T-120	15.75	ALSOOP HEADCLEANER	
SCOTCH T-120	11.95	VHS-BETA	14.95

To order by mail, send money order, check or MasterCard VISA (card number, expiration date and signature). PLEASE add shipping charge of \$3.50 or 4% whichever is more (U.S. only—foreign higher) C.O.D. to dealers only. Credit card orders subject to 3% handling charge. To order by phone call 212-434-1720

QUALITY TAPES
864 East 7th Street, Dept. MR, Brooklyn NY 11230

BEFORE YOU BUY—CHECK OUR PRICES. Send for free catalog featuring audio and video equipment and accessories at discount prices. Discount World, P.O. Box 191, Mineola, NY, 11501.

HARMAN/KARDON high technology separates, receivers, cassette decks; ELECTRO-VOICE Interface, A,B,C,D speaker systems; THORENS turntables. All products in stock—immediate shipment. East (904) 262-4000; West (213) 243-1168.

ACCURATE, QUALITY AUDIO. Reasonable Prices! Car/Home. Send stamp: Denco Audio, P.O. Box 6104-H, El Monte, CA 91734 (213) 961-6158. Evenings, weekends. MONTHLY SPECIALS

CABLE TV DESCRAMBLERS AND CONVERTERS. Microwave antennas and downconverters. Plans and parts. Build or buy. For information send \$2.00 C&D Electronics, P.O. Box 21, Jenison, MI 49428.

HAFNER, FRIED KITS, KLIPSCH, SAE, CARVER, more. In stock. Immediate, FREE shipping! READ BROTHERS STEREO, 593-C King Street, Charleston, South Carolina 29403. (803) 723-7276.

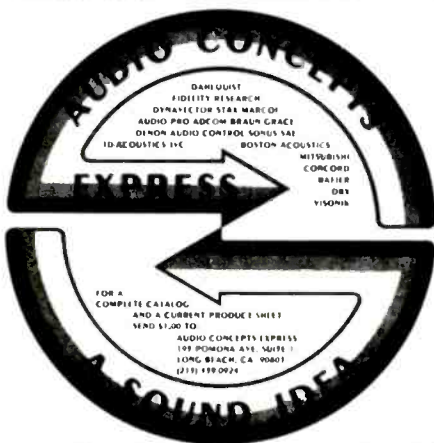

WE HAVE IT ALL!! Audio and Video Tape, Accessories, Recording Equipment, Fine Audio Components. KNOWLEDGEABLE Staff! COMPETITIVE Prices! FREE Buyer's Guide! SOUND IDEAS, Dept. HF, Box 671, Cary, NC 27511-0671, (919) 467-8578.

BEST SOUND PER DOLLAR: 3D ACOUSTICS, NAD, MISSION, Cizek, Dynavektor, Amber, Marcol, Snell, Leach, etc. Shipping AudioFile, 1202 South Congress, Austin, Texas 78704 (512)443-9295.

SUBSCRIPTION TV DECODER KIT, \$39.00. Includes parts, manual and etched board. Informative catalog on other subscription TV products \$2.00. J&W Electronics P.O. Box 61-E, Cumberland, RI. 02864.

Save 60% to 75%, Build Your Own Speaker Systems. P/C crossovers, woofers, mids, tweeters, instructions. Complete selection, Hi-Fi, M.I., Pro, Disco and Auto Systems. Send \$2.00 for catalog refundable with purchase. DK1 Audio, Box 284, Davis, IL. 61019.

SPEAKER BUILDERS: JBL, ELECTRO-VOICE, + computer designed plans. Catalog \$2.00, refundable. Gold Sound, Box 141HF, Englewood, CO 80151.

ATTRACTIVE PRICES: DYNAVECTOR, DENON, GRACE, FULTON, STAX, FR, LINN ITTOCK, ASAK. ALSO SOTA SAPPHIRE, QUAD. (713) 728-4343 MAURY CORB 11222 ATWELL, HOUSTON, TEXAS 77096

SPEAKER BLOWN? RIPPED? SAVE \$\$\$ BY RECONING IT! Guaranteed Work. For information send SASE. A&TRC, 527 Charles Ave., Solway, NY 13209. (315) 468-4031

AND EVEN MORE RAVE REVIEWS FOR VMPS LOUDSPEAKERS

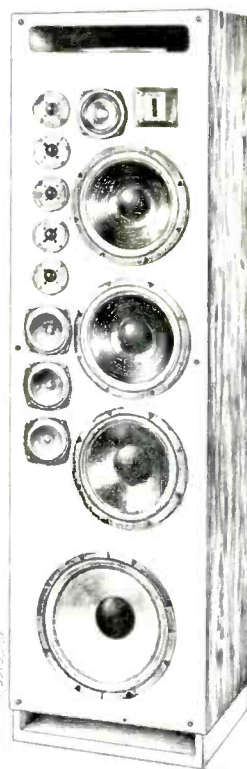

The VMPS Super Tower IIa/R, \$999ea black kit, \$1199ea walnut or oak kit, \$1499ea black, \$1699ea walnut or oak assembled. 76" x 21" x 17" (H x W x D), 300 pounds. Sold in mirror-image pairs.

B. V. Pisha, Senior Editor of AUDIO, writing in "Stereo & HiFi Times":

"Speakers are becoming larger and larger, but the behemoth of them is the new VMPS Minimum Phase Response Loudspeaker Super Tower IIa/R. Being almost 6 1/2 feet tall, this system needs no artificial assistance to produce a large apparent sound source, but there is no stretching or distortion of the sonic image to our ears: all instruments appear lifesize, whether solo, chamber, ensemble, or orchestra. The sound emanating from this system is breathtaking in its opulence. The bass is super with no doubling of the low-frequency fundamentals.... After hearing this speaker perform there is no question in my mind that it is one of the very few that will be able to handle the dynamic range of true digital records when they become available in the very near future."

VMPS manufactures nine loudspeaker systems with lower distortion, wider bandwidth and greater dynamic range than any others regardless of price, with accuracy and linearity to match the finest audiophile monitors. Also available in kit form are the MiniTower II (\$309ea), Tower II (\$419ea), and the Super Tower/R (\$649ea). Kits come with fully assembled cabinets and their price includes free shipping in USA. Write for our brochures and copies of reviews by Bert Whyte, HiFi News & Record Review, and HiFi Buyer's Guide.

VMPS AUDIO PRODUCTS

a division of Itone Audio

1016 Contra Costa Drive, El Cerrito, CA 94530 (415) 526-7084

Hear VMPS at: The Listening Studio, Boston; Mike Hilliard Audic, Shreveport, LA; Sound Alternative, Ft. Myers, FL; Star Audio, Oklahoma City, OK; Bedini Electronics, Sylmar, CA; The Long Ear, Big Bear Lake, CA; A-Vidd Electronics, Long Beach, Itone Audio, El Cerrito, CA.

"This may be the first slick product worth getting a hold of."

STEREO—Chicago Sun-Times

"Our ears tell us this product is a smashing success . . . Gruv Glide geometrically elevates some disks and systems to near perfection . . . the listener is transported 20 rows forward into the lap of luxury."

AUDIOGRAM #17, 1/82



GRUV-GLIDE IMPROVES RECORD FIDELITY!

Gruv-Glide is a new dry record treatment that maximizes the fidelity of records as well as reduces friction, eliminates static electricity, improves tracking and cleans record surfaces. One treatment lasts indefinitely, too.

There is no doubt about it. Records treated with Gruv-Glide sound better.

Ask for a demonstration at your favorite audio specialist or record store.

Send inquiries to Trego Sales, 2239 Benedict Canyon Dr., Beverly Hills, CA 90210 (213) 274-8351.

GRUV-GLIDE™

© 1982 Rozoil Lubricant Co.

Rozoil Lubricant Co.
P.O. Box 19003, Las Vegas, NV 89119



New Subsonic Filter
model 4000-X24 improves bass performance (24dB/octave slope). **FREE CATALOG.** ACE AUDIO CO., 532-5th St., East Northport, NY 11731-2399.

So What's New??

Consider the following—**DIRECT SOUND MARKETING** can provide you with virtually any brand of audio or video components (including the esoterics) at extremely competitive pricing, on an in-stock basis. Moreover, we maintain a complete service facility to handle any service problems. So, if you're looking for price, selection, fast shipments, in-house service and competent advice we have it all, and more. Before you buy anything please call us at 404-233-9500 for more information. Or write to **DIRECT SOUND MARKETING**, 3095 Bolling Way, N.E., Atlanta, Ga 30305. For your convenience use your M/C, Visa or AMEX for fastest service. Sales tax charged to Georgia residents only.

ATTN: COLLEGE DEALERS for midwest distributor: 20-40% off list, many brands. Hear Now, Inc., P.O. Box 2008, River Grove, ILL. 60171, 312 685-6435. MC/VISA.

THE ABSOLUTE SOUND®, the international magazine about sound, recordings and audio components, will feature, in its June CES special issue, an exclusive comparative amplifier survey (written by HP, no less) that ranks and rates: the Perreux from New Zealand, the Doga from Norway, the Exposure IV from England, the Ruffel from Japan, the new FM Acoustics from Switzerland, the BRB, the BiPolar Systems, and the BEL all from Silicon Valley, the Acciuphase from Japan, three Electrocompaniet from Norway, and Matti Otala's 7,500 design for Citation, the XX. A short cartridge survey will feature the Grace F-11L, the EMT Van den Hul, the improved Dyna-ectors, the Signature Seven, and the radically improved AKG. All this, plus an expanded review section of classic analogue recordings that are about to be deleted as the Money Boys rush to digital and judgment, for \$20 (four issues, US; \$22 (Canada); \$35 (outside North America) from The Absolute Sound, Box 233, Sea Cliff, New York, 11579. Or, with VISA or MasterCard, call 516-671-6342 11 to 4 (ET). [PS: Soon, we'll be bi-monthly.]

A SINGER'S DREAM!

REMOVES VOCAL FROM MOST STEREO DISCS
The Thompson Vocal Eliminator can actually remove most or virtually all of a solo vocalist from a standard stereo record and yet leave most of the background music untouched! Not an equalizer! We can prove it works over the phone. Write or call for a brochure and demo record below. **COST: \$349.00**

YOU SHOULD SEE US

For:

- Time Delay/Ambience
- Studio Echo/Reverb
- Tape Noise Reduction
- Parametric Equalization
- Electronic Crossovers
- Compressor/Expanders
- Mic Preamp/Mixers

We manufacture a full line of high quality audio and recording equipment. You will probably have to pay twice as much elsewhere to obtain comparable quality. Only Direct Sales make our prices and quality possible. Write or call for a 24 page brochure and demo record.

Write to: **LT Sound**, Dept. HF, P.O. Box 338, Stone Mountain, GA 30086, Phone (404) 493-1258

SOUND VALUES AT AUDIO AUDIO. . . 110-220 VOLTS. FEATURING: AMBER, AUDIO PRO, AR, AUDIO CONTROL, AIWA, BEYER, CELESTION, DUAL, DYNAVECTOR, ELECTRO VOICE, GRACE, KOSS, LAST, LUSTRE MONSTER CABLE, NAIAD, ORTOFON OPTONICA, PREMIER, 3D, QED, SONY, SUPEX, TEAC, THORENS VAMPIRE WIRE AND OTHERS. OPEN 7 DAYS, 11am-6:30pm EST. MasterCard and Visa. 42 CANAL ST., NYC, NY 10002. 212-925-5868.

POLYPROPYLENE DRIVERS, RIBBON TWEETERS, PLANS, CROSSOVERS, REPLACEMENTS. NEW 1982 Catalog \$1.00. **SOUNDBOX**, Dept HF, 411 South Carlisle Street, Philadelphia 19146.

Fuzzbuster Superhet	199.00	Maxell UDXL1 or 2C90	3.49
Whistler 270	99.00	Maxell UDXL1S or 2S C90	4.25
Whistler Q1000	229.00	Fuji FX1 or 2C90	2.95
Whistler Q1000 Remote	269.00	Audio Technica AT130E	39.00
Sony Walkman 2	129.00	Audio Technica AT125LC	40.00
Sony Walkman 3	139.00	Sony Car Audio XR35	179.00
Sony TCS310 Record	129.00	Sony Car Audio XR50	198.00
Toshiba KTS1 Cas w/FM	129.00	Sony Car Audio XME7	129.00
Toshiba KTR2 Cas w/Rec FM	139.00	Sony Car Audio XM45	69.00
Aiwa CSJ1 FM Cas w/Rec	159.00	Sony Car Audio XM120	209.00

DISCOUNT WORLD P.O. BOX 191, MINEDOLA, NY 11501 516-294-6136
Shipping charges are \$4.00 per order except orders destined for Puerto Rico, Alaska, Hawaii, APO and FPO (these orders require shipping charges of \$8.00 per order)

EVERY MONTH • EVERY MONTH
We deliver the best noncommercial audio journalism and product reviews. Want to see for yourself? Write for **FREE** excerpts: **IRA, 2449 Dwight, Berkeley, CA 94704.**

CALL TOLL FREE 1-800-826-0520 FOR ACOUSTAT, DAHLQUIST, NAD, CARVER, TANDBERG, DENON, AMBER, HAFNER, dbx, 3D, B&W, THORENS, DCM, GRACE, DYNAVECTOR, MICRO-SEIKI, VANDERSTEEN, BEDINI, ARISTON. THE SOUND SELLER, 1706 MAIN ST., MARINETTE, WI 54143.

Inventions Wanted

INVENTIONS WANTED. FREE CONSULTATION, NO IDEA TOO SMALL. Disclosure registration. Potential cash or royalties from manufacturers seeking new ideas. For free information on how to register your ideas, call or write: **AMERICAN INVENTORS CORP.**, 2280 South Xanadu Way, #300, Dept HF Aurora, Co. 80014 (303) 695-6500. A Fee Based Marketing Company.

IDEAS, INVENTIONS, NEW PRODUCTS WANTED! Call toll free 1-800-528-6050. In Arizona. 1-800-352-0458. Extension 831.

Miscellaneous

DIAMOND NEEDLES and Stereo Cartridges at Discount prices for Shure, Pickering, Stanton, Empire, Grado. Audio Technica, Ortofon, Acutec and ADC. SASE free catalog. **LYLE CARTRIDGES**, Dept. H, Box 69, Brooklyn, New York 11218. For Fast C.O.D. Service, call TOLL FREE 800-221-0906. N.Y.: (212) 871-3303

PROTECT YOUR ALBUMS. WHITE CARDBOARD REPLACEMENT JACKETS 35c. PLASTIC LINER INNER SLEEVES 15c. POSTAGE \$1.25. OPERA BOXES. 78 SLEEVES AVAILABLE. FREE CATALOG. **CABCO 301-3**, BOX 8212, COLUMBUS, OHIO 43201.

COLLEGE STUDENTS!—Improve your grades!—Term-paper catalog—306 pages—10,278 titles—Rush \$1.00 (Refundable!)—Research, Box 25916R, Los Angeles, 90025. (213) 477-8226.

Equipment For Sale

IDEAL ACOUSTICS OUTSTANDING SHOWROOMS. CUSTOM Installations. Luxman, Klipsch, NAD, Nakamichi, and comparable lines fully represented. Complete service center. Visit us 110 Willow Rd., Starkville, MS. 39759 (601) 324-1020.

Tapes & Records

1 • 800 • 245 • 3986
TAPE WORLD

TDK SA-C90	2.79	TDK VAT-120 L-750	12.89
TDK SAX-C90	3.60	TDK MAR-C90	7.49
TDK AD-C90	2.25	TDK LX35-90B	5.89
TDK ADX-C90	3.29	TDK GX35-90B	7.99
TDK SA-C80	2.19	TDK SA 35-90	9.79
TDK D-C90	1.99	<i>Maxim: Use any price in this book</i>	
TDK MA-C90	4.89	TDK HD-01 (Cass. Head Damag)	14.69
TDK VAT-HG120 L750HG	15.99	BASF PRO I, II, III C90	2.69
Fuji Metal C90	5.19	FUJI FX I or II-C90	2.79
LORAN	CALL	Sony UCKS-90	3.49

3.75 shipping any size order in US. Dealers COD no extra charge. PA 6% sales tax. We will honor any price in this book. VISA, MC, no extra charge. All orders shipped within 4 days by UPS. Personal Checks 2 Wks Delay.
120 Spring St Butler, PA 16001 412-283-8621

MUSICAL CONCEPTS: 64 page catalog of imported & domestic classical/contemporary recordings, \$1.00 (refundable). Musical Concepts, Box 53HF 6 Cedarhurst, N.Y. 11516.

OPEN REEL TAPES from studio masters. Philips, Argo, Telefunken, Vanguard, Unicorn. Catalogue \$1.00. Barclay Crocker, Room 1470-H, 11 Broadway, NYC 10004.

SEARCHING FOR OUT-OF-PRINTS? Try for Discontinued Records, 444 South Victory, Burbank, California 91502 (213) 849-4791.

LIVE OPERA TAPES. INCREDIBLE VARIETY. FREE CATALOGUE. Live Opera. Box 3141. Steinway Station, L.I.C.N.Y. 11103.

JAZZ—SWING—BIG BAND BROADCASTS, TRANSCRIPTIONS LAST 50 years exclusively. Reels cassettes 75 pg. catalog \$2.50. Refundable. Citation P.O. Box 23644, Ft. Lauderdale, Fla. 33307.

AUDIOPHILE RECORD GALLERY discounts direct disc, digital, Japanese imports, more. Free catalog. Post Office Box 2668, La Mesa, CA 92041.

ORGAN AND CHORAL RECORDS. For free catalog write Gothic Records, PO Box 743-A New York, N.Y. 10101.

1930-1962 RADIO PROGRAMS. \$1.00 HOUR! Informative 250 page catalog \$1.25. AM Treasures, Box 192HF, Babylon, N.Y. 11702.

TOSCANINI, great conductors, instrumentalists. Live concerts: reels, cassettes, Free lists, state artists. WSA, BOX 1112HF, El Cerrito, CA. 94530.

"SOUNDTRACKS, SHOW, NOSTALGIA & JAZZ—FREE Catalog & Offering List—A-1 Record Finders, P.O. Box 75071-H, L.A. CAL. 90075."

SHOW ALBUMS—Rare, out-of-print lps, 64-page list \$1.00. Broadway-Hollywood Recordings, Georgetown, CT. 06829. STORE: 68 Sugar Hollow (Route 7) Danbury, Conn.

RECORDING TAPE. Major Brands. Free Catalog. Ron Cooper Company, Post Office Box 599, Jellico, Tennessee 37762.

VIENNESE OPERETTA RECORDS, INC. Extensive range, superb vocal performances, on currently available LP's. Free list. P.O. Box 50-B, Dover, Mass. 02030.

FREE ALBUMS

IN EXCHANGE FOR YOUR OPINION.

We need Record Raters. Your opportunity to build a substantial album collection. Small membership fee. Write EARS, Dept. HF, Box 10245, Milwaukee, WI 53210.

RAVI SHANKAR MUSIC CIRCLE. The finest Indian classical music on L.P. and stereo cassette. Free catalog: 7911 Willoughby Ave., Los Angeles CA 90046.

OPEN REEL TAPE - MOSTLY AMPEX 641/671, used once, unspliced, unboxed. 7" 1800' or 2400' 50 reels; \$65.00 sample: \$2.00. Ten 3600' 10 1/2" reels; \$25.00. sample: \$2.50 NEW PREMIUM CASSETTES, sample C-60; \$1.00. AUDIO TAPES, Box 9584-J, Alexandria, VA. 22304. (703) 892-8722 VISA/MC.

HOW MUCH DO YOU HAVE INVESTED IN RECORDS? Protect your investment with a unique record care system. Samples \$1.00 Copack Sales, Box 443, Fairport, New York 14450.

We have the WORLD'S LARGEST, MOST UNIQUE LIBRARY of Concert Band and Solo recordings. Send \$3.00 for catalogs (refundable with first purchase). GOLDEN CREST, Dept. H, P.O. Box 2859 Huntington Station, N.Y. 11746.

OVER 300 AUDIOPHILE RECORDINGS AVAILABLE! Detailed monthly Bulletin offers latest releases, Special sales and more. 20% off initial order! Send for FREE catalog issue. The Essentials Marketing, Dept. HF-6, P.O. Box 7724, Eugene, OR 97401.

CUSTOM LOADED CASSETTE TAPES. SUPPLIES. low prices, free catalog. Royal A/V 4114 Montgomery, Cincinnati, Ohio 45212.

ON REQUEST NEW CLASSICAL LP CATALOG OF over 3,500 out-of-print entries, including much opera. Very reasonable set-sale prices. Record Heaven, 1046 N. Highland Ave., Atlanta, Ga. 30306.

VIDEOCASSETTES: Send \$2.00 for catalog, refundable with order. Renault Enterprises Dept. N. P.O. Box 7098 Mpls, MN 55407 (612) 724-4961.



The powerful Speakerlab Super 7 returns, now dramatically improved with an open and clear sound that's so awesome you'll soon understand why we call it "legendary". The 10" and 12" polypropylene Polyflam™ woofers, a 6-1/2" midbass/midrange and the LT215S Samarium cobalt leaf tweeter can handle up to 200 watts of power if you can. Available in lacquered oak or rosewood Clearseal® finish. Read about the Super 7 and our 15 other great speakers in our **FREE CATALOG**. Write to:

speakerlab
Dept. HF26, 735 N. Northlake Way
Seattle, Washington 98103

Quality is the Principle.

Stereo Review says it for us.
"The GFP-1 can obviously be considered, for all practical purposes, distortionless.... The preamplifier noise rating exceeded our measurement capability" (Sept. 1981)
They continue: "It's a no frills preamplifier, one without the unnecessary gimmicks. At its modest price, this is one of the better preamplifiers on today's market."
of power at no more than 0.05% THD and 0.1% IM distortion.
The GFA-2 also has separate power supplies, one for each channel, which permit complete power consistency without interference between channels—especially at maximum power output.
These excellent performers prove that going first class doesn't mean a high price.
Call or write for the name of an Adcom dealer near you.

*RMS: 20 Hz to 20 kHz both channels driven into 8 ohms



ADCOM
9 Jules Lane, New Brunswick, NJ 08901
USA (201) 828-8590
© 1982 ADCOM

OPERA VIDEO—Magnificent performances from Europe. Beta, VHS Formats. Free catalog. HRE, Box 12, Kew Gardens, N.Y. 11415.

GOLDEN AGE RADIO—your best source for radio tapes. Free catalog. Box 25215-J, Portland, Oregon 97225.

RARE JAZZ VOCAL LP's SOLD BY AUCTION. FREE Lists. Leon Leavitt, P.O. Box 38395, Los Angeles, CA 90038.

Business Opportunities

YOUR OWN RADIO STATION! AM, FM, licensed, unlicensed, low cost transmitters! Free information. BROADCASTING, Box 130-D6, Paradise, CA 95969.

SALES REPRESENTATIVES for one of the nation's largest distributors of quality high fidelity components. Many desirable schools and residential areas still available. Complete selling program: posters, sample ads, sales training. **SALES LEADS FOR YOUR SPECIAL TERRITORY!** Call today for information. Ask for Andy or George. TOLL FREE 1-800-638-8806 or 1-301-488-9600.

Wanted To Buy

McINTOSH, MARANTZ tube amps. **WESTERN ELECTRIC** drivers, speakers, amps, others. Tel: 213/576-2642 David Yo. Box 832 Monterey Park, Ca 91754.

SCHWANN RECORD AND TAPE GUIDE, now available by subscription. Includes 12 monthly issues of Schwann-1, 2 semi-annual issues of Schwann-2, Annual subscription \$25.00 U.S. and Possessions \$35.00 Canada and Mexico, all other foreign \$40.00. Order from: Schwann Record & Tape Guide, P.O. Box 2131, Radnor, PA 19089.

Publications

CLASSICAL RECORD COLLECTORS: Newsletter features tips on cutouts; sources used; rare records; upcoming releases; comparative reviews. U.S., British, French publications; free want, for-sale notices; collecting tips. Sample copy \$1.50. **DISCOPHILIAC,** Garrison, NY 10524.

1981 Records in Review "The Bible for Record Collectors"

The invaluable reference guide to the who, what, when and where of the year's classical and semiclassical recorded music. Provides comprehensive critiques by High Fidelity's reviewers describing both the work and the performance. Only \$12.97 plus \$1.00 shipping and handling. Supplies limited.

**ABC Leisure Magazines-Dept. A,
754 4th Avenue,
Brooklyn, NY 11232**
Allow 6-8 weeks for delivery

Video Tape/Disc Guide (1st ed.) — 3 vol. set

Comprehensive reference guides providing over 7,000 video/disc listings for sports and recreation, movies and entertainment and children's programs. Gives program descriptions, where-to-buy/rent, formats, casts, directors and producers. Only \$17.95 plus \$1.50 shipping and handling. Supplies limited.

**ABC Leisure Magazines-Dept. B,
754 4th Avenue,
Brooklyn, NY 11232**
Allow 6-8 weeks for delivery

Place Your Own Ad!

HIGH FIDELITY CLASSIFIED ORDER FORM

RATES PER WORD: 15 word minimum
No charge for zip code

Regular Type: \$2.30 per word.
Imperial Type: \$3.10 per word.
Discounts for 3 times: 6 times: & 12 times.

Check one: Regular Imperial
3x 6x 12x

Name _____

Company _____

Address _____

City/State/Zip _____

Phone _____

Signature _____

Payment must accompany order.

Send to: Yetta Peltzman
HIGH FIDELITY
825 Seventh Avenue
New York, N.Y. 10019
(212) 265-8360

Payment enclosed \$ _____

MASTER CHARGE Card # _____

VISA Card # _____

Please print or type message below or on separate paper.

RETSOFF'S REMEDIES

(Continued from page 37)

Once the signal enters the power amp, its path is essentially straight through to the loudspeakers. Occasionally, though, a speaker-selector switch is located just before the speaker-wire terminals.

Usually, you can isolate circuit faults by establishing whether a problem occurs on all inputs or only on some; whether it happens under all conditions or only in recording; and whether it appears all the time or only when certain circuits are activated (see diagram). A totally dead system points to a problem in a section common to everything, such as the power amp, the preamp's line amplifier, or a power supply. When only part of a system doesn't work, circuitry peculiar to that section is at fault. This logic may seem very simple, but it is the same method of analysis that a technician follows to diagnose malfunctions.

Next time, I'll give you some tips on eliminating hum, noise, and intermittent signals in the phono playback chain. **HF**

FRENCH BAROQUE

(Continued from page 54)

Christie's *Les Arts Florissants* (named for a Charpentier work), the latter mainly through Corboz on Erato.

Christie's accounts of *Caecilia, virgo et martyr* and *Filius prodigus* stress the works' Italianate origins. They sound just like Carissimi, with their Latin texts, Italian recitative style, short-breathed choruses, and theorbo accompaniments. The singing is a little affected, always fading away, never hinting at a legato line; the playing is all one-to-a-part. *Caecilia* has striking little choruses; *Filius* is chiefly interesting for its three joint narrators.

Charpentier's Christmas midnight Mass is well-known; less so are his three Requiem settings, though they are even finer. Corboz' account of the huge *Messe pour les Trepassés* with double choir and six soloists suffers from some ill-focused cho-

With recent attention given to Charpentier, posterity has begun to take its revenge on Lully.

ral singing and fuzzy playing and recording. John Elwes provides excellent solo work, however, and the "*Dies Irae*" accumulates surprising power. Resourceful counterpoint and carefully crafted imitative textures—trademarks of Charpentier's style—are present in abundance in the two smaller Requiems, which move slowly and calmly (sometimes too sweetly), with an approach to death and judgment that prefigures Fauré's. The performances, by mainly Belgian forces under Louis Devos, are careful but languid.

Finally, an American contribution to this French baroque celebration: The Schola Cantorum of the Church of St. Mary the Virgin in New York (which every Sunday stages liturgical extravaganzas of more musical than pastoral significance) has recorded Charpentier's *Messe pour le Samedi de Pâques*, a sunny and serene combination of imitative and declamatory choral writing. The performance is attractive, though the church's organ, which plays an important role in the *alternatim* Kyrie, is too woolly.

On the other side of the disc (though not mentioned on the front cover) are good attempts at two of the earliest polyphonic Mass cycles, from Toulouse and Tournai, which really deserve an extra review outside this French-baroque context. Suffice it to say that they are lively and competent, but that the noise they make is rather too sweet for the music. **HF**



TOM COPI

Rodney and Sullivan: tunes with more to offer than a dozen other jazz LPs

(Continued from page 80)
 the more recent collection, the other is more interesting: Not only can she use a broader range of approaches in the quartet context, but Flanagan contributes some enlivening solos of his own. Osborne turns *I Surrender Dear* from the warm ballad of its first chorus to a big, open swinger, and *Mary's Blues* is full of interesting anticipations of B. B. King's style. —JOHN S. WILSON

**Charlie Parker with the Orchestra:
 One Night in Washington**
 Bill Potts, producer
 Musician E 1-60019

Any "new" Charlie Parker recordings that appear now, twenty-seven years after his death, are inevitably of special interest. This set is no exception. It is a report of a Parker guest appearance at a big-band concert in Washington, D. C., on February 22, 1953. The band, called the Orchestra, was organized by drummer Joe Timer and local disc jockey Willis Conover, who has since become known around the world as the voice of jazz on the Voice of America.

It is one thing to sit in with a rhythm section and work through familiar chord structures. It is quite another to sit in with a big band without charts or at least some indication of where the music is going. Parker has no such road maps here and yet, in addition to soloing, moves freely in and out of ensemble passages. Occasionally he is fooled by an unexpected key change, but within a few notes he is back with the ensemble.

"One Night in Washington" also finds him playing a plastic saxophone, four or five years before Ornette Coleman startled the jazz world with his plastic sax. A brief Red Rodney interview at the end of Side 2 (Rodney had been in Parker's regular quintet a few years before this concert) reveals that a manufacturer's representative had given Parker the plastic sax in Detroit.

Rodney suggests that he continued to play it because he had hocked his metal horn. "We were amazed that he could get anything out of it," Red recalls. "But he could play a tomato can and make it sound great."

In a recording that often makes the Orchestra sound muffled and somewhat heavy, Parker's playing is beautifully phrased and articulated, his tone bright, clear, and full-bodied. As a rule, his solos are most fully realized on the ballads, particularly *These Foolish Things*. But his most brilliant moments come on Bill Potts's *Willis*. Here, he not only fills the solo space admirably but constantly adds imaginative colors and accents to the ensemble. —JOHN S. WILSON

**Red Rodney and Ira Sullivan:
 Spirit Within**
 Mike Berniker, producer
 Musician E 1-60020

Red Rodney was playing at Bubba's in Fort Lauderdale two years ago when he ran into Ira Sullivan, whom he hadn't seen since they made a record together in 1957. Their paths had diverged in the intervening years: Red was working from the same charging, volatile bop foundation while Ira—on trumpet, flugelhorn, flute, and saxophone—was still turning over new ground. Nonetheless they hit it off, and Red convinced the notorious nontraveller Ira to go to New York with him and play the Village Vanguard. They have been a duo ever since.

"Spirit Within" is a revelation, both of the sounds the twosome have developed and of the compositional talents of their pianist, Garry Dial. Five of the six tunes are his, and three have enough individuality to inspire unusual performances both here and possibly by other musicians in the future—which is more than can be said for most jazz "originals" these days.

Rodney and Sullivan face off in gorgeous two-flugelhorn duets and in flugelhorn-soprano saxophone blends that bring unexpected colors to some marvelously warm harmonies and charging rhythms. The tunes range from the most contemporary kind of Swing to the loose moodiness of Dial's *Spirit Within*. There is more to listen to here than in a dozen or more other jazz albums. —JOHN S. WILSON

Bobby Short: Moments like This
 Dick Hazard & Bobby Short,
 producers. Elektra E 1-60002

This record is somewhat of a departure for Bobby Short. Though the repertoire is fairly characteristic of what he might sing in his supper-club or concert appearances, his performances are quite different. Two assets in particular emerge, both of which would probably be lost amid the chatter of his usual audiences. One is a sense of intimacy; the other is a strong, true, full-bodied tenor voice that he is often forced to leave behind in favor of sheer volume.

Short and his coproducer Dick Hazard show an ability to avoid clichés, even though they use the most typical tools of their trade. Many of the songs are given a very deliberate, dramatically paced development. Strings are used sparingly and thoughtfully, providing touches of color—an accent here, a highlight there. Harry Edison's muted trumpet creates some fascinating sparks behind Bobby's voice; Plas Johnson's tenor saxophone fills *Body and Soul* with gentle echos of Coleman Hawkins.

Bobby has chosen a program that is constantly provocative, either because the songs are rarely heard (*I'm Satisfied*, which Ivie Anderson sang with Duke Ellington, and Noel Coward's *Sigh No More*) or because they are so well known as to pose an interpretive challenge (*Body and Soul*, *Georgia on My Mind*). They all reflect the new, fresh Bobby, a change that is superbly summed up in his controlled, gently simmering delivery of Cy Coleman's lovely old song *Sometime When You're Lonely*. —JOHN S. WILSON

**Muggsy Spanier:
 At Club Hangover, Vol. 2**
 Storyville SLP 4056

In the final analysis, Muggsy Spanier was a very limited cornetist. He had a punching, jabbing attack that could, at its best, bring a lot of driving energy to a performance. His brilliant use of a plunger mute—which he modeled after King Oliver, rather than the usual Ellington-band sources—was particularly effective on a slow blues, epitomized in his classic *Relaxin' at the Touro*.

But Muggsy was totally predictable—even more so than most Dixieland music. (Continued on page 86)

ADVERTISING INDEX

57	Astatic Corp.	25
	Akai America, Ltd.	35
16	BASF	43
46	BES	4
	Bose Corp	Cover III
59	Cybernet Intl, Inc.	21
32	Denon America, Inc.	2
44	Denon America, Inc.	22
51	Discount Music Club	79
53	Discwasher, Inc.	Cover IV
9	Empire Scientific Corp	13
	Illinois Audio	57
45	International Hi Fi	75
34	International Wholesalers of Miami	41
27	J&R Music World	7
4	Jensen Sound Laboratories	17
	Kenwood	12
15	Loranger Mfg. Corp.	61
12	Maxell Corp.	15
56	McIntosh Laboratory	70
6	Mobile Fidelity	59
34	Norman Laboratories, Inc.	10
2	Pickering & Co	4
1	Pioneer High Fidelity	Cover II, 1
58	Polk Audio	9
35	Rhoades National Corp	42
14	Sansui Electronics Corp	27
48	Santa Fe Express	77
	Sennheiser Electronics Corp	7
50	Shure Brothers Inc.	18
	Sony Corp of America	6
38	Sound Reproduction	77
29	Stereo Corp	79
10	TDK Electronics Corp	11
60	TDK Electronics Corp	70
8	TEAC Corp of America	8
5	Technics by Panasonic	5
	US JVC Corp.	31
43	Wisconsin Discount Stereo	8
	Yamaha Audio	28

BACKBEAT REVIEWS

(Continued from page 85)

cians. He played the same small set of tunes, in the same way, over and over. The surprise, and the pleasure, in a Muggsy performance comes from the excitement he can generate from the expected.

Such is the case with this pair of broadcasts from the Club Hangover in San Francisco in 1953. The disc starts out with *Relaxin' at the Touro, Royal Garden Blues, Basin Street Blues*, and continues on through a repertoire that, with the possible exception of *If I Had You*, is about as standard as it could be. But once Muggsy gets past the atrociously fast tempo of the second cut, everything falls into place: his own cornet work; Darnell Howard's warm, searching clarinet; Ralph Hutchinson's lazy, big-toned trombone (whose slides and accents owe a considerable amount to Jack Teagarden); and Mel Grant's light, swinging piano. The recording includes the original, on-the-spot announcements by Jimmy Lyons, now the man behind the Monterey Jazz Festival. His introductions are brief, informative, and very knowledgeable—a sharp contrast to the vague ramblings of most such announcers.

—JOHN S. WILSON

Jesper Thilo Quartet: Swingin' Friends

Kenny Drew, producer
Storyville SLP 4065

Albums by contemporary saxophonists tend to be self-conscious demonstrations of endurance or technical displays of hard-to-attain or unbelievable sounds. Tenor saxist Jesper Thilo is quite contemporary, but he takes his inspiration from a time when tonal quality, swing, melody, and nuance were of primary importance.

"Swingin' Friends" opens with *Just One of Those Things* and Thilo's bright, sunny lines sound like a light-toned variation of Eddie Daniels' bubbling drive. He creates an almost effortless momentum, building in intensity without making an issue of it or overdramatizing. His playing flows as easily on the ballads as it does on the uptempo numbers. On *Sophisticated Lady*, for example, he sounds like a light-toned, thinly phrased Ben Webster. But though his sources are apparent, Thilo has distilled them into a style that is his own. His tone is light but sharp, his phrasing clean and precise and filled with the subtle shadings of a distinctive jazz musician.

Long-term Copenhagen resident Kenny Drew, who produced this album in 1980, sounds more personal and less trend-ridden as a pianist than he did in the post-bop days of the Fifties. Filling out the rhythm section are Mads Vinding, yet another impressive bassist from Denmark, and Billy Hart, whose drumming supplies lithe support for Thilo's sinuous, assertive style.

—JOHN S. WILSON

Weather Report

Zawinul, producer
Arc/Columbia FC 37616

"Weather Report" won't provide much in the way of surprises for anyone who has been tracking the band's recent recorded output. The key questions it poses are familiar enough: Can Zawinul (now there's something new: he dropped his first name!) make his battery of synthesizers sound like a lead rock guitar? You bet. Can he single-handedly provide brass section fills, spooky electronics, and vocalized interjections? Yes indeed.

Of course we've known all that since "Heavy Weather" and "Mr. Gone." What we don't know is what has happened to the creative juices of this once-vital jazz group. Bassist Jaco Pastorius, who brought a few brief episodes of excitement to the band, has faded into the background, his role almost completely submerged by Zawinul's synthesizers. In the instances where he surfaces (*Speechless* is one) he seems restrained, like a tightly-reined thoroughbred.

Wayne Shorter, who is, at the very least, Zawinul's creative equal, continues to be content in his Cinderella role. His always-fascinating saxophone solos are, variously, buried in layers of electronics, used as background riffing, or splashed like highlights against the ensemble texture. Fortunately (and perhaps contractually), he contributes one original, *When It Was Now*. As usual, it is the only track that reminds one of the group's real jazz-playing potential. Nonetheless, Zawinul's production eventually dominates, and Shorter's characteristically long-limbed melody is superceded about halfway through by a choppy, repetitious, overextended vamp section from Zawinul and Pastorius.

That Weather Report's jazz skills still exist is without question. But it's hard to see how and when they will surface through the massive coating of synthesizers and general production fussiness. Even *that* might not be a terminal problem were Zawinul not so determined to dominate the composing, as well. But he seems unable to separate the intellectual employment of electronics from the far more primitive act of creating music. As a result, most of his recent work has been made up of blocks of sound. Each block consists of rhythmic repetitions overlaid by a virtual bell-curve of electronic textures. When a segment concludes, a new rhythmic/textural block begins. Melodic variation, harmonic tension, and rhythmic subtlety have all been laid aside in the service of control-board music-making.

Zawinul is far too perceptive to have chosen this style casually. But for this listener the choice sounds wrong, primarily because it is leading him, and Weather Report, into that most damaging direction of all, a creative cul-de-sac.

—DON HECKMAN

2

The Second Fundamental Difference

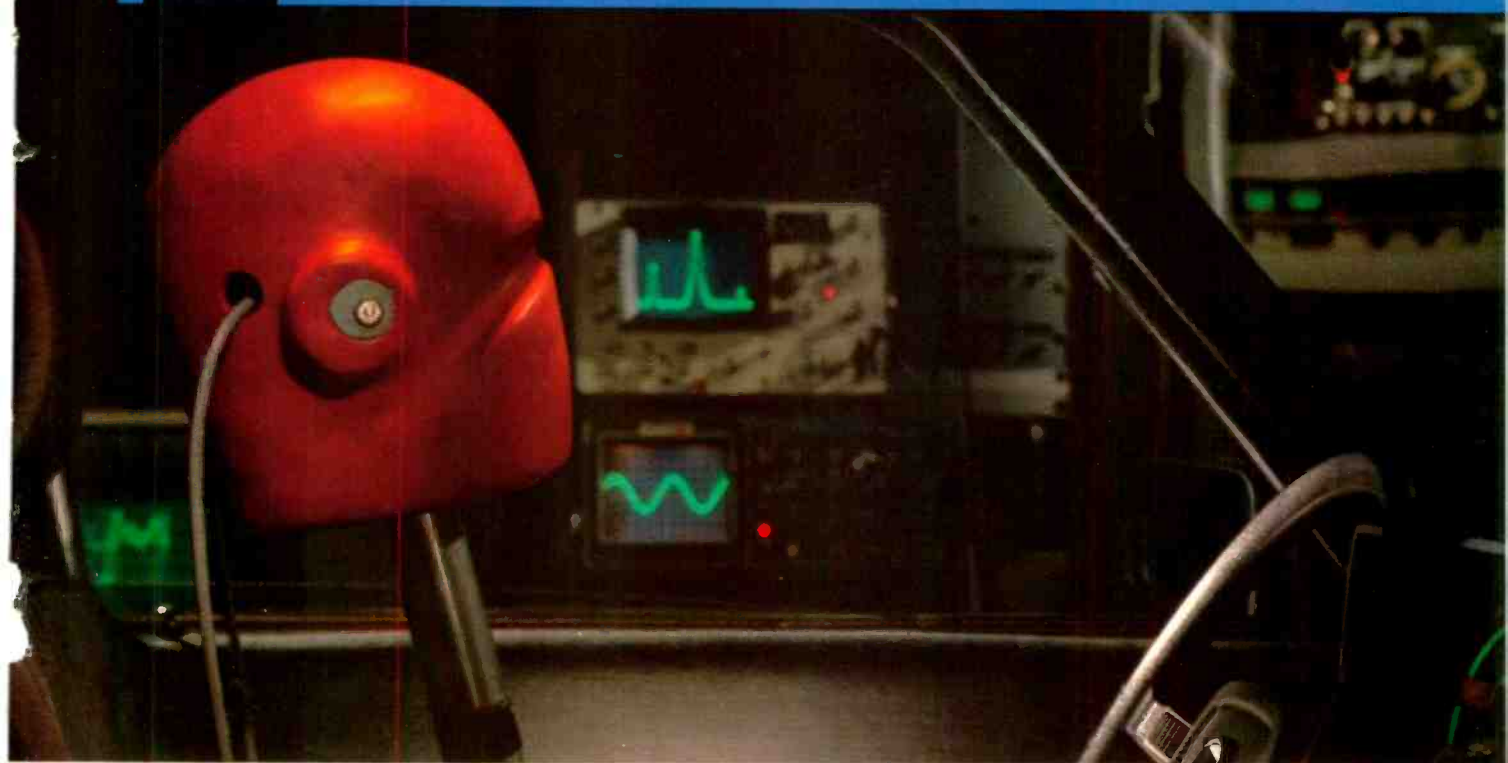

Active Equalization in the Bose® Car Stereo System.

The Bose Car Stereo System is fundamentally different from conventional car stereo components. It is designed as an integrated system. It is tested to withstand the demanding requirements of the automotive environment. And it is engineered to include innovations like Direct/Reflecting® Speakers and Active Electronic Equalization.

This is the second in a series examining each of the fundamental differences more closely.

The dummy head in the photograph was an important part of Bose's study of automotive sound. High-resolution microphones in



each "ear" analyzed the acoustics of more than 50 different cars and vans to determine how various combinations of seating, upholstery, window shape and placement affect the quality of reproduced music.

This information was processed by a computer to develop the sophisticated Active Electronic

Equalization circuitry in the Bose 1401™ Car Stereo. This circuitry, in combination with two simple controls, enables you to compensate for these acoustical effects with exceptional accuracy. It works together with four separate power amplifiers and four full-range speakers to give your music clarity and detail that can only be compared to a live performance.

Get a live demonstration of the Bose® 1401/CRC Direct/Reflecting® Car Stereo System. Compare it to even the most expensive conventional components. The difference is fundamental.

For more information, contact your local authorized Bose sales representative or write Bose Corporation, The Mountain, Framingham, Massachusetts 01701.

Protect Your Stereo System and Maintain Its Sound

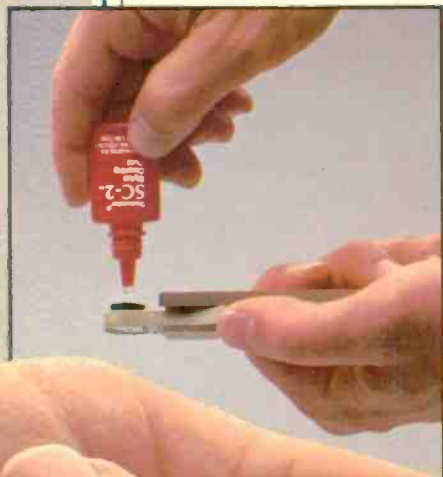

The D4™ Record Care System

The highly active D4 fluid and unique directionally fibered pad removes harmful microdust and debris that can cause permanent damage to your recordings.

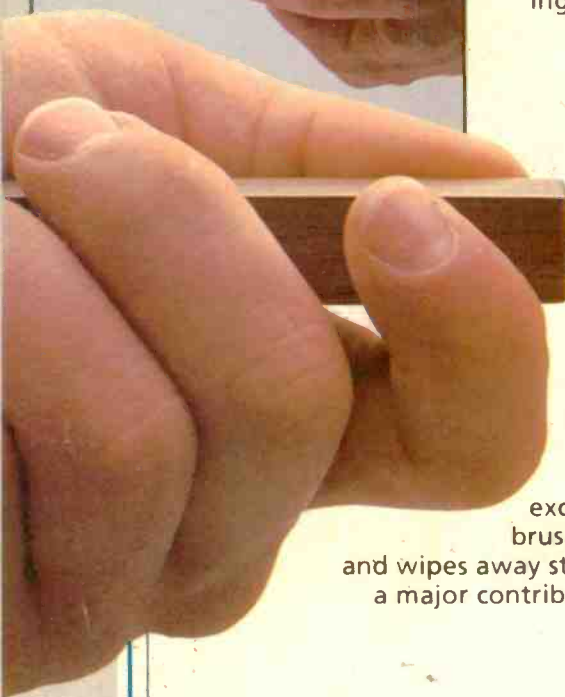

The SC-2™ Stylus Care System

SC-2 fluid with the exclusive nylon fibered brush effectively loosens and wipes away stylus contamination, a major contributor to record wear.



The Discwasher® D4 Record Care System and the Discwasher SC-2 Stylus Care System are available separately or together as DiscSet™.

discwasher®
PRODUCTS TO CARE FOR YOUR MUSIC

For a free copy of our "Guide To Record Care" write to Discwasher.

1407 North Providence Road, Columbia, MO 65201 USA
A DIVISION OF JENSEN an ESMARK Company

Circle 53 on Reader-Service Card