

stereo

1964 EDITION

LATEST STEREO EQUIPMENT

A complete buyer's guide

STEREO INSTALLATIONS

Good sound can also
mean good looks

A MUSICIAN LOOKS AT STEREO

An interview with Skitch Henderson

PLUS

Shopping Hints
Year's Best Recordings
Simple Maintenance Tips
F/M Stereo Guide



Price \$1

PUBLISHED BY high fidelity MAGAZINE

McIntosh

PROMISES

YOU

— In every specification McIntosh makes a solemn promise. For 15 years McIntosh has made and kept such promises to you. We have guaranteed to equal or exceed our published specifications or refund our advertised price.

— McIntosh specifications hide no tricky evasions. For example, you need not fear fine print subtly limiting the specifications of our stereo amplifiers to one channel at a time.

— Nor will you find that McIntosh amplifiers are limited to 15 seconds at full treble power as are some of today's transistor amplifiers.

— You will not be oversold by McIntosh exaggerating the importance of square wave response or useless extension of high-frequency response.

— The promise to you in McIntosh specifications is not based on a single "LAB MODEL." The maximum realizable performance of a McIntosh instrument is well above the written McIntosh specifications.

For example, our MC 240 Stereo Amplifier which is rated at 40 watts per channel, both channels at the same time, will actually deliver 50 watts 20 cycles to 20,000 cycles at less than $\frac{1}{2}$ of 1% harmonic distortion. There is no other commercial audio amplifier with this margin of performance above specifications coupled with such low power dissipation in its output tubes as the McIntosh MC 240.

— If you want stereo amplifiers and tuners in your home that give life-like pleasing sound, you can trust McIntosh to fulfill its promise to you.

McIntosh LABORATORY INC.

2 CHAMBERS STREET, BINGHAMTON, N. Y.

Phone—Area Code 607-723-5491

Zip Code 13903

NEW ROBERTS CROSS FIELD "770"®



*15
high fidelity
stereo albums
for the price of one*

Records automatically—imagine! Eight hours of full-range high fidelity stereophonic music, or 16 monaural hours, are now yours on one 7" reel with the new Roberts Cross Field "770" Tape Recorder. The average tape cost per album: only 33¢. The "770" has an exclusive patented third head, the Cross Field Head, which separates recording and biasing functions. It records 40-22,000 cps... produces true fidelity at 1 7/8 ips, and preserves the high frequency harmonics that breathe life into a music playback. The "770" playback head has a gap width of only 40 micro inches, and is made of a new alloy, NC-88, that is practically wear-proof. Other features: 2-speed, electrically switched, heavy duty hysteresis synchronous motor; miniscule wow and flutter at low speeds; special ventilation keeps "770" cool even after 8 hours; 5"x7" self-contained, extended range, heavy duty Alnico V magnet speakers; automatic total shut-off, vertical or horizontal operation. Only \$499.95.

Specifications: 7 1/2, 3 3/4, 1 7/8 ips. Power Amplifier Output: 12 watts • Frequency response: at 7 1/2 ips, 40 to 22,000 cps ± 2 db; at 3 3/4 ips, 40 to 18,000 cps ± 2 db; at 1 7/8 ips, 40 to 13,000 cps ± 3 db • Signal to noise ratio: -55 below 0 recorded level • Wow and flutter: at 7 1/2 ips, less than 0.12% rms; at 3 3/4 ips, less than 0.20%; at 1 7/8 ips, less than 0.30% • 5"x7" elliptical, extended range, heavy duty Alnico V magnet speakers • Hysteresis synchronous electrically controlled 2 speed motor • Automatic total shutoff • Operates Horizontally or Vertically.

THE ROBERTS CROSS FIELD "770" AND OTHER ROBERTS RECORDERS FROM \$269.95 TO \$699.95 AT BETTER SOUND AND PHOTO CENTERS



New #330 lets you listen as you record. Three heads for separate record, playback and erase. Sound-on-sound multiple recording. Two 7" full range speakers. Special biasing for FM multiplex recording systems. 7 1/2, 3 3/4 ips. \$349.95

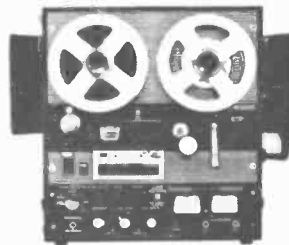

New! 3-motor professional model #455. Three electrically switched dual-speed motors. Separate bass/treble controls. 4 simultaneous mixing inputs. Playback loudness controls. Two full range 5"x7" speakers. 7 1/2, 3 3/4 ips. \$599.95. Remote control: \$49.95

SEND FOR
FREE BOOKLET!
"40 AND MORE WAYS TO USE
A ROBERTS TAPE RECORDER"



IN CANADA: J. M. Nelson Electronics Ltd., 7725 Adera St.,
Vancouver 14, B. C. (Prices slightly higher in Canada)

Roberts Electronics, Inc.
5978 Bowcrot, Dept. SA
Los Angeles 16, Calif.

Please send free booklet
Please send me complete information
about Roberts Tape Recorders

Name _____
Address _____
City _____ State _____

TYPE A
Automatic Turntable
\$79.50

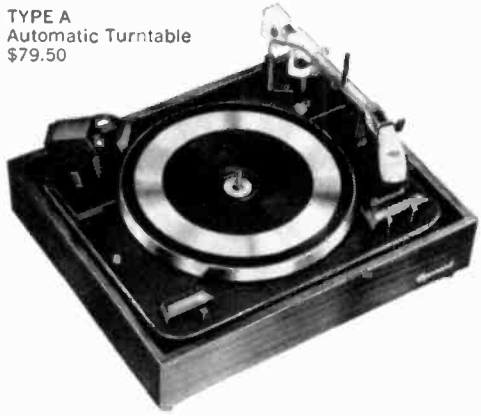

AT6
Automatic Turntable
\$54.50

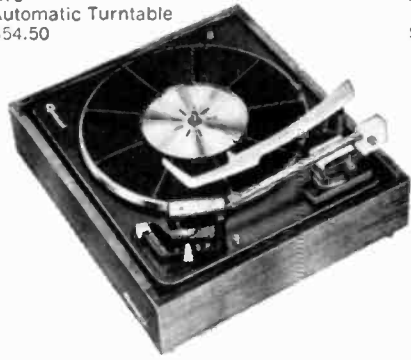

AUTOSLIM/P
Intermix Changer
\$39.50



This year again, more people will choose one of these 3 Garrard models than all other record playing components combined.

To help find the Garrard which is best for you—let us send you the new Comparator Guide.

Clearly and concisely, it describes the important Garrard advances—all of which play a vital part in insuring top performance and longer life for your records. Every Garrard model is pictured in full color . . . with detailed photographs, descriptions of its features and explanations of how they contribute to your enjoyment. The coupon below will bring you a copy of the Garrard Comparator Guide—without charge.



GARRARD, Division of British Industries Corp., Port Washington, N. Y.
Canadian inquiries to Chas. W. Pointon, Ltd., 66 Racine Road, Rexdale, Ontario
Other territories to Garrard Engineering & Mfg. Co., Ltd., Swindon, Wilts., England

Dept. GY-1393, Garrard
Division of British Industries Corp.
Port Washington, N. Y.
Please send a Garrard Comparator Guide
Name _____
Address _____
City _____
State _____

CIRCLE 13 ON READER-SERVICE CARD

stereo 1964 EDITION

Warren B. Syer
Publisher

Norman Eisenberg
Editor

Roy Lindstrom
Art Director

Sue Severn
Managing Editor

Emily G. Smith
Copy Editor

Ruth Dunton
Editorial Assistant

Walter F. Grueninger
Circulation Director

Claire N. Eddings
Director of Advertising Sales

Ruth M. Martin
Advertising Production

A D V E R T I S I N G

Main Office
Claire N. Eddings, The Publishing House
Great Barrington, Mass. 01230. Telephone 1300

New York
165 W. 46th St., New York 10036
Telephone: Plaza 7-2800
Seymour Resnick, Andrew Spanberger

Chicago
The Billboard Publishing Co.
188 W. Randolph St., Chicago 60601
Telephone: Central 6-9818
Jerry Taylor

Los Angeles
434 So. San Vicente Blvd., Los Angeles 90048
Telephone: Olympia 2-2100
Robert J. Friedman, Michael R. Simon

- 31 Round Sound in Square Rooms: *An Editorial*
- 32 Pickup, Arm, and Platter *by Bob Marx*
- 41 Amplifiers—Tubes or Transistors *by Martin L. Borish*
- 49 Tuning In FM Stereo *by Leonard Feldman*
- 55 FM Station Guide
- 57 A Musician Looks at Stereo: *An interview with Skitch Henderson*
- 60 —And It Comes Out Here *by Charles Tepfer*
- 70 Stereo on Tape *by Robert Silverberg*
- 80 Sound Can Be Slightly *by Susan Ritchie*
- 88 Rx for Healthy Hookups *by Lewis A. Harlow*
- 92 Keep It Playing *by Len Buckwalter*
- 100 Year's Best Recordings *compiled by Shirley Fleming*

Cover design by Roy Lindstrom

Saxophone courtesy Sammy Vircent

Records that are appreciated all year 'round!



A.



B.



C.



D.



E.



F.



G.



H.



I.



AUDIO FIDELITY RECORDS

Your first choice
in high fidelity
and stereophonic
recordings!

Please write for *FREE* complete record catalog.

A. THE BRAVE BULLS, Banda Taurina—Stirring music of the Bullfight Ring. *El Relicario, Cielo Andaluz, La Virgen de la Macarena, others.* AFLP1801/AFSD5801

B. HOME MOVIE SOUND EFFECTS—Will lend startling realism to home movies and slides. Enliven viewing pleasure. Incl: *Baby, Bird & Animal sounds, Indoor & Outdoor sounds, Jet, Ocean Liner, Sports, Crowds, many more.* DFM3018/DFS7018

C. RAILROAD SOUNDS — A vanishing era revisited! Dynamic realism! Perfect model train background. AFLP1843/AFSD5843

D. PATACHOU at Carnegie Hall—Her ebullient French charm was never more appealing. *Ma Fetes A Moi, Que Reste-t-il, A Paris, etc.* AFLP2109/AFSD6109

E. LOUIE and the DUKES OF DIXIELAND—Classic talent combination! Inspired festival of great Dixieland! *Bourbon St. Parade, Sheik of Araby, Avalon, Dixie, etc.* AFLP1924/AFSD5924

F. FAST, FAST, FAST RELIEF FROM TV COMMERCIALS — Hilarious parodies! The public fights back! 34 skits: *Punjab Cigarettes, Greasy Kid Stuff, Biblical Spectacular, etc.* AFLP2112/AFSD6112

G. ROME WITH LOVE, Jo Basile his Accordion & Orch. — Perennial favorite! Musical portrait of the Eternal City. *Luna Rosa, Non Di-*

menticar, Tarentella, Arrivederci Roma, Torna a Sorrento, etc.

AFLP1822/AFSD5822

H. GREAT MOVIE THEMES, Johnny Puleo & his Harmonica Gang—Loveable, zany group of harmonica experts. Inimitable treatment of: *Moon River, Tonight, Never on Sunday, Exodus, Col. Bogey, etc.*

AFLP1969/AFSD5969

I. STEREO SPECTACULAR DEMONSTRATION & SOUND EFFECTS—Fast moving tour of dramatic situational stereo effects. Cited for engineering excellence by Nat'l Academy of Recording Arts & Sciences. DFS 7013—stereo only

\$4.98—MONO or STEREO / AVAILABLE AT LOCAL RECORD SHOPS OR WRITE TO:



AUDIO FIDELITY RECORDS

770 Eleventh Avenue, New York 19, N. Y.

CIRCLE 9 ON READER-SERVICE CARD

Wharfedale



W60 In the streamlined look of fine modern furniture or handsomely crafted provincial, this full-range two speaker system continues to provide superlative performance—making it the automatic choice when the finest reproduction is desired. True Wood \$116.50. Unfinished, in sanded birch hardwood, without curved molding or dividers \$101.50.

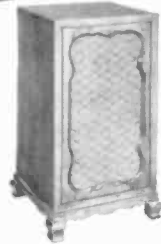

W60 PR Provincial in genuine Fruitwood \$134.50

Superb...because Wharfedale Achromatic Speaker Systems are crafted to reproduce music—as music really is. No spurious resonances, no artificial colorations mar the fidelity of reproduction. Listen to your favorite musical work on a Wharfedale—hear, perhaps for the first time, the clear transparent highs, the rich mid-tones, the fullness of a superb low-range.

Sand Filled Baffle

Chief characteristic of the Achromatic construction is the sand-filled technique, which consists of packing white sand densely between layers of hardwood. The resulting inert mass is incapable of resonating, no matter how deep or strong the bass backwave projected against it. This exclusive Wharfedale technique yields a full range of sound, a perfectly pure "Achromatic" musical image, without acoustical coloration.

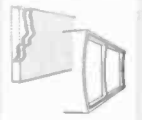

W90

A magnificent new 6 speaker dual 3-way system, destined to restore the legendary sound of the great Wharfedale systems used by G. A. Briggs in his famed Carnegie Hall Concert demonstrations. The meticulously crafted cabinet is proportioned specifically to accommodate the speakers and construction required to accomplish this ambitious purpose: yet the size (32 1/4" x 27 3/4" x 13 1/4") is sufficiently compact to fit into the modern living room. Oiled or Polished Walnut \$259.50. Utility model in sanded birch hardwood without curved molding or dividers \$244.50.

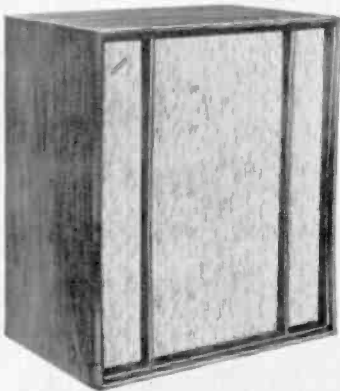

W70

A three-speaker system—handsome by itself, yet still sufficiently compact for shelf or wall integration. The beauty and excellence of performance of this remarkable system makes it unusually attractive to experts and laymen alike. True Wood \$164.50. Unfinished in sanded birch hardwood, without curved molding or dividers \$146.50.



W70 PR

Provincial in genuine Fruitwood \$189.50

W40

Ultra-compact (24" x 12" x 10") full-range system at a most attractive price. Two superior speakers: A newly developed 8 1/2 inch low frequency driver with an extremely high flux density magnet—and Wharfedale's outstanding 5 inch tweeter—the same used in the larger W60 system. True Wood \$79.50. Unfinished in sanded birch hardwood, without curved molding \$69.50.

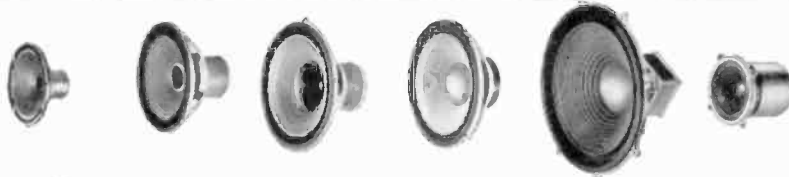
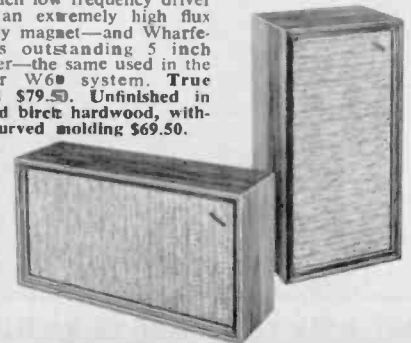

Full Range 8" Super II RS/DD \$26.50

Full Range 10" Super 10 RS/DD \$47.50

Full Range 12" Super 12 RS/DD \$69.50

Woofer W 12/RS \$52.50

Woofer W 15/RS \$89.50

Tweeter Super 3 \$26.50



Universal Mounting base for W60, W70 and W90 systems in matching woods. Easily installed to enhance the beauty of the enclosures.

True Woods \$9.95.
Utility model in sanded birch hardwood \$8.95.



For illustrated literature write: Dept. WY24
Wharfedale, a Division of British Industries Corp., Port Washington, N.Y.

CIRCLE 14 ON READER-SERVICE CARD

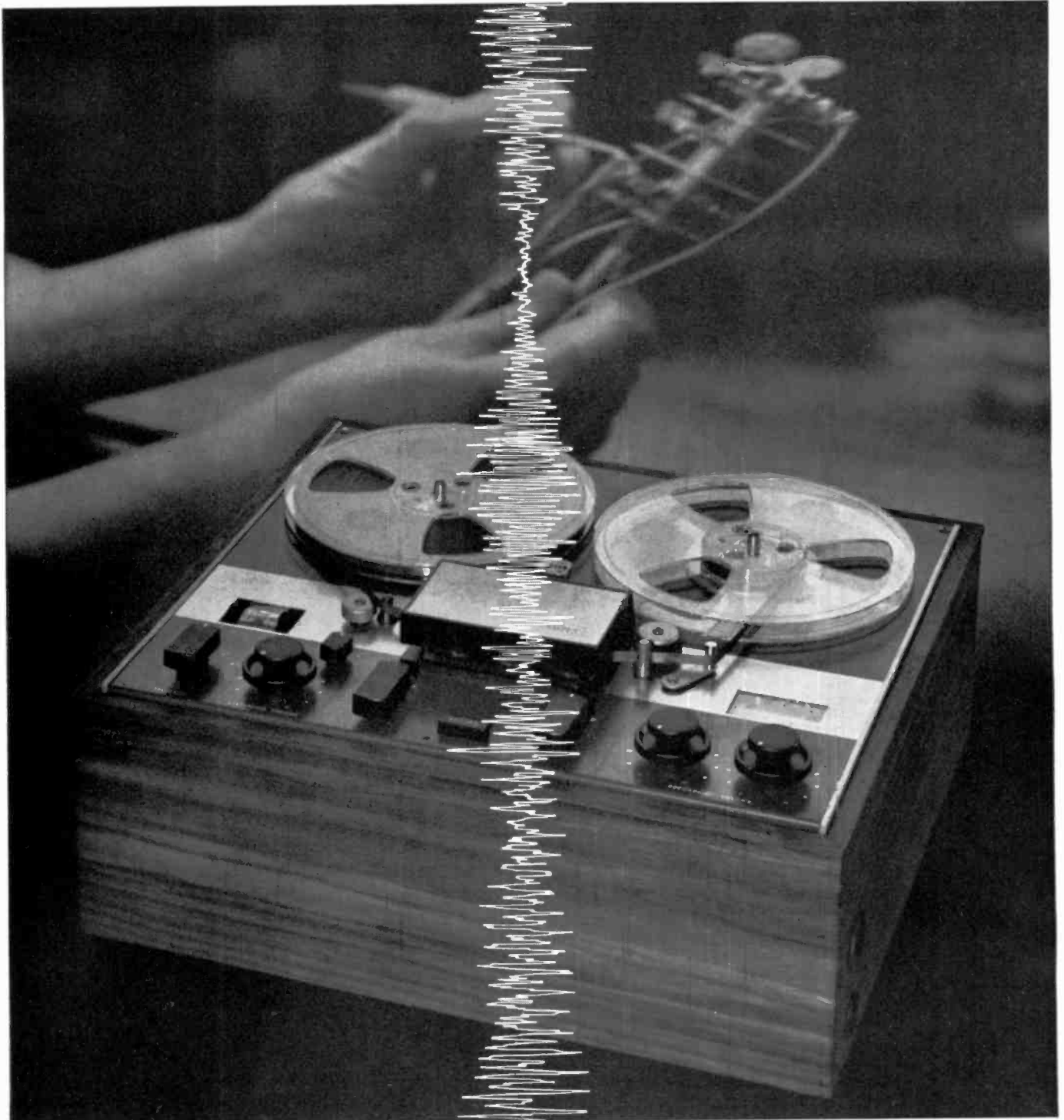

What new recorder is virtually custom-built?

AMPEX F-44

The F-44 is a brand new 4-track stereo recorder from Ampex. It's Ampex through and through. And there's this, too: at every stage of manufacture Ampex tunes, adjusts and aligns each F-44 to obtain its maximum performance — far beyond minimum specifications. Thus, no two F-44s are quite alike. Each is virtually a custom-built recorder. Each performs to the utmost of its capabilities. And each gives you the best possible sounds today — and for many years to come. As an F-44 owner, you'll receive from Ampex a record of the individual performance specifications of your own F-44. This record shows the frequency



response curve, the signal-to-noise ratio, the flutter and wow, and the crosstalk rejection measurement. And it is signed by the Ampex engineers who tuned and adjusted your recorder. The new Ampex Fine Line F-44 also features a new special design hysteresis motor for smooth, quiet, accurate operation; an easy-to-read point-to-point record level meter for each channel; multiple sound-on-sound capability; new simplified controls; and the Ampex one year warranty. See and hear the new F-44 at your local Ampex dealer. Brochure? Write: Ampex Corporation, Redwood City, California. Sales and service throughout the world.

CIRCLE 6 ON READER-SERVICE CARD

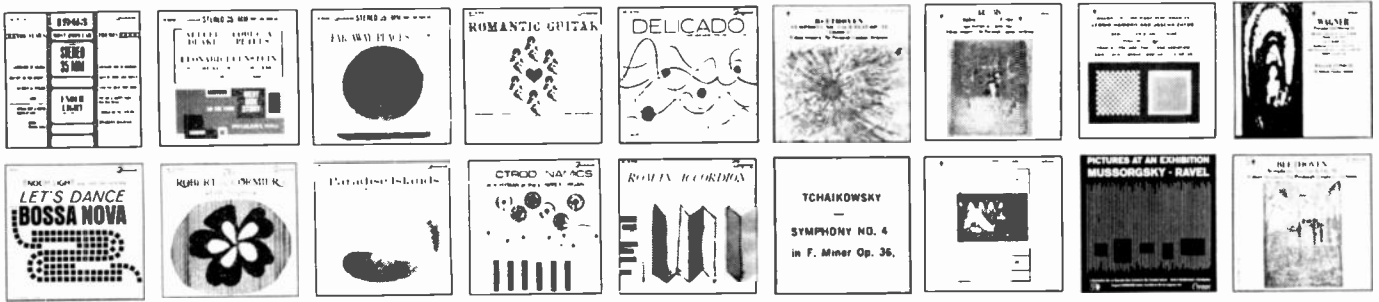

JUST RELEASED NEW SAMPLER OFFER FROM COMMAND

**12 COMPLETE SELECTIONS
FROM 10 NEW BEST SELLING
COMMAND POPULAR ALBUMS.
YOURS FOR ONLY \$2.98.**

**Also available 8 complete selections
from 8 new Command Classical Albums. \$2.98.**

Command Records has just released two new special-edition sampler albums to acquaint you with the best of Command albums . . . both popular and classical. These magnificent albums will open your eyes to the broad scope and magnitude of Command recordings . . . will reveal to you the unparalleled technical advances Command engineers have achieved in master recording on tape and on 35 mm magnetic film.

Here is your opportunity to savor the full range of Command artistry. The POPULAR SAMPLER contains 12 of the most exciting selections from 10 different Command Popular Albums. The CLASSIC SAMPLER contains 8 magnificent selections from 8 different Command Classical Albums. Unlike many sampler albums, Command Albums were created to give you full, uninterrupted musical pleasure. There is no sales message . . . no talk. The musical selections in the Popular Albums are complete — not excerpts! In the Classical Album, great care was taken to select complete movements for your greatest possible enjoyment.

For the first time you will hear music reproduced in all its full power and glory, with all of its widest, widest breadth, and with every last element of imposing depth. You will hear sound so intensely real that you can actually feel the presence of each instrument. In fact, Command records capture such astonishing realism that manufacturers of stereo sets use Command records to demonstrate the full potential of their equipment.

THESE ALBUMS ARE NOT AVAILABLE IN STORES

The complete albums from which these selections were chosen are available at all record stores. However, to obtain your Command Sampler Albums (which are not sold in stores), simply mail coupon today. You may select either the Popular or the Classical Album for only \$2.98 each. (Command Stereo Albums are sold nationally up to \$5.98 each.) If you wish, you can take advantage of an additional saving by ordering both albums for only \$5.00. Your albums will be shipped postpaid — Command pays all postage and handling. And, you may order as many albums as you wish, but don't delay . . . mail your order today!



NEW POPULAR SAMPLER

12 Complete Selections From 10 Different Popular Albums

- PUT ON A HAPPY FACE (1963 The Year's Most Popular Themes)
- TONIGHT (The Popular Music of Leonard Bernstein)
- LUCKY TO BE ME (The Popular Music of Leonard Bernstein)
- ISTANBUL (Far Away Places — Vol. II)
- MITZI (Romantic Guitar)
- ALONE TOGETHER (Delicado)
- BIG BEN BOSSA NOVA (Let's Dance the Bossa Nova)
- DANCE, BOATMAN, DANCE (The Robert De Cormier Folk Singers)
- GEE, OFFICER KRUPKE (The Popular Music of Leonard Bernstein)
- BEYOND THE REEF (Paradise Islands)
- STOMPIN' AT THE SAVOY (Electrodynamics)
- GUAGLIONE (Roman Accordion)

NEW CLASSIC SAMPLER

8 Complete Selections From 8 Classical Albums

- BEETHOVEN — SYMPHONY NO. 3 in E Flat, Op. 55 ("Eroica"), 3rd Movement — Steinberg . . . The Pittsburgh Symph. Orch.
- BRAHMS — SYMPHONY NO. 3 in F. Op. 90, 3rd Movement — Steinberg . . . The Pittsburgh Symph. Orch.
- POULENC — SONATE, 1st Movement "PRELUDE" Leonid Hambro and Jascha Zayde.
- TCHAIKOWSKY — SYMPHONY NO. 4 in F. Minor Op. 36, 3rd Movement — Steinberg . . . The Pittsburgh Symph. Orch.
- WAGNER — INTRODUCTION TO ACT III — LOHENGRIN, Steinberg . . . The Pittsburgh Symph. Orch.
- MESSIAEN — DIEU PARMINOUS, Virgil Fox . . . The Philharmonic Organ at Lincoln Center.
- MUSSORGSKY-RAVEL — PICTURES AT AN EXHIBITION, Vandernoort . . . L'Orchestre de la Societe des Conservatoire.
- BEETHOVEN — SYMPHONY NO. 7 in A, Op. 92, 4th Movement — Steinberg . . . The Pittsburgh Symph. Orch.

MAIL COUPON TODAY

**COMMAND RECORDS, Dept. 64-HF
1501 BROADWAY, NEW YORK 36, NEW YORK**

Gentlemer: Please send me the Command Sampler Albums I have checked below. I understand Command pays all postage and handling costs.

QUANTITY	ALBUM	PRICE	TOTAL
___	POPULAR SAMPLER	<input type="checkbox"/> STEREO or <input type="checkbox"/> MONAURAL \$2.98 ea.	___
___	CLASSICAL SAMPLER	<input type="checkbox"/> STEREO or <input type="checkbox"/> MONAURAL \$2.98 ea.	___
___	SPECIAL OFFER (Both Popular & Classical)	<input type="checkbox"/> STEREO or <input type="checkbox"/> MONAURAL \$5.00	___

Enclosed is \$ _____ (Check or Money Order)

NAME _____

ADDRESS _____

CITY _____ ZONE _____ STATE _____

CIRCLE 18 ON READER-SERVICE CARD

Long play never had it so long!



New! Triple the length on a 7" reel!

Longest non-stop tape time ever! That's what you get with a 7" reel of new SCOTCH® BRAND Recording Tape No. 290—any way you play it! At 3¾ ips, for example, it provides 3 hours of uninterrupted stereo or monaural—6 hours of recording in both directions.

This exclusive triple length tape offers 3600' lengths on 7" reels. That's three times the footage possible with standard length tape on a 7" reel. And compared with regular double length tape, you get 50% more recording time, pay less per foot.

What's 290's secret? A superior new coating technique, developed by 3M, makes possible thinner high potency oxide coatings to reduce tape thickness, allow bonus tape footage per reel. Backing for No. 290 is the same extra-strong, half-mil tensilized polyester used on regular "SCOTCH" Double Length

Tape. No. 290 is made to demanding stereo quality standards to ensure brilliant sound characteristics. And exclusive Silicone lubrication, which lasts the life of the tape, protects against recorder head wear, actually extends tape life.

Full hour on a miniature reel! No. 290 is also offered in 600' lengths on 3¼" reels that fit most miniature recorders, play a full hour at 3¾ ips, 2 track. Ask your dealer about both sizes of new No. 290.

"SCOTCH" AND THE PLAID DESIGN ARE REGISTERED TRADEMARKS OF MINNESOTA MINING & MANUFACTURING CO., ST. PAUL 19, MINNESOTA EXPORT: 99 PARK AVENUE, NEW YORK CANADA: LONDON, ONTARIO. ©1963, 3M CO.

Magnetic Products Division **3M**
COMPANY

MORE CLEAN,

UNDISTORTED POWER, BANDWIDTH AND FEATURES THAN
EVEN COSTLIER STEREO HIGH FIDELITY RECEIVERS

THE NEW AWARD TA7000X



What makes a stereo receiver great? Performance, reliability, versatility, simplicity of operation. The new Award TA7000X fulfills all these requirements! Here's how:

- A distortion-free 70 watt stereo amplifier engineered to drive any speaker system made—and to provide unprecedented bandwidth! The frequency response of the TA7000X is 12-70,000 cps \pm 1 db. No other stereo receiver, regardless of price can even approach it! What makes the difference? A solid state power supply, plus massive, grain-oriented steel output transformers. By insuring the reproduction of frequencies well beyond the normal range of hearing, phase shift and transient distortion are reduced to negligible levels. The result—flawless reproduction within the audible range at all power levels!

- A stereo preamplifier offering every control and facility you require, sensibly arranged and simple to operate. These include: a blend control for perfect stereo regardless of speaker placement or room acoustics; stereo contour to boost

bass response at low listening levels, stereo headphone, rumble and scratch filters, separate bass and treble, tape monitor—you name it, the TA7000X has it!

- An FM tuner offering extreme sensitivity, plus the unique STEREO LOGIC CIRCUIT. This is the exclusive solid state device that literally thinks for you! It automatically switches the tuner to stereo the instant a station begins to broadcast stereo!

- An AM tuner offering low-noise, wideband circuitry designed to make AM listening a totally new experience!

Compare the new TA7000X to all other brands. From input to output, this is the newest, most exciting receiver on the market today. And the price is only \$369.95 (slightly higher in the West.) Add speakers, a turntable or record changer, and your stereo system is complete! For complete specifications, write Dept. ST-64, Harman-Kardon, Inc., Plainview, New York.

harman kardon

A subsidiary of THE JERROLD CORPORATION

HOW TO BUY AN ORIGINAL

BARZILAY

Each of these stereo component cabinets is an original. Every Barzilay is. Designed by Jack Benveniste, visual excellence and solid craftsmanship are only part of the reasons Barzilay is acknowledged as the finest made. We take pride that our furniture not only looks well, but "works" well. Proper function is emphasized from preliminary sketches to final prototype. Design tricks which compromise the cabinet's specific use to enclose stereo components are rigidly eschewed. Barzilay furniture is thoroughly engineered to fit the units you choose; enclosures enhance the performance of the finest loudspeakers. To the right you will find a list of dealers. Each has a display of Barzilay stereo furniture for your examination. Ask to see the Barzilay Counter Display for specific details on the complete line or write us directly for brochures. Address Dept. S-4 BARZILAY FURNITURE MFG. INC. P. O. Box 48 Gardena, California

900 Console

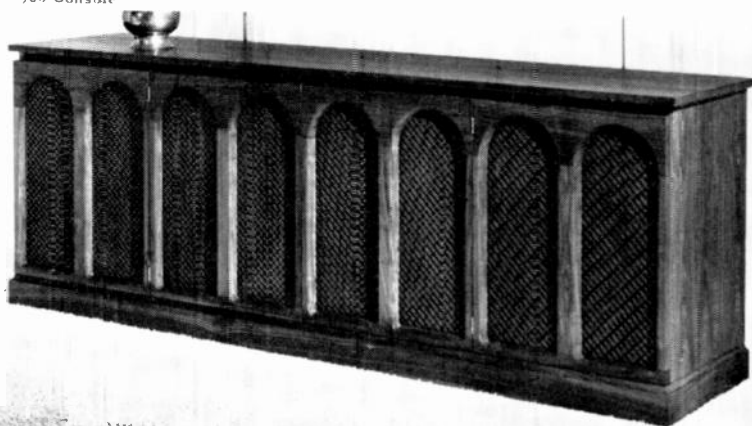

950E 3-piece Ensemble



H500 Console



ALABAMA
Lawrence Hi Fi Center
1927 11th Avenue South
Birmingham 5, Alabama

ARIZONA
Audio Specialists
333 E. Camelback Road
Phoenix, Arizona

The Sound Shop
4659 E. Broadway
Tucson, Arizona

CALIFORNIA
Acorn-Arrow Electronic Distr.
7035 Laurel Canyon Blvd.
North Hollywood, Calif.
2650 E. Colorado
Pasadena, Calif.
4736 W. Century Blvd.
Inglewood, Calif.
2713 S. Main Street
Santa Ana, Calif.
4686 Long Beach Blvd.
Long Beach, Calif.
1015 S. Figueroa
Los Angeles, Calif.
1065 W. Badillo
Covina, Calif.

Audio Mart
921 W. Magnolia Blvd.
Burbank, Calif.

Beverly Electronics
8413 Beverly Blvd.
Los Angeles 48, Calif.

Crenshaw Hi Fi Center
107 Santa Barbara Plaza
Los Angeles 8, Calif.

Dow Radio
1707 E. Colorado Blvd.
Pasadena, Calif.

Gmora Stereo Center
12024 Wilshire Blvd.
W. Los Angeles 25, Calif.

Graffey Electric
235 N. Pacific Coast Hwy.
Redondo Beach, Calif.

Henry Radio
931 N. Euclid
Anaheim, Calif.

Hi Fi Haven
442 Greenleaf Avenue
Whittier, Calif.

Hi Fi House
536 S. Fair Oaks Blvd.
Pasadena, Calif.

Hi Fi Matic
5534 Sepulveda Blvd.
Culver City, Calif.

House of Sight & Sound
14413 Victory Blvd.
Van Nuys, Calif.

Inglewood Electronics
4701 W. Century Blvd.
Inglewood, Calif.

Midway Electronics
Santa Monica at Lincoln Blvd.
Santa Monica, Calif.

Net Electronics
8115 Firestone Blvd.
Downey, Calif.

Olson Electronics
4642 W. Century Blvd.
Inglewood, Calif.

Oxbow Electronics
15914 E. Whittier Blvd.
Whittier, Calif.

Rancho Sound
18532 E. Acosta Blvd.
Azusa, Calif.

Stereo Hi Fi Center
13996 Crenshaw Blvd.
Gardena, Calif.

Telrad Electronics
3453 University Avenue
San Diego, Calif.

Woodland Stereo
21128 Ventura Blvd.
Woodland Hills, Calif.

Alco-Paramount
79 S. Third Street
San Jose, Calif.

Allegro Hi Fi
367 Market Street
San Francisco, Calif.

Audio Center
293 State Street
Los Altos, Calif.

Audio Phil's
448 S. Winchester
San Jose, Calif.

CALIFORNIA (Cont.)
Fisher Electronics
520 13th Street
Oakland, Calif.

Lakeshore Hi Fi
222 W. Portal Drive
San Francisco, Calif.

Mateo Hi Fi
2199 El Camino Real
San Mateo, Calif.

Podium
1005 12th Street
Sacramento, Calif.

Sounding Board
2442 Shattuck Avenue
Berkeley, Calif.

Stephenson-Bradford
624 W. Olive
Fresno, Calif.

Mal Sykes TV Hi Fi
1720 Fulton Avenue
Sacramento, Calif.

COLORADO
Howard Sound
843 Broadway
Denver 3, Colorado

CONNECTICUT
Phonograph Shop
66 Broad Street
Stamford, Conn.

David Dean Smith
262 Elm Street
New Haven, Conn.

Stereo Shop
227 Aslin Street
Hartford, Conn.

FLORIDA
Electronic Wholesalers
9390 N.W. 27th Avenue
Miami, Fla.

Hi Fi Associates
3180 Biscayne Blvd.
Miami 47, Fla.

Music Box
333 Park Avenue
Winter Park, Fla.

Salon of Music
2245 Central Avenue
St. Petersburg, Fla.

Viviano Stereo
1538 S. Dale Mobry
Tampa, Fla.

GEORGIA
Maker Audio
1140 Peachtree Road N.E.
Atlanta 7, Ga.

MARYLAND
Audio Center
4962 Fairmont Avenue
Bethesda, Maryland

Silver Springs Electronics
8203 Georgia Avenue
Silver Springs, Maryland

MASSACHUSETTS
The Music Box
58 Central Street
Wellesley, Mass.

MICHIGAN
Music Center
304 S. Thayer
Ann Arbor, Michigan

Pecar Electronics
11201 Morang Drive
Detroit 24, Mich.

MINNESOTA
Anderson's Hi Fi
38 W. 66th Street
Minneapolis 23, Minn.

Audio King
913 W. Lake Street
Minneapolis, Minn.

MISSOURI
Hi Fi Showroom
6383 Clayton Road
St. Louis, Mo.

NEW JERSEY
Custom Stereo Center
530 Riverside Drive
Lyndhurst, New Jersey

Music Age
Route 4
Paramus, New Jersey

NEW YORK
Atrex Radio
85 Cortlandt Street
New York 7, New York

Audio Exchange
153-21 Hillside Avenue
Jamaica 32, N.Y.

Audio Service Co.
130 State Street
Binghamton, New York

Craig Audio
139 N. Union Street
Rochester, N.Y.

CIRCLE 12 ON READER-SERVICE CARD

NEW YORK (Cont.)

F. M. Sound
1241 Main Street
Buffalo, N. Y.

Kitcraft

738 Washington Ave.
Brooklyn, N. Y.

Rabson's

119 W. 57th Street
New York, N. Y.

Seaman's Photo Hi Fi

386 Broadway
Newburgh, N. Y.

OHIO

Olson Electronics
2020 Euclid Avenue
Cleveland, Ohio

Pioneer Audio

5403 Prospect Avenue
Cleveland, Ohio

Shaker Music

16505 Chagrin Blvd.
Cleveland, Ohio

PENNSYLVANIA

Sam Goody of Philadelphia, Inc.
1125 Chestnut Street
Philadelphia, Pa.

TEXAS

Larry's Speaker Service
1121 S. Main
Fort Worth, Texas

UTAH

House of Music
156 S. Main
Salt Lake City, Utah

VIRGINIA

Key Electronics
100 S. Wayne Street
Arlington, Va.

The Television Workshop

116 W. Broad Street
Falls Church, Virginia

WASHINGTON

Lakewood Sound
10557 Gravelly Lake Dr. S. W.
Tacoma, Washington

Seattle Radio

2117 Second Avenue
Seattle, Washington

Seattle Stereo Center

2440 1st Avenue South
Seattle, Washington

WASHINGTON D. C.

Custom Hi Fi Radio TV
1811 Columbia Rd. N. E.
Washington, D. C.

Electronic Wholesalers

2345 Sherman Avenue N. W.
Washington, D. C.

Shrader Sound

2803 M Street N. W.
Washington, D. C.

STEREO FURNITURE KITS



In a recent issue of High Fidelity, under the title "A Cabinet for Connoisseurs", Norman Eisenberg wrote: "Designer Jack Benveniste has created an equipment cabinet that is visually attractive, is sensibly priced, and -- above all -- caters to the special needs of a component installation and its owner.....available as a kit and one which goes together easily and quickly".

Want to know more about Barzilay Stereo Furniture Kits? Visit one of the dealers listed. For information including a complete reprint of Mr. Eisenberg's article write Dept. K-2
BARZILAY FURNITURE
MFG. INC. P. O. Box 48
Gardena, California



The JBL Energizer/Transducer raises audio reproduction to a degree of perfection and precision never before available to the home listener. You hear music re-created in all its detail, rich and splendid, life size, without hum or distortion. The Energizer/Transducer sets new standards for fully controlled bass, completely realistic mid-range, immaculate highs, and transient reproduction without equal.

An Energizer/Transducer has its own source of power: the Energizer. The Energizer is exactly matched to the specific loudspeaker-and-enclosure system in which it is used. Energizer and transducer are engineered as a unit. Given a flat, pure signal from a preamplifier, the Energizer/Transducer delivers sound that is perfectly flat and pure — an exact replica

NOW! ALL ARE AVAILABLE SELF- ENERGIZED

your matched Energizer, you need only provide your Audio Specialist with the complete model number of your system. Write for your free copy of the new Energizer/Transducer six-page brochure.

— with exactly the right amount of damping at all frequencies. No other home high fidelity equipment can give you these results.

The JBL Energizer is a stereophonic all-solid-state device of scientific-instrument quality. Devoid of microphonics, generating negligible heat, it can be mounted within an acoustical enclosure. All JBL loudspeaker systems are available as Energizer/Transducers. The JBL loudspeaker system you now own can be made into an Energizer/Transducer. When ordering

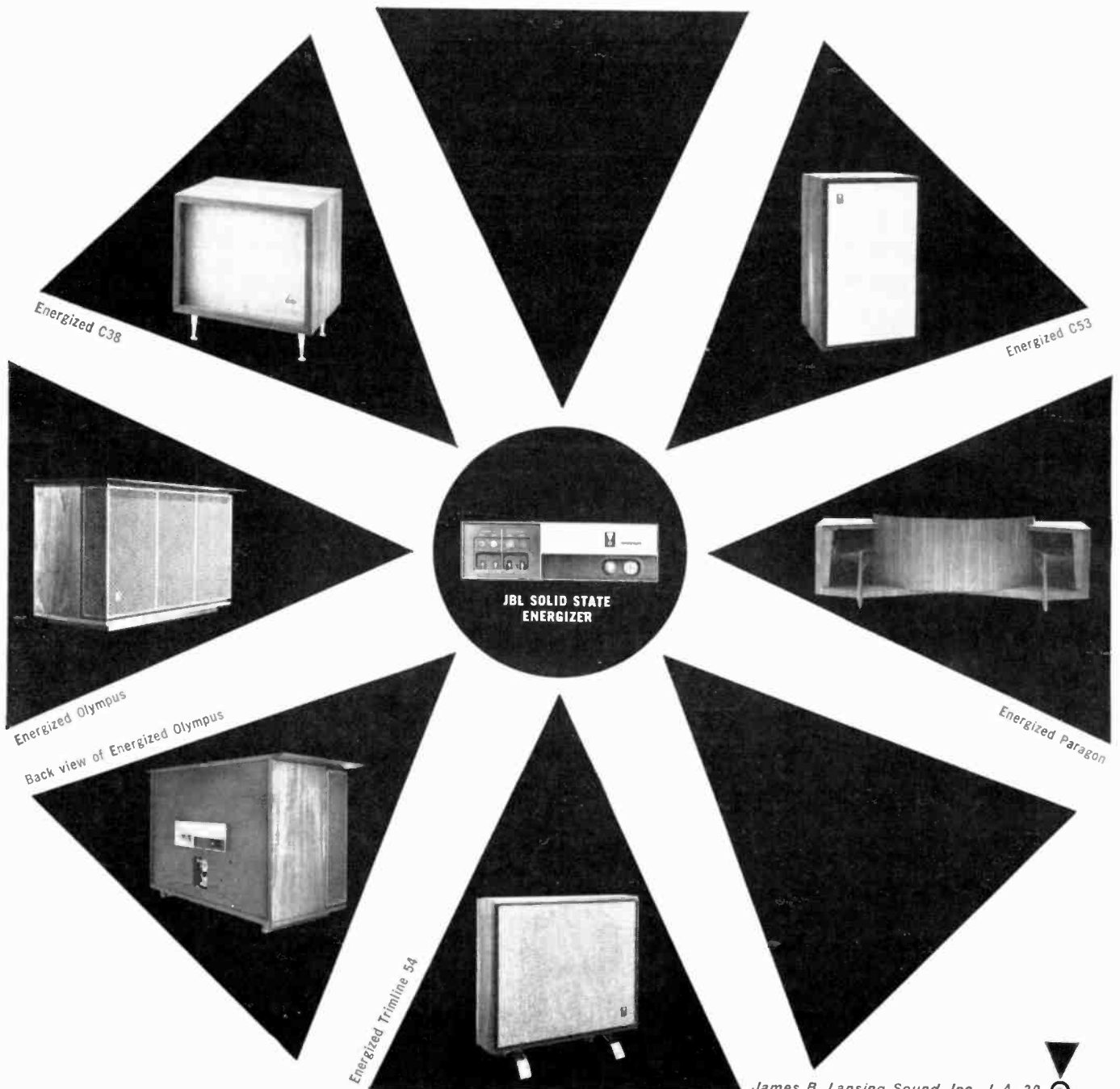

James B. Lansing Sound, Inc., L.A. 39

CIRCLE 36 ON READER-SERVICE CARD

FREE

MAIL
CARD
TODAY

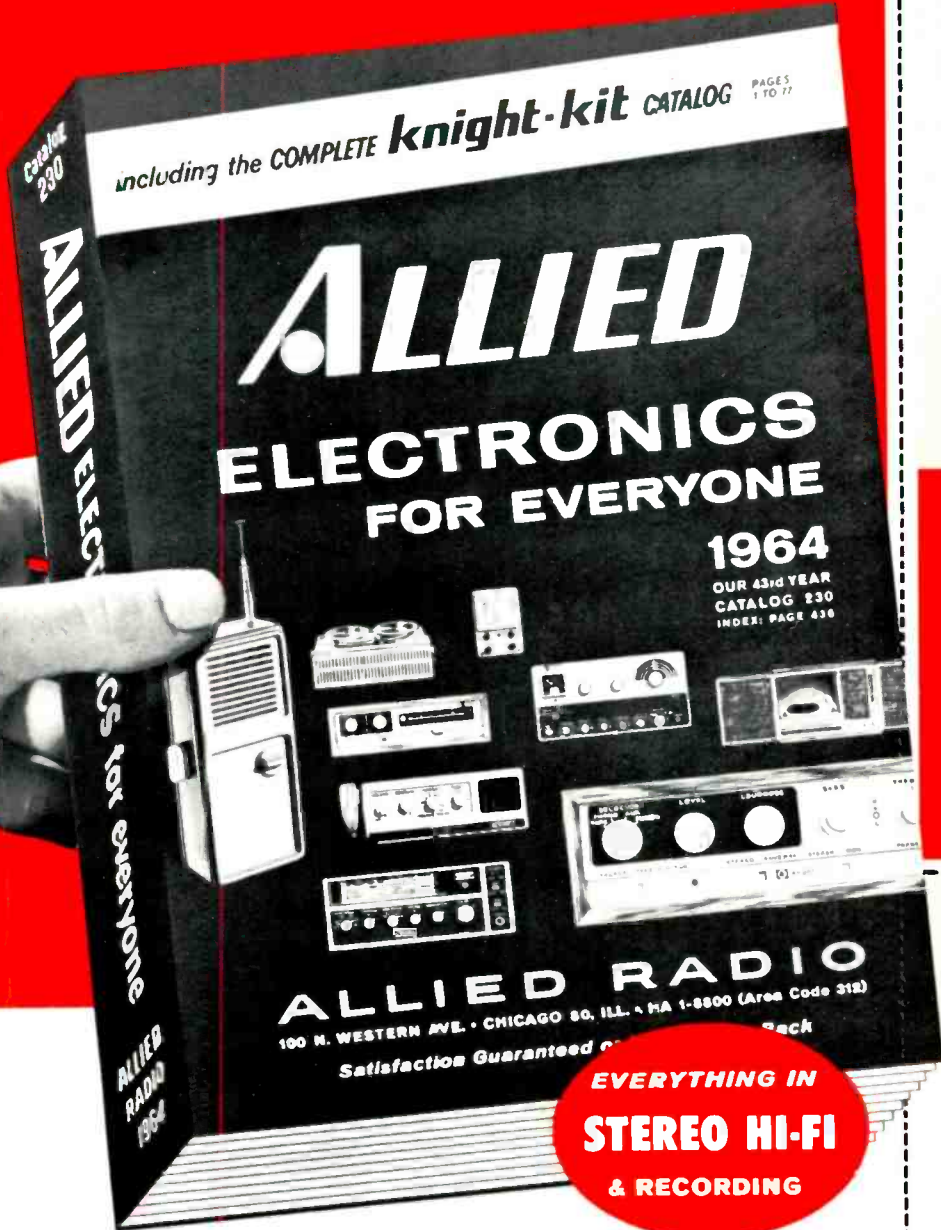

Name
PLEASE PRINT

Address

City Zone

State

45-M

YOUR **FREE**
ALLIED
1964 CATALOG

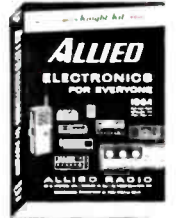

EVERYTHING IN STEREO HI-FI

Name
PLEASE PRINT

Address

City Zone

State

45-M

YOUR **FREE**
ALLIED
1964 CATALOG

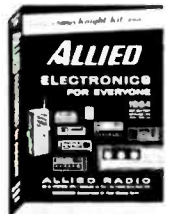

EVERYTHING IN STEREO HI-FI

send card today for your money-saving

ALLIED

444-PAGE 1964 CATALOG

WORLD'S LARGEST HI-FI—ELECTRONICS CATALOG
BIGGEST SELECTION • BIGGEST SAVINGS!

satisfaction guaranteed or your money back

NO MONEY DOWN: NOW! MORE BUYING POWER WITH
YOUR ALLIED CREDIT FUND PLAN!

SEE
OTHER
SIDE

For your FREE 1964 ALLIED Catalog, fill in card, detach and mail now. (Please give other card to an interested friend.)

SEND
CARD
TODAY

MAIL
NOW

P. O. Box 4398

TO:
ALLIED RADIO
CHICAGO 80, ILLINOIS

TO:

PLACE
STAMP
HERE

P. O. Box 4398

TO:
ALLIED RADIO
CHICAGO 80, ILLINOIS

TO:

PLACE
STAMP
HERE

MAIL
NOW

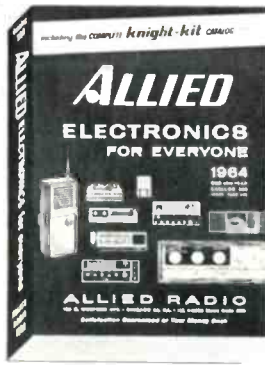

FREE send card today
for your 444-page
money-saving

ALLIED

HI-FI—ELECTRONICS
1964 CATALOG

WORLD'S LARGEST • BIGGEST SELECTION • BIGGEST SAVINGS!

Best Buys in Stereo Systems and Components

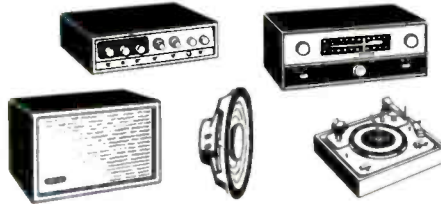

Choose from the world's largest selection of famous-make components and complete systems. See the latest all-transistor Stereo Hi-Fi. Save most on amplifiers, tuners, speakers and enclosures, record changers and players. Get our unbeatable price on a hi-fi system of your own choice.

Newest *knight-kit*® Build-Your-Own Hi-Fi



Build your own—build the best at big savings. It's easy, it's enjoyable to assemble your own KNIGHT-KIT Stereo hi-fi—and you get absolutely professional performance and appearance. Over 100 great hi-fi, hobby, CB radio, ham and instrument kits available.

Money-saving *knight*® Stereo High-Fidelity

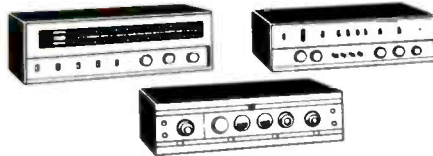

Allied's own top-value hi-fi line. Famous KNIGHT components and systems are equal in quality and performance to the very best, yet they're far lower in cost, give you most for your money. Full selection for every hi-fi need.

Everything in Tape Recorders, Tape and Recording Accessories



Enjoy the largest selection of complete recorders, including latest Stereo and professional types; tape decks, tape record/play preamplifiers, and recording accessories. Top values in quality recording tapes in all leading makes.

More for Your Money in Beautiful Hi-Fi Cabinetry



Wide selection of contemporary and authentic period styles—finest woods, construction and finish—at incomparable low cost. Includes complete equipment cabinetry and speaker enclosures.

Everything in Electronics for Everyone

- FM-AM & AM Radios • Phonographs & Accessories
- Citizens Band 2-Way Radios • Amateur Equipment
- TV Tubes & Antennas • Tools & Hardware
- Test & Lab Instruments • PA Systems & Intercoms
- Electronic Parts, Tubes, Transistors • Books

NO MONEY DOWN
Now! More Buying Power
with Your Allied
Credit Fund Plan!

satisfaction guaranteed or your money back

MAIL
NOW

FREE SEND CARD TODAY FOR YOUR
1964 ALLIED CATALOG
and give one card to an interested friend

3 GREAT NEW SCOTT AMPLIFIERS

POWERHOUSE

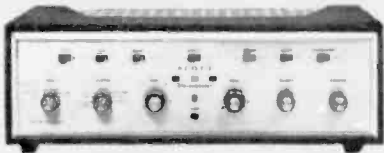

New 299D 80-Watt Stereo Amplifier

This best-selling stereo amplifier, topped by all leading consumer testing organizations, is now better than ever. New luxury features include: direct connection for powered center channel and extension speakers, speaker switch for private listening, new switching for choice of five low level inputs, non-magnetic electrolytic aluminum chassis, exclusive Scott Balance Left/Balance Right level balancing system, and massive output transformers. Behind the handsome panel, with its easy-grip knobs, is a lifetime of trouble-free performance and power to spare. \$229.95

TOP PERFORMER

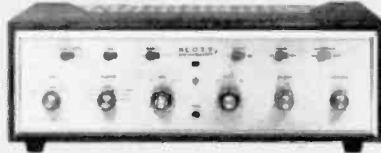

New 222D 50-Watt Stereo Amplifier

There's a new look to the ever-popular 222 series . . . and new performance, too. Massive transformers deliver enough power to drive even the most inefficient speaker systems . . . and the 222D gives you power in the low frequencies, where it's really needed. This value-packed performer incorporates a center channel speaker connection without the need for an additional amplifier, speaker switch for private listening, front panel switch for selection of phono or tape deck. Build a quality music system around this most versatile, feature-filled amplifier. \$179.95

SCOTT KIT

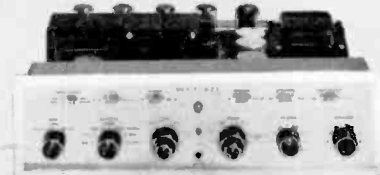

New LK-72 80-Watt Stereo Amplifier Kit

The latest version of the most popular high power integrated stereo amplifier kit ever produced. Every conceivable control feature is found on this versatile amplifier. The LK-72 has special equalization positions for phonograph and tape deck . . . and separate bass and treble controls for both channels provide maximum flexibility. Assembly is simple and fool-proof, thanks to exclusive full-size full-color instruction book . . . critical and difficult areas all pre-wired. \$164.95

How to select the right one for your system

FEATURES

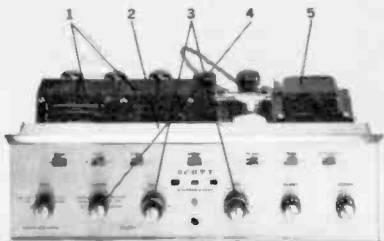

Wide Range of Features and Controls

1. Oversized output transformers for full bass response.
2. Non-magnetic electrolytic aluminum chassis for cool operation and lowest hum.
3. Dual tone controls for maximum adjustment of any program material
4. Exclusive Scott balancing method for perfect stereo regardless of speakers or program material.
5. Conservatively designed power-supply assures years of trouble-free enjoyment.

SPECIFICATIONS

	299D	222D	LK-72
Power per channel (IHF) watts	40/40	25/25	40/40
Power band (cps)	19-25,000	19-25,000	20-20,000
Hum level (db)	-80	-80	-80
Tape Monitor	Yes	Yes	Yes
Dual Tone Controls	Yes	Yes	Yes
Stereo Head-phone Output	Yes	Yes	Yes
Low Level Inputs	2	2	2
High Level Inputs	3	3	3

WANT MORE INFORMATION?

Mail this coupon for complete information on all the great new Scott components and kits.

H. H. Scott, Inc. Dept. 585-64
111 Powdermill Road
Maynard, Mass.

Send me complete information on the new 1964 Scott line of stereo components & kits.

Name

Address

City Zone State

Include names of interested friends, and we'll send them duplicate materials.



Export: Morhan Exporting Corp., 458 Broadway, N.Y.C.
Canada: Atlas Radio Corp., 50 Wingold Ave., Toronto
All prices slightly higher west of Rockies. Accessory cases extra.



If not for University's Classic Mark II...

this would be the finest speaker system of them all—

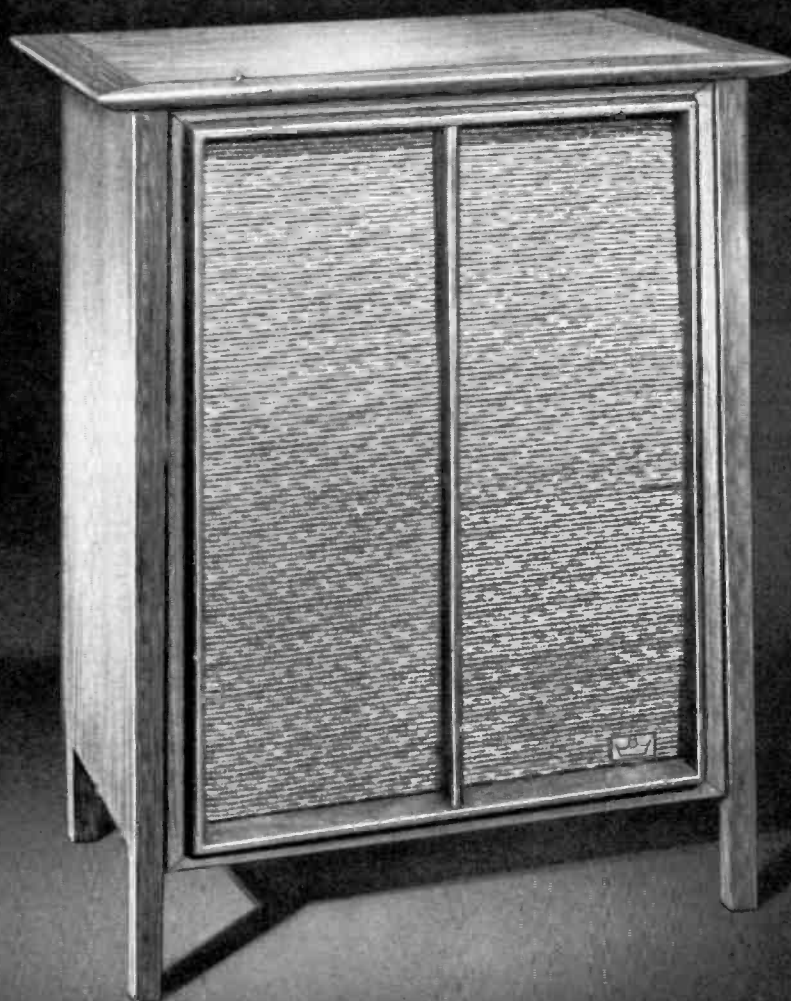

the new Classic Dual-12

the three-way system with two 12" speakers—plus!

From the first moment of its appearance, the Classic Mark II won instant and unanimous acclaim as the most exciting new instrument in the world of music reproduction. Its range, its presence, its spaciousness and dimension are truly outstanding, even when compared with the so-called "world's bests." Its reputation, however, posed this immediate challenge: Could University now create a speaker system with the essential qualities of the Mark II, but in a more compact size... and at a more moderate price? Could University now bring the pleasure of uncompromising big system high fidelity to a broader range of music lovers?

The challenge has been answered with the new Classic Dual-12, created by a totally new approach to the design

of speaker systems. Instead of the conventional 3-speaker arrangement, University's Dual-12 incorporates two 12" speakers...plus the Sphericon Super Tweeter! One 12" speaker is a woofer specifically designed for optimum reproduction of the ultra-low frequencies (down to 25 cps); the other, a woofer/mid-range, reinforces the woofer, removes the peaks and valleys that cause harsh, strident sounds in ordinary systems and provides flawless mid-range performance. The renowned Sphericon is included to assure silky, transparent highs soaring effortlessly up to 40,000 cps! Power Requirements: 10 watts. Size: 23³/₄" x 31¹/₄" x 15¹/₂". Oiled walnut finish. \$229.95 Hear it at your hi-fi dealer, or write: Desk HF64.

CIRCLE 55 ON READER-SERVICE CARD

 **UNIVERSITY
LOUDSPEAKERS**
OKLAHOMA CITY, OKLAHOMA
A Division of Ling-Temco-Vought, Inc.

3 GREAT NEW SCOTT TUNERS

SUPER SENSITIVE

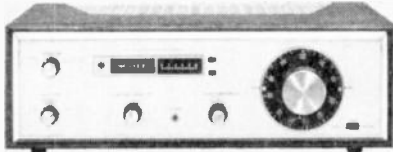

New 310E FM Stereo Tuner

Here's the multiplex version of the famous tuner used in the "Telstar" experiment. Its extreme sensitivity of $1.9\mu\text{v}$, high selectivity, and low distortion make it the logical choice for the most critical installations. Equipped with completely automatic facilities for switching from monaural to stereo, the 310E is effortless to use. A unique "stereo only" mode of operation helps you find stereo broadcasts faster than ever before. This is the very finest tuner possible at the present state of the art. \$279.95

TOP PERFORMER



New 350C FM Stereo Tuner

The first, and most popular, multiplex tuner ever made now has a new look, and vastly improved performance to match! Time-Switching multiplex circuitry pioneered by Scott assures low distortion and maximum separation. New improved sensitivity of $2.2\mu\text{v}$ guarantees perfect stereo or mono reception in the most difficult signal areas. The 350C offers a variety of exclusive Scott features like the precision illuminated tuning meter, separate level controls, convenient front panel tape outlet, and Scott's Sonic Monitor. Truly a delight to use. \$224.95

TOP VALUE

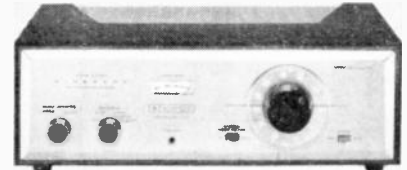

LT-110 FM Multiplex Tuner Kit

This is the kit the experts have unanimously acclaimed as one of the finest, easiest to build on the market. The fabulous LT-110 tuner gives unsurpassed reception of both FM Stereo and monophonic FM broadcasts. Critical front end and multiplex sections are pre-wired and factory tested. Wires are already cut to exact length and mechanical parts are in place on chassis. Scott's exclusive full-color instruction book positively identifies each part in full color so you can't make a mistake. Even a novice can expect top performance. \$164.95

How to select the right one for your system

FEATURES

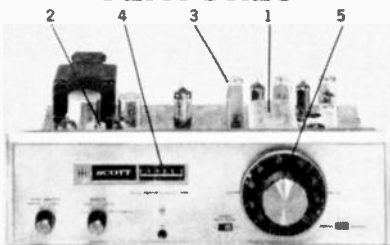

Wide Range of Features and Controls

1. Heavily silver-plated "front-end" for maximum usable sensitivity, lowest hum, distortion, and noise.
2. Time-Switching multiplex circuitry for full frequency response with extremely low distortion.
3. Famous 2 mc Wide-Band detector for drift-free operation.
4. Sensitive indicator for accurate tuning and best antenna orientation.
5. Easy-to-use vernier tuning dial with logging scale.

SPECIFICATIONS

	310E	350C	LT-110
Usable Sensitivity (μv)	1.9	2.2	2.2
Signal: Noise Ratio (db)	65	60	60
Harmonic Distortion (%)	0.5	0.8	0.8
Drift	0.02	0.02	0.02
Frequency Response (cps \pm 1db)	30-15,000	30-15,000	30-15,000
Capture Ratio (db)	2.2	6.0	6.0
Selectivity (db)	50	35	35
Spurious Response Rejection (db)	85	80	80
AM Suppression (db)	60	55	55
Separation (db)	30+	30	30+

WANT MORE INFORMATION

Mail this coupon for complete information on all the great new Scott components and kits.

H. H. Scott, Inc. Dept. 585-64
111 Powdermill Road
Maynard, Mass.

Send me complete information on the new 1964 Scott line of stereo components and kits.

Name

Address

City Zone State

Include names of interested friends and we'll send them duplicate materials.



Export: Morhan Exporting Corp., 458 Broadway, N.Y.C.
Canada: Atlas Radio Corp., 50 Wingold Ave., Toronto

All prices slightly higher west of Rockies. Accessory cases extra.

plays your precious records with a light, gentle touch

Whether you use your Miracord as a manual turntable, an automatic turntable or an automatic changer; whether you play stereo or mono; you enjoy the same gentle quality, the same flawless performance that has made Miracord first choice in the finest consoles and component systems.

It is the only unit of its type obtainable with self-regulated, constant-speed hysteresis motor, the only one with a one-piece, 12-inch turntable and mass-balanced tone arm employing no springs, and the only one with feather-touch pushbutton controls.

Incredibly quiet, smooth and gentle, the Miracord brings out the best in your records with every play, and preserves that quality for long-lasting enjoyment.

Before you choose a record player for your system, be sure to see and hear the Miracord at your high fidelity dealer. Model 10H with hysteresis motor, \$99.50; model 10 with 4-pole induction motor, \$89.50 (less cartridge and base). For complete details, write to:

**BENJAMIN
MIRACORD**



SOLID-STATE* STEREO

BY HEATHKIT



**Solid-State*—a term used to refer to germanium or silicon transistors which are of a solid crystalline structure as opposed to vacuum tubes which are evacuated glass bottles containing various fabricated wire structures.

Cooler, faster operation . . . lower power consumption . . . longer life . . . and the clean, quick realism of "transistor sound." You'll enjoy all this and more with Heathkit's newest All-Transistor Stereo "Twins." Compact, low-silhouette styling magnificently fashioned in rich walnut cabinets neatly fits this handsome pair into a "proud place" in any hi-fi stereo system. Add to this extruded brushed gold-anodized aluminum front panels that serve practically to conceal secondary controls and decoratively to enhance over-all beauty. The AA-22 Amplifier provides 40 watts of continuous power at ± 1 db from 15 to 30,000 cps with no fading, no faltering . . . just pure solid sound! The AJ-33 Tuner offers selection of AM, FM, or FM Stereo to please any listening preference. Check both unit's features and discover why Heathkit leads in Transistor Stereo. The price? A great value, you'll agree . . . \$99.95 each!

AA-22 40-watt Transistor Stereo Amplifier, 14 lbs. \$10 mo. \$99.95

AJ-33 Transistor AM-FM FM Stereo Tuner, 14 lbs. \$10 mo. \$99.95

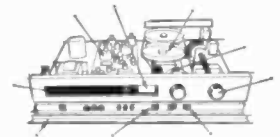
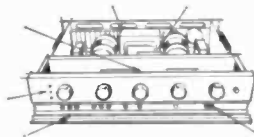

- 40 watts of power (20 per channel)
- 5 stereo inputs
- Speaker phase switch
- Miniature indicator light for each position on mode switch
- Transformerless output circuits
- Brushed gold-anodized aluminum front panel conceals secondary controls
- Walnut cabinetry

- Stereo phase control
- Automatic stereo indicator
- AFC and AGC
- Filtered stereo tape recorder outputs
- Built-in stereo demodulator
- Tuning meter
- Flywheel tuning
- Slide-rule dial
- Prealigned FM tuner and circuit board construction
- Brushed gold-anodized aluminum front panel conceals secondary controls
- Walnut cabinet



NEW! FREE 1964 HEATHKIT CATALOG
See the latest new products in Heathkit's wide, wonderful line. Over 250 do-it-yourself kits for stereo/hi-fi, marine, TV, electronic organs, amateur radio, test instruments, educational, and home and hobby items that will save you up to 50%. Send for your free copy today!

HEATH COMPANY Benton Harbor 8, Michigan 49023

Enclosed is \$_____, plus postage. Please send model No. _____

Please send Free Copy of New 1964 Catalog.

Name _____

Address _____

City _____ State _____

CIRCLE 28 ON READER-SERVICE CARD

Enjoy the CONCORD 550-4, the quality tape recorder that puts life into recorded stereo sound... adds the professional touch to your own recording and playback. Exclusive Trans-A-Track gets you in on the act, records while you sing-or-play-along with your favorite artists. Use with amplifiers and speakers of a hi-fi system or as a self-

*life
of the
party*

WITH EXCLUSIVE
TRANS-A-TRACK

contained music system. FM multiplex, stereo and four track monaural recording. Create your own music library with the help of the 550-4's advanced design features. ■ Transistorized Pre-amps ■ All Pushbutton ■ 3 Speeds ■ Automatic Shutoff ■ Separate Speakers ■ VU Meters. Model 550-4 under \$320. Other models from \$100.*



For Connoisseurs Of Sound

CONCORD 550-4

CONCORD  ELECTRONICS CORPORATION 809 North Cahuenga Blvd., Dept. 31, Los Angeles 38, Calif. In Canada: Regal Industries Ltd., Montreal and Toronto. *Slightly higher in Canada
THE SIGNATURE OF QUALITY ■ Tape Recorders/Industrial Sound Equipment/Dictation Systems/Communications Devices/Closed Circuit Television

SOLID-STATE STEREO

BY HEATHKIT®



New! Deluxe All-Transistor, All-Mode Stereo Tuner & Matching 70-Watt Amplifier

Instantaneous bursts of power as the music demands...clean, uncompromising "solid" sound...cooler, faster, "hum-free" operation...this is the exciting performance of Heathkit's new deluxe all-transistor twosome. Add luxurious deluxe styling, plenty of deluxe features, plus "Heath-Engineered" quality, and you have the neatest, most advanced tuner and amplifier in the industry today! You'll enjoy deluxe extras like the unique "push-to-turn-off/on" switch, the concealed secondary controls to prevent accidental system changes, the automatic switch-to-stereo feature of the tuner, and the prebuilt, prewired encapsulated component modules in the amplifier for quick, easy assembly. You'll enjoy high fidelity AM-FM-FM Stereo reception, plus a full 70 watts of continuous power, 100 watts music power at all frequencies from 13 to 25,000 cps. You'll enjoy handsome matched tan, vinyl-clad steel cabinet styling with polished aluminum trim and soft refracted lighting...complements any decor! Both units are easy to build...easy to own! These are reasons you should move up to this all-transistor twosome from Heathkit now!

Kit AJ-43, Tuner, 18 lbs., no money dn., \$11 mo. \$119.95
 Kit AA-21, Amplifier, 29 lbs., no money dn., \$13 mo. \$139.95

AJ-43 All-Mode All-Transistor Stereo Tuner, 18 lbs., \$11 mo. \$119.95

AA-21 70-Watt All-Transistor Stereo Amplifier, 29 lbs., \$13 mo. \$139.95

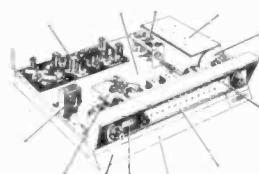

THE LATEST IN FEATURES

- 25 transistors, 9 diodes • Built-in circuitry • Automatic Stereo Indicator • Automatic Stereo switching to eliminate manual switching to receive stereo • Built-in Automatic Frequency Control and Automatic Gain Control • Adjustable FM squelch • Stereo phase control • Filtered stereo tape recorder • Built-in AM & FM antennas • Separate AM & FM tuning meters • Lighted slide-rule dial • Flywheel tuning • Regulated power supply • Factory assembled FM tuning unit and 4-stage IF circuit board • Concealed controls behind hinged front panel.

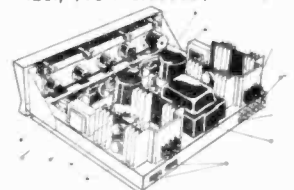

THE LATEST IN FEATURES

- Eight Germanium Power Output Transistors mounted on four finned heat sinks • Output circuit breakers • Power amplifier circuit boards containing four transistors and six diodes • Two driver transformers • Two preamplifier circuit boards contain six epoxy-sealed component modules and ten transistors • Two Germanium driver transistors plus two electronic filter transistors • Filter condensers and four power supply diodes • Output terminal boards • Input jacks • Tape recorder output • Power transformer • AC outlets.



HEATH COMPANY, Benton Harbor 8, Michigan 49023

Enclosed is \$_____, plus postage. Please send Model No. _____
 Please send FREE copy of New 1964 Catalog.

Name _____

Address _____

City _____ State _____ Zip No. _____

HEATHKIT-1964



NEW! FREE 1964 HEATHKIT CATALOG
 See the newest products in Heathkit's wide exciting line. Over 250 do-it-yourself kits for stereo/hi-fi, marine, TV, electronic organ, amateur radio, test instruments, educational and home & hobby items that will save you up to 50%. Send for your free copy today!

CIRCLE 28 ON READER-SERVICE CARD

**The best thing that can happen to
a good amplifier:**

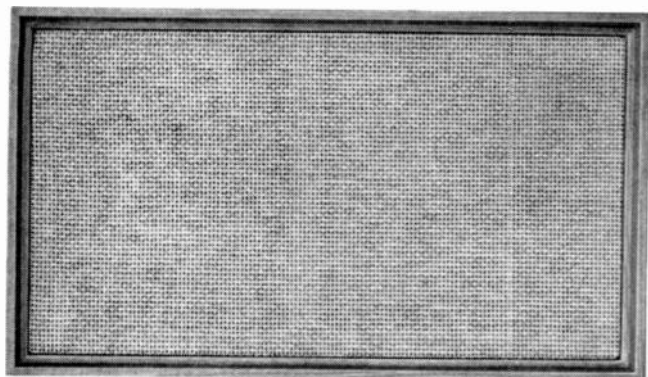

(a Fisher loudspeaker)

No matter how good an amplifier you own—even if it is one of the new Fisher stereo amplifiers—you will never realize its full potential unless you feed its output into a loudspeaker that 'knows the difference.' Very few loudspeaker systems are genuinely *analytical*, revealing all the nuances of inner detail in those complex musical passages that only the finest amplifiers leave unblurred. The most remarkable systems in this distinguished category are the revolutionary XP Series free-piston loudspeakers by Fisher, priced from \$84.50 up to \$249.50.*

**The best thing that can happen to
a good tuner:**



(a Fisher amplifier)

Even if you own one of the world's finest FM tuners—in which case it is undoubtedly a Fisher—you will not fully appreciate the unsurpassable tonal qualities of a live FM broadcast without an amplifier of the highest caliber. Not many amplifiers can preserve a totally undistorted input without imparting to it a slight 'veil' of distortion in the reproduction—enough to remove that ultimate feeling of presence. The Fisher X Series stereo control amplifiers are faultless even in this critical sense and are priced from \$169.50 to \$339.50.*

*SLIGHTLY HIGHER IN THE FAR WEST. CABINETS NOT INCLUDED IN PRICE. FISHER RADIO CORPORATION, 21-71 44TH DRIVE, LONG ISLAND CITY 1, N.Y.
EXPORT: FISHER RADIO INTERNATIONAL, INC., LONG ISLAND CITY 1, N.Y. CANADA: TRI-TEL ASSOCIATES, LTD., WILLOWDALE, ONT.

**The best thing that can happen to
a good antenna:**



(a Fisher tuner)

Not even the most sophisticated multi-element Yagi antenna will give you completely distortion-free, low-noise reception of the new FM Stereo broadcasts in a difficult area, unless the tuner it feeds has exceptional sensitivity and genuine wide-band circuitry. The Multiplex method of FM Stereo transmission makes unprecedented demands on the receiving equipment. Fisher FM Stereo Multiplex tuners meet these demands on the most advanced level of FM engineering in the world today. Their price ranges from \$199.50 up to \$439.50.*

**The best thing that can happen to
a good wife:**



(an all-in-one Fisher receiver)

She wants the best of everything. A neat, uncluttered house and, at the same time, the finest in stereo. She is all for components—but please, no 'electronics' all over the house! Unreasonable? Not at all. Any of the integrated, single-chassis Fisher stereo receivers will meet her wifely specifications. In only 17½ inches of shelf space, she can have the tuner, the control-preamplifier *and* the power amplifier—all on *one* chassis and all of the highest Fisher quality. Fisher stereo receivers are available with FM only or with FM-AM, from \$329.50 to \$449.50.*

(for further information, turn page)

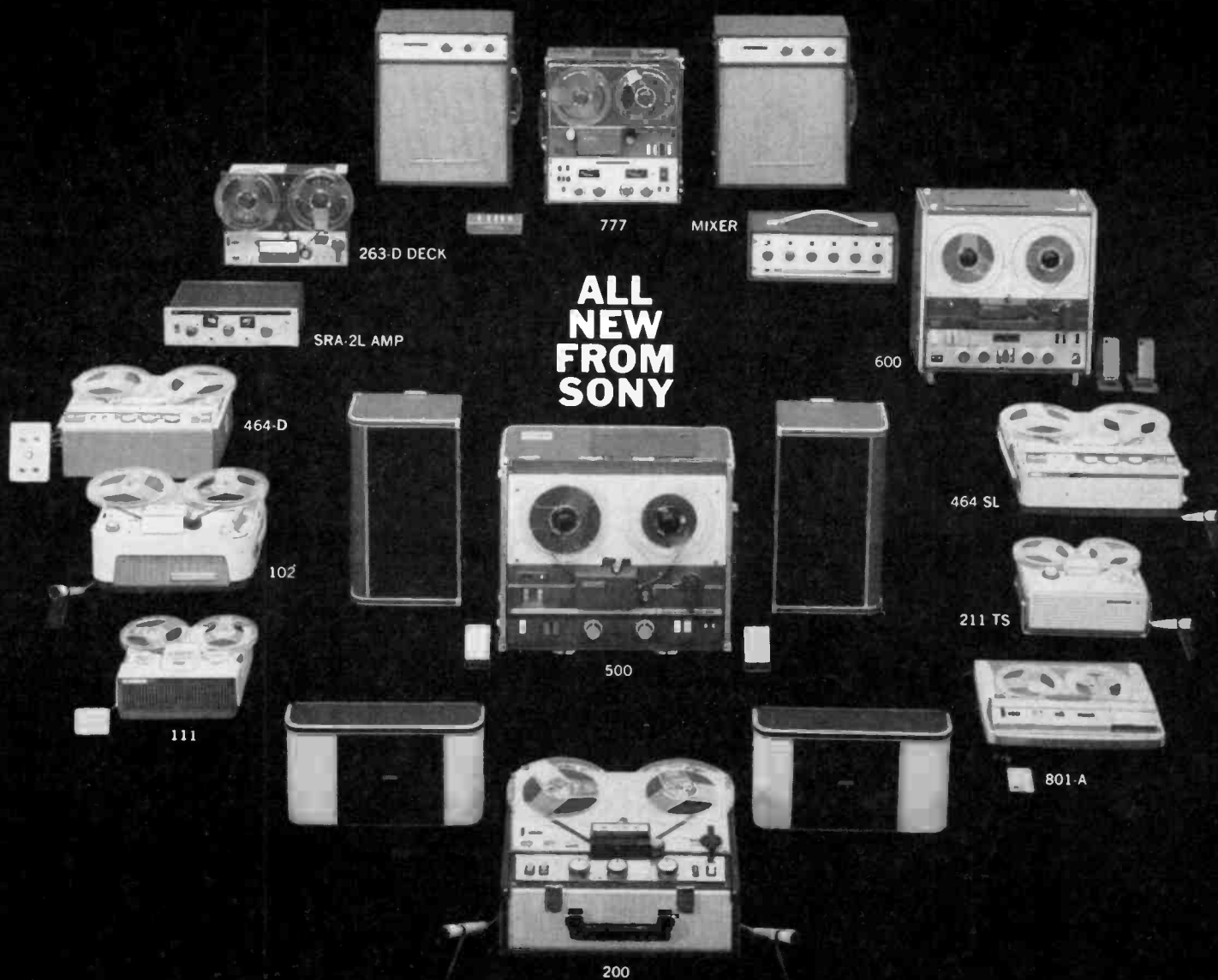

**ALL
NEW
FROM
SONY**

THE MOST COMPLETE LINE OF QUALITY TAPE RECORDING EQUIPMENT IN THE WORLD

■ Sony Sterecorder 777 S—Professional, all transistorized 2 or 4 track stereo/mono tape recording system featuring remote control and the exclusive Sony Electro BiLateral head system. World's finest tape recorder. Less than \$695. ■ Sony Amplifier/Speaker System SSA 777—All transistorized, 10 watt, extended range 8" infinite baffle hi fidelity speakers created to produce perfect, full-sound reproduction with the 777 S. Less than \$175. ■ Sony Stereo Mixer MX 777—For advanced recording techniques, this all-transistorized, battery-powered 6 channel stereo/mono mixer is the perfect accessory to complete the 777 professional system. Less than \$175. ■ Sony Stereo Tape Deck 263-D—Add tape to any sound system with this 4 track stereo playback tape transport. 3 heads, 2 speeds, vertical or horizontal operation. Less than \$119.50. ■ Sony Stereo Recording Amplifier SRA-2L—All the facilities for adding stereo recording to the 263-D unit. Less than \$99.50. ■ Sony Sterecorder 464-D Deck—2 speed, 4 track, stereo/mono, record/playback compact tape deck with built-in pre-amps. Ideal for custom installation. Less than \$199.50. ■ Sony Portable Tape recorder 102—Rugged 2 speed, dual track, hi fidelity recorder with deluxe features and 7" reel capacity satisfies the most exacting recording requirements. Less than \$129.50. ■ Sony Tape recorder 111—A popularly priced, high quality bantam recorder for everyday family fun. Less than \$79.50. ■ Sony Sterecorder 200—The most compact and lightweight quality 4 track tape recording system on the market today. Carrying case lid separates into

NOW ON DISPLAY
AT YOUR FRANCHISED
SONY / SUPERSCOPE
AUDIO / TAPE DEALER

2 full range speaker systems. Unequaled for performance and price. Less than \$239.50. ■ Sony Sterecorder 500—A complete 4 track stereo/mono tape system with unsurpassed studio quality. The full range, infinite baffle detachable speaker systems integrate into the recorder lid, and separate 15 feet for optimum stereo effect. Less than \$399.50. ■ Sony Battery-Operated Executive Portable 801-A—A distinctively styled, transistorized, 2 speed all purpose recorder of utmost precision and quality. For the executive desk or portable use. The self-storing mike features a remote stop and go switch. Tape it with you for less than \$250. ■ Sony 'Slide-Sync' Tape recorder 211-TS—Incredibly versatile, serves the photo enthusiast with an exclusive, automatic built-in 'programmer' to activate a slide projector in 'sync' with your own recorded narration. Also the most compact tape teaching recorder available. Less than \$129.50. ■ Sony Tape Teaching Recorder 464-SL—A deluxe language and music teaching aid, 2 speed, 4 track, stereo and mono. Less than \$219.50. ■ Sony Sterecorder 600—3 heads, tape and source monitoring, sound on sound, vertical or horizontal operating, this 4 track stereo recording and playback unit is perfect for professional quality home installation. Less than \$450. ■ Also available, an extensive line of professional studio quality microphones and accessories. All Sony Sterecorders are Multiplex Ready! For detailed literature and name of nearest franchised tape dealer write Superscope, Inc., Dept. S4, Sun Valley, Calif.

IN NEW YORK, VISIT THE SONY SALON, 585 FIFTH AVENUE.



CIRCLE 51 ON READER-SERVICE CARD

Before you spend \$400 to \$2000 for hi-fi, will you spend 5¢ for know-how?

(Buy a 5¢ stamp and mail this coupon
for the free
Fisher Handbook, an authoritative 52-page
guide to hi-fi and stereo.)

FREE! \$1.00 VALUE! Protect your future investment in high fidelity equipment. Mail this coupon for your free copy of the new 1964 Fisher Handbook, a lavishly illustrated 52-page reference guide, idea book and component catalogue for custom stereo installations. The Fisher Handbook tells you exactly what stereophonic high fidelity is about, how to avoid costly errors in buying components and how to install a complete custom stereo system in your home.

FISHER RADIO CORPORATION
21-71 44th Drive, Long Island City 1, N.Y.

Name _____

Address _____

City _____ State _____

01A22

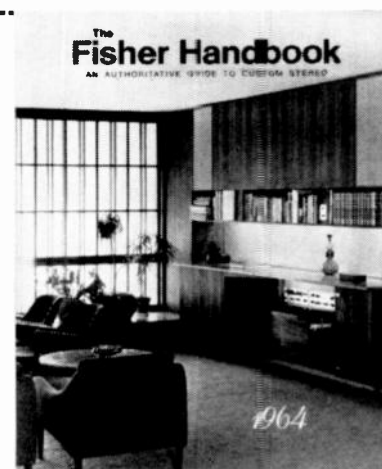

Why did Sherwood zero-in on the problem of tuning accuracy?



S-3000 ∇ FM Stereo Multiplex Tuner with professional zero-centered tuning meter and Stereo Indicator Light.

It takes wider bands to broadcast the multiple information for stereo FM multiplex, and the most precise "dead-on-center" tuning to receive it . . . with maximum stereo separation and minimum distortion.

This is why in the new S-3000 ∇ Tuner, Sherwood engineers incorporated a professional zero-centered tuning meter. Superior to tuning eyes, better than peak meters, it uses the same D'Arsonval meter needed to design, align and test FM tuner circuits. When the meter reads "zero" . . . you're right on. No guesswork. No maybe's.

Gain three tuning advantages

- Tune accurately, the first time.
- Tune low-power Class "A" stations interspaced between more powerful broadcasts.
- Tune with professional surety.

Added value features of the S-3000 ∇

- Stereo Indicator Light: identifies stereo broadcasts.
- Superb sensitivity: $1.8\mu\text{v}$ (IHF) for -30db . noise and distortion.
- No background noise: pace-setting 2.4db. capture effect.
- FM Interchannel Hush: suppresses between-station noises.
- Flywheel tuning: smooth as silk.
- 20% longer dial scales: professional accuracy.
- Price: \$165.00. (Leatherette case optional at \$7.50.)

Dept. Y-64

For complete information write, Sherwood Electronic Laboratories, Inc., 4300 North California Ave., Chicago 18, Ill.

CIRCLE 49 ON READER-SERVICE CARD

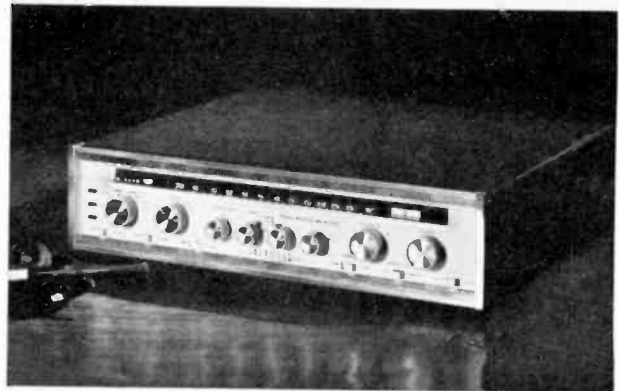

New S-8000 III FM Stereo MX Receiver. Combines above tuner features with an 80-watt stereo amplifier. Price: \$319.50. (Leatherette case optional at \$9.50.)

Prices slightly higher in the Far West.

Sherwood
HIGH FIDELITY

Stereo Receivers • Tuners
Amplifiers • Stereo Indicator Lights
Speaker Systems • Contemporary Cabinetry

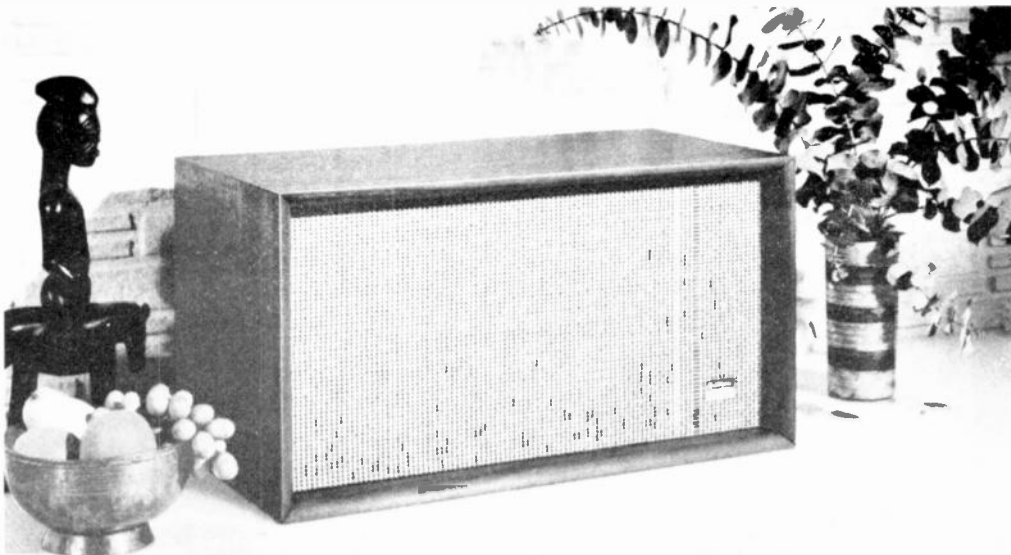

The Most Sweeping Change in Speaker System Design... Starts with the New E-V FOUR!

Until now, there have been just two ways to determine the absolute quality of a speaker system: the scientific method, and the artistic approach. But each, by itself, has not proved good enough.

The scientist, with the help of impersonal equipment, charts and graphs, has strived to obtain the finest possible measured results. If the figures were right, then it *had* to sound right, and anyone disagreeing was dismissed as "not objective". But often, two speakers measured substantially the same, yet sounded quite different.

On the other hand, the artistic school of loudspeaker design has depended on the judgement of a handful of experts whose "golden ears" were the final yardstick of perfection. If you didn't agree with the experts, your ear was "uneducated" and not discriminating. But too often the measured response of the expert's system fell woefully short of reasonable performance—proof that even trained listeners can delude themselves when listening to loudspeakers.

Now, with the introduction of the E-V FOUR, Electro-Voice has pioneered a blend of the best features of both measurement methods to lift compact speaker performance to a new level of quality. It wasn't easy. The use of both techniques required extensive facilities, something E-V enjoys in abundance.

For instance, E-V has one of the industry's largest, most completely-equipped laboratories for the study of acoustical performance. Actually, the E-V engineering staff alone is larger than the entire personnel complement of many other speaker firms. In the E-V lab, measurement of speaker performance can be made with uncommon precision. And the interpretation of this data is in the hands of skilled engineers whose full time is devoted to electro-acoustics.

But beyond the development of advanced scientific concepts, E-V embraces the idea that a thorough study of the

subjective response to reproduced sound is essential. E-V speakers must fully meet both engineering and artistic criteria for sound quality. Where we differ from earlier efforts is in greatly increasing the sample of expert listeners who judge the engineering efforts.

To this end, experts in music and sound from coast to coast were invited to judge and criticize the E-V FOUR exhaustively before its design was frozen. Adjustments in response were made on the spot—in the field—to determine the exact characteristics that define superb performance. It was not enough to say that a unit needed "more bass". What kind of bass? How much? At what frequencies? These are some of the more obvious questions that were completely settled by immediate adjustment and direct comparison.

The new E-V FOUR is the final result of this intensive inquiry into the character of reproduced sound. According to widespread critical comment, the E-V FOUR sound is of unusually high calibre. And careful laboratory testing reveals that there are no illusions—the measurements confirm the critics' high opinion of this new system.

Of course, it is one thing to design an outstanding prototype—and something else to produce an acoustic suspension system in quantity at a fair price. It is here that extensive production facilities, combined with creative engineering approaches, guarantee the performance of each E-V FOUR. And these same facilities ensure reasonable value. For instance, the E-V FOUR sells for but \$136.00 with oiled walnut or mahogany finish and just \$122.00 in unfinished birch. Yet, in judging its sound qualities, it was successfully compared with speaker systems costing as much as \$200.00.

We urge you to join in the analysis of E-V FOUR compact speaker performance. Visit your E-V high fidelity showroom and compare, carefully, this new system. We feel certain that you will agree with the engineers and the critics that the new E-V FOUR offers a truly full measure of high fidelity satisfaction.

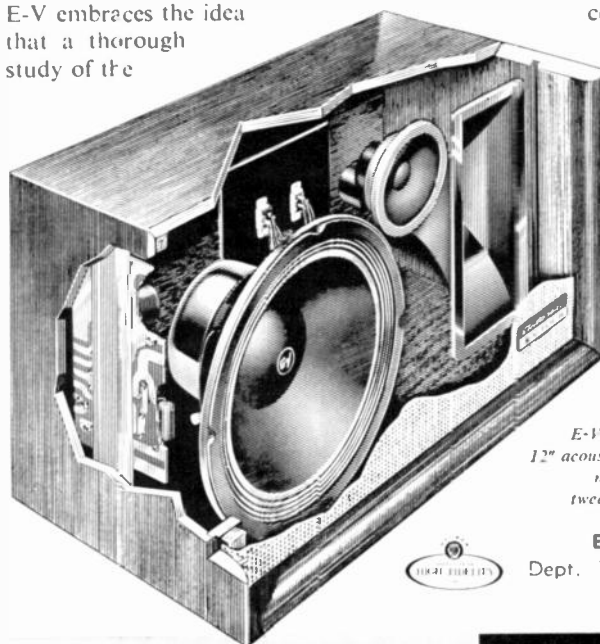

*E-V FOUR components include:
12" acoustic suspension woofer | Ring-diaphragm
mid-range driver | 5" dynamic cone
tweeter | Etched circuit crossover*



ELECTRO-VOICE, INC.
Dept. 1234DD, Buchanan, Michigan



E-V TWO

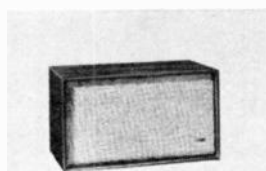

E-V FOUR

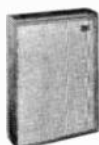

REGINA



E-V SIX

Electro-Voice
SETTING NEW STANDARDS IN SOUND

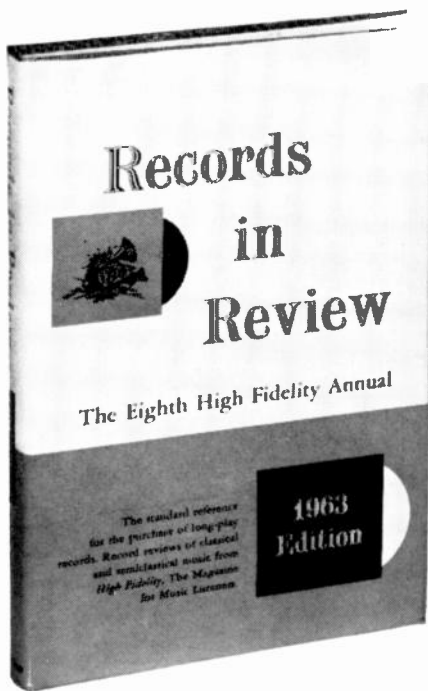

SAVES MONEY

RECORDS IN REVIEW—1963 edition brings you in one convenient book hundreds of reviews of stereo and mono records which appeared in High Fidelity Magazine in 1962—classical and semiclassical music exclusively.

This hardcover book will save you countless hours in your dealer's listening booth or ear-phone corner. And it will help you build a distinguished collection of music YOU enjoy, for it is the most complete and authoritative book of its kind—the standard reference work that gains in value as the years roll by. No duds on YOUR shelves.

Each reviewer stands high in his field—Nathan Broder, for example, reviews Bach and Mozart, Alfred Frankenstein the moderns . . . Paul Affelder covers the romantics, Robert C. Marsh specializes in Haydn and Beethoven . . . Conrad L. Osborne writes on opera recordings. Forthrightly, they discuss the composition, performance and fidelity. And they compare new discs with earlier ones. Over 500 pages.

You'll find the reviews organized alphabetically by composer for quick, easy reference—and in the case of composers frequently recorded, further subdivided by such categories as Chamber Music, Vocal Music, etc. You'll find, too, a special section on recitals and Miscellany.

RECORDS IN REVIEW—1963 Edition sells for \$5.95. Payment with order, please—but satisfaction guaranteed or your money back!

THE WYETH PRESS, S/64
A DIVISION OF HIGH FIDELITY
The Publishing House, Great Barrington, Mass.

Send me **RECORDS IN REVIEW—1963** Edition. I enclose payment in full—\$5.95 on a satisfaction guarantee or money-back basis.

Name _____

Address _____

City _____

State _____

Zip Code _____

Add 25c for postage on foreign orders.

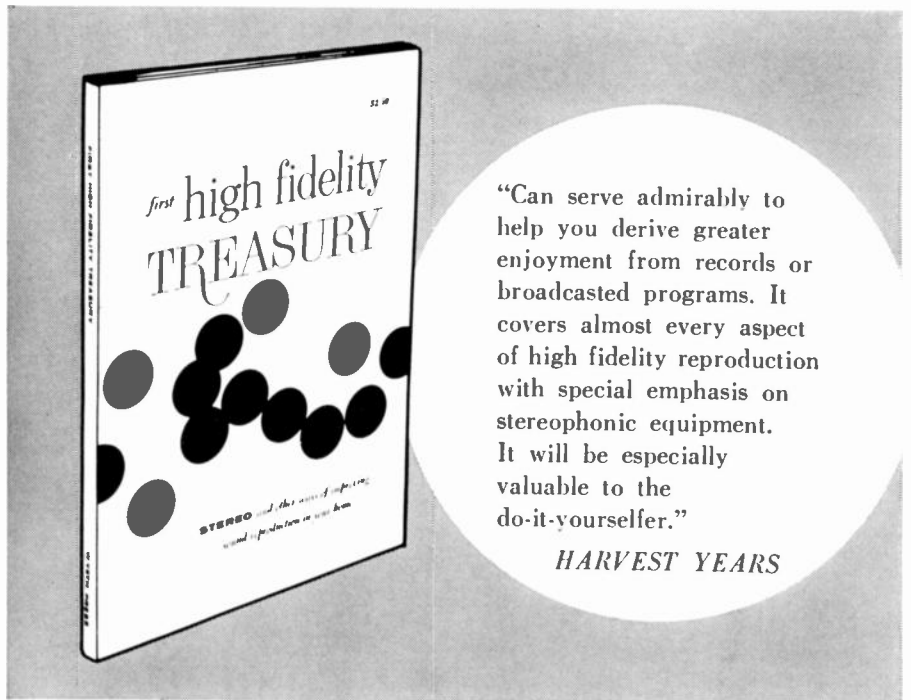

"Can serve admirably to help you derive greater enjoyment from records or broadcasted programs. It covers almost every aspect of high fidelity reproduction with special emphasis on stereophonic equipment. It will be especially valuable to the do-it-yourselfer."

HARVEST YEARS

For more than a decade, readers tell us, the most literate and informative writing on sound reproduction in the home has appeared in **HIGH FIDELITY**.

Now, for those who may have missed some of **HIGH FIDELITY**'s top audio articles (plus a few from sister publications) and for those who requested they be preserved in a book, we have selected 31 of them for inclusion in the **First High Fidelity Treasury**.

It's not a "layman's guide" to high fidelity, but it tells you just about everything you need to know for achieving good sound reproduction in your home.

Each piece was selected with these qualifications in mind: Will it help today's reader understand the principles of recording and reproduction, including stereo? Will it help the reader plan a new reproducing system to suit his needs at a price he is willing to pay? Will it help the reader get the most out of that system or his present system?

This new, illustrated paper back of 132 pages, measuring 6½ x 9½ inches, will stimulate and inform anyone who has ever thought about owning a "rig" of his own.

If audio perks up *your* interest—fill in and mail the coupon here—before we sell out. Payment with your order, please, to prevent book-keeping expense. But satisfaction guaranteed or your money back!

PARTIAL CONTENTS

The ABC's of Stereo
Stereo for the Man
Who Hates Stereo
Music and Stereophony
Stereo Recording Today
Cabinets for Components
The Music Wall
Improvements in
Cartridges and Arms
From One Speaker to Many
FM Stereo in the
Marketplace
Antennas for FM
FM for Motorists
Anyone Can be a
Sound Engineer
A Mike or Two Around
the House
High Fidelity Servicing
Noise—the Uninvited Guest
—and many more!

Wyeth Press, a division of S/64
High Fidelity Magazine
Great Barrington, Mass., 01230

Please send me a postpaid copy
of the **First High Fidelity Treasury**
for the \$2.50 enclosed.

Name _____

Address _____

The sound from this new Shure cartridge is awesome in its vitality & clarity

A NIGHT-AND-DAY DIFFERENCE

From the very first prototype, the sound from the new Shure Series M44 Stereo 15° Dynetic Cartridge was incredible. Even skeptical high fidelity critics have expressed unconcealed surprise at the audible increase in brilliance, clarity, transparency, presence, fullness and smoothness of this amazing new Shure development. A close analysis of its performance reveals startling differences in this cartridge—although not extraordinarily improved in the “usual” areas of frequency response (still a virtually flat 20-20,000 cps) or in compliance (25×10^{-6} cm/dyne)—rather it is in the distortion measurements where Shure engineers have achieved a highly significant and dramatic reduction of 75% to 90% in IM and harmonic distortion from even such admirably distortion-free cartridges as earlier versions of the Shure Stereo Dynetic. Further, cross-talk between channels has been effectively negated in the critical low frequency and mid ranges . . . providing superior channel separation throughout the audible spectrum.

SCRATCH-PROOF RETRACTILE STYLUS

And, as if that were not enough, the new 15° cartridge incorporates a totally efficient retractile stylus that momentarily retracts whenever excessive forces are applied to the tone arm. It cannot scratch records—even if bounced onto the record or dragged across the grooves.

PERFECTION IS A MATTER OF DEGREE

It has been known for some years that a difference between the angle used to cut stereo records and the angle of the stylus of the cartridge used to play them would result in an increase in IM and harmonic distortion audible on certain records. With widely different cutting angles employed by the record companies, the effective angle of the playback cartridge stylus had of necessity to be a compromise so as to provide the best possible results from records of all makes.

Recently, industry attention was focused on this problem by a series of technical articles ascribing the difference in effective vertical angles between the cutter stylus and the playback cartridge stylus as a cause of distortion and urging the adoption of a standard effective angle to which records would be cut.

Major record companies have now begun to use an effective cutting angle of 15° which is the proposed standard of the RIAA (Record Industry Association of America) and EIA (Electronic Industries Association.)

With the emergence of the single standard effective vertical tracking angle for cutting records, Shure engineers immediately began what seemed on the surface the seemingly simple but in actuality the arduous and exacting task of converting their formidable Stereo Dynetic cartridge to the 15° effective tracking angle. It couldn't be done. So Shure designed this radically new moving-magnet cartridge that will track at an effective angle of 15°. Graphically, this is the kind of cartridge geometry involved in the new Shure Series M44 15° Stereo Dynetic Cartridge:

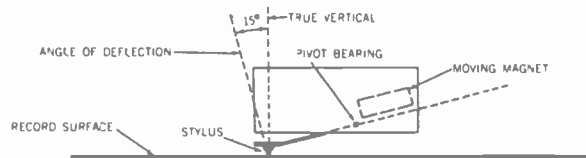

THE ULTIMATE TEST

You must hear this cartridge to appreciate the totality of the sound improvement. It will be instantly recognizable to the ear without the necessity for elaborate test instruments or A-B listening tests—although we assure you, instruments and A-B tests will more than substantiate our claims.

M44 SERIES SPECIFICATIONS

	M44-5	M44-7
Frequency Response:	20-20,000 cps	20-20,000 cps
Output Voltage at 1000 cps (Per Channel, at 5 cm/sec peak velocity):	6 millivolts	9 millivolts
Channel Separation (at 1000 cps):	Greater than 25 db	Greater than 25 db
Recommended Load Impedance:	47,000 Ohms	47,000 Ohms
Compliance:	25×10^{-6} cm/dyne	20×10^{-6} cm/dyne
Tracking Range:	$\frac{3}{4}$ to $1\frac{1}{2}$ Grams	$1\frac{1}{2}$ to 3 Grams
Inductance (Per Channel):	680 millihenries	680 millihenries
D.C. Resistance (Per Channel):	650 Ohms	650 Ohms
Stylus:	.0005" diamond	.0007" diamond
Stylus Replacement:	N44-5	N44-7
Cartridge Price, Net (Including stylus):	\$49.50	\$44.50
Replacement Stylus Price, Net:	\$21.75	\$16.75

Monophonic Styli:

Model N44-1—For monophonic LP records, with .001" diamond \$16.75 net
 Model N44-3—For 78 rpm records, with .0025" diamond \$14.25 net

SHURE

Stereo **15°** *Dynetic*®

SERIES M44 SCRATCH-PROOF CARTRIDGE WITH RETRACTILE STYLUS

the new standard
in distortion-free
hi-fi cartridges



LITERATURE: Shure Brothers, Inc. 222 Hartrey Avenue, Evanston, Illinois

Manufactured under U.S. Patents 3,055,988; 3,077,521 and 3,077,522. Other Patents Pending

CIRCLE 65 ON READER-SERVICE CARD

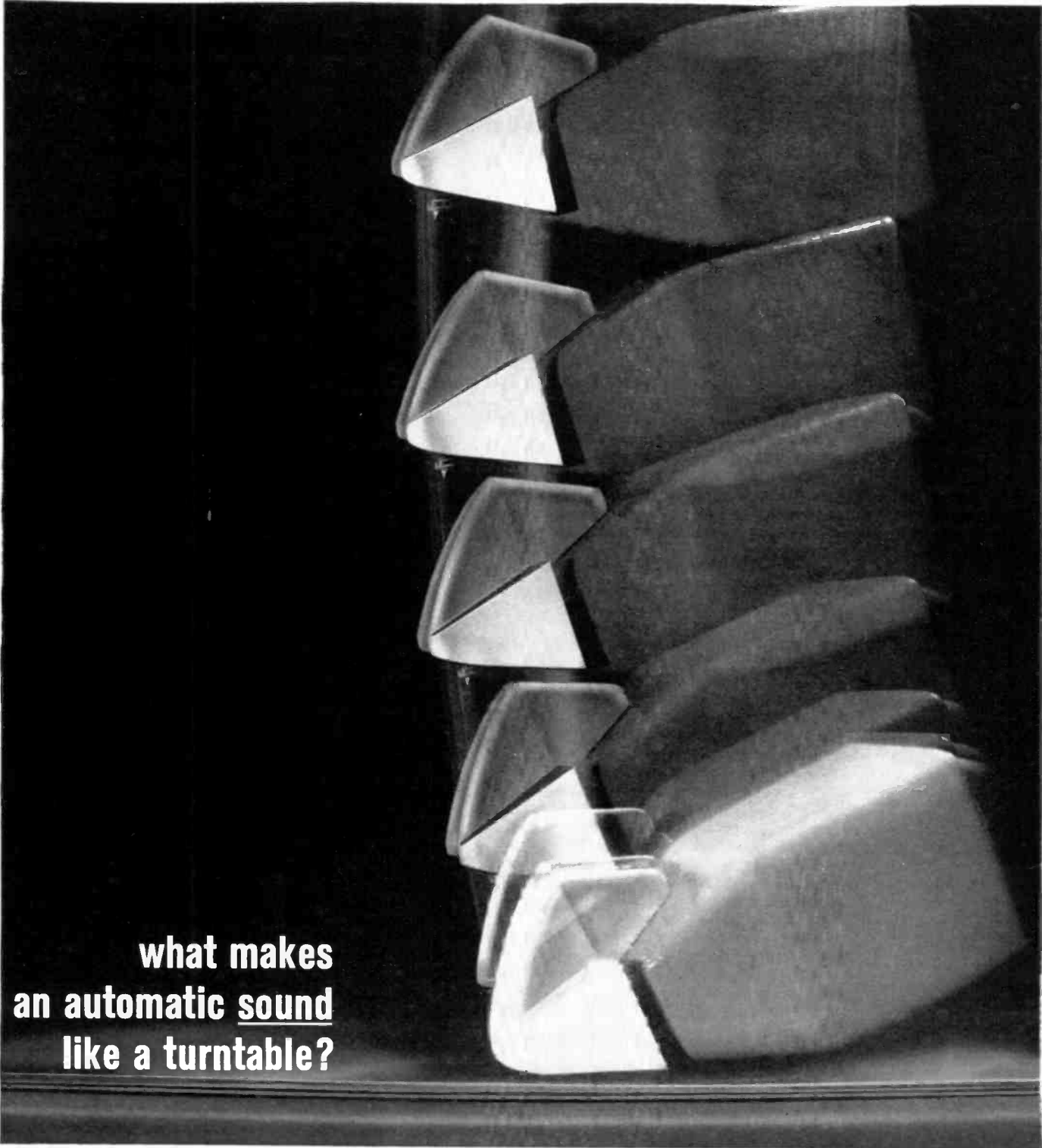

what makes
an automatic sound
like a turntable?

The U38!
expressly designed
for automatic
turntables

The new generation of automatic turntables tracking and tripping at lower and lower forces demands this new kind of cartridge. Demands a "floating stylus" that protects your diamond and record as it plays...demands complementary electrical characteristics which maximize the use of forward-looking circuitry whether vacuum tube or solid state. The U-38 meets these demands and makes your automatic **sound like** a turntable. With Pickering's famous plug-in replaceable stylus assembly you get a cartridge with a life-time of trouble free performance. Pickering and Company, Inc., Plainview, New York.

Pickering



U38 cartridge with
AT Stylus... 2-5 grams tracking force
ATG... 1-3 grams



Plug-in head assembly for
Garrard Type A and Model AT6

CIRCLE 43 ON READER-SERVICE CARD



Round Sound In Square Rooms

ON A RAINY Saturday morning not long ago, we sat in our study-workshop, glad to be snug and dry. We were wiring a new audio kit while listening to one stereo record after another, and our spirits were soothed by a sense of well-being, relaxation, accomplishment, and enjoyment. The morning passed. By the time we were summoned to an early afternoon dinner, we were at peace with the universe, and a kind of wisdom or insight had come that transcended all the nerve-end ragging and tension built up during the hectic week of work just past. Perhaps we had been anesthetized by a new formula consisting of wiring diagrams, hot solder, and the sound of Ormandy, Szell, and Leinsdorf; at all events, our feeling was, if this be the "stuff as dreams are made on," we'd be happy to stay that way.

Thinking back on this episode, it strikes us that on that day we had been enjoying stereo in both its technical and its aesthetic aspects in a way that until fairly recently would have been impossible. For one thing, we had been listening to stereo reproduction more or less "casually"—that is to say, without being seated in one prescribed spot before the speakers—a position once thought mandatory and often, in stereo's early days, lampooned or held to be a limitation on stereo's acceptance. Our workbench is located well off that imaginary center line from between the two speakers, yet the breadth, depth, and clarity of the stereo recordings were apparent throughout the room.

This freedom to enjoy stereo virtually anywhere in a room is a direct result of the increasing excellence of both the recordings and the equipment on which they are played. For instance, instead of the "Ping-pong" style so rampant in stereo's early days, modern microphone techniques and close attention to studio and hall acoustics have brought about a natural sound-spread, so that the breadth and depth of a live performance are faithfully preserved. The aim of the conscientious recording director no longer is to squirt sound at the listener from two discrete sources, but rather to re-create the natural "air and space" that surrounded the original performance.

Happily, the newest high fidelity components for playing stereo serve the musical ends of such re-

cordings well. Today's cartridges, with their higher compliances, can pick out subtle musical nuances and the "air and space" around recorded sounds more accurately than in the past. Amplifiers, with versatile control features and lower distortion, permit the listener to tailor the volume and tonal character of each channel to suit his own tastes and environment. Speakers in general are more linear in response and—very important—are much less directive than their ancestors in the propagation of the midrange and treble tones; they thus further enhance the spreading-out characteristic of stereo to permit its enjoyment from many spots in the room, rather than from one or two.

Again recalling our work-and-listening session, it strikes us that the experience demonstrated in yet another way the meaning of stereo. Its pursuit, through the use of high fidelity components, combines both aesthetic and technical elements. The proportion of interest in each varies with the individual, of course. Nonetheless, the listener who is essentially music-oriented and comes to stereo because of its revelation of musical values usually becomes absorbed in the "how" as well as the "what" of sound reproduction. We are reminded of the man who buys a high-performance auto, insisting that "I don't care what's under the hood, as long as it runs," only to become fascinated a short time later with details of transmission and horsepower. Similarly, at the opposite end of the "stereo-techniques interest scale," a mechanically minded person—with no strong musical background—may be attracted to stereo because of its sheer technical interest, only to find eventually that the music his system reproduces so clearly is an end in itself, with its own rewarding discoveries to be made. Stereo thus offers to everyone an engrossing field of interest in which decibels are balanced with triads, response curves with diminished sevenths, tone arms with batons.

The world of stereo is teeming with exciting disclosures—available to the new entrant who comes seeking them as well as to the more seasoned fideliarian. It is the aim of STEREO, 1964 EDITION to serve as a guide in this search for treasure.

Norman Eisenberg



BY BOB MARX

Pickup, Arm, and Platter

Notes on the latest playback equipment

WHEN MOST people think of “music in the home,” they think first of records—the many excellent FM stereo broadcasts and the splendid quality of the ever-lengthening listings of prerecorded tapes notwithstanding. And so the noticeable improvement of discs in the past two years, through small changes in recording and processing, is of very general interest. Along with this improvement there has been apparent a growing excellence in disc-playback components, to be attributed to the solution of problems in small details of equipment design.

While this general upgrading means there is more top quality equipment available than ever before, it also implies that there are more details to be taken into account by the prospective buyer. For instance, the wider the frequency range of the rest of his equipment (amplifier and speakers), the more

important it is for him to look for a turntable that has the least mechanical noise—not only when it is placed on careful display in a showroom, but also under the conditions that will apply in his own living room. Again, the brighter or duller the sound of a speaker system, the more important the choice of a complementary cartridge—to avoid a final sonic “brilliance” or “mellowness” that has nothing to do with high fidelity.

Not all of the considerations to be outlined in this article may apply to everyone’s requirements for record playing. But the explanation to follow of some details in connection with the performance of today’s disc equipment should help to get individual needs into focus.

● Turntables and Changers

Like other components, record-playing equipment ideally is expected to make no alteration in the sound engraved on a record: it must reproduce the original

Bob Marx is a free lance who spends as much time amid his stereo components as at his typewriter.

sound with no addition or subtraction of its own. Today's equipment comes startlingly close to that ideal. But there is another requirement for disc equipment: careful handling of the records. No one buys records with the idea of wearing them out and replacing them over a reasonable period; hopefully, they are to last forever, with all or most of their sonic virtues intact. This may be impossible, but it is a major objective in the design of everything down to stylus tips.

One very apparent change in equipment, with regard to the life expectancy of records, has been the development of a new breed of record changer—the “automatic turntable.” A radical departure from earlier models, such units as the Garrard Type A, the Miracord Studio, and the Dual 1009 have most of the features once considered impossible to design into a record-changing apparatus: they operate at low tracking forces, handle records gently, and employ tone arms relatively free to follow the inward spiral of record grooves at low tracking forces.

This new type of record-changing equipment should be appreciated by the listener who prefers the convenience of automatic operation, feeling that the playing of records should not be a chore, but a relaxing way to spend an evening. He may not insist that automatic changing is a necessity for LPs, but he does consider it another of life's little amenities. This point of view, and the consequent selection of one of today's automatic turntables, need no defense. On the other hand, the all-out perfectionist, willing to handle discs carefully one at a time, still prefers the single-play turntable and arm assembly.

Those who choose to play records automatically should note that some units are more definitely *changers* than others. Garrard's Model AT-6, for instance, uses an overarm changing mechanism that may not provide the utmost in the very gentle type of handling that is a feature of the “pusher” device on the Garrard Type A; but it does allow the intermixing of records of various sizes, and it is built to withstand the onslaughts of a household's teen-age contingent. Once an automatic player of some kind is decided on, matters like these may be important considerations.

For the best combination of automatic operation and transcription turntable performance, not only are there units like the Garrard A, Miracord, and Dual to choose from, but also a luxury automatic—the Lincoln—from Fisher which plays both sides of a record in sequence automatically. This unit costs \$250. Alternately, for this amount, there is the new changer from Thorens which is literally a transcription turntable (the TD-124) made automatic; it takes a single record from a stack off to one side of the turntable, handles it by the rim, and lowers and raises it into and out of playing position. The man who may find this process especially desirable—and worth the price—is the collector of vintage 78s, who unquestionably needs a record changer but is unwilling to have his easily breakable Nellie Melba discs dropped, either by a small boy or a record changer.

And inasmuch as the new Thorens runs at all four speeds and has a fine transcription-type tone arm, it may well appeal to any collector who can afford it.

Whatever the type, any turntable has one basic function—to revolve a disc at a steady speed with a minimum of mechanical vibration that may cause noise to obtrude on music. Yet, the mechanics of converting the operation of an electric motor into smooth, steady rotation of a record proves to be surprisingly complex.

For high fidelity sound, a turntable—to start with—must have the least possible long-term speed drift, short-term speed variation (wow), and very-short-term eccentricities (flutter). The first of these requirements presents fewer design problems in the turntable than in the changer, inasmuch as a single-play turntable works under a relatively constant load (one record instead of the one-to-ten of a changer). Since the turntable's load does vary a bit with various tracking forces, and also with the movement of an arm from the outside to the inside of the disc, painstaking attention to design has been necessary to make the drive mechanism independent of load variations over a reasonable range, as it now generally is.

The problems of wow and flutter, however, are harder to combat—in both single-play and automatic units. Both hinge on the fact that an electric motor itself is not an inherently smooth rotator but an alternating-current device that is turned by a series of power “kicks” supplied by electromagnetic poles in its construction. The more poles, the more power kicks a motor receives during each revolution, and the smoother its basic rotation for a given speed. But basic rotation may have little or nothing to do with the motor's performance under a load—or under the normal and slight variations that exist in power-line voltages. Too, no motor can turn smoothly, if at all, at the same slow speed at which the turntable itself—the “platter”—is meant to revolve. Obviously, what is needed is not only a motor that can be relied on to turn smoothly under its normal working conditions, but also an effective way of reducing the relatively high speed of a motor to the 33⅓ rpm of the standard record.

The exact methods used differ from model to model; it is fruitless to judge one unit in the light of the techniques employed in another. Of today's top-quality turntables, for instance, one (the Thorens TD-124) uses a fairly high-speed, four-pole motor, while another (the Acoustic Research) has a lower-speed, eighteen-pole type. And one of the traditional ways of smoothing out the series of power kicks supplied by a motor—the use of a very heavy turntable platter whose mass and momentum tend to keep it going smoothly at all times by “flywheel” effect—has been challenged successfully by turntables such as the Weathers, where very light platters are coupled to smooth-running lightweight motors of the kind used for electric clocks. No technique for rotating a turntable has proved better than all others. What remains most important is painstaking care in manu-

Tiny Stanton 500AT, with very low mass, is designed for use in the new breed of automatic turntables.



Fairchild 412 model is a single-speed manual turntable available as a kit.

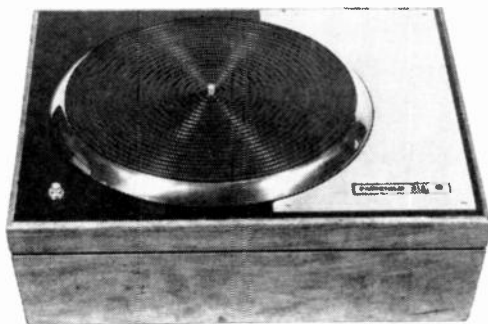

Bogen B51 features continuously variable speed and comes with integral tone arm.



Empire's three-speed turntable, and Dyna-Lift tone arm, available together or separately.

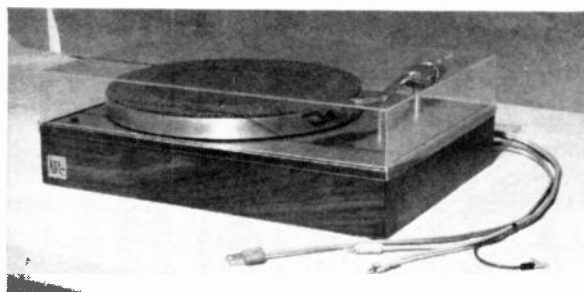

Acoustic Research's turntable and arm combination comes in single- or dual-speed models.

facture and, beyond that, attention to all the small details of correct installation.

The extreme care for detail applied to avoiding wow and flutter in a good turntable seems, however, almost a minor matter in comparison to the attention given to reducing mechanical vibration (rumble) in the entire record-playing assembly. Inasmuch as stereo cartridges respond to stylus motion in both the lateral and vertical planes, any mechanical vibration that makes its way to a stylus tip will be heard through the speakers. This problem is anything but academic. The effects of low-frequency rumble vary from a slightly annoying background noise when records are played all the way to a potent, ominous sound that blots out much of the definition in the music and/or actually modulates higher frequencies to cause an especially unpleasant form of distortion.

Rumble has three generally significant sources: vibration of the motor itself (particularly of a high-speed motor), the construction and functioning of the drive-linkage from motor to platter, and the minuscule amount of vibration that may make its way—not from motor to turntable—but from motor to tone arm through the turntable's mounting board. The worst form of rumble occurs when both a turntable platter and a tone arm receive significant amounts—but different kinds—of vibration from various sources. As with wow and flutter, there is no single answer to the problem of rumble, but an almost incredible lot of attention to both the small details of basic design and the tolerances used in manufacture is necessary to solve it. The Thorens turntables, for instance, use a complicated, three-stage drive system employing both a compliant belt and idler wheel to supply effective filtering of the motor's basic vibration, which is necessarily extremely low to justify the entire drive technique.

Ingenuity of the kind that evokes "Why didn't I think of that!" expressions has always characterized good turntable design, and it may take any of several forms. Belt-drive (used in various ways in such units as the Gray, Rek-O-Kut, AR, Empire, Fairchild, and Thorens) is one example: a designer may use any of several approaches to solve the many problems of detail inherent in this very effective



Automatic player by Thorens combines TD-124 turntable, BTD-12S arm, and novel change mechanism.

way of moving a turntable. Again, it is not necessary or helpful for the buyer to think that the solutions which are a part of one approach should be answers required for another: what counts is whether or not rumble can be heard.

In making a pragmatic judgment of whether a turntable is quiet, the question of how a unit behaves under less than ideal conditions is particularly important. In the average living room, for instance, the sound from a loudspeaker may find its way to a turntable, and it does not have to be of an abnormally low frequency or high amplitude to cause unwanted vibration either of the platter or tone arm. One solution to this problem is embodied in the AR turntable, which employs a platter-and-tone arm assembly that is not only shock-mounted from its motor board but also designed to hold arm and platter in a rigid relationship. If excited by outside disturbances, both turntable and arm tend to move in the same direction, to the same degree, thus substantially overcoming the problem of *relative* vibration of the arm and platter. An additional advantage of this combined shock-mounting is that the tone arm, which makes no contact with the motor board, will receive not even minute amounts of vibration directly from the unit's dual motors. In the Grado turntable (which also employs a new dual-flywheel form of drive system), the problem is attacked by shock-mounting the motors themselves, shock-mounting the arm on the motor board, and providing an over-all assembly whose heaviness resists effects of external disturbances. Again, in the new Stanton "Gyropoise," the platter is suspended magnetically to eliminate vertical noise transmission from the motor.

For the man who likes to deal with facts and figures, the situation with regard to turntables is not nearly as clear-cut as that, say, for amplifiers. Rumble, for instance, is expressed in specifications as a number of decibels lower than a given recording level. But the frequency at which the rumble occurs, determined among other things by the basic rpm of the unit's motor, is seldom stated—and yet is vitally important. A given amount of rumble is less objectionable (if suitably low to begin with) at 10 cps



Garrard AT6 offers four speeds, manual or automatic play, and intermix of different size discs.



Lafayette/Weber is new low-cost, four-speed automatic or manual player with intermix feature.



Rek-O-Kut model R34 is two-speed turntable supplied with integral tone arm and mounting base.

New from Shure, right, is a lightweight head for the SME arm, a plate for installing the arm on a Thorens TD-124 turntable, and the M44-7 pickup.

Wooden tone arm has a hinged head to reduce pickup's tracking error.



Weathers Model 66 turntable, a single-speed manual, is shown here with same company's tone arm.

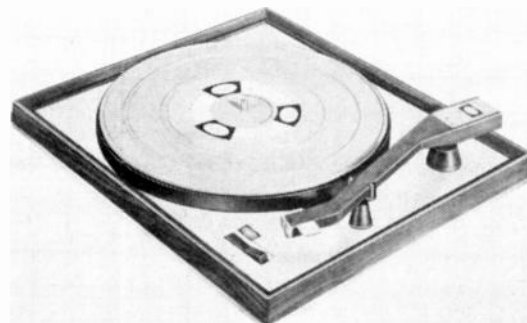

than at 60 cps. A "raw" or "unweighted" rumble figure gives no indication of the effective rumble that may, on the one hand, be completely inaudible, or on the other, become enhanced by acoustic or mechanical feedback in certain installations. The existing NAB standard for measuring rumble is woefully inadequate in this regard and, it is to be hoped, will be bettered soon. In any case, rather than a prolonged study of specifications, a careful listening session (at a time when a showroom itself is relatively quiet) to a turntable that is mounted in a less-than-ideal placement and playing through a wide-range stereo amplifier and speakers will be a reliable determinant of mechanical noise. Similarly, speed variations of all types should be judged by such expedients as trying the heaviest record and heaviest pressure (including both the tracking force of an arm and the weight of a cleaning device such as the Dust Bug or Dustat) that the turntable is likely to encounter in the living room.

Those looking for amenities as well as good performance will find turntables that are tailored for a variety of individual requirements. For the extremely pitch-sensitive listener who may want to do something about an off-pitch record, or match a recorded instrument to a live one, or simply compensate for changes in power-line voltage, Thorens offers a vernier control for fine speed adjustment. So do the Fairchild 440 and (through the addition of an optional electronic speed control) the Fairchild 412. Both of the latter, incidentally, are now available as kits. For the listener who would like to sneak in just a bit of automation, Bogen and Thorens offer turn-

table-arm combinations fitted with devices that raise and lower the tone arm (together with automatic shutoff at the end of a record). Rek-O-Kut's optional "Auto-raise" device provides for push-button automation of a professional turntable; and Empire offers a clip-on magnetic device that raises its tone arm off the record after playing. With regard to playing speeds, there are single-, dual-, three-, and four-speed models that enable the buyer to choose just what he needs.

The Tone Arm—and Integration

The arm that carries a cartridge across a record (the "tone arm") has never been taken for granted either by designers or by critical listeners. Its performance depends on small, but readily discernible, details. Any arm, for instance, must have low enough pivot friction to move easily across a record. In doing so, it must not "favor" either wall of a stereo record groove because of drag from its lead wires, bad vertical alignment toward the groove, or changes in its delicate mass-vs.-balance distribution as it moves toward the center of the record. Too, the arm must have a minimum of tracking error (lateral misalignment with a record groove) as it swings in a fairly wide arc across the record. One familiar technique for achieving this objective is having the arm curved along its length. And as long as records are not perfect, the pivot-position and the method used to balance the arm should allow it to track warped records without audible wow (which can result from the speed-up and slow-down of an arm following

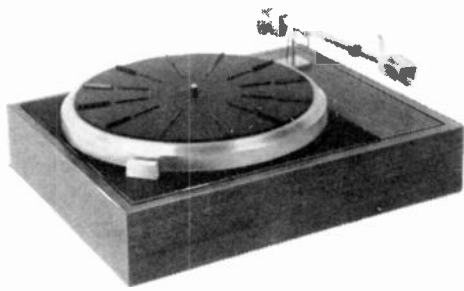

Stanton Gyropoise turntable features unique air and magnetic suspension; is shown here with same company's Unipoise arm and Fluxvalve cartridge.



Knight KN-990 is four-speed automatic or manual player that intermixes different size records.



Dual 1009 is four-speed manual or automatic player with vernier adjustment to set the exact speed.

a warp). If all of these objectives are realized, the arm will not only behave close to the theoretical ideal but will also track at the lowest forces of which a cartridge is capable.

A tone arm that is sold for use with any turntable and any cartridge should also be adjustable to various requirements. For optimum tracking of a given arm and cartridge, for instance, it is necessary to set the overhang (the amount by which a stylus is calculated to project past the center spindle of the turntable) correctly. This adjustment is necessitated by the varying distances between the mounting centers and stylus tips of various cartridges; thus it must be possible to adjust either the arm itself or the position of the cartridge in the arm's shell for the correct amount of overhang. The varying weight of cartridges also calls for a technique (there are several) to keep arm and cartridge in balance, as well as a foolproof way to set and maintain the required tracking force. Another adjustment, which may not be necessary for integrated turntable-arm combinations, regulates the height of the vertical pivot, which must provide the proper angle of contact with turntable platters of varying thicknesses.

The tone arms offered by component manufacturers meet the above requirements easily—and, of course, with apparently dissimilar techniques. For a premium price, the SME arm (now marketed by Shure) provides an incredibly wide range of adjustments to meet all likely operating conditions. And for those arms that do not have built-in cuing devices to help cope with the sometimes delicate job of handling at low tracking forces, suitable low-cost



Garrard Autoslim/P is a compact automatic or manual player; has four speeds and intermix feature.



Gray Model PK-33 is a single-speed manual turntable in kit form; shown here with Gray tone arm.

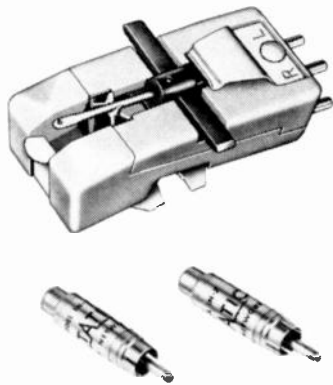

New ceramic cartridge from Sonotone, the "Sono-Flex," features very flexible stylus assembly; networks equalize signal for magnetic inputs.

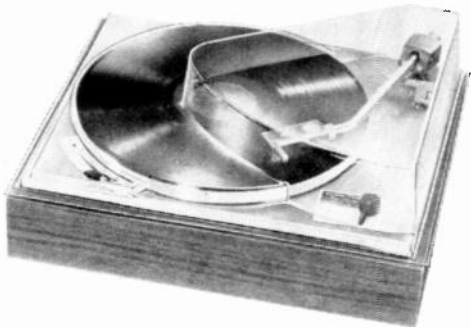

Bogen B61, shown with dust guard, has continuously variable speed control, automatic cueing.



Garrard Type A is four-speed manual or automatic player with pusher-platform for changing records.



Danish-made B. & O. Stereodyne, in 16-inch or 12-inch models, is distributed in U.S.A. by Dynaco.

accessories are readily available and easy to install.

One further aspect of good tone arm design will not be feasible for all arms until integration of arm and cartridge—or at least an agreement between manufacturers of those two components—takes place. Any arm should be as light as practicable, especially at its head assembly. The most significant reason is that a light arm, if disturbed by outside forces, will neither leave the groove as easily as a heavy arm nor travel as far in an unwanted direction once it is disturbed. The rub here is that the weight of some cartridges obviates any designer's attempt to design for lowest mass in a tone arm shell or for lowest mass in the arm over-all (including its counterweight). For the sake both of listeners' nerves and the protection of high-compliance cartridges (which themselves will be damaged by groove-jumping long before they are likely to scratch a groove), the low-mass arm should become very much more common.

In evaluating arms in a showroom—and even, to a large degree, in a professional test—a significant amount of insight can be gained by some simple observations. An arm should track without audible strain at the stylus force specified for a given cartridge. It should not jump grooves easily when adjusted for the tracking force recommended for a given cartridge. It should "handle" comfortably and easily when you are cueing up or lifting it off the record. An arm that satisfies on these three counts initially is unlikely later to prove deficient for more esoteric reasons.

Cartridges

As compared to tone arms and turntables, the unique thing about a cartridge is that it is *supposed* to make sound—the kind of sound that faithfully reproduces what is engraved on the disc. By all standards, most of today's cartridges are incredibly good. If you choose any of several that now cost thirty dollars or more, you are almost certain to come up with one that approaches the ideals of over-all performance very closely. This is not to say, however, that similarly priced pickups of identical excellence will sound alike. They won't. In the region of 10,000 cps or so, virtually all of them show either a slight peak or dip in response that seems to be related to basic design differences (between moving-magnet, moving-coil, and variable-reluctance types, for instance) rather than a basic flaw of one kind or another. These slight irregularities lend each cartridge a distinct "flavor" of its own. For this reason, the important consideration is to choose a cartridge whose particular peak or dip does not combine with a similar one in a speaker to provide really exaggerated response.

The technical ideals of cartridge performance—smooth and wide-range sound, low stylus force for preservation of records—seem to hinge on two related factors. Low moving mass (in simplest terms, this refers to *all* the weight reflected back to a stylus tip as it moves) generally is more conducive to wide,

smooth response. For one thing, low mass means that the mechanical resonance of a stylus assembly can be designed to occur above the audible range of frequencies, thus eliminating the peaks that give sound a distinctly unpleasant coloration. And it is also low mass that allows a stylus to be "hinged" loosely enough to a cartridge to follow the undulations of record grooves with the greatest of ease and with the lightest of downward forces. Because the latter considerations are easiest to see, it is the freedom of movement of today's styli (high compliance) that has been publicized most, but the less obvious reduction of dynamic mass probably deserves as much, if not more, credit for the clean sound of today's stereo pickups.

With regard to stereo, the matter of channel separation is also vitally important. The news here is that the moving-coil cartridge, far harder to adapt to stereo than the moving-magnet type, is now fully competitive, thanks mainly to the design of very light coil assemblies that usually rely on outside help to develop sufficient signal strength. The Ortofon SPU, for instance, uses tiny transformers for high output with minimum effort from stylus-and-coils; the Fairchild F-7 has a transistorized pre-preamplifier for the same purpose. Still eschewing outside aid are models like the Grado and the Neat, both of which rely on new construction techniques for achieving respectable output from minuscule coils.

Among the moving-magnet cartridges, the ADC, which popularized the term "high compliance" once and for all, is now available in three different series, with varying degrees of compliance to suit all tone arms. Other recent models include the Stanton 481, the Empire 880, the Shure M-44, the Fairchild SM-2, and the ELAC 322. All of these cartridges allow the listener to replace a stylus quickly and easily on his own, an amenity offered in the moving-coil category only by the Neat.

Although somewhat harder to manufacture than the moving-magnet pickup, the variable-reluctance cartridge is also capable of excellent performance. Current models include Dynaco's Stereodyne and the GE VR-1000, both of which offer easy stylus replacement. The English Decca, now imported by Lectronics of Philadelphia, is currently available only as part of an integrated arm-cartridge combination.

The ceramic cartridge, long considered unable to compete in the top-performance category, currently offers its strongest challenge to the magnetic pickup's popularity. Among the new breed of ceramics are such designs as the Astatic 45 series, the Decca Deram, the Sonotone Velocitone Mark III, and the Weathers LDM. In addition to the ceramic's traditional strong point—freedom from induced hum—these new models offer wide-range sound, low tracking forces, and the gentle treatment of records once considered attainable only in magnetic pickups. All but Decca's Deram are intended for connection to an amplifier's standard magnetic inputs.

The general ease of stylus replacement in most cartridges has led to a new development. It has been



BSR changer was designed in U.S.A. and built in Great Britain; has four speeds, intermix feature.



Benjamin's Miracord Studio is automatic or manual player; four speeds, push-button controls.



Heathkit AD-102 is four-speed manual or automatic player; turntable pauses during the change cycle.



Stereomixer-3 is new four-speed player from Radio Shack; comes with pickup; has intermix feature.

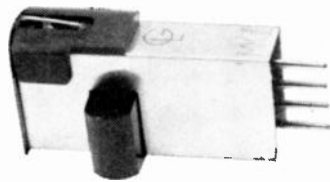

Grado's new Mark III cartridge, above, and the MK-1 turntable, shown with the Grado arm and this company's Dustat for keeping discs clean.



generally agreed that the 0.7-mil stylus provides optimum mono/stereo compatibility and enables the same pickup to play both stereo and mono discs. However, recent thought has it that the best performance, particularly with regard to high frequency and transient response, from stereo record grooves requires a 0.5-mil stylus. For this reason, more and more companies now offer both 0.7-mil and 0.5-mil styli that can be quickly interchanged in the same cartridge to play mono and stereo discs respectively; they also provide 1-mil stylus assemblies designed specifically for older mono LPs. It would seem sensible, then, for the quality-minded listener to keep two styli around the house, since neither the added cost (\$10 to \$15) nor the time required to change a stylus (a few seconds) seems prohibitive for the gain involved in the adaptability of the same cartridge for best performance with records of every type.

It is sometimes possible to predict the tonal "flavor" of a cartridge by closely examining its response chart, but the best way to determine how this flavor will blend with the sound of the rest of your equipment is to listen to a pickup with the speakers you own or intend to buy. As mentioned earlier, it is wise to choose a cartridge whose sonic dips and peaks do not exaggerate those of your speakers. Beyond this sort of strategy, and particularly for the ultimate purpose of achieving the best sound under your own listening conditions, it may be helpful to think about moving the tone controls—slightly but significantly—from their sacrosanct "flat" settings. The treble controls on today's good amplifiers, for instance, operate at or around the 10,000-cps region where cartridges tend to exhibit their irregularities; using them to "iron out" a cartridge's response may introduce some theoretically undesirable phase-shift, but its effect is not likely to be as noticeable as the desirable over-all gain in sonic balance.

In the Living Room

Aside from the possible manipulation of tone controls, living happily with the record-playing equipment you choose depends mainly on recognizing and using the adjustments built into it. The overhang of a tone arm and cartridge is audibly important,

and should be attended to. So, with equal care, should the manufacturer's instructions for balancing an arm and setting the tracking force. Most recent high quality arms have built-in stylus force gauges that are accurate, but even so, a separate stylus gauge is a helpful gadget to keep on hand.

With some disc players, acoustic or mechanical feedback in your listening room may prove to be anything from a minor annoyance (a source of apparent rumble) to a major problem (turning volume control up beyond a very low point may bring a howl of protest from your speakers). The most obvious remedy, an attempt to isolate the turntable by placing it on a pad of foam rubber, may help—or it may serve only to make the unit oscillate even more freely. When, as is often the case, the sound from a speaker causes not only furniture but also the floors and walls to transmit vibrations, the solution is sometimes the liberal use of foam rubber under the *speakers*—particularly when they are floor-mounted. In the case of a wall-mounted furniture arrangement, it is often mandatory to remove either the turntable or the speakers from the shelf unit. Whether or not the cure of feedback requires ingenuity, it is helpful to recognize the problem even when its only symptom is a slightly muddy sound from your stereo system; eliminate the problem, and you suddenly find yourself with a music system that sounds brand-new.

With everything shipshape, your only remaining decision is just how important your records are to you—whether they are "periodicals" or "permanent documents." If the latter, it will pay to invest in a good record-cleaning device, a host of which are available. For instance, the popular "Dust Bug" has been joined by a new gadget from the same inventor, the "Preener," which some may find easier to use. Also available are the "Parastat," an elaborate device meant both to preserve and restore records, and other new entries such as the Grado "Dustat" and the ADC "Hush-Brush." Less elaborate, but quite effective, are such low-cost cleaning kits as the Lektrostat. One or another of these should be used by anyone who wants the longest life for his discs.

Once the record is on your turntable, however, you can relax and enjoy the kind of sound that today's equipment is capable of reproducing.

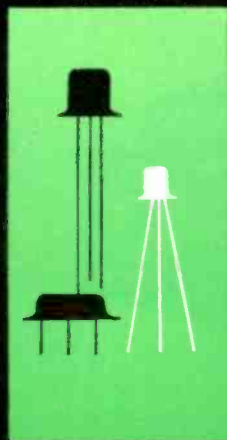

AMPLIFIERS

TUBES OR TRANSISTORS

EITHER TYPE CAN DELIVER FINE PERFORMANCE FOR STEREO.

BY MARTIN L. BORISH

FOR THE FIRST TIME in high fidelity history, the prospective buyer of an amplifier faces a choice between two major types of equipment. The bulk of available models are, of course, "conventional" amplifiers, with their familiar rows of tubes and huge output transformers. Alongside these in increasing numbers are the "solid-state" amplifiers, in which such products of the space age as tiny transistors and other semiconductors replace tubes; large finned aluminum sections known as "heat sinks" hold the transistors; printed circuit boards predominate (these are found in some tube equipment also); and transformers are smaller (or absent entirely in the audio stages). Since at present and probably for some years to come, good high fidelity stereo reproduction can be secured from both types of amplifiers, the choice

is not between "tubes and transistors" but rather of power rating and control features needed in either category of amplifier.

Whether it uses tubes or transistors, an amplifier has the same basic job: that of increasing the strength of an electrical signal initially (preamplification), and then converting it to watts of power sufficient to drive a loudspeaker (power amplification). Some signals—those from a phono cartridge or tape playback head—also require, in the early stages, a form of frequency contouring (equalization) to compensate for a previous derangement used in the recording process. The "preamplifier-equalizer"

Martin L. Borish owns three complete stereo systems, one on each floor of his suburban home.



Altec's 351B, solid-state 50-watt basic.



Dyna SCA-35, integrated dual 17.5-watt.

thus comprises one main section of an amplifier; the "power" or "basic amplifier" is the other. These two sections may be made as separate units, or they may be combined on the same chassis, known by such names as a complete, or integrated, or combination amplifier. A stereo amplifier, of course, requires two identical sound channels and so it has two pre-amplifier-equalizers and two power amplifiers. Again, these may be offered as separate units (a stereo pre-amp-control and a stereo basic amplifier) or combined on one chassis (a stereo integrated amplifier). A variation on this basic idea might be a stereo preamplifier-control feeding two monophonic basic amplifiers.

A preamplifier, which magnifies some signals—such as those from a magnetic phono pickup—as much as a thousand times their original strength, must be carefully designed so that it produces no extraneous noise which could be amplified right along with the signal. Some of the methods used in tube preamps to minimize the introduction of noise are the use of direct current, rather than alternating current, to heat the filaments; shock-mounting the tubes; careful filtering; and other circuitry measures. With transistors, which have no filaments to be heated, the problems of warm-up voltage and warm-up time are neatly sidestepped. Too, transistors are fairly immune to vibrations and do not require the kind of shock-mounting that tubes need. Transistors, however, can generate noises of their own, often of greater magnitude than tube noise. It is only fairly recently that manufacturers have made available low-noise transistors in suitable types and numbers for practical use in the critical and demanding circuits of high fidelity preamplifiers, and even more

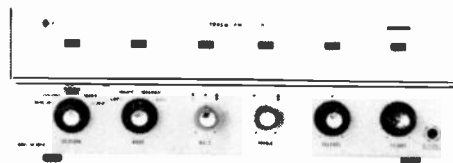

Kenwood KW-200A, rated at 20 watts per channel.



McIntosh 275, dual 75-watt-per-channel basic.

recently, the types and quantities of transistors for use in the output stages of hefty power amplifiers. More of this in a while; for now, back to the preamp.

A preamplifier offers a variety of tone-shaping features. Some controls, such as those for bass and treble, are optional with the user. One tone-shaping method which is a basic requirement for the accurate reproduction of phonograph records is the equalization circuit, an integral part of all preamplifiers.

Recording engineers deliberately reduce the bass and boost the treble when cutting master records. Reducing the low frequencies makes it possible to have a narrower groove and thus a path on the record that can be more easily followed by the playback stylus. Increasing the high frequencies during record-cutting insures that the desired sounds in this region will not be overwhelmed by the inevitable surface noise of the record. This very necessary frequency gimmicking is known as the recording curve. In playback, the preamplifier restores the sound to normal by rolling off the highs and boosting the lows by amounts that are reciprocal to the recording curve. The resultant signal then is, or should be, uniform or "flat" across the audible range. Since 1955, all records (stereo and mono) made in this country have been processed by an equalization curve standardized by the Record Industry Association of America and known as the RIAA curve. Most listeners will find that the RIAA playback curve is the only one needed in a preamp, although fussy owners of large collections of older records may want a preamp that includes alternate curves as well. Such preamps are available, and naturally cost more.

Pre-recorded tape is made with a somewhat dif-

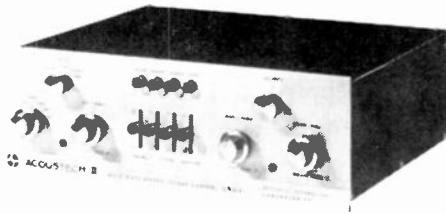

Aconstech II is solid-state preamp-control.

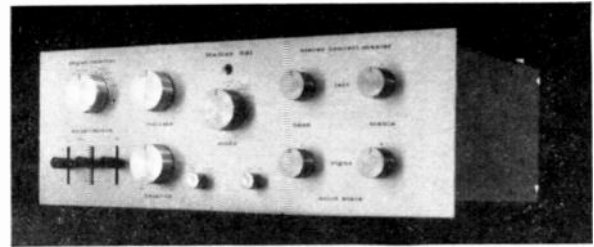

Hadley 621 is solid-state preamp-control.



Aconstech I is solid-state dual 40-watt basic.

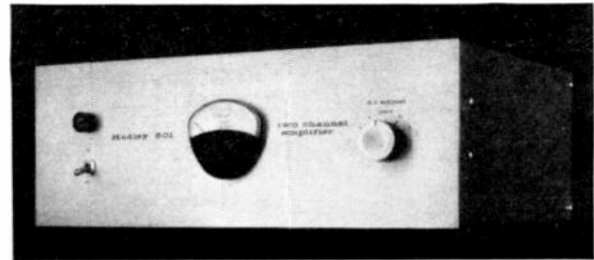

Hadley 601 is tube-type dual 40-watt basic.

ferent amount of equalization, standardized by the National Association of Broadcasters and known as the NAB curve. Correct playback equalization for this curve is provided in the playback circuits of tape recorders. It also is found in many preamplifiers and combination amplifiers, a useful feature for those who own a tape playback deck that has no electronic circuits of its own and thus must be connected to an external amplifier for playback.

FM broadcasts also are equalized at the station to compensate for the electrical needs of the broadcast waves. In reception, this equalization is handled by a "deemphasis" network built into an FM tuner. The tuner also "preamplifies" the audio signal, strengthening it to a degree that is about the same as a phono signal after it has been preamplified. For this reason, the signal from a tuner is known as a "high level" signal; those from phono cartridges and tape heads, as "low level" signals. Each must be connected to an appropriate input jack on the preamp (or combination amplifier, as the case may be). Then, the selector knob on the front permits a choice of the signal desired.

Once past the preamp, the signal is fed to the power amplifier which converts it to the wattage needed to drive a loudspeaker. In a tube amplifier, this job is done by a group of special tubes, usually larger and hotter than any others. Beyond power conversion, however, is the matter of power transfer—from the amplifier to the speaker. Electrical energy is transferred most efficiently, and with the least loss of signal, when the load impedance (the speaker) is greater—or at least equal to—the source impedance (the amplifier). It so happens that the impedance of output tubes generally is more than 3,000 ohms,

while the impedance of a speaker is nominally 4, 8, or 16 ohms. To match these widely different impedances and effect an efficient transfer of power to the speaker, a final device is required in the tube amplifier—the output transformer. The transformer not only lowers the impedance of the output tube circuit, but it also provides for specific amounts of impedance (4, 8, or 16 ohms) by having its secondary winding tapped at suitable points. Thus, an 8-ohm speaker may be connected to the 8-ohm tap, and so on, for optimum transfer of power and best possible sound.

Actually, the performance of a tube amplifier is determined largely by the quality of its output transformer. For instance, if it is poorly designed with respect to the amplifier's circuitry, it can cause instability and distortion in the amplifier's high-frequency response. Too, unless it is large and heavy enough, it may not permit full power and thus clean response in the low frequencies.

One way of meeting these needs has been, simply, to design and use massive, and costly, transformers. In fact, the pair of output transformers used in a typical high fidelity amplifier might well represent more than half its total cost and weight.

Another approach has been to seek a way of avoiding the dependence on such transformers—which brings us to transistors. Unlike vacuum tubes, power transistors have very low impedances to start with. It is thus entirely feasible to couple the output transistors to the loudspeaker system without the use of an output transformer. This is exactly what is done in many transistor amplifiers. There is more to this apparently simple dodge than meets the eye, however, inasmuch as output transistors have unique

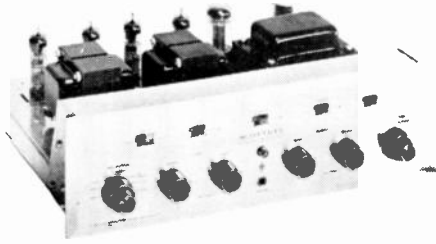

Scottkit I.K-30 is an integrated, 15-watt-per-channel amplifier in kit form. Below, Scott's I.K-150, a basic in kit form offering 50 watts per channel.

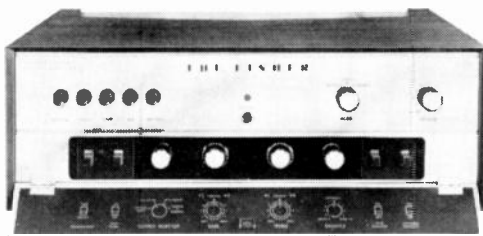

Fisher X-101-C is an integrated, 30-watt-per-channel amplifier. Below, Fisher SA-1000, basic amplifier, 150 watts music power, kit or wired.

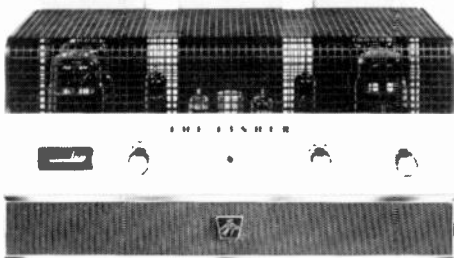

limitations of their own. To begin with, most of the ones first available for audio use were made of germanium and were not capable of providing full power at frequencies above 8,000 cycles (a distinct limitation on amplifier performance). Today, however, it is possible to obtain germanium output transistors that cover the audio range up to and beyond 20,000 cycles. One high-priced power amplifier has gone a step further by using output transistors made of silicon rather than germanium: silicon transistors, ordinarily found in military equipment, are capable of response up to the megacycle region. But with either type, the other problem remains—that of getting specific impedances to match any speaker. With the transformer eliminated, an amplifier provides full power at only the natural impedance of the transistors: with germanium transistors, usually in the region under 4 ohms. At 8 ohms the amplifier may supply about one half its maximum output, and at 16 ohms it may be down to one fourth.

Several solutions to this dilemma have been advanced. One is to double the number of germanium output transistors, effectively raising their natural impedance to 8 ohms. The dropoff in power at 16 ohms is still present but not as severe as before. Alternately, a circuit using silicon transistor outputs can be optimized for power output between 8 and 16 ohms, but will not provide quite as much power to a 4-ohm load. Another solution is to employ an auto-transformer. This device differs from its more complex relative, the output transformer; it is, essentially, "half" of a transformer in that its primary and secondary windings are part of the same coil. Its job is also simpler: instead of changing 3,000 ohms to 4, 8, or 16 ohms, it is called on merely to change 4 ohms to 8 and 16 ohms. Whichever method—or combination of methods—is used, the buyer should check the impedance of his speakers and make sure that the amplifier he purchases will supply sufficient power to drive them adequately.

Experts differ somewhat over just how much amplifier power is "adequate," but in general the amount needed depends on three factors: the efficiency of the loudspeaker, the size and acoustics of the listening room, and the desired level of sound. If you have a low efficiency speaker, a large, well-damped room (lots of rugs, drapes, and upholstered furniture), and if you like your music loud, you will need relatively more power for a given speaker. If the converse is true, you can get along on less.

Even if your requirements do not call for high power, it is desirable to get as much as you can afford. A good 30-watt amplifier will probably sound better when furnishing 10 watts than will a good 10-watt amplifier. A famous analogy is the riding comfort of a car capable of going 120 miles an hour, cruising along at 50 miles an hour, as compared with a car capable of going only 50 miles an hour being operated at its capacity.

Along with power and the other qualities that an amplifier should have, there is one thing it should not—distortion. Since the output should be an am-

plified replica of the input, any deviation is distortion. All amplifiers have some, but it is the amount and type that distinguish the better ones from the common variety.

Harmonic distortion is the production of spurious overtones not in the original musical signal. When excessive—say more than 2% of the total output—harmonic distortion adds an unnatural “hardness” to the reproduced sound.

Intermodulation distortion describes the by-products of two pure tones interacting to produce sum-and-difference frequencies. A 60- and a 6,000-cycle tone may produce new ones of 6,060 and 5,940 cycles along with the original. Inasmuch as the new tones are not in harmony with the original, they produce harsh, discordant sounds. When excessive—say more than 1%—intermodulation (IM) distortion lends a “nasality” to the reproduced sound.

A third type, transient distortion, is something of a controversial subject. Audio experts disagree on the relative importance of transient response. A “transient” is an instantaneous burst of sound—like that created by a piano key or a clash of cymbals. At one moment there is complete silence, at the next there is full output. Unlike some sounds which build and decay over an interval of time, transients are either “all or nothing.” Some audio experts hold that all music is a series of transients. For example, they say, a violin bow pulled across the string produces a rapid series of tiny transient tones which blend together in our ear. Therefore, unless an amplifier can properly reproduce transients, it will not be performing adequately, and the sound produced will not be true to life.

There is no percentage figure that immediately tells the amplifier’s ability to reproduce transients. The most generally accepted method of determining it is to feed a test signal known as a “square wave” into the amplifier, and then study the amplifier’s output on an oscilloscope. A square wave resembles a music transient in that it also starts from nothing, jumps to full output at once, stays there for an instant, and then returns to nothing (see the drawing on page 48). No amplifier can reproduce a square wave perfectly. To the audio expert, however, the type and amount of deviation from perfection provide clues to the amplifier’s ability. He measures how rapidly the signal goes from nothing to full output (rise time). When it gets to full output, does it stop or does it go beyond and then bounce around for a while (overshoot and ringing)? When it levels off at full output, does it follow a straight path or is there some deviation (tilt)? Determination of these things requires spectacularly good test equipment and experienced judgment. Yet, to many experts, no test is more important.

In designing amplifiers for best square-wave reproduction, the engineer must consider many elements that he might not otherwise bother with. One of these is extended frequency response, because the actual response of a square wave extends well below and above its nominal frequency. Thus, if the square

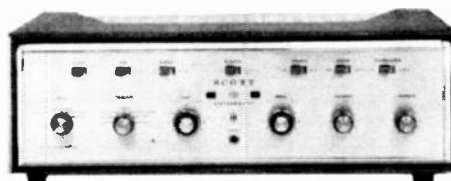

Scott 299D is integrated amplifier, rated at 40 watts per channel music power; below is solid-state type 4270, rated at 30 watts per channel.

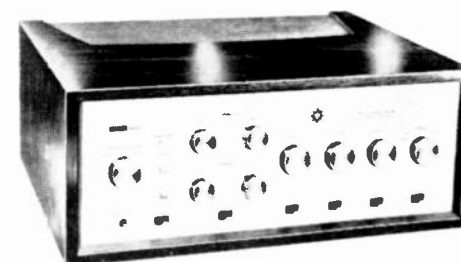

Harman-Kardon A-700, 35 watts per channel.

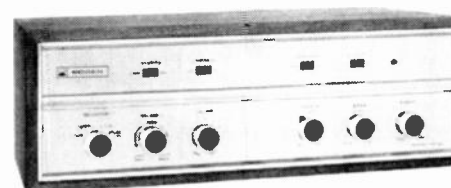

Bogen AP30 offers total of 30 watts music power.



Marantz 8B is dual 40-watt-per-channel basic.

What About Controls?

Some of the knobs and switches which adorn the control panel of a preamplifier or a combination amplifier are in the "must have" category, while others are more "fringe benefits." The exact array provided varies with different amplifiers, depending on what the manufacturer feels "belong" on a particular model in a given price and performance class. The buyer when shopping is advised to take into account his own tastes and needs, keeping in mind that additional controls and convenience features add to over-all cost but not necessarily to ultimate performance and sound.

The power off/on control is, of course, essential. It turns off and on the amplifier, and any other equipment plugged into the AC outlets on the rear.

The volume or gain control adjusts the loudness of the sound. Obviously in the "must have" category, this control often is associated with what is known as a "loudness" or "contour" control that boosts the bass somewhat to compensate for a natural loss of it at very low listening levels. In some amplifiers, the loudness compensation is built into the volume control; in others, it comes as a separate switch to be used at the listener's option. When the gain control on a stereo amplifier is a single control for both channels simultaneously, then an additional balance control ought to be provided to get equal sound from both speakers. If the gain, however, is controlled by two independent knobs—one for each channel—then they themselves can serve both to adjust the loudness and to regulate channel balance.

Tone controls, for high fidelity amplifiers, are separate controls for boost or cut of treble and of bass. The costlier models permit these adjustments on each channel independently so that the sound can be tailored precisely to suit listening tastes as well as to compensate for small variations in the two speaker systems and in room acoustics.

Equalization—for signals from a phono cartridge or from a tape head—is in one of two forms. On some amplifiers, it is automatically selected when the selector switch is turned to a given program; on others it is provided as a separate control.

RIAA is the standard for all modern discs; NAB equalization is required for playing prerecorded tapes.

The input signal, or program, selector permits you to connect various program sources (turntable, tape deck, tuner) to the rear of the amplifier and then choose which one you want to hear. The markings on this control always correspond to the input jacks on the rear of the chassis.

The balance control—to adjust the relative amount of sound from the two stereo speakers—may be a separate control, or balancing may be accomplished by means of a dual volume control (see above).

A stereo mode selector should, at the very least, permit you to choose between normal or full stereo, in which the left or "A" signals and the right or "B" signals enter and leave the amplifier separately—or a combination of the two ("A + B"), in which the left and right channels are blended to produce a monophonic signal. This feature enables the stereo system to play monophonic program sources with the least amount of noise; it also is useful for certain installation and test procedures, such as balancing the two speakers. Other "stereo mode" functions often provided include channel reversal, and the playing of one side of a stereo signal through both channels. If these somewhat specialized features are present, their use is explained in the amplifier instruction manual.

A phase reversal control may be used to get both stereo speakers to vibrate in step with each other, in the event they have been incorrectly hooked up to their respective amplifier output taps. When speakers are "in phase" they produce a fuller sound, particularly noticeable in the bass response. Speakers that are "out of phase" sound thinner and often farther apart than they really are. Occasionally, a stereo program may itself be out of phase and so—even though the speakers may be in phase—the sound may be improved by flipping the phase reversal switch for that particular program. This does not happen very often any more, and so the phase reversal switch is not as critically needed as it used to be.

A blend control varies the amount of separation between the two stereo chan-

nels, from maximum (full stereo) to partial, or sometimes to no separation (full mono). It helps fill the "hole in the middle" in some installations where the speakers are very far apart, or on some stereo programs that have been recorded with exaggerated separation. On some amplifiers it also serves as a gain control for a "center channel" (A + B) signal that may be fed to another amplifier and speaker.

A tape monitor switch enables you to check the sound quality of a tape while it is being recorded. In one position of the switch, the original program material (an FM broadcast, for instance) is fed to the speakers and you hear just what the recorder "hears." In its alternate position the monitor switch feeds the same program material the split-second after it has been taken down by the tape recorder. Thus, by moving the switch back and forth, you can compare the original sound with what your recorder is making of it. Note: this feature works only with tape recorders having separate heads for recording and playback. It will not work when the recorder has a combined record/playback head.

Scratch and rumble filters are designed to reduce high and low frequency noises respectively, without losing too much of the music itself. No filter is perfect, and so the perfectionist tries to keep his records clean, and to use a silent turntable. However, the scratch filter also can help reduce other noises over which the audiophile has little direct control—such as tape hiss or the surface noise of an old, hopelessly worn disc.

A speaker selector switch enables you to connect more than the usual complement of speakers to the amplifier—such as an additional one or two for a second room—or to beef up the sound in the first room. Another handy gadget, but certainly not absolutely needed.

A stereo headphone jack, found on some amplifiers, makes it easy to hook in a headset without the need to get at the speaker connections at the rear, or to use a special adapter unit to drive the headphones. For those who listen in this way, such a jack is unquestionably of great convenience.



Harman-Kardon A-1000T is solid-state integrated amplifier, 35 watts per channel power output.

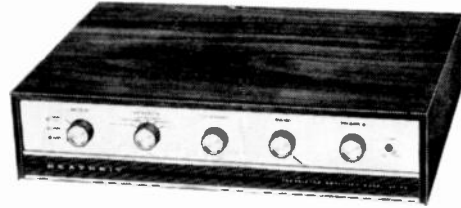

Heathkit AA-22, a solid-state integrated amplifier in kit form, supplies 70 watts total music power.



New idea for Dynakit components is walnut wrap-around by Ruxton. Same preamp and tuner can be housed separately in cabinets made by Kitcraft.

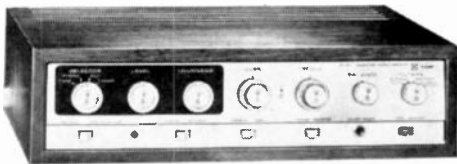

Knight-Kit KG-870 is solid-state preamp-power amp combination rated at 35 watts per channel.



Bogen AP250 is a compact preamp-power amp combination offering 25 watts per channel. Below, a dual 40-watt basic in kit form, Heath AA-121.

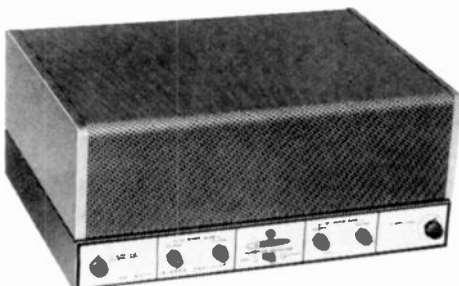

wave is to be reproduced with fast rise time and minimum tilt at all audible frequencies, then the amplifier's frequency response must extend far beyond the audible range. This can be anything from zero cycles to one megacycle, depending on the amplifier designer's viewpoint.

Opposing this view is the designer who decries extending the frequency range beyond the audible limits of 20 to 20,000 cycles. Many experts on this side of the question point out that, in the regions above and below the audible range, there is much undesirable noise. If this is amplified along with the music, it will waste much of the amplifier's usable power and overload the loudspeaker. By preventing this inaudible noise from entering the amplifier (through the use of filters, or deliberately designing for response rolloff, or both) it is held that there will actually be an improvement in the sound one hears. While these experts recognize that with the limiting of the frequency response, the square-wave response also will be degraded, they just don't think that it is terribly important. Who is right? From a theoretical standpoint, the debate can be waged endlessly. Practically, it would seem to depend on the individual amplifier being considered. Both types are amply represented on dealers' shelves.

The arrival of transistor amplifiers has added fuel to the controversy, for it is somewhat easier to extend the frequency response above and below the audio range with transistors than with tubes. A few manufacturers of solid-state units have done just that. They claim that their products sound better than equivalent tube units because of this extended response, and despite the fact that the transistor amplifier may measure no less, or even slightly higher, distortion than a tube amplifier.

Other manufacturers of transistor amplifiers have made no attempt to extend the frequency response beyond the audio range. They claim that their solid-state products sound better than equivalent tube units because transistor amplifiers are capable of handling enormous music power peaks without distortion—again, despite the fact that the transistor amplifier may measure no more, or even slightly lower, output power than a tube amplifier.

Regardless of which theory is correct (possibly both are), and in spite of the widespread belief that a good transistor amplifier sounds better than a good



Lafayette KT-900WX is solid-state preamp-power amplifier, 120 watts music power, kit or wired.

tube unit, the prospective buyer is advised to listen comparatively and to evaluate every amplifier on its own merits.

Less controversial is the fact that transistors make possible a new kind of amplifier. Previously, a person wanting the best possible performance purchased a separate preamplifier and power amplifier. Unless he built the units from kits, he paid over \$400 for the combination. To save on money and space, he could make some compromises on performance and purchase a complete, integrated amplifier for under \$300. The amount of compromise necessary has been shrinking rapidly over the last few years as integrated amplifiers have been improving.

Nevertheless, there is a limit to what can be squeezed into an integrated, one-piece tube amplifier. Power means heat, weight, and size. To go beyond a certain point means either reducing component life or using an oversized chassis. Transistors do not produce nearly as much heat and are far smaller. On the other hand, transistor performance can be degraded by heat, so whatever is produced must be quickly drawn away by those large, finned metal pieces known as heat sinks. Even with them, it is still possible to combine a feature-packed preamplifier with a power-packed amplifier on one relatively compact chassis. This new integrated unit is directly comparable to separate units in performance—and with some saving in money and space.

Regardless of the kind of amplifier you settle on, be it kit or wired, integrated or separate, tube or transistor, keep in mind that the amplifier is the heart of a music system. A good amplifier will improve the sound of even an inferior speaker, while a poor amplifier will detract from a good speaker. You can always upgrade your speaker system at a later date and put the original speakers in the game room or den. If you want to upgrade your amplifier, you may have to trade in your original unit at a considerable loss.

In choosing one, remember: the specifications are important, the advice of friends and salesmen is useful, the appearance and reputation are worth considering, but when all is said and done—how does it sound, particularly after hours of concentrated listening? And does it have the control features you want? If the answers to these questions are "good" and "yes," you've found your amplifier.

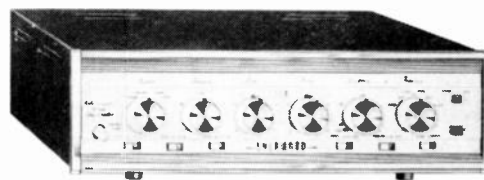

Sherwood S-5000II stereo preamp-power amp packs total of 80 watts in a relatively sleek chassis.



Fisher 400-CX, stereo preamp-control for use with basics, features push-button selector controls.

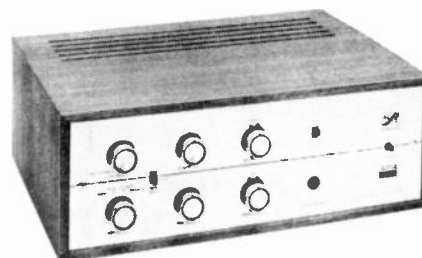

Eico 2036 integrated amplifier has new styling, is rated at 18 watts of music power per channel.

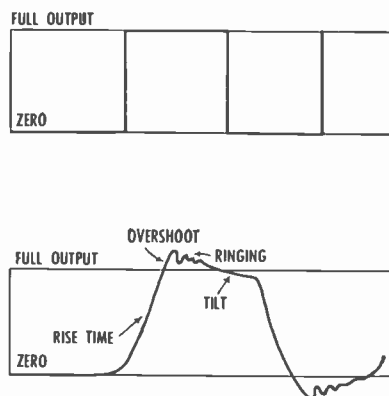

Square-wave signal, very rich in harmonics, is used for testing amplifiers. Top, a perfect square wave. Bottom, the portions of the reproduced signal, as shown on an oscilloscope, that engineers refer to in evaluating performance.



TUNING IN FM STEREO

How to capture the new dimension in broadcast music.

By Leonard Feldman

SELECTION of an FM stereo tuner poses some unique problems. For instance, when a prospective buyer reads the specifications, he is likely to find tuners boasting "3 microvolts sensitivity" in all price ranges. The sensitivity specification (if stated in a logical way) is a vital measure of performance—to be discussed in detail further on—but it is not the sole criterion by which a tuner may be evaluated for use. Such fairly familiar characteristics as frequency response and distortion, as well as those not so well known—bandwidth, image rejection,

capture ratio, phase response, and so on—all enter into the picture.

FM stereo tuners may be classified broadly in three categories: basic inexpensive types, average, and "super-performance-replete-with-extra-feature" models. Even the lowliest of these in certain situations will receive FM stations. In fact, under very specific and limited conditions, the astute listener—

Leonard Feldman's new book, Hi-Fi Projects for the Hobbyist, is published by Howard W. Sams.



Bogen TP 250 FM stereo tuner.



Korvette NAM Mark VI FM stereo tuner/amplifier.

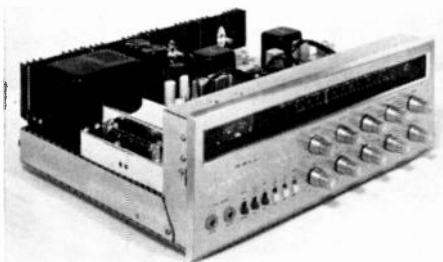

New idea from Bell is tuner added optionally to stereo amplifier. Top, the complete chassis, the Imperial 1000. Bottom, the separate tuner section which fits onto chassis and is connected by four cables. Both units are solid-state.

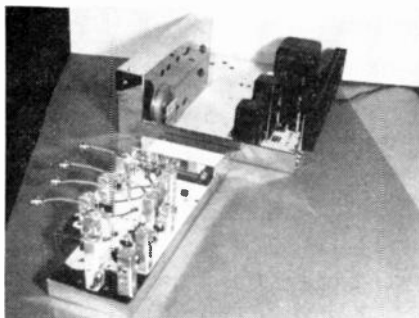

Kenwood KW-70 is AM/FM stereo tuner/amplifier.

using the most and the least expensive tuners available—might not be able to distinguish between them as to performance and quality of reception. Wherein, then, lie the difference? For one thing, the main feature that distinguishes the higher-priced tuner is the increased number of stages in both the RF (radio frequency) and IF (intermediate frequency) amplifying sections. These are the "workhorse" elements of the tuner, the circuits which take a minute signal from the antenna, and build it up, strip it of its background noise, and feed it to the detector, which—in the form of either a ratio detector or a discriminator—extracts the audio signal. Thence, the signal is fed to the amplifier.

Quieting sensitivity, or the ability of the tuner to reject noise and pass on program material, is of course governed, generally, by the effectiveness of these sections. An RF section comprised of a separate amplifier, oscillator, and converter is likely to provide more amplification and a lower noise figure than the less expensive, all-in-one RF design. By way of clarification, quieting sensitivity must be stated for specific conditions. For example, to say that a tuner has a quieting sensitivity of "3 microvolts" is not unlike saying that the weight of water is 10 pounds. How much water? 3 microvolts for what? The Institute of High Fidelity recommends that the term "least usable sensitivity" be substituted for the somewhat antiquated "quieting sensitivity" term. They further suggest that the "least usable sensitivity" be defined as the least number of microvolts of signal at the antenna required to produce a signal which is 30 db (about 30 times) greater than the background or residual noise and distortion. Stated this way, the sensitivity figure has immediate meaning and can be used as an accurate measure of comparison between tuners. Obviously, if supplied with 1,000 microvolts of signal (a condition not uncommon when one is fairly close to the FM station), tuners in all three categories will provide more than adequately "quiet" reception, since "quieting" can only increase with signal strength until the background is "totally quiet" (or at least so quiet that no background hiss or noise whatever can be heard).

The number of IF and limiting stages in an FM stereo tuner, in addition to contributing to its sensitivity, determines the "bandwidth" of the receiver. Broad bandwidth has always been a criterion for good FM reception. Unlike AM receivers, FM sets must have a bandwidth of at least 150 kc in order to perform with the least amount of distortion.

This minimal figure is fifteen times greater than that required for adequate AM reception. In practice, bandwidths of good FM tuners vary from about 300 kc to 1 megacycle or more; the wider bandwidths make for easier tuning and extremely low distortion. Tuners having only one or two stages of IF amplification must put "gain" ahead of bandwidth, and each stage is made to operate at maximum amplification. This results in a somewhat narrower bandwidth, adequate but not ideal. As more stages are added, however, each can have a somewhat lesser amplification and hence is capable of greater bandwidth.

For FM stereo, adequate bandwidth is particularly important, since ultrasonic subcarrier components up to 53 kc must be amplified along with the regular audio material. The minimum requirement is still only 150 kc, but it has been found that tuners designed to conform just to this are extremely difficult to tune in accurately for stereo reception. The extra margin of bandwidth means that even if the set is not tuned precisely to the "center of channel," reception still can be virtually free of distortion and background noise.

Much has been said, of late, of the increased sensitivity requirements of a stereo, as compared with a mono, FM tuner. To be sure, the program information contained in the complex FM stereo signal arrives at the antenna with only one fifth the voltage intensity of the monophonic component of the signal, but this need not be catastrophic if proper remedial measures are taken. For one thing, if the monophonic signal intensity was 1,000 microvolts, this means that the equivalent FM stereo information is at a level of about 200 microvolts. Even the lowliest of FM tuners is capable of providing adequate reception at this level. On the other hand, the 1,000-microvolt figure may well be available, *but not properly utilized* in a particular installation. More often than not, a signal of that intensity in any location may be represented by a signal of only 100 microvolts actually reaching a tuner. The reason? An inadequate antenna. Over the years we have been conditioned to "built-in" antennas on AM, TV, and even FM sets. AM, because of its long-wave characteristics, can be received at great distances with only a "loop-stick" antenna built right onto the chassis. The outdoor TV antenna is no longer a standard fixture on rooftops (in any but remote locations) owing to the higher transmitting power granted to most TV transmitters. And so many TV sets operate quite well with their own built-in antennas. FM, however, is not yet that fortunate. To receive the relatively low-powered FM station, especially stereo FM, a properly selected and installed outdoor FM antenna may well be necessary; it may mean a ten-to-one difference in signal intensity. Compare this with the specifications of sensitivity offered by the least expensive and the most elaborate, costly tuner, and you will conclude, rightly, that the budget-minded FM stereo listener often can achieve highly satis-



Heathkit AJ-33, solid-state AM-FM tuner.

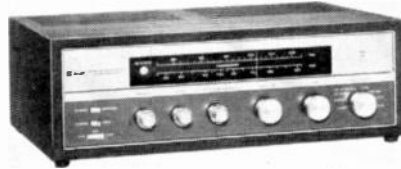

Knight-Kit KU-45A stereo tuner/amplifier.



Marantz's first tuner, the Model 10.

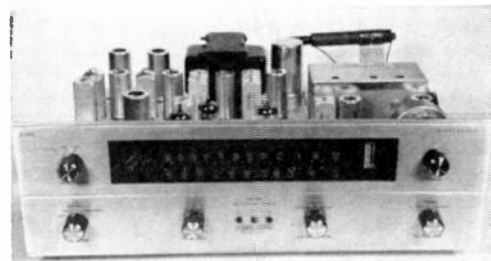

Fisher R-200, above, is AM/FM stereo tuner; below is Fisher 500, stereo tuner with amplifier.





McIntosh MX110 is stereo tuner with preamp.



Scott 4312X is solid-state FM stereo tuner.

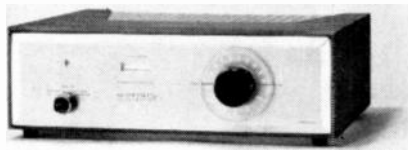

Type LT-111 by Scott is tuner in kit form.

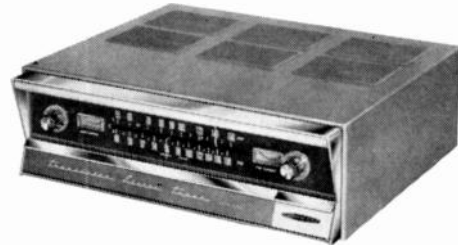

Heathkit AJ-43 is solid-state AM/FM tuner.

GLOSSARY OF FM STEREO TERMS

- AFC**—Automatic frequency control. Helps lock in stations to prevent drift.
- AGC**—Automatic gain control. Prevents overload of set on strong stations, opens up gain or amplification for weaker stations.
- Capture Ratio**—Ability of tuner to select stronger of two FM signals at same frequency. The lower the specification figure, the better the capture ratio.
- Cascade Amplifier**—Used in RF section of FM tuners. Provides high amplification with low noise factor.
- Conical Antenna**—A moderately directional, medium gain antenna, suited for near suburban use.
- Converter**—Changes incoming FM frequency to more easily amplified, IF frequency (usually 10.7 megacycles).
- De-emphasis**—A standard treble cut incorporated in FM receivers, to compensate for pre-emphasis used in transmission.
- Discriminator**—One form of FM detector, which converts IF frequency to audio.
- Folded Dipole**—Popular, bi-directional, low gain antenna, suitable in close-by installations for receiving stations from opposite directions (as between two close cities).
- Harmonic Distortion**—Same as term used in amplifiers. Describes amount of distortion in terms of multiples of fundamental, pure tone. The lower the figure, the better the equipment.
- IF Amplifier**—Section of a tuner that amplifies IF frequencies prior to limiting and detection. Better sets feature more IF amplifiers.
- IM Distortion**—As in an amplifier, distortion resulting from mixture of two divergent tones, producing sum and difference tones not present in original program. The lower the quoted figure, the better the equipment.
- Image Rejection**—Ability of tuner to suppress spurious frequencies bearing a mathematical relationship to the desired FM frequency. The higher the figure, the better the equipment.
- Limiter**—Portion of FM receiver which "clips" away noise and static pulses in for incoming signal.
- Multiplex**—Technique used to transmit FM stereo. In general, any means for transmitting two programs over one carrier frequency.
- Pilot Carrier**—19-kilocycle tone sent along as a locking signal for FM stereo transmission.
- Quieting Sensitivity**—Former sensitivity specification, denotes FM quieting ability but, unlike later IHF specification, does not take into account distortion. Thus, equal quieting sensitivity specification between two sets does not mean equally low distortion.
- Ratio Detector**—Alternate form of FM detector; serves same function as discriminator.
- Reflex Converter**—Combined RF amplifier, oscillator-converter used in less expensive tuners.
- Regeneration**—Form of oscillation caused by poor alignment of FM tuner or improper layout of parts. Its presence, not always audible, reduces bandwidth and causes distortion of program material.
- RF Amplifier**—First stages of an FM tuner, used to amplify incoming signal prior to conversion to IF frequencies.
- Rotator**—A device for automatically positioning an outdoor antenna by remote control.
- Sensitivity**—A tuner's ability to receive weak or distant stations. "IHF sensitivity" (also known as "usable sensitivity") refers to the number of microvolts of RF signal required by an FM set to yield an audio signal whose total noise, hum, and distortion is 30 decibels below the level of a 400-cps test tone. The smaller the number, the more sensitive the set.
- Separation**—Same as term used in stereo records and amplifiers. The greater the separation, the better the stereo effect, providing figure is maintained for all frequencies from 50 to at least 10,000 cycles.
- Sidebands**—Portion of ultrasonic signal used to transmit stereo FM information.
- Subcarrier**—Ultrasonic signal upon which stereo sideband information is modulated in broadcasting stereo. This portion of signal is not utilized in monophonic FM receiver.
- Turnstile Antenna**—Nondirectional FM antenna, resembles turnstile in appearance.
- Yagi Antenna**—A multiple-element antenna array, considered to be the highest-gain type suitable for FM and FM stereo reception. Extremely directional and must be oriented very carefully.

factory performance by the addition of a suitable outdoor antenna. That is not to imply, of course, that the highly sensitive, expensive tuner also won't benefit from a better antenna. Realistically, any installation not within six to ten miles of the transmitter will. The improvement is not limited to quieter performance only. Reflected FM stereo signals create a form of distortion analogous to TV ghosts so prevalent in the early, low-power days of TV. Properly oriented antennas reduce this problem, too, to a minimum.

The choice of a correct antenna is governed by many factors, among them distance to transmitter, location of each station to be received in FM stereo (if more than one station is broadcasting stereo), the nature of the immediate terrain (mountains, tall steel structures, and the like), and the usable sensitivity of the tuner.

In general, suburbanites attempting to receive several stations from the same approximate locale would do well to install a "yagi," or directional, high-gain antenna. Because of its narrow directionality, such an antenna must be carefully oriented or "aimed" at the station or stations. This phase of the installation should be performed under actual listening conditions. If your tuner is equipped with a signal strength indicator (either the "magic eye" or meter type) rotate the antenna until maximum signal strength is indicated. This setting will usually be the right one to give you most satisfactory distortion-free operation and best stereo separation.

A metropolitan dweller, in the midst of stereo FM stations, should select a nondirectional or "turnstile" type of antenna. If distortion caused by reflected signals results, the only satisfactory solution may be to change to a more directional antenna, which should be controlled by a rotator that permits orientation of the antenna (for best reception of the station desired) from the listening room.

During the past year, so-called electronic antennas have come upon the scene. These devices are essentially radio-frequency amplifiers or boosters, designed to increase the strength of a relatively limited or weak signal. Whatever one calls them, they do work under certain conditions. For apartment dwellers prohibited from installing roof antennas, they often mean the difference between FM stereo and no FM stereo. Boosters are particularly useful when the available signal is just below marginal acceptability, or when a particular FM set needs more RF gain in order to supply a usable audio signal. They will not, however, enable you to pick up stations in stereo that you formerly were not receiving satisfactorily in monophonic FM. Too, the booster will not eliminate "ghosts" or multiple reflections. To solve these reception problems, the outdoor directional antenna remains the best means.

Sometimes, a booster can be used successfully as an adjunct to a directional antenna for really remote or fringe reception. For average conditions, however, a good outdoor antenna—correctly in-



Fisher KM-60 is stereo tuner in kit form.



Stereo tuner from Altec is its Emperor Royale.

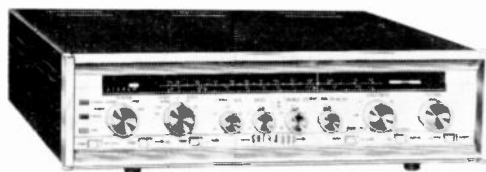

Sherwood S-7700 is stereo tuner with amplifier.



New stereo tuner/amplifier from Scott is 340-B.

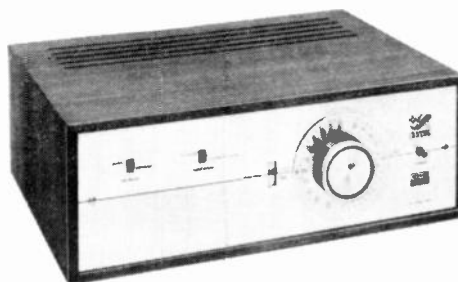

New style for Eico is shown by its 2200 tuner.



Harman-Kardon F-1000T is solid-state tuner.



Lafayette LT-78C is AM/FM stereo tuner.

stalled (usually this means by a professional technician)—is the wisest choice.

The budget-minded FM stereo listener may well consider building his own tuner from a kit. Time was when the standard advice given to prospective kit builders was, "Try an amplifier first, and then possibly a preamplifier—but stay away from FM tuner kits." But high fidelity equipment manufacturers, long noted for their originality and ingenuity, have circumvented the troublesome aspects of kit construction very nicely. FM tuner kits today might well be called semi-kits. Often, the kit builder is faced not with a carton of resistors, capacitors, and a host of nondescript electronic parts, but rather with a series of preassembled modules, in which the tricky critical wiring has all been done by the manufacturer. Success with a present-day FM stereo tuner kit is practically certain, if the well-written and -illustrated manuals are followed to the letter.

Earlier difficulties with FM tuner kits centered about the problem of alignment and consistency of performance. In high frequency radio circuits (such as those involved in FM tuners), much of the ultimate performance depends upon precise layout of parts. The kit builder who routes a wire over one path may not get the same results as the builder who positions the same wire somewhat differently. While manufacturers tried to prealign the various tuned circuits, coils, and other parts requiring adjustment, such prealignment was usually seriously offset by the builder's own variations in assembly of a unit.

Today, by prepackaging and prewiring the critical stages of an FM stereo tuner, the manufacturer can guarantee satisfactory prealignment. The interwiring left to the home builder generally involves noncritical power supply and audio circuits. Even at that, the monetary savings compared with a fully factory-wired unit are considerable. For the adventurous kit builder, the joy of having "put it together and made it work" is in no way diminished.

A cursory check of several kits currently available showed that professional attempts to align the tuner over and above the manufacturers' prealignment yielded only a very moderate improvement in sensitivity. The perfectionist may, nevertheless, want to have this final alignment done by a competent high fidelity service technician. Even with the cost of this work added, there will still be a net savings over the purchase of a ready-made unit.

As one leaves the lower-price and medium-price

categories of FM stereo tuners, one encounters so-called special-feature circuits which are partly related to the audible performance of the product. In general, these features are to be found in the higher-price category.

Among these are tuning meters and tuning eyes—perhaps more important in wide-band tuners than in those of more limited bandwidth. In the latter types, there is usually only one precise distortion-free setting for each station, and it can be determined by careful listening. Wide-band sets have a somewhat "milder" tuning action so that stations sound "tuned in" over a considerable movement of the tuning knob. Inadvertent tuning to the edge of the channel, in the absence of a visual tuning indicator, may well result in later distortion as loud passages of music or speech are broadcast. The tuning indicator serves, therefore, to determine the exact "center-of-channel" and thus permits maximum utilization of the broad bandwidth characteristics engineered into the tuner.

Many of the better tuners have circuits that do nothing more than silence the tuner as you tune between stations. Such muting circuits are generally variable, permitting the reception of very weak signals which might not normally cancel the muting feature if it were left fully operative at all times.

AFC, or automatic frequency control, is now found in all three categories of FM tuners. It is extremely useful for accurate tuning. Even if the listener does not set the dial to the exact center-of-channel point, AFC will "pull" the setting electronically toward that precise center, reducing the possibility of noisy and distorted reception. Contrarily, there are some manufacturers who do not incorporate AFC, even in their most expensive tuners. They maintain that wide-band circuits, of themselves, make accurate tuning simpler and, further, that some AFC circuits actually introduce a small amount of amplitude distortion, particularly in the bass frequencies.

Despite the added complexity of FM stereo circuits, the new crop of FM stereo tuners are handsomely styled. These units are ideally suited for open display as well as for custom installation in an ever increasing array of fine furniture cabinetry.

As for the actual choice of FM tuner from the three basic categories enumerated, budget alone must dictate. Suffice it to say that manufacturers have done everything necessary to make FM stereo available to you, whether you choose the most modest, the average, or the most elaborate tuner.

FM STATION GUIDE

IN JULY 1963 the Federal Communications Commission took the first step in implementing a plan to permit 2,378 stations in over 1,800 cities and towns to broadcast FM signals on the 80 commercial channels available in the 92.1- through 107.9-megacycle FM broadcast band. Specific channel numbers (from 221 to 300) have been assigned to specific locations in all states except Alaska and Hawaii, in compliance with a recent ruling requiring that FM stations be twenty-five miles apart. Allocations of channels were so made that very few existing stations have been affected by this new ruling. In those cases where stations are now less than the required distance apart, the Commission will consider assigning higher power to some and changing the broadcast frequencies of others. Thus, with about 1,100 FM stations now in existence, there is space for a potential of more than 1,200 new stations. With the alloca-

tion of channels throughout the country definite, new applications are again being considered by the FCC. It has been noted that almost all applicants for new stations have indicated they will install multiplexing equipment. There are now about 250 already broadcasting FM stereo signals and many others who have announced plans to do so in the near future. In the listing of stations which follows, (S) after the call letters indicates FM stereo broadcast.

With such complete coverage of the entire country at last possible, the real potential of FM broadcasting may come to be realized by the advertisers (who supply the wherewithal to keep the stations operating), by the listeners (who enjoy the clear FM sound and the high quality of the programs), and by the manufacturers of FM stereo equipment (who supply the necessary instruments for reception).

88.1 mc		Berea, Ohio	WBWC	Albuquerque, N.M.	KANW	Columbia, S.C.	WUSC
Angwin, Calif.	KANG	Hampton, Va.	new	Akran, Ohio	WAPS	Cheney, Wash.	new
Long Beach, Calif.	KLON	Calfax, Wis.	WHWC	Williamsburg, Va.	WCWM	Highland T'w's'p., Wis.	WWSA
Middletown, Conn.	WESU						
Honolulu, Hawaii	KVOK	88.5 mc		89.3 mc		90.1 mc	
Galesburg, Ill.	WVKC	Phaenix, Ariz.	KFCA	Berkeley, Calif.	KPFB	San Francisco, Calif.	KSFX
Park Forest, Ill.	WRHS	San Francisco, Calif.	KXXK(S)	Pasadena, Calif.	KPCS	Washington, D.C.	WGTTB
Wheaton, Ill.	WETN	Washington, D.C.	WAMU	Hartford, Conn.	WRTC	Atlanta, Ga.	WABE
Winnetka, Ill.	WNTH	Park Ridge, Ill.	WMTM	Evanston, Ill.	WNUR	Chicago, Ill.	WMBI
Gary, Ind.	WGVE	Amherst, Mass.	WFCR	Franklin, Ind.	WFCI	Indianapolis, Ind.	WIAN
New Albany, Ind.	WNAS	Ralla, Ma.	new	Louisville, Ky.	WFPL	Ames, Iowa	WOI
Cedar Falls, Iowa	KTCF	Oxford, Ohio	WMUB	Royal Ock, Mich.	WOAK	Geargetawn, Ky.	new
Des Moines, Iowa	KDPS	El Paso, Tex.	KVOF	Spring Arbor, Mich.	WQZK	Kansas City, Mo.	KTSR
Manhattan, Kon.	KSDB			Kansas City, Mo.	KCUR	Cedarville, Ohio	WCDR
Ottawa, Kan.	KTJO	88.7 mc		Central Square, N.Y.	WCSQ	Philadelphia, Pa.	WRTI
Baltimore, Md.	WBJC	Claremont, Calif.	KSPC	High Point, N.C.	WHPS	Salt Lake City, Utah	KUER
Cambridge, Mass.	WTBS	Pocatello, Idaho	KGBl	Marietta, Ohio	WCMO	Ripon, Wis.	WRPN
Highland Park, Mich.	WHPR	Elmhurst, Ill.	new	Parliland, Ore.	KRRC		
Point Lookout, Mo.	KSOZ	Indianapolis, Ind.	WICR	Havertawn, Pa.	WHHS	90.3 mc	
Brookville, N.Y.	WCWP	Emporia, Kan.	KSTE	Chilltan, Wis.	WHKW	San Francisco, Calif.	new
Elmira, N.Y.	WECW	Buffalo, N.Y.	WBFO			Durham, N.H.	new
Springville, N.Y.	WSPE	Clinton, N.Y.	WHCL	89.5 mc		Albany, N.Y.	WAMC
Winston-Salem, N.C.	WFDD	Hempstead, N.Y.	WVHC	San Diego, Calif.	KEBS	Floral Park, N.Y.	WSHS
Akron, Ohio	WAUP	Oberlin, Ohio	WOB	Amherst, Mass.	WAMF	Cleveland, Ohio	WBOE
Bowling Green, Ohio	WBGU	Madison, Wis.	WHA(S)	South Orange, N.J.	WSOU	Nashville, Tenn.	WPLN
Kent, Ohio	WKSU	San Juan, P.R.	WIPR	Tulsa, Okla.	KWGS	Holmen, Wis.	WHLA
Oretech, Ore.	KTEC						
Clemson, S.C.	WSBF	88.9 mc		89.7 mc		90.5 mc	
College Dale, Tenn.	WSMC	Tampa, Fla.	WTUN	La Sierra, Calif.	KSDA	Arcata, Calif.	KHSC
Brownwood, Tex.	KHPC	Notre Dame, Ind.	WSND	Los Altos, Calif.	KFJC	Colorado Springs, Colo.	KSHS
Dallas, Tex.	KNER	Boston, Mass.	WERS	Tampa, Fla.	WUSF	Storrs, Conn.	WHUS
Plainview, Tex.	KHBL	Wilberforce, Ohio	WJSC	Terre Houte, Ind.	new	Galesburg, Ill.	WVKC
Logan, Utah	KUSU	Oklahoma City, Okla.	KOKH	Mount Vernon, Iowa	new	E. Lansing, Mich.	WKAR
Huntington, W.Va.	WMUL	Philadelphia, Pa.	WXPn	Boston, Mass.	WGBH(S)	Mankato, Minn.	KMSU
		Pravo, Utah	KBYU	Columbus, Ohio	WOSU	Columbus, Ohio	WCBE
88.3 mc						Easton, Pa.	new
Loma Lindo, Calif.	KEMR	89.1 mc		89.9 mc		South Norfolk, Vo.	WFOS
San Diego, Calif.	KSDS	Los Angeles, Calif.	KXLU	Santo Monica, Calif.	KCRW		
Lafayette, La.	KRVS	Pella, Iowa	KCUl	Springfield, Moss.	WSCB	90.7 mc	
Interlocken, Mich.	WIAA(S)	Waverly, Iowa	KWAR	New York, N.Y.	WKCR	Los Angeles, Calif.	KPFK
Newark, N.J.	WBGO	Wichito, Kan.	KMAUW	Scranton, Pa.	WUSV	San Jose, Calif.	KSJS
Syracuse, N.Y.	WAER	Duluth, Minn.	KUMD				

An Interview with Skitch Henderson

A MUSICIAN LOOKS AT STEREO

KKNOWN TO millions of television viewers as the “talented beard” who bestows the charms of music on the Johnny Carson “Tonight Show” (NBC-TV, Monday through Friday nights), conductor-arranger Skitch Henderson also is an audiophile with enviable credentials for admission to the fraternity of “sound nuts.” From the environs of recording studios to the informal comfort of his apartment in mid-Manhattan, Skitch has had an acquaintance of long standing with sound equipment and techniques. In fact, he finds it difficult to think of “music” apart from “sound”; for him high fidelity came not as a sudden revelation, but as a gradual development that inevitably became a necessary adjunct to his work.

“I remember discovering early in my career,” he told us recently, “the fascinating and evasive quality of that mysterious ‘intangible’ that comes from an orchestra. As a pianist and orchestrator in the film studios of Hollywood during the 1940s, I was constantly amazed by the tricks that one’s ears can play. Study theory and harmony all your life (most of us do) but the indisputable fact remained that when all this theory was transferred from the scored page to the player and the room wherein he performed, something always took place over which no one had any control.”

“Were attempts made to explain this effect?” we asked.

“Not to explain it,” replied Skitch, “but to manipulate it by means of room acoustics. At that

time it was the style, as it still is in some instances, unfortunately, to use studios whose reflecting surfaces acted as huge sponges. I can remember some engineers bravely suggesting that a recording studio should have the same good acoustic qualities as a concert hall, but immediately a mystical society of dial-twisters decreed that this was a fallacy, and we went on performing in our aquarium.”

“Then such a room didn’t satisfy you, I take it.”

“Not at all. During the years 1947 and 1948 I organized my own ensemble. Playing one-night stands in different types of rooms and halls, we learned a good deal about the effects of acoustics on the sound we made. We experimented with structural shells over the band, with seating arrangements, with blending different orchestral colors. I became convinced that any conscientious musician, popular or symphonic—with the right music—ultimately rises or falls on the total sound color generated by his organization.”

“Does the ‘sound color’ problem exist for all kinds of music?” we asked.

“There are specific differences,” explained Skitch, “but the basic problem is common to all music. For instance, in 1949 I conducted for Frank Sinatra at NBC. To my ears, the magnificent musicianship of Sinatra and of the orchestra was terribly restricted by the spongy walls of the studio and by prevailing engineering practice at that time. I also was fortunate enough to conduct the NBC Sym-



phony Orchestra for a brief period. This prodigious ensemble had to play against the tight, dry acoustics of Studio 8H, which has become, since then, a legend among musicians. My experiences here only confirmed my hostility toward the 'old guard' school of engineers. They seemed to be guided by two very simple rules: if the music is *forte*, turn down the level; if it's *pianissimo*, turn it up—and composer and conductor be damned. Fortunately for all, including the poor listener, things have changed."

"Would you say," we asked, "that stereo has helped bring about the more natural sound approach to recorded and broadcast music?"

"In the main, yes," Skitch said. "But we had a lot to learn at first. My first contact with stereo was at the Toscanini home in Riverdale. The rig there had been built by a man unique in our business: an engineer and a musician too, David Sarser. He designed the 'musician's amplifier,' which to my mind remains to this day the very best possible amplification unit for stereo. (Unfortunately, he refuses to build them.) Under David's tutelage I went through the formative days of stereo: express trains and DC7s rushing through the house, and Ping-pong games between the two speakers. At about the same time, RCA Victor was talking about recording stereo in the popular department, and they chose me to be the guinea pig. Knowing nothing about the technical side but enchanted by this dual system of sound, I decided to record with a large woodwind section plus rhythm and my own Steinway. We all were very confident during the recording sessions, but little did I know how far our efforts were from the actual sonic truth that stereo had to offer. My dream of the large sound spectrum evaporated completely by the time it was mechanically reproduced, and that first album has remained reasonably obscure, thank goodness."

"But this didn't sour you on stereo," we ventured to remark.

"Not at all," Skitch said. "In seriously trying to determine the extra benefits this multiple medium could offer, the first thing I examined was the placement of the musicians. Unfortunately, in the early days most of us had to sit where the engineering staff thought we should, thereby losing a great deal of musical value. In the monophonic days we achieved the supreme balance when the inward sound and the outward sound of the orchestra could be picked up by one mike. (Remember Claude Thornhill's band, or some of the old Beecham recordings?)"

"In my opinion, the first efforts of stereo retarded the level of performance in recording studios. How many times have you listened to a record by either a vocalist or an instrumentalist only to find the accompaniment so overpowering that the artist seemed secondary? It was like having chocolate sauce on a maplenut sundae. All of us, I think, in the early days of stereo lacked the restraint we should have had as we followed our first inclination: to utilize the mallet instruments in the percussion section. I personally remember a trip to the United Nations gift shop looking for a certain type of cymbal which I thought would be the perfect solution to something in the B channel."

"What happened after the novelty of the percussion school began to pale?" we asked.

"We went back to the 'Rimsky-Korsakov' school, putting the piccolo as high as possible above the whole orchestra. The reproduction of the contrabassoon presented great problems, so we dragged out the double-bass clarinet, and the baritone horn, not to mention the E flat clarinet and the soprano saxophone or fishhorn. I frankly doubt that we enhanced the musical stature of recording very much—about all we did was form a temporary bridge between sound and the album dealer so that a few more records ultimately could be sold.

"I somehow suspect that stereo has had a reverse effect psychologically which none of us care to

admit. Sound quality is so emphasized that it sometimes takes the edge off the performances of a truly great artist. This is especially true in the classical school. The opposite can also be said—mediocre performers, and in some instances really dreadful no-talents, can be made to sound presentable, through use of the technical advantages that stereo reproduction offers. This is true particularly of male vocalists of the popular school today. Sinatra, Como, and the premier Crosby still generate much more warmth and character on just a good old Victrola.”

“Despite all this, however, you really are all for stereo, aren’t you?” we suggested.

“By all means,” Skitch rejoined. “You must not think that I am without sympathy for ‘the new school’ in recording. What I object to (and this is purely personal) is the use of technical gimmicks to obscure a good performer, or to enhance a mediocre one beyond his or her natural capabilities. But when stereo techniques are bestowed on truly great performances, the results on playback are simply marvelous. In the magnificent opera albums put out by such companies as Angel, London, Deutsche Grammophon, and Victor, the union of the talents of composers, musicians, conductor, and engineer show the heights stereo can reach for the betterment of music. I recently experienced this at RCA while conducting a recording of *Porgy and Bess* with a brilliant cast headed by Leontyne Price. This was my first look at the stage through the sound of recording. When I listened to the playback, it was as though I were sitting in the audience. Being familiar with the stage action, I take great pleasure in being able to re-create it through the medium of sound.”

We looked in the direction of Skitch Henderson’s own stereo system. “As an audiophile, as a stereo listener at the opposite end of the chain, how do you feel about the equipment used in the home, and its performance?”

“To begin with,” Skitch replied, “there are, in the main, two general classes of high fidelity owners. There is the man with impeccable taste for good things generally. He is likely to select stereo as a piece of decorative furniture with little regard for the quality of the electronic equipment within the carved and polished cabinet. I am sure you are familiar with this type and with his choice. The visual impact of a dazzling stretch of teak or maple and an infinite number of shining dials is far more important to him than the quality of the sound which emerges from it. For him, stereo is primarily an essential part of a tasteful and well-furnished home. He is, unfortunately, carefully catered to by the ever watchful manufacturer who knows that the eyes have it before the ears do.”

“And the other class of listener?”

“Well, then you have a growing body of sincere lovers of pure sound. To such listeners, stereo is as functional and necessary as the family vacuum cleaner, and gets just as much use. Because they demand so much from equipment, they face some problems. The first of these has to do with selec-

tion. There is now an infinite variety of components available, ranging from the ridiculous to the sublime—in both quality and price. I leave *that* problem to you. But beyond that, there is installation of the equipment, getting it into position for optimum listening pleasure. This is generally more difficult than it sounds. There are those who move the rest of the room around the speakers. I am one who moves the speakers. After a half dozen or so experimental positionings, I have found the best placement for my particular room. I don’t think dead-center listening is essential for the full impact of stereo. Placing the speakers closer together has proved the most important single move in bettering my own stereo setup.”

“I notice that you have your speakers mounted on the wall. Any special reason?”

“I prefer having them that way for the slightly ethereal effect; besides, I don’t like to be in a direct line of audio fire. Placing speakers is mostly a question of personal preference, and experimentation is better than any hard and fast rules about distance from each other or from the listener.”

“What about the other components? They’re hidden away, aren’t they?”

“Yes,” Skitch said. “I don’t know about your home, but in mine turntable, amplifier, and tuner always seem to get shunted away into the smallest possible area. Right now, they’re all in a little closet, which spills over in a gallant attempt to house all those electronic boxes.”

“To return, finally, to the end product itself,” we interjected, “how does the kind of supersensitive playback equipment we have affect our listening to recorded music?”

“Well,” said Skitch, “with today’s high fidelity stereo components, a listener is in a position not only to hear music performed, but to judge the acoustical merits of the recording itself. Progress and perfection have created a record that is the summation of a myriad of talents, artistic and mechanical. This is a mixed blessing. You must trust the artist or you would not have added the record to your collection. Do you also trust the engineering skill of the men who controlled the balance and tonal quality of the sound? If so, you will merely switch on the power and adjust the volume. So many dials spun in the control booth by the expert sound men, and you as a listener can undo all their work with your modern, highly sensitive, multiple-adjuster amplifier. Just what is balanced listening? Perhaps it is also a question of personal taste, and the more dials the merrier. However, to my mind and ear, modern equipment is capable of distorting and destroying the balance of sound which was created in the studio and reproduced, with high fidelity, by recording engineers. The complexity and quality of modern recording technique make it desirable to simplify the controls on the listener’s components.

“May I reiterate that I am indeed a fan of stereo, and that I consider it a most potent innovation on the modern musical scene.”



...And
It
Comes
Out Here

*Dozens of fine speaker systems are available.
All you need is a matched pair.*

BY CHARLES TEPFER

OF ALL THE COMPONENTS needed for assembling a high fidelity stereo system, the most exciting and challenging to select is probably the speaker. The differences in sound between several models can be very apparent. And, as if this were not enough, there is an incredible variety in size and shape of enclosures, a variety that has been augmented by recent advances in speaker design—both in the cone type and the models which generate sound by new meth-

ods (such as the electrostatic and the "induction").

But whatever the design, a high fidelity speaker has one basic function: to reproduce transparently the signals fed to it by the amplifier. This is not as easy as it may seem. Ideally, a loudspeaker, like the other components of a stereo high fidelity system, should not influence the sound it is called upon to reproduce. But in fact, no speaker is completely transparent. The stuff of which it is made—paper, wood, plastic, or metal—resonates as it vibrates under the influence of the signal from the amplifier, and this resonance changes the vibrations ever so slightly. Insofar as a particular speaker has a char-

Charles Tepfer lives in a remodeled barn high on a hill. "It's good for FM reception, and it affords me a large room for listening to stereo."

acteristic sound of its own, to that extent it introduces some "coloration."

Before buying a speaker system, one must decide what type of sound he likes best and can live with. Some want, in their living room, the sound that thrills them in the concert hall. But what is this sound? Is it what they hear in the balcony or in the parquet, and at what concert hall? Jazz buffs like to perceive the texture of individual instruments, but do they like mellow or reedy sound, and how much bass do they prefer in their rhythm? Once a listener is aware of the kind of sound he wants, he can trust his ears to help select the best speaker system for him, the one whose aural presentation matches his tastes.

Of course, coloration is not the sole criterion by which to judge a speaker. Frequency response, transient response, distortion, and directionality—technically contributors to over-all coloration—are important characteristics in their own right and need to be listened for specifically.

One of the performance goals set for all speaker systems is ability to deliver the full audible range from the lowest organ tones to the highest audible harmonics. Within this range—roughly from 20 or 30 cycles per second to 20,000 cps or even beyond—a speaker should respond evenly and not discriminate against or emphasize any group of tones.

Some speaker systems attempt to do this with a single loudspeaker of the cone type. This most familiar style consists of a paper cone, magnet, and voice coil—a small cylinder containing a coil of conducting wire, attached to the apex of the cone. The cylinder, riding free within the field of the magnet, constitutes a simple motor. The electrical audio signal from the amplifier, fed to this coil, causes it and the big paper cone to which it is attached to vibrate. These vibrations generate the sound.

Many cone speakers do not reproduce the full audible range, at least not without considerable reduction in strength of the lowest and highest frequencies. If the cone is made large, say 10 or 12 inches across the opening, to vibrate efficiently at the low frequencies, it is too large to be rigid at the very highest frequencies and so "breaks up" at this range and produces spurious sounds, a form of distortion. A small cone can handle the highs, but has little ability to reproduce the long wavelengths of the low frequencies.

This is not to say that some cone speakers do not reproduce the full range. Careful selection and treatment of cone material and its shape has enabled some to do the job. One widely used technique has been to divide the cone into two parts, one stiffer than the other, separated with a flexible ridge that allows both sections to vibrate together for the lows but separates them for the highs, on which the inner cone alone is effective. A more common method is to insert a small separate cone into the large one at its apex. This "whizzer," as it is called, is

effectively the high frequency reproducer, while the larger cone handles the lows.

It isn't far from this step to the next, which is to separate the two cones into two completely independent speakers: a larger (called "woofer") for the lows, and a smaller (or "tweeter") for the highs. A frequency-dividing circuit (a "crossover network") is needed to channel the low frequencies to the woofer and the highs to the tweeter, because each speaker works best only for those frequencies for which it is designed. Further efficiencies and lower distortion can be effected by making the twosome a threesome and introducing a midrange speaker to handle the central portion of the audio spectrum. The woofer then reproduces tones up to, say, 700 cps; the midrange carries on to about 5,000; and the tweeter takes care of tones beyond that.

Tweeters which reproduce the highest frequencies present some problems. First, there is "beaming"—that is, the tendency for the tweeter to send forth its high frequency sounds in a narrow air angle directly in front of the speaker and only slightly to the sides. Then even a small cone may break up somewhat at very high frequencies. As correction for extreme directionality and breakup, some tweeters have hemispherical plastic or metal diaphragms that look like half a Ping-pong ball. Since every part of the surface of this hemisphere vibrates, sound is sent forth in all directions. Another device is the horn diffuser whose long and narrow opening spreads sound in a wide arc. One speaker has two ice-cream-cone-like forms, one within the other, to send out "smoke rings of sound" in a perfect circle around the speaker.

Loudspeakers are aided in their job by suitable enclosures. Not every enclosure will suit any speaker. An enclosure too small for the speaker bottles up the air within so that it acts as a spring against the back of the speaker cone, impeding its freedom to vibrate in direct step with the audio signal and so causing distortion. On the other hand, a speaker which might resonate at 100 cycles, producing an unusually loud sound at that frequency, may be corrected by an enclosure specifically designed for the purpose. In a word, speaker or "driver" and enclosure ideally should be matched to suit each other's characteristics.

A relatively simple enclosure is the infinite baffle, a completely closed box which approximates an infinitely large sheet of wood. This baffle would prevent the vibrations from the back of the speaker from coming around to interfere with the vibrations from the front. Such interference can produce unnatural "peaks" and "valleys" in the sound. An ordinary infinite baffle enclosure must be large (at least 6 cubic feet for a 15-inch speaker) so that the air within is not so constricted that it limits the cone's movement and thereby its bass response. Too, the enclosure must be constructed solidly of thick wood and braced internally so that it does not

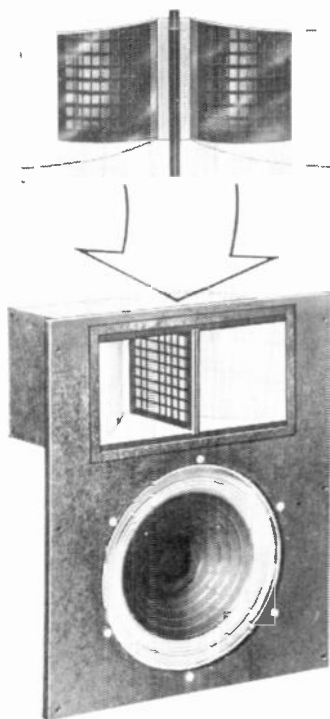

Speaker system in kit form, left, includes electrostatic tweeter and cone woofer, by Neshaminy. B310.A by Bozak, right, houses fourteen speakers in a huge infinite baffle, or sealed enclosure.

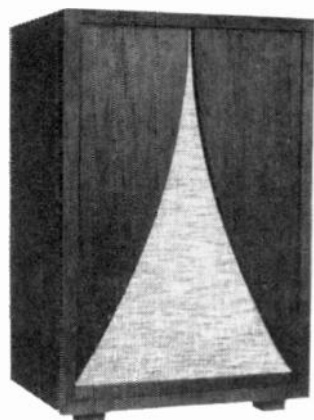
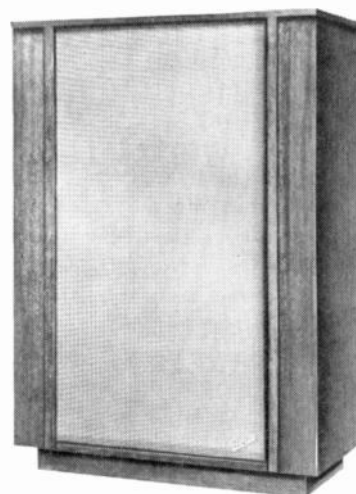

Karlson Supreme 15 employs 15-inch coaxial.

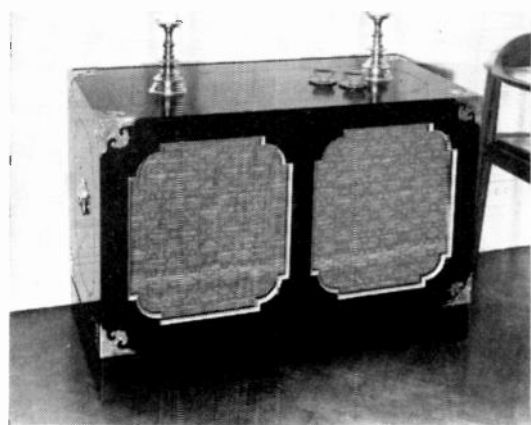

Hartley Concertmaster features 18-inch woofer.

vibrate and produce sounds of its own. The amount of bass one gets from an infinite baffle system is limited to that which comes from the front of the speaker. To get more bass a larger speaker, or more than one, may be used.

The acoustic suspension system, is, in a sense, a variation of the infinite baffle idea. It uses the constricted air in a compact enclosure as a brake on the cone, which is very loosely held to the speaker frame. The voice coil can move freely and linearly within the magnetic field to produce clean, strong bass tones.

Infinite baffle systems, of any type, radiate only half the sound that a speaker produces, the vibrations from the rear being absorbed in the enclosure. Consequently, these systems are somewhat inefficient, as compared with those utilizing both front and rear vibrations. This inefficiency is not in itself a real problem, inasmuch as there are numerous amplifiers that can furnish enough power to drive these speakers to full output.

Another type of enclosure is the bass reflex. Here, the bass frequencies from the rear of the speaker are permitted to emerge from the front of the box in step with the bass from the front of the cone. The classic bass reflex is a large box with a rectangular hole in the front under the round speaker-mounting hole. The degree of separation of the two holes and the sizes of the reflex "port" and the box are all carefully calculated to get the in-step reinforcement of rear and front vibrations.

There are several variations of the reflex idea which allow the enclosure to be made relatively small. One of these is the use of a ducted port (that is, a cylindrical or rectangular tube or shelf within the enclosure that lengthens the path the rear sound waves must travel before they arrive at the port). This delay provides an effect similar to that obtained with a larger cabinet.

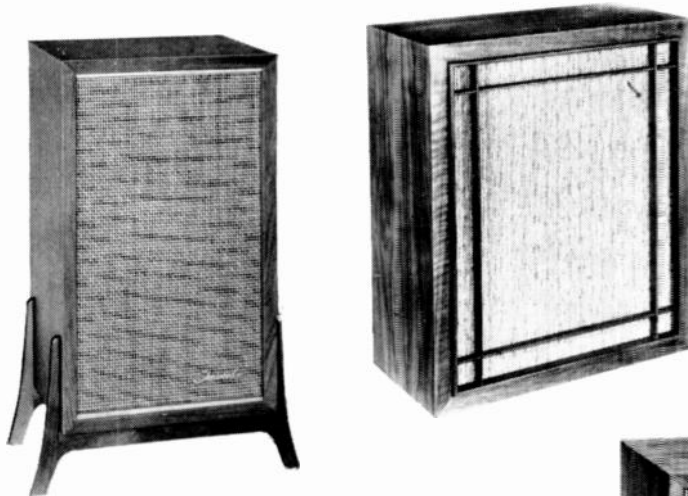

W90 is Wharfedale's largest A-chromatic system; two woofers.

Sherwod Ravinia is compact, full-range system.

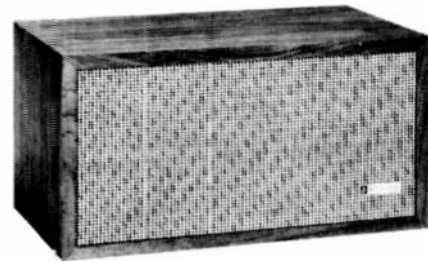

Knight KN-1284 is enclosure for 8-inch speaker.

Reflex enclosures are popular with speaker designers because they may be "tuned" to an individual loudspeaker. Tuning can lower the resonant frequency of a speaker or compensate for variations in its frequency response. Tuning an enclosure involves adjusting the dimensions of the port with respect to the resonant frequency of a particular speaker. Instructions for doing so are furnished by those speaker manufacturers who recommend the reflex type of enclosure.

A third major class of enclosures are the horns, which are most efficient in coupling the vibrations produced by the relatively small loudspeaker to the mass of air in the room. A horn, attached to the front of a speaker, can produce prodigious bass if made long enough; a practical solution has been to fold the horn passage onto itself to confine its required length to reasonable dimensions. The sound from such a system is enhanced by placing it in a corner of the room, the walls serving as extensions of the horn. Horns are often used within a smaller enclosure for the rear of the speaker.

An attempt to make speaker enclosures as inconspicuous as possible has led to the development of the ultrathins—complete speaker systems only about five inches thick. Some—very light in weight—are meant for hanging, and may feature a tapestry for the grille cloth.

Thin enclosures require thin loudspeakers. To get minimum depth, some speakers have a flat "cone"—actually, a disc of polystyrene foam that is light and rigid enough to respond to audio signals without diaphragm breakup. Others of this type use magnets of thin, but reliable, structure.

Also flat in shape, but operating on an entirely different principle, is the electrostatic speaker. Here, a thin sheet of foil-like material is the vibrating

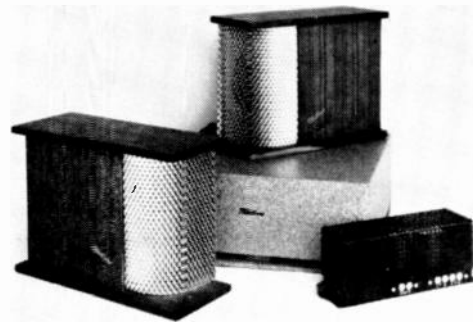

Weathers speaker system employs a compact bass unit and stereo tweeters; uses special network.



J. B. Lansing Energizer-Reproducer is company's speaker system fitted with solid-state amplifier whose output is tailored to speaker response.

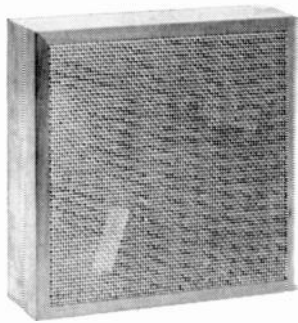

Electrostat 5 from Radio Shack employs electrostatic tweeter and cone woofer; compact system.

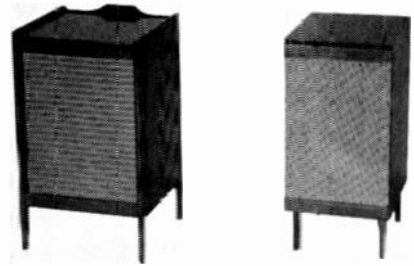

Heathkit AE-40 enclosure, left, takes a 15-inch speaker; Model AE-30 accommodates 12-inch driver.

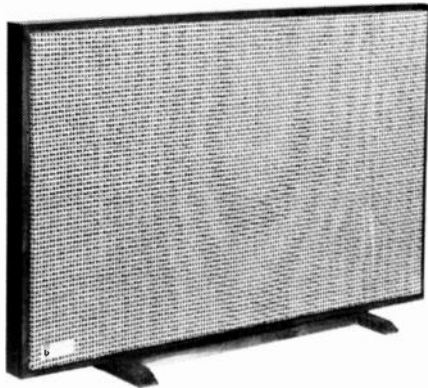

University Tri-Planar is very narrow, three-way reproducer; sound radiates from front and rear.



Newest reproducer from Fisher is Model XP-10, a three-way system of medium size; 15-inch woofer.

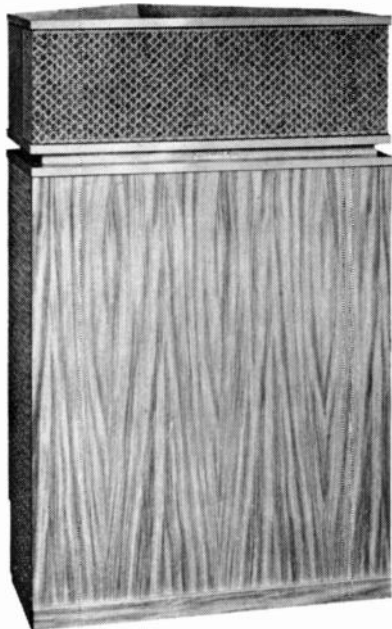

Klipschorn is huge folded horn for corner placement; bass comes out from sides, treble from top.

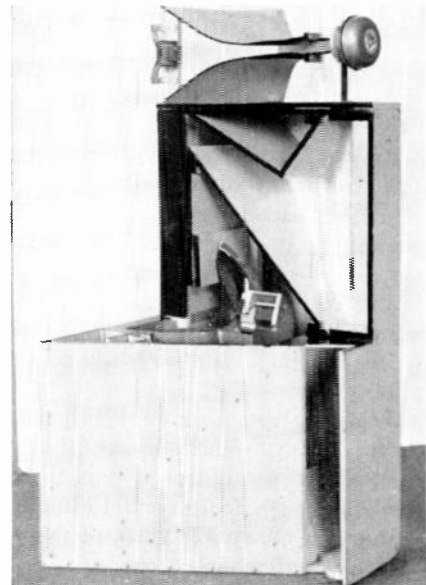

Cutaway view of the Klipschorn shows part of complex interior which forms horn for woofer.

element: this diaphragm moves as its electric charge, varied by the audio signal, is either attracted to or repelled by the electrostatic field of an adjacent fixed plate. Originally, this technique was used to produce some very smooth-sounding tweeters and midrange speakers, but the full-range electrostatic—covering the bass range as well—also has been introduced and accepted with enthusiasm by many.

Another new design is the “flat induction” speaker which uses conductive tape or printed wiring as the “voice coil,” laminated to a large flat panel which is the vibrating element. An enclosing magnetic field causes the panel to vibrate in response to the audio signal from the amplifier.

One interesting tweeter, the ionic, uses no solid vibrator. Instead, the air within a small quartz tube is ionized, and the ions are made to vibrate by the audio signal. These minute vibrations are coupled to the air mass in the room by a short horn. The response of this speaker over the high frequency range is remarkably smooth. No full-range ionics have yet been produced, however.

The advances in speaker design are intended to reduce various forms of distortion that mar listening pleasure. One of the most disturbing is transient distortion. For example: brass fanfares, which should be exciting—martial and sharp—are slurred into one another and linger on past their optimum time if a speaker system has poor transient response. The cause may be a deficient speaker whose vibrator keeps moving after the signal producing the movement has stopped, or a badly matched enclosure. If oscillations from abrupt transient signals are not damped by the enclosure-speaker combination, ringing, spurious sounds unrelated to the program material result.

Another form of distortion due to speaker-enclosure mismatch or poor enclosure is bass boom (unnatural emphasis and indistinctness of the lower frequencies). A good enclosure avoids this by depressing the natural resonant frequency of a loudspeaker so that any excessive resonant vibrations will occur below the normally audible range or at a frequency too weak for the speaker to reproduce.

These and some other types of distortion (harmonic and intermodulation) prevent poor speakers from realizing pure tones and clarity throughout the sound spectrum. An excellent standard by which to judge speakers is the sound of live instruments. The prospective buyer should attend “live” concerts and fix in his memory the sounds of the ensemble and of the different instruments, particularly plucked violin strings, sharp unpedaled piano chords, and the tone texture within a crescendo. He should also test the speaker system with familiar but complex, and therefore demanding, music on a good recording. Is the sound pleasing? How does it compare with what the listener remembers from the “live” performance? Are the individual instruments clear and undistorted? Are percussive entrances sharp, plucked strings clearly articulated? A pure tone test record can be very effective for checking the uniformity

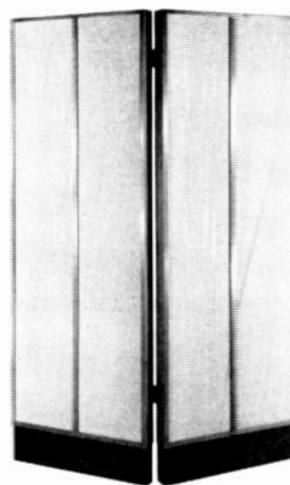

Model Nine, by K.L.H., is full-range electrostatic: panels may be separated for stereo spread.



Electro-Voice's Georgian 400 is four-way system designed for corner placement: 18-inch woofer.

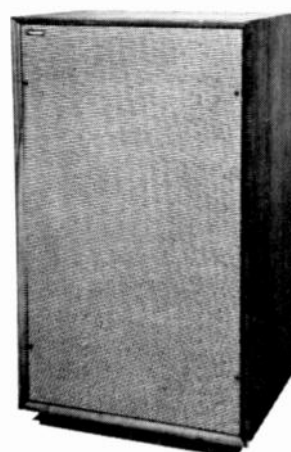

Tannoy offers front horn-loaded enclosure separately or with its own Monitor speaker installed.

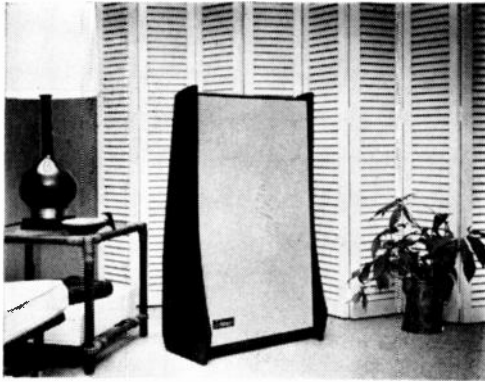

J. Harned speaker is a full-range electrostatic.

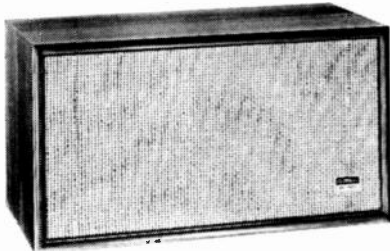

Electro-Voice EV-Two is a full-range compact.



One of a new line of compacts by Argus-X.

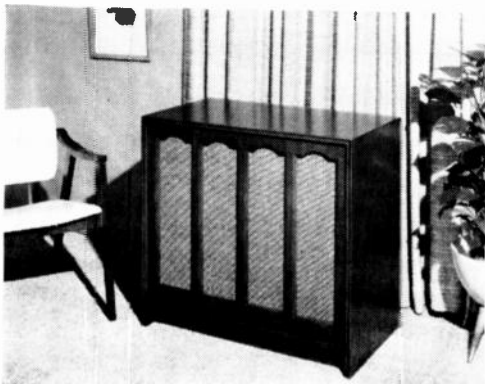

EV-Six by Electro-Voice has 18-inch woofer.

and width of frequency response of a speaker. Test records include a section in which the entire audio spectrum is played or "swept" from one end to the other, an excellent means for detecting bass boom and resonances.

Once two or three speakers are selected as satisfying, they should be compared to each other, at the same volume and through the same amplifier. The comparison may make apparent some weaknesses in one or another not previously perceived.

Sometimes a speaker that seems "live" in a store may sound less than ideal in the home. A room with draperies, rugs, and upholstered furniture may absorb too much of the high frequencies and decrease the sparkle in the music. Lots of glass, wood paneling, and hardwood floors may bounce the highs around too much, making the sound unnaturally live. A speaker on the floor in a corner of the room may sound excessively "bassy," while one hung up on the wall or placed in a bookshelf may lack bass. The listener should spend some time in speaker placement and room arrangement if he is to get the best sound his music system can deliver.

The two speakers in a stereo system should be identical, or at least employ midrange and tweeter units that have similar response and dispersion characteristics—in order to facilitate balancing them in the room. Sometimes dissimilar speaker systems can provide acceptable stereo, but this would presume that their relative imbalance matched a particular acoustic imbalance in the room—a condition that would be impossible to predict and which, in any case, involves calculations best left to the professional sound man in a studio. For installations at home, matched speakers are the rule.

Setting up a pair of speakers for stereo involves connecting each to the correct amplifier output and then balancing the volume from each. An easy way to balance the two speakers is to play a monophonic record (or a stereo record as if it were mono) through each in turn, adjusting the two for equal sound. This adjustment may be made with the amplifier controls. If balancing indicators are desired to assist the ear, they may be purchased in electronic parts and audio stores.

Considerations of décor and room acoustics also should be taken into account for an optimum stereo installation. In most normal-size rooms the two speaker systems will provide fine stereo when they are placed along one wall, and spaced about six to ten feet apart. Installing the speakers along one of the shorter walls will enhance the bass because of the reinforcement provided by the adjacent walls. On the other hand, some speakers in some rooms may sound boomy when so arranged. Or, the furnishings in the room and the placement of shelves, cabinets, and chairs may dictate that the speakers be placed against the long wall. If so, the strongest bass will be heard if the speakers stand directly on the floor or—if they are compacts—can be installed near the ceiling (again, such placement takes advantage of adjacent surfaces to reinforce the low



University Classic is three-way system.

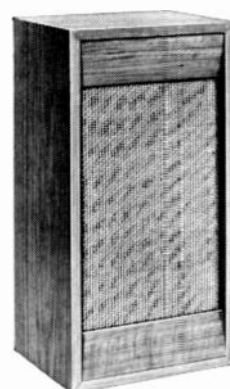

Model S-3 is one of line of compacts from Scott.

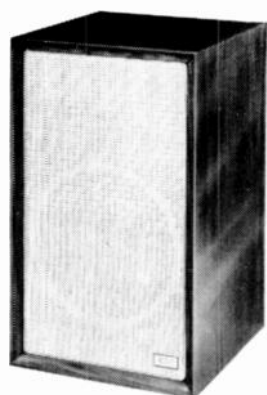

KSC is recently introduced compact system. Below, the new stereo pair from Grado Labs.

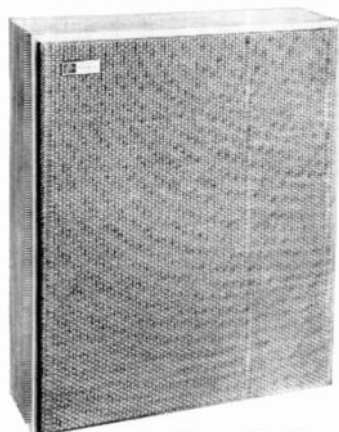

New slim-line kit from Fisher, the KS-2.



Novel idea from University, below, is detachable decorative grille cloth.



Heatbkit AS-21 uses Altec drivers.



E-V Coronet, below, uses 8-inch speaker.

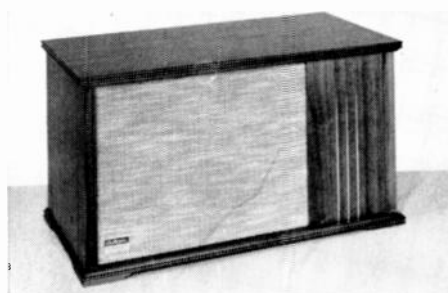

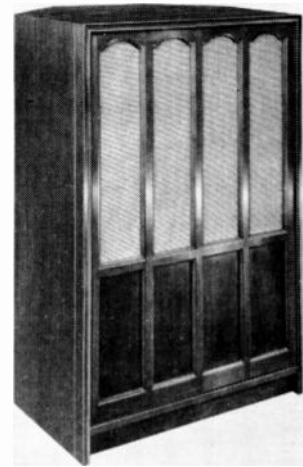

EMI model 711A, above, is one of several new compacts offered by Scope Electronics. Left, the Bel-Aire by Frazier, full-range in the thin-line style. Right, the Patrician 800, latest version by Electro-Voice.

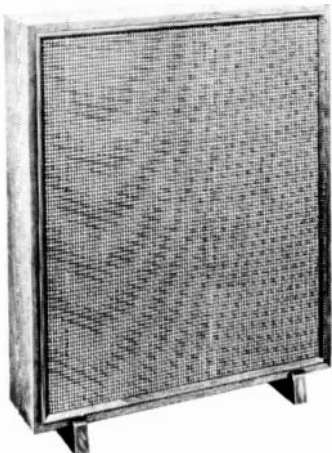
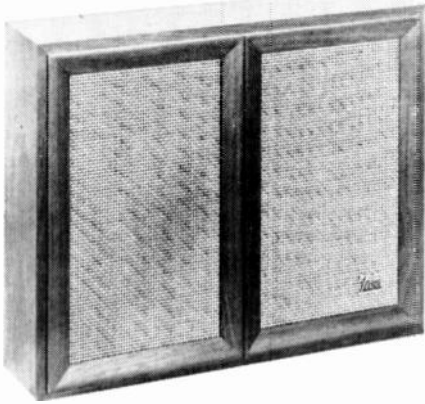

Lafayette Decor-ette includes five drivers in thin cabinet; may be placed on floor or shelf.

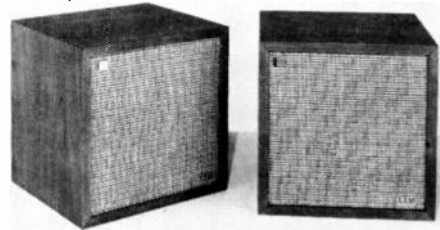

Korvette's XAM-1D is a compact, two-way system.

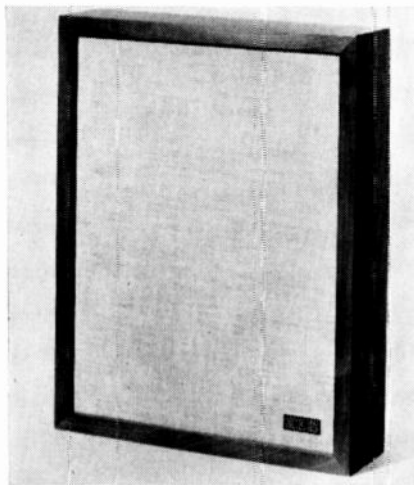

KLH Model 14 uses special network to get full response from a pair of three-inch speakers.

frequencies). Obviously, the critical listener would do well to experiment with speaker placement in order to achieve tonal balance in a particular room, using a given pair of speakers. Such seemingly bizarre tricks as facing speakers into a corner or directing them at reflector panels have been used to good effect. Draperies, floor coverings, and ceiling materials may be used too, if the room ambience severely affects listening pleasure. For example, if there is a predominance of high frequencies at particular parts of the room, draperies may be hung on the nearby walls to absorb a portion of these highs. Upholstered furniture is an effective low frequency absorber. A wall-to-wall floor rug will reduce an over-all liveliness, if this is desired. Finally, it should be remembered that, in addition to the use of absorbent and reflecting materials to correct spotty conditions within a room, the tone controls on an amplifier as well as the controls found on some speaker systems can be adjusted to help achieve a satisfactory tonal balance.

Stereo speakers must also be "phased": that is, the diaphragms must be made to move in and out together. For proper phasing, play monophonically a record with extremely low bass passages. Listen to the bass and then reverse the leads at one speaker only. If the bass increases, then that is the proper



Jensen TF-4 is thin-line four-way system that may be installed in a number of different ways.

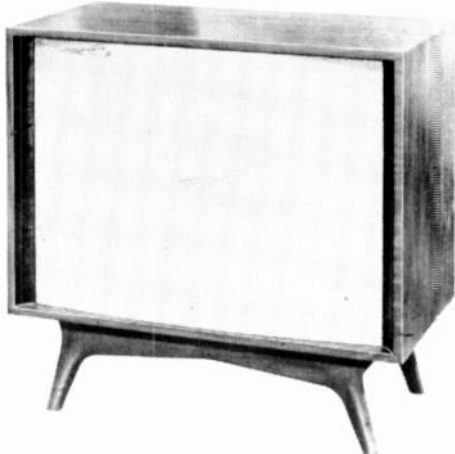

Altec Carmel is floor-standing infinite baffle system with two woofers and horn-loaded tweeter.

connection; if it decreases, the original hookup was correct. If your amplifier has a phasing switch to reverse the connections to one speaker, you need not of course bother with the speaker leads. Another way to check phasing is to play a mono record with both speakers connected for stereo. Listen at a point midway between the speakers and then move slightly to one side. If the speakers are in phase, the sound will remain between them and not shift from speaker to speaker as you move about.

A final word concerns the "center channel" speaker, useful for filling an acoustic "hole-in-the-middle" when the two regular speakers are too far apart and—according to some experts—desirable in any stereo system to beef up the sound, add depth to the stereo presentation, and widen the acoustic perspective to increase the area for optimum listening. This center speaker should be connected to the center-channel output of the stereo amplifier, if one is provided. Otherwise, connect one speaker lead to the 4-ohm terminal of the right-channel output and the other lead through an audio level control to the 4-ohm terminal of the left-channel output of the amplifier. Use the level control to adjust the center speaker to balance with the other two. For other methods for obtaining a "phantom channel" signal, consult your audio dealer.

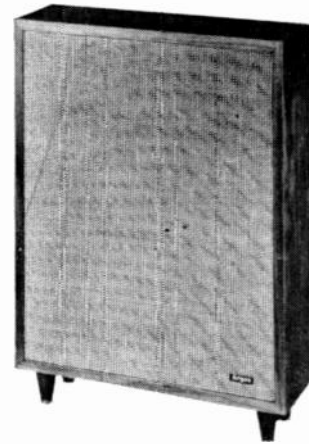

Argos Contempora is a thin-line system that employs three drivers, including a 12-inch woofer.

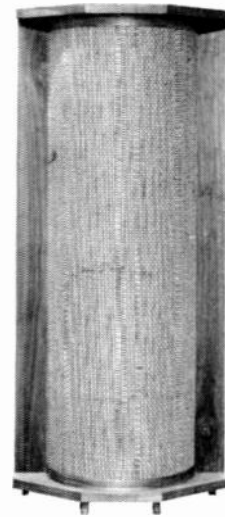

Model LH-500 Concert Master by Leonhardt is designed to radiate sound over very wide angle.

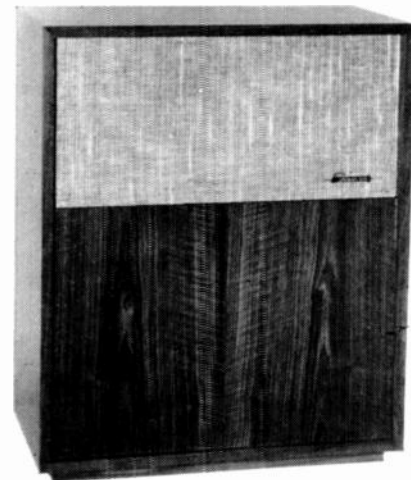

Latest model from Sherwood is the medium-size Tanglewood, four-way system with five drivers.



Stereo

ON TAPE

BY ROBERT SILVERBERG

A DOZEN YEARS ago, a tape recorder in the home was an unusual sight, a plaything for the gadget-minded and adventurous. Today, the tape recorder is ubiquitous, and is proving itself a vital adjunct to any home music system.

Tape recorders are versatile instruments. In their playback capacity, they give the listener access to the opulence of sound offered by a wealth of superb, commercially recorded ("prerecorded") tapes. As recording devices, they enable one to capture, and release at will, a live performance, or some musical rarity on an out-of-print disc, or an FM program otherwise forever lost.

Robert Silverberg writes science fiction and educational texts, but he perennially returns to music and audio for Stereo and for High Fidelity.

But the audiophile who shops for a tape machine today must decide many things. Shall he get a tape deck, or a completely equipped self-contained unit? Two-track or four-track for recording? What speeds shall his machine have? What kind of tape shall he buy—Mylar or acetate? What thickness, what length? Would a "playback-only" tape machine be suitable, or is a "playback/record" facility necessary? Is a \$450 tape recorder really three times as good as a \$150 one? What are the merits of cartridge machines versus manual-thread or "reel-to-reel" models? Actually, the tape recorder situation isn't as complex as this barrage of questions suggests. Let's begin with the basics.

A tape recorder is a device that converts sound into electrical impulses, which are magnetically imprinted on a narrow strip of coated plastic tape. In playback the magnetic information is reconverted to electrical signals which then are amplified and heard via loudspeaker or headphone.

The accuracy with which the tape recorder per-

With a tape recorder you can record your own or listen to the work of professionals.

forms its function depends, of course, on the quality of its recording and playback heads, its mechanical construction, and its electronic components. The \$20 machine you buy in a novelty store cannot be expected to have high-quality parts. The \$25,000 machine used to record signals from space satellites is a paragon of quality and sensitivity. The amount you spend will be somewhere in between, naturally. But how high do you need to go in order to get high fidelity quality?

It depends on what you're looking for, and on what you consider a minimum quality level, and on the state of your bank balance. Some tape machines provide only playback of recorded tapes, others both play back and record. Some have speakers, some don't. Others, equipped either for playback or recording, are designed so that the other function can be added later.

The basic item of equipment is called a tape deck. It consists of a tape transport (the mechanism for moving the tape), tape heads, and whatever "electronics" are included for playback and/or recording. The deck has no power amplifier or speaker system. To be used, it must be connected to an external sound system or to headphones. If you already have a suitable high fidelity component system, the tape deck is generally your best buy, since you have no need for the power amplifiers and speakers that come with a "complete" tape recorder package. The complete tape package, of course, will permit you to play back what you have recorded "on-the-spot," away from your home sound system—a possible advantage for some users.

If a deck is your choice, you will obviously pay more for a playback/record deck than for a playback-only model, other things being equal. But if you want to make the fullest use of your tape recorder, you will need the record as well as the playback facility. A playback-only deck has just one function: to reproduce a tape previously recorded on another machine. It might seem strange that anybody would want so limited an item, but it serves a definite need: that of the music-lover who has no interest in making his own recordings, but who collects and plays "prerecorded tape," that is to say, tape on which music has been professionally recorded for commercial sale. Thousands of such tapes are available, containing operas, symphonies, cham-

ber music, lighter classics, and "popular" music. Despite their higher cost, vis-à-vis the same selections on disc, prerecorded tapes appeal to many because of their clean sound initially, plus the fact that tapes are not subject to the scratches, dust damage, and natural deterioration inflicting discs. A prerecorded tape, if handled with care, will sound as good on the hundredth playing as on the first; a disc will not. This extra element of quality only a few years ago commanded a staggering premium—an hour-long prerecorded tape program cost three or four times as much as the equivalent stereo disc—but the price differential has narrowed and probably will continue to do so, as prerecorded tape becomes more of a "mass-produced" commodity.

A "complete" tape recorder includes a record/playback tape deck plus power amplifier and speakers, generally mounted in a carrying case. A unit of this sort provides an added degree of flexibility, since it can be used anywhere, and does not have to be connected to a home music system to be heard. Of course, its sound will be limited by the capabilities of its built-in speakers. An improvement almost always can be realized by connecting the recorder into a high quality audio system so that the output from the recorder's playback preamplifier feeds the external amplifier. Instructions for making such a hookup generally come with the recorder, but if not, your audio dealer can help you.

Tape recorders offer a variety of speeds, from 15 inches per second on "professional" machines down to 1 $\frac{7}{8}$ ips on the cheapest models. The faster a tape moves past a head, the less information there is packed into each inch of tape—and the sound quality increases as the amount of information per inch of tape decreases. Time was when tape enthusiasts insisted that only at 15 ips could the full range of the musical spectrum be properly recorded, but recent technological advances have made full frequency recording and playback possible at 7 $\frac{1}{2}$ ips. The better machines provide acceptable sound at 3 $\frac{3}{4}$ ips, and even the slowest of speeds—1 $\frac{7}{8}$ ips—has been demonstrated as capable of surprisingly good sound—in fairly costly machines.

Most tape recorders sold today offer two speeds, customarily 7 $\frac{1}{2}$ and 3 $\frac{3}{4}$ ips. The cheaper makes and the battery-powered portables provide 3 $\frac{3}{4}$ and sometimes 1 $\frac{7}{8}$; these machines, while useful, are not



Roberts 330 has built-in monitor speakers.



Eico 2400 is available as kit or prewired.

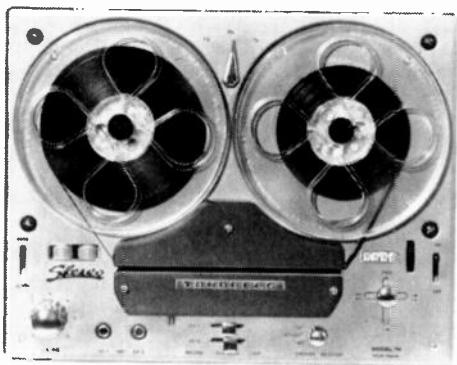

Tandberg model 74 is record/playback deck.



Model AD-22 from Heath is tape deck in kit form.

high fidelity instruments. The standard speed for prerecorded tapes is $7\frac{1}{2}$ ips, and in making your own tapes you'll also need to use that speed for best results in recording music. The slow speeds are suitable for taping spoken material and in making dubbings of old, narrow-range recordings where extended response is not needed. They also are used in tape cartridges, more of which later.

The amount of sound that can be recorded on a given length of tape depends not only on the tape speed but also on how many tracks can be recorded in the $\frac{1}{4}$ -inch width of tape. The early tape recorders were "two-track" monophonic machines. The tape passed through from the left spool to the right; when it came to its end you flipped the spools over and played it through again. This provided a "Side One" and a "Side Two" which were actually on the same side of the tape, since the uncoated reverse side is never used.

These early two-track tapes were all monophonic. But the possibilities inherent in two-track recording led to the development of stereo tapes in the mid-Fifties: the upper half of the tape contained the sonic information of one channel, the lower half the other; the tape played through in one direction, giving a stereo response.

The trouble with this was that it halved the amount of music one tape could contain. Two-track mono recording permitted an hour of recording at $7\frac{1}{2}$ ips on a standard 1,200-foot tape; two-track stereo, only half an hour. This was fairly expensive, but the four-track breakthrough several years ago changed all that and made prerecorded tape for the first time a moderate-priced item.

In four-track recording, tracks 1 and 3 (counting down from the top edge of the tape) provide stereo in one direction of tape travel; when the tape is reversed, tracks 2 and 4 continue the music in the



Benjamin Truvox PD-100 is record/play deck.



Magnecord 728 takes professional size reels.



Viking 88 Stereo Compact supersedes model 86.



Korting TR-4000 copies tapes as it plays.

opposite direction. By reducing the width needed for a track, engineers have been able to squeeze the four tracks onto the same $\frac{1}{4}$ -inch-wide tape. A further attempt to increase playing time, or reduce cost, or both is the use of four-track tape at $3\frac{3}{4}$ -ips speed. This tape contains exactly four times as much music as the two-track stereo tape at $7\frac{1}{2}$ ips. For a while, prerecorded tapes appeared in four-track at both speeds—although the standard prerecorded tape today is four-track, $7\frac{1}{2}$ -ips. Monophonic prerecorded tapes are extinct; two-track stereo tapes are rarely issued; four-track $3\frac{3}{4}$ -ips tapes are available in cartridge form. The newest thing is stereo at $1\frac{1}{8}$ ips—again, however, available only in a special cartridge which is intended for use on a particular machine.

The novice tape recordist would do best, in my view, to equip himself with a four-track machine. It will enable him to play the current prerecorded,

as well as the older two-track, stereo tapes. Even if he simply plans to make his own home recordings, using four-track equipment cuts the cost of raw tape in half by doubling recording time per reel.

Which brings us to the tape itself. A dozen or more manufacturers produce tape of two main kinds and in a variety of sizes and thicknesses. One type is made with a cellulose-acetate backing; the other, with a Du Pont-made polyester-film backing trade-named "Mylar." The Mylar tape is tougher and more durable; acetate is cheaper, nearly as robust, and easier to splice. Sonic response can be fine with either kind.

The customary tape reel is of 7-inch diameter (though smaller reels are available); a few machines can handle larger reels. A "standard" (1.5-mil-thick) 7-inch, 1,200-foot acetate reel is good for an hour of $7\frac{1}{2}$ -ips taping in four-track stereo. Mylar's greater strength permits the manufacture of 1-mil



Norelco 401 has two speakers, one in cover.



American Concertone S505 reverses tape travel.

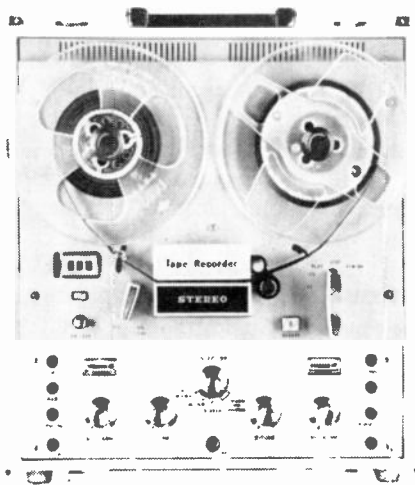

Intermark Cipher VII has detachable speakers.

tape, of which 1,800 feet will fit on a 7-inch reel—thus permitting an hour and a half of four-track 7½-ips stereo taping. Also available is an extra-thin, extra-long Mylar tape—½ mil, 2,400 feet to the reel—yielding two hours of four-track stereo at 7½-ips speed or four hours at 3¾ ips. Both this and the 1-mil acetate tape have certain disadvantages that may override their economic strong points. Acetate tape breaks fairly easily, and may deteriorate chemically over a period of decades. Mylar tape is subject to stretching under stress and is not as easily spliced as acetate. The best way to determine your own preference is to sample various kinds, judging them in terms of your particular tastes and needs.

Even within the general tape type, the price can vary astonishingly from brand to brand, with some tape selling for little more than \$1.00 a reel, other labels at \$5.00 or so. (These are prices for raw, blank tapes, remember—not the prerecorded kind.) Although you need not use the luxury-price tapes only, you should be wary of extremely cheap ones. The bargain or unbranded tape may have technical flaws that can result in distorted recordings or, worse, actual damage to your tape recorder.

No matter what kind of tape you use, you'll have to master the knack of threading it through the machine, which calls for some digital dexterity—that is, if you use an "orthodox" reel-type recorder. If you find fooling with tape spools too much trouble (though it's not really all that difficult) you may want to investigate the various tape cartridge recorders now on the market.

A tape cartridge machine is as simple as a phonograph changer. You have no tape to thread, no spools to fiddle with. Both supply and take-up spools are housed within the cartridge; when you place the cartridge in its slot, spindles automatically go to work and the tape is played. Prerecorded tapes supplied by the cartridge manufacturers generally move at 3¾ ips, and the music is recorded with considerable fidelity—more, in fact, than the rather limited playback facilities of the present cartridge-type machine can handle. Prerecorded cartridge tapes played back through external amplifiers and wide-range speakers have produced creditable sound, often hard to distinguish from 7½-ips reel-type tapes.

A recent development in the cartridge field is a 1⅞-ips cartridge machine offered by Minnesota Mining's Revere Camera subsidiary. This unit provides recording and reproduction at half the speed of earlier cartridge machines. The sound quality, for 1⅞-ips speed, is astonishingly good, and betokens, therefore, further developments from competing manufacturers.

The whole cartridge idea is an appealing one for many people; the tape need never be handled, there is no danger of spill-over or breakage, and even the most fumble-fingered can operate the machine. At the moment, though, the cartridge machines, in general, hold a status vis-à-vis the better



American Concertone 605 has push-button controls.



Magnetophon M97 is new entry from Telefunken.



The new Revere-3M automatic cartridge recorder.

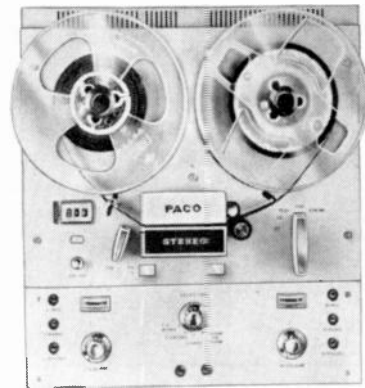

Paco's first record play tape deck.

The Care and Feeding of Tape Recorders

A tape deck or recorder may get along for many years with no nourishment other than electricity. But even a small amount of spoon feeding (fifteen minutes a week is enough) will keep it running smoothly until obsolescence suggests its retirement.

During normal operation of a tape machine, oxide deposits (as well as dirt and oil) tend to adhere to the magnetic heads, capstan, guide bolts, pressure pads, and rollers. This results in erratic tape movement, loss of high frequency response, and incomplete erasure, all of which can be avoided by a program of "preventive medicine."

Use a soft cloth and denatured alcohol (or carbon tetrachloride, if you keep it away from synthetic rubber rollers) to remove all deposits from the capstan, guides, and rollers. In cleaning the heads, take care not to scratch or displace them. If the felt pressure pads remain packed or glazed in spite

of a good cleaning, rub gently with a nail file to restore the nap.

A small amount of silicone oil may be used on squeaky switches and slides, and the drive motor should be lubricated if the manufacturer recommends it, or if oil holes are provided. But under no condition should any oil touch the capstan or pressure rollers—unless you want to go through the entire cleaning procedure all over again.

To keep the noise and distortion levels at a minimum, occasional demagnetization of the heads, especially on machines used primarily for recording, should be made part of the standard cleaning procedure.

A final check to make sure that the ventilation screens aren't clogged and that all cords and cables are connected properly, and your work is done. This little bit of tender loving care will keep your tapes and tape machine making sweet music together for many years to come.



Sony Model 500 has detachable speakers.

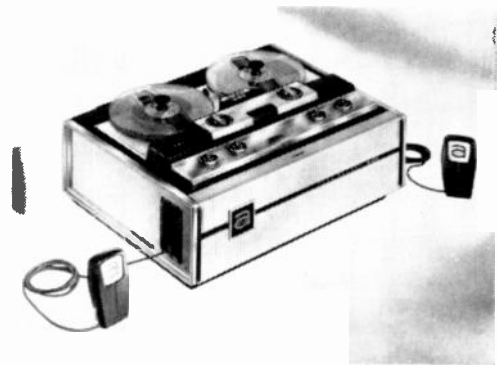

Argus 800, a new entry by the camera company.

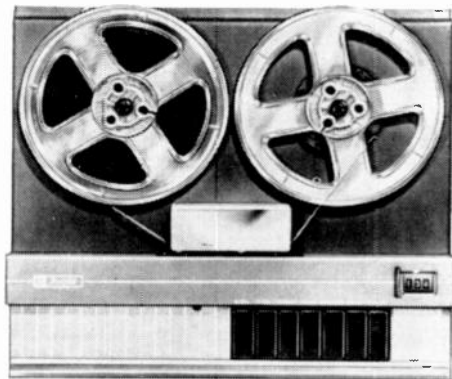

Knight KN-4000 deck uses push-button controls.



Roberts Crossfield 770; special 17/8-ips speed.

7½-, 3¾-ips playback/record tape decks roughly equivalent to the relation of the packaged stereo phonograph to the individual-component audio system. But each year brings new advances in tape technology, and perhaps there soon will be a cartridge system that matches in performance, and exceeds in convenience, the best of the current reel-to-reel tape recorders. This will not render existing reel-to-reel machines obsolete, naturally, and there will be many who will continue to prefer them for substantial reasons (the chief one being ease of editing as compared with the cartridge type).

Once you have chosen your machine and have it installed, there remains the challenge of using it. Making home recordings involves mastering a fairly intricate technique, but the results are well worth the effort.

First, do not try to record the sound of the radio through a microphone; you will pick up extraneous household noises (barks, coughs, telephones, doorbells) and will lose a fair amount of the broadcast signal. The job is better done by tapping off the signal directly from its source. The closer to that source the tape is made, the more accurate the recording will be. In recording an FM broadcast, the ideal place to tap from is the tuner itself; most tuners today are equipped with tape output jacks for just this purpose. It is simpler, though, to tap the preamplifier or combination amplifier, which will also probably have a tape output. Hook your recorder in at that point and you can make tapes from your phonograph as well as from the tuner without a separate link each time you want to record. (When playing your tapes back, you will, of course, feed the signal through your main audio system by connecting the recorder's output to a suitable jack on the main preamplifier or combination amplifier.)

While making a recording, it's helpful to know whether the signal you're taking down is coming through undistorted. Most tape recorders have some



Vernon 47/26 includes amplifiers and speakers.

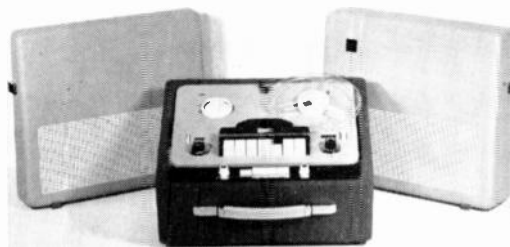

United Audio Dual and its detachable speakers.

sort of built-in indicator that will tell you if you are over-recording (feeding too much signal to the recording head, causing distortion) or under-recording (not feeding enough signal, allowing the underlying and irremovable noise on the tape itself to mask what you are recording). These meters provide an approximate idea of what's getting onto the tape, but the "magic eye" devices on the cheaper machines often give such a vague report that they're hardly any use at all. A better way to monitor the recording while it is in progress is to hook in a pair of headphones; you can listen along, and make control adjustments as necessary. Another means of monitoring, possible when a machine has separate recording and playback heads, involves hooking things up so that the just-recorded signal is immediately played back through loudspeakers. (Instructions for these hookups come with the recorders.)

A tape recording is only as permanent as you want it to be. Whenever you weary of it, you can wipe the tape clean simply by recording directly over its contents; the new recording will automatically erase what lies beneath. For this reason, incidentally, be sure before recording on a tape to check to see what, if anything, it may contain; otherwise you may find that you've obliterated something precious by accident. Erasing a tape unintentionally during playback is impossible: erasure only takes place when the recording head is in use. Perfectionists, by the way, are not content to erase tapes by recording over them, since this leaves a minute quantity of residual noise that tends to accumulate with repeated erasures. For the particular, there are bulk erasers available which will degauss (demagnetize) a tape swiftly and effectively in a single swoop.

Tapes can be edited with remarkable ease. If you are recording a live concert and decide you don't want to preserve all the applause for eternity, you can snip it out and join the cut ends of the tape



Wollensak W1980 deck and mating preamps.



Freeman 200 recorder in C-246 cabinet.



Lafayette RK-600WX has speakers at sides.



Freeman 600 with speakers along the sides.



Miranda Sorrento comes with teak cabinet.



Viking's Retromatic 220 reverses tape travel.



Uber Royal fits into compact carrying case.

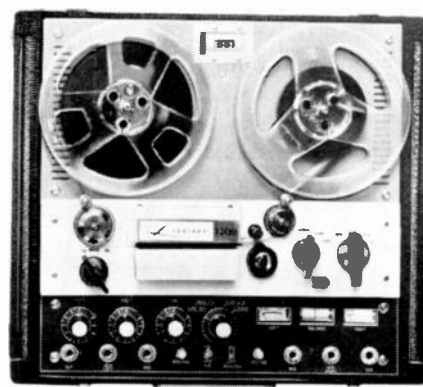

Lincor 1200 features three signal meters.



The F-44 deck, new from Ampex, in its case.



Telectro SS500W-A with speakers and cabinet.

with special splicing tape. A tape that snaps in use can be repaired the same way. And you can assemble one tape out of several, selecting sections here and there and splicing them together.

A novelty whose popularity has been on the increase since the advent of the stereo tape deck and recorder is "sound-on-sound": the separate channels of the stereo recorder are used to take down two different signals, which are then combined. If you like, you can tape music in one channel, and add your own playing and singing in the other, creating amusing and even musically interesting trick effects. Not all tape recorders, even of the stereo species, are equipped for sound-on-sound, be it noted. Such diversissements require a machine that can dub one signal onto another without erasing one of them.

Even more up-to-the-minute is a tape deck that can make a copy of an existing tape on a fresh, blank one. Until recently, it was impossible to do this without using two tape recorders—and usually some of the highs and lows got lost in the copying process. The latest arrival on the tape scene, however, is an unusual tape recorder with built-in tape-copying facilities, and the idea is such a good one that it will probably have a host of imitators before long. The pioneer is Bell Sound's Model RT-360, which is an orthodox tape deck plus a pair of out-board reels and a special head assembly; a tape can be played in the regular way and simultaneously copied onto another reel.



Sony 777, with remote control, from Superscope.

In shopping for a tape recorder, you may, at this point, find such an accessory superfluous. But there are other gadgets that are highly desirable, even for the neophyte. An elapsed-footage counter, for instance: this built-in device helps you to note down the precise location of a specific selection on a given tape, and will save you hours of hunting through your collection. Fast-forward and rewind speeds, which are present on all but the cheapest of tape recorders, enable you to range rapidly through a tape to find a special item. An automatic shut-off switch, stopping the motors when the tape has run entirely off one reel, saves wear and tear on the tape and on the machine. Monitor headphone jacks, volume level indicators, and output jacks enabling a hookup with external amplifiers and speakers are all desirable features.

Adding a tape recorder to your home sound system involves some forethought and a little homework. Choosing the most satisfactory type of machine is an individual matter, depending on your particular purposes, tastes, and budget. To do without a tape recorder entirely, though, is to forego one dimension of music in the home: permanence. In hundreds of cities, FM stations offer a stunning wealth of broadcast treasures, which, but for tape recorders, would be lost forever after the moment of hearing. All over America, the reels are turning, and music is coming forth—yesterday's broadcast has become today's lasting heritage of sound, via the magic medium of tape.

Sound Can Be Sightly

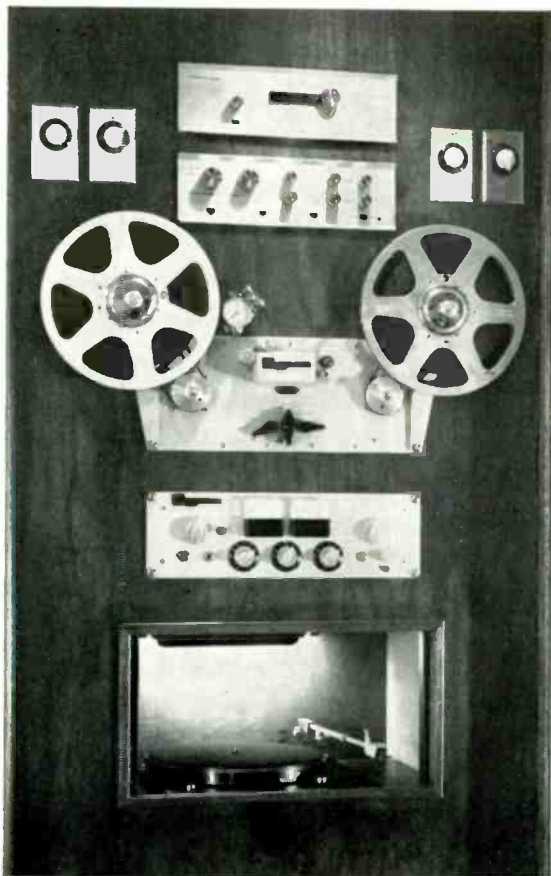

For his installation, Manuel Blumkin, owner of Mannie's High Fidelity and TV Shop, Las Cruces, New Mexico, designed a complete storage wall, using shelves, vertical partitions, a built-in for the audio control center, and special lighting. Close-up, at left, of the audio center indicates how tuner, preamplifier, tape deck, and turntable were installed.



THE INSTALLATION for a stereophonic system, like modern dentistry, can be not only sightly but even relatively painless: it can satisfy a living-and-décor need in the home without being a strain on the family budget. The happy fact is that at last—and about time, too—the home music system no longer need be hidden away on the floor. It is now most often seen on shelves, or in cabinets, or as part of a “music wall.”

Like our rugged cave fathers, who used their stone walls for storage of spears and other family accouterments, we too make use of our walls to store some of our possessions. And we cannot make claim to having invented the entertainment wall, since cave murals are so well known. But what we

Susan Ritchie, part-time decorator and full-time housewife, for ten years has been teaching others and herself to learn to live with audio equipment.

BY SUSAN RITCHIE

can really boast is that *our* walls "talk." Gone is the early concept of a radio console placed against a wall with the inevitable nostalgic print of Venice above; today our entertainment walls literally "come alive" with sound, color, and individuality.

The stereo walls we create in our living rooms, family rooms, or wherever, can be geni-of-all-work. They play music, they provide storage, and they can at the same time be a source of visual joy. To conjure up this work-play wall, you don't need Aladdin's magic lamp—just a little mental "elbow grease" on your part is enough.

By way of looking in at the happy integration of stereo components with normal family surroundings, let's first analyze the requirements of any room about to be equipped with a stereo system. The installation, basically, consists of two speakers and the necessary components—amplifier, turntable, tuner, tape recorder—to drive them. Naturally, the speakers must be separated for that "stereo effect," but all the other equipment can be grouped together. The discerning stereo listener will consider speaker placement first, inasmuch as it can influence the sound—but even this requirement can be met in an over-all design that is pleasing and livable. Usually, the other equipment can be arranged between the speakers on the same wall, or along another, or even in some kind of room-divider that itself serves as a "wall." These various placement possibilities, coupled with the increasing variety of storage products—shelf systems, modular or full-

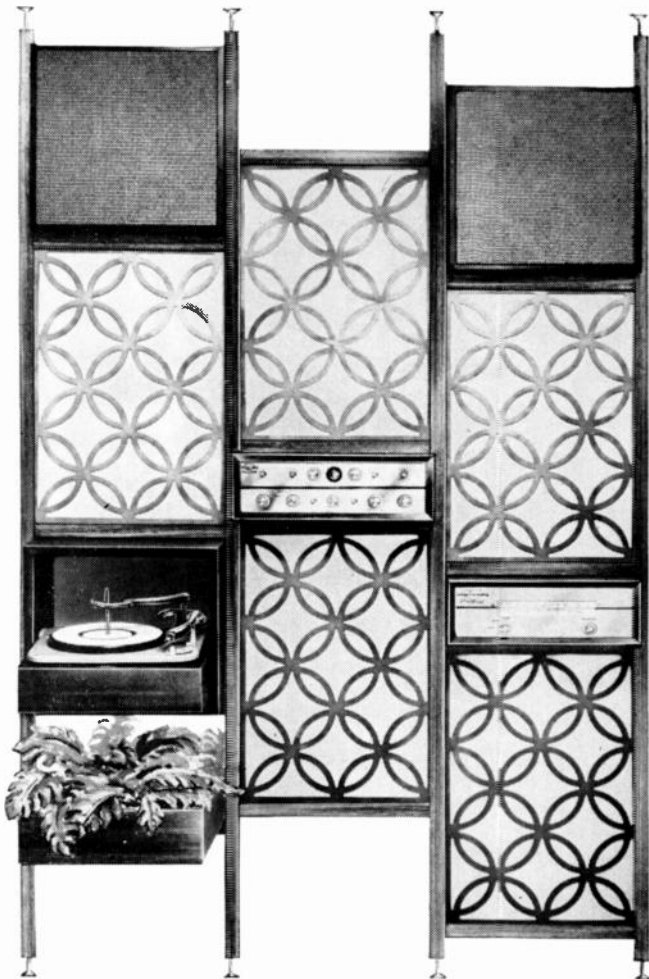

An unusual modular arrangement, supported by floor-to-ceiling poles, is shown at left. The equipment and the housing system are by Hawthorne Stereophonics, a division of Electronic Transmission Corp., Valley Stream, N.Y. Below is a new ensemble by Lafayette, with the equipment cabinet flanked by speaker housings.



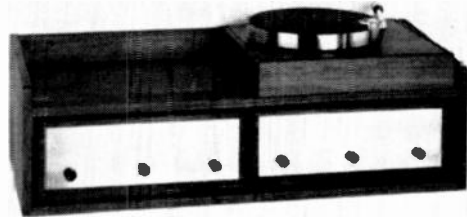
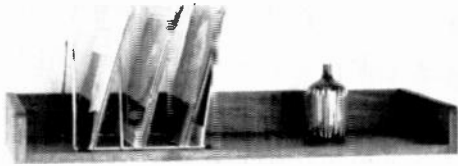

Two related shelf units, by Audio Originals of Indianapolis, form a neat and attractive housing for a compact installation of record player and any option of control amplifier with or without tuner. The speakers, of course, would be located elsewhere in the room.

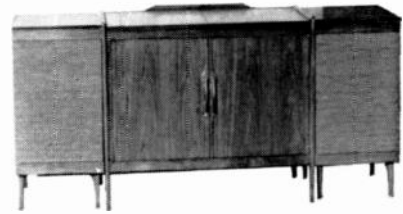

This ensemble by Heath is available in unfinished birch, or finished in walnut or mahogany. The center cabinet may be ordered alone, or together with matching speaker enclosures.



In this custom installation by Allied Radio, Chicago, a partial wall between two rooms was used for floor-to-ceiling storage. The speakers occupy the ends of very top shelf; their spacing is good for stereo; their nearness to the ceiling reinforces the bass.

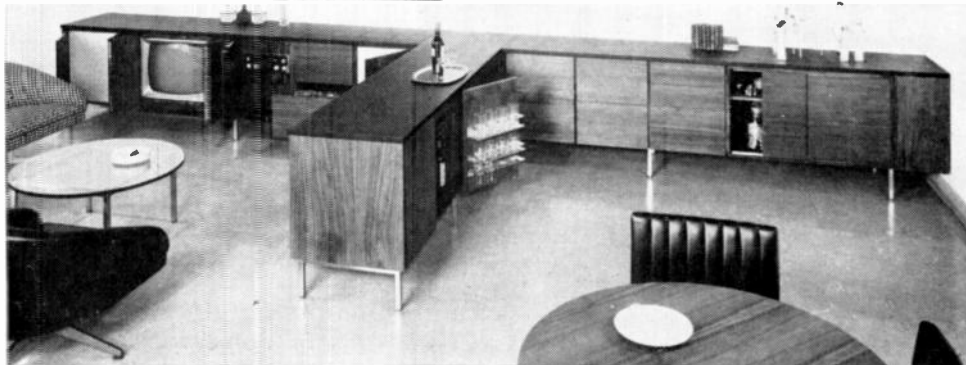

A thirty-foot-long rosewood cabinet houses stereo components and other items, and relates to the adjacent buffet. Cabinetry is by Lehigh Furniture; installation by Audio Exchange.



Components are housed in the owner's reproduction of an antique cupboard in this installation by Harman-Kardon.

size cabinets, custom-built units—now available mean that there is virtually an infinite number of solutions to the stereo décor problem.

Which is the best one for you? That depends largely on your tastes, living space, and budget. Where to start? Perhaps with a visit to the nearest furniture or department store, a good place to see an assortment of storage units and systems. More and more audio dealers are displaying their electronic wares in tasteful settings, and even the mail-order catalogues are featuring "stereo furniture" in greater variety. If you abjure "store-boughten" you can, if handy enough, design and build your own, or—if you care to spend more—you can engage the services of a professional interior designer and cabinetmaker. And one need not confine the installation to one type of storage; it is perfectly feasible—indeed often desirable—to combine a shelf system with small cabinets, or to create a storage wall that is mostly built-in but which has some elements built out—projecting sections or modules.

Each major type of storage method, of course, does have its unique advantages. Shelf systems, for instance, can be set up quickly by people without any particular mechanical skill. They consist of metal or wood uprights, some sort of bracket that fits into these supports, and the shelves themselves that sit on the brackets. Cost ranges from a few dollars for the kind that must be bolted into the wall itself to hundreds of dollars for the handsomely finished all-wood or wood-and-polished-metal systems that are "free standing" and yet provide a permanent look. Any shelf system chosen offers the dual advantage of facility in changing one's arrangement and ease of dismantling and setting it up elsewhere—especially desirable for people who may perhaps move to new quarters.

Shelves themselves—for placing on any kind of

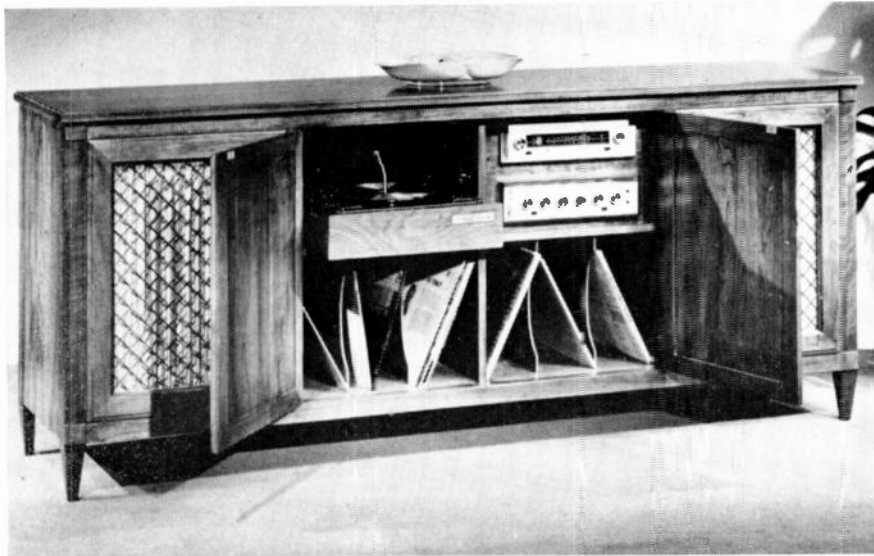

A self-contained cabinet for housing components, including speakers, is this Italian Provincial model by Furniture Craftsmen, Comstock Park (Grand Rapids), Mich.

supporting system—today come in different sizes, woods, and shapes. Some have molded edges, others are prefitted with pieces at the ends to keep the stray bric-a-brac, books, and whatnot from falling off. Using shelves, one can treat as much of a wall as is desired. Like the audio components themselves, shelves make it possible for you to start with a basic system, which can be enlarged or modified later. And not to be overlooked is the fact that a shelf system lets you mix business with pleasure: you can use different-size shelves as well as the vertical spacing between them to hold components large and small, and to combine with them art works and books.

Placing components on shelves is easy enough, but how will it look? Those who have felt that an amplifier or tuner is unsightly should glance appraisingly at the latest models. For some time now, the audio manufacturers themselves have been setting the pace in interior design by making components attractive enough to sit out in the open. The old feeling that the component skeletons should be hidden in a box or closet is fading rapidly now that they come clad in walnut jackets, or in the sheen of brushed gold armor. Their styling has been helped by the coming of transistors: the components can now be more compact. Industrial designers—quick to take advantage of the aesthetic possibilities of solid-state tuners and amplifiers—have been creating a new look to go with the new technology. Chassis are sleeker, knobs and switches less obtrusive and more stylistically laid out, and even the fillip of colored indicator lights graces some control panels. Despite these appeals, many people still may feel that a component should be hidden, or at least dressed up if it is to sit on a shelf; for such folk there are small cabinets or wrap-arounds into which components can be placed, made to size by some component manufacturers as well as by cabinet-



This eleven-foot-long ensemble, for housing components, speakers, and TV was designed by Jack Benveniste for Barzilai of Gardena, California.



Versatile and attractive, this storage cabinet by Audio Originals has a lift-up top as well as doors hinged to open from the front.

This assemble-it-yourself group by Knight (Allied Radio) offers an equipment cabinet with optional speaker enclosures designed to match.

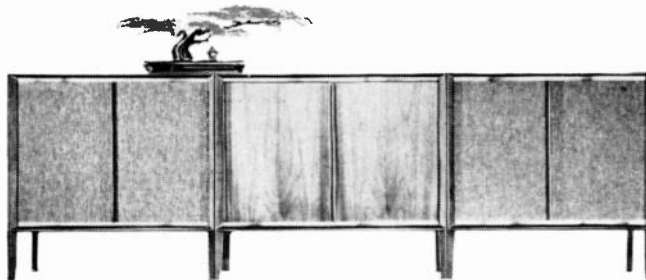

Part of a headboard houses stereo equipment; by Prelude Stereo, a division of Ace-Hi Modern Furniture, Gardena, Calif.



This desk, by Prelude Stereo, can be fitted with stereo components. Speakers, of course, are located elsewhere in room.

makers. The stereo owner who is handy can fashion his own wrap-arounds from plywood.

A related feature of transistorized components that makes it possible to place them on shelves—or, indeed, install them in any fashion fairly readily—is a need for ventilation less demanding than their tube counterparts'. Remember the good old audio days when you could count on your amplifier to heat up the room after a few minutes of playing? Solid-state equipment, while still requiring some ventilation, does not run nearly as hot, and so choice of location for it is less critical.

The blandishments of shelves, however, are lost on those who hanker after the solid and more unified look of a floor-based cabinet. Among cabinets, of course, the variety is endless. One simple, and economical, approach to the problem is simply to take an old console or cabinet that happens to be around doing nothing and refit it for stereo storage. The possibilities inherent in revamping of old materials should encourage many more families—including some who were convinced that even a monophonic system took too much housing—to own stereo components. On the other hand, those who prefer something new can find styles galore, from low-cost assemble-it-yourself or finish-it-yourself models to professionally crafted and custom-built cabinets. Some appeal to the traditionalist, and others to the most modern-minded.

A cabinet, of course, can stand more or less

alone, or be flanked by the speakers, or indeed by anything else you care to couple with it. The wall above the cabinet? A painting or tapestry—or again our general purpose shelves—will do very nicely. This treatment begins to suggest a storage wall, but of course the all-out wall treatment—usually reserved for home owners—involves a fairly permanent structure against, or sometimes right in, the wall, combining floor-based cabinets and shelves rising to the ceiling. This most elaborate of storage methods can be carried out with ready-made units, arranged and stacked as you please, or it may be turned over to a professional designer. Either way, this treatment permits a total kind of stereo décor, in which the storage system—its motifs, design, colors, and such—can be coordinated with such other aspects of interior design as draperies and furniture. One of the nice features of using a storage wall incorporating shelves with other storage is that it gives much leeway in the matter of lighting. There are lamps that clip on, bolt on, or simply stand on a shelf; there are others specifically made to hang from the ceiling or be fastened to the same pole holding up a shelf.

With the possibility of getting more and better sound equipment in less space than ever before, and with a greater choice of components to fill both listening and décor needs, people are beginning to think of stereo not as a luxury item but as an indispensable part of modern living.



For those stereophiles who do not scorn video, the top of a TV set can serve as the place for tuner/amplifier and record player. Matching walnut benches, that flank the equipment, support compact speakers. Installation designed by author.



Designed by Allied Radio to fit behind a client's couch, this eight-foot-long cabinet consists of four separate pieces; houses all equipment, including two speaker systems.

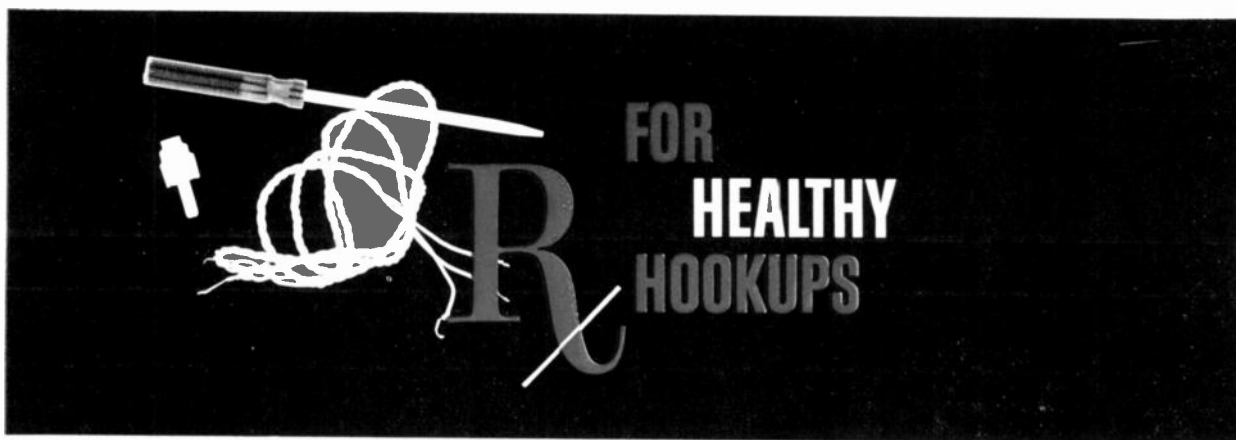

Use the right wire and plug if you are installing your own.

By Lewis A. Harlow

The several components in a home music system must, quite obviously, be connected to one another and also to outside sources of power and signal. The wires and cables which do this connecting perform distinct types of service, each requiring unique electronic or mechanical characteristics for the job.

The classes of service are: 1) AC power supply—that is, the connection between the wall outlet and one or several components; 2) interconnections between components—from phono pickup to preamp, from FM tuner to preamp, from preamp to power amp, to and from the tape recorder, and so on; 3) antenna lead-in to an FM tuner; 4) speaker cable from power amp to speakers. A possible final class would be 5) hookup wire—of interest to kit builders and others who assemble or possibly repair their own components.

AC Supply. Wires and connectors to be used for power supply are designed and manufactured to meet safety code standards established by Underwriters' Laboratories and other regulatory agencies. The power supply wire to be used in the home music system is called zip cord. Two lengths of wire running parallel, and molded into rubber or plastic insulation, it is so called because of the ease with which its ends can be zipped apart and stripped of insulation for attachment to an approved connector. The rubber insulation is the more flexible, the plastic is the less expensive; either type is satisfactory for use in the home.

The standard size of zip cord is "18-gauge." This, in reasonable lengths, provides a power-carrying capacity of about 800 watts, quite enough for lamps, fans, refrigerators, vacuum cleaners,

Lewis Harlow has been an audiophile for twenty-five years, ever since he chopped a hole in his living room wall to install a huge loudspeaker.

small household appliances—and high fidelity systems. Gauge numbers go down as wire thickness and power-carrying capacity go up. Electric irons, washers, and small heaters need 16-gauge cable. Stoves may require as heavy as 10-gauge. The larger cables are not available as zip cord but rather as a round two-conductor, rubber-insulated cable often bulked with asbestos fiber and always more messy than zip cord when you are faced with the problem of attaching a plug.

Pin-up lamps and small table lamps sometimes come factory-equipped with 20-gauge or even 24-gauge zip cord, but these sizes, inadequate for the high fidelity system, are almost impossible to buy by the foot for replacement service. When you ask for zip cord at any reputable dealer's, you will get 18-gauge, which is what you should use. There is no harm, of course, in using heavier cable if, for instance, you need an extension and happen to have on hand a 16-gauge cable with plugs attached.

How to splice zip cord? Don't. Your fire inspector will take a dim view of even a good splice (with the joinings soldered and properly insulated with approved electrician's tape). Instead, you are expected to use the approved male and female plugs and treat your power cord extension as an independent detachable unit. These approved plugs are available at any five-and-ten, hardware store, or electronics dealer. The clamp-on type that bypasses the need for wire stripping and screwdriver application is satisfactory.

Interconnectors Between Components. With the exception of antenna lead-in and speaker cable, all of the wire that carries signals in the home music system is shielded cable. This is a two-conductor cable concentrically or "coaxially" arranged. At the center is the inner or "hot" conductor wire, sur-

rounded by insulation. Around this in turn is an outer conductor in the form of a braided wire which serves as a shield to protect the hot conductor from unwanted electronic disturbance. Finally there is the outside insulation, usually plastic or rubber.

The shielding is vital inasmuch as this cable is transmitting from one component to another a signal which will be amplified many times before it reaches the speakers. Unshielded cable would pick up hum and transient electrical noises which would then get amplified along with the signal—an impossible situation.

Shielded cable is available in many sizes (outside diameters), of which the most common are 1/8-inch, 1/4-inch, and 3/8-inch. The center conductor used with all three is usually 24-gauge, though larger or smaller would make little difference. The two larger sizes of cable are for professional microphone service, and the choice between them is determined by the mechanical strength needed. For instance, how much beating is the cable likely to get as it is kicked around and stepped on? The 1/8-inch has been designed expressly for home music systems where there is scarcely any problem of protection from such abuse. This small cable is available in the local supply shops with appropriate connectors preattached, and also may be purchased by the foot if you are making up your own.

The terminal connectors used on this cable will be phone plugs—or phono plugs. These are not two spellings for the same product name. They are confusingly similar names for two quite different products which—to add to the confusion—perform identical functions.

A phone plug (short for TELEPHONE) has a ball tip which terminates the hot center conductor of the cable. This tip is insulated from the shank (about an inch long) which in turn is connected to the braided shield of the cable. The phone plug—and the jack which accepts it—have been used by telephone companies for more than fifty years. Essentially heavy-duty equipment, these devices will stand up for years under the strain of hundreds of pluggings and unpluggings per day. Although home music system service does not normally need such durability, phone plugs often are used for panel connections that may be made or unmade fairly often, as in tape recorders.

The phono plug (short for PHONOgraph and sometimes more completely identified as an “RCA phono plug”) is smaller than the phone plug and cheaper to manufacture. Its entire shank carries the hot side of the signal, while the braided shield of the cable is connected to its outer shell. Its mating jack, too, is smaller than a phone jack, permitting extremely compact assemblies of rows or banks of phono jacks on the back panels of amplifiers and control units. The phono plug and jack are intended for semipermanent installation where they probably will be handled no more than a half dozen times a

year. In this service, they are a more sensible design choice than the more costly and space-consuming telephone company equipment.

Not all manufacturers of home audio components agree to these arbitrary rules for choosing between phone and phono plugs. You will occasionally find a portable recorder with top-panel-mounted phono jacks, or you may find phone jacks back-panel-mounted in semipermanent service. The industry (in the U.S.A. at least) is standardized, however, in one important respect: all components will accept phone plugs *or* phono plugs—either one or the other.

Similarly, in America the two-conductor shielded cable is standard: a hot center with a cold shield. Multiconductor shielded cable, however, is available for certain professional applications, and a three-conductor type (two hot wires and one shield) might seem appropriate for stereo applications. Its use has been vetoed, however, in order to keep the stereo signals from interfering with one another in transit. It is safer to carry them in separate cables, and this decision, incidentally, simplifies the plug problem for most American-made equipment. On some imported equipment, however, connections require the use of multiconductor cable and suitable plugs. These either are supplied with the equipment, or may be purchased separately, or—in some cases—may be adapted for use with the simpler domestic connectors. Occasionally, an imported tape recorder requires miniature phone plugs, a type not stocked by the average dealer but available from the larger mail-order suppliers.

The size and screw-on connections in phone plugs make connecting them to signal cable fairly easy, but attaching your own phono plugs to shielded cable is a messy operation, even for those skilled in soldering. The braided wire is not easy to handle, and is difficult to solder to the outer shell of the plug. The resulting connection is almost always crude-looking and often electrically unsound. It is better, when possible, to buy shielded cables ready-made. These are available in seven standard lengths up to 144 inches, with every conceivable desired combination of male and female phone or phono connector on either end. The female connectors or jacks are for extending the length of a cable you already have, and there are also adapters which will join any kind of connector to any other kind. Cable assemblies are sold at all audio dealers and radio supply houses.

Whether buying a shielded cable or making one up yourself, keep it as short as practical. Unless the specifications with your equipment indicate that the signal is coming from a low-impedance “cathode follower output,” there will be a certain amount of high frequency loss that is directly proportional to the length of the cable. The most critical length of cable with respect to high frequency loss is the connector between the phono pickup and the preamplifier or combination amplifier, as the case may be. Here

there cannot be a cathode follower output to minimize the loss. If yours is a very old turntable and tone arm, the chances are it uses a shielded cable whose diameter falls somewhat short of meeting today's standards of high fidelity reproduction. Too, this cable is usually a bit longer than needed and the combination of narrow diameter and excess length can cause a loss of highs. An excellent replacement for such cable would be the type known as RG 58/U coaxial. This is recommended too for installations in which the run from the tone arm to the phono input must be longer than three feet. If this wire—designed primarily for other than high fidelity uses—is not available, a good second choice is $\frac{3}{8}$ -inch microphone cable. As a last resort, the old cable—if it must be used—should be shortened as much as possible.

Antenna Lead-in. FM and TV receivers normally are joined to their antennas by 300-ohm line ("twin-lead"), a flat insulated two-conductor cable in which the wires run parallel and are separated by an exact quarter inch of insulation. This spacing contributes to the 300-ohm impedance of the line, and the antennas and tuner inputs are therefore designed to match it—or suffer great loss of signal. An incorrect lead-in can reduce the strength of the signal fed to a tuner to a mere one thousandth of what a 300-ohm lead-in would supply. Of course, 72-ohm cable for antenna lead-in sometimes is required in very noisy situations or in multiset distribution systems. If so, it must be connected to a 72-ohm (or 75-ohm) terminal on the set (if there is one) or else via a special adapter, sold at radio dealers'.

300-ohm line is usually encased in a brown polyethylene plastic insulation, though transparent and silver-colored lines are available for indoor use in conspicuous locations. The gauge of the wire is ordinarily 20 or 22, either being satisfactory. The costlier versions of 300-ohm twin-lead offer greater mechanical strength and better protection against sun and rain. The same type of 300-ohm line is used for both FM and TV. Many listeners who have installed roof-mounted antennas and rotators for stereo FM (as well as improved TV) reception have encountered a type of flat lead-in that has four conductors—two for conducting power to the rotator

and two for carrying the signal down to the set.

300-ohm line can be connected to the terminal board of your FM tuner (or TV set) without plugs or special devices. The ends of the parallel wires are stripped, formed into hooks, and secured to the terminal board with a screwdriver. Inasmuch as this is a stranded wire, it is good practice to tin the hooks with solder before making them fast.

The rabbit-ears antenna which you may contemplate or already own comes equipped with an appropriate length of 300-ohm line, and its ends terminate in spade lugs, a professional touch which takes the place of your homemade hooks. You can buy similar spade lugs and solder them to the ends of your own twin-lead. Another bit of professionalism extremely convenient when you are preparing for electronics servicing or general housecleaning is the ability to "unplug" the antenna without crawling way inside and fumbling around with the screwdriver. For this convenience, you cut the line at some accessible and inconspicuous point not too far from the tuner, and here install a pair of Mosley lead-in connectors, male and female.

The mention of the name of Mosley, by the way, suggests the subject of catalogues. Wire, plugs, and other electronics hardware are manufactured by special firms, rather than by makers of tuners, amplifiers, speakers, and recorders. Your local dealer will stock some of this hardware, but it can only be a very small part of the variety which is available if you know where to find it and—even more important—what to look for. This valuable information is contained in the catalogues of the big electronics jobbers and mail-order houses. You can well use these catalogues for reference from time to time. Published annually, they are available for the asking.

Speaker Cable. For "speaker cable," any insulated pair of wires—parallel, twisted, or shielded—will carry the signal from the power amplifier to the speaker. Twenty-four-gauge wire is sold as "speaker-cable" and is suitable for compact installations, with short runs—no more than a few feet—between amplifier and speaker. A 20-gauge wire is recommended when connections cross a normal-size room. For longer distances, an 18-gauge will do, and some purists insist that for runs of thirty feet or longer,

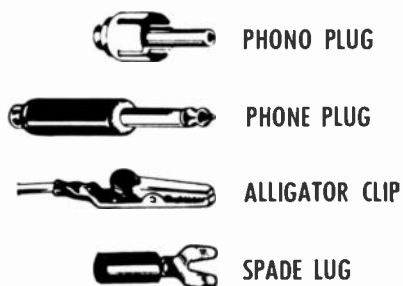

Connectors most often used in high fidelity installations; right, shielded cable prepared for soldering to plug; far right, section of 300-ohm twin-lead.

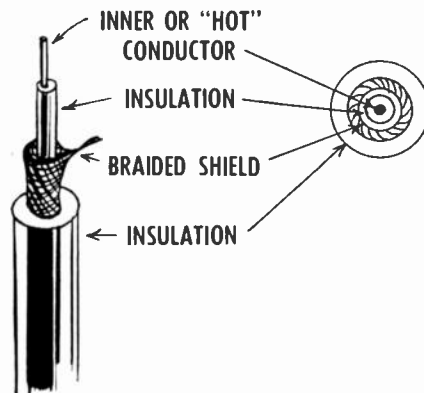

nothing thinner than 16-gauge should be used. Speaker lines, of course, must be insulated to avoid short circuits, but they do not require shielding; by the time the signal leaves the power amplifier and enters the speaker cable, it has experienced all the amplification it is going to get. Any hum or other electrical disturbance which may be picked up on an unshielded speaker cable cannot possibly be heard through the speakers.

Zip cord is satisfactory as speaker cable. Twin-lead is good, too, as it can be secured with ordinary tacks and will lie flat under a carpet if concealment is desired. For connecting at either end—to the amplifier or to the speaker—spade lugs add a professional touch and simplify the connections, and again a pair of Mosley or similar connectors installed about a foot from the amplifier (or speakers) will permit easy unplugging at housecleaning time. Some speakers come with screw-on terminals; to connect to them all you need do is strip back about one half inch of insulation from the wire and insert it.

Wire that is listed as "speaker cable" generally costs less than zip cord because its insulation does not need to meet the high standards imposed by the power cable codes. For the amount of speaker cable to be used in a home installation, the saving is unimportant, though you would certainly look into it if you were wiring speakers into a 400-room hotel.

Polarity is important in wiring speakers to an amplifier. In stereo hookups, if the wrong choice is made, the speakers will be "out of phase" with each other—that is, one will "push" while the other "pulls" at the same instant. This action will cancel part of the over-all sound, particularly the bass. Some mono woofer-tweeter systems must be connected just right or there will be a loss of balance between highs and lows on the one channel. The speaker manufacturer will warn you if this precaution should be observed, and you should follow his instructions. In general, it is a good idea to identify both ends of the same length of speaker line. Some zip cord is already coded. For instance, one conductor will be tinned and the other raw copper. Or, one insulation may

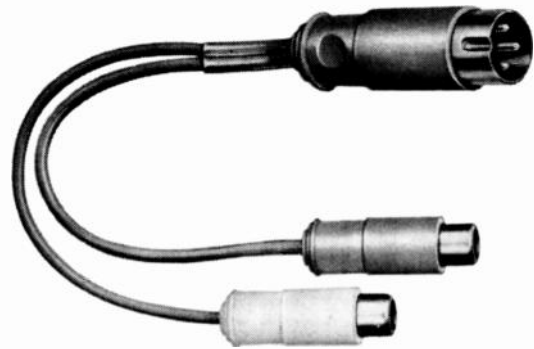

This adapter, which permits connecting a pair of two-conductor cables to a single three-conductor input, may be required on certain tape recorders.

be smooth and the other slightly ridged. On 300-ohm line, the insulation often is imprinted with some legend; simply note which side of the print is connected to either terminal at the amplifier. Alternately, you can—with any flat cable—run the cable between thumb and finger so that what started as "right-left" does not twist and become "left-right" at the other end. If your speaker cable is to be a twisted pair or a "round" cable in which the two conductors cannot be traced by sight or feel, or by color of wire or contour of the insulation, the trace must be a test of electrical continuity. Professionals use an ohmmeter for this test, and you can improvise a combination of dry cell battery and flashlight bulb that will do the same job (see accompanying drawing). Once the corresponding ends are identified, a further aid would be to label them with plastic tape or simply to tie knots at the ends.

Hookup Wire. If you are already a kit assembler—or contemplate the pleasures which this hobby presents—a final word about hookup wire is appropriate. Although the kit manufacturer will have supplied you with enough of it, you may need more—perhaps you have been a little extravagant, or perhaps some wire has been lost or destroyed accidentally. If so, you can buy "push-back wire"; its name is the clue to the manner of stripping its ends for connecting and soldering. The more popular hookup wire is "solid-conductor" (as contrasted with stranded), and its ends are stripped with a knife or specialized tool. Stranded wire is used only rarely for circuit hookup where rehandling is anticipated and thus extreme flexibility is needed to avoid the possibility of breakage. For instance, certain portable television sets require the unsoldering and removal of the chassis for servicing. This is a rehandling job, and the speaker leads here logically are stranded wire.

Whatever its type, hookup wire is generally 20-gauge. Smaller or larger diameters would be as satisfactory electrically but not as convenient to handle. However, if you find that you need just one more short piece of hookup wire on Saturday at midnight to finish building a kit, or whatever, simply use the required length from an odd piece of zip cord. It will serve excellently.

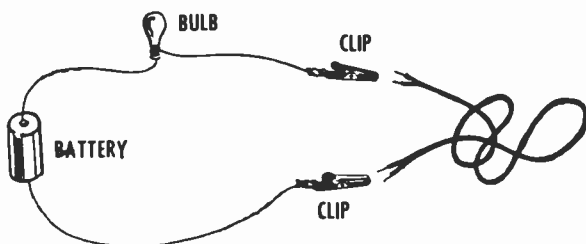

A simple continuity tester made of a flashlight battery and bulb, some wire, and two alligator clips. The bulb will light up when the clips are connected to the ends of the same length of wire.

KEEP IT PLAYING

*Some simple, do-it-yourself
maintenance hints.*



BY LEN BUCKWALTER

SOME STEREO equipment failures are remedied only through skilled treatment by a technician using professional test gear. But a number of troubles can be cured, even forestalled, by the equipment owner—using little more than his eye and ear. Indeed, many instruction manuals recommend simple steps to be performed routinely in the home: cleaning tape heads, adjusting stylus force, balancing output tubes, and so on. But limited space in manuals precludes coverage of sizable problem areas that may be detected by the nontechnical person. Some additional insight into these areas can help him determine whether to pick up a screwdriver—or the telephone to summon professional help.

The first reaction to virtually any equipment failure is: "It's a tube!" Indeed, statistics show that such a diagnosis will be correct over 80% of the time. The sheer weight of this figure, plus the fact that many audiophiles will not hesitate to replace a tube, calls for close scrutiny of the tube problem. Indiscriminate tube changing not only can introduce trouble that didn't exist before, but can prove costly when factors that govern tube life are not taken into account. Moreover, there are several ways of minimizing the occurrence of this greatest single cause of equipment breakdown.

Tubes inevitably produce the element of their own destruction: heat. Anything that tends to reduce surrounding temperature delays the day when distortion caused by a tube creeps beyond acceptable levels or the tube filament burns out. So critical is the heat factor that some manufacturers issue two guarantees for the same tube: each for a different bulb temperature. Significantly, the guarantee period is five times longer for the lower temperature.

To what use can this fact be put in connection

Len Buckwalter—broadcast engineer, radio announcer, editor, and writer—has published two books and dozens of articles on electronics and audio.

with a high fidelity installation? To begin with, the manufacturer of an audio component designs it with a ventilation system—a series of holes punched in the bottom, top, and sides of the chassis or cabinet. Expanded air rising from the top of the hot tubes induces suction at the bottom or sides for entry of cooling air. Unfortunately, this ventilation system often is rendered ineffective by the manner of installation of the components. Any arrangement that obstructs the free flow of air takes its toll in shortened tube life. But the nefarious part of the process may occur before outright failure. Audio quality may waste away in barely perceptible amounts, causing the listener to wonder if the system still sounds as good as when new. For this reason, the wise first step in "preventive maintenance" would be to reassess physical aspects of the installation—cabinets, shelves, and such. Check to see if openings or doors are capacious enough to permit needed air currents. Are some components stacked vertically? A tuner atop an amplifier may receive warmed air from the tubes below, upsetting its delicate adjustments. Whatever the arrangement, recheck the manufacturer's recommendation for the number of inches required for top and side clearance. Remember: considerations of space and appearance notwithstanding, the requirements for ventilation should prevail.

Solid-state equipment lessens the thermal problem, but does not remove it completely. Although a transistor has no glowing filament, it does develop some heat that must be dissipated. In some ways, transistor performance is even more critically linked with temperature than is that of tubes. It is possible for transistors to be triggered into a condition of "thermal runaway" in which unwanted heat raises the current through them, which in turn produces more heat—and so on until the component "lifts itself by its own bootstraps"—to the point of destruction. Well-designed equipment has numerous coun-

termesures, such as "heat sinks"—finned or large masses of metal that operate much like a radiator. Even so, the user should install his equipment so that air can flow about the heat sinks.

I have observed that breakdowns do not often occur in the midst of a listening or recording session, but rather very soon after the equipment is turned on. Such failure frequently results from the ravages of "thermal shock" in tube filaments not rugged enough to withstand repeated hot-cold (on-off) treatment. One remedy, used in commercial and military equipment, is never to turn off the power completely. Oddly enough, this will permit the tubes to have a longer life, although it would increase the monthly electric bill by some \$5.00 or \$6.00. Of course, in professional or military fields, instant response of equipment is a prime requisite, and the added power cost is less important. For the owner of home audio equipment, there is, alternately, a simple device that lowers the toll exacted by thermal shock. It's the "surgistor," a component that sells for about \$1.50 at radio supply houses. It operates by delaying the full surge of current into the tubes until their filaments are allowed a warm-up period of several seconds. The surgistor, which will pay for itself in increased tube life, can be installed by any serviceman or by the handy do-it-yourselfer. It connects in series with one side of the AC line inside the equipment chassis.

Of course, even with care, all tubes inevitably come to the end of their useful lives. Apropos of this, and with the advent of the self-service tube tester (now common in drugstores, discount houses,

etc.) and the increase in number of outlets where tubes may be bought, tube replacement has become almost as commonplace as toothbrush replacement. Although replacement (which should be with a good brand) is at times necessary, serious problems can arise in the testing itself. Judging by the ominous warnings given in military equipment manuals as well as the data supplied by tube engineers, it may be categorically stated that no tube should ever be tested as a matter of preventive maintenance. The tube-testing process, especially in the simple emission testers found in self-service checkers, may actually damage good tubes. This sort of apparatus can deliver excessive current, causing warped tube elements, creating contaminating gases, and otherwise altering tube performance. Such checkers, moreover, frequently are misleading, since they test only emission (the number of electrons streaming from a heated element)—and not the web of variables that determine tube performance.

This presents a real problem, especially since tubes account for so many equipment failures. If suspicious tubes cannot be checked on a reasonably good professional tester (of the trans-conductance type, for example) there are two "substitution-method" alternatives. In a stereo amplifier, the two channels are duplicates. If one is faulty, it is practical to substitute an identical tube type from the good channel and note if the trouble disappears. A better, although costlier, method is to insert a new tube into the socket and note the results. This does not mean that a whole new set of tubes must be kept in reserve. Examine the equipment's instruction manual and you will find many instances of repeated type numbers. If there are four identical output tubes, for example, just one new substitute need be kept on hand.

After tubes, an additional major trouble area can be the maze of wires and cabling that ties together the stereo system. These interconnections seem to suffer from standard kinds of faults, causes of which, in many cases, can be ferreted out before complete failure occurs. Shielded cables comprise the largest number of interconnections. The site of greatest weakness often develops where the plug joins the cables, since most flexing occurs at this point as the plug is inserted into, or removed from, its jack. Weakened wires, or a shield that could cause a potential short circuit, can often be located by grasping the cable an inch or two from the plug and bending in every direction. If a program is being heard during this check, a short or open circuit will disturb it. If the shield wire loses positive contact, a loud hum will be superimposed on the program material. Repair of the molded-on type of phono connector is impossible, but the cable itself can be snipped short by a few inches and a new plug installed.

Twin-lead wiring that brings an FM signal from the antenna to the tuner also can become a source of trouble. For instance, an errant strand of twin-lead at the tuner's antenna screw terminals may bridge them and short-circuit the signal. A good pre-

When To Call the Serviceman

1. When a defect persists and you have determined that tubes, cables, or mechanical components are not at fault.
2. When replacement of a defective tube cures the trouble only temporarily.
3. When some parts in the chassis appear scorched or emit a burnt odor.
4. When the tuner drifts excessively or sounds distorted even with the tuning indicator showing strongest signal.
5. When routine maintenance given in instruction manual—cleaning and demagnetizing tape heads, checking stylus force, and so on—does not restore proper performance.
6. When output and quality of the two channels are not comparable, or readily balanced.
7. When there is repeated blowing of fuses.

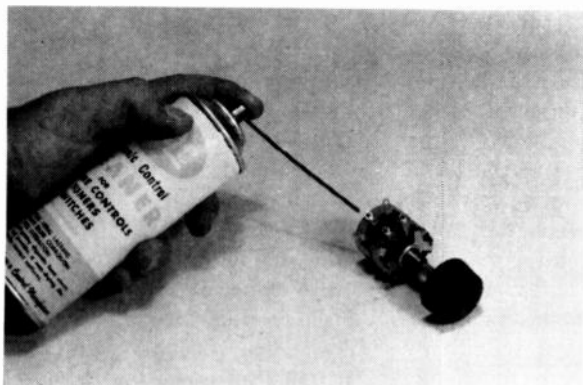

Switches and controls may require cleaning with a special spray, found at radio supply dealers'.

ventive remedy is to "tin" the stranded leads with a touch of solder. Another technique is the attachment of small spade lugs to the twin-lead ends. During any checking of twin-lead, perform this simple test: remove the wires from the tuner terminals and—while a program is being received—touch each wire, independently, to one screw at a time. If one side of the twin-lead produces considerably more signal than the other, it's strong evidence that a break or short exists somewhere in the run up to the antenna: most probably, a disconnected wire at the terminals of the antenna itself. Often, however, and especially in strong signal areas, a faulty line may not sharply reduce FM signals, but may affect channel separation during FM stereocasts. A defective lead-in introduces multiple signals (standing waves) that cancel part of the coded stereo information. Coiling excess twin-lead behind the tuner also reduces the line's effectiveness. Actually, the lead-in should be as short and direct as possible—and so for the meticulous audiophile, a "pruning" procedure may help produce a stronger signal. It's done by snipping off a few inches of twin-lead (the end that goes to the tuner) and noting any improvement in signal strength. This may be repeated several times, trial-and-error fashion—but don't snip so much that the lead-in becomes too short.

Another set of operating faults can be traced to the infiltration of dirt into the electronic chassis. In fact, the ventilation process described earlier forms—unfortunately—an effective dirt-catching system: as the radiation of heat from tubes creates a steady influx of cooling air, foreign matter such as dust is trapped and deposited on internal parts. Most susceptible are those (such as controls, switches, and tuning capacitors) that have mechanical as well as electrical features. "Reconditioning" these elements—which should be an annual chore—requires no particular skill. It involves carefully removing the chassis from its housing or cabinet, and following the disassembly instructions usually given in the manual, a job accomplished with a screwdriver.

Potentiometers, used for many front panel controls that move smoothly and continuously, deteriorate in time. The symptoms are scratchy sound when

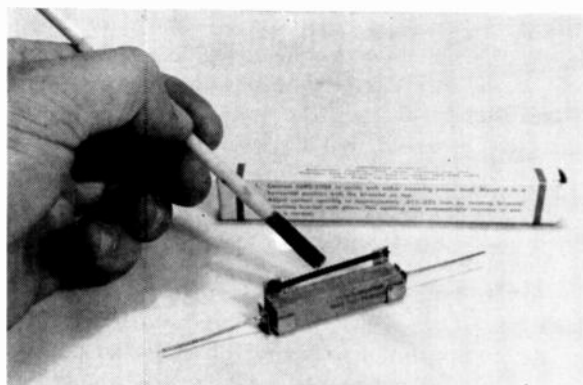

A surgistor protects tubes by allowing their filaments to warm up before full voltage comes on.

the control is turned, complete loss of program or function (such as tone) at certain settings, or even intermittent sound when a person walks across the room. A common cause is the encrustation of airborne grease and dirt on the control's internal carbon element. The control can be magically revived by injecting a small amount of a suitable cleaner. The most convenient method is to use a control cleaner packaged in an aerosol bomb. The long nozzle of the unit is inserted into any of the openings on the body of the control. As the spray enters, the knob on the front panel is rotated briskly in both directions to obtain the correct cleaning action. The same treatment is given to other moving parts such as rotary selector switches. Toggle switches (usually equipped with "bat" handles) are sealed, but switches of the slide type may be treated. Tuning capacitors should *not* be coated with control cleaner. Instead, their dirt accumulation can be blown out by the breath or removed with the aid of a soft brush.

A general wiping of the top of the chassis—using a dry cloth—will eliminate matter that tends to insulate against proper heat dissipation. At the chassis underside, however, the cloth might disturb component layout. Below chassis, it is advisable to give each tube socket a close spray of control cleaner to remove electrical leakage paths that build up between the lugs. The top surface of the tube sockets, accessible after the tube is removed, should be sprayed briefly, then wiped shiny with a cloth. And of course the tubes themselves should be wiped clean with a dry rag.

To the question "when to call the serviceman" there is no clear-cut answer in terms of a set of symptoms. A leaky capacitor (hidden deep in the circuitry, requiring technical skill to find and replace) may produce the same symptoms as a gas-invaded tube, a partial short circuit in a speaker lead, or other faults that can be corrected by the relatively unskilled. It is possible, however, to eliminate a significant number of service consultations by treating the common trouble spots discussed: tubes, cables, and mechanically operated components. If these measures prove fruitless, it's time for professional assistance.

FM STATION GUIDE

Continued from page 56

Norwich, N.Y.	WCHN	Pittsburgh, Pa.	WWSW(S)	Montreal, Canada	CBF	Franklin, Ind.	WIFN
Burlington-Graham, N.C.	WBAG	Greenville, S.C.	WMUU			Glen Burnie, Md.	WISZ
Dayton, Ohio	WFCJ	Gainesville, Tex.	KGAF(S)	95.3 mc		London, Canada	CFPL(S)
Stillwater, Okla.	KSPI	Harlingen, Tex.	KELT	Cambridge, Mass.	WHRB	Montreal, Canada	CJFM(S)
Ottawa, Canada	CFMO(S)	Houston, Tex.	KARO	St. Paul, Minn.	KNOF		
Windsor, Canada	CKLW	Richmond, Va.	WRVA	Lincoln, Nebr.	KFMQ	96.1 mc	
		Milwaukee, Wis.	WTMJ(S)	Norwalk, Ohio	new	Blytheville, Ark.	KLCN
94.1 mc				Medford, Ore.	KBOY	Sacramento, Calif.	KCRA
Little Rock, Ark.	KMMK	94.7 mc		Dumas, Tex.	KDDD	San Luis Obispo, Calif.	KATY
Bakersfield, Calif.	KERN	Los Angeles, Calif.	KRHM(S)	Big Spring, Tex.	KFNE	Jacksonville, Fla.	WMBR
Berkeley, Calif.	KPFA	Dover, Del.	WDOV	Charlottesville, Va.	WINA	Marietta, Ga.	WKLS(S)
San Diego, Calif.	KOGO	Honolulu, Hawaii	KHUA			Richmond, Ind.	WGML
Pensacola, Fla.	WPEX(S)	Chicago, Ill.	WENR	95.5 mc		Clinton, Iowa	KROS
Atlanta, Ga.	WDJK	Indianapolis, Ind.	WFBM	Phoenix, Ariz.	KELE	Owensboro, Ky.	WVJS
Caldwell, Idaho	KBGN	Mayfield, Ky.	WNGO	Los Angeles, Calif.	KABC	Worcester, Mass.	WTAG(S)
Mt. Vernon, Ill.	WMIX	Bethesda, Md.	WJMD(S)	Fort Pierce, Fla.	WIRA	Bay City, Mich.	WBCM
Wauseka, Ill.	KGFA	Springfield, Mass.	WMAS	Athens, Ga.	WGAU(S)	Holland, Mich.	WHTC(S)
Kansas City, Kan.	KCKN	Birmingham, Mich.	WHFI	Kaimuki, Hawaii	KAIM(S)	Minneapolis, Minn.	WAYL(S)
Jackson, Mich.	WQIX	Springfield, Mo.	KTTS	Chicago, Ill.	WDHF	Omaha, Nebr.	KICN
Omaha, Nebr.	KQAL(S)	Newark, N.J.	WJRZ	Indianapolis, Ind.	WFMS(S)	Auburn, N.Y.	WMBO
Scottsbluff, Nebr.	KNEB	Raleigh, N.C.	WPTF	Prestonsburg, Ky.	WDOC(S)	Buffalo, N.Y.	WDIF
Albuquerque, N.M.	KDEF	Columbus, Ohio	WVVO	Oakland, Md.	WPGC	Raleigh, N.C.	WKIX
Lexington, N.C.	WBUI	Midwest City, Okla.	KEFM	Detroit, Mich.	WLDM(S)	Shelby, N.C.	WOHS
Canton, Ohio	WHBC	El Paso, Tex.	KSET	Reno, Nev.	KNEV	Eugene, Ore.	KWFS(S)
Cincinnati, Ohio	WOIO	Bayamon, P.R.	WBYM	Albany, N.Y.	WROW	Easton, Pa.	WEST
Philadelphia, Pa.	WIBG	94.9 mc		New York, N.Y.	WABC(S)	Pittsburgh, Pa.	WRYT
Sunbury, Pa.	WKOK	San Diego, Calif.	KLRO(S)	High Point, N.C.	WHPE	Red Lion, Pa.	WGCB
Providence, R.I.	WHIM	San Francisco, Calif.	KSFR(S)	Cleveland, Ohio	WCLV(S)	Mt. Pleasant, Tex.	KIMP
Amarillo, Tex.	KCHO	Miami Beach, Fla.	WAEZ(S)	Lancaster, Ohio	WHOK	Opportunity, Wash.	KZUN
Dallas, Tex.	KCPA	Atlanta, Ga.	WAVQ	Tulsa, Okla.	KIHI	Halifax, Nova Scotia	CHNS
Seattle, Wash.	KOL	Mt. Carmel, Ill.	WSAB	Portland, Ore.	KGMG(S)		
Oak Hill, W.Va.	WOAY	Des Moines, Iowa	KNDR	Johnstown, Pa.	WJAC(S)	96.3 mc	
Ecu Claire, Wis.	WIAL(S)	West Yarmouth, Mass.	WOCB	Providence, R.I.	WPFM(S)	Eureka, Calif.	KIEM
Timmons, Canada	CKGB	East Lansing, Mich.	WVIC	Nashville, Tenn.	WLWM	Los Angeles, Calif.	KRKD
		Kansas City, Mo.	KCMO(S)	Austin, Tex.	KAZZ	Washington, D.C.	WTOP
94.3 mc		Mt. Washington, N.H.	WMTW(S)	Corpus Christi, Tex.	KMFM	Miami, Fla.	WGBS
Garden Grove, Calif.	KGGK(S)	Barberton, Ohio	WDBN(S)	Dallas, Tex.	new	Chicago, Ill.	WBBM
San Fernando, Calif.	KVFM	Hamilton, Ohio	WFOL	Diboll, Tex.	KSPH	Albuquerque, N.M.	KHFM(S)
Colorado Springs, Colo.	KLST(S)	Harrisburg, Pa.	WMSP	Waco, Tex.	KEFC	New York, N.Y.	WQXR(S)
New Haven, Conn.	WYBC	Westerly, R.I.	WERI	Wausau, Wis.	WSAU(S)	Columbus, Ohio	WTVN
Elgin, Ill.	WRMN	Greeneville, Tenn.	WGRV(S)			Murfreesboro, Tenn.	WMTS
Asbury Park, N.J.	WJLK	Cleburne, Tex.	KCLE	95.7 mc		Ft. Worth, Tex.	WBAP(S)
Alamogordo, N.M.	new	Roanoke, Va.	WDBJ	Tuscaloosa, Ala.	WTBC	Lubbock, Tex.	KBFM(S)
Babylon, N.Y.	WQFM(S)	Seattle, Wash.	KUOW	San Francisco, Calif.	KKHI	Martinsville, Va.	WMVA(S)
Celina, Ohio	WMER	Greenfield, Wis.	WWCF	Hartford-Meriden, Conn.	WBMI(S)	Rice Lake, Wis.	WJAC
Mertinsburg, W.Va.	WPEM(S)	Sydney, Nova Scotia	CJCB	Clearwater, Fla.	WTAN(S)	Kingston, Canada	CKWS
Fort William, Canada	CKPR			Effingham, Ill.	WSEI		
		95.1 mc		Ottawa, Kan.	KOFO	96.5 mc	
94.5 mc		Mammoth Spring, Ark.	KAMS	New Orleans, La.	WWMT(S)	Birmingham, Ala.	WCRT(S)
Phoenix, Ariz.	KOOL	San Bernardino, Calif.	KRCS(S)	Grand Rapids, Mich.	WKLW	San Diego, Calif.	KFMX(S)
Fresno, Calif.	KCIB(S)	Ventura-Oxnard, Calif.	KUDU(S)	Brainerd, Minn.	KLIZ	San Francisco, Calif.	KRON
Daytona Beach, Fla.	WNDB	Brookfield, Conn.	WGHF(S)	Manchester, N.H.	WKBR	Colorado Springs, Colo.	KFMH
Naples, Fla.	WNFM	Jacksonville, Fla.	WJAX	Olean, N.Y.	WHDL	Hartford, Conn.	WTIC(S)
Lexington, Ky.	WLAP	Aurora, Ill.	WMRO	Hickory, N.C.	WIRC(S)	Orlando, Fla.	WHOO(S)
Shreveport, La.	KWKH	Ft. Wayne, Ind.	WPTH	Lumberton, N.C.	WTSB	Shreveport, La.	KBCI
Boston, Mass.	WHDH	Glasgow, Ky.	WGGC	Piqua, Ohio	WPTW	Battle Creek, Mich.	WELL
Holland, Mich.	WJBL	Baltimore, Md.	WRBS	Philadelphia, Pa.	WFLN(S)	Kansas City, Mo.	KXTR
Mt. Pleasant, Mich.	WCEN(S)	Flint, Mich.	WFBE	Houston, Tex.	KHUL	St. Louis, Mo.	KADI(S)
Poplar Bluff, Mo.	KWOC	Worthington, Minn.	KWOA	Farmville, Va.	WFLO	Rochester, N.Y.	WCMF(S)
Trenton, N.J.	WTTM(S)	Atlantic City, N.J.	WRNJ	Norfolk, Va.	WTAR(S)	Laurinburg, N.C.	WEWO
Buffalo, N.Y.	WEBR	S. Bristol, N.Y.	WMIV	Seattle, Wash.	KGMJ(S)	Akron, Ohio	WCUF
Syracuse, N.Y.	WSYR(S)	Charlotte, N.C.	WIST	Milwaukee, Wis.	WMIL	Hamilton, Ohio	WQMS
Leaksville, N.C.	WLOE	Bethlehem, Pa.	WGPA	Rio Piedras, P.R.	WFID(S)	Tulsa, Okla.	KRAY
Port Clinton, Ohio	WRWR(S)	Chambersburg, Pa.	WCHA(S)			Montrose, Pa.	WPEL
Eugene, Ore.	KBMC	Grove City, Pa.	WEDA	95.9 mc		Philadelphia, Pa.	WHAT(S)
Lancaster, Pa.	WDAC	Charleston, S.C.	WTMA	Anaheim, Calif.	KEZR	Chattanooga, Tenn.	WDOD
		Beaumont, Tex.	KHGM(S)	Carlsbad, Calif.	KCLB	Houston, Tex.	KXYZ(S)
		Wichita, Falls, Tex.	KNTO(S)	Darien, Conn.	WDRN	Williamsburg, Va.	WBCI
		Kenosha, Wis.	WLIP(S)	Aurora, Ill.	WKKD	Seattle, Wash.	KLSN(S)
						Milwaukee, Wis.	WFMR(S)

96.7 mc		New Bedford, Mass.	WBSM	San Francisco, Calif.	KAFE(S)	Greensboro, N.C.	WMDE(S)
Redlands, Calif.	KCAL	Millville, N.J.	WMVB	Princeton, Ind.	WRAY	Beaufort, S.C.	WBEU(S)
Santa Ana, Calif.	KWIZ	Ithaca, N.Y.	WHCU	Cedar Rapids, Iowa	KHAK(S)	Dallas, Tex.	KLIF
Stamford, Conn.	WSTC	Harrisburg, Pa.	WHP	Kansas City, Kan.	KCJC	Salt Lake City, Utah	KCPX
Newnan, Ga.	WCOH	San Antonio, Tex.	KEEZ(S)	Baton Rouge, La.	WJBO	Norfolk, Va.	WNOR
Lewiston, Idaho	KOZE	Newport News, Va.	WGH	New Bedford, Mass.	WNBH	Wheeling, W.Va.	WWVA
Madison, Ind.	WORX	Tacoma, Wash.	KTNT	Saginaw, Mich.	WSAM		
Belgrade, Mont.	KGWV	Wheeling, W.Va.	WKWK	St. Louis, Mo.	KSTL	98.9 mc	
Roxboro, N.C.	WRXO	Milwaukee, Wis.	WISN	Binghamton, N.Y.	WNBF	Montgomery, Ala.	WFMI
Fostoria, Ohio	WFOB			Fayetteville, N.C.	WFNC	San Francisco, Calif.	KCBS(S)
Hot Springs, S.D.	new	97.5 mc		Canton, Ohio	WTOF	Tallahassee, Fla.	WBGW
Kitchener, Canada	CKCR	Mabile, Ala.	WTUF	Altoona, Pa.	WFBG	Rock Island, Ill.	WHBF(S)
		Riverside, Calif.	KDUO(S)	Philadelphia, Pa.	WCAU	Salem, Ind.	WSLM
96.9 mc		Santa Barbara, Calif.	KRCW	Seneca, S.C.	WSNW(S)	Leavenworth, Kan.	KCLO
Phoenix, Ariz.	KEPI(S)	Winter Haven, Fla.	WINT(S)	Texarkana, Tex.	KTAL	Brunswick, Me.	WCME
Monterey, Calif.	KHFR(S)	Hanolulu, Hawaii	KPOI(S)	Galax, Va.	WBOB	Kennett, Mo.	KBOA
Sacramento, Calif.	KSFM(S)	Champaign, Ill.	WDWS	Richmond, Va.	WCOD(S)	Kearney-Holdrege, Nebr.	KRNY
Jacksonville, Fla.	WZOK	Rackford, Ill.	WROK	Seattle, Wash.	KING	Rochester, N.Y.	WHFM
Mattoon, Ill.	WLBH(S)	Louisville, Ky.	WLVL(S)	Spokane, Wash.	KHQ	Van Wert, Ohio	WERT
Paducah, Ky.	WPAD	Lansing, Mich.	WJIM	Madison, Wis.	WISM(S)	Youngstown, Ohio	WKBN
Alexandria, La.	KALB	Trenton, N.J.	WTOA	Edmonton, Canada	CKUA	Oklahoma City, Okla.	KYFM(S)
Boston, Mass.	WXHR	Patchogue, N.Y.	WALK	Quebec City, Canada	CHRC(S)	Philadelphia, Pa.	WPBS
Grand Rapids, Mich.	WLAV	Akron, Ohio	WAKR	Toronto, Canada	CHFI(S)	Spartanburg, S.C.	WSPA(S)
Columbus, Nebr.	KJSK	Tulsa, Okla.	KOCW(S)			Burlington, Vt.	WJOY
Atlantic City, N.J.	WFPG(S)	Beaumont, Tex	KAYD	98.3 mc		Seattle, Wash.	KMCS
Buffalo, N.Y.	WGR	Charlottesville, Va.	WCCV	Sylacauga, Ala.	WMLS	Tomah, Wis.	WTMB
Goldsboro, N.C.	WEQR	South Boston, Va.	WHLF	West Covina, Calif.	KDWC		
Statesville, N.C.	WDBM	Charleston, W.Va.	WKAZ	Danbury, Conn.	WLAD	99.1 mc	
Grants Pass, Ore.	KGPO	Winnipeg, Canada	CJOB(S)	Paris, Ill.	WPRS	Huntsville, Ala.	WAHR(S)
Braddock, Pa.	WLOA(S)	Mayaguez, P.R.	WORA	Skokie, Ill.	WRSV	Riverside, Calif.	KPLI
Lancaster, Pa.	WLAN			Greenfield, Mass.	WHAI	Santa Cruz, Calif.	KSCO
Charleston, S.C.	WCSC	97.7 mc		New Brunswick, N.J.	WCTC	Santa Maria, Calif.	KEYM(S)
Bristol, Tenn.	WOPI	Lodi, Calif.	KCYR	Hempstead, N.Y.	WHLI	Macon, Ga.	WMAZ
Odessa, Tex.	KQIP	Caribou, Me.	WFST(S)	Thomasville, N.C.	WTNC	W. Lafayette, Ind.	WBAA
Kenosha, Wis.	WAXO(S)	Brockton, Mass.	WBET	Austin, Tex.	KHFI	Hutchinson, Kan.	KMAH
Verdun, Canada	CKVL(S)	Oxford, Ohio	WOXR			Annapolis, Md.	WNAV
		Edmund, Okla.	KWHP	98.5 mc		Plymouth, Mass.	WPLM
97.1 mc		Butler, Pa.	WBUT	Sacramento, Calif.	KXRQ	East Lansing, Mich.	WSWM(S)
Los Angeles, Calif.	KFMU(S)	St. Catharines, Canada	CKTB	San Jose, Calif.	KRPM	Clayton, Mo.	KFUO
Washington, D.C.	WASH(S)			Denver, Colo.	KFML(S)	Zarephath, N.J.	WAWZ
Gainesville, Ga.	WDUN(S)	97.9 mc		Atlanta, Ga.	WSB(S)	Binghamton, N.Y.	WKOP
Chicago, Ill.	WNIB	Tempe, Ariz.	KUPD	Boston, Mass.	WRKO	Whiteville, N.C.	WENC
New Orleans, La.	WRCM	Fresno, Calif.	KMJ	Coldwater, Mich.	WTVB	Dayton, Ohio	WHIO
Bangor, Me.	WABI	Lang Beach, Calif.	KNOB(S)	Houghton Lake, Mich.	WJGG	Fremont, Ohio	WFRO
Detroit, Mich.	WWJ	Palm Beach, Fla.	WQXT(S)	Minneapolis, Minn.	KTIS	Eugene, Ore.	KUGN
Minneapolis, Minn.	KWFM(S)	Boise, Idaho	KBOI(S)	Las Vegas, Nev.	KLUC(S)	Houston, Tex.	KODA(S)
Billings, Mont.	KURL	Chicago, Ill.	WHFC	Los Alamos, N.M.	KRSN(S)	Odessa, Tex.	KWMO
Las Vegas, Nev.	KORK(S)	Anderson, Ind.	WAFM	Niagara Falls, N.Y.	WHLD	Roanoke, Va.	WSLS(S)
Roswell, N.M.	KBIM	Sioux City, Iowa	KDVR	Grifton, N.C.	WITN	Milwaukee, Wis.	WEMP
New York, N.Y.	WNBC	Portland, Me.	WLOB	Cleveland, Ohio	WERE	Mayaguez, P.R.	WKJB
Greensboro, N.C.	WQMG(S)	Baltimore, Md.	WBAL(S)	Portland, Ore.	KPOJ	Toronto, Canada	CBC
Ashtabula, Ohio	WREO	Detroit, Mich.	WMZK	Oil City, Pa.	WDJR(S)		
Columbus, Ohio	WBNS(S)	Grand Rapids, Mich.	WXTO	Pittsburgh, Pa.	WPGH	99.3 mc	
Portland, Ore.	KPFM(S)	New York, N.Y.	WEVD	Wilkes-Barre, Pa.	WBRE	Boane, Iowa	KFGQ
Memphis, Tenn.	WMP5	Rochester, N.Y.	WROC	York-Hanover, Pa.	WYCR	Abilene, Tex.	KFMN
Ft. Worth, Tex.	KFJZ	Concord, N.C.	WEGO	Kingsport, Tenn.	WKPT(S)		
Salt Lake City, Utah	KLUB	Columbus-Worthingtan, Ohio	WRFD	Part Arthur, Tex.	new	99.5 mc	
Sparta, Wis.	WCOW	Eugene, Ore.	KFMY(S)	Charleston, W.Va.	WKNA(S)	Birmingham, Ala.	WAPI
Belleville, Canada	CJBQ	Hazletan, Pa.	WAZL	San Juan, P.R.	WPRM	Tucson, Ariz.	KFMM
		Columbia, S.C.	WCOS(S)	Victoria, Canada	CKDA	Los Angeles, Calif.	KHOF
97.3 mc		Nashville, Tenn.	WSIX(S)			Denver, Colo.	KDEN
San Diego, Calif.	KSEA	Dallas, Tex.	WFAA	98.7 mc		Washington, Del.	WJBR(S)
San Francisco, Calif.	KEAR(S)	Houston, Tex.	KFMK(S)	Phaenix, Ariz.	KTAR	Washington, D.C.	WGAY
Boulder, Colo.	KRNW(S)	Stevens Point, Wis.	WSPT	Los Angeles, Calif.	KCBH(S)	St. Petersburg, Fla.	WTCX(S)
Miami, Fla.	WCKR			Washington, D.C.	WOL	Chicago, Ill.	WEFM(S)
Savannah, Ga.	WTOC			Fort Pierce, Fla.	WARN	Quincy, Ill.	WTAD
Carmi, Ill.	WROY	98.1 mc		Chicago, Ill.	WFMT(S)	Greenfield, Ind.	WSMJ
Des Moines, Iowa	KDMI(S)	Andalusia, Ala.	WCTA	Hopkinsville, Ky.	WRLX	Henderson, Ky.	WSON
Garden City, Kan.	KNCO	Osceola, Ark.	KOSE	Detroit, Mich.	WBF6(S)	Lowell, Mass.	WLLH
Topeka, Kan.	WIBW	San Diego, Calif.	KJLM	New York, N.Y.	WOR	Detroit, Mich.	WABX(S)

Minneapolis, Minn.	WLWL(S)	Franklin, Tenn.	WFLT	Bayaman, P.R.	WRSJ	Jahnsan City, Tenn.	WJOW(S)
Albuquerque, N.M.	KARA(S)	Lynchburg, Va.	WWOD	Manreal, Canada	CBM	Fredericksburg, Va.	WFVA
Buffalo, N.Y.	WDCX(S)	Sharewaad, Wis.	WSHR			Seattle, Wash.	KETO(S)
New York, N.Y.	WBAI			100.9 mc		Madison, Wis.	WIBA
Schenectady, N.Y.	WGFM(S)	100.3 mc		Clanton, Ala.	WKLF	Isabella, P.R.	WISA(S)
High Point, N.C.	WMFR	Tuscumbia, Ala.	WVNA	San Rafael, Calif.	KTIM	Rimauski, Canada	CJBR
Cleveland, Ohio	WGAR	Globe, Ariz.	KWJB	Syracuse, N.Y.	WONO		
Tulsa, Okla.	KAKC	Las Angeles, Calif.	KMLA(S)	Albamarle, N. C.	WABZ	101.7 mc	
Ft. Worth, Tex.	KXFM(S)	San Jase, Calif.	KEEN	Elkin, N.C.	WIFM	Hayward, Calif.	KBBM
San Antonio, Tex.	KISS	Denver, Cal.	KLIR(S)	Lethbridge, Canada	CHEC	Lynn, Mass.	WLYN
Beckley, W.Va.	WBKW	Washington, D.C.	WFAN				
Edmonton, Canada	CJCA	Orlando, Fla.	WKIS	101.1 mc		101.9 mc	
Kingston, Canada	CKLC	Altan, Ill.	WOKZ	Cullman, Ala.	WFMH	Mantgamery, Ala.	WHHY
		Chicago, Ill.	WFMB	Auburn, Calif.	KAIJ	Janesbar, Ark.	KBTM
99.7 mc		Cannersville, Ind.	WCNB	Las Angeles, Calif.	KHJ	Fresno, Calif.	KARM
San Francisco, Calif.	KNBC	Des Moines, Iowa	WHO	Washington, D.C.	WWDC	Glendale, Calif.	KUTE
Atlanta, Ga.	WLTA	Tapoka, Kan.	KTOP	Cocoa Beach, Fla.	WZBR(S)	Chicago, Ill.	WCLM
Frankfort, Ind.	WILO	Wichita, Kan.	KFH	E. St. Louis, Ill.	WBBR	Central City, Ky.	WNES
Muscataine, Iowa	KWPC	Hopkinsville, Ky.	WKOF	Greenville, Ky.	WKYF	Baltimore, Md.	WAQE(S)
Louisville, Ky.	WKLO	Dearborn, Mich.	WKMH	Hazard, Ky.	WKIC	Detroit, Mich.	WDET
Midland, Mich.	WQDC(S)	Minneapolis, Minn.	new	Shreveport, La.	KRMD	Las Vegas, Nev.	KRGN
Kansas City, Mo.	KMBC(S)	Laurel, Miss.	WNLS	Detroit, Mich.	WXYZ	Cherry Valley, N.Y.	WJIV
Kannapolis, N.C.	WRKB	Newark, N.J.	WYNJ	Carrollton, Mo.	KADL	New York, N.Y.	WBFM
Columbus, Ohio	WMNI(S)	High Point, N.C.	WNOB	Manchester, N.H.	new	Gastonia, N.C.	WGNC
Pittsburgh, Pa.	WJAS	Newark, Ohio	WCLT	New York, N.Y.	WCBS	Cincinnati, Ohio	WKRC(S)
Manchester, Tenn.	WMSR	Portland, Ore.	KQFM	Burlington-Graham, N.C.	WBBB(S)	Oklahoma City, Okla.	KFN7(S)
Memphis, Tenn.	WMC	Meadville, Pa.	WMGW	Youngstown, Ohio	WRED	Pottsville, Pa.	WPPA
Norfolk, Va.	WIFI(S)	Media, Pa.	WXUR	Portland, Ore.	KOIN		
		Dallas, Tex.	KBOX	Philadelphia, Pa.	WDYR(S)	102.1 mc	
99.9 mc		Houston, Tex.	KOST	Tyrone, Pa.	WGMR	Decatur, Ala.	WHOS
Mobile, Ala.	WKR(S)	Pampa, Tex.	KBMF	Andersor, S.C.	WCAC	Anchorage, Alaska	KBYR(S)
Bijou, Calif.	KHYR	Salt Lake City, Utah	KSL(S)	Dallas, Tex.	WRR	Oceanside, Calif.	KUDE(S)
Marysville, Calif.	KMYC	Edmonton, Canada	CFRN	Houston, Tex.	KTRH	San Francisco, Calif.	KDFC
San Bernardino, Calif.	KFMW			Green Bay, Wis.	WBAY(S)	Danville, Ill.	WPBI
Santa Barbara, Calif.	KGUD	100.5 mc				Kalamazoo, Mich.	WMUK
Bridgeport, Conn.	WJZZ	Annistan, Ala.	WHMA	101.3 mc		Minneapolis, Minn.	KMSJ
Boca Raton, Fla.	new	Sacramento, Calif.	KEBR	San Francisco, Calif.	KPEN(S)	Kansas City, Mo.	WDAF
Harrisburg, Ill.	WEBQ	New Britain, Conn.	WRYM	Hamden, Conn.	WDEE	Reidsville, N.C.	WREV
Kankakee, Ill.	WKAK	Jacksonville, Ill.	WLDS	Richmand, Ind.	WKBY(S)	Cleveland, Ohio	WDOK(S)
Terre Haute, Ind.	WTHI	Kokomo, Ind.	WFKO	Wichita, Kan.	KWBB(S)	Lima, Ohio	WIMA
Salina, Kan.	KAFM	Rochester, N.Y.	WRVM	Augusta, Me.	WFAU	Dubais, Pa.	WCED
Lafayette, La.	KQNK	Bellaire, Ohio	WOMP	Grand Rapids, Mich.	WMAX	Philadelphia, Pa.	WFIL
Frederick, Md.	WFMD	Findlay, Ohio	WFIN(S)	Minneapolis, Minn.	WPBC	Sevierville, Tenn.	WSEV(S)
Benton Harbor, Mich.	WHFB	Oklahoma City, Okla.	KIOO	Rochester, N.Y.	WBBF	Alvin, Tex.	KAJC
Omaha, Nebr.	KFAB	Laurens, S.C.	WLBG	Ashland, Ohio	WNCO	Ft. Worth, Tex.	KFMF
Clovis, N.M.	KTQM	Norfolk, Va.	WCMS	Lancaster, Pa.	WGAL	Richmand, Va.	WRNL
Cortland, N.Y.	WKRT	Huntington, W.Va.	WKEE	Scranton, Pa.	WGBI	Milwaukee, Wis.	WMKE(S)
Plattsburgh, N.Y.	WEAV			Sumter, S.C.	WFIG	Brampton, Canada	CHIC
Asheville, N.C.	WLOS	100.7 mc		Sinton, Tex.	KTOD(S)		
Kettering, Ohio	WKET(S)	Palm Springs, Calif.	KPSR	Hampton, Va.	WVEC	102.3 mc	
Toledo, Ohio	WTRT	San Diego, Calif.	KFMB			Long Beach, Calif.	KFOX
Easton, Pa.	WEEX	Ventura, Calif.	KVEN	101.5 mc		Waukegan, Ill.	WEFA(S)
Erie, Pa.	WERC	Ft. Lauderdale, Fla.	WMFP	Bakersfield, Calif.	KQXR	Bethesda, Md.	WHFS(S)
El Paso, Tex.	KTSM	Tampa, Fla.	WDAE	San Diego, Calif.	KGB(S)	Babylon, N.Y.	WBAB
Waco, Tex.	WACO	Elkhart, Ind.	WTRC	Miami, Fla.	WWPB(S)	Carlisle, Pa.	WHYL
Seattle, Wash.	KISW(S)	Terre Haute, Ind.	WVTS(S)	St. Petersburg, Fla.	WGNB	Prosser, Wash.	KACA
Spokane, Wash.	KXLY	Westminster, Md.	WTTR	Marietta, Ga.	WBIE		
Janesville, Wis.	WCLO	Boston, Mass.	WCOP	Bloomington, Ill.	WJBC(S)	102.5 mc	
San Juan, P.R.	WFQM	Lansing, Mich.	WMRT(S)	Columbus, Ind.	WCSI(S)	Jasper, Ala.	WWWB
Toronto, Canada	CFRB	Wildwood, N.J.	WCMC	South Bend, Ind.	WSBT	Phoenix, Ariz.	KNIX(S)
		Peekskill, N.Y.	WLNA	Storm Lake, Iowa	KAYL	Salinas, Calif.	KWBW
100.1 mc		Rocky Mt., N.C.	WFMA	Springfield, Mo.	KTXR(S)	San Diego, Calif.	KBBW(S)
Chicago, Ill.	WMAQ(S)	Cleveland, Ohio	WHK	Trenton, N.J.	WBUD(S)	Santa Maria, Calif.	KSMA
Plentywood, Mont.	KPWD(S)	Springfield, Ohio	WEEC	Poughkeepsie, N.Y.	WEOK	Woodland, Calif.	KATT(S)
Kent, Ohio	WKNT	Allentown, Pa.	WFMZ	Releigh, N.C.	WRAL	Sarasota, Fla.	WYAK(S)
Bartlesville, Okla.	KVOW	New Kensington, Pa.	new	Gallipolis, Ohio	WJEH	New Castle, Ind.	WCTW
Altoona, Pa.	WVAM	Cleveland, Tenn.	WCLE	Taledo, Ohio	WSPD	Waltham, Mass.	WCRB(S)
Lebanon, Pa.	WLBR	Blackburn, Va.	WCBR	Pittsburgh, Pa.	WPIT	Bay City, Mich.	WNEM(S)
Levittown-Fairless Hills, Pa.	WBCB	Harrisonburg, Va.	WSVA	Waynesboro, Pa.	WAYZ	St. Louis, Mo.	KWIX(S)
		Seattle, Wash.	KIRO	Providence, R.I.	WXCN(S)	Buffalo, N.Y.	WBEN
		Racine, Wis.	WRJN			Hendersonville, N.C.	WHKP

Zonesville, Ohio	WHIZ	Ottawa, Canada	CBO	Jackson, Tenn.	WTJS	Detroit, Mich.	WQRS
Pittsburgh, Pa.	KQV			Houston, Tex.	KRBE(S)	St. Joseph, Mo.	KUSN(S)
Reading, Pa.	WFRF	103.5 mc		Madison, Wis.	WMFM(S)	De Ruyter, N.Y.	WOIV
North Charleston, S.C.	WKTM(S)	Sun Valley, Ariz.	KTPM(S)			New York, N.Y.	WRFM
Hillsboro, Tex.	KHBR	Los Angeles, Calif.	KGLA	104.3 mc		Durham, N.C.	WDNC
Norfolk, Va.	WRVC	Denver, Colo.	KOA	Athens, Ala.	WJOF	Cincinnati, Ohio	WCPO
Winchester, Va.	WHPL	Washington, D.C.	WGMS	Avalon, Calif.	KBIQ	Salem, Ohio	WSOM
Seattle, Wash.	KPRN	Ft. Lauderdale, Fla.	WWIL	Cocoa Beach, Fla.	WRKT(S)	Ephrata, Pa.	WGSA
Madison, Wis.	WRVB(S)	Chicago, Ill.	WKFM(S)	Miami, Fla.	WUPY(S)	Williamsport, Pa.	WLYC
San Juan, P.R.	WIAC	Detroit, Mich.	WMUZ	Augusta, Ga.	WBBQ	Providence, R.I.	WPJB
		Mankato, Minn.	KYSM	Chicago, Ill.	WJJD	Arlington, Va.	WAVA
		Princeton, N.J.	WPRB	Baltimore, Md.	WITH		
102.7 mc		Lake Success, N.Y.	WFTM(S)	Detroit, Mich.	WOMC(S)	105.3 mc	
Fresno, Calif.	KXQR(S)	Hamilton, Ohio	WHOH	Kansas City, Mo.	KBEY	Anchorage, Alaska	KNIK
Los Angeles, Calif.	KLAC	Steubenville, Ohio	WSTV	New York, N.Y.	WNCN	San Diego, Calif.	KITT
Manitou Springs, Colo.	KCMS(S)	Knoxville, Tenn.	WBIR	Utica, N.Y.	WRUN	San Francisco, Calif.	KBCO(S)
Oak Park, Ill.	WOPA	Vancouver, Canada	CHQM(S)	Asheville, N.C.	WLOS	New Orleans, La.	WDSU
Terre Haute, Ind.	WPFR	Christiansted, V.I.	WIVI	Tallahassee, Fla.	WCPS	Hornell, N.Y.	WWHG
Baltimore, Md.	WCOA			Cincinnati, Ohio	WAEF(S)	Forest City, N.C.	WAGY
Mt. Clemens, Mich.	WBRB	103.7 mc		East Liverpool, Ohio	WOHI	Mansfield, Ohio	WCLW
New York, N.Y.	WNEW	Little Rock, Ark.	KARK(S)	Bellingham, Wash.	KBLE(S)	Philadelphia, Pa.	WDAS
Cincinnati, Ohio	WSAI	San Diego, Calif.	KTSD	Cornwall, Canada	CKSF	Dallas, Tex.	KMAP
Sandusky, Ohio	WLEC	San Francisco, Calif.	KGO			Edmonds, Wash.	KGFM(S)
Oklahoma City, Okla.	KJEM	Gainesville, Fla.	WRUF(S)	104.5 mc			
Williamsport, Pa.	WRAK	Springfield, Ill.	WTAX	San Francisco, Calif.	KBAY(S)	105.5 mc	
Sherbrooke, Canada	CHLT(S)	Bloomington, Ind.	WFIU	Albany, Ga.	WGPC	Hemet, Calif.	KHSJ
		Davenport, Iowa	WOC	Indianapolis, Ind.	WAJC	Long Beach, Calif.	KLFM
102.9 mc		Havre de Grace, Md.	WASA	Cedar Rapids, Iowa	WMT(S)	Dover, N.J.	WDHA(S)
Harrison, Ark.	KHOZ	Berlin, N.H.	WMOU	Wooster, Ohio	WWST	Eatontown, N.J.	WHTG
Berkeley, Calif.	KPAT	Keene, N.H.	new	Philadelphia, Pa.	WPCA	Sanford, N.C.	WWGP
Hartford, Conn.	WDRC	Atlantic City, N.J.	WOSH	Gallatin, Tenn.	WFMG		
Columbus, Ga.	WRBL(S)	Newton, N.J.	WNNJ	Dallas, Tex.	KIXL(S)	105.7 mc	
Decatur, Ill.	WSOY(S)	Ithaca, N.Y.	WEIV	Norfolk, Va.	WXRI	Siloam Springs, Ark.	KUOA
Cumberland, Md.	WCUM	Charlotte, N.C.	WSOC			Augusta, Ga.	WAUG
Grand Rapids, Mich.	WFUR	Williamston, N.C.	WIAM	104.7 mc		Indianapolis, Ind.	WAIV
Saline, Mich.	WOIA(S)	Tiffin, Ohio	WTTF	Birmingham, Ala.	WJLN	Waterloo, Iowa	KXEL(S)
Minneapolis, Minn.	WCCO	Dallas-Highland Park, Tex.	KVIL(S)	Mesa, Ariz.	KBUZ	Cantonsville, Md.	WCBC
Jackson, Miss.	WJDX(S)	Richmond, Va.	WFMV(S)	Oxnard, Calif.	KAAR	Framingham, Mass.	WKOX
Hickory, N.C.	WHKY(S)	Tocoma, Wash.	KTWR	Palm Springs, Calif.	KDES(S)	Grand Rapids, Mich.	WOOD(S)
Springfield, Ohio	WBLY(S)	Wauwatosa, Wis.	WTOS	Tampa, Fla.	WPKM	Statesville, N.C.	WFMX
Philadelphia, Pa.	WPEN			Athens, Ga.	WDOL	Cleveland, Ohio	KYW
Sharon, Pa.	WPIC	103.9 mc		Morris, Ill.	WRMI	Houston, Tex.	KHCB
Shelbyville, Tenn.	WHAL	Inglewood, Calif.	KTYM	Jasper, Ind.	WITZ	Longview, Tex.	KLUE
Dallas, Tex.	KQRO	Elgin, Ill.	WELG	Hagerstown, Md.	WJEJ	Vancouver, Canada	CBU
Houston, Tex.	KQUE(S)	Riverhead, N.Y.	WAPC(S)	Fitchburg, Mass.	WFGM		
Milwaukee, Wis.	WRIT	White Plains, N.Y.	WFAS	St. Cloud, Minn.	KFAM	105.9 mc	
		Springfield, Ohio	WBLY(S)	Pt. Pleasant Beach, N.J.	WJLK	Los Angeles, Calif.	KBMS(S)
103.1 mc		Xenia, Ohio	WHBM	Fulton, N.Y.	WOSC	Hartford, Conn.	WHCN
Newport Beach, Calif.	KNBB	Ebensburg, Pa.	WEND	Poughkeepsie, N.Y.	WKIP	Ft. Lauderdale, Fla.	WFLM(S)
Santa Monica, Calif.	KSRF	Jenkintown, Pa.	WIBF	Charlotte, N.C.	WYFM	Elmwood Park, Ill.	WXFM
Highland Park, Ill.	WNHS			Dayton, Ohio	WONE	Detroit, Mich.	WCHD
South Beloit, Ill.	WBEL	104.1 mc		Toledo, Ohio	WTOL(S)	Newark, N.J.	WHBI
Sturgis, Mich.	WSTR	Los Altos, Calif.	KPGM	Columbia, S.C.	WNOK	Middletown, Ohio	WPFB(S)
		Modesta, Calif.	KTRB	Crewe, Va.	WSVS	Pittsburgh, Pa.	WAMO
103.3 mc		Waterbury, Conn.	WWCO	Watertown, Wis.	WTTN	York, Pa.	WNOW
Montgomery, Ala.	WAJM	La Grange, Ga.	WLAG	San Juan, P.R.	WKAQ	Nashville, Tenn.	WFMB
Modesta, Calif.	KBEE	Evansville, Ind.	WIKY(S)			Woodbridge, Va.	WXRA
Santa Barbara, Calif.	KMUZ(S)	Muncie, Ind.	WMUN	104.9 mc		Charleston, W.Va.	new
Atlanta, Ga.	WPLO	Monroe, La.	KMLB(S)	College, Alaska	KUAC		
Indianapolis, Ind.	WGEI	Waldorf, Md.	WSMD	Fremont, Calif.	KHYD	106.1 mc	
Boston, Mass.	WEEL	Boston, Mass.	WBCN(S)	Elkhart, Ind.	WCMR	Alexander City, Ala.	WRFS
Kansas City, Mo.	KPRS	Grand Rapids, Mich.	WVGR	Fulton, Ky.	WFUL	San Francisco, Calif.	KFRC
St. Louis, Mo.	KMOX(S)	St. Louis Park, Minn.	KRSI(S)			Toccoa, Ga.	WLET
Princeton, N.J.	WPRB	Buffalo, N.Y.	WWOL	105.1 mc		Litchfield, Ill.	WSMI
Amherst, N.Y.	WIFE(S)	Winston-Salem, N.C.	WSJS	Albertville, Ala.	WAVU	North Vernon, Ind.	WOCH
Cleveland, Ohio	WCRF	Cleveland, Ohio	WJW	Los Angeles, Calif.	KBCA	Cumberland, Md.	WTBO
York, Pa.	WSBA	Portsmouth, Ohio	WPAY(S)	Sacramento, Calif.	KHIQ(S)	Jackson, Mich.	WKHM
Nashville, Tenn.	WNFO(S)	Allentown, Pa.	WAEB	Denver, Colo.	KTGM	Claremont, N.H.	WTSV
Gretna, Va.	WMNA	Harrisburg, Pa.	WTPA(S)	Coral Gables, Fla.	WVCG(S)	Corning, N.Y.	WCLI
Wisconsin Rapids, Wis.	WFHR			Evanston, Ill.	WEAW	Patchogue, N.Y.	WPAC(S)
				Quincy, Ill.	WGEM(S)	Wilson, N.C.	WVOT

Mansfield, Ohio	WVNO(S)	Bloomsburg, Pa.	WHLM	Marion, Ohio	WWRN	Detroit, Mich.	WGPR(S)
Philadelphia, Pa.	WQAL(S)	Chattanooga, Tenn.	WLOM	McKenzie, Tenn.	WMKT(S)	New York, N.Y.	WLIB
Denton, Tex.	KDNT	Richmond, Va.	WRFK	Dallas, Tex.	KAMA	Winston-Salem, N.C.	WYFS
Tacoma, Wash.	KLAY(S)	Lynden, Wash.	KLYN	Seattle, Wash.	KFIN	Boyetown, Pa.	WBYO
Waukesha, Wis.	WAUX	Montreal, Canada	CFCF(S)				
106.3 mc		106.7 mc		107.1 mc		107.7 mc	
Sun City, Ariz.	KTPM(S)	Pasadena, Calif.	KPPC	Sierra Madre, Calif.	KMAX	San Mateo, Calif.	KUFY
San Fernando, Calif.	KSFV	Denver, Colo.	KLZ	Glen Ellyn, Ill.	WELF	St. Louis, Mo.	new
Santa Ana, Calif.	KFIL	Ft. Lauderdale, Fla.	WFTL	Long Branch, N.J.	WRLB(S)	Bridgeton, N. J.	WSJN
Lansing, Ill.	WLNR	Boston, Mass.	WBZ	Mt. Kisco, N.Y.	WRNW	Wethersfield, N.Y.	WBIV
Crawfordsville, Ind.	WBBS	Detroit, Mich.	WDTM(S)	Durant, Okla.	KSEO	Greenville, N.C.	WGTC
Great Falls, Mont.	new	New York, N.Y.	WRVR	107.3 mc		Dayton, Ohio	WAVI
Red Bank, N.J.	WFHA	Hillsboro, Ohio	WSRW	Florence, Ala.	WOWL	Gettysburg, Pa.	WGET
Mt. Kisco, N.Y.	WVIP(S)	Beaver Falls, Pa.	WBVP	Stockton, Calif.	KSTN	Warwick, R.I.	WYCE
Woonsocket, R.I.	WWON	Elizabethtown, Pa.	WEZN	Washington, D.C.	WMAL	Warrentown, Va.	WARR
Yakima, Wash.	KNDX	Manassas, Va.	WPRW	Greensburg, Ind.	WTRE	Seattle, Wash.	KRAB
Cheyenne, Wyo.	KVWO(S)			Warsaw, Ind.	WRSW	Milwaukee, Wis.	WBON
106.5 mc		106.9 mc		Wichita, Kan.	KCMB(S)	107.9 mc	
Sacramento, Calif.	KJML	Birmingham, Ala.	WBRC	Worcester, Mass.	WAAB	Sacramento, Calif.	KXOA
San Diego, Calif.	KPRI(S)	San Francisco, Calif.	KMPX(S)	Greenville, Mich.	WPLB	Manchester, Conn.	WINF
San Jose, Calif.	KPLX	Hartford, Conn.	WCCC(S)	Utica, N.Y.	WUFM(S)	Westport, Conn.	WMMM
Washington, Ind.	WFML	Marion, Ind.	WMRI	Elyria, Ohio	WEOI	Indianapolis, Ind.	WISH(S)
Baltimore, Md.	WCBM	Hagerstown, Md.	WARK	Lebanon, Tenn.	WLOU(S)	Annapolis, Md.	WXTC
Buffalo, N.Y.	WADY(S)	Muskegon, Mich.	WMUS	Ft. Atkinson, Wis.	WFAW	Medford, Mass.	WHIL
Salisbury, N.C.	WSTP	Crestwood, Mo.	KSHE(S)	107.5 mc		Flint, Mich.	WGMZ(S)
Cleveland, Ohio	WXEN	Camden, N.J.	WKDN	Los Angeles, Calif.	KBBI(S)	Charlotte, N.C.	WBT(S)
Greenville, Ohio	WDRK	Clingman's Peak, N.C.	WMIT	Chicago, Ill.	WFMQ(S)	Cleveland, Ohio	WNOB(S)
		Canton, Ohio	WCNO(S)			Pittsburgh, Pa.	WYRE

Tapes in Review

1963 EDITION

by R. D. Darrell



Brings you in one convenient book the pre-recorded tape reviews—about 500—which appeared in HIGH FIDELITY during 1962 and 1961. All were written by R. D. Darrell, contributing editor of HIGH FIDELITY, pioneer in the art of discography, author of The High Road to Musical Enjoyment and Good Listening and many, many articles.

If you buy pre-recorded tapes, this book will help you build a fine library of the music you enjoy. Mr. Darrell's interests range from Beethoven to romantic Italian songs. There's a piece, too,

on The Basic Tape Library, and an index. And that's it!

If you are not yet one of our readers who buys pre-recorded tapes, you will find Tapes in Review: 1963 Edition helpful as a guide to discs for performances on tapes are available, also, on discs. And the book will enlighten and entertain every musically minded reader.

It measures 6½" x 9¼". Soft cover.

Payment with order. Satisfaction guaranteed or your money back. Use the handy order form alongside.

S-64

Wyeth Press, a Division of High Fidelity
Publishing House, Great Barrington, Mass., 01230

Send me a copy of Tapes in Review: 1963 Edition
for the \$2.50 I enclose.

Send to _____

Name _____

Address _____



Year's Best Recordings

Compiled by Shirley Fleming

The
pick of
1963's
outstanding
discs and
recorded
tapes.

BACH: *Brandenburg Concertos, S. 1046-1051* (complete). Philharmonia Orchestra, Klemperer. Angel S 3627B (two discs). If you want these works in modern instrumentation, you cannot do better than this set. The difficult problem of balances has been solved with almost complete success.

BACH: *Magnificat in D, S. 243*. Lee Venora, Jennie Tourel, Russell Oberlin, Charles Bressler, Norman Farrow; Schola Cantorum; New York Philharmonic Orchestra, Bernstein. Columbia MS 6375. This performance embodies a number of excellent qualities, and without any trace of romanticizing Bernstein conveys the individual "affection" of each section. Sound is magnificent.

BACH: *Organ Works*. Carl Weinrich, organ. RCA Victor LSC 2649. The new organ at the General Theological Seminary in New York is magnificent, admirably suited to bring out the power and beauty of these massive designs in tone. First-class performances, by and large, with fine sound.

BACH: *Passacaglia and Fugue in C minor, S. 582*. **MESSIAEN:** *La Nativité du Seigneur: Dieu parmi nous*. **FRANCK:** *Grande pièce symphonique, Op. 17*. Virgil Fox, organ. Command CC 11018SD. A virtuoso with an amazing technique, Fox is also a sensitive musician. Command engineers have captured an unusually wide range of dynamics, without any distortion whatever. In some respects, this is the most thrilling disc of serious music the company has yet issued.

BARTOK: *Bluebeard's Castle*. Rosalind Elias, Jerome Hines. Philadelphia Orchestra, Ormandy. Columbia MS 6425. Ormandy's conception is imaginative and attractive, the orchestra plays marvelously well, and the soloists sing with accuracy as well as dramatic awareness and sensitivity. Sound is highly rated.

BARTOK: *Concerto for Orchestra*. Boston Symphony Orchestra, Leinsdorf. RCA Victor LSC 2643. Leinsdorf plays this

Concerto with exceptional sensitivity to its Hungarian elements and long melodic lines, at the same time losing none of the dramatic quality of the music. The result is a performance as exciting as any on records. The perspective is essentially that of a good main-floor seat.

BARTOK: *Quartets for Strings* (complete). Hungarian String Quartet. Deutsche Grammophon SLP 138650/52. These performances are comparable to the best, and perhaps even have an edge in sheer vibrant warmth. They have also the advantage of DGG's excellent recorded sound.

BEETHOVEN: *Concerto for Piano and Orchestra, No. 5, in E flat, Op. 73* ("Emperor"). Rudolf Serkin, piano; New York Philharmonic, Bernstein. Columbia MS 6366. This disc should be a best seller, as it boasts strong musical worth and exceptional sound.

BEETHOVEN: *Concerto for Violin and Orchestra, in D, Op. 61*. Nathan Milstein, violin; Philharmonia Orchestra, Leinsdorf. Angel S 35783. This set should please the many persons who like to hear this music with the expressive manipulation of line that we associate with Russian violinists. Well engineered.

BEETHOVEN: *Quartets for Strings, Op. 18*. Amadeus Quartet. Deutsche Grammophon SLP 138531/33. If you like young Beethoven singing, this edition is the right one for you. Well recorded in stereo.

BEETHOVEN: *Quartets for Strings: Op. 127, Op. 130, Op. 131, Op. 132, Op. 135; Grosse Fugue, Op. 133*. Budapest String Quartet. Columbia MS 677 (five discs). Probably the finest thing the Budapest has ever given us, with skillful engineering that is equal to making a quartet recording that really sounds like a quartet.

BEETHOVEN: *Symphonies* (complete). Berlin Philharmonic Orchestra, Von Karajan. Deutsche Grammophon SKL

101108 (eight discs). Karajan's Nine will certainly go down in history as one of the best sets produced in the mid-twentieth century. DGG has much to be proud of. Made in a Berlin church, the recording is very spacious, and the engineers have sensibly eschewed stereo tricks. The forces are well-balanced.

BEETHOVEN: *Symphony No. 4, in B flat, Op. 60; Leonore Overture No. 3, Op. 72a.* Pittsburgh Symphony Orchestra, Steinberg. Command CC 11016SD. These two performances rank as some of the best Beethoven in stereo and prime items in the Steinberg discography. Antiphony between strings and winds is beautifully realized.

BEETHOVEN: *Symphony No. 5, in C minor, Op. 67.* New York Philharmonic, Bernstein. Columbia MS 6468. The line is always firm, the meter clear, the phrase evident, here. As attractive a Beethoven Fifth as you can find today.

BEETHOVEN: *Symphony No. 7, in A, Op. 92.* Pittsburgh Symphony Orchestra. Command CC 11014SD. Many listeners will probably regard this as the best two-channel version of the music to be heard on records. The orchestra is recorded in such a way that it sounds exactly as a symphony orchestra should.

BELLINI: *La Sonnambula.* Joan Sutherland, Nicola Monti, Fernando Corena, et al. Chorus and Orchestra of Maggio Musicale Fiorentino, Bonyngé. London OSA 1365 (three discs). The present recording is quite good, and often remarkable so far as Sutherland is concerned. Bonyngé's leadership is well ordered and nicely balanced.

BERG: *Concerto for Violin and Orchestra.* **BARTOK:** *Two Rhapsodies for Violin and Orchestra.* Isaac Stern, violin; New York Philharmonic, Bernstein. Columbia MS 6373. This is the first stereo recording of the Berg and it is a good show all around—for Stern, for Bernstein, and for Columbia.

BERLIOZ: *Béatrice et Bénédict.* April Cantelo, Josephine Veasey, John Mitchinson, et al. St. Anthony Singers; London Symphony Orchestra, Colin Davis. Oiseau-Lyre SOL 256/57. The joy of listening to this work is that of communicating with a mind of magnitude. The recording is a lovely one, distinguished by almost perfect sound, superb orchestral playing, and knowledgeable work by the principals.

BERLIOZ: *Harold in Italy, Op. 16.* William Lincer, viola; New York Philharmonic, Bernstein. Columbia MS 6358. The first really satisfying disc presentation of this work. The reading is beautifully paced, and combines poetry and fire.

BERLIOZ: *Symphonic fantastique, Op. 14.* Boston Symphony Orchestra, Munch. RCA Victor LSC 2608. Munch provides the exact kind of performance Berlioz very likely had in mind. The engineering

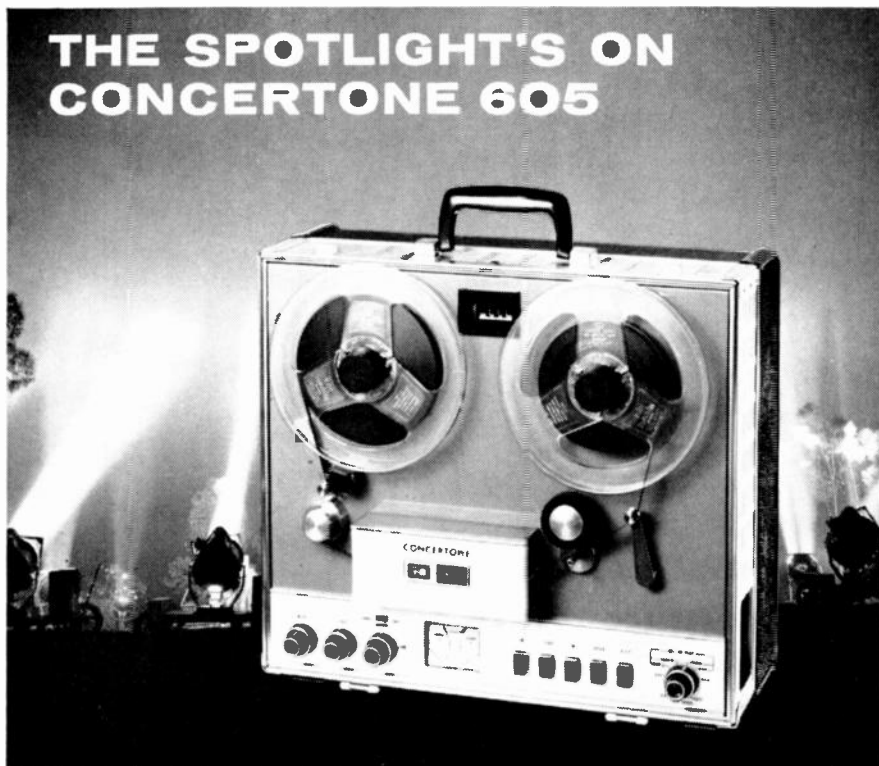

A new standard of perfection from Concertone

Concertone introduces a new standard of perfection in professional quality tape recorders. The 605 brings you the ultimate in advances of the state of the art in tape recorder engineering. ■ Never before have so many features and so much professional quality been packed into one recording instrument...and for such a low price!

IN THE SPOTLIGHT:

- Precision plug-in head assembly: Includes four precision heads.
- Separate microphone and line controls: Input can be mixed!
- Delay memory control circuit: Never spill or break tape!
- Automatic glass tape lifters: Including electric cue feature!
- Sound on sound and add sound: With convenient front panel switch!
- Solenoid operated brakes: For fast, sure action!
- Three motors: Includes 2-speed hysteresis synchronous drive.
- Automatic rewind: Fast rewinds at end of tape.
- All electric push button operation: Remote control optional.
- Reverse-O-Matic®: Play tape from end to end and back *automatically!*
- New magnetic heads: Ferrite erase, laminated and lapped. 4-track has no reverse channel cross-talk.
- Frequency response: 7.5 ips 50-15 KC ± 2 db.
- Wow and flutter: Less than .2% R.M.S. at 7.5 ips.

Broadcast Version Model 607: 19" x 14" in size; special plug-in transformers!

For complete details of the versatile performer, write to:



AMERICAN CONCERTONE, INC.
A DIVISION OF ASTRO-SCIENCE CORPORATION
9449 WEST JEFFERSON BOULEVARD • CULVER CITY, CALIFORNIA

AMERICAN CONCERTONE, INC.
9449 West Jefferson Boulevard • Culver City, California
ATT: Dept. HFS-64
Please send me complete information on the new Concertone 605:

name _____
firm name _____
address _____
city _____ zone _____ state _____

FOR EXPORT: J. D. Marshall, Int. 170 W. Washington St., Chicago 2, Ill.
CIRCLE 5 ON READER-SERVICE CARD

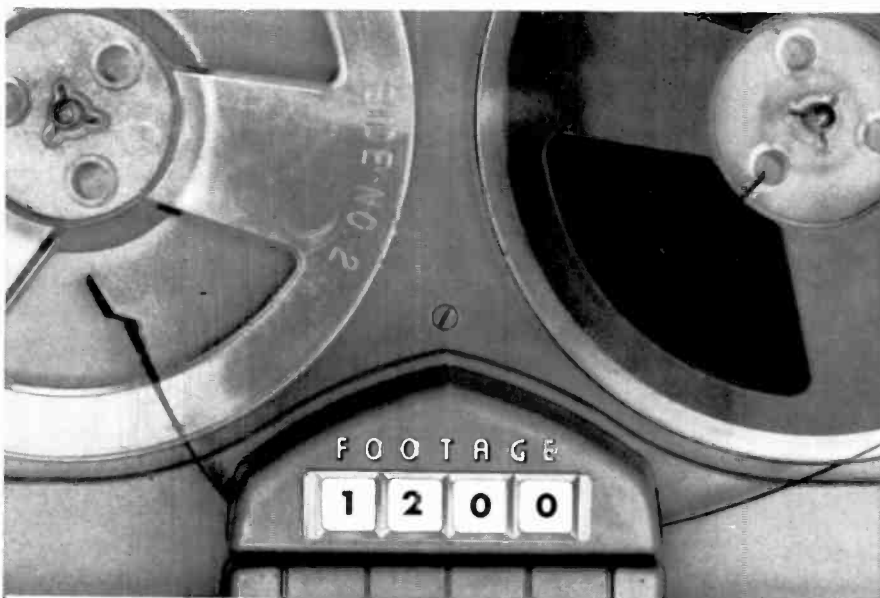

WHEN OTHER TAPES HAVE RUN OUT...

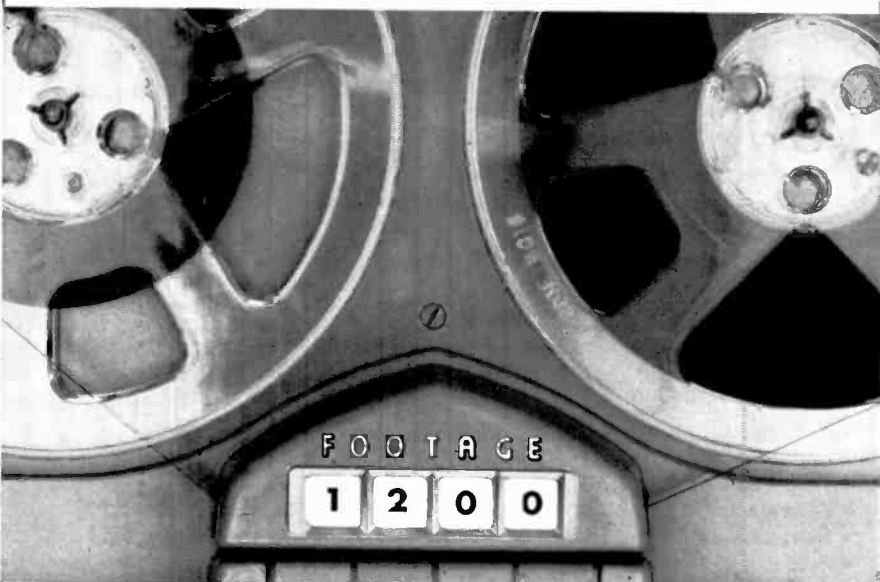

**AMERICAN'S "PROFESSIONAL LENGTH"
STILL HAS 25% MORE ON THE REEL**



Only American's Revolutionary New "Professional Length" Tapes offer up to 25% more tape and 25% more playing time on the standard 7" reel. Available in 1500', 2000', 3000' and 3600' reels at little or no more than you would pay for other leading brands in standard lengths.

See your dealer or write to:

GREENTREE ELECTRONICS 291 S. LA CIENEGA BOULEVARD
BEVERLY HILLS, CALIFORNIA

CIRCLE 61 ON READER-SERVICE CARD

is uncommonly good, making the disc competitive with recordings that go in primarily for sonic showmanship.

BRAHMS: *Concerto for Piano and Orchestra, No. 2, in B flat, Op. 83.* Leon Fleisher, piano; Cleveland Orchestra, Szell. Epic BC 1253. Almost every measure suggests the dynamic freshness of a brilliant musical intellect. Epic's stereo places the ear very close to the performers. The resulting sound is admirably rich.

BRAHMS: *Concerto for Piano and Orchestra, No. 2, in B flat, Op. 83.* Gina Bachauer, piano; London Symphony Orchestra, Skrowaczewski. Mercury SR 90301. A performance of immense assurance and propulsive vitality. The musical conception is grandly sonorous, and the stereo version has great richness.

BRAHMS: *Concerto for Violin and Orchestra, in D, Op. 77.* David Oistrakh, violin; French National Radio Orchestra, Klemperer. Angel S 35836. Both the violinist and the conductor understand and execute perfectly the true spirit of the music. An honest performance, marked by first-rate orchestral playing and fine engineering.

BRAHMS: *Hungarian Dances (19).* Hartford Symphony Orchestra, Mahler. Decca DL 710058. These works are well interpreted. The stereo sound, as well as the orchestral playing, is very good.

BRAHMS: *Liebesslieder Waltzer, Op. 52.*
SCHUMANN: *Spanische Liebes-Lieder, Op. 138.* Veronica Tyler, Regina Sarfaty, William Warfield, et al. Arthur Gold and Robert Fizdale, pianos. Columbia MS 6461. Scarcely anything in this performance of the Brahms could be improved upon: it is ideally lively, expressively passionate, and beautifully organized vocally, with some choice antiphonal effects. This is the initial recorded performance of the Schumann cycle, a lovely work, comparable to the Brahms in every way.

BRAHMS: *Quintet for Piano and Strings, in F minor, Op. 34.* Leon Fleisher, piano; Juilliard String Quartet. Epic BC 1265. A somewhat severe performance, but superbly judged and magnificently integrated as ensemble playing. Brilliantly lifelike reproduction.

BRAHMS: *Sonata for Piano, No. 3, in F minor, Op. 5. Intermezzos: in E flat, Op. 117, No. 1; in C, Op. 119, No. 3.* Clifford Curzon, piano. London CS 6341. Really distinguished performances. In recorded sound, much to be preferred to the nearest competition.

BRAHMS: *Sonatas for Violin and Piano: No. 2, in A, Op. 100; No. 3, in D minor, Op. 108.* Henryk Szeryng, violin; Artur Schnabel, piano. RCA Victor LSC 2619. A wonderful chamber music disc. An ideal sonata team. Faultless engineering.

BRAHMS: *Symphony No. 3, in F, Op.*

90: *Tragic Overture, Op. 81*. Pittsburgh Symphony Orchestra, Steinberg. Command CC 11015SD. The Pittsburghers play the symphony with incisiveness and tonal glow, and the recorded sound is notable for presence and definition in all choirs.

BRITTEN. *Canticles: My Beloved Is Mine; Abraham and Isaac; Still Falls the Rain*. John Hahessey, boy contralto; Peter Pears, tenor; Benjamin Britten, piano; Barry Tuckwell, horn. London OS 25332. Magnificent works, deeply felt, brilliantly designed and crafted. Performances are perfect, and London has produced a gorgeously warm, clear recording.

BRITTEN: *War Requiem, Op. 66*. Galina Vishnevskaya, Peter Pears, Dietrich Fischer-Dieskau; Highgate School Choir; Bach Choir; London Symphony Orchestra Chorus; Melos Ensemble; London Symphony Orchestra, Britten. London OSA 1255 (two discs). Performances are extraordinarily good, and London has brilliantly met the challenge of recording the various levels of soloists, chamber orchestra, large orchestra, full chorus, and boys' choir. It would seem that this is the sort of piece for which stereophonic recording might have been invented.

BRITTEN: *Young Person's Guide to the Orchestra, Op. 34*. **SAINT-SAËNS:** *Carnaval des animaux*. Henry Chapin, narrator (in the Britten); Leonard Bernstein, narrator (in the Saint-Saëns); New York Philharmonic, Bernstein. Columbia MS 6368. This recording really shines in stereo. The instrumental distribution gives a distinct left, right, and center illusion without exaggeration.

BRUCH: *Concerto for Violin and Orchestra, No. 1, in G minor, Op. 26*. **MOZART:** *Concerto for Violin and Orchestra, No. 4, in D, K. 218*. Jascha Heifetz, violin; New Symphony Orchestra of London, Sargent. RCA Victor LSC 2652. The Bruch provides one of the most dazzling examples of incandescent fiddling to be heard on records. Sound is ideal, with stereo emphasizing airy clarity. A magnificent record.

BRUCH: *Scottish Fantasia, Op. 46*. **VIEUXTEMPS:** *Concerto for Violin and Orchestra, No. 5, in A minor*. Jascha Heifetz, violin; New Symphony Orchestra of London, Sargent. RCA Victor LSC 2603. Heifetz is in rare form, and Victor's sound is very, very fine.

BRUCKNER: *Mass No. 3, in F minor* ("Great Mass"). Pilar Lorengar, Christa Ludwig, Josef Traxel, Walter Berry, Choir of St. Hedwig's Cathedral (Berlin); Berlin Symphony Orchestra, Forster. Angel S 35982. Vocal and instrumental soloists are all first-rate, and the orchestra is highly polished. Good stereo balance, and an illusion of vast spaciousness.

BRUCKNER: *Symphony No. 7, in E*. **WAGNER:** *Siegfried Idyll*. Philharmonia

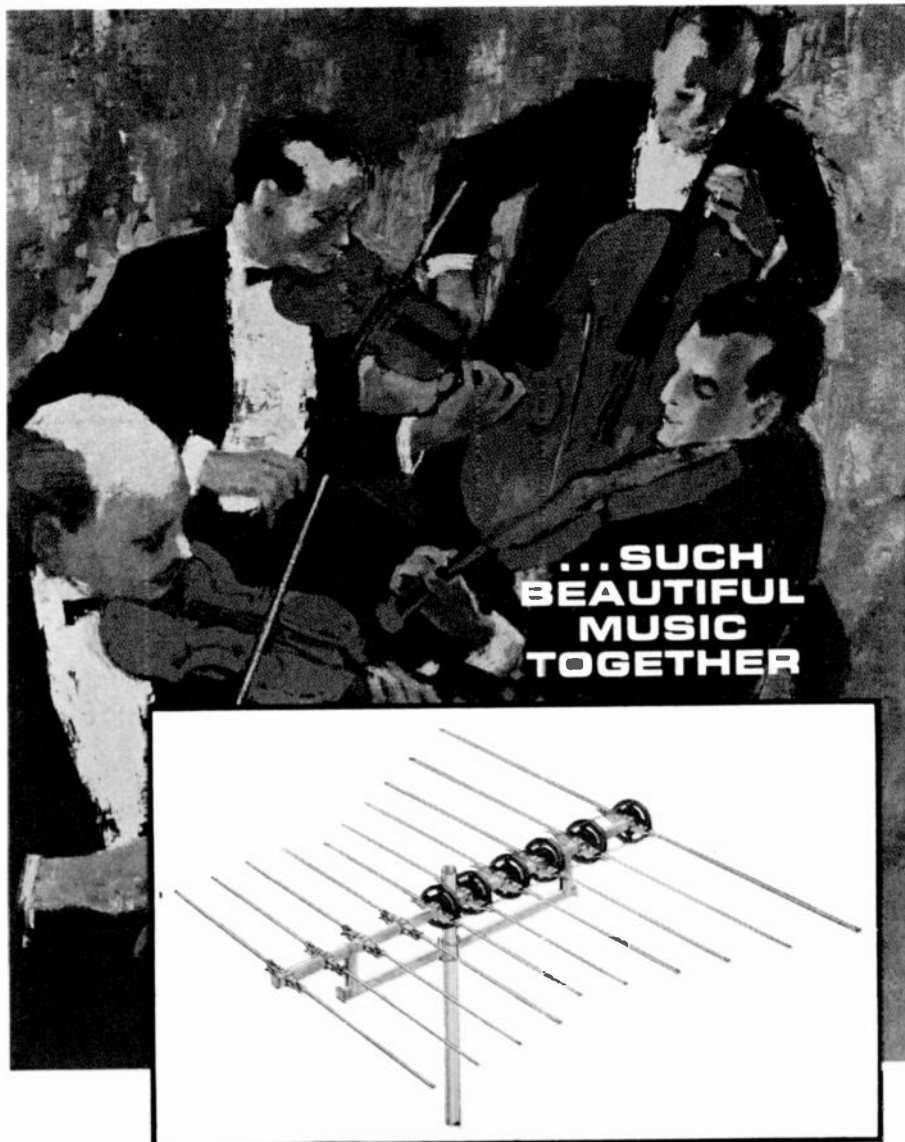

FM STEREO and the new **PARALOG** ANTENNA

Sure, you've got a fine FM tuner, superb amplifiers, the world's greatest speakers.

But FM multiplex reception begins at the antenna. And without a new PARALOG you compromise on stereo quality regardless of how good the rest of your system may be.

Extremely high gain and directivity coupled with low VSWR throughout the entire FM band solve the nettling problems of "multipath" in metropolitan locales and low signal strength in fringe reception areas. A PARALOG FM antenna will bring to your system a new order of hiss-free monaural or stereo performance.

The PARALOG is the product of the same engineering brains and the same manufacturing facilities that produce the most sensitive and rugged satellite-tracking and telemetry antennas for the U. S. Government. No other home-antenna manufacturer has the actual space-probe antenna experience of Jerrold-TACO.

There are three models of the PARALOG FM antenna, priced from \$29.95. Why waste FM signal quality and range another day when such a small investment can give you the ultimate in reception? Insist on a PARALOG, sold only by Jerrold-TACO dealers.



Write for literature and the name of the dealer near you. Jerrold Electronics, Distributor Sales Division, Philadelphia 32, Pa.

CIRCLE 31 ON READER-SERVICE CARD

**Do you
own one
of these
fine amplifiers?**

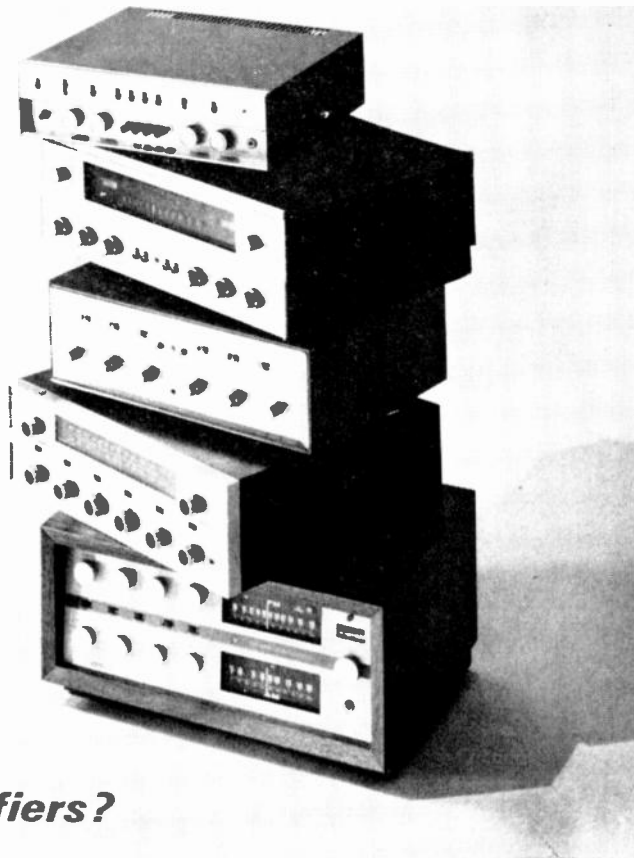

From top: Knight, Fisher, Scott, Bogen, Harman-Kardon

If you do . . . and you don't own a set of Koss stereo headphones . . . you've got a lot of fun still coming! You've got the whole great experience of Koss "solo flight" listening ahead, because your amplifier is equipped with a jack just right for Koss Stereophones.

Just plug them in, slip them on and . . . well, prepare for take-off. Your Koss phones will send you soaring into private sonic bliss. You'll hear it all with startling clarity and a new "up-closeness" you've never experienced before. What's more, you'll listen in complete seclusion, with no disturbance to or from the others in the room.

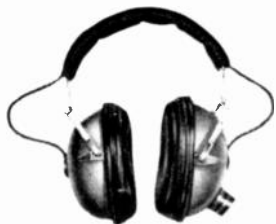

PRO-4 STEREOPHONES

Fluid-filled earpads for tight, comfortable seal. A durable phone designed for professionals. 30-20,000 c.p.s. response 4-16 ohms impedance. \$45.00.

SP-3X STEREOPHONES

Wide range 10-15,000 c.p.s. response obtainable only through earphone listening. Sensitive 3½" sound reproducers mounted in each earpiece. Soft sponge foam ear and head cushions. Impedance 4-16 ohms. \$24.95.



KOSS

ELECTRONICS, INC.

2227 NORTH 31ST STREET
MILWAUKEE 8, WISCONSIN

CIRCLE 34 ON READER-SERVICE CARD

Orchestra, Klemperer. Angel S 3626 (two discs). Bruckner's Seventh is one of the greatest achievements of the nineteenth century, and this is one of Angel's best stereo productions. The performance of the *Siegfried Idyll* is obviously that of a great Wagnerian.

CHOPIN: *Concerto for Piano and Orchestra, No. 2, in F minor, Op. 21; Polonaises: No. 3, in A, Op. 40, No. 1 ("Military"); No. 6, in A flat, Op. 53 ("Heroic")*. Stefan Askenase, piano; Berlin Philharmonic Orchestra, Ludwig. Deutsche Grammophon SLP 138791. An undeniably beautiful though somewhat perplexing performance of the concerto. The piano playing in the polonaises is altogether patrician. Recorded sound is vivid but always intimate.

COPLAND: *El Salón México; Appalachian Spring; Dance from "Music for the Theatre."* New York Philharmonic, Bernstein. Columbia MS 6355. This is music cut to Bernstein's conducting style and the results are exciting. Stereo has clarity and depth.

DEBUSSY: *La Mer. Nocturnes: No. 1, Nuages; No. 2, Fêtes; No. 3, Sirènes*. Philharmonia Orchestra, Giulini. Angel S 35977. All in all, Giulini's *La Mer* is the most interesting version yet to appear in stereo.

DEBUSSY: *Nocturnes: No. 1, Nuages; No. 2, Fêtes. Prélude à l'après-midi d'un faune. Printemps*. Boston Symphony Orchestra, Munch, RCA Victor LSC 2668. Performance and sonics are spellbinding throughout. Realistic as the stereo version is, it faithfully captures the complex blend as well as the individual strands of the scores' tonal textures.

DELAHIANDE: *De profundis*. Soloists; Vienna Chamber Choir; Vienna State Opera Orchestra, Deller. Vanguard BGS 5052. This is one of the masterpieces of the French baroque, full of noble melody, poignant harmony, and expressive and transparent counterpoint. Vanguard's stereo is rich in sound.

DITTERSDORF: *Partita in D; Divertimento in B*. HAYDN. MICHAEL: *Divertimento in D*. STAMITZ. KARL: *Quartet for Winds, in E flat, Op. 8, No. 2*. Vienna Wind Ensemble, Music Guild S 28. All of the music in this album is excellently and crisply constructed, and the Viennese players perform beautifully. The stereo registration is cleanly spaced, and admirably transparent in a lifelike manner.

DURUFLE: *Requiem, Op. 9*. Various soloists; Philippe Caillard and Stéphanie Caillat Chorales; Orchestre des Concerts Lamoureux, Duruflé. Epic BC 1256. The work is deeply moving, and the combined choirs superbly disciplined. Clarity, balance, and naturalness are striking, and stereo effectively pinpoints each section of the choir.

DVORAK: *Concerto for Cello and Orchestra, in B minor, Op. 104*. Pierre

Fournier, cello; Berlin Philharmonic, Szell. Deutsche Grammophon SLPM 138755. This is a perfectly poised performance, terse in attack, sumptuous in tone. Every note of the score is discernible in DGG's magnificently balanced reproduction.

DVORAK: *Symphony No. 4, in G, Op. 88: Scherzo capriccioso, Op. 66.* Philharmonia Orchestra, Giulini. Angel S 35847. A superior recording of what is probably Dvořák's finest symphonic creation. High quality of sound, characterized by depth, resonance, and general naturalness.

DVORAK: *Symphony No. 4, in G, Op. 88.* BRAHMS: *Academic Festival Overture, Op. 80.* Columbia Symphony Orchestra, Walter. Columbia MS 6361. This Dvořák performance is a classic now, and the orchestra is full and roundly radiant. The Brahms further reflects Walter's genius.

DVORAK: *Symphony No. 5, in E minor, Op. 95 ("From the New World").* New York Philharmonic, Bernstein. Columbia MS 6393. This reading is a dynamic one, admirably reproduced.

FAURE: *Requiem.* Victoria de los Angeles, Dietrich Fischer-Dieskau. H. Puig-Roget, organ; Elisabeth Brasseur Choir; Orchestre de la Société des Concerts du Conservatoire de Paris, Cluytens. Angel S 35974. Perhaps the finest version of this work on records. There is ample definition, satisfactory balance, and fine stereo spread.

GABRIELI, G.: *Sacrae Symphoniae.* GABRIELI, A.: *Ricercari.* Paris Instrumental Ensemble, Holland. Vox STDL 500540. The double-choir pieces sound especially rich and imposing in this excellent stereo recording.

HANDEL: *Alcina.* Joan Sutherland, Graciella Sciutti, Teresa Berganza, Ezio Flagello, et al. London Symphony Chorus and Orchestra, Bonyngé. London OSA 4361 (three discs). The cast is exceptionally strong, and London's sound is unimpeachable.

HANDEL: *Music for the Royal Fireworks; Concerto a due chori, No. 2, in F.* Wind Ensemble, Pro Arte Orchestra, Mackerras. Vanguard BGS 5046. The creamy reediness of the forty woodwinds, the brazen trumpets, the noble horn blasts, and the thundering drums add up to an enormous strawberry shortcake of sound. A delightful treat.

HANDEL: *Saul.* Jennifer Vyvyan, Helen Watts, Herbert Handt, Thomas Hemsley; Copenhagen Boys' Choir; Vienna Symphony Orchestra, Wøldike. Vanguard BGS 5054/56. This oratorio contains some magnificent music. Wøldike does not strain after monumentality but achieves power when it is needed. The chorus is first-class, the sound splendidly real.

HAYDN: *Mass No. 9, in D minor ("Nelson").* Sylvia Stahlman, Helen

NOW...FAMOUS FREEMAN PROFESSIONAL RECORDERS

*Offer Studio Performance
In Your Family Circle*

easiest to operate...most fun to use

**World's
first...**

**Stereo-
phonic
Robot**

Shown with C-246 Console Cabinet Price \$149.50 Audiophile Net



FREEMAN "200" STEREOPHONIC ROBOT
Audiophile Net \$995.00

- Automatic Reverse
- 4 Broadcast Heads
- 100% Transistorized
- 4-Channel Mixer
- Touchbutton Operation
- Automatic Continuous Play
- 40 Watt Stereo Output
- Tape or Source Monitoring
- 3 Hysteresis Synchronous Motors
- Echo Chamber

Audiophile Net \$399.50



**ONLY THE FREEMAN
"600" OFFERS**

- Automatic Shut-off
- Hysteresis Synchronous Motor
- 3 Head Professional Stereo Design
- 15 Watt Stereo Output
- Qualifies For School Use
- A Complete Home Music System
- No Competition Under \$600



Audiophile Net
\$139.50

THE UNEQUALED "550"

Tapes up to two hours. The finest lecture, report and conference recorder in the world. Battery or AC power.



Audiophile Net
\$159.50

THE FABULOUS "660"

Now, everyone can tape high fidelity anytime, anywhere in a 6-lb package. Battery or AC power.



FREEMAN ELECTRONICS CORP., Dept. S-64

729 N. Highland Avenue, Los Angeles 38, California

In Canada: 1156 Beechwood Crescent, North Vancouver, B.C.
19 Le Royer St., W., Montreal 1, Que.

International Office: Ovimpex, Inc., 176 Broadway, New York 38, N.Y.

Please send me:

- Booklet containing ingenious suggestions on how to get the most from a tape recorder at work or play. I enclose 25¢ (coin, stamps) for postage and handling.

- Name of nearest dealer.

Information on:

- Model 200 Model DM-166
 Model 600 Microphone
 Model 550 Model SEP-100
 Model 660 Stereophones

Name _____

Address _____

City _____ Zone _____ State _____

WHEN IN LOS ANGELES, BE SURE TO VISIT THE FREEMAN RECORDER SALON, 731 N. HIGHLAND

CIRCLE 25 ON READER-SERVICE CARD



Command Performance

at your fingertips ...

... every time you capture the magnificent world of full fidelity sound on tape.

Taped sound retains full fidelity even after hundreds of playbacks ... yours to enjoy always ... on VIKING tape components, naturally.

A VIKING invests you with unlimited versatility to record live programs or off the air including F.M. multiplex, duplicate, put sound on sound and edit with perfect ease.

Retro-matic 220 — ultimate performance with tomorrow's features for discriminating audiophiles and professionals only.

Two-directional playback, quarter track stereo at two speeds. "Feather-touch" push buttons, remote control, 12 watt amplifier, simultaneous record/playback with 20-25,000 cps frequency response. Independent channel controls, "luma-touch" record buttons and illuminated VU meters. Photo electric run-out sensor, four heads, hysteresis capstan motor plus two reel drive motors and digital counter. Superbly styled with stainless steel face plate this compact operates vertically or horizontally.



88 Stereo Compact—for connoisseurs of the fine things in high fidelity stereo sound.

Two speed tape recorder with choice of half or quarter track stereo. Three new type hyperbolic heads—no more old fashioned pressure pads. New design amplifier with excellent 30-18,000 cps frequency response, lets you monitor off the tape with "A-B" comparison switch. Independent channel controls and VU meters, two motors, record indicator light, counter, automatic tape shut-off. With its attractive, brushed aluminum face panel, the 88 Compact fits any installation for vertical or horizontal operation.

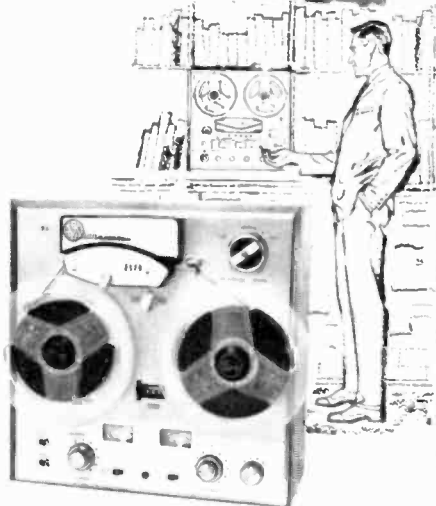

Put Command Performance at your finger tips with VIKING tape components — made by skilled American craftsmen.

Tape recorders, transports, cartridge players—even for your car or boat—at reputable high fidelity dealers most everywhere.



VIKING OF MINNEAPOLIS, INC.

9600 Aldrich Avenue South, Minneapolis, Minnesota, 55420

Your assurance
of Quality in
Tape Components

CIRCLE 56 ON READER-SERVICE CARD

Watts, Wilfred Brown, Tom Krause; Choir of King's College, Cambridge; London Symphony Orchestra, Willcocks. London OS 25731. The high baroque trumpet parts are well realized, and counterbalanced by the roll and thunder of the drums. Acoustics are those of soaring Gothic vaults.

HAYDN: *Symphonies: No. 3, in G; No. 21, in A; No. 23, in G; No. 96, in D.* New York Sinfonietta (in No. 3); Vienna State Opera Orchestra, Goberman. Library of Recorded Masterpieces HS 8/9. The performances are wonderfully true to the spirit of the works, and the sound is excellent.

HAYDN: *Symphonies: No. 56, in C; No. 12, in E; No. 40, in F; No. 13, in D.* Vienna State Opera Orchestra, Goberman. Library of Recorded Masterpieces HS 5/6. Goberman's performances and engineering again fulfill the high expectations of this distinguished series.

HAYDN: *Symphonies: No. 82, in C ("Lours"); No. 83, in G minor ("La Poule"); No. 84, in E flat; No. 85, in B flat ("La Reine"); No. 86, in D; No. 87, in A.* Orchestra de la Suisse Romande, Ansermet. London OSA 2306 (three discs). The merits of these performances equal or are greater than those of rival sets. This is a very vivid, bright picture of a small orchestra. The stereo separation is excellent, and the sense of presence forceful in the extreme.

HEROLD: *La Fille mal gardée* (excerpts). Orchestra of the Royal Opera House, Covent Garden, Lanchbery. London CS 6252. Performed with zest and reproduced in wide-ranging stereo. The recording should be especially welcomed by those who have seen the ballet.

HINDEMITH: *Concerto for Violin and Orchestra.* BRUCH: *Scottish Fantasia, Op. 46.* David Oistrakh, violin; London Symphony Orchestra, Hindemith (in the Hindemith), Horenstein (in the Bruch). London CS 6337. Hindemith's Violin Concerto is one of the most beautiful works of its kind. The sound leaves nothing to be desired. Oistrakh's performance of the *Scottish Fantasia* engenders in the hearer enormous respect for everybody concerned.

HINDEMITH: *Mathis der Maler* (excerpts). Pilar Lorengar, Donald Grobe, Dietrich Fischer-Dieskau; Radio Symphony Orchestra (Berlin), Ludwig. Deutsche Grammophon SLPM 138679. These excerpts are simply stunning, and Hindemith places himself in the company of the great masters of the declamatory style. A superb production.

LEHAR: *Die lustige Witwe.* Lisa Della Casa, Laurel Hurley, Charles Davis, John Reardon, et al. American Opera Society Chorus and Orchestra. Allers. Columbia OS 2280. A fine new presentation, displacing older versions. An excellent cast, with ensemble numbers tily and extremely well sung. The entire production runs along at a brisk pace and has plenty of spirit.

MEDELSSOHN: *Trio for Piano and Strings, No. 1, in D minor, Op. 49.*
 MARTINU: *Trio for Piano and Strings, No. 2, in D minor.* Albeneri Trio. Music Guild S 24. Altogether, an excellent disc. The three instruments are separated fairly widely; they are faithfully reproduced, and the effect is realistic.

MOZART: *Concertos for Bassoon and Orchestra, in B flat, K. 191; for Flute and Orchestra, in G, K. 313; for Oboe and Orchestra, in C, K. 314; for Clarinet and Orchestra, in A, K. 622.* Bernard Garfield, bassoon (in K. 191); William Kincaid, flute (in K. 313); John de Lancie, oboe (in K. 314); Anthony Gigliotti, clarinet (in K. 622); Philadelphia Orchestra. Ormandy. Columbia MS 6451/52. It was a fine idea on Columbia's part to show off some of the first-desk woodwind players of the Philadelphia Orchestra. Performances are admirable, the balances very good throughout; and the sound is glorious.

MOZART: *Concertos for Piano and Orchestra: No. 21, in C, K. 467; No. 23, in A, K. 488.* Artur Rubinstein, piano; Orchestra, Wallenstein. RCA Victor LSC 2634. Rubinstein, Wallenstein, and Victor combine here to do a magnificent job. These are the best versions of K. 467 and K. 488 in stereo.

MOZART: *Concertos for Piano and Orchestra: No. 26, in D, K. 537 ("Coronation"); No. 27, in B flat, K. 595.* Robert Casadesu, piano; Columbia Symphony Orchestra. Szell. Columbia MS 6403. Casadesu's elegant and polished playing and Szell's deft handling of the orchestra combine to make this a highly enjoyable reading. Excellent sound.

MOZART: *Così fan tutte.* Elisabeth Schwarzkopf, Christa Ludwig, Hanny Steffek, Alfredo Kraus, Giuseppe Taddei, Walter Berry. Philharmonia Chorus and Orchestra, Böhm. Angel S 3631 (four discs). This is an artistically distinguished and a highly enjoyable *Così*. The sound is not only splendid with respect to balance, clarity, and definition; it also exploits every advantage of stereo.

MOZART: *Fantasias for Piano: in D minor, K. 397; in C minor, K. 475. Sonatas for Piano: No. 8, in A minor, K. 310; No. 11, in A, K. 331.* Wilhelm Kempff, piano. Deutsche Grammophon SLPM 138707. Kempff is a Mozartean of astonishing breadth, vision, and grandeur. This release is a truly great Mozart recording, and DGG has beautifully caught the rich solidity of Kempff's instrument.

MOZART: *Quartets for Strings: No. 14, in G, K. 387; No. 15, in D minor, K. 421; No. 16, in E flat, K. 428; No. 17, in B flat, K. 458; No. 18, in A, K. 464; No. 19, in C, K. 465.* Juilliard String Quartet. Epic BSC 143 (three discs). A magnificent set—it has elegance and strength, fire and poetry. Sound is practically ideal.

MOZART: *Serenade for Strings, No. 13, in G, K. 525 ("Eine kleine Nachtmusik").*



the best seat in the house...

... and it's right in your living room if your FM is equipped with a

FINCO® AWARD WINNING FM ANTENNA

Broadcasting authorities agree that an outdoor antenna is absolutely essential for the reception of full quality monaural and multiplex FM sound.

A *FINCO* FM antenna will deliver a clean undistorted signal and bring in more stations, regardless of location.

Guarantee yourself the best seat in the house for tonight's FM concert... install a fidelity-phased *FINCO* FM antenna.

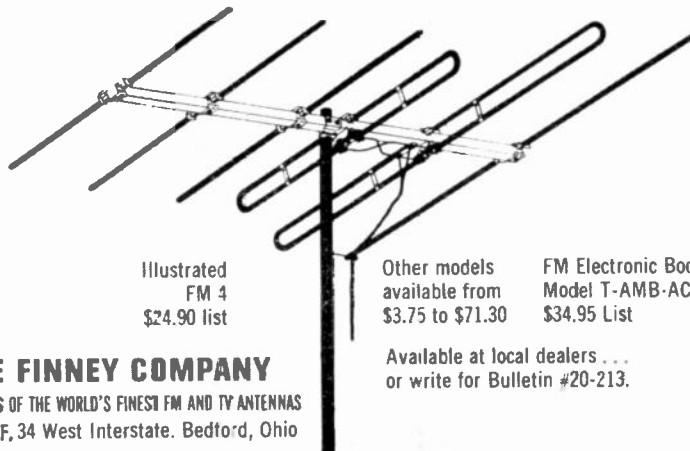

Illustrated
 FM 4
 \$24.90 list

Other models
 available from
 \$3.75 to \$71.30

FM Electronic Booster
 Model T-AMB-AC
 \$34.95 List

THE FINNEY COMPANY

PRODUCERS OF THE WORLD'S FINEST FM AND TV ANTENNAS
 Dept. HF, 34 West Interstate, Bedford, Ohio

Available at local dealers...
 or write for Bulletin #20-213.

CIRCLE 23 ON READER-SERVICE CARD



What is this?

IT'S AUTOSTEREO – STEREO FOR YOUR CAR!

This new cartridge-loading stereo tape player is installed with four special speakers that surround you with big, beautiful sound wherever you go. Drive along in mountains, desert, wilderness—with no reception problems, no static, and no commercial interruptions. Easier to operate than a car radio—just slip in a tape cartridge and pull the lever. Instant stereo! Ingenious tape cartridges are continuous loop and rewind themselves as they play. And they play *your* kind of music—with a vast library of taped music to choose from. AUTO-STEREO is fully transistorized and powered by the car battery, using less current than your cigarette lighter. Frequency response: 40 to 10,000 cps. Easily installed in any car. Fully guaranteed with a 1-year warranty. See your AUTOSTEREO dealer and get an “inspiration” for the road—a free demonstration. For a free brochure, taped music catalog, and the name of your nearest dealer, write: AUTOSTEREO, 14617 Keswick Street, Van Nuys, California.



CIRCLE 11 ON READER-SERVICE CARD

Overtures: Der Schauspieldirektor; Così fan tutte; Le Nozze di Figaro; Die Zauberflöte. Maurerische Trauermusik, K. 477. Columbia Symphony Orchestra, Walter. Columbia MS 6356. Each of these little masterpieces is shaped lovingly, with a perfection of detail. Sound is very fine.

MOZART: *Serenade for Wind Instruments, No. 10, in B flat, K. 361.* Members of Bavarian Radio Symphony Orchestra, Jochum. Deutsche Grammophon SLPM 138830. The glorious sound of Mozart's wind band is beautifully reproduced on this disc. Highly enjoyable.

MOZART: *Symphonies: No. 35, in D, K. 385 ("Haffner"); No. 41, in C, K. 551 ("Jupiter").* Amsterdam Concertgebouw Orchestra, Jochum. Philips PHS 900004. A fine example of modern Mozart playing, pointed and precise yet flexible and always singing. This *Jupiter* and *Haffner* belong at the top of the list.

MUSSORGSKY: *Boris Godunov* (arr. Rimsky-Korsakov). Evelyn Lear, John Lanigan, Boris Christoff, et al. Chorus of the National Opera of Sofia, Orchestre de la Société des Concerts du Conservatoire de Paris, Cluytens. Angel S 3633D/L (four discs). Christoff is the finest Boris of our day. The supporting roles are all well sung, and Angel has never used stereo to a better advantage or provided a more vivid sense of theatre.

NIELSEN: *Symphony No. 5, Op. 50.* New York Philharmonic, Bernstein. Columbia MS 6414. A powerful, deeply affecting work by the Danish composer. It comes across extremely well, thanks to the conviction of Bernstein's direction, the playing of the Philharmonic, and the broad stereo spectrum, which brings unusual depth, width, and overall spaciousness to the sound.

POULENC: *Concerto for Two Pianos and Orchestra, in D minor; Concert champêtre.* Francis Poulenc, piano; Jacques Février, piano; Aimée van de Wiele, harpsichord (in the *Concert champêtre*); Orchestre de la Société des Concerts du Conservatoire de Paris, Prêtre. Angel S 35993. This is a beautiful record, in which the concerto is recreated with a delightful, sentimental refinement and elegance.

POULENC: *Concerto for Two Pianos and Orchestra, in D minor.* **SHOSTAKOVICH:** *Concerto for Piano and Orchestra, No. 1, in C minor, Op. 35.* Arthur Gold and Robert Fizdale, duopianos (in the Poulenc); André Previn, piano (in the Shostakovich); New York Philharmonic, Bernstein. Columbia MS 5792. Superb performances of these gems of musical wit. The recorded sound is faithful.

PROKOFIEV: *Concerto for Piano and Orchestra, No. 3, in C, Op. 26.* **RACHMANINOFF:** *Concerto for Piano and Orchestra, No. 1, in F sharp minor, Op. 1.* Byron Janis, piano; Moscow Philharmonic, Kondrashin. Mercury SR 90300. Janis gives an extremely brilliant account

of the Prokofiev, and the recorded sound is enhanced by the spacious quality of the Moscow Conservatory Auditorium's acoustics. Stereo adds just that extra bit of suaveness and separation to justify the extra cost.

PROKOFIEV: *Romeo and Juliet, Op. 64: Orchestral Suites: No. 1; No. 2.* Minneapolis Symphony Orchestra, Skrowaczewski. Mercury SR 90315. Everything is played with great style, character, and affecting Prokofievian elegance. Fine sound.

PUCCHINI: *Madama Butterfly.* Leontyne Price, Rosalind Elias, Richard Tucker, Philip Maero, et al. RCA Italiana Opera Chorus and Orchestra, Leinsdorf. RCA Victor LSC 6160 (three discs). Beautiful, thrilling singing on Miss Price's part. Conductor Leinsdorf must share praise with his orchestra. And there is very little doubt that this is the finest sound yet heard on a Victor operatic recording.

PURCELL: *Dido and Aeneas.* Janet Baker, Patricia Clark, Raimund Herinx, et al. St. Anthony Singers; English Chamber Orchestra, Lewis. Oiseau-Lyre SOL 60047. Oiseau-Lyre's new recording of this work is a superb achievement, and the sound is cushiony and clear.

RACHMANINOFF: *Concerto for Piano and Orchestra, No. 2, in C minor, Op. 18.* Van Cliburn, piano; Chicago Symphony Orchestra, Reiner. RCA Victor LSC 2601. This performance has an irresistible beauty stemming from lucidity, simplicity, and plain good taste. Stereo offers vividness and accuracy of detail.

RACHMANINOFF: *Concerto for Piano and Orchestra, No. 3, in D minor, Op. 30.* Vladimir Ashkenazy, piano; London Symphony Orchestra, Fistoulari. London CS 6359. London's new version has the most satisfactory balance of any recording of this work available. Ashkenazy gives a highly intelligent, lyrical, and flexible reading of the music; he is backed by extremely sympathetic conducting and a suave-sounding LSO.

RAVEL: *Bolero; Pavane pour une infante défunte; La Valse.* Boston Symphony Orchestra, Munch. RCA Victor LSC 2664. Neither of the larger scores has ever been brought to more searchingly delineated, powerful, and incandescent sonic life in reproduction.

SCHUBERT: *Symphonies: No. 3, in D; No. 8, in B minor ("Unfinished").* Pittsburgh Symphony Orchestra, Steinberg. Command CC 11017SD. This recording is one of the best produced recently for sheer fidelity of sound. The sense of presence is phenomenal.

STAINER: *The Crucifixion.* Alexander Young, Donald Bell, Eric Chadwick, organ; Leeds Philharmonic Choir, Bardgett. Angel S 35984. Clear, reverent, and sensitively phrased. Sound is very distinct in well-spaced stereo.

STOCKHAUSEN: *Gesang der Jünglinge; Kontakte.* Realized at the Electronic

A HADLEY Triumph!!!
ENGINEERING
CONCEPTS AS NEW
AS TOMORROW...
for your Sound Pleasure

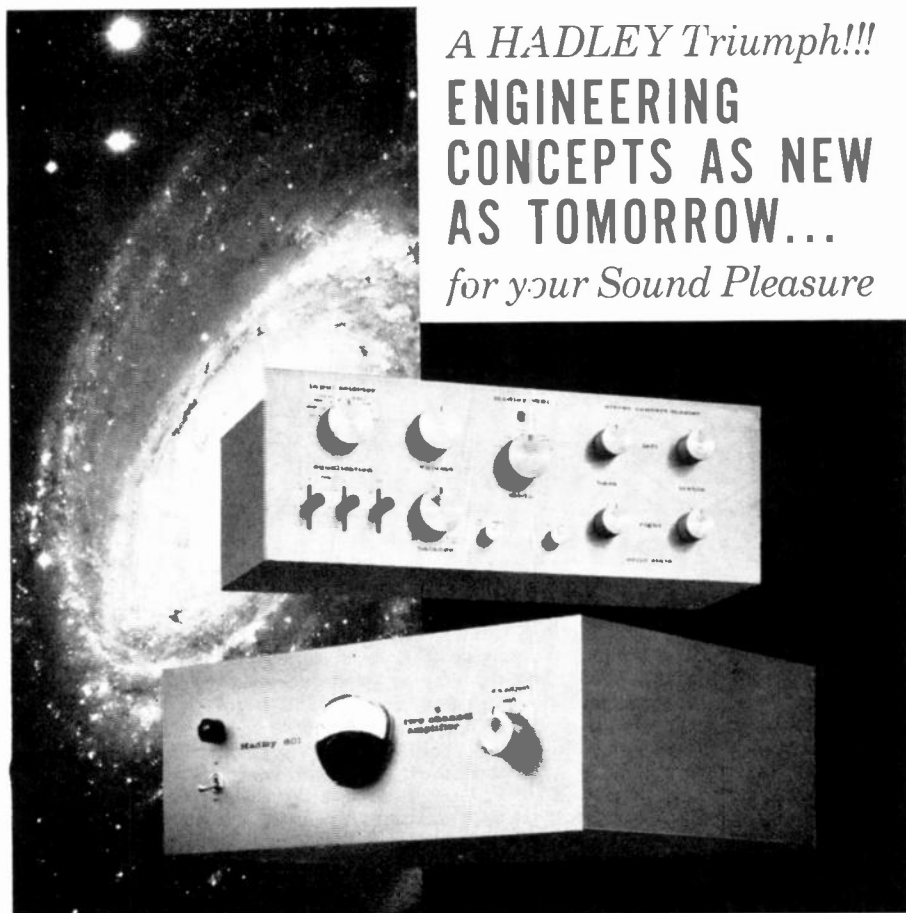

As conceived, designed and developed by Hadley Laboratories, the Model 601 Dual Power Amplifier and Model 621 Solid State Stereo Control Amplifier, offer the maximum in audio pleasure. With this duo, Hadley engineers have created tomorrow's real-life amplifier electronics for today's stereo reproduction. Here, for your listening pleasure, is the ultimate in high fidelity sound with it your home easy chair becomes a seat at Lincoln Center, Covent Gardens, or your favorite contemporary jazz spot. Music and voice are magically born again in their original perfection through the knowledge of Hadley engineers. However, words are mere words, so why not prove the claims for yourself by listening to Hadley today.

Model Specifications: 601: 100W x 2, 100W RMS Output, 40 Watts per Channel
621: Specification: 15" x 12" x 5", 100W RMS Output, 100W RMS
Price \$319.50 each

IF YOUR DEALER CANNOT DEMONSTRATE HADLEY 601 AND 621, CONTACT US DIRECTLY. DEALERS, WRITE FOR FURTHER SPECIFICATION DATA INFORMATION.

HADLEY LABORATORIES

115 Spring Street, Claremont, California
CIRCLE 26 ON READER-SERVICE CARD

WRITE FOR QUOTATION
ON ANY HI-FI COMPONENTS

DISCOUNTS • QUICK SHIPMENT
• FACTORY SEALED CARTONS
• FRANCHISED DISTRIBUTOR

SOUND REPRODUCTION, INC.
34 New Street, Newark, N. J. (07102)
(201) Mitchell 2-5816

CIRCLE 50 ON READER-SERVICE CARD



WHICH DRIVER HAS CAR-STEREO?

Music hath charm to soothe the savage breast. However, it's pretty hard to hear the music you like on radio these days. Commercials (yes, Virginia even on FM) run rampant during rush hours. Cars run rampant, too, and that causes problems, traffic jams, crinkled fenders, frayed nerves, etc. Put it all together and it doesn't spell Mother — it spells bugged driver. ■ So . . . we've prepared a special bugged drivers kit for you. It's guaranteed to help you relax when traffic is rotten. It contains six proven nostrums to ease your day. It's free, write. ■ We'd also like to tell you about our product — The Wayfarer Car-Stereo. The Wayfarer is a cartridge stereo tape player that fits easily in every make of car. It plays self-wind stereo tape albums and produces fantastic sounds in traffic — or anywhere! You'll want car-stereo! ■ To get your free "Bugged Drivers Kit" direct your cards to Curtis Howard. He's our Prez. and keeps us unsnarled. Don't write to D. J. Reiner. He's only a V.P. and thinks we should charge more for our four track, four speaker car-stereo. By the way, the guy on the left doesn't have a Wayfarer Car-Stereo. But that's kind of obvious.



WAYFARER CAR-STEREO

6505 Wilshire Blvd., Suite 302, L. A. 48, Calif.
CIRCLE 57 ON READER-SERVICE CARD

The elegant touch

by

Karlson

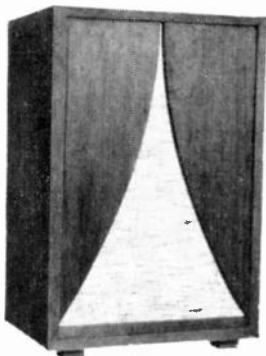

Stereo requires the elegant touch of the artisan to reach its full potential. Elementary bookshelf speakers, with their power-hungry appetites, are just too sluggish to respond to the fine transients needed for complete stereo definition.

For the utmost in stereo, all of the essential factors of dispersion, definition, dynamic range, efficiency, and full bass must be present in their most perfect form. There's none more perfect than a Karlson speaker system or enclosure. In fact, they have out-performed the next best in the industry, in objective listening tests, by the amazing ratio of 9—1! Such performance is only made possible by a most elegant combination of musical artistry and engineering finesse.

There's a patented Karlson speaker system, enclosure, or kit to meet your needs. Write or call for more information on this remarkable invention.

K.R.C. CORP. Box 117
W. Hempstead, L.I., N.Y., 11552
Phone: 516—IV 9-3641

CIRCLE 32 ON READER-SERVICE CARD

Studios of the West German Radio, Cologne. Deutsche Grammophon SLPM 138811. There is a great deal that is remarkable in the quality of thought in this electronic music. The works were originally designed for multichannel performance, and the spatial aspect is built in as an essential part of the music.

STRAUSS, JOHANN II: *Waltzes*. Chicago Symphony Orchestra, Reiner. RCA Victor LSC 2500. The somewhat deliberate tempos and heartfelt eloquence make these readings unique. They have the power, solidity, and breadth of big-hall symphonic sound.

STRAUSS, RICHARD: *Also sprach Zarathustra, Op. 30*. Chicago Symphony Orchestra, Reiner. RCA Victor LSC 2609. This is the finest *Zarathustra* available. The stereo meets the highest standards of our day.

STRAUSS, RICHARD: *Concerto for Horn and Orchestra, No. 1, in E flat, Op. 11*. **MOZART:** *Concerto for Clarinet and Orchestra, in A, K. 622*. Myron Bloom. French horn; Robert Marcellus, clarinet; Cleveland Orchestra, Szell, Epic BC 1241. A most attractive and unusual coupling. Fine literature for stereo.

STRAUSS, RICHARD: *Don Juan, Op. 20; Till Eulenspiegels lustige Streiche, Op. 28; Salome: Salomes Tanz*. Philharmonia Orchestra, Klemperer. Angel S 35737. Through this recording, one can really see into the heart of Strauss's writing. The stereo sound is excellent.

STRAUSS, RICHARD: *Tod und Verklärung, Op. 24; Metamorphosen*. Philharmonia Orchestra, Klemperer. Angel S 35976. The Opus 24 comes to life when you turn up the volume and let its Wagnerian sonorities grow to full scale. *Metamorphosen*, on the other hand, is a chamber score, treated here with the skill Klemperer bestows on the baroque masters.

STRAVINSKY: *Oedipus Rex*. John Westbrook, narrator; Shirley Verrett, George Shirley, Donald Gramm, et al. Chorus and Orchestra of the Opera Society of Washington. Stravinsky. Columbia MS 6472. First-rate artistic realizations on the part of the soloists, with a skilled and responsive chorus and orchestra. Columbia's dry, close sound is appropriate to the music.

TCHAIKOVSKY: *Capriccio italien, Op. 45; Marche slave, Op. 31; 1812 Overture, Op. 49*. New York Philharmonic, Bernstein. Columbia MS 6477. Excellent performances, including a fiercely enthusiastic yet always tautly reined *Capriccio*. Thrillingly vivid sound.

TCHAIKOVSKY: *Concerto for Piano and Orchestra, No. 1, in B flat minor, Op. 23*. Sviatoslav Richter, piano; Vienna Symphony. Von Karajan. Deutsche Grammophon SLPM 138822. A performance of great maturity and probity, with the freshness of a world premiere. Sonically, the recording leaves Richter's old mono version far behind.

TCHAIKOVSKY: *The Nutcracker, Op. 71.* London Symphony Orchestra, Dorati. Mercury SR 29013 (two discs). Dorati keeps this music alive and on its toes. Mercury's 35-mm film recording offers the purest, most realistic sound yet to come from that company.

TCHAIKOVSKY: *Symphony No. 6, in B minor, Op. 74 ("Pathétique").* Philharmonia Orchestra, Klemperer. Angel S 35787. One of the most lucid readings this work has ever had on records. The solidity and transparency of the interpretation have been carried over to the stereo reproduction.

TOCH: *Quintet for Piano and Strings, Op. 64.* André Previn, piano; American Art Quartet. Contemporary S 8011. Op. 64 has suavity, elegance, richness, and beauty of expression within a conservative framework. Playing is just about perfect, and recording is on the same plane.

VARESE: *Arcana; Déserts; Offrandes.* Dona Precht, soprano (in the *Offrandes*); Columbia Symphony Orchestra, Craft. Columbia MS 6362. This record should cinch the fact that Varèse is one of the great figures of twentieth-century music. Since he thinks in stereo, the music is obviously perfect for modern sound reproduction, and Columbia doesn't miss a trick.

VAUGHAN WILLIAMS: *Fantasia on a Theme by Thomas Tallis; Fantasia on "Greensleeves."* **ELGAR:** *Introduction and Allegro, Op. 47; Serenade for Strings, in E minor, Op. 20.* Allegri String Quartet; Strings of the Sinfonia of London, Barbirolli. Angel S 36101. The highlight of this record is the intense, admirably recorded performance of the Tallis Fantasia, a work conceived in stereophonic terms. The effect of space and reverberation is enhanced here by the acoustics of Temple Church, London.

VAUGHAN WILLIAMS: *Symphony No. 5, in D.* Philharmonia Orchestra, Barbirolli. Angel S 35952. An elegant and amiable recording of one of Vaughan Williams' most thoughtful and persuasive works. Rich recording adds much to its effect.

VERDI: *La Traviata.* Joan Sutherland, Carlo Bergonzi, Robert Merrill, et al. Chorus and Orchestra of the Maggio Musicale Fiorentino, Pritchard. London OS 25779 (three discs). An excellent effort, meriting serious consideration in choosing among available versions. The sound is very fine, and the aural "staging" sensible.

WAGNER: *Brünnhilde's Immolation Scene; Wesendonck Songs (5).* Eileen Farrell (s); New York Philharmonic, Bernstein. Columbia MS 6353. This version of the Immolation Scene is the best since Flagstad's prewar recording and Traubel's interpretation under Toscanini. Magnificent engineering—one of the finest of stereo vocal releases.

WAGNER: *Orchestral Excerpts.* Philadelphia Orchestra, Ormandy. Columbia MS 6442. This disc is intended to exploit the richness of Wagnerian orchestration, but what it really emphasizes is the gorgeous string tone of the Philadelphians. For those who want to luxuriate in luscious sound, it will be appealing.

WAGNER: *Siegfried.* Birgit Nilsson, Joan Sutherland, Wolfgang Windgassen, et al. Vienna Philharmonic Orchestra, Solti. London OSA 1508 (five discs). Nilsson is splendid, the over-all sound of the orchestra is gorgeous, and London has struck an excellent vocal-orchestral balance. A solid production.

WEBER: *Der Freischütz (highlights).* Irmgard Seefried, Rita Streich, Richard Holm, Eberhard Wächter, et al. Chorus and Orchestra of the Bavarian Radio, Jochum. Deutsche Grammophon SLPEM 136221. An excellent once-over of the opera, recorded in very good stereo.

Continued on next page

RECORDS AT COST through our Special Membership Plan...

BUILD YOUR RECORD LIBRARY INEXPENSIVELY, QUICKLY, CONVENIENTLY — NO "AGREE TO PURCHASE" OBLIGATION — CHOOSE THE RECORDS YOU WANT

The Citadel Record Club is a membership club that entitles its members to purchase singles, hi-fi and stereo albums at cost; classical, popular, jazz, show hits, folk.

All are available and at prices that never vary from our published price list. There are never any "list price" purchases through Citadel.

CITADEL MEMBERSHIP — THE PROVEN METHOD OF RECORD BUYING USED BY THOUSANDS OF SATISFIED CLUB MEMBERS BECAUSE . . .

- * **YOU DECIDE ON YOUR PURCHASES** — You are not obligated to purchase any particular quantity of records. Buy as few or as many records as you want . . . the choice is yours. Citadel has no "agree to purchase" requirement.
- * **YOU HAVE COMPLETE FREEDOM OF SELECTION** — Virtually any record or album, by any artist on any label is available including all major labels plus hundreds of smaller labels as well as most imports. Again, the choice is completely up to you. Citadel has no "pre-selected" list of recordings for you to choose from.
- * **PROMPT SERVICE** — Many orders are shipped the same day received, rarely later than the next several days. In the event of a delay, partial shipments are made and your order completed as soon as the record is available and, of course without any additional cost to you.
- * **PERIODIC SPECIALS** — Periodically you receive a list of hit albums from all categories of music at prices up to 55% off list. The selections depend on those special purchases we have been able to make. Again, you are under no obligation to purchase any of these selections.
- * **FREE! SCHWANN RECORD CATALOG** — With your membership you receive this quick reference to over 25,000 albums. This easy-to-use catalog contains separate sections for classical, popular, ballet, opera, musical shows, folk music, jazz, etc., and lists a separate section for all new releases. You are not restricted to this catalog, it is simply a handy guide.
- * **100% GUARANTEE** — Citadel completely guarantees their records against defects or damages of any sort. If a damaged or defective record does get through our inspection, we shall immediately replace with a perfect copy.

Membership dues is \$3.00 a year . . . a nominal amount if you reflect for a moment on the record purchases you have made within the past year and the prices you have paid. AS A CITADEL MEMBER BUYING RECORDS AT COST, YOUR DUES WILL BE PAID FOR WITH VIRTUALLY THE FIRST PURCHASE YOU MAKE THROUGH THE CLUB. Additional savings quickly mount up, permitting you to buy many more albums on your record budget.

If you have been faced with the problem of a

complete record source . . . may we suggest that you give Citadel Record Club an opportunity of proving its value to you. You enter no obligations, take no risks . . . simply complete the coupon below, include your \$3.00 yearly membership dues and upon receipt we shall immediately forward all club membership material to you. We cordially invite you to join thousands of other satisfied Citadel members who are purchasing their records at cost price through their Citadel Club membership.

SATISFACTION GUARANTEED Try membership in the Citadel Record Club for 30 days. If at the end of that time you are not completely satisfied, simply request your membership dues back, and it will be immediately refunded.

FREE!

Act now. Fill out the coupon, enclose your dues and we will include a free quality record cleaning cloth as a gift. This is our way of thanking you for your confidence in us.



CITADEL RECORD CLUB

545 Fifth Avenue, New York 17, N. Y. HF-1

Enroll me in Citadel for one year. I am under no obligation to purchase any particular quantity of records, but those that I do purchase will be at member prices . . . NEVER more. I am to receive a current Schwann catalog immediately and subsequent periodic lists of specially priced hit albums. I understand that if, after trying membership in Citadel for 30 days, I am not completely satisfied I can get my full membership dues back immediately. Also, include the free quality record cleaning cloth as a gift. \$3.00 dues enclosed.

FULL NAME _____

STREET _____

CITY _____ ZONE _____ STATE _____

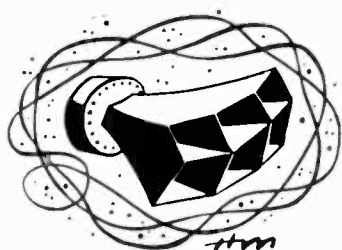

RECITALS AND MISCELLANY

E. POWER BIGGS: "Heroic Music for Organ, Brass, and Percussion." Biggs; New England Brass Ensemble. Columbia MS 6354. These works, which make a splendid sound, are beautifully performed and superbly recorded.

JULIAN BREAM CONSORT: "An Evening of Elizabethan Music." RCA Victor LDS 2656. A superb program that strikes a perfect balance between historical authenticity and latter-day considerations of musicality. Recorded stereo sound is absolutely flawless.

JASCHA HEIFETZ: "The Heifetz-Piatigorsky Concerts, with Primrose, Pen-nario, and Guests." RCA Victor LDS 6159 (three discs). Works by Mozart, Mendelssohn, Brahms, Franck, and Schubert. A set of chamber music that will stand as a landmark among such collections. Stereo is entirely lifelike.

VLADIMIR HOROWITZ: *Recital.* Columbia KS 6371. Lyrical passages in works by Chopin, Liszt, Rachmaninoff, etc., have a basic simplicity and a relaxed flow; there is magnificent rhythmic *elan*, and uncanny accuracy. Spaciousness and solidity in sound.

INDIAN MUSIC: *Sangeeta Madras.* Ba-

lachander, veena; Ramani, venu; Ram-abhadran, mridangam, ghatam; Sivara-man, mridangam; Natesan, tambura. World Pacific WPS 1426. The recorded stereo sound is excellent, admirably capturing the resonance of the veena, the dry percussiveness of the various drums, and the breathy sweetness of the flute. A provocative experience.

ALI AKBAR KHAN: "Master Musician of India." Ali Akbar Khan, sarod; Mahapurush Misra, tabla; Anila Sinha, tan-pura. Connoisseur CS 462. 12-in. 45-rpm. The music throughout is eloquent, often deeply moving, and frequently exciting. The sound is excellent.

MORMON TABERNACLE CHOIR: "The Lord's Prayer." Vol. 2. Mormon Tabernacle Choir; Philadelphia Orchestra, Ormandy. Columbia MS 6367. The enormous dynamic range of the broad-spread stereoism reproduces the reverberant sonorities with impressive authenticity.

I MUSICI: *Christmas Concertos.* Philips PHS 900025. Lovely playing of works by Corelli, Manfredini, Locatelli, Torelli. Solo violins are on separate tracks, and the added interest and clarity of their dialogues is a distinct advantage.

EUGENE ORMANDY: "Dances for Orchestra." Philadelphia Orchestra, Ormandy. Columbia MS 6457. Playing throughout is of the highly polished order one expects from this orchestra, while the stereo reproduction is full and natural.

PAUL PARAY: "Ballet Highlights from French Opera." Detroit Symphony Orchestra, Paray. Mercury SR 90318. Even jaded ears will appreciate these performances, which are fresh, lively, and clean. Reproduction is bright and crisp.

reproduction so good
... from an enclosure so small
... it's almost unbelievable

Petite

HIGH FIDELITY SPEAKER SYSTEM



USE ANYWHERE

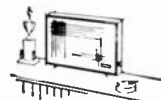

SHELF



WALL



FLOOR

Performance of the Petite is unmatched by any enclosure close to its 18" x 12" x 3¾" size. Bass notes come through rich and resonant . . . highs clean and brilliant. The secret? Argos system-engineered techniques . . . techniques which precisely coordinate the enclosure with the moving system of two Jensen speakers custom-made to Argos specifications. Trim design and beautiful hand-rubbed ¾" oiled American walnut veneer cabinetry make the Petite a distinctive addition to any room setting. Graceful solid brass legs, plus wall hangers, make your Petite useable anywhere . . . shelf, table, wall or floor. See it at your hi-fi store, or write direct for descriptive catalog.

Price \$24.95

ADDITIONAL FEATURES

- Speakers include: custom-designed Jensen high-compliance woofer with 200% more cone travel, and Jensen tweeter with matching network
- Frequency range, 50 to 17,000 cps.
- 8-ohm input
- Screw terminals polarized for stereo
- Volume control recessed into side of cabinet.

Argos

PRODUCTS COMPANY
Dept. I-64, Genoa, Illinois

CIRCLE 7 ON READER-SERVICE CARD

RECORDED TAPES

The following reviews are of 4-track 7.5-ips stereo tapes in normal reel form.

BARTOK: *Divertimento for Strings.*
VIVALDI: *Concerti grossi, Op. 3: No. 10, in B minor; No. 11, in D minor.* Moscow Chamber Orchestra, Barshai. London LCL 80116. The fourteen members of the Moscow ensemble command exceptionally wide dynamic and coloristic spectra. The vibrant bite and floating silkiness of string tone are captured in the most translucent stereoism. Technically, a well-nigh ideal reel.

BEETHOVEN: *Concerto for Piano and Orchestra, No. 3, in C minor, Op. 37.* Leon Fleisher, piano; Cleveland Orchestra, Szell. Epic EC 828. Outstanding in merit and appeal. Lucid, strong recording and impeccable tape processing contribute toward making this version a clear-

cut first choice for one of Beethoven's most delightful concertos.

BEETHOVEN: *Concerto for Piano and Orchestra, No. 5, in E flat, Op. 73* ("Emperor"). Rudolf Serkin, piano; New York Philharmonic, Bernstein. Columbia MQ 489. The impetuous vitality of Serkin and Bernstein gives this version priority in the Emperor sweepstakes. The taping is one that is outstanding for the sheer vividness and grandeur of its big-hall sound.

BEETHOVEN: *Fidelio*. Ingeborg Hallstein, Christa Ludwig, Jon Vickers, et al. Philharmonia Chorus and Orchestra, Klemperer. Angel ZC 3625 (two reels). This version of the opera combines vitality and integration of performance with warmth and naturalness in its recording. Definitely a superior tape.

BEETHOVEN: *Mass in D, Op. 123* ("Missa Solemnis"). Eileen Farrell, Carol Smith, Richard Lewis, Kim Borg, Westminster Choir; New York Philharmonic, Bernstein. Columbia M2Q 509. Somewhat "emotional" performances by the soloists, but first-rate over-all. Lucid stereo works miracles in clarifying Beethoven's complex textures.

BEETHOVEN: *Symphony No. 3, in E flat, Op. 55* ("Eroica"). Philadelphia Orchestra, Ormandy. Columbia MQ 454. This admirably processed tape boasts an abundance of tonal splendor—matchless for its opulence and luminosity.

BEETHOVEN: *Symphony No. 4, in B flat, Op. 60; Leonore Overture No. 3, Op. 72a*. Pittsburgh Symphony Orchestra, Steinberg. Command CC 11016. This performance is marked by strength, good humor, and songfulness, as well as a technical blend of a reverberant auditorium ambience and closely delineated orchestral sonics.

BELLINI: *La Sonnambula*. Joan Sutherland, Nicola Monti, Fernando Corena, et al. Chorus and Orchestra of Maggio Musicale Fiorentino, Bonyng. London LOR 90057 (two reels). Miss Sutherland's unique artistry is well served by the recording itself—pure, sweet and smoothly spread. Fine processing.

BERLIOZ: *Roméo et Juliette, Op. 17*. Rosalind Elias, Cesare Valletti, Giorgio Tozzi; New England Conservatory Chorus; Boston Symphony Orchestra, Munch. RCA Victor FTC 7003. If ever stereo was necessary, it is here, and happily all involved have risen nobly to their tasks.

BERLIOZ: *Symphonic fantastique, Op. 14*. **SCHUMANN:** *Manfred, Op. 115; Overture*. Boston Symphony Orchestra, Munch. RCA Victor FTC 2113. An outstanding, impassioned performance. Seldom if ever has the Boston Symphony played better or has it been recorded with more tonal fidelity and auditorium authenticity.

BRAHMS: *Symphony No. 3, in F, Op.*

90: Tragic Overture, Op. 81. Pittsburgh Symphony Orchestra, Steinberg. Command 11015. Steinberg does it again! His Brahms Third matches his memorable Second in interpretative verve and superbly transparent stereoism, boasting perhaps even more resiliency and glowing expansiveness.

BRUCH: *Scottish Fantasia, Op. 46*. **VIEUXTEMPS:** *Concerto for Violin and Orchestra, No. 5, in A minor, Op. 37*. Jascha Heifetz, violin; New Symphony Orchestra of London, Sargent. RCA Victor FTC 2111. Heifetz's warmth is enhanced by Sargent's support and the British engineers' seamlessly spread, luminously glowing stereoism.

COPLAND: *Appalachian Spring; Dance from "Music for the Theatre"; Danzón Cubano; El Salón México*. New York Philharmonic, Bernstein. Columbia MQ 559. Listeners may be surprised at the warmth and restraint here, in addition to the expected zest. Vividly recorded and admirably processed.

DEBUSSY: *Prélude à l'après-midi d'un faune; La Mer*. **RAVEL:** *Daphnis et Chloë; Symphonic Suite No. 2*. Philadelphia Orchestra, Ormandy. Columbia MQ 473. The Philadelphians play at their best throughout, and the recorded sonics are a model of luminous stereoism.

DVORAK: *Symphony No. 2, in D*

LAFAYETTE RADIO ELECTRONICS LAFAYETTE 24-WATT STEREO



LA-224

YOU GET THESE MATCHED COMPONENTS

- Lafayette LA-224 24-Watt Stereo Amplifier featuring a full range of control facilities
- Garrard Autoslim/Mark II 4-Speed Automatic Record Changer
- Base for Record Changer (oiled walnut, mahogany or blonde)
- Pickering U38/AT Stereo Cartridge with .7 mil diamond stylus
- 2 Lafayette SK-124 2-Way Speaker Systems (walnut or mahogany)

**True Hi-Fi Need Not
Be Expensive—
And Isn't at
LAFAYETTE**

PHONO SYSTEM
Outstanding Performance
at a Low, Low Price



Garrard Autoslim/Mark II on Base
Pickering U38/AT 2 Lafayette SK-124

**LAFAYETTE
SYSTEM
PRICE** **129⁵⁰**
LS-225CWXM \$7 monthly

FREE!

**LAFAYETTE'S
1964
CATALOG 640
422 Giant-
Size Pages**



**LAFAYETTE
GIVES YOU
MORE IN '64**

More Stereo Hi-Fi • More Tape Recorders
• More Citizens Band • More Ham Gear • More
Test Equipment • More P.A. Equipment • More
Cameras • More Radio and TV Tubes, Parts,
Accessories

LAFAYETTE PROFESSIONAL 4-TRACK STEREO RECORD/PLAYBACK TAPE DECK

Built-in
Transistorized
Record
Playback
Preamps



RK-40WX

99.50 Case and
Mikes Optional
\$5 monthly
• Plays 4-Track and 2-Track Stereo; 4-Track, 2-
Track Full Track Mono
• Records 4-Track Stereo and Mono from FM, AM,
FM Multiplex Radio or Phono Sources; Live
from Mikes
• Complete with Preamps, 4 Connecting Cables,
Take-up Reel • Imported

RK-143 Deck with Carrying Case 114.50
PA-401 Dynamic Mike 4.75; 2-for-8.95

**Mail the Coupon
for Your FREE
Lafayette Catalog**

**LAFAYETTE SALES CENTER
SYOSSET, L. I., N. Y.**

JAMAICA, N. Y. NEWARK, N. J.
NEW YORK, N. Y. PLAINFIELD, N. J.
SCARSDALE, N. Y. PARAMUS, N. J.
BRONX, N. Y. BOSTON, MASS.
NATICK, MASS.

Lafayette Radio Electronics Dept U-4, P. O. Box 10
Syosset, L. I., N. Y. 11791

Send my FREE 1964 Lafayette Catalog 640
 Send me Stock No. _____, shipping charges
collect. \$ _____ enclosed
 I would like to order Stock No. _____ on the
Easy-Pay Credit Plan

Name _____
Address _____
City _____ Zone _____ State _____

CIRCLE 35 ON READER-SERVICE CARD



\$1.00

Who says Christmas is over?
It isn't—not when you can get a superb recorded tape for a fraction of its usual cost!

Just buy a reel of Double Recording Audiotape on Tempered "Mylar" at the regular price (a great tape: double length plus double strength). Then add only \$1.00 and come away with The Melody Lingers On, featuring luxurious arrangements of great standards like April in Paris, Embraceable You, The Song is Ended, I Could Write a Book and 14 other unforgettables. 55 minutes of music from the Everest stereo library, long noted for the superb quality of its recordings. Remember, one reel of Double Recording Audiotape Type 2431T and \$1.00 add up to a recorded tape you and the women in your life will treasure for years. Available only in 4-track stereo.

audiotape TRADE MARK
"it speaks for itself"

AUDIO DEVICES, INC., 444 Madison Ave., New York 22, N.Y.
Offices in Los Angeles • Chicago • Washington, D.C.

CIRCLE 8 ON READER-SERVICE CARD

minor, Op. 70. Cleveland Orchestra, Szell. Epic EC 823. This tape merits unqualified recommendation: it possesses verve and eloquence and is immaculately processed with expansive recorded sonics.

HANDEL: *Concertos for Organ and Orchestra: Op. 4, Nos. 1-6; Op. 7, Nos. 1-6.* Karl Richter, organ; Chamber Orchestra. Richter. London LCK 80111/12 (two twin-pack reels). Delectable reels, capturing an inexhaustible flow of melodic invention and vitality. The organ is thrilling, and the recording is sonic enchantment throughout.

HANDEL: *Music for the Royal Fireworks: Water Music; Suite* (arr. Stokowski). RCA Victor FTC 2117. No sound fancier can fail to respond to these extraordinarily robust, pungent, and panoramic sonics, which capture authentically and gloriously the martial and reedy sonorities produced by a grandiose 125-man orchestra.

HOLST: *Hymn of Jesus, Op. 37; Ballet music from "The Perfect Fool," Op. 39; Egdon Heath, Op. 47.* BBC Chorus and BBC Symphony Orchestra (in Op. 37); London Philharmonic (in Op. 47), Boult. London LCL 80117. The performance could scarcely be bettered, and neither could the spaciouly stereogenic recording or flawless tape processing.

HOLST: *The Planets, Op. 32.* Women of the Vienna State Opera Chorus; Vienna Philharmonic Orchestra, Karajan. London LCL 80097. A genuine triumph which no tape collector can afford to miss. The crisp transients of even the low level percussion passages come through without veiling or perspective shifts, while the midrange and extreme low frequencies achieve satisfying warmth and solidity.

HONEGGER: *Le Roi David.* MILHAUD: *La Création du monde.* Martial Singher, narrator; Netania Davrath, Jean Preston, Marvin Sorenson, et al. University of Utah Chorus (in the Honegger); Utah Symphony Orchestra. Abravanel. Vanguard VTP 1651. This recording triumphantly exploits the expected virtues of stereo and the performance is even more satisfactory than the old version led by Honegger himself.

LEHAR: "The Land of Smiles" and "Paganini" Highlights. Sandor Konya, Willy Hoffman, et al. Chorus and Orchestra, Marszalek. M-G-M STC 4100. The outstanding numbers are done with real flair and appeal. The strong, bright, and acoustically warm recording, unexaggeratedly stereoisitic, does full justice to the singers and to the deft orchestral accompaniment.

MAHLER: *Symphony No. 2, in C minor ("Resurrection").* Elisabeth Schwarzkopf, Hilde Rössl-Majdan, Philharmonia Chorus and Orchestra, Klemperer. Angel ZB 3634. One of the most imaginative, moving, and magnetically gripping of Mahler's masterpieces. The tape is a stereo triumph, notable for its power and breadth.

Popular Science SEPT. 1963

hi-fi experts panel picks

CABINART MARK 3

"best buy"

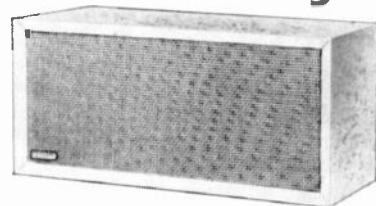

... To pick a low priced system that would still give you musically acceptable sound by true, high-fidelity standards ...

You'll agree Cabinart Mark 3 is most incredible!

First to offer bookshelf Reflex-Horn enclosure around precision engineered loudspeaker. Value and quality beyond compare!

CABINART MARK 3

\$19.50 Unfinished

Oiled Walnut, \$27.00

SPECIFICATIONS: 23" long, 11" high, 9½" deep. Loudspeaker: 8", with rolled annulus • 8 ohm impedance, 10,000 Gauss • 6.8 Dual Diameter Alnico 5 magnet • 3" whizzer cone for HF dispersion • Free air resonance: 65 cycles. **FREQUENCY RESPONSE:** SPL 50 to 19,000 cycles. **SENSITIVITY:** ½ watt input for 85 DB 10 feet on axis. **POWER HANDLING CAPACITY:** 10 Watts.

CABINART GUARANTEES

You must be satisfied for 10 full days or your money back.

ONE FULL YEAR WARRANTY

Written registration card and warranty included.

Pioneers in hi fi quality since 1948

CABINART

ACOUSTICAL DEV. CORP.

GEYER STREET, HALEDON, N. J.

Cabinart Acoustical Dev. Corp.
40 Geyer St., Haledon, N. J.

Please ship the following to be used in my home for 10 full days. I understand unit(s) may be returned and my money refunded within that time unless fully satisfied.

... Mark 3 Unfinished \$19.50 each

... Mark 3 Oiled Walnut \$27.00 each
(Please make check or money order payable to Cabinart Acoustical.)

Name _____

Address _____

City _____ State _____

CIRCLE 63 ON READER-SERVICE CARD

The Ultimate in
Entertainment is on
20th Century-Fox
Records

Cleopatra!

THE TOP ALBUM FROM THE TOP MOTION PICTURE... capturing in sound all the pageantry, the excitement, the romance of the greatest spectacle ever filmed.

FXG 5008 (Mono)

SXG 5008 (Stereo)

CLEOPATRA



The Longest Day.

This original soundtrack recording presents a condensed version of the film story with the actual stars.

FXG 5007 (Mono)

SXG 5007 (Stereo)



The Leopard.

The stirring score from the Burt Lancaster epic on an original soundtrack recording.

FXG 5015 (Mono)

SXG 5015 (Stereo)



presented by



the ultimate in entertainment

444 West 56th Street • New York 19, New York

CIRCLE 54 ON READER-SERVICE CARD

MAHLER: *Symphony No. 9, in D minor*. Columbia Symphony Orchestra. Walter. Columbia MQQ 516 (twin-pack). Walter's Ninth is quite above any competition, and Columbia's West Coast orchestra has never played more radiantly than it does here. It has never, either, been more richly and broadly recorded.

MOZART: *Concerto for Flute, Harp, and Orchestra, in C, K. 299*; TELEMAN: *Suite for Flute and Strings, in A minor*. Julius Baker, flute; Hubert Jelinek, harp; I Solisti di Zagreb, Janigro. Vanguard VTC 1659. Despite the somewhat thin tone of the harp's upper register, this Mozart performance—thanks to the matched artistry of Baker, Janigro, and the Vanguard engineers—is one of the best available.

MOZART: *Concertos for Horn and Orchestra: No. 1, in D, K. 412; No. 2, in E flat, K. 417; No. 3, in E flat, K. 447; No. 4, in E flat, K. 495*. Albert Linder, horn; Vienna State Opera Orchestra. Swarovsky. Vanguard VTC 1648. The highest critical praise is an inadequate tribute to a recording like this one: no words can convey its musical delights. The transparent stereo taping and pre-echo-free processing are well-nigh ideal.

MOZART: *Così fan tutte*. Elisabeth Schwarzkopf, Christa Ludwig, Alfredo Kraus, Giuseppe Taddei, et al. Philharmonia Chorus and Orchestra, Böhm. Angel ZD 3631 (two reels). Another transparent and glowing tape recording that makes imaginative, yet always artistic, use of stereophony.

MOZART: *Maurerische Trauermusik, K. 477*; *Overtures: Così fan tutte, Le Nozze di Figaro, Der Schauspieldirektor, Die Zauberflöte, Serenade for Strings, No. 15, in G, K. 525* ("Eine kleine Nachtmusik"). Columbia Symphony Orchestra, Walter. Columbia MQ 543. Everything blends miraculously to make this reel a matchless memorial to Bruno Walter. The recording serves excellently in providing spaciouly authentic re-creations of gracious performances.

MOZART: *Symphonies: No. 35, in D, K. 385* ("Haffner"); *No. 41, in C, K. 551* ("Jupiter"). Amsterdam Concertgebouw Orchestra, Jochum. Philips (via Bel Canto) PT 900004. Sinewy, precise, and exhilarating performances. Every coloristic detail is caught to perfection in smoothly spread and balanced stereo.

PUCCHINI: *La Bohème*. Anna Moffo, Richard Tucker, Robert Merrill, et al. Chorus and Orchestra of the Rome Opera House, Leinsdorf. RCA Victor FTC 7002. Miss Moffo seems almost ideal, both dramatically and vocally, in the role of Mimi. The soloists are positioned slightly forward, vis-à-vis the orchestra, and the sonics are light, pure, and natural.

PUCCHINI: *Madama Butterfly*. Leontyne Price, Rosalind Elias, Richard Tucker, et al. RCA Italiana Opera Chorus and Orchestra, Leinsdorf. RCA Victor FTC

ANOTHER RE Tandberg ACCOMPLISHMENT!

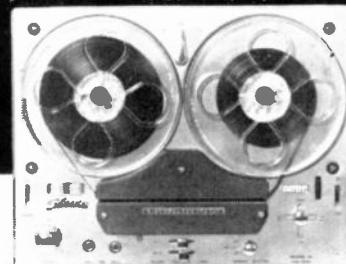

MODEL 74

3 SPEED — 4 TRACK

Complete STEREO Music System

Designed particularly for those who demand renowned Tandberg quality performance and versatility in a self-contained, complete stereo music system! Incorporates power amplifiers, preamplifiers, matched speakers, microswitch operated tape stop, free position tape load, start/stop/pause control, precision laminated combination record/playback head, erase head and many other features consistent with Tandberg's undeniable excellence in craftsmanship and design. This new addition to the Tandberg family is available in four track with Sound-on-Sound, Track Adding and Source Monitor. Frequency response is unsurpassed, wow and flutter virtually non-existent. Yes, this is another fine example of Tandberg leadership in "Better, Clearer, More Natural Sound"!

List \$449.50

IMPORTANT: Ask your dealer about the new Tandberg Model CX 266 5" coaxial speaker in a hand rubbed Teakwood enclosure. Ideally suited for use as an external speaker addition to your Model 74 stereo tape recorder system.
Speaker List... \$89.50

MODEL 64*

3 SPEED — 4 TRACK

Stereo Record/Playback Deck

America's highest rated record/playback deck for incorporation into new or existing high fidelity systems. Features 3 separate heads; direct monitor facilities; built-in filter for FM multiplex stereocasts.

List \$498.00

RE Tandberg OF AMERICA, INC.,

P.O. Box 171, 8 Third Avenue, Pelham, N. Y.

CIRCLE 52 ON READER-SERVICE CARD

What are five ways to tell good recording tape from bad?

This question, and many others about tape and tape recorder use for fun, education, and profit, are answered in Tarzian Tape's new 32-page illustrated booklet, "Lower the Cost of Fun With Tape Recording." Send for your copy today...use Tarzian Tape for your next recording session.

FREE!



Sarkes Tarzian, Inc.
Department HFS-64
Magnetic Tape Division
East Hillside Drive
Bloomington, Indiana

Please send a free copy of "Lower the Cost of Fun With Tape Recording" to:

Name _____

Address _____

City _____ State _____

I have have not used Tarzian Tape
My dealer does does not stock Tarzian Tape.



CIRCLE 46 ON READER-SERVICE CARD

8006 (two reels). A superb production, with the present reels providing praiseworthy sonic qualities.

PUCCHINI: *Il Tabarro; Suor Angelica; Gianni Schicchi.* Renata Tebaldi, Mario del Monaco, et al. Orchestra of Maggio Musicale Fiorentino, Gardelli. London LOL 90052/54 (three reels). The first tape edition of all three short operas. Performances are briskly competent; Tebaldi sings well in all three of her roles. These reels provide vivid stereo.

PURCELL: *Come, Ye Sons of Art; Re-joice in the Lord Alway; My Beloved Spake.* Soloists of the Deller Consort; Oriana Concert Choir and Orchestra; Kalmar Orchestra of London, Deller. Vanguard VTC 1657. This first taped program of Purcell's vocal works is an invaluable contribution to the rarer repertoires sparsely represented on tape. The intricate writing for soloists and small orchestra is captured with lucid clarity of detail in transparent stereoism.

RACHMANINOFF: *Concerto for Piano and Orchestra, No. 2, in C minor, Op. 18.* **CHOPIN:** *Etudes: in E, Op. 10, No. 3; in A minor, Op. 25, No. 11.* Van Cliburn, piano; Chicago Symphony Orchestra. Reiner. RCA Victor FTC 2114. This performance equals the Cliburn/Reiner *Emperor* in over-all sonic grandeur and dramatic impact. Boldly ringing piano tone.

SCHUBERT: *Symphonies: No. 3, in D; No. 8, in B minor ("Unfinished").* Pittsburgh Symphony Orchestra, Steinberg. Command CC 11017. The verve and ardor of Steinberg's reading of the *Unfinished* rank it as a peer of the best-liked earlier versions. Superb sonics.

SCHUMANN: *Symphony No. 2, in C, Op. 61.* Cleveland Orchestra, Szell. Epic EC 829. This work seems extremely congenial to Szell, whose masculine ardor, exhilarating vitality, and songful serenity have ample room to expand here. Brightly recorded, immaculately processed.

STRAUSS, JOHANN II: *Waltzes.* Chicago Symphony Orchestra, Reiner. RCA Victor, FTC 2093. All five waltzes here seem even more intoxicating on second hearing than on first. The bravura *Thunder and Lightning* Polka encore proves to be a demonstration of sonics that puts to shame most more overtly showy examples.

STRAVINSKY: *The Rite of Spring.* Columbia Symphony Orchestra, Stravinsky. Columbia MQ 481. Other 4-track versions can't compete with the composer's own. Here are fresh revelations of the music's essential clarity of detail and architectural coherence.

WAGNER: *"The Glorious Sound of Wagner."* Philadelphia Orchestra, Ormandy. Columbia MQ 552. The Philadelphia string and brass choirs are captured in incandescent and panoramically broadspread stereoism. Regardless of how

RECORD SPECTACULAR!



A COMPLETE STORY IN THRILLING STEREOPHONIC SOUND

"the banshee whistling virtuosity of engineer a.j. lee is enhanced by some of the most startlingly realistic rain, thunder, and lightning ever captured on discs." "One of the most technologically enterprising of specialists recording companies, a pioneer in the adoption of the static-free 'polymax' disc materials, now advances a solution of the compatibility problem"—with stereomonic excerpts from review, **HIGH FIDELITY** April 62-RDD MF 8 Steam Railroading under **THUNDERING SKIES.**

12" L.P. Stereomonic & Polymax.

ORDER DIRECT! \$4.98

MOBILE FIDELITY RECORDS

P. O. Box 336, Burbank, California
Complete free catalog upon request
or at any Cosnat Branch

CIRCLE 64 ON READER-SERVICE CARD

Quick-See Album File



FRONT-VIEW, FLIP-THROUGH SELECTION

Stop stooping, squinting, straining, to find albums stacked on edge. Quick-See units glide in and out of cabinet or wall for fast, simple selection...you see the full face of your album without removing it. Ends jacket-bottom wear, too. Installs anywhere in five minutes. Sturdy welded steel and ball-bearing construction, brass finish. Nine models for LP's and tape, hold up to 125 albums...available separately or in special cabinet furniture.

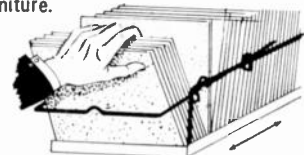

Dealer inquiries invited

KERSTING MFG. CO.
504-T S. Date, Alhambra, California

CIRCLE 33 ON READER-SERVICE CARD

**GUARANTEED
FM and FM STEREO
Up to 200 Miles!**

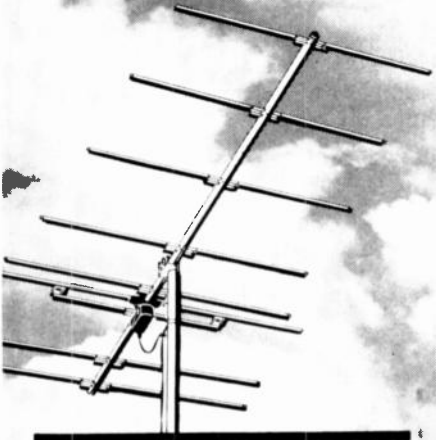

**NEW Winegard
STEREOTRON
FM ANTENNA
with Twin Nuvistor Amplifier**

The reception ability of *even* the most expensive FM or FM stereo outfit is restricted by the performance of the antenna to which it is connected. If you want to see what your equipment can *really* do, you need a new Winegard Stereotron.

The Stereotron antenna and twin nuvistor amplifier is the only antenna amplifier combination that can be used anywhere—responds to 1 microvolt of signal, yet takes up to 200,000 microvolts of signal without overloading. Antenna is GOLD ANODIZED, amplifier completely weather-sealed. Exceptionally high front-to-back ratio to prevent multi-path distortion. Antenna and amplifier are available separately.

We firmly believe that the Stereotron FM antenna is in a league by itself and therefore we make the following written guarantee:

1. We guarantee the Winegard Stereotron to be the most effective, sensitive, finest constructed antenna available.
2. We guarantee the Stereotron with Stereotron amplifier will pull in 85% of all FM stations in a 200 mile radius over average terrain.
3. We guarantee you will be 100% satisfied with a Stereotron or your money back.

STEREOTRON ANTENNA Model SF-8—\$23.65

STEREOTRON NUVISTOR AMPLIFIER Model AP-320 input 300 ohms, output 300 ohms—can be used with any FM antenna—\$39.95

Amplifier Model AP-375 for use with coax cable. Input 300 ohms, output 75 ohms—\$44.95

Write for technical spec's, gain charts, polar patterns, VSWR, etc., plus Free FM Station Log and Map.

World's Most Complete Line of FM and TV antennas, FM-TV Couplers and Amplifiers

 **Winegard**
ANTENNA SYSTEMS

3014S Kirkwood Blvd. • Burlington, Iowa
CIRCLE 58 ON READER-SERVICE CARD

you like your Wagner, the luscious aural appeals of the recorded performances here can't be minimized.

WAGNER: *Orchestral Excerpts*. Pittsburgh Symphony, Steinberg. Command CC 11012. A technological triumph—which is, thanks to the choice of materials and Steinberg's blazingly vital performances, as dramatic musically as it is sonically.

WAGNER: *Siegfried*. Birgit Nilsson, Joan Sutherland, Wolfgang Windgassen, et al. Vienna Philharmonic Orchestra, Solti. London LOY 90062 (three reels). Magisterial in impact and remarkably clear sonics. This performance brings renewed realization of Wagner's ability to hold an audience spellbound

WAGNER: *Die Walküre*. Birgit Nilsson, Jon Vickers, George London, et al. London Symphony Orchestra, Leinsdorf. RCA Victor FTC 9500 (three reels). The uniformity of excellence here provides a quite incomparable experience for the home listener. Immaculately processed, with marked channel differentiation and richness of bass.

E. POWER BIGGS: *Heroic Music for Organ, Brass, and Percussion*. E. Power Biggs, organ; New England Brass Ensemble, Mazzeo. Columbia MQ 486. The various English marches, trumpet tunes, and voluntaries are fine rousing stuff, and stereo effects are often electrifying. The recording is superb, and the tape processing, except for frequent pre-echoes, is excellent.

WILLI BOSKOVSKY: *Cream Puffs aus Wien*. Boskovsky Ensemble, Willi Boskovsky. Vanguard VTC 1658. Delectable sweetmeats in vivid sound. A model of stereogenic lucidity.

ALFRED DELLER: *Madrigal Masterpieces*. Deller Consort, Deller. Vanguard VTC 1652. Deller's ensemble is fresh-voiced and enthusiastic, as well as notably skillful, and it is recorded with the matchless intimacy and airy sonic transparency that only stereo can provide.

VLADIMIR HOROWITZ: *Recital* (Chopin, Schumann, Rachmaninoff, Liszt). Columbia MQ 499. One of the finest recorded piano recitals within memory, captured with superbly authentic and boldly ringing tonal qualities in a miraculously processed tape.

Accordiorama. Hohner Accordion Symphony Orchestra, Würthrer. Vanguard VTC 1645. This taping matches the stereo disc exactly in its reproduction of the extraordinary timbre and dynamic range commanded by these artists.

Adventures in Time. Stan Kenton and His Orchestra. Capitol ZT 1844. The big band's robust sonorities are recorded in full-blooded stereo.

**STEREO
DEMANDED IT!**

TANNOY

ENGINEERED IT!

THE NEW

"MONITOR"

DUAL CONCENTRIC



"MONITOR"
10", 12" AND 15"

**the most advanced co-axial
to date**

- ★ New revolutionary magnetic shunt circuit increasing useful low frequency flux by more than 20%.
- ★ Unique treatment of low frequency diaphragm surround providing improved response and stability.
- ★ New acoustic balance cavity improving high frequency response, reducing distortion.

Tannoy engineers have produced a speaker of unsurpassed quality, already being used as a 'Monitor' by world wide recording, radio, and television companies. The extended range and increased efficiency of the low frequency unit make it ideal for use in relatively small enclosures, whilst still maintaining the "presence" of unrestricted sound. This, combined with the fully integrated sound source of the 'Monitor' Dual Concentric, makes it especially suitable for stereophonic reproduction.

WRITE FOR DETAILS

TANNOY (AMERICA) LTD.
BOX 177, EAST NORWICH, L.I., N.Y.

TANNOY (CANADA) LTD.
36 WELLINGTON ST. EAST, TORONTO, ONT.
CIRCLE 53 ON READER-SERVICE CARD

EICO new Transistor Stereo/Mono

4-track Tape Deck

Model RP 100W
Completely assembled, wired and tested with 3 heads, stereo record and stereo playback preamplifiers.

Model RP 100K
Semi-Kit includes transport completely assembled and tested with 3 heads; and control electronics, stereo record and stereo playback pre-amplifiers in easy-to-assembly kit form.

Write for full specifications

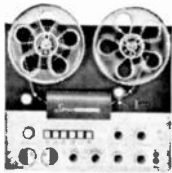

TAPE STORAGE OR CARRYING CASE

reg. 9.95, now 5.95

Heavy wood construction, waterproof vinyl covering. Holds up to 24 tapes.)

reg. 2.75, now 1.79

(Pressed cardboard, holds 10 tapes or 60 45 rpm records.)



PLUS POSTAGE

SAXITONE RECORDING TAPE

*oxide guaranteed not to run off or squeak — or money back. Compare ours with other "Bargain" tape. You'll find it's more than just "price" when you deal with us. We are original pioneers in the tape recorder business and our reputation means everything to us.

- 225' MYLAR, 3" (in mailable box) .39
- 600' acetate (plastic), 3 inch75
- 600' MYLAR 3 inch reel85
- 600' MYLAR (polyester), 5 inch . . .89
- 1200' MYLAR, 1 1/2 mil, 3 inch reel 1.18
- 1200' MYLAR, tensitized, 3 inch . 1.59
- 1200' acetate (plastic), 7 inch . 1.15
- 1200' MYLAR, 1 1/2 mil, (strong) 1.29
- 1800' acetate (plastic), 7 inch . 1.39
- 1800' MYLAR 1 mil, thick, 7 inch 1.89
- 2400' MYLAR, untensitized, 7 inch 2.59
- 2400' MYLAR, tensitized, 7 inch 2.89

PLUS POSTAGE

(Large Users Even Lower)

Empty 3 1/4" 9¢ Plastic Reels ea.

Save 30% on 4-Track
STEREO MUSIC ON TAPE!

BARGAIN PRICES! SEND FOR OUR FREE
Tape Recorder/Blank/Pre-recorded Tape Catalog

NORELCO SPEAKER

Famous AD3800M, twin cone 8" (75-19,000 cycles) comparable net 9.00 now 4.95, 2 for 9.00, plus postage.

OTHER Norelco models at BIG DISCOUNTS.

Specifications on entire Norelco line sent on request.

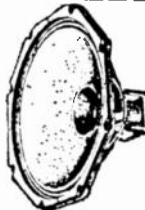

SAXITONE TAPE SALES
(DIV. OF COMMISSIONED ELECTRONICS, INC.)

1776 Columbia Rd., NW, Washington 9, D.C.

CIRCLE 19 ON READER-SERVICE CARD

Pre-recorded 4 Track Stereo Tape at Cost!

Through Our Special Membership Plan Citadel Membership — Proven by thousands of satisfied club members because . . .

- **YOU DECIDE ON YOUR PURCHASES** — Buy as few or as many tapes as you want .
- **FREEDOM OF SELECTION** — Virtually any tape, on any label, by any artist is available.
- **FREE! COMPLETE TAPE CATALOG** — With membership you receive this current catalog of all 4-track stereo tapes.
- **PROMPT SERVICE** — Many orders are shipped the day received . . . rarely later than the next several days.
- **100% GUARANTEE** — All tapes are guaranteed factory fresh and free of defects. (Special! All LP records also available under your Citadel Tape membership.) Membership dues is \$4.00 a year . . . a nominal amount when you consider that as a CITADEL MEMBER BUYING TAPES AT COST, YOUR DUES WILL BE PAID FOR WITH VIRTUALLY THE FIRST PURCHASE YOU MAKE THROUGH THE CLUB. Additional savings quickly mount up, permitting you to buy many more tapes on your tape budget. Try membership for 30 days. If not completely satisfied, your dues will be refunded immediately. Complete the coupon below, include your \$4.00 yearly dues and upon receipt we shall forward all membership material to you.

CITADEL TAPE CLUB

division Citadel Record Club H-1

545 Fifth Ave., New York 17, New York

Name _____
Street _____
City _____ Zone _____ State _____

CIRCLE 17 ON READER-SERVICE CARD

"All the Hits from 'Oliver!'" Melachrino Strings and Orchestra. RCA Victor FTP 1181. With each rehearing, Lionel Bart's score sounds better and better, and these symphonic transcriptions are extremely attractive. Expressive performances are enhanced by the luminous, acoustically warm recording. First-rate processing.

"Anything Goes." Eileen Rodgers, Hal Linden, et al. Chorus and Orchestra, Simons, Epic FLT 825. One of the most exhilarating show revivals on records. There is considerable preëcho, but the use of panoramic stereo spacing is extremely effective.

"Balalaika Favorites." Osipov State Russian Folk Orchestra, Gnutov, Mercury ST 90310. One of the finest recordings available on tape today. The crisp transients, wide dynamic and frequency ranges, and vivid presence are flawlessly captured.

"Carousel." Roberta Peters, Alfred Drake, et al. Command Chorus and Orchestra, Blackton, Command RS 843. This taping is the finest recorded edition of a musical show to be produced in quite a while. Notable for excellent performances and vivid sonics.

"Cleopatra." Original Sound Track Recording, Alex North, 20th Century-Fox (via Bel Canto) SXT 5008. One of the best and most imaginative scores ever provided for a film epic. Glowingly warm and lucid stereo recording.

"Exotic Strings." Percy Faith and His Orchestra, Columbia CQ 504. First-rate mood music, recorded ultrabrightly but warmly.

"For the Nero-Minded." Peter Nero, piano; Orchestra, Gold, RCA Victor FTP 1141. There is genuine zest and bounce in Nero's performances. The engineers have captured the piano in particular with impressively natural and ringing solidity.

"Gerry Mulligan '63." The Concert Jazz Band, Verve VSTC 289. This best-varied of Mulligan's concert-band series has a wealth of attractions. The recording is beautifully transparent, the stereoism panoramically smooth-spread, and the tape processing first-rate.

"Hoedown." The Fantastic Fiddles of Felix Slatkin, Liberty LT 14024. Exuberant and dazzling performances, in which the clean stereoism makes the most of the timbres, sonorities, and delectable antiphonal interplays.

"In Praise of God." Frank Chacksfield and His Orchestra, Richmond RPE 45029. The glowingly rich stereoism, the magnificent orchestral playing, and the imaginative symphonic scorings combine to place this program among the finest "devotional" releases to come along.

"Nightfall." Capitol Symphony Orchestra, Carmen Dragon, Capitol ZP 8575. The

Suh!



Are Prices Too High?
Write
Dixie Hi Fi!

Largest discount High Fidelity component distributors in the South. Wholesale prices on package or individual components. Latest models in factory sealed cartons.

Special attention given to Audio Clubs, Churches and Schools.

DIXIE

HIGH FIDELITY WHOLESALERS

12402 Connecticut Ave., Silver Spring, Md.

CIRCLE 20 ON READER-SERVICE CARD

SAVE

WHEN YOU BUY FROM HI-FIDELITY SUPPLY

GET THE BEST PAY LESS

All top name brand Components, Tapes, Recorders, Kits.

- ALL FACTORY SEALED
- MANUFACTURERS' WARRANTY
- ALL SHIPMENTS INSURED

Get a fast quotation on your High Fidelity Package or Components.

BEST BUY in Packaged Hi-Fi	
*Fisher 500-C or Scott 340-B Receiver	List \$389.95
*Garrard A Changer & Walnut Base	84.95
*Shure M3D Diamond Cartridge	45.00
*2 Wharfedale W-70 Walnut Speaker Systems	329.90
Total Mfrs. List Price	\$848.90
OUR SPECIAL PRICE	\$539.90

INTERNATIONAL SHIPPERS

HI-FIDELITY SUPPLY CO.

2817-X THIRD AVE., NEW YORK 55, N. Y.

CIRCLE 29 ON READER-SERVICE CARD

**erase tape
without rewinding!**



AEROVOX Professional Heavy-Duty DEGAUSSER

Acclaimed by leading hi-fi magazines. Quickest and easiest to use. Completely erases new and old tape . . . without rewinding! Handles all 7" and 10" spools up to 1/2" widths. Operates from any 110 VAC supply. Most powerful demagnetizing field of any device. Comes with 6' line cord and screw-in fuse, shipping wt. 15 lbs. Available at all Aerovox Parts Distributors at \$49.95 net. Write for name and address of nearest distributor.

AEROVOX CORPORATION
Distributor Division
New Bedford, Mass.

CIRCLE 1 ON READER-SERVICE CARD

Why?

DO THOUSANDS OF HI-FI
ENTHUSIASTS BUY FROM
AUDIO UNLIMITED

It's Obvious!

- LOWEST PRICES
- FAST SERVICE
- FACTORY SEALED UNITS
- FULLY INSURED SHIPMENTS
- UP TO 2 YEAR
MANUFACTURERS' WARRANTY
- TIME PAYMENT PLAN
 - only 10% down
 - up to 36 months to pay
- FRANCHISED DISTRIBUTORS

Write for **FREE** Catalog Today

**SEND US YOUR LIST
FOR OUR AIR MAIL
QUOTE TODAY**

Visit Our Showroom and Warehouse

AUDIO unlimited, inc.

715-X Second Ave. (Nr. 38), New York 16, N. Y.
3 blocks from the U. N.

CIRCLE 10 ON READER-SERVICE CARD

recording is glowing, the stereoism smoothly spread, the tape processing immaculate, the performances rich in feeling yet never effusively sentimental.

"On My Way and Shoutin' Again." Count Basie and His Orchestra. Verve VSTC 284. The old Basie charm is superbly reanimated. Verve's engineers contribute a translucent sonic medium.

"Peter, Paul, and Mary." Warner Brothers WSTC 1449. A charming reel, beautifully recorded and processed.

"Pops Roundup." Boston Pops Orchestra, Fiedler. RCA Victor FTC 2105. These performances reveal fresh humor and virtuoso éclat with every replaying. Impressive stereo recording.

"Rendezvous in Paris." Michel Legrand and His Orchestra. Philips-Bel Canto PT 600045. The music is handled with immense bravura, and the most imaginative scores are downright dazzling. Superbly expansive and floating sonics.

"Scottish Soldiers." Massed Military and Pipe Bands of the Royal Scots Greys and Argyll and Sutherland Highlanders, Turner and Pope. London LPM 70057. A genuine sonic spectacular, brilliantly recorded with an uncommonly wide dynamic range. Not to be missed by anyone who responds to Highland tunes and bagpipe skirling.

"Themes of the Great Bands." Glen Gray and the Casa Loma Orchestra. Capitol ZT 1812. Gray displays undiminished gusto for the fundamentals of the swing era spirit. Fine recording and processing, with the former notably attractive for its naturalness, the precision of its stereo orientations, and the warmth of its acoustical surroundings.

LIGHTER SIDE DISCS

"All the Hits from 'Oliver.'" The Melachrino Strings and Orchestra. RCA Victor LSP 2660.

"Anything Goes." Eileen Rodgers, Hal Linden, Mickey Deems, Barbara Lang, Margery Gray. Epic FLS 15100.

"Balalaika Favorites." Osipov State Russian Folk Orchestra, Gnutov. Mercury SR 90310.

"The Big Band's Back in Town." "Doc" Severinsen, trumpet; Orchestra. Command RS 837.

"Big-Band Polkas on Parade." Ira Ironstrings and His Polka Marching Band. Warner Brothers WS 1457.

"Brazen Brass: New Sounds in Folk Music." Henry Jerome and His Orchestra. Decca DL 74344.

This is a dangerous loudspeaker

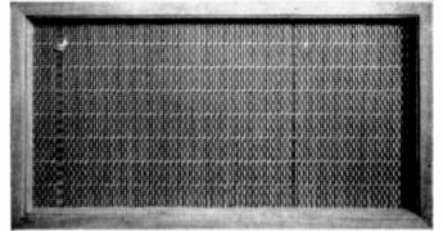

MODEL DLS 529

Caution—it will mercilessly reveal the flaws in any defective or outmoded equipment used with it. The transient-perfect sound reproduction is totally different from all other Bookshelf speakers, regardless of size or price!
\$159.00*

EMI

*Higher in South and West.

For further information write

Scope Electronics Corp.

235 East 42nd Street, New York, N.Y. 10017
CIRCLE 47 ON READER-SERVICE CARD

**SAVE OVER 40% ON
HI-FI**

USE OUR EASY-PAY-PLAN Up to 24 months to pay

DON'T BUY HI-FI-COMPONENTS

Take Recorders or Electronic Equipment until you get return mail quotation from "your friend in the business."

- Trade-Ins—Highest Allowance—Send us your list.
- 15 day money-back guarantee.
- Full 2-year warranty—parts & labor.
- We are factory franchised all lines. We ship from stock.
- 18th year of dependable & reliable service throughout the world.
- We guarantee "We Will Not Be Undersold."
- Call us at (212) EN 9-3700 from any part of U.S.A. You may deduct 3-minute toll charge if your order is in excess of \$100.00.

BEST BUY HI-FI LIST FREE. Send 10c for stereo tape catalog—All labels save 33 1/3%.

ELECTRONIC WORLD HI-FI RECORDING TAPE

7" Spools - Splice Free - Freq. Resp. 30-15KC

60M	3 1/4"	600' Mylar	3-11	12+
12A	7"	1200' Acetate	\$1.09	\$.99
18M	7"	1800' Mylar	1.89	1.79
24M	7"	2400' Mylar	2.59	2.39
24MT	7"	2400' Mylar-Ten.	2.89	2.79

Any assortment permitted for 12+ price. Add 15c per reel postage & handling, continental U.S.A. Write for complete listing & 100+ price

HI-FIDELITY

CENTER

"The House Of Low Low Prices"

1797-A First Ave., New York 28, N. Y.

CIRCLE 30 ON READER-SERVICE CARD

PRECISION HI-FI ACCESSORIES



HUM-BUCKING TELEPHONE PICKUP COIL

Hum free transcription, no connection to telephone, rugged cast case.

MODEL HP-70 NET \$6.95

TAPE RECORDING HEAD DEMAGNETIZER

Removes permanent magnetism, protects tape from erasure, minimizes noise and distortion, extended pole piece — easy access.



MODEL HD-40M NET \$6.15

MAGNETIC TAPE ERASER

Bulk erasure of recorded tape, restores tape like new, reduces noise, reel size to 10 1/2" x 1/2" W, epoxy case, sealed for life.



MODEL HD-11M NET \$18.95

STEREO 3RD CHANNEL SPEAKER OUTPUT TRANSFORMER

Add a monaural remote speaker. Fill "hole-in-middle." Matches impedance, polarity and power level. Rating 30 watts. Response 40 to 20,000 CPS.

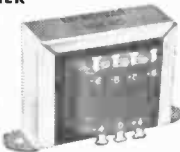

MODEL HM-90 NET \$6.33

MICROTRAN company, inc.
145 E. Mineola Ave., Valley Stream, N. Y.

CIRCLE 39 ON READER-SERVICE CARD



* Fill in coupon for a FREE One Year Subscription to OLSON ELECTRONICS Fantastic Bargain Packed Catalog — Unheard of LOW, LOW, DISCOUNT PRICES on Brand Name Speakers, Changers, Tubes, Tools, Stereo Amps, Tuners, CB, Hi-Fis, and thousands of other Electronic Bargains. Credit plan available.

NAME _____
ADDRESS _____
CITY _____ ZONE _____ STATE _____

If you have a friend interested in electronics send his name and address for a FREE subscription also.

OLSON ELECTRONICS, INC.

1002 Forge Street, Akron, Ohio 44308

CIRCLE 42 ON READER-SERVICE CARD

"Carousel." Roberta Peters, Alfred Drake. Command RS 843 SD.

"Choral Spectacular." Chorus and RCA Victor Symphony Orchestra, Luboff. RCA Victor LSP 2522.

"Cleopatra." Recording from the sound track of the film. 20th Century-Fox SXG 5008.

"Cleopatra Themes." Rome Sound Stage Orchestra. Riz Ortolani. RCA Victor LSP 2766.

"Dark Eyes." Don Cossack Choir, Jaroff. Deutsche Grammophon SLPEM 136367.

"The Desert Song." Dorothy Kirsten, Gordon MacRae; Chorus and Orchestra, Van Alexander. Capitol SW 1842.

"Don't Go in the Lion's Cage Tonight." Julie Andrews; Orchestra, Mersey. Columbia CS 8686.

"Emil Coleman Lights Up the Plaza." Emil Coleman and His Orchestra. Philips PHS 600041.

"Enoch Light and His Orchestra at Carnegie Hall Play Irving Berlin." Command RS840 SD.

"Exciting Rhythms of Piano Pasha." Erdogan Capli, piano. Time S 2074.

"The Exotic Sounds of Bali." Gamelan Gong Sekar Anjar and Gender Wajang Quartet, Hood. Columbia MS 6445.

"Exotica Suite." Si Zentner Orchestra and Martin Denny Ensemble. Liberty LSS 14020.

"Far Away Places," Vol. 2. Enoch Light and His Orchestra. Command RS 850 SD.

"Fifty Guitars Go Country." Tommy Garrett, cond. Liberty LSS 14025.

"Film Spectacular." London Festival Chorus and Orchestra. Stanley Black. London SP 44025.

"Fire and Jealousy." Andre Kostelanetz and His Orchestra. Columbia CS 8698.

"Flamenco Fire!" Sarita Heredia. World Pacific WPS 1427.

"Folk Music and Songs from the Middle East." Philips PHS 600063.

"The Garden of Allah." Yaffa Yarkoni; Trio Bel Canto; George Stratis and His Ensemble. Epic BF 19025.

"The Garland Touch." Judy Garland; Orchestra. Capitol SW 1710.

"Hail the Conquering Nero." Peter Nero, piano; Orchestra, Marty Gold. RCA Victor LSP 2638.

"High Life." Olatunji and His Drums of Passion. Columbia CS 8796.

PURCHASING A HI-FI SYSTEM?

TRADE-INS OK—TIME PAYMENTS
Up to 2 years to pay!

Send Us Your List of Components For A Package Quotation

AIREX WON'T BE UNDERSOLD

All merchandise is brand new, factory fresh & guaranteed.

Visit our N. Y. Showroom. Free cabinet brochure.

AIREX RADIO

CORPORATION

85-HF Cortlandt St., N.Y. 7, WO 4-1820

Jim Lansing*
Altec Lansing
Electrovoice
Jensen • Harlicrafter
Hartley* • Gonset
USL Citizen Band
Texas Crystals
Internat'l Crystals
University
Acoustic Research
Janszen • Viking
Wharfedale
Concertone
Bell • G.E.
Weathers
Harman-Kardon
Eico • Pilot
Sherwood*
Tandberg*
ESL • Frazier
Superscope
Dual Changer*
Bogen • RCA
Dynakit • Fisher
H. H. Scott • Leak*
ECL • Roberts
De Wald • National
Sony • Challenger
Browning
Garrard
Miracord
General Radio
Rek-O-Kut
Polytronics
Norelco • Finco
Fairchild
Pickering • Sonar
Audio Tape
Magnecord*
Rockford Cabinets
KSC Speaker
Systems*
* Fair Traded

CIRCLE 2 ON READER-SERVICE CARD

build your own bozak

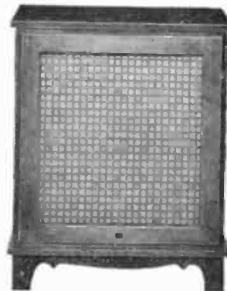
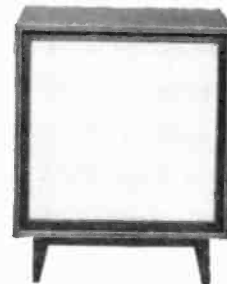

URBAN OR EARLY AMERICAN
INFINITE-BAFFLE SPEAKER CABINETS

Complete kits ready for assembly, and finishing to your taste. For the Bozak 2-way B-300 and 3-way B-302A Systems. See your Bozak Dealer, or write Bozak.



DARIEN / CONN.
06821

CIRCLE 67 ON READER-SERVICE CARD

Tracks and Trips
Automatically at 1/2 Gram!



The fabulous NEW
DUAL 1009
AUTO/PROFESSIONAL
with dynamically balanced tonearm

Use the finest high compliance cartridges in this superb automatic record playing instrument that equals or surpasses costly manual turntables in total performance. Features: fine-thread precision counterweight, direct-dial stylus force from 0 grams up, 6% variable speed control, 7 1/2 pound non-ferrous platter, manual and automatic single play plus automatic changer operation. \$94.75.

UNITED AUDIO  DUAL

For literature, write: United Audio,
12 West 18th St. New York 11, N. Y.

CIRCLE 60 ON READER-SERVICE CARD

ROCK GET OUR QUOTE
BOTTOM
STEREO • HIGH FIDELITY
PRICES

PLUS THESE RABSONS EXTRAS

- Established 1905 - 58 Years of Reliability
- Franchised Protection - Plus
- Rabsons Special Six Month Guarantee
- Easy Payment Plan - Up to 24 Months to Pay
- Each Component Double Packed to Insure Safe Arrival - At no extra charge
- Rabsons Sells ONLY Factory Fresh Merchandise in Original Factory Sealed Cartons

SO WRITE RABSONS

Whatever your HI-FI requirements end receive

FREE

A \$1.00 genuine Miracle Record Cleaning Cloth with EVERY Quotation from Rabsons on a component or system of your choice

RABSONS -57 ST. INC.

115 West 57th St., New York 19, N.Y.

Diagonally opposite Carnegie Hall

CIRCLE 44 ON READER-SERVICE CARD

"How the West Was Won." Original Sound Track Recording. Alfred Newman. M-G-M S 1F5.

"I Wanna Be Around." Tony Bennett; Orchestra. Marty Manning. The Ralph Sharon Trio Columbia CS 8800.

"Italian Mandolins." Claudio Bonelli and His Orchestra. Time S 2068.

"My Silent Love." Living Strings Plus Two Pianos. RCA Camden CAS 754.

"Oliver." Original Cast Recording. RCA Victor LSOD 2004.

"On Tour." University of Michigan Band. Revelli. Vanguard VSD 2124.

"Our Man in Hollywood." Henry Mancini and His Orchestra. RCA Victor LSP 2604.

"Our Man in London." The Melachrino Strings and Orchestra. RCA Victor LSP 2608.

"Paris with Love." Jo Basile (accordion) and His Orchestra. Audio Fidelity AFSD 5938.

"Peter, Paul and Mary (Moving)." Warner Brothers WS 1473.

"Ravi Shankar in Concert." World Pacific WPS 1421.

"Ritmos de España." Orquesta Tipica de Madrid, Echevarria. M-G-M E/SE 4070.

"Screamers!" Fastman Wind Ensemble. Frederick Fennell. Mercury SR 90314.

"Soft Lights and Sweet Music." The Enchanted Strings and Organ, Dick Jacobs. Coral 757416.

"Songs of Old Germany." Heinz Schachtner. trumpet; Chorus and Orchestra. Capitol ST 10330.

"Supercussion." Dick Schory's Percussion Pops Orchestra. RCA Victor LSC 2613.

"Tell Tall Tales." The New Christy Minstrels. Randy Sparks. Columbia CS 8817.

"This Is My Country." Robert Shaw Chorale; RCA Victor Symphony Orchestra, Shaw. RCA Victor LSC 2662.

"Two of Us." Robert Goulet; Orchestra, Glenn Osser. Columbia CS 8626.

"Victory in Review." Eric Rogers, cond. London SP 44024.

"Viennese Waltzes." Marcel Pagnoul and His Orchestra. Time S 2069.

"Where Did the Night Go?" The Living Strings. RCA Camden CAS 738.

"Yves Montand: Paris Recital." Philips PCC 602.

REVOLUTION in STEREO PHONES



high and low frequency response like SUPEREX

the only stereo phones with built-in woofer and tweeter in each phone

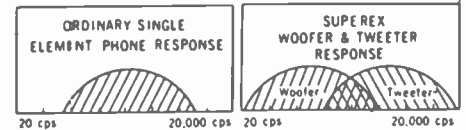

Obviously single element phones must compromise on high or low frequency

Superex delivers the full range because of separate woofer and tweeter in each phone

You deserve the most advanced phones... adjustable treble control in each phone... miniaturized cross-over network in each phone... single lead with stereo plug! For true stereo or monaural listening (full 20-20,000 cps range; 8-16 ohms impedance) get the most remarkably engineered stereo-phones ever built.

Write for Free Valuable Handbook ST-M \$29.95

SUPEREX stereo/phones

SUPEREX ELECTRONICS, 1 RADFORD PLACE YONKERS, N.Y.

CIRCLE 59 ON READER-SERVICE CARD

SELLING HI-FI WORLD WIDE SINCE 1948

COMPONENTS • RECORDERS
KITS • SPEAKER SYSTEMS • TAPE

- LOWEST PRICES
- ALL BRAND NEW FACTORY-SEALED CARTONS
- FULLY GUARANTEED BY MFR.'S WARRANTY
- FAST, INSURED SHIPMENTS from OUR WELL-STOCKED WAREHOUSE
- GET 'QUOTES' on PACKAGE DEALS AND SAVE MORE
- SAME DAY REPLY TO YOUR HI-FI INQUIRY

• SPECIAL: STEREO DYNE II DIAMOND STEREO CARTRIDGE - \$7.95 ppd.

Send for FREE "MONTHLY SPECIALS" on other Cartridges, Tapes, and Components.

WRITE FOR MONTHLY SPECIALS VISIT OUR STORE

CARSTON Studios
125 East 88 St., New York 28, N. Y.

CIRCLE 15 ON READER-SERVICE CARD



Attention Shun

In Britain,

the symbol of precision drill is the Royal Guards. Such precise accuracy and faultless skill can be found in every Leak High Fidelity instrument. In fact, many editors refer to Leak's construction as the "military assembly."

This is another reason why Leak products are universally used in professional applications—where durability and performance cannot be compromised.

If you are of the esoteric few, seeking the ultimate in quality components, may we post to you authentic TEST REPORTS on Leak equipment? Then, visit the listening salon of your nearest Leak Authorized Specialist . . . for in the final analysis, listening under "home conditions" is the indisputable test.

See the dramatic yet graceful exterior designs of Leak equipment . . . the new "deco-discs and deco-plates" for interior color coordination . . . features which won the coveted international medals of the Fashion Foundation of America and the British Council of Industrial Design. If you haven't as yet heard the revolutionary Leak "piston-action" Sandwich Speaker System . . . by all means do so now!

Though Leak equipment is first in quality
it is reasonably priced!

Leak Point One Control Center	\$119.50
Leak Stereo "60" Amplifier	\$219.00
Leak Stereo "20" Amplifier	\$149.00
Leak Mark IV Tuner	\$149.00
Leak Sandwich Speaker System	\$199.00

prices slightly higher west of the Mississippi

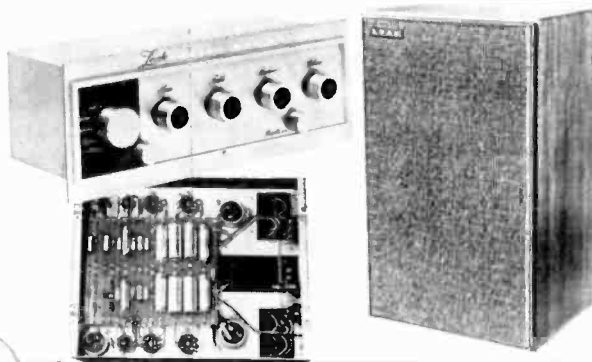

FASHION FOUNDATION OF
AMERICA'S GOLD MEDAL FOR
DISTINCTIVE STYLING.

For TEST REPORTS and
descriptive literature write Dept. HFA-11

ERCONA CORPORATION,
432 Park Ave., New York, N. Y.

Exclusive
U.S. Representatives:

ADVERTISING INDEX

Key No.		Page
1	Aerovox Corp.	119
2	Airex Radio Corp.	120
3	Allied Radio	13, 14
5	American Concertone, Inc.	101
6	Ampex Corp.	6
7	Argos Products Co.	112
8	Audio Devices, Inc.	114
9	Audio Fidelity, Inc.	4
10	Audio Unlimited, Inc.	119
11	Autostereo	108
12	Barzilai Furniture Mfg. Co., Inc.	10, 11
62	Benjamin Electronics	18
67	Bozak, R. T., Mfg. Co.	120
13	British Industries Corp.	2
14	British Industries Corp.	5
63	Cabinart	114
15	Carston Studios	121
16	Citadel Record Club	111
17	Citadel Tape Club	118
18	Command Records	7
19	Commissioned Electronics	118
4	Concord Electronics Corp.	20
20	Dixie Hi-Fi	118
60	Dual	121
21	Electro-Voice, Inc.	27
47	EMI. See Scope Electronics	
66	Ercona Corp.	122
23	Finney Co.	107
24	Fisher Radio Corp.	22, 23, 25
25	Freeman Electronics Corp.	105
13	Garrard	2
61	Greentree Electronics	102
26	Hadley Laboratories	109
27	Harman-Kardon, Inc.	9
28	Heath Co.	19, 21
30	Hi-Fidelity Center	119
29	Hi-Fidelity Supply Co.	118
31	Jerrold Electronics	103
33	Kersting Mfg. Co.	116
34	Koss Electronics, Inc.	104
32	K.R.C. Corp.	110
35	Lafayette Radio Electronics	113
36	Lansing, James B., Sound, Inc.	12
66	Leak	122
37	Magnecord	Cover III
38	McIntosh Laboratory, Inc.	Cover II
39	Microtran Co., Inc.	120
41	Minnesota Mining & Mfg. Co.	8
64	Mobile Fidelity	116
40	North American Philips Co.	Cover IV
42	Olson Electronics, Inc.	120
43	Pickering & Co., Inc.	30
44	Rabson-57 St., Inc.	121
45	Roberts Electronics, Inc.	1
46	Sarkes Tarzian	116
19	Saxitone Tape Sales	118
47	Scope Electronics Corp.	119
48	Scott, H. H., Inc.	15, 17
49	Sherwood Electronics	26
65	Shure Bros., Inc.	29
50	Sound Reproduction, Inc.	109
59	Suprex	121
51	Superscope	24
52	Tandberg of America, Inc.	115
53	Tannoy (America), Ltd.	117
54	20th Century-Fox Records	115
60	United Audio	121
55	University Loudspeakers	16
56	Viking of Minneapolis, Inc.	106
57	Wayfarer Car-Stereo	110
14	Wharfedale	5
58	Winegard	117
	Wyeth Press	28, 99

CIRCLE 66 ON READER-SERVICE CARD

WHERE CAN YOU BUY 40 SOUND QUALITY FEATURES?

1. Modular construction featuring complete plug-in record amplifier, reproduce amplifier, and bias oscillator 2. Fully solid-state electronics 3. Hysteresis synchronous metering capstan drive 4. Solenoid operated tape gate, brakes and pressure roller 5. Separate reel drive motors 6. Safely handles all tape, including half mil 7. Front panel microphone jacks 8. Mixing inputs for high level line 9. Front panel mode switch with tally lights 10. Monitoring from tape or source 11. Separate channel monitor and output switches 12. Durable, easily cleaned, easy-on-the-eye professional vinyl finish 13. Standard readily available American transistors and components 14. Superior tape guiding 15. Military type fail-safe differential band brakes 16. Sturdy die-cast main plate 17. Signal switching available at remote socket 18. Position for optional fourth head 19. Remote "start-stop" 20. Local-remote front panel control 21. Pushbutton transport controls 22. Record safety interlock 23. New "cue" transport control 24. Large, rugged hardened stainless steel capstan 25. Ball bearing inertial stabilizer flywheel 26. Payout compliance arm and tape break shut-off 27. Automatic capstan motor stop for tape run-out 28. Take-up compliance arm 29. Regulated power supply 30. Emitter follower outputs 31. Stereo-mono front panel earphone switch 32. Simultaneous record and playback 33. Double flywheel capstan drive 34. Switchable equalization 35. Auxiliary emitter-follower outputs 36. Auxiliary high impedance inputs 37. Standard "hi-fi" connectors 38. Large "operator" type knobs 39. Earphone monitor jack on front panel 40. V.U. meter for each channel

FULLY SOLID-STATE ELECTRONICS

SOUND-ON-SOUND & SOUND-WITH-SOUND

FOR QUARTER-TRACK STEREO
OR MONAURAL OPERATION

TAPE SPEEDS: 3.75 and 7.5 inches per second.

REEL SIZE: 5-, 7- and 8-inch E.I.A. hubs.

HEADS: Four. Selectable ¼-track Erase, ¼-track Record and ¼-track Play are Standard. Accessory two-track Stereo Play available as fourth head.

DIMENSIONS: 19" wide, 15-¾" high, 12" deep.

Unprecedented in our industry, Magnecord, America's first manufacturer of magnetic tape recorders, now introduces a unique model. The NEW Magnecord 1024 offers you the highest possible quality at the lowest conceivable price! For professional sound, design simplicity, moderate price, engineered performance and quality throughout — BUY the most versatile of them all . . . BUY the NEW 1024!



Buy the NEW

 **magnecord**
1024

ONLY
\$595.

for further information write

MAGNECORD SALES DEPARTMENT
MIDWESTERN INSTRUMENTS, INC.
P. O. BOX 7509 • TULSA 35, OKLAHOMA

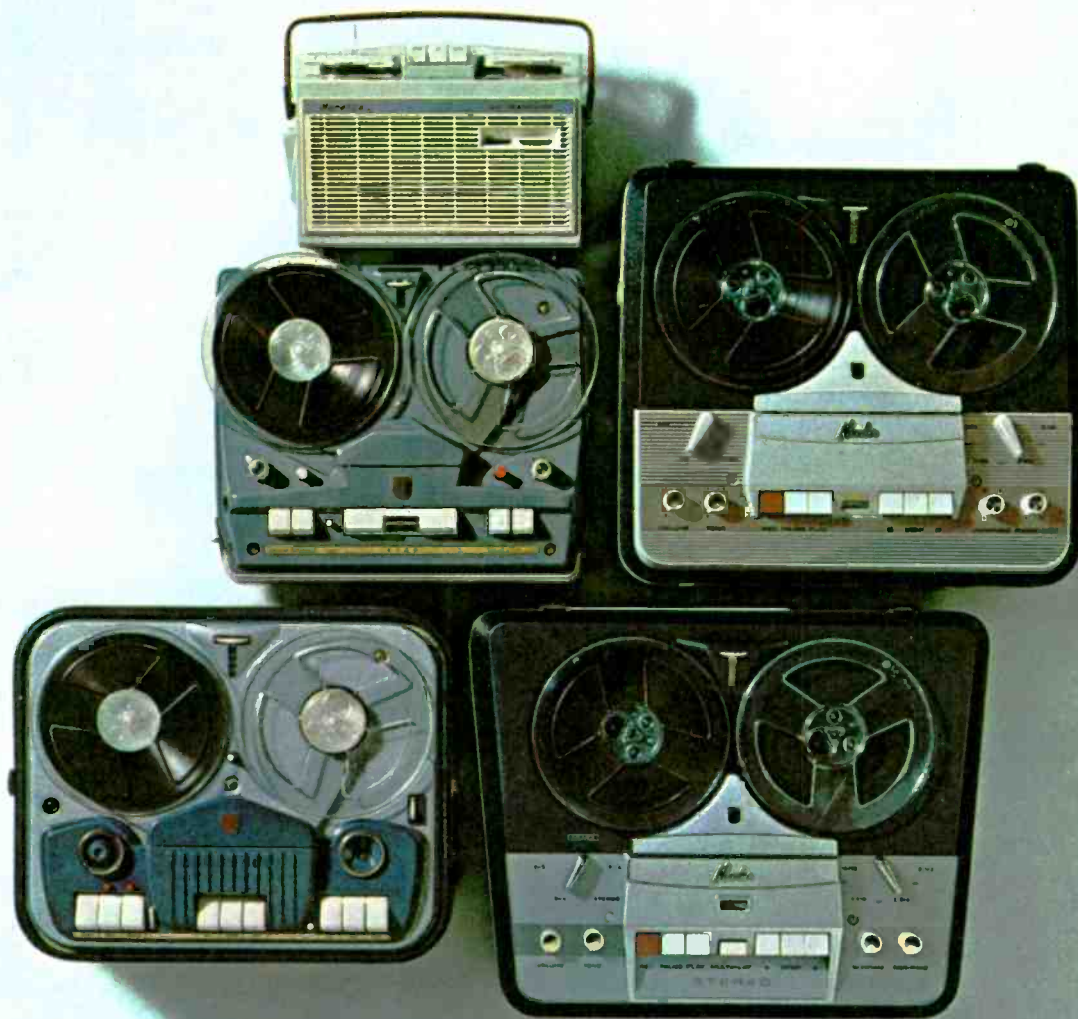

Which of these five Norelco recorders was designed expressly for you?

The **Continental '401'?** (lower right) 100% transistorized with professional quality 4-track stereo/mono/record/playback . . . with 4 speeds, including 7 $\frac{1}{2}$, 3 $\frac{3}{4}$, 1 $\frac{1}{2}$ and 15/16 ips providing up to 32 hours on a single 7" reel . . . with completely self contained dual hi-fi pre-amps, power amps, speakers and dynamic stereo microphone.

The **Continental '301'?** (upper right) 100% transistorized with 4-speed, 4-track mono record/playback capability . . . with dual hi-fi preamps for stereo playback with radio, phono or TV as well as through external high-fidelity stereo system . . . with recording stand-by facility; mixing; monitoring; dynamic microphone.

The **Continental '300'?** (lower left) . . . with 3-speed, 4-track mono record/playback capability and stereo head output for stereo playback through external equipment . . . with dynamic microphone and versatility to match the varied requirements of churches, schools, etc.

The **Continental '200'?** (center) with special suitability for portable hi-fi tape deck applications . . . with self-contained mono record/playback capability and 4-track stereo output from tape heads. High impedance microphone.

The **Continental '100'?** (upper left) 100% transistorized "trip-mate" battery portable (only 7 lbs.) . . . with big machine record/playback quality

. . . constant speed motor and capstan drive . . . self-contained loudspeaker . . . dynamic microphone . . . records/plays back 2 hours on a 4" reel.

Whatever your requirements in a tape recorder, the choice of the one right Norelco machine for you is easy as A-B-C. For a pleasant demonstration, visit your favorite hi-fi dealer or camera store. Write for free brochure. North American Philips Company, Inc., High Fidelity Products Division, 100 East 42nd Street, New York 17, New York.

Norelco[®]

CIRCLE 40 ON READER-SERVICE CARD