

VOL. 2 NO. 9  
SEPT. 1977

\$1.50  
#06691 Ⓢ

# MODERN RECORDING

SERVING TODAY'S MUSIC/RECORDING-CONSCIOUS SOCIETY

A Session with

**Blue Oyster Cult**

YB033623900000 D  
D POMEROY  
193 BALTIC ST  
BRUCKLYN  
NY 11201  
7804

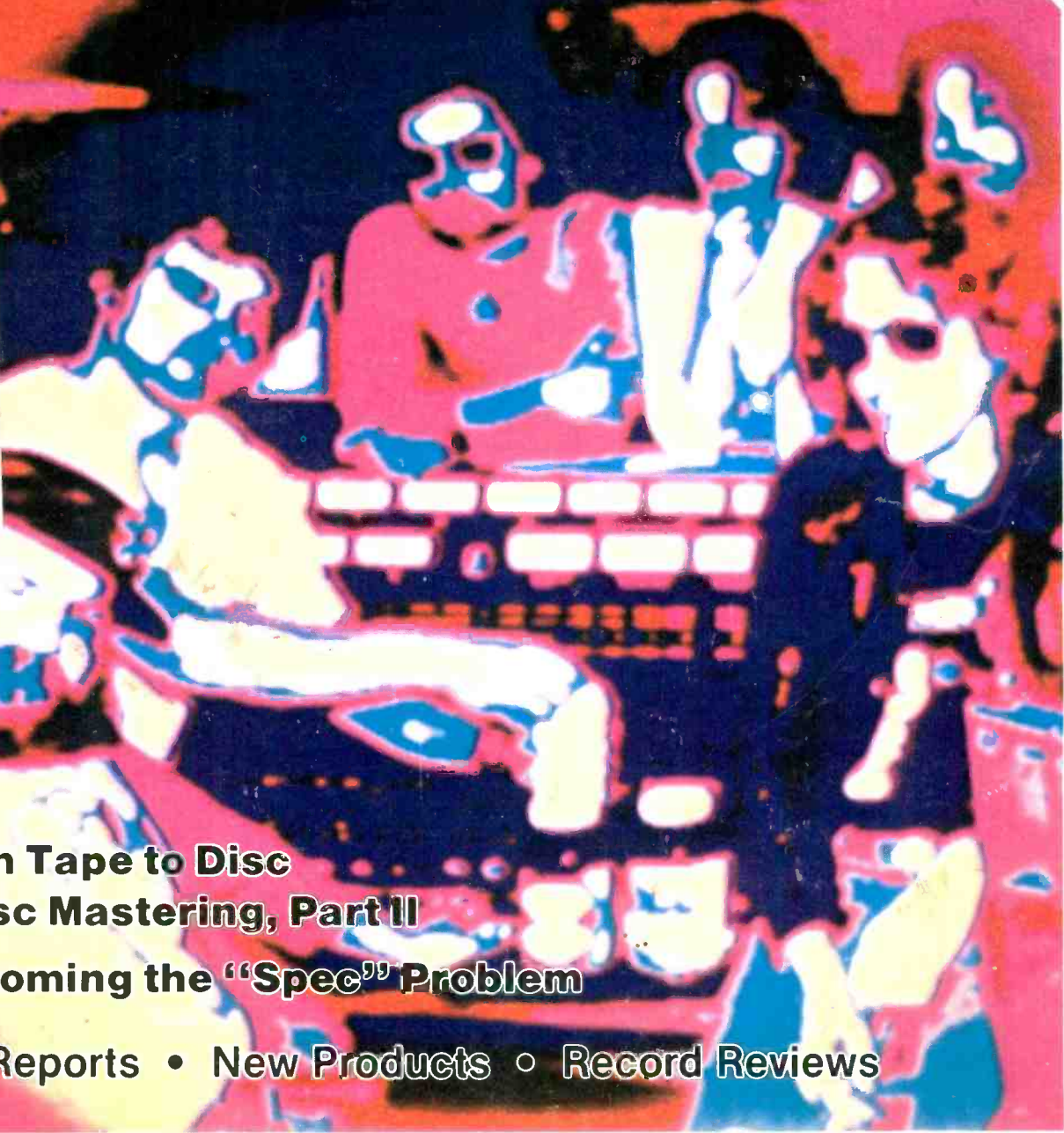

**From Tape to Disc**

**—Disc Mastering, Part II**

**Fathoming the "Spec" Problem**

**Lab Reports • New Products • Record Reviews**



# YOU'VE PLAYED HERE BEFORE

You know what to expect from brick walls, low ceilings and hard floors. Your bass gets eaten by the drapes and your guitar solo echoes right back at you. The environment of a small club is designed to make it a good place to drink and dance, not necessarily a good place to perform. What you need is the ability to tailor your sound to the room.

At MXR, we realize that quality sound is essential to a musician, wherever he plays. MXR Graphic Equalizers can give you the control to make that sound, your sound, possible, whether you are playing in a small club, in a large auditorium, or any place in-between.

Available in either Six or Ten-band ranges, MXR Graphic Equalizers are designed to precisely modify selected frequency ranges in order to compensate for aural discrepancies caused by the acoustical environment.

MXR's Six-band Graphic Equalizer has been designed for modification over the tonal response range (100 Hz—3.2 KHz) and is ideal for use with electric and acoustic guitar, bass and brass. Its overdrive capa-



bility enables the Six-band Graphic Equalizer to selectively distort at any given frequency. The MXR Six-band Graphic Equalizer is battery powered with battery life of up to one year in normal use.

The Ten-band Graphic Equalizer expands the capability of sound control even farther. Ten bands cover the entire frequency spectrum in octave incre-

ments that allow you to specifically boost or diminish the tonality of any part of your performance. Its frequency range (31.2 Hz-16KHz) is sufficient to allow the widest range of application, including; musical instruments such as keyboard and drums as well as PA mains and/or monitor equalization. The MXR Ten-band Graphic Equalizer is AC powered, can handle both low and high impedance signals and is extremely quiet.

Both the Six and Ten-band Equalizers are ruggedly constructed for long-term reliability. So, now you can make any environment a controlled environment with an MXR Graphic Equalizer. To hear the difference for yourself, see your MXR dealer. MXR Innovations, Inc., 277 N. Goodman St., Rochester, N.Y. 14607.

**MXR**

**Professional  
Products Group**

CIRCLE 56 ON READER SERVICE CARD

[www.americanradiohistory.com](http://www.americanradiohistory.com)





# Our new AD cassette takes the normal bias position to extremes.

We made a name for ourselves by creating the world's first non-chrome, "high" (CrO<sub>2</sub>) bias/EQ cassette tape, TDK Super Avilyn (SA). The state-of-the-art tape that has quickly become the standard of reference for cassette tape performance.

Our latest innovation is called AD (ay-dee), and we predict it will soon become the standard of performance and economy in the "normal" bias/EQ position.

We produced the first high fidelity ferric oxide cassette tape some ten years ago, and we've been perfecting the formulation ever since. Our new AD delivers superior performance, especially at the critical high-frequency range (7kHz to 20kHz), where many mid-priced cassette decks and even premium-priced cassettes tend to fall off too quickly.

AD is our ultimate ferric oxide tape designed for the "normal" bias/EQ position. Overall, it provides the lowest noise, highest frequency response and widest dynamic range of any pure ferric oxide cassette tape. In 45, 60, 90 and 120 minute lengths, AD has the same super-precision cassette mechanism found in TDK SA, in a new blue-gray shell.

And AD brings its audible benefits to all cassette decks, with and without switchable bias/EQ, including those found in cars, portables and home stereo systems. So the music you love can travel with you, with all of the clear, crisp, brilliant sounds that make music so enjoyable.

AD is the finest pure ferric oxide cassette tape you can buy at any price. And it has TDK's full life time warranty. Give our new high-fidelity, moderately-priced AD a try—it's anything but normal.

TDK Electronics Corp., 755 Eastgate Boulevard, Garden City, New York 11530.  
In Canada: Superior Electronics Industries, Ltd.

 **TDK**  
The machine for your machine.

CIRCLE 79 ON READER SERVICE CARD



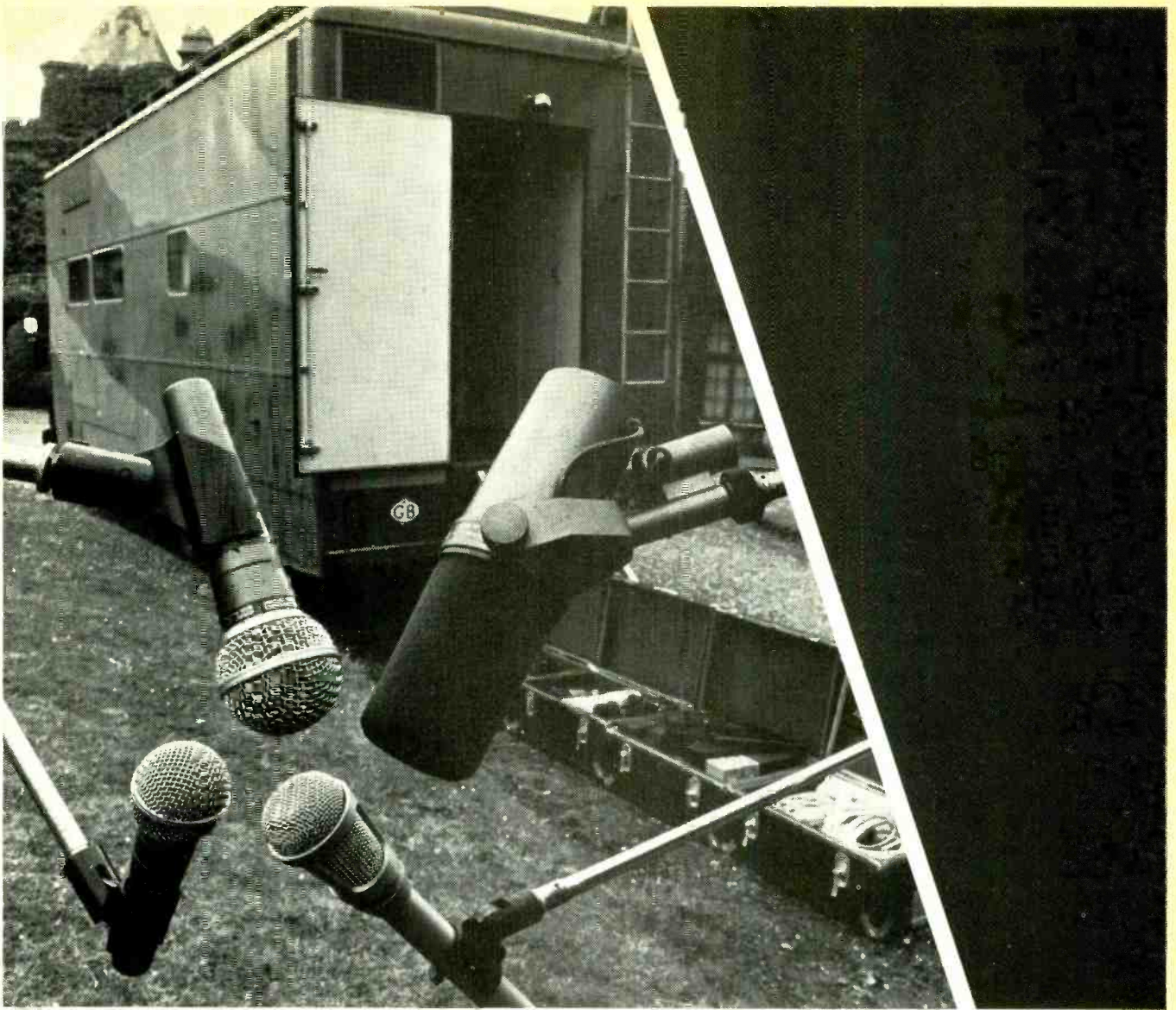

## Stones' Rolling Studio



A complete recording studio in a van? For Mick Jagger, it is almost a necessity. Mick and the Stones can be inspired to produce their next hit anytime, but when they're on tour or on vacation, the best recording studios aren't always around the corner. The Stones rely on their Shure-equipped mobile studio for the unmatched recording perfection they insist upon for these moments of midnight inspiration. Whether in a recording session or on stage, the Stones' SM7, SM58, SM82, SM53 and SM56 microphones are their assurance of consistent quality and natural sound.

Shure Brothers Inc.  
222 Hartrey Ave., Evanston, IL 60204  
In Canada: A. C. Simmonds & Sons Limited



Manufacturers of high fidelity components, microphones, sound systems and related circuitry.

CIRCLE 34 ON READER SERVICE CARD



# MODERN RECORDING

SEPTEMBER 1977

VOL. 2 NO. 9

SERVING TODAY'S MUSIC/RECORDING-CONSCIOUS SOCIETY

## THE FEATURES

### FATHOMING THE DEPTHS OF THE SPECS

By Dick Rosmini

29

Specifications. They were originally intended to help us compare and evaluate quality and performance, but let's face it—confusion reigns. Find out how knowing your specs can help you to create better recordings.

### A SESSION WITH BLUE OYSTER CULT

By Veda Neu Solomon

36

How do three producers, an engineer who "produces his end" and five band members who have extremely diverse writing styles manage to stay together long enough to record six previous albums? Author Solomon sits in on the new Blue Oyster Cult album and describes the sessions.

### FROM TAPE TO DISC

—DISC MASTERING, Part 2

By David Moyssiadis

44

Mastering engineer Moyssiadis continues with his views and explanations of the disc mastering field. In this final part we learn what we can do to make the mastering process easier for all involved, and how to insure ourselves of a quality disc.

### COMING NEXT ISSUE!

Chicago "Live"

Sound Reinforcement at Newport

Profile: Producer/engineer Roy

Halee

Modern Recording is published monthly by Cowan Publishing Corp., 14 Vanderventer Ave., Port Washington, N.Y. 11050. Design and contents are copyright by Cowan Publishing Corp. and must not be reproduced in any manner except by permission of the publisher. Second class postage paid at Port Washington, New York, and at additional mailing offices. Subscription rates: \$12.00 for 12 issues; \$22.00 for 24 issues. Add \$3.00 per year for subscriptions outside of U.S. Subscriptions must be paid in American currency.

## THE STAPLES

### LETTERS TO THE EDITOR

4

### TALKBACK

The technical Q & A scene.

10

### THE PRODUCT SCENE

By Norman Eisenberg

22

The notable and the new, with a comment on direct-to-disc recording.

### MUSICAL NEWSICALS

By Fred Ridder

New products for the musician.

26

### AMBIENT SOUND

By Len Feldman

Reviewing one of our constant but very often confusing audio companions—impedance.

54

### LAB REPORT

By Norman Eisenberg

and Len Feldman

BGW 500D Power Amplifier

H.H. Electronic Echo Unit

Teac A-650 Cassette Tape Recorder

58

### HANDS-ON REPORT

By Jim Ford

and Brian Roth

Uni-Sync Trouper Series III

66

### GROOVE VIEWS

Reviews of albums by the Earl Scruggs Revue, Symphonic Slam, Kursaal Flyers, Genesis, Ornette Coleman, George Duke and Anthony Braxton.

70

### ADVERTISER'S INDEX

80

Cover photo © 1977 Lynn Goldsmith



**H.G. La TORRE**  
Editor

**ROBERT ANGUS  
NORMAN EISENBERG  
LEONARD FELDMAN**  
Audio Editorial Board

**FRED RIDDER  
JIM FORD  
BRIAN ROTH  
NAT HENTOFF**  
Contributing Editors

**STEFFON A. KACHOCKI**  
Production Manager

**MELANIE DEUTSCH**  
Production Assistant

**RICHARD FERTELL**  
Advertising Director

**BILL SLAPIN & CO.**  
West Coast  
Advertising Representative

**BILL TRAVIS**  
Art Director

**SHERYL STERN  
LIZ BEENER  
HAROLD PERRY**  
Art Staff

**VINCENT P. TESTA**  
Publisher

Editorial and Executive Offices  
Modern Recording  
14 Vanderventer Ave.  
Port Washington, N.Y. 11050  
516-883-5705

COWAN PUBLISHING CORP.  
Chairman of the Board Sanford R. Cowan  
President Richard A. Cowan  
Controller Cary L. Cowan

Editorial contributions should be addressed to  
The Editor, Modern Recording, 14 Vanderventer  
Ave., Port Washington, N.Y. 11050. Unsolicited  
manuscripts will be treated with care and must be  
accompanied by return postage.

# LETTERS TO THE EDITOR

## TIM Pleases Reader

The July, 1977, issue of *Modern Recording* was the first copy I've had the pleasure of reading. The magazine seems to be filling the pro/am gap by providing basically informative as well as moderately technical articles.

I was extremely pleased with Mr. Feldman's article on "Otala" distortion or TIM (transient intermodulation distortion) (Ambient Sound, page 66).

As Mr. Feldman points out, the industry hasn't yet set up a criteria for quantifying TIM, but it is possible to "graphically and visually detect the presence or absence of TIM" and make direct comparisons between different amplifiers.

Paul Klipsch, of Klipsch and Associates, has begun to do just that, and some of his initial findings are quite interesting (though his research is moving a little slowly since it's one of his "non-profit" activities).

So far the "top" two amplifiers (those exhibiting the lowest TIM) are the BGW 100 (solid state) and the Marantz Model 7 (tube type) while the two at the other end of the spectrum were also transistor and tube. The battle between tube and transistor continues.

Again, I would like to commend you on an excellent publication, and look forward to reading more articles by Mr. Feldman, and more on TIM, possibly with some sort of reference to it in future equipment test reports.

—Michael Morrow  
Little Rock, Ar.

## Impedance Confusion Remains

Mr. Blakely's answer to Stephen Kayser's query on impedance (Talkback, June, 1977, p. 13) is typical of the confusion that still remains, both in and outside of the industry. While there is no one rule that defines every situation, to say that "any output is happy feeding any input that is the same impedance..." is in many situations quite incorrect and often results in gross distortion.

Admittedly, I am not familiar with the output circuitry of the dbx 154, and perhaps Mr. Blakely's reply is correct with regards to that specific product. But many products utilize transformerless output circuits such as emitter followers, voltage followers, etc., whose tolerance to loading varies with the particular design. While most of these circuits provide a low impedance source, many of them will not drive an equivalent load without an increase in distortion or a decrease in output level, or both. This type of output circuit is intended, typically, to feed a high impedance input (10K ohms and up).

Where matching impedances are required, one typically finds output transformers utilized which transfer signal power rather than voltage, e.g., 600-ohm studio lines. These, too, may feed high impedance inputs, but usually require a load resistor so that the transformer is properly terminated.

I have little doubt that Mr. Kayser's equipment is satisfactorily compatible; my concern is for other unwary readers who may conclude from Mr. Blakely's reply that they can now, for example, connect their "semi-pro" or hi-fi deck into a 600-ohm line



# NOW YOU HAVE A CHOICE...

Stack the new Mitchell BC/84 up against the competition . . .  
you'll hear why it's the pros best friend.

Compare our features against the "competition".

✓	8 long—throw 4 1/4" full range transducers	✓	Power rating: 100 RMS (270 Watts) per set.
✓	Silicone sealed speakers	✓	8 OHM or 16 OHM impedance
✓	Airtight inner cabinet	✓	3/4" birchwood cabinet/laminated fiberglass outer shell
✓	<b>NO EQUALIZER REQUIRED</b>	✓	Dimensions: 19 1/4" x 15" x 13" Just 45 lbs.
✓	Frequency response: 60 Hz — 15000 Hz	✓	Ideal for all electronic instruments
		✓	Price: \$300 ea.



You know--there really isn't any competition.

For further information and our free catalog write to :

## MITCHELL SPEAKER ©.

2906 Rubidoux Blvd. Riverside, CA. 92509



# FINALLY!

## A Professional Instrument Line at Reasonable Prices

CARVIN features the finest in Professional Instrumentation equipment at incredibly **LOW FACTORY DIRECT PRICES**. This is made possible because we manufacture and sell direct — eliminating retail markups. • The CARVIN Doubleneck Guitars feature 4 APH-6S Double Coil Humbucking Pickups, Ebony fingerboards, Nickel-Silver frets, Shaller M6 mini-gears & Phase-Switching. Plus 14 other guitar models and a line of GUITAR PARTS.

CARVIN offers TUBE & Solid-State Amplifiers featuring 7 Band Graphic Equalizers, Channel-to-Channel Switching with Sustain Channel. JBL or MagnaLab speakers. • CARVIN Mixing Consoles feature 6, 10, 12, and 18

Channels with Bal. Inputs, 10 Band Graphic Equalization, Bi-Amp Crossover Networks, Stereo Panning, plus more. • CARVIN'S Professional Club and Commercial sound-reinforcement systems offer MagnaLab Electro-Voice, or JBL Horn Drivers and Speakers. Plus

Power Amps featuring Electronic Crossovers. • Professional quality and reliability are not sacrificed for price at CARVIN. All systems are carefully crafted by CARVIN in the U.S.A. and are backed by a

Solid 5 YEAR Warranty. Try CARVIN on a 10 Day Money-Back Trial Period. Call (714) 747-1712 Mon.-Fri. (or Write CARVIN, Dept. MR12, 1155 Industrial Avenue, Escondido, CA 92025 for your FREE Color Catalog.



send for  
**FREE CATALOG**  
with  
**Factory Direct Prices**

Name \_\_\_\_\_  
Address \_\_\_\_\_  
City \_\_\_\_\_  
State \_\_\_\_\_ Zip \_\_\_\_\_

CIRCLE 66 ON READER SERVICE CARD

input, or "Y" the outputs on a similar device, with no penalty.

—Arne Berg  
Consultant  
La Puente, Ca.

### Our Fans In Mexico

Congratulations! Going monthly is a fantastic decision. So I want to thank you all for this, and the valuable information in each issue.

Also I want to thank Mr. Eisenberg and Mr. Feldman for the "Lab Report" column. It's always good to have someone else spend time testing equipment and devices and figure out accurately its pluses and drawbacks. I have a suggestion to make. I would like to read an article about techniques in mix-mastering and disc-mastering. I'm sure that plenty of readers will love it.

And finally a simple question. What does "A & R" stand for?

—J.M. Anzaldúa  
Mexico 18, D.F., Mexico

*Articles on mastering procedures will be forthcoming in Modern Recording. "A & R" stands for "Artist and Repertory."*

### An Order from Austria

In a TAPCO manual, I found your address. I'm interested in the book, *Modern Recording Techniques* by Robert Runstein published by Howard W. Sams Co. and a few newer issues of *Modern Recording*. Please tell me their prices and the cost to send it to me. I could order a bank to do it for me and I could inform my friend Mr. Cernohouse the same way.

—Michael Tomoff and  
Christian Cernohouse  
Wien, Austria

*For back issues of MR, simply write to our Subscription Department and order them at \$1.75 per copy plus \$1.20 for postage to Austria. Current issues are available by subscribing and including a \$3.00 mailing charge for overseas delivery. The book Modern Recording Techniques by Robert Runstein is available for \$9.95 plus postage from Howard Sams Co., 4300 West 62nd Street, Indianapolis, Indiana 46268. Please pass this information along to your friend, Mr. Cernohouse.*

### We're Down To Earth

First off, I wish to commend you on your excellent publication. It has given

me invaluable information needed to learn my trade. I am a staff assistant at Sound Ideas Studios, N.Y., and will be the first to admit that I am not a terribly technical person. So when reading trade magazines and such, I usually end up like I just tried to decode the Dead Sea Scrolls. However, along comes *Modern Recording* giving me that which I want to know in layman language. Right on, fellas!

One of those items of invaluable info which was of immense aid to me and I'm sure to others was your "P.A. Primer" series. It was what I needed and loved it. But... I missed the first part. What I need is to get a copy of that article... better yet the whole magazine for that matter. If you could send it to me or a copy of the article, or how I might even purchase a back issue, I'd be grateful.

Oh, one thing. The authors were right about "P.A. Primer." They probably could go on forever writing about it. In fact, they ought to make it a permanent column in the publication. Please let's have more of the quality info MR has been putting out... and keep the language down to earth. You've got my subscription!

—T. Roberts  
New York, N.Y.

*Issue Vol. 1 No. 5, which includes "P.A. Primer Part I" is still available. Simply write to our Subscription Department and request them (\$1.75 per issue).*

### Excited Reader

I have received several issues of your magazine throughout your first year through various local music outlets. I recently subscribed, so that I would not miss any future issues.

I am excited over your news of being published monthly, and congratulate and wish you the best of luck with this move. It looks like I'll have to renew my subscription sooner than I thought!!

Is there any possibility of your doing an interview with either the group, engineer, or producer of America? I find articles which detail style, technique, etc., in the studio, are very helpful and give me ideas to work with when I record.

Thanks for your great contribution to the world of music and recording.

—Donald R. Goldberg  
Hamden, Conn.

### It's a Long Way to Argentina

I would be very pleased to receive the following information. I am a musician in my free hours and I want to buy



# The only pickups players ask for by name.

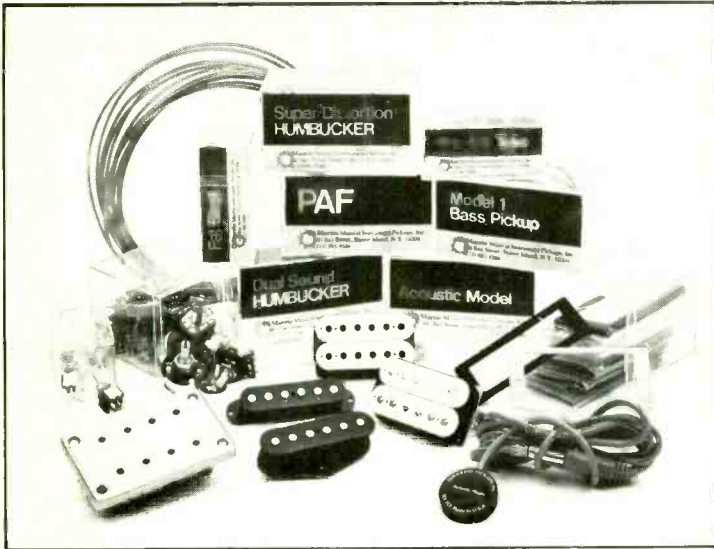

## New in '77

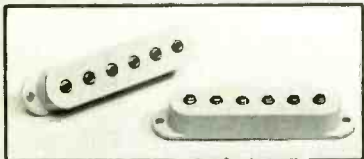

Strat Replacement Pickup

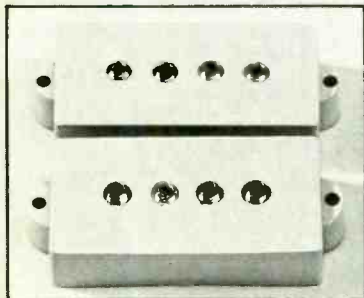

Precision Bass Replacement Pickup

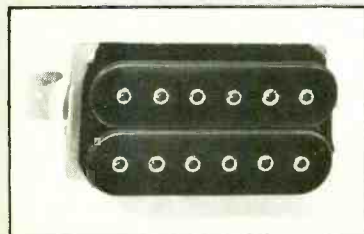

**Super II**  
The Super II is a budget priced, black body version of our Super Distortion model, with slightly less output and increased high end response. Easily adapts to any electric guitar.

How do you choose a pickup? You can't hear and compare different makes in most stores, so which do you choose?

Rick Derringer chose DiMarzio. So did Ted Nugent. And Roy Buchanan. And Kiss & Lynyrd Skynyrd. In fact, DiMarzio pickups are used by more musicians than any other pickup on the market.

These professionals have discovered DiMarzio pickups offer them the sound they want, from our Super Distortion Model (the hottest pickup on the market) to our vintage PAF to our new Acoustic Pickup.

But, the proof is in the playing, because that's when you can't afford to be fooled. We know it. You know it. That's why you should choose DiMarzio.



**DiMarzio**  
Musical Instrument Pickups, Inc.

Dept. TB, 643 Bay St., Staten Island, N.Y. 10304 (212) 981-9286  
Write for a free catalog on our full line of pickups for guitar, bass & piano.  
Available at fine music stores throughout the U.S.  
Exclusive Canadian distributor: GHI Music Sales, 5000 Buchan St., Suite 506, Montreal, Quebec H4P 1T2

# On stage, everywhere.





# Theirs:

Julian S. Martin  
HI-FI STEREO BUYERS' GUIDE, March-April, 1976

*"Superb from every viewpoint. An outstanding achievement in headphone design. One of the most comfortable."*

The Len Feldman Lab Report  
TAPE DECK QUARTERLY, Winter, 1975

*"Response of these phones extends uniformly from 20 Hz to over 22,000 Hz with no more than  $\pm 2$ dB variation over this entire range...this is nothing short of incredible."*

New Equipment Reports  
HIGH FIDELITY, January, 1976

*"The sound quality the AT-706 presents [to you] is exceptional: very wide range and smooth...Within this excellent operating range the sound is exceedingly clean and open...an extremely fine stereo headset."*

If you asked the critics they'd tell you to listen critically to a variety of products before you buy. We agree. Because the more carefully you listen, the more you'll be impressed by the sound of Audio-Technica.

## AT-706

Electret Condenser  
Stereo Headset \$129.95  
Our finest Personal Transducer



**audio-technica**<sup>®</sup>

® INNOVATION □ PRECISION □ INTEGRITY

AUDIO-TECHNICA U.S., INC., Dept. 97MR, 33 Shiawassee Avenue, Fairlawn, Ohio 44313  
Available in Canada from Superior Electronics, Inc.



some good instruments to play on and record with in my house or for my friends. While reading your magazine, I saw some interesting advertisements like the one from Ibanez guitars. I have never seen that advertised guitar here in Argentina. What information would I need to buy that guitar which I have seen in your magazine?

In Argentina, your magazine arrived very late, I have just received the Jun/Jul 1976 issue.

—Mariano Cesar  
Buenos Aires, Argentina

*We suggest that you write directly to Ibanez at 1716 Winchester Road, Cornwell Heights, Pennsylvania 19020, and inquire if they have a distributor in Argentina or are available from them by mail.*

*Your magazine will arrive late because it is being mailed by boat. If you want it to arrive promptly, it would have to be sent air mail at an additional cost of \$1.08 per issue or \$12.48 a year for postage alone.*

### Credit Due

*We neglected to note that the photos which appeared with the article, "Crosby, Stills and Nash: Recording Again," by Stan Soucher in the July, 1977, issue of Modern Recording were the work of Barry Paul Levine.*

*In that same issue, Ed Perlstein was responsible for the photos which appeared with the cover story, "A Session With Patti LaBelle," by Steve Whiting as well as the cover shot.*

*We regret these oversights and would like to take this opportunity to rectify the situation.*

—Ed.

### Blooming Engineer

I am interested in recording techniques and it would be greatly appreciated if you would be so kind as to send me information regarding course descriptions at the Recording Institute of America. Thank you very much for your time in this matter.

—Peter Jacobson  
Saugerties, New York

*We suggest that you write to the RIA directly for this information. Their mailing address is 15 Columbus Circle, New York, New York 10023. They will be happy to forward the information that you want, but are flooded with like requests, so be prepared for a bit of a wait.*





# dbx noise reduction & signal processing

## Tape noise reduction for the professional studio

216 16-channel simultaneous record/playback noise reduction system



187 4-channel switchable record/playback noise reduction system



K9-22 single-channel noise reduction card replacement for Dolby "A"



- 30dB noise reduction with 10dB more headroom
- Reduces tape hiss to inaudibility
- Preserves full dynamic range
- Cable assemblies furnished ready to plug in
- Spare two-channel 310D module included
- Available on modular basis for as few as four channels, expandable to 24 or 32 channels
- Electrically interchangeable and fully compatible with dbx 216 and other professional studio systems
- Remote control switching capability
- Direct plug in replacement for the Dolby® CAT 22 card; converts Dolby 361, M16 or M24 to dbx noise reduction
- Fully compatible with other dbx professional noise reduction systems
- Less than half the cost of a free standing noise reduction system
- Carrying case available for easy portability

## Tape noise reduction for the semi-professional studio

154 4-channel switchable record/playback noise reduction system (152 2-channel switchable system also available)



157 2-channel simultaneous record/playback noise reduction system



- Single-ended inputs and outputs terminated in RCA type phono connectors to interface with semi-professional recorders, mixers, etc.
- Small package for ease of portability
- Excellent choice for the small studio or location recordist
- 30dB noise reduction with 10dB additional headroom
- Fully compatible with dbx professional studio systems
- Inexpensive noise reduction system with professional performance
- Rack mount option available for all dbx 150 and 160 series models

## Compressor/limiters



160 single channel compressor/limiter



162 true stereo compressor/limiter

- True rms level detection
- Compression ratio variable from 1:1 to infinity
- Threshold variable from -38 to +12dBm
- Low distortion even at high compression ratios
- Wide dynamic range and low noise

For complete information on these and other dbx signal processing systems, circle reader service number or contact:

dbx, Incorporated, 296 Newton Street  
Waltham, Massachusetts 02154 • (617) 899-8090

CIRCLE 62 ON READER SERVICE CARD



# TALK BACK

*"Talkback" questions are answered by professional engineers, many of whose names you have probably seen listed on the credits of major pop albums. Their techniques are their own and might very well differ from another's. Thus, an answer in "Talkback" is certainly not necessarily the last word.*

*We welcome all questions on the subject of recording, although the large volume of questions received precludes our being able to answer them all. If you feel that we are skirting any issues, fire a letter off to the editor right away. "Talkback" is the Modern Recording reader's technical forum.*

## Graphic Equalizers Exposed

There appear to be two kinds of graphic equalizers available on the market. There are those that boost and cut, and those that just cut.

I'm curious about whether or not the "cut only" types could be used in exactly the same way as the boost/cut types by positioning all sliders halfway down before EQ-ing and then making a graph by moving them up and/or down. If the unit has a master gain facility, it seems that this method is valid. It's been my experience that when using a cut only type I occasionally need to get more from one set of frequencies (1-2 sliders) and, therefore, must move all the others farther down. It would obviously be far simpler and accurate to just move the necessary sliders up. Are there any unforeseen negative effects in using such a unit this way?

—Jay Parks  
Waterbury, Ct.

Your basic concept of the operations of the graphic equalizers is correct. In answer to your specific question about the "cut only" type being used in a similar fashion to the other type, it will work.

You mentioned in your discussion that, "if the unit has a master gain facility it seems this method is valid." Most of the "cut only" equalizers are passive-type equalizers. When all of the sliders are in the zero cut position the signal is going into the unit and out of the unit at essentially the same amplitude. Introducing a certain amount of cut with one of the sliders simply means that you are attenuating the amplitude of that frequency (or group of frequencies) with respect to the rest of the spectrum. If all of the sliders were pushed down to maximum cut, then the whole audio spectrum would be attenuated by the amount specified by the manufacturer. At that point, you have a signal going into the unit that is considerably greater in amplitude than the signal going out of the unit. In other words, at its maximum cut position, the unit has an insertion loss basically equal to the attenuation capabilities of the unit.

You may use such a passive-type unit in the fashion that you describe, that is, putting sliders halfway down, with the understanding that you are attenuating the spectrum by that amount in your initial setting. By increasing the setting from the center point with each of the sliders you are not actually boosting, but merely attenuating that portion of the spectrum less. In this passive-type device, it is easy to degrade the signal-to-noise ratio of your audio chain if you are not careful to observe the gain structure of the system in which it is being used. To briefly clarify gain structure, I shall use the analogy of a turntable with a very low magnetic pickup. In order for it to be usable, we must amplify it quite a bit before it has the ability to drive earphones or loudspeakers. In the first stage of amplification, the signal, called a preamplifier signal, is brought up to a more usable level. Following additional amplification in the main amplifier, the signal strength is

increased to the point where it will perform the functions of driving loudspeakers or headphones. By design, in any given system there is an optimum step-by-step increase of gain to provide the best signal.

Since the amplifier is not selective, it also amplifies noise, present at its input, in a similar fashion to the signal. If, with a given cartridge, preamplifier, and amplifier combination, I had a certain signal-to-noise ratio and I introduced attenuation between the magnetic pickup and the input to the preamplifier, I would then find it necessary to increase the overall amplification to bring my signal level up to what it was before the addition of the attenuation. When I do, it will increase the noise along with that weaker signal and therefore degrade my signal-to-noise ratio.

Applying this to the use of the passive-type equalizer you are describing, you must be careful that the attenuation introduced at a chosen point on the signal path will not appreciably affect your signal-to-noise ratio. Since there are so many graphics built by so many different manufacturers, it is hard to specify exact usage of your particular unit. However, it is preferable to obtain a unit which has no insertion loss; in other words, a device with built-in amplification to overcome the insertion loss of equalization circuitry. However, using a passive equalizer in the fashion described should not have any adverse effect on any other aspects of the signal quality.

—Skip Frazee  
Manager  
Sound Techniques  
Dallas, Tx.

## Helpful Information

In your May, 1977, issue, Norman Eisenberg and Len Feldman tested the Tandberg TCD-330 cassette recorder in



their Lab Report (pages 54-57). In the General Description, they note that the TCD-330 is equipped with a mechanical override eject button at the rear of the unit to eject a cassette in case it is left in as the power is being turned off. Why is there a need to eject the cassette before turning off the power? I've never before heard of this being harmful to the tape. Is it?

—Pete Giannosa  
Detroit, Mi.

It is not necessary to eject a cassette from a cassette deck prior to turning the power off. However, it is suggested that your deck be put in the "stop" mode prior to shutting the power off to insure that all cassette drive parts are disengaged. Many cassette decks depend on mechanical shutoffs to disengage the pinch roller or rollers from capstans and, if left engaged without movement for long periods of time, flat spots may form resulting in an increase in flutter. The same is true of the rubber drive wheels (idlers) inside many cassette decks.

On the Tandberg TCD-330 all functions are full logic (electronically controlled) so turning the power off automatically disengages all drive parts. The mechanical eject button on the rear of the machine is a convenience to allow you to remove a cassette from the machine without turning the power on.

—Robert S. Blumberg  
East Coast Regional Sales Manager  
Tandberg of America, Inc.  
Armonk, N.Y.

### Oh, Those Blinking Lights!

I have a Sansui 551 receiver whose lights begin to pulsate and blink when the volume control is turned to "4" or higher. I replaced the power amplifier in it just last October. The system I'm using it in consists of Bose 301 speakers and a BIC 940 turntable in which I have an Empire 2001E3 cartridge. Could you tell me what might be causing this malfunction or how it can be stopped?

—Joe Donohue  
West Hempstead, N.Y.

*After sending your question to Sansui, we were advised that they felt the best way to handle this question was to ask you to send your receiver (along with a detailed description of the problem) via United Parcel Service prepaid, together with proof of purchase, to their offices at 55-11 Queens Blvd., Woodside, New York 11377. Mark it to the attention of*



# Number One EQ

**\$65<sup>00</sup>/ch.**

**IN STOCK RIGHT NOW  
FOR FAST DELIVERY**

We're not sure just how many ten band octave equalizers we have to sell to become the World's No. 1 supplier but the more you know about our graphic (and all the others) the better our chances become.

We've delivered over 2,000 of these EQ kits since the Editors of Popular Electronics selected it for the cover story in their September '76 "Special Focus on Audio" issue. This broad range of customers

provided an ideal "proving ground" for ease of assembly, reliability and customer satisfaction in general.

Musicians, recording studios, system installers, radio and TV broadcasters, equipment manufacturers, research labs and hundreds of private citizens ranging from eighth-graders to aerospace electronics designers have ordered, received and built the EQ-10 kits. Our record speaks for itself.

Only two kits have been returned for factory troubleshooting and not one customer has ever requested a refund after seeing the kits...out of over 2,000 kits delivered!

If you need graphic equalizers for any system where performance, reliability, hum-immunity and versatility cannot be compromised regardless of cost or, if you're "bargain-hunting" but refuse to accept downgraded quality in your audio system then we're your equalizer supplier.

Example: Our basic per-channel kit cost is only \$65.00 and we sell direct to you by mail. We guarantee every part in every kit to be 100% functional and up to specs. We give you 90 days to exchange below-spec or defective parts free. We pre-test every active device in every EQ kit before it ever gets packed. We offer system packages for mono, stereo, quad and eight-channel applications with or without power supply kits and cabinetry and with system and quantity discounts available.

Every kit comes with our 32 page Assembly, Installation & Applications Guide and all necessary parts. The slide controls are precision metal-shielded types with metal levers, hydraulic damping and long-throw center-detented action. Noise and distortion figures are guaranteed (at all EQ settings) to levels that make some so-called "pro" gear look bad by comparison. Each individual-channel module is housed in a solid metal die-cast enclosure suitable for direct 19" rack or custom mounting. Both balanced and unbalanced I/O facilities are provided. We mean it...real quality and real value! This unit was designed by a professional for use by professionals.

For complete details, specs, ordering directions and a personalized order blank just send your name and address to us on a postcard. We'll respond FAST! Guaranteed!

**Delta-Graph** (206) 525-7196  
**Box 247 Northgate** Seattle WA 98125

I would like more information on the DELTA--GRAPH EQ-10.

Please Rush to:

Name \_\_\_\_\_

Address \_\_\_\_\_

City \_\_\_\_\_ State \_\_\_\_\_

MR7709 Zip \_\_\_\_\_



Mr. S. Fujii, Service Administrator, who will see that Sansui's technical people get right on the problem. —Ed

### Figuring Speaker Impedance

I'm building my own speakers and have come upon a stumbling block—what is the proper way to figure the impedance? I have three 8-ohm speakers with an 8-ohm crossover plus another 8-ohm tweeter with capacitor. When measured on the ohmmeter, the impedance equals 5 ohms. I've been told that 8-ohm speakers should be rated no higher than 4 ohms. However, I like the sound of the bass better at an 8- or 16-ohm rating.

Is 4 really the necessary rating or is an 8- or 16-ohm impedance allowable?  
—Daniel Blanchard  
Wheeling, W. Va.

You seem to be confusing two terms: impedance and resistance. The impedance of a loudspeaker consists of resistive and reactive components, which cannot be added in a simple manner since the inductive reactance is 90 degrees out of phase with the resistive component of the impedance. Your ohmmeter reading of 5 ohms for the

combination of drivers you have assembled is typical of an 8-ohm system. As for how to "rate" the impedance of your home-built speaker system, we don't see that this really makes much difference. If you are using it with a

will be transferred from amplifier to speaker system.

You should also be aware that the nominal impedance of a loudspeaker system is just that—nominal. Impedance of loudspeakers varies with frequency.

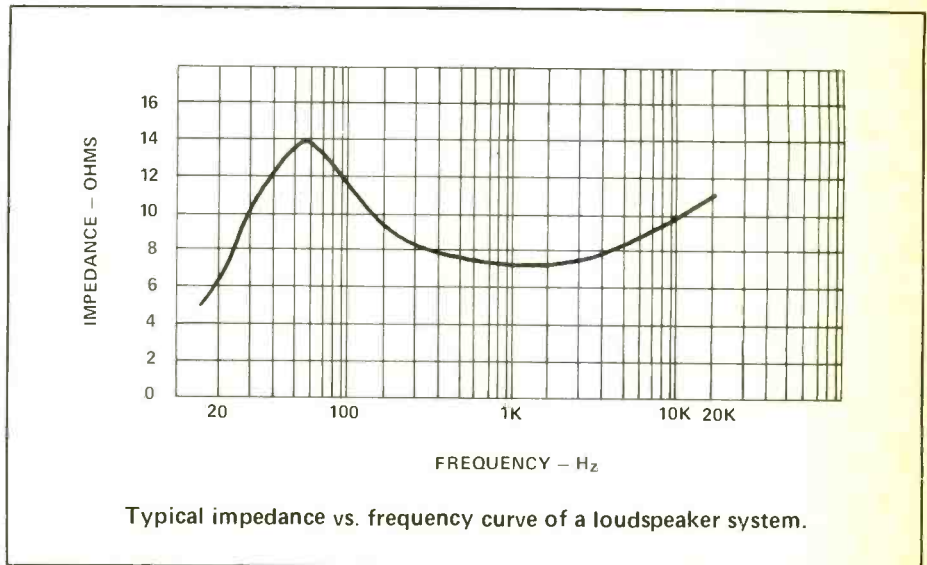

solid state amplifier, that amplifier can handle nominal impedances of 4, 8 or 16 ohms with equal ease. The only difference will be in the total power which

Thus, using proper instrumentation (not just an ohmmeter) you may find that your system measures 8 ohms at 400 Hz, or thereabouts, while at the low frequency resonance of the system, the impedance may well rise to twice that number or more and at some other frequency, the net impedance may dip to below 8 ohms. The only thing to be sure of is that the impedance remains above the 4-ohm point throughout the audio range so that your power amplifier, when driven to near its rated power output, does not draw too much output current and endanger the life of the output transistors. Most better solid-state amplifiers are equipped with protection circuits which would disconnect signals from the output if that occurred.

—Len Feldman  
Audio Editorial Board  
*Modern Recording*

### More on Cleaning Heads

[The following is yet another response to the Talkback query, "Cleaner Heads," which appeared in the August issue of *Modern Recording*.]

I have found 99% anhydrous (water free) isopropyl alcohol, which contains no "perfume" or other additives, to be most satisfactory. This solvent should be available at local drug stores although you will have to ask for it. It is used to clean oxide and edit pencil deposits from tape heads and all elements of the

## OCTAVE BAND ANALYZER

### THE NEW MODEL 150

#### FEATURES

Simultaneous display • TEN one octave bands—31.5 Hz to 16 kHz  
• Light Emitting Diode readout • Meets ANSI 1.11, Class II for Octave Band Filter Sets • Fully calibrated in dBspl • Broadband dBspl • Line Input—calibrated in dBm • Flat or A-weighted measurements • Hand held—battery operated (rechargeable nickel-cadmium cells) • Precision microphone, carrying case, noise generator, battery charger included

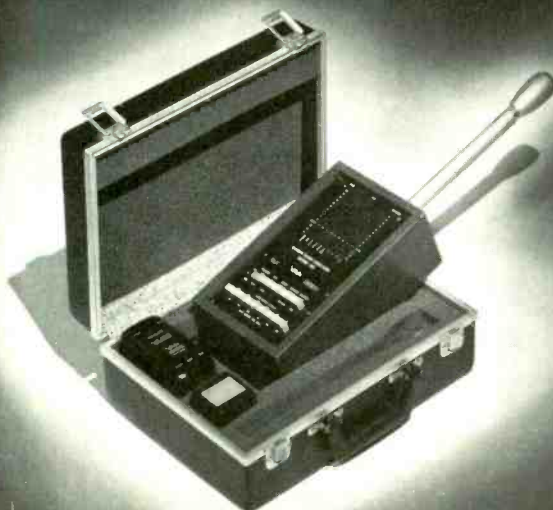

#### APPLICATIONS

- Sound system set-up
- Noise surveys
- Octave equalizer adjustment
- Speaker checkout
- Horn alignment
- Room surveys and speaker placement

ALSO: Active and passive equalizers • Other real time analyzers  
Dealer inquiries invited

*White*

Call or write today: WHITE INSTRUMENTS, INC.  
P.O. BOX 698 512/892-0752 Austin, Texas 78767



tape path, i.e. tape guides, tape lifters, capstan and pinch roller.

Cleaning is accomplished by rubbing tape path elements with alcohol-saturated cotton-tipped swabs, repeated until no oxide or other foreign matter appears on the swab, followed by dry swabs to remove excess solvent. It is not recommended to attempt to clean the pressure pads which are found on some consumer equipment. These pads should be replaced before they become loaded with oxide.

—Don Cuminale  
Technician

Mediasound Recording Studios  
New York, New York

### A Realistic Problem

I have a Realistic 999-B 3-head tape deck which performs relatively well for me in every way but one. When it is in the "play" mode, the motor becomes extremely noisy. This does not happen when it is in rewind or fast forward. Do you have any idea why this occurs and how I can make it stop? I'm using it with Bose 301 speakers—could they have any bearing on this problem?

—Joseph Stephens  
West Hempstead, New York

*We sent this question on to Realistic but the people there felt that without actually seeing your machine they couldn't accurately diagnose the problem. They did tell us, however, that there is no inherent weakness or problem with the motor of this model. Your problem is most probably an internal one and is not affected by your system. They advise you to take it to the Realistic dealer nearest you for a thorough going over.*

—Ed.

### Splitting Mic Signals

In reading all of the articles on "live" P.A. set-ups of actual groups, I notice that they all use a separate mixing board and monitor board.

As soundman for a rock band, I am currently using a mixing board with built-in monitor sends. However, I cannot hear what the monitors sound like on stage so I would like to switch to using a separate monitor board approach.

Unfortunately, your articles have never explained how the mic signals are split to go to the two separate boards. Is there a device that splits those signals to go to each board or does the signal go to one board and then the other? Both methods seem very impractical. Split-

# Beyer lets you Beat the drum

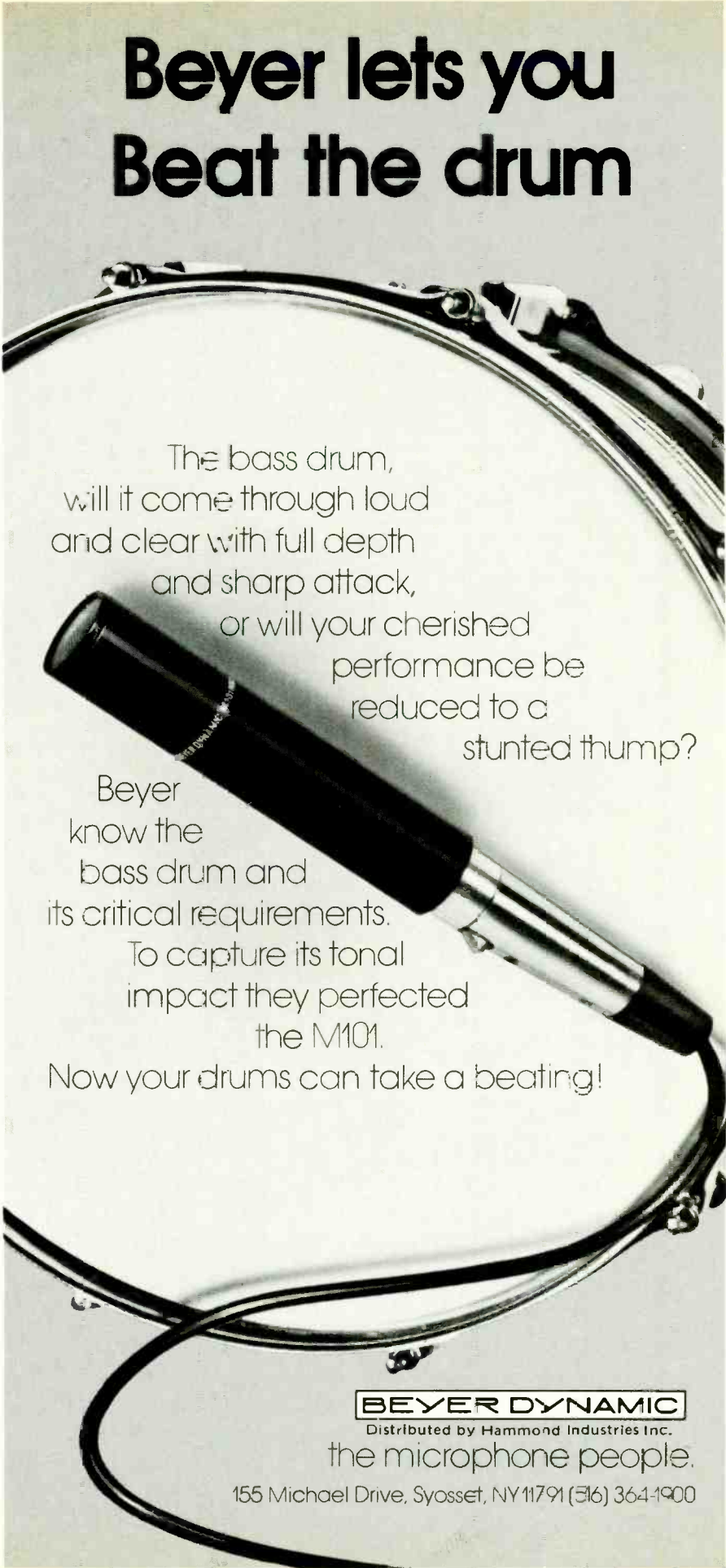

The bass drum,  
will it come through loud  
and clear with full depth  
and sharp attack,  
or will your cherished  
performance be  
reduced to a  
stunted thump?

Beyer  
know the  
bass drum and  
its critical requirements.

To capture its tonal  
impact they perfected  
the M101.

Now your drums can take a beating!

**BEYER DYNAMIC**

Distributed by Hammond Industries Inc.

the microphone people.

155 Michael Drive, Syosset, NY 11791 (516) 364-1900

ting mic signals seems like it would upset the impedance and levels of the entire system.

Going from one board to the other would require special pre-fader balanced line outputs on each channel since the boards are quite far apart. Please explain the method or methods used to accomplish this.

—Steve Mandel  
Elmont, N.Y.

The signal is usually split at the mic connector box on stage, with separate lines running to the monitor board and the

main board. If expense is of little concern, the most fool-proof method of splitting is to use transformers with multiple secondaries, connecting the mic to the primary, one secondary to the main board, one to the monitor mixer, and if required, additional secondaries may be used to provide isolated feeds for recording, "live" radio or TV, etc. Transformers for this application are made by Sescam and other manufacturers of high quality mic transformers. Primaries and secondaries should all be in the microphone range (150-300 ohms) and of course, the transformers must be able

to handle the highest input level anticipated without going into distortion.

You will find that transformers of this type will probably fall in the \$20 to \$30 range. If this seems a bit steep (like if your monitor mixer didn't even cost that much per input) you can be brave and simply connect the inputs of the two mixers in parallel. This is not really as drastic as it sounds. Most mic inputs, although rated for use with input impedances of 150-250 ohms, are actually of a much higher value (usually around 1000 ohms or more). Thus, two such inputs in parallel would still only represent 500 ohms and would not bother the mic. Assuming that both mixers use transformer inputs, isolation should still be maintained by such a splitting system, although you may have to fiddle with your grounding points a bit to remove any resultant buzzes or hums. It might also be helpful to put both mixers on the same power line. One conceivable problem that might result from such a system is that if either mixer uses resistive input padding before the first amplification stage, there might be some interaction between the two mixers if the pads of either do not represent a constant impedance over their range of settings. I think this problem would be barely noticeable (if it even existed at all).

Looking at the two solutions and their relative costs, I think I would try the direct paralleling first (assuming you are only looking for a two-way split; beyond that, transformers would be indicated). You can always buy the transformers later if it doesn't work out, which would be easier than trying to unload them when you find out that they really weren't necessary in the first place.

—Bruce Howze

President

Community Light & Sound, Inc.  
Philadelphia, Pa.

### Different Driver Usages

How does a compression driver differ from regular drivers? Where would you use a compression driver? (Indoors, outdoors, small or large rooms?)

—C. Goutas

San Francisco, Ca.

Regular drivers are what most people call cone speakers. Compression drivers are usually called plain "drivers." The most typical application for a compression driver would be coupled to a horn for reproduction of high frequencies. All kinds of combinations of both types

# professional series

Have you been impressed (in the past) with a so called "pro series" of equipment only to find that once the tinsel and glitter has worn off, all that's left is a toy? If so, HEIL SOUND could be the answer to your audio dilemma. Since 1970 we've been producing rugged and reliable touring gear for such discrete professionals as The Who, Peter Frampton, Joe Walsh, BTO, and a host of other major concert artists. HEIL knows what it takes to do a quality job on stage and has just created a line of equipment that rivals any in the industry at a price that will please even the most modest budget. The "Professional Series" of amplifiers uses the same "Mod-U-Pac" plug in module as our renowned Omega line thus allowing you—the musician—to carry a spare side of your amp for instant repairs on the gig.

## PRO-MIX



Our new and exciting 8 channel mixer is a low impedance cannon type with unbalanced inputs. Bass and treble controls are  $\pm 20$ dB for superior EQ. The effects are preEQ and levels from the main or effects outputs are monitored by a high quality 4" lighted VU meter.

**\$299<sup>00</sup>**

## PRO-GRA



This dual channel graphic equalizer has 10 bands and is now available at a very favorable price, in fact we assure you that there's no better value on the market today. It's black anodized with a standard rack mount panel and comes equipped with level controls for each channel and defeat switch.

**\$199<sup>00</sup>**

## PRO-XO



Featured here is a two way electronic crossover model with 800 Hz, 12dB pre-octave and separate level controls for high and low outputs. Also contained in this unit is a 19" x 1 1/4" black anodized, standard rack panel.

**\$135<sup>00</sup>**

## PRO-100



Included in this package is a dual channel 85 watt (per channel) unit at .1% dist. and 4 ohms per channel using our Omega 100 series plug in modules. Balanced line inputs, binding post outputs and a black anodized 19" x 3 1/4" standard rack mount panel are also standard.

**\$299<sup>00</sup>**

## PRO-200



Presented here is a dual channel power amp with 150 at .1% and 4 ohms per channel using our 200 series plug in modules. Balanced line inputs, binding post outputs and a black anodized 19" x 5 1/4" standard rack mount panel round out this package.

**\$429<sup>00</sup>**

## PRO-400



Our top of the line model is loaded with 250 watts RMS at .1% distortion into 4 ohms per channel using our popular 400 series plug in. Balanced line inputs, binding post outputs and 19" x 7" standard rack panel complete this winner.

**\$589<sup>00</sup>**



ALL PRICES ARE  
SUGGESTED RETAIL.

**Heil Sound Company**  
No. 2 Heil Industrial Drive  
Marrissa, Illinois 62257  
Phone 1-618-295-3000





of drivers constitute most sound reinforcement and studio monitor systems around today.

Compression drivers are named so, because they work into a "higher compression" than regular drivers. They produce sound pressure level (SPL) by creating a large compression on a small volume of air (between a driver's diaphragm and its phase plug). Regular drivers accomplish much the same thing by creating a small amount of compression upon much larger quantities of air.

I personally feel that the main thing compression drivers have going for them is that they are always used in conjunction with horns. This combination is unbeatable for overall efficiency and control of sound dispersion. Compression drivers (as well as horn loaded speakers) are almost always used for creating high SPL in large rooms. In small rooms, with lower requirements for SPL, there are a lot of other transducers (such as electrostatics) which will hold up better to the scrutinizing ear. In all types of rooms and situations, cone speakers are what you will more than likely be hearing for bass and low mids.

—Richard Krueger  
Gallien-Krueger  
Campbell, Ca.

### Shure's Side of the Story

[The following is another response to Paul Tenhula's question, "Capacitance Requirements," which appeared in the August, 1977, Talkback section on page 13.]

Many audio manufacturers do not realize the need to include certain specifications critical to the match of the phono cartridge to the preamplifier circuit. These specifications are important and are necessary for the flattest possible frequency response of any stereo system. The specifications which are essential for this critical match-up are the phono preamplifier input termination, which is made up of the input resistance and the input capacitance, the capacitance of the tone arm wiring, and the capacitance of the cables to the preamp. These values should agree with the termination recommended for the phono cartridge.

In answering your questions, the input resistance of the Dynaco PAT-4 preamplifier is 47,000 ohms. This figure just happens to match the optimum load resistance of the Shure M91ED Cartridge, which is specified at 47,000 ohms resistance in parallel with 400-500 Pf total capacitance per channel. How-

## Mix Down Like a Pro for \$20

The KIK Mixdown Box lets you Ping Pong channels easily. Transfer tracks to give your 4 Channel tape recorder a 7 Channel capacity. No channel will be more than one generation away from the original. The KIK Mixdown Box is available in 3 versions, a 10,000 Ohm model, or a 100,000 Ohm unit, or the Dual Impedance model for 10,000, and 100,000 Ohm operation. Die-cast unit construction. 4 in, and 1 out. The Mixdown Box has no active devices to generate hiss, or distortion.

The KIK Mixdown Box Warranty is for a full year against a failure of any kind, under normal usage.

To order, state which model you want;

Model 10K ..... @ \$20 each  
Model 100K ..... @ \$20 each  
Dual Impedance Model ..... @ \$35 each

Send cash, check, or money order plus \$1 handling, (CA residents, add 6% state tax) to;

**KIK** 6620 Whitsett Ave., North Hollywood, CA. 91606

Please PRINT clearly to insure prompt shipment and allow 2-4 weeks for delivery.

CIRCLE 58 ON READER SERVICE CARD

**AUDIOARTS ENGINEERING**  
286 DOWNS ROAD, BETHANY, CT. 06525

**EQUIPMENT DESIGNED TO LAST**

PARAMETRIC EQUALIZERS, TUNABLE ELECTRONIC CROSSOVERS, FEEDBACK SUPPRESSORS, AND MIXING SYSTEMS

IN STOCK AT:

Audio and Organ Services  
2780 Erie Boulevard East  
Syracuse, N.Y. 13224

Ludwig Sound and Stage  
164 Washington Avenue  
North Haven, Ct. 06473

CIRCLE 29 ON READER SERVICE CARD





At those rare and magic times, when the heavens are in proper alignment, a wonderful old Wizard visits this planet from the Land of Ohm. With him he brings marvelous extraterrestrial electronic devices to delight musicians everywhere.



Spoke the Wizard, "Call this the Ibanez Phase Tone, a mini-phaser so compact and durable it will astound you. For those who wish to have more control over their sound, here is the Ibanez Phase II, with a depth control for phase effects from a subtle hint to a bold sweep."

For musicians who want sustain with no distortion, I give you the Ibanez Compressor. It will help you to stand out and be heard, without having to shake the heavens with volume. And for those who want a bit of grit with their sustain, here is the Ibanez Overdrive, a hard-driving sustain and distortion device."



With a snap of his fingers the Wizard produced the Ibanez Renometer. "Captured in this compact package is a veritable rainbow of tone color, with 5 bands of equalization and a preamp/ tone booster - perfect for any instrument or vocal system."

Then reaching deep into his bag, the Wizard said, "Now this is a most interesting effect - the Ibanez Stereo Box. It will give you an automatic variable speed pan between two amplifiers or two channels of the same amp."

"But here is the device of which I am most proud", said the Wizard with a grin. "The Ibanez Flying Pan, a combination automatic panning device and state of the art phase shifter which can make the sound of your instrument literally fly around the room."

And then, with a dramatic wave of his arms, the Wizard of Ohm disappeared into a cloud of smoke and a crackle of lightning - but promising to return soon with more electronic marvels for musicians.

# Ibanez

ever, the load resistance can be up to 70,000 ohms with almost no audible change in frequency response. It should be noted that total capacitance (400-500 Pf per channel is required for the M91ED) will include tone arm wiring, cable capacitance, and the preamplifier input circuit. In the case of Shure cartridges and other magnetic phono cartridges, if the total capacitance per channel is less than the recommended value, the result will be a gradual slope down from 5 kHz to 11 kHz, and will rise slightly in response above 12 kHz. If the total capacitance is greater than the required capacitance of the phono cartridge, the response will rise in the region from 5 kHz to 11 kHz, with a slight roll-off above 12 kHz. These changes in frequency response are dependent upon the changes in capacitance, and will only be audible if the capacitance mismatch is significant (such as 200 Pf above or below the suggested capacitance value). It should be noted that varying capacitance values and their effect on response will be audible to some individuals and not to others, as well as being desirable to some and not to others, depending on the listener's preference.

What is needed with your equipment for a match in capacitance values is 270 Pf per channel. This will result in a total of 400 Pf per channel and will produce the flattest response for your system.

—Gary Rogers  
Sales Engineering  
Shure Brothers, Inc.  
Evanston, Ill.

## Sound Modifiers

My question concerns outboard sound modifiers. In what order, and why, in an electric guitar system (from guitar to amp) would you connect a wah-wah pedal, fuzz, phase shifter, graphic equalizer and a linear booster or preamp?

—Charlie Moretti  
Olyphant, Pa.

When connecting sound modification devices in series, order is determined by the desired effect and operational characteristics of each device. I suggest connecting the instrument's output into an equalizer first if you wish to emphasize its tonal characteristics or modify them to emulate other instruments. Next in the chain would be the distortion (fuzz) device which adds variable amounts of distortion and sustain. By placing a wah-wah pedal next, the distortion products and upper harmonics can be selectively



emphasized. A phase shifter or flanger would be next, creating a comb filter response. Last in the chain would be a linear booster or preamp, primarily used to overdrive the inputs of the amplifier, creating amplifier induced distortion.

The above devices are needed at other points in the chain occasionally. A pre-amp could be placed directly after the instrument where low output levels are encountered, permitting optimization of dynamic range and reducing the chances of hum and noise pickup through the cables. An equalizer, if placed directly before the amplifier, can compensate for response aberrations of the amp and speakers.

Reverberation, echo and other delay devices would normally be placed near the amplifier end of the chain. An envelope filter can be placed before or after a distortion device depending on the desired effect. A limiter or compressor, if placed directly after the instrument, helps to reduce the possibility of overdriving succeeding stages and adds sustain.

Noise problems creep into any sound modification system and are magnified by high gain devices such as compressors, distortion units and linear boosters. A noise gate, if placed at the amplifier's input, can be set to gate off this residual noise while allowing any signal above a certain threshold to pass through unaltered. A number of currently available noise gates also offer direct tap facilities.

It is important to note that the desired effect dictates order in many applications. For example, a wah-wah, envelope filter or phase shifter would typically be placed after a distortion device. However, if the order were reversed, then the frequencies at which distortion occurs could be controlled.

—Richard Neatrout

Chief Engineer

MXR Innovations Inc.

Rochester, New York

### Taped Confusion

How much does different kinds of tape really affect the record and playback response on any type of tape machine?

—Thomas Heiple

Lyndhurst, N.J.

If different tapes are run on one tape machine, with no change made to the tape machine to optimize it for those tapes, then the results will merely be confusing. The greater the differences in

basic magnetic properties from those to which the machine is set, then the greater the confusion. Tapes cannot, and should not, be compared on this basis.

Consumer tape machines attempt to remedy this problem with switched equalization and biasing. Tape manufacturers, with increasing standardization of the biasing settings, are forced into trying to make tapes which "fit" the standards.

On professional tape machines, with reproduce equalization, set correctly to the prevailing standards, reproducing tapes which are recorded correctly to

those standards, will show differences in noise, signal fluxivity at a specific distortion, etc.

It is under these conditions that valid comparisons can be made. However, the required adjustments in the recording chain, to make a recording which conforms to a standard, and which also optimizes the characteristics of that piece of tape, may be most revealing as to the important parameters of the tape.

—Alastair M. Heaslett

Staff Engineer

Ampex Corp.

Redwood City, Ca.

# Soundcraftsmen

## THE NEW OCTAVE EQUALIZER THAT INTERFACES WITH ANYTHING —

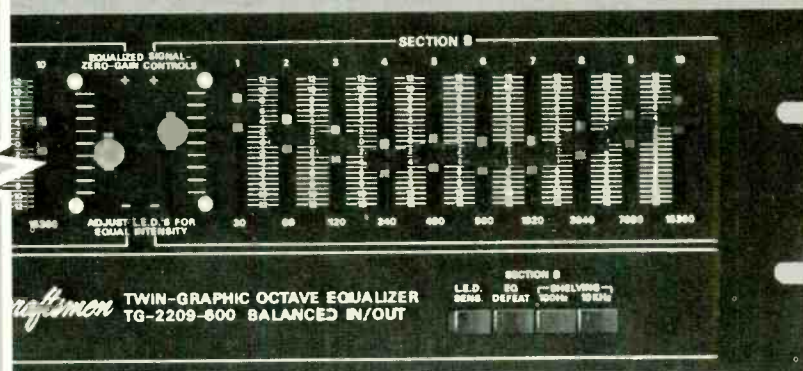

### SPECIAL DESIGN FEATURES

- SWITCHABLE HI or LO IMPEDANCE
- SWITCHABLE BALANCED or UNBALANCED INPUTS
- SWITCHABLE BALANCED or UNBALANCED OUTPUTS
- TWO SEPARATE MONO SECTIONS, IDENTICAL CONTROLS
- L.E.D.'S FOR VISUAL INPUT/OUTPUT BALANCING
- SWITCHABLE HI and/or LO SHELIVING
- SEPARATE ZERO-GAIN SPECTRUM CONTROLS
- GOLD-PLATED CONTACTS ON ALL SWITCHES

### TECHNICAL SPECIFICATIONS

**ZERO-GAIN:** Unity  $\pm 0.5$  dB, controllable 20-20,480 Hz  $+6$  dB,  $-12$  dB.

**FREQUENCY RESPONSE:**  $\pm 0.5$  dB 20 Hz to 20,480 Hz at zero setting.

**DISTORTION:** Less than 0.05% THD @ 2 volts.

**RATED OUTPUT (600-OHM BALANCED):**  $+20$  dBm into 600 ohms.

**OUTPUT CIRCUIT:** FET Op-Amps (Balanced or Unbalanced).

**MAXIMUM INPUT LEVEL:**  $+20$  dBm.

**EQUIVALENT INPUT NOISE:** Below 90 dBm with E.Q. switched in. Below 110 dB at max. output.

**EQUALIZATION FREQUENCIES:** Each octave centered at 30, 60, 120, 240, 480, 960, 1920, 3840, 7680 and 15,360 Hz.

**BOOST/CUT RANGE:**  $\pm 12$  dB at center frequencies.

**FILTER TYPE:** Toroidal and Ferrite-core.

**POWER REQUIREMENTS:** 120  $\pm 15\%$  VAC 50/60 Hz less than 10 Watts or 240  $\pm 15\%$  VAC 50/60 Hz less than 10 Watts.

**FULL-SPECTRUM LEVEL:** Front panel 18 dB, variable master level controls.

**OCTAVE-EQUALIZATION:** 10 Vertical controls each channel,  $\pm 12$  dB per octave.

**E.Q. IN-OUT:** Front panel pushbutton switch for each channel.

**TERMINATIONS:** 3-pin XLR's for inputs and outputs.

**WEIGHT:** 18 pounds.

**SHIPPING WEIGHT:** 23 pounds.

**FINISH:** Front panel horizontally brushed, black anodized aluminum. Chassis cadmium plated steel, with black textured finish.

**QUESTIONS? CALL ANTHONY, (714) 556-6191 COLLECT!**

Soundcraftsmen • 1721 Newport Circle, Santa Ana, California 92705 FOR MORE DETAILED INFORMATION, CIRCLE READER CARD

## Eliminating Amplifier Noise

Is there something I can put between the output transformer and the speaker terminals to eliminate or cancel noise or interference generated within the amplifier? I am trying an isolation transformer at the A.C. line and a noise gate line driver at the output of the guitar;

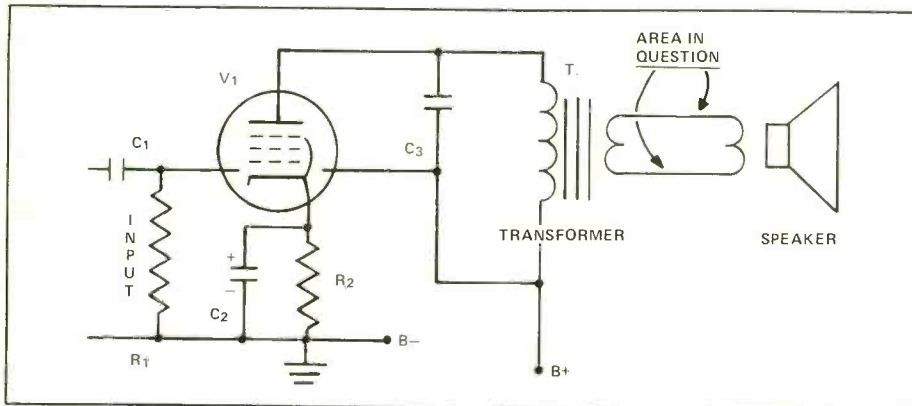

these are line transformers designed to eliminate or cancel interference at the A.C. line and at the output of the guitar for noisy pick ups, ground-looping, or A.C. line hum. I want to know if there's something to place here (see drawing) to cancel or eliminate noise coming

from within the amplifier if the noise is not caused by the plate capacitor or other various noises generated within the amplifier.

—Stephen Snell Brown  
Ashtabula, Oh.

Unfortunately, no. Any device that would be installed between the ampli-

er and the loudspeaker cannot usually eliminate noise. The best way to eliminate the noise problem is at its source. The next best way is to stop the noise from entering the amplifying system.

Some typical noise sources are fluorescent lights, universal motors (motors

without brushes), and light dimmers.

Keep in mind that noise comes in two forms, conducted and radiated. Conducted noise is noise that travels on wires (A.C. power lines) and can be eliminated by installing an A.C. line filter. Radiated noise is noise that travels in the air (like radio waves). This type of noise will change levels as you move around the room. The most common culprit is poorly shielded guitar cords. "Cheap" cords usually have very poor shielding properties. Also, poorly shielded guitar pickups or controls that are not grounded can cause this problem. To cancel A.C. hum, you should try the above steps and/or purchase a good set of hum bucking pickups for your guitar.

I would not, however, suspect the plate capacitor of generating noise. Any noise generated within the amplifier circuitry would usually be cancelled out by the amplifier's feed-back loop, unless you have a defective component.

Please note that if you don't have any noise unless the guitar is plugged into the amplifier, your amp is okay.

—Duke Aquiar  
Chief Engineer  
Acoustic Control Corp.  
Van Nuys, Ca.

# SOUND ADVICE.

Gallien-Krueger advises you to check out the 1000-1S before you buy any power amp.

Compare the 1000-1S *guaranteed specs.*

Compare the 1000-1S *rugged construction.*

(The Gallien-Krueger 1000-1S is the only professional quality amp that is rugged enough to be truly portable.

We do our own fabrication, build our own transformers, and print our own circuit boards. So we know.)

Compare the 1000-1S *sound.* Then decide.

Sound advice. Take it from us at your Gallien-Krueger sound dealer.

Gallien-Krueger, 504 B Vandell Way, Campbell, CA 95008

**GK GALLIEN-KRUEGER**

You'll hear from us.



# 1974



**We still make them like we used to!**  
**We also still price them like we used to!**

Two interesting events just happened that will change everything you thought about the price of tape recorders. Most other machines will cost more. As new 15% tariffs push their price higher, those flashy inexpensive tape recorders will become just plain flashy tape recorders.

Revox machines will cost less. As we switch to direct US distribution, we are able to reduce prices to our 1974 level. Which will save you money on every product in our Revox line.

Times are rapidly changing. So you have to really keep your eyes open as well as your ears. When less costs more, and more costs less, here is the one name to remember.

*Revox. You can't buy better at any price. Especially now that our price is less.*

For more information about Revox contact: **STUDER REVOX**

Studer Revox America, Inc., 1819 Broadway, Nashville, Tenn. 37203 / (615) 329-9576 • In Canada: Studer Revox Canada, Ltd. / (416) 423-2831  
CIRCLE 52 ON READER SERVICE CARD

## More On Impedance Differences

(The following is another answer to the question, "Impedance Differences," which appeared on page 13 in the Talk-back section of the June, 1977, issue of Modern Recording. —Ed.)

In the course of his answer, there are some misleading comments made by Larry Blakely on impedances. He makes

appropriate to "G," the output of the source, being a constant voltage, before any losses in its own internal impedance.

Now, if the generator, or output stage, is a true constant voltage source, the voltage across "G" will not change, regardless of the current drawn. That basic property is characteristic of much professional gear, particularly when the unit is to feed a 600-ohm (or other) line. In that case,  $Z_{INT}$  or source impe-

to half that of open circuit, or by 6 dB.

If, however, the generator/output has limited power, or current, delivery capability,  $E_{OUT}$  will not remain a constant as  $Z_{LOAD}$  is made lower and lower. When a load is applied equal to the internal impedance in such cases, the output may fall drastically (over 20 dB) and distortion rise sharply (over 100:1 in some cases).

The correct general rule, then, is to use loads as recommended by the manufacturer. If the manufacturer does not specifically state that his unit will drive a load impedance equal to the source impedance, assume that you should use a load impedance of at least ten times the source impedance for minimum loading and distortion. If this restriction cannot be met, try to restrict the loading to that causing a maximum 2 dB drop at the output terminals. Loading greater than that might be acceptable from a level standpoint, but the effects on distortion should be checked carefully.

—Howard A. Roberson, P.E.

Sound Measurements,  
Audio and Acoustical Evaluation  
Pittsfield, Ma.

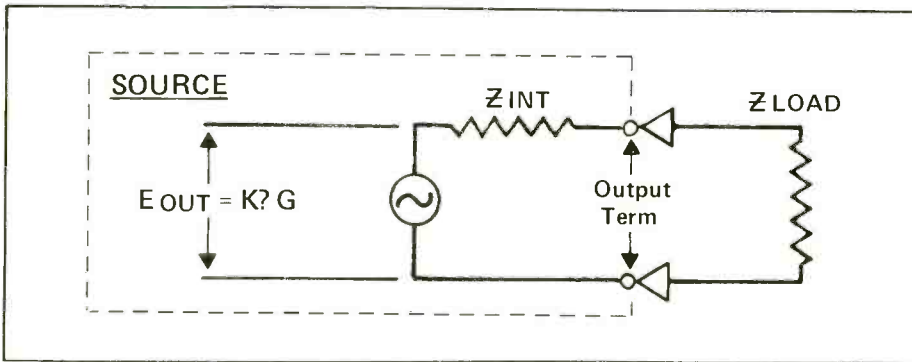

what is a most common error, but it calls for correction, nonetheless. To aid in the discussion of what really happens, I have drawn an equivalent circuit for the output of some devices.

The circuit is drawn in the form appro-

dance is 600 ohms, and with a 600-ohm load, the voltage out is voltage divided equally between the internal impedance and the load impedance. The result, commonly observed, is that the voltage at the output terminals of the unit drop

# ASHLY P.A. PROBLEM SOLVERS

## THE PROBLEMS:

*Miserable acoustics, feedback, bland drum sound, hand held vocals, distortion. . . Sometimes it seems you can't win. You don't create these problems, but it's your job to solve them.*

## SOLUTIONS:

Model SC-50

**\$299** suggested list price



Model SC-66

**\$599** suggested list price

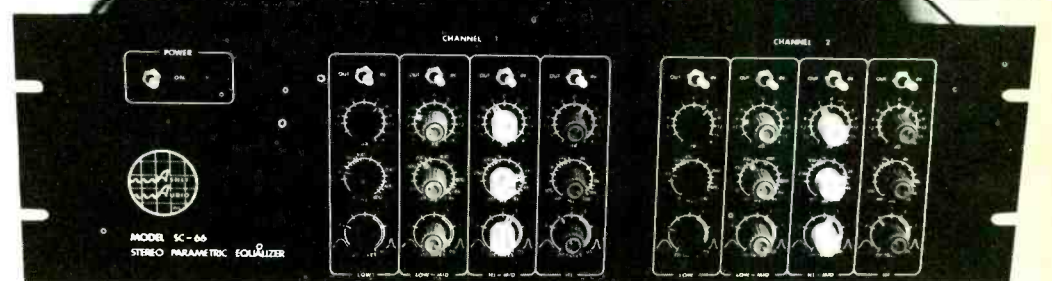

Our SC-66 Stereo Parametric Equalizer is a powerful tool to combat acoustical troubles and eliminate feedback. It lets you make things sound the way you want them to sound. Our SC-50 Peak Limiter-Compressor controls peak levels to increase loudness and prevent distortion. Both are superbly clean and quiet and will dramatically improve the quality of any sound system. Try them out at your ASHLY dealer.

## ASHLY AUDIO, INC.

1099 Jay St.  
Rochester, N.Y. 14611  
(716) 328-9560

dealer inquiries invited



# SAE Power

SAE's goal today, just as it has been for over 12 years, is the design and production of fine audio components which offer the best value in both sonic performance and quality construction. Our line of amplifiers stand as a testament to this goal.

First, their design — all SAE amplifiers have fully complimentary circuitry. In this unique design approach, not only the output (as in conventional amplifiers), but the drive and input stages, are completely complimentary. This ensures low transient and steady-state distortion, plus full stability and fast overload recovery. Combine this with our high slew rate for accurate transient response, feedback gain controls which will not degrade the input signal (2600, 2400L), and monocoque construction with its low weight and high reliability (2200, 2400L).

The result is state-of-the-art performance, but to realize this performance we must have the second part of our goal — production. In order to ensure optimum performance from these unique design concepts, SAE retains total control over the manufacture, selection, and assembly processes. We maintain 40,000 sq. ft. of production area where the latest techniques in metal and circuit board fabrication, component selection and product assembly are employed. The result of these efforts is the line of high quality amplifiers pictured here, each an outstanding value in its power range and each a true SAE component where performance and value come together — that's SAE Power!



2600 - 400 Watts\* — our most powerful amplifier, designed for high power home environments. The 2600 ensures clean dynamic reproduction at the highest power levels.



2400L - 200 Watts\* — combining performance and reliability in a surprisingly compact package. This amplifier can reproduce the most demanding program material without strain.

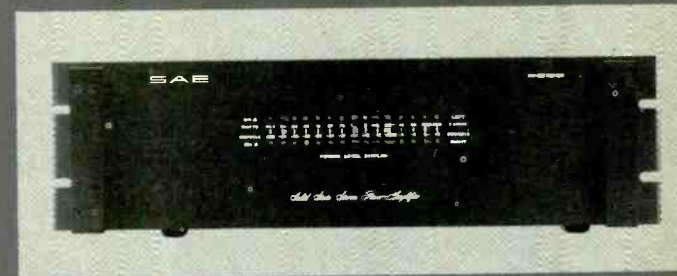

2200 - 100 Watts\* — Incorporating our advanced circuitry and technology, the 2200 offers high levels of clarity and definition at a popular power level.

\*All power ratings are per FTC requirements and are stated with the following parameters: 20Hz to 20kHz from 250 mW to rated power with less than 0.05% Total Harmonic or Intermolecular distortion.

**SAE**  
Scientific Audio Electronics, Inc.

P.O. Box 60271 Terminal Annex, Los Angeles, CA 90060

CIRCLE 28 ON READER SERVICE CARD

# THE **PRODUCT** SCENE

By Norman Eisenberg

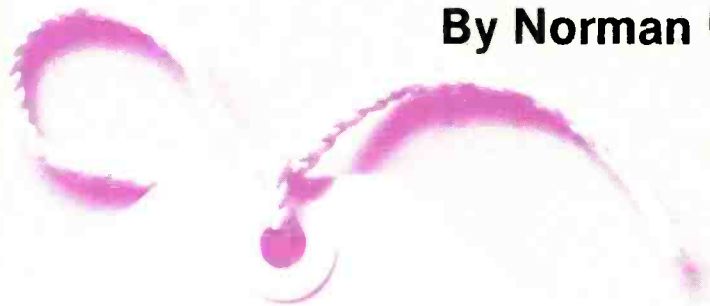

## NEW TOP OF THE LINE SPEAKER

The model AS-1348 is the new top-of-the-line speaker system from Heath, the electronic kit giant. Drivers include a 15-inch woofer, two 4½-inch midrange units, and three 1-inch dome tweeters. The woofer faces the rear to enhance bass performance when the system is placed near a wall. The midrange drivers radiate directly forward, while the tweeters are positioned forward, angle-right, and angle-left. System response is claimed to be from below 30 Hz to beyond 20 kHz. The AS-1348 is mail-order priced at \$269.95.

To get a free copy of Heath's latest catalogue, write Heath Co., Dept. 350-22, Benton Harbor, Mich. 49022.

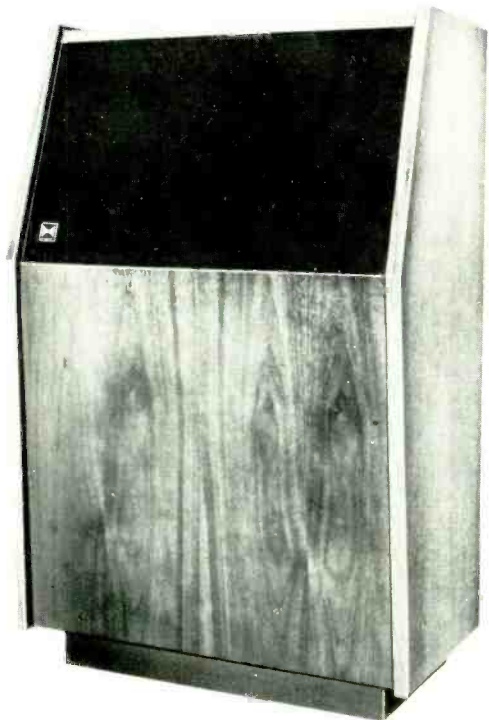

CIRCLE 11 ON READER SERVICE CARD



## NAKAMICHI UPGRADES 700 CASSETTE DECK

A new version of Nakamichi's 700 cassette recorder, the 700II, is claimed to have greater dynamic range, improved high-frequency headroom and lower residual noise than its predecessor. The playback EQ amplifiers have been redesigned with



phase correction; mic inputs have increased sensitivity, linearity and dynamic range; the headphone amplifier has higher output. The closed-loop dual capstan transport also has been refined with fewer moving parts and a quicker fast-wind than before. The head is an improved crystal permalloy type with extended life and a precision 0.9-micron gap, according to Nakamichi. The 700II's meters provide an expanded scale, ranging from -40 dB to +10 dB, and the record-level calibration controls have been moved to the front panel for easier access. Bias and EQ are now controlled by two independent switches. A three-head configuration, the 700II has Nakamichi's patented record-head azimuth alignment beacon, plus feather-touch transport controls with IC logic, Dolby noise reduction, memory rewind, 3-mic/line mixing, playback pitch control and switchable MPX filter. Price is \$950.

CIRCLE 6 ON READER SERVICE CARD



## LOW COST DELAY SYSTEM

Designed for sound-reinforcement work in clubs, theatres, churches and small auditoriums as well as in the studio and "live"-performance applications is Lexicon's Delta-T Model 92 time delay system



priced "well under \$2,000." The model 92 provides two adjustable audio signal delays of up to 120 ms, each controlled by a front-panel knob. Also provided are input and output audio transformers, fail-safe, audio bypass, silent power up/power down circuitry and rear-mounted XLR-3 connectors. A five-position LED headroom indicator, calibrated in 10-dB increments below limiting, simplifies level adjustment and verification. Designed for rack-mounting and weighing 8½ pounds, the Delta-T 92 uses Lexicon's proprietary floating point digital encoding techniques. Dynamic range is claimed to be better than 90 dB; noise and distortion are rated at less than 0.1 percent.

CIRCLE 10 ON READER SERVICE CARD

## "QUASI-MODULAR" MIXING SYSTEM

The Chilton QM-1 system (the letters stand for "quasi-modular") is a flexible and adaptable mixing system available in several formats: 12 inputs, 4 groups, 8 tracks monitor; 16 inputs, 4 groups, 8 tracks monitor; 24 inputs, 4 groups, 8 tracks monitor; 16 inputs, 8 groups, 16 tracks monitor; 24 inputs, 8 groups, 16 tracks monitor. Numerous features are standard, including 4 or 8 bus assignment routing, pan and remix on a separate stereo bus, complete talkback, complete oscillator with 40, 150, 330, 1000, 5000 and 10,000 Hz on pushbuttons (two may be pressed for additive frequencies), complete sub-grouping into stereo for P.A. through the monitor mixing system, and more. Optional features include a choice of modules, faders, comp/limiter and balanced outputs. Chilton—made in England—is distributed in the U.S. and Canada by La Salle Audio Products Ltd., Montreal, Canada.

CIRCLE 2 ON READER SERVICE CARD

## CLASS A POWER AMP

From Threshold Corp. of Sacramento, California there is news of the model 400A stereo power amplifier which, says the manufacturer, has a patented active bias system that enables the unit to operate in class A mode to 500-watt transient output levels per channel, but without the efficiency and thermal problems associated with conventional class-A amplifier design. The conservative power output of the model 400A is 100 watts per channel into 8 ohms at 0.05% distortion, 20 Hz to 20 kHz. At idle, the amplifier draws 250 watts, and it maintains its correct operating temperature without fan cooling. Frequency bandwidth at small signal levels is rated within +0, -3 from below audibility to 500 kHz. Protection circuits include current limiters with analog controlled reaction times, thermal monitoring, output fuses and resettable circuit-breaker. For each channel there are individual peak vs. average output level readings. Price is \$1,147.



CIRCLE 20 ON READER SERVICE CARD

## BURWEN SHOWS NEW ITEMS

New products from Burwen Research include the Transient Noise Eliminator TNE 7000 and five stereo headphones.

The TNE 7000—priced at \$289—is designed to remove scratches, ticks and pops from discs; its patented technology copes with transient noise on disc surfaces. According to Dick Burwen, the TNE 7000 in combination with his Dynamic Noise Filter 1201A "offer the best total noise reduction capability available today."

The headphones include models PMB 6 and PMB 8, described as top-of-the-line orthodynamic units in which an ultra-thin voice-coil diaphragm is positioned between two perforated sintered ferrite disc magnets. The models PMB 4, PMB 40, and PMB 20 utilize dynamic design. Prices range from \$39.95 up to \$99.95.

CIRCLE 12 ON READER SERVICE CARD

## MIC/PROGRAM EQUALIZER

Spectra Sonics of Ogden, Utah has announced its model 501 Microphone/Program equalizer, a compact device designed to provide high and low frequency reciprocal equalization for use in recording, broadcasting, motion pictures, sound reinforcement and other audio applications. The equalizer is a passive network that becomes an active feedback element in conjunction with the Spectra Sonics model 101 audio amplifier. The EQ/amp combination provides 40 dB of gain so that insertion loss for the equalizer becomes zero, and a gain advantage of about 14 dB over conventional passive equalizers is obtained. Continuously variable EQ ranges are about 8 dB of boost or cut at high frequencies, and about 10 dB of boost or cut for the lows. Distortion is claimed to be unmeasurable (less than 0.01 percent residual). The device is 3 $\frac{1}{2}$  inches high and weighs 11 ounces.

CIRCLE 19 ON READER SERVICE CARD

## MINI MONITOR

Described as "the world's first miniature studio quality loudspeaker" is the model 300 from Analog & Digital Systems, Inc., Wilmington, Ma. The ADS 300 has an aluminum housing that provides the smallest possible external dimensions for a given inside cubic volume. If the enclosure were made of wood, says ADS, it would be at least fifty percent larger. The woofer here is a 5 $\frac{1}{4}$ -inch unit claimed to produce bass down to below 50 Hz. A soft-dome tweeter completes the system. The model 300 is rated to handle power levels up to 50 watts of musical material, and will tolerate peaks beyond 100 watts. Efficiency is fairly high, and the small speaker is said to be capable of producing "amazing volume." Impedance is 4 ohms; weight is 7 $\frac{1}{2}$  lbs. Dimensions are 8.45 inches by 5.8 inches by 5 $\frac{1}{4}$  inches. Price is \$140.

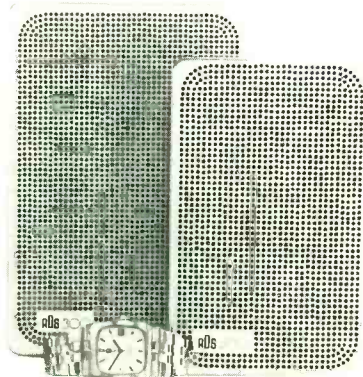

CIRCLE 1 ON READER SERVICE CARD

## AKG REVISES STUDIO MICROPHONE

Said to be completely redesigned and vastly improved vis-a-vis the older model C-414 is AKG's new version, the C-414EB, a studio-grade condenser microphone featuring twin diaphragms. Miniaturization of componentry, says AKG,



enables them to provide numerous practical performance features plus improved resistance to rough handling. All switching controls are incorporated within the mic itself. The twin-diaphragm design permits the user to select four different polar patterns (cardioid, omnidirectional, figure-8 or hypercardioid). For close-up recording, pre-attenuation levels of 0, -10 and -20 dB are provided. A bass-cut filter with a better than 14-dB/octave-slope provides response that is flat, or cut off at 75 Hz or at 150 Hz. Rejection of RF interference is aided by an all-metal housing. Using a standard XLR connector, the mic may be energized via 12/48 V phantom powering to further minimize the possibility of extraneous interference. The C-414EB is stated to be extremely quiet with an equivalent noise level of 20 dB SPL. Optionally available with the mic is a new elastic suspension, boom-mounting facilities and wire-mesh windscreen. Professional user net price is \$495.

CIRCLE 5 ON READER SERVICE CARD

## 3M ADDS LABELS

Extra exterior drawer labels and insert cards for indexing selections now are available for 3M Company's "Scotch" C-Box cassette storage boxes. Drawer labels are backed with pressure-sensitive adhesive, and both the labels and the cards can be typed or written on. A poly bag containing twenty-five each of labels and drawer inserts costs under \$2. The C-Box storage system consists of plastic boxes grooved top and bottom for locking together.

CIRCLE 13 ON READER SERVICE CARD





## RACK 'EM UP

Rack-mounting of audio gear seems to be getting more popular outside studios. Mitsubishi recently made a rack-mount system available as a dealer display only to learn that audio/recording enthusiasts began wanting them. Accordingly, the racks are slated for consumer sale. Capable of housing a fair assortment of audio units plus some records, the rack is six feet high, rests on casters that can be locked in place, and has openings in the rear to facilitate component hookups. A real fancy touch: the audio gear can be viewed through twin vertical glass doors. Price is expected to be somewhere above \$100.



CIRCLE 8 ON READER SERVICE CARD

## DON'T GIVE UP YOUR CONSOLE

The direct-to-disc recording technique has been getting a fair share of publicity recently as a few more releases embodying this method have become available. In the direct-to-disc technique, the master record is cut right during the actual performance. No tape is made first, no retakes, no overdubbing, no mixdowns and so on. Everything happens on the spot and in "real time." Obviously this puts great

demands on both the performers and the recording team, but the end results are claimed by its partisans to justify the rigors of the sessions. Cleaner sound generally, and wider-range dynamics specifically are held as audible evidence that the direct-to-disc technique is better than the existing tape-and-mix method. If you want to sample this type of recording, check the list supplied in this magazine's June 1977 issue which ran with Jeff Weber's detailed story on the whole process. To this list, by the way, we can add one more—the first direct-to-disc recording of classical music played by a symphony orchestra. That would be the release under the Telarc label of the Cleveland Orchestra, conducted by Lorin Maazel, playing selections by Tchaikovsky, Berlioz, Bizet and Falla.

In a sense, direct-to-disc is hardly new. It was, in fact, exactly how records were made in the early days before tape, before mixing, before the concept of a recording as a "production" rather than as "eavesdropping with a microphone." The question now bothering many in this field is whether we have come full cycle back to where we started—that is to say, are recordings made by modern tape and associated signal-processing techniques so hopelessly inferior when measured against the sonic potential of modern playback equipment that we must give it all up in order to make clean recordings with full sonic response?

Some purists insist it is just so. These devotees, however, usually are connoisseurs of the listening situation rather than practitioners of recording. From a workaday standpoint their view on this may be impractical, but who can deny that their promptings and criticism over the years have not spurred the recordist to greater achievement.

Be that as it may, the fact that a few direct-to-disc recordings have been made that do sound better in many respects than conventional recordings does not in itself rule out the conventional techniques. I can make up a list of recordings that will stand up to any comparison, and I know that most of my contemporaries can do the same. Proving what? Simply, that the secret to great recording is to be found not so much in any overall method, but rather in *how* the method is applied. It's not that mixing is "bad" or "good"—but rather how good a piece of gear is the mixer, and—just as important—how expert is the mixing personnel doing the job. The vital elements in making really good recordings remain the same: the excellence of the hardware employed, and the knowledge, skill, and sensitivity of the human being employing it.



# MUSICAL

# NEWSIGALS

**SOUND REINFORCEMENT** ... The Trouper I Live Mixing System from Uni-Sync, Inc. (742 Hampshire Road, Westlake Village, Ca. 91361) is a low-cost, high-performance mixing console designed specifically for P.A. use. The Trouper I is a semi-modular system comprising an Output Control Module (\$749), which contains eight input modules and all the controls for the various outputs (and thus can function as a self-contained 8-input mixer), and an Expander Module (\$698) which contains ten input modules only. Each input module has connections for a low impedance, balanced mic input, a high impedance, high level input, and output and input jacks for an insertion point for connecting limiters and such. Controls on each input module include a 20 dB mic attenuator switch, three-band graphic equalizer, monitor send, solo switch and channel fader. The output section of the Control Module houses a variety of functions including house and monitor master faders with high-pass and low-pass filters, echo send master fader, house and monitor echo returns, LED meter and headphone level control.

The echo send is normally connected to a built-in spring reverb unit, but jacks are provided for send to and return from an external echo, reverb, or effects device in addition to connections for main (house) and monitor outputs and a headphone jack. The Control and Expander modules interconnect via a single "umbilical" cable. Both units are rack mountable, or they are available in separate or combined carrying cases.

Brand new from the people at Shure Bros. Inc. (222 Hartrey Avenue, Evanston, Ill. 60204) is a moderately priced, professional quality microphone, the SM59 (\$132). This new mic is a dynamic type and has a cardioid response pattern. Frequency response is 50 Hz to 15 kHz, and the response curve has been designed for flatness and natural reproduction rather than having the usual presence peak in the upper-frequency range which can often lead to harshness in a microphone's sound. A special feature of the SM59 is a patented mechano-pneumatic shock mount system designed to reduce handling noise and pickup of floor or desk vibra-

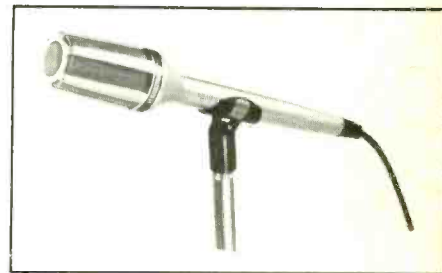

tions through the mic stand. A pop filter is integral in the mic to protect against breath sounds and wind noise while retaining a slim, modern appearance.

An interesting new line of sound reinforcement equipment has been introduced by Emilar Corporation (2837 Coronado Street, Anaheim, Ca. 92806). First is the EH800 Exponential Horn, a compact, cast-aluminum horn with an 800 Hz cutoff frequency. Energy distribution is  $\pm 2\frac{1}{2}$  dB over a 90 degree horizontal range and 40 degrees vertically. The EH 800 directly accepts the Emilar EA175 or EC175 compression drivers, and other drivers with a one-inch throat can be adapted. The EH800 horn is particularly noteworthy for its very shallow design—it's only eight inches from front lip to driver flange. The EA175 and EC175 are 8-ohm compression drivers designed for use with the EH800. Both models have a 1.75-inch voice coil/diaphragm, and the throat diameter is one-inch in both cases. The voice coil/diaphragm assembly was designed for maximum ease in replacement, requiring only a screwdriver. The EC175 has a power rating of 30 watts RMS using pink noise band limited to 500 Hz to 5 kHz, and weighs five pounds, while the EA175 is rated at 40 watts RMS, weighs eleven pounds, and has 1 dB higher pressure sensitivity. When used with the EH800 horn the EA175 will produce 108.7 dB/SPL at one meter with a 1-watt input of band limited pink noise. To round out the

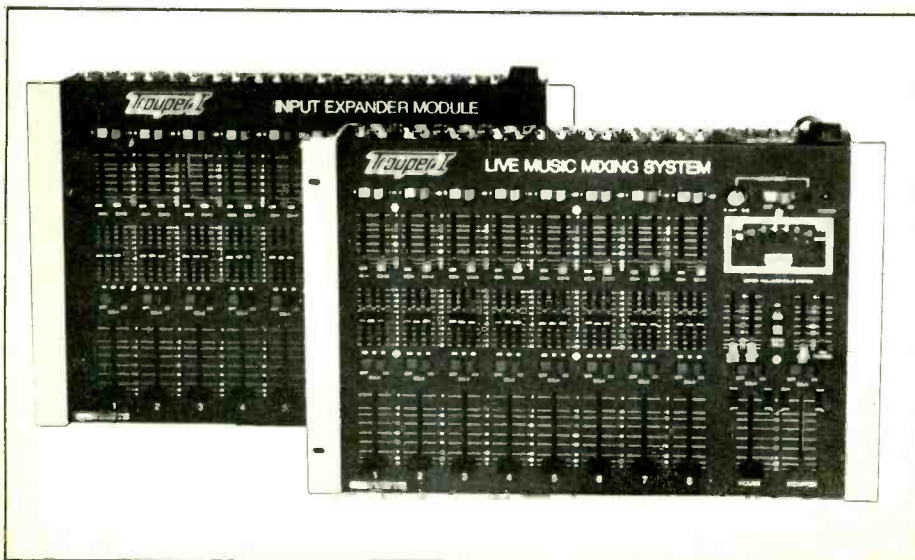



line, Emilar offers the EW15, a 15-inch low-frequency driver, and the EX800, an 800 Hz crossover network for 8-ohm drivers, rated at 100 watts RMS.

**INSTRUMENTS.** . . One of the most remarkable new products shown at the National Association of Music Merchants trade show held in Washington, D.C., back in March, 1976, was the all-electric Piano Plus from RolandCorp, US (P.O. Box 22289, East Los Angeles, Ca. 90022). At that time, the instrument was only available in a contemporary spinet-type cabinet, but company spokesmen indicated that a portable version was in the works. Roland recently announced that the portable Piano Plus, officially called the MP-700, is finally available, and that the home version will be made available in a variety of cabinets, including the HP-763 in Italian Provincial, to complement any decor. All the Roland Piano Plus models are purely electronic instruments which have been carefully engineered to have the same sensitivity, touch and dynamics as an acoustic piano and to sound like an acoustic instrument. The 75-note keyboard uses special piezo-electric elements to generate a control voltage proportional to the force with which the individual keys are struck, making the Piano Plus fully touch sensitive. Besides the acoustic piano voice, which is remarkably lifelike in sound, the Piano Plus has tab selected voices for jazz piano, harpsichord and bass. In addition, electronic controls are provided for variable decay time, glide and Roland's much-used "chorus" effect, and two foot pedals for sustain and damper.

The biggest advantages of an instrument like the Piano Plus over the various electro-mechanical keyboards come from the fact that it is purely electronic and doesn't have strings, tines or reeds to break or go out of tune. Tuning stability is consequently excellent, and occasional retuning is accomplished by a simple series of precise screwdriver adjustments. The HP-763 model is completely self-contained with its own solid-state power amp and exclusive Revo Sound speaker system housed in the finely crafted hardwood veneer cabinet. The MP-700, as befits a portable model, is a separate keyboard unit with tubular steel supporting frames for use with external amplification equipment. Available from Roland is the MPA-100, an amplifier/speaker system specifically designed to fit under the MP-700 keyboard unit, and which also houses the

sustain and damper pedals for the keyboard. Roland calls the MP-700 Piano Plus "the instrument the world has been waiting for," and while that is probably an overstatement, the instrument is nonetheless a significant advancement in the state of the art in electronic keyboards.

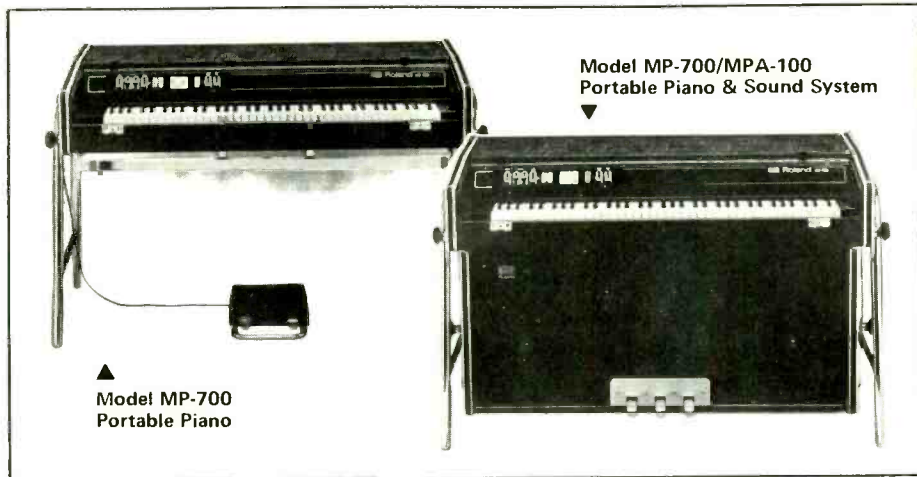

News of an interesting and, we dare say, unique synthesizer comes to us from Audio Arts, Inc. (5615 Melrose Avenue, Hollywood, Ca. 90038). The new instrument, called the Stylophone 350 S, is made in London by Dubreq, and is a very compact (five pounds) 44-note synthesizer with a total range of 6½ octaves counting the upper and lower voices. The unique feature of the Stylophone is that it lacks a conventional keyboard, but rather is played by touching one of the 44 "keys" printed on a flat metal plate with a special pencil-like stylus provided with the unit. Also provided is a second stylus which

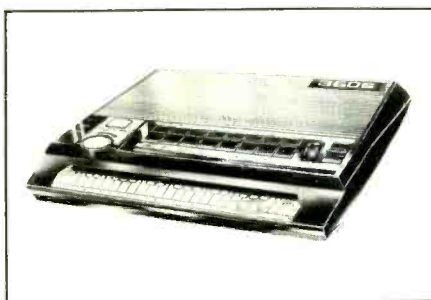

allows the user to play two-note harmonies. Above the touch-plate is a row of eight 3-position rocker switches. Three of these switches control the three "expression" functions of vibrato, reiteration and decay, and four of them select the various voices of the instrument (4 "woodwind," 2 "brass," and 2 "strings"). The eighth switch selects the function of the unique photo control, which is operated by placing one's hand over the control to block the light hitting

it; the selectable functions of the photo control are swell, vibrato or waa-waa.

**AMPLIFIERS.** . . Beckman Musical Instruments has announced two new models in Roland's Jazz Chorus line of

guitar amplifiers. The Jazz Chorus amp line, which already includes a single-channel 60-watt amp with a single 30cm (12-inch) speaker and a dual-channel 120-watt amp with 2 x 30cm (12-inch) speakers, features a unique vibrato/chorus circuit which produces frequency modulation (vibrato) or instrument-doubling chorus effects rather than the usual tremelo (amplitude modulation) circuit. The new models are the JC-80, a single-channel 60-watt RMS amplifier with a single 38cm (15-inch) speaker, and the JC-160, a dual-channel, 120-watt RMS amp with 4 x 25cm (10-inch) speakers. The JC-80 and the "Effects" channel of the JC-160 have controls for volume, bass, mids, treble, distortion, reverb, vibrato speed, vibrato depth and a vibrato/chorus switch, while the "Normal" channel of the JC-160 has volume, bass, mid and treble controls only.

In addition to a line of mixer/amplifiers and PA speaker systems, Osborne Sound (7901 Palm Avenue, Lamont, Ca. 93241) offers two bass amplifiers and a guitar amp. The G1501TR (\$499.00) is a single-channel, 200-watt RMS, solid-state guitar amplifier in a compact cabinet with 2 x 12" speakers. The amp has controls for volume, bass, treble, tremelo speed, tremelo intensity and reverb. The model B1502 bass amp is available with either a 15-inch folded horn enclosure (\$579.00) or a 2 x 15" bass reflex cabinet (\$549.00). The bass amp itself has "Normal" and "Deep" channels and is rated at 100 watts RMS.





# One year later

## Mic Spec Sheet—Neumann KM84

- A. Type — KM84
- B. Directional pattern — cardioid
- C. Acoustical principle — pressure gradient
- D. Frequency range — 40-20,000 Hz
- E. Effective output level — -38 dBm  
ref level 10 dynes/cm<sup>2</sup>
- F. E.I.A. rating GM — -137 dBm
- G. Output impedance — -150 balanced  
(needs floating amplifier input)
- H. Equivalent loudness level — IEC  
due to inherent noise 179 -18 dBA  
(0 dB = 2 · 10<sup>-4</sup> dynes/cm<sup>2</sup>)
- J. Equivalent loudness level  
due to inherent noise  
(0 dB = 2 · 10<sup>-4</sup> dynes/cm<sup>2</sup>) — DIN  
45405-25 dB
- K. S/N ratio (A weighted)  
ref level = 10 dynes/cm<sup>2</sup> @ 1 kHz — 76 dB
- L. Max SPL for less than 1% THD — 133 dB
- M. Total dynamic range of the microphone amplifier  
referred to I.E.C. 179 weighted equivalent loudness  
level on line "H" — 115 dB
- N. Power supply — DC, +48 volts, +6, -8 at 0.4 mA  
(Note: The letter "J" is not listed in the original Neumann chart.)

references that you will find printed on the sheet for a Neumann KM84 condenser microphone. At the present time it has a nationally advertised retail value of \$260. It requires a power supply. That's another \$50. What's a power supply? Have patience ole buddy, we'll get to it in a while. Let's start with the sheet.

On one sheet of specs we now have dBm, dB, dBA, two government standards (IEC and DIN) with number references and several other unspecified abbreviations such as SPL and EIA. Asking someone to explain all this is going to take some time, and it's just the sheet of numbers for *one* little microphone. It gets even more complicated when you have a big stack of spec sheets and you're trying to compare one product with another product of the same type. Different companies don't always use the same reference points.

Well, that's what this magazine is for. We'll try to make some sense out of this mess, and be your "ole buddy." To do the job we'll have to start at the beginning and find out how sound is measured and converted into all those system numbers and references.

## Our Debt to Ma Bell

Who started all this anyway? Sound converted to electricity, so you could do something about it?

Would you believe—Ma Bell?

That's right. The telephone company started it all.

When you start digging into the beginnings of sound measurement and electronics, Alexander Graham Bell is usually there first, last and always. The phone company has done almost all of the research, both theoretical and practical, about sound and sound

equipment. The standards that they set are still (with minor modifications) what everybody uses and deals with. An Englishman by the name of Lord Rayleigh gets credit for a lot of theory, and actually comes first in many basics, but the inventor of the microphone itself was Alexander Graham Bell. After that, we are off and running after the buck right along with the phone company.

Now, if you think it's rough trying to get a signal from your mic to your tape recorder through ten feet of cable, and then playing it back, try putting your mic in Nutley, New Jersey, and your tape recorder in Boston. That's no joke, and the phone company had to solve that kind of problem or go out of business. Right away a lab was set up to investigate everything that Alexander could think of about sound and electricity—Bell Labs. One of the first things they had to deal with was developing a mathematical system of units to work with that would express large quantities of electrical change in a convenient and easy-to-use format. The original unit was called the "Loop Mile." It represented the loss in signal in two miles of standard 19-gauge telephone wire. One mile out and one mile back. This was changed to something called a "transmission unit," which then changed to a unit called a "Bel," in honor of Alexander. The unit proved a bit large when things got a little easier to achieve technically, so now we have the deci-bel, or one tenth of a bel. It has no absolute value, being a measure of change expressed as a proportion, but can be nailed down to an absolute value if you define a starting point to work with. What went into the cable to begin with? What's the reference? On our sample mic spec sheet we have three methods of nailing down a reference for dB calculations.

**dBm**—Zero dB equals one milliwatt of electrical power into an impedance of 600 ohms. Most of the dBs are minus, or less than zero dB using this reference.

**dBA**—This isn't a fixed reference, rather it's a method of referring to a non-flat frequency response. The "A" curve. On the sheet an extra line is added to define a start, or zero dB point. It says that zero dB for this reference is 2 · 10<sup>-4</sup> dynes/cm<sup>2</sup>. That's a sound pressure measurement. Hang in there, we'll get to it. Just takes time.

**dB SPL**—Decibels, sound pressure level. This is usually assumed to be referenced to the lowest level of sound

that an average person age 20-25 can detect at 1,000 cycles per second. (This is line "L" on the sheet, maximum SPL for less than 1% total harmonic distortion.) This specification tells you how loud a sound the mic can pick up before it overloads—133 dB louder than the quietest sound you can detect at 1,000 cycles if you have "average" hearing.

Finally we have something that might be useful. Now we have to find out how loud a noise our instruments are going to make. What kind of sound power is generated by music? Let's charge ahead to the chart of . . . Hold it. Right here, ole buddy we had better deal with what sound actually is. If we don't get it over with now, the lack of information will bite us pretty badly later. How do you hear? Is your ear the same as a mic?

## Pressure Changes and Hearing

Pretty close. People "hear" by detecting changes in air pressure. The same way a mic "hears." What is the smallest change in pressure you can detect and what are the units used to describe that change? There are several systems. Here's the setup. One atmosphere, smog and all, has a static pressure of 14.70 pounds per square inch. This will vary with altitude and the weather, but not rapidly enough to detect as sound. People have difficulty hearing twenty cycles of pressure change per second so anything like one cycle per day, or week, doesn't count. You can ignore the weather, because even though the changes are large, they're too slow to hear. Also, one pound per square inch is much too large to use as a unit. So, let's split it down to a unit that is small enough—the microbar. 14.70 lbs/square inch = 1.013250 bar = 1,013,250 microbars.

At Bell Labs two research scientists found that even a microbar was almost too large, but it would do. They were the guys given the job of finding out how quiet a sound the "average human" could hear. Fletcher and Munson found (among other things) that the smallest change in pressure that was detectable at 1,000 Hz was .0002 microbar. The tests were conducted in a totally soundproof area, so only the small change in pressure was part of the measurement. This is now used as the base line or zero dB point for sound pressure level charts. Remember that this measurement is a change in the static pressure around the fixed



LOOK, BRAD!  
ISN'T THAT THE  
ULTRA-VERSATILE  
TAPCO 2200  
GRAPHIC EQUALIZER  
WITH AUTOPAD  
CIRCUITRY?

REET, DEIRDRE!  
WE SOUND ENGINEERS  
DEPEND ON IT TO  
CORRECT FREQUENCY  
RESPONSE DEFICIENCIES  
AND FOR A MYRIAD OF  
OTHER STUDIO AND  
PUBLIC ADDRESS  
PURPOSES.  
IT'S THE BERRIES.

PROFESSIONAL  
MUSICIANS LIKE ME  
KNOW THE TAPCO  
2200 IS EASY TO  
USE AND  
DEPENDABLE TOO.  
ALL THE GUYS  
CALL IT  
"THE PROBLEM  
SOLVER."

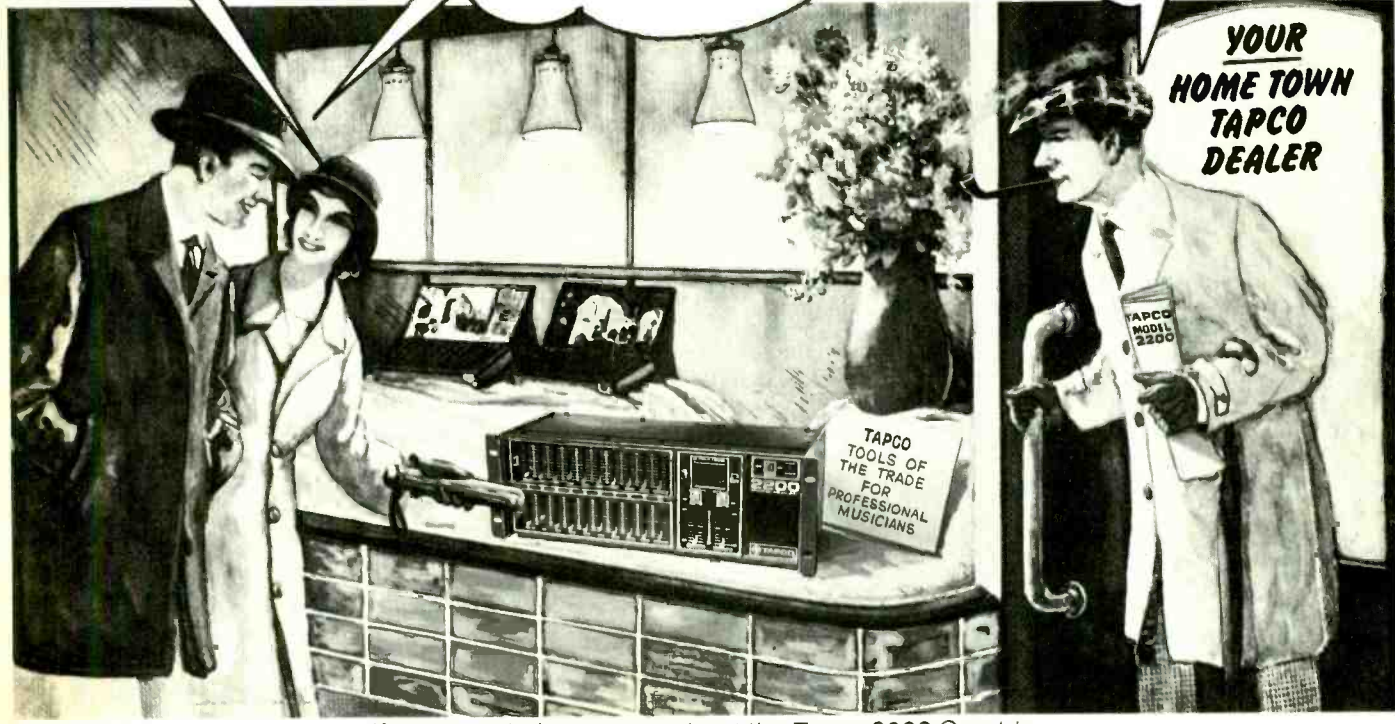

If you want to learn more about the Tapco 2200 Graphic Equalizer, drop us a coupon and we'll send along complete information and specifications. And we'll include a complete list of home town Tapco dealers.

**TAPCO**  
TECHNICAL AUDIO PRODUCTS CORPORATION

Reet. Send me information, specs, and dealer list.

Write:  
Laurie Jackson Tapco, 3810 148th N.E.  
Redmond, Washington 98052

---

name

---

address

---

city

---

state zip

CIRCLE 53 ON READER SERVICE CARD

reference of one atmosphere, and this is the whole number. 1,013,250.0001 microbar changing to 1,013,249.9999 microbar. That's 0 dB SPL at the bottom of our chart. At the top you have a change of two whole atmospheres to hard vacuum (no air at all) and that's 194.1 dB SPL. In microbars, 2,026,500 change in pressure. Sounds in the upper magnitudes of pressure change are created by explosions and high-speed aircraft shock waves. Not good for your ears at all, and will literally "blow you away." There are also several other systems of measurement that are used along with the microbar when the sounds get loud enough to make their unit quantities comfortable to use. We'll stick them on the chart of musical noises along with the microbar scale—the dyne per centimeter squared, and the Newton per square meter. These number systems can also be found on mic sheets, so you'll need the cross references.

This kind of sound power chart is usually filled up with noises. Jet planes, trucks, gunshots and things like that. We left in the gunshot, but re-did everything else.

Some of you old pros reading this article may twitch a little looking at these SPL figures. They look pretty high compared to what you remember. Well, get out those old textbooks and look again. In the past, most sound power measurements on musical instruments were made at much greater distances than are currently used in modern multi-channel recording. The closer you get with the mic the higher

the SPL gets, and ten feet just don't hook it these days on a snare drum. At this point you might say, "But these levels are above the threshold of pain." Right. Stick your head in front of that acoustic guitar if you want to hear what you're going to get, but don't put your head inside the bass drum. The drummer might give it a good sock and make you deaf for a week! Take care.

It's also obvious that you don't have to play a snare drum with a tire iron. A little less vigor means a lower SPL and perhaps a little less trouble for sensitive mics.

## Standard References

On this sound power chart you will find a couple of reference points that are not music. 94 dB SPL, which is 10 microbars, 10 dynes per centimeter squared and also 1 newton per square meter. All three of these reference numbers will produce a 94 dB SPL figure when plugged into the formula for finding a ratio in dB along with their respective "zero sound pressure" numbers at the bottom of the chart. (DB SPL = 20  $\text{Log}_{10} \frac{P}{P_0}$ , where P = pressure change you want to convert to dB SPL.

If you use the formulas with the smaller values found at the 74 dB point you should get "74 dB" as a result. The formula is constant, only "P" (the pressure change value) shifts.

These two points are the standard reference for sound pressure used in testing mics. Ninety-nine times out of one hundred you will find the 94 dB sound pressure used, but to be dead sure we have given you everything, we must mention the lower value as well. Here's how it works. You stick the mic to be measured into a sound field of 10 dynes per square centimeter (10 microbar, 1 newton per square meter, they're all the same), call it 94 dB SPL if you like. Then you measure the voltage that comes out of the mic. This number, gets plugged into the dB formula with one change. The reference that you are comparing the microphone against is now dBm. Since the voltage the mic produces at 94 dB sound pressure is lower than "0 dBm," you get a minus number. For a KM84 Neumann it says on line "E," that for a 10 dyne per centimeter squared sound pressure (94 dB SPL) the mic will produce an output of -38 dBm. The relationship between SPL in and dBm out is linear in dB. In other words, raise the sound power, or vol-

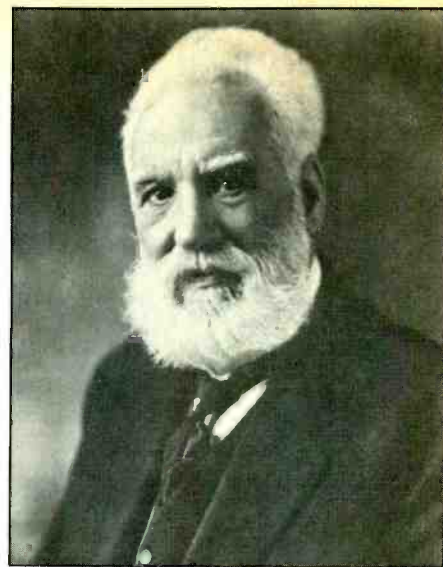

Alexander Graham Bell

ume, 10 dB and the mic will put out 10 dB more, up to its electronic limit of 133 dB. That figure is line "L" on the spec sheet. For 133 dB sound in, you get +1 dBm out.

Did we lose you? Okay, once more, real slow.

94 dB SPL in = -38 dBm out

104 dB SPL in = -28 dBm out

114 dB SPL in = -18 dBm out

124 dB SPL in = - 8 dBm out

and at clip, 133 dB SPL in = +1 dBm output from the mic.

Once you have a sensitivity figure in dBm you can usually figure out what you need to know about almost any type or style of mic. Most mic companies give the sensitivity conversion using a 94 dB SPL source noise even if they don't list all the references. Condenser, or powered mics usually run from about -50 dBm to -38 dBm or so. Most dynamics (Shure, Electro-Voice, AKG) run from a low of -60 dBm to a high of -52 dBm. It's also useful to know that the overload or clip point for most dynamic mics is so high that most manufacturers don't even bother to list it. A recent Sennheiser ad for the MD 421 showed its undistorted response to a pistol shot. Back to the SPL chart again. 178 dB SPL! And still going! Dynamic mics also create very little noise—no active electronics at all, so no big noise figures. Their actual noise measurements run pretty close to the theoretical limit, which is just the movement due to heat of electrons in the voice coil.

This is beginning to sound like an ocean of praise for dynamic mics, so we better say something to set you

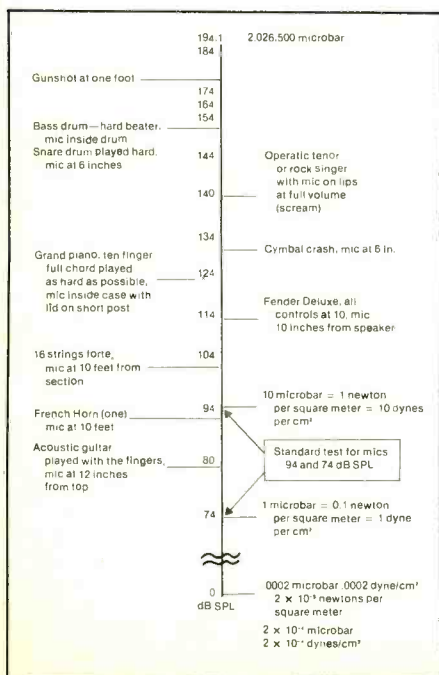





5 LED peak level indicators help eliminate distortion.



Long life Sen-Alloy head improves performance, reduces distortion.

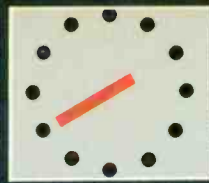

Automatic recording when you're not there.



Dolby reduces tape hiss.



Bias and EQ switches for all types of tape.

# No cassette deck can give you better performance without all these recording ingredients.

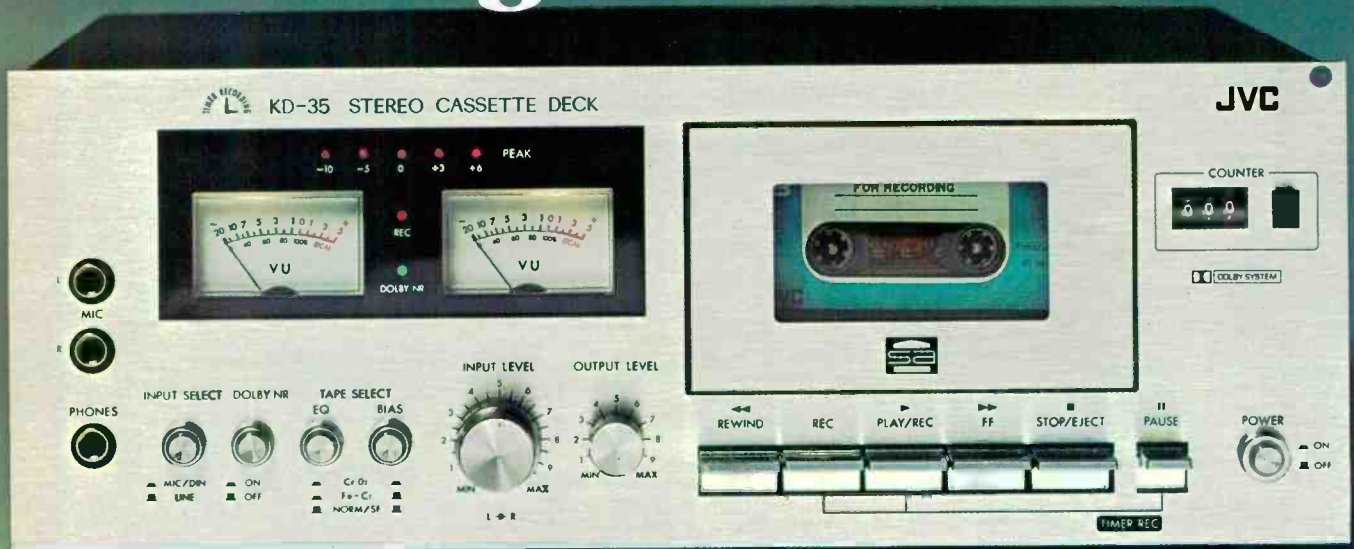

Most quality cassette decks look pretty much alike on the outside. So at first glance you might take the new JVC KD-35 for granted.

But take a second look. You'll see something no other make of cassette deck has—five peak-reading LED indicators. With a faster response than VU meters, or even peak-indicating meters, they help you avoid under-recording and they eliminate tape saturation and distortion. It's as close as you can come to goof-proof recording.

Then there's JVC's exclusive Sen-Alloy head for record and playback. Designed to give you the best of two worlds, it

combines the truly sensitive performance of permalloy with the ultra long life of ferrite.

Of course, the KD-35 has many other features like Dolby, bias and equalization switches, and automatic tape-end stop in all modes. It's also possible to go from one operating mode to another without going through Stop. What's more, you'll never have to miss taping a favorite broadcast because you're not

there; just connect the KD-35 to a timer and switch to automatic record.

And yet, with all this built-in capability, at \$260,\* the KD-35 is priced just above the least expensive model in JVC's new cassette deck lineup. Just imagine what our top model is like.

JVC America Company, Division of US JVC Corp., 58-75 Queens Midtown Expressway, Maspeth, New York 11378 (212) 476-8300. For nearest JVC dealer call toll-free (outside N.Y.) 800-221-7502. Canada: JVC Electronics of Canada, Ltd., Scarborough, Ont.

# JVC

**We build in what the others leave out**

\*Approximate retail value. Dolby is a trademark of Dolby Labs. Inc.

CIRCLE 43 ON READER SERVICE CARD

www.americanradiohistory.com



straight. As good as a dynamic mic can be, a good condenser or powered mic is usually better. How? Transient response primarily. The moving parts of a condenser mic weigh much less than the moving parts of a dynamic mic. They can respond to impulses and fine detail in complex sound much more rapidly and accurately. *If* you can afford them. (They usually cost anywhere from two to ten times as much as good dynamics.) We highly recommend the purchase of a pair. Good microphones are the key to really good sound.

A final look at the spec sheet for the KM84 will show you that most of the numbers we haven't dealt with directly are obtained by adding or subtracting one line to or from another.

The signal to noise figure is found by subtracting line "H" from the reference pressure—94 dB SPL - 18 = 76.

The dynamic range on line "M" is found by subtracting line "H" from line "L"—133 dB - 18 = 115 dB.

### IEC and DIN

Now about line "H," what's "A" weighting anyway? Well, you could

call this a legal form of cheating. The human ear does not hear low level sound with the same frequency response as it does higher levels. The effect becomes quite pronounced as you approach that .0002 microbar limit, so the International Electrotechnical Committee (IEC) allows you to disregard low bass and high treble noise when you prepare a signal to noise figure. The "curve" is the human ear sensitivity curve turned upside down. This lowers the total noise energy by quite a lot, but the reasoning is probably valid. You probably can't hear it very well, so why worry about it. Now the Germans are a little fussier about this, so on line "I" they have a more rigid standard with a much flatter weighting curve defined by the Deutsche Industrie Normen (DIN) specification number 45405. Result? More dB of noise. If you want to read exact systems for IEC 179 or DIN45405 you will need the Berlitz crash course we talked about at the beginning of all this. The IEC paper is in French and the DIN standard is written in German.

Well, that's just about all the specs on the sheet. The frequency response is

simple and the pattern, or directivity (cardioid) is fairly well understood by now, so it's safe to say we have covered just about everything of interest. By this time you may think we have lost sight of ol' Ma Bell, but that's not so. Where did that reference of 94 dB SPL come from? It just happens to be the average power of human speech at two inches. Telephones have mics in them, remember? Ma Bell is without a doubt the world's largest user and tester of microphones and has been in the mic business longer than anybody else.

Once you have converted the sound power of your music to dBm it's not too difficult to apply the numbers to your mixer specifications and discover things like, "How much amplification will I need to get it on the tape?" or "What's the maximum dBm I can plug into the mic preamp without creating distortion?"

The better mixer companies will give you a continuation of dB numbers to keep this process going and produce more useful information about the process of recording. This article won't solve all your problems or make every tape perfect, but we hope it helps.



## Let's talk about the best!

### MORLEY—the electric failsafe pedal...no pots, gears or batteries

Check these features:

- Pedal control of phasing rate.
- Manual phasing like a wah wah.
- Three additional controls that can be preset for virtually any phasing effect known.
- Straight volume pedal when phasing is switched off. There's much more.

Like this Volume Phaser that is free of the most common causes of equipment failure because it features opto-electronic circuitry that obsoletes pots and gears. And, direct feed AC power that eliminates batteries. That's three ways in which advanced state of the art technology makes Morley superior. Built-in reliability for sure — and increased versatility with the best signal to noise ratio and extended range performance in the industry.

The pedal is built of heavy gauge steel to take brutal road abuse and is protected with 11fatime chrome plating. Like all Morley pedals it passed 33 on-line inspections and was individually tested before being packed.

**We built it failsafe because your career depends on it...and so does ours.**

FREE catalog and crazy bumper sticker

## MORLEY®

2301 W. Victory Blvd.  
Burbank, CA 91506  
Phone (213) 843-7122

Name \_\_\_\_\_

Address \_\_\_\_\_

City \_\_\_\_\_ State \_\_\_\_\_ Zip \_\_\_\_\_

MR-9



# QUICK,

## WHAT COMPANY MAKES THE MOST EFFICIENT P.A. AND DISCO SYSTEMS UNDER \$500?



Acoustic Model 806



Acoustic Model 807

# WRONG, IT'S ACOUSTIC!

Introducing the Acoustic 806 and 807, two new speaker designs for maximum performance at a very modest price. Both are three way systems that cover the audio range with incredible efficiency. And efficiency means more dollars in your pocket since they don't require a monster amplifier to get the sound out. Visit your nearest Acoustic dealer, and compare the 806 and 807 to whatever you thought was the best. You'll be pleasantly surprised. Now check the price tags. When we said "Under \$500," we meant "WAY UNDER \$500." From Acoustic... the surprising company.

**acoustic**

professional sound reinforcement  
high fidelity components

7949 Woodley Avenue, Van Nuys, Ca 94106

CIRCLE 26 ON READER SERVICE CARD

Murray Krugman and I sat at an old picnic table on the tar and gravel roof of the Record Plant, New York, discussing his introduction to Blue Oyster Cult. He explained how in 1970 he had been in the marketing department at Columbia Records and had decided that he no longer wanted to take finished product and run with it. Instead he wanted himself to be involved with *making* the product. He began looking for a completely unknown group to take into the studio.

He shook his shaggy head as he spoke about finding a group to produce: "I had done a 'live' Johnny Winter recording, *John Dawson Winter III*, when Clive Davis sent me a tape of this group, The Soft White Underbelly. I had no interest in them. A short while later he sent me another tape of a group called Stark Forest—more or less the same group with a couple of new players—but I had no interest in them either, though they had quite a cult following in New York.

"A few months later I was at a Log-gins and Messina press party when this guy Sandy Pearlman walked up and said, 'You're the guy who passed on my group twice! The Soft White Underbelly and Stark Forest. . . How come you passed?'" It sounded like lame acid stuff, you know, east coast-west coast. 'I'm really looking for an American Black Sabbath.' His eyes lit up and he said, 'Well I've got it—come hear us!' I didn't believe him of course, but I went and I heard enough good material to say, 'Yeah, if they do everything right they could happen. . . with a whole lot of luck.'"

### Raw Sound

The luck stayed with Blue Oyster Cult. They did the first album with Murray and David Lucas at his Warehouse Studio, and are now working on their sixth album for Columbia with Murray, David, Sandy Pearlman their manager, and behind the console, Record Plant's Shelly Yakus.

BOC is Allen Lanier on keyboards; Albert Bouchard, drums; Don Roesser, guitars; Joe Bouchard, bass; Eric Bloom, guitars and vocals; and to quote Murray, "They are all very different personally and professionally."

They have been together for about seven years, on the road and off, and although commercially they cannot be termed a "monster" group they have managed to maintain a fairly stable

group relationship as well as stay on the charts. Their fans call them "Heavy Metal, Man!" and they have a rather loud and elaborate laser light show, but their producers are material-conscious. Most of their albums (*Blue Oyster Cult*, *Tyranny and Mutation*, *Secret Treaties*, *Agents of Fortune*) have been conceptual and thematic—speaking out against the evils of the environment and society. The only "live" album, *On Your Feet or On Your Knees* is a good example of that raw, heavy metal "live" sound.

### Broad Spectrum

The latest album is being done piecemeal fashion—in between road tours. Six songs have been recorded, three are finished with overdubs and one has been mixed. The material again is of great importance. The group and producers are leaning a bit toward that ugly word "commercialism," but with seemingly fine results, and they are looking for a more polished sound than in previous works.

"The album comes across as very diverse, which most people think is an asset," Krugman said, "but when you have five people writing material, each in a totally different universe . . . well . . . none of the songs appear as if they *shouldn't* be on the album, but it's a broad spectrum. The only thing that I avoid is music that has no artistic value. . . but we are looking for a *hit*."

On this project there are three (count them) producers: Krugman, Lucas and Pearlman, and one engineer who "produces his end of it," Yakus. Murray explained the breakdown of responsibilities: "Shelly is instrumental in getting the sound on the record as is Sandy in the mix; David is instrumental in the performance of the group—he conducts the sessions in the studio; I concentrate more on the arrangements."

Actually this album is a real co-production. It breaks down into the song. When one producer is stuck for an idea another usually comes up with something that they all, the group included, can agree upon. Although there are times when it is simpler to avoid discussion. "When you have eight or nine people in the room, sometimes it's easier to just tell someone to do something and if it's great, fine. If something has to be added or changed, in that case I would rather do it later."

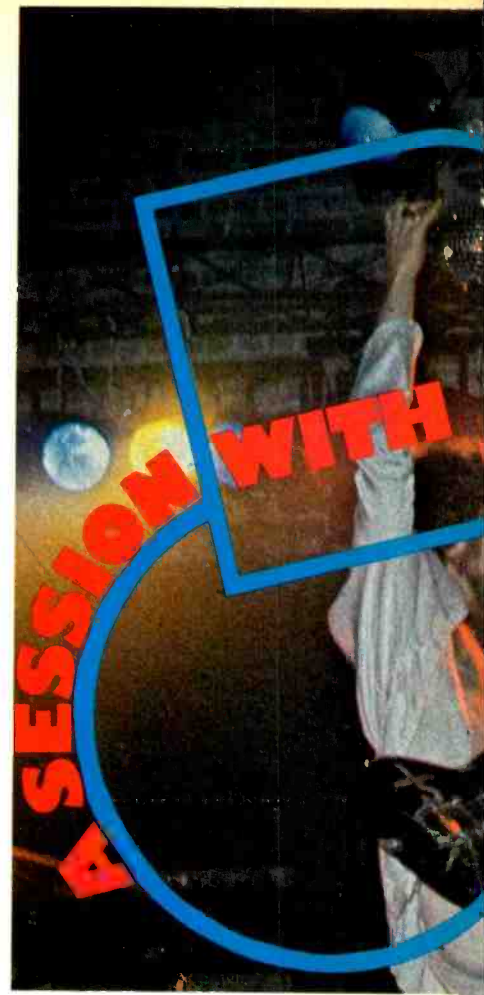

Krugman does respect, though, the high sound standards of the individuals in BOC. "About four years ago we insisted that they all have top quality, four-track home systems. As a result their standards and ours went way up so that now only the highest quality recording is acceptable."

### Studio "C"

"Going Through The Motions" is a stirring four-section rocker that Krugman describes as "sort of rock and roll pop." The sessions for "Motions" took place in Studio C at the Record Plant with Yakus engineering and Thom Panunzio assisting. Murray likes to work at this particular studio for a variety of reasons: He lives in NYC and hates to travel to work, he likes the reasonable and cooperative attitude that prevails, the maintenance staff impresses him and "though I can't talk numbers the way engineers can, I know that the top-end spectrum [of the studio] gives me anything I want."

The basic equipment in "C" is as follows: A Datamix console that has





Photos by Lynn Goldsmith

been customized by the maintenance and engineering staffs to accommodate the needs and whims of the clients. It has the availability of thirty inputs with the possibility of thirty to fifty positions out. There is an MCI multi-track and an Ampex 440 Electronics two-track with an A300 Deck. The out-board equalizers are Pultec; the phaser and digital delays are Eventide and the system includes Pye, Teletronics and Fairchild limiters. The monitors in "C" are Hidley Monitors, but Yakus likes to play back on KLH 6's.

"They're a little warm or "dull" sounding and they don't play back the real high top. That's good because it takes off a lot of edges and you really hear if you have the meat of the mix. They show me if my relationships are

in the right place. If something is hardly there when I listen back, that means it's gone—which makes me go for the higher frequencies."

### Recording Expertise

Shelly has worked with Blue Oyster Cult and its producers for a few years

#### MIC Chart

Piano—Sennheiser 421—Low strings Neumann U87 —Top	Bass Amp—Shure 57 Direct
Organ — Neumann U47-FET—Top Leslie — Shure 57 —Bottom	Drums—Tom Toms—2 Neumann U87s Snare —Shure 57 High Hat —Shure 57 Bass Drum—Shure 57
Guitar — Sony C38 Amps — Shure 57 Neumann U87	Vocal— Neumann 47 (old type) Neumann U87

# Comment

**Blue  
Oyster  
Cult**

and appreciates their musicianship—  
“In recording a group like this we try  
to make them forget they’re in the  
studio and give them a “live” feeling.  
But on this album we are also trying  
for a more finished sound.”

In reaching for this “live” but finished sound Yakus starts recording at 30 ips which gives a better signal-to-noise ratio. He feels it is a lot more alive sounding and captures the excitement from the room, and as he is not using Dolby, there will be less tape hiss and a broader high-frequency response. “The bottom response is better at 7½ or 15, but our multi-track machine leaves us no problem there.” He is not using Dolby because “with the high levels we put on tape it’s not



Blue Oyster Cult: (Left to right) Joe Bouchard, Eric Bloom, Don Roesser, Albert Bouchard and Allen Lanier.

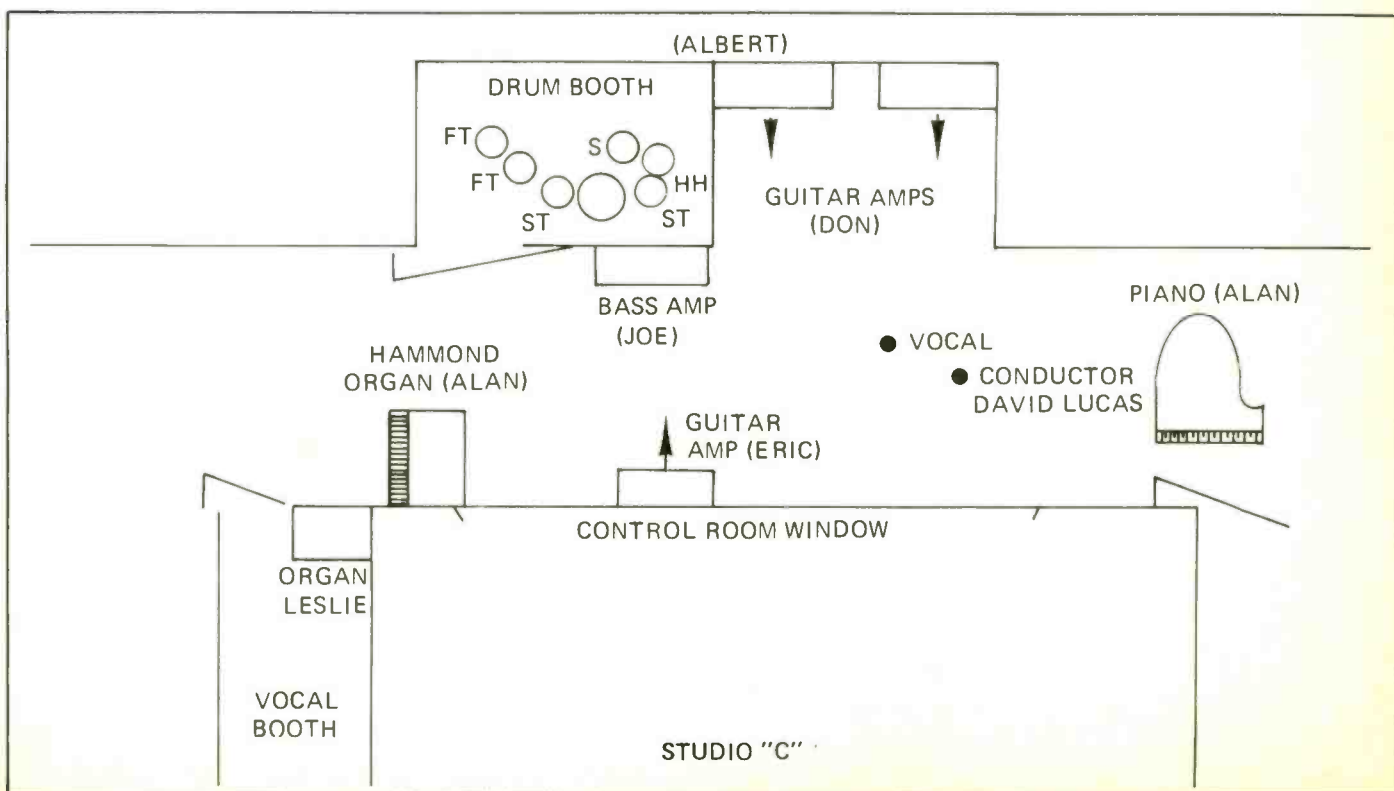



necessary." He feels it kills some of the excitement at the high end and is rather sterile for the purposes of BOC. However, if the same group were doing something quiet with a great deal of dynamics Shelly would then use Dolby.

Another technique this engineer relies upon for that polished sound is the use of Kepexes. On the tune "Motions" they are used to keep down the noise level between guitar solos, prevent too much leakage onto the bass drum track, and where a particular problem came up with a vocal:

"There was a very slight problem with noise during the recording of a lead vocal. Rather than stop the performance we put a Kepex on the track during the mix."

However, Shelly tries not to compensate at the board too much during recording. He uses digital delays to thicken, and equalizes the echo chambers in a way he says is unusual and difficult to explain because it's done by "feel."

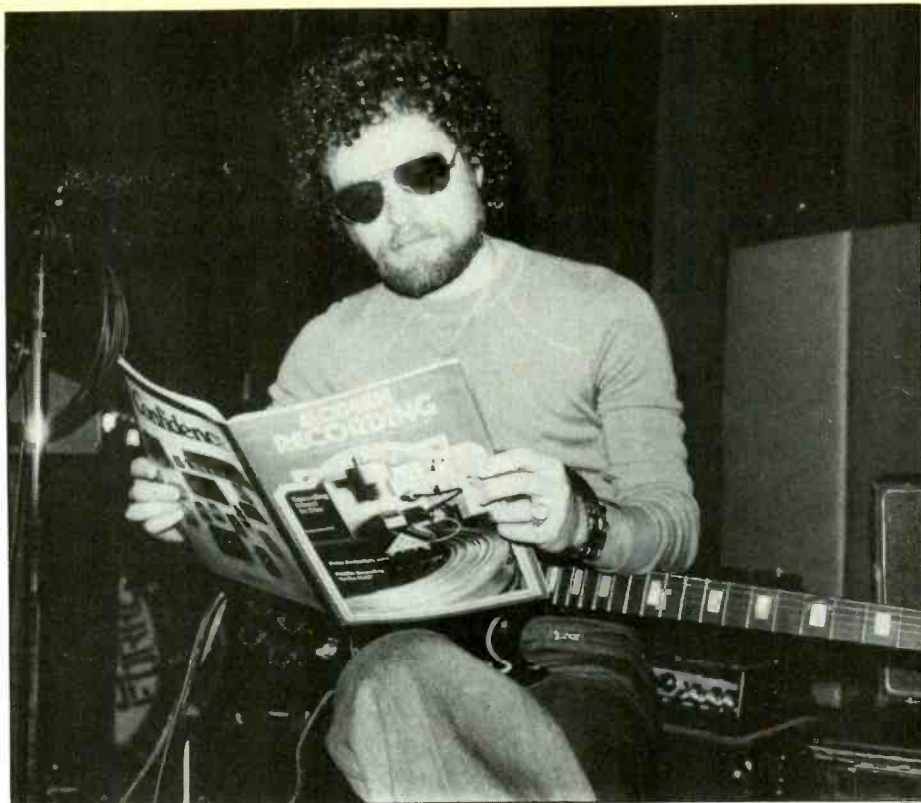

"Cult" guitarist Eric Bloom taking a little time out.

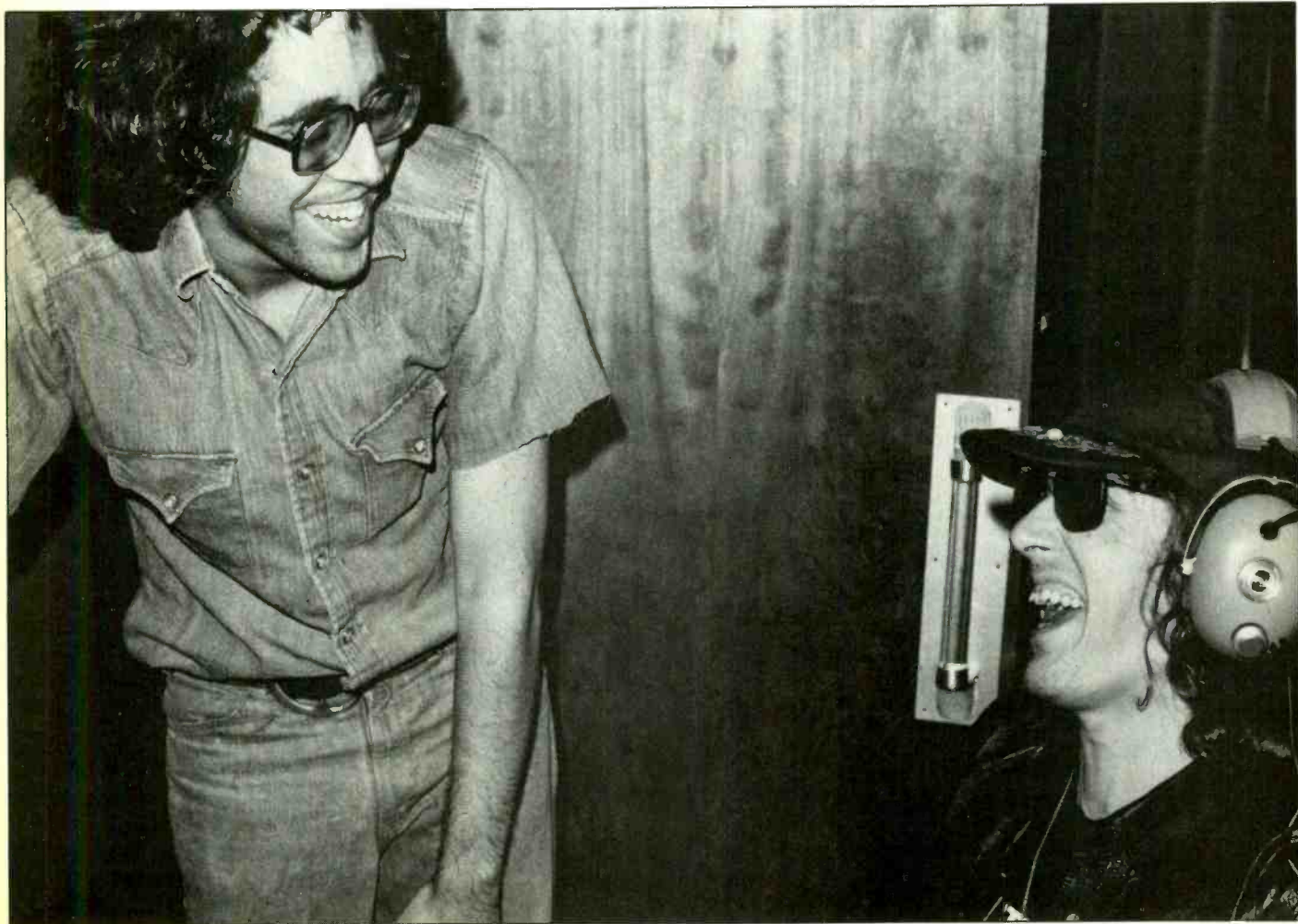

Producer Murray Krugman (left) and keyboardist Allen Lanier.





Guitarists Don "Buck Dharma" Roesser (left) and Eric Bloom.

During the basic tracks Murray, Sandy and Shelly found themselves out in the studio listening, especially when it came to miking. "If the mic placement doesn't sound good in the studio then it's not going to work well at the console," Shelly said. He trusts his BOC mic combinations for the most part although he will go into the studio for the drums at the beginning of the session. In a time when most engineers get caught up in an overabundance of drum mics, Shelly uses as few as possible; five in all on Albert's drum kit. They will work on the balance together to find the room sound first. "I like the drums to ring as much as possible without hanging over into the next beat. I like a full tom-tom sound—if you deaden the drums a lot they don't speak . . . they have to be responsive because this music swallows up so much of the ring anyway. So we tune them so they'll ring like crazy." And then he puts them on seven tracks, two of which are *stereo drums*, comprised of all of the mics except the bass drum. In this way

Shelly uses the combined sound during the mix adding bass drum, snare and toms when needed. Again here he feels he is going for a more finished sound.

On bass, Joe Bouchard played both with his fingers and guitar picks in "Motions." Consequently, Shelly miked the bass amp as well as taking it directly through the board. "We miked the bass amp looking for something interesting. On this song we almost used the mic track completely, but when we gave it more bottom end it became mushy. The direct track had more solid bottom so we went back to it but added a little of the mic track for top."

### Basic Perfection

The recording sessions were a straight-ahead combination of talent and work. As BOC is self-contained there were very few extras on the tracks: a phased string synthesizer for a realistic string sound, doubled vocals for strength, some dazzling extra guitar work peppered throughout; but the sound remains exciting and basic,

the tracks and musicianship sophisticated and competitive.

In mixing these tracks Shelly took the time needed. He is not a "quick mix" theorist and believes that taking two to three days for one long tune is ideal although not always acceptable. Murray and Sandy like to mix for a day, leave the tune overnight and come back fresh the next day. "Sometimes magic happens by accident," Yakus explained, "but I like to *feel* I'm going for it [the magic] when I'm going for it. Once you get one thing to sound great you must get the rest sounding great. Of course, there's only so much time you can spend . . . but Blue Oyster Cult mixes need a lot of attention."

Shelly played the finished mix of "Going Through The Motions." I liked it fine . . . it was moving and exciting, "live" sounding yet very polished. "Yeah," he said wrinkling his brow, "but it could use more bass."

Well, perfection is never an easy thing to find.





# Our amp had a few rough critics to please. Moog. Gibson. Les Paul. Ronnie Montrose. Our oscilloscopes. And you.

Nobody knows everything there is to know about amplifiers. The Lab Series engineers were ready to admit it... and do something about it. We went to several outstanding audio experts. And they helped us put more good ideas into the Lab Series than any one company could ever think of.

When you're making a guitar amp, it helps to work with an expert on guitars. So, the Lab Series engineers studied with the world's foremost experts—Gibson®. And we learned the nuts and bolts, from humbucking pickups to "f" hole acoustics.

As for musical electronics, there's no better place to go than Moog®. So that's where we went. And we studied with the people who have an ingenious reputation for putting electronics under the musician's control.



Then we put the Lab Series amplifiers through some heavy studio sessions. And set out to please some heavy artists, like Les Paul and Ronnie Montrose.

Next, we took it to the streets to talk to our most important critics—the people we really built the Lab Series for—working musicians.

And for two years, we kept asking for criticism, until all we got were compliments.

Advancing an amplifier takes advanced technology—something that today's amplifiers haven't really enjoyed. For example, the Lab Series engineers applied new advancements in high voltage transistor technology that let us overcome the problems of low voltage transistors. And that enabled us to create the exact sound our musician advisors

were after. But technology has a lot more to offer. After all, if Moog can engineer an orchestra of sounds into a small, 20 lb. keyboard, we felt an amplifier should offer more control over its voicing. Our new circuits overcame basic amp shortcomings. For example, if you like the overtones you get when you overdrive your amp, chances are you like your sound at high volume levels. But if the room is small, you're either too loud, or too lackluster. The Lab Series Compressor lets you sound great at any volume level, so you can turn on intense overdriving distortion without overpowering the room. You can even equalize your sound to help overcome poor room acoustics.

What's more, we engineered several outstanding sounds into the Lab Series. The Frequency and Midrange controls let you tune into different frequency bands and tone colors the same way you tune in stations on your radio. It also lets you overdrive sections of a chord, so you can create new chord colors that really expand your rhythm horizons.

There's more, including some guitar tricks Gibson helped develop. The Lab Series lets you match the voicing

of your guitar. Sustain notes that swell as you hold them. Vary your picking attack from a punchy delivery that explodes off your pick, to a smooth, even flowing performance. The Multi-

filter control rearranges the high harmonics to add an acoustic guitar flavor. And get rid of those transient peaks of overload that send recording meters into the red.

But technology doesn't mean much if an amp can't take the punishment of the road. Lab Series amps are rugged, reliable and lightweight. With pine sides that fingerlock at each corner. Eight steel corner caps. An oversize heat sink. Even 8-teenuts

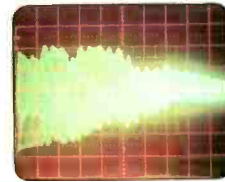
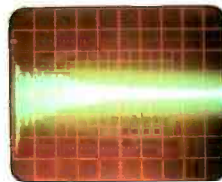

Uncompressed sound (left) vs. Compressed sound. Note difference in loudness and time relationships.

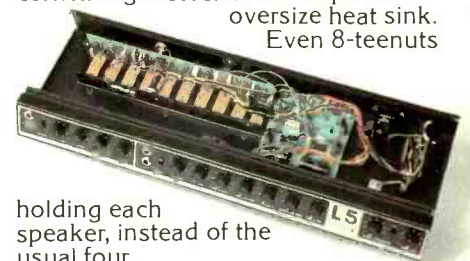

holding each speaker, instead of the usual four.

We put a lot of thought into the Lab Series. And so did a lot of other people. The result is an amp that pleases the critics, like you and your audience.

And that's why there are only two types of amps today...the old ones, and the new one—the Lab Series.

## LAB SERIES

7373 N. Cicero Avenue, Lincolnwood, Illinois 60646  
51 Nantucket Blvd., Scarborough, Ontario, Canada

Write for free Lab Series brochure.

CIRCLE 73 ON READER SERVICE CARD

[www.americanradiohistory.com](http://www.americanradiohistory.com)



**THE NEW  
GENERATION OF  
RECORDING  
INSTRUMENTS IS  
AVAILABLE AT THESE  
TASCAM DEALERS:**

**ALABAMA**

Birmingham  
Sonic Associates Inc.  
Gadsden  
Roy Grantlands Sound World

**ALASKA**

Anchorage  
Team Electronics  
Juneau  
Alaska Music Supply

**ARIZONA**

Phoenix  
Bruces World of Sound  
Tangent System

**ARKANSAS**

Fayetteville  
BSC Audio

**CALIFORNIA**

Burbank  
United Sound Systems  
Chico  
Sounds By Dave  
Costa Mesa  
The Express Sound Co. Inc.  
Hollywood  
Audio Industries  
Long Beach  
ACT Electronics  
Los Angeles  
Audio Concepts  
Federated Electronics Inc.  
West LA Music  
North Hollywood  
Everything Audio  
Oakland  
Leo's Music Inc.  
Redwood City  
Accurate Sound Company  
Sacramento  
Advance Sound &  
Electronics Inc.  
San Diego  
Apex Music Co. Inc.  
Pacific Recorders &  
Engineer Corp.  
San Francisco  
Sound Genesis  
San Jose  
Alco Paramount  
Electronic Corp.  
Guitar Showcase  
San Louis Obispo  
Warehouse Sound Co. Inc.  
San Rafael  
Bananas At Large  
Santa Barbara  
Fancy Music  
Torrance  
Quantum Audio  
Upland  
Sun Tronics  
West Los Angeles  
The Eighth Note

**COLORADO**

Denver  
DTR Sound Corporation  
Sight & Sound Entr Inc.

**CONNECTICUT**

Berlin  
Fred Locke Stereo  
Stamford  
Audiotechniques Inc.

**DISTRICT OF COLUMBIA**

Washington  
Shrader Sound Inc.

**FLORIDA**

Fort Lauderdale  
Modern Music  
Jacksonville  
Stereo Systems Inc.  
Miami

Ace Music Center Inc.  
Hi-Fi Associates  
World Electronics  
Orlando  
Discount Music Center Inc.  
Pensacola  
Grice Electronics Inc.  
Tallahassee  
Norton Music  
Tallahassee Music Studio Inc.  
Tampa  
Audio Visual Services

**GEORGIA**

Atlanta  
Citizens Jewelry Co.  
Environmental Electronics  
Meltons  
Chamblee  
Pro Audio Atlanta  
Tucker  
B & H Distributing

**HAWAII**

Honolulu  
Audissey  
Electronic Views Inc.  
Mountain View  
Rain Recording

**ILLINOIS**

Arlington Heights  
Roy Baumann Music  
Chicago  
Continental Music House  
Midwest Enclosure  
Midwest Sound  
Sound Market Recording Co.  
Cicero  
D J Music Ltd.  
Collinsville  
Swing City Music  
Marissa  
Ye Olde Music Shop  
Normal  
Glenn Poor's Audio Video  
Palos Hills  
Gill Custom House Inc.  
Pekin  
Milam Audio  
River Grove  
BSC Inc.  
Roselle  
Roselle Music  
Schaumburg  
The Stereo Studio

**INDIANA**

Evansville  
Risley Electronics  
Fort Wayne  
Classic Stereo Pak  
Indianapolis  
Graham Electronics Supply, Inc.  
South Bend  
Audio Specialists  
Communications Systems  
The Stereo Scene

**IOWA**

Des Moines  
Triad Productions, Inc.  
Victor's House of Music  
Iowa City  
Advanced Audio  
Engineering Inc.

**KANSAS**

Hays  
Hayes Music Company  
Lawrence  
Innovative Electronics  
Overland Park  
David Beatty Stereo  
Wichita  
Superior Sound

**KENTUCKY**

Covington  
American Sound &  
Electronics Inc.  
Louisville  
Hi Fi Corner  
McDonald Sound Goods  
Paducah  
Risley Elect.  
Rowton TV & Sound Corp.

**LOUISIANA**

Baton Rouge

Home & Commercial Audio  
Kadairs Inc.  
Monroe  
Specialty Sound  
New Orleans  
Sound Enterprises Inc.  
Southern Radio Supply Co. Inc.

**MAINE**

Portland  
New England Music Co. Inc.

**MARYLAND**

Elkton  
Mars Piano & Organ  
Timonium  
Sound Factory  
Wheaton  
Washington Music  
Sales Center Inc.

**MASSACHUSETTS**

Boston  
Lebow Labs Inc.

**MICHIGAN**

Ann Arbor  
Ann Arbor Music Mart  
Detroit  
Fiddlers Music Company  
Farmington  
Sound Patterns DXM  
Rec. Studios  
Grand Rapids  
Audio Distributors Inc.  
Jackson  
Jackson Music Mart  
Kalamazoo  
Sound Room  
Livonia  
Audioland  
Mt. Clemens  
Audio Land Men of Music Inc.

**MINNESOTA**

Minneapolis  
Audio King, Inc.  
AVC Systems, Inc.  
Moorhead  
Marguerite's Music

**MISSISSIPPI**

Jackson  
Sound & Communications Inc.

**MISSOURI**

Kansas City  
Burstein Applebee Co. Inc.  
David Beatty Stereo  
Superior  
Springfield  
Mr. Music's Rock Shop  
St. Louis  
Antech Labs Inc.

**NEBRASKA**

Omaha  
Seco Labs, Inc.

**NEVADA**

Las Vegas  
Commercial Sound Studios

**NEW JERSEY**

Burlington  
Eastern Audio  
New Brunswick  
Hi Fi Haven Inc.  
Paterson  
Professional Audio Video Corp.  
Oakhurst  
Sound Arts Co. Inc.  
Scotch Plains  
Audio International Corp.

**NEW MEXICO**

Albuquerque  
Hi Fi House  
Maynards

**NEW YORK**

Albany  
Seiden Sound  
Amherst  
Transcendental Audio Ltd.  
Buffalo  
Purchase Radio  
Unistage Inc.  
Hemstead  
Professional Sound Labs Inc.

Ithaca  
Stereo Shack of Ithaca  
Jamestown  
Transcendental Audio Ltd.  
Massena  
Michelle Audio  
Morris  
Boynton Studio Inc.  
New York City  
Harvey Sound Inc.  
Lyric Hi Fi Inc.  
Manny's Musical Instruments

**NORTH CAROLINA**

Burlington  
Don's Music City  
Charlotte  
Reliable Music  
Sounds Impressive  
Greensboro  
Audio Unlimited of  
No. America  
Raleigh  
Sound Ideas  
Winston-Salem  
Long Engineering Corp.

**OHIO**

Akron  
Audio Hall  
Chillicothe  
Appalachia Sound  
Cincinnati  
Swallens Inc.  
Columbus  
Custom Stereo Electronics Inc.  
Palmer Stereo Center  
Sound Advocate Inc.  
Dayton  
Dayton Communications Corp.  
Niles  
United Electronics  
Parma  
Winter Radio Inc.  
Youngstown  
New York Music  
United Electronics

**OKLAHOMA**

Oklahoma City  
Ford Audio & Accoustics Inc.  
Stillwater  
Stillwater Music Center  
Tulsa  
Ford Audio & Accoustics  
Imperial Sound Inc.  
Music Sound World

**OREGON**

Oregon City  
Electronic Control Co. Inc.  
Portland  
Rex Recording Co.

**PENNSYLVANIA**

Allentown  
Heiffrich Recording Lab.  
Narberth  
Barclays Electronics  
New Brighton  
Television Parts Co.  
Pittsburgh  
Audio Innovators Inc.  
Wynnwood  
Barclays Electronics

**SOUTH CAROLINA**

Columbia  
Pecknel Music Co.  
Florence  
Whitestone Inc.  
Greenville  
Pecknel Music Co.

**SOUTH DAKOTA**

Sioux Falls  
U A Recording

**TENNESSEE**

Bristol  
Joe Morrell Music Co.  
Chattanooga  
Music Mart  
Memphis  
Strings & Things  
Nashville  
Audio Systems Inc.  
Hi Fi Corner Inc.  
Nashville Studio System

**TEXAS**

Amarillo  
Billy's Band-Aid  
Dallas  
Recorder Center  
El Paso  
Casa Sonida, Inc.  
Garland  
Arnold & Morgan Music Co.  
Houston  
Sound West of Texas  
Irving  
Audio Video Designs  
Odessa  
Electronic Service Centers  
Richardson  
Collins Radio  
San Antonio  
Bill Case Sound

**UTAH**

Ogden  
The Hi Fi Shop  
Salt Lake City  
Broadway Music  
Sound Systems

**VIRGINIA**

Norfolk  
Ambassador Sound  
Music & Sound

**WASHINGTON**

Bellingham  
Quad Corner  
Seattle  
Electricraft Stereo Centersinc  
Electronic Music Box  
Joe Farmer Music Inc.  
Spokane  
Hoffman Music Co. Inc.  
Wenatchee  
Belmont Music Center Corp.

**WEST VIRGINIA**

Huntington  
Pied Piper Inc.

**WISCONSIN**

Green Bay  
Sound Design  
Madison  
American TV & Appliance  
Spectrum Audio  
Milwaukee  
Harry Melcher

**TASCAM SERIES  
BY TEAC®**





# THIS IS WHERE TOMORROW'S GREAT MUSIC IS COMING FROM.

We think musical styles change because musical talents change.

There is hardly a musician making money today who doesn't know as much about recording music as he does about playing it. And recordists know as much about playing music as they do about recording it.

Because both know the equipment that captures music can also be used to improve it.

So while musical styles may change, the interdependence of musician, recordist, and the instruments they use will not. And that is the reason for the TASCAM Series by TEAC.

For not very much money TASCAM lets both musician and recordist get their hands on mixers and recorder/reproducers that let both tailor their music their way.

The Model 5-EX shown with four Model 201 input modules.  
Model 5 shown with Model 204 talk back/slate modules.

For every kind of music, for every kind of need, at home and on the road, by price and application, everything we make

has the same goal as everything you make—be the best.

Because it still takes great talent to make great music.

## TASCAM SERIES BY TEAC®

A new generation of recording instruments for a new generation of recording artists.

TEAC Corporation of America  
7733 Telegraph Road  
Montebello, California 90640

In Canada TEAC is distributed by White Electronic Development Corporation (1966) Ltd.





# From Tape To Disc

## Disc Mastering Part II

Last month we painted a rather dark picture of the record mastering process—which is understandable, since to begin with most records are black. However, as we shall soon see, there is a bright side to all of this.

Just a quick review of last month. We mentioned the space limitations (both lateral and vertical) on records, and tracing distortion (the round peg in the triangular hole), which tends to have an adverse effect on the high-frequency information. We briefly discussed how to get two signals out of one groove. You'll just have to take my word for it that it works pretty well, since an in-depth discussion of that aspect of groove geometry easily would fill the next dozen issues of *MR*.

did. The effect is that it (the playback stylus) tends to be pinched out of the groove. Thus it either "chatters" through the section (too much high-frequency information), or there is a slight vertical aberration with lower-frequency information. The latter example is rarely noticeable, while the first type is the most annoying.

Tracking error on the other hand is a

Photomicrographs (clockwise from left).

Fig.1: (A) Lateral modulation—100 Hz sine wave.

Fig.2: (B) Lateral modulation; 10 kHz sine wave (in-phase).

Fig.3: (C) Vertical modulation; 1 kHz sine wave (out-of-phase); (D) Right channel modulation (no left channel modulation); (E) Left channel modulation (no right channel modulation).

Fig.4: (F) Lateral sine wave modulation (1 kHz); (G) No modulation; (H) 300-400 Hz sine wave.

Photos by David Moyssiadis  
Courtesy of Frankford/Wayne Mastering Labs, Phil., Pa.

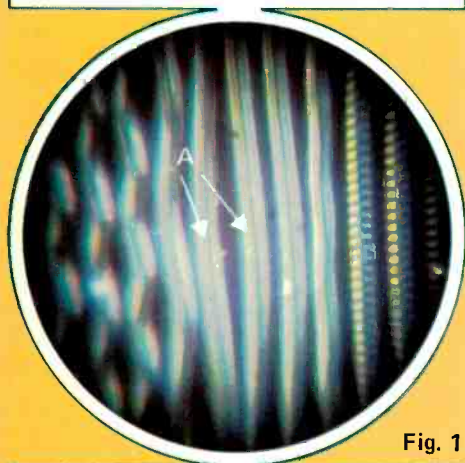

Fig. 1

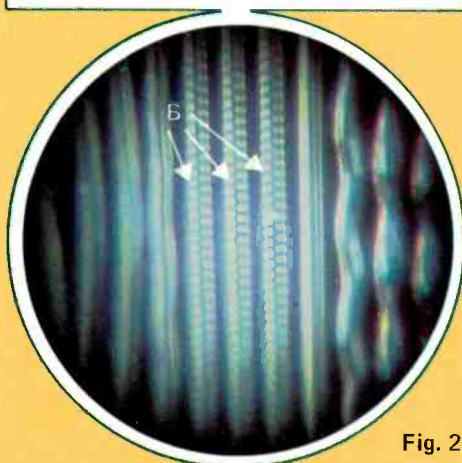

Fig. 2

By Dave Moyssiadis



Fig. 3

Also, we talked about making trade-offs and compromises in order to get the things we want. In disc work, that is what it really boils down to—either having your cake or eating it; or having some of your cake and eating some of it. From the mastering standpoint having the cake isn't really necessary—just eating it is. I promise I'll explain that soon.

### Tracing and Tracking

We promised [last issue] to explain the difference between tracing and tracking errors. As you know, tracing distortion is the inability of the playback stylus to fit into the groove in the same manner the record stylus

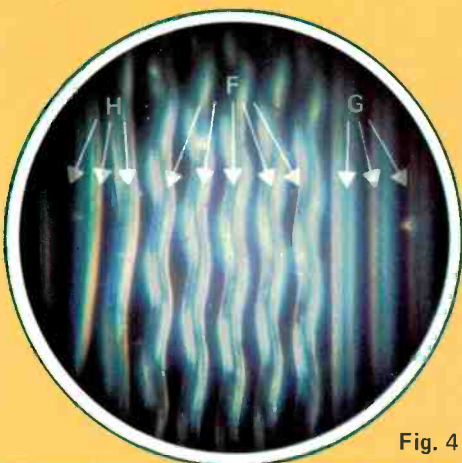

Fig. 4

result of trying to make a pivoted tone arm keep the cartridge on a tangent with the record groove. The recording lathe travels across the disc on a perfect tangent in a straight line. We are all familiar with how the record player tries to do it. With a straight arm there is only one point at which this tangency is achieved. With a bent arm we still can find only two points

on the whole record where the playback stylus lines up with or tracks the recording stylus. The rest of the time the playback stylus is cocked in the groove. This results in another cause of distortion.

We have all played a record and heard the first notes before the record actually began. This is called "pre-echo" or "groove-echo." It is similar or rather analogous to print-through on tape. It starts in the mastering stage where the grooves are too close together, and the problem is compounded in the plating and pressing stages. The only known way to effectively reduce this is to spread the grooves apart at the beginning and end of each song—where it is most apparent. And as with



most things, different types of program material are affected differently. Piano, with its incredibly high peak attack, usually is the most troublesome in both mediums.

## Diameter Losses

Diameter losses are what happen to the high-frequency response as the record gets in closer to the inner diameters. On some records you may notice that if you play the first cut and then skip to the last cut (similar material) there will be a noticeable drop in the treble, almost as if you turned your treble control down a bit. The reason for this is that the groove is traveling much slower near the label area than it is at the beginning of the record. As a matter of fact, the first revolution of the recording is traveling slightly over twenty inches per second, but by the time you get to the innermost permissible groove on an LP, because of the smaller diameter, the groove is only moving at about 8.3 inches per second.

Similar velocities for a seven-inch 45 RPM record are 15.6 ips at the outermost groove of recorded program and 10 ips at the innermost recorded groove. For the benefit of any walking computers out there who have noted the discrepancy between the 45 and LP inner diameters, it is a little-known fact that a 45 record goes in about half an inch closer to the center on diameter ( $\frac{1}{4}$ -inch closer radius) than the 12-inch LP. You people with sharp eyes will note that a 45 label is smaller than an LP label. The LP label is four inches in diameter and the 45 label is correspondingly less. But what we do about the inner diameter losses?

Years ago when it was a miracle if any highs got on a disc to begin with, there was an automatic compensation made. This simply consisted of an equalizer mechanically linked to the lathe carriage which turned up the high-frequency response 2-4 dB as the carriage moved in toward the center of the disc. Years later as technology improved and it was taken for granted that highs could easily be put on the disc, disc people were so pleased with themselves that the compensating device was eliminated from lathe design (perhaps in over-compensation of technology). Today there is a more realistic approach appearing as more knowledgeable mastering engineers will include such compensation in their over-all "artistic" approach. There is

another easier method: we close our eyes and pretend it isn't there, and 99% of the time it isn't even noticed.

The reason we no longer compensate becomes obvious as you think about it. If the oval stylus is too large to fit into the notch made by the chisel-shaped record stylus, it does little good to make the notch any deeper. If you can't get your finger into a small hole in a wall it doesn't help to make the hole deeper. This is directly analogous to tape. Once you pass the point of tape saturation with high frequencies, adding more treble only leads to more problems. Again, with disc, a lot of this is dependent on program material. On certain program content where the original high-frequency information is minimal it is possible to compensate and effectively boost highs on the inner diameters.

## Blood On the Tracks

Now to the nitty-gritty. You've got this tape. You've placed an order for a few thousand records. You get the records. *But . . .* the records don't sound anything like your original tape. The bass isn't there, the cymbals sound like trash can lids, the record sounds muffled. It's not nearly so loud as Elton John's latest and it's as noisy and scratchy as a bag of kitty litter.

Immediately you run back to the record plant with blood in your eye demanding an explanation from the manager. He matter-of-factly says that it is not his fault, he can't help what the plating company did. Furious, you grab the nearest blunt instrument and head for the plating plant, where the manager there says you can't blame him, it's all in the mastering. This time you take out a firearm permit and a hunting license, and blast your way into your friendly neighborhood disc mastering place. There you hear that all those scratchy sounds are the fault of the pressing plant. But, you still have the business end of a shotgun resting on the bridge of the mastering engineer's nose. What about the bass? What about the cymbals? *What about the level?* Calmly, he explains why all those problems occurred. Just as you have read in these two issues.

Specifically, in order to keep the record from turning white on the first playing a good deal of the treble had to be rolled off (all because of the too-loud cymbals). That's why the whole record sounded muddy. Don't forget, what

ever you do to correct one thing on the tape happens to everything else on the tape. It is *not*, repeat *not*, possible to remix a master tape in the mastering stage. The old, worn-out, procrastination-inspired cop-out "we'll fix it in the mix" has degenerated into passing the buck with the phrase, "Don't worry about it, that can be taken care of in mastering." *Wrong!* The only way to take care of something in mastering is to nearly annihilate everything else. If the cymbals are too loud they can't be lowered without lowering all of the high end. If the vocals are too low they can't be brought out. Sometimes we can cheat with the equalizers and make apparent changes, but again, not only will the vocals sound a bit louder but so will everything else in that range, such as the guitars, etc. In addition, the bass and bass drum will change character.

The bass was not predominant on your record because there was too much "mud" in it. This caused too much lateral excursion (using up too much room), so that had to be altered accordingly. Finally, the level was so low because the record was very long. A simple trade of level for time had to be made. But the surface noise probably *did* come from the pressing.

## Avoiding Trouble

Needless to say, the above episode was an extreme case. But these things do happen, although hopefully, not all at once. So what do you do to avoid any of the above? Simple. Take a course in accounting and go for your CPA. On the other hand, if you are a masochist like the rest of us. . . . First, choose a reputable studio that has been around for a while and has a staff that has been around for enough time to know that the concoction they mix onto the tape will eventually have to be crammed onto a disc. Or just be sure your mix-down guy has his act together, and you can relax.

If you're out there like a babe in the woods and haven't the slightest idea of what constitutes a good studio and/or good engineer then you have to work hard at it. Watch the guy like a hawk, but try to respect his abilities. Make sure your bass and bass drum are clear, clean and well defined—not too muddy. Don't try to get into the building demolition business with your low end. Try to keep all the low-frequency stuff in the middle—dead

center—if at all possible. There are records that have the bass off to one side, but the people who have done that sort of thing knew exactly what they were doing (I presume) and took certain precautions (and still gave the mastering engineer nightmares). Besides, if you put the bass on one side you only have one speaker pushing out the bass. If you use the center, both speakers are pumping it out and you get just as much bottom but it's cleaner because each speaker doesn't have to work as hard. Remember, the vast majority of power is expended in the low end.

Keep sibilant sounds from being recorded. If you have a vocalist that could win a hissing contest with a snake, proper mic selection can save your life. Usually a velocity or ribbon such as the old RCA 77 DX or the old 44s will prevent the damage, and also smooth out a thin-sounding voice. Once the esses get into the system it's too late. The equipment has already been pushed to the limit and if you can save it at all you will have to do a fix with a de-esser. Now isn't it easier to stop it before it becomes a problem, like at the microphone? Same goes for cymbals, wind chimes, finger cymbals, bell trees, etc. The thing to do is to just keep things under control at the control panel. If the speakers sound like razor blades and your ears start to bleed, it's time to back off somewhat on such instruments—mix them in at judicious levels.

Keep your program *balanced*. In other words, left and right should *sound* balanced and read just about equal on each meter. Avoid outlandish peaks, and keep the level up. Master lacquers are quiet, pressings are a different story. In general, if the mix is good, sounds good and is a good balance chances are that there will be little trouble in the mastering stage. Be sure everything is in phase. If some mics are out of phase or the board wiring is out of phase it will wreak havoc with the cutter head. If the above principles are adhered to you should expect to get pressings which are readily recognizable as your work. If there is too much bass (even though you want it there) it will undoubtedly be removed by the mastering engineer.

### Sitting In

If you are still unsure of how well your tape was recorded with regard to

disc transfer, sit in on your mastering session. Time was when disc cutters were a breed of back room introverts, who went about their toils behind closed doors—their very existence unknown to the world. Tapes went off someplace and magically thousands of little, round, black plastic frisbees appeared. No longer. The disc-mastering

### Helping Out

One thing that should be included with all your tapes is a set of tones. If the tape is Dolby encoded there first should be a Dolby tone at Dolby level, then there should be a 1 kHz tone at the recorder's operating level to set balance, following that should be a 10

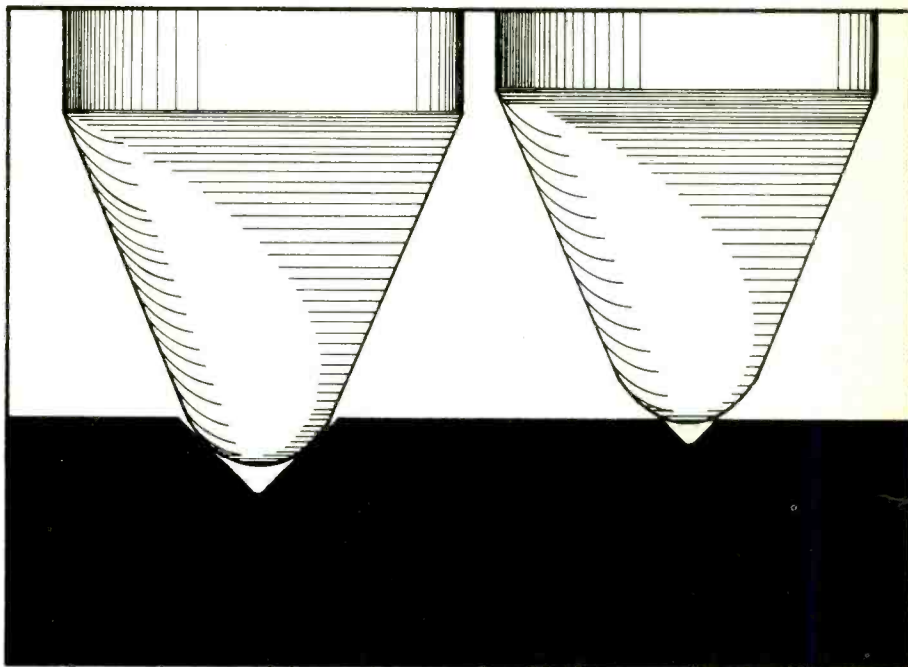

Playback stylus (left) in groove of sufficient depth; playback stylus (right) in groove of insufficient depth, where groove is unable to hold stylus.

process has been discovered. Now producers have one more chance to futz around with their tape. For the privilege of harassing another technical person, you must of course pay. It often will cost you more to kibitz with a mastering engineer than it will to have your masters cut. But it may well be worth the expense to see exactly what happens when your tape is transformed into record format. You also get the instant gratification of being able to shove a 14-inch master blank down the engineer's throat if he doesn't do what you want. (This procedure is not recommended, since it is difficult—if not impossible—for mastering engineers to work at peak efficiency in that sort of condition.) Nevertheless, once in a while it might be nice to see and get to know the guy who does your mastering work. That way you will have a mutual understanding. He will know what your preferences are and you will understand some of the problems that he may encounter.

kHz tone for azimuth (even if your recorder is out of alignment, the mastering playback machine can be realigned to play back the way your machine recorded it), then 100 Hz and/or 50 Hz tones to see what the low end is doing. These tones are important if you want to get the most out of your tape. They should be put on the tape immediately before the recording is made, and on the same machine used to record. If you forgot to put the tones on and the machine settings were since changed, don't bother. The idea of the tones is to reflect what the recorder was doing with its input. If the recorder was out of alignment when the recording was made, don't adjust the tone afterwards to make them look good or you'll defeat your purpose. The tones are worth a handful of valium to a mastering engineer.

You can also prevent your disc-mastering engineer from heading for the pills by properly preparing your tape for disc transfer. A single should have head and tail leaders at least five



*It's not for you.  
It's for them.*



Why do you think it's called public address?

The audience is there to have a good time. You're there to work. But, if you're not projecting the sound you've worked so hard to perfect, you just wasted all those long hours in rehearsal.

Now that you're increasing your public, it's time to address yourself to an investment in PA. Check out Yamaha's EM-Series of affordable, fully-integrated sound reinforcement systems.

The EM-80, 100 and 150 integrated mixer/amplifiers. From four to six input channels, from 60- to 150-watts RMS. Link them together for even greater flexibility. They're reliable and roadable because they're built Yamaha tough.

Yamaha's unique stereo balance control lets you optimize sound levels in different parts of a room. Practically any setup is possible with combinations of microphones and electric instruments taken direct, amplified and submixed.

When it comes to speakers, Yamaha has two impressive models to choose from.

Every component is made by Yamaha to our own exacting specifications. Yamaha's super-efficient, two-way S4115H enclosures with a horn-loaded 15" woofer, HF horn/driver combination with level control, and 100 watts power handling, make perfect mains. On the other hand, our S0112T enclosure with 10" and 12" woofers, four 2" cone-type tweeters, and 80 watts power handling, are ideal as stage monitors or excellent low-cost house mains. Both models have built-in passive crossovers, and are available with built-in power amps.

For all the facts, send this ad along with four dollars. (Please, certified check or money order only. No cash or personal checks.) We'll rush you an operation manual complete with block diagrams on our EM-Series. Or better yet, see your Yamaha dealer and plug-in to an EM. It may be for your audiences, but their enjoyment is going to pay off for you.



Musical Instrument/Combo Division  
6600 Orangethorpe Avenue, Buena Park, CA 90620  
Write: P.O. Box 6600, Buena Park, CA 90622

☐RCLE 42 ON READER SERVICE CARD

seconds long. An LP should have about ten feet of leader at the head and tail of each side and four seconds of leader between each selection or wherever you want a band or spiral. This is essential for the automatic equipment. Again, *don't* forget the tones. A Dolby-encoded tape *must* have a Dolby tone at Dolby level or you can forget quality.

### Time vs. Level

Well, now a few short words about length. Usually the first question is, "How much time can I get on a record?" The answer is easy. How loud do you want the record to be? See, isn't that clever? I answered a question with a question. No, I won't try to avoid the problem. Here are some more cold cruel facts about life in the mastering world. If you want maximum levels with "acceptable" distortion figures, the average LP side should not exceed eighteen minutes and the corresponding figure for a 45 single would be about 3:30. This of course to a large extent would depend on program material. If the entire side consists of bass and bass drum solos, that time would be significantly reduced. On the other hand, if half of the record is upper register harpsichord you can get away with a few more minutes. "MacArthur Park" is the famous seven minute plus record that has lots of level—but only at the end. There is no way that that particular record could have been cut that loud if it were as loud throughout as it was at the end. It was accomplished by utilizing

the variable pitch system, which will be explained shortly.

But the question still hasn't been answered. Actually, you can cut an LP side as long as 45 minutes and still have it track on the average record player. Once, just for kicks, I put 60 minutes on one side. However, the finest playback system today can just barely track it. The 45 minutes by the way would have to be silent grooves. If you want to breath in the studio then the time gets shorter. A practice limit for LPs is about 30 minutes, and even then you are pushing it. If you go much beyond that, about half the record players in the country will set down on the lead-in, skip right across the record and up onto the label. As far as 45s go, try to keep the time under six minutes. Pass that and you start to buy trouble in the form of a high record returns rate. There are some record players such as the "Nineteen Ninety-Five Special" that won't track anything, let alone a 35-minute LP featuring Ludwig Von Leadfoote playing pipe organ. So to narrow it down, a reasonably long LP with reasonable level should be 18-24 minutes, and a single should be 4-5 minutes. [Both figures are per side.] Remember almost anything can be put *on* a disc, if you insist. Your problems begin when you try to get it *off* the pressing.

that we couldn't have our cake and eat it too, *but*, that we shouldn't want to have it, we should just want to eat it.

First of all, present day state-of-the-art equipment will permit +4 dB of level on a 45 rpm single as a practice maximum limit with a reasonable degree of distortion (on an LP this limit is 0 dB). Unfortunately it is hard to relate to these figures as they are not the same thing as tape levels. Tapes are referred to nanowebers/meter and the present range is 185 to about 250 nanowebers/meter to give a 0 dB output. That is a reference to magnetic power. The range just mentioned is about 3 dB. In disc parlance this translates into stylus velocity (not to be confused with groove velocity) of cm/sec. Current standards refer to 7 cm/sec. to give 0 dB. The older standard was 5 cm/sec., which was approximately 2 dB lower. So to make matters worse some companies still use the old standard and claim that they are cutting a record at +6 dB—which would be lunacy at the new standard. It is really +4 dB. Confused yet?

Well, the figure 7 cm/sec. simply means that if the stylus were to travel sideways (which it does), it would move 7 cm every second. It does this however by going from side to side and reaches a peak velocity of 7 cm/sec. These are only permissible standards. The limitation is again in the playback equipment. Present day cutter heads actually can drive styli to peak velocities of 74 cm/sec., which is above anything that can be played back. This is actually corresponding to record levels of +15 dB or better! No play-

### Creating Hot Problems

This brings us to the question of "hot" levels and not so "hot" levels. At the beginning of this article we said

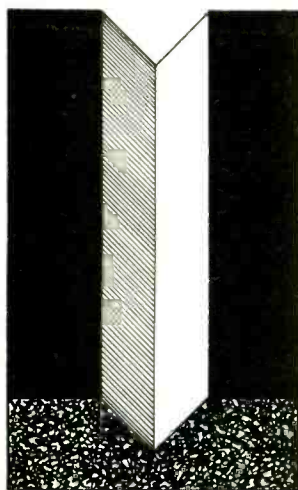

Unmodulated record groove.

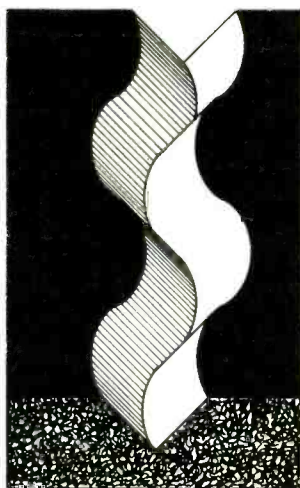

Lateral modulation (sine wave); monophonic or in-phase signal.

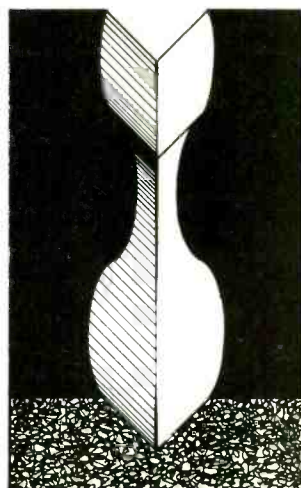

Vertical modulation; out of phase signal.

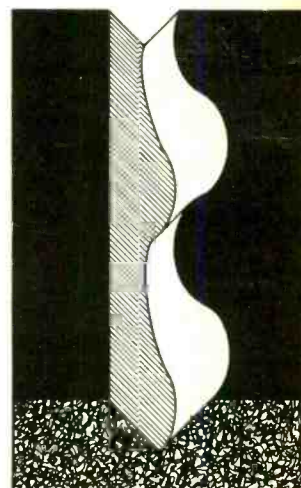

Left channel modulation only.



back system today can even begin to track those kind of levels. But the real question: why would any one want to?

Hot levels create unnecessary problems. In actual practice, when there is difficulty with a particular record, there are two ways to solve the problem. The first would be to adopt extraordinary measures such as rolling off the bass, or the top, or squashing it with a limiter, or to eliminate too much vertical lift, bleeding the left and right so much as to make the record almost mono. The second solution, which usually solves almost *any* problem, is to drop the level by only 1 dB. In reality, 1 dB is almost unnoticeable! But most people would prefer a night on the rack rather than sacrifice that insignificant iota of level. Hot levels bring you into distortion—not to mention the other problems—and cause the record to wear much faster. It will cost in cleanness too. Have you ever noticed how a record—no matter how old, worn and distorted it is—almost always sounds cleaner and clearer on the fade-out? That is an example of what you could have if only there wasn't this incessant demand for high levels—both in the mix studio and the cutting room. First of all, it does absolutely no good to bludgeon the mix-down engineer into bending his VU meters over the pin. No matter what the level on the tape is, it will be knocked down to within reason so it can get onto a disc. That works the other way too. If it is too low on the tape, it will be brought up to the maximum possible along with the hiss on the disc.

The preceding discussion has been from a purely technical standpoint. I realize that you have to go out into the real world and compete with other records which were cut hot. That is really a sad situation. If only we stayed a dB or two under the absolute maximum and let records compete on musical value rather than on how much distortion you can get away with, we would have a much better final product. If you want to hear a loud sound, the place to turn up the volume is on the two-kilowatt amplifier, not an unnoticeable dB in a microscopic groove. The situation could be likened to pulling a railroad train with a small motorcycle and supercharging the motorcycle in order to go one mph faster, when what you really need is a diesel locomotive. Well, before this begins sounding like a sermon, let's get on to another aspect of this medium.

### Quiet Masters

Here is the bright side. It may be interesting to note that there is very little noise generated by the disc mastering system. Master lacquers are at least as quiet (without any noise reduction at all) as most professional tape recorders are *with* noise reduction. Sometimes they are even quieter, depending on the stylus and the particular batch of lacquers.

A worn stylus will of course cut a noisy groove, but such a stylus would become immediately apparent under the 'scope. Any mastering house

worth its salt will never let a stylus get to the dull point of noisyness. Usually a test cut is first made on the outer edge (outside the 12-inch diameter of a 14-inch blank) to check groove depth and pitch. A bad stylus would at that point be immediately discovered. The cut is then played, and, if the stylus is beginning to wear, the silent groove will not be so silent. Again the stylus will be replaced before a master is cut. After every master or reference dub is cut it is inspected under the 'scope. Here again the groove is checked for a sharp stylus all the way through. A dub is played to confirm quality; a master should never be played. The acetate is like butter when compared to the relatively iron-like vinyl, and if played would ruin the master. If something goes wrong, such as the stylus hitting an imperfection below the surface of the disc, usually the stylus is ruined and again this would be evident upon inspection with a microscope. If there is an imperfection in the surface, it will be found during the initial inspection of the lacquer, and the lacquer will be discarded.

There have been attempts recently to revert back to the old way of making records by avoiding the tape medium completely and recording directly onto disc. Unfortunately, we have become so dependent on our myriad of sound mangling devices—such as automated mix and so forth—that it is difficult to do a really good job of recording an entire ensemble "live," keeping the levels from shooting through the dropped ceiling and getting the mix just right. In

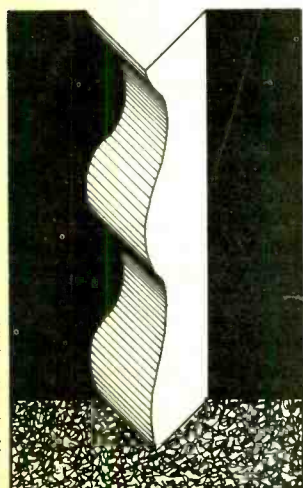

Right channel modulation only.

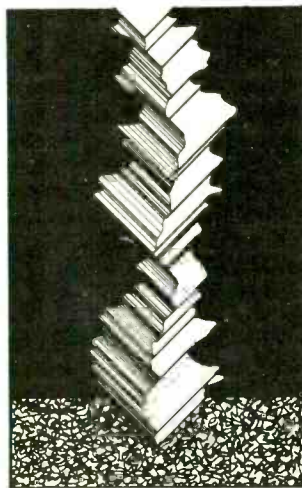

Complex stereo signal—similar to typical musical program.

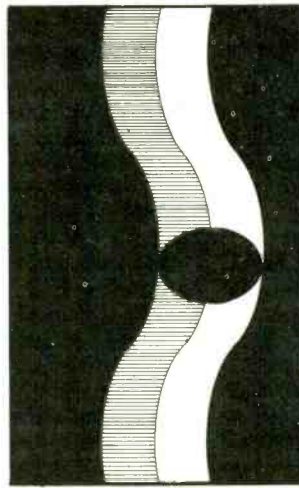

Elliptical playback stylus tracing low-frequency modulated groove.

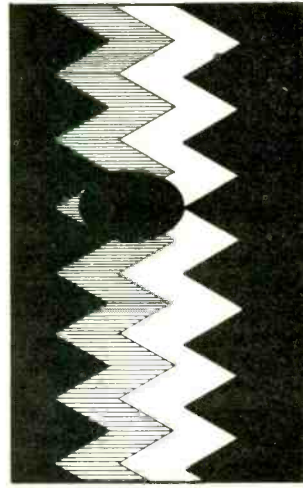

Elliptical playback stylus improperly tracing high-frequency modulated groove (causing distortion or "smearing").

short, doing a one-shot stereo mix "live." (The way they used to do it before 32-track synced recorders . . . even before three-track recorders!) All the above problems, combined with the difficulty of getting forty musicians to play for eighteen minutes straight without making a single noise or mistake between them, makes a rather monumental task of such a project. Kudos to those who have tried. Their efforts have at least given us a glimpse of what is possible and of how immaculately clean a record can be.

Unfortunately, the limit is eighteen minutes even if you could persuade a group of musicians to do the near-impossible. Don't forget that with disc if there is only one mistake, even at the very end, the whole thing must start from the top again. Try to recall how many mistakes were made the last time you were in a recording session and multiply that by eighteen minutes. *That's* how long these poor guys would have to be playing without a break. Talk about a bill for overtime!

Now after all this blapping about how quiet master lacquers are, you're probably saying to yourself, "Man, is this guy full of crap. That last record I bought sounds like it was pressed on asphalt." Well, you are pretty close to the truth (about the asphalt I mean). Most of the problems encountered originate in either plating or pressing, and I'm not just saying that because I do mastering. It's just that noise can be generated in many ways in those two processes.

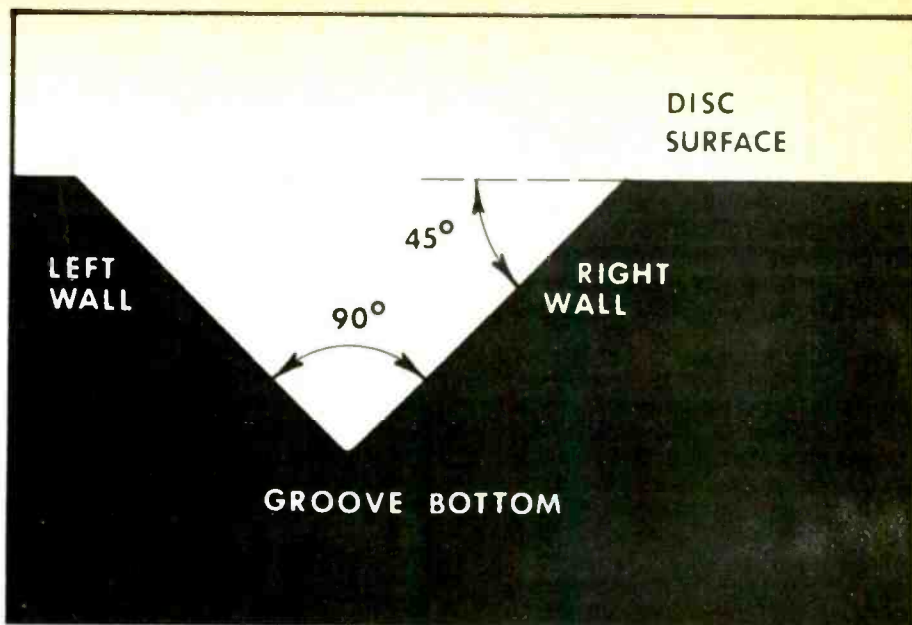

Cross section of groove showing the important angles.

In mastering, noise is readily detectable and easily remedied. Not so easily in plating and pressing. First of all, in mastering there are usually only one or two parts made and you have time to closely scrutinize nearly every millimeter of the surface with a microscope. A pressing plant may be turning out a million copies of the master. Clearly it would drive the cost per record up to about twenty dollars to get excellent pressings. It can actually be done, but the consumer doesn't insist that the thing he buys be top quality. He will unfortunately settle for nearly any kind of junk, and he gets it. Some

pressing plants don't care and others can't afford to, with regard to obtaining the highest possible quality. And make no mistake, quality costs. Some plants use re-ground records and cheap compound. Some don't know how to cycle the presses for optimum speed and proper orientation. This lack of knowledge results in a warp if the cooling cycle is too short, or something called "non-fill" if the heating cycle is too short. Non-fill occurs when the vinyl does not reach every part of the groove. You can hear it usually as a once around gravelly sound. None of these things can occur in the mastering stage, although we get blamed for almost anything that goes wrong with a pressing. But we are already into another topic.

### Fixed and Variable

Let's talk about the amazing and dazzling variable pitch/depth machine. Before this system was developed all records were cut "fixed pitch." This meant that the grooves were all evenly spaced and the carriage moved toward the center of the record at a constant speed. The pitch was a simple calculation of available space relating to angular velocity and time. Level was solely dependent on the resultant pitch. If the record was soft until the very end, as in some classical music, the level had to be set for that maximum point and all else had to fall below that no matter how low it was. That system wasted large amounts of space and cost dearly in level.

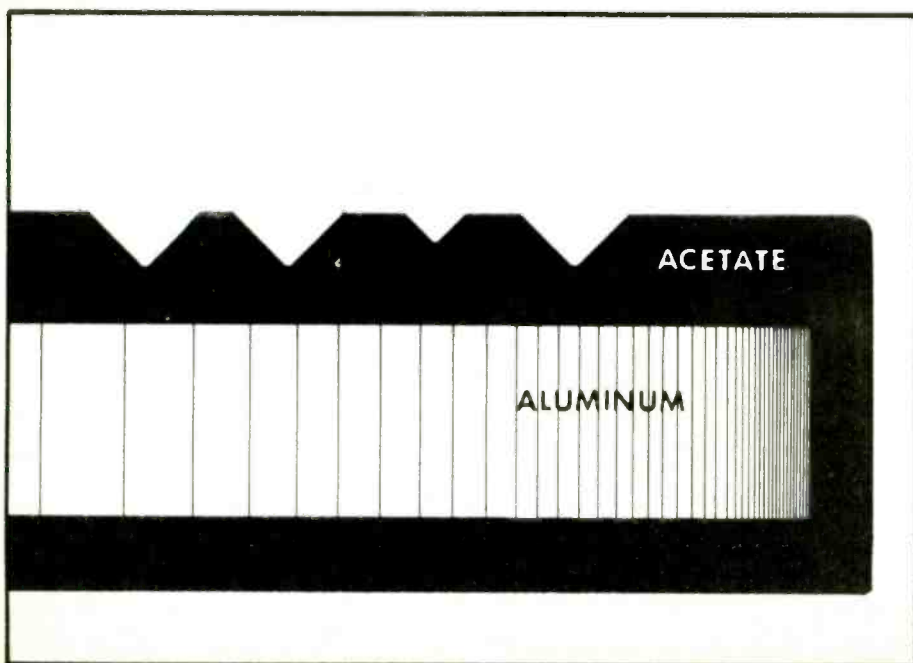

Cross section of master blank with grooves cut into its surface.



# 8 to 18 from 749...

## **TROUPER**

### Live Music Mixing System

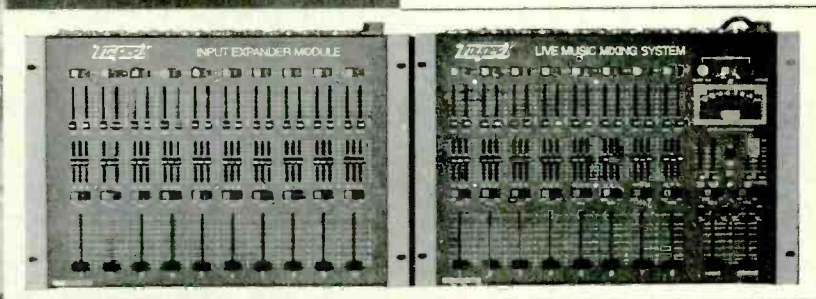

#### INPUT FEATURES

- BALANCED MIC INPUTS
- HIGH Z LINE INPUTS
- IN/OUT JACKS
- 20dB ATTENUATION
- MONITOR SEND
- ECHO SEND
- 3-BAND GRAPHIC EQUALIZER
- SOLO/PREVIEW SWITCH
- LEVEL CONTROL

#### OUTPUT FEATURES

- SOLID STATE LED VU METER
- HEADPHONE JACK/LEVEL CONTROL
- BUILT IN SPRING REVERB
- HIGH/LOW CUT FILTERS
- HOUSE/MONITOR LEVEL CONTROLS
- HOUSE/MONITOR OUTS

See your local dealer or write for our free catalog:



A BSR COMPANY

742 Hampshire Rd.  
Westlake Village, CA 91361

(805) 497-0766

**TROUPER I Live Music Mixing System, expandable from 8 inputs (\$749 suggested retail value) to 18 inputs (\$1447 suggested retail value).**

CIRCLE 23 ON READER SERVICE CARD



itch system on the  
 s the program one  
 o the point at which  
 orded. This is ac-  
 eans of a preview  
 nply another play-  
 head on the deck spaced, by  
 means of a special tape path, a  
 distance equal to one revolution (about  
 1.8 sec.) in advance of the program  
 playback head. By knowing in advance  
 what is about to occur in the program  
 (with regard to level) this system takes  
 advantage of the quiet passages by  
 keeping the grooves as close together  
 as possible. Thus it conserves space,  
 and when a loud passage comes along  
 it can spread the grooves as far apart  
 as necessary to keep from overcutting.  
 The preview head also "reads" the ver-  
 tical information, and if there is out-of-  
 phase signal which would cause bad  
 vertical lift, it sends a signal to the cut-  
 ter to drive the stylus down deeper  
 into the lacquer—thereby reventing  
 the cutter from lifting off the surface.  
 Now this part gets complicated be-  
 cause if there is a deepening of the  
 groove, this extra width takes up more  
 room on the disc. So whenever this  
 happens, a signal is sent instructing

the system to accomodate the wider  
 groove and the lateral excursion.

### Future Discs

The older systems were purely  
 analogue devices which operated on  
 the program material itself. The latest  
 units are digital and use computer  
 technology. They sample the program  
 more often and more precisely and get  
 just about the maximum use out of  
 those 86 square inches. In fact, they  
 are so fast and so good, that they ac-  
 tually border on being self-defeating  
 by causing their own problems.

In the future, when technology per-  
 mits, the preview head will be a thing  
 of the past and the whole thing will be  
 done with digital delay. The current  
 problem with doing that today is that  
 the program signal would have to  
 come from the delay signal. This would  
 mean that the realtime signal would  
 have to be wasted on the less demand-  
 ing preview signal. At present, getting  
 a DDL signal of acceptable quality  
 with a delay of nearly two seconds  
 would cost more than an entire cutting  
 system. But when that problem is  
 solved it will be possible to master

directly from an automated encoded  
 multi-track tape, a digitally encoded  
 multi-track quarter-inch tape or even  
 direct from a "live" recording such as  
 we spoke of earlier. These things are  
 not going to arrive tomorrow—if they  
 are in the future at all—but by then we  
 may have a whole new concept of disc  
 recording, including video with audio.

In these two issues we obviously  
 have only scratched the surface of disc  
 recording. It is a highly technical sub-  
 ject involving a fair knowledge of  
 physics, geometry and mathematics.  
 Knowledge of these fields is not  
 essential to get a feeling for magnetic  
 tape recording, but to really under-  
 stand disc cutting such knowledge is  
 necessary, and enables one to appre-  
 ciate the precision and close tolerances  
 of the disc system. Many of the con-  
 cepts are difficult to explain or under-  
 stand without talking about groove  
 geometry, stylus accelerations, groove  
 velocities, vectors and a hundred other  
 facts of physical science. However, the  
 principles covered in this two-part arti-  
 cle should give you a solid idea of what  
 you are up against when you want to  
 put your artistic efforts onto the disc  
 format.



# CLASS

Snake and UltraSnake.

The classic connector cords especially designed  
 for use with musical instruments and systems. The  
 exclusive Snake cable, manufactured for Whirlwind  
 Music by Belden, features a tough neoprene  
 exterior lined with a unique noise-free shield.  
 UltraSnake comes tipped with two solid brass  
 military plugs; Snake with a pair of nicked brass  
 Switchcraft plugs. Both are designed to take the  
 strain of on-stage patching without fraying at the  
 ends. Both are available only at your Whirlwind  
 dealer. There is no substitution.

You get the Snake, or you're left with the hiss.

## whirlwind

P.O. Box 1075 • Rochester, N.Y. 14603 • (716) 663-8820

CIRCLE 69 ON READER SERVICE CARD



# If you can't decide between getting a sunn P.A. system and an inexpensive P.A. system, get both!



At Sunn we've learned that, too often, lean bank accounts get in the way of your ability to purchase a P.A. that will suit your needs. So we've taken the electronics and manufacturing expertise that went into our Automated Sound Systems and applied it to three, new, inexpensive systems with features that reflect the latest in technology and the most musically practical benefits. We call them our ALPHA SERIES. Each Alpha P.A. console (4, 6 or 8 channels) features 100 Watts RMS, Phase-Sync<sup>®</sup> tone controls, high and low impedance operation, and the same "integrated" design of Automated Sound—Generation I. And they start in price at \$299.00 (suggested list price)! Write us for more information. Or better yet, see your nearest Sunn dealer for a free demonstration. After all, music's the thing...and we're here to help!

 **sunn**  
 SUNN MUSICAL EQUIPMENT COMPANY  
 A HARTZELL CORPORATION COMPANY  
 AMBURN INDUSTRIAL PARK  
 TUALATIN, OREGON 97062  
 Name \_\_\_\_\_  
 Address \_\_\_\_\_  
 City \_\_\_\_\_  
 State \_\_\_\_\_ Zip \_\_\_\_\_ 01C.02.7'09 MF  
 \_\_\_\_\_

CIRCLE 22 ON READER SERVICE CARD



# Ambient Sound

BY LEN FELDMAN

## Z Stands For Impedance

In the course of my musings about various audio subjects in this column since it began some two years ago, I have touched upon some complex—and sometimes even controversial—technical subjects. This time I'd like to discuss a fairly basic audio subject—impedance. Professionals and sophisticated recordists may find some of what I'm about to explain old hat, but I have the feeling that many of our readers are often confused about impedance specifications, and perhaps some fundamentals concerning good old "Z" might be worth reviewing.

## Some Definitions

Impedance, like resistance is always specified in ohms. The output impedance of an electronic device may, however, be purely resistive in nature or it may have a reactive component, either capacitive or inductive. Reactive components in a given impedance

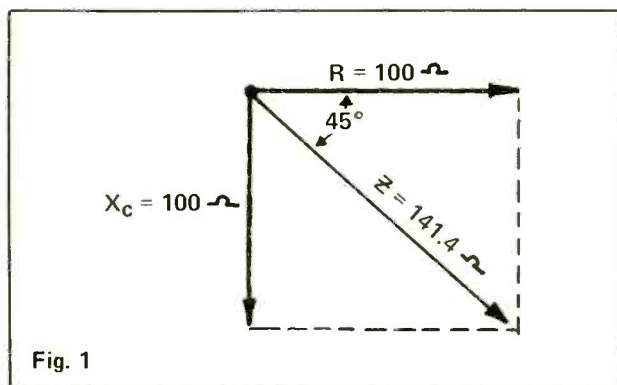

Fig. 1

Resistive and reactive components must be "added" vectorially to arrive at composite "net" impedance, "Z."

have the effect of introducing phase shift, or time delay to an alternating voltage or current. For example, if a given circuit has an output impedance consisting of 100 K ohms of "pure" resistance, and a capacitance of 1600 micro-micro farads (picofarads) of capacitance, at around 1000 Hz, the reactive components of that impedance will also be about 100 ohms. You might therefore suppose that the *total* im-

pedance of the combined reactive and resistive components would add up to 200 ohms, but you'd be wrong. That is because the two forms of impedance are 90 degrees apart in phase and therefore cannot be added directly. Vector diagrams are often used to calculate complex impedances such as these, and, in the case cited, the vector diagram would look like that illustrated in Fig. 1. The total impedance (at 1 kHz) in this example would actually add up to 141.4 ohms (the hypotenuse of a triangle whose sides equal the resistive and reactive components of the complex impedance) and the phase-angle of the net impedance would be at 45 degrees, which means that the current in such a circuit would *lead* the applied AC voltage by that amount. In such a complex impedance containing a reactive component, the value of impedance will, of course, vary at different frequencies, for while the resistive part does not change with frequency, the reactive part does. In the case of a capacitive reactance (as in our example), impedance gets lower and lower with increasing frequency, while if the complex impedance contained an inductive component, the reverse would be true.

## Microphone Impedances

Armed with the above concepts, let's see why it is desirable to use low-impedance microphones in audio circuits when long cables are needed between the microphones and the input terminals of a preamp or recording console. Suppose, for a moment, that we used a high-Z microphone (one having an impedance of perhaps 10,000 ohms) and had to run a cable of 100 feet between the mic and the tape recorder input. A diagram of the setup is shown in Fig. 2. The 10 K impedance of the microphone is represented as a resistor in series with the microphone element. Across it, to ground, is the effective capacitance of the shielded cable. Shielded cable, typically, may have a capacitance of as high as 50 picofarads, so a 100 foot run would "look like" a capacitor of 0.005 mfd sitting across the line. We can calculate that at a frequency of only 3,000 Hz, that capacitor would have a reactive impedance of 10,000 ohms—the equal of the microphone's resistive impedance. What that means is that at that frequency, response would already be "down"



by 3 dB. At higher frequencies, the situation would be even worse, as the capacitive reactance gets lower and lower and shunts more and more of the microphone signal output voltage directly to "ground."

connected. Suppose a console preamplifier has an output impedance of 600 ohms and is to be connected to a tape deck input having the same impedance. If the preamplifier were delivering, say 1.0 volt rms of audio

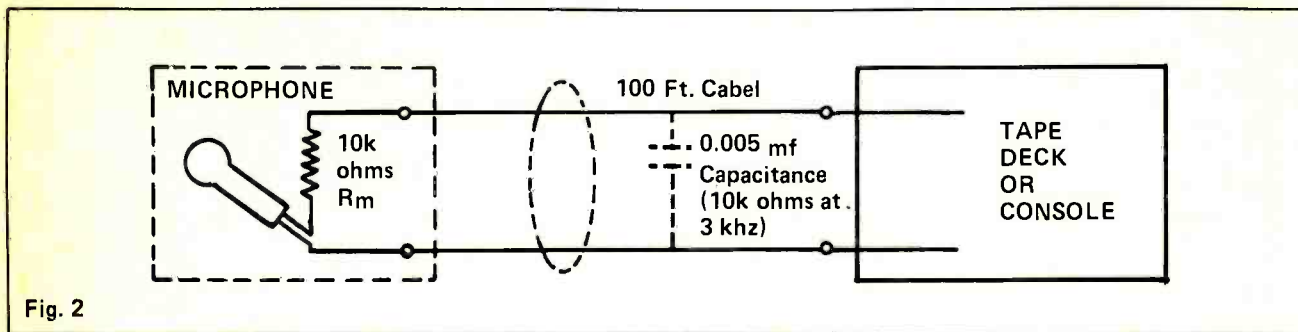

Fig. 2

Long cable capacitance "shunts" high frequencies of high impedance mic to "ground."

Now let's see what happens in the case of a low-impedance microphone (one having an internal impedance of only 250 ohms, for example). The 100-foot cable hasn't changed and still looks like a 0.005 mfd capacitor hanging across the line. But we can calculate that in order for its reactance to equal 250 ohms (the new "series resistance" of the low-impedance microphone) we would have to apply a frequency of 100,000 Hz before the signal would be attenuated 3 dB. For these reasons, high impedance microphones should only be used with very short cable runs, whereas low-impedance mics are preferred where longer runs (in studios, and the like) are required. (To

signal before the interconnection was made (or the output impedance was "terminated," as we prefer to say in audio parlance), the voltage appearing across the "line" (measured either at the output of the preamplifier or at the input of the tape deck) would have dropped by 6 dB and would now measure only 0.5 volts rms. The diagrams of Fig. 3 help to explain why this is so. In the unterminated condition, no signal current flows, so no voltage drop occurs and 1.0 volt appears if measured by a high-impedance voltmeter. The moment connection is made to the deck, however, signal current begins to flow. The value of this AC current can be simply calculated from Ohms Law ( $I = E/R$ , where I

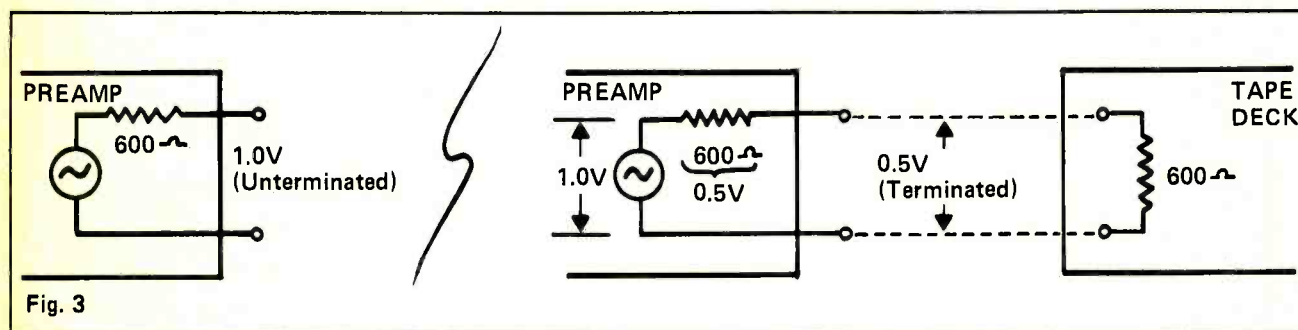

Fig. 3

Voltage appearing at unterminated 600 ohm impedance drops to half its open-circuit value when terminated with a matching 600 ohm load impedance.

achieve the same roll-off at 100 kHz with our 10 K ohm mic, the cable would have to be reduced to a mere three feet long or less!)

### Impedance Matching

Even if we discount the presence of reactive components in considering output and input impedances of audio products that are to be interconnected, certain rules must be observed. In professional installations, it is common practice to use 600-ohm output and input impedances for products whose signals are to be inter-

is current, E is voltage and R is total circuit resistance). The total current in this case is equal to 1.0 volt, divided by the total circuit resistance or 1200 ohms (600 ohms of source impedance and 600 ohms of terminating impedance), or 0.0008333 amperes. That current causes a voltage drop of 0.5 volts ( $E = IR$ ; or  $E = 0.000833 \times 600$ ) across the internal output resistance of the preamp, leaving only 0.5 voltage drop available to appear across the terminating resistance of the tape deck input.

In the case of consumer-type audio equipment, it is common practice to disregard voltage drops of this sort completely because they are usually insignificant.

That is because low-impedance *outputs* are usually connected to high-impedance inputs. As an example, let's assume you have a preamp which has a rated output impedance of a mere 100 ohms (a not uncommon value) and it is to be connected to a power amplifier input which has a 10,000 ohm input impedance. Now, the current flowing in this connection loop (illustrated in Fig. 4) equals voltage applied (assume 1.0 volt rms again) divided by the total circuit resistance, or 10,100 ohms. The current works out to be 0.00009901. The voltage drop across the 100 ohm internal impedance of the preamp works out to be a mere 0.00990099 volts,

(or should) be connected to 8-ohm impedance loudspeakers (or 4-ohm types, or whatever) he does *not* mean that the *internal* impedance of the amplifier is 8 or 4 ohms. In fact, the internal, or "looking back into" impedance of a solid-state amplifier is usually a small fraction of 1 ohm. It is for this reason that the voltage appearing at the speaker output terminals is almost the same whether those output terminals are "open" or connected to a loudspeaker or other load. What the manufacturer does mean when he speaks of speaker output impedances of 4 or 8 ohms is that speakers of this impedance will draw rated power output (in stated

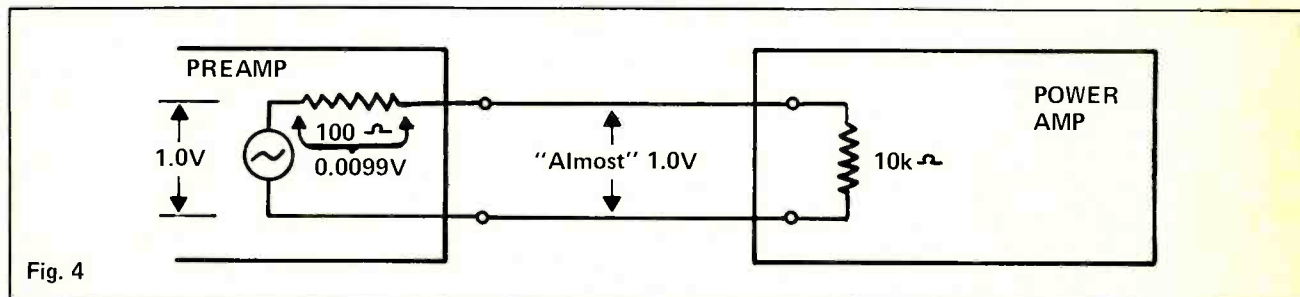

When low-Z output drives high-Z input, voltage drop across "source" impedance is negligible.

leaving 0.99009901 volts available to be delivered across the input impedance (or to the first stage) of the power amplifier. This is so close to the 1.0 volts of signal available at the "open circuit" output terminals of the preamplifier that no one bothers to even calculate the minute difference and we just assume that the input signal to the amplifier is the full 1.0 volt.

The use of low impedance outputs feeding high impedance inputs in home audio equipment also permits fairly long cable runs between components, just as in the case of microphones. There is one important exception to the "long cable" theory and that occurs in the case of a phono cartridge connected to a phono preamplifier input. As we have already mentioned, audio cables introduce shunt capacitance in the line and just about all phono cartridges (although they "look like" low impedance sources) are designed so that they will perform optimally when loaded with specific values of shunting capacitance. The recommended values may range from 100 pF or so (for CD-4 type cartridges) to 200 or 300 pF for stereo pickups. Load such cartridges with less than their optimum capacitance and they will exhibit rising response at some high audio frequency. Hang too much cable capacitance on the line and high-frequency roll-off will rear its ugly head and your hi-fi can turn into low-fi.

### Amplifier Output Impedances and Speaker Impedances

One common source of confusion when it comes to impedance matching concerns so-called amplifier output impedances and rated speaker impedances. When an amplifier manufacturer says that his product may

watts) from the amplifier safely. Since the voltage is almost constant at the output of an amplifier regardless of load, connecting a 4-ohm impedance to an amplifier generally results in higher power delivered to the load than does connecting an 8-ohm load. (Power equals voltage squared, divided by load impedance, so, if the voltage remains constant and load impedance goes down, power delivered to the load increases.) Of course, current limitations and thermal considerations terminate this linear relationship long before you reach a "dead short," or zero impedance load condition across the speaker terminals—where, in theory but not in practice, power delivered should be "infinite."

Those of you who remember the days of vacuum tube amplifiers will recall that output transformers used to couple the high-impedance tube-type output stages to low-impedance speaker loads were equipped with taps, or multiple screw terminals so that you connected the speaker in accordance with its rated impedance (4, 8 or sometimes 16 ohms). With such transformers, optimum power transfer was obtained from amplifier to load regardless of load impedance. In the case of solid state amps, where such multi-tap transformers have been eliminated, a change of load impedance changes the maximum power delivered to the load. But, since transistor output stages are of low impedance to begin with, a good match is generally obtained over a fairly wide range of speaker impedances without the need for a matching transformer.

We realize that this brief discussion, as it relates to audio and recording equipment, only touches upon the broad question of impedance. If we haven't covered everything from A to Z, we hope we've at least shed some light on Z.







# The Peavey CS Series

Last year when Peavey introduced the CS-800 Stereo Power Amp, professional sound men and engineers acclaimed it as the most versatile high performance power amp available for under \$1,500.00.

Now, there are two superbly engineered additions to the Peavey CS series, the CS-200 and CS-400. These new high performance amplifiers are built with the same meticulous quality control and engineering standards that go into the CS-800.

We invite you to compare the features designed into the CS series. You'll see why no other power amp offers the value built into a Peavey.



## CS-200 \$324.50 \*

Monaural power amplifier

- 200 Watts rms
- 20 Hz to 50 kHz response
- Less than 0.1% THD
- Less than 0.2% IMD
- LED overload indicator
- 19-inch rack mount
- Forced air cooling

## CS-400 \$424.50 \*

Stereo power amplifier

- 200 Watts rms per channel
- 20 Hz to 50 kHz response
- Less than 0.1% THD
- Less than 0.2% IMD
- LED overload indicators
- 19-inch rack mount
- Forced air cooling



## CS-800 \$649.50 \*

Stereo power amplifier

- 400 Watts rms per channel
- 5 Hz to 60 kHz response
- Less than .05% THD
- Less than 0.1% IMD
- LED overload indicators
- Loudspeaker protection system
- Balanced input and electronic crossover capabilities
- 19-inch rack mount
- Forced air cooling

\*Suggested Retail

Peavey Electronics, Corp. / Meridian, Mississippi 39301

CIRCLE 33 ON READER SERVICE CARD





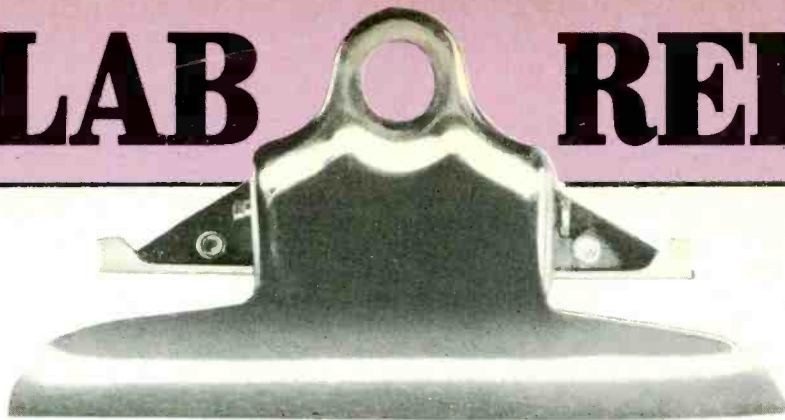

NORMAN EISENBERG AND LEN FELDMAN

## TEAC A-650 Cassette Tape Recorder



**General Description:** Teac's model A-650 is a front-loading stereo cassette recorder with numerous features including Dolby, bias and EQ switching, mic/line mixing, LED peak indicators, and more. The front panel, while reflecting all this, is logically planned. The cassette compartment at the left has a swing-out door with guides into which a cassette is inserted. The button to open the door (marked Eject) is at the lower righthand corner of this area.

The center portion of the front panel is given over to transport controls. There's a three-digit index counter and its reset button; next to it is a memory switch with three positions: play is for "memory play" after rewind; "off" disables the memory feature; "stop" will automatically stop the tape when the recorder's counter reaches 999.

Pushbuttons for transport action are quick-responding and permit a "limited" degree of fast-buttoning in that it is possible to go from any of three modes (play,

fast-forward, rewind) into any other of those three without first pressing the stop button. There actually are seven transport buttons. First is the record control. Next is a "record mute" control which, if pressed during the record mode, will disconnect the input signal from the heads while the deck continues to record with no signal (erase) on the tape until the pause or play button is pressed. This feature permits creating silent portions during a recording. Next is the pause button which can stop the tape entirely during record or play. Each of these buttons has its own indicator light. Below them are the buttons for rewind, fast forward, and normal forward (play). The stop button is a larger control under this group.

The righthand portion of the panel contains the VU meters and various electronic controls. Each meter has its own LED peak indicator. Calibration is from -20 to +3, and the Dolby calibration point is indicated on the scale. To the right of the meters is the deck's power



off/on switch. Below the meters are five switches. One is a three-position bias switch; the next is a three-position EQ switch. The third switch engages a built-in limiter for possible use in "live" recording. The last two switches handle the Dolby system, with options provided for direct-copy recording of Dolbyized tapes; recording of any non-Dolby encoded source; for direct-copy recording of Dolby FM broadcasts that use the 25-microsecond preemphasis; for decoded monitoring (hearing normal sound) when recording Dolby-encoded tape or when playing back a Dolby-encoded tape; to disable the Dolby system when recording or playing back non-Dolby signals; and finally for decoded monitoring (normal sound) when recording a Dolby-FM broadcast. The last option also applies a multiplex filter to the input FM signal.

Below these switches are the level controls for input and output. Mic level controls are separate per channel, as are line input and output controls. Finally, at the lower righthand portion of the panel are the input jacks for left and right channel mics, and the stereo headphone output jack. The output level knobs control headphone volume as well as the line output volume from the rear-panel line-out jacks.

At the rear are the line-out jacks plus a pair of line-in jacks and an optional DIN connector. The rear also has a pair of adjustments for Dolby FM/copy calibration which is accomplished with the aid of the front-panel meters.

For cleaning and degaussing the heads, it is possible to remove the cassette compartment door cover. Supplied with the A-650 is a small kit containing a head-cleaning stick, several applicators and a vial of cleaning fluid. The owner's instructions are given on a large fold-out form rather than in a booklet, and include a comprehensive list of tape brands and types with the recommended bias and EQ settings for each.

**Test Results:** While the Teac A-650 is no slouch in audio terms, MR's testers were more impressed with its mechanical operation than with its response. Best audio performance was obtained with CrO<sub>2</sub> tape (TDK SA) and with the bias and EQ switches set to their no. 1 positions. In this mode, we clocked response within +1, -3 dB from 35 Hz to 14 kHz. Signal-to-noise, without Dolby, was 56 dB down; with the Dolby switched in, it improved by 8 dB to an excellent 64 dB down. Input and output level readings were all within the ball park and the A-650 should interface readily with just about any other audio gear.

Mechanically, the A-650 ran like a champion. Wow and flutter were 100% better than manufacturer's

specs; fast-wind time beat the claimed time by 5 seconds. Most impressive was the flawless action of the solenoid-logic transport controls which gave the user a definite feeling of professional-grade equipment. Examination of the deck indicated that it is extremely well engineered and ruggedly built in addition to smooth-operating.

**General Info:** Dimensions are: 17<sup>1</sup>/<sub>8</sub> inches wide; 7 inches high; 12<sup>13</sup>/<sub>16</sub> inches deep. Weight is 28<sup>3</sup>/<sub>4</sub> pounds. Advertised price is \$550.

**Individual Comment by L.F.:** For years I have been a great fan of Teac. The company traditionally has avoided the use of superlatives in its product descriptions, and also has taken pains to set the record straight when it comes to the interrelationships between signal-to-noise, distortion and frequency response. Tending to go the route of professional recording equipment, Teac has—in many of its open-

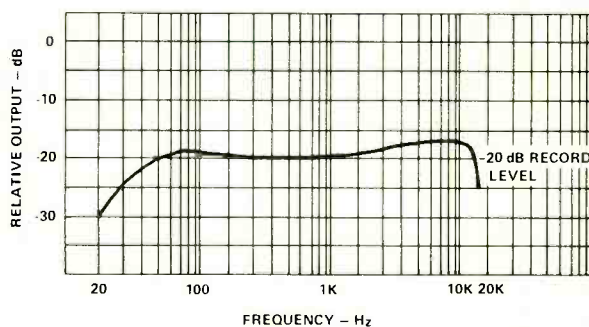

**TEAC A-650: Record/play frequency response using TDK Audua cassette tape.**

reel and cassette models—favored better S/N ratios and lower distortions while willing to give up the "last kHz or two" of r/p frequency response.

This is all well and good, say I, except that in the A-650—which is hardly an inexpensive unit—they seem to have gone a step too far. In this model, they have gone all out for front-panel features (described above) which are useful and which do work as claimed. But what bothers me here is that the basic performance of the sample I tested (and perhaps this one may not have been "up to snuff") was not quite what I would have expected these days from a unit in the over-\$500 category. I could easily accept the rather average frequency-response results, but I was con-

cerned that S/N ratios were also only about average, considering the deck's cost. Nor could I justify the rather high THD levels measured for two tape types at the 0 VU recording level. I know that "0 VU" can be calibrated wherever a manufacturer chooses for it to

assume that a company with its experience and savvy deliberately chose its design and performance parameters, not to mention the unit's features, for what it regards as a definite market for this product. I feel that the response, while not spectacular, is still very



occur (in terms of actual recording level, measured in nanowebers), but I fail to see why Teac elected to make their "0 dB" indication come so close to the saturation point of the tapes involved, as indicated by the rather low headroom (+2.5 dB) available with the SA sampler before reaching the 3% THD level.

On the plus side, no one can fault the transport system of the A-650. Its wow and flutter exceed Teac's spec by far and it is indeed as low a figure for wow and flutter that we have measured in any home-type cassette recorder. Nor is Teac "covering up" anything by using a weighted figure, for even measured without weighting (RMS), the wow and flutter still turned out to be an impressively low 0.08%.

good. Signal-to-noise, topping the 60-dB mark with the Dolby switched in, seems to me better than "average." Distortion for 0 VU recording level does stay under two percent with either normal or chrome tape, and the headroom for using normal tape is a healthy +6 dB. This drops, of course, to only +2.5 dB with chrome tape and so here we encounter a design trade-off which one can either accept or not, depending on his philosophy of cassette recording. In view of these factors, and of the unit's sterling mechanical operation, it is difficult to say unequivocally who will "like" it or not. I suppose if the price were significantly lower, there would be no hesitation about recommending it more "universally."

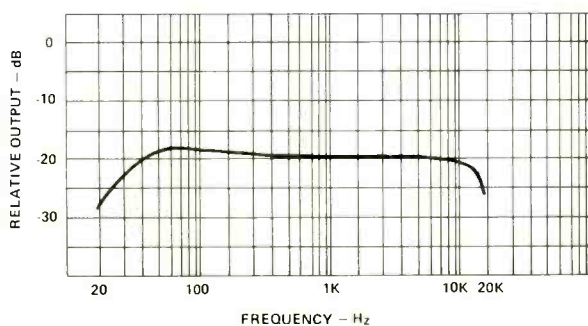

**TEAC A-650: Record/play frequency response using TDK "SA" cassette tape.**

**Individual Comment by N.E.:** It seems obvious that Teac, with an already extensive line of recorders, opted to introduce this model in terms of its possible special appeal to one group of users in the steadily increasing army of cassette-recorder buyers. One has to

**TEAC A-650 STEREO CASSETTE RECORDER: Vital Statistics:**

PERFORMANCE CHARACTERISTIC	LAB MEASUREMENT
Frequency response, normal tape (TDK-Audua)	±3 dB, 35 Hz to 14.5 kHz
Frequency response, CrO <sub>2</sub> tape (TDK-SA)	+1, -3 dB, 35 Hz to 14 kHz
Harmonic distortion at 0 VU (tape 1 / tape 2)	1.8% / 2.0%
Recording level for max 3% THD (tape 1 / tape 2)	+6 dB / +2.5 dB
Signal-to-noise, unweighted w/o Dolby (tape 1 / tape 2)	54 dB / 56 dB
with Dolby (tape 1 / tape 2)	61 dB / 64 dB
Wow and flutter (WRMS)	0.03% (0.08% unwt'd).
Fast-wind time (C-60)	85 seconds
Mic input sensitivity	0.26 mV
Line input sensitivity	60 mV
Line output level	270 mV
Phone output level	9 mW into 8 ohms
Bias frequency	100 kHz
Power consumption	25 watts

CIRCLE 16 ON READER SERVICE CARD



## H. H. Electronic Echo Unit

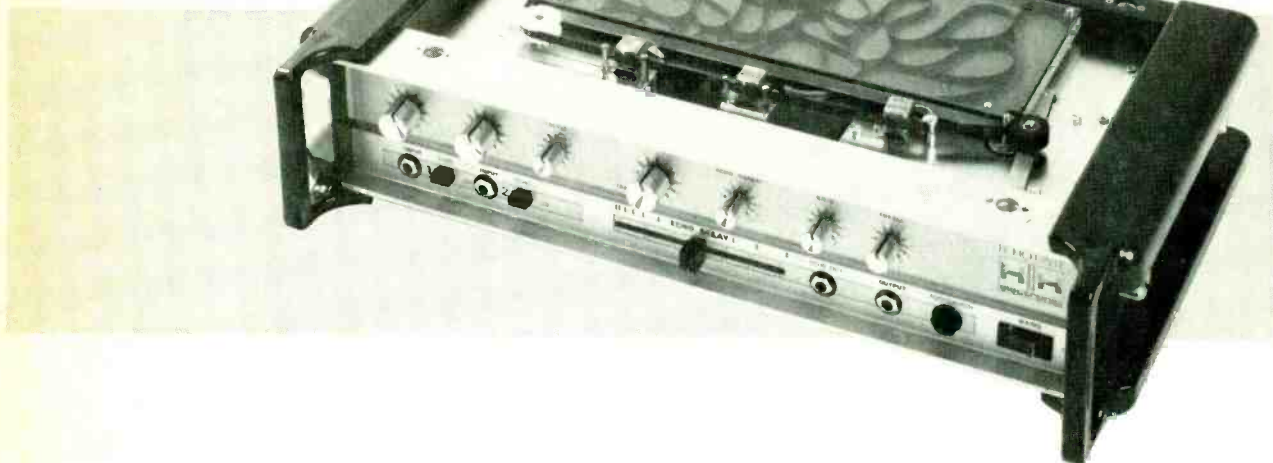

**General Description:** The "Echo Unit" (no model number is given) from H. H. Electronic uses a tape loop system to produce echo sound and is primarily intended for use in conjunction with instrument or P.A. amplifiers or mixers. A stereo connection option permits splitting the "clean-feed" and echo into two separate component signals. This method is designed to produce a full stereo image with clean-feed handled by a stage amplifier and the delayed echo signal delivered through the main P.A. system (or a separate instrument stack if desired). It also is possible to add effects to a stage amplifier in the normal way (e.g., sustain or reverb, etc.) without affecting the echo signal.

Front panel facilities include gain controls for signals connected to inputs 1 and 2; a treble control (handles both channels simultaneously); an echo volume control; an echo repeat or "duration" control; a bass control (affects the echo signal only); another

third accepts a hookup from an optional footswitch to provide remote control of the echo signal on or off. At the extreme right is the power switch for the device.

The rear panel contains standard phone-jacks for the input from echo send, and the output to echo return. There also is an operating voltage selector (110-120 VAC; 220-240 VAC); a fuse-holder (1 amp serves for both AC positions); and the power connector line which is a Euroconnector having three pins. The unit is supplied with a suitable power cable two meters (about 79 inches) long plus two shorter signal cables. It is finished in a leatherette surround and has a slip-on cover.

The signal-producing tape loop is found just under the top cover of the device and consists of a length of recording tape enclosed in a transparent casing and forming a loop. The tape emerges from an opening at one end of the housing, passes through a tension

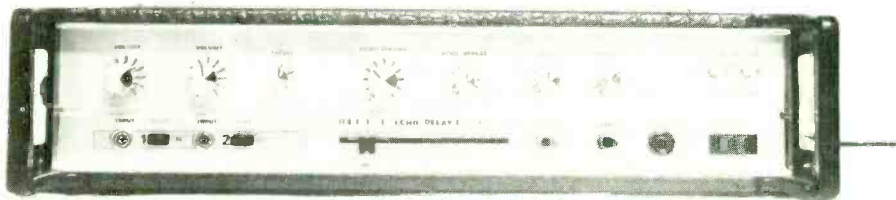

H.H. Electronic Echo Unit: Front panel view.

treble control (also for the echo signal only). Centered below these knobs is a horizontal slider for echo delay which may be adjusted to vary the time delay of the echo. To its left are phone-jack inputs for channels 1 and 2, and an echo-on pushbutton for each input. To the right of the delay slider are three more phone jacks. One is for the echo-out signal; another is for the normal output connection to other equipment; the

spring and guide wheel, goes past three widely-spaced heads, and is engaged by the motor shaft and a rubber pinch wheel just before it returns to another opening at the opposite end of the housing. According to the manufacturer, the tape will run for at least 300 hours or more without perceptible loss of performance if transport and heads are kept clean. Instructions for replacing the tape are given in the owner's manual

which also cautions that only the special tape supplied by H.H. is to be used.

**Test Results:** MR checked the measurable performance areas of the H.H. Electronic Echo Unit in both its "clean feed" and "delayed feed" sections, and

monizers and audio-delay circuits that I had almost forgotten how these audio tricks used to be performed. Well, if nothing else, the H.H. Electronic Echo Unit has served to restore some of my lost perspective. This is actually the way echo effects were (and still are) produced before the advent of all those miraculous circuit

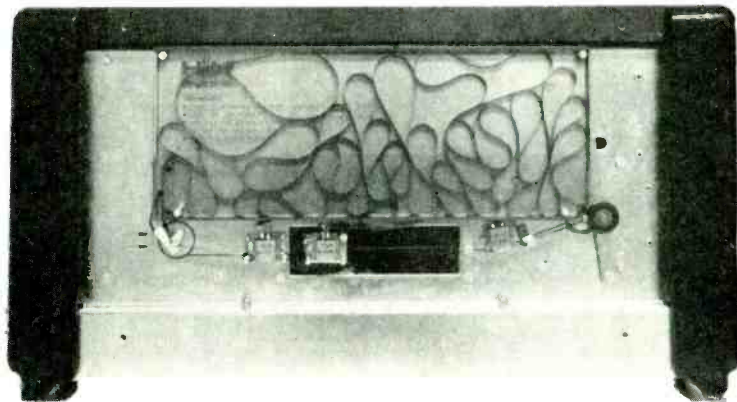

**H.H. Electronic Echo Unit: Internal view shows tape storage area and tape heads which are used to produce echos.**

came up with results that either confirmed or exceeded the published specs for the device. To study the action closely, a tone burst was introduced, and the echo gain was set somewhat below the input level gain, with the repeat control adjusted to about three-quarters of the way to maximum. The resultant signal is shown in the accompanying 'scope photo, which portrays graphically the delayed repeat echo action.

The tape in the loop travels at 12 inches-per-second speed, and the movable head (controlled by the echo delay slider) can vary the echo time from about 100 milliseconds to more than 700 milliseconds.

In "live" use tests, a guitar player used the device connected to a guitar amplifier and the results were judged to be versatile, very effective and clean sounding. The double input facilities on the Echo Unit were considered to be a clever addition since they permitted a pair of instruments to take advantage of the machine's echo capabilities, though—to be sure—the degree of echo and of the echo repeat settings come out the same for both inputs. Only the level of each can be varied individually since the tone controls act on both sources simultaneously.

**General Info:** Dimensions are 19¾ inches wide; 4½ inches high; 11½ inches deep. Weight is 19 pounds. Advertised price is \$575.

**Individual Comment by L.F.:** It is interesting to see how some of our more sophisticated electronic equipment's functions can be duplicated by electro-mechanical means. I suppose I have become so blasé about digital time-delay units, "bucket brigade" har-

chips that manage to compress time, alter frequency, and do all the other magical things that performers bring to their stage appearances and recordings.

So obviously there is still something to be said for tape-loop echo. With the digital and all-electronic

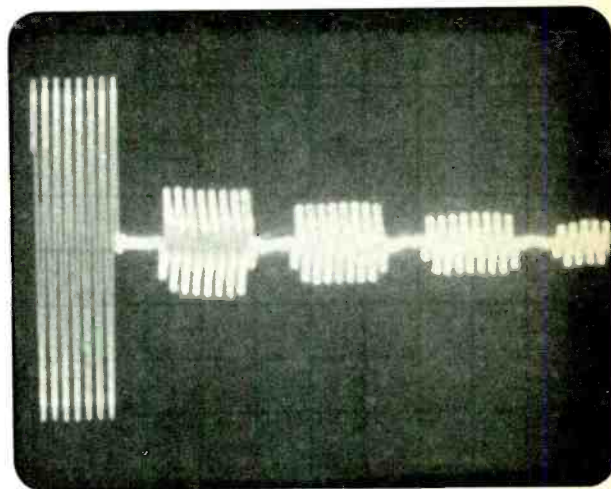

**H.H. Electronic Echo Unit: Signal at left is "clean feed" tone burst, followed by "delayed" repeating echo signals.**

devices we have seen, there are limits to the quality of sound you can get as you approach the extremes of time-delay of the electronics. The frequency response of the delayed signal also can be affected by changing the time of the delay. In the case of this electro-mechanical system, the fidelity, the distortion and the consistency of the recovered echo signal are main-



tained intact regardless of the time of the echo selected. This also applies to the repeat-echo function, which means there is no need to compromise for a change in the quality of the echo effect just in order to be able to vary the time parameters.

The one problem we experienced with the device was the failure of the capstan pinch wheel to disengage from the capstan when the echo feature is turned off, or when power to the unit is turned off. This, despite the statement in the owner's manual that a solenoid is supposed to have disengaged the pinch wheel. Obviously, with this problem, the unit will develop flat spots after some period of use.

**Individual Comment by N.E.:** This British-made unit has all the solid, no-nonsense "feeling" about it that is customarily associated with quality products from the U.K., as well as some of the uniquely British "shticks"—like the unfamiliar AC power socket (fortunately a mating cord and connector is supplied), and such terminology as "earth" for "ground" or "mains" for AC power lines. If you can get over these little differences from U.S. usage (including the spelling of "colour" and the term "screened" instead of "shielded" when referring to hookup cable) you really might take a liking to this device, since it does its job

very much "as advertised." My sample too had no way of disengaging the capstan from the pinch wheel, and I really wonder about that. It could be a real blooper on someone's part and should be checked out before buying the device.

H. H. ELECTRONIC ECHO UNIT: Vital Statistics

PERFORMANCE CHARACTERISTIC	LAB MEASUREMENT
"Clean Feed" Section"	
Gain	7 dB
Normal level	Reference
Maximum input	5.3 V
Treble control range	+ 15 dB at 10 kHz
Nominal output (for reference input)	225 mV
Maximum output	11.8 V
Frequency response	- 3 dB, 20 Hz to 10kHz
"Delayed Feed" Section	
Minimum delay	100 milliseconds
Maximum delay	720 milliseconds
Frequency response	- 3 dB, 60 Hz to 10 kHz
Bass control range	+ 10, - 11 dB at 100 Hz
Treble control range	+ 13, - 15 dB at 10 kHz
Compression slope	3 dB increase in output for 30 dB increased input
Echo Out level	100 mV for 50 mV input
Tape speed	12 ips

CIRCLE 4 ON READER SERVICE CARD

## BGW Model 500D Power Amplifier

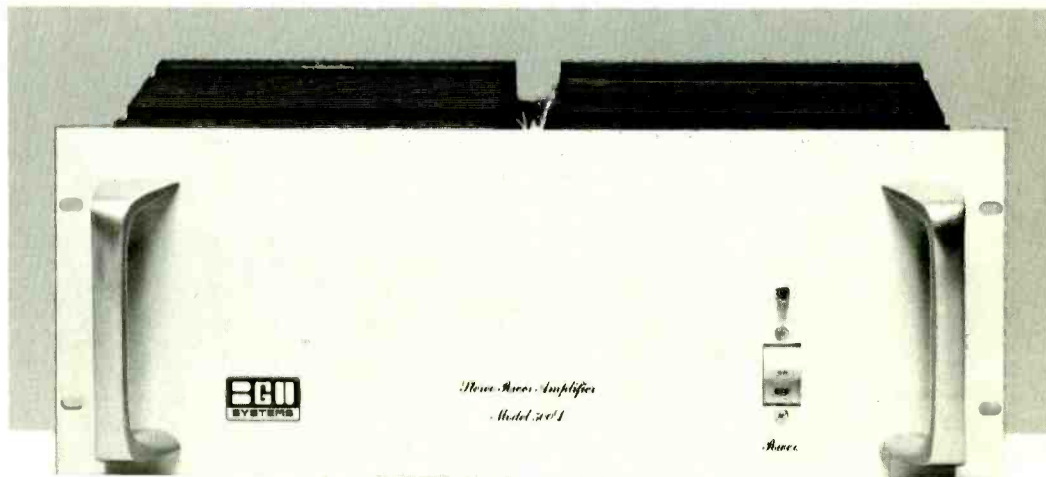

**General Description:** The model 500D is a stereo power amplifier conservatively rated for 200 watts output power per channel, and capable of offering higher power than that without exceeding rated distortion. It can drive 8-ohm loads or 4-ohm loads, and also

may be operated monophonically for an output of at least 500 watts. It also can cope with 2-ohm loads, and even lower with the use of an isolating series capacitor.

The front panel, of rack-mount dimensions and fitted with handles, sports only a power off/on switch (and in-

indicator lamp) which also serves as a circuit-breaker. Built into the amplifier is a sophisticated protection system that includes a so-called "crowbar" circuit which, in the event of excessive DC voltage at the output, will trigger a fast discharge pulse that gates an SCR crowbar—essentially a direct short across the two power supplies. When activated, the normally

Input jacks are at the rear and each jack has its own gain adjustment. Speaker terminals are standard binding posts, and a warning note advises the use of speaker fuses. The owner's instruction manual explains their use, and what size to add with regard to speaker impedance and peak-power anticipated. Also on the rear panel is a switch to convert the amplifier to

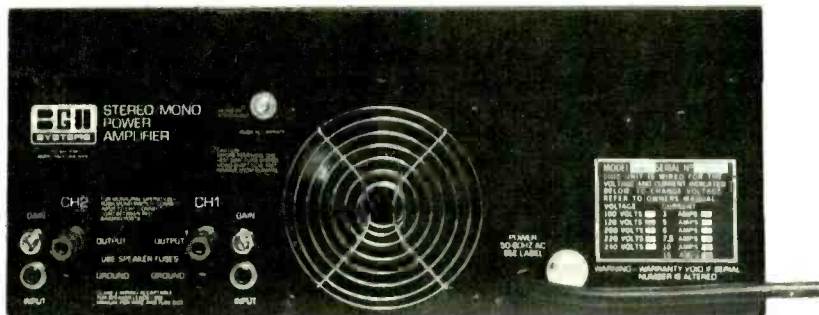

**BGW 500D: Rear panel view.**

high current that then flows in the primary circuit disconnects all power via the circuit breaker in a fraction of a second, thereby protecting the loads (speakers) hooked up to the unit.

There are ten output semi-conductors per channel,

mono operation. Instructions for the correct speaker hookup in this instance are provided. As supplied, the BGW 500D is internally wired to operate on the power source in a given locale; alternate power line values (the full list is 100, 120, 200, 220 and 240 VAC) may be

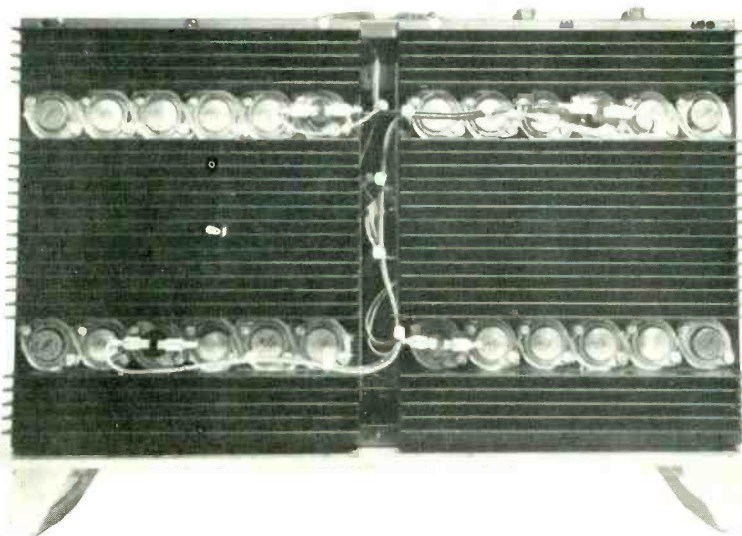

**BGW 500D: Top view with cover removed to disclose output transistors and heat sinks.**

and all are in intimate contact with massive heat-sinks. The bias circuit also is mounted on this assembly which helps ensure bias stability with regard to temperature.

Built into the amplifier is a cooling fan whose rotational speed varies in accordance with the temperature of the heat sinks. The fan vents via the rear panel of the amplifier.

used with internal wiring modifications, described in the owner's manual. The AC power cord has three conductors and is fitted with a grounding plug that should not be defeated.

**Test Results:** The BGW 500D did everything claimed for it, and then some. In all performance areas



it exceeded published specs for 8-ohm loads, and did extremely well too at 4-ohm loads (significant performance tests for both loads were run by MR and are summarized in the accompanying data). In addition to furnishing extremely high, very clean power output

can be installed and just about forgotten from the standpoint of worrying about it or having to get at it for servicing. Of course our tests were necessarily limited in time but even so, careful examination and putting the unit through its paces seem to bear out this "vote of confidence." The 500D not only puts out a hell of a lot of power but it does so cleanly and with a good deal of built-in "resistance" to external disturbances, as from improper loads. Indeed, there seems virtually no load that could be considered "improper" for this monster.

In our tests the amplifier did not exhibit any significant "rising distortion" at low power output levels.

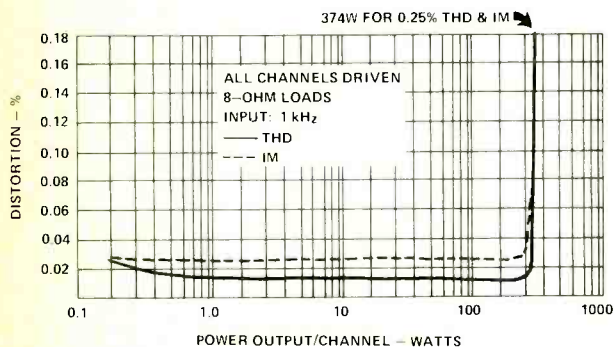

**BGW 500D: Harmonic and intermodulation distortion characteristics, 4-ohm loads.**

levels, the model 500D also proved to be a very ruggedly built amplifier that would appear to be capable of functioning reliably for long periods of time under all sorts of environmental conditions. It thus seems like an ideal unit to consider for use as a studio monitor amplifier, or a sound-reinforcement amplifier. It also could serve as a hi-fi system amplifier except

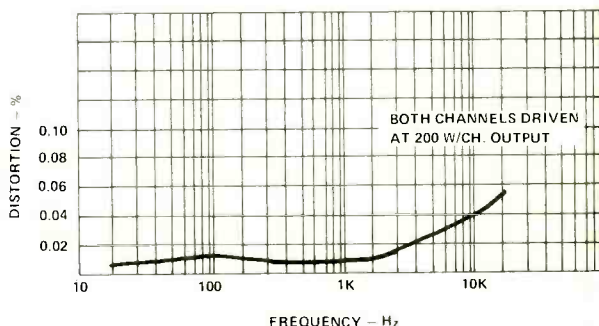

**BGW 500D: Distortion vs. frequency, 8-ohm loads.**

Our measurements speak for themselves, but we did listen to the 500D too. It did extremely well reproducing material loaded with high transient content. Since BGW makes a big point of the great open-loop gain of their amplifier (which means a great deal of negative loop feedback) we half expected to hear some evidence of transient distortion. But we did not. Apparently, BGW's use of fast-switching devices, and their overall circuit arrangement, are such that they have been able to get away with such extremes of feedback without encountering its presumed disadvantages.

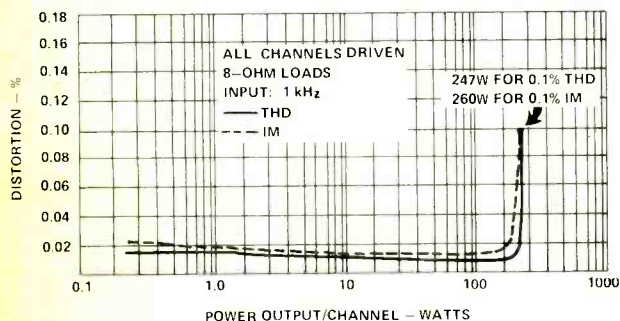

**BGW 500D: Harmonic and intermodulation distortion characteristics, 8-ohm loads.**

for the obvious problem of the noisy fan. If used in a home sound system, MR advises installing the 500D in such a way that you won't hear the fan whirring, especially during quiet musical passages.

**General Info:** Dimensions are 19 inches (standard rack mount) wide; 7 inches high; 12 inches deep. Weight is 52 pounds. Price: \$879.

**Joint Comment by N.E. and L.F.:** BGW's model 500D seemed to us like the sort of amplifier that

**BGW MODEL 500D POWER AMPLIFIER: Vital Statistics**

PERFORMANCE CHARACTERISTIC	LAB MEASUREMENT
Continuous power/channel at 1 kHz	247 watts into 8 ohms; 347 watts into 4 ohms
Continuous power/channel, 20 Hz to 20 kHz	211 watts into 8 ohms
Power bandwidth	10Hz to 30 kHz into 8 ohms
Frequency response	- 3 dB, 1 Hz to 65 kHz
Damping factor	200 +
THD for rated performance	0.006% into 8 ohms 0.01% into 4 ohms
IM for rated performance	0.011% into 8 ohms 0.023% into 4 ohms
Residual hum and noise	- 110 dB
Input sensitivity	2 volts

CIRCLE 9 ON READER SERVICE CARD



# Uni-Sync Trouper III Output Control Center

By Jim Ford  
and Brian Roth

**General Description:** Uni-Sync, Inc. manufactures a range of four different "live" sound mixing systems. Each system consists of an output control module and up to three input expander modules that allow system expansion to thirty-four microphone inputs, depending upon the configuration.

We field tested the "TROUPER III" output control center. In this particular system, each microphone input channel includes:

- A) Slider-type volume control.
- B) A "solo" rocker switch.
- C) Low-, mid- and high-frequency equalization slider controls.
- D) An echo-send slider.
- E) A monitor-send slider.
- F) Two rocker switches that alter the microphone input sensitivity by 10 or 20 dB (or 30 dB when used together).
- G) Four output bus assignment rocker switches.
- H) A peak overload "LED" indicator.

Since the Trouper series is specifically designed for "live" applications, a number of features that are not found on most mixers have been included. For example, the Trouper provides a mono output mix derived from the four output bus submasters (which are

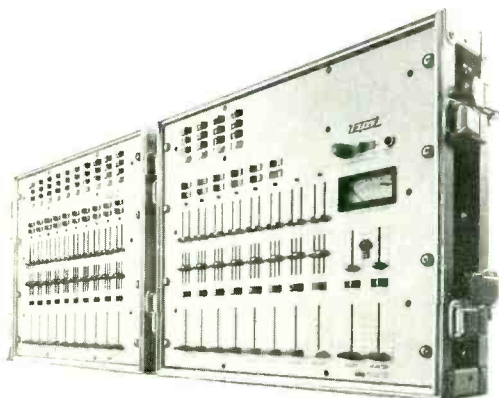

straight line sliders). This allows the inputs to be sub-mixed into the four submasters, which then act as group master controls. This simplifies "live" mixing situations particularly when using a large number of microphones. Additionally, each of the four groups has additional equalization available in the form of three sliders for low-, mid- and high-frequency control. A solo rocker switch is included above each group master level control slider, as is a peak overload "LED."

Other features of the Trouper are two "Announce" microphone inputs. Each of these provides two volume-control sliders. One feeds the announce



microphone to the "house" mix that is derived from the four submasters, and the other slider feeds the announce microphone to the monitor mix bus. Two rocker switches associated with each announce input vary the input sensitivity by 10, 20 or 30 dB.

Two line inputs are included, and these can be fed to the monitor or house mix by means of two slider controls on each line input.

Straight-line sliders are provided for the "house" level master and the monitor master. Each of these outputs also includes a "solo" rocker switch. A straight-line slider controls the echo return level to the "house" mix. Another slider varies the level of the headphone output signal which appears at the front panel "phones" jack.

A rocker-type power switch is located on the front panel as is the fuse holder (the latter is usually located in the least accessible place on most mixers). On our review sample, a standard mechanical VU meter was provided, although Uni-Sync's literature indicates they are now using an "LED" light meter instead.

Last, but not least, of the front panel controls is a rocker switch labeled "prefader" and "solo bus." This switch is associated with the solo switches on the input, submaster and output positions. The position of the switch determines the signal monitored by the VU meter and the headphone output. When this switch is in the "solo bus" position and any of the solo switches are turned on, the meter and phones output monitor the level of that particular input or output *after* the fader volume control. In the "prefader" position, the solo feed is derived *before* the volume control of the input or output that has a solo switch in the "on" position. All in all, a most unusual and effective monitoring arrangement.

The rear panel contains the necessary 3-pin "cannon" type connectors for the four microphone inputs, the two announce microphone inputs, and the house



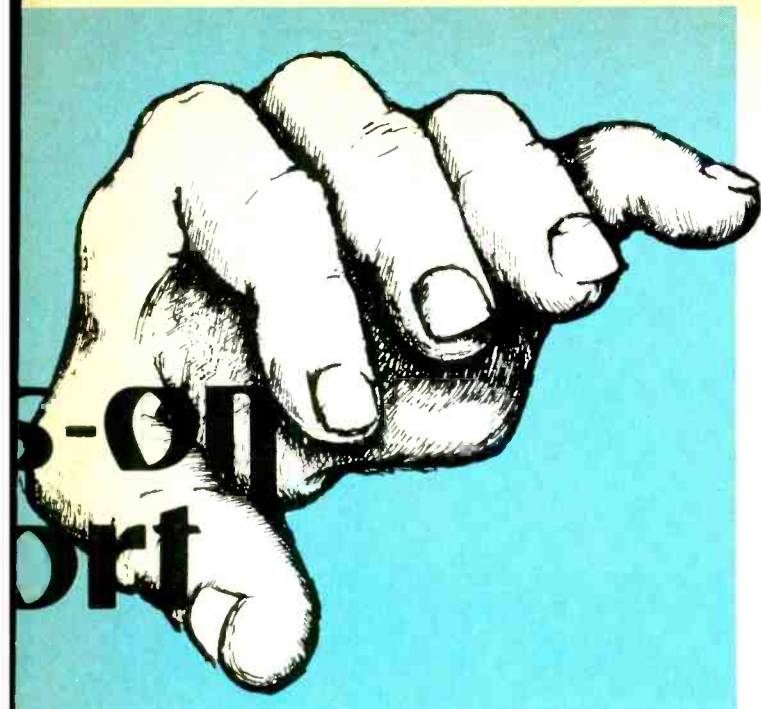

and monitor outputs. These inputs and outputs are balanced, low impedance and transformer isolated. A pair of 1/4-inch "phone" jacks provide the two line inputs. Four other phone jacks allow outboard equipment (equalizers, limiters, etc.) to be patched into the four submasters. Two other phone jacks provide echo send and echo return facilities. Phone jacks also allow external equipment to be patched into the house and monitor outputs.

Multi-pin connectors provide the necessary connections for three input expanders. Each input expander provides ten low-impedance microphone inputs with facilities identical to the output control unit's microphone inputs (described earlier). Other multi-pin connectors on the rear of the master control unit provide DC voltage to power other Uni-Sync accessories (graphic equalizer, etc.)

A slide switch on the rear panel bypasses the submaster facility and mixes the microphone inputs directly into the "house" output slider control. Another slide switch activates a phantom power supply which allows certain condenser microphones to be used with the mixer.

The Trouper unit is designed for rack mounting. Our sample was housed in an optional road carrying case.

In summary, the Trouper system is of very flexible design. It incorporates a number of unique functions that make the soundman's job easier.

**Field Test:** Since we had only the output control module available, we used it as an outboard submixer in conjunction with another mixer.

We found the extensive use of sliders most unusual, although not impossible to adapt to. We wished that the equalization sliders weren't so close together; it was somewhat difficult to vary an equalization control without moving one of the others. This was particularly true of the mid-frequency control.

The color-coded rocker switches were a nice feature. However, these particular switches do not have a very positive action, and it was possible to have the switches in an undesired middle position that would negate their function.

The solo/preview system was quite useful for monitoring various signals throughout the mixer. We would have preferred that the meter and headphone monitoring circuits automatically switch back to the house output if none of the solo switches were turned on; this would eliminate a bit of confusing switch flipping when attempting to solo one of the inputs.

The mixer appeared to have a tremendous amount of gain. In fact, the amount of gain seemed to be excessive. In moderately loud situations we found it necessary to operate the input sliders toward the bottom end of their range even with both the 10 dB and 20 dB pads switched in. Also, we occasionally found it possible to overdrive the inputs with very loud signals (e.g. a condenser mic on a snare drum), even with all

#### HOUSE OUTPUT NOISE (see text)

Unweighted noise, referenced to 0 VU (+4 dBm)  
Output terminated into 600 ohms

	20 Hz-20 kHz	400 Hz-20 kHz
House master off	-88 dB	-89 dB
House master normal (-15)	-69 dB	-70 dB
House master and all group masters normal (-15)	-60 dB	-69 dB
House master and 1 group master normal, 1 input set for 20 dB gain	-64 dB	-70 dB
House master and 1 group master normal, 1 input set for 40 dB gain	-62 dB	-68 dB
House master and 1 group master normal, 1 input set for 60 dB gain	-61 dB	-65 dB
Equivalent input noise	-121 dBm	-125 dBm
Typical mix (see text)	-54 dB	-63 dB

#### Harmonic Distortion at 0 VU (1.25 volts RMS) (see text)

40 Hz	.07%
1 kHz	.02%
10 kHz	.025%

#### Harmonic Distortion at +20 VU (12.5 volts RMS)

40 Hz	.12%
1 kHz	.012%
10 kHz	.3%

#### Intermodulation Distortion (60 Hz and 7000 Hz mixed 4:1 — SMPTE method)

At 0 VU (1.25 volts RMS)	.015%
At +20 VU (12.5 volts RMS)	.02%

#### Maximum output level at clipping, in volts RMS and dB (0 dB = .775 volts RMS)

Frequency	With high impedance load	With 600 ohm load
50 Hz	18.5 volts (+27.5 dB)	15 volts (+25.8 dBm)
1 kHz	19 volts (+27.8 dB)	16.5 volts (+26.5 dBm)
10 kHz	19.5 volts (+28 dB)	16.5 volts (+26.5 dBm)
20 kHz	10 volts (+22 dB)	8.75 volts (+21 dBm)

the pads "in." High gain is nice to have but not at the expense of handling really hot signals.

In our application, the mixer was moderately quiet, although for situations requiring more gain (i.e. acoustic groups, public speaking applications, and other quieter situations) the Trouper might be a little bit noisy.

The unit had a clean sound overall when operated properly. We felt that the low-frequency equalizer

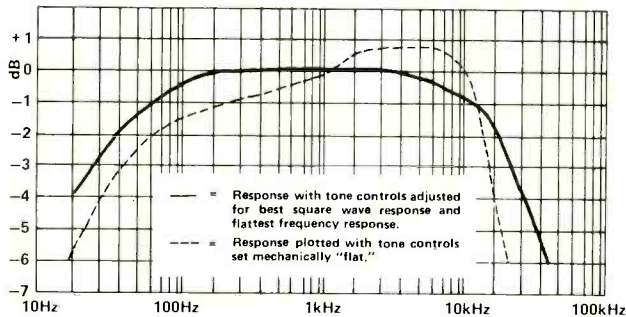

**Trouper III: Response (overall). Microphone input, House output.**

sounded a bit "boomy" or "boxy," an indication that it is affecting the upper bass and lower midrange regions more than necessary. The midrange control was rather "peaky" sounding. The high-frequency control sounded fine.

We noted that the phantom power supply wouldn't operate Neumann condenser microphones, which require 48 volts DC as opposed to the 24 volts that the Trouper supplies. However, just about every other brand of condenser microphone will operate at this voltage.

Basically, the Trouper seemed to behave in a good fashion with only a couple of exceptions, mainly the very high amount of gain.

**Lab Tests:** The tables and charts outline our measurements of the Trouper. While running noise tests, we noted that a good portion of the noise consisted of hum components. We didn't notice an excessive amount of hum in actual usage, which indicates very clearly that the human ear is very insensitive to low frequencies at low levels (just like Mr. Fletcher and Mr. Munson said many years ago). Consequently, we have included a set of measurements that filter out the low-frequency region. These figures are more representative of the actual perceived noise level of the mixer. As usual, we have included a "typical mix" measurement that was made with all controls in a position similar to that used in our field test.

We checked the maximum amount of gain of the mixer (level controls wide open and all pads switched out) and found it to be in excess of 100 dB! Since the noise level naturally increases with increasing gain, we feel that this much gain is not necessary since a very high noise level would result. A maximum gain of perhaps 70 or 80 dB would allow easier operation of the mixer with sufficient amplification for low level inputs.

The house and monitor outputs are capable of a very high output level, an important feature in "live" applications. Few mixers on the market can achieve these levels.

The frequency response plot taken with the equalizers set mechanically "flat" is fairly good, with the frequency extremes rolled off. Square wave tests seemed to indicate that the equalizer controls were not actually "flat" when set to their mid positions. Adjusting the equalizers for best square wave response improved the overall response somewhat, particularly at the frequency extremes.

Harmonic and intermodulation distortion figures were overall quite low. The low frequency THD measurements at "O VU" were masked by the hum level, so actual distortion figures are lower. High-frequency distortion was generally low; at higher output levels we noted slew rate limiting, a characteristic of the operational amplifier "I.C.s" used in the mixer. This phenomenon causes a rapid increase of high-frequency distortion at high-output levels. As we have noted in other reviews, this characteristic was not noticed in usage, but "faster" I.C.s most likely would improve matters.

The maximum input that the microphone inputs could handle was around -2 dBm (about .625 volts RMS), slightly less at low frequencies. The input overload light illuminated at about 2 dB below input clipping. The overload light in the VU meter assembly illuminated at about +5.75 dB above "O VU." All of the overload indicator "trip points" of the Trouper III are internally adjustable.

We checked the inside of the mixer, and construction standards appeared to be good. All of the active circuitry plugs into a motherboard that also holds the numerous faders and switches. Serviceability appears excellent with perhaps the exception of access to the sliders and switches. Sockets are provided for the integrated circuits and transistors, making their replacement a breeze. The overall quality of components (resistors, capacitors, etc.) seems adequate.

Generally, the Trouper III performed as satisfactorily on the test bench as it did in the field.

**Conclusion:** Uni-Sync has designed a remarkable series of very flexible mixing systems. It is obvious that they have listened to some design suggestions from the real world rather than simply adhering to the design engineer's "slide rule" approach so often found in equipment. Some areas could stand improvement, but overall the Trouper performed well.

One final note—the owner's manual was one of the most extensive and informative we have seen. In particular, the service manual portion was superlative. Page upon page of schematics, printed circuit board layouts, parts location diagrams and detailed parts lists should make repairs of the Trouper very straightforward. Too many other manufacturers keep their "innards" a dark secret, much to the chagrin of the service man. Uni-Sync has wisely taken the opposite approach. Well done!

CIRCLE 3 ON READER SERVICE CARD





# The Art of Recording.

**Now!**... LEARN HOW THE PRO'S DO IT! THE RECORDING INSTITUTE OF AMERICA OFFERS ON-LOCATION CLASSES IN THE LATEST MULTI-TRACK RECORDING TECHNIQUES AT A 16-TRACK STUDIO IN YOUR CITY.

Today's music conscious society has made recording "the new art of self expression."

The Recording Institute of America offers a ten week course in the art of multi-track recording. The course, entitled MODERN RECORDING TECHNIQUES, is unique in that all sessions are held on location in professional 16 Track RIA affiliated recording studios in order that the students may see, hear, and apply the techniques of modern recording. Under the guidance of qualified, professional recording engineers as instructors, the student will become familiar with modern state of the art equipment.

Selected sampling of topics covered are:

- Mono, Stereo, Multi-Track (4, 8, 16 Track) Magnetic Tape Recorders—Theory and Operation.
- Microphones—Basic Theory and Operation.
- Control Console—Function and Operation—Record and Mixdown Principles
- Over-dubbing Principles.
- Echo Techniques.
- Equalization and Limiting Principles.
- Multi-Track "Mixdown" Principles (16 Track to 2 Track Stereo)
- Tape Editing Techniques.

The course includes live 16 Track recording sessions offering the student an opportunity to apply the related techniques learned.

The Recording Institute of America, is the only national institute of its kind, striving to provide a higher standard of artistry within the recording industry and its related fields.



RIA is looked to as the first credible and informative link between



musicians, artists, recording enthusiasts and future producer/engineers of our industry.



**Call Toll FREE:  
(800) 421-0550\***

\* OR CALL OUR LOCAL REPRESENTATIVES  
IN THE FOLLOWING CITIES:

NEW YORK, N.Y.  
RIA  
(212) 582-0400

CHICAGO, ILL.  
RIA - Chicago  
(312) 383-7494

LA/ORANGE COUNTY, CA  
United Audio  
(714) 542-4427

PITTSBURG, PA.  
Audio Innovators  
(412) 391-6220

NEW HAVEN, CT.  
Troj Nossel Productions  
(203) 269-4465

BALTIMORE, MD.  
Sheffield Rec's Ltd., Inc.  
(301) 252-2226

DENVER, COLO.  
Applewood Studios  
(303) 279-2500

CHARLOTTE, N.C.  
Reflection Studio  
(704) 377-4596

COLUMBUS, OHIO  
Mus-I-Col Rec'g  
(614) 267-3133

ATLANTA, GA.  
Axis Sound Studios  
(404) 355-8680

SEATTLE, WASH.  
Holden, Hamilton  
& Roberts Recording  
(206) 632-8300

INDIANAPOLIS, IND.  
TapeMasters  
(317) 849-0905

RICHMOND, VA.  
Alpha Audio  
(804) 358-3852

DETROIT, MICH.  
Pro Sound Studios  
(313) 779-1380

DALLAS, TEXAS  
Sound Techniques Inc.  
(214) 638-3256

HOUSTON, TEXAS  
Wells Sound Studios \*  
(713) 688-8067

TULSA & OKLA. CITY, OKLA.  
Ford Audio and Acoustics  
(405) 525-3343

PHOENIX & TUCSON, ARIZ.  
Lee Furr Studios  
(602) 792-3470

WASHINGTON, D.C.  
United Recording Co. \*  
(301) 588-9090

FORT SMITH, ARK.  
Village Recording Studios \*  
(501) 782-5051

KANSAS CITY, MO.  
Master Sound Recording  
(816) 333-9617

CLEVELAND, OHIO  
Agency Recording  
(216) 621-0810

CANADIAN  
REPRESENTATIVES

OTTAWA, ONT.  
MARC Productions  
(613) 746-7523

TORONTO, ONT.  
Phase One Recording Studio  
(416) 291-9553

MONTREAL, ONT.  
RIA  
(212) 582-0400

\* 8-TRACK FACILITY



RECORDING INSTITUTE OF AMERICA, INC.  
15 Columbus Circle • New York, N.Y. 10023

CIRCLE 25 ON READER SERVICE CARD

www.americanradiohistory.com

# GROOVE VIEWS

Reviewed by:  
SEDGWICK CLARK  
NAT HENTOFF  
JOE KLEE  
GIL PODOLINSKY  
HOWARD ROLLER  
RUSSELL SHAW

## POPULAR

**EARL SCRUGGS REVUE: *Family Portrait*.** [Ron Bledsoe, producer; Gene Eichelberger, Ron Reynolds, engineers; recorded at Columbia Studio A, Nashville, Tenn.] Columbia PC 34346.

Performance: **More varied than most**  
Recording: **Where's the banjo?**

By now, most Earl Scruggs fans have readily accepted the fact that, at least for the present, ol' daddy Earl is just gonna sit in the background, play two or three solos per record, and let his sons do the rest. Obviously trying for a more contemporary sound, his shrinking violet approach has been scorned by those who rightfully consider the contributions of his sons an exercise in derivative plagiarism.

The tunes on *Family Portrait* are catchy; some of the lyrics capture the ear. Nobody has ever found any fault with the guitar playing of Randy Scruggs, who could be a major voice on the instrument if he wanted to be. Yet the tunes are photocopies of familiar themes made popular by other so-called "country rock" bands such as Pure Prairie League, Marshall Tucker, the New Riders and many others. It doesn't truly break new artistic ground when the Scruggs sons write something cliched like "Tall Texas Woman," which discusses the implied and hackneyed subject with the obligatory idolatrous references to the revered lady in question.

By locking themselves into this narrow format, the Earl Scruggs Revue

has consistently avoided stressing their main attribute—an uncommon degree of musical dexterity. Save a few bars on "Daydream," most of Randy Scruggs' work is obligatory chordal maintenance. Daddy Earl, a legendary banjoist, seems to play as little as possible, and when he does, he's deeply buried in the mix.

Why are pickers such as Randy and

Earl embarrassed to solo? Worse yet, when they do succumb to the urge, why are they then buried in the mix? The only possible answer is that somewhere, there lurks a heavy a&r man convinced that the public prefers watered-down musicianship and familiar harmonies over the more ethereal bluegrass material which lies at the root of the Scruggs legend. R.S.



**EARL SCRUGGS REVUE: Avoiding their main attributes.**



**SYMPHONIC SLAM: *Symphonic Slam*.** [George Semkiew, Timo Laine, producers; George Semkiew, Mick Walsh, engineers; recorded at Phase One Recording Studios, Toronto, Canada.] A & M Records SP 4619.

Performance: **Intriguing**  
Recording: **Needs work**

Don't be misled by the title and group name to think that this is another disco treatment of the classics. Rather, this modern day trio is comprised of drums, synthesized guitar and keyboards. This is the first album to feature the new 360 Systems Polyphonic Guitar Synthesizer, and the age and versatility of the synthesizer seems to be coming into its own. The combinations of synthesized instruments and engineering and the possibilities rendered thereof are limitless, though this album did little more than introduce the speculation.

The recording itself is rather busy, with many things going on at once. The instruments were all placed upfront in the mix with the vocal tending to be rather flat and slightly removed. Echo is a common occurrence and the ensuing music tends to drown out the last words of each vocal line. There is a frequent use of panning the synthesized guitar, usually on a descending run which is always too short for effect and therefore meaningless. The effect of recording cymbal crescendos climaxing into synthesized strings is quite reminiscent of early King Crimson. The use of sound effects which tend to dilute rather than supplement, such as the train effects in "Modane Train," has to be questioned. The use of synthesized bass is more adaptable and varied than the electric, though it cannot be as active without extensive overdubbing of instruments to compensate for too few hands. Although a good point of reference, *Slam* needs vocal and lyrical work and both musicians and engineers need to lose old cliches. G.P.

**GENESIS: *Trick of the Tail*.** [David Hentschell, Genesis, producers; David Hentschell, Nick Haddock Bradford, engineers; recorded at Trident Studios, London, Eng.] ATCO SD 36-129.

Performance: **Best yet**  
Recording: **Well suited**

Hentschell, who also engineered



**GENESIS: Distinctive and paying off.**

their previous album, *A Lamb Lays Down On Broadway*, seems to have caught the knack for showing the best side of Genesis—one of the few progressive English groups who still allow an outsider to partake in production. The results in the past have been inconsistent due to the constant change in producers and engineers. However, by using virtually the same production team on the last two albums, their sound has been enhanced to the point of becoming distinctive.

This album is quite a surprise and comes at an unexpected time in Genesis' career. Having just lost singer/songwriter/main focal point Peter Gabriel, one would expect that it would take several albums for the group to get on track again. Instead, this eight year old band has released its best effort yet. Rather than replacing Gabriel, Genesis now functions as a quartet. The writing credits are now evenly spread amongst the band's members, giving Genesis more energy and unification.

Overall, this is the first time that the production and engineering have been able to "bring home" the material consistently. Not so busy a band as, say, Yes, for example, the concept behind the music is to create the proper moods behind the lyrical content. Therefore, the mix features the vocals up front cushioned by synthesized strings and other assorted keyboards. The drums are fairly subdued with the guitar and bass basically playing the same melodic line as the keyboard, thereby creating a three-part harmonic line. Although I would prefer to hear more activity from the drums and more diversity on guitar, it may be an either/or situation regarding the drums. Drummer Phil Collins now

handles all the vocals and may prefer to downplay his percussive line in deference to being able to do it "live." Be that the case, it should be remembered that recording and performing are two separate entities. Regardless, after eight years of near misses, I'm glad to see that Genesis has stuck it out and that it's paying off. G.P.

**KURSAAL FLYERS: *Golden Mile*.** [Mike Batt, producer; Tim Friese-Green, Bob Butterworth, engineers; recorded at Messex Studio and Landsdowne Studio, London, England.] CBS Import 81622.

Performance: **No complaints**  
Recording: **Veddy nice, thank you**

Well, right away you're spoiled, being that it's an import. The separations are more pronounced, no surface noise, a very clean production all around. Musically, the Kursaal Flyers pull surprises like Billy Carter pulls beers. To look at them (note the pedal steel in the group), one would think that they're England's answer to Dr. Hook. Let's face it, these guys are a fun bar band, and I'd have no problem visualizing them at the Longbranch Saloon in Berkeley. That, however, is not to say that they lack sophistication. The occasional classical cliches dropped with deference throw you off. Strings float through songs, connecting passages and succeed in giving them another dimension, not just filling up tracks.

When does a cliché stop being a cliché? When it does not distract your attention and allows you to focus on the overall. The castanets and Spanish bullfight-type brass add the perfect touch to "Two Left Feet." Lyrically, they play it straight, whereas a Dr. Hook would





**KURSAAL FLYERS:** Pulling surprises

ham it up. Straight-ahead rock is no stranger to the Kursaal Flyers, with "Street of the Music" being a perfect example. With female back-up singing the background chorus, a horn section complementing a chunky rhythm part to a non-distorting rhythm guitar, the throttle is wide open for them to let go. The odd thing about the song is the guitar solo. It's so muddy and so buried

in the mix that it has no effectiveness. After another vocal chorus we're switched to it again, and this time it's pumped up a few dB, but still to no avail. It's so inconsistent with this recording that it must have been done deliberately, although why is beyond me. Vocals are separated from the backing instruments to the extent that you'd swear you could measure the distance.

But, all in all, there's no doubt that the Kursaal Flyers had fun making this record, and that that fun is contagious to the listener.  
G.P.

## JAZZ

**ORNETTE COLEMAN:** *Dancing In Your Head*. [Ornette Coleman, producer; James Jordan and Robert Burford, associate producers; John Snyder, creative director; Steve Goldstein, engineer, Joujouka, Morocco, January, 1973; Francis Maimay, engineer, Barclay Studios, Paris, France, December, 1976.] A & M Horizon SP 722.

Performance: **Avant Garde but tasteful**  
Recording: **Oui, Oui, Paris;**  
**So-So, Morocco**

Ornette Coleman's conspicuous absence from the recording studio and the concert and club scene indicates a change of direction, a rethinking of the player's art. Gone are the intertwining horn lines played with Don Cherry and Dewey Redman over the churning rhythms of bassist Charlie Haden and Billy Higgins.

# The only professional stereo reverberation system for under 500 dollars.

**It Sounds Better.**

The Sound Workshop 242A Stereo Reverberation System . . . \$450.  
The Sound Workshop 242AB (Transformer Balanced Outputs) . . . \$500.

Sound Workshop Professional Audio Products, Inc., 1040 Northern Blvd., Roslyn, New York 11576 (516)-621-6710



Ornette's new group, Prime Time, has the structure of a rock band (two guitars, bass and drums) but the musical direction will be familiar to all Ornette



**ORNETTE COLEMAN:** A rethinking of the player's art

Coleman fans. The horns have been replaced by the guitars of Bern Nix (right speaker) and Charlie Ellerbee (left speaker). Bassist Rudy McDaniel and drummer Shannon Jackson lay down a beat that's more insistent and less flexible than those of Ornette's previous rhythm sections. Ornette sometimes finds himself molding his improvisations to what the bass and percussion insist upon.

The piece which composes most of this LP, "Theme From A Symphony," is from Ornette's major work, "Skies of America." The two variations were recorded in Paris in 1976 with no overdubbing and only an occasional rhythm track added.

The final brief selection, "Midnight Sunrise," is an experiment in blending the Western music of Ornette Coleman on alto sax and Bob Palmer on clarinet with the Eastern music of the master musicians of Joujouka, Morocco. Although vastly different, these two sub-cultures improvise together without the kind of disastrous fragmentation that one might have expected. The recording was made in 1973 in Joujouka where there are no sixteen track studios available. For an album recorded on two-track portable equipment, it's all right but I wish circumstances had allowed for more presence and definition of the ensemble instruments. J.K.

**GEORGE DUKE:** *From Me To You.*  
[George Duke, producer; Kerry McNabb,

engineer; recorded at Paramount Recording Studios, Los Angeles, Ca.] Epic PE 34469.

Performance: **Uneven**  
Recording: **A bit sloppy and uninventive**

This is a curious recording for each song seems to lack purpose. The current trend among progressive jazz/rockers, like Duke, has been to turn to the use of vocals, which ordinarily is fine, except that in Duke's case, one detects immediately that he has nothing to say.

George Duke's keyboard work has taken the back seat and is making serious moves towards the trunk. Side One is beset with the problem of having everything geared around the vocals so, artistically, the music serves no other purpose than that of a bed. In terms of engineering, the LP starts out with a clearly recorded introduction, over one minute long, which creates a great feeling of expectation for what's to come. But it's all for nought, as this brief period seems to be the only time the engineering is on top of things.

This record lacks an overall equal presence level. Background vocals are nearly inaudible, instruments are buried, synthesizer panning reduced to the

effect of a volume/wah going from full to thin. With headphones, one detects towards the end of "Carry On" that the right side of the mix is, in volume, totally disproportionate with the left. On "What Do They Really Fear?" (a Hendrix-influenced vocal and guitar piece) the piano sounds terrible, apparently played through a phase shifter. The echo used on the fuzz guitar in no way blends with the rest of what's going down, serving only to detract from what otherwise might've been a nice Hendrix-style guitar solo.

The hand claps on "Scuse Me Miss" need definition. The introduction of a horn section is also damaging to the piece because they either: a) were too closely miked, b) peaked on the VU meters, c) should have been redone, for in several places the musicians couldn't hold their notes, or d) all of the above.

The mix is the weirdest I've ever heard. In the stereo field, the left side of the mix—containing the drums and bass—is so much louder than the keyboard/guitar on the right that the listener will be tempted to use his balance control and maybe even an equalizer, if he has one, in an attempt to even the balance.

The music on Side Two is more ener-

## Get your signal processed

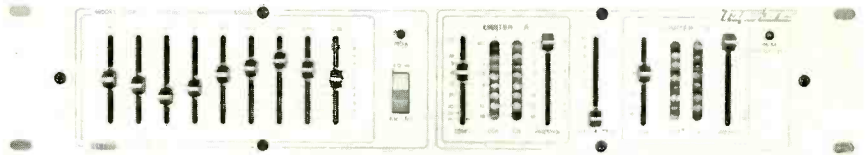

### THE TROUPER SOP-1 OUTPUT SIGNAL PROCESSOR

#### NINE BAND GRAPHIC EQUALIZER

±10 dB adjustment at one octave frequencies

Peak Indicator  
In/Out Switch

#### ELECTRONIC CROSSOVER

16 Individually selectable frequencies

High Frequency Level Control  
Peak Indicator

#### DUAL LIMITER

Two Independent Peak Limiters  
On Cross-Over Outputs

Input / Threshold Level Controls  
Solid State LED Output and Gain Reduction VU Indicators

Interaction Control determines amount of cross limiting  
May be used to limit high and low frequency outputs of the crossover separately.

#### ADDITIONAL TROUPER SERIES ACCESSORIES

METER LINE AMP PACKAGE  
QUAD LIMITER  
DUAL 9-BAND GRAPHIC EQUALIZER  
DUAL ELECTRONIC CROSSOVER  
9-BAND EQUALIZER/CROSSOVER COMBINATION

See your local dealer or write for our free catalog:



A BSR COMPANY  
742 HAMPSHIRE ROAD  
WESTLAKE VILLAGE, CA 91361

CIRCLE 88 ON READER SERVICE CARD

**YOU CAN  
GET OUR  
TANGENT KNOBS  
WET...**



**AND THEY'LL STILL  
WORK!**

The next time some klutz drops his drink on your mixer with slide pots, remember *our knobs!* We chose to go all-rotary on our PA mixing consoles because of the better reliability and durability. The whole idea is to make sure nothing gets in the way of the ultra-clean sound of our Super-Fi circuitry. Write or call us today for a better look at our knobs.



**Tangent**  
musical engineering

2810 south 24th street  
phoenix, arizona 85034  
602-267-0653

CIRCLE 84 ON READER SERVICE CARD

## Keeping "The Shout" Is What Its All ABOUT

by Nat Hentoff



**ANTHONY BRAXTON:** Missing that visceral force

Anyone curious about—or already immersed in—post-Coltrane jazz should have *Anthony Braxton: The Montreaux/Berlin Concerts*. Recorded in 1975-76, the compositions, all by Braxton, reinforce his position as perhaps the most provocative *intellectual* force in the new music of this decade. Braxton's precise, demanding criteria of extraordinarily sensitive collective dynamics and his absorbing command of textural nuances make him the commanding presence in all these performances. Furthermore, as a soloist, he handles the alto, clarinet, soprano sax, and contrabass clarinet with such total mastery that no anti-avant-grade jazz traditionalist can accuse Braxton of jiving on his instruments. He knows exactly what he wants and how to achieve it.

Yet I have a reservation. The Chicago-born Association for the Advancement of Creative Music, from which Braxton evolved, has a motto, "Keeping 'the shout' in the music is what's all about." The shout is the life-force, "the goat-cry" (as novelist Thomas Wolfe used to put it). Some call it "soul;" older players would talk of telling a story—with human horns. Braxton has everything but that shout, that visceral force. His stories are impeccably crafted but they are not likely to change lives—as the tales of Bird and Pres and Trane did.

"The shout," however, is in this four-sided album—from the astonishing young trombonist, George Lewis, whose emotions as well as ideas are larger than life-size. And the life force is in drummer Barry Altschul and bassist Dave Holland, among others. My sense is that the shout is also deep inside Anthony Braxton, and if he's ever able to let it

out, he could be the colossus of the 1980's. In any case, the album is fascinating in its continual tension between the leader's penetrating intellect and the more earthly imaginative souls around him.

The recording quality throughout is superb—exceptional presence, individually and collectively. In fact, a model of crystalline balance for all sessions of post-Coltrane jazz.

As a further measure of the key element Braxton is thus far lacking, there is an utterly delightful reissue set, *Sarah Vaughan, Recorded Live* in sessions in Chicago and Copenhagen from 1957 to 1963. Here is a musician-singer, with more prodigious technical resources than any of her contemporaries. And while it is true that occasionally, she delights in just stretching those skills—"showboating" it used to be called—there is in everything Sarah does a high-energy, deeply swinging, soaring, exultation of the life-force. She has that inner "shout," even when caressing a ballad; and so, listening to her through all four sides has a marvelously re-energizing effect. And *that* too is what jazz is all about.

Both the original recording and the tape re-mastering keep the "live" excitement while focusing on an optimum recorded rather than concert experience.

**ANTHONY BRAXTON:** *The Montreaux/Berlin Concerts*. [Michael Cuscuna, producer; John Temperley, Carlos Albrecht, engineers.] Arista AL 5002.

**SARAH VAUGHAN:** *Recorded Live*. [Robin McBride, reissue producer; no engineering credits.] Mercury/EmArcy Jazz Series EMS-2-412.



## Here's A Guide To The Record Business By The Pros!

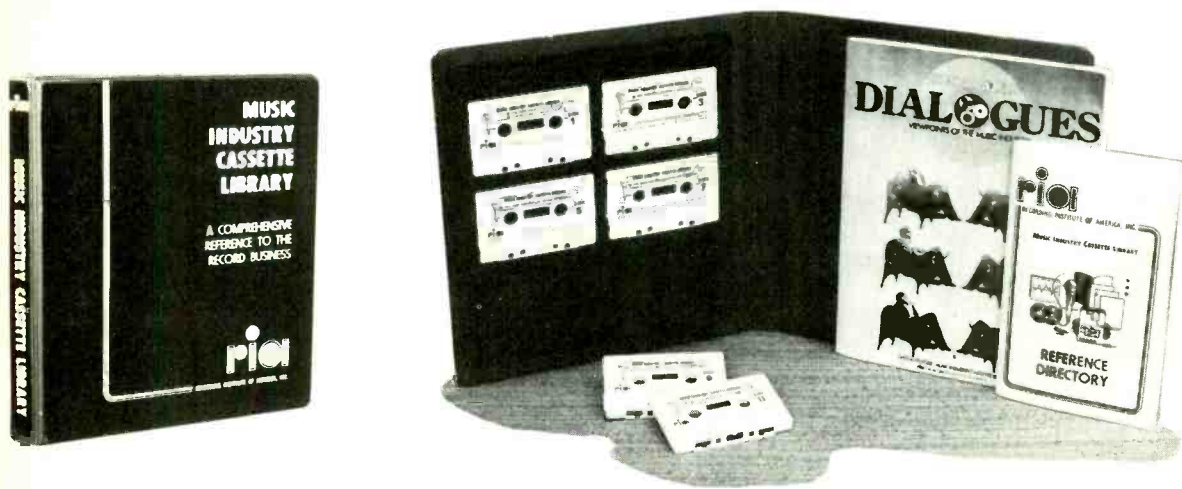

Compiled from Recording Institute of America's interviews with key executives and "hit-makers", plus Reference Directory and Dialogue's Viewpoints of industry "stars".

Listen to the industry "pros" describe the workings of the Music Business. Hear the most respected attorneys of the entertainment field define and discuss the legal terminology of Recording Contracts, Songwriter Contracts, Professional Management Contracts. Over 3½ hours of professional reference... could be the most important 200 minutes of your life!

Plus... RIA Reference Directory, including sample songwriter affiliation forms, sample artist contracts, writer contracts, etc., in addition to a Directory of Record Manufacturers, Music Publishers, Personal Managers, Producers and Booking Agents. Also **Record World's "Dialogues"** with over 50 candid interviews from **Record World** magazine, and a cross-section of "star" personality interviews.

You get all the above (regularly \$49.95) for only \$39.95 for MR readers.

## Home Recording Course

—a must for every *creative* tape recorder owner!



HOME RECORDING TECHNIQUES is three hours on two 7-inch, 7½ ips, 4-track tapes, including a booklet of diagrams on:

- sample microphone placement
- instrument set-up
- console and machine patching for special effects
- and MUCH MORE!

ONLY \$15.95

ORDER FORM — MAIL TODAY

MODERN RECORDING Magazine

14 Vanderventer Ave., Port Washington, N.Y. 11050

- Please send [ ] copies of "Music Industry Cassette Library" at \$39.95 each
- Please send [ ] copies of "Home Recording Techniques" at \$15.95

Please Print

Name \_\_\_\_\_

Signature \_\_\_\_\_

Address \_\_\_\_\_

City \_\_\_\_\_ State \_\_\_\_\_ Zip \_\_\_\_\_

Total Amount \_\_\_\_\_ Check/ Money Order for \$ \_\_\_\_\_

10 Day Money Back Guarantee

DATE \_\_\_\_/\_\_\_\_/\_\_\_\_

## DON'T SETTLE FOR LESS THAN THE BEST IN INTERCONNECTING DEVICES

- AUDIO CONNECTORS
- JACK PANELS
- SNAKE CABLES
- CABLES
- MULTISWITCHES®
- AUDIO ACCESSORIES
- CONNECTORS

IN DEPTH INVENTORY  
IMMEDIATE DELIVERY  
SEND FOR FREE CATALOG

PRO SOUND

13717 S. Normandie Avenue  
Gardena, CA 90249  
(213) 770-2333

CIRCLE 90 ON READER SERVICE CARD

## WHERE CAN YOU FIND JOY

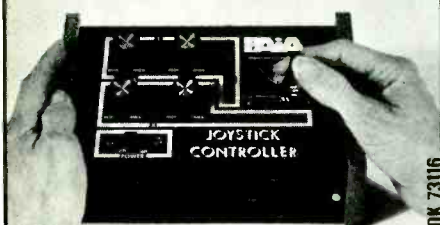

### for less than \$40?

What a shame that a joy stick is the missing controller on most American synthesizers.

A joy stick gives you total, infinitely variable control of two parameters simultaneously.

Our **JOY STICK CONTROLLER** works in either of two modes:

#### CONTROL VOLTAGE SOURCE

With your exponential front-end equipment. Use with any processing system/device that has provision for voltage control.

#### CONTROLLABLE MULTIPLIER

For linear response elements.

**ALL THIS AND:** A touch-activated "gate" trigger that activates with the slightest touch of the joy-stick's metal shaft. No buttons to search for. And at a typical "down-to-earth" price.

**no.4780 JOY STICK CONTROLLER KIT \$39.95**  
(plus \$3.00 postage)

Free 20 page catalog of affordably priced synthesizers, modules & accessories.

From **PAIA** of course!

CIRCLE 97 ON READER SERVICE CARD

getic, but comes off sounding like the quartet version of Return To Forever, which isn't unusual since Stanley Clark [bassist for Return To Forever] plays

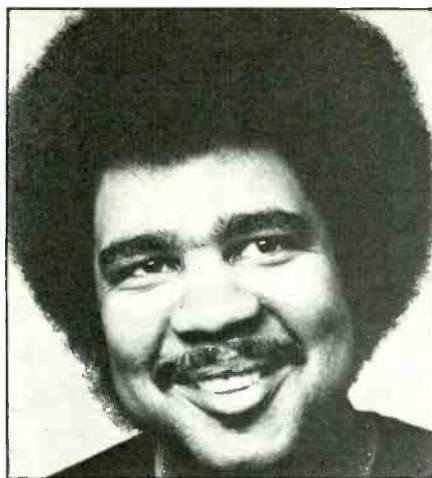

GEORGE DUKE: On an uneven keel

on half the album. The overdubs, sounding as though they were possibly room miked for added ambience—an unusual situation in multitrack recording—don't blend with the rest of the side. The mix doesn't give equal time to everything.

The one thing that can be shared equally by all concerned is the blame for this directionless, and pointless, recording. G.P.

## CLASSICAL

**BEETHOVEN: Symphony No. 7.** London Symphony Orchestra, Colin Davis cond. [Vittorio Negri, producer; recorded in London, April 1976.] Philips 9500 219.

Performance: **Among the best**  
Recording: **Ideal**

This is the best of Davis' Beethoven cycle on Philips so far. His early '60's recording of the Seventh still on Angel is a fine one, and perhaps his long acquaintance with the work contributes to the sense of maturity which pervades this performance. Only Haitink, of the younger generation of conductors who have recently recorded this work, demonstrates comparable mastery, and Davis scores over him with better pacing of the trio in the *scherzo* and a recording of more presence and guts. A measure of Davis' success is that he

takes all the repeats—which I usually find too much of a good thing in this symphony—and sustains interest and excitement throughout.

Out of forty-one recordings of the Seventh presently in the Schwann catalogues, three superb performances on budget labels should be mentioned for the adventurous: Toscanini's 1936 New York Philharmonic recording on Victrola, Cantelli on Seraphim and Walter on Odyssey (unfortunately, only available in a box of all the symphonies)—the first in unadulterated mono and the last two in good early stereo sound. S.C.

**BARTOK: The Wooden Prince, Op. 13.** (Complete Ballet). New York Philharmonic, Pierre Boulez, conductor. [Andrew Kazdin, producer; Bud Graham, Milt Cherin, Ray Moore, engineers; recorded at Manhattan Center, New York.] Columbia M-34514.

Performance: **Nothing short of phenomenal**

Recording: **Refined yet very natural**

Recordings by Pierre Boulez and the New York Philharmonic, produced by Andrew Kazdin, have been praised before in these pages, but this is their finest collaboration yet. In all respects—interpretation, performance and sonics—this is undoubtedly one of the best records of the year and perhaps the finest-sounding orchestral recording on the Columbia label.

One would not expect *The Wooden Prince* (1917) to interest Boulez so. A product of Bartok's folk-nationalist years, lacking the Freudian introspection of *Bluebeard's Castle* (1911) and the otherworldly barbarism of *The Miraculous Mandarin* (1919), there is nothing innovative or particularly striking about the score. This is Bartok at his most benign, and while the music may seem at first a bit overlong, further acquaintance increases one's appreciation. Not surprisingly, Boulez emphasizes the colorful orchestration, the heavy influences of Debussy and Stravinsky (*The Firebird*, especially). The dance character, breadth and affectionate *rubato* of his conducting makes the fine 1965 Dorati/LSO recording (which should be reissued on Mercury Golden Imports) seem monochromatic and insensitive by comparison. The playing of the New York Philharmonic is little short of phenomenal, perfectly in tune with Boulez's warm, elastic shaping of the music. This record has turned on my



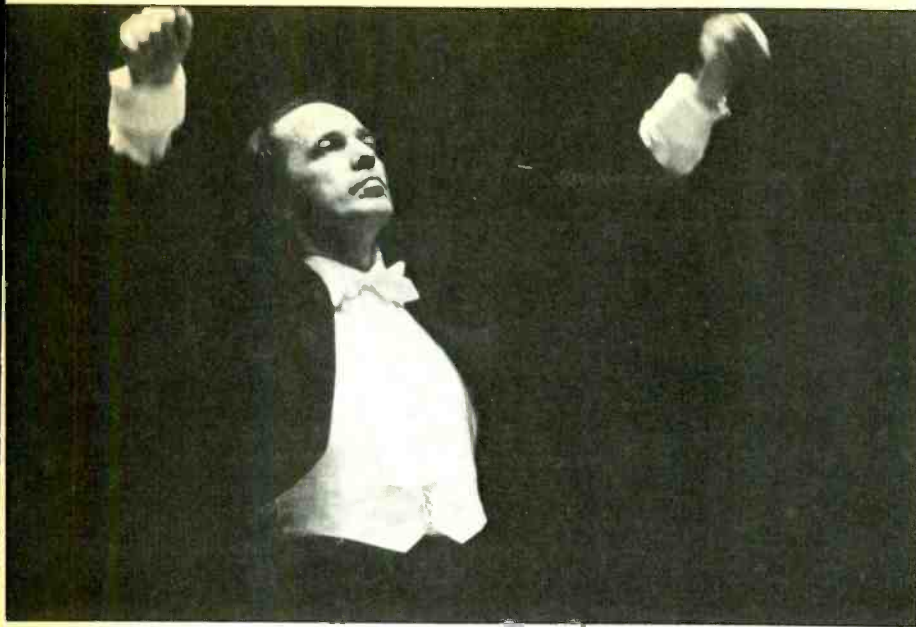

PIERRE BOULEZ: A warm, elastic shaping of Bartok

table during leisure hours more than any other disc this year.

Having attended many of this team's sessions I am consistently surprised that despite close placement of the many microphones, the final perspective appears somewhat distant and refined—never flat and without depth, as, for example, London's consciously blockbusting Solti/Chicago recordings (e.g., *Zarathustra*, *Enigma Variations*). It's all in the mix, of course, and Kazdin won't tell his secrets. Whatever his technique, though, he has produced a rich, warm transparent orchestral palette, with no distracting spotlighting. It sounds very natural—which is what it's all about. S.C.

## SHOWS and SOUNDTRACKS

**WEILL:** *Threepenny Opera*. Raul Julia, Macheath; Caroline Kava, Polly Peachum; Ellen Greene, Jenny Towler; Blair Brown, Lucy Brown; C.K. Alexander, Jonathan Peachum; Elizabeth Wilson, Mrs. Peachum; David Sabin, Tiger Brown; Roy Brocksmith, Ballad Singer; chorus and instrumental ensemble, Stanley Silverman, cond. [Larry Morton, producer.] Columbia PS 34326.

Performance: **Pales by comparison to earlier versions**

Recording: **Best yet sonically**

**WEILL:** *Mahagonny Songspiel*, *Kleine Dreigroschenmusik*, *Pantomime*, *Vom Tod im Vald*, *Berliner Requiem*, *Violin*

*Concerto*, *Happy End*. Meriel Dickinson, mezzo-soprano; Mary Thomas, mezzo-soprano; Philip Langridge, tenor; Ian Partridge, tenor; Benjamin Luxon, baritone; Michael Rippon, bass; Nona Liddell, solo violin; London Sinfonietta, David Atherton, cond. [Dr. Rudolph Werner, producer; Wolfgang Mitlehner, engineer.] DG 2709 064 (three records).

Performance: **Excellent, yet a trifle stodgy**

Recording: **Among DG's best work**

For devotees of the music of Kurt Weill—and I am one—this is a time of boundless opportunity to appreciate and savor his music. Recently there have been simultaneous productions of *Happy End* (written with Brecht) and *Knickerbocker Holiday* (Maxwell Anderson). Neither of these shows is done frequently; in fact, *Happy End* has just premiered in New York. *Threepenny Opera* has recently concluded a successful run at Joseph Papp's New York Shakespeare Festival and was revived in Central Park last summer. Finally, we have recent releases of the original cast recording of this *Threepenny Opera* production as well as a three-record set on Deutsche Grammophon of much of Weill's work with Brecht, which includes several previously unrecorded works plus music from *Happy End*, *Threepenny Opera* and *Mahagonny*.

Of the five recordings in existence which document various productions of *Threepenny Opera*, three are in German (the oldest, with original cast members

# That Good Sound

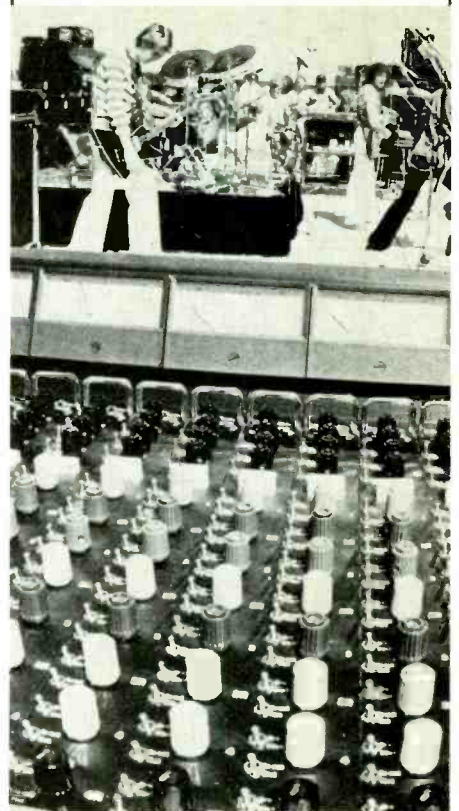

More and more groups are insisting on mixers by Interface Electronics because their rugged advanced design, high quality components, modular construction, immunity to stray fields, and multiple options result in much better performance and a flexibility that allows you to have it your way, with everything in one frame including submasters, large lighted VU meters, equalizers and cross-overs. Series 104/108 can handle up to 32 inputs and up to 8 stereo submasters; and we make the only professional Stage Monitor mixer, available complete with equalizers and intercom. Write for more information.

## INTERFACE ELECTRONICS

3810 Westheimer, Houston, Tx 77027  
Telephone (713) 626-1190

CIRCLE 44 ON READER SERVICE CARD

# Audio Tape for professionals

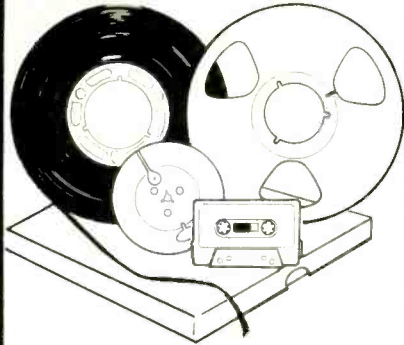

## REEL TO REEL TAPE

Ampex, 3M. All grades,  
On reels or hubs.

## CASSETTES, C-10-C-90,

with Agfa, Ampex, 3M Tape

## LEADER & SPLICING TAPE

## EMPTY REELS & BOXES

All widths, sizes.

— COMPETITIVE • FROM STOCK —



Recording Supply Co.

1233 Rand Road  
Des Plaines, IL 60016

Div. of  
Polyline Corp.

312/297-0955

CIRCLE 67 ON READER SERVICE CARD

from Berlin, is out of print), making the current issue only the second English language version on record. Therefore, a comparison of the two is unavoidable.

The previous recording comes from the Theatre De Lys production of 1954 and utilizes the English version of *Three-penny Opera*. This version, the work of Marc Blitzstein, retains its stature since it is at once stageworthy and reasonably faithful to the spirit of the original. In comparing the Blitzstein adaptation with the Papp production, adapted by Ralph Manheim and John Willett, there are several considerations. Blitzstein, clever as he is, makes no attempt to preserve the meter of the German song lyrics when he adapts. His versions of the songs are singable but rather free. Manheim and Willett have tried to be more literal, as well as singable, but with only intermittent success. Their settings are mainly awkward and hard to follow, and frequently no closer to the German than Blitzstein. Although Manheim and Willett occasionally do significantly better (a notable example is the "Canon Song"), mostly they are somewhat more accurate in translation but vastly less performable than Blitzstein, who was a better poet in his own right.

There are other points of consideration as well. A fair amount of the uglier, coarser verses in the original show were softened or deleted for the 1954 revival. Many of these are restored for this 1975 production. Well and good, but to interrupt the self-congratulation expressed by Mr. Papp in his notes for the album, 1975 is a much more permissive age than 1954 was on Broadway. What had to be censored then is no great piece of courage to restore now. Also, the recent production seems to have taken the attitude of smut for smut's sake.

It is hardly being prudish to point this out, since Brecht and Weill certainly provided their seamy moments in *Three-penny Opera*, but Manheim and Willett (perhaps encouraged by Mr. Papp) seem obsessed with providing raunchiness in places poor Bert and Kurt never dreamed of—or desired. Examples abound, but one very good one should suffice: in the song which translates as "The Procurer's Ballad" but which Manheim and Willett call "Ballad of Immoral Earnings," there is a line referring to an unwanted child which Jenny at one time had by Macheath—and the rather ambiguous disposal of it. Mr. Papp, in his liner notes, makes a big deal about how Blitzstein excised it and they have restored it. However, the Manheim/Willett version is grossly incorrect and ugly in a way

## DON'T MISS OUT on back issues of MR!



Just send \$1.50 plus \$.25 for postage and handling per issue to:

**Modern Recording**

Back Issues Dept.

14 Vanderventer Avenue

Port Washington, N.Y. 11050

### Check Box:

Vol. 2, No. 4

Vol. 2, No. 7

Vol. 2, No. 5

Vol. 2, No. 8

Vol. 2, No. 6

Vol. 2, No. 9

Sorry! All other back issues are out of print.

Name \_\_\_\_\_

Address \_\_\_\_\_

City \_\_\_\_\_

State \_\_\_\_\_

Zip \_\_\_\_\_

## MODERN RECORDING

BUY • SELL • TRADE

- PRODUCTS
- EQUIPMENT
- SERVICES

*Classified Rates*  
60¢ per word

Minimum 10 words. Copy must be received at Modern Recording, 14 Vanderventer Avenue, Port Washington, N.Y. 11050 by the 1st day of the 2nd month prior to cover date (for example, the Dec/Jan issue closes October 1st). Payment must accompany order. Phone numbers count as 1 word. Zip codes are free.

DISPLAY ADVERTISING  
\$80.00 per column inch

# CLASSIFIED

## ice cube SUSTAIN COUPLER

© 1976  
PAT. PEND.  
TRADE MARK



### Transforms any Fender Reverb Amp!

The Ice Cube™ is the first Professional Quality gain-boost/overdrive device to use your amplifier's built-in controls and power. Highly reliable, with no batteries or cords to wear out, the Ice Cube™ is virtually indestructible.

Manufacturer's suggested retail: \$19.95  
JHD Audio, 1370 Logan Ave., Unit E  
Costa Mesa, California 92626

**JHDAUDIO**

CIRCLE 41 ON READER SERVICE CARD



SUBSCRIBER SERVICE

## CHANGE OF ADDRESS

Planning to move? Please let us know six weeks in advance so you won't miss a single issue of MODERN RECORDING. Attach old label and print new address in space provided. Also include your mailing label whenever you write concerning your subscription to insure prompt service on your inquiry.

Date \_\_\_\_\_

City \_\_\_\_\_

Address \_\_\_\_\_

Name \_\_\_\_\_

State \_\_\_\_\_

Zip \_\_\_\_\_

New Address Here

Attach Label Here

Please print

MODERN RECORDING Magazine  
14 Vanderventer Ave. • Port Washington, N.Y. 11050

Brecht and Weill had no interest in. The original line is best translated by Eric Bentley as "at that this child was destined for the rushes." This is clearly a cryptic allusion to Moses in the Bible, something Brecht was fond of doing. Manheim and Willett give us this: "But in the end we flushed it (the child) down the sewer." Totally uncalled for and flagrantly unfaithful. Brecht and Weill knew that a little vulgarity goes a long way; but Manheim and Willett cram it in everywhere they can and seriously weaken their accomplishment.

A word is also in order about the musical arrangements. The Papp production

ful, but not as well performed as the old one, nor as much fun. There is a pall about this new version that weighs it down. Own them both if you feel so inclined, but I'd rather live with the previous recording.

Turning to the DG box of Kurt Weill music: this set fills a vital gap in the Weill discography. Focusing primarily on the Brecht-Weill collaboration, it provides us with several previously unrecorded works. Dealing with material composed between 1924 and 1928, it is a good selection of Weill's Berlin work as well as an evidence of Kurt Weill, the serious composer. Speaking personally, the



WEILL: Filling a vital gap

is a good deal closer musically to the published score than the Theatre De Lys recording. However, Eric Salzman's statement in his review of the Papp production disc, "... we have never really heard Weill's orchestration before, ..." is absurd. To begin with, much of the published score was not orchestrated by Weill at all. Weill's autograph appears on many of the unorchestrated songs. Many hands have interposed between Kurt Weill and the published score, so Weill's orchestral intentions are far from clear. Stanley Silverman has done reasonably well in arranging his version of the score—though it is no closer to the Universal Edition of *Threepenny Opera* than is the German recording on Columbia.

If you are like me, you'll want all versions of *Threepenny* since it is a masterful piece of musical theatre. If you are less obsessive, the new recording is better sonically and somewhat more faith-

most enjoyable material in this collection includes the music from *Happy End* and the suite from *Threepenny Opera* called "Kleine Dreigroschenmusik." The *Mahagonny Songspiel* leans toward a more serious opera form and the remaining works show us Weill's efforts in such forms as the cantata, dramatic lieder and violin concerto.

These recordings are equal to DG's best work sonically and are provided with a highly informative booklet which is notable also for including Michael Feingold's superb English versions of the songs from *Happy End* and *Mahagonny Songspiel*. The performances are stronger musically than any collection of Kurt Weill's material I know of and intelligently, if a trifle stodgily, interpreted. Whether you are an old Kurt Weill fan (as I am) or just discovering him, this set is indispensable.

H.R.

### By Popular Demand!

## THE HISTORY OF RECORDING

By Robert Angus

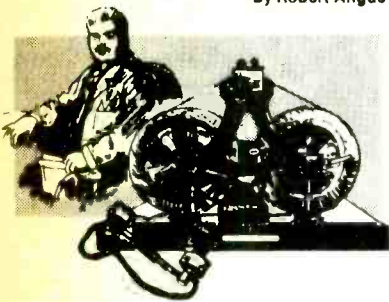

The entire six-part series from Modern Recording Magazine.

Reprinted as a specially bound book for only . . . \$3.50

Send for this edition today!

Send check or money order to:

**Modern Recording Magazine**  
14 Vanderventer Ave.  
Port Washington, N.Y. 11050

**MODERN  
RECORDING**  
**Is NOW  
Published  
Monthly**

**Subscribe Now! Renew Now!**

*\$22.00 for 24 Issues—Save \$14.00  
\$12.00 for 12 Issues—Save \$6.00*

Check  Money Order

enclosed for the amount of \$ \_\_\_\_\_

Name \_\_\_\_\_

Address \_\_\_\_\_

City \_\_\_\_\_

State \_\_\_\_\_ Zip \_\_\_\_\_

New Subscription  Renewal

*(Foreign subscriber add \$3.00 for each year.  
Foreign subscriptions payable ONLY in U.S.  
funds by international draft or money order)*

**Advertiser's Index**

Reader Service #	Advertiser	Page #	Reader Service #	Advertiser	Page #
26	Acoustic Control	35	73	Norlin	41
74	Ashly Audio	20	97	PAIA	76
No#	Audio Technica	8	33	Peavey	57
29	Audioarts Engineering	15	67	Recdg. Supply	78
51	Beckman/Roland	5	25	RIA	69
90	Calif. Switch & Signal	76	28	SAE	21
66	Carvin	6	34	Shure	2
62	DBX	9	No#	Sound Workshop	28
No#	Delta Graph	11	83	Sound Craftsmen	17
70	DiMarzio	7	No#	Sound Workshop	72
21	Gallien Krueger	18	52	Studer/Revox	19
24	Hammond Industries	13	22	Sunn	53
32	Heil	14	82	Superscope	Cvr. III
57	Ibanez	16	84	Tangent	74
44	Interface	77	53	Tapco	31
41	JHD	78	79	TDK	1
43	JVC	33	No#	Teac	42, 43
58	KIK	15	75	Technics	Cvr. IV
47	Morley	34	23	Unisync	51 & 73
56	MXR	Cvr. II	69	Whirlwind	52
			40	White	12
			42	Yamaha	47



**CLASSIFIED ADS**



A 140-page comprehensive directory listing names, addresses, and phone numbers of every major record company, publishers, booking agents, managers and independent record producers. Also, sample contract forms for each. All for \$4.95. R.I.A., 15 Columbus Circle, New York, N.Y. 10023.

AST: THE PROFESSIONAL SOUND STORE. Full line of Altec, Cerwin-Vega, Crown, Dynaco, Electro-Voice and Telex audio equipment; factory authorized service on most speakers. Large stock of Altec diaphragms. AST, 281 Church St., New York, N.Y. 10013. (212) 226-7781.

THE INFORMATIVE SOUND People. Specialists in \$10k-\$20k studio packages and professional P.A. JBL, Altec, CL&S, Gauss, Electro-Voice, Beyer, AKG, Shure, Sennheiser, Malatchi, Yamaha, Revox, Otari, Ampex, many more. Call, write or come in. DIMENSION FIVE SOUND CO., 24 North 3rd Street, Womelsdorf, Pa. 19567. (215) 589-5312 / Philadelphia: 100 North 17th Street, third floor, 19103 (215) 568-1545.

Tascam, Teac, Sound Workshop, Nakamichi, Otari, dbx, MXR, Dynaco, ADS, Eventide, EV, Shure, Maxell, Ampex, AKG Pro, Beyer, UREI, Stax, Sennheiser, Tapco, BGW and more! Send for price quotes. ZIMET PRO AUDIO, Dept. MR, 1038 Northern Blvd., Roslyn, N.Y. 11576.

If you have an 8 or 16 track studio, and are interested in becoming a licensed representative for R.I.A.'s Modern Recording Techniques courses, call or write: Mr. P. Gallo, R.I.A., 15 Columbus Circle, New York, N.Y. 10023 (212) 582-3680. A Large profit potential with low operating costs.

FOUND: Limited supply of classic Beatles poster (Capitol Records), rare collectors item. Mint \$10.00 each. Whistling Swan Enterprises, P.O. Box 9332, Glendale, Ca. 91208.

WASHINGTON, OREGON, B.C.—Professional and semi-pro audio equipment now available in Seattle, Washington. Names like Tascam, DBX, Eventide, Tapco, Teac, BGW, AKG, Oberheim synthesizers and more—all displayed at out new "in-store studio." ELECTRONIC MUSIC BOX COMPANY, 2320 Sixth Ave., Seattle Wash. 98121 (206) 622-6984.

Tascam 10 mixing console—sacrifice—call after 6 pm—(201) 836-5185 or 641-2827.

AKG, Altec Pro, Atlas, Anvil Cases, BGW, Beyer, Crown, DBX, Gauss, Helpinstill, Otari, MXR, EV, Shure, Tapco, Bi-Amp, Soundcraft, Interface, Malatchi, Uni-Sync, Telex, UREI, Showco, Sound Workshop and more! Send for price quotes. CMG Sound, Inc., 12266L Wilkins Ave., Rockville, Md. 20852 (301) 881-2660.

TRACKS! Total recording systems specializing in semi-pro studios. Tascam, Teac, BGW, Neotek, Mic Mix, DBX, Sennheiser, MXR, Shure, Tapco, SAE, and many others. Complete studio packages available. TRACKS, 9520 Forty-Seventh St., Brookfield, Ill. 60513 (312) 485-0020.

TASCAM Studio on demo at BARCLAY RECORDING & ELECTRONICS featuring 80-8, Model 5, Model 1, Model 3, Otari eight-track, Malatchi, Gauss, EMT, Neuman, AKG, Sennheiser, RTR Monitors, Crown power amp, Mic-Mix, UREI limiters, Orban Parametrics, IVIE pocket-sized spectrum analyzers. Free room tuning with purchase. All units in stock and immediate delivery shipping pre-paid, insured, 233 E. Lancaster Ave., Wynnewood, Pa. 19096 (215) 667-3048.

SHURE MICS: SM57CN's \$76.16 each, SM58CN's \$91.61 each, E-V 1776P mics \$84.00 each. All new in sealed boxes. Send orders to CMG Sound, Inc., 1226L Wilkins Avenue, Rockville, Md. 20852 (301) 881-2660.

FOR SALE: Sony 880-2 tape recorder, AKG BX 10 reverb, Cooper Time Cube, Akai 400DDSS tape recorder, Mark Levinson LNP2. Call: H.F. Royal, (404) 253-6419.

FOR SALE: MCI JH 528 recording console, \$46,000; replacing with new automated JH 528-B Plasma Display. Sound 80, Inc. (612) 721-6341.



# THE SUPERLATIVE SONY.

## THE NEW TC-766-2 HAS THE LOWEST WOW AND FLUTTER OF ANY DECK SONY EVER BUILT



TC-766-2

**AN INCREDIBLE 0.018% (WRMS) AT 15 IPS, AND 0.04% (WRMS) AT 7½ IPS. Closed Loop Dual Capstan Tape Drive System.** One capstan extends from the motor shaft itself, eliminating intervening gears that can hamper speed accuracy. The other tape drive capstan connects through an extremely steady belt-drive inertia flywheel.

**PHASE COMPENSATOR CIRCUIT.** The goal of any recording is a "mirror image" of the original signal. Sony's exclusive Phase Compensator Circuit comes closest to achieving this by rectifying phase distortion and producing sound quality virtually identical to the original source.

**PROFESSIONAL STUDIO STANDARD VU METERS.** Illuminated, calibrated and ultra-clear for the best monitoring possible, are identical in size, shape, color and sensitivity to those on professional consoles.

**SYMPHASE RECORDING.** Because of Sony's outstanding

**Ferrite & Ferrite Heads,** plus the remarkably precise fabrication and alignment of the head gap, recordings retain exact positioning of signal throughout the stereo field. The "location" of individual sounds won't wander. There's no annoying phase shift.

**MORE PROFESSIONAL FEATURES.** The TC-766-2 has **4 incredibly durable Ferrite & Ferrite heads** for 2-track recording and playback, 4-track playback and erase, **direct-coupled playback FET amplifier**, flashing **Standby Signal**, **Punch-In Record** and solenoid-operated **Logic-Controlled Transport Functions** to let you move instantly to and from any mode without stopping. Standard equipment: RM-30 full-function remote control unit with record mute and hinged head cover.

# SONY®

Brought to you by  
**SUPERSCOPE**

© 1977 Superscope, Inc. 20525 Nordhoff Street, Chatsworth, CA 91311. Prices and models subject to change without notice. Consult the Yellow Pages for your nearest Superscope dealer. Finished in genuine walnut veneer over plywood side panels.

CIRCLE 82 ON READER SERVICE CARD

www.americanradiohistory.com



# How to get a three-motor, direct-drive, isolated-loop deck. And save \$5,500.



"Ingenuity of design can be fascinating for its own sake, but when it results in a product of demonstrable excellence, as with this tape recorder, one can only applaud. . ."

The review is from *Modern Recording*. The tape deck is Technics RS-1500JS. And the ingenuity of design that *Modern Recording* and *Audio* have praised in recent issues is Technics' advanced "Isolated Loop" tape transport with a quartz-locked, phase-control direct-drive capstan.

By isolating the tape from external influences Technics has minimized tape tension to an unprecedented 30gms. Eliminating virtually all signal dropout. While reducing modulation and wow and flutter to a point where conventional laboratory measurement is seriously challenged. A considerable achievement when you realize Technics RS-1500JS is priced substantially below its professional counterpart. \$5,500 below.

Electronically, too, Technics has provided the ultimate in professional control and performance. A separate microphone amplifier. Record amplifier. Mixing amplifier. And three-way bias/equalization. While IC full-logic function controls permit absolute freedom in switching modes.

Compare specifications and prices. Then you'll realize there's no comparison. TRACK SYSTEM: 2-track, 2-channel recording, playback and erase. 4-track, 2-channel playback. FREQ. RESPONSE: 30-30,000Hz,  $\pm 3\text{dB}$  (-10dB rec. level) at 15ips. WOW & FLUTTER: 0.018% WRMS at 15ips. S/N RATIO: 60dB (NAB weighted) at 15ips. SEPARATION: Greater than 50dB. RISE TIME: 0.7 secs. SPEED DEVIATION:  $\pm 0.1\%$  with 1.0 or 1.5mil tape at 15ips. SPEED FLUCTUATION: 0.05% with 1.0 or 1.5mil tape at 15ips. PITCH CONTROL:  $\pm 5\%$ . SUGGESTED RETAIL PRICE: \$1,500\*.

Technics RS-1500JS. A rare combination of audio technology. A new standard of audio excellence.

\*Technics recommend price, but actual retail price will be set by dealers.

**Technics** Professional Series  
by Panasonic

CIRCLE 75 ON READER SERVICE CARD

[www.americanradiohistory.com](http://www.americanradiohistory.com)