

Ray  
Manzarek

MODERN

# RECORDING

& MUSIC

MARCH 1984 VOL. 10 NO. 3 \$1.95

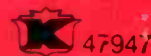

*breaks*

*through*

RECORDING  
TECHNIQUES:

Helpful Procedures  
and Flowcharts

HANDS ON:

Tec... M253X  
Co... ck

BUILD A  
DIRECT MIXER

MUSICIAN'S  
NOTEBOOK

The Roland  
Proform Family



# PRODUCTION VALUES.

Producing your music with professional results has never been so easy. Or so affordable. Introducing the Yamaha Producer Series multi-track Personal Studio System.

The heart of the system is the MT44 4-track cassette recorder. With it, you can record up to four channels at a time, or independently in any combination. Overdub with complete synchronization. Do ping-pong recording. And punch-in/punch-out recording with the MT44's full logic controls.

The 17/8 IPS tape speed lets you play pre-recorded tapes. And there's also Dolby\* B and C noise reduction, zero play/zero stop, optional remote control and out-

standing specs.  
For mixing, there's the built-in analog delay, 7-band

MM30 4x2 mixer with master graphic

# Produced





equalizer, and LED peak reading meters.

And the RB30 combines the MT44 and the MM30 in a system rack complete with patch bay and accessories compartment.

But there's more to the Producer Series than multi-track.

There's also the CS01 synthesizer, MA10 headphone

amp, MM10 portable mixer, MR10 drum machine, MS10 powered monitors, and the MH10 headphones. A full range of equipment to produce professional results at an affordable price.

No one else has it all together like the Yamaha Producer Series. Visit your Yamaha dealer for complete information and a demonstration. Or write us.

# Producer Series™



 **YAMAHA**

\*Dolby is a registered trademark of Dolby Labs, Inc.

# We Didn't Believe it Either.

*Our introduction to the Pressure Zone Microphone® broke our previous record for skepticism. But the hardware converted us. Like Orville Wright's gas powered kite, it outperformed its appearance. The rest, as they say, is history. In the 3 years since we began production, sales*

*have mushroomed and the best recording studios use PZM®. So do a whole lot of other people on a whole lot of stages, church podiums, and conference room tables. Success has changed us. One of these days we'll probably start telling you we knew it would work all along.*

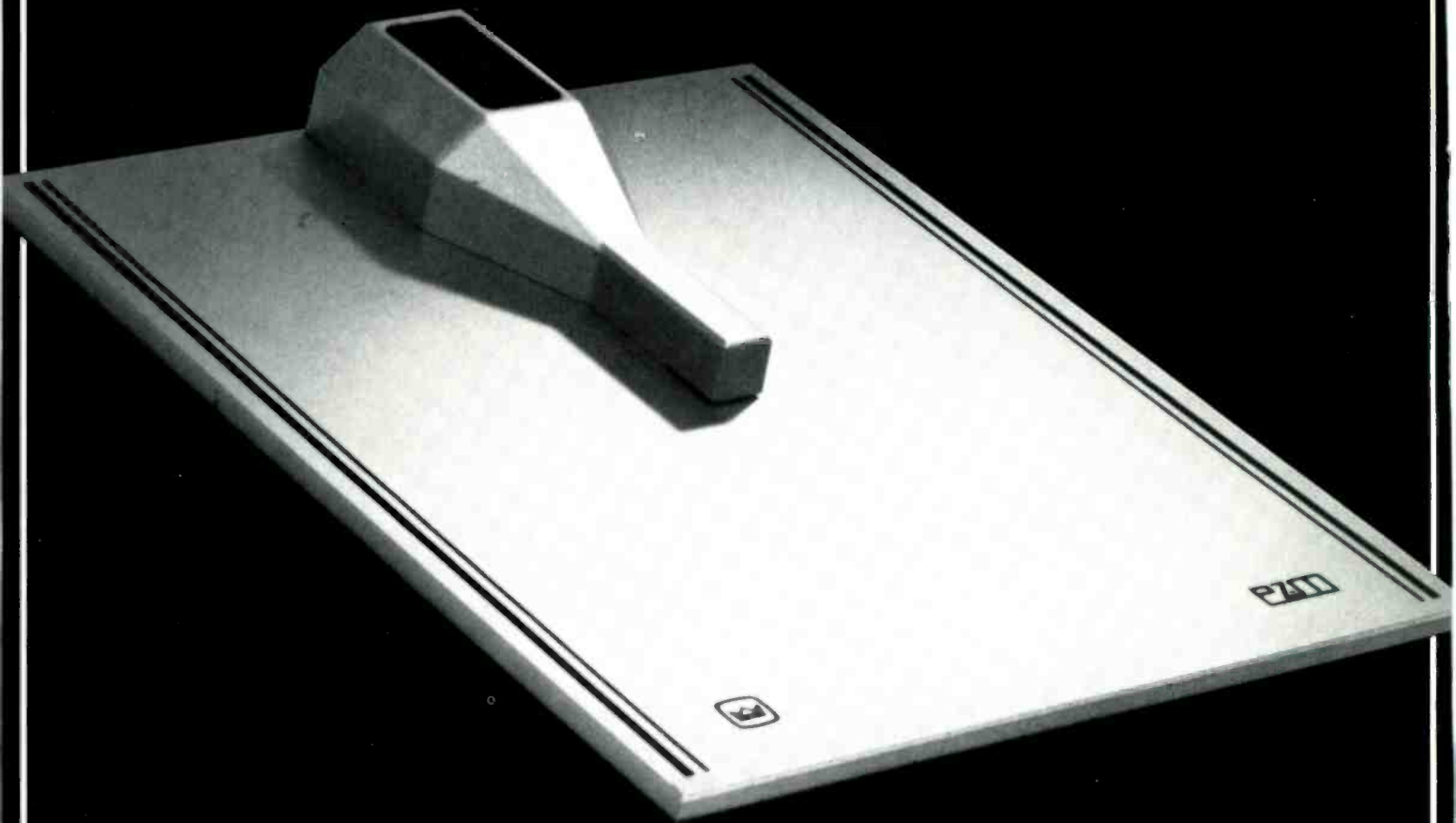

## CROWN

1718 W. Mishawaka Road, Elkhart, IN 46517  
219 294-5571

Call or write for details

# MODERN RECORDING & MUSIC

## FEATURES

**8 RECORDING TECHNIQUES**  
*by Bruce Bartlett*  
Through the use of flowcharts and diagrams, this month's column analyzes ways of troubleshooting bad sound, sorting out signal processor and microphone types, and choosing the proper microphone.

**14 BUILD A DIRECT MIXER**  
*by Charles Cummings*  
A stereo mixer with ruler flat frequency from DC to radio frequencies and virtually unlimited headroom can be yours for around \$10. How? See page 14 for all the details.

**22 X BREAKS THROUGH**  
*by Martin Basch*  
With their fourth album, *More Fun in the New World*, X may finally have achieved the popularity critics have been prophesying for years. Here, John Doe and Billy Zoom offer some insight on what it's like when X hits the studio.

**34 RAY MANZAREK:  
FROM MONKS TO MORRISON**  
*by Vicki Greenleaf*  
The ex-Door speaks his mind on his latest album, *Carmina Burana*, his work with X, and Jim Morrison—among other things.

**40 STUART YOUNG AND THE  
VIDEO AGE**  
*by Gilbert Elliott*  
For better or worse, the age of music video is upon us. In this interview, the first of a two-part series, Mr. Young gives an overview of this emerging medium and provides a look at what it takes to make a video demo.



## DEPARTMENTS

LETTERS TO THE EDITOR	4
TALKBACK The technical Q and A scene.	6
¼ NOTES New and noteworthy events in the recording industry.	58
& MUSIC Reviews of albums by Bob Dylan, Midnight Oil, Diana Ross, Hod O'Brien, Zoot Sims, Stewart Copeland, and others.	59
ADVERTISER'S INDEX	66

## SOUND IDEAS

STUDIO NOTEBOOK <i>by James F. Rupert</i> At last, the Design-A-Studio Contest winners are here. This month, Mr. Rupert unveils the first of three winners, Grand Prize Winner Michael Loomis, and reviews his winning entry. Stay tuned for the next installment, 'cause you could be the next winner.	42
MUSICIAN'S NOTEBOOK <i>by Craig Anderton</i> This time around Mr. Anderton reviews the Roland Proform (Programmed Performance) Family.	45
AMBIENT SOUND <i>by Len Feldman</i> Thanks to units like the PCM-F1, the digital revolution is now available to even the smallest of recording studios.	48
HANDS ON <i>by Greg Hodge</i> The Technics RS-M253X Cassette Deck.	51

Modern Recording & Music (ISSN 0273-8511) is published monthly by MR&M Publishing Corp., 1120 Old Country Rd., Plainview, NY 11803. Design and contents are copyright 1984 by MR&M Publishing Corp., and must not be reproduced in any manner except by permission of the publisher. Second class postage paid at Plainview, New York, and at additional mailing offices. Subscription rates \$15.00 for 12 issues, \$26.00 for 24 issues. Add \$3.00 per year for subscriptions outside of U.S. Subscriptions must be paid in advance in U.S. funds. Postmaster: Send Form 3579 to MR&M Publishing Corp., 1120 Old Country Rd., Plainview, NY 11803.



**MARK WALDSTEIN**  
Editor

**RICKI ZIDE**  
Managing Editor

**LINDA CORTESE**  
Technical Editor

**JOHN WORAM**  
Technical Advisor

**CRAIG ANDERTON**  
**BRUCE BARTLETT**

**RICK CHINN**  
**LEN FELDMAN**  
**VICKI GREENLEAF**  
**STAN HYMAN**

**JAMES RUPERT**  
**JEFF TAMARKIN**  
Contributing Editors

**SUSAN BOREY**  
**ELLEN ZOE GOLDEN**  
**ROBERT HENSCHEN**  
**GENE KALBACHER**  
**JOE KLEE**

**ALLAN KOZINN**  
**MICHAEL ROBERTS**  
**STEVE ROW**  
Music Reviewers

**KAREN COHN**  
Advertising Coordinator

**KATHI LIPPE**  
Layout and Design

**SUSAN MONAHAN**  
Circulation

**SPARTAN PHOTOTYPE CO.**  
Typographers

**ELAINE ZIDE**  
Associate Publisher

**LARRY ZIDE**  
Publisher

Editorial and Executive Offices  
MR&M Publishing Corp.  
1120 Old Country Road  
Plainview, NY 11803  
516 433-6530

Editorial contributions should be addressed to The Editor, Modern Recording & Music, 1120 Old Country Road, Plainview, N.Y. 11803. Unsolicited manuscripts will be treated with care and must be accompanied by return postage.

### **Eurythmics, Yes**

Thank you so much for your feature story on Dave Stewart of Eurythmics (December 1983). I subscribe to several audio magazines, yet I enjoyed the December issue of *MR&M* most of all.

I was very interested to learn Eurythmics recorded their album on a Teac 8-track. Since I record with similar equipment, I found it particularly refreshing to read that someone had broken through the "sound" barrier of endless effects and high priced tape recorders. I was also delighted with Dave Stewart's open and honest opinions about the music industry's approach to new bands.

Keep up the good work!

—Tom Reeves  
Cats' Voice Recordings  
Newport Port, MA

### **Informative Reinforcement**

I'm a working musician and bandleader. I own and purchase sound reinforcement gear, but find it difficult to get much practical information on this subject. I'd really appreciate any and all information on sound reinforcement in night clubs seating 200 to 500.

Also, any articles on lighting—especially with audio interface—would also be appreciated.

—Scott Liberty

*In February, we began a column on sound reinforcement (Sound Advice) that should be just what you are looking for. In fact, the author, Susan Borey, welcomes any questions pertaining to sound reinforcement in clubs just the size you mentioned. Just address your inquiry to Sound Advice, c/o MR&M, 1120 Old Country Rd., Plainview, NY 11803.*

*As to the suggestion for articles on lighting, we'll take it under advisement. Perhaps at some later date you'll be pleasantly surprised by opening an issue of MR&M and finding an article on just that subject.*

### **Addressing the Situation**

I enjoyed Susan Crane's (Dec. '83) interview with Dave Stewart very much. As I am a songwriter and leader of my own recording band, "The Force," I've had many of the same feelings he expressed, especially in terms of experimentation with different sounds, and using things found in the house.

Would you have an address as to where I may write to Dave and Annie? Any information and help you could give would be greatly appreciated.

—David L. Green  
Portchester, NY

*We contacted RCA Records and they told us you can write to Eurythmics c/o RCA in England. The address is:*

*RCA Records  
1 Bedford Avenue  
London, England*

*We're glad you enjoyed the article. Good luck with your own musical career.*

# The proof is in the listening.



## The surprise is in the price. \$425.

### The New Orban Model 412A Compressor/Limiter

The new 412A Compressor/Limiter is Orban's entry into the general-purpose level control sweepstakes—it's designed to make you, the audio professional, the winner! Available in mono (412A) and stereo (414A) versions, it's loaded with features that most other low-cost units don't offer—but the real proof is in the *listening*. We invite you to compare its natural, transparent sound to any other compressor/limiter you might know or use. After you do, we feel confident you'll make it *your* essential AGC. Contact your Orban dealer for a demonstration, and find out how affordable Orban-quality processing can be!

#### Performance Highlights

- Streamlined, straightforward front panel offers the most-demanded user controls, including ATTACK TIME, RELEASE TIME, RATIO, and THRESHOLD. These wide range controls permit extremely natural sound or special effects.
- Exclusive Orban feedback control circuitry (adapted from our popular 424A Gated Compressor/Limiter/De-Esser) achieves remarkably transparent sound.
- User controls interact intelligently to simplify and speed setup, and to prevent errors.
- Peak limiting and compressor functions are cross-coupled to eliminate potential pumping and modulation effects.
- THRESHOLD control with 20dB range allows user to determine the level at which gain reduction first occurs, without changing below-threshold gain. Ideal for sound reinforcement applications.
- Proprietary circuitry achieves optimum headroom and signal-to-noise regardless of THRESHOLD control setting.
- Front-panel OUTPUT ATTENUATOR control with OUTPUT CLIP LED to indicate line amplifier clipping.
- Illuminated, true peak-reading GAIN REDUCTION meter is more accurate and readable than LED displays.
- GAIN REDUCTION OVERLOAD lamp warns of control circuit overload due to a demand for G/R which exceeds the range of the VCA.
- Hard-wired system bypass switch for fail-safe protection.
- Side-chain externally accessible for special effects such as frequency-selective limiting.
- Active-balanced, floating input and output interfaces easily to any system, balanced or unbalanced.
- Proprietary Class-A Orban VCA features very low distortion and noise.
- Stereo 414A has STEREO COUPLING switch to permit either stereo or dual-mono operation; an unlimited number of units can be wire-coupled to track 0.5dB.
- All-metal chassis with RFI suppression on input, output, and AC leads.

Suggested List Prices:  
Model 412A (Mono), \$425.  
Model 414A (Dual Channel/Stereo), \$799.

## orban

Orban Associates Inc.  
645 Bryant St.  
San Francisco, CA 94107  
(415) 957-1067 Telex: 17-1480

# Talk Back

## Space Connections

In the April 1980 issue of *Modern Recording & Music* there appeared a review of the Ursa Major SPACE STATION. It stated that an auxiliary line amp may be required for systems working on -10 dBV. I would like to know what models of amp would be recommended.

Also, I would like to know if the outputs of the Space Station can be directly connected to the mic inputs of a mixing board like the Tascam M-35 or M5.

—John Tucki  
Westchester, IL

A line amplifier is not necessary when using the SPACE STATION with

TASCAM equipment. Most users find that just directly connecting the SPACE STATION input to the output of the TASCAM works satisfactorily. If, however, you find that you need a bit more sensitivity, here is a simple change: Locate resistor R7 on the Analog board (a 39K resistor); take an ordinary 5 percent 18K resistor and carefully tack solder it in parallel with R7. This will increase the gain by 10 dB so that it will certainly handle nominal -10 dBV signals.

Good luck!

—Christopher Moore  
President  
Ursa Major, Inc.

## PCM Problems

I recently made a digital recording of a french horn recital using a Technics SV-100 Pulse Code Modulator (PCM) and video cassette recorder. Other equipment used in the recording consisted of two Shure SM-81 condenser microphones and a Tascam System 20 mixer. For the most part, I was pleased with the quality of the recording, but it did have some flaws.

Flaw #1: Although the fundamental pitch of the horn was reproduced with great accuracy, the upper harmonics of the horn sounded distorted, grainy and "digitized." To hear this, you may have to place your head in close proximity to the speaker.

Flaw #2: Although the dynamic range of the recording was very impressive (manufacturer's spec. is 86 dB), the signal-to-noise ratio was not. For a ballpark figure, the S/N ratio sounded to be around 70 dB. While this figure would be acceptable for an analog device such as a cassette deck, it is not acceptable for anything I labelled "digital." At first I thought this lack of sound quality could be traced to another part of the recording chain. The S/N ratio of one mic input on the Tascam System 20 mixer is 65 dB (weighted). To test whether the mixer was the source of the noise, I made a recording of a bass guitar, going direct from the guitar's output to a high Z input on the PCM. When I played the tape back, the bass sounded sharp and clear, but there was a definite background noise. I turned the power of the PCM off to check if the noise was in the monitor system. This test was negative.

Have you experienced any of these problems? Would a 16-bit sampling rate improve the quality of the recording (the SV-100 has a 14-bit sampling rate)? If one only needs to use two microphones, and these microphones are low Z, what



*The affordable*  
**Neumann Collection**

You can now buy a genuine NEUMANN KM 84 Condenser Microphone for under \$350! That's what many electrets cost but NEUMANN is NOT an electret!

And the NEUMANN KM 84 routinely includes the features other manufacturers substitute for quality, like interchangeable capsules (omni, cardioid and cardioid with roll-off), capsule extension tubes, colored pop screens, elastic suspension and a wide range of accessories.

NEUMANN, *The Microphone Standard of the World*, designs microphones for studios that earn their living recording today's major talent. But whether you're a recording professional, sound contractor, church group, university or a serious home user, the KM 84 brings you superb NEUMANN quality at a very affordable price. Write today for our brochure and a list of our franchised dealers.

**GOTHAM**  
AUDIO CORPORATION  
741 Washington Street, New York, NY 10014 (212) 741-7411  
West Coast Sales Office: (213) 841-1111

GA 101



is the cleanest, lowest noise method of bringing the signal from the microphones up to line level (-10 dB, in this case)?

—Matthew Benz  
Burnt Hills, NY 12027

*We received the following response from Len Feldman:*

With respect to what you call "Flaw #1," I strongly suspect that peak signals from the french horn may well have overloaded the Pulse Code Modulation (PCM) processor which you used. My own experience with PCM processors has shown that the metering system (LEDs or whatever) is not always calibrated accurately. As you probably know, in digital recording there is no headroom whatsoever, and nominal "0 dB" must never be exceeded. So, if calibration is a bit off, you may well have gone above "0 dB record level" without knowing it. This would account for the audible distortion.

As for "Flaw #2," your account of the S/N ratio and the steps you took to isolate the cause of the trouble suggest to me that the noise level you heard was either caused by a defective PCM processor or by extraneous noise induced by overly long cables, faulty contacts at interface points, or plain old familiar "ground loops." You did not indicate whether the noise was coherent (e.g., power supply frequency or its harmonics) or random (e.g., white/pink noise, etc.).

I doubt very much if a 16-bit system would improve the situation noticeably. In any case, the 14-bit format for PCM processors used with VCRs has been standardized by the industry and, in theory at least, it should be capable of providing a signal-to-noise or dynamic range of better than 80 dB. As for mic pre-amplification, published specifications are usually quite reliable in this product area, so what you need to look for is an ultra-low-noise microphone preamplifier or mixer that will not degrade the S/N of the signal you ultimately apply to the inputs of your PCM processor.

# FOSTEX

## THE 8-TRACK FOR THE 80's.



When 4-track just isn't enough anymore, the A-8LR is everything you need for 8-track recording, and not a penny more.

#### **Uncompromised Performance**

- 8-track simultaneous record/reproduce with -55 dB adjacent channel crosstalk.
- Built-in Dolby C\* noise reduction for a 72 dB signal-to-noise ratio.
- Overall frequency response from 40 Hz to 18 kHz  $\pm$  3 dB.

#### **More Flexibility**

- The A-8LR is small, compact, portable. Take it with you on remotes or wherever the music is.
- It's easy to understand and easy to use. Punch-In/Out with a remote foot switch (optional).

#### **Best Buy**

- \$2500.00 is the Suggested Retail Price. And if you don't need to record all 8 tracks in one pass, save more than \$500.00\*\* and go for the A-8. The original 1/4" 8-track.
- 1/4" tape is a whole lot easier on your wallet. Besides, 1/2" tape is for 16 tracks.

#### **See Your Fostex Dealer Today**

Getting your act together on tape may be the next step in taking it on the road. To success.

## FOSTEX

PERSONAL MULTITRACK

Fostex Corporation of America  
15431 Blackburn Avenue, Norwalk, CA 90650 (213) 921-1112

\* Dolby is a registered trademark of Dolby Labs., Inc.

\*\* Based on suggested retail prices.

# Recording Techniques

## Helpful Procedures and Flowcharts

This being the age of personal computers, it seems appropriate to apply flowcharts and programs to recording techniques. In this article I'll present some procedures and diagrams to help you do the following: troubleshoot bad sound; sort out signal processors; sort out microphone types, and choose the right microphone for the job.

These are not computer programs, but could easily be written as programs in BASIC.

### Troubleshooting Bad Sound (on pop music recordings)

Listed below is a step-by-step procedure to solve audio-related problems. To follow this procedure, read down the list of "bad sound" descriptions until you find one matching what you hear. Then try the solutions in the order listed until your problem disappears. Only the most common symptoms and cures are mentioned; console maintenance is not covered.

Before you start, check for faulty cables and connectors. Also, check all control positions; rotate knobs and flip switches to clean the contacts, and clean the tape heads.

### Bad Sound On All Recordings (including other studios' recordings): Upgrade your monitor system.

1. Adjust speaker tweeter and mid-range controls. In a biamped monitor system, adjust the relative gains of the tweeter and woofer amplifiers.
2. Relocate speakers.
3. Improve room acoustics.
4. Equalize the monitor system.
5. Try different speakers.
6. Upgrade the power amp and speaker cables.

### Dull Sound Or Dropouts In Tape Playback Only:

1. Check that the oxide side of the tape is against the heads.
2. Clean tape path.
3. Demagnetize tape path.
4. Try another brand of tape.
5. Align tape heads.
6. Calibrate record/playback electronics.
7. Do maintenance on tape transport.
8. Check and replace tape heads if necessary.

### Distortion On Tape Playback Only:

1. Reduce record level.
2. Increase bias level.

### Bad Sound From Console Output:

#### *Muddy (excessive leakage)*

1. Place microphones closer to sound sources.
2. Spread instruments and microphones farther apart to reduce the level of leakage.
3. Place instruments and microphones closer together to reduce the time delay of the leakage.
4. Use directional microphones (such as cardioids).
5. Overdub instruments.
6. Use baffles (gobos) between instruments.
7. Deaden room acoustics (add absorptive material, flexible panels, or slot absorbers).

#### *Muddy (excessive reverberation)*

1. Reduce echo-send levels or echo-receive levels.
2. Place microphones closer to sound sources.
3. Use directional microphones (such as cardioids).
4. Deaden room acoustics.

#### *Muddy (lacking highs, dull or muffled sound)*

1. Use microphones with better high-frequency response.
2. Change microphone placement.
3. Boost high-frequency equalization.
4. Change musical instruments; replace guitar strings.

#### *Muddy (lacking clarity)*

1. Use fewer instruments in the musical arrangement.
2. Adjust or equalize instruments differently so that their spectra don't overlap.
3. Try less reverberation.
4. Delay the reverb-send signal by about 20 milliseconds.
5. Using equalizers, boost the presence range of instruments that lack clarity.

#### *Distortion*

1. Switch in the pad built into the microphone (if any).
2. Increase input attenuation (reduce input gain).
3. Readjust gain staging (set faders and pots to their optimum signal-level points).

#### *Bad tonal balance (nasal, honky, boomy, dull, shrill, etc.)*

1. Change musical instruments; change guitar strings; change reeds, etc.
2. Change microphone placement.
3. Use the 3:1 rule of mic placement to avoid phase cancellations: when multiple microphones are mixed to the same channel, the distance between microphones should be at least three times the mic-to-source distance.
4. Try another microphone.
5. If you're mic'ing the sound source near a hard reflective surface, try

**GUESS  
WHO JUST PUT  
450 WATTS-PER-CHANNEL\*  
IN A 21-POUND  
PACKAGE?**

Who else but Bob Carver.  
Introducing the Carver **PM-1.5** Professional Low-Feedback High Headroom Magnetic Field Amplifier.

The most power in the lightest weight package ever offered to the hard knocks, no-compromise world of pro sound.

An amplifier that can run heavy metal flat-out into any impedance down to 4 ohms all day long.

When Bob first began working on his PM-1.5, he knew a great deal about amplifiers but not enough, he believed, about the night-in night-out requirements (and wish dreams) of the pro sound world. And so he spent much time consulting with a large number of sound reinforcement professionals, including the "pros' pro," Clair Brothers.

Clair Brothers asked for lower input ac line current, greater transformer thermal capacity, dual modes of precision balanced inputs with 1% resistors, back-to-front cooling with a fully proportional fan system that can just tick over at idle or blast 1000 ft/min. to keep output transistor temperatures constant. They wanted greater noise immunity and unbelievable long-term, high-power operation, as well as a 3/16" front panel with deep-recessed controls.

Others wanted rear rack-mounts, adjustable protection circuit thresholds, front panel selectable clipping eliminator, and even a sequential, soft-start power-up mode.

Now that the PM-1.5 has undergone thousands of lab test hours and seven months of hard road testing, Clair Brothers, Bob, and you get all that and more.

The PM-1.5 is designed to run balls-to-the-wall, even into 4 ohms day and night without compromising itself or your drivers. Because the PM-1.5 has three special adjustable speaker

protection circuits.

An adjustable Short-Term Speaker Protection circuit adjusts dynamic headroom between 60 and 77 volts with a short term burst capability of 70 volts rms at 8 ohms, or 60 volts rms at 4 ohms.

The circuit locks-in to the control setting after 0.5 seconds.

An adjustable Long-Term Speaker Protection circuit matches the time constant of the output shutdown circuit to your PA or monitor system.

Finally, the Clipping Eliminator detects clipping lasting longer than 30 milliseconds and attenuates the input signal just enough to pull the PM-1.5 out of clipping.

As for sound quality, consider this quote from **The Audio Critic Magazine**, "...the equal of any power amplifier in transparency, focus and smoothness. We especially enjoy hearing spatial detail, instrumental definition and completely natural dynamics. At this level of sonic performance, the astoundingly small size and cool operation become icing on the cake..."

Roy Clair and Ron Borthwick of Clair Brothers said it this way, "We are amazed that Bob was able to put the same wattage into one-fourth the volume of conventional amplifiers without sacrificing audio performance. It's hard to believe that an amp so small and lightweight can put out so much clean power. But it does!"

Whether you run a megawatt sound company, a struggling bar band, or a recording studio gearing up for digital, the PM-1.5 will pay you. In increased portability and reduced freight costs. In freedom from expensive blown drivers. In sheer sonic excellence.

Write for a detailed brochure today or give your local pro store no peace until they order you 21 pounds of pure power.

\***Power:** 8 ohms, 450 watts/chan. 20 Hz-20 kHz both channels driven with less than 0.1% THD. 4 ohms, 600 watts/chan. rms 20 Hz-20 kHz both channels driven with less than 0.1% THD. 16 ohms, 300 watts/chan. 20 Hz-20 kHz both channels driven with less than 0.1% THD. 2 ohms, 525 watts/chan. at clipping, 1 kHz, with less than 0.2% THD. Note: 2-ohm specification for information purposes only. Operation at 2 ohms is permissible but not recommended. **IM Distortion:** Less than 0.1% SMPTE. **Frequency Response:** -3 dB at 3 Hz, -3 dB at 80 kHz. **Damping:** 200 at 1 kHz. **Gain:** 26 dB. **Noise:** Better than 115 dB below 450W A-weighted. **Input:** Balanced to ground. XLR or phone. **Impedance:** 15k-ohm each leg, balanced to ground. **Bridging:** 1200W into 8 ohms, 1000W into 16 ohms, accessed through rear-panel recessed switch. **Dimensions:** 19 in wide, 3 1/2 in high, 10 1/16 in deep. Weight: 21 lbs.



**CARVER**

(206) 775-1202 P.O. Box 1237 Lynnwood, WA 98036

a PZM microphone mounted on the surface to prevent phase cancellations.

6. Change the equalization.

#### Lifeless sound (unexciting)

1. Work on the live sound of the instruments in the studio.
2. Add special effects—reverb, echo, equalization, etc.

#### Lifeless sound (dry or dead acoustics)

1. Place microphones farther from sound sources.
2. Use omnidirectional microphones.
3. Add reverberation or echo.
4. Add hard reflective surfaces in the studio.

#### Noise (hiss)

1. Reduce ambient noise in the studio; check for noisy guitar amps or keyboards.
2. Switch out the pad built into the microphone (if any).
3. Reduce console input attenuation (increase input gain).
4. Use a more sensitive microphone.
5. Use a quieter microphone (one with a low self-noise level).
6. Increase the sound pressure level at the microphone by mic'ing closer. If you're using PZMs, mount them on a large surface or in a corner.
7. Use a noise gate.
8. Use a low-pass (high-cut) filter.

#### Noise (low-frequency rumble)

1. Reduce air-conditioning noise or temporarily shut off the air conditioning.
2. Use a high-pass filter set around 40 to 80 Hz.
3. Use microphones with limited low-frequency response.

#### Noise (thumps)

1. Change microphone position.
2. Change musical instrument.
3. Use a high-pass filter set around 40 to 80 Hz.
4. If the cause is mechanical vibration traveling up the microphone stand, put the microphone in a shock-mount stand adapter. Or, use a microphone that is less susceptible to mechanical vibration (such as an omnidirectional microphone, or a unidirectional microphone with a good internal shock mount).
5. Use a microphone with limited low-frequency response.

#### Hum

This is a subject in itself. See the October '83 issue of *MR&M*.

#### Pop (explosive breath sounds in the vocalist's microphone)

1. Place the microphone above, below, or to the side of the mouth.
2. Place a foam windscreen (pop filter) on the microphone.
3. Place the microphone farther from the vocalist.
4. Use a microphone with a built-in pop filter (ball grille).
5. Use an omnidirectional microphone, because it is likely to pop less than a directional (cardioid) microphone.

#### Sibilance (overemphasis of "s" and "sh" sounds)

1. Use a de-esser.
2. Place the microphone farther from the vocalist.
3. Place the microphone toward one side of the vocalist, rather than directly in front.
4. Cut equalization around 5 to 10 kHz.
5. Change to a duller-sounding microphone.

#### Bad mix

1. Change the mix.
2. Compress vocals or instruments that occasionally get buried.
3. Change the equalization on certain instruments to help them stand out.
4. During mixdown, continuously change the mix to highlight certain instruments according to the demands of the music.

#### Strange dynamics

1. Check the tracking of noise reduction units. For example, a 10 dB level increase at the input of the encode unit should appear as a 10 dB level increase at the output of the decode unit.
2. Use less compression or limiting.
3. Avoid overall compression.

#### Instruments sound too isolated, or sound like they're in different acoustical environments.

1. Place microphones farther from sound sources to increase leakage.
2. Use omnidirectional microphones to increase leakage.
3. Use stereo reverberation or echo.
4. Pan extreme left-and-right tracks slightly toward center.
5. Make the echo-send levels more similar for various tracks.

### Troubleshooting Bad Sound (on classical music recordings)

#### Too dead (insufficient ambience, hall reverb, or room acoustics)

1. Place microphones farther from performers.
2. Use omnidirectional microphones.
3. Record in a concert hall with better acoustics (longer reverberation time).
4. Add artificial reverberation.

#### Too detailed, too close, too edgy

1. Place microphones farther from performers.

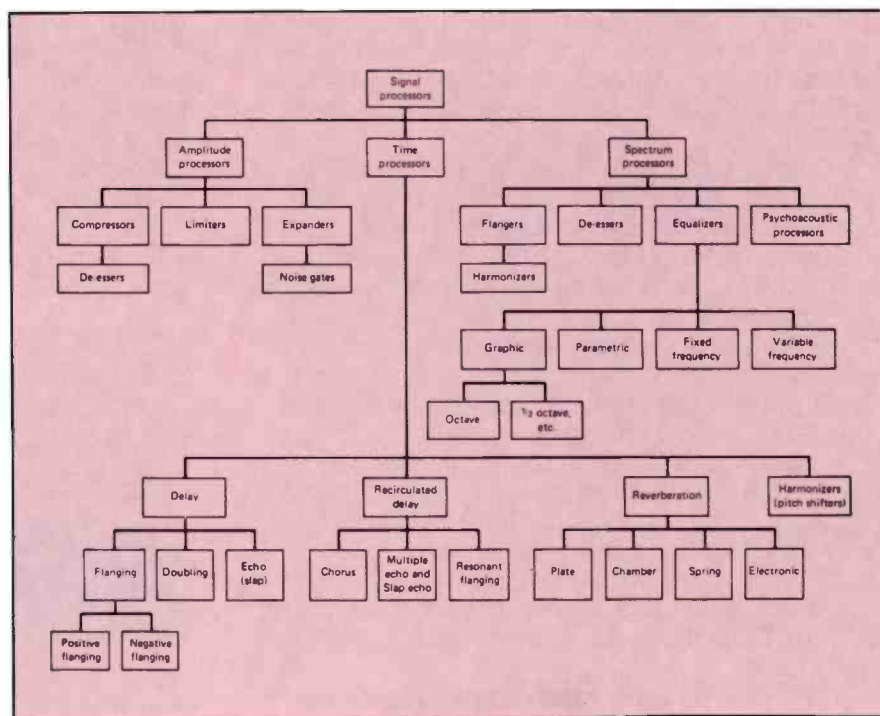

Figure 1. Signal processor categories.

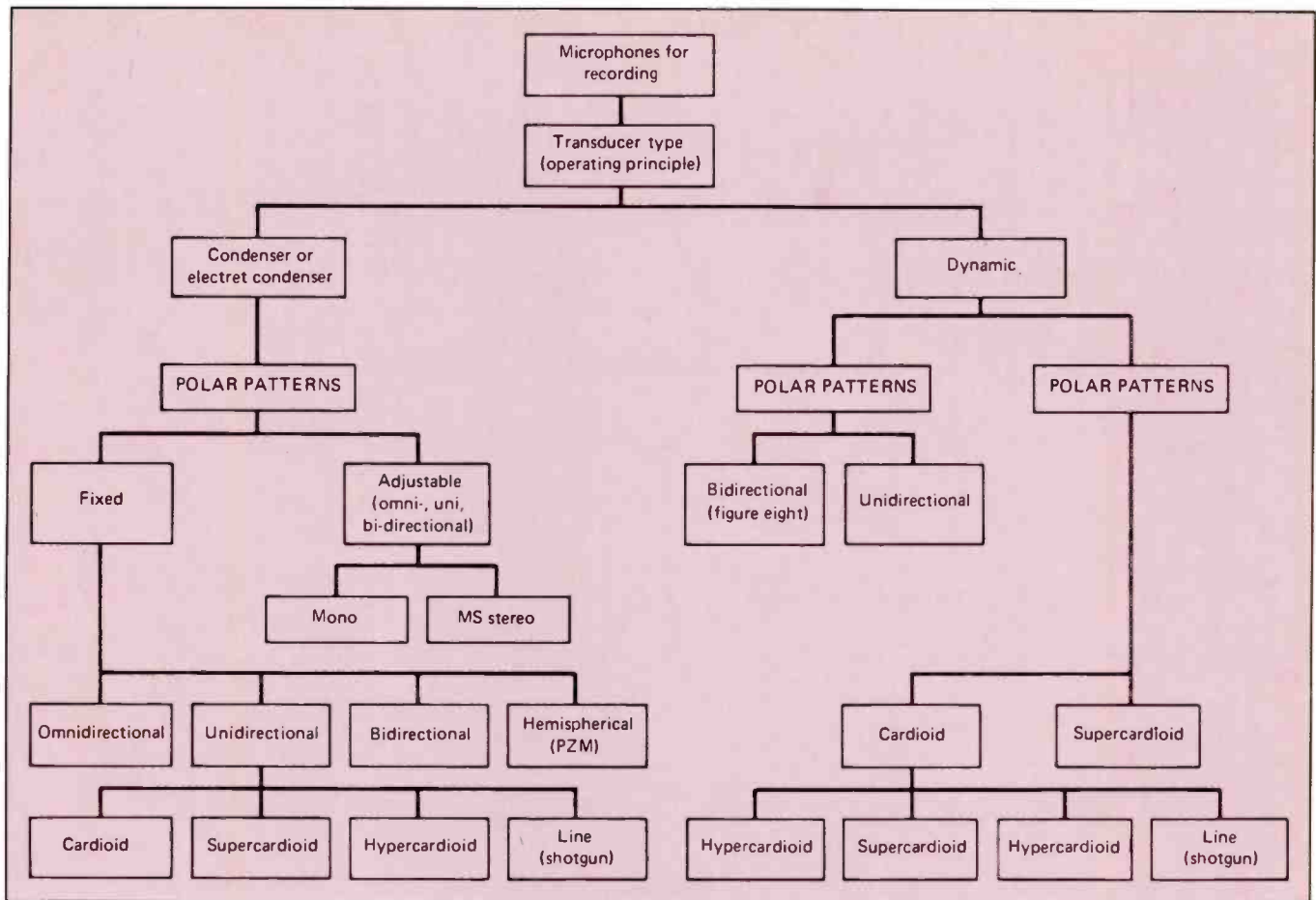

Figure 2. Microphone categories.

2. Place microphones lower or on the floor (as with a PZM).
3. Roll off the high frequencies.
4. Use duller-sounding microphones.

*Too distant (too much reverberation)*

1. Place microphones closer to performers.
2. Use directional microphones (such as cardioids).
3. Record in a concert hall that is less "live" (reverberant).

*Narrow stereo spread*

1. Angle or space the main microphone pair farther apart.
2. If you're doing mid-side stereo recording, turn up the "side" output of the microphone.
3. Place the main microphone pair closer to the performers.

*Excessive separation of hole-in-the-middle*

1. Angle or space the main microphone pair closer together.
2. If you're doing mid-side stereo recording, turn down the "side" output of the microphone.
3. In spaced-pair recording, add a microphone midway between the outer pair, and pan its signal to the center.
4. Place the microphones farther from the performers.

In A/B tests, this tiny condenser microphone equals *any* world-class professional microphone.  
*Any size, any price.*

Compare the Isomax II to any other microphone. Even though it measures only 5/16" x 5/8" and costs just \$149.95,\* it equals **any** world-class microphone in signal purity.

And Isomax goes where other microphones cannot: Under guitar strings near the bridge, inside drums, inside pianos, clipped to horns and woodwinds, taped to amplifiers (up to 150 dB sound level!). Isomax opens up a whole new world of miking techniques—far too many to mention here. We've prepared information sheets on this subject which we will be happy to send to you free upon request. We'll also send an Isomax brochure with complete specifications. Call or write today.

\* Pro net price for omnidirectional, Cardioid, Hypercardioid, and Bidirectional models. \$189.95

 COUNTRYMAN ASSOCIATES INC.  
 417 Stanford Ave., Redwood City, CA 94063 - (415) 364-9988

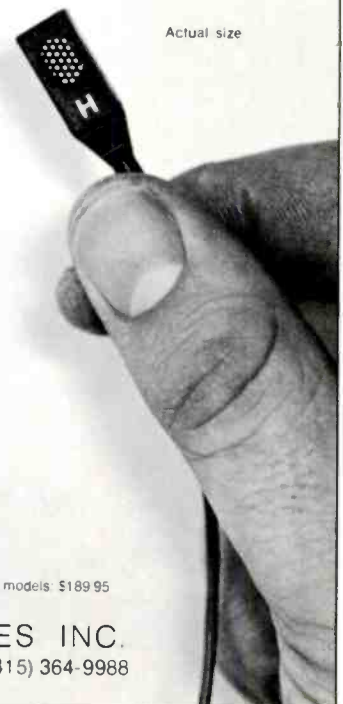

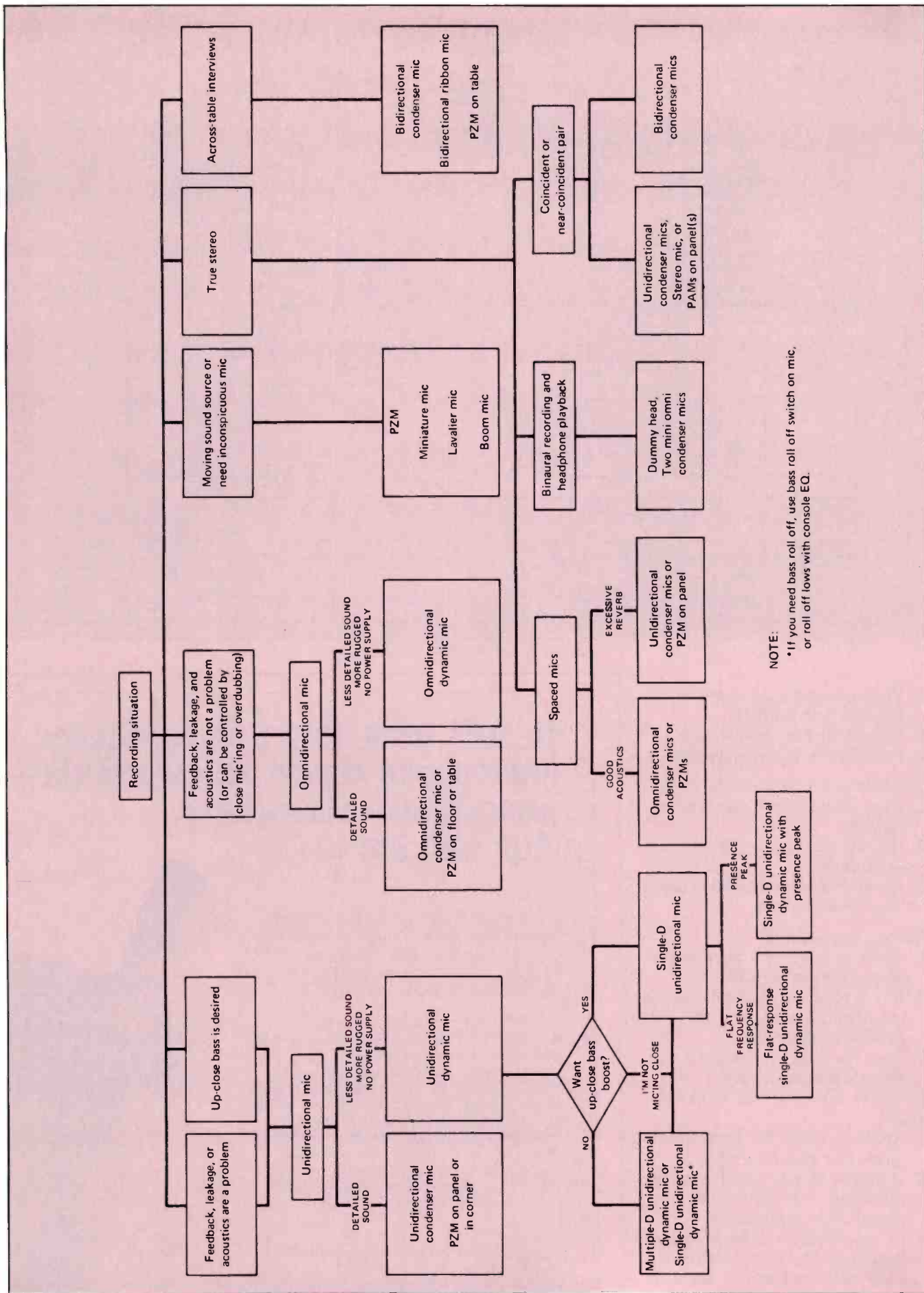

NOTE:  
 \*If you need bass roll off, use bass roll off switch on mic, or roll off lows with console EQ.

Figure 3. Choosing the right microphone (Method One).

### Lacks depth

1. Use only a single pair of microphones out front. Avoid multi-mic'ing.
2. Add more artificial reverberation to distant instruments than to close instruments.

### Bad balance

1. Place the microphones higher or farther from the performers.
2. Ask the conductor or performers to change the instruments' dynamics.
3. Add "spot" microphones close to instruments or sections needing reinforcement. Mix them in subtly with the main microphones' signals.

### Muddy bass

1. Aim the bass drum head at the microphones.
2. Put the microphone stands and the bass drum stand on rubber isolation mounts, or place the microphones in shock-mount stand stand adapters.
3. Roll off the low frequencies or use a high-pass filter set around 40 to 80 Hz.
4. Record in a concert hall with less low-frequency reverberation.

### Rumble from air conditioning, trucks, etc.

1. Temporarily shut off air conditioning.
2. Record in a quieter location.
3. Use a high-pass filter set around 40 to 80 Hz.
4. Use microphones with limited low-frequency response.

### Distortion

1. Switch in the pads built into the microphones (if any).
2. Increase console input attenuation (reduce input level).

## Sorting Out Signal Processors

There are many kinds of signal processors in use. The chart in *Figure 1* should help you sort them out by showing how these devices are classified. Note that some signal-processing units combine several effects in a single package.

## Sorting Out Microphone Types

There's a perplexing variety of microphones available for recording. *Figure 2* should reduce the confusion. It classifies microphones according to transducer type and polar pattern.

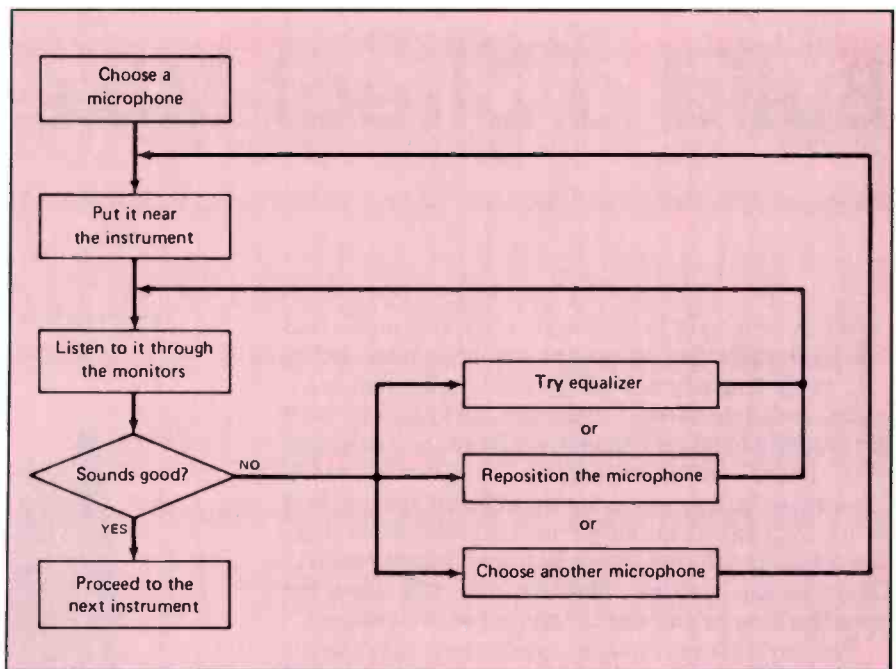

Figure 4. Trial-and-error method of choosing a microphone (Method Two).

## Choosing the Right Microphone (Method One)

*Figure 3* shows a procedure for choosing a microphone for recording. Follow the chart from top to bottom, making decisions along the way; you should end up with the right mic for the job (listed in the boxes). If the microphone you selected still sounds bad, try Method Two (described later).

Note: For hand-held vocal use or outdoor recordings, put a foam windscreen (pop filter) on the microphone or use a microphone with a built-in pop filter (ball grille).

Let's run through some examples to see how the chart is used. Suppose you want to record a grand piano playing with several other instruments. That's the recording situation. Leakage is a serious problem, so you follow down the left side of the chart and see that a unidirectional mic is recommended.

Your next choice is between a "detailed sound" and a "less-detailed sound." You want a detailed sound, so you choose a unidirectional condenser mic, or a PZM on the underside of the lid. Those are the best mics for the job.

Now suppose you're recording an acoustic guitar on stage, where the guitarist roams around. This is a moving sound source, for which the chart recommends a miniature microphone attached to the guitar. Since you're mic'ing close, feedback and leakage are not a problem. (That's the situation described in the upper middle of the chart.) The chart suggests an omnidirectional mic.

You try an omnidirectional condenser mic. On this particular guitar, it sounds too detailed (too much pick noise and string noise). You want a less-detailed sound, so you finally choose a miniature omnidirectional dynamic mic—the best microphone for this particular application.

## Choosing the Right Microphone (Method Two)

Method Two is trial and error. Follow the chart in *Figure 4* from top to bottom, making decisions along the way. Eventually you'll find a combination of microphone, mic placement, and equalization that pleases your ears.

# Build a Direct Mixer

If someone were to tell you about a stereo mixer that had ruler flat frequency response from DC to radio frequencies, had virtually unlimited headroom, added no noise or distortion, and could be built for around \$10.00 per channel, would you be interested? Well, you can *build* such a mixer, but there is a catch. This mixer is designed to use the external speaker jack of an instrument amplifier as a source rather than conventional microphone or line level inputs found in other mixer designs. The low cost and excellent specifications are a result of using passive design.

Don't wrinkle your nose simply because the design is passive. We're not talking about the four knob, \$9.95 black box that you probably discarded years ago. The \$9.95 models are no good because they are designed to work with low level, high impedance microphone inputs. As a result, they invariably have lots of control interaction, are susceptible to hum pickup, and have a very low output signal. You may also have tried the \$14.95 deluxe model, which is the same thing with a transistor in the output to boost the noise for you. Both are a waste of money.

But you can build a high-quality mixer by using the high level, low impedance signal at the output of an instrument amplifier as the source to the mixer. With this type of input, the mixer can be designed with very little control interaction, low enough impedance levels to prevent hum and high frequency loss problems, and still have enough signal at the output to make additional gain unnecessary.

You may object that using an instrument amplifier as a source means that you pick up all of the noise from the amp electronics. This is true. However, even your \$1000 microphone will pick up the same noise, as well as the noise of air conditioners, passing cars, etc. A mic lets you use the coloration of the instrument speaker, room acoustics, and microphone characteristics to artistic advantage. But mics (and mic mixers) aren't cheap. They're not perfect either. You pay a price in extraneous sound pickup, loss of separation, and the imperfections the mic mixer adds.

The direct mixer requires some extra care in use to prevent grounding problems. (This will be discussed later.) Keep in mind that although the mixer doesn't accept microphone inputs, that doesn't mean you can't use it as part of a larger system that does. On the simple side, if your recorder will accept simultaneous mic and line inputs, this mixer and a pair of mics may be all you need to make a demo tape. On the other hand, if you are running out of mics and channels on a small microphone mixer, you can probably patch the output of this mixer into a spare line input to expand the capabilities of your system at low cost. Of course, don't overlook the fact that some instrument amplifiers will accept microphone inputs.

As you can see from the schematic diagram (*Figure 2*),

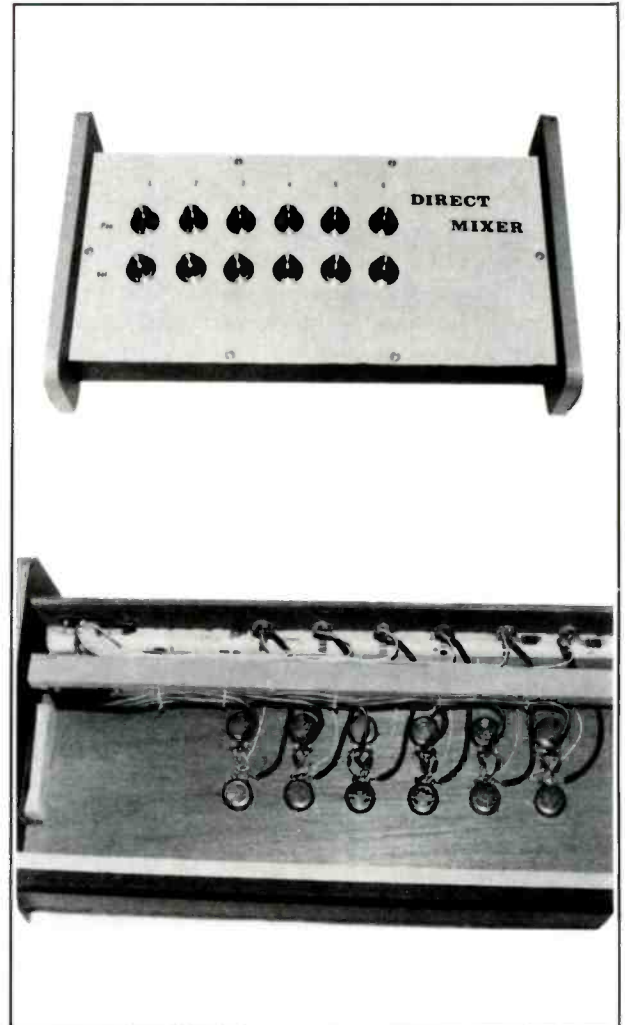

Figure 1. The prototype Direct Mixer was built in a wooden enclosure using point-to-point wiring and a small piece of perf board.

the basic mixer has six inputs and two outputs. Each channel has volume and pan controls. If you understand Ohm's Law and voltage dividers, you can read through the design section at the end of the article to get a better understanding of the mixer's operation. Calculations show that the output impedance of the mixer is about 1240 ohms, and the mixer should have no problem delivering a line level signal. Worst case calculations show that a given channel's level should be within .1 dB of ideal at any setting of that channel's pan pot. Panning full left to full right should not affect the level of any other channel more than .2 dB. In fact, if five channels are panned full left to full right, the effect on the remaining channel is only about .7 dB. If you consider the fact that the mixer adds no distortion, noise, or frequency response limits, the specifications are most impressive.



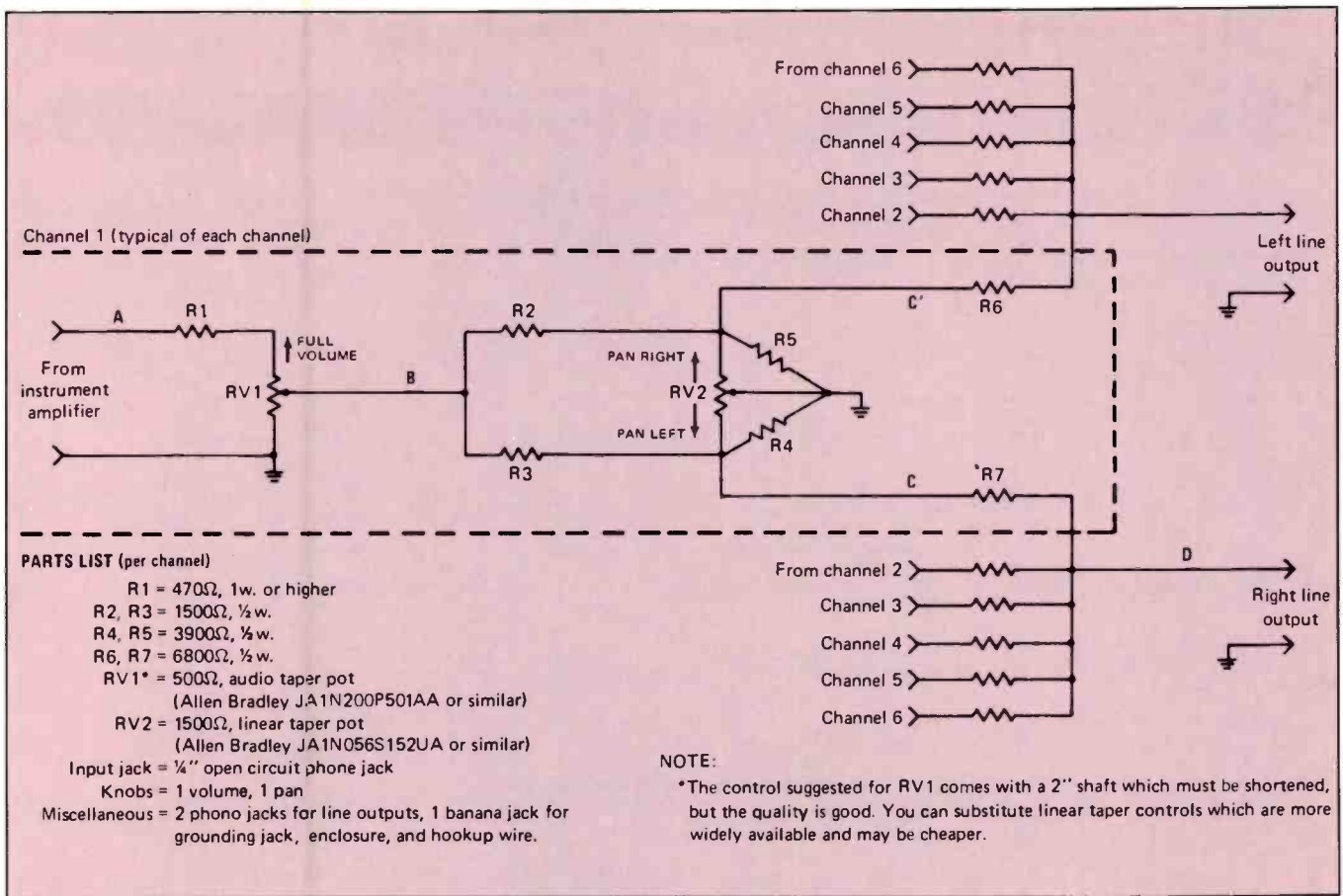

Figure 2. Schematic and parts list for the Direct Mixer.

## Construction

Since the mixer has high signal levels and low impedances, no particular precautions need to be taken during construction. For economy's sake, I built the prototype in a wooden enclosure with a plastic laminated top. You can use a metal enclosure if desired. One advantage of the plastic top is that you can use a soft pencil to note which instrument goes into each channel right on the top rather than having to rely on your memory. The enclosure of the prototype was built large enough to allow for future expansion.

I used point to point wiring with shielded cable, except for a small piece of perf board used to mount the mixing resistors. As a precaution, I ran separate wires from each ground point in the circuit, tying them together at the grounding jack on the rear of the enclosure.

The mixer design can be easily modified to meet your particular needs. I've shown a 6 in, 2 out version, but you can change the number of inputs if you like. The attenuation of a given input signal is increased when you add channels, but when you sum them at the output, the peak level will remain the same (assuming uniform input signals). If, for example, you build a 10 input mixer and want to use just three inputs, you could have excessive loss in the mixer stage. You can add "channel off" switches to eliminate this problem (see *Figure 3A*). Each channel that you turn off will increase the output of the remaining channels. You can also eliminate or put a shorting switch across R1 for low power amplifiers. It is only included to protect RV1 from excessive power dissipation. In my prototype, I omitted R1 on four of the channels with no ill effects.

You can also change the number of outputs on the mixer. For mono applications, simply eliminate the pan stages. If you really must have four outputs, you can pan between any two of the four outputs by adding a two pole, six position rotary switch to each input channel, as shown in *Figure 3B*.

The simple version of the mixer has no master left or right output level controls, assuming that you will use the line input controls on your tape deck for this function. Adding these controls increases the output impedance of the 6 channel mixer to a maximum of about 1550Ω (depending on the control setting) and also decreases the maximum output signal slightly (see *Figure 3C*).

Although it wouldn't be hard to add passive tone controls to the mixer, I don't recommend it. I have not found simple bass and treble controls particularly useful, and adding them would double the cost of the mixer. Presumably, the instrument amplifiers have tone controls, so you can make adjustments there if necessary.

A more useful option would be the addition of line level sends and returns on each channel. This allows you to use an accessory such as a graphic equalizer on a particular channel. The line level sends are simply attenuating taps connected to the output of the channel volume controls. The returns connect to the input of the pan stage.

You may observe that using an accessory limits the mixer peak output voltage. However, in practice this limitation may be academic. Since we are using instrument amplifiers as sources, the input voltages to the mixer are also limited by the instrument ampli-

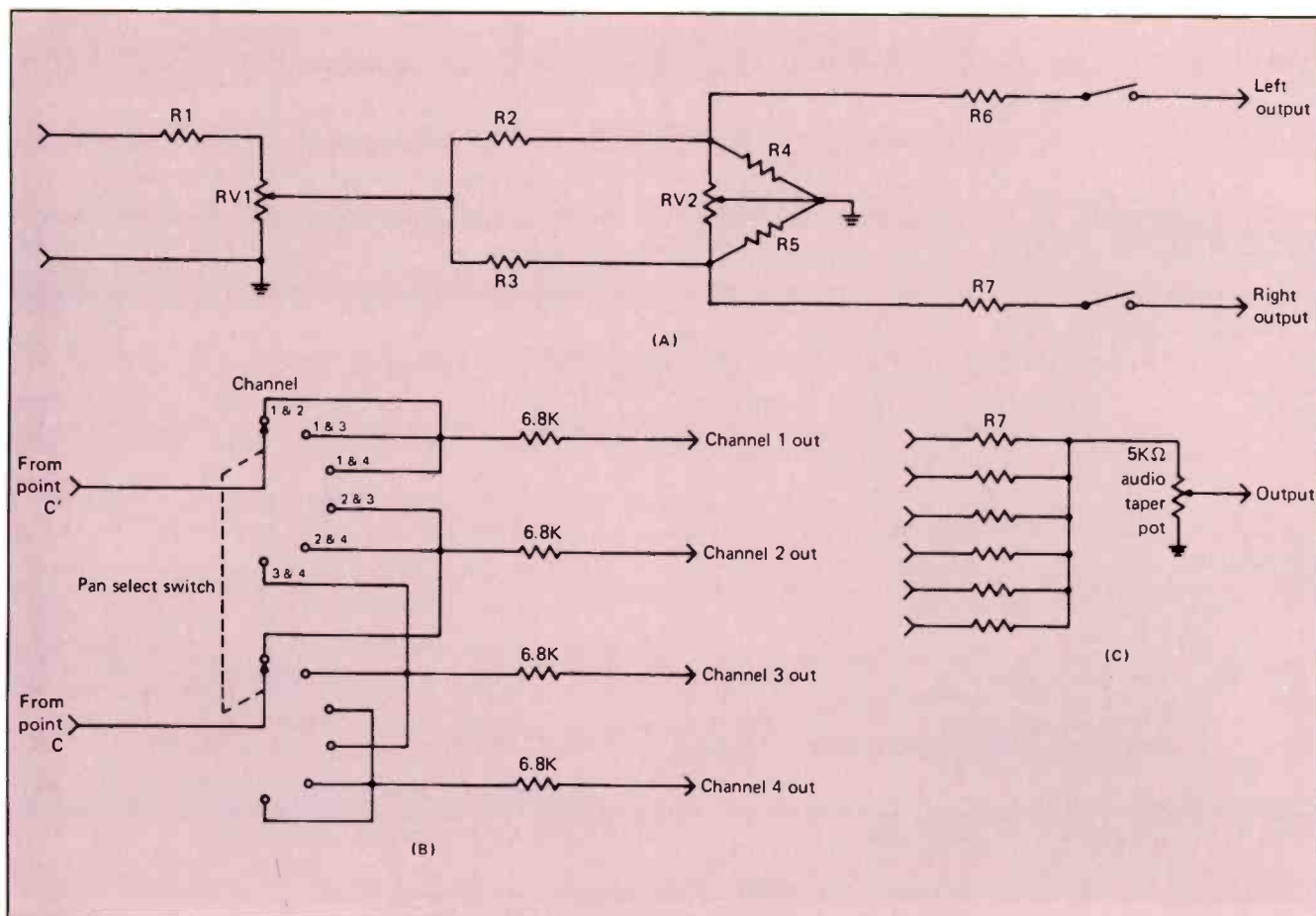

**Figure 3. Some typical mixer modifications. (A) shows the addition of a DPST switch to turn off a channel; (B) shows the addition of a 2-pole, 6-position switch to allow panning between any two of four outputs; (C) shows how Master Output controls can be added with 5 k $\Omega$  audio taper pots.**

fier ratings. If we assume the accessory can supply 8 volts into 1k $\Omega$ , the output limitation would be .35 volts. In order to get a greater output voltage by-passing the accessory, the instrument amp must be able to provide a voltage swing of 19.6 volts. This is equivalent to 48 watts into 8 $\Omega$ , 96 watts into 4 $\Omega$ , or 192 watts into 2 $\Omega$ . Unless the instrument amp has a higher rating, the accessory will not be the limiting factor on the mixer output voltage. The above figures assume the channel's volume control is on full. If the channel volume is reduced, the amplifier rating could be higher before the accessory becomes a limiting factor.

### System Grounding

Since this mixer doesn't provide isolation between the instrument amplifier sources and the recording system, extra care is required to prevent grounding problems. Briefly, in order to reduce the possibility of shock in case of an internal defect, equipment manufacturers often provide a three-wire grounding power cord on their equipment. The problem arises when you interconnect two pieces of equipment that are both grounded. This creates a ground loop, which can introduce hum into your system. Some professional equipment uses isolation transformers, allowing signals to pass between equipment without connecting

their grounds. The other (non-UL approved) solution involves lifting one of the grounds of the interconnected piece of equipment. Both pieces are still grounded, *but only as long as they are interconnected*. If you remove the signal cable without reconnecting the original ground lead, one piece of equipment is ungrounded and could deliver a dangerous shock if defective or used improperly. Grounding through the interconnections is frowned upon by the safety folks because the grounding wire is not permanently attached. If you plan to record outdoors, on a damp floor, or in other high risk environments, either ground each piece of equipment and live with the hum, or don't use this mixer.

For typical recording situations, the grounding scheme shown in *Figure 5* will give safe, quiet results. All of the instrument amps and recording equipment should be powered from a single grounded three-wire power distribution box. This insures that the system is running from a single circuit with a common grounding point. Add up the power consumption of the equipment involved to insure that your power distribution box and the circuit breaker which runs it can handle the load. The mixer connecting cables should provide a ground through the mixer for the entire system.

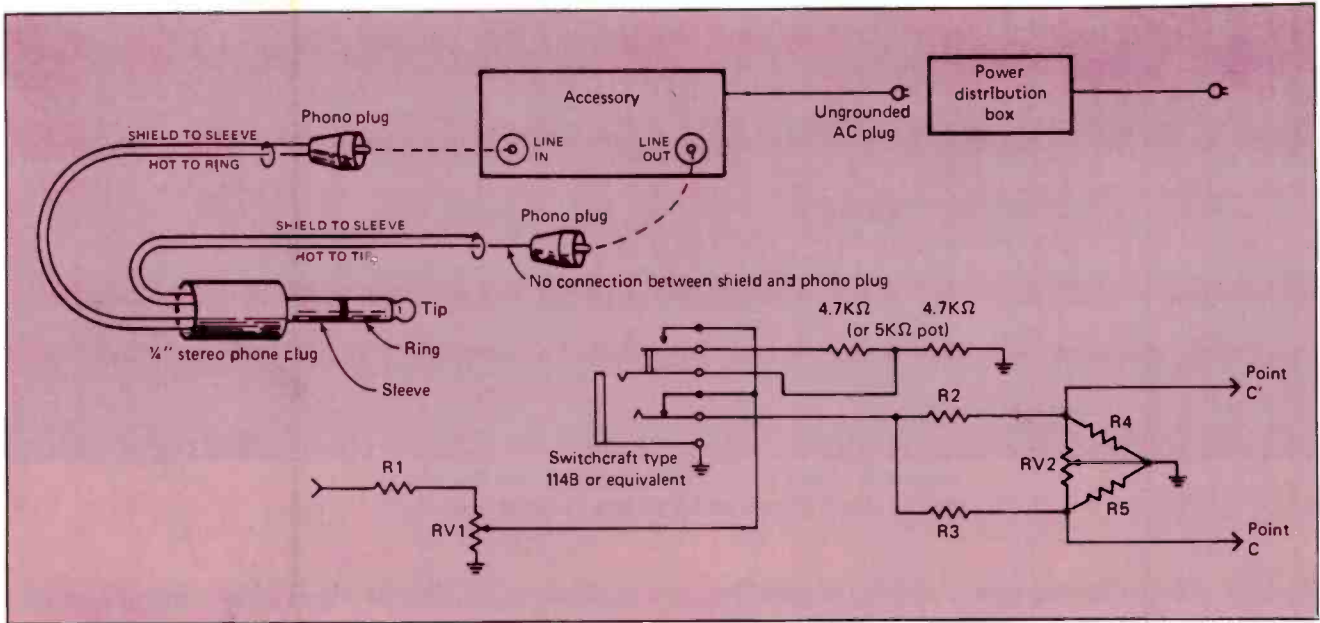

Figure 4. Adding line level sends and returns to an input. The diagram assumes that the low sides of the line input and output jacks on the accessory are connected to the accessory chassis. If this is not the case, the accessory chassis should be grounded to the power distribution box, and the shield of the line output cable should be connected to the low side of the plug.

## Signal Connections

The connecting cables between the mixer output and the line input of the tape recorder should be kept short. Since you'll be using the VU meters on the recorder to monitor the levels (and the line input controls if you have not added left and right output level controls to the mixer), the two pieces of equip-

ment must be close together anyway. Phono jacks are the most common type of connector found with line inputs.

Although there is quite a bit more variation, 1/4-in. phone jacks are the most common connector found on instrument amplifier speaker outputs. A "Y" cord will

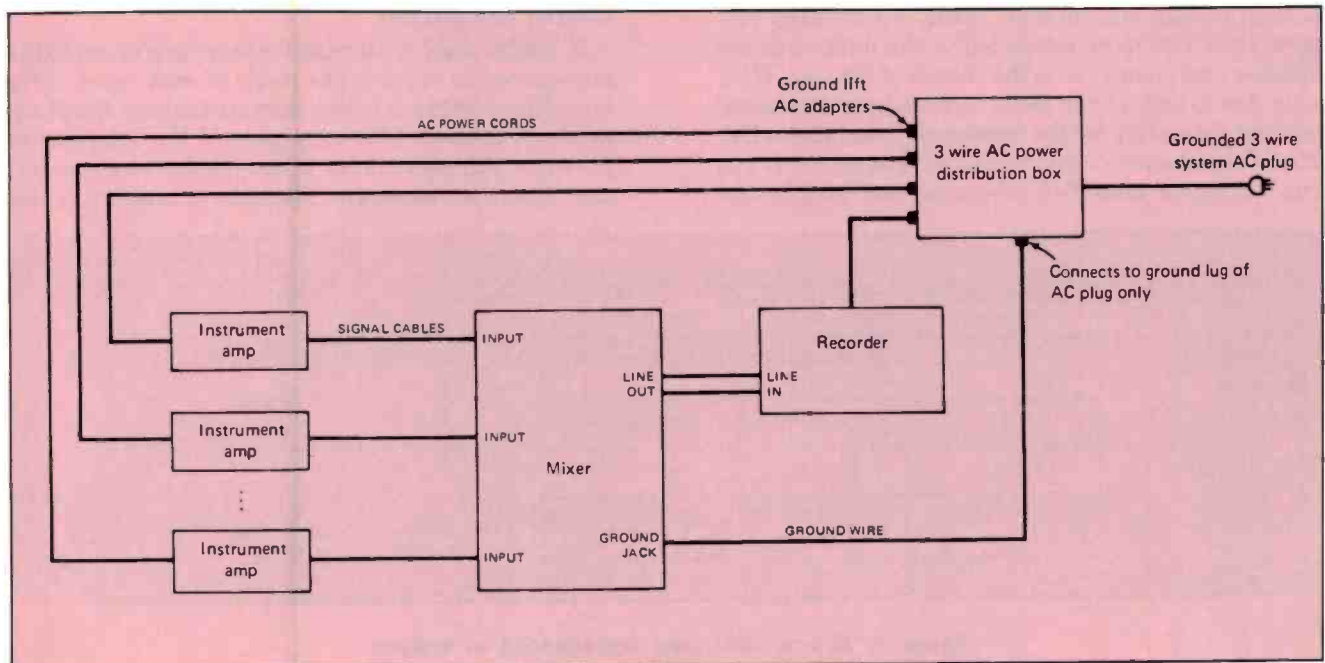
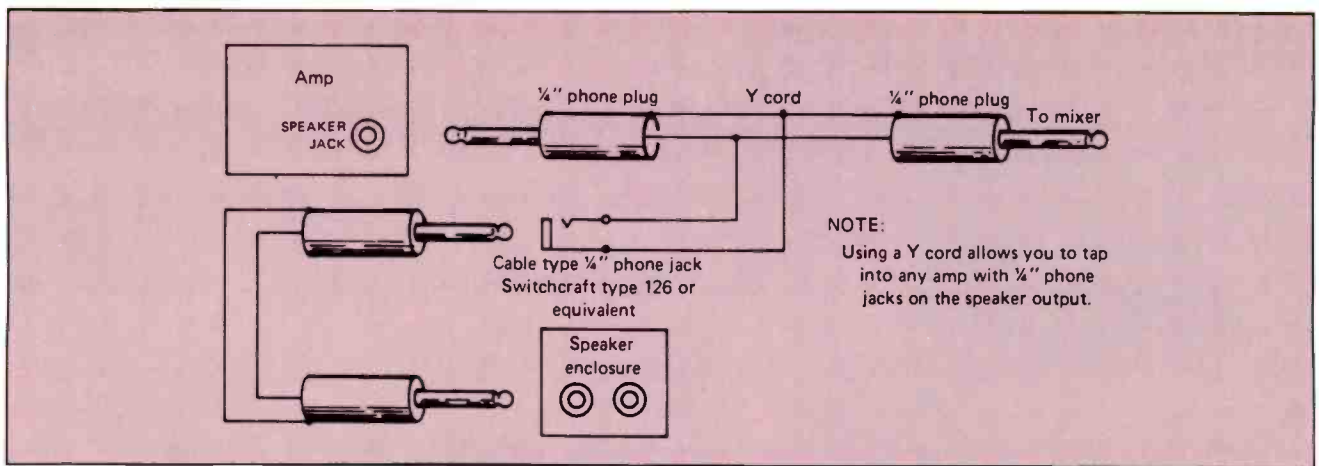

Figure 5. Suggested hookup scheme for using the mixer.



**Figure 6. Using a Y cord allows you to tap into any amp with 1/4-inch phone jacks on the speaker output.**

give you a convenient way of tapping into the amplifier output (see *Figure 6*). The speaker jacks on most transistor amplifiers are wired in parallel and provide another place for taking your mixer feed. In the case of tube amps or other amps with an output transformer, plugging into the external speaker jack may activate some switching that puts the speakers on a different tap of the output transformer or in series. Since the mixer doesn't provide a speaker load, this creates a mismatch in the amplifier. In this case, use the "Y" cord.

If the amplifier runs into a speaker enclosure that has two jacks, the enclosure jacks are usually in parallel also. If you tap into a spare, it's wise to check that the cable connecting the amp and the speaker is wired correctly (tip to tip, sleeve to sleeve). If it's not, you'll actually be connecting the hot side of the amp to ground. Not a good idea.

### Testing the System

As you're connecting the recording system, there are several checks that must be made. First, verify that each amplifier to be connected to the mixer has one speaker lead connected to the chassis of the amp. If the amp has 1/4-inch phone jacks mounted on the chassis without insulators for the speaker outputs, you're OK. If you're not sure, check it with an ohmmeter. If you run across an amplifier where neither lead is con-

nected to the chassis, check with a technician before trying to use it with the system. Next, plug the mixer connecting cable into your amplifier tap and measure the resistance between the sleeve of the mixer end of the cable and the amplifier chassis. You should measure the resistance of the cable (less than 1Ω). The tip of the cable should give you a much higher resistance to the chassis. If this test checks OK, you can plug the cable into the mixer.

Once you have gone through this test for everything connected to the mixer, it's a good idea to check each chassis for ground continuity to your system grounding point. Assuming this checks out OK, plug each piece of equipment that hooks into the mixer into the power distribution box using three-prong to two-prong adapters. *It's important to plug in the AC power last.* Remember, the equipment isn't grounded until it's interconnected, and you don't want to get a shock while you're hooking up the system. It's also important that your system ground is securely in place before plugging in any power.

### Using the Mixer

If you've used a standard mixer, you're probably accustomed to running the levels of each input fairly low. This is because with a standard mixer, the channel level controls affect the gain of the microphone preamps. Since gain adds noise, you don't want to add any more than necessary. Also, the preamps will clip

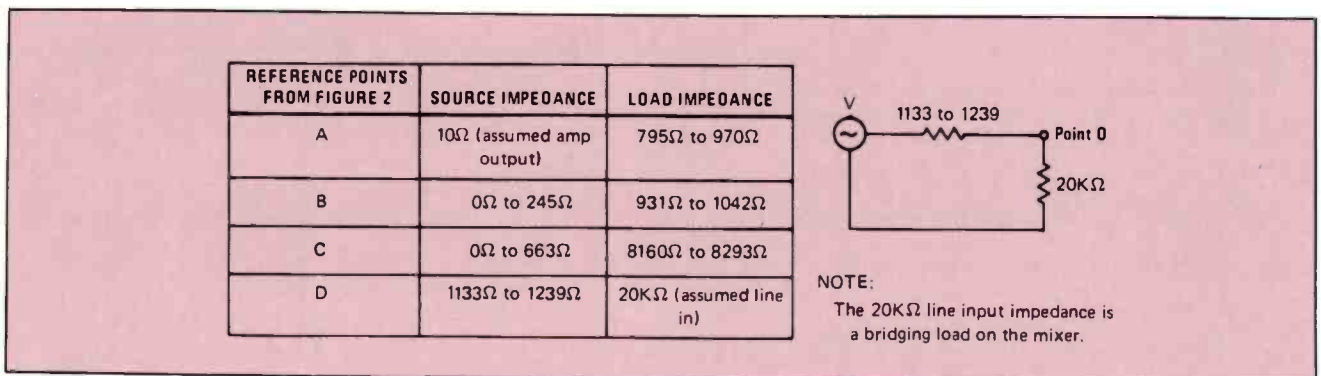

**Figure 7. Source and load impedances at various points in the mixer. (The 20 kΩ line input impedance is a bridging load on the mixer.)**

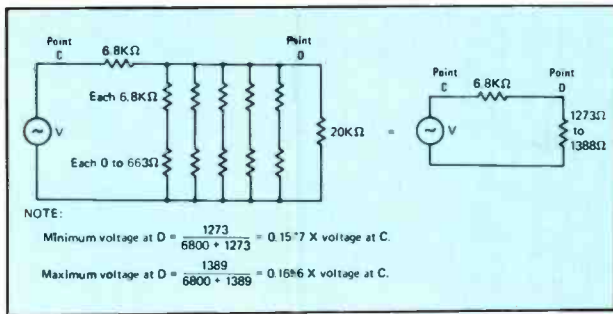

Figure 8. Loss calculations between points C and D.

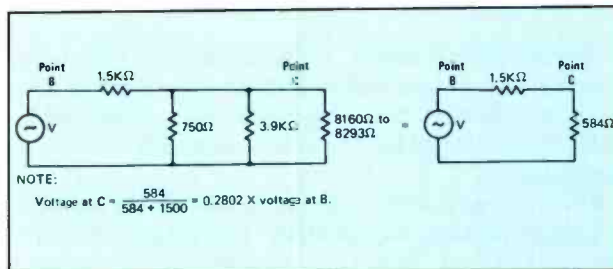

Figure 9. Loss calculations between points B and C with pan pot in center position.

above a certain point, so you must run the levels low enough for adequate headroom.

With the direct mixer, you have no headroom problem. In addition, the signal to noise ratio will be that of the instrument amplifier sources and is not dependent on the channel volume settings. Most instrument amps aren't very quiet, but the only solution to that problem is better amps. Therefore, it's OK to run the volume controls as high as necessary. Incidentally, the line input controls on most recorders work the same way. Most are simple attenuators, so you're not degrading your signal if you run them high (unless you overdrive the subsequent active stages, of course).

As you might expect, recordings made with the direct mixer will be a bit different from those made with microphones. There is no leakage, so signals have total separation, and no room ambience. This results in very clean signals (and noises) and a rather dry recording. First, a note about noises.

When I was testing the prototype mixer, I connected it to a tape recorder and guitar amp and used headphones to monitor the results. I noticed a distressing amount of buzz and an odd rattling noise at high volume. Further investigation revealed that the guitar amplifier had a microphonic tube causing the rattling, a problem I had not noticed earlier. I also discovered that the buzz heard at the speaker was the same volume whether the mixer was connected or not. As a further check, I hooked up a dropping resistor, which allowed the headphones to be connected directly to the speaker output, and disconnected the mixer. The buzz was still there. To me, at least, the noise sounded louder when monitored through headphones than when listening to the speaker in a room.

Although I'm no expert in this area, I'd guess that the room has a masking effect on the noise. As noise impulses bounce around the room, they tend to "average out," making the noise less objectionable to the

listener. With headphones, the extraneous room noises are blocked out and there is no "averaging effect."

The point is, if you are using headphones to monitor the direct output of an amplifier for the first time, don't be surprised if you hear buzzes and other garbage that you never noticed before. Chances are, the noises have been there all along, but you may not have heard them as clearly before monitoring with headphones. When you play back your recording through speakers, the normal listening environment will once again mask the noise.

If the instrument amps have an electronic source (electric guitar, bass, organ, etc.), the signal through the mixer won't include any room reverberation. Of course, you can add electronic reverb if the instrument amp has that feature. However, I have not found this necessary. If the group is using one or more mics for vocals, there is usually substantial leakage into the vocal mics. When the signal from the PA is mixed in, it keeps the recording from being excessively dry.

If you want to pick up more room noise, you can always set up a spare mic and run it into an unused amp, feeding the output into the mixer. (Use an 8Ω 100 watt dummy load if your amp requires it.) Since the amplifier is functioning as a level and impedance matching device, any good quality amp will do. I've used a home stereo amp with good results for recording drums or a Leslie organ speaker.

The proof is in the pudding, so to speak. I've made simultaneous recordings with the direct mixer and with conventional mics and mic mixer. Naturally, the two tapes don't sound exactly alike, but the tape made with the direct mixer sounds as good or better to me. Although you sacrifice some of the flexibility of a commercial mixer, you can hardly beat the price. If you have a band that wants to make a demo tape, this mixer will let you do it without a big investment in equipment.

## Mixer Design

Understanding the mixer circuit requires knowledge of Ohm's Law and voltage dividers. It's easiest to analyze the mixer by working from the output towards the inputs.

Figure 7 shows an equivalent at the right output (point D in Figure 2). The impedance of the output is found by calculating the impedance to ground at that point. With the pan controls full left, we simply have six 6.8KΩ resistors in parallel, giving us 1133Ω. Other control settings will give a slightly higher impedance, but a few calculations show that the output impedance can't be more than 1239Ω. Since we can expect the recorder's line input to have an input impedance of around 20kΩ, the tape deck is a "bridging" load on the mixer output. In other words, the voltage at the mixer output will essentially be the same, regardless of whether it is connected to the tape deck line input or not.

Using a similar procedure, we can calculate an equivalent circuit (Figure 8) at the input of the mixing stage (point C in Figure 2). The output impedance of the pan stage is less than 663Ω and the rest of the mixer provides a load of at least 8160Ω, so again we have a bridging load. However, the output signal will be about 1/6 of the signal at point C.

Figure 9 shows the situation at the input to the pan

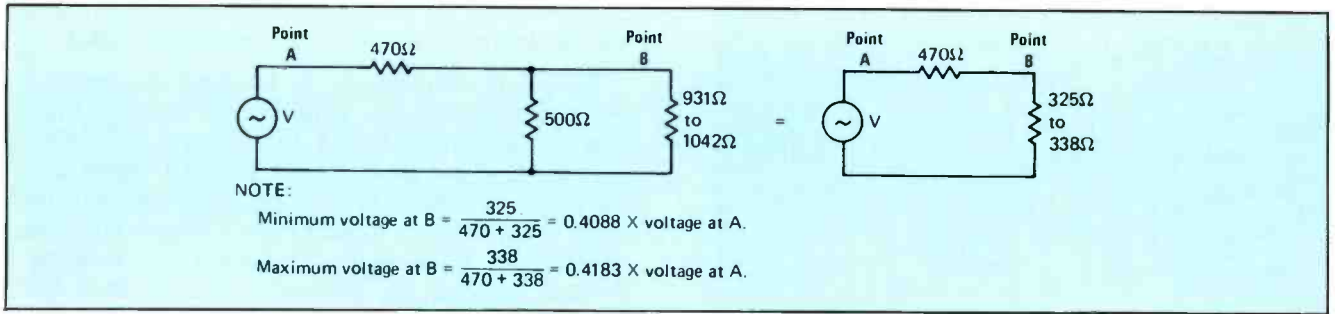

**Figure 10. Loss calculation between points A and B with channel volume on full.**

stage (point B in *Figure 2*) when the pan pot is in the center position. The voltage at point C will be about 3/10 of the voltage at point B. When the channel volume control is on full, we have a source impedance of about 245Ω seeing a load of about 931Ω. Since the pan stage is providing a substantial load on the volume stage, we can expect some interaction between the pan pot control and the volume control. We'll investigate this further in a moment.

We finally arrive at the input model (*Figure 10*), shown with the channel volume on full. Since the impedance at the input of the mixer (point A in *Figure 2*) is much higher than the amplifier output impedance, there should be no loading of the amplifier. The full amplifier voltage will be seen at point A; about 4/10 of this voltage appears at point B.

Looking at the losses, we find that the output signal is about  $\frac{4}{10} \times \frac{3}{10} \times \frac{1}{6} = \frac{12}{600}$  of the input signal when the volume is on full. If we assume the amplifiers are each delivering 10 watts into eight ohms, each channel will have about nine volts at the input or .18 volts at the output. Since the total output is the sum

of the individual outputs, the peak output is 1.08 volts, which is in the right ballpark for the line input of our recorder. We've verified that the output is about right, so let's go back and take a closer look at a few possible problems.

Since the mix bus is essentially a bridging load on the pan pot output, we can safely ignore its effect while investigating the interaction between the pan pot and volume controls. *Figure 11* shows the equivalent mixer input circuit when the volume control is on full. With the pan pot in the center position, we would (ideally) like the voltage at point C to be .707 times the voltage when panned full right. A few calculations show that when panned to the center position, the voltage at C is  $.12405 \times V_{in}$ . When panned full right, the voltage at C is  $.17214 \times V_{in}$ . The ratio of these voltages is .7026, rather than the desired .707. This is due to the loading of the pan stage on the volume stage, which resulted from the desire to keep the impedances in the mixer low. However, this one percent error is certainly acceptable since it causes less than .1 dB difference in the overall level when using the pan pot.

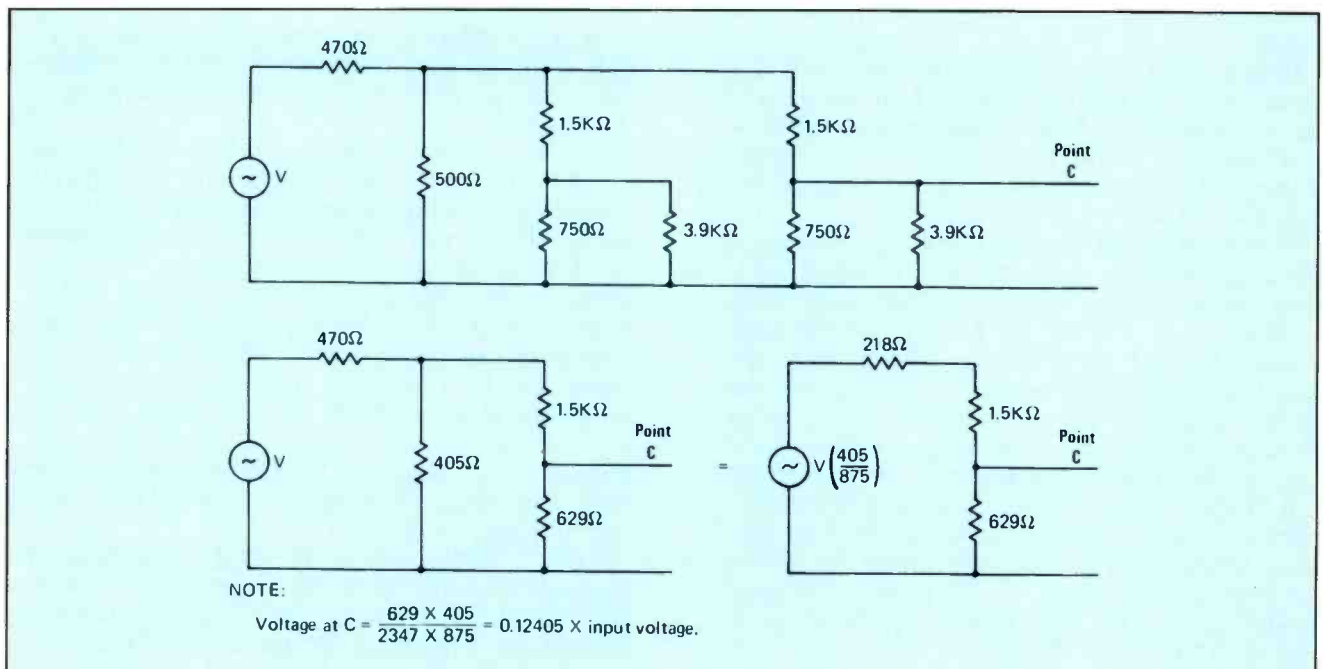

**Figure 11. Equivalent input models at point C with volume on full, pan in center.**

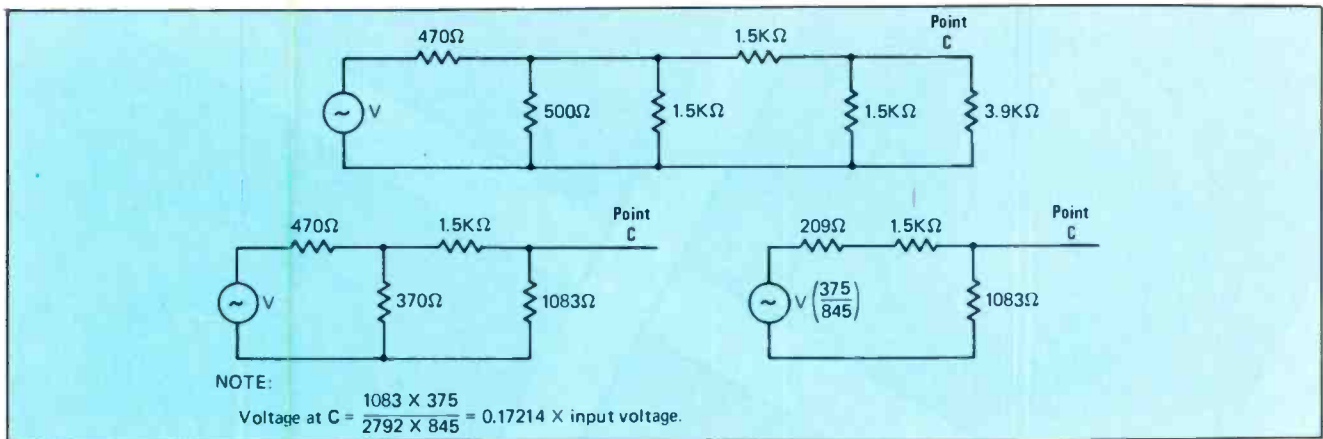

Figure 12. Equivalent input models at point C with volume on full, pan full right. The ratio of the output voltage when panned to center compared to when panned full right is .7026, very close to the ideal ratio of .707.

The error is even less when the volume control is set lower, approaching a ratio of .7045.

The fact that the voltage at point D is not constant in relation to the voltage at point C is due to the effect of the pan pot settings on the mixer stage loss. The worst case is calculated by assuming an input signal in channel one and calculating the signal at one of the outputs with channels two through six panned full left. This output is then compared with the output when channels two through six are panned full right. The ratio of these outputs is .1696/.1577 or 1.075, indicating

that the output from channel one changes 7.5 percent, or about .7 dB.

However, this is the worst case. You're not likely to make such extreme changes in control settings during a recording. Measuring the effect on channel one of changing a single pan pot from full left to full right gives a ratio of 1.013, or .2 dB error. This is certainly a negligible variation, especially when you consider that the pan controls usually aren't changed much during a given recording.

# MODERN RECORDING & MUSIC

Because you are ... creatively involved in how sound is produced and reproduced, and are serious about creating and recreating music both live and recorded. **Modern Recording & Music can help you develop your talent. *Subscribe Now.***

1120 Old Country Rd.  
 Plainview, NY 11803  
 (516) 433-6530

011C

I wish to  subscribe  renew today and save \$16.00.  
 \$15.00 for 12 issues—Save \$8.40. \$26.00 for 24 issues—Save \$20.80.  
 Check  money order enclosed for the amount of \$ \_\_\_\_\_

My account number is:  Visa  Mastercharge

Name \_\_\_\_\_ Exp. Date: \_\_\_/\_\_\_/\_\_\_

(Foreign subscribers add \$3 for each year. Foreign subscriptions payable ONLY in U.S. funds by international draft or money order.)  
 Address \_\_\_\_\_ City \_\_\_\_\_ State \_\_\_\_\_ Zip \_\_\_\_\_

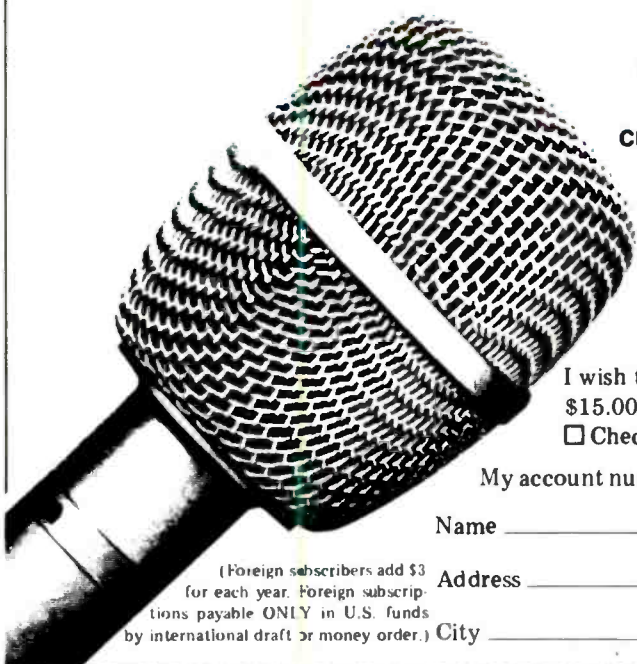



**T**hey are distinctive, this band called X. At least that's what the press agents say. It's easy to pick out the combo of Exene Cervenka and Joe Doe's vocals, a sort of scratch blend of mono and whine, if that's possible. And who couldn't notice the barnstorming, machine gun zing of Billy Zoom's Silver Jet guitar. Then there's DJ Bonebrake and his marching snare. Not too many of those in rock'n'roll these days.



martin basch



# THE WORLD OF DELTALAB DIGITAL DELAY

## *Super* TIME LINE®

Versatility, proven reliability, rugged construction, full audio bandwidth/dynamic range, FULL PROGRAMMABILITY for as low as \$699.00\*. Both the ADM-512 (1/2 second) and the ADM-2048 (2 seconds, \$899.00\*) are complete single channel special effects processors. This allows you to program such widely used effects as flanging, vibrato, tremolo, feedback flanging, doubling, chorusing, echo and multiple echos. Each unit also contains nondeteriorating infinite repeat. Programs are stored in a non-volatile memory. Easy operation from the front panel of the ADM-STL foot pedal.



*EFFECTRON JR...Deltalab Value.*



*ECHOTRON...Deltalab Long Delay.*

## EFFECTRON® JR SERIES

The Effectron JR series has taken digital technology to the Price/Performance limit. With a wide bandwidth (12KHz) and a typical dynamic range of 85db, the JR series provides flanging, doubling, chorusing and echo to the first time effects user. DeltaLab's rugged construction and proven reliability are maintained in the JR 35C (350ms, \$239.00\*), The JR 700 (700ms, \$269.00\*) and the JR1050 (1050ms, \$299.00\*).

## EFFECTRON® II SERIES

The Effectron II series has become the popular choice of the pros when only the best will do. Full audio bandwidth (16KHz all settings) and full dynamic range (90db typ.) with rugged construction and proven reliability, place flanging, doubling, chorusing, vibrato, tremolo, echo and slapback at every musician's fingertips. The ADM-64 (64ms, \$299.00\*), the ADM-256 (256ms, \$399.00\*) and the ADM-1024 (1024ms, \$499.00\*) feature the finest and most natural sounding digital effects available.

## ECHOTRON™

The Echotron is a full bandwidth (16KHz at all delay settings), solid state digital delay loop. With a delay range from 256ms (1/4 second) to 4096 (4 seconds) the Echotron is capable of producing very subtle to very spacey effects. Using the METRONOME feature and the DELAY FACTOR allows the musician to create bass lines or rhythm tracks. Hard and soft (roll off) feedback and synchronization for drum machines top off the versatile features of the Echotron. Only \$699.00\*



*EFFECTRON II...DeltaLab Performance.*



*Super TIME LINE...DeltaLab Programmability.*

X is anything but mundane, and the Los Angeles-based quartet is in the midst of converting listeners to its hybrid folky punk rock sound. Helping out in the process is producer Ray Manzarek, best known as keyboard man for the Doors. While he hasn't given the band its sound, he has aided them in finding it.

Formed in 1977 through a series of quirks, the foursome released *Los Angeles* three years later on the Slash label. The record was quite a hit—with the critics that is. The same thing happened in 1981 with the release of *Wild Gift*, as their rough edge and rawness mixed with provocative lyrics to capture the ear. 1982 saw X land a contract with Elektra Records and a "hit" with "The Hungry Wolf" off of *Under the Big Black Sun*.

Speeding along, *More Fun in the New World*, album number four, contains a rocking roadhouse version of "Breathless" and a quasi-hit, "Make the Music Go Bang," featuring Zoom's guitar and those unique vocals.

Although their producer's forte is the keyboards, the instrument is hardly used in production. X maintains that they are democracy of four, all involved in the production process. Here, Billy Zoom and bassist John Doe give us an insight as to what it is like when X goes into the studio.

**Modern Recording & Music:** Can you give me an idea as to what a typical recording session has been for X?

**Billy Zoom:** A typical recording session?

**MR&M:** Is there such a thing?

**BZ:** No, there is a general plan. Well, lately there has been. Things are becoming more typical as we figure out what we're doing.

**John Doe:** We never spend more than eight weeks. No, seven weeks was the longest. Usually its between four weeks and six weeks.

**BZ:** We go in to Cherokee [Recording Studios in Los Angeles] and into the big room.... They put us in this huge room where the drums go and put John and I in closets, basically. They baffle off a little back part of the room and stick me in there. We spend a day tuning drums and mic'ing things. Not doing much of anything, we run through a few things to get some sounds. Then we get cracking and do as much as possible.

**We tried to do some stuff down at the Record Plant. We went there and talked to them. They were like, "Well, Rod Stewart records here and Fleetwood Mac records here." And you just say, "Well, !\*# you. My money isn't as green as Rod Stewart's." They just have a snotty attitude and it's way too expensive (at the Record Plant).**

**MR&M:** Now that you've recorded four albums, does the process get easier or harder for you?

**BZ:** It gets easier.

**JD:** You learn from your mistakes.

**BZ:** Once in awhile you figure out something that works and then you remember it. Soon you have a list of things that work.

**MR&M:** Before signing with Elektra Records you were with Slash. How did the studios you used compare to Cherokee?

**BZ:** The first one [Los Angeles] was recorded at a really nice studio run by a friend of mine. It had just opened, so it wasn't booked that steadily. The second one [*Wild Gift*] was done at a smaller, older sort of nice studio.

**JD:** The second one was at Clover. I guess Bob Dylan recorded one of his gospel records there, "Saved."

**MR&M:** What's the appeal of Cherokee?

**BZ:** Sounds good.

**JD:** The best thing about Cherokee is that they've got all the gear that you need. They've got a Trident board and good monitor speakers. They've got all this equipment, but they lose the attitude. We tried to do some stuff down at the Record Plant. We went there and talked to them. They were like, "Well, Rod Stewart records here and Fleetwood Mac records here." And you just say, "Well, !\*# you. My money isn't as green as Rod Stewart's." They just have a snotty attitude and it's way too expensive [at the Record Plant]. It's just outrageously priced.

**MR&M:** I guess that's one of the benefits of having signed onto a major label.

**JD:** Yeah. Well evidently, I was reading how the top studios in Nashville go for 60 to 70 dollars an hour. But they're not accustomed to recording rock 'n' roll. The thing is, in Los Angeles, it's anywhere from \$125, which gets you a decent 24-track, to Record Plant and other high-flown ones that are, I think, like \$225—easy. Cherokee is like what....

**BZ:** Cherokee isn't quite as fancy as the Record Plant or the other ones.

**MR&M:** Have you become more involved in the recording process as you make more records?

**JD:** More involved in understanding how to get a good sound, but less involved in actually turning the knobs. For the first two, actually the first three records, I mixed a lot of the vocals. But I knew them too well, so I had a tendency to lose things.

**MR&M:** So that's where a third party comes in—Ray Manzarek.

**BZ:** I was pretty involved in [the recording process] during the first one and then it sort of tapered off. I'll try to get a little more involved on the next one.

**JD:** The other thing that we did was that we worked with an assistant engineer. On the third record, we walked in there after we recorded all the basics, all the overdubs, everything, we just brought him in for the mixing. So he didn't know any of the lyrics, any of the old guitar overdubs, any of the counterpoint melody lines

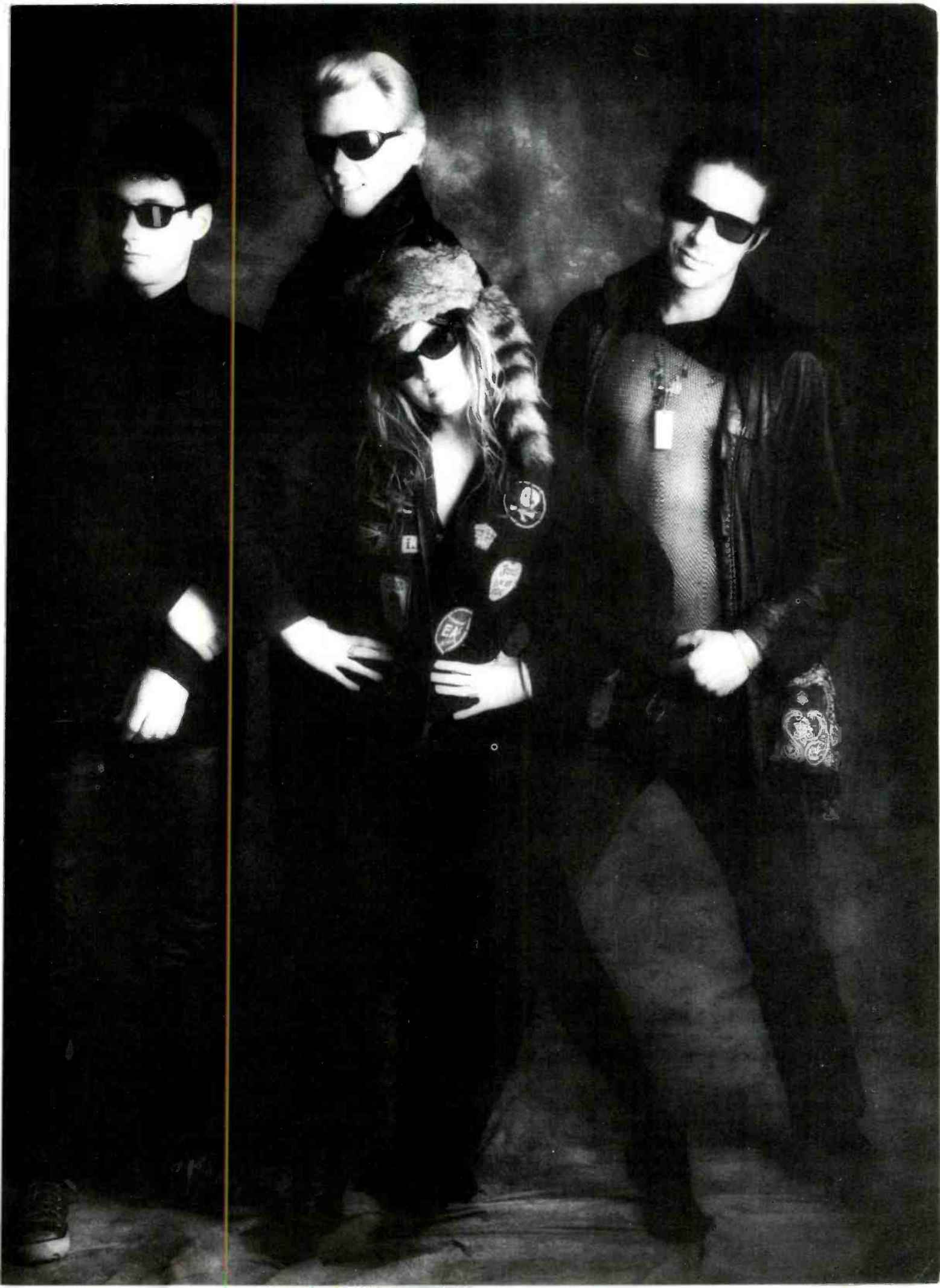

# Synthesizers were made for people who wanted to play music but didn't have enough talent to learn how to play an instrument.

---

or any of that. So he would just sit there and listen. He'd say, "Well, let's bring this up, because you can't hear it right," when everyone was used to hearing it. You tend to lose it because you aren't objective anymore.

**MR&M:** When Ray first saw you perform at the Whiskey, did he offer that night to produce you?

**JD:** We met him about a week after that.

**MR&M:** Did you get any other offers?

**JD:** No.

**BZ:** No.

**MR&M:** Were you afraid he might give you a "Doors sound" so to speak?

**BZ:** Not after we spoke with him a few times.

**JD:** I really think that attitude is confined to people with big egos. Ray just wanted to work with the band.

**MR&M:** On your first record, *Los Angeles*, Ray played a little keyboards. Since then, there haven't been any keyboards until now with "Riding with Mary."

**BZ:** There was piano on that. It's the flipside of the single "Breathless."

**JD:** We completely re-recorded "Riding with Mary."

**MR&M:** Does Ray push keyboards on you?

**JD:** We were naive enough to think that if we put an organ on the [first] record, people would think, "Oh, this is neat. There's a little bit something extra." After [that came out] we were touring and everyone was saying, "Where's Ray?" They thought he was a part of the band. We had to say well, unfortunately, we can't have keyboards on the records.

**MR&M:** Billy, wasn't there a song that you played saxophone on?

**BZ:** "Come Back to Me," from *Under the Big Black Sun*. There's a clarinet in that too, but it's hard to find.

**MR&M:** Was that the first time you've recorded something other than your guitar on a record?

**BZ:** It's the first time I played saxophone on an X record. I've played the saxophone for many years and have been a sax player in a lot of bands and have done lots of session work with the sax.

**MR&M:** Do you enjoy the role reversal?

**BZ:** Yeah. It's fun to do.

**MR&M:** Whose idea was it to record "Breathless"?

**BZ:** The people who made the movie.

**MR&M:** They came to you and said...

**BZ:** They called us up and said we've got this movie and hear you do a really great rendition of this song, would you like to do it in the movie. It sounded fine, so we said sure.

**MR&M:** What do you do differently in regard to getting the X-sound live versus in the studio?

**BZ:** Everything has to be different because the studio changes the sound. That's the whole part about recording. It's the hardest thing in the studio to get it to sound anything like it does live. I think we keep getting closer to how we play. It's hard to give a quick answer because you try a lot of different things in different situations.

## Tour Equipment for X

Gretsch Silver Jet Guitar with Bigsby tailpiece and hardshell case  
Fender Quad Reverb 135 RMS amp with four Celestion G-12-80 speakers  
Fender Precision bass  
Randall RB-15-BH cabinet  
Randall RBA amp  
Gretsch drums:  
10" x 14" tom tom  
18" x 18" floor tom  
14" x 24" bass  
Ludwig Drums:  
12" x 15" classic marching snare  
Premier Drums:  
12" x 15" marching snare  
Cymbals:  
22" Zildjian ride  
18" Zildjian crash  
17" Zildjian crash  
14" New Beat hi-hats

## An X Discography

1980 Los Angeles (Slash)  
1981 Wild Gift (Slash)  
1982 Under the Big Black Sun (Elektra)  
1983 More Fun in the New World (Elektra)

# MICROPHONES!

At long last, all the questions you ever asked...all the problems you ever grappled with...are answered clearly and definitively!

## The Microphone Handbook

In 256 fact-filled pages, liberally sprinkled with over 500 illuminating photographs, drawings and diagrams, John Eargle covers virtually every practical aspect of microphone design and usage.

Completely up to date, this vital new handbook is a must for any professional whose work involves microphones. Here are just a few of the topics that are thoroughly covered:

- Directional characteristics—the basic patterns.
- Using patterns effectively.
- Microphone sensitivity ratings.
- Remote powering of capacitors.
- Proximity and distance effects.
- Multi-microphone interference problems.
- Stereo microphone techniques.
- Speech and music reinforcement.
- Studio microphone techniques.
- Microphone accessories.
- And much, much more!

**THE MICROPHONE HANDBOOK. You'll find yourself reaching for it every time a new or unusual problem crops up. Order your copy now!**



**JOHN EARGLE,**

noted author, lecturer and audio expert, is vice-president, market planning for James B. Lansing Sound. He has also served as chief engineer with Mercury Records, and is a member of SMPTE, IEEE and AES, for which he served as president in 1974-75. Listed in *Engineers of Distinction*, he has over 30 published articles and record reviews to his credit, and is the author of another important book, *Sound Recording*.

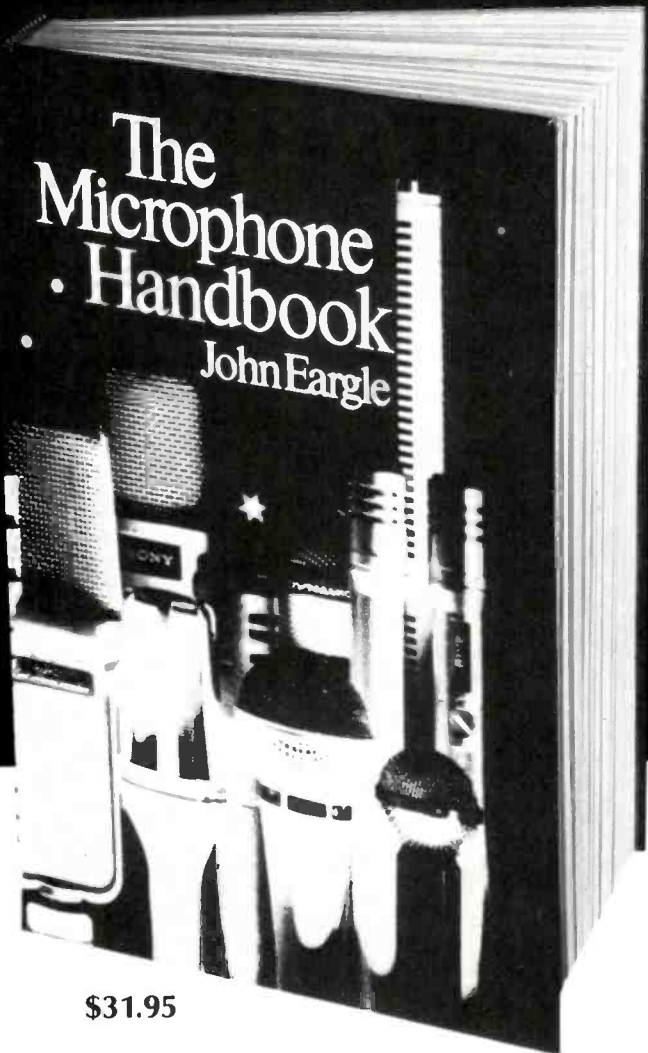

**\$31.95**

**ELAR PUBLISHING CO., INC.**

1120 Old Country Road, Plainview, NY 11803

**Yes!** Please send \_\_\_\_\_ copies of **The Microphone Handbook @ \$31.95** per copy. (New York State residents add appropriate sales tax.)

Payment enclosed.

Or charge my  MasterCard  Visa

Acct. # \_\_\_\_\_ Exp. Date \_\_\_\_\_

Name \_\_\_\_\_  
(please print)

Address \_\_\_\_\_

City \_\_\_\_\_

State/Zip \_\_\_\_\_

Signature \_\_\_\_\_

Outside U.S.A. add \$2.00 for postage. Checks must be in U.S. funds drawn on a U.S. bank.

**If you aren't completely satisfied, you may return your copy in good condition within 15 days for full refund or credit.**

# MX1688 Recording Console

16 x 8 x 2 with control room mixing

The CARVIN MX1688 is a full function recording mixer designed to serve as the control center for eight-track recording studios. Recording basic tracks, overdubbing sessions, and final mixdown are all handled with ease by the MX1688; signals are automatically routed to the appropriate sections of the console for each recording operation. You will rarely (if ever!) need to reconnect any signal cables with the MX1688. One of the key features provided by the MX1688 but rarely found on PA "recording" mixers is an independent control room monitor mixer with buss/tape source selection. Working groups will find this mixer perfect for the double duty requirements of recording and live sound mixing.

The input channels of the MX1688 include sweepable three-band parametric equalization with defeat switch, four auxiliary mixing busses with pre/post switching and solo/mute functions. Quiet performance starts with an ultra low noise differential mic preamp and is preserved throughout the mixer by careful attention to gain structure and use of the finest low-noise integrated circuits.

Construction of the MX1688 is all modular with individual circuit cards for each channel and master strip. High quality connectors and ribbon cable permit easy field servicing. The same professional quality components as used in \$100K consoles are featured in the MX1688 such as Switchcraft™ connectors, ITT Schadow™ switches, and controls that are optimally damped for smooth operation and made for years of service.

Efficient manufacturing, and direct marketing allow us to load the MX1688 with all the features required for multitrack recording and still offer a price that represents real value. Try it on the job for 10 days and if not convinced that it's better than consoles selling for twice the price, we'll refund your money! Send for your FREE CARVIN 84 pg catalog today or include \$2 for 1st Class mail, \$5 Foreign. For an extensive overview of the MX1688 or MX1644, send \$7 ea for their 32 pg Operating/Service manuals. Refundable with purchase.

**MX1688**  
**\$2995**

# MX1644 Recording/Live Sound Mixer

16 x 4 x 2 with control room mixing

The MX1644 shares many of the advanced features and construction of the MX1688 but in a less expensive 4 out configuration. The 16 input channels of the MX1644 feature four band equalization, two monitor busses, two effects busses, 4 sub assign plus L & R assign, and a host of other features. The 4 main sub-outs can utilize the optional (\$200) nine band graphic equalizers (4) which can also be patched into the channels. The MX1644 comes with a studio quality Hammond reverb system. Compare the quality and price of the MX1644 and discover its value!

**MX1644**  
**\$1695**

### Product Information

TOLL FREE 800-854-2235  
Calif. 800-542-6070

# CARVIN

DeptMR-58, 1155 Industrial Ave.,  
Escondido, CA 92025

Free Catalog  1st Class \$2  MX1688  MX1644 Manuals \$7

Name \_\_\_\_\_  
Street \_\_\_\_\_  
City \_\_\_\_\_  
State \_\_\_\_\_  
Zip \_\_\_\_\_

MX-58

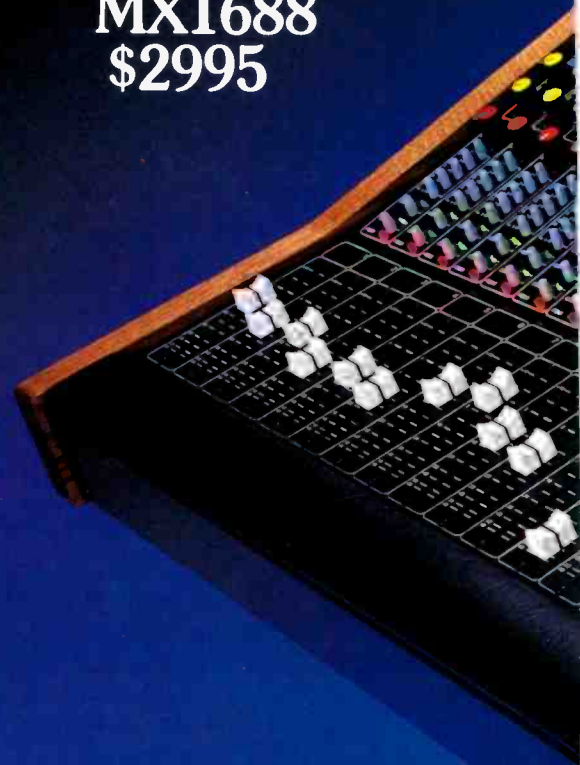





## MX1688

### Recording Features

- Eight Track Studio Control Center
- Input/Output Channel Organization
- Independent 8 Into 2 Monitor Mixer
- Four Auxiliary Busses w/ Pre/Post
- Three Band Parametric EQ w/ Defeat Switch
- Mute and Solo on all Input and Output Channels
- Two Effects Returns w/ Pan and Solo
- Talkback w/ Built-in Mic and Monitor Dimming
- Peak Warning Indicators w/ Peak Stretching
- Patch Points on all Channels
- Microphone Phantom Power
- Cue and Effects Sends from Output Channels
- Alternate Metering of Cue and Two-Track
- Quick Tape Playback Through Monitors
- Independent Mic and Line Preamps
- Studio Feed w/ Source Selection
- Totally Modular Internal Construction
- Input Noise of -127 dBv
- 50 dB headroom at All Stages
- +4 dB or -10 dB Operating Level
- T.H.I. less than .05%

### P.A. Features

- Eight Sub-Groups w/ Solo and Mute
- Four Independent Monitor Mixes Available
- Headphone Monitoring of Main or Monitor
- Talkback to Monitors
- 11 Step Gain Controls for Easy Set-Up
- Channels Assignable to L & R Stereo Output

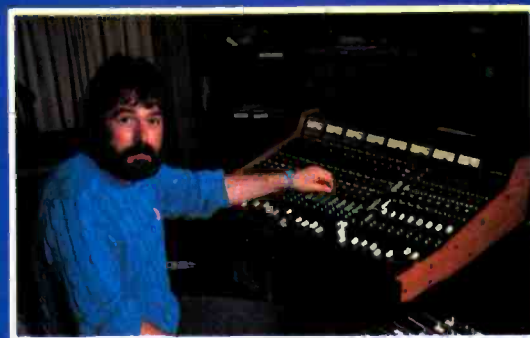

"The flexibility of the effects and clean layout of the MX1688 allows creative control, usually found only in desks selling at over twice the price I'm very impressed!"

— Peter McIn, Producer for Men at Work

Circle 25 on Reader Service Card

**JD:** I think in general, though, rather than try to make live sound like the studio, the trick is to try to make the studio sound like you're live. You have so much technology to wade through before it actually becomes a vinyl record. Half the time it sounds like it doesn't sound like there are musicians together in a room playing music.

**BZ:** Like I said, modern recording techniques put this wall of progress in between the band and the listener. You have to get through that.

**MR&M:** D.J. (Bonebrake, the drummer) has a marching snare that isn't used too much by other bands. It gives you a much rougher sound.

**BZ:** The marching snare? It sounds good. It's deeper.

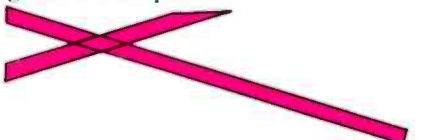

**JD:** We recorded it pretty much just like any other snare. It's just the sound, the sound of the instrument is different. It's like if you used a jazz bass or a Rickenbacker. The instrument just sounds different.

**MR&M:** Do you ever stack tracks? Like first D.J., then John and then Billy.

**BZ:** No, it's all done at the same time, just like live.

**JD:** We've never stacked tracks in that way. First of all, I never think we'd know where we were in the song if there wasn't a scratch vocal and if it wasn't everyone doing it together. In that way it sounds like a song.

**BZ:** On "Devil Doll" and "Hot House" I did the solos live. Just did it.

**MR&M:** You (Billy) have a Gretsch Silver Jet guitar. Is it stock?

**BZ:** Yeah, got a pair of them. They sound great.

**MR&M:** Has the band ever thought of using synthesizers in future projects?

**JD:** Actually, we used a synthesizer on our first record. It's on "Sex and Dying in High Society."

**BZ:** Yeah, there's four notes. Four notes in each chorus.

**JD:** But, no. Until you can really understand an instrument well enough to be able to know all its capabilities, I don't think you should use it until you spend enough time to do that. And really, I haven't heard too many synthesizers that have as warm a sound as say an organ would. I think the organs were made to replace orchestras. That's why they

have flutes and clarinets and oboes. I would like to use more of *them* again.

**BZ:** Synthesizers were made for people who wanted to play music but didn't have enough talent to learn how to play an instrument.

**JD:** It's easy to make sounds and then program them and re-program them to make the sound keep repeating. Then if you repeat something long enough, it begins to get a groove by itself.

**MR&M:** Have you people had any offers to produce someone else?

**BZ:** I've done some producing.

**MR&M:** For whom?

**BZ:** I've produced some cuts for a rockabilly band from L.A. called the Red Devils and I've been working with another L.A. band called the D-I's, making a demo tape and trying to get a deal going. I think we're going to do a single when I get back.

**MR&M:** Are you looking forward to that?

**BZ:** Yeah. I like that... I like being a producer, lending whatever knowledge I've gained along the way to a new band. I just try to help them get their sound down.

**MR&M:** John, the harmonies you do with Exene are very distinctive, particularly in today's music. How do you work on that?

**JD:** Just sing. It's natural. That's just the way that we sing together. A lot of it comes from Exene not going through the typical playing-bar-bands-doing-cover-songs-learning-music sort of thing. We got together and she just started singing. As time goes on, you learn how to control your instrument better. But she wasn't aware of your standard third or fifth harmonies. She would sing something that would fit. Then I do the same thing.

**MR&M:** Are there any other instruments, other than guitar, bass, drum, organ and the ones we've discussed, that are on your songs?

**JD:** There's a real slick marimba on "Come Back To Me" that you can't hear that well. You can hear it a little bit, but it's not really present.

**MR&M:** Who plays them?

**JD:** D.J.

**BZ:** There are vibes on "Riding with Mary," on the album, and also a '56 Ford car horn.

**MR&M:** Is that your car?

**BZ:** No, it's John's. But it was the weirdest thing though. It's on key. It's the right note, real strange. It just happened. We stuck a mic down on the street on a rainy day. John was driving around the block to get the

sound of the tires on a wet pavement and he honked his horn and it was on key. You get a nice Doppler Effect when it trails off. It's real neat.

**MR&M:** Are your songs written before you go into the studio?

**BZ:** They're all written before, rehearsed before, and arranged before.

**JD:** Except on the ones where there are some overdubs and things that you don't figure on. On "Come Back to Me," where Billy did the sax, we couldn't have him play the sax and guitar at the same time, so we just had to make it up as we went along. "True Love Pt. #2" was sort of put together in the studio.

**MR&M:** When things are made up in the studio, that may lead to certain disagreements among the band members. Having four members, how do you resolve them? Is that where Ray steps in?

**BZ:** Yeah. We have a democracy of four, so that's one of Ray's minor roles. He gets the deciding vote. We have discussions. We don't try to strangle one another.

**MR&M:** What kind of amp do you use Billy?

**BZ:** I've got a Fender quad reverb with four Celestion G-12-80s. I've rewired the phase-inverter circuit and boosted the gain all through the amp and put bigger bypass caps on the cathodes all the way through, basically to get a little more balls. Just a few other things here and there.

**MR&M:** Where did you pick up the skills to do that?

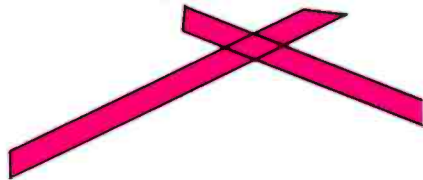

**BZ:** I was an electronics tech when we started the band. That's what I was doing to support my music habit. In the studio I use several amps, a '63 Fender Bassman with a pair of Celestion 12's, a Trainer 50 watt tube bass amp with a homemade 410 cabinet and a '60 Fender Concert amp with 810's that have been hot-rodded up to about 115 watts.

**MR&M:** Is there anything that you two would like to talk about that we haven't yet?

**JD:** Direct to disc was probably a better idea.

**BZ:** Direct to disc is high-tech. I think recording it live on a full-track was a bad idea in one room.

*Like they said, democracy in action.*

# Updated Recording Studio Handbook

A must for every working professional... student... audio enthusiast

Features latest state-of-the art technology of creative sound recording.

## 21 Fact-Filled Chapters

- I. The Basics
  1. The Decibel
  2. Sound
- II. Transducers: Microphones and Loudspeakers
  3. Microphone Design
  4. Microphone Technique
  5. Loudspeakers
- III. Signal Processing Devices
  6. Echo and Reverberation
  7. Equalizers
  8. Compressors, Limiters and Expanders
  9. Flanging and Phasing
- IV. Magnetic Recording
  10. Tape and Tape Recorder Fundamentals
  11. Magnetic Recording Tape
  12. The Tape Recorder
- V. Noise and Noise Reduction
  13. Tape Recorder Alignment
  14. Noise and Noise Reduction Principles
15. Studio Noise Reduction Systems
- VI. Recording Consoles
  16. The Modern Recording Studio Console
- VII. Recording Techniques
  17. The Recording Session
  18. The Mixdown Session
- Three all-new Chapters
  19. The In-Line Recording Studio Console  
(The I/O Module. The Basic In-line Recording Console. Signal flow details.)
  20. An Introduction to Digital Audio  
(Digital Design Basics. Digital Recording and Playback. Error Detection and Correction. Editing Digital Tapes.)
  21. Time Code Implementation  
(The SMPTE Time Code. Time-Code Structure. Time-Code Hardware.)



**\$39.50**

The *Recording Studio Handbook* is an indispensable guide with something in it for everybody. It covers the basics beautifully. It provides in-depth insight into common situations and problems encountered by the professional engineer. It offers clear, practical explanations on a proliferation of new devices. **And now it has been expanded with three all-new chapters... chapters on the in-line recording studio console, digital audio and time code implementation.**

### Sixth printing of industry's "first" complete handbook

The *Recording Studio Handbook* has been so widely read that we've had to go into a sixth printing to keep up with demand (over 30,000 copies now in print). Because it contains a wealth of data on every major facet of recording technology, it is invaluable for anyone interested in the current state of the recording art. (It has been selected as a textbook by several universities for their audio training program.)

### Highly Acclaimed

Naturally, we love our book. But don't take our word for it. Here's what others have to say:

"John Woram has filled a gaping hole in the audio literature. This is a very fine book... I recommend it highly." *High Fidelity*

"A very useful guide for anyone seriously concerned with the magnetic recording of sound." *Journal of the Audio Engineering Society*

### 15-Day Money-Back Guarantee

When you order *The Recording Studio Handbook* there's absolutely no risk involved. Check it out for 15 days. If you decide it doesn't measure up to your expectations, simply send it back and we'll gladly refund your money.

### Easy to Order

You can enclose a check with your order or charge it to Master Charge or BankAmericard/Visa. Use the coupon below to order your copies of the new updated *Recording Studio Handbook* (\$39.50).

### ELAR PUBLISHING COMPANY, INC.

1120 Old Country Road, Plainview, N.Y. 11803

Yes! Please send \_\_\_\_\_ copies of THE RECORDING STUDIO HANDBOOK. \$39.50. On 15-day approval.

Name \_\_\_\_\_

Address \_\_\_\_\_

City/State/Zip \_\_\_\_\_

Total payment enclosed \$ \_\_\_\_\_  
(In N.Y.S. add appropriate sales tax)

Please charge my  Master Charge  
 BankAmericard/Visa

Account # \_\_\_\_\_ Exp. date \_\_\_\_\_

Signature \_\_\_\_\_

(changes not valid unless signed)

Outside U.S.A. add \$2.00 for postage.

Checks must be in U.S. funds drawn on a U.S. bank.

**RAY**



**MANZAREK**

As former keyboardist and founding member of the Doors—one of the most influential rock 'n' roll groups of the formulative and turbulent '60s—Ray Manzarek's reputation precedes him as a manical rock 'n' roller. Some 20 years later, Doors records continue to reap laudable sales as they are discovered by each new generation of rock fans. A newly-released LP, *Alive She Cried* (Elektra)—containing previously unreleased, live Doors material—will undoubtedly garner even more listeners. Parasitic films such as the recent *Eddie and the Cruisers* keep alive speculation on whether Jim Morrison is truly dead or whether he's residing in Africa in obscurity. What did occur in Miami? What happened to the lost tapes—now found and used on the aforementioned Elektra release—which contained rare footage of the Doors live in concert at the Aquarius Theatre in Hollywood?

Therefore, it came as a surprise when Manzarek's most recent solo endeavor was a jazz/rock interpretation of a classical cantata, written in 1935 by the late German composer, Carl Orff. The cantata, *Carmina Burana* (A&M), was originally based on the poetry of 13th century "drop-out" Latin monks, who left the Medieval clergy to roam the countryside drinking and enjoying the pleasures of the flesh that had been forbidden in the celibate, cloistered life of the monastery. Orff transformed the writings into invocations and profane chants, accompanied by instrumentation and magical representations.

Manzarek believes, however, that this should come as no surprise whatsoever. According to him, the monks were expressing the same thing that Morrison and the Doors were expressing in the '60s and what he's expressing today; the meaning of being alive and the pleasure of the moment and life. Working with renowned composer Philip Glass, Manzarek contemporized the piece for the 1980s.

Musically, the emotionally stirring quality of the dark and haunting piece is primarily attributable to its minor overtures, which are readily apparent in Manzarek's keyboard style, in the Doors' music, in the blues that so heavily influenced Manzarek while growing up on the south side of Chicago, and in the Polish/Russian music that is part of Manzarek's Slavic roots. The emotion of the human voice was treated as an instrument rather than a vocal performance.

Manzarek took the time to speak with *MR&M* in his living room in the hills overlooking Hollywood. He discussed his solo work, working with Glass, who his audience is, his time with the Doors, his friendship with Jim Morrison, his work as record producer of the critically-acclaimed underground rock group X, and his outlook on life.

Technology changes. That's what changes. The monks who wrote this stuff in the 13th century were writing about the same sort of thing that we're writing about today and that Morrison was writing about in the '60s. It's the same kind of revelry—drunken revelry, just reveling in life; love, sex, drinking, wandering, springtime, drinking. It was the same back then, the same in the '60s and it's the same today.

**Modern Recording & Music:** Your newly released solo album, *Carmina Burana*, doesn't seem like it was undertaken as a commercial venture, but as an artistic endeavor.

**Ray Manzarek:** It isn't a party album, no. But you can still dance to it. I figure it will take a while for people to get used to it and get into it. But the piece itself has a long life. It has been performed repeatedly since 1937. And I think my interpretation of it will have a long life as well. I really don't know what commercial is. What is commercial? To me, commercial is something that a lot of people like. If a lot of people like it and buy the record, it's commercial. If a few people buy it, then it's not commercial. If people like it is the important thing. I would like a lot of people to like it, but if only a small group of people like it, that's okay too. I enjoyed doing it. I really enjoyed doing it. It was lots and lots of fun. Philip Glass was great to work with. All the guys on the record are really good musicians, engineers and producers. First and foremost, the person making the record has to have a good time doing it. Then hopefully the people hearing the record will also have a good time listening to it. That's what I'm hoping for.

**MR&M:** Don't you think that an interpretation—even a jazz/rock interpretation—of a classical cantata will put a few rock fans, in particular Doors' fans, into culture shock?

**RM:** Let's hope so. But I don't think that this is a cultural piece. I think this is an apocalyptic piece. I think this is a piece of music for the end of the world. I think rock fans—in particular heavy metal people—can really get behind this record and understand it. I think they can understand the power of it. When I made this record, I didn't want to exclude anybody or do any kind of big-deal intellectual trip. This music is for the end of the world, the apocalypse. These are the sounds you will hear when the apocalypse comes.

**MR&M:** So, you're comparing the dark underworld of the monks in the 13th century to the dark underworld of rock 'n' roll?

**RM:** Yes, exactly! Exactly. That's perfect. That's exactly what's going on. It's representative of the dark underside where all the devils and demons live, but also where the power to create is and where the power of the planet to create life is. Life comes out of the mud, out of the ooze and the muck. That's where life comes from. You inject electricity into the muck and life forms. That's the dark underside. *Carmina Burana* and rock 'n' roll represent the same thing. Ozzy Osbourne is the dark side, a little overly theatrical, but nonetheless the dark side. He's been wallowing in the mire for some time now, so he could use a little sunlight in those dark corners.

**MR&M:** So, rather than evolving,

art moves in a circular pattern, always returning to the same basic premises?

**RM:** Circular, circular. The first cut on the album is called "Wheel of Fortune," and that's what happens. Things go around. They don't go in a straight line. They go around and then they disappear for a while, but they come back. Around and around.

**MR&M:** So art never changes.

**RM:** Technology changes. That's what changes. The monks who wrote this stuff in the 13th century were writing about the same sort of thing that we're writing about today and that Morrison was writing about in the '60s. It's the same kind of revelry—drunken revelry, just reveling in life; love, sex, drinking, wandering, springtime, drinking. It was the same back then, the same in the '60s and it's the same today. The only thing that has changed is that we now have tape recorders and electric lights and a television set. You can have this printed in a newspaper. Back then, it was all done by hand and that's all they had. Technology changes, but the needs of humanity don't.

**MR&M:** You've mentioned "the power" of *Carmina Burana*? What is that power?

**RM:** The spiritual power, not in a religious sense, but meaning the power of the spirit; the spirit that animates your body... the soul, if you want. It's what leaves your body when you die. If somebody dies, the body is there, but the spirit—the power—has left that body. And it's the power of all creation, the spirit of all creation.

**MR&M:** Is *Carmina Burana* your legacy?

**RM:** I don't know exactly what to tell you. The moment is infinite, but the moment is the moment. Pleasures of the flesh are so immediate. It's the only thing that exists, but at one in the same time it's lasting. Life is immediate and infinite. Not being concerned with what's going to happen to you. We all have things we have to take care of, but living is for the moment. It's exactly the same thing that Morrison was talking about. This is like Doors' music; living for the moment and for the here and now. Just really living life to the fullest, enjoying it here and now.

**MR&M:** That's what it touched in you?

**RM:** Yeah. I've always wanted to do the piece. I've enjoyed it for a long time and I came to the conclusion that

I would do it two or three years ago. I got the music and was sitting at the piano reading it and I thought, "Gee, this is perfect. This rocks out. This is classical music, but it rocks out. It can be done with drums, bass, electric guitar and synthesizers with an entire chorus on top of it." I did the entire symphonic part electronically, generated by synthesizers.

**MR&M:** Are listeners ready for this?

**RM:** They're ready for it. They *are* ready for it.

**MR&M:** But is radio programming ready for it?

**RM:** Radio programming is almost ready for it. The more adventuresome radio programmers—certainly KNEC [Los Angeles] and others like them—are ready for it. KMET [Los Angeles] and KLOS [Los Angeles] need it. They need to find a direction for a little bit more mature person who still enjoys listening to rock 'n' roll. If they turn their backs on this and say, "No, no, no. We can't play this," then they're turning their backs on their adulthood. But it's also music for kids, because the kids are going to get off on this. They're open to a lot of things. They know the apocalypse is coming. They know that the shit might hit the fan at any moment now.

**MR&M:** You certainly seem to have a pessimistic outlook on life.

**RM:** No, no, no! Don't put me down as a pessimist—negative. I'm not a pessimist. Don't say that Ray has a pessimistic, gloomy outlook on life. I don't want to read that. No! It's coming, but it doesn't have to happen. But I'll tell you that the only way to stop it from coming is to dance madly, to dance wildly and to celebrate life, to go into drunken orgies of wild celebrations of life. And what could be more fun? What could be more fun than having a real orgiastic wild celebration. And not in a negative, sexual sense. "Oh, Manzarek wants orgies..." Well, yeah, Manzarek *does* want orgies. Exactly. Yeah, right. I want big, joyous, in-touch-with-the-earth orgiastic drinking and love-making. I think we could use a lot more of that, especially in America. If we could just get that kind of action going in America and Russia, I think everything would be just fine.

**MR&M:** The Doors' approach—as well as your own approach—to music is extremely intense and serious. Yet people are so caught up in the vicarious thrills of speculating on such matters as whether or not Jim

Morrison is alive and well in Africa. Movies like the recently released *Eddie and the Cruisers* overtly make reference to that legend. Does that superficiality bother you when you're putting so much of your soul into the music?

**RM:** As Jim always said, "Just listen to my words. Just listen to my words." Naturally, people are going to be attracted to Morrison's persona. I can't fault them for that. What happened in Miami? Is he really dead? Did he disappear? Those are sensational aspects of the guy's life. It all happened and it's fine if you're intrigued with that. But you really ought to know what he was talking about, what the words are about. I can't fault people, but I wish they would get into the music and the words, so they could get into the reality of being alive, to being on this planet. I think it's a hell of a lot more important for them to get into realizing what the power is that makes a tree grow. They may say, "Who cares man? I don't care what makes trees grow." Well, you had better care about that, because that same power that makes a tree grow is the power that animates me and you. So, there's a lot more to life than *Eddie and the Cruisers*.

**MR&M:** I suppose that most people are just sad that he died so young and wish they could resurrect his creativeness through fantasy.

**RM:** He lived a very, very full life. It's the intensity with which you live your life that's important. People could live for 85 years and it's all mashed potatoes and marshmallows. Yuck. Who cares? You've got to grab life and live it; live it fully, madly, wildly and fall in love with it. I'm not promoting angel dust madness, that's just "kookooness." [What] I'm talking about [is] a heightened state of consciousness through intoxication and being madly in love with life. That's what it's about.

**MR&M:** Do you miss the craziness of your days with the Doors?

**RM:** No. I didn't particularly like the craziness while it was going on and I certainly don't miss it now. What I do miss is the intensity of performing with Jim Morrison, John Densmore and Robby Krieger. The kookooness was peripheral stuff that nobody really liked. It's part of the game, but it's certainly not what you play the game for. We played the game to be able to get on stage and play our music and to get into a recording studio and play our music

and have people appreciate our music. It got to the point where people in the audience were having the same kind of emotional experience that we were having on stage. We had this real communion of soul and spirit that was locked into the music. That's the part that I miss.

**MR&M:** One of your other projects has been producing X. Why did you get involved with X? Is that same substance in their music?

**RM:** They believe in their music. They believe that what they say matters. They believe that it isn't *just* entertainment. It is entertaining, but it isn't *just* entertainment. What they are saying the way they're playing means something to them and they want it to mean something to the audience. They're talking about life. They're talking about being alive. They're talking about exactly the same thing that the monks were talking about, that *Carmina Burana* is talking about, and that Morrison was talking about. We're all talking about the same thing—about being alive.

**MR&M:** What do you add to their sound?

**RM:** I'm just sort of a quality control in the studio. I make sure that everything runs right and smoothly. I just try to get the best performance out of them that I can. They're really a wonderfully self-contained group and have it all together. As a matter of fact, as much as I enjoy working with them, they've got it down so well that they could produce their next album themselves. Billy Zoom is going to be a big producer some day. He's really wonderful in the studio and knows what he's doing. I can see him taking the reins. Billy is also totally on top of his instrument. I don't really have that much to do. I just get the best possible sound. X pretty much knows what they want to do. I'm just their ultimate cheerleader.

**MR&M:** Back to *Carmina Burana* for a moment. Was it difficult to translate a classical cantata into a jazz/rock interpretation of the piece?

**RM:** Oh sure, it starts off easy, but then—if you do the entire piece—you find places that get a little tricky and you have to negotiate the turns... piece number seven and things like that. Some time signatures are more complex to fit together within a contemporary rock 'n' roll framework. Figuring out how to put the drum kit behind some of the songs became a little tricky sometimes. But for the

most part we were pretty faithful to what Carl Orff put down on paper. We're playing Carl Orff's music and just electrifying it...electrocuting it, perhaps.

**MR&M:** What do you think Carl Orff would have thought of your interpretation?

**RM:** I think Carl would really be behind it. Unfortunately, he passed on about a year and a half ago. But I think he'd be right with us. He'd understand it. He intended it to be a big and powerful piece. The fact that we've taken it and made it into 1980's music—while continuing that whole Gregorian chant tradition that he set up—I think he'd love it. I think it would get him very, very excited. It would probably get him up and dancing.

**MR&M:** Since the lyrics were done in Latin—or Gregorian chant—it seems as if the chorus was treated like a melodic instrument, rather than a vocal.

**RM:** Yes, exactly. The voices should be treated as a melodic instrument. The voices are playing the melody. They're singing the melody in Latin, but it wouldn't really matter what language they were singing in. They could sing it in any language. It's just the power of the human voice. With 20 people—sopranos, altos, baritones and tenors—you're getting the full range of the human voice; high women, low men and everything in between. That's really strong and powerful. It has a lot of emotion to it. The Latin lyrics are something you shouldn't even pay attention to. It's the power of the voice that's important. You can read the translation if you want to get into that side of it. The lyrics also have something to say. But I think it's just a matter of letting the music and the sound wash over you.

**MR&M:** What is the significance of the Gregorian chants?

**RM:** I don't think they have anything to do with the album (laughs). You don't need to know anything about Gregorian chants to enjoy *Carmina Burana*. Gregorian chants don't mean anything to this album. On the other hand, they have a whole bunch to do with it. But that's something for you to go out and buy a couple of Gregorian chant records and to go to the library and pull out a couple of books if you're really interested (laughs).

**MR&M:** There is a striking similarity—such as the music's tendency to be done primarily in a minor

overture—between Doors' music and *Carmina Burana*.

**RM:** Doors' music is minor as opposed to a lot of major. The Doors worked in major and minor. But you can hear a kind of moodiness in *Carmina Burana*. The same moodiness that exists in Doors' music; pulsating rhythms, the same rhythmic sense of punching four—one, two, three, four—pulsating rhythm having to do with the flow of blood in the body and the pumping of the human heart.

**MR&M:** How did you get hooked up with Philip Glass?

**RM:** We made a demo tape of three or four songs and they were sent around. Somebody at RCA Records in New York heard them—Nancy Jeffries, the wife of Kurt Munkacsi. Kurt Munkacsi and Philip Glass are co-producers of the album. They've been working together for the last decade. Nancy gave it to Kurt and said, "Listen to this." Kurt listened to it and took it to Philip and the two of them decided to do it. They came to Los Angeles to finish up the soundtrack for the Francis Ford Coppola movie, *Koyaanisqatsi*, and while they were in town, they came over here. They thought the music was great and wanted to be involved. So I said, "Wonderful. You've got it. You're just the kind of people I want to work with." After we decided to work together, Jerry Moss, over at A&M Records, said he wanted us to do the record on A&M. We said, "Great, let's go."

**MR&M:** Did it take a long time to record?

**RM:** It took a while to put together. We started recording last year, during the first week in December. This is a winter project and it's appropriate that it's coming out now. That's where this music belongs. Anyway, between Philip's schedule and my schedule, it took us almost a year to complete. We did some of it in L.A. and some of it in New York. We went back and forth, back and forth. Time added up and so did the expenses, unfortunately.

**MR&M:** Was your studio approach to *Carmina Burana* similar to the approach you took to recording with the Doors and in your other solo work?

**RM:** Different...much different. There was a lot of overdubbing on this, because each part had to be added separately; the string parts, the horn parts, etc. Our basic track was put down with piano, drums, bass and guitar. Then we just started layering on everything after that; all the solos and singing. So it took a lot more time to do it that way, as opposed to making an X record or some of the early Doors records. But basically, the recording technique used to make any record is pretty much the same. You have 24 tracks, you put the songs down and you mix it up.

**MR&M:** Did you have any formal training?

**RM:** Yes. I attended the Chicago Conservatory of Music. I studied with various teachers in Chicago; Bach and two-part inventions, although classical music really didn't hold that much of an interest for me while growing up on the southside of Chicago. The area was blues and rock 'n' roll. When I first heard Muddy Waters, Jimmy Reed, Johnny Lee Hooker and Howlin' Wolf, they just killed me...just killed me. It really touched something deep inside of me. It had a minor overtone, which was the black man singing the blues. The minor overtones of that music probably struck some Slavic core in me. It's the same kind of minor sense as in Polish/Russian music. It almost has a weeping quality to it. Well, black music had that same kind of weeping quality, yet it also had a rhythmic sense, an African sense of rhythm. Nothing mattered if it didn't have a strong rhythmic foundation. Gosh, when I heard that stuff on the radio, I was knocked out by it. That's what turned me from just playing regular piano into the rock 'n' roll crazed, maniacal person that I am today.

**MR&M:** Can you describe your playing style?

**RM:** No, I can't. But I'll try. When I sit down at the piano, it's me. What I do is all the things that come out of my background. It's certainly blues piano and Bill Evans-influenced jazz piano. The piano player—I don't



know what his name is—who played keyboards behind Chuck Berry on “Johnny B. Goode” and “Roll Over Beethoven” was very important to me. Jerry Lee Lewis and his piano style and Little Richard and his da-da-da-da piano. All my classical studies; doing my little Bach two-part inventions, Romanoff and Tchaikovsky. All that together makes up me. My Slavic background, Polish ancestry, growing up on the south side of Chicago with black blues and being exposed to psychedelic Venice Beach in Los Angeles. When I play, that’s what I’m playing.

**MR&M:** What are your weaknesses and strengths as a musician?

**RM:** My weakness is that I don’t do my exercises enough. No one ever practices enough. I feel that my strength is that I have a good intuition; a well-developed feminine side to my personality. I’m not afraid to be a woman or a man. Femininity touches both sides, my psyche and my psychological makeup. So I’m pretty intuitive... which I use as an excuse not to practice (laughs).

**MR&M:** What keyboards did you use to record *Carmina Burana*?

**RM:** A Steinway grand piano, a nine-foot concert grand; a Prophet, an OBX; an Emulator; a Fender Rhodes; a Hammond organ, and a tiny little toy synthesizer that Adam Holzman—the other keyboard player—picked up somewhere. I don’t know where he picked up that damn thing, probably at a dime store. But we plugged that thing in and it sounded great too.

**MR&M:** Did any of the synthesizers serve as a primary instrument?

**RM:** No. We mixed it all up. Sometimes the Prophet would handle it, sometimes the OBX and sometimes the Emulator. We would switch around between those three. The Emulator—since it is actual sounds stored on a floppy disc—did a real nice job on the trombones, for instance. But string sounds can be obtained on pretty much anything. Sometimes we would mix all three of them together for string sounds. I like to use as many keyboards as possible, since we were doing orchestrations. Michael Reisman did a lot of that. He was sitting there with the orchestral scoring; we had the basic track, we had our singers and some solos that were necessary and then we started putting on the orchestral parts. We looked at the string parts and examined the violins, cello and bass. We figured out what the string

parts were doing, which instrument would best approximate the sound of that instrument and whether or not we needed particular parts. Sometimes, we would just use the violins and eliminate the cello. Then we did the horns. Sometimes we’d use a combination of the Emulator playing the trombone part and the Prophet or the OBX for the trumpet sound. Sometimes we would just make up sounds and not really try to approximate the instruments. That was a great deal of fun. That’s a great way to work.

**MR&M:** Were you reveling in the studio?

**RM:** We were really drinking, wenching and recording.

**MR&M:** What boards were you using?

**RM:** We used a Trident board over at A&M to record and mixed on a Neve Necam automated system over at Capital here in Los Angeles. That was wonderful. We had UREI time-align™ speakers. We also used Yamaha MS10s, just because they are small. They were actually a little bit too edgy for me. You have to paper off the cone a little bit to keep some of the brightness down. We had Studer machines. We also recorded at Greene St. studio in New York. They had the Fents Jazz band come into the studio. John “Bev” Jones and Joe Chiccarelli were the engineers. The machines at both A&M and Greene St. were MCI and both places had Trident boards. That’s why we recorded at Greene St. We were able to keep the same boards and tape machines. Then we mixed it on the Necam.

**MR&M:** Any special effects?

**RM:** Not really. We used live echo chambers. That’s one of the reasons we worked over at Capitol, because they have some live echo chambers. Rather than plate, we put the voices into the live echo chambers. We had two tracks of voices and sent them off into the live chamber and that was real nice. Just light noise generators on the snare. Pretty much regular stuff. I mean, the piece is so big that it didn’t need a hell of a lot of fleshing out.

**MR&M:** Are you going to tour?

**RM:** I don’t know. We might. It’s such a big piece that it would be hard to take on the road. And damned

expensive. That’s why we’re going to do a video opera instead. It’s in the works. The script is by Louis Valdez. Zoot Suit and Kit Fitzgerald will do the videography. I think it will be very, very exciting and a real trip. We want to expand the boundaries of rock videos. In the meantime—since that will take another six months to put together—we’re going to release a single—a three-and-a-half minute rock video for MTV, Nite Flite, MV-3 and all the other places that show short videos.

**MR&M:** Will you be able to catch the tone of the album in three-and-a-half minutes?

**RM:** Well, we’ll capture a portion of it. You’ll get a wham bam trip through heaven and hell (laughs).

**MR&M:** Do you really feel that your audience is limited to heavy metal fans?

**RM:** I would think that this album is ideal for anyone in the 28-on-up age bracket; people who were around in the ‘60s or early ‘70s. I think that a lot of them kind of outgrew rock ‘n’ roll, and this album is perfect for all those people. I hope that the 28-to-45-year-old age bracket—people who still like music, but don’t really find themselves hearing a lot to like in rock ‘n’ roll—are going to hear *Carmina Burana* and say, “Yeah, that’s the kind of music I like.” I’m from that generation. I was there in the ‘60s and this is the kind of music that I, Ray Manzarek, personally like to listen to. This is my music, the kind of music that I want to make. Hopefully, other people from that era will plug into it. I also think young kids are going to get off on it in the apocalyptic sense. Heavy metal people will understand the end-of-the-world sound of this record. The older—I hate to call them older, but let’s face it, they’re older than 14—kids will also be able to get off on it. Because it has something else to it rather than just simple entertainment. You can dance to it, but this dancing means something. We can get down on the planet and dance. I think it’s going to cut across a wide area, certainly college students. I meant this album is ideal for college people. That is the gain market. People in college and graduating from college.

# STUART YOUNG

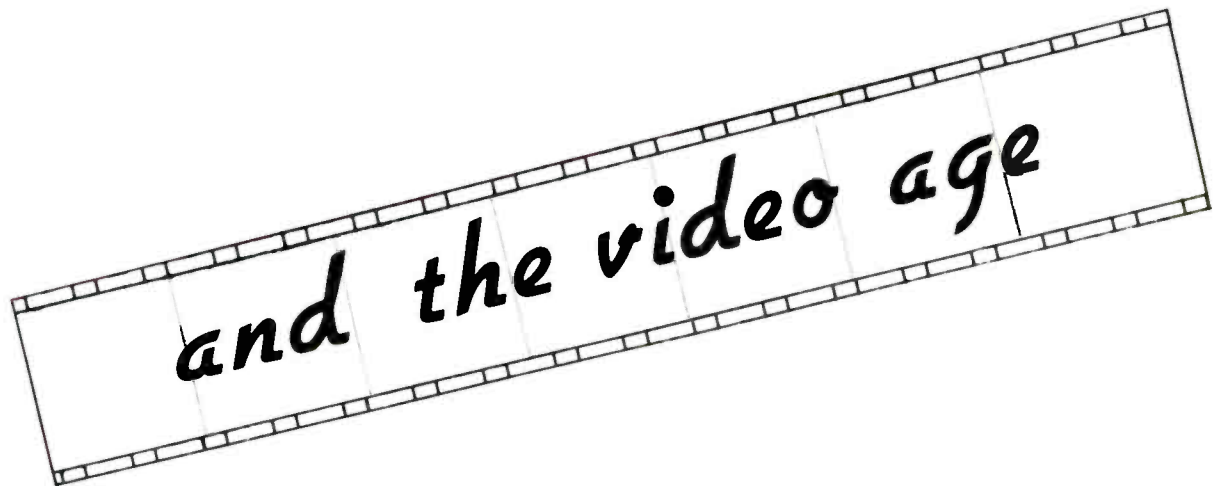

**W**hat color was to television and stereo is to radio, music video is to the leisure time entertainment industry," says Stuart Young of Telemusic Video, Inc.

Stuart Young is a young turk in a young industry—Music Video. Yet the 32 year old president of Telemusic is, at the same time, an old hand in the music and entertainment business. He has been in show business since he was a five year old, standing inches taller than the dummy he used in a magic and ventriloquism act.

At the ripe old age of 12, Young entered the music business. For 13 years he was a lead singer/rhythm guitarist in a rock 'n' roll band.

"I quit the business in 1973, when rock 'n' roll began to die," said the articulate graduate of Emerson College. "I was a film major and earned a degree in mass communications, so I looked for work in television."

He found it as an on-air host before the cameras, as well as behind the camera and in the editing bay. It was just a matter of time, luck, and a changing music industry before all these elements could be put together to form Telemusic, he says.

"Music video is the '80s twist on the talkies our grandparents watched. Today's music video speaks the language of one of the largest consumer groups in the world. Weaned on TV, computers, and video games, the 14 to 35 year olds are no longer satisfied with a simple audio experience. They want to be entertained with stimuli to their eyes as well as to their ears," said Young.

The business people in the music industry understand this, and the musicians had better grasp the idea if they want to be successful, Young warned. He analyzed the industry by looking back at recent history.

According to Young, the nature of the record business changed drastically with the introduction of The

Beatles and the so-called "British Invasion." This was the beginning of the end of theatrical soundtrack albums and easy listening music. It was also the beginning of the multi-billion dollar business of rock 'n' roll—with its tours, personal appearances and big buck contracts for the stars.

As Young sees it, rock 'n' roll became stagnant in the mid-'70s. The end of the post-war baby boom saw the beginning of record sale declines. The major record companies trimmed their executive and artist ranks. Tour money was tough to obtain. The show-biz atmosphere at the record companies was not-so-subtly changed into one of corporate board rooms. Big money was at stake and the accountants and comptrollers were determined to cut losses to a minimum.

Disco didn't help. It reflected the monotony of the '70s, and though it made money for a short while, it never lived up to industry expectations, says Young.

## Get Ahead of the Gang



Whether you're faced with a monumental decision—or a routine one—the free Consumer Information Catalog can offer concrete advice.

There are more than 200 government booklets listed in the Catalog. And they can help you... improve your job, health, or financial profile... start a business or a car... plan a house or a diet. And many of these booklets are free.

So order your free Catalog today. Any way you look at it, you'll be head and shoulders above the crowd. Just send your name and address to:

**Consumer  
Information Center  
Dept. MR  
Pueblo, Colorado  
81009**

Record company executives began searching for a "new" sound. They came to realize that the new phase of music had more to do with sight than with sound. The "new" music led them right back to the original roots of rock 'n' roll.

Radio stations, however, weren't playing the new artists. So the record companies needed new ways to promote records. Cable television offered one possibility.

In August, 1981, Warner Amex Satellite Entertainment Corporation created MTV—the world's first video music channel. Costing more than \$20 million to start up and targeted for the 12-34 age group, MTV is seen 24 hours a day, seven days a week by more than 12 million viewers.

The troubled record industry, says Young, sees music video as the most promising marketing tool to come along since FM rock stations. The cable industry, concerned about the high costs of wiring homes, sees MTV as different and financially viable programming. And, advertisers—more than 125 companies representing some 200 products—see music video as a way to reach a pinpointed, specific audience of young people with money, Young's research revealed.

Even free television has used music video, on syndicated and network music programs as well as talk shows. But music on free or cable TV is not the whole story. One company started packaging videos by the same performer on 10 to 15 minute videocassettes and is selling them in stores as video 45s. In the future they may produce and package full length video LP formats.

The distribution channels for music video are wide open—hotels, motels, ski resorts, luxury ocean liners, lumber camps, military installations, standing bars, hospitals, prisons—indeed any place a videocassette recorder can be installed.

One theatre pub in West Hollywood, The Revolver, invested about \$100,000 in equipment and runs videos 12 to 14 hours a day. The nine-outlet Southern California restaurant/nightclub chain, Red Onion, plans a quarter of a million dollar investment in the hardware to play music videos.

All of these facts point to one thing: Musicians serious about the business will have to think video. Without video, Young says, it will be tough to get club dates or a record contract.

The record industry underwrites most of the videos seen on television; the television stations get them free. With the exception of several hour-long documentaries or video tapes of rock concerts, rock-video clips are song-length blends of rock music and visual images. Some have plots and are known as concept videos; others are more like concert performances of the song. They can be expensive. The average cost is \$30,000 for a three-minute tape.

Once you make it in the industry, says Young, you may want a video costing much more. Michael Jackson's tape of "Beat It," for example, is said to cost six figures. But for the new group who needs a video to show the record companies or club owner, Telemusic Video has a package that costs about \$2,000.

"We're able to do a professional video for that price because we expect them to do their homework... to know what look they are after," commented Young.

Telemusic's package consists of four hours of studio time during which time one song will be taped onto a ¾-inch videocassette, using one camera. The tape will be edited and checked for quality before the group gets it.

Included in the four hours is at least one hour for consulting. Record companies take several considerations into account before committing to video. The most important consideration is the musician or group itself. Some musicians are not ready for video and should wait for a higher level of sophistication and technique in their live presentations. As a matter of fact, Young has advised some that they are not ready.

"We use well-trained professional video people to prepare our videos. All are on our staff and all work at the production facilities that belong to the corporation. Most important to our musician client is that our video people have been working with non-video people for quite a while," noted Young.

There are several important "dos" Young lists in order for musicians to be ready to video tape. The first, and probably most important, is to decide on a "look." This will help determine whether a concept tape or a literal tape should be shot. Devo has a space-age look; the Stray Cats, a rockabilly fifties look; Prince's look is out of Liberace.

Once the "look" is established, the next step is to pick a song that fits the look, *but is commercial*. The video is, after all, an attempt to sell the group to a club owner or record company. In these days of tight money, the record companies take few chances with newcomers.

Check the television to see what is working. Analyze what other artists are doing. Then ask yourself if it will work for you. Don't look only at MTV for this; check the smaller local, independent stations as well.

Come prepared, with your music and moves down pat. Expensive taping time is no time for rehearsals or blocking moves. Many of the groups that come to Telemusic brings an audio tape of the song they will perform. This "best sound" tape is then lip-synched along with the video. The result is excellent audio without the costly problems of retakes.

With tape in hand, the musician is ready to look for work and get exposure on music television, says Young. Without tape in hand, be prepared to sell guitar strings or someone else's record.

*Editor's Note: In an upcoming issue, author Gilbert Elliot and Stuart Young will return to take us through an actual shoot.*

# Studio Notebook

**F**ree at last! After a long siege as the prisoner of the 'Design-A-Studio' Contest entries, it's finally time to begin announcing the winners of the competition. Modern Recording & Music managing editor Ricki Zide was so happy to hear of my safe release that she told me that she was only going to dock me half of my check for the time I missed. What a gal!

Picking winners from all the entries received proved to be no easy task since we were sent dozens of outstanding studio designs that displayed obvious hours of careful research and attention to detail. With the consistent high quality of the designs submitted, there's no doubt in my mind that I'd be delighted and proud to have many of MR&M's readers plan and build a studio for me anytime. My hat is off to all of you.

For any new readers of our magazine, let's drift back to the April '83 issue of these holy pages and briefly review the ground rules of our contest. We got things rolling by providing you with a choice of a sample basement, garage and free-standing building layout from which to start, using only the basic exterior dimensions for each plan. Other than sticking a furnace and stairway in the basement layout, all three plans were left pretty wide open for you to determine wall placement, ceiling design, and heating and air conditioning duct arrangement. All buildings were hypothetically placed approximately 50 feet from the street, where noise levels fell in the 45 to 60 dB volume range. Other than these most elementary guidelines, the rest was up to you. Our accent was clearly on producing a minibucks studio that could produce a potentially megabuck sound and versatility. Perhaps the most important sentence in the entire article was this: "...our intention is to see who can do the most effective job for the least amount of money."

And therein lies the problem. Many of the entries sent to us would have made an interior decorator's tongue hang out. Conversion plans for residential basement four-track studios would occasionally run in the eight to ten thousand dollar range by the rough estimates of our judges and this was non-inclusive of equipment costs. This does not mean they were bad designs; in fact, just the opposite. We were sent some of the most beautiful small studio plans I've ever seen that just plain did not fall in a price range that was affordable to the average first-time studio builder. The general rule that seemed to surface was that the more innovatively complicated the design, the more prohibitive the construction costs became. As tempting as it was to zero in on some of the gorgeous, professionally printed blueprints received, the password for this contest was

"cost effectiveness." We have tried to select winners who offered studio plans that all of MR&M's readership could profit from, and that spells dollar-stretching time in the valley.

Keeping this in mind, it is with great pride that we offer our congratulations to Mr. Michael Loomis at Sound Capsule Studios in Tahoe City, California, as our grand prize winner. Michael opted to go with the garage layout and has submitted a plan that we felt was simple enough to be cost-effective and yet sound enough to give him a good base to work from for quality results. Here's how Michael explained it:

Here is my entry in your Design-A-Studio Contest. My design philosophy tried to strike a balance between dollars and efficiency.

For example, the ultimate design would take construction a step farther and float the control room and the studio separately—or even cut the concrete slab to achieve better isolation between the two. But these would be expensive measures, to say the least. I chose to float the control room only and add a floating riser to decouple the two areas as much as possible without resorting to extremity.

The key is for the engineer to know his studio and the varied sounds resulting from placements of instruments and mics in different parts of the room. In this design example, let's not forget the adjacent house for potential recording areas. (In my work at home, I've used every room at least once for this purpose.) Hundreds of square feet of extra space for zero dollars expenditure is truly cost-effective!!

'Atta boy, Mike! I was impressed by this entry for several different reasons. In too many floor plans submitted to us, new walls were being constructed over old walls at an angle to eliminate parallelism and consequential standing wave problems. While Mike also showed concern for the question of parallel wall surfaces, he kept two existent converging walls, walled in the old garage door opening and utilized an angled control room wall and an extended membrane absorber bass trap as his solution to the problem (see Figure 1). This makes much more sense to a financially strapped new studio owner than totally redesigning a room from the inside out. Existing walls have 5/8-in. sheet rock on 1 x 2 furring strips (16-in. O.C.) with fiberglas insulation. The angled control room/studio wall uses 5/8-in. sheet rock over 1/2-in. sound board (both

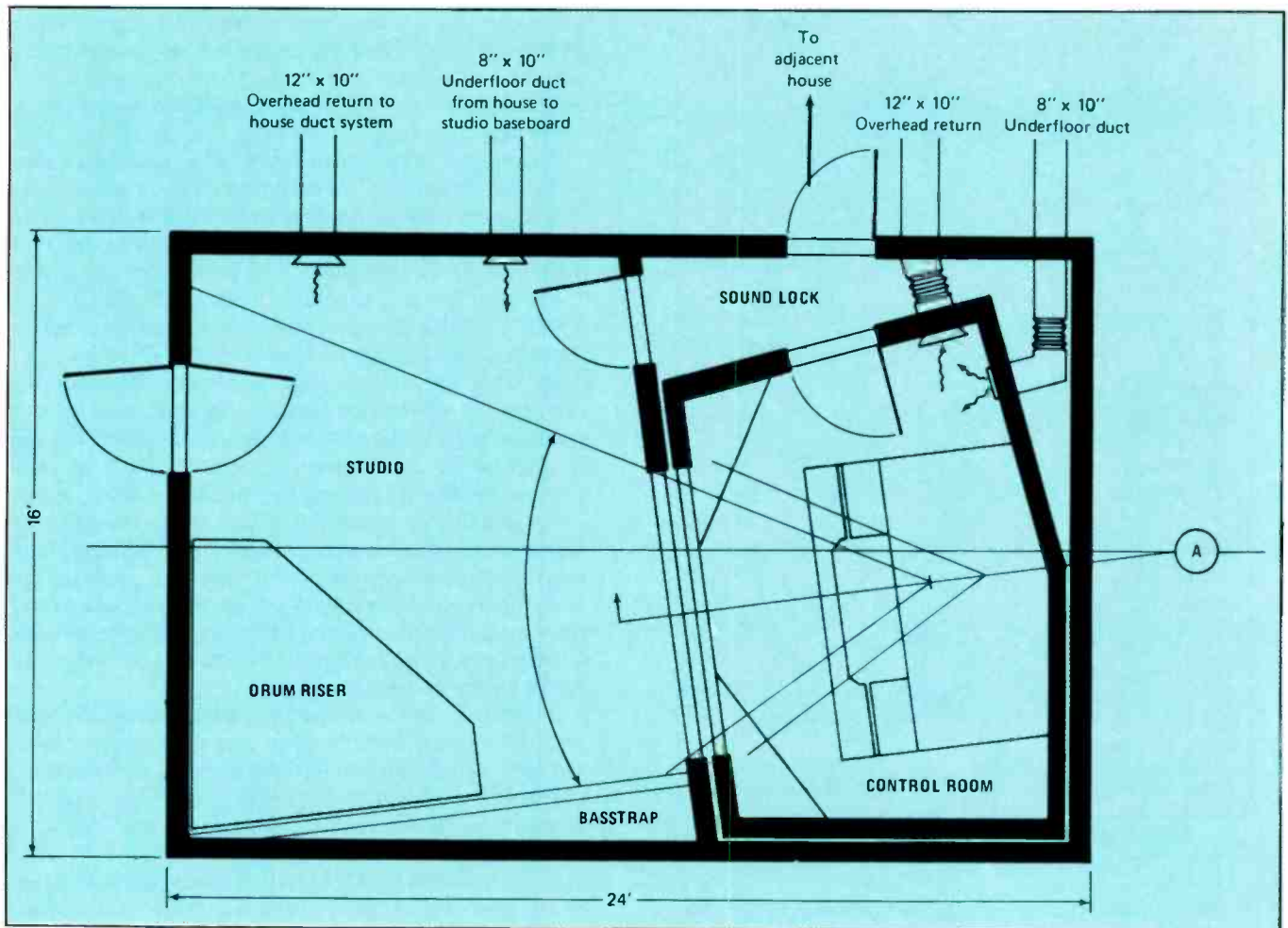

Figure 1. Control Room design.

sides) with fiberglass insulation between. In both cases, a sound transmission coefficient (STC) of 45-50 is reached. Control room walls use 2 x 4's on a 16-in. center with 1/2-in. sheet rock over 1/2-in. sound board on one side with 3 1/2-in. fiberglass insulation. The control room ceiling is a 2 x 4 frame on 12-in. centers, using 1/2-in. sheet rock over 1/2-in. soundboard with 3 1/2-in. fiberglass insulation. Overlapping seams, caulking and taping of sheet rock joints must be done to insure that all construction is airtight. All doors are solid core with an extra layer of soundboard on both sides. The drum riser is made of 12-in. center 2 x 4's between two 3/4-in. plywood sheets, filled with kiln-dried sand for density. It is all floated on vibration insulators 16-in. O.C. and spaced one inch from each wall to decouple any high level impact sounds from the studio shell and the concrete slab. The drum riser can be covered with carpeting that may be removed when desired. The bass trap is also framed on the ever-popular 2 x 4 16-in. O.C. frame with fiberglass insulation and 1/2-in. plywood on the studio side. (Be sure and seal this puppy airtight also.)

Michael was in the minority of designers who realized that a heating and air conditioning system requires both air delivery ducts and return ducts to insure circulation to the main unit. Most people planned for underfloor or baseboard ducts but only one out of ten allowed for returns. (Time for all of us to bone up on our construction homework, gang.)

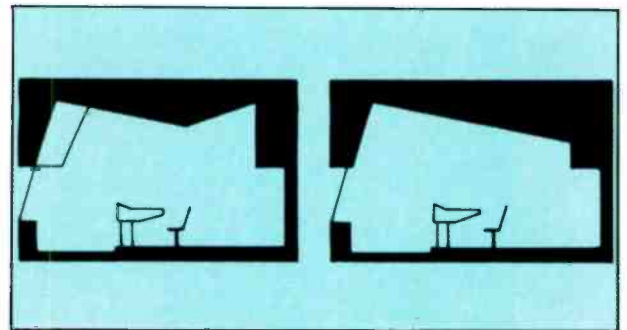

Figure 2. Tier-drop (double slope) ceiling.

Figure 3. Single slope ceiling.

If budgets allow and ceilings are high enough, you might wish to consider the possibility of adapting a tier-drop ceiling to the control room pictured here. This is a type of ceiling that angles downward from the front of the room and in the case of a double slope ceiling angles back upward to the rear wall (see Figure 2). A single slope ceiling will continue to the rear wall with no upward break in its construction (as shown in Figure 3). A downward angle of approximately 12 degrees should prove about right, but you might have to experiment a bit depending on how much room height you would be losing in your control rooms. Both of these designs prove to be of great help in breaking up those pesky standing waves, eliminating floor and ceiling parallelism, and nipping unwanted rear-reflected waves in the bud.

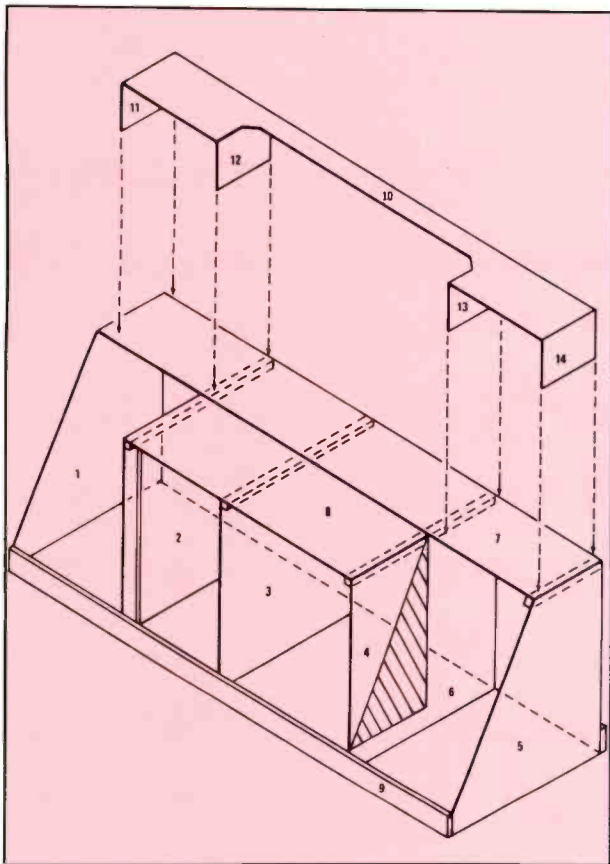

Figure 4. Plans for equipment housing.

Mike's itemized price list tells us that the materials for his garage conversion will come to about \$1,375.00, excluding duct work and carpet and pad costs. If the

labor costs for the conversion have to be added to this figure, the total dollars will skyrocket. We will, however, assume that anyone who is going to try a project of this nature knows how to swing a hammer or wrestle a sabre saw.

To put the finishing touches on your new studio, Mike has graciously included plans for a console to house your new equipment in, and it's a dandy! For about \$60 you can build a complete work center that keeps all of your gear within convenient reach and is the answer to a prayer for those recordists with limited space available to them. These plans are detailed in Figures 4 and 5. Thanks Mike!

So there you have it. Next month we'll be featuring another winner in our contest. So that none of the finalists feel less than the others, we won't be referring to anyone as a first, second, or third place winner. Instead, as the months go by you'll be reading about our grand prize winner, our first place winner and lastly, our overall design championship winner. This way, everyone who ends up winning, placing, or showing in our competition will have earned the bragging rights for his or neck of the woods. (If anybody can figure out a way to handle this more diplomatically, I'd be happy to hear about it.)

In the last feature in the series on contest winners we'll be congratulating all of the most outstanding entrants, so be sure and look for your name in a couple of months. Even though you might not have won a prize, you still might see your name in print—and that ain't all bad either!

In the meantime we'll keep you in suspense until the next issue. Join us here next time when we'll be featuring the first place winning design of... you, maybe?

See you next time.

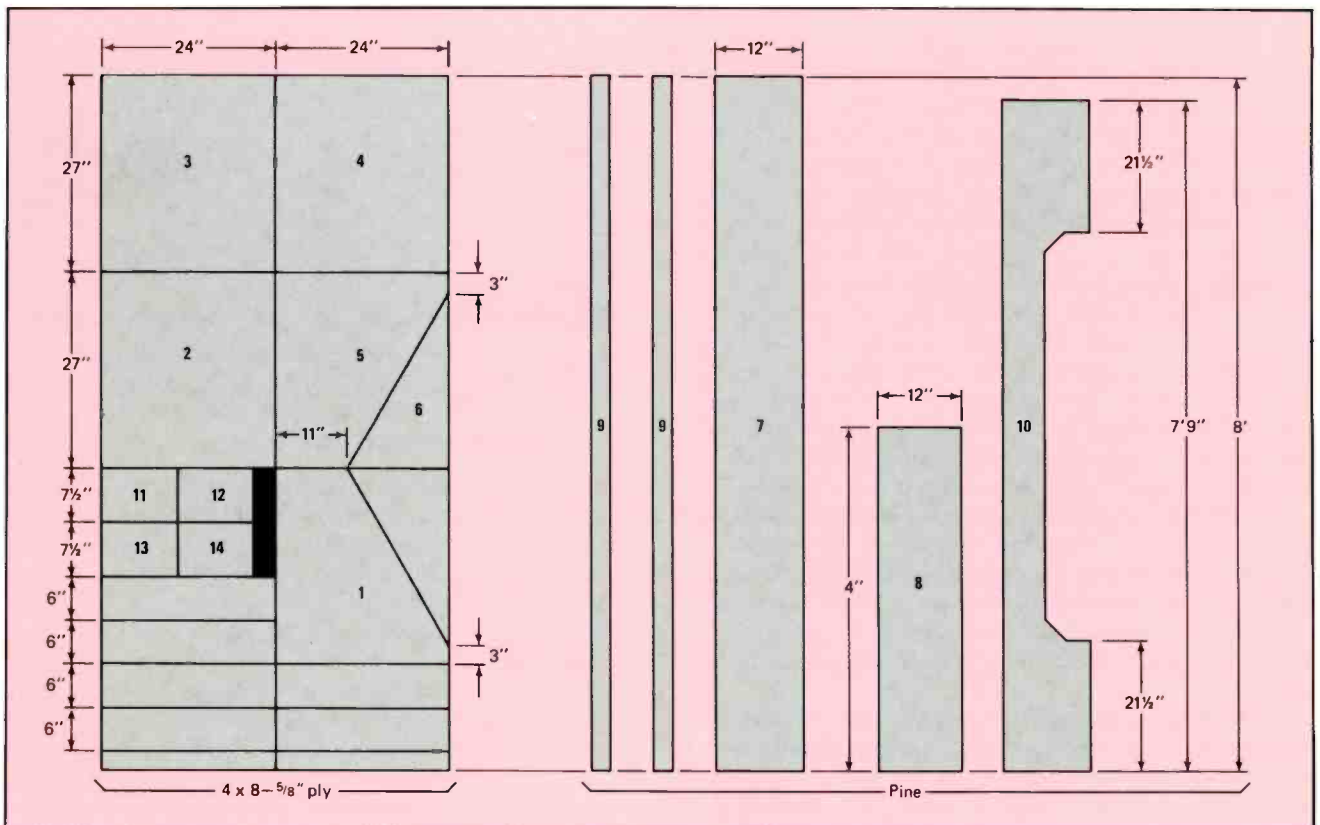

Figure 5. Measurements for equipment housing.

# Musicians Notebook

## The Roland Proform (Programmed Performance) Family

As I understand it, the population density in Japan is such that space is at a premium—which may help to explain why there have been so many low-cost, compact, high quality musical devices coming out of Japan recently. Items such as the miniature Casio keyboards, Yamaha “Performer” series devices, and the Fostex X-15 provide good quality at a very low cost in a truly compact package.

The Roland Corporation has come out with several compact musical devices in the past (such as the “Doctor Rhythm,” reviewed in the November, 1980 issue of *MR&M*). Their most recent contribution to the genre is the “Proform” series, which comprises the TR-606 Drumatix analog drum machine (\$395 list), TB-303 programmable Bass Line (\$395 list), MC-202 MicroComposer (two channel sequencer/synthesizer combination, \$595 list), and SH-101 “lead” synthesizer (\$495 base list price). Unfortunately, trying to cover all four items in a review like this is a difficult task; there could easily be a review of each product, plus a fifth article on what happens when you hook them all together! So, in this issue’s *Musician’s Notebook*, we’ll take more of an overview approach in order to best explain how these devices work, both individually and together.

**Proform Instrument Basics.** Proform instruments may be powered by batteries or an AC adapter; but even if you use AC, it’s important to leave the batteries in, since they back up the memory when power is off. Thus, any data (music, drum patterns, etc.) that you enter into the memory stays intact as long as the batteries remain good. All Proform instruments are portable, and, perhaps most interestingly of all, they incorporate a number of sync features so that the various devices can work with one another in a rhythmically cohesive (synchro-sonic) way.

**TR-606 Drumatix Drum Machine.** Unlike the newer generation of programmable drum machines that use computer techniques to store actual drum sounds, the TR-606’s drum sounds (bass drum, snare drum, low tom, high tom, cymbal, open hi-hat, and closed hi-hat) are synthesized using traditional analog synthesizer technology. This helps keep costs

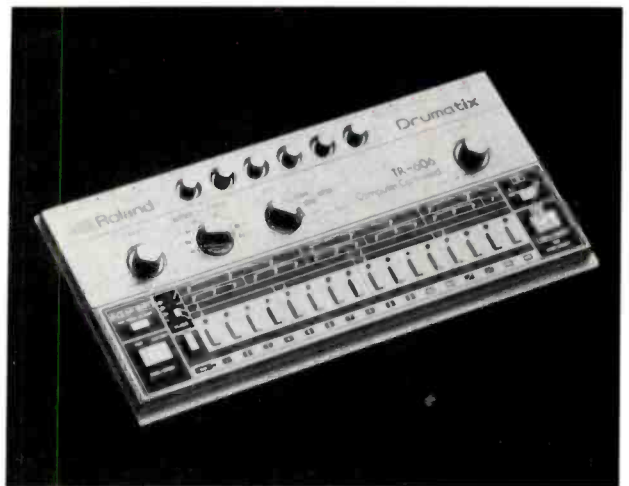

under control, although the sound is more limited in its applications than higher-priced digital drums. There are separate level controls for each drum, but unfortunately, there is only one mono output—no individual drum mixing or processing is possible. (However, an article in the October issue of *Polyphony* magazine describes how to add separate buffered outputs for each Drumatix drum.)

As with most drum units, you write individual drum patterns and then combine these to make complete songs. The TR-606 simplifies programming through the use of 16 LEDs, each with an associated switch. These 16 LEDs can represent sixteenth notes, thirty-second notes, or two types of triplets (which also come in handy when programming in 3/4). To program a pattern, you select the drum sound you want to program and start the machine. The LEDs flash sequentially to let you know where you are in the pattern. Pressing the switch below a given LED deposits a drum beat at that point in the pattern. Don’t like it? Press the switch again to turn off the sound, and try again. You can have a drum sound happen wherever you want in the pattern. After recording one drum sound, you move along and record the remaining sounds.

This type of programming approach encourages experimentation, and as a bonus, gently teaches

rhythmic notation if you're a little shaky on such matters. It's also easy to try out different patterns on-the-fly; with more sophisticated drum units, you often have to have a pretty good idea of what you want to program before you actually begin the programming process.

Concerning dynamics, you can add accents in the pattern in the same way you would add a drum sound. The accent increases the level on the particular beat where you place the accent. Regarding memory capacity, the TR-606 stores up to 32 different patterns and seven different songs (called "tracks" on the TR-606) of up to 64 measures. Track position #8 can combine the total memory of the Drumatix for up to 256 measures.

There are other features, such as the ability to create non-4/4 time signatures, repeat functions, step insert and step delete, and so on. The TR-606 also has two trigger outputs (which trigger along with the two toms and can trigger such things as synthesizer arpeggiators), along with a sync jack for coordination with other members of the Proform family. Overall, the TR-606 has a great deal of capability for the price, but it does have some limitations. And while it's easy to get the TR-606 to make noise, it's another matter altogether to learn about—and use—the complete set of functions tucked away in its little microprocessed brain (I didn't find the owner's manual particularly helpful in this respect, either). So, don't expect this to be the end-all drum machine—but don't sell it short either.

**TB-303 Bass Line.** Although the TB-303 has a good synthesized bass sound, and you have control over such parameters as cutoff frequency, resonance, envelope mod, decay, and accent, this is one device that didn't really knock me out. You could probably learn how to play electric bass in the time it takes to program a relatively complex song using the TB-303's one-measure-at-a-time programming mode. I also noticed some tuning problems at the extreme ranges of the tuning control. And I found it bothersome that you generally need to program the pitch and rhythmic values of notes independently; while I don't know how you would get around this, there surely has to be a less time-consuming way to write a bass part. Add the fact that lots of buttons do double or even triple duty, and the end result is a machine that requires a fair amount of effort and learning before you'll get anything approaching a musically useful bass line out of the thing. Maybe if I couldn't play electric bass or keyboards I'd find the TB-303 more useful, but it frustrated me to sit there punching buttons and trying to decipher the manual—it's a lot easier to just pick up an instrument and play a part.

The TB-303 does have one particularly outstanding feature, though, a sync jack on the back that lets the TR-606 and TB-303 sync together. If you're mostly interested in working out a good groove with these two boxes, the combination of the two units looks pretty good... as you play the TR-606, you can have a nice bass line chugging along on the TR-303, and then play guitar or keyboards on top of that. Maybe I'm being too hard on the TB-303; it does have some nice features, such as 1024 step memory (comprising 64 one measure bass patterns with up to 16 notes per measure), track or song memory that functions in the same manner as the Drumatix, and control voltage and gate outputs for

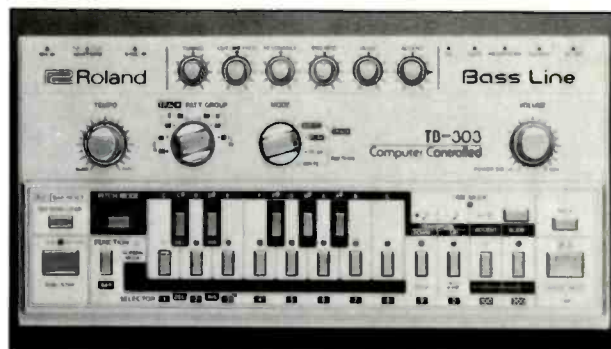

driving other synthesizers—very handy if you want the programming capabilities of the TB-303, but the sound of a "big" synthesizer. Yet I just can't seem to get too interested in programming the machine—the process is just too tedious for my taste.

Incidentally, if you do like the idea of working out rhythm section parts, the TR-606 and TB-303 are battery powered (although AC adapters are available) and come with cute little silver carrying cases for easy portability. Hook the two units together with some cords, plug in some headphones, and you can groove away on the bus, plane, or in a hotel room at 3 AM.

**MC-202 MicroComposer.** The MC-202 MicroComposer, a combination 2600 event sequencer/synthesizer, could n't get a full workout, unfortunately, due to the fact that it had some kind of intermittent problem that periodically made the display go blank. Nonetheless, I was able to form a pretty good opinion of what the thing can do—which encompasses a considerable array of options. While I feel the MC-202 is still somewhat cumbersome to program, the final results are a lot more gratifying than what you get out of the TB-303, which seems to make the programming worth your while. Again, the manual is not all that great, but with patience you can muddle your way through.

If you think the MC-202 resembles the ultimate Casio VL-Tone, you're not too far off. There's a little pushbutton 3-and-a-half octave keyboard connected to a surprisingly complete synthesizer, as well as an LCD display that shows you the status of the MC-202's operations. The single-oscillator synthesizer includes an LFO with adjustable rate and delay; multi-waveform VCO (oscillator) with sub-octave signal; waveform mixer; filter with cutoff frequency, resonance, and three modulation controls (envelope, LFO, or keyboard track); ADSR envelope; portamento and more. Not bad.

But the big attraction is the sequencer. You can program two independent channels of control voltages and gates; one of these can drive the MC-202's internal synthesizer or an external synthesizer, while the second channel can only drive an external synthesizer. You program by first entering pitch, then timing information, then gate information (essentially, whether the notes are staccato, tied together, or somewhere in between). There are numerous editing functions, including insert, delete, copy, alter pitch, alter timing, assign accent, step forward and backward, and so on. You can also edit music on a measure-by-measure basis as well as on a note-by-note basis. There's a tempo display (although the tempo is non-programmable), memory capacity check feature,



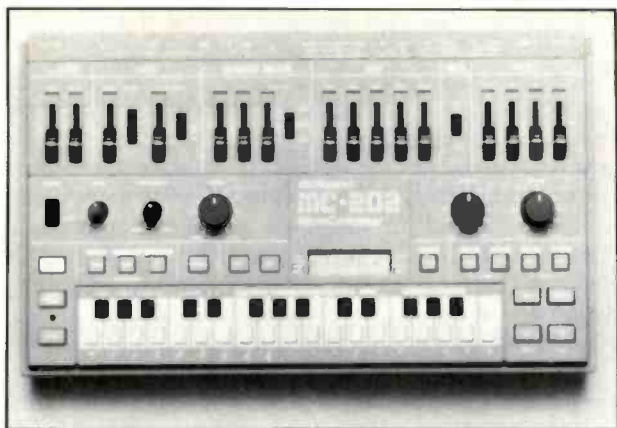

cassette interface for storing song data, sync-to-tape capability for doing overdubs (very important), and, as you might expect, sync jacks for driving other members of the Proform family. We could go on...and on...and on...but enough's enough. The MC-202 is a hip little sequencer that is powerful, not too expensive, interfaces neatly with the other Proform family members, and can indeed help you compose songs.

**The SH-101.** Featuring a 32 key, full-size keyboard, the single-oscillator SH-101 is a monophonic "lead" synthesizer which has got to be one of the better deals going right now in the music industry. Designed for portability—you can even wear it around your neck like a guitar, and comfortably too—the SH-101 includes a remarkable number of useful features and is capable of getting some excellent sounds for the bucks. VCO controls include tuning (varies tuning  $\pm$  one semitone), four octave range switch, modulation amount fader (this lets the LFO cyclically vary the oscillator's pitch), and pulse width control with three options—manual control, envelope control, and LFO control. With one of the latter two selected, the pulse width control functions as a depth control.

A source mixer combines various waveforms from the oscillator, including the pulse output, a sawtooth, and suboctave sound (switchable between square wave one octave lower, square wave two octaves lower, and pulse wave two octaves lower). Filter controls include cutoff frequency, resonance, amount of envelope modulation, amount of LFO modulation, and keyboard track (where the filter cutoff frequency changes according to the frequency of the notes you're playing). You can also make the VCF resonate to create another sound source, or to make ring modulator type sounds and other special effects. There's one switch for the VCA, which selects between tying the VCA to the envelope and simply switching the VCA on and off like an organ. Envelope generator controls include the standard attack, decay, sustain, and release controls, along with a highly useful three-position switch that selects the triggering mode. In "Gate + Trig" mode, the keyboard re-triggers each time you press a key, with last-note priority. In "Gate" mode, the keyboard re-triggers only if you lifted your fingers off the keys before pressing another key. This mode gives low-note priority. The LFO mode triggers the envelope from the LFO for repeating effects.

Are we finished? No way. Don't forget the portamento control, with three way switch (portamento on, off, and "automatic"). With automatic,

portamento only occurs if you press a key while your finger is still on another key; if you leave a space between notes, the portamento effect will not be present. There's a three position transpose switch (get the feeling Roland got a good price on three-position switches?) and a well-implemented modulation bender/lever. Pushing the bender to the right increases pitch by the amount set by the VCO Bender control and simultaneously increases the filter cutoff frequency by the amount set by the VCF Bender control. Pushing the bender to the left decreases pitch and filter cutoff frequency in a similar manner. Pushing the bender to the rear of the unit introduces LFO modulation to the oscillator, but this is a switched function—you can't bring the vibrato in slowly, it's either in or out.

We still haven't mentioned the arpeggiator (which arpeggiates up, down, or up and down *and* includes hold and transpose functions), or the 100 note sequencer. Unlike most sequencers, with the SH-101 you can change the length of the notes, or introduce rests, to create a less metronomic feel. The arpeggiator rate and sequencer playback speed are set by the LFO control, although it would have been helpful if these functions could have had their own clock, because the proper rate for the arpeggiator or sequencer isn't always the proper rate for vibrato or pulse width modulation. Oh well, you can't have everything for \$495...and you especially can't have the optional modulation "grip" unit, which costs another \$100. This bolts on to the SH-101 and duplicates the pitch bend up and vibrator functions. It also includes strap buttons so that you can add the shoulder strap for live performance jollies. (I might add that it really is fun to walk around playing keyboard.) Frankly, I like the action of the stock bender better than the "grip," but it is still highly useful. What I don't understand is how a pot and switch in a piece of plastic with a wire coming out of it can cost \$100; if the "grip" cost \$30 I'd recommend it unconditionally, but at its current price, try before you buy and make sure you like it.



I would advise being pretty careful about getting too excited with an SH-101 strapped around your neck, since I doubt if the output jack could stand up to repeated strain from a cord (going wireless is a fine but expensive way to deal with this problem). Speaking of jacks, the SH-101 also has a headphone jack, control voltage in and out jacks plus gate in and out jacks (so



# Ambient Sound

## The Not-So-Secret Cult of the PCM-F1

When the Sony PCM-F1 PCM Audio Processor was introduced nearly two years ago, it was intended for use by affluent and demanding consumers who wanted a home, state-of-the-art digital recording system but weren't prepared to pay the \$25,000 or so for a professional-type PCM processor such as that same company's PCM-1610. Both machines deliver what amounts to an NTSC video signal, in which audio data is positioned in the form of sixteen-bit "words" (the PCM-F1 can record in either a 14-bit or a 16-bit digital mode) where the normal video picture data would otherwise be located. While the PCM-1610 professional digital audio processor has traditionally been used with professional U-matic (¾-inch) video tape recorders, the PCM-F1 was intended to be used with home-type Betamax or, as Sony reluctantly admits, with VHS-format home-type VCRs.

On that basis (allowing some \$13,000 for a BVU 800 U-matic Recorder), going the professional route for digital audio recording would cost the recording company around \$38,000 just for the master recording system (accessories and editing facilities extra). The home recordist, on the other hand, could buy a PCM-F1 for under \$2000 and add a portable Sony SL-2000 for about \$600 more, for a total cost of around \$2600. Even if the serious amateur recordist wanted to record at the higher Beta I speed for better results and fewer dropouts (the portable SL-2000 records only at Beta II or Beta III speeds), a semi-professional SLO-383 Direct Drive Beta unit (still using ½-inch video tape, of course) could be had for around \$2650, for a total recorder system cost of under \$5000.

From analyzing the prices quoted above, you can imagine what began to happen. Small recording studios on limited budgets were willing to overlook the fact that the PCM-F1 was labeled a "consumer" product, and sales of this tiny portable PCM processor increased remarkably—not to the consumers for whom the product was intended, but to recording studios that weren't about to spend upwards of \$38,000 to get into digital mastering.

At first, Sony did everything they could to discourage this growing cult of PCM-F1 users. After all, the company stood to make a much greater profit selling PCM-1610s at \$25,000 than they would make selling PCM-F1s at less than 10 percent of that price.

Then, too, there were definite limitations as far as recording quality and flexibility were concerned when using the PCM-F1. Nevertheless, the popularity of the PCM-F1 for professional applications continued. Not only that, but other companies, sensing the need for accessories and interface units for the PCM-F1, began to market a variety of level matching boxes and other devices to make professional use of the PCM-F1 even easier. Finally, Sony must have decided that if they couldn't beat them, they would join the supporters of the PCM-F1 for professional use. The result of that decision was a day-long seminar, held at the end of September in the famed RCA Recording Studio A in New York City which I attended. By my count, over 150 technicians and recording engineers were interested enough in the subject matter to attend as well.

### Accessories and Interface Units

The seminar was sponsored by Audiotechniques of Stamford, CT, who also have a branch at 1619 Broadway, New York City. An introduction to the capabilities of the PCM-F1 was delivered by Marc Finer of—get ready for this—Sony Corporation. Other speakers then described the functions of a variety of level matching and interfacing systems, all of them designed around the PCM-F1. Included were the Propak I and Propak II by Audio & Design Recording Inc., the HH2x2 Level Matching Interface by Valley People, Inc. of Nashville, and what was perhaps the most comprehensive piece of gear of all, the RTW Studio-Processor-Set, distributed by Audiotronics, Inc. of Memphis, TN.

The Propak I is designed to facilitate a professional interface between consumer items such as the PCM-F1 and professional studio equipment such as consoles, mixers, etc. At the "pro" end of the unit, XLR connectors are provided and gain can be adjusted to suit any professional operating level. Inputs and outputs are electronically balanced with +24 dBm headroom, and provision has been made for inserting transformers if necessary. On the semi-pro or consumer side, gold plated phono-tip sockets are used for linking to such items as the PCM-F1.

Normally, in consumer PCM processors designed to the EIAJ (Electronic Industries Association of Japan)

PCM/VCR format, outputs are multiplexed so that the recording on the tape has a time delay of 11.34 microseconds between left and right stereo channels. When reproduced through the D/A conversion, this time error is corrected so that the final analog outputs are identical to the inputs. However, since it is also possible to dub direct digital outputs from the PCM-F1, tapes recorded in that way will not be compatible with such processors as the PCM-1610 because the signals are not time coincident. Although it would be possible to correct the recorded signals by digital processing, the Propak II offers a more cost-effective solution. This more elaborate model also provides the facilities found in the Propak I.

Valley People Inc. have come up with a simple, small level matching interface box which they call Model HH2x2. It is nothing more than a system capable of boosting -10 dB signals (that's the level normally available at the output of the PCM-F1) to a nominal +4 or +8 line level output. A stereo attenuator section pads +4 or +8 dB levels by 14 dB to avoid overload problems at the inputs of devices such as the PCM-F1 Processor. XLR connectors are provided for inputs and outputs of professional devices, while both RCA phono jacks and a 5-pin DIN connector provide for connection to inputs and outputs of the "consumer" device.

### The RTW Studio-Processor-Set

As I mentioned earlier, the most comprehensive set of equipment demonstrated at the seminar was the RTW Studio-Processor-Set, which consists of the Sony PCM-F1 processor itself, and an RTW Analog and Digital Interface. The primary purpose of the latter piece of equipment is to adapt the Sony PCM-F1 to the PCM-1610 digital format for subsequent editing or compact disc (CD) mastering. The device takes the digital output of the PCM-F1 (formatted to video) and converts it to 1610 compatible code—complete with wordclock output for synchronization. It will also interface between two VCRs for rough editing or direct digital copying, and it performs several other useful functions.

It is not necessary to use the RTW interface during the recording process. The digital portion of the interface is involved only during the reproduction process, so tapes recorded using this interface are still in PCM-F1 format. To use the Interface with a PCM-F1, the latter unit must be modified. This modification is done at Audiotronics and involves the addition of a 25-pin connector to route various logic and video signals between the interface and the PCM-F1. Two relays must also be installed for manual control of the Emphasis function of the PCM-F1. While this modification does not inhibit normal use of the PCM-F1 without the interface, it was emphasized that making the modification *does* void Sony's warranty of the unit.

Once modified, the video output of the PCM-F1 is routed during record and playback to the interface, where it is converted to PCM-1610 data format. Outputs of the interface to the PCM-1610 are always written in 16-bit format, even if the PCM-F1 recording was made in 14-bit format (though, in such cases, the PCM-1610 outputs will only have 14-bit resolution). The video recorder used in the system can be connected either to the PCM-F1 or to the RTW Interface. The

latter provides connection for two VCRs, both inputs and outputs, plus a copy-out (video) that can be used for selective direct digital copying from either VCR or for rough editing if the two VCRs can be externally synchronized. While VCRs used can be Beta, VHS or U-matic, they must record using the NTSC video standards.

Indicator LEDs on the face of the RTW unit display the status of the error correction taking place within the PCM-F1. Other LEDs indicate 14- or 16-bit operation during both record and playback.

The analog portion of the RTW includes balanced line level inputs and outputs, buffering of the unbalanced -10 dB inputs and outputs of the PCM-F1, and left and right reciprocal gain controls for headroom optimization in 2 dB steps. The device is available with either transformer-isolated or active balanced inputs and outputs. Also included in the Interface are 12 VDC outputs for powering the PCM-F1 and two VCRs, so that you don't have to carry along bulky AC power supplies or heavy batteries when doing remote recordings. Each of the DC outputs is individually regulated.

Audiotronics sells the RTW Analog and Digital Interface for \$2280, but that includes modification of the PCM-F1. The list price of the Valley People level matching interface, described earlier, is \$215; it is also available from Audiotronics, for \$185, while the Audio & Design Propak II, which carries a list price of \$315, is available at Audiotronics for \$270.

Aside from informing the attendees about all of the products that have been designed for use with the PCM-F1 (and other consumer-type digital audio processors intended for use with VCRs), many of the speakers at the seminar stressed the importance of new microphone placement techniques in the new world of digital recording, something I have written about in this column more than once. Not only was there a general consensus that we should be using fewer mics than we normally do in professional multi-channel studio recording, but that all of the mics we use have to be top-quality ones. Noise introduced by inferior mics is now going to be heard where it was previously masked by other noise in the analog world of recording.

Another point that emerged quite clearly from this seminar was the importance of high-quality video tape and a high-quality VCR in any PCM/VCR digital recording setup. Dropouts, even if excessive, cause relatively insignificant audible problems in analog recording, but they can be disastrous in digital recording if they exceed the ability of the system to "error correct." As for the VCR that's used in such combinations, several speakers suggested that with some of the money saved by employing a PCM-F1 (or other consumer-type PCM processor), serious professionals ought to consider using a semi-pro VCR or even a U-matic 3/4-inch VCR for best results.

No mention was made of the successor to the PCM-F1, Sony's Model PCM-701. This second generation unit, though lacking portability (it operates from AC only) and microphone inputs, offers the same level of performance (including a choice of 14- or 16-bit operation) but sells for only \$1200. With PCM available at such incredibly low prices there would seem to be little reason why even the smallest recording studio can't join in the digital revolution.

# Hands On

## Technics RS-M253X Cassette Deck

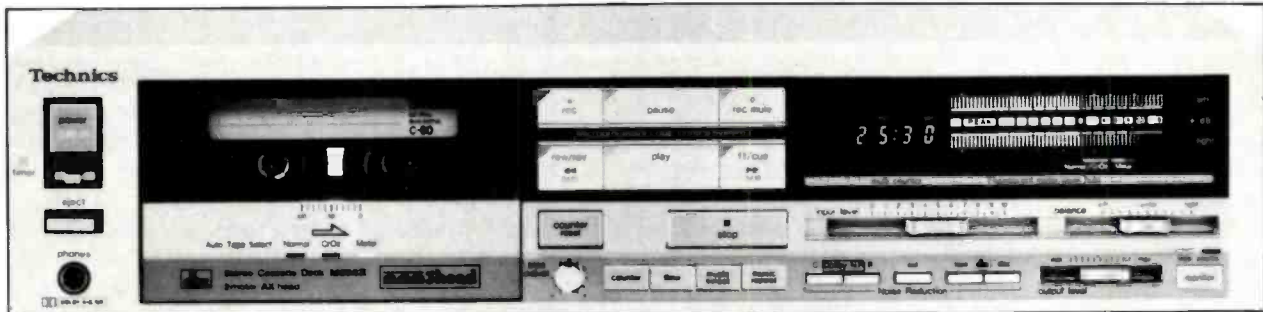

The Technics RS-M253X Cassette Deck is a 2-motor, 3-head machine boasting three types of noise reduction as well as many features such as Music Select and Repeat. It features automatic tape selection, tape/source switching, and mic/line input switching, thus removing several switches often seen on cassette decks. The front panel is accented by a very functional metering section using eighteen-segment bar graph peak-hold meters, a four-function counter, and indicators for music repeat and microphone inputs.

One of the RS-M253X's most obvious strong points is its emphasis on versatile features. The omission of the tape selector switches normally found on other cassette machines exemplifies this focus on user conveniences. Of course, this means that you can't switch the EQ setting to Normal for "boosted treble" when playing back high bias tapes, but it does keep you from having to worry about setting the controls every time you change tapes. The design uses the standard slots on the top of the cassette casing to indicate which type it is, thus setting both the bias and EQ for the proper tape type. There is, however, the added freedom of being able to trim the bias to cater to the needs of your specific tape type and brand. The bias adjust has its greatest effect on normal bias tapes, but the trim also has an effect on CrO2 and Metal tapes.

### Features

Manufacturers continue to pack more features into extremely small packages and this unit is certainly no exception, weighing in at under 12 pounds and probably smaller than any other component you're likely to have on your shelf.

The unit is very sleek and well styled; there are no clumsy dual concentric knobs or long toggles. While you won't be able to impress your friends and neighbors by showing them the "cockpit" of your new cassette deck, you will have many handy features at your fingertips without having to take a crash course on how to drive a cassette deck.

The Meter/Counter section on the front panel serves a multitude of functions. The counter itself serves as

four different counters: 4-digit remaining time, 3-digit tape counter, music selection number, and record mute timer. The remaining time counter can save many a headache for those who do live recording or find themselves in situations where running out of tape could prove disastrous. The counter counts down the time (in minutes and seconds) remaining on standard cassettes. Prior to initiating a Play/Record or Record/Ready mode, the selector allows you to select 15, 23, 30, 45 and 60 minute starting times from which the counter counts minutes and seconds in reverse, indicating the time remaining for C-30, -45, -60, -90 and -120 tapes respectively. The counter will count time in a forward motion from the zero point to time certain pieces on the tape. However, it only counts up to 10 minutes in the forward direction and then resets back to zero. I wonder if Technics was able to save us unwary consumers a substantial amount of money by limiting the forward count time to 10 minutes. The 3-digit tape counter is similar to those found on most other decks counting from 000 to 999 except for the addition of a 4-segment precision wheel that allows you to notate four points between numbers. The precision wheel is actually the lower half of the next digit, designed to display one segment at a time in the direction of tape travel. This figure rotates in the direction of the hubs of the cassette to show the direction of tape travel even when rewinding or fast-forwarding.

The Music Select counter allows one to program a number (0-20) onto the screen. When Fast Forward is actuated, the unit passes that number of selections on the tape and plays the next consecutive selection. When rewinding, the unit passes the indicated number of selections and continues to rewind to the beginning of that selection before initiating the play mode. Using the Select feature with the counter at 00 merely passes to the end of the selection underway or rewinds to the beginning of the passage underway.

The Record Mute Counter displays the amount of time (in minutes and seconds) that the Record Mute button has been depressed. The Record Mute button has no effect unless you're already in the Record/Play mode. When the button is released, the counter returns

# Noise Reduction

Since the beginning of the age of the tape machine as we know it today, mankind has sought to reduce if not totally eliminate the noise inherent to the medium itself. It seems desirable that analog tapes should merely reproduce the music (or lack of same) recorded onto them without imposing any of their own noise.

Probably the most common type of noise reduction used for the cassette medium is Dolby B. This is most likely due to its compatibility with machines not equipped with the electronics to decode encoded tapes. Dolby B, named after its studio counterpart Dolby A, only affects the high frequency component of the source material, since this is the spectrum in which tape noise is most obvious. During the record (encode) process, low level high frequencies are boosted, enabling them to rise above the noise on the cassette tape. During playback (decode), Dolby B attenuates the high frequencies along with the high frequency noise on the tape, thus reducing tape noise by about 10 dB above 5 kHz. The only major problem with this system is the risk of high frequency tape saturation. With the Dolby system boosting high frequencies, one must use more care than normal to assure that the signal does not saturate the tape, causing more unwanted sound than the noise itself.

Dolby C, the most recently introduced form of consumer oriented noise reduction, encodes and decodes as does Dolby B, but over the middle and high frequencies. This results in about a 20 dB reduction of tape noise above 1 kHz, but is much more obvious to the listening ear if the tape isn't properly decoded. As with Dolby B, Dolby C is more susceptible to saturation because of boosted high frequencies.

The dbx system of noise reduction was actually designed to improve the dynamic range of the cassette medium, which in turn drastically reduces tape noise—not just at midrange or high frequencies, but over the entire audio band. dbx realizes the dynamic range of the cassette (about 70 dB) and uses a compressor (compressor/expander) to increase this dynamic range to about 110 dB. During the record (encode) process, the signal is compressed, thus lowering the louder portions of the signal to a point further from tape saturation and raising the lower level signals above the noise floor. The tape is decoded during playback by an expander (operating inversely to the compressor) to restore the signal to its original form. The overall effect of the dbx system is about a 30 dB reduction of tape noise at all frequencies. The most obvious drawback of the dbx system is its incompatibility with systems lacking the decode circuitry. dbx encoded tapes are so drastically different from the original signal that listening without decoding is far from satisfying.

The assumption behind every system of noise reduction is that the signal one puts onto the tape will in turn be played from the tape with only the addition of tape noise. The truth is that even the best cassette player undergoes wear that causes signal degradation—something noise reduction circuits cannot account for. The general rule is that the more radical the change made to the signal in the encode process, the more inaccurate the signal will be if played back on a unit with abnormalities.

to whichever counter mode was in use before muting. Above the counter itself there are indicators for Music Repeat On and Microphone Input On (activated when plugs are inserted into the rear-mounted ¼-in. microphone jacks).

The metering system is comprised of two 18-segment horizontal fluorescent bar graph meters (left above right) that measure peak-hold—holding the highest peak incurred in each two-second interval. The metering scale is much wider than most systems, spanning from -40 dB to +8 dB (up to +18 dB when dbx noise reduction is in use), and uses three colors as opposed to the more common two-color scheme. From -40 dB to 0 the meters glow a pale blue, from 0 to +8 dB, amber, and from +8 to +18 dB, bright red.

The unit is also equipped with a timer operating capability that is fairly commonplace on most newer tape machines. This feature allows the unit to automatically enter the Play or Record/Play mode when the unit is powered up by a timer or merely by turning the unit on. This feature is useful in recording program material when not at home or for turning on the stereo as one would the lights when leaving your home for vacation.

The M253X has a unique system of searching that is very convenient—once you get used to it. When either Fast Forward or Rewind is initiated directly from the Play mode, it is executed with the tape lifters at an intermediate position. This allows you to hear your program material whiz by so you can manually listen for your selection; the catch is that it only does this while the Fast Wind button is depressed. Releasing it causes the deck to go directly back into the Play mode. This can take some getting used to for those who, like me, are used to solenoid operated machines that go directly from play to rewind, etc. When entering a Fast Wind mode from the stop position, the music search system that allows the tape lifters to be deactivated is not operable. This allows you to avoid listening to the high pitched noise of the selections winding by unless you want to. I personally kept forgetting that you have to stop the Play mode before attempting to fast wind; it takes some getting used to.

The Music Select system uses the same principles as the Music Search feature. The unit will find any 4-second-or-longer blank segment and assume it is a quiet segment between passages. While operating Music Select, you don't hear the squeak of high-speed winding; however, the machine bases its stopping point on it.

Unfortunately, the select system has some bugs. If your cassette library consists largely of classical music, you'll probably notice that the sensor has a hard time differentiating between a quiet passage in the music and blank tape. Perhaps Technics could check into the feasibility of incorporating more accuracy in defining silence between selections. There are also more frequent errors when using dbx encoded tapes as opposed to Dolby or no noise reduction. When the system fast winds over a dbx encoded section, the expansion process never begins operation, since the level of the signal is significantly lowered. This means that sections in the middle of a dbx encoded selection that are only moderately low in level may be interpreted as blank tape. If the dbx tape is recorded at a low level overall, the unit may never find a large enough signal to mark as the beginning or end of a selection and thus fast wind to the beginning or the end of the tape.

The Music Repeat function will repeat any selection as many as 16 times. The switch must be activated prior to playing a selection or during its play. When the selection is over (the sensor detects silence for four seconds or more), the tape is rewound until the beginning of the selection (the next four second pause) is encountered, and plays from that point. Anyone wishing to record a full tape with no pauses could have up to 16 hours of music with only pauses long enough to rewind the tape back to the beginning and play it again without pressing one button during that time span.

## Noise Reduction

I should mention a few words about the types of noise reduction offered by the M253X. The dbx system is a system of reducing tape noise and increasing dynamic range by compressing the input signal so that extremely quiet passages that would normally drown in tape hiss are actually recorded at a level above the noise floor, and levels that would normally saturate the tape are recorded at a level lower than normal. During playback, the reverse operation takes place. The entire output signal, including the tape noise, is expanded in a reciprocal process such that the quiet passages are still above the noise floor and the peaks are as loud as they were before encoding. The compression (encode) side of the chain compresses at a ratio of 2:1 and the expansion (decode) process expands at 1:2, thus returning the signal to normal while greatly reducing the level of noise on the tape. Since the dbx process (and Dolby as well) affects the signal only to return it to its original state when playing back, there is no reduction of the noise present in the source signal itself; only in the noise added to the signal through the use of a tape medium. The M253X is also equipped with circuitry to decode dbx encoded discs—albums that have been compressed in the same way as dbx encoded tapes.

Dolby noise reduction needs little or no explanation; Dolby B has become widely recognized as the most universal type of noise reduction for the cassette medium, probably since it is the most compatible with machines not capable of the decode process. Dolby C uses the same principles as Dolby B except that it has an effect over a wider frequency range and is more audible if not properly decoded; it does, however, do a better job at eliminating tape hiss than does Dolby B. Since the M253X is a three head machine, the noise reduction systems have dual circuitry to decode the signal from the play head as it is recorded.

When the unit is placed into the Play mode, the tape/monitor switch automatically switches to the tape position, or to the input position when in Record-Ready mode. The operator can also change between the two by merely pressing the monitor switch until the desired indicator is lit.

I appreciated the fact that Technics chose a single horizontally sliding fader to control the input level instead of two rotary knobs such as many other manufacturers choose. For those times when right to left levels have to be adjusted, there is an input balance control with a center detent to keep it from affecting the recording when it is not in use. At last you can fade out without having to pull down two faders or turn two knobs or even worse, those dual concentric input controls.

Other than the dynamic range specification (discussed later), there were no major surprises in the manufacturer's information. Frequency response ratings include: Metal tape 20-22,000 Hz, CrO2 tape 20-21,000 Hz, Normal tape 20-19,000 Hz. The unit has an inaudible Wow and Flutter of 0.04 percent (WRMS) and Signal-to-Noise ratios of 92 dB (dbx in), 78 dB CCIR (Dolby C NR), 70 dB CCIR (Dolby B NR), and 60 dB with no noise reduction (all specifications with maximum input level A-weighted with CrO2 type tape). These are the Manufacturer's quoted specifications, which have been corroborated by lab tests by B & K.

## Testing

I tested the unit with all three types of tape and all available types of noise reduction, on live and pre-recorded source material, using line and microphone inputs. As one might expect from a new cassette deck, I didn't encounter any major disappointments in the sound quality. I was especially impressed with the levels that the unit could handle without distorting. I was able to record material with +20 dB peaks using the dbx noise reduction system and heard no audible distortion or loss of frequency response or level. Likewise, there was a sufficient amount of clean gain available at the input controls to boost signals to the +18 dB ballpark for the dbx encoding process.

I honestly did not quite believe the specification chart when I glanced over it upon receipt of the unit. The rated dynamic range—"110 dB or more (at 1 kHz) with dbx in"—seemed more like a dream than a specification for a recorder that speeds tape at 1 $\frac{1}{8}$  ips using such a small amount of tape area. Because of my skepticism I proposed a test which knowingly was so unfair that the cassette deck would inevitably meet its downfall. Simultaneous recordings were made with the M253X side by side with a professional half track  $\frac{1}{4}$ -in. machine moving tape by at 15 ips. Obvious differences in operating level were accounted for and an A-B monitoring system was set up so that the two could be monitored and switched without knowing which was being heard. I was quite surprised at the results. Using the dbx noise reduction system and metal tape, the underdog cassette deck performed admirably. I can't say that there was no audible difference between the two machines, but the headroom encountered was higher than any cassette machine I've crossed paths with. It is unique to see a cassette deck's output pushing +20 dB, even on peak meters, without hearing a sound comparable to that of the AM radio speaker in my Firebird.

## Summation

I was generally impressed with the overall sonic quality of the M253X. The superb record/playback characteristics of the unit would be enough to make the M253X worthy of note, and the special features merely augment its usability. For those who need a cassette machine that will be dependable as well as versatile, the M253X is recommended. There are a lot of features packed into this little machine and they're all ergonomically placed to be of the most convenience to someone who wants good quality without a lot of hassle.

# The Market Place

what's new in sound and music

## MARSHALL ONE HUNDRED WATT COMBO

The new Marshall 4103 one hundred watt combo, distributed by Unicord, is the latest addition to the popular JCM 800 Series of Marshall amplifiers. A technically updated version of the famous Marshall 4104 "Master Volume" 50 watt combo, the new model 4103 features two Celestion 12-inch speakers with a 100 watt tube-type amplifier. Marshall's unique Master Volume circuitry allows for the low volume recreation of the classic hundred watt overdrive sound favored by many contemporary rock guitarists. Varying the preamp volume and master volume controls can modify the overall output from a crisp, articulate sound suitable for country, jazz, and more traditional rock 'n' roll to the creamy, rich distortion required for modern rock styles. The 4103 also features high and low gain inputs and a direct line out for recording.

Circle 28 on Reader Service Card



## SEYMOUR DUNCAN PICKUP

Seymour Duncan's new Classic Stack™ is a direct replacement, noise cancelling pickup for Strat-type guitars. No guitar body modifications are required. The unique hum-bucking design features dual coils stacked on each other to eliminate the hum found in traditional single coil designs. Staggered pole pieces through the cover provide the classic styling of stock

pickups. Covers are available in white, black, and maroon. Alnico II magnets are used to provide a distinctive, rich sound with excellent sustain. Wiring schematics are included with every unit to provide maximum tonal combinations. Standard four-conductor cable allows players to wire pickups in series or parallel, and in or out of phase.

Circle 29 on Reader Service Card





## ADA DIGITAL DELAY

ADA's new 2.56i Digital Delay is a full-functioned delay processor for both live performance and recording uses. The 2.56i produces delay times from a short .3 milliseconds for flanging to over 2.5 seconds of delay for digital tape loop effects—all at a full 16 kHz bandwidth. An LED rate indicator blinks at a rate equal to the delay time for accurate, real-time echo setting. For producing special effects, the 2.56i has Regeneration, Modulation, and Repeat Hold features. For a natural decay, the Regeneration Hi-Cut control reduces the high frequency content in the delayed audio signal as it is recirculated, and is variable between 16 kHz and 1 kHz. The modulation section



has an 8:1 sweep range that produces flanging that sweeps over three octaves. The Waveform control continuously blends the shape of the modulation from a triangle to a sine to a square wave. Modulation LEDs give visual indication of the speed, direction, and location of the sweep to its upper and lower limits. The

Repeat Hold feature allows the entertainer to lock in up to a 2.56 sec. musical segment and repeat it indefinitely for background rhythm effects. Repeat Hold and Bypass functions are remote-switchable. The 2.56i is covered by ADA's full one year parts and labor warranty and carries a suggested retail price of \$799.95.

*Circle 30 on Reader Service Card*

## MORLEY SWIVEL TONE VOLUME

Morley's new Swivel Tone Volume, model SLST, is a dual action Slimline pedal utilizing electro-optical circuitry to control all vertical and horizontal functions. Swiveling the pedal to either right or left of center boosts the treble or bass accordingly. A pointer indicates your position (signal is flat in center position). Two master controls may be preset independently for the amount of treble or bass boost, up to 20 dB, reachable at maximum horizontal throw. At any point in its horizontal travel,

volume control is accomplished in the usual vertical manner. Boosting the treble has no effect on the mid or bass spectrum. Likewise, boosting the bass has no effect on the treble spectrum. The SLST is compatible with all amplified musical instruments but is highly recommended for synthesizers and other keyboards. The unit is battery or AC powered, and its suggested retail price is \$149.95.



*Circle 31 on Reader Service Card*

## TS ENGINEERING'S TRIGGER

TS Engineering's new TS101 Trigger enables you to drive any Simmons set from drum machines and real drums. With no distortion, clipping, or double-triggering, the Trigger is variable between dynamic following and uniform output. TS102 contact mics (\$20.00 each) give you the luxury of Simmons sounds played from your own drumset without changing playing style, and enables you to mix Simmons and live drum sounds without crosstalk. Studio users include such artists as Stanley Clarke, Phil Ramone, and Earth, Wind & Fire. The price of the unit is \$895.00.

*Circle 32 on Reader Service Card*



## ADVANCED TECHNOLOGY'S LINE MONITOR

Advanced Technology's Model 8100 is a line monitor that allows actual line levels to be viewed on a back-lighted VU meter. Meter sensitivity is front panel selectable with -20, -10, 0, and +8 dBm levels, referenced to a level reading of 0 VU. A multi-selectable front panel switch allows selection from eight different input sources. The input is electronically balanced at 600 ohms. An internal MOSFET amplifier with volume control supplies rear terminals with clean, undistorted amplified output.



The user simply attaches an external 8-ohm speaker. A headset amplifier with volume control supplies the front panel headset jack with ampli-

fied output for private listening. The 8100 is 19-inch rack-mountable and is available from stock for \$695.00.

*Circle 33 on Reader Service Card*

## GARFIELD'S LOW COST SYNCHRONIZER

Garfield Electronics' new Mini Doc Synchronizer is a low cost companion to the industry standard Doctor Click. Mini Doc simultaneously coordinates timing for sequencers, drum machines, and arpeggiators from Roland, Oberheim, Sequential Circuits, Linn, Korg, Moog, E-mu, Synclavier, Fairlight, Simmons, Wave PPG, and MXR. Mini Doc's two independent clock circuits control arpeggiators in 22 synchronized rhythms. With Mini Doc, all instruments sync to tape.

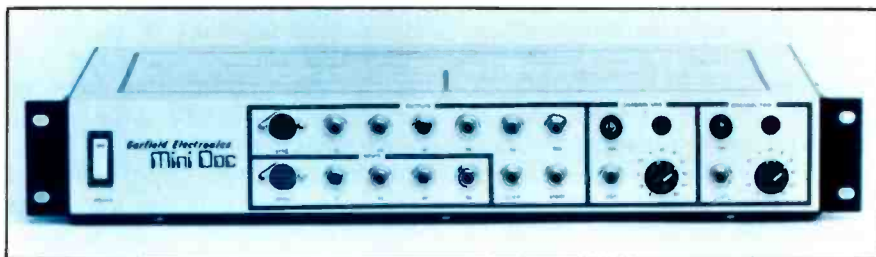

Mini Doc also generates individual triggers from audio. Inputs, outputs, and other controls are on the front

panel, and Mini Doc mounts in the standard 19-inch EIA rack. Suggested retail price is \$595.00.

*Circle 34 on Reader Service Card*

## HARDY'S MICROPHONE SHOCK MOUNT

Hardy Technologies' "The Silencer™" is a microphone shock mount for both stage and studio. It is designed to cut down on stage induced vibration and rumble. The Silencer™ fits all standard stands or booms and features a three-inch Neoprene foam shock insulator contained in a tough Lexan® housing. The unit's suggested retail price is \$19.95.

*Circle 35 on Reader Service Card*



## YORKVILLE SOUND'S TIME-ALIGNED REFLEX ENCLOSURE

Yorkville Sound's Traynor CS-150H is a two-way, time-aligned reflex enclosure. The design was produced by the computer at R.C.F.'s acoustic R&D facility in Reggio Emilia, Italy. Since the CS-150H is likely to see a predominance of sound reinforcement usage, its exterior is sheathed in heavy gauge vinyl and aluminum edge extrusion with an aluminum grille screen for the speaker. Under the vinyl and aluminum is 3/4-inch, 13-ply Baltic birch. The speaker, a 15-inch, RCF model L15/554, is nominally rated at 200 watts rms featuring deep excursion capabilities resulting in an extremely low reso-

nance for this type of speaker—32 Hz. Sensitivity is 102 dB peak-to-peak at 1 watt, 1 meter, and the high frequency rolloff is 4 kHz. The horn, an RCF H3709 exponential, is cast aluminum with a 120 degree by 110 degree dispersion pattern at 10 dB down. This is coupled to an Emilar EC-175 compression driver regulated by a modified Chebishev second-order crossover at 4 kHz. Bi-amp inputs are included along with a horn attenuator. Effective bandwidth of the CS-150H is 60 Hz to 16 kHz; dimensions are 26 inches by 19 inches by 18 1/2 inches, and the unit weighs 85 lbs.

Circle 36 on Reader Service Card

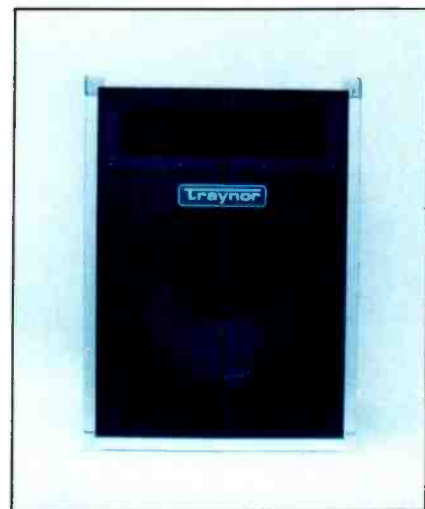

## NEW KORG EFFECTS MODULES

Korg's new Analog Delay, Noise Gate, and Phaser effects modules have been added to the expanding Korg PME-40X effects system. The Korg PME-40X system includes a compact, lightweight, and rugged floor-mounted console that holds up to four effects and features exceptionally quiet electronic switching. Existing PME-40X effects initially included Stereo Chorus, Stereo Flanger, Overdrive, Compressor, Distortion, Graphic EQ, and an EXT Selector module for patching in additional outboard effects. The new Korg KAD-301 Analog Delay module features a delay range of 20 to 300 milliseconds, which can produce anything from a subtle doubling sound to long echo effects with low distortion and excellent clarity. The Analog Delay's two outputs can be used with the PME-40X's stereo outputs for routing to two input channels or amps for sweeping panoramic effects. The new Korg KNG-101 Noise Gate module uses special filtering circuitry to eliminate unwanted noise from an instrument's signal. A unique Release Time control adjusts the rate at which the sound is cut off, from a subtle slope to a sudden stop with no residual noise. The new Korg KPH-401 four-stage Phaser module produces an unusually thick phasing effect. A special Manual control determines the center frequency of the effect and works together with the unit's feedback control for a unique, fat phasing sound.

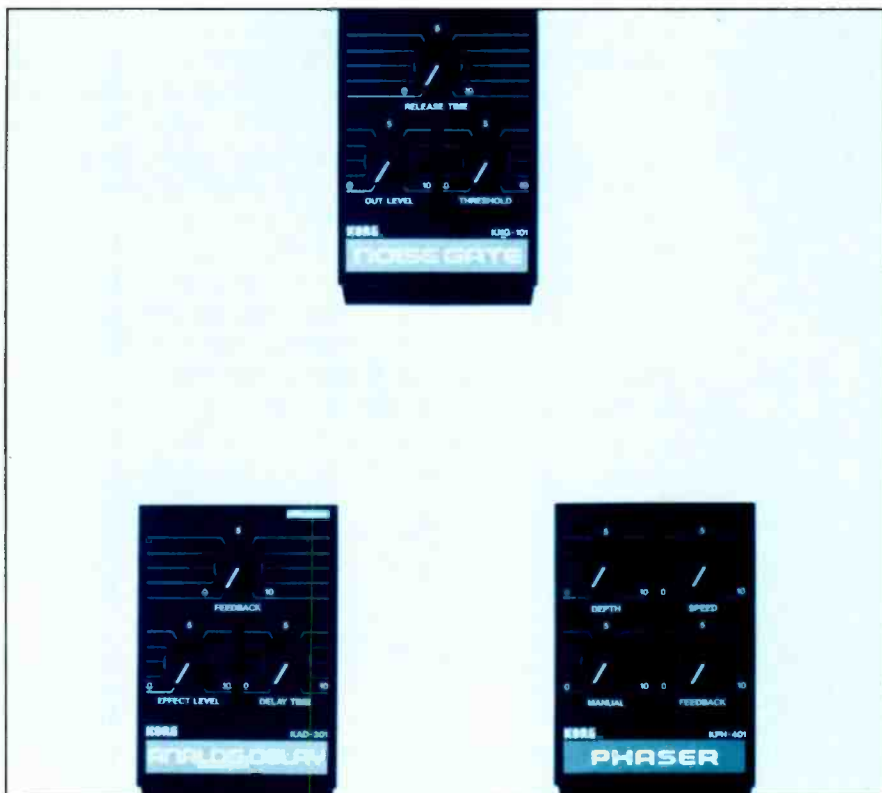

the unit's feedback control for a unique, fat phasing sound.

Circle 37 on Reader Service Card

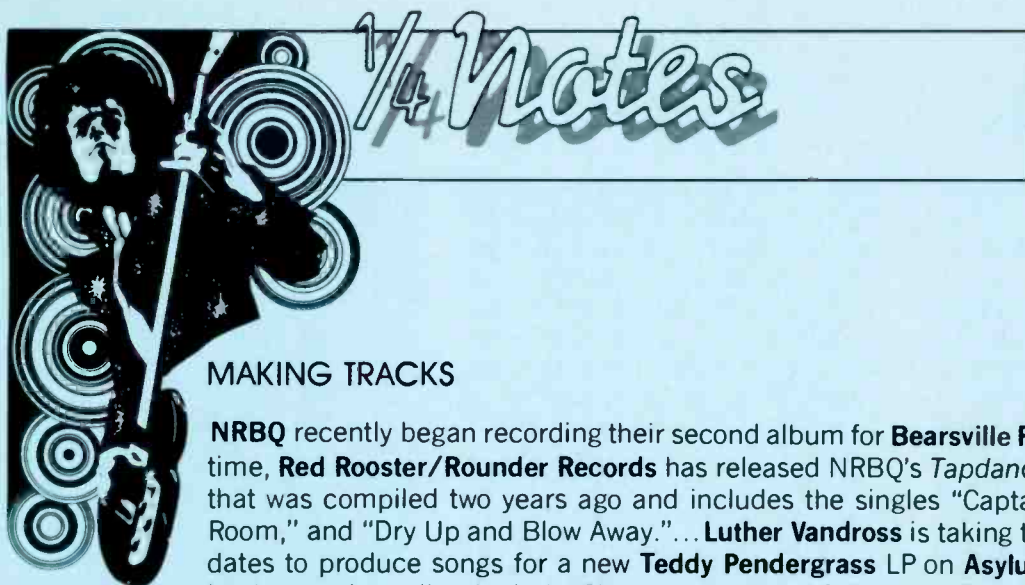

## MAKING TRACKS

**NRBQ** recently began recording their second album for **Bearsville Records**. In the meantime, **Red Rooster/Rounder Records** has released NRBQ's *Tapdancin Bats* LP, an album that was compiled two years ago and includes the singles "Captain Lou," "Rats in My Room," and "Dry Up and Blow Away."... **Luther Vandross** is taking time off between tour dates to produce songs for a new **Teddy Pendergrass** LP on **Asylum Records**. Possible background vocalists include: **Cissy Houston, Fonzi Thornton, Tawatha, Nick Ashford** and **Valerie Simpson**... At **Unique Recording Studios**, horn section **Chops**, whose credits include the recent **Rolling Stones** release and the **Police's** world tour, are recording their debut album for **Atlantic Records**. **Marvin Daniels** and **Fred "Funkii" Mills** are producing. **Chris Lord Algae** is engineering with **Thomas Lord Algae** assisting. Former **New York Dolls** member **Sylvain, Sylvain** is cutting tracks for **Body Rock Records**. **Tom Silverman** and **Robin Halpern** and **Cathy Gazzo** assisting... International reggae artist **Judy Mowatt**, formerly of the **I Three's** (Bob Marley's background vocalists) is mixing her album at **Kajem**. **Skip Drinkwater** is producing with engineer **Mitch Goldfarb**. Also at **Kajem**, **Brave New World** was produced by **Steve Doughty** for **World Records**. **Joseph Alexander** engineered; utilized in the mix was a prototype Maxi-Spective Ambient Synthesizer designed by **Kurt Schweiker**... **Percy Jones** has formed **Stone Tiger** with **Bill Frisell** on guitar, **Dougie Bowne** on drums. They are currently preparing to record their first album and are performing dates in the northeast area... **Bernard "Pretty" Purdie** is writing a suite together with **Galt McDermott** (Hair). The suite will be recorded and released in 1984... The **Look**, a Detroit based band, has released *Everybody's Acting*, their **Fantasy Record** debut. Producing the album was **Paul Kaffel**... Columbia Records is set to release *Footloose*, the original motion picture soundtrack album from the Paramount Pictures feature film, *Footloose*. The title track and single is performed by Columbia recording artist **Kenny Loggins**... On Columbia Records, the beginning of this year has brought releases by **Dan Fogelberg, Bill Nelson, The Clash**, and **Eddy Grant**... On the video scene: **Sony's** video software operations and **EMI's** Picture Music International have just concluded a deal. The arrangement enables Sony to issue video 45s on eleven major rock acts, two major R&B acts and an assortment of other music video projects. Included are videos by **David Bowie, Phil Collins, The Motels, J. Geils Band, Thomas Dolby** and others... Sony is about to release the uncensored version of David Bowie's "China Girl." It will be included on a Sony video 45 along with "Let's Dance" and "Modern Love"... **Christine McVie** completed concert taping to air on MTV. McVie has also released her first solo album for **Warner Bros.**, *Christine McVie*.

## ON THE ROAD

Presently out on concert tours are Columbia recording artists **Luther Vandross, Adam Ant**, and **Quiet Riot**. Coming up this spring are tours by the **Jacksons** and **Culture Club**... After a successful concert swing in Europe, **ZZ Top** is back in the U.S. ready to begin the second leg of its tour... **38 Special** has kicked off their Tour de Force in support of their new album by that title. The tour extends through August, taking them to Europe and Japan... **Billy Idol** is planning a tour for early 1984. He's already been out there warming up, as seen at a recent show at Fordham University...

# & MUSIC...



**DIANA ROSS: *Ross*.** [Gary Katz, Ray Parker Jr., and Diana Ross, producers; Larry Alexander, Steve Halquist, Ray Parker Jr., Daniel Lazerus, Wayne Yurgelun, and Andy Hoffman, engineers; recorded at The Power Station, New York, Ameraycan Studios, California, and Soundworks Studios, New York; mastered at Masterdisk, New York, by Bob Ludwig.] RCA-AFL1-4677.

**Performance:** The singer lessened its impact

**Recording:** Digital and analog; what more can I say!?

If you are one of those people who need further proof of digital audio's virtues, you may want to take a listen to Diana Ross's latest LP, *Ross*, which features digital recording technology juxtaposed against analog recording technology.

The analog portion of the set was produced by Ross and Ray Parker, Jr., the Cosmopolitan "bachelor of the month" type who does everything in the record-making process—from writing to engineering. The digital portion was produced by Gary Katz, whose most famous client is, undoubtedly, Donald Fagen. Fagen's album, *The Nightfly*, holds the honor today of being the best digitally recorded pop album. But while Katz's antiseptic, close mic'ed timbres and sophisticated harmonic structures work well for Fagen, they go nowhere for Ross. Katz, in this production, has brought together songs by ex-Doobie brother Michael McDonald and, of course, Fagen.

McDonald's "That's How You Start Over" begins quite promisingly with a gospel-tinged piano solo that is made more palpable thanks to a quiet RCA pressing. It builds interest when the bass, guitar, drums and horns kick in. But when Diana Ross enters, with her laid back, whispery vocal style, the promise is transformed into pure disappointment. A song of this sort requires a full,

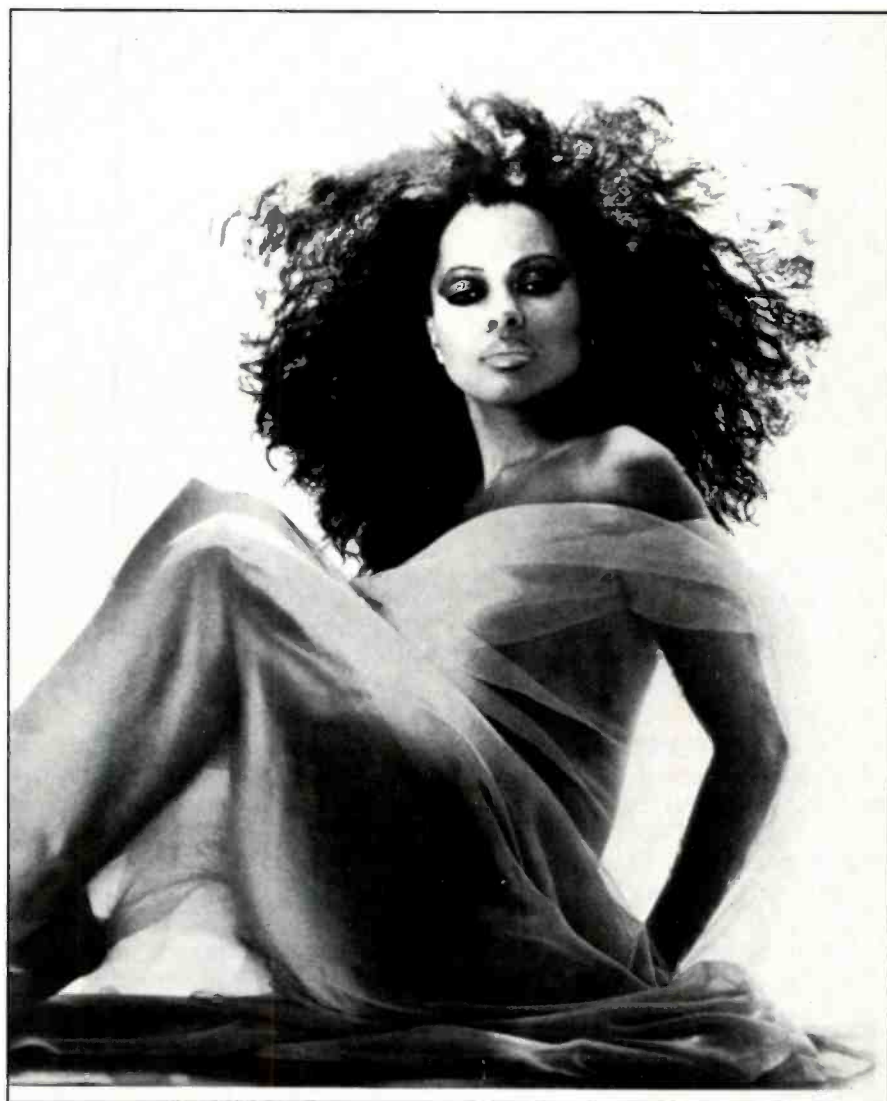

expressive voice—like Jennifer Holiday's—to make its simple, down to earth advice of letting go seem genuine. Fagen's "Love Will Make It Right," whose orchestration is a bit darker, once again finds Ross at the losing end. Irregular drum accents and unexpected melodic contours (characteristics of Fagen's songs) overpower the singer's restrained vocals. "Let's Go Up," with its walking bass line, seems, at first, like something she could handle. But

when the pulse speeds up and she reaches for higher notes, singing: "Let's go up/Forget about down..." her voice once again falters, and the music leaves it in the dust.

Ross fares better with Ray Parker Jr.'s material. His tune of questionable dedication, "Love Or Loneliness"—a mid-tempo funkier with a narrow emotional range—gives Ross's voice (finally!) something it can handle. In the chorus, which demands a sexually charged delivery, her whisper fits.

Parker's "Up Front," a big, brash guitar-oriented rocker, however, places Ross back at her familiar vocal disadvantage, as does "Girls," the song she produced that attempts to motivate women listeners.

The question I had to ask myself while listening to *Ross* is: Why the heck didn't Diana Ross get the entire album digitally recorded? During the gaps on an all digital record, tape noise isn't noticed very much; during the gap between a song recorded using the digital format followed by a song recorded using the analog format (as was the case with "Let's Go Up" and "Love or Loneliness"), a sudden, sharp entry of tape noise is brought into prominence. Moreover, the digital stuff possesses more presence and high-end punch.

For her next album, Diana Ross should select songs that highlight her natural emotional evocativeness—instead of her lack of dazzling vocal technique—and record it *all* digitally.

havelock nelson

**BOB DYLAN: *Infidels*.** [Produced by Bob Dylan and Mark Knopfler; engineered by Josh Abbey; recorded by Neil Dorfsman; mixed and re-mixed by Ian Taylor; Frank Dickinson, digital engineer; mastered by Ian Taylor and Bill Kipper at Masterdisk, New York City; recorded at the Power Station, New York City.]

Performance: **Inspired and inspiring**  
Recording: **Clean and cleansing**

Devoid of excessive instrumentation, rife with imagery, the strength of *Infidels* lies in an unhurried, unhurried presentation that is reinforced by its rustic simplicity. Betraying no concessions to trendiness, the eight songs reflect the latest stage of Dylan's spiritual journey, and show the development of religious ideals as they are seen in earthly terms and situations.

Like a meeting of the country mouse and his city cousin, guitarists Mark Knopfler and Mick Taylor provide amiable accompaniment and create the musical framework for the album. Reinforcing the songs with non-competitive, understated lines that nonetheless let the personalities of the two unique guitarists shine through, Knopfler's sliding chords shimmer beside the sustain of Taylor's



the semi-complicated phrases (such as the chorus of "Jokerman"). If only for the moment, Dylan doesn't seem to be wrestling with the Muse, but peacefully obedient to her dictation.

*Infidels*, resplendent in its calm intensity, seats the listener dead center in a hurricane.

susan borey

**STEWART COPELAND: *Rumble Fish*** (Motion picture soundtrack). [Produced by Stewart Copeland; engineered by Robin Yeager; tape operator, Gordon Lyons; recorded at Tres Virgos, San Rafael; additional recording at Long Branch Studios, Tulsa, Oklahoma; engineered by Bill Belknap; and at Zoetrope Studios, San Francisco; engineered by Richard Beggs and Kathy Morton; mixed at the Worried Rabbit, Ninevah, Assyria; engineered by Jonney Jeronymides; mastered by Bernie Grundman at A & M Studios, Hollywood.]

Performance: **Cultured and creative**  
Recording: **Clean, full-bodied**

Able at last to step out from behind the Police's drum kit, Stewart Copeland shows considerable skill at weaving his fine sense of rhythm into the warp of melody to produce this tapestry of a soundtrack. A clean and sensitive production makes the full range of sounds accessible, even when both ends of the spectrum—ranging between the deep, pipe organ-like sounds of mooring string tones and the brittle tinkling of tuned percussion—overlap.

Lyricaly, *Infidels* offers some of the most unstrained lines the poet has produced; images, intense on their own, are reinforced with poetic craftsmanship. Often bordering on the axiomatic, they are sometimes posed beside blunt, matter-of-fact lines that have an equally effective charm. Political themes are broached in a straightforward manner and then ornamented with imagery, as in "License To Kill," which paints a portrait of a war machine-bred politician. Justaposed with this is the image of a woman seen in various postures of bewilderment about safeguarding herself (and the world) against the man's madness.

There is an aura of relaxation conveyed on the album, and it is clearly reflected in Dylan's voice. No hesitancy here; there's a steady approach taken toward each note, and no temerity is apparent, even on

*Rumble Fish* definitely was created from a percussionist's point of view, but it is not merely an exercise in rhythmic abandonment. With his regular trio, Copeland has ventured into non-Western music, and an association with rhythms unfamiliar to most rock 'n' rolled ears surfaces on *Rumble Fish* with a myriad of off-kilter, stumbling beats. Sometimes steadied by solid frameworks, they often are left on their own, like the percussive introduction to "Hostile Bridge To Benny's." In fact, Copeland zooms in on, and fleshes out, off-rhythms and plays them against rhythms that are ingrained on Western ears e.g., the banjo theme that counterpoints another

rhythmic figure in "Tulsa Rags," and ends with impeccably recorded exploding bottles.

A few of the songs follow a formula that finds the rhythmic shadowplay anchored by bass parts that are played on the piano's low notes as well as on bass guitar, including "West Tulsa Story" and "Party at Someone Else's Place," which carries the slightly sped-up sounds of people reveling against a claptrack.

There are many pensive, spacious moments on *Rumble Fish*, like the saxophone-laden "Our Mother Is Alive." The saxophone is one of the few instruments Copeland does not play on a record that finds him manning piano, guitar, Fender bass, double bass, keyboard and rhythm synthesizers, tuned percussion, drums, kazoo and typewriter.

One of the composer's strong points is his ability to combine wildly diverging types of music. This is evident on "Brothers On Wheels," where motor-like machinery is overlaid with whimsical finger-picked guitar, slightly atonal French horns, and textural strings.

One motif that Copeland cavorts with on *Rumble Fish* is the reggae keyboard. In one case ("Hostile Bridge To Benny's"), it is strangely enveloped, perhaps recorded backwards. On "Personal Midget/Cain's Ballroom," the reggae backdrop sounds like a calliope, giving a dreamlike quality to the song. With its highly processed arpeggiated guitar chords, deep and stringlike bass, and full tilt finale, this is the most Police-like cut. Most of *Rumble Fish*, however, clearly indicates Copeland's ability to stand on his own as a composer and performer, just as this soundtrack album, musically, stands on its own.

susan borey

**JAMES BLOOD ULMER: *Odyssey*.**

[Produced by Ulmer; engineered by Larry Alexander; recorded at the Power Station, New York. Mastered at CBS Recording Studios, New York on the CBS DisComputer System by Vladimir Meller.] Columbia BFC 38900.

Performance: **Refreshing, a pioneer's work**

Recording: **Fine**







Columbia Records is the one major label that comes to mind which presently records pioneering im-

provising artists, and even Columbia fills the bill with only a small showing. Other than Wynton Marsalis, the young trumpeter positioned by Columbia to lead bebop into the future, and the alto saxophonist Arthur Blythe, there is only James Blood Ulmer, the guitarist who constitutes heroism of a somewhat different sort. When one considers all the wonderful talents inching along with one-shot labels or no labels at all, it becomes clear how Ulmer can be the substance of a good argument to other labels to support like-minded musicians. Thankfully, those warring on the front have potent ammunition; Ulmer's albums—and *Odyssey* (his third for Columbia) leads the pack—are great.

While the recordings which brought Ulmer to critical light, those for Artists House and Rough Trade, were outgrowths of his work with Ornette Coleman's harmolodic unit, the first two for Columbia, *Free Lancing* and *Black Rock*, foreshadowed what is now apparent on *Odyssey*: Aside from the stimulating changes brought on by a new band, Ulmer is courting not just the blues, but its earliest forerunners as well.

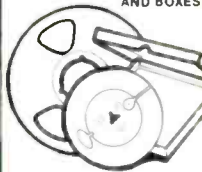
For his new trio, Ulmer has changed drummers, now employing Warren Benbow, and swapped a bassist for violinist Charles Burnham. The new instrumentation clearly allows Ulmer a breadth of arranging possibilities wider than had been possible. While the interplay is still limited to that of three musicians, the supportive melodic and electronic possibilities made newly available by the violin play a marked role in the success of Ulmer's newest concepts.

Although he never completely casts aside his penchant for the jagged edges of harmolodics, Ulmer's naturally rough sound can assume an easy momentum at times. "Love Dance" and "Swing & Things" are instrumental pieces featuring melodies and rhythms like those at the foundation of today's country music. The progenitors of country proceeded only after having been provided with blues rhythms by the children and grandchildren of former slaves. "Little Red House" and "Please Tell Her" seem to confirm Ulmer's desire to make these origins clear, offering vocals reminiscent of field songs as well as early blues forms. "Are You Glad To Be In America?" is Ulmer's remake of his own song only three years after the fact, but the possible

CONNECTORS AND MICROPHONE CABLES 	 BLANK-LOADED AUDIO CASSETTES
 TAPES & CASSETTES from AMPEX    MAXELL AGFA     TDK BASF     3M	EMPTY REELS AND BOXES 
 NAB BROADCAST CARTRIDGES	CASSETTE BOXES, LABELS, ALBUMS 
ACCESSORIES 	

Ask for our  
**44 PAGE CATALOG**  
of  
**PROFESSIONAL  
SOUND RECORDING  
& DUPLICATING SUPPLIES**

Recording Supply Div. of Polyline Corp  
1233 Rand Road, Des Plaines IL 60016  
(312) 298 - 5300

35

**INVEST IN A  
SOUND FUTURE**  
YOUR CAREER IN THE  
**MUSIC INDUSTRY**



in a 2 year professional training program in the  
**RECORDING  
ARTS AND SCIENCES**  
80 courses in  
• RECORD PRODUCING  
• SOUND ENGINEERING  
• MANAGEMENT  
80% of graduates placed.  
Limited Internships available.  
For courses starting Oct/84  
**APPLY NOW!**  
For application FREE brochure describing courses and tour of the facilities visit the institute  
225 Mutual Street  
Toronto, Ontario  
Canada M5B 2B4  
Phone: (416) 977-9797



TREBAS INSTITUTE OF RECORDING ARTS

Circle 26 on Reader Service Card

interpretations are numerous as ever, and Ulmer doesn't sound any too enchanted about his particular version.

Ulmer produced this album to best highlight his new arrangements. The trio is very much a cohesive unit, and to Ulmer's specifications, the engineering has kept the violin right along side the guitar. The drums are afforded partnership here by crisp pick-up in the studio and prominent stance in the final mix. There is no technical gimmickry here; everything has been undertaken simply in support of accurately recording a very human, very important album.

michael fishman

**VARIOUS ARTISTS: *Almost Forgotten*.** [Jim Fishel, producer; Arthur Kendy, engineer; unknown recording site.] Columbia FC 38509.

**VARIOUS VOCALISTS: *Singin' Till the Girls Come Home*.** [Jim Fishel, producer; Marty Greenblatt, engineer; unknown recording site.] Columbia FC 38508.

Performance: **Largely forgettable**

Recording: **Typical for quality jazz sessions of the early Sixties**

I'm beginning to suspect that the phrase "all material is previously unreleased," which graces the back covers of these albums, raises more questions than it answers. These two releases are part of an effort by Columbia to dig deep into their jazz archives and release material under the logo of the "Contemporary Masters Series." If these two records represent the work of jazz "masters," bring on the slaves.

There are several explanations as to why Columbia initiated this series. Let's be kind and assume that hundreds of historically valid and musically exciting tapes have been overlooked over the years. A less kind possibility is that a series like this makes for a profitable coup, since we consumers are forever hearing how the poor record companies just can't turn a big enough profit margin. Reissues are cheap to manufacture and potentially yield high returns—particularly if the ill-informed public *really* believes that Columbia has unearthed magnificent old performances.

Let's examine the better of these two disasters. *Almost Forgotten* opens crisply enough with the Dave Bailey Sextet doing a bop tune propelled by some acidly taut blowing by trumpeter Clark Terry. Curtis Fuller sustains a molasses-thick tone on trombone and drummer Bailey does a workmanlike job keeping the rhythm section moving. Nothing spectacular, but a perfectly fine effort. This is followed by a completely disgraceful Coleman Hawkins/Clark Terry Quintet version of the classic "Ain't Misbehavin'," with the most feeble and idea-free sax solo I've ever heard from Hawkins. The Pony Poindexter Nonet does a blue dirge that is only saved from total tedium by a restrained Eric Dolphy alto sax solo. Side one closes with a very immature Wes Montgomery guitar solo framed by the equally immature playing of his brothers.

Side two is a slight improvement. Two well-executed jazz waltzes nearly redeem this record. Randy Weston is rhythmically clever playing with Johnny Coles on "Babe's Blues" while an English sax player, Tubby Hayes, proves himself deserving of more reissues. The J.J. Johnson Quintet does the familiar "Bag's Groove" with the usual swing and precision. The total clunker on this side is an arrangement of Thelonious Monk's "Well You Needn't" for a big band led shoddily by Slide Hampton. I wish Hampton had followed the advice implicit in the song title. Everyone sounds sour and the whole effort misses the economy and wit of the Monk original.

As generally lackluster as *Almost Forgotten* is, it is a veritable masterpiece compared to *Singin' Till the Girls Come Home*. What can a jazz reviewer say about an anthology of jazz vocals which opens with *Tony Bennett*???? I suppose that the justification for this gaffe comes from the fact that Bennett is backed on his three cuts by a stellar band led by tenor sax master Stan Getz. But even remarkably delicate playing by Getz cannot goose Bennett into sounding like a jazz singer. In short, Bennett, in spite of his various virtues, cannot make a song *swing* to save his life. He gives the same glitzy pop sheen to a slow ballad like "Just Friends" as he does to the upbeat "Have You Met Miss Jones." His delivery is too woodenly contrived to even follow the rhythms

put down by bassist Ron Carter and drummer Elvin Jones.

Lest one believe that the Bennett/Getz band mismatch was simply a singular lapse in taste, wait until you hear the Carmen McRae/Louis Armstrong duets which follow. Both are forced (at gunpoint [?] one wonders) to do justice to the banal and insipid bourgeois lyrics by Dave Brubeck, whose band almost limpwristedly backs these songs. During one stanza of "You Swing Baby" McRae actually sings to Satchmo, the hippest trumpeter and vocalist to grace our jazz landscape: "Although you talk those hip cliches..." I can't understand why McRae and Armstrong didn't walk out of the studio at that juncture to throw up. "Good Reviews" has Armstrong voicing agreement to McRae's assertion that "There's nothing like a good review to make our lives complete." Bet you never knew that was what Armstrong needed to make his life complete.

Side two is an improvement over the first side. Mose Allison does a funky blues full of his characteristically cynical lyrics. Jon Hendricks puts some bite and snap into "Don't Mess Around With My Love" and is heard again in fine form on two decent Lambert, Hendricks and Ross cuts. The album closes with an embarrassingly thin song performed by an obscure group of teenagers who called themselves The Gordons: a jazz-flavored version of the Partridge Family with just that much innocent lack of talent.

Sound quality is quite good on both releases. The only weakly recorded cut on *Almost Forgotten* involves the Montgomery Brothers. Wes Montgomery's guitar is nearly lost in the mix as the drums overwhelm. I would have liked a closer mic'ing of Ron Carter's bass on the Tony Bennett cuts on the vocal anthology record. Then again, I would have preferred hearing Carter tune up to hearing Bennett sing.

I have heard some quality releases on this Columbia series; these are the misses. Maybe by "masters," Columbia really means tapes. Time will tell.

norman weinstein

**MIDNIGHT OIL: 10, 9, 8, 7, 6, 5, 4, 3, 2, 1.** [Nick Launay and Midnight Oil, producers; Nick Launay, engineer; recorded at the Town House, London, England.] Columbia BFC 38996.



Performance: **An experience in chaos**  
Recording: **Sparkling**

Highly political and musically extemporaneous, *Midnight Oil* is as unpredictable as Bob Dylan's religion. Each song on this raw and gutsy album is distinct with frequent shifts in tempo, style, and instrumentation, plus sharp and gnawing lyrics. The Australians leave room for themselves to bend, twist, and mame every structure they erect.

These street rockers take it upon themselves to tell the world what is wrong with it through a balanced blend of psychedelic garage-rock and heavy-handed punk with a twist of folk. Jim Moginie and Martin Rotsey alternate in a grand fashion between acoustic and electric guitars, keeping the listener on edge as to what is coming next within each song, while the vocals of bald singer Peter Garrett border on the edge of hysteria.

Producer Nick Launay shows his deft hand as instruments seem to appear out of nowhere, play a little tune, and then creep back into the shadows. On "Scream in Blue," a shrill, minimalistic guitar leads the way and fades to the sounds of a Spanish-flavored acoustic guitar. From there, a lonely piano intercedes, only to be replaced by a swirling orchestration of synthesizers. All this underneath Garrett's moaning and crooning makes for an effectively chilling ballad.

The same holds true on the album's opening cut, "Outside World." Throbbing synthesizers team up with an alienated violin for an unlikely duet. Drums are introduced as are whirling keyboards for an overwhelming crescendo. All this evaporates and is replaced with reverberating guitars as steady as drops of water. It seems both the Oils and their producer like to play with sounds.

Another favored toy of the entourage is the acoustic guitar, used flamboyantly in a steady, vibrant rhythm. The two songs where this technique is evident are "U.S. Forces," a clearly anti-American military stand, and "Read About It," the only "popular" piece on the vinyl. The latter brings up thoughts of the early Stones with splendid, fluid acoustic rhythm introductions. The former is less snappy, but more thought-provoking.

Two other cuts on the record worth mentioning are "Short Memory" and "Power and the Passion." Both are

## Long Distance Swingers: Hod O'Brien and Zoot Sims

nat hentoff

Hod O'Brien is one of those players who has never won a poll or been featured at a Kool Jazz Festival. He works clubs in and around New York. Some of the customers know that he was a vital part of the bop scene toward the end of the 1950s. Musicians know that he also fitted in with swinging ease, during the 1970s, with such post-bop innovators as trombonist Roswell Rudd. But to most of the listeners in the clubs he plays, he's just a guy who makes you feel good on up tempo numbers, and who can get inside your memories on ballads.

At long last, O'Brien, who has been on many record dates as a sideman, is the leader on his own session, *Bits and Pieces* (Uptown). That puts him ahead of scores... hundreds of underappreciated pianists who may never wind up with their own album. Yet O'Brien plays with such crisp imagination and so resilient a beat that it's hard to figure out why this debut took so long.

The sidemen are drummer Jimmy Wormworth, who *listens* as well as counts, and bassist Teddy Kotick, once a renowned figure on the jazz scene as a frequent associate of Charlie Parker—until he became kind of obscure. But Teddy plays with verve and authority on this new session.

The recorded sound has the immediacy, the vividness, that is most apt for these sometimes swashbuckling bop lines—ranging from O'Brien and Kotick originals to a Tadd Dameron medley.

Unlike Hod O'Brien, Zoot Sims has been a jazz figure of international renown for decades. But in his attitude toward jazz, Zoot has not changed in any fundamental way since his first anonymous gigs. There is no grandstanding, no flashy virtuosity,

and no "fusion." Zoot's pleasures are in swinging time, melodic flow and invention, and what used to be called tasty harmonies. He plays only what he feels like playing, and the audience has to take him on his own straightaway terms.

Musically, Zoot has evolved over time. He leaves himself more space than he sometimes used to; and the result, particularly on ballads, is a delightfully uncluttered view of the theme and the variations. He also has continually strengthened and deepened his own sound and conception. That sound is one of the most satisfyingly whole in all of jazz, as is the conception. Nothing extraneous.

Of all the pianists Sims has worked with on record in recent years, he appears to be happiest—as Norman Granz says in the notes to "*Suddenly It's Spring*" (Pablo)—with Jimmy Rowles. The reason, as Granz adds, is that Rowles is so subtly stimulating "with his original, surprising, almost secretive, harmonic investigations." Add bassist George Mraz and drummer Akira Tana—along with a wondrously "live" recorded sound, one of Pablo's best—and you have an album that will last for generations of listeners.

**HOD O'BRIEN: *Bits and Pieces*.**  
[Dr. Mark Feldman and Dr. Sunenblick, producers; Elvin Campbell, engineer.] UPTOWN RECORDS UP 27.08, 276 Pearl St., Kingston, NY 12401.

**ZOOT SIMS: *Suddenly It's Spring*.**  
[Norman Granz, producer; Jim Crotty, engineer.] PABLO RECORDS 2310-898.

# HAVE A RECORDING STUDIO PROBLEM?

Call *DataLine*  
(213) 651-4944

The Society of Professional Audio Recording Studios, a non-profit organization, offers SPARS members, and non-members referred by a SPARS member, a national telephone 'hot-line.'

Questions regarding any area of recording studio operations including business practices, audio engineering, and technical maintenance will be answered by SPARS-approved sources at no charge.

Want a problem solved? . . . call SPARS—(213) 651-4944



Dedicated to Excellence Through  
Innovation • Education • Communication

## SPARS Board of Directors and Consultants

Murray R. Allen  
Universal Recording  
Corporation, Chicago

Jerry Barnes  
United Western Studios  
Los Angeles

Charles Benarty  
Soundworks Digital  
Audio/Video Studios  
New York

Larry Boden  
JVC Cutting Center  
Los Angeles

Bruce Botnick  
Digital Magnetics  
Los Angeles

Mack Emerman  
Criteria Recording  
Miami

Bob Liftin  
Regent Sound  
New York

Lenard Pearlman  
Editel-Chicago

John Rosen  
Fanta Professional  
Services, Nashville

Malcolm Pierce Rosenberg  
Wolov & Rosenberg  
Philadelphia

Christopher Stone  
Record Plant, Inc.  
Los Angeles

Joseph D. Tarsia  
Sigma Sound Studios  
Philadelphia

David Teig  
New York

John Woram  
Woram Audio Associates  
New York

atypical in their instrumentation and lyrics. "Short Memory" features Garrett's hysteria with a biting Fender guitar plus a piano that is tender and soft. "Power and the Passion" seems to have a little twist of everything from raucous percussion to a synth-simulated brass refrain to quirky funk.

Midnight Oil's lack of continuity may not have the same effect on everyone. Their style is certainly original and will not be confused with other Australian bands like AC/DC and Men at Work. Whether they will achieve the heights of popularity of the aforementioned groups is another matter. It's highly unlikely. But no matter, because Midnight Oil has a sound all its own.

martin basch

**UB40: 1980-83.** ["King" and "Food for Thought" produced by UB40 and Bob Lamb; recorded at Home of the Hits, Birmingham, England 1980; "Present Arms," "One in Ten" and "Silent Witness" produced by UB40 and Ray "Pablo" Falconer; recorded at DeLane Music Centre, Wembley, England 1981; "So Here I Am," "I Won't Close My Eyes" and "Don't Do the Crime" produced by UB40 and Ray "Pablo" Falconer; recorded at Windmill Lane, Dublin, Ireland, 1982; "Dubmobile" and "I've Got Mine" produced by UB40 and Ray "Pablo" Falconer; recorded at Mountain Studio, Montreux, Switzerland, 1983; engineers unknown.] A&M SP-4955.

Performance: **Lively and festive**  
Recording: **Cool, really cool**

When UB40 first came together in the summer of 1978, they couldn't play their instruments. Their name is the number of a British unemployment benefit card. Their first introduction to studio recording was in the confines of a cellar with a homemade eight-track machine. But this anthology of British hits proves that UB40 has come a long way in both the way they play their instruments and their studio techniques.

The beauty of this record is that it traces the band's origin to the present, showing how their production grew lavishly from the early times of Bob Lamb to current producer Ray "Pablo" Falconer. It also is indicative of the group's trail to a more funky sounding approach. Never restrained

in the studio, UB40 takes advantage of echo and reverb, especially on the vocals and horns. Another trademark of the band is the solid and consistent guitar solos that are sometimes piped underneath the horns for a more substantial force.

Side one features the group's earlier work (from 1980 and 1981). "King" and "Food For Thought" are from the UBs' debut *Signing Off*. "King" features a sharp, choppy toy organ that is brought outright along side of the vocals for a splendid performance. We are introduced to the UBs' infatuation with echoes at the end of this piece as the instruments cease and a heavy a capella ends the song. The throaty horn section of the UBs comes alive in "Food For Thought" as traces of guitar—colorful and festive—swim along with the horns, taking turns at centerstage.

Also on this side are three songs from *Present Arms*: the title cut, "One in Ten," and "Silent Witness." The title track features a smashing marching snare intro, top-heavy horn choruses and brilliant cymbal crashes. "One in Ten" is breezy and playful, yet its poignant lyrics about being a government statistic are straightforward and hardened.

The flipside consists of three cuts from *UB44* and two previously unreleased singles. "So Here I Am" is coated with Stevie Wonder influences plus a slick, prominent bass and more complex percussion. This is more of a funk than a reggae number, and it introduces more synthesizers than heard on past recordings. Harmonies and percussion are the mainstays of "I Won't Close My Eyes." The horns and sparse keyboards are kept at a distance as more attention is paid to the vocals.

Previously unreleased, "Dubmobile" is something of a reggae-rap piece. Its fast-paced singing is loaded with echo. Also noteworthy is the dub effect, which sounds as if someone is stopping the record, spinning it backwards and then releasing it.

This "greatest hits" collection of UB40 is a fine introduction for American listeners to a band that has been popular in Britain for a few years. They are both fun and intelligent. If one can't find UB40 imports, this is the album for you.

martin basch

# Classified

# Classified Classified

## THE RECORDING BOOK THAT IS ROCKING THE MUSIC INDUSTRY

"Practical Techniques for the Recording Engineer" by Sherman Keene is endorsed by major Colleges, Universities, Recording Schools, Studios, Musicians and our Correspondence Students around the world. Recommended by reviewers of the MIX, Re/P, Guitar Player and other top publications. THE BOOK: hard cover, 380 pages, 28 chapters (4 on computer assisted mixing), illustrations. \$29.75 (\$31.69 in Calif.) plus \$2.50 shipping.

THE CORRESPONDENCE COURSE: certificate course using two textbooks, corrected and graded homework, unlimited dialog with the author via cassette, Basic, Intermediate and Advanced levels.

THE CURRICULUM: for schools only, Teacher's manual (lesson plans for two textbooks, charts, suggested session content), Student's Workbook, Final Exams.

FOR INFORMATION OR TO ORDER contact:

S.K.P.  
P.O. Box 2519-C  
Sedona, AZ 86336  
(602) 282-1258

Order by phone using Visa or MasterCard by calling (805) 969-6639.

GITARS/FREE DISCOUNT CATALOG: Martin, Ovation, Guild, Dobro, Fostex Multitrack, mandolins, banjos, accessories. Mandolin Bros., 629-MR Forest, Staten Island, NY 10310. (212) 981-3226. Visit our showroom.

---

FOR SALE: 3M 79 2-track—30 + 15 ips, Tascam Model 5 Mixer, several Otari 5050 2 tracks. Priced to sell—Call Jim at (614) 663-2544.

---

FOR SALE: (SEALED FACTORY CARTONS) dbx 150 \$215.00 (2 ea.); Delta-Lab ADM256 \$275.00, ADM4096 \$375.00; EV/Tapco 2230 \$295.00, 5212 \$600.00; JBL E110-8 \$100.00 (2 ea.), E140-8 \$118.00 (3 ea.), 2370 \$80.00 (4 ea.), 2425 \$155.00 (4 ea.); Rane MM-12 \$750.00, Tascam 38 \$1,725.00, M-30 \$825.00, Yamaha MQ1602 \$1,000.00, P-2050 \$240.00, P-2210 \$675.00, PC2002 \$775.00 (2 ea.); JBL and Yamaha monitors; microphones. Barney O'Kelly (614) 268-5643.

- PRODUCTS
- EQUIPMENT
- SERVICES

## Classified Rates

**\$1.00 per word.**

**Minimum \$25.00.**

**Copy must be received at Modern Recording & Music, 1120 Old Country Road, Plainview, NY 11803 by the 15th day of the 2nd month prior to cover date (for example, the April issue closes February 15th). Payment must accompany order. Phone numbers count as 1 word. Zip codes are free.**

## DISPLAY ADVERTISING

**\$40.00 per column inch.**

## Advertiser's Index

Carver .....	9
Carvin .....	30-31
Countryman .....	11
Crown .....	4
DeltaLab .....	24-25
DOD .....	Cover III
Fostex .....	7
Gotham .....	6
LT Sound .....	Cover IV
Orban .....	5
Polyline .....	61
Trebas .....	12
Yamaha .....	Cover II, 1

FOR SALE: Soundworkshop Mod. 1280B, Recording Console \$2,300. New Yamaha Mod. 1608 Recording Console 16 x 8 x 2 w/16tk. Monitor \$5,000. Tascam Mod. 38 1/2" new \$2,000. Scully 1" 8tk. Mod. 280, good condition \$3,000. WILL DICKER PRICE. WILL PAY SHIPPING IN STATES. (801) 258-5350 Joe, P.O. Box 37, Lewiston, UT 84320.

UHER, Sennheiser, Sony, AKG, Beyer, E-V. Send SSAE, Model, Quantity. **CARPENTER SOUND, BOX 1321, MEADVILLE, PA 16335-0821.**

Otari 5050-8D 8-track. Low hours, within specs. wseb for personal in-house production. Also available, custom cabinet for same. Call (312) 889-7550 or (312) 935-9131.

FREE your copy of yesterday's prices on the industry's leading Pro Audio and Stage Lighting Equipment and Accessories Mixers, amps, equalizers, mics, lights, dimmers, lamps, gel and much more. Check our prices before you buy. All-Pro Audio and Lighting, P.O. Box 3992 Centredale, RI 02911. Big Savings from the Smallest State.

BLANK AUDIO AND VIDEO CASSETTES direct from manufacturer, below wholesale, any length cassettes: 4 different qualities to choose from. AMPEX and AGFA mastertape—from 1/4-inch to 2-inch. Cassette duplication also available. VHS T-120's \$6.00. Brochure. **Andol Audio Products, Inc., Dept. MR, 42-12 14th Ave., Brooklyn, NY 11219.** Toll free 1-800-221-6578. NY residents (212) 435-7322, ext. 2.

LEXICON DIGITAL DELAYS—We Carry The Full Line. Ramsa Soundboards, Telex Wireless Communications, H&H, Anvil Cases, Conquest Sound Cables. Plus Many Other Brands. COMPARE OUR PRICES. Write For Price List or Call. **F&L SYSTEMS: (201) 627-3270. 22 Iroquois Ave. Rockaway, NJ 07866.**

AUDIO KITS Active Direct Box, Power Supply, Compressor, Sine Oscillator, more. Pro quality at a kit price. **Gaines Audio, Dept. MR, Box 14099, Rochester, NY 14614.**

SAM ASH MUSIC STORES Mail Order Service. Deal with the professionals. N.Y.C.'s largest inventory and best prices on musical instruments, sound and recording gear. **1-800-645-3518, N.Y. State 1-800-632-2322.**

### SUBSCRIBER SERVICE CHANGE OF ADDRESS

Planning to move? Please let us know six weeks in advance so you won't miss a single issue of MODERN RECORDING.

Attach old label and print new address in space provided. Also include your mailing label whenever you write concerning your subscription to insure prompt service on your inquiry.

MODERN RECORDING  
1120 Old Country Road  
Plainview, NY 11803

Attach  
Label  
Here

▼ New Address Here ▼

Please print

Name \_\_\_\_\_

Address \_\_\_\_\_

City \_\_\_\_\_ State \_\_\_\_\_

Date \_\_\_\_\_ Zip \_\_\_\_\_

# DIGITAL DELAY DIGITAL CHORUS DIGITAL FLANGER



The new 900 series Digital Delay systems from DOD can do much more than just echo effects. ONLY with DOD do you truly get all three delay functions in one unit. The DOD R-908, R-909, and R-910 all have sweep widths of 10 to 1; this allows each unit to flange and chorus like no other digital delay system.

R-908 Digital Delay: PCM (900 ms.-30-8KHZ)  
R-909 Digital Delay: PCM (450 ms.-30-15KHZ)  
R-910 Digital Delay: PCM (1900 ms.-30-15KHZ)

\*When comparing digital delay systems, check the specifications—you will find that the effect specialists at DOD have developed the only full function digital delay systems available today.

\*Note: Most other digital delays have sweep widths of less than 6 to 1.

**DOD**

DOD Electronics, Manufactured in the U.S.A.  
2953 South 300 West, Salt Lake City, Utah 84115  
Telephone (801) 485-8534

# Everyone Says They're Better — We Prove It!



- Time Delay
- Reverberation
- Crossovers
- Tape Noise Reduction
- Compressor / Limiters
- Expanders
- Spectrum Analyzers
- Parametric EQ

Before you purchase another piece of signal processing gear for Studio or Performance use, you would be Wise to listen to our Demo Album. Instead of merely "Saying" we're Better, we Prove It in side by side comparisons with the competition. You really can pay Less and get a Better product through our factory direct sales!

We're out to set new standards for Quality and Performance as well as dollar value. We want you to choose us for our Quality more than our Prices. Our 15 day Satisfaction Guarantee and Two Year Warranty on our Crossovers, Time Delays, Reverberation, Compressor/Limiters, Expanders, Parametric EQ, and Tape Noise Reduction, allow you to purchase with Confidence.

The Demo Album is both fun and Educational. Examples are drawn from the master tapes of Top 40 Hits and show some of the most sophisticated effects ever devised. You will hear our phenomenal MICROPLATE® Reverb with over 18 KHz bandwidth in side by side comparisons with the \$7,000 EMT® Plate on percussion and vocals. No other spring reverb would dare attempt such a comparison! The cost is incredible too, under \$600 mono and \$1,200 in stereo!

Write or call for a free 24 page Brochure and Demo Album.

**LT Sound, Dept. M-2, P.O. Box 338, Stone Mountain, GA 30086**  
**TOLL FREE: 1-800-241-3005 - Ext. 6** In Georgia: (404) 493-1258

## **LT Sound**

**We Make A Better Product**