



Directory:  
Keyboard  
Synthesizers

MODERN

# RECORDING

& MUSIC

SEPTEMBER 1985 VOL. 11 NO. 9 \$2.25

## FOREIGNER

**PROFILES:**  
Corey Hart  
Paul Laurence  
Natalie Cole

01011201PQWEI9  
0985 8707  
MR. D. POMEROY  
193 BALTIMORE ST  
BROOKLYN  
NY 11201

**SOUND ADVICE:**  
At Home In A Club

**POOR RECORDER'S ALMANAC**

**LARRY ZIDE**

Editor/Publisher

**ELAINE ZIDE**

Associate Publisher

**RITA WOLCOTT**

Associate Editor

**SAMMY CAINE**

Technical Editor

**JOHN EARGLE**

Technical Advisor

**CRAIG ANDERTON**

**BRUCE BARTLETT**

**BRIAN BATTLES**

**SUSAN BOREY**

**BOB BUONTEMPO**

**RICK CHINN**

**LEN FELDMAN**

**JON GAINES**

**BOB GROSSWEINER**

**JIMMY GUTERMAN**

**GENE KALBACHER**

**MELINDA NEWMAN**

**JAMES RUPERT**

Contributing Editors

**MERV KATZ**

National Advertising Director

**KAREN COHN**

Layout and Design

**ELOISE BEACH**

Circulation Manager

**SPARTAN PHOTOTYPE CO.**

Typographers

**K&S GRAPHICS**

Graphics

### Key Problems

I enjoyed the Sound Advice column, Piano Mic'ing (*MR&M* June 1985). But one area that hasn't been covered very much is being able to eliminate the high singing noise particularly in studio uprights. American made pianos (mostly upright) have a high treble zone that comes off the bridge, or a pressure plate in which this problem shows up when sensitive mics (partially PZM) are used. This causes a very unfavorable high end (less fundamental tone) which takes away the clarity in the middle and high end range of the piano. Yamaha voicing is different. It gives a more true tone. Maybe you could talk with some top engineer about mic'ing techniques or whatever to bring this problem into perspective. Keep up the good work.

—Burt Teague  
E. Granby, CT

*We sent a copy of your letter off to Susan Borey and Mark Oppat. They are considering it in an upcoming column.*

### Studio Notes

I'm a new subscriber. About a year ago I purchased my first multitrack recorder, a portastudio, and subsequently I've added a variety of outboard processing gear and additional microphones. Recently I "customized" a large bedroom in my house and have begun to make this personal hobby a part-time business.

I'm sure you have a lot of readers that, like me, finance this expensive hobby by selling time in their home studio. Since I don't have the luxury of constructing an area specifically designed for a studio, I have to make the best use of an existing room, basement, garage, or whatever. How can I find out more about adapting existing space to make the best possible studio. Also, I'd like to learn about the business end of running a part-time studio (Do I buy my own equipment and rent it to the studio so if it goes under I won't lose it, tax breaks on using space in your home, recommend basic studio gear for various applications, etc.). I realize I'm asking a lot, but I'm planning on accomplishing a lot. Any advice you can give me will be greatly appreciated.

—Marc E. Diebold  
Indianapolis, IN

P.S. Love the magazine

*Thanks for the kind words. Jim Rupert's semi-regular column, 'Studio Notebook' is written specifically for people in your situation. We'll be happy to pass your specific comments and questions on to Jim. As for adapting existing space for recording, the March, 1985 issue had a feature dealing with small home studios. You might want to check it out...*

**Editor's Note:** Our apologies to Melinda Newman who is a contributing editor for *MR&M*. Melinda's byline was inadvertently left off of the David Foster cover feature (July 1985).

MODERN RECORDING & MUSIC

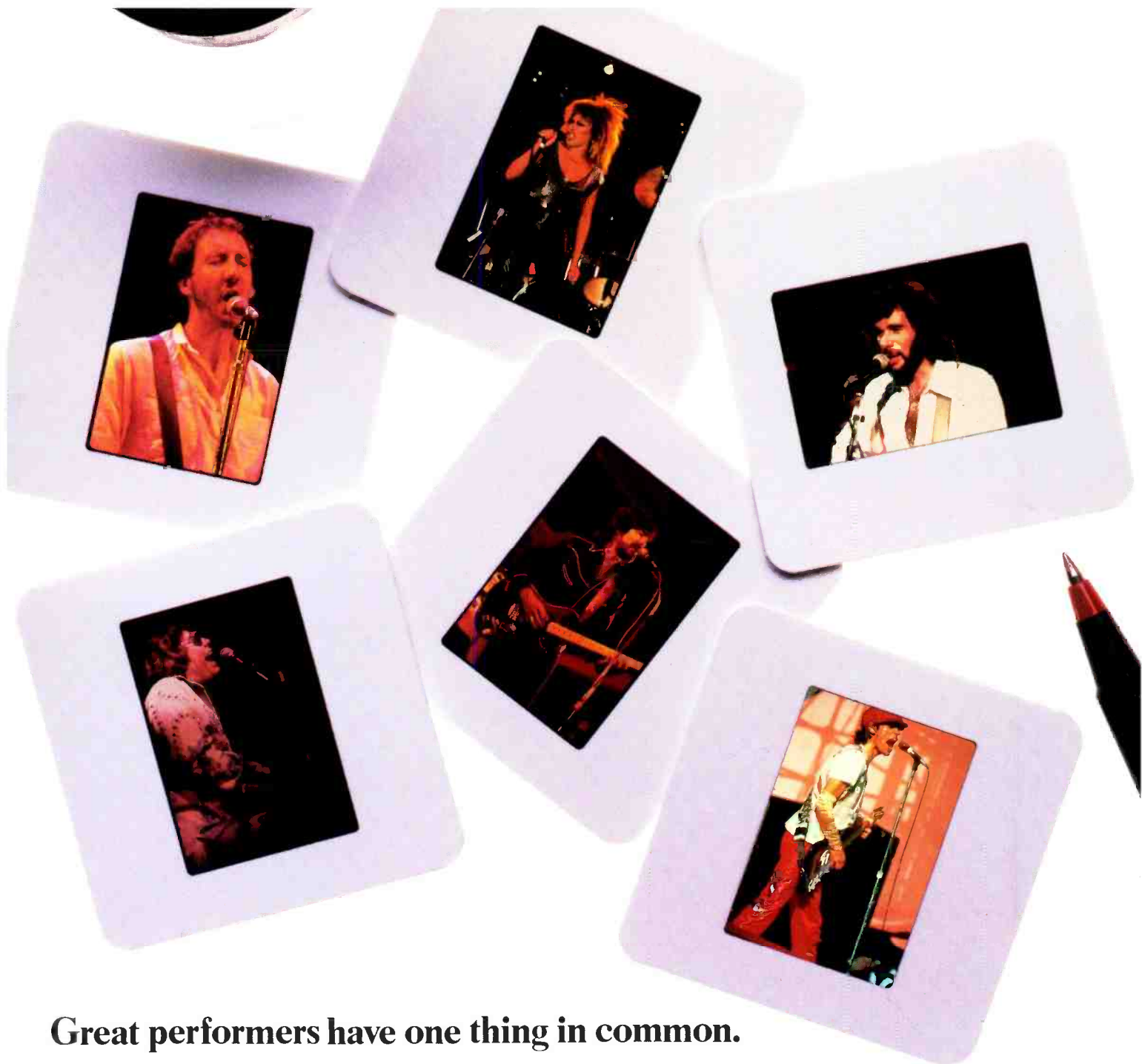

## Great performers have one thing in common.

Mick Jagger, Pete Townshend, Tina Turner, Ronnie Milsap, Eddie Rabbitt, Randy Owen—great performers know their legendary stature depends on the quality of their voices. That makes the purity of vocal reproduction critical. That makes rugged, reliable Shure mics essential.

Shure mics have been the number one choice of top professionals for many years from the legendary SM58 dynamic to Shure's newest trailblazer, the SM87 condenser.

Whether you're on your way up, or you've already made it, don't trust your great performances to anything less than the best—Shure mics.

**SHURE**®  
**BREAKING SOUND BARRIERS**

Circle 13 on Reader Service Card



# Talk Back

## Hot Springs Help

I would first like to say thanks for all the fine articles and projects you've given us in *MR&M*. I think it's wonderful that you share your talent and genius with those of us who are less endowed with electronic understanding.

I am a musician turned home

recordist. Several years ago I purchased your book, *Home Recording For Musicians*, and successfully built the 6 in 4 out mixer minus the EQ and Noise Gate sections. It has served me well through many home sessions and I've never had a single problem with it functioning properly. My

only complaint is that the reverb section leaves much to be desired. I'm not sure if I did something wrong in the construction process or perhaps mismatched some electronic component. In any event, this being my first adventure into the world of do-it-yourself electronics, I've been afraid to go back



## Old faithful.

In a time of changing technology, "newest" often seems "best". While fancy, expensive digital reverbs are popping up right and left, "old faithful"—the Orban 111B Dual Spring Reverb—still offers some unexpected advantages.

The first is *cleanliness*. The 111B offers a decay which is smooth and clean, without buildup of irritating noise and "granular" distortion found in many low-cost digital reverbs.

The second is *simplicity*. The 111B's circuitry is vastly simpler than the circuitry used in the digitals. This can be important in any application where a failure can cost you money or downtime.

Most importantly, the 111B offers the best price/performance value in the industry. Where else can you get quasi-parametric EQ and a protection peak limiter in a *two-channel* unit for \$899? So, if you don't want to spend four figures for a *mono* digital reverb, check out "old faithful": a proven performer with the right sound at the right price.

**orban** Orban Associates Inc., 645 Bryant St.  
San Francisco, CA 94107  
(415) 957-1067 Telex: 17-1480

and try to correct the problem for fear of ruining the entire project. The problem is a scratchy type of noise introduced when any or all of the six channels has reverb added to them. I'm using a reverb spring from a Fender Super Reverb amp.

My question is as follows. I have purchased the PAIA Hot Springs Reverb Kit hoping to solve my problem, but on receiving it I find that I can only use it on one channel or tape track at a time which would mean having to add reverb on basic tracks instead of mix-down or building individual Hot Springs Reverb Kits, one for each input channel. This would be not only cost prohibitive, but also too time consuming.

Is there a way to revise the reverb mixer circuitboard so one would be able to send any or all of the six input channels to the single Hot Springs reverb unit and return the reverberated signals via the mixer reverb return control? I having very little electronics knowledge other than being able to follow instructions. Please help.

Thanks again for all your help and inspiration.

—Terry Wetzel  
Douglasville, GA

*The following is Craig's response. (Please refer to the diagrams in the "Hot Springs" Project in the Oct. 1980 issue of MR&M for a better understanding of the following reply.)*

You can use the Hot Springs with the mixer by feeding the reverb mixer output (point A) to point I on the Hot Springs. Short out or jumper capacitor C8 on the reverb board.

Short point B on the reverb mixer board to ground, and remove capacitor C5 completely from the reverb mixer board. Connect point 0 from the Hot Springs to point C on the reverb mixer board, adjust the Hot Springs input gain trimpot, and you'll be all set.

Even in this digital age, there is a sound the Hot Springs offers that is unique and rather "soft/warm" in effect. You can enhance that sound somewhat by patching a delay line between the reverb mixer output and the Hot Springs input to add pre-delay;

this is covered thoroughly in my "Delay Line Handbook."

I think you will find the Hot Springs considerably better than the reverb circuit given in "Home Recording for Musicians." Good luck with your modification.

### Reverb Reaction

I read with interest Bob's Part I of the Poor Recorder's Almanac (June 1985). First let me say that as I am just beginning to develop a small home studio and am basically ignorant concerning many of the technical aspects of recording and also much of the new auxiliary equipment, I would love to be able to listen to a "sound sheet" so that I can actually hear what this equipment does.

Secondly, I have a question about a reverb unit. Since 90% of my recordings will be from keyboard equipment (my two main units are a Yamaha DX-7 and an acoustic grand) and from a drum machine, will a reverb unit enhance the sound and make it more lifelike?

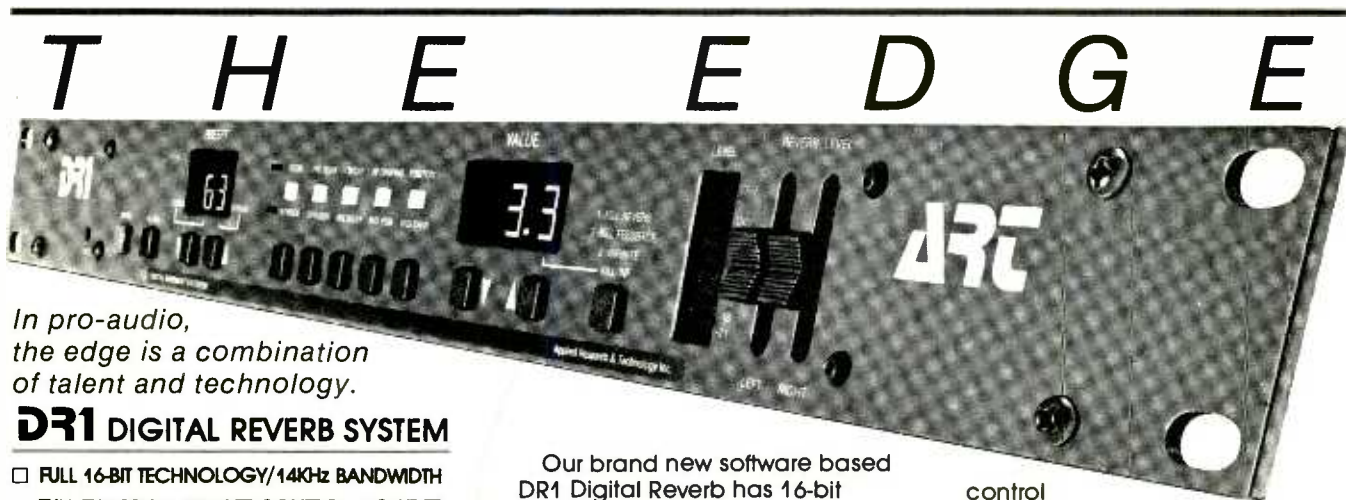

In pro-audio,  
the edge is a combination  
of talent and technology.

### DR1 DIGITAL REVERB SYSTEM

- FULL 16-BIT TECHNOLOGY/14KHz BANDWIDTH
- FULL FUNCTION REMOTE CONTROL INCLUDED
- OVER 100 PRESETS/USER PROGRAMMABLE
- FULL MIDI CAPABILITY
- STEREO IN/OUT/FULL MIX CONTROL
- SOFTWARE BASED/UPDATEABLE

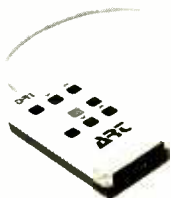

Full  
Function  
Remote Control

Our brand new software based DR1 Digital Reverb has 16-bit technology and 14KHz bandwidth, giving you wide dynamic range and frequency response. This range and response result in high definition performance.

Couple this technology with the convenience of full function remote control, over 100 user presets and full MIDI capability. Add your talent and you've got the edge in high definition.

And that's not all. We've gone several steps beyond by providing stereo in and out with full mix

control and our famous FIR programs so that all the sound you're looking for can be realized.

There's one more thing. Our powerful software is updateable. That means when you buy a DR1 today, you won't lose your edge tomorrow.



**Applied Research & Technology Inc.**  
215 Tremont Street  
Rochester, New York 14608  
(716) 436-2720

■ DR1 DIGITAL REVERB ■ DR1A DIGITAL REVERB ■ DR2 DIGITAL REVERB ■ 1500 DIGITAL DELAY ■ 1/3 OCTAVE EQUALIZER ■ 2/3 OCTAVE EQUALIZER ■ PITCH TRANSPOSER PACKAGE

An additional bit of information you might need to know is that my basic recording unit is a Teac A 3440 with a Teac 2A mixer and a dbx.

—Bob Gordon  
Punta Gorda, FL

*The following reply comes from Bob Buontempo...*

I don't think you'll find any engineer who will disagree that reverb will enhance the sound of your drum machine or synth. Reverb, along with delays, compressors, and gates, are really essential for today's pop music, and, except for some classical or orchestral music, I doubt you can find a contemporary recording that doesn't have at least one of these pieces of gear on it.

Reverb adds depth, size, and warmth to a mix, and the difference between a "wet" signal with reverb and a "dry" one without is sometimes staggering!!

I would suggest that you get the *BEST* reverb unit you can afford. It is usually the most expensive piece of outboard gear that a studio owns. A plate or a digital reverb is the best

way to go so you don't "twang" or "boing" to death with a spring (although there are some springs that do keep these side effects down to a minimum), especially when using your drum machine or a percussive patch on the synth. And try to find one that has a high end that exceeds 8 kHz, something that is next to impossible on most spring units.

But when you find one that you like, I'm positive that you will be delighted with the results.

As far as the "sound sheet," it looks good for the near future, especially if more people write to *MR&M* requesting it.

Good luck, and thanks for writing!!

### Poor Recorder's Error?

There seems to be a small error in Bob Buontempo's "Poor Recorder's Almanac" (July 1985). Unless I've missed something, those fancy lead guitar parts that are to be added live during bouncing are going to wind up hard left and hard right, no matter *how* you set the levels or pan pots. Right?

—Steve Graham  
WUOM-FM  
Ann Arbor, MI

*Bob comes to the rescue again...*

Well, yes and no. If the guitars are added in the order presented in the article, yes, one will be hard left and one will be hard right. The way to get something centered on two tracks panned left and right is to record the IDENTICAL signal SIMULTANEOUSLY on both tracks. Not the same part done twice, as I had noted, but the same part on both tracks at once, the way the bass was done. So yes, you got me on that one. So if one did use the same guitar part doubled, it would appear one track hard left, and one track hard right. However, this is usually thought to be a "Stereo" track, and if it is left heavy, it will appear that the guitar is panned left and is "delayed" to the right, or "travels" left to right and visa versa. This is because your ear perceives volume and time in determining directionality, and is "fooled" into hearing whatever track is louder as happening first, and therefore polarized in that direction. When they are of equal volumes, the image will shift to whatever track does occur first, and constantly change as the player does. This is the way you can create a pseudo-stereo effect. Pan a signal left and pan its delayed return right with slightly less level. It will then appear as a "Stereo" signal, or a doubled signal, "traveling" left to right.

To backtrack a bit, my friend, Les Miller, pointed out to me that there may be some confusion as to what a "Stereo mix of the drums" might be construed, where they should be panned, and on what tracks they should be recorded.

My preference to a stereo drum mix is that of a drummer sitting behind a kit. When using two tracks (track one panned left and track two panned right) this becomes:

High hat—left on track one.

Snare—center on tracks one AND two.

Bass drum—center on tracks one AND two.

Small tom—left on track one.

Middle tom—center on tracks one AND two.

Floor tom—right on track two.

Crash cymbal—left on track one.

Ride cymbal—right on track two.

Some people prefer just the opposite, as if you were facing the kit. Some drum machines don't give you a choice, but, for whatever you decide, remember: assigning to **BOTH** tracks at once will give you the center image.

# EXCITEMENT!



Bring your sound to life with our new Exciter/Imagers. These professional psychoacoustic processors will add clarity, brightness, definition and intelligibility to audio signals, while improving stereo imaging. Increase spaciousness and perceived loudness without actually adding gain or output level.

Our Exciter/Imagers provide greater user control than other exciter type devices, with outstanding performance features. Our unique selectable phase mode offers both frequency enhancement and phase notching, as well as providing tonal coloration that can not be duplicated by simple equalization.

Both the RX1 model and the RX2H will accept direct instrument input, and unlike other exciter type devices, Rocktron Exciter/Imagers WILL NOT increase noise during processing. And only our RX2H includes built-in **HUSH II** noise reduction, making it the QUIETEST psychoacoustic enhancement device available anywhere.

Use our Exciter/Imagers on your guitar or keyboard, live or in the studio, on individual vocal tracks, live sound reinforcement, monitor mixes, broadcast, tape duplication, video sound production, and more.

**And the best thing about this audio wonder . . . is the PRICE!**

See Your Rocktron Dealer.

All products patent pending



2146 Avon Industrial Drive Auburn Heights, Michigan 48057 (313) 853-3055

# If it's worth doing, it's worth doing right.



## We did it right.

It's no surprise that when the key engineers of our PZM® microphone technology set their sights on combining the benefits of the boundary effect with unidirectionality, the fruits of their efforts would be nothing less than superior.

After all, Crown has been leading the way in boundary technology longer than anyone in the industry. And, like the PZM project, our commitment to developing the "premiere" unidirectional, surface-mounted microphone rings true.

Introducing the PCC™-160 Phase Coherent Cardioid™ from Crown.

Designed for easy mounting on a boundary surface, the PCC-160 utilizes a subminiature supercardioid mic capsule to create a directional pattern which improves gain-before-feedback, reduces unwanted room noise and rejects sounds from the rear.

For stage reinforcement, podiums, news desks, or for hiding in sets, the PCC-160 offers superior performance.

And because the microphone is mounted on a boundary, direct and reflected sounds arrive at the diaphragm in-phase. The result...wide, smooth frequency response free of tonal coloration or unnatural sound which can occur with conventional microphones.

Self-contained electronics eliminate the need for a sometimes awkward in-line preamp box. The PCC-160 can be powered directly from the console or other remote power source. Or if battery power is convenient, a battery supply unit can be inserted anywhere in the mike line...right up to the console or mixer.

For maximum flexibility, the

PCC-160 features an exclusive three-way "bass tilt" switch which allows you to tailor, up or down, the low-end response for special applications or unusual boundary sizes.

Due to its low profile and "go away gray" finish, the PCC-160 microphone becomes nearly invisible in use, making it ideal for the stage, newsroom or lectern top.

But beneath its cloak of dark gray, the PCC-160 is protected by a heavy-gauge, all-steel body, tough enough to stand up to even the most severe abuse.

The PCC-160. A microphone meeting the needs of today's sound professional with today's most advanced technology.

We did it right.

Call or write for more information and complete specifications.



Crown International, 1718 W. Mishawaka Rd., Elkhart, IN 46517 (219) 294-8000

Circle 17 on Reader Service Card

# Sound Advice

## The House Engineer:

### At Home in a Club

Some audio engineers are steadily employed by a club or theater as a house, or staff, sound-person. This situation, like all others,

involves a unique spectrum of responsibilities that extends beyond the mechanics of mixing. This month we spoke about being a house engi-

neer with Danny Kapilian, an audio engineer, tour manager, and concert producer who lives in New York City.

**MR&M:** Let's start by explaining what a basic club PA system consists of.

**DK:** You'd have a house mixing console, and sometimes a stage mixing console for monitors. There will be a power supply for the mixing console, graphic or parametric equalization, a crossover network, and outboard gear with effects units, tape machines, and other things of that nature. You will have speaker cabinets for the house, stage monitors, and usually a pair of sidefill speakers and a big drum monitor. The amplifiers that power the speakers and monitors are usually backstage or under the stage. There will be all the wiring necessary to connect everything, and mic input boxes onstage that run out, via the snake, to the mixing console. You'd also have a supply of mics, stands, direct boxes, and your tool kit. Most clubs and theaters have a tech office—a room where spare audio and lighting equipment is kept with tools and lockable cabinets for microphones and other small, expensive things.

**MR&M:** What are the general responsibilities of a house sound person?

**DK:** They are probably threefold. The first is to keep the venue's equipment in good running order,

MODERN RECORDING & MUSIC

### GET CARRIED AWAY~ WITH SECK PORTABILITY

- 3 band EQ with sweep midrange - on each balanced mic/line input.
- 2 monitor and 2 effects sends - 4 sends on each input.
- Full throw faders for complete control.
- Insert points on all inputs - for extra control of your music.
- Rugged wire-less design for road dependability.
- Solos on all inputs and auxiliary returns.
- Powerful headphone monitor amplifier.
- All metal construction - rugged and quiet.

Ask for it at your local dealer - or call (203) 324-2889 for further information. Then, let the music carry you away!



CONNECTRONICS CORPORATION  
652 Glenbrook Road Stamford CT.06906 U.S.A.  
Telephone: (203) 324 2889 Telex: 643678

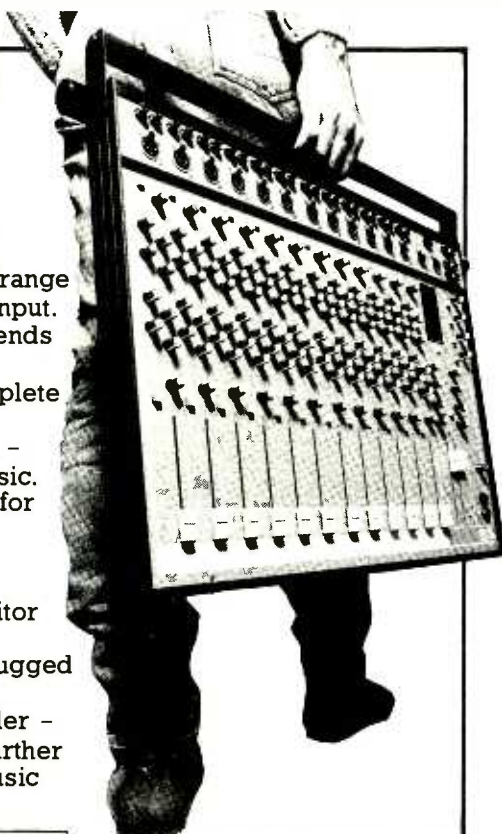



which means being responsible for maintenance and troubleshooting anything that might go wrong. This includes maintaining the mixing console, looking for blown speakers and bad wiring, and keeping an eye on anything that might break, down to the smallest cable.

The list of what can go wrong is endless; it's just Murphy's Law. Dirty pots on the board can cause crackling and noise, or a channel can go out on the board. Microphones can be dropped, and diaphragms have to be replaced. Power supplies for direct boxes and condenser mics can stop working. You can have bent and broken mic stands and bases, constant problems with bad mics and speaker cables, and blown speakers, to name just a few areas of possible malfunction. The house sound person has got to be on top of every bit of that and be able to *quickly* locate exactly what a problem is when it arises. For example, if you lose an instrument during a show you should be able to determine immediately whether something has gone wrong with that channel in the board, if something is wrong with the mic or direct box that

is on that instrument, if the problem's in the snake, or if something is patched wrong. When cables go bad, you've got to know how to solder ends together, and track down problems in the mic box or snake, which might have loose connections or loose pins.

When there's feedback, you've got to be able to pin that down immediately, as well. There isn't a moment to wait because the crowd is right there and they don't want to hear it. Obviously, the first thing you'd do is turn to your graphic e.q. and pull the frequency that's feeding back. Maybe the mic placement is bad, or something is wrong with the level or equalization you're running.

**MR&M:** Do you suggest that the engineer follow a specific procedure for testing the equipment for each show?

**DK:** No. Generally a house engineer will be privy to any lingering problems with the system. Usually, when he or she comes in for soundcheck, the first thing to do is to turn the power amps on, then the board, and the outboard gear after the amps are up. After that, you'd set out mics and DIs in the proper configuration

to accommodate each act. Usually, just before the soundcheck starts, there'll be a mic check, with one person onstage running through the mics after they're patched into the box onstage. The engineer can check these levels through the PA, through the VU meters on the board, or through a headset. You should run through the speakers, too, possibly with a tape, to make sure none of them got blown during the previous show.

**MR&M:** What's the second general responsibility of the house engineer?

**DK:** Mixing shows for artists who do not bring their own soundperson in.

This involves balancing the needs of the artist, the audience, and the club management. Obviously, a house engineer knows his or her system better than anyone else, but sometimes a band will come in and demand that certain instruments should be run at certain levels. Perhaps they'll have an uncooperative attitude about how they want themselves to sound. If they're smart, they'll leave as much responsibility as is possible in the hands of the

## WOULD YOU LIKE A SAMPLER™ FOR LESS THAN \$1,000.00? (SO WOULD 348,000 OTHER SYNTHESIZER PLAYERS!)

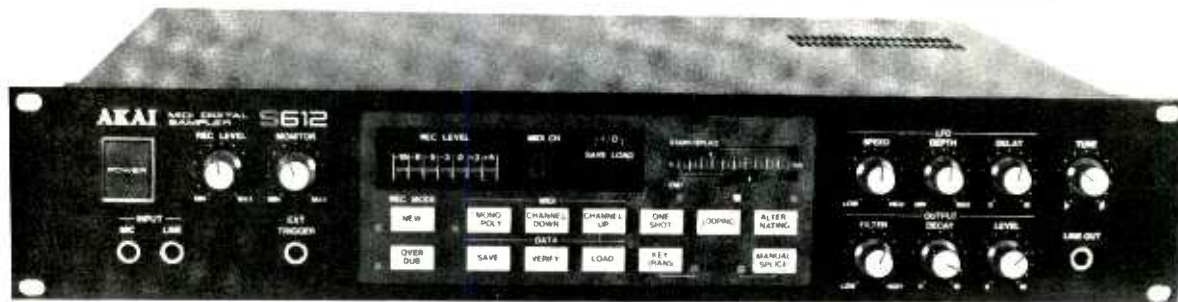

Now the **S-612 SAMPLER™** by AKAI enables thousands of synthesizer owners the freedom of sampling technology without mortgaging their wife and kids! AKAI has introduced and is delivering a 12-bit, 32K Band width, 6-voice SAMPLER™ for \$995.00. Remember, nothing is sacred with an AKAI

612 SAMPLER™. Sample a ... voice, a train, a bell or any analog or digital signal ... and then 8 seconds later be playing it on **any** MIDI keyboard.

Call or write for all the AKAI SAMPLER™ facts and see it at your local dealer.

# AKAI

**AKAI PROFESSIONAL PRODUCTS**  
P.O. Box 2344 Fort Worth, TX 76113  
(817) 336-5114

IN CANADA: **AKAI AUDIO-VIDEO CANADA**  
121 Watline  
Mississauga, Ontario, Canada L4Z1P2  
(416) 890-2300

engineer, who knows how to make the most of the system.

There's a tremendous difference between the way you'd run your system for an acoustic act and for, say, a reggae band. Many of the better known clubs around the country book an eclectic assortment of talent, and that opens up a lot of challenges for a house engineer, creatively, technically, and politically. Creatively, because you've got to open your mind and expand your musical sensibility to all the different kinds of music you'll be dealing with. It's not unusual for a club to have Joe Jackson one night, UB40 the next night, the Washington Squares the next night, followed by the Replacements. The house person has got to be on top of the changes, and sometimes you've got to throw your own personal taste out the window and be open to new music. You've got to be able to maintain the creative sensibility for each different kind of music in order to make every one of them sound great on your one system, which could be bottom heavy, or top heavy, or create weird dead spots in the room. A good engineer can overcome these things.

You need to be on top of everything,

technically. You should know proper mic'ing, amplification, and mixing techniques, and make judicious use of outboard equipment.

As important as the technical and creative aspects of this job are the political aspects. I'm talking about dealing with the artist, their technicians, their tour management, record company personnel, the club management, and the members of the audience. You are responsible for a lot of communication here, keeping open to ideas but knowing when and how to put your foot down about certain things, too, when you know the limits of your system, or when you're sure you really do know the best way to conduct a particular mix. Sometimes you may be doing a job efficiently, and someone's acting like an egotistical ass, telling you how to do your job. Sometimes you don't know who it is that's telling you that in their drunken stupor; it could be some executive from a booking agency. You've got to be a bit of a diplomat, too. The same goes for dealing with the management and personnel who are out with the band. If they come to you with an attitude of any sort, you know you've got to be a real diplomat. If you're not, they may

remember it and, you never know, they could have been your future employer. It's very common for staff sound people at clubs to take the next step of moving out into the tour circuit, picked up by a band who played at their club and remembered that they did a great job.

(Will Danny explicate the third general responsibility of a house sound person? How do you discover what a given band needs? How do you work from a rider? Tune in next month for the answers to these and other questions.)

"Sound Advice" is a question and answer column that focuses on the procedures, products and problems associated with live audio engineering. We cover topics that primarily pertain to mixing in venues that seat less than a thousand, and have geared "Sound Advice" to run on reader input. Do you have a question, a particularly sticky problem, or an interesting experience in the world of sound to share? Pick up a pen and do it right now! Write to:

*"Sound Advice"*  
c/o MR&M  
1120 Old Country Road  
Plainville, NY 11803



# LOFT Performance & Quality.

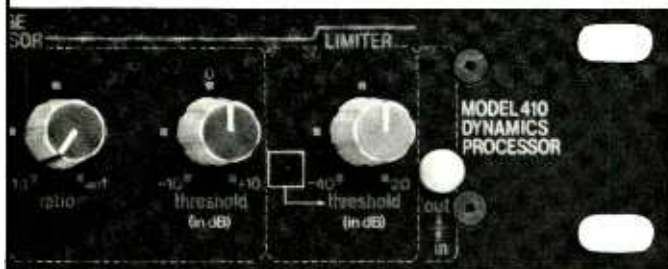

In the audio business two things are important. Distinctive sound and the ability to consistently perform to high standards. These are qualities that make up the LOFT product line. From our earliest product entry, the model 450 Delay Flanger, to our new 410 Dynamics Processor which offers multi-function signal condition-

ing. LOFT audio products give you that performance edge. In order to give you the best prices we sell direct from our factory in the United States. Give us a call for additional information. In the U.S.: call LOFT (203) 649-1199 • Telex: 333666 LOFT. In Canada: Nova Sound (514) 631-5787, International call: J.C. Audio (617) 365-2130, Telex: 951546 J.C. AUDIO.

## PHOENIX AUDIO LABORATORIES, INC.

Box 127, Manchester, CT 06040.

### LOFT PRODUCTS:

- SERIES 600 FREQUENCY DIVIDING SYSTEMS
- MODEL 450 DELAY LINE/FLANGER
- MODEL 601 PARAMETRIC EQUALIZER
- MODEL 400B QUAD GATE LIMITER
- MODEL 410 DYNAMIC PROCESSOR
- SERIES 400 COMPRESSORS

### SOME LOFT USERS:

- |             |                 |              |
|-------------|-----------------|--------------|
| AC/DC       | LONG VIEW FARMS | RUSH         |
| CLAIR BROS. | LOVERBOY        | STEVE HOWE   |
| JOURNEY     | MARYLAND SOUND  | Z LAND AUDIO |
| LE STUDIO   | R.E.M.          | ZZ TOP       |

# NOW THAT DIGITAL IS HERE, A RECORDING STUDIO DOES NEED A PIANO THIS GOOD.

Times have changed.

Digital technology produces recordings of magnificent clarity, full dynamic range, and virtually zero distortion. The piano, to capitalize on this technology, must deliver exemplary tone, timbre, and presence.

Steinway® is the logical choice.

Its expense, however, has tempted some studio owners to consider buying a lesser piano. A fact that many musicians accept with reluctance. When performers sit down at a Steinway piano, they know they are playing the best.

Having a Steinway speaks for the overall integrity of your studio. It also attracts return business. And now it's easier than ever to have one.

## LEASE A STEINWAY \$350/mo.

Steinway & Sons is now leasing new Steinway grands directly to recording studios. A model B leases for \$350.00 per month. This leasing includes an attractive option to buy at the end of the term.

For full details, contact Mr. Ed Bezursik at Steinway & Sons, Steinway Place, Long Island City, NY 11108. Or call him at: (718) 721-2600.

Be sure to visit the Steinway Suite at this year's Audio Engineering Society (A.E.S.) Show, New York Hilton Hotel, October 13-16.

STEINWAY & SONS 

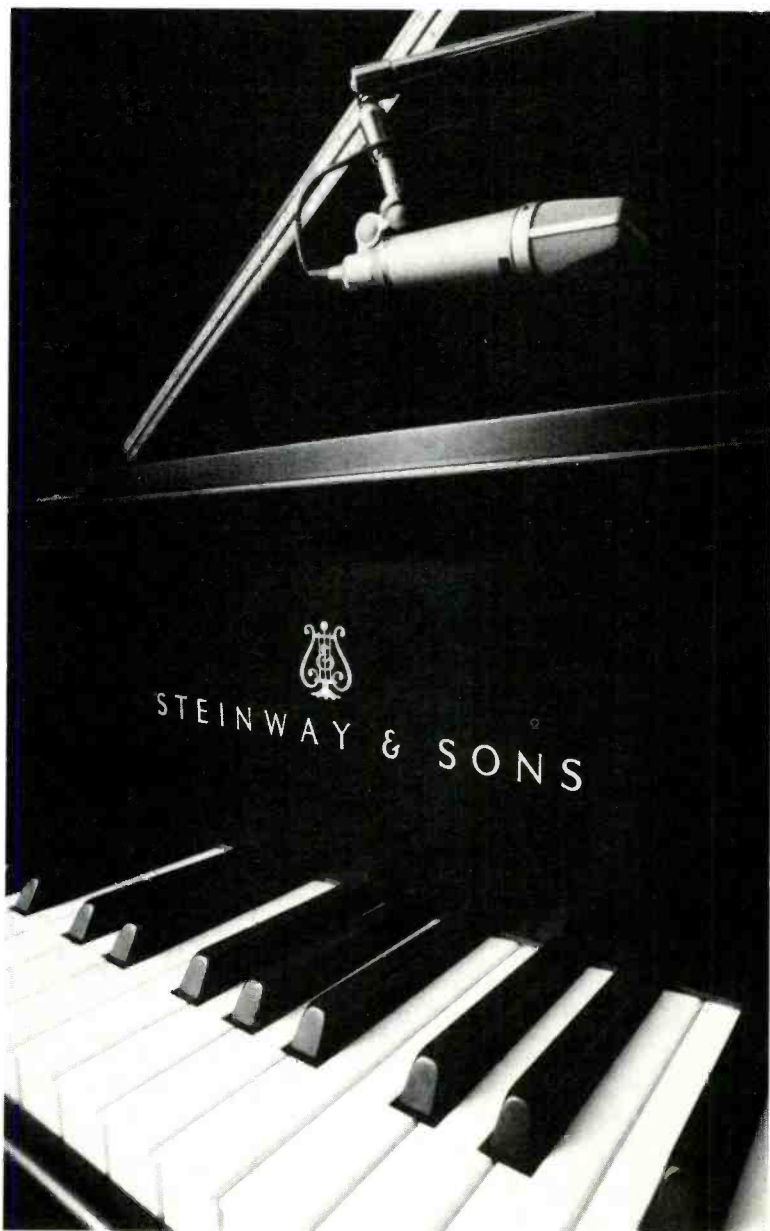

In use at the recording studio: Kampo Cultural Center, New York.

Circle 21 on Reader Service Card

[www.americanradiohistory.com](http://www.americanradiohistory.com)

# Computers, Midi, and Recording

This month we'll be getting into putting together a MIDI interfaced recording system around a personal computer, like the IBM PC, but many of the connections and techniques illustrated here are applicable to other computers and even sequencing machines. Since MIDI follows certain industry standards,

most of the connections done outside a particular computer or software program will be the same, no matter what computer you may be using.

Last, we took a look at the decision process and purchase of a computer system for your home studio. Now we need to put that system together. The best place to start is by attaching the

Roland MPU-401 MIDI processing unit to the computer. A circuit board needs to be installed inside the computer so the back must come off first. After sliding the card in place and tightening the screws back down, the external processing unit is then attached to the board via a cable supplied with the unit.

The MPU-401 is an intelligent interface that is capable of recording and timing up to 8 tracks of MIDI information. The term intelligent is used because the MPU-401 has its own computer chip which makes the whole MIDI translation process easier for the computer it's attached to. The unit is designed so that if a particular software package supports more than 8 tracks, special interfaces can be created to support multiple MPU's. The front panel of the unit contains one MIDI-in, two MIDI outs, one Sync Out, a Tape Sync in and out, and an audio metronome out.

The MPU-401 is shown in *Figure 1*; *Figure 2* illustrates a typical MIDI set-up. The master keyboard, a Roland Juno-106 in this case, is attached to the MPU-401's MIDI-in and MIDI-out ports. This keyboard is used to record all of the musical information to the tracks of the music software program. During playback it can be used along with the other keyboards in the arrangement. Notice that a MIDI cable runs from MIDI-out on this keyboard to the only available MIDI-in port on the MPU-401.

We can put together a fairly inexpensive system by starting out with a relatively cheap and powerful



## Freedom in the studio with cordless headphones: the Nady Infrared Studio Monitor System.

**NADY'S IR Studio Monitor System** gives you total freedom in the studio. Work without the restriction of headphone cords. The extra mobility assures the natural expressive movement that enhances every performance.

Here's how it works

Audio is transmitted on FM modulated infrared light by a *master or master and slave* combination of Nady infrared transmitters, each covering 600 square feet. The master transmitter connects to a mixing board or amplifier headphone feed.

This signal is picked up by the Nady infrared headphone/receiver. And crisp, clear audio is delivered to the wearer, with volume adjustable as needed — even at the highest studio noise levels

The Nady Monitor System is an invaluable tool for recording studios of all sizes. Call us today with your order — and get rid of those cords! We guarantee your satisfaction with the system — you can return it within 15 days for your money back.

Mail check or money orders. Add \$2.00 per order. California residents add sales tax. *Or, call us toll free to order for fastest service*

**Standard System:** Includes one IRT-200 M Master Transmitter and one IRI-210 M Headphone/Receiver w/Standard AC/DC Adapter to power Master and one Slave  
**\$169**

**Headphone/Receiver Model IRS-210 M**  
Any number of the Headphone/Receivers can be used with the system. Powered by single 9V battery.  
**\$90**

**Slave Transmitter Model IRT-200 S**  
Link up to ten in series w/ Master Transmitter Powered by Master. If more than one ordered, high power AC/DC adapter must be ordered  
**\$50**

**High Power AC/DC Adapter**  
Powers one Master and up to ten Slave transmitters. **\$19**





**NATIONWIDE:**  
**800-222-8228** EXT 59

**IN CALIFORNIA:**  
**800-624-1784** EXT 59



# BE A TRAK STAR!

Keep your music on the "right track" with the new Multi-Trak, TOM and MAX from Sequential!

## THE AMAZING NEW MULTI-TRAK!

Take a look at Sequential's new Multi-Trak! Features include a 5 octave velocity-sensitive keyboard for controlling loudness, brightness or modulation. A powerful built-in digital recorder lets you record up to 1600 notes and provides 4 independent sequence locations, an audible metronome, 5 different resolutions of auto-correction, sequence appending and the ability to erase your recorded music by track or by single note. To facilitate your recording needs, each sequence track has its own audio output.

Unique to the Multi-Trak is its polyphonic "SuperStack" mode. "SuperStack" lets you layer two, three, or six sounds and play them

"live" from the keyboard! Also featured are a stereo chorus with programmable On/Off and adjustable rate and depth, a cassette interface for program and sequence storage, and a latching arpeggiator with transposition at the touch of a key.

## MAX: THE ULTIMATE MIDI EXPANDER!

MAX is a 6-voice, polyphonic synthesizer designed to let you play six completely different instrument sounds at one time. And MAX's comprehensive MIDI implementation makes it the ultimate MIDI expander!

## TOM: A UNIQUE NEW DRUM MACHINE

Like all Sequential drum machines, TOM features programmable tuning and volume. TOM adds to these features unique new capabilities like programmable stereo pan for each instrument and the ability to play sounds in reverse! Other features include a programmable "Human Factor" to add subtle variances to instrument tuning and volume levels during playback. And there's a new feature called "Improv", that subtly alters your rhythm patterns with the automatic introduction of occasional "fills". These exciting features let TOM more exactly mimic a "live" drummer! TOM comes with 8 digitally recorded percussion instrument sounds. A cartridge port is provided for easy sound expansion!



MAX  
suggested retail \$599.00



TOM  
suggested retail \$799.00



Multi-Trak  
suggested retail \$1499.00

# SEQUENTIAL

For a complete catalog, please send \$2.00 to Sequential,  
3051 North First Street, San Jose, CA 95134.

Circle 23 on Reader Service Card

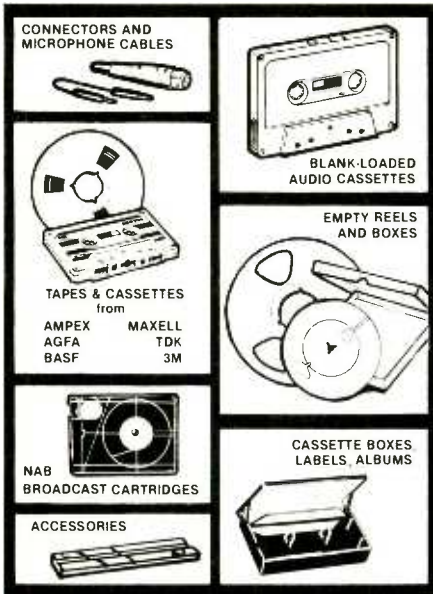

Ask for our  
**44 PAGE CATALOG**  
 of  
**PROFESSIONAL  
 SOUND RECORDING  
 & DUPLICATING SUPPLIES**

Recording Supply Div. of Polyline Corp  
 1233 Rand Road, Des Plaines IL 60016  
 (312) 298 - 5300

35

Circle 30 on Reader Service Card

**THE High Performance Kit Company**

**P-522-NR Kit \$79.00  
 TAPE NOISE REDUCTION  
 (2:1 Compondr)**

\*\*\*\*\*

**P-250-DL Kit \$179.00  
 AMBIANCE-SURROUND SYSTEM  
 (L-R matrix plus time delay)**

\*\*\*\*\*

**P-94-SR Kit \$129.00  
 PARAMETRIC EQUALIZER  
 (Stereo 2-band, fully parametric)**

\*\*\*\*\*

**(404) 934-9626**

**PHOENIX SYSTEMS, INC.**  
 P. O. Box 338-B  
 Stone Mountain, GA 30086

Circle 32 on Reader Service Card

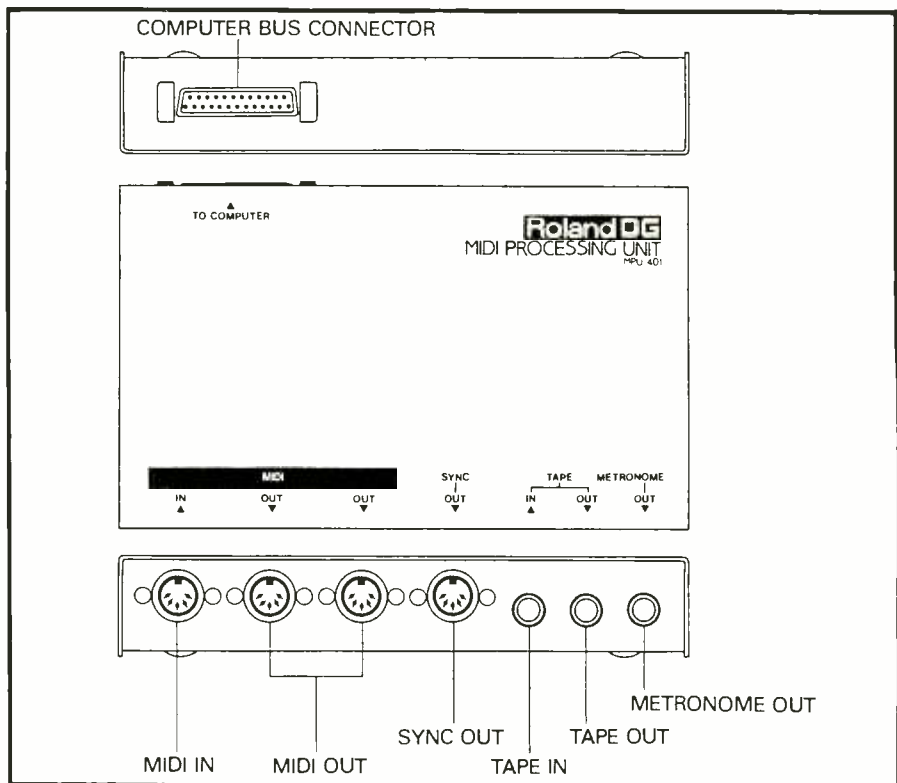

Figure 1. Roland MPU-401.

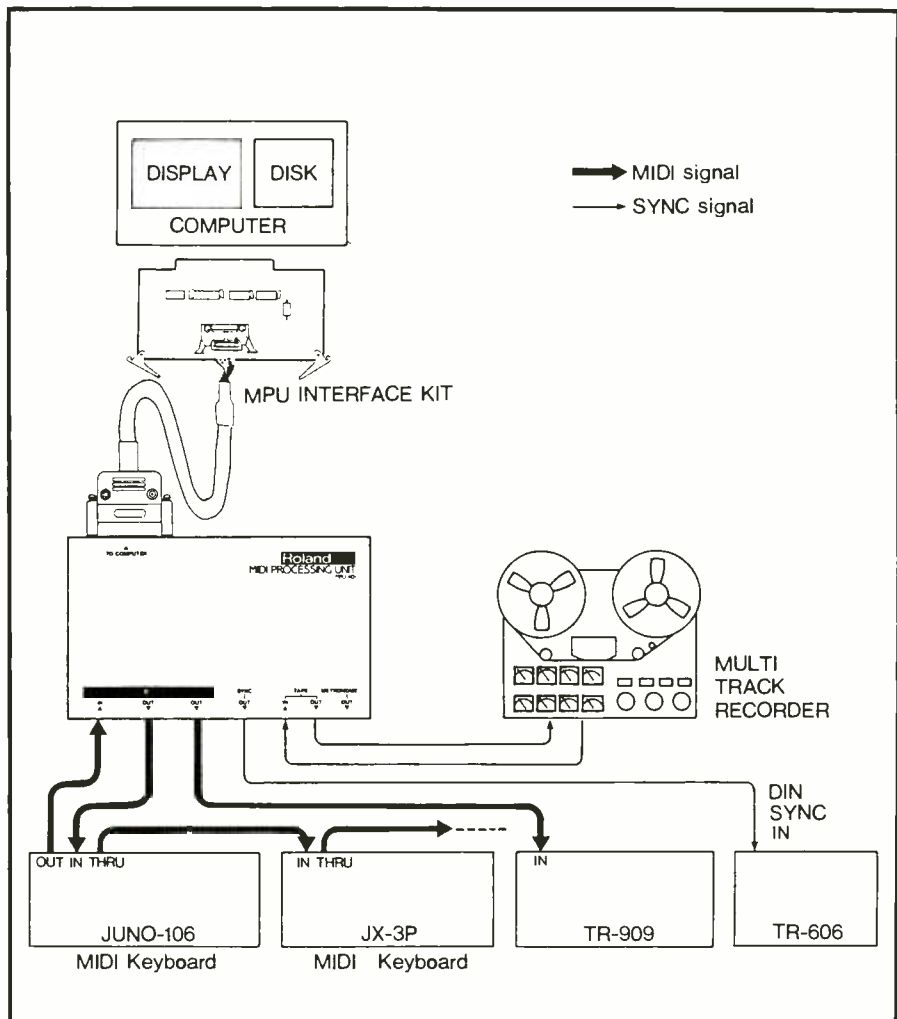

Figure 2. Typical MIDI set-up using MPU-401.

MODERN RECORDING & MUSIC



CASIO CZ-101

# We engineered this synthesizer so you don't have to be an engineer to play it.

## The CZ-101, \$499.

Casio thinks music should be an art, not a science. So we developed the first digital synthesizer you don't have to be a PhD in electronics to play. For while it gives you the bright, crisp performance of a digital, it's as easy to program as an analog synthesizer.

Our CZ-101 will let you create not just fantastic music, but fantastic sounds as well. And sound for sound, it can be placed on the same music stand with the best synthesizers on the market today.

Sound unbelievable? Listen to these features: a 49 key polyphonic

keyboard; 32 sound memories—16 permanently pre-set and 16 internally programmable; optional RAM cartridges storing up to 16 sounds per cartridge; MIDI in/out with multi-timbral capabilities; separate 8-stage envelope generators for pitch, filter and amplifier; polyphonic portamento; an optional battery operated amp/speaker that makes the whole system portable. And the list goes on.

But perhaps the most remarkable thing about the CZ-101 is that not only is it easy to play, it's easy to pay for.

So if your fingers are fabulous on a keyboard but

all thumbs when it comes to things electronic, get a Casio CZ-101. For a little money you could make it very big.

**8 lb. Amp/Speaker \$129.50**



# CASIO

Where miracles never cease®

Casio, Inc. Electronic Musical Instrument Division: 15 Gardner Road, Fairfield, N.J. 07006 New Jersey (201) 575-7400. Los Angeles (213) 803-3411.

Circle 24 on Reader Service Card

## A SINGER'S DREAM!



### REMOVES VOCALS FROM RECORDS!

Our VOCAL ELIMINATOR can remove most or virtually all of a lead vocal from a standard stereo record and leave most of the background untouched! Record with your voice or perform live with the backgrounds. Used in Professional Performance yet connects easily to a home component stereo system. Not an equalizer! We can prove it works over the phone. Write or call for a free brochure and demo record.

Listen...



Before You Buy!

- Time Delay
- Reverberation
- Crossovers
- Noise Reduction
- Compressor/Limiters
- Expanders
- Spectrum Analyzers
- Parametric EQ

Don't have regrets about paying too much for a lesser product. In demos and comparisons, we'll show you why we're Better! Our Factory Direct sales allow us to produce a Superior product and offer it to you at a Lower price. Call or write for a free full length Demo Album and 24 page brochure.

Write to: **LT Sound, Dept. MR, PO Box 338**  
Stone Mountain, GA 30086  
In Georgia Call (404)493-1258

**TOLL FREE: 1-800-241-3005 - Ext. 6-A**

multi-voice synthesizer like the Casio CZ-101. The unit comes with a MIDI-in and MIDI-out port, but no MIDI-thru port. Two MIDI cables are connected between the in and out ports of the CZ-101 and the MPU-401. Once the connections have been made, the software program you are using can then be loaded into the computer and you can begin recording.

When the CZ-101 is first turned on, it comes up in an eight voice polyphonic mode, which can be recorded to one track of the music software program. To begin recording, a track must be selected and the record function of the program is initiated. When you are finished recording, the play function of the program can be initiated to listen to the recorded track. During playback, various patches can be selected on the keyboard to produce different sounds. You can even play along with the sequence, as long as no more than eight keys at a time are played.

That's the basic setup and operation of the system. As you can probably see, one track of music doesn't really give you much in the way of music; the real fun starts when you begin to record multiple

tracks of MIDI music. The CZ-101 has a special mode that allows you to play up to four separate voices at one time. In this mode, each of the four sounds is played monophonically on the keyboard, so what you have are essentially four separate monophonic synthesizers in one unit. Each of these separate synths can be set to record and play back one of the tracks from the music program. To explain how to take advantage of this, we'll first need to talk about the concept of MIDI channels.

Unlike a mixing board or tape recorder which use separate cables for each in and out port, MIDI uses one cable that transmits up to 16 channels of MIDI information. The concept is very similar to that of television, in which one of many different viewing channels may be selected. If you have bass sound recorded on track 3 of your music software program, you can set this track to transmit on channel 3 (a logical choice). Now, setting any synthesizer in your arrangement to channel 3 will cause that instrument to play the bass track. *Figure 3* illustrates a synthesizer arrangement that support three units connected by MIDI cables. The mother keyboard is connected to the MIDI-in and out plugs of the MPU-401 and is set to transmit and receive over channel 1. Two other keyboards are attached to the remaining out jack of the MPU-401; the first is set to receive only on channel 2 and the second is set to receive only on channel 3. Note that the third synth is connected to the second synthesizers MIDI-thru port.

Now, say the third synthesizer is a Casio CZ-101. Since it will act as four independent monophonic synthesizers in which each will receive MIDI information on a different channel, we can actually set it to play back channels 3 through 6 in our arrangement. So, with the setup shown in *Figure 3*, up to six channels of MIDI can be recorded and played at one time. Each voice "unit" in the setup is assigned its own channel, with the Casio being assigned a range of four channels between 3 and 6. You can, of course, have two or three synths playing the same channel if you want to produce fatter layered sounds. To set the Casio to a range of four channels beginning with channel 3 requires a little more explanation of the concept of channels.

There are actually four different channel modes available in the MIDI



#### Other Products

The "Electronic Foot-switch" provides any triggering situation you can imagine: [drum machine, sampling keyboards, auto punch in/out, etc.]

## ACHIEVE HARMONY THROUGH SYNCHRONICITY

Now Your Drum Machines, Synthesizers, and Sequencers Can All "Play" Together

**SOLVED!** Since most companies have not standardized their clock rates, the Reasonable Alternative Digital Clock Divider has a solution for the clock differences facing owners and users of drum machines, sequencers, and synthesizers made by different manufacturers.

Our digital clock divider will take an incoming clock signal from any source and divide by 1, 2, 4, 8, 16, 32, or 64. Now any two previously incompatible units can suddenly become compatible.

**ROLAND REMEMBERED!** We've included a Roland "Sync-24" DIN jack, and supplied the +5 run/stop

voltage needed, so Roland products can be used with brand names such as Linn, Oberheim, Emu-Systems, Sequential Circuits, Yamaha, Lexicon, even Fairlight and Synclavier. A unique feature, our "divide by 1" mode, allows a product with a clock rate of 24 pulses per quarter note, (such as an Emu-Systems Drumulator\*\*), to run Roland's "Sync-24" system.

**GET CREATIVE!** If you have a digital delay line with an external clock input, (such as the Lexicon PCM 42\*), you can get exotic effects, such as having the unit repeat, flange, or use any other delay effect, "in time" with the clock of a drum machine, sequencer, etc.

An optional accessory cable is also available to plug into the DIN switch socket making all the clock divisions accessible simultaneously.

The Reasonable Alternative Digital Clock Divider also allows sequencers, drum machines, and synthesizers to sync to tape for multi-track recording.

Retail price for the Reasonable Alternative Digital Clock Divider is \$89.00.

Send or call for free information on all of our other products.

**Reasonable Alternatives**  
professional audio products

P.O. Box 733, Cranford, NJ 07016  
(201) 549-2100

DEALER INQUIRIES INVITED

\*\*Sync-24 is a registered trademark of the Roland Corp. U.S.

\*\*Drumulator is a registered trademark of Emu-Systems Inc.  
\*PCM-42 is a registered trademark of Lexicon, Inc.



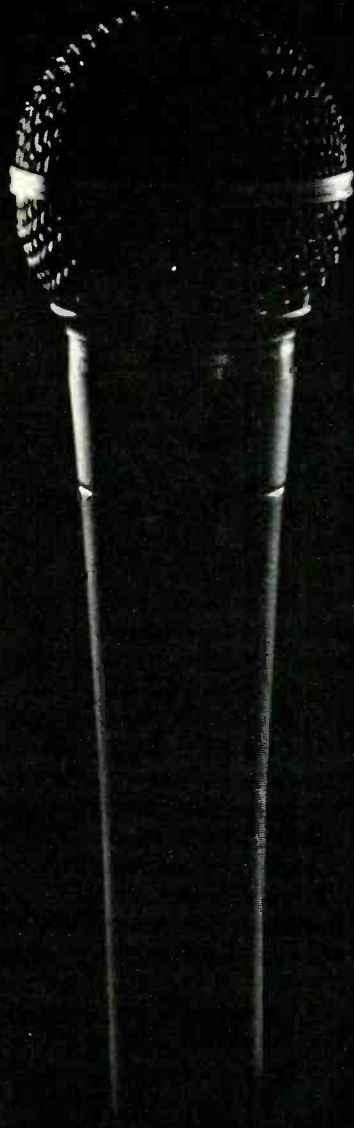

You know what "old reliable" can do. It's a remarkably durable design. And still hanging on.



We dare you to look for more. For instance, rejection of off-axis sound that continues working even at the lowest frequencies. Plus our famed **Road Tough** construction that made A-T a favorite for reliability from the start.

The differences may seem subtle to the layman...but will be obvious — and most welcome — to you and other sophisticated listeners.

ATM41a

*It's a far better sound value...  
for just a little more!*



**audio-technica**

Audio-Technica U.S., Inc., 1221 Commerce Dr., Stow, OH 44224  
(216) 686-2600

Circle 26 on Reader Service Card

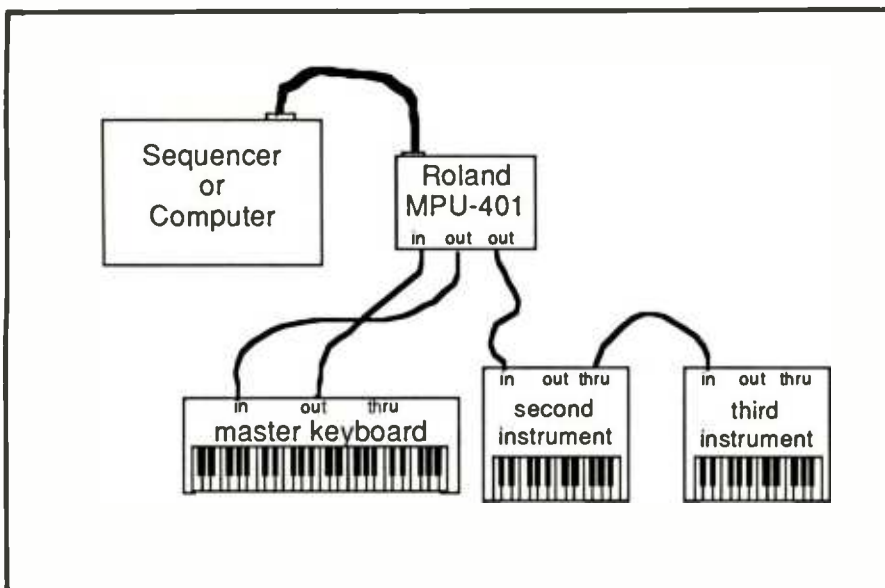

Figure 3. Typical connections of synthesizers to a computer through a MIDI interface (MPU-401).

system. Each of the modes allows the instruments in the setup to be configured to respond to all messages coming over the line or only certain messages. The four modes depend on whether your synth is set to polyphonic or monophonic mode and whether it is receiving over all channels or just one. The possible combinations are explained below and illustrated in *Figure 4*.

### Omni-On Polyphonic Mode

This is the mode that is set when you first turn on a MIDI-equipped synthesizer. In this mode, a synthesizer will respond to information coming over any channel. If you had a synth set to poly and connected to a computer music system, it would attempt to play the MIDI information coming over all of the recorded channels. This may be impossible since more notes may be attempted than the synthesizer has voices to handle. The Omni-On Poly mode is most useful when two or three synthesizers are connected to each other, say in a live performance, and a rich, multi-layered sound is desired. If two keyboards are attached to a master keyboard, the two slaves will play the same keys as are played by the musician on the master. The slaves, of course, can be set to different patch settings to produce a wide variety of sounds.

### Omni-On Monophonic Mode

This mode is the least useful and

set. When a new key signal comes across the lines, the previously played key goes immediately silent. You've probably experienced this when trying to play several keys at one time on a monophonic synth. Only one key will play out of all of those pressed, depending on which was pressed first.

### Omni-Off Polyphonic Mode

This mode is the most useful to those who have several synthesizers in their setup. With it, you can record multiple keys or chords to one of the tracks of your computer music program and play them back polyphonically on one polyphonic keyboard. This mode will give you the richest music but one polyphonic synthesizer will be tied up for each track of polyphonic music. A typical music software setup might include one polyphonic keyboard playing chords recorded on a single track and a four voice monophonic keyboard like the

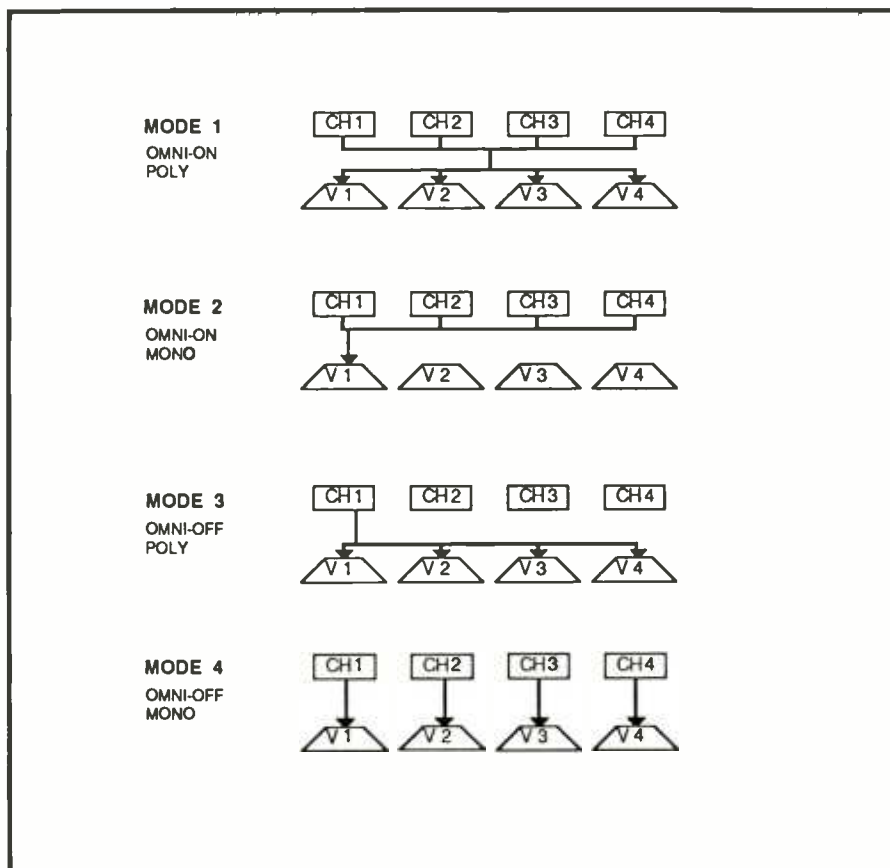

Figure 4. Four different MIDI modes showing four separate channels and voices.

simply exists as a by-product of the mono mode available on some synthesizers. In this mode, a synthesizer set to monophonic mode (only one key will play at a time) will receive information from all channels. That's like trying to watch three or four television stations at one time on one

Casio CZ-101 playing four additional tracks of monophonic sounds.

### Omni-Off Monophonic Mode

I like to call this mode the budget mode. In it, multiple tracks can be recorded and played by inexpensive

# Oberheim

A Division of ECC Development Corporation



## Matrix-6

### Practical innovation continues.

The Matrix-6 is the newest addition to the Oberheim line of professional synthesizers. It combines our unique Matrix Modulation System with a touch sensitive keyboard, and an integrated voice technology that could only come from Oberheim. The result is the most powerful synthesizer available under \$2,000.

Now . . . you can afford the best

Matrix-6 at \$1,595

#### Six Voices, each with:

- 2 DCCs
  - Pulse, Triangle-Sawtooth, Noise, Click
  - 2 Sync Modes
- 4 Pole VCF
  - Filter FM
- 2 Audio VCAs
- 3 Envelope Generators (DADSR)
- 2 LFOs plus Vibrato
- 2 Ramp Generators
- 1 Tracking Generator
- 1 Portamento Generator

#### Keyboard:

- Velocity
  - 3 Response Scales
  - 32 Destinations
- Release Velocity
- After-Touch Pressure
  - 32 Destinations
- Patches
  - 100 single plus 50 multi

#### Matrix Modulation™

Controllers, Reversible and MIDI assignable:

- Pitch Bend Lever
- Double Modulation Lever
- Footpedal
- Footswitch

#### Two Zones:

- Keyboard Split and Double
- Note Spillover System



® OBERHEIM

A Division of ECC Development Corporation

2230 South Barrington Avenue, Los Angeles, California 90064, (213) 479-4948

Circle 27 on Reader Service Card

synthesizers like the Casio CZ-101 or the Sequential Circuits MAX. In the case of the Casio, four tracks can be played back and in the case of the MAX, six tracks can be played. The only disadvantage here is that the synthesizers will be playing in monophonic mode.

In Omni-Off Mode, information is received from as many channels as the receiving synthesizer has voices. The channels that this information is received on are determined by the initial channel setting set on the synthesizer. Let's go back to our original setup shown in *Figure 3* and assume that the Casio CZ-101 is the third synthesizer in the arrangement and is set to receive information on channel 3 from track 3 of our computer music program. By pressing the MONO key on the keyboard, each of the four voices will then respond to a separate voice which is determined by the setting of the base channel. Since we set the base channel to 3, this channel will play back information from track 3. The next three voices will then be automatically set to channels 4, 5 and 6 respectively. When MIDI music is recorded to the newly available tracks 4 through 6 on the music software program, it will playback on the additional voices, assuming that the software and synthesizer channels have been assigned correctly.

Once you've got everything connected and the MIDI channel assignments set correctly, you can begin recording music. As you lay down each track, you can listen to each of the previously recorded tracks play in real time over the channels and on the synthesizer they have been assigned to. During playback, you can change the patch number on any synth to produce a different sound. The music program itself provides almost unlimited control over the recorded music. For instance, you can increase or decrease the tempo of the recorded piece without changing the pitch of the sound because it is the MIDI performance data that is being altered, not the sound. This is analogous to speeding up the roll of punched paper in a player piano.

You can, of course, add more synthesizers to your basic system, but there are some things to watch for. In *Figure 3*, the third synthesizer was connected to the MIDI-thru port of the second synthesizer. MIDI-thru is a special MIDI port that allows music information from the source, our computer music program in this

case, to pass through any synthesizer on down the line to other synthesizers. This information will pass through, no matter what the channel setting is on the synthesizer. Since each MIDI piece of information is assigned a channel, it will be read by those synthesizers on the chain that have the same channel assignment.

With MIDI-thru, many synthesizers can theoretically be "daisy-chained" off of each other in a long series. Each synth in the series can be given a channel assignment of its own. The problem with this type of arrangement is that the farther you go out in the chain, the more you are likely to introduce timing problems and subsequent distortion in the furthest synthesizer. To eliminate this problem, you will need to attach a MIDI-thru box like the Roland MM-4 to your system. *Figure 5* shows a typical arrangement of up to 4

channel the audio signals of each individual synthesizer into your stereo, PA or tape recorder. Along with this mixer you can add other equipment like MIDI equipped digital delays and reverb units. One trend that seems to be catching on is the use of Modular systems, where only one keyboard is used to control several voice boxes. The voice boxes are small compact units that are stacked in racks and controlled by a MIDI master keyboard and sequencer. Both Roland and Yamaha have complete systems designed around this modular approach.

Starting with a basic system like the one described here you can begin to explore the potential of a MIDI music system. Because the computer is so versatile, you will be able to expand your system over time in many different ways. As MIDI catches on, more and more software

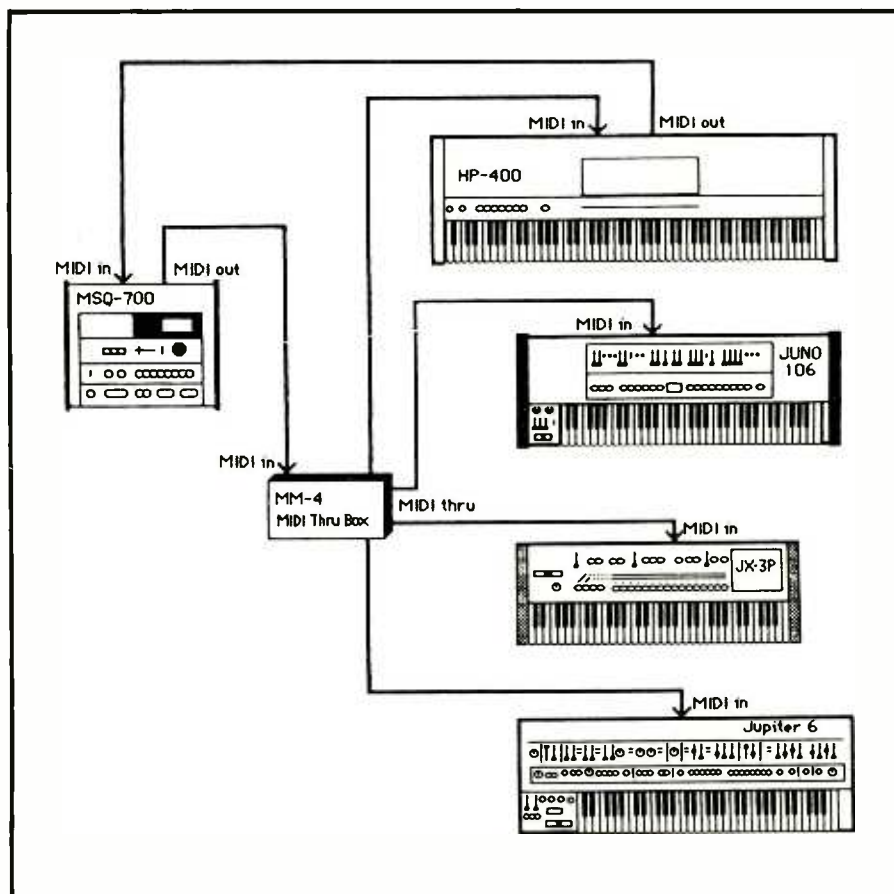

**Figure 5. Typical arrangement of up to four synthesizers using Roland MSQ-700 and MM-4.**

synthesizers connected to a Roland MSQ-700 digital sequencing unit, which could also be a computer running a music software program.

One thing to keep in mind when developing any MIDI system is that you will need some sort of mixer to

will be available, not only for recording, but for other applications like the control of studio equipment or lighting equipment. By providing the link to the world of computers, MIDI has secured its place in the music world.

# State of the art shouldn't create a state of confusion.

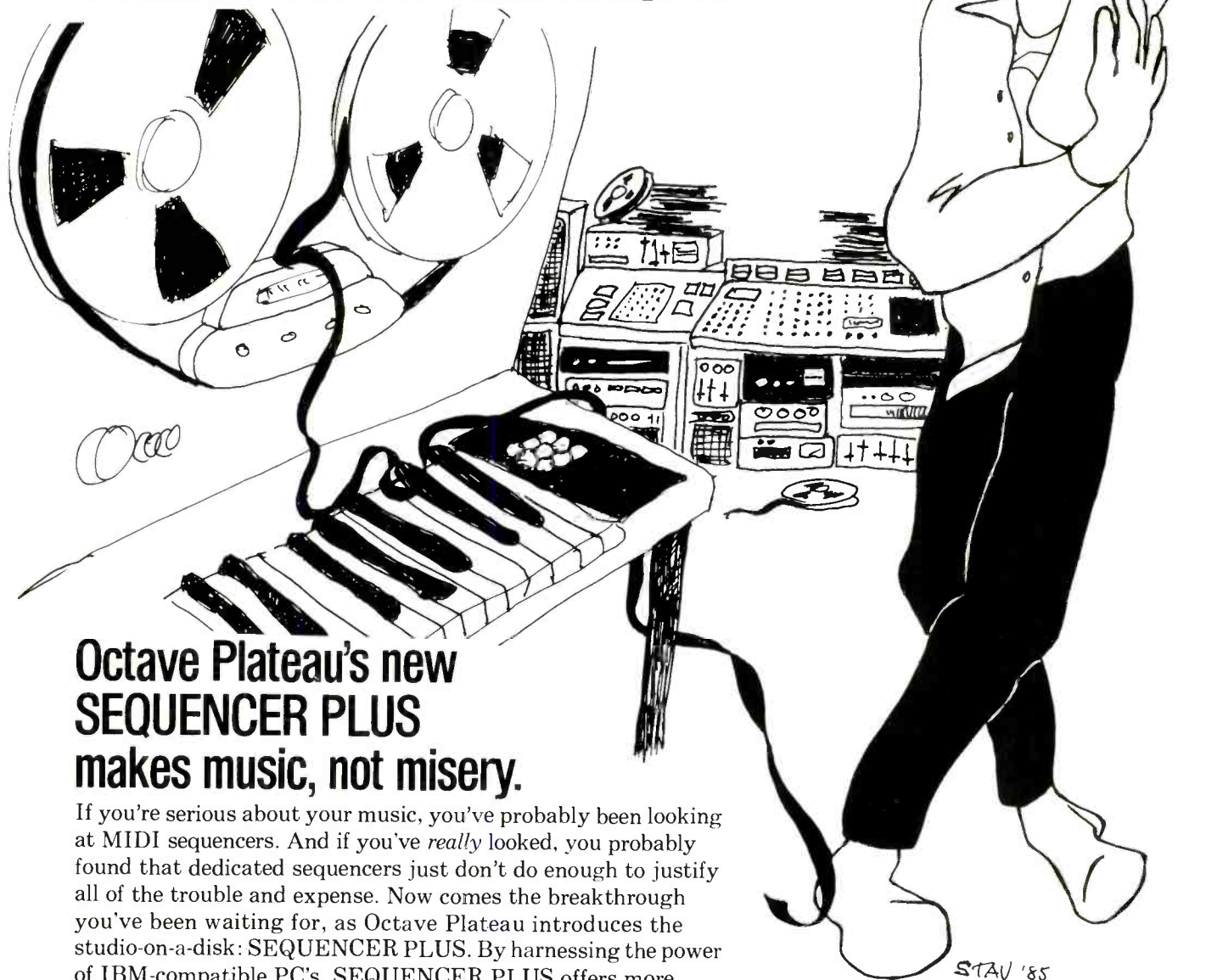

## Octave Plateau's new SEQUENCER PLUS makes music, not misery.

If you're serious about your music, you've probably been looking at MIDI sequencers. And if you've *really* looked, you probably found that dedicated sequencers just don't do enough to justify all of the trouble and expense. Now comes the breakthrough you've been waiting for, as Octave Plateau introduces the studio-on-a-disk: SEQUENCER PLUS. By harnessing the power of IBM-compatible PC's, SEQUENCER PLUS offers more features and ease of use than any dedicated sequencer ever could.

64 tracks. 60,000 notes. Punch-in/punch-out. Complete editing. And we mean *complete*. Track by track, and note by note. All of the flexibility you've wanted from a sequencer, but never thought you'd get. If you'd like to know more about SEQUENCER PLUS, or any of our other American-made products, like the Voyetra Eight synthesizer, drop us a line. We'll be glad to send you one of our informative brochures and a list of dealers in your area. And if you're still not convinced, go ahead, check out the competition. When your options are state of the art or a state of confusion, the choice is simple.

Circle 28 on Reader Service Card

**Octave Plateau**

The sound approach to technology



51 Main Street  
Yonkers, NY 10701  
914•964•0225

# Product Profile

## The Fairlight CMI Series III

The Fairlight CMI (Computer Musical Instrument) Series III is the culmination of over three years of development by the same team who invented the first electronic sampling instrument. The Series III is a complete music and sound production system. It combines virtually unlimited power for production of sounds with an equally powerful and easy to use "sequencing and real-time composition" facility.

The Series III system—utilizing 12 microprocessors—is a new generation hardware and software system which provides 16 simultaneous channels (each having their own 16-bit DAC, VCF and VCA) of audio with independent and grouped outputs. A 50 kHz sampling rate and 16-bit linear stereo encoding provide excellent sampling quality. The system is available with up to three megabytes of waveform memory allowing 30 second samples at full bandwidth in 16-bit mode, (at 50 kHz) or 60 seconds in 8-bit mode. This will be expandable to 14 megabytes allowing a sample time of over two minutes duration. Sectional multi-sampling will be possible and maximum playback sample rate is 200 kHz.

Another feature of the Series III is its 80 channel SMPTE-based recorder allowing possible replay of up to 16 CMI channels simultaneously. This feature, called CAPS (Composer/Arranger/Performer/Sequencer), ac-





## SOME OF MAN'S GREATEST TRIUMPHS ARE PERSONAL.

Sure, making music is often a group effort. But there are crucial moments when it all comes down to a one-on-one relationship between you and your music. Moments when only you can give form to a creative inspiration that is uniquely your own. When you've got it, you know it. But the only way to be sure is to hear it.

That's where the TASCAM Ministudio can help. There's no better way to capture those personal triumphs whenever and wherever they occur. Bring TASCAM's portable production facility to rehearsals, out on the road... anywhere you and your music want to travel. Four assignable input channels give you plenty of space to work out songs and arrangements, or to document practices and performances.

Overdub parts, combine tracks and modify them at will with the convenient punch-in facilities. The battery-powered Ministudio has all you need to bring your ideas to life. And TASCAM quality means that with the Ministudio you can put your message across with wider dynamic range and crisper sound than with anybody else's ministudio.

The personal satisfaction of creating music on your own can be yours with the remarkable TASCAM Ministudio. Why not visit your local TASCAM dealer for a demonstration? Or write to TASCAM for details (and your free copy of "Are You Ready For Multitrack") at 7733 Telegraph Road, Montebello, CA 90640.

THE TASCAM MINISTUDIO



**TASCAM** THE SCIENCE OF BRINGING ART TO LIFE.

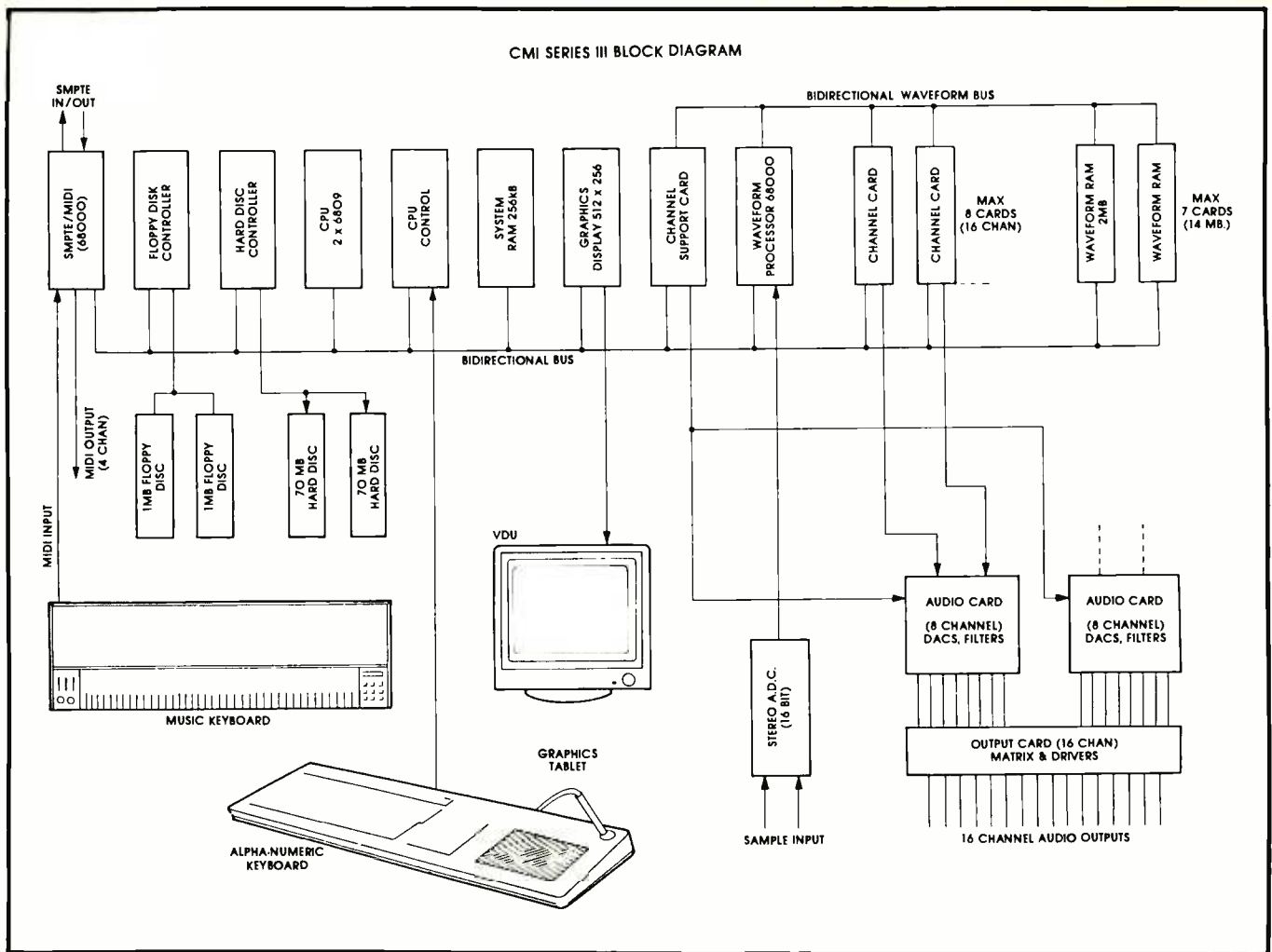

tually allows the user to "orchestrate" up to 80 tracks (using the CMIs 16 internal voices and 64 more tracks being transmitted via MIDI). This can also be achieved via a special parallel link to Fairlight 16 voice slave sections. The 16 voice channels allow the Fairlight to be played in one of a few different ways: 16 note polyphonic mode, 16 different mono voices, or any combination totalling 16.

You might ask: "What can one do with all these features?" Well, it would be more appropriate if the question was, "What doesn't the Fairlight do?"

Books and books can be written (and in fact, they have been) on the use and applications of sampling instruments.

Once a sound—any sound, you chose it—is sampled on the Fairlight, it can be manipulated in a number of ways. The entire envelope of the sound (attack, decay, sustain and release) can be rearranged in any way. For example, you can take the beginning of a sound, the attack, and

patch it on to the end, then you can pull the middle (sustain) out and stretch it a little before putting it at the beginning. It is completely variable.

You can also perform a Fourier analysis on any sound. A Fourier analysis is a three dimensional display (shown on the video display screen) of amplitude, time and pitch. This shows complex harmonic functions of the sound which aids in the manipulation of sounds. With the Series III the reverse process can also be performed. Fourier synthesis is the process by which sounds can be created by actually drawing a sound wave on the Fairlight video screen with the light pen.

With 'Music Composition Language' you can actually "type-in" notes, time values, and expressions, just like a word processor, for the computer to store and play.

The system also interfaces with a guitar synthesizer and the Voice-tracker, an instrument that allows the human voice to be a controller for the Fairlight.

The uses and applications of the CMI are indeed endless and limitless. For a free demonstration of some of the things the Fairlight can do, simply listen to any of Herbie Hancock's recent records. He is one of the most avid users of the CMI, but there are many records released every day that utilize the CMI to some degree.

Of course, all of these features come with a price. The CMI Series III replaces the Series II-X which sold for \$34,000. For a home musician/recorderist or small studio, this price might be a bit exuberant. But for a larger studio, the investment would certainly be well worth it. The Fairlight would not only be a superb addition to your equipment list, it could justify raising your rates.

And, for those of you already owning the CMI, Fairlight will give you priority if you wish to upgrade to the recommended Series III configuration.

For more information, please circle number 50 on the Reader Service Card.



# Poor Recorder's Almanac

## Backwards Hand Erasing

After all that about keeping your hands and equipment clean last issue, I have a little story to tell. Upon returning from the NAMM Convention in New Orleans in June, I had to deal with the same airline that I went down there with a few days before. They were constantly late, (which is not too bad by me, because I'm always late too, especially with deadlines, [Ed: And he's not kidding!]) but even worse, we got bumped off a flight that we had booked months before. Anyway, to make a long, boring story short, when we finally did get on the delayed flight, I peeked into the cockpit. I'm one of those guys that likes my pilot to be an older, gray haired, conservative, Republican kind of guy. Well not only was he young and

daring looking, but there he was, over the controls, wolfing down what appeared to be cole slaw, potato salad, or some other mayonnaise kind of food!!

Apparently, the plane had just gotten in from somewhere, and with no time to eat, he was doing it while we were boarding!! Well, I don't know how many of you saw the film "Fate Is The Hunter," but I kept thinking about cole slaw juice shorting out the right engine, and greasy mayonnaise fingers slipping off the flap controls (cause I didn't see the pilot wash his hands).

Anyway, we made it back home, but PLEASE, out of respect for your console, don't spill no mayo-cabbage juice down your faders.

Now, to get to the subject at hand: erasing by it backwards.

Let's say that you have a vocal track with a loud throat clearing, or a guitar with a bunch of buzz recorded. The unwanted sounds are very noticeable during the rest of the track, (or if you did like I recommended last month and punched in right before the cue), just before their entrance. "No problem," you say, "I'll just gate them out."

Well, if you remember last month you'll also remember that sometimes a gate will get "fooled" into thinking that the unwanted sound is part of the wanted signal. This occurs because gates are level sensing devices, and, if the dynamic range between the signal and the noise is not considerable, the gate will simply

### MX1688 Recording Mixer

16 x 8 x 2 with control room mixing

The Carvin MX1688 recording console offers the professional quality features and signal performance you've grown to expect from Carvin! Use of the finest components and professional audio design enable the MX1688 to interface with any professional tape deck. For additional info on this console and Carvin's complete product line send \$1 to Carvin, Dept. MR62, 1155 Industrial Ave., Escondido, CA 92025. A similar 16 x 4 x 2 MX1644 mixer is available for \$1995.

#### Recording Features

- Eight Track Studio Control Center
- Input/Output Channel Organization
- Independent 8 Into 2 Monitor Mixer
- Four Auxiliary Busses w/ Pre/Post
- Three Band Parametric EQ w/ Defeat Switch
- Mute and Solo on all Input and Output Channels
- Two Effects Returns w/ Pan and Solo
- Talkback w/ Built-in Mic and Monitor Dimming
- Peak Warning Indicators w/Peak Stretching
- Patch Points on all Channels
- Microphone Phantom Power
- Cue and Effects Sends from Output Channels
- Alternate Metering of Cue and Two-Track
- Quick Tape Playback Through Monitors
- Independent Mic and Line Preamps
- Studio Feed w/ Source Selection
- Totally Modular Internal Construction
- Input Noise of -127 dBv, THD less than .05%
- 20 dB headroom at All Stages

#### P.A. Features

- Eight Sub-Groups w/ Solo and Mute
- Channels Assignable to L & R Stereo Output
- Four Independent Monitor Mixes Available
- Headphone Monitoring of Main or Monitor
- 11 Step Gain Controls for Easy Set-up
- Talkback to Monitors

**MX1688**  
**\$2995 +49 Frt.**

**Product Information**  
**Toll Free 800-854-2235**  
**Calif 800-542-6070**

**CARVIN CATALOG**  
 \$1 for 24x Mail  \$2 for Rush 1st Class Mail  
 Name \_\_\_\_\_  
 Street \_\_\_\_\_  
 City \_\_\_\_\_ State \_\_\_\_\_ Zip \_\_\_\_\_  
**MR62**

assume that the unwanted noise is part of the signal. If the gate is set to attenuate the noise successfully, it may also do the same to the signal. And a perfectly clean track that has a loud noise just prior to the entrance of the instrument or voice the track contains, is worse than hearing the noise slightly subdued for the entire length of the piece.

So, what will you do? What will you do?

Well "shutting off" or muting the track until the proper time is a good solution.

The only problem here is that this gives you an extra cue to remember during mixdown, and if you have several cues and blow the last one five seconds before the end of the song, you've got to do the whole mix again, or at best, do the end and splice it on to the good part.

I know all you owners of Neve with Necam and SSL boards say, "Hey! That's what my computerized console is for!!" But I don't mean you guys!!

What's a 3340/Model 5 owner to do?!!!

Well, what if you could erase the track, right up until the desired signal all the way through the tune?

Sounds a little risky, doesn't it?

And it would be, cause no matter how fast you are at punching in and out, or no matter how accurate your number counter is, chances are you will make a mistake somewhere down the line, and then it comes to calling up the band and arranging for a free session to redo the track you screwed up (and, of course that session will take at least three times as long as the original did—and on YOUR time).

Well, how about trying this in the meantime?

To make it simple for yourself, on your own free time, ask a friend to come over and help you out.

Record only a snare drum and bass drum, one on each track. No gates, no nothing.

Now, solo only the snare track. Listen to where the bass drum leaks onto the snare track (to make matters easier, have the snare play on two and four, and the bass drum play on one and three).

If you have a three head machine, put it into the sync mode (although this is not absolutely necessary, it will make it easier for me to explain), if you have a two headed machine, you're set. (If you have a cassette machine, you'll have to sit this one

out. Although there are ways of hand erasing with cassettes, it is more difficult because of the access to the heads. However, if enough of you out there ask for it, I will devote a column JUST to erasing by hand for cassettes. Let me know!) Now, EVERY machine ever made—that I know of—has the following order for the heads. Erase, Record, Playback for three headed machines—Erase, Record/Playback combination for two headed machines. If you have a machine that has MORE than three heads, the extra head(s) is usually an extra playback head for a different format, for auto-reverse, or for a sync tone to lock up to film or tape. Consult your owner's manual to find the location of the normal Erase, Record, and Playback heads.

Anyway, find the head that plays back in your Sync mode. This will normally be the Record head for three head machines, and the Record/Playback combination head for two head machines.

While the machine is in the STOP mode, slowly rock the reels so the tape moves over the head doing the playback. You will be able to hear the envelope of the snare begin and end, and the lower level of leakage from the bass drum. The faster you move the tape, the more up to pitch the drum will be. The slower you move the tape, the more exact the location of the envelope of the snare drum becomes. Now, with a white or yellow "grease (yuk!) pencil" or china marker (available in any local hardware store), mark EXACTLY BEFORE the beginning of the snare beat. You will find this by rocking the tape back and forth on the head doing the playback. When you find the EXACT beginning of the snare, it will be in the CENTER of the head doing the playback. Make your mark MICRONS before the center of this head.

Now, rock the tape backwards until you find the end of the envelope of the snare beat before. Don't be fooled by the bass drum leakage—learn to hear and differentiate between the two. When you are POSITIVE you have the end of the previous snare envelope over the center of the head playing back, again mark it microns away. (This is the same technique that you use for splicing and editing tape. In fact when this exercise is over, try removing a few snare beats by cutting the tape and splicing it back together with the beats removed.)

Now rock the tape back and forth a few times while observing your marks passing over the head. When you are POSITIVE that you have correctly marked the end of one snare and the beginning of the next, with nothing but the bass drum leakage between the two marks, CAREFULLY, (with CLEAN hands), take the tape out from between the capstan and the pinch roller.

Now, if you were to hit the play button, the tape would not move. Align the first mark you made (the beginning of the snare beat) with the ERASE head. Now move the tape BACKWARDS by HAND (a la Backwards Hand Erasing) until you come to your next mark (the end of the beat before). Practice this a few times until you feel comfortable and confident with this procedure. When you are sure you've got it down, do the same thing but put the snare track into Record (making sure that nothing is assigned to that track), and hit the RECORD and PLAY buttons at the same time to record silence between the two marks. CAREFULLY stop the erasure by hitting the STOP button; re-thread the tape between the capstan and pinch roller, and play back the track.

You should hear two snare beats with absolutely nothing in between.

Caveat!! Some machines will "pop" into and out of RECORD. If this is so in your case, unfortunately, you cannot use this technique. However, most newer, better machines won't do this. Also, some engineers will thread the tape around "backwards" through the capstan so the tape plays and records backwards. I don't recommend this because you are still dependent upon the mechanics of the machine (brakes, start up tension, etc.) to control the erasure, and if they are the slightest bit off, you can "clip" the beginning or end of the snare envelope.

When you are pleased with your work on this beat, try it on the rest of the track and on the bass drum track, too.

It may take you a while, but just think, no more unwanted mouth noises, breaths, or headphone feedback squeals on vocal tracks; no more buzzy, hummy guitars; no more splashy high hat leakage on the snare, no more noises at the beginning or end of a tune; no more nothin' you don't want!!

Next time: ambiance and acoustics at home.

Directory:  
Drum Synthesizers

# MODERN RECORDING & MUSIC

JULY 1985 VOL. 11 NO. 7 \$2.25  
#37947

David  
Foster

PROFILES:

POOR RECORDER'S ALMANAC  
Part II

## The Technology of Tomorrow... Today!



### Subscribe to Modern Recording & Music





# LOU GRAMM

FOREIGNER'S

VOCAL

PROVOCATEUR

Over Foreigner's impressive eight year history, Lou Gramm has lent his vocal expertise to six LPs, yielding 15 hit singles. The band's latest album, *Agent Provocateur*, has finally given them something that has eluded them in the past—a number one single in "I Want To Know What Love Is." On the new release, Lou, along with the rest of Foreigner—Mick Jones (guitars and keyboards), Dennis Elliott (drums), and Rick Wills (bass guitar)—show their widest musical mood and style range to date.

Group founder Mick Jones describes *Agent Provocateur* as "an evolution, a natural development of some of the things we were starting to think about on the *Foreigner 4* album. The rock end has become more brutal, and the slower, more melodic things have become more refined."

Lou is the only American among the three Englishmen that round out the band, whose first LP, *Foreigner*, was certified multi-platinum and was one of the best debut albums of all time. They continued with a string of four more hit studio albums, each selling at least two million copies after only 28 weeks on the Billboard charts. The album also features quite a few songs co-written by Mick and Lou—more than on any previous release—and marks the first time Lou Gramm has a solo writing credit, "Two Different Worlds."

Lou's development is also apparent in the sheer range of vocal expression on this album. "I think when you've had enough hits, there is supposed to be an appealing range to one's voice. But then that can be over used, and another range that exists can be neglected," Lou explains. And Lou's enormous range is well-demonstrated, even on the first LP. From "Cold As Ice" and "Long Long Way Home" to "The Damage Is Done" on the first LP, and from "Tooth And Nail" and "Reaction To Action" to "I Want To Know What Love Is" on the new LP Lou has always demonstrated a wide range of style. As he puts it, "It covers a lot of textures and in-betweens that we haven't hit upon too much before. It's a very strange album in that respect; there's a lot of different moods and tempos, a lot of different sides that are very stark against each other."

Lou Gramm should know. He was no foreigner to professional rock n' roll before being asked to join Foreigner by Mick Jones in 1976. In 1971, he formed Black Sheep in his native Rochester, NY. With Black Sheep he released two albums, on which he was responsible for both vocals and drums. With Foreigner, a band that has achieved "Superstar" status, selling over 26 million records, Lou's voice is one of the most recognizable in music today. *MR&M* got together with Lou in the midst of Foreigner's current world wide tour.



**Modern Recording & Music:** You were one of the forming members of the band. Correct?

**Lou Gramm:** Pretty much, yes.

**MR&M:** Did you expect the first record to be such a success back in 1976 when you first started out?

**LG:** No, you really can't put any gauge on that. We just hoped that we'd make a little noise and it would let us grow up as a band a little bit. It kind of turned out a little bit differently than that.

**MR&M:** Did you expect the success to continue over such a long period of time and so many records?

**LG:** Again, you really don't know what to expect. You just gauge your own progress against yourself. We didn't really take sideways glances towards the groups that were popular at the time—Boston, Kansas, people like that—we were concerned about ourselves, to grow as a band, just being better with every album.

**MR&M:** Is the success you achieved

what you thought it would be?

**LG:** Success, I suppose is what you make out of it. It's just gratifying to know that the albums sell well and they have a place in a lot of kids' record collections. That's great. And I'd be a liar if I didn't say that it's made my life a little more comfortable in some material things, but that also brings big problems and you just have to keep your feet on the ground and adhere to the way you were brought up. Success shouldn't change the person radically, and I don't know if it has me or not, but I feel pretty much like the same kid who had nothing ten years ago.

**MR&M:** How do you feel now that you're back up on the charts?

**LG:** It feels good. I don't like being

natural, but as we listened back to things and saw that the album was turning out this way we made it even more of a spectrum. We ran the gamut of extremes on hard rock and the other end, "I Want To Know What Love Is." And all the moods in between are pretty distinct as far as I can see.

**MR&M:** So it was very intentional?

**LG:** Yes, it was. It started off as being a natural thing, but pretty soon, as it came to our attention, we decided to aim it that way.

**MR&M:** There seems to be an ever present R&B influence in the music.

**LG:** Yes. Lately it's a lot more than it has been.

**MR&M:** Who were some of your earlier influences?



Photo by Ebel Roberts

away that long. *I felt* the long layoffs in between. For a lot of reasons it's the way it had to be. For other reasons, it could have been different. It's hindsight now, and it's really not too important talking about it, I don't think. I know how it felt to be away from the charts and the public for that long. I'm not going to let it happen again.

**MR&M:** Agent Provocateur has a really wide range of musical moods and influences. Was this intentional or was it just the result of the natural musical evolution, since each record has had a wider range of music?

**LG:** Yes, that's right. I think it's natural because a lot of the themes are based on the things that are going on in my life and Mick's life. You know, the themes of the songs. And the spectrum of the moods was

**LG:** Definitely the late Marvin Gaye, Aretha Franklin, Levi Stubbs, mostly the old great ones who could really bite down on a song and make your hair stand on end.

**MR&M:** What do you think about today's music?

**LG:** I think it's pretty encouraging actually. I think I hear a lot of good songs and some of the vocals are really excellent...you know Paul Young, Alison Moyet...there's actually a lot of good vocals...U2, Tears for Fears...I'm a fan of U2 from album one. I had that album when I don't think anybody around here even heard of them. I think it's very promising. I think the eighties are very exciting musically, and I'm glad we're still a current band to be in with that.

**MR&M:** What did you do before

MODERN RECORDING & MUSIC

Foreigner? How did you get your start professionally?

LG: I was a drummer for a long time. Then I played drums and sang in a band called Black Sheep in Rochester, NY, and we had a couple of albums on Capitol Records...and that's basically how I met Mick. And we were a pretty damn good band. If circumstances were different, maybe that band would still be together and hopefully have some sort of success right now.

MR&M: When did you decide to try to make it as a singer? Was it something you always wanted?

LG: Not really. Singing and drumming was a burden. I could do it, but we were always looking for a good singer and at some point I started enjoying singing a lot. It was actually easier to find a good drummer than a good singer so while we were looking for a good singer we fell upon this guy who played the drums really well. So

doing is compiling my stuff to do a solo album at the end of this tour.

MR&M: How did using Jennifer Holliday and a choir come about?

LG: Actually the choir idea was an idea that came up after listening to the chorus with Mick's one harmony to my melody. It was haunting even then, but we thought it could be so much more than it was. And there's one song in particular that I brought to Mick's attention, "Oh Happy Day," by the Edwin Hawkins singers. It was a great song and it was chilling as a classic. You know, we just kind of tossed around the idea of maybe using a choir, wondering what it would sound like. And the clincher was after we spoke about it Mick bumped into a friend of his who was involved in a gospel music label. And that was irony...so it was like... 'Who have you got on your label?' 'Oh, we have the New Jersey Mass Choir'... 'put me in touch with them.' So we had them come down—and we just

next door. I don't think she had a clue! She came in and was just a real thrill. Of course all those people knew who she was and we asked her if she would come down and sing on the song. She couldn't that evening, but she did come down the next day and put down some parts that really touched the song up nice.

MR&M: You just finished touring right?

LG: We're not done. We're going back out in two days. We're going in Montreal and Quebec City and doing the end of North America. We do the West Coast and a bunch of other places. We're not done until Christmas.

MR&M: Where did you just come from now?

LG: Europe. The last stop was Tel Aviv.

MR&M: How was the crowd there?

LG: It was large and very enthusiastic because I don't think they get much hard rock down there.

MR&M: How are you handling the choir parts on "I Want To Know What Love Is" on stage?

LG: We have a lady who does some advance work for us and in every city we go to we have a local choir on stage with us. It's good for community involvement and it's a kick for them too.

MR&M: You really do long tours. Your last one was about 160 dates. How long is this one?

LG: This one's going to be nine months. I think we're talking about 125 to 130 dates. It's a little less (than the last one), but it's still not what I would call a short tour.

MR&M: You have a very high energy show.

LG: We enjoy what we do.

MR&M: How do you manage to keep up such a high energy level over such a long period of time?

LG: Clean living, a lot of vitamins.... It's just something that once you step on stage you can't help—you cannot lay back at a show like that. It's not like there are no days off. We get a day or two off a week and you just kind of cool out. We do take care of ourselves pretty good. Not to say we're angels. But we keep fairly reasonable hours and we make sure that we're taken care of.

MR&M: When you write and perform do you take into account the expectations and conceptions of your audience?

LG: Yes, I do. Not to the point where it affects my performance. If I'm having a tough time with monitors I'm not all smiles ear to ear. I'm

---

***I'd be a liar if I didn't say that (success has) made my life a little more comfortable in some material things, but that also brings big problems and you just have to keep your feet on the ground and adhere to the way you were brought up.***

---

he became the drummer and I became the singer. It was almost out of practicality that I put the sticks down.

MR&M: How much writing do you do now?

LG: A lot.

MR&M: Mostly co-writing with Mick?

LG: No. Well, as you see on the album we co-write a lot of things, but I have just a slew of things that don't quite get the attention on the album because he's so prolific and he has ten ideas to my one. But my one is just as good as any of his ten. So what I'm

tossed around ideas. It was very moving. There were some tears flowing that night just from the sheer emotion of it. They loved the song and they put their hearts and souls into it and it turned out great.

MR&M: It sounds great. What about Jennifer Holliday?

LG: We were in Studio A and she was in Studio B. She was working on her album. While this was going on Mick just ran out of the studio, went right into her studio—she was actually doing vocals—just ran right in there, took her by the arm, and said you've got to hear what's going on



giving my monitor mixer dirty looks and I'm trying to find one spot on stage where I can hear myself over all the guitars. I'm not Mr. Entertainment when it gets to that point. I'm a singer first and an entertainer second.

**MR&M:** When you're writing and performing are you consciously trying to be commercial—to make a hit?

**LG:** No. If we did that I think we would have struck out a long time ago.

**MR&M:** So you write what you want and then hope people are going to like it?

**LG:** Yes. You do tailor some things like editing to tighten things up for the sake of radio airplay. There are not many stations that are going to play the eight minute song any more. You kind of keep things down to a reasonable length of time, but that's the craft of creating a good rock song that gets into all the emotion that you want and compact it into three and a half or four minutes. You can say it all in that length of time and leave people very satisfied. If there's a craft to it, that's it, not—what chords do you think would be a hit and this melody sounds hit bound so let's use it. It's none of that stuff.

**MR&M:** This is the first album you've done video for. How do you feel about videos? How do you like doing them?

**LG:** We weren't sure we really wanted to, but I'm glad we did. We just wanted to make sure that the

videos kept true to the mental image you get of the song coming off of the radio. We didn't want to spoil how anybody imagined a song would be by throwing in a real cumbersome video with special effects that would just blow the whole image of the song. So we try and keep our videos to a basic concept of what the song is actually about. And that's it, just execute it correctly and produce it the best possible way. We had some great guys helping us out.

**MR&M:** How involved were you with the writing and production of the video?

**LG:** Well, pretty much, because we had a lot of people who really saw "I Want To Know What Love Is" in a totally different visual perception than Mick and I had. We did want it very earthy and to show interaction between people and the question of what is love, and some of the ideas we got were very bizarre and totally off the mark. We just kind of knew those people were wrong for the video until we actually came upon someone who in a very general way had the same idea and wanted to point the video in the same direction that we wanted and that's the person we chose. It was our approach and his direction.

**MR&M:** Do you think the video helped sell the song and the record?

**LG:** Not really. I think it must have made some difference. I think it was just good for people to just see our faces in a way to know that we actually do exist as a band and we're capable of doing a meaningful video—

especially the first one. I think it's different than a lot of things that are out and it's not bizarre. It's totally the other extreme. I think that the end of it was good. Considering we weren't on the road then either, so it wasn't like kids could run out and see us in concert the next week because it was like two and a half months before we hit the road. So that might have held them over until we were back touring again.

**MR&M:** You've only done one video then?

**LG:** We did a video for "That Was Yesterday" too. It was more like a live situation.

**MR&M:** You've had a different producer for each LP. Why is that?

**LG:** I think it's basically to get a little bit different chemistry for each album, and so we don't get a particular producer's production stamp on us continually. We get the best out of everybody we use. I think after recording with us once maybe they just will not do it again anyway (laughs).

**MR&M:** Can you tell me a bit about each producer you've worked with? Let's start from the beginning—John Sinclair and Gary Lyons, co-producers of *Foreigner*?

**LG:** We were barely a band and there was constant movement and constant jabbering between them and inciting us to do crazy things. They were pretty much responsible for the middle part of "Cold As Ice"—the breakdown where the voices just solo. That was basically their idea because we were fresh out of ideas and it was some odd hour of the morning and they were throwing anything at us just to get us to try something. They were really responsible in a certain way for that album sounding the way it did and our performing it the way we did.

**MR&M:** How about Keith Olsen with *Double Vision* (co-produced with Mick Jones and Ian McDonald)?

**LG:** Keith is excellent in his capacity. He's really a master sound technician. The sounds on the *Double Vision* album, to me, were some of the best we've ever had—very crystalline. He's really easy to work with from the standpoint of what work I did with him by and large. I was just doing vocals then and co-writing. I didn't hang around for a lot of the late night sessions—the actual production and mixing. That was when Ian [McDonald] was still in the band. It was Mick and Ian handling those chores with Keith. I have nothing bad



to say about Keith. He's actually very good at what he does.

**MR&M:** What about Roy Thomas Baker, *Head Games*?

**LG:** Total wild man, total lunatic—a lot of fun... a lot of fun. I *did* hang around for some of those mixes and they are so extreme and so radical and they're usually very, very exciting. He's a very crazy guy. I like him. He's cool.

**MR&M:** What about the producer of *Foreigner 4*—[Robert John] Mutt Lange?

**LG:** Mutt pushed us because when we came back after *Head Games*, we pared down to four. We had our work cut out for us and he pushed us and didn't take our best for our best. He just made us go to another level. And I think, song for song, *Foreigner 4* may be the best album we've ever done. I have a lot of respect for him, and other than professionally he's a friend. He's a guy you want to have as a friend.

**MR&M:** And Alex Sadkin—*Agent Provocateur* (co-produced with Mick Jones)?

**LG:** Alex is The Great Motivator. If I were to stop doing what I'm doing today, I would probably be the type of producer that Alex is. He appeals on a very gut level musically. He's got great placement of sound, dimension wise, and he's a motivator. He insists that it could be better, and you're just a little lazy, and why don't we try it this way. Alex is an ever present *up* in a studio. He's like a pal throwing off

**LG:** I was there for everything. But I'm not the type of person who pays too much attention to the kind of effects they're using. I'm more concerned about the make up of the songs.

**MR&M:** Do you feel that any of the albums were over- or under-produced?

**LG:** I think *Head Games* was a little bit, maybe, under-produced, but I think it was basically our fault. We didn't take the songs to the level that they should have been. We left a lot of things half finished. Other than that it's a little difficult to tell because for the early albums we didn't know what we were as a band yet. I don't feel nauseous when I hear anything like, 'Boy this is over blown or that could have been better.' I'm pretty much satisfied, especially with the last two albums in production.

**MR&M:** Did you find any difference in the recording between the first and the last LPs?

**LG:** Oh yeah. It's completely different now. On the earlier LPs I was taking vocal suggestions from all angles. I mean I didn't even know what I was capable of singing then. I was just trying everything. It shows in a way. There's a certain naiveté, a certain inexperience on the first two albums, I would say, that kind of shows, but it's all right because I was growing as a vocalist. I think that for the last couple of albums I pretty much know what I want to sing. Not that I'm above taking anybody's suggestions, but I'm specifically

mobbed. How do you feel about that?

**LG:** I don't know about mobbed, but as far as being recognized I can't do that anymore. I think that the people who would be mobbed are the people who actively pursue being on page six of the Post and being at every party where personalities gather. Those are the people who would be mobbed. I don't want to be mobbed. I actually enjoy being recognized by people who know and like the music. But mobbed? That's something that certain people want. I don't want that.

**MR&M:** So you're glad that your pictures aren't plastered all over everything?

**LG:** Yes. I don't want that kind of popularity. I don't particularly want the anonymity of no one knowing who the hell you are. That's a little bit the other extreme. You know I'm out and around and somebody will come by and say, 'God, I know who you are and I've got your records.' That's cool if it's one or two people every now and then. That's terrific. That's gratifying for me. That's enough.

**MR&M:** Which do you like best from all of your recordings with *Foreigner*?

**LG:** I think there's probably a couple from a lot of the albums. The earlier stuff like "The Damage Is Done"... I like the song "Head Games" a lot. "Jukebox Hero" is really good for me, "Waiting For A Girl," "Urgent," "Reaction To Action" is cool. There's a handful. And it changes a lot too. Songs you haven't paid that much attention to you'll hear some time some place and you'll go, 'I've forgotten how much I really like that song.' So they all mark a certain period of time for me and I like just about everything for its own reason. And there are some songs that I could do without hearing again ever (laughs).

**MR&M:** Some of the older stuff like "A Long Long Way From Home" and "Cold As Ice" have a 'classics' status.

**LG:** I like it a lot. That feels nice. It feels good. You know we step on stage and we start running down our song list and it's just really good to know that after eight years you've got a pile of good songs to show for it. The kids remember it—even the young kids, kids 13 or 14 years old who probably were half that age when those songs came out and they know all the words to "Cold As Ice" and they're singing right along with it. It's a great feeling.

**If I'm having a tough time with monitors I'm not all smiles ear to ear... I'm not Mr. Entertainment when it gets to that point.**

his opinions on things and you listen to him because he knows the person first, then he knows the music.

**MR&M:** Where was *Agent Provocateur* recorded?

**LG:** Part of it was recorded at the Hit Factory and most of the overdubs were done at the Right Track.

**MR&M:** How involved were you in the recording of the new album?

aiming for certain things when I approach the mic and the song. Actually it's a lot more pleasant doing it that way than fielding everybody's suggestions and not knowing what the hell you're doing.

**MR&M:** You have sold about 26 million albums worldwide, but you guys can walk down any street anywhere and probably not be

Photo courtesy of JLM Public Relations



# Corey Hart

# the world surrenders

Corey Hart's secret for success is quite simple. He possesses unrelenting drive, confidence, and ambition, along with strong talent as a serious singer and writer. In the process, Corey also manages to throw off an aura of unaffected charm and sincere optimism.

Achieving a readily acceptable pop/rock sound in an already swamped market is an accomplishment in itself. Add to that the fact that his hit, "Sunglasses At Night," was achieved on his debut album—at 21 years old—and it becomes a staggering reality. That's exactly what happened with Corey's LP, *First Offense*, which contained the hit singles, "Sunglasses At Night" and "It Ain't Enough."

Now, at 23, Corey has both created and co-produced a second album, *Boy In The Box*, recorded at Le Studio with Phil Chapman and John Astley (of the Who, David Bowie and Eric Clapton fame). Due to his growing experience he became more technically involved by outlining the arrangements and structure of material and then working closely with Phil to achieve the technical end.

"Never Surrender," the first single from *Boy In The Box*, shot straight up the top 20 shortly after release (and at the time of printing is number one in Canada). The tune characterizes Corey's philosophy as a fighter who never gives up when he believes in something. In this case, it's himself. Do we believe in him? Yes...and one gets the feeling that we haven't heard anything yet.

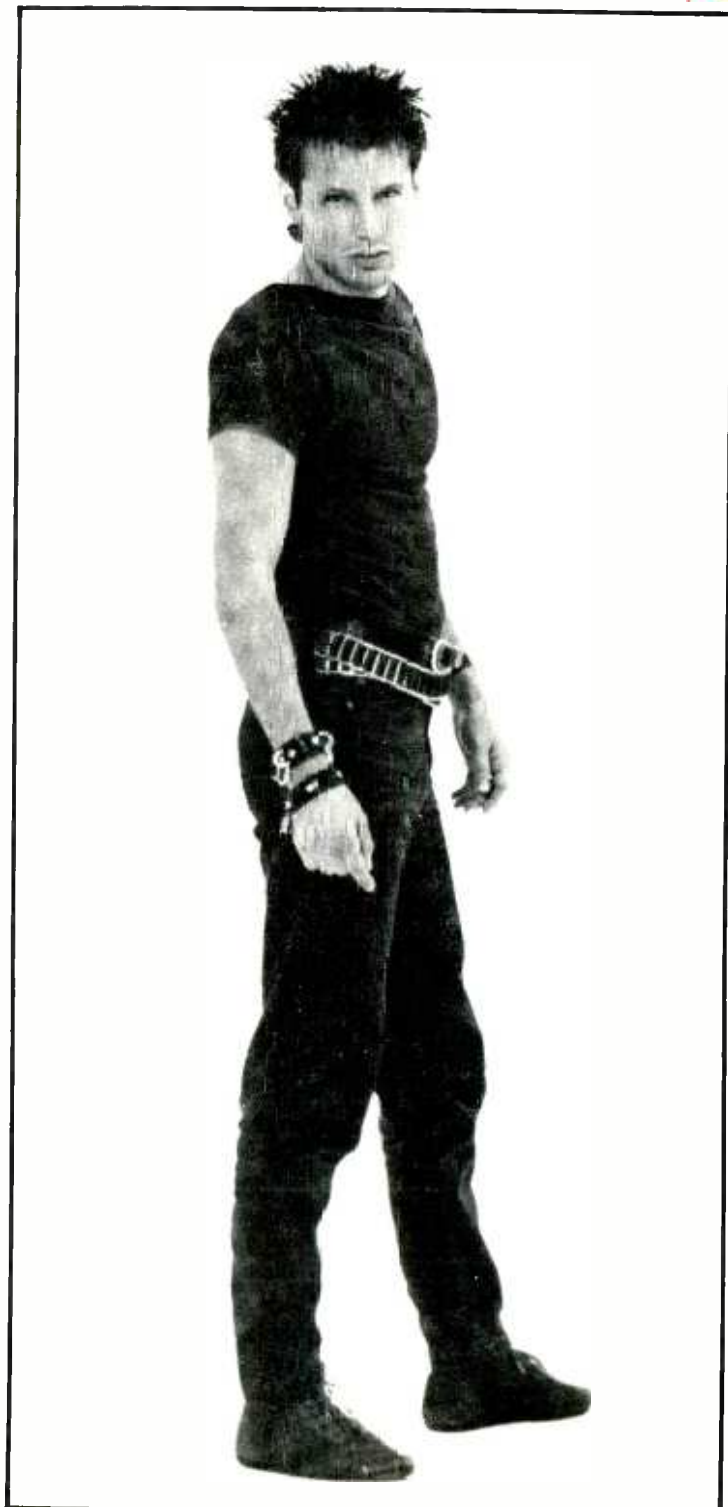

Photo courtesy of JIM Public Relations

**Modern Recording & Music:** Your career is advanced for your age. When did you decide to become a singer/songwriter?

**Corey Hart:** When I was about fifteen I decided it was what I wanted to do. It didn't happen one night, but it was a general feeling inside of me. I really wanted to be a songwriter, and I wanted to perform, and every day was geared toward obtaining that goal.

**MR&M:** Did you have any formal music training?

**CH:** No. I think what really propelled me, what really got me going was when I started writing my own songs. That really sort of hit me over the head and made me realize that this is what I should be doing.

**MR&M:** When did you start writing?

**CH:** I started writing when I was sixteen.

**MR&M:** I read somewhere that you had some studio experience when you were twelve. Is that true?

**CH:** My sister is a figure skater and she knew Paul Anka. He had sent me a couple of songs through her. I was just in high school so I went in and did a couple of demos with him, but it wasn't anything to write home about. I mean it was my first experience in the studio, at 12, but it's not really important. It didn't really shape me or anything.

**MR&M:** Do you play any instruments?

**CH:** Yes, I play keyboards.

**MR&M:** So you started recording at about sixteen?

**CH:** Yes. Well, for me, my ambition was to get a recording contract. So for me to achieve that I felt that I should get into the studio and try to put some of my songs down on tape and go see a record company. So I would go in on off hours at studios and work that way and sort of build up a repertoire and some demos.

**MR&M:** Do you think that you met a lot of resistance because of your age?

**CH:** I think you meet resistance if you're thirty or twenty. It doesn't make a difference. There are a lot of people that passed on me, but I just think that's part of the process. You have to sort of expect it.

**MR&M:** Does the song "Water From the Moon" reflect what you went through getting involved in the business?

**CH:** I think that if there's a song that would sort of characterize my philosophy on things it would prob-

ably be "Never Surrender" more than "Water From The Moon." "Water From The Moon" represents the unattainable because there's no water on the moon. And so the unattainable was always what my dream was. And I'm fulfilling it right now. A line from the song says you can draw your water from the moon...so if you have a dream you can achieve it if you believe strongly. But "Never Surrender" is more a general theme throughout.

**MR&M:** You worked with Billy Joel's band when you were seventeen.

**CH:** When I was up in the studio I met his band, and they invited me down to Long Island and I did some demos with them.

**MR&M:** That must have been educational.

**CH:** Yes it was, because it was the first time I played with musicians that were of a caliber that was well above me so it was gratifying.

**MR&M:** When you were a little older you got involved in the Japan Song Festival.

**CH:** Yes. I just went over there and played some songs, went over and performed.

**MR&M:** And that's when you got a recording contract?

**CH:** Well, I think that it was an accumulation of things. That was one of them that was sort of important because my name got around a bit when I was over there so people got in touch with me when I got back.

**MR&M:** How involved were you in the recording of *First Offense*?

**CH:** The first album was done

---

**"Water From The Moon" represents the unattainable because there's no water on the moon. And so the unattainable was always what my dream was. And I'm fulfilling it right now.**



Photo courtesy of JLM Public Relations

really quickly, and I was not in control of a lot of different things—like the musical directions—despite the fact that they were all my tunes. I wasn't intimidated, but the producers geared it towards more of the way they wanted things to sound. So overall I didn't think that my involvement with the actual recording process, laying down the tracks, was as much as it was in this case with *Boy In The Box*. But all of the songs were mine, and the way I sung it was mine. It had my stamp on it, but not as much as this one.

**MR&M:** What is your writing process like?

**CH:** I usually jot down ideas in a little notebook I carry around and from there I get a lyrical phrase which will dictate the theme of the song including the song's chorus. I write the rest of the music around the song's theme and then fill in the rest of the lyrics. For example, on "Sunglasses" I took the phrase: 'I wear my sunglasses at night,' and I wrote the chorus. Then I built music around the rest. At that point I wrote the rest of the song's lyrics.

**MR&M:** So you basically write before you go into the studio?

**CH:** I usually write all of my material before going into the studio. Before *First Offense* I had everything written except "Sunglasses At Night" which I wrote after recording the LP. For *Boy In The Box* I had most of the songs written beforehand, but I want to be able to write something the day I'm in the studio so I know it's the freshest thing that I'll be able to put out. So I wrote a couple of songs when I was up there. I wrote "Never Surrender" when I was in the studio.

**MR&M:** What about for *First Offense*?

**CH:** Well, *First Offense* was like a collection of songs from when I first started writing. A song like "Jenny Fey" was one of the first songs I ever wrote so it was on *First Offense*. They were a collection from over three years or so.

**MR&M:** Is it true that you added "Sunglasses" at the last minute?

**CH:** I didn't have it written when I went over to do the album. It was an afterthought. Phil Chapman used to wear his sunglasses so I got the idea about him wearing his sunglasses all the time. That's where the lyrical idea came from. I wanted to write a song about it when I was over there, but I did the album in England and it just never came to me until I got back.



Photo courtesy of JLM Public Relations

**I would sit home and be really pissed off and mad so I'd write a song about it, about the frustration. But my outlook was a lot more positive on the new LP.**

**MR&M:** How did you go about picking Phil Chapman and John Astley as your producers?

**CH:** Well, the first time around it was more like they picked me than I picked them. Some of my demos were sent to John Astley through his management and he wrote back saying that he was really interested in meeting me and I flew over to England and I met him. I felt at the time it was important for me to go over to England and to meet new musicians and be in a different environment. But I think the most important thing I got from John was that he introduced me to Phil Chapman.

**MR&M:** So you're closer to Phil?

**CH:** Well, yes. John was more involved on the first album than on the second album. His parts were strictly confined to the Fairlight. He owns the Fairlight and he brought it

over so he programmed it. Working with Phil—to me, he's like a genius because he knows me so well and he's so perceptive to sounds that I want. You know if I describe something he'll get the sound. He'll critique my songs better than anyone.

**MR&M:** What was the basic process you used to record *Boy In The Box*?

**CH:** Well, we didn't do anything live with the band. I just put together a band. I never had a band, and I put together a band in the course of touring. We've played about 120 shows, but it's still not the E Street Band. Therefore, when we have a live track I want it to sound like there's a band playing. And so we can record much more meticulously. You know I'd hate to think that it sounds so polished that there aren't edges to it. I mean, I would opt for style more than intonation at times.

**MR&M:** How much input do the other members of the band have as far as the direction or musical content?

**CH:** As far as musical direction or style, no, I wouldn't say they do, but they're talented individuals so if you give a talented individual something to do they're going to be good at it. And I'm very lucky to have good musicians—particularly my guitar player, Mike Hehir, who played on *First Offense* and met me when I was 18. It's a very special feeling for me because he's been with me all the time. Now when I come in with a song he knows what I like and how to compliment the song.

**MR&M:** Was the recording process very different from the second album to the first?

**CH:** I was there for every minute. At times I find the actual technical process of it frustrating because I want things faster than they are. But the Fairlight was probably the most significant difference on this album because of the wealth of sounds you can get. You can just spend hours and hours listening to samples. It's amazing. Some people have this attitude that it's artificial, but I think that it gives a nice texture. It sounds different.

**MR&M:** What equipment are you using in the studio or taking on the road?

**CH:** Well, as far as keyboards I take the PPG 2.3 and the DX-7. But I find playing live behind the keyboards restrictive so I probably won't be behind them so much.

**MR&M:** Is that what you used in the studio?

**CH:** That's what we used in the studio.

**MR&M:** Any MIDI?

**CH:** Yeah, we had a 2.2 and we just stuck some hardware in the back to get it to be a 2.3. So it's really a 2.2, but it's got MIDI capabilities.

**MR&M:** Do you find yourself now with any preferences as far as studio equipment goes?

**CH:** Well, I used a Neumann mic in the studio, and usually on the road I use a wireless. I still haven't found the proper wireless mic, but they have a bunch of new ones now. We used the Neumann on the album and I liked the sound of that on record, but there's a difference between the studio and live. I don't know how well it would translate live.

**MR&M:** Are you touring?

**CH:** Well, I'm headlining in Canada

in July and August and then I'll come down to the States. I was grateful to the bands for taking me on tour with them. I've opened for Culture Club, Thomas Dolby, Rick Springfield, Hall & Oates, and April Wine. I have good memories, but I'd rather put that behind me and move on...so I'm really excited about headlining in Canada.

and my own pleasure. I'm writing them for other people.

**MR&M:** Where is your career heading now?

**CH:** I think it's very important for me to challenge myself and creatively to put out as much as I'm capable of doing and I think that I'm still only just skimming the iceberg and I just want to get better at it and keep

---

## ***Phil Chapman used to wear his sunglasses so I got the idea about him wearing his sunglasses all the time. That's where the lyrical idea came from.***

---

**MR&M:** How do you feel about video and its relationship to music? Do you ever write with video in mind?

**CH:** No, I don't think one should because I think the beauty of the music is the audio. But for the three videos I've done, I've been involved with the storyboards for them. I did all three of them with Rob Quartly who's a Canadian director. So I'm involved with that, but I never sit down and write a song with video in mind.

**MR&M:** Is there a lyrical theme throughout the album?

**CH:** I think there's a general theme about never giving up. I think there's a general optimism throughout the album, much more so than on the first album. The first album is sort of forlorn and lonely.

**MR&M:** Was this a conscious thing at all?

**CH:** I don't consciously write any particular way. I think the first track was reflective of the frustration. I would sit home and be really pissed off and mad so I'd write a song about it, about the rejection. But my outlook was a lot more positive on the new LP. I've always been a fighter, but it's changed somehow to more positive.

**MR&M:** Are you concerned about being commercial?

**CH:** I've always liked pop records. I've always wanted to be able to write a good pop record, and I always wanted to write an arty record. I'm not concerned with it (being commercial). I just think I'd like to appeal to a lot of people. I mean, I'm not writing my songs for my four walls

improving. And obviously to keep making records and playing live is very important.

**MR&M:** Do you think you'd like to expand into anything else besides music?

**CH:** Maybe acting, but before I would act I would invest some time in taking acting lessons. I feel I'm capable of doing it. It's just a gut feeling. I'd like to write a screenplay eventually. But I could never think of not writing songs. It's the most exhilarating experience for me and to have it devoid in my life—I couldn't think of it. So that's the way I feel now. Maybe when I'm 28 I won't feel that way, but I feel that way now and I've felt that way since I was 15 so I don't think it's going to go away. My aspirations are really to be a better performer and a better singer.

**MR&M:** Is there a political message to "Komrade Kiev?"

**CH:** No. I would say more social. It was something that was bothering me and it was a way for me to express myself through the song. So it was a comment on the Soviet Union and the West and their perceptions of each other. What's interesting is that on Sting's new album he has a song called "Russians" which deals with the same subject matter. It's different in the way it's recorded, the style of music, but lyrically it's similar in its message...it's ironic.

**MR&M:** He's a major influence of yours, isn't he?

**CH:** Yes. Yes. It was nice to know that he was concerned with something I was concerned with.

## In Session With Producer Phil Chapman

**Modern Recording & Music:** You produced and engineered *Boy In The Box*. Was there any difficulty or conflict doing both?

**Phil Chapman:** Not really, because engineering came first. That was a skill I picked up along the way. I'd always been fascinated by records as a teenager, and I was always interested in the way they were made. At the time I joined a studio, I didn't really realize there was any difference between the engineer and the producer.

**MR&M:** Where was *Boy In The Box* recorded?

**PC:** We recorded it at Morin Heights [Montreal, Canada]—Le Studio.

**MR&M:** What equipment was used for the recording?

**PC:** Le Studio is very well equipped. It has an SSL console, but one of the earlier types so it's naturally a little slow. But we had the place on a 24 hour lockout basis—which is the norm these days—so we had no problems. We could just take our time. In terms of what we used technically, as you can probably hear, a lot of the sounds are quite processed, so we were mainly using a Fairlight and a PPG. For the vocal mics we used a standard Neumann.

**MR&M:** What about outboard effects?

**PC:** I've been engineering for quite a number of years, so I tend to use a stock set of outboard effects which basically would consist of an AMS on two rather close delays to get a sort of artificial spreading across the speakers effect. I also tend to use an old Roland Chorus/Echo if I can get a hold of one, because I prefer the warmth of a tape delay rather than a digital delay. The drums are mainly on a DMX, the Oberheim drum

machine, and again, I don't like the sound of machines, but I tend to find them very convenient for working out parts. So with a good use of echo, I can get them to sound real. I prefer them to sound real.

**MR&M:** How much pre-production was involved on this recording?

**PC:** Quite a lot, because from the production point of view, somebody like Corey Hart is a producer's dream because he has no preconceived ideas. He basically has these songs which would stand up at the piano, for example, and it would consist of a verse and a chorus and I would spend many hours with him getting the song in the form it should be in to start with before the technology takes its course. So we spent quite a lot of time pre-producing because I got the songs in a workable form with Corey and then we went into a hall and we worked the songs through with the rhythm section which included the use of a Fairlight.

**MR&M:** What was the actual recording process used?

**PC:** There were no preconceived ideas. Corey didn't fancy one way over another. He liked some tracks to sound live and some tracks to sound dead, and I'm a bit like that as well. I go according to how the song dictates. It was a bit inconvenient to try and get a live drum sound at Le Studio, but it is a very good room. We weren't working with a drummer, we were working with a machine, so all the liveness that was created on the record was done with artificial echo. Again, I did use the Lexicon 224 and the LARC, because there are some excellent ambient settings in there, but I was brought up on EMT plates and I know how to manipulate those to get good effects, so I used those as well.

**MR&M:** Were there any unusual

techniques used on the album?

**PC:** I have a lot of stock techniques I use. I have a way of getting artificial top end excitement by the use of a flanger across the echo sends. For many years I've used a gated echo, long before it became popular. I also had this habit of turning an EMT plate off with rather a bang. I record all the sounds with their echo—that's something I do that I feel is different from other engineers—I tend to put an individual echo for each particular sound. And Corey's voice was sampled on the Fairlight and used for some of the choir effects.

**MR&M:** You worked on Corey's first album as well. Did you find any differences working with Corey on the second album?

**PC:** He had a hell of a lot more confidence. On the first album he was prepared to accept professional guidance within limits. He was difficult from the first album because he was quite stubborn about some things. But on the second album it was like he was let loose and he was quite uncontrollable, which I quite enjoyed. I found that quite stimulating because as an engineer I'm out to record anything. As a producer I might veto some of it for commercial direction, but as an engineer I kind of enjoy recording whatever comes along. On the second album he was open to anything—anything that made a noise was put on tape. May not get used but... We both approached this album on the basis that it didn't have to be technically well recorded. I've never regarded myself as a brilliant engineer, but I have regarded myself as knowing what kind of sounds suit the mood of the production. So I've always tried to go for a feel thing in the rhythm and musical content, more than the actual quality of recording.

# NATALIE COLE

susan borey



**CAUTION:  
DANGEROUS  
AHEAD!**

Natalie Cole developed a sophisticated musical sensitivity early in life, started to perform publicly at age 5, and polished her musical skills to a professional level before graduating college. Nevertheless, it took time for any record company to understand or accept her apart from her father's name. However, after her first album went gold and garnered two Grammy Awards, Natalie was recognized as an important figure on the contemporary scene.

*MR&M* spoke with Natalie shortly before the release of her latest album, *Dangerous*, which she co-produced.



**Modern Recording & Music:** It must have been interesting to grow up within the radius of your father's musical world.

**Natalie Cole:** He influenced me very much. When I was young I listened to a lot of jazz at an age when most kids are listening to R & B, rock you know, commercial music. I got into people like Sarah Vaughn, Nancy Wilson, and Count Basie at a very early age. When I was twelve years old I was singing Ella Fitzgerald music for my father.

**MR&M:** Did he recognize some kind of promising talent in you?

**NC:** I don't know. I think that my dad wasn't really sure about what I was going to do. After the initial time he heard me sing the Ella Fitzgerald music I think he was really pleased, but he wasn't sure it was going to be anything permanent. As a result of that, though, I worked with him onstage in Los Angeles.

**MR&M:** These days, how do you choose the songs you record?

**NC:** Sometimes it has to do with what will show my voice off best and reflect what's happening contemporarily without making me sound cloned. I've found that I'm very fortunate in that I sell albums, so I need to put a whole album together that has some real good stuff on it. At one time it wasn't so much that you had to have hits on your album as good songs, and continuity, and that is still just as important to me.

**MR&M:** Are there people who help you screen songs?

**NC:** Definitely. There are different approaches to that one. Sometimes people who know me well will know basically what to bring to me, so it's cut down a lot. One time I was checking out a very well-known producer. I went to his house and he sat me down and played one hundred songs for me. I was so sick by the time I left that I didn't want to hear another note for a month.

Sometimes I'll just hear a good tune. But it's definitely a team effort.

**MR&M:** Do you take your audience's musical expectations into consideration?

**NC:** Yes, absolutely. That's one of the reasons that on this album, although, there's a lot of uptempo stuff, there are still some really nice ballads. I know that people expect that from Natalie Cole, and I expect that from Natalie Cole because I love ballads. The three ballads on the album are really strong, and there are also some musical styles that

people haven't heard me do that I think they'll be real excited to hear.

**MR&M:** How do you work out arrangements?

**NC:** I usually go into the studio with a rhythm section and we put down a scratch vocal for the arranger, whether it's for additional rhythm, strings, or other orchestration. I keep singing with the rhythm section until they really feel the groove, and that's usually the cut, the final version. Then they'll take that track to the arranger, who in this case was Gene Page. He'll listen to what I'm doing with my voice and arrange around it. It's very flattering to an artist to have it done that way, because a lot of times the voice gets stuck on at the last minute.

**MR&M:** Do you have a home studio?

**NC:** I had a home in Beverly Hills for several years, and in the process of moving, a lot of that stuff was misplaced, and I had a theft, so I have to start all over again. My cousin, who is my musical director on the road, has a lot of nice stuff and I can sit down with him when I feel like writing.

I have a couple of keyboards around the house besides a piano. One of them is a Casio that you can store melodies in.

**MR&M:** How do you think things like the computerized Casios are

changing the music making process?

**NC:** It can make it more difficult for a layman without technological knowledge who just wants to write a song. At least there's flexibility, though. If there's a certain sound you have in mind, you can take it to someone with the appropriate knowledge. I get concerned with getting too carried away with technology and missing out on the richness of the music.

**MR&M:** How do you feel about things like drum machines, which can take a human element out of music?

**NC:** I'm sure that there are a lot of producers who would love to get away with a totally electronic rhythm section, no human beings at all, but I like to have some folks on my rhythm. When I'm on the road I'm very leery about taking a lot of technical stuff because it can break down. Unless you take computer whizzes with you on the road, it can be a real problem.

**MR&M:** What do you think accounts for the music business' recovery from its big slump a few years ago?

**NC:** I think the public has become less narrow-minded about music, and so have radio stations and record companies. There's a lot of stuff going on now that I heard years ago, but

*When I was young I listened to a lot of jazz at an age when most kids are listening to R & B, rock, you know, commercial music. I got into people like Sarah Vaughn, Nancy Wilson, and Count Basie at a very early age. When I was twelve years old I was singing Ella Fitzgerald music for my father.*

***I'm very critical, which is why I insist on having co-producers. I think you can get too close to a project and you need other ears. I always want to stay open, and avoid tunnel vision.***

people thought it was too wild to get anywhere. Now it's like a free-for-all. You can just about do anything, and if it's got a good beat, it'll work.

**MR&M:** What do you think makes a hit?

**NC:** Having a song that's doing the right thing at the right time. It should be unique, not too commercial. Sometimes lyrics make a hit, sometimes a distinctive voice.

**MR&M:** How important is video to your work?

**NC:** Nowadays it's very important. It's more work for the artist, but people like them. I am looking forward to doing one for *Dangerous*, but I don't like to make my videos like a mini-series.

**MR&M:** How do you think videos have changed the music industry?

**NC:** They've allowed the public to see more artists perform, and watch a song come to life. It's given them an insight into what these people are like and how creative they can be, how well they look on screen. It's given the artist a chance to do some acting, and to do some cutting up. It helps sell records.

**MR&M:** You did some producing on *Dangerous*, right?

**NC:** Yes, and it was exciting for me because I got to see a lot of the new technological things that are happening in the studio. My co-producers, Mark Sharon and Jerry Skardina, are really into innovations. They used

a lot of techniques I never knew of. Sometimes they would show me different effects and I'd say 'Let's keep that,' like the echo on the beginning of "Dangerous."

**MR&M:** Do you have a certain approach to producing?

**NC:** I'm very critical, which is why I insist on having co-producers. I think you can get too close to a project and you need other ears. I always want to stay open, and avoid tunnel vision.

The engineers play a big role, especially at this stage of my producing where I'm learning a lot. I know what I want to hear and the engineers know how to get it. Their ears, and how well they hear me, are everything. An engineer has to be an expert for me, and have a lot of patience.

I really did enjoy co-producing and I want to do more of it, but I'm a team person and I'd never take on a project alone.

**MR&M:** Has producing changed your view of the music making process?

**NC:** It's made me realize that it's much easier to produce someone else than to produce myself.



***It's that time again..!***

...time to renew your subscription to Modern Recording & Music! Don't wait until it expires—DO IT TODAY! Then you can sit back and relax...!

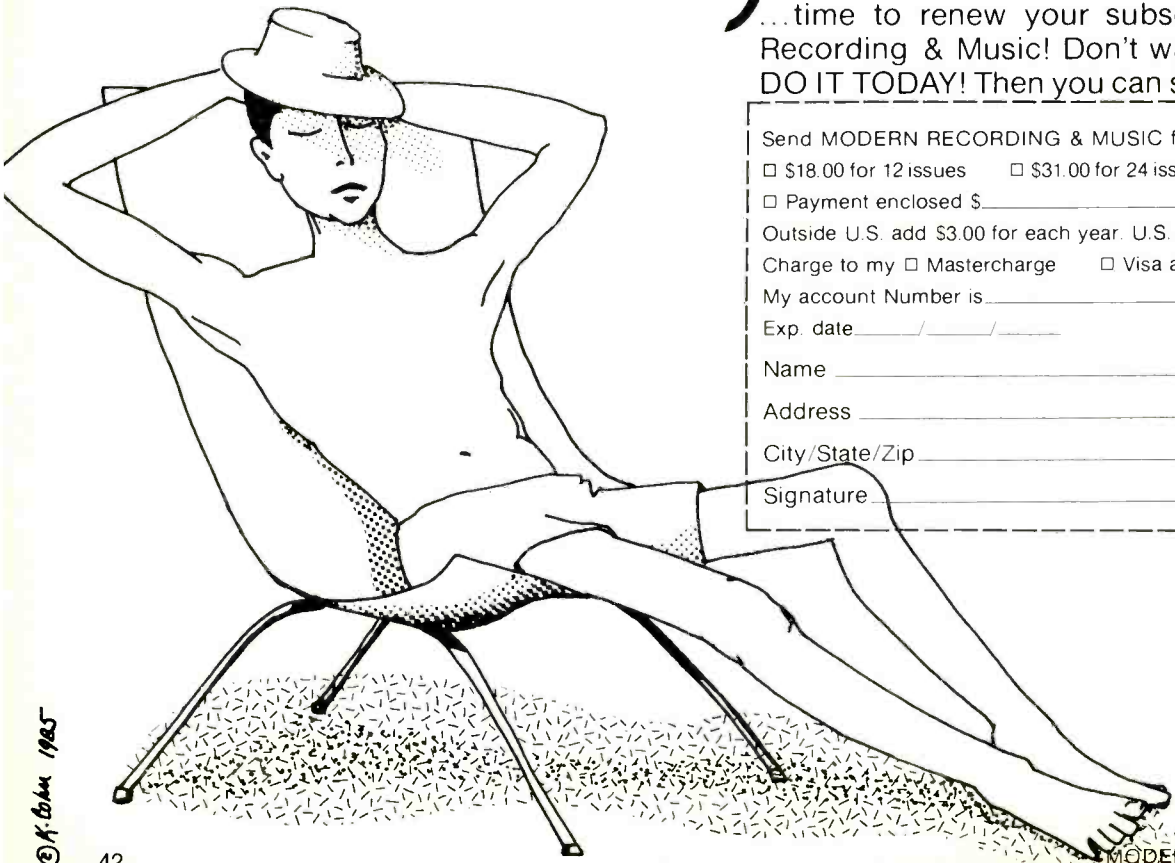

Send MODERN RECORDING & MUSIC for:

\$18.00 for 12 issues     \$31.00 for 24 issues     \$45.00 for 36 issues

Payment enclosed \$ \_\_\_\_\_

Outside U.S. add \$3.00 for each year. U.S. FUNDS ONLY.

Charge to my  Mastercharge     Visa account

My account Number is \_\_\_\_\_

Exp. date \_\_\_\_\_/\_\_\_\_\_/\_\_\_\_\_

Name \_\_\_\_\_

Address \_\_\_\_\_

City/State/Zip \_\_\_\_\_

Signature \_\_\_\_\_

© M. Cohen 1985

# Freelancing:

## Who's Behind the Bucks You Make?

**T**he thoughts of no more 9 to 5, lots of free time, and working for yourself are tempting as well as very deceptive. Leaving the 9 to 5 job often results in no jobs at all, the free time may be mostly unpaid and unbillable, and working "for yourself" may contribute to socially confusing situations.

As a professional musician and freelance writer I accept these conditions (with varying degrees of tolerance) as facts of life. So do most of my colleagues. Drawing on their help (in live music, recording engineering, producing, and consulting) I took a look at who freelancers actually work *for*, juggling rival or conflicting-interests, jobs, money, and socializing.

### READING COMPREHENSION

#### Directions

Read the following paragraph and

SEPTEMBER 1985

*answer (if you can) the question at the end.*

You (a freelance music type) are doing your usual shtick, which is hanging out by the phone. You get a call to play/engineer a gig/session from someone who says he got your name through a mutual colleague who needed a sub. You show up and meet the bandleader/producer as well as the purchaser of music/studio owner. You're paid in cash by somebody else and get told by yet another somebody, "I'm sure we'll use you again sometime.

#### Question

*Who actually hired you?*

- (a) the person who phoned
- (b) the colleague you subbed for
- (c) the bandleader/producer
- (d) the purchaser of music/studio owner
- (e) the person who physically paid you
- (f) the person who said they wanted to use you again

- (g) all of the above
- (h) none of the above
- (i) some of the above
- (j) Santa Claus

\* \* \*

Silly, you say! Follow what happened to indy producer Man Parrish when he recently got involved (musically, that is) with Boy George and Marilyn. The whole sequence of events is interesting if for no other reason than it involves other people (mobile studio owner Steve Remote and Fairlight programmer/musician Mike Rudetsky), and all too clearly illustrates the hiring question.

Our story (much abbreviated) opens with Man getting a call from Boy George and Marilyn, asking if he would be interested in working with them on a demo—a new version of *Spirit in the Sky* for Marilyn. Man was, and asked both Steve and Mike to participate, assuming that monetary arrangements for all three would be made imminently. Man,

who had a dance hit with *Hiphop Bepop*, and whose records get a lot of British airplay, knew Boy George socially and didn't anticipate any B.S. Therefore, he had no hesitation in sub-contracting both Steve and Mike.

At the appointed time, Boy George and Marilyn didn't show, but called and came six hours later. (Since no hourly rate had been arranged, this became unbillable "down time.") However, Boy George said, "Sorry for the inconvenience—don't worry, I'll take care of it." (This statement, by the way, ranks right up there with that all time favorite: The check is in the mail.)

For whatever reason, Boy George and Marilyn didn't care for the results, and scrapped Steve Remote's audio work. Then they took Man and Mike to the Hit Factory and recut the tune. Shortly thereafter, Man read in the papers that the tune was being co-produced by someone else in another location. Both Boy George and Marilyn are unreachable by phone. Neither Mike, Man, nor Steve has been paid for anything. Man's chance to co-produce with a really big name has seemingly turned into a momentous non-event. And everyone's pissed. In retrospect Man says, "Confirm your title and credit line before you do anything. I should have asked who Boy George's business manager was, since I never knew who was really responsible for paying us."

\* \* \*

Man's last statement is worth exploring further. Engineer Frank Roszak, freelance writer/musician Freff, and Yvonne Sewall, founder of I Contact, (an audio engineer referral service), feel one works for oneself. Says Freff, "I didn't always feel this way until a few things backfired when I identified too much with the company or project that hired me. When you forget you're working for yourself, you tend to make hasty short term decisions, rather than long term ones."

Engineers Holly Peterson and Nyya Lark think differently, and feel that anyone who pays them is the employer, no matter how long or short term the job. So do freelance classical musicians Claire Bergman and Joan Waryha. However you feel, it should be clarified, especially come tax time when a substantial cash job may send you a 1099 (independent contractor) tax form.

All seven people, plus Man Parrish, agree that a "special touch" is needed when dealing with arch competitors who have a certain something in common—namely you. Says Freff, "You can minimize any jealousy by establishing that you're a business—if they want exclusivity, they should pay for it. And be careful not to inject yourself into any ongoing feud."

Using one account as leverage to either gain or drop another one or to raise the ante is tricky. Both Lark and Peterson try to do each job independently of any other, and will only mention rival clients if it can help in negotiating better money and establishing credentials.

\* \* \*

Negotiating good money for oneself is laudable. Actually collecting it is sometimes even more so. Yvonne Sewall is very blunt about it, "I'll immediately ask: who am I billing and *how* will we be paid?" Both Freff and Nyya Lark say that it's important to know the accounting people in an organization—those who are responsible for keeping the books and mailing the checks. Lark says she's been known to go to the client and "walk through" an unpaid invoice until she finds the right person. A common practice that Claire Bergman and many other musicians follow regarding single engagements is to ask for half the money up front. When engineering a longterm project, Frank Roszak tries to arrange to get paid weekly, so even if the job falls through, he's made some money. As Man Parrish learned, don't get "seduced" by big names; their projects can collapse as well. The old saying "It's better to have 3% of something than 6% of nothing" applies quite nicely.

\* \* \*

Any job usually brings you into some kind of social network. It may lead to friendship, other work, and romance—sometimes all three. Socializing is part of work and very important; obviously if you make friends, they'll throw work your way. However, when friendship "gets in the way" of business, both suffer. As far as romance goes....

Many articles in all sorts of publications have been written about the dangers of sex on the job and office romances, particularly when women enter professions co-equal with men. The term sometimes used to describe

screwing around in the business hierarchy with the chain of command is *corporate incest*. (Isn't that lovely?)

If you freelance, you ARE free—more or less—of the social constraints imposed upon a 9 to 5 office environment. However, common sense should still prevail as to who you hang out with. Without getting terribly specific (or embarrassing) most successful freelancers have found that "heavy social involvement" should be delayed until after the particular project or job is completed and paid for.

What 10 points do everybody, including myself, agree upon?

- 1) Make sure you know *where* your pay comes from, especially if it's a cash job.
- 2) Know the name AND title (contractor, manager, producer, etc.) of the person responsible for paying you.
- 3) Understand the organization's or client's bureaucracy and billing cycle. Accounts receivable are NOT funny!
- 4) There are differences between socializing, networking, and asskissing. Learn them!
- 5) Ask if you're being put on the payroll, or being paid as an independent contractor. Save any and all expense receipts.
- 6) Know the going rate for a particular gig or project. If you're a musician, consult the Union. Remember to include such pre- and post-job items as rehearsals, transcribing, overdubbing, etc.
- 7) Scope out the people and/or organization hiring you. Are they profit or non-profit? Do you have to supply any instruments or equipment? If the project expands beyond its original expectations can you sub-contract? Have they ever taken advantage of any of your friends?
- 8) Don't mess around (in *any* way) with anyone who has any say over your paycheck.
- 9) If a one time engagement, be it a session, gig, or short term project takes more than a few phone calls to arrange and confirm, something's wrong.
- 10) Freelancing can be wonderful IF you look upon it as a serious business enterprise. You are the president, treasurer, and the sales manager of the best product on the market—yourself!

MODERN  
**RECORDING**  
& MUSIC

Looks At

***Keyboard Synthesizers***

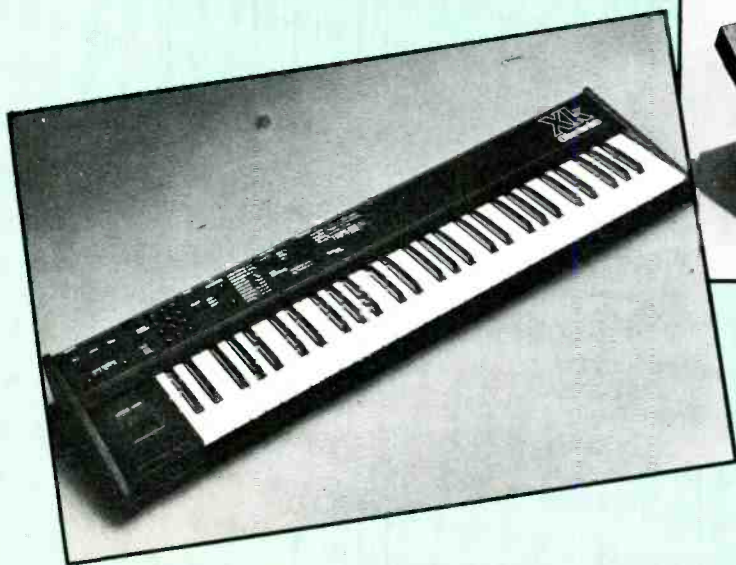
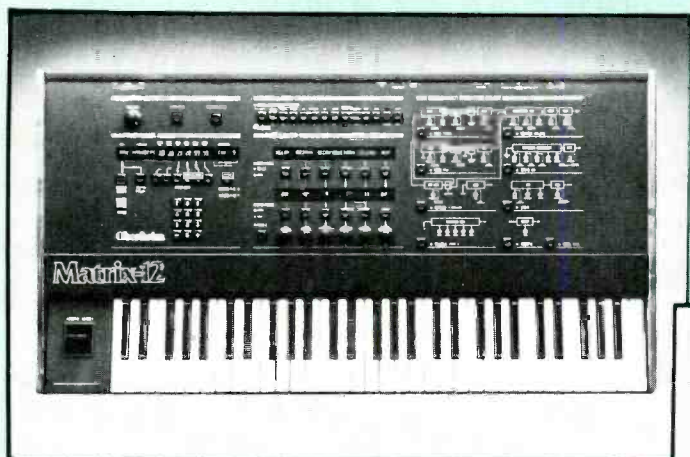

On the following pages, we have compiled a directory of keyboard synthesizers. In all cases, the information supplied comes from the manufacturers themselves. This, of course, includes all pricing information shown. Each manufacturer was limited to a maximum listing of eight products.

We believe that we have attempted to contact every U.S. manufacturer/distributor of keyboard synthesizers. Nevertheless, you may notice that some companies are not represented. We assure you that this oversight is unintentional and may have resulted from our being unaware of a given company (due to the constant proliferation and changes of manufacturers) or it may have simply been a company's inability to deliver to us the necessary information in time for our deadline. If we did miss anyone, we hope to catch them next time.

At the end of the directory we have provided a page which lists each manufacturer represented, along with their complete mailing address. Please feel free to correspond directly with any of them, and please do tell them that you saw it in the following pages.

---

#### AKAI

##### AX-80

8-voice polyphonic, key velocity, 24 oscillators, 2 ADSRs, 3 LFOs. Independent MIDI assigns, 96 programmable memories, easy editing fluorescent graphic display tape interface. \$995.

##### AX-60

6-voice, split keyboard, 6 oscillators, 3 ADSRs, 3 LFOs, 64 memories, chorus, digital delay, arpeggiator, sampler input jack, tape interface. \$795.

##### S612

6-voice MIDI sampler, 8 second sampling time, 32 sampling rate, 16 Hz bandwidth, LFO, filter, auto looping, velocity sensing optional disk drive storage. \$995.

##### MX-76

MIDI keyboard controller, 73 keys, velocity, aftertouch split keyboard, independent MIDI assigns. \$599.

---

#### CASIO

##### CZ-101

A 49-key digital programmable synthesizer. It is 8-note polyphonic when using a single line of sound controllers and 4-note polyphonic when combining 2 lines for richer, three-dimensional sound. The MIDI interface will read four MIDI channels at once allowing multi-timbre performances from one keyboard. \$499.

##### CZ-1000

The CZ-1000 has all the features of the CZ-101. However, it has 49 full size keys whereas the CZ-101 has mini keys. \$699.

#### CZ-5000

A 61-key programable synthesizer featuring a 16 note polyphonic keyboard when using a single line of sound generators and is 8-note polyphonic when combining two lines. It features 32 presents, 32 internal memory locations and can store sounds on an optional RAM cartridge or cassette. \$1,199.

---

#### E-MU SYSTEMS, INC.

##### EMULATOR II

A digital sampling keyboard that allows you to digitally record any sound and play it back polyphonically. Features include a velocity sensing keyboard, powerful MIDI sequencer with auto correct, SMPTE reader/generator. Analog equipment include filters, VCAs envelope generators, and eight independent LFOs. \$8,645 with two disk drives.

---

#### EUROPA/PPG

##### PPG Wave 2.3

Digital/analog hybrid synthesizer. Creates complex digital and familiar analog sounds. Unique ability to sweep through series of waves. Over 1900 waveforms available. Polyphonic sequencer included. \$8995.

##### PPG Waveterm B

Sampling/processing computer. 16-bit sampling with complete processing abilities. Construct sequence chains of up to 70,000 notes. Loads 8 sampled sounds in 16 seconds into Wave 2.3. \$14,495.

##### PPG E.V.U.

Rack mountable version of Wave 2.3 without front panel controls. Control and programming accessed by Wave 2.3 via Waveterm. \$6995.

##### PPG PRK-FD

Wooden-weighted, piano-action keyboard with multi-parameter velocity control. Uses floppy disk for loading sampled sounds and sequence chains into Wave 2.3. \$4650.

---

#### KAWAI

##### SX240

Features include a 61-key, splittable keyboard with Poly 8, Poly 4, mono, and chord memory modes. Sequencer features 8 memory banks of approximately 1500 notes each. MIDI In/Out/Thru. \$1,349.

## KURZWEIL MUSIC SYSTEMS

### KURZWEIL 250

Using Contoured Sound Modeling, the Kurzweil 250 features the sounds of the Kurzweil grand piano and strings. The fully programmable sequencer, voice editor, keyboard editor, and assignable controls, and optional Sound Block adds Human Choir, tympani and others, for a total of 45 instruments. \$12,970.

### KURZWEIL MIDI BOARD

The most advanced MIDI keyboard controller available, with independent polyphonic pressure sensitivity on each key, impact sensitive touch sensing system for fast note repeatability. Powerful MIDI operating system. \$2,195.



## MUSIC TECHNOLOGY/SIEL

### DK-600

A 6-voice polyphonic synthesizer, touch sensitive, and programmable. Real time editing of the 95 factory programs is easily accomplished with panel analog controls. \$1,295.

### DK-80

A twelve DCO/6-voice polyphonic, bi-timbric synthesizer. It features split capabilities and a two-track sequencer. Additional voices can be added via a RAM/ROM port. \$995.

## MUSIC TECHNOLOGY/DIGITAL KEYBOARDS

### BIT ONE

A 6-voice, polyphonic, digital synthesizer. It features assignable split, doubling mode, unison mode and 64 preloaded factory programs. \$1,395.

### SYNERGY

A completely digital 32-oscillator touch sensitive synthesizer. Used in conjunction with the Synergy host control system, complete voice editing and creation is possible via computer. \$5,395.



## NEW ENGLAND DIGITAL

### ENHANCED SYNCLAVIER® DIGITAL MUSIC SYSTEM

Standard features include: 76-note velocity/pressure sensitive keyboard, 16-track memory recorder (soon to be upgraded to 32-track via a software release), enhanced central processing unit, and super floppy disk drives. The Synclavier has the following options available: Sample-to-disk®; Music Printing; Polyphonic Sampling; Multi-Channel Outputs; and SMPTE. Range: \$35,000-200,000.



## OBERHEIM/ECC

### MATRIX-12

This is a MIDI programmable synthesizer based on the Oberheim Xpander. It features a five-octave velocity, after touch pressure and release velocity responsive keyboard, controlling twelve independently programmable voices. \$4,995.

### MATRIX-6

It features a five-octave, velocity, pressure, and release-velocity responsive keyboard. The six voices can be split or doubled by means of two independent keyboard zones. Memory capacity is 100 single patches and 50 multi-patches. \$1,595.

### XPANDER

This is a six-voice, individually programmable synthesizer. Each voice contains two oscillators, a filter, two output amplifiers, five envelope generators, five LFOs, four ramp generators, three tracking generators and a lag processor. \$2,995.

### Xk

This is a five-octave, velocity, release velocity and pressure sensitive keyboard. The keyboard can be split into three zones, overlapping if desired, with each having its own MIDI channel. \$995.

---

## OCTAVE PLATEAU

### VOYETRA EIGHT REV 4

This now responds to all MIDI controllers. Any synthesizer that transmits pressure, breath controllers, mod wheel, etc. can be used to control the Voyetra controllers. It also responds to MIDI pitch bend. The sensitivity is adjustable, and can track any synthesizer used as a master. It now has the velocity sensitivity feature. The new velocity clipping feature allows the user to adjust velocity response when used with the VPK-5 or external MIDI keyboards. \$4,595, VPK-5 \$995.

---

## ROLAND

MKS-80 SUPER JUPITER is an 8-voice MIDI Sound Module that responds to single or dual MIDI channel assignments, velocity, pressure sensitivity, hold pedal, system exclusive, pitch bend, volume, and patch change information. \$2,495.

### MKS-30 PLANET S

A 6-Voice MIDI Sound Module featuring 64 patches plus RAM cartridge storage, and can be programmed with the PG-200 Programmer. The MKS-30 responds to MIDI velocity, pitch bend, patch change, and hold pedal. \$1,195.

### MKS-10 PLANET P

A 16-voice, velocity-sensitive, MIDI Sound Module containing 8 preset keyboard instrument sounds (pianos, clarinet, harpsichord, and electronic piano), and featuring MIDI In/Thru and a built-in stereo chorus and flanger. \$1,195.

#### JX-8P

A fully MIDI-compatible synthesizer/controller featuring 32 user programs, 64 presets, and RAM cartridge storage. The JX-8P sends and receives velocity and after-touch. Programming is possible using the PG-800 (\$295) or by parameter/step editing. \$1,695.

#### JX-3P

Features 32 presets, 32 user-programmable patches, an on-board 128-step sequencer, and MIDI In/Out/Thru ports. Programming is possible via parameter/step editing or with the PG-200 Programmer (\$295). \$1,395.

#### JUNO 106

A 6-voice MIDI synthesizer with 128 user programs, a 61-note keyboard, and MIDI In/Out/Thru. The Juno-106 uses system exclusive for patch storage/editing to personal computers. \$1,095.

#### MKS-7 SUPER QUARTET

A multi-timbral MIDI Sound Module that features four sections including Melody, Chord, Bass, and 11 PCM Drum Sounds. Each section can be assigned to a separate MIDI channel for use with controllers/sequencers/MIDI software. \$1,095.

#### MKB-1000/300 MIDI KEYBOARD CONTROLLERS

The Roland Mother Keyboards are master keyboard controllers designed to send specific MIDI information to MIDI-compatible instruments, sound modules, and devices. MKB-1000-\$2,195, MKB-300-\$1,295.



#### SEIKO

##### DS250 DIGITAL KEYBOARD

Features MIDI with selectable channels for two 8-note polyphonic digital sound sources. Up to 32 tone presets may be mixed or split and detuned. \$599.50.

##### DS310 SYNTHESIZER

This is a programmer module for the DS250 keyboard. Its unique method lets the user create digital sounds by adding harmonic overtones in separate envelope stages. \$249.50.

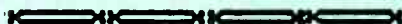

#### SEQUENTIAL CIRCUITS

##### MODEL 620-MAX

MAX is a multi-timbred 6-voice polyphonic synthesizer featuring a library of 80 sounds, a built-in digital 6-track sequencer with transpose, and a complete MIDI implementation which includes Omni, Poly, Double modes, and velocity sensing. \$599.

#### MODEL 610-SIX-TRAK

The Six-Trak features 6 fully programmable voices and 100 pre-set sounds, pitch & modulation wheels, built-in digital recorder, arpeggiator, cassette dump, complete MIDI implementation. \$899.

#### MODEL 615-MULTI-TRAK

Sequential's multi-timbred synthesizer, offers 6 completely programmable polyphonic voices, 100 pre-set sounds, pitch & modulation wheels, a 5-octave keyboard featuring velocity & programmable split capabilities, a 6-track digital recorder with auto-correct, metronome, arpeggiator, stack mode, stereo chorus, transpose, and cassette dump. \$1,499.

#### MODEL 1008-PROPHET T-8

This is an 8-voice polyphonic synthesizer whose velocity and after-touch sensitive 76-key wooden keyboard offers a unique piano-like "feel". Other features include programmable keyboard split, built-in sequencer, pitch & modulation wheels, 128 programs, cassette dump, and MIDI. \$5895.



### YAMAHA

#### DX7

16-voice FM digital synthesizer with 61 keys. 32 presets, 6 operators, and 32 algorithms to the FM sound source. Velocity and after touch keyboard, full MIDI capability, RAM and ROM memory cartridges. \$1995.

#### DX5

FM digital synthesizer with 2 FM tone generation systems. Velocity and after touch 76-note keyboard. 64 memories and 64 additional performance memories. Full MIDI capability. \$3495.

#### DX1

FM digital synthesizer with 73 wooden piano type keys. Dual FM tone generation system. Velocity and after touch for each individual note. MIDI capability. Extensive LED display to aid programming. \$10,900.

#### DX21

FM digital synthesizer with 61 keys, 128 voice memory. 2 FM tone generators, 4 operators, 8 algorithms, 8 note polyphonic. Built-in chorus \$795.

#### KX5

Keyboard control for use with any DX synthesizer, TX7, or TX816. 37-note velocity sensitive keyboard. Transmits on 2 MIDI channels. \$495.

#### KX88

88-note master MIDI keyboard. For use with any MIDI compatible keyboards. Can also control QX1 sequencer \$1695.

### Keyboard Synthesizer Manufacturers

Akai International Music Co.  
1316 E. Lancaster  
Fort Worth, TX 76102

New England Digital  
Box 546-49 N. Main  
White River Junction, VT 05001

Casio Inc.  
15 Gardner Road  
Fairfield, NJ 07006

Oberheim/ECC Development Corp.  
2230 South Barrington Ave.  
Los Angeles, CA 90064

E-MU Systems, Inc.  
2815 Chanticler  
Santa Cruz, CA 95065

Octave Plateau  
51 Main Street  
Yonkers, NY 10701

Europa Technology, Inc.  
1638 W. Washington Blvd.  
Venice, CA 90291

RolandCorp US  
7200 Dominion Circle  
Los Angeles, CA 90040

Kawai America Corp.  
24290 S. Vermont Ave.  
Harbor City, CA 90240

Seiko-Kamen Corp.  
PO Box 1  
Bloomfield, CT 06002

Kurzweil Music Systems, Inc.  
411 Waverly Oaks Road  
Waltham, MA 02154

Sequential Circuits  
3051 North First Street  
San Jose, CA 95134

Music Technology, Inc.  
105 Fifth Avenue  
Garden City Park, NY 11040

Yamaha Combo Division  
PO Box 6600  
Buena Park, CA 90622

Please write directly to the manufacturer(s) of your interest.  
Please also tell them you saw it in **Modern Recording & Music**.

# Otto Klemperer's Turbulent Times

By Peter Heyworth

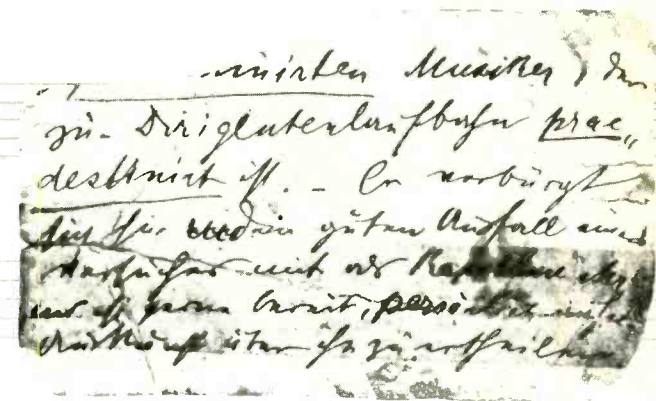
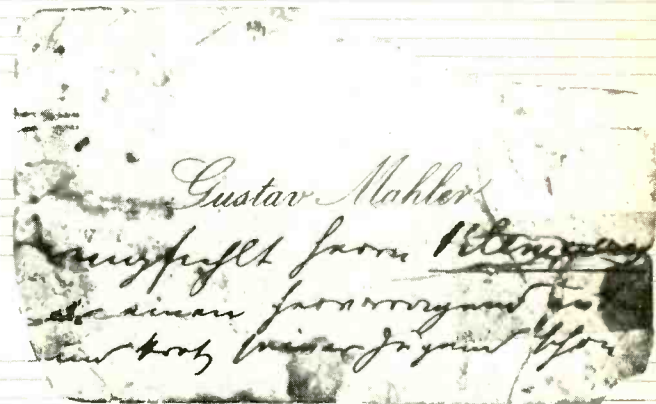

(above) Mahler's door-opening recommendation of Klemperer: "Gustav Mahler recommends Herr Klemperer, despite his youth, as an exceptionally good and well-versed musician who is predestined for a Conductor's career. He vouches for the successful outcome of any trial of him as Conductor and is prepared to give more information about him personally." Photo courtesy of Werner Klemperer.

**A**mong the outstanding conductors of this century, Otto Klemperer enjoys a less high reputation in America than he does in Europe. That is not wholly surprising. For a variety of reasons the two decades he spent in the United States represent a trough in his long career. Conversely, his principal claim to fame rests largely on two periods, both of which occurred in Europe. Between 1927 and 1931 he was the driving force behind an attempt to establish at the Kroll Theatre in Berlin an opera house that would in every sense be contemporary: its aim was to perform new works and to stage old works in new ways. That is the period of the radical Klemperer. Almost 30 years later London witnessed the Indian summer of his long career, when after much tribulation he was hailed as the outstanding conduc-

tor of his time of the great Austro-German classics from Bach to Mahler. That was the period of Klemperer the old master.

Paradoxically, both reputations are based in part on legend. Klemperer was never the "cultural bolshevist" (as the jargon of the time had it), whom right-wing critics assailed so fiercely in the Berlin press and the Prussian parliament in the years before Hitler came to power. Nor, on the other hand, was he ever the great traditionalist with a hot line to Beethoven, as his more fervent admirers (to his irritation) liked to see him in his last years. The truth of the matter is that Klemperer was a profoundly unaccommodating character, who at no time fitted into ready-made categories. His spirit of opposition was highly developed. Confronted with conservative views, he would assume a radical stance. In the face of avant-gardists, he would assume the role of traditional-

ist. He was a Catholic convert who in old age reverted to Judaism. In the Germany of the Weimar Republic, he was acutely aware of his Jewishness. In America, however, his approach to music seemed to be essentially German. He was a hard man to pin down.

## A Truthful Conductor

If there was one characteristic that set Klemperer apart from many of his colleagues it was unyielding artistic integrity. He was pre-eminently a truthful conductor. That may sound faint praise. But it was his refusal to project subjective or egotistical interpretations on music that won him the respect of many of the greatest composers of his time. Schoenberg and Stravinsky, dissimilar in so many respects, were at one in regarding him as an outstanding interpreter of their own works. So, too, did Hindemith and Weill.

## Otto Klemperer

This closeness to the creative forces of his age was a crucial element of Klemperer's greatness, for his insights into the music of his time permeated his approach to the classics. If in Germany in the Twenties Klemperer seemed the embodiment of a new sensibility, that was not merely because he performed new works. The expressive and structural insights he thereby gained also transformed his approach to the classics. As he grew older, Klemperer included ever less contemporary music in his programs. Yet he never closed his ears to what was going on. At the age of 83, for instance, he attended a rehearsal of Stockhausen's *Gruppen* and was much impressed by it.

This involvement with the creative energies of his time, which conditioned his entire development during the first 50 years of his life, started from his earliest years. In 1889, his parents brought the four-year-old child, who had been born in Breslau, back to Hamburg, his mother's home town, where he grew up. Two years after their arrival, Mahler became first

conductor at the city theater, and during his six years there lived in the same area as the Klemperers. In later years Klemperer retained a vivid memory of seeing in the street "a small man, who limped." That, his intensely musical mother told him, was "the Kapellmeister Mahler."

Klemperer was too young to hear Mahler conduct in Hamburg, but good fortune brought a personal encounter with the great man in Berlin in 1905. Although still a student, he had been engaged by Oscar Fried to conduct the offstage band in a performance of Mahler's Second Symphony. The composer came from Vienna to attend the last rehearsals and afterwards Klemperer offered to accompany him to another part of the city, where he was to lunch with Richard Strauss. It was not, however, until Klemperer experienced Mahler conducting his *Symphony No. 3* in Berlin in 1907 (a performance in which he himself played the bass drum) that he fell completely under his spell, both as a man and as a musician.

Henceforth, Klemperer, who had

seemed destined to become a pianist, had only one ambition: to work under Mahler at the Vienna Opera. But by the time that Klemperer got to Vienna in 1907 Mahler was already under the shadow of dismissal. He was, nonetheless so impressed by a piano reduction that the young student had made of his Second Symphony that he gave him a card of recommendation. That was sufficient to procure an engagement as chorusmaster and assistant conductor at the German Opera in Prague. When, two years later, Klemperer fell out with the theater's autocratic old director, Angelo Neumann, it was again Mahler's telegram, "Grab Klemperer," that secured a position in Hamburg.

### Manic-Depressive Temperament

It was in Hamburg that the 25-year-old Klemperer began to establish a name for himself as a conductor of exceptional promise. After his opening performance of *Lohengrin* he was described as a "meteor" in the city's leading newspaper. Yet work in a repertory theater brought him little satisfaction. "Every night another opera. All badly rehearsed, none properly prepared," as he later lamented. There was, however, a deeper reason for his low spirits. In addition to his musicianship, Klemperer had inherited from his mother a manic-depressive temperament. Throughout his life he was plagued by depressions that, sooner or later, were followed by periods of euphoria. In these "highs" he was liable to behave in an unpredictable or irresponsible manner that on more than one occasion came close to destroying his career.

Within a space of two years Hamburg experienced both extremes. In the course of his first season, a depression became so acute that Klemperer was advised to take a year's leave. Later he regarded this enforced retreat as a blessing, for it enabled him to study scores in depth. The euphoric condition in which he returned to the Hamburg Opera in 1912 had no such positive side. There he fell in love with an enchanting young singer, Elisabeth Schumann, who was later to become a soprano of world renown. In spite of the fact that she had only recently married, Klemperer embarked on an affair which he conducted with a minimum of discretion. Having failed to engage Klemperer in a duel, the outraged husband assaulted him with a horsewhip in the opera house as the cur-

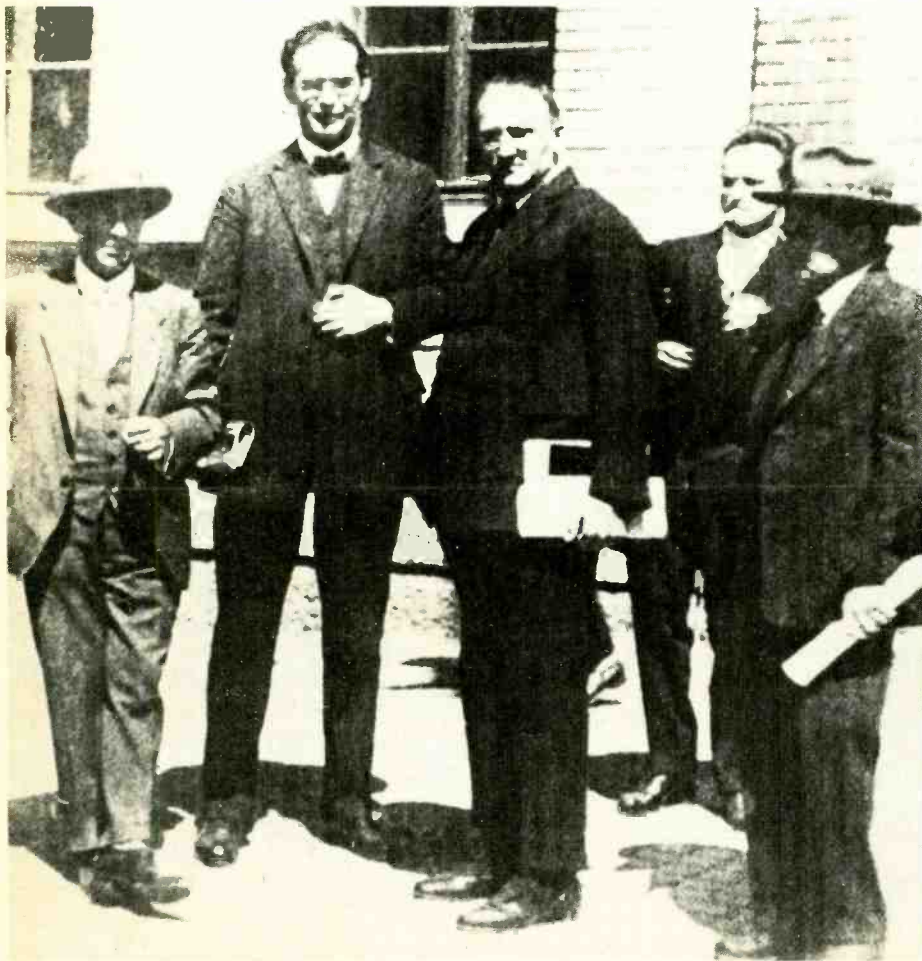

(left to right) Schoenberg, Klemperer, Herman Scherchen, Webern, and Erwin Stein at the Donaueschingen Festival, July 1924. Photo: Cambridge University Press, courtesy of Lotte Klemperer.



Klemperer, 1915, in Strasbourg, where he grew to maturity as a man and artist. Photo: Cambridge University Press, courtesy of Lotte Klemperer.

tain fell on a performance of *Lohengrin*. Unabashed, Klemperer shouted at the audience, "This man has attacked me because I love his wife." That was the end of his career in Hamburg.

Other appointments followed in Strasbourg and, in 1917, in Cologne. It was during his seven years there that he grew to maturity as a man and artist. Several factors combined to bring this about. In 1919 Klemperer converted to Catholicism. Three months later he married Johanna Geissler, a young soprano at the Cologne Opera, by whom he had two children. In spite of many turbulent periods (in manic phases Klemperer found it hard to resist a pretty face), this marriage was the rock upon which his life was founded until his wife's death in 1956.

At much the same time he had started to undergo a musical development whose

roots are less easy to determine precisely. In Berlin, Klemperer had studied composition and conducting with Hans Pfitzner, a composer of distinctly conservative stance, now best known for his masterpiece, *Palestrina*. Though Pfitzner never rivaled Mahler as an influence, Klemperer nonetheless chose to spend his year of retreat in Strasbourg, where Pfitzner was musical director. In 1911 Klemperer had also struck up a cordial relationship with Strauss, whom (after Mahler's death) he regarded as "the greatest of living composers now" (as he cautiously put it in a letter to his parents). Up to 1918 Klemperer developed broadly within a late-Romantic context, as is evident both from his own compositions and the almost expressionistic fury of his conducting.

But with the end of the war in 1918, Germany entered what was widely as-

sumed to be a new age. With it came new sensibilities, and in particular a revulsion against the post-Wagnerian values of the pre-war period. No one was more prophetic of this deep-seated change than Ferruccio Busoni, the Italian pianist and composer who before the war had settled in Berlin, where Klemperer had got to know him as a student. In 1917 a savage musical polemic broke out between Pfitzner (the upholder of Wagnerian Romanticism) and Busoni (the apostle of a new classicism). Klemperer wrote to tell Busoni that he was entirely on his side in this epoch-making dispute. In doing so he was allying himself with new aesthetic forces that were in large part to shape the musical life of the new Weimar Republic which had been established in Germany in 1919.

### The Kroll Opera Years

The young Republic was anxious to establish new institutions that would mirror its progressive sympathies. Just as the old Court Opera in Unter den Linden had been the embodiment of the monarchy, so it determined to establish an opera house in its own image in the Kroll Theatre, which stood adjacent to the Reichstag on the Tiergarten side of the Brandenburg Gate. The Prussian Ministry of Culture felt it had found in Klemperer the man to direct this bold undertaking. By the mid-Twenties he had come to be widely considered a conductor in the same league as Furtwängler. But in contrast to Furtwängler, who was deeply conservative in his musical attitudes, Klemperer was seen as a representative of the new age. His disenchantment with repertory theater had also prepared him for the task of running an



Klemperer, 1929, conducting at the Kroll Opera. Photo courtesy of Werner Klemperer.

# Otto Klemperer

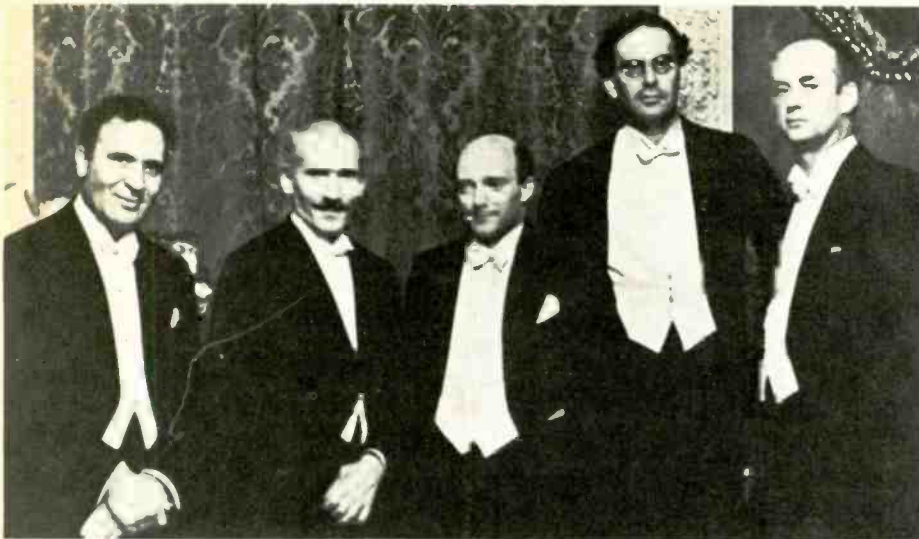

Five 20th-century giants of the podium: (left to right) Walter, Toscanini, Kleiber, Klemperer, and Furtwängler in Berlin, 1929. Photo courtesy of Werner Klemperer.

opera house based on a limited number of productions that would not be allowed to run down after their premiere.

Although Klemperer subsequently came to regard his achievements during his four years (1927-1931) at the Kroll as the keystone to his entire career, it is not possible here to discuss these in detail or to examine the complex web of cultural, economic, and political factors that led to the end of this brave experiment just as it was getting into stride. With the support of his close friend Ewald Dülberg, an artist and stage designer who was a crucial influence on his entire approach to the theater, Klemperer established a severely stylized, near-cubist manner of production that came to be regarded as the hallmark of the Kroll. He himself on a number of occasions produced as well as conducted. Twentieth-century masterpieces, such as Stravinsky's *Oedipus Rex* and a double bill consisting of Schoenberg's *Erwartung* and *Die glückliche Hand*, were staged; so, too, were Hindemith's *Cardillac* and his comic opera, *Neues vom Tage*, which had its premiere at the Kroll. These and many other achievements are now part of the operatic history of the twentieth century.

Less attention has, however, been given to the hardly less remarkable series of concerts that Klemperer gave at the Kroll. Unencumbered by the apparatus of opera, with its inborn propensity to disaster, he was often able to realize his artistic ambitions more completely in the concert hall than in the theater. Klemperer's concerts rapidly established themselves as a feature of Berlin's cornucopian musical life and stood

in sharp contrast to the far more conservative series given by Furtwängler, Walter, and Kleiber. Nowhere was the spirit of the age more apparent than in programs in which Klemperer performed the old classicism of J. S. Bach alongside the new classicism of Stravinsky, Hindemith, and Weill.

## Flight from Nazi Germany

In 1931 the Kroll shut its doors, a victim of economic stringency and political opposition, and also, it must be said, of mistakes made in its early days. Klemperer

er moved to the Berlin State Opera's other theater on Unter den Linden. Once again, he found himself enmeshed in the toils of repertory opera and became deeply depressed. He was nonetheless able to conduct a handful of new productions, including a stylized staging of *Tannhäuser*, which (like an epoch-making *Der fliegende Holländer* that he had mounted four years earlier at the Kroll) caused great offense when it was first seen less than two weeks after Hitler had come to power. This unhappy and frustrating period of Klemperer's life came to an end when, early in April 1933, he suddenly realized the dangers to which he was exposed both as a Jew and as a noted *Kulturbolschewist* and within 24 hours left Germany. Thirteen years were to pass before he returned.

Unable to believe that the Nazi regime was more than a passing aberration, he at first made his home in Vienna. But the assassination of the Austrian Chancellor, Dollfuss, in July 1934, in the course of a Nazi attempt to seize power, finally forced him to look for a safer home. On the basis of a chance encounter, Klemperer had been invited at short notice to conduct the Los Angeles Philharmonic Orchestra during its winter season of 1933-34.

Both the place and its musical life (the orchestra was at that time the plaything of a single immensely rich man) appalled

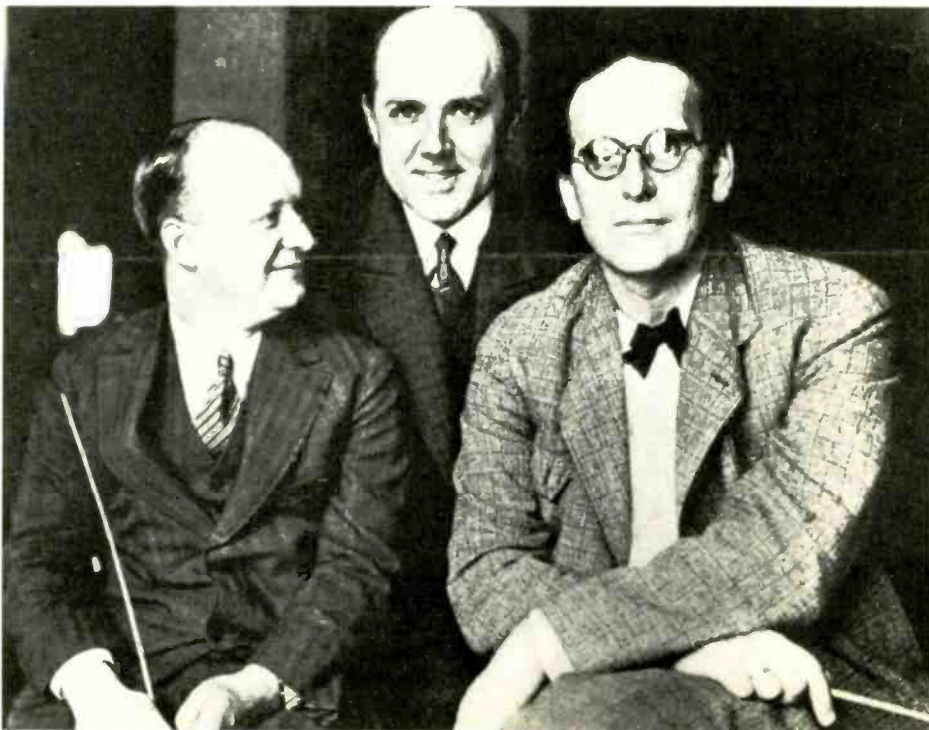

Klemperer with Hindemith (left) and Gieseeking (center) in Berlin, December 1932, only five months before he was to flee Nazi Germany. Photo: Cambridge University Press, courtesy of Lotte Klemperer.





With his family in Los Angeles, 1937: (left to right) son Werner, wife Johanna, Klemperer, and daughter Lotte. Photo courtesy of Werner Klemperer.

him. Accustomed to the great cities of Europe, he missed in the Los Angeles of half a century ago most of the amenities of urban life. In particular, Klemperer, who spoke English only haltingly, felt deprived of intellectual stimulus. When, however, he was invited to conduct both the New York and Philadelphia orchestras for several weeks in the coming season and Los Angeles held out the prospect of a three-year contract, he was obliged to overcome his initial aversion to Southern California. In the summer of 1935 he and his family settled in Los Angeles and took out American naturalization papers.

#### A Career in America?

His real hopes remained centered on the eastern seaboard, the hub of America's musical life and of its recording industry, and the seat of what were then its three outstanding orchestras. When he was invited to return to conduct the New York Philharmonic during the opening three months of the 1935-36 season, his expectations rose. It was an open secret that Toscanini was planning to retire, and Klemperer naturally hoped that, having been invited to conduct the entire portion of the season that Toscanini was not to undertake himself, he would in due course be appointed to succeed him. Klemperer put an end to that prospect by insisting, against the wishes of Arthur Judson, the orchestra's manager, on conducting Mahler's Second Symphony. The performances were an artistic triumph but a financial disaster. Klemperer was not an ambitious man in the conventional meaning of the word,

but in January 1936 he returned, angry and disappointed, to Los Angeles.

Musical conditions in Southern California were still primitive, and financial restraints limited Klemperer's field of action. He worked conscientiously and with some success to improve his orchestra and to expand its repertory. But his bad relationship with Judson, the all-powerful head of Columbia Artists, America's largest agency, was enough to ensure that other engagements were not forthcoming. It is a significant fact that during the 15 years that he lived in the United States, Klemperer did not make a single recording. Though one of the outstanding operatic conductors of his age, he was not invited to the Met until 1958.

One of the few redeeming features of life in Los Angeles was the friendship that developed between him and Arnold Schoenberg, another exile who felt that America had failed to recognize his true worth. In Berlin, relations between the two men had been difficult. In Los Angeles they flowered to a point where Klemperer took lessons in composition from Schoenberg. Yet he remained ambivalent in his attitude to Schoenberg's 12-tone music and, to the composer's annoyance, conducted relatively little of it in Los Angeles.

#### A Physical Wreck

In 1939 Klemperer began to suffer from headaches and disturbances to his sense of balance. A brain tumor was belatedly diagnosed, and in September a growth the size of a small tangerine was removed in Boston. In view of the state of

brain surgery at that period, it is unlikely that Klemperer would have survived had the operation not been performed in America. Even so, the surgeons were compelled to sever nerves that left him partly paralyzed on one side of his body. The operation was followed by a meningitis that nearly killed him (antibiotics had not yet been invented). But worse was to come. After the operation, probably the most intense manic phase he suffered began to gain momentum.

Before the operation, Klemperer had been a huge and imposing figure, 6 feet 5 inches tall and proportionately broad. After it, he was a physical wreck. His balance was uncertain. A patch covered one eye. He slobbered and had difficulty feeding himself. In manic phases Klemperer tended to spend money recklessly and as a result he soon found himself in financial difficulties. In his younger and more prosperous days it had been easy for outsiders to attribute exuberant and erratic behavior to artistic temperament, and his wife (whom he had left) had been on hand to ensure that he was properly turned out. Now he wandered the streets of New York, a shabby, down-at-the-heels figure, who moved from one cheap apartment to another, cadging meals, raising small loans, and disturbing his colleagues' rehearsals.

Not unnaturally, it was widely assumed that the operation had affected his mind. In fact his behavior was due purely to his psychological condition. Agents and managers were, however, uninterested in such fine distinctions. To them he seemed unemployable, and the Los Angeles Philharmonic terminated his contract. He conducted a modest series of chamber concerts in the New School of Social Research, where one of the artists who appeared with him was Elisabeth Schumann. Another series of concerts with a second-rate WPA orchestra ended when he refused to conduct *Siegfried Idyll* in any but the original chamber version. By February 1941 he had no work.

At the end of that month, however, Klemperer was persuaded to enter a psychiatric home. Hardly had he arrived, than its director tried to prevent him from going out to buy a newspaper. When Klemperer angrily pushed him aside and left, the doctor notified the authorities that a dangerous man had escaped. After a 24-hour police hunt, Klemperer was discovered in a cheap up-

## Otto Klemperer

state lodging house, violently arrested, and flung into jail, where he was photographed. That, of course, was front-page news. Doctors declared him to be sane. But the damage to his reputation had been done. In a desperate attempt to reinstate himself, Klemperer hired Carnegie Hall. The concert he gave there in April 1941 was hailed by the critics. But that changed nothing; hardly anyone would employ him.

Toward the end of 1942 the manic phase started to ebb, and Klemperer returned to his wife and family who were living in reduced circumstances in Los Angeles. As usual, the "high" gave way to a "low"; for three years Klemperer sat at home in so deep a depression that it was only with difficulty that he could be persuaded to accept such few modest engagements as came his way. He was a forgotten man. Only a handful of people who had heard him in his glorious days in Berlin knew what the world had lost. Among them was Thomas Mann, another exile in Los Angeles. In his novel, *Dr. Faustus*, it is Klemperer who conducts his composer-hero's masterpiece.

### An Uncrowned Emperor in Budapest

With the end of the war, the way was open for Klemperer to return to Europe, and his wife prevailed on him to undertake a concert tour in the summer of 1946. People who had not seen him since the Thirties were appalled by his appearance. But, though he could not hold a baton, his musical powers were manifestly undiminished, and he was invited to return on a more extensive tour in the following year. By that time, however, depression had again given way to a euphoria as extreme as that he had suffered after his operation. Almost everywhere he conducted there were scenes and difficulties, which often ended in Klemperer stamping out in one of the rages to which he was prone when crossed during a manic phase. By the end of the summer of 1947 he had made himself as unemployable in Western Europe as he already was in America. Thus an invitation to conduct at the Budapest Opera for a month came at the right moment.

At that time the city was still enjoying what was to prove an all too brief respite between the end of German occupation and the establishment of Soviet rule. Klemperer's success was so great that he was at once invited to return on a more permanent basis. Thus began one of the



Klemperer in Budapest after the War. Photo: Hungaroton Records.

strangest and most fruitful interludes in his entire career.

Klemperer liked Budapest. The hectic post-war exuberance of the Hungarians corresponded with his own euphoric condition. Always a man of the theater, he was delighted to be able to conduct opera regularly for the first time since he had left Berlin in 1933. He was also able to give concerts as and when he wished. But the key to Klemperer's success in Budapest was the unfailing understanding and support he received from Aladár Tóth, the director of the opera house. Tóth, who was married to the pianist Annie Fischer, recognized in the shabby, eccentric, and partially paralyzed figure of Klemperer a musician of genius. In Budapest, too, there were difficulties and incidents in abundance. But Tóth backed Klemperer through thick and thin. For three years he bestrode the musical life of Budapest as an uncrowned emperor.

By 1950, however, Stalinism had established an iron grip on every department of Hungarian life. Thus when Klemperer announced his intention of performing Schoenberg's inoffensive *Theme and Variations*, Op. 43b, the Ministry of Culture decreed the work not to be in accordance with the tenets of socialist realism. He was further irritated that his rehearsals at the opera house were frequently hindered by the priority given to a Russian choreographer who was preparing *The Nutcracker*. Though politically left of center and by no means enamored of America, Klemperer was no Marxist. He realized that the time had come to resume his career in the West.

### The Philharmonia Connection

His return to America in 1951 corresponded to the rise of McCarthyism, and after having spent three years behind

the Iron Curtain, Klemperer was inevitably suspected of Communist sympathies. On the basis of legislation that has since been declared unconstitutional, his passport was confiscated, which effectively confined his activities to North America. Misfortune again followed misfortune. On arriving in Montreal (entry to Canada did not require an American passport), he slipped, broke a femur, and was confined to hospital for six months. Thereafter he had so few engagements that he was obliged to conduct a concert in a city as small and remote as Portland. It was not until the end of 1953 that he was able to negotiate the return of his passport and to leave for Europe, this time to settle there.

Two and a half years earlier, in the summer of 1951, Klemperer had made one of his few appearances in London. As the occasion was the opening of the Royal Festival Hall, the management wanted him to conduct Elgar's "Enigma" Variations. Klemperer was not unfamiliar with the score, but he obstinately insisted that he should end his program with Mozart's "Jupiter" Symphony. It was, he acidly observed, a better piece of music. As usual, he got his way, and it was as well that he did so. In the audience was Walter Legge, founder of the Philharmonia Orchestra and artistic director of Columbia Records in Britain, at that time one of the most powerful concerns of its kind. Legge was so deeply impressed that he offered Klemperer a contract to give concerts and make records on a regular basis in London. Before agreement could be reached, how-



In an EMI recording session, London, 1965. Photo: G. MacDonnic, courtesy EMI Records, Ltd.

ever, Klemperer had lost his passport. It was thus not until the spring of 1954 that a contract was signed, on the basis of which Klemperer took an apartment in Zurich, where he lived for the remainder of his life, and reclaimed his German citizenship.

In 1954 Klemperer was, however, only one of the strings in Legge's bow. Karajan, who had raised the Philharmonia to a level never before achieved by a British orchestra, was its chief conductor. Furtwängler and Cantelli were regular guests. Within a short space of time both were dead, and Karajan had resigned from the Philharmonia in order to succeed Furtwängler as conductor of the Berlin Philharmonic Orchestra. The half-forgotten Klemperer now moved to the center of the stage as the last outstanding representative of a fast-disappearing generation. After long years of misfortune he had entered at the age of 70 into what was to prove the Indian summer of his long and turbulent career.

#### Fulfilment in London

London provided a happy constellation. Legge's perfectionism saw to it that Klemperer had a magnificent instrument at his disposal. Hitherto he had commanded respect rather than affection from the orchestras that played under him. Now London instrumentalists found themselves warming to this fierce-looking old gentleman with the profile of an eagle. Beneath an austere exterior they discovered a mordant wit and unyielding musical integrity. The public, too, was attracted by this maimed giant, who struggled painfully to the podium and scarcely bothered to acknowledge its applause. Klemperer concerts began to be regarded as special events. When in 1957 he conducted a Beethoven cycle that reached its climax in two overwhelming performances of the Ninth Symphony, Legge wrote to an associate in New York that London had experienced nothing to equal it since Toscanini's pre-war concerts.

There were, of course, setbacks. In 1958 Klemperer fell asleep while smoking his pipe. Awakening to find his bedclothes smoldering, he reached for the nearest liquid, which contained spirits of camphor. The burns he received were so severe that he nearly died of them. Among the engagements he was forced to cancel was one from the Metropolitan Opera. He was also obliged to abandon



Demonstrating to Daniel Barenboim how a passage should go during a break in recording sessions for the complete Beethoven concertos. Photo: G. MacDonnic, courtesy of EMI Records, Ltd.

plans for him to conduct at Bayreuth and to collaborate with Wieland Wagner in a production of *Tristan and Isolde* at the Holland Festival. But in London Klemperer continued to enjoy a sustained period of fulfilment such as had eluded him since he had left Berlin. In addition to regular series of concerts, he was also enabled to return to the world of the theater that had always in a real sense been his home. At Covent Garden he conducted and himself produced *Fidelio* and *Die Zauberflöte*. In 1963 he conducted *Lohengrin*. In 1962 he returned to America to conduct the Philadelphia Orchestra in a series of concerts that put a stamp on the new reputation his recordings had won for him in the United States.

#### Declining Years

This golden autumn lasted until 1964, when Legge with brutal abruptness dissolved the Philharmonia Orchestra, of which he had paradoxically only five years earlier appointed Klemperer principal conductor for life. With Klemperer as president, it was reconstituted as the New Philharmonia Orchestra. But the absence of Legge soon began to make itself felt. Klemperer had never been particularly concerned with orchestral virtuosity as an end in itself (perhaps a contributing cause of his relative lack of success in America). He was now approaching the age of 80 and was too old to act as orchestral trainer. Standards of playing began to decline.

There were still great evenings: in particular, a superb account of Mahler's Ninth Symphony and a tempestuous

concert performance of *Der fliegende Holländer* as late as 1968 stand out in the memory. But thereafter there were concerts at which Klemperer's grip seemed to slacken. His tempos grew appreciably slower. His hearing worsened. He tired more easily, and at moments his beat grew alarmingly vague. He came to be increasingly dependent on the unwavering support of his orchestra. Yet the fires would flare up, as they did in a performance he conducted of *Das Lied von der Erde* in 1970 on the occasion of his 85th birthday. Early in 1972, Klemperer, by then in his 87th year, felt unable to continue. Characteristically decisive, he at once announced his retirement without any farewell ceremony.

"When you cannot work, life is finished," Klemperer had said to me in the course of a series of interviews he gave in 1969 (to be published later this year in America under the title *Conversations with Klemperer* [Faber and Faber]). After retirement he slowly began to sink, while remaining lucid to the end. On July 6, 1973, he died at the age of 88. Having returned to Judaism a few years earlier, he was buried in Zurich according to Jewish rites. There was no music. After the service the huge coffin was slowly lowered into the ground and those present took it in turn to throw a shovel of earth into the grave. ■

*Peter Heyworth is music critic for The Observer of London. His book Otto Klemperer: His Life and Times. Volume 1. 1885-1933 was published last year by Cambridge University Press.*



.....

pon Frank Miller's retirement, Chicago Symphony Music Director Georg Solti issued the following statement:

*"It is with deepest personal regret that I have received and accepted the resignation of our Principal Cellist, Frank Miller.*

*"We are losing not only a wonderful musician but a most faithful and devoted friend to the Orchestra. Frank Miller is that rarest of jewels amongst orchestral musicians and has rightly become a legend in his own lifetime. In over 15 years of working with him, I have had nothing but the most loyal and wonderful collaboration, which has always been the greatest joy. The inspiration he has given to his section, to the whole Orchestra, and to me is inestimable, and making music without our beloved Frank will not be the same.*

*"I hope that in the time ahead his health will improve in such a way that he might enjoy the retirement that he has so richly earned and many more happy years."*

.....

# Frank Miller:

# Inspiring Presence of the Chicago Symphony

.....

By Sedgwick Clark

# Paul Laurence - Rocking the R&B Charts



Photo by Cheryl Lynne

**P**aul Laurence is a songwriter and producer from Harlem whose tunes shoot a bullet of warmth straight into the hearts of everyone who hears them.

He's a master of feeling who took lessons in soft soul from teachers like the Delfonics, the Stylistics and Billy Stewart. Listening to his most recent songs (a plaintive "All Of You" and a yearning "Rock Me Tonight" which spent six weeks at number one of the black charts), I could almost see him sitting behind a mixing console grinning slyly to his engineer, "We're gonna hook this one up *real* tough, and show no mercy on the girls; let 'em swoon." They're teardrop inducers.

The bouncy hits, ("You're A Good Girl," "Keepin' My Lover Satisfied," and "Who Do You Think You Are" among them), that introduced me to Paul, barely scratched the surface of his talents. They stood out of New York's hip hop mismatch because of their skillful use of metaphors, melodic peaks and valleys and aural candy. But I'll take the updated doo-wop with the extended breathing room anyday. Their timelessness and reliance on lyrics to create a mood is, unquestionably, a rarity in today's R&B and pop scene. *MR&M* spoke with the tugging-on-your-heart-string king, just after he completed his first solo LP for Capitol/EMI.

**Modern Recording & Music:** Paul, you began your career producing records with Morrie Brown and Kashif. How'd you guys initially hook up to produce Evelyn King?

**Paul Laurence:** I had a group act (L.J.E.), and I was trying to get a deal on them. After saving some money, we recorded some demos and shopped them around. One of the people we contacted was Morrie Brown, who liked my stuff, and expressed interest in me getting together with him to do some projects. At the time he had Evelyn King lined up.

When we were looking for other songs—because we didn't think I could do the whole album—we kept getting tapes from MCA, with three or four writers per tape. On each tape we liked maybe one song. We came to find out all the songs we liked were from one writer, Kashif. MCA got word of this and told Kashif. His response was, "If they keep picking my songs I want to meet them." So we got together. Morrie got the gigs to produce, but he let Kashif and me (help). We spent just as much time in the studio as Morrie doing everything from preproduction on. He acted more as the A&R type person making sure the songs were good.

**MR&M:** On the albums you did with him, you and Kashif were credited as assistant producers. Were you paid as producers?

**PL:** Yes. Morrie had the overall say and got the gigs. I guess that gave him status as producer. We worked under him.

**MR&M:** As far as styles of producing, how would you say you differ from Kashif? My evaluation is that he is more concerned with technology than you are, seeing that he uses the Synclavier and he just bought a new house and instantly threw in a full digital studio.

**PL:** Just a little. Not that technology isn't good, it's good to experiment with. It's there and if you don't use it, it'll just stunt your creative growth. Not to say he doesn't feel the same way too, but I think the song is the most important thing.

**MR&M:** What do you think of digital recording technology?

**PL:** I'm in love with it.

**MR&M:** Will you be doing digital projects now?

**PL:** Well, Freddie Jackson's track was digital and my album is digital.

**MR&M:** What format did you use?

**PL:** 3M.

**MR&M:** Did you experiment with other formats before choosing 3M?

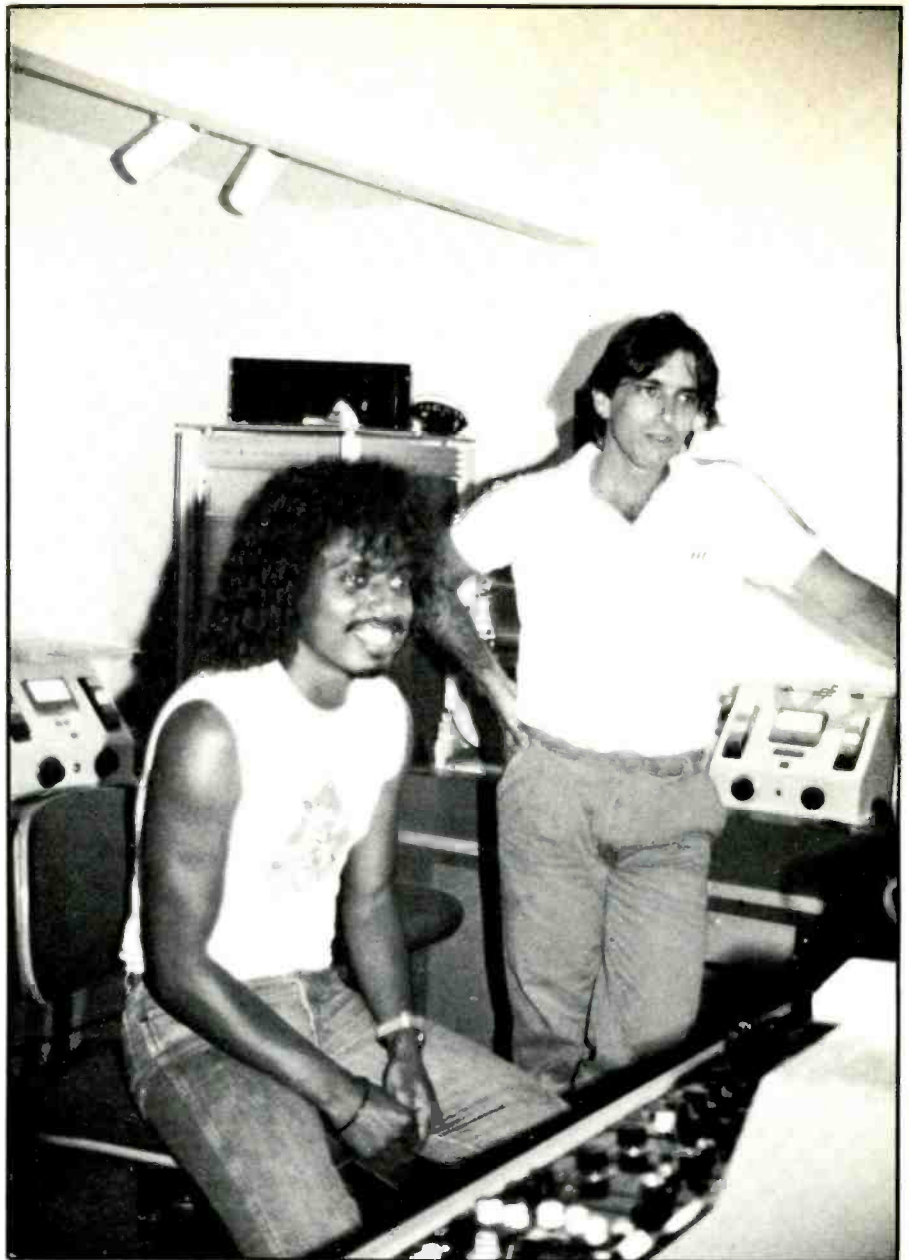

Photo by Cheryl Lynne

Paul Laurence with Jack Skinner, mastering engineer at Sterling Sound in New York City.

***I wouldn't want to hear somebody sample something I've done and make a million dollars off of it without sharing it.***

**PL:** No. I made my choice based on word of mouth from my friends Carl Beatty and Steve Goldman, engineers whose opinions I trust. I asked them what system was best, and they said "3M." I don't know what is best now, but I'm really in love with 3M.

**MR&M:** Describe an instance when the machine floored you.

**PL:** 3M is seriously quiet. When I first played back Freddie's track, I

had to actually check to see if the sequencer that we used for one of the licks was off. I couldn't believe how clean it was. It sounded just like it was going down.

**MR&M:** So will you be going digital all the way?

**PL:** I wouldn't say I'll never do another analog record, but it'll be hard.

**MR&M:** The songs you write really suit the artists that sing them.

MODERN RECORDING & MUSIC

Did you know Freddie, Lillo and Melba before you went into the studio with them?

**PL:** The only one I've known for a long time was Freddie. We've known each other for about ten years, after singing together in various groups. I began writing using his voice. Anything I write, he can sing.

As far as Lillo, I met him two or three months before going into the studio. I fell in love with his voice instantly. While Freddie has a straight ahead gospel sound, his is more a smokey, Michael Jackson timbre. I met Melba a month before I produced her.

**MR&M:** I thought I had you pinned down perfectly. I would hear a song on the radio and say 'that's a Paul Laurence record.' But recently you've expanded your breadth of emotion and styles. You bated us with bouncy, uptempo songs to, perhaps, get established and charted. Now you're giving us the *really* good stuff that I could never tire of.

**PL:** Actually, the stuff that I'm trying to do now is what I've always wanted to do. Before there was a "brain washing" thing going on. As a black songwriter/producer, I was expected to do dance music to be accepted. This was proven true. When I was shopping demos around, my group wasn't really doing disco, we were doing basic *songs*. No one ever said our songs weren't good, they just said they didn't fit what was going on. I didn't know how to write disco; I just couldn't do it, so I kept pondering and pondering. It was with the help of Morrie Brown driving me to write dance tunes that I broke. Once I clicked I knew what to do.

Now I'm writing the kind of songs I grew up with—by Smokey Robinson, Blue Magic and the Stylistics. They're black records, but they also have a crossover overtone.

**MR&M:** They're also timeless songs. They're still around, and something like "Roxanne, Roxanne" is finished already.

**PL:** Yes. The success of Lionel, Michael and Prince also gave me incentive to go ahead and write what was in me and not copy a trend. The songs they write are so believable; that's why they reach so many people. I was saying to myself recently, 'If you keep doing things because of a trend, people, after a while, will see through it.' I started going back to my roots and writing records that are believable.

**MR&M:** Do you see a healthier trend back to songs and not just mere grooves? I'm hearing a lot more human songs on the radio, and seeing them growing legs on the charts.

**PL:** I see that—grooves are seriously song orientated. No longer are they copped easily. There always has to be a good groove; even the ballads have nice grooves.

**MR&M:** In the middle of hip hop and the continuing B-Boy Craze, you and Kashif, two New Yorkers for



gawds sake, crafted very melodic, chrome plated songs. What do you think of hip hop and electronic "beep boop"?

**PL:** I think it's going to be around for a long time (laughs) because my little brothers and sisters are seriously into it. If it's got that kind of effect on children who still have to grow up, I figure it'll last. I don't necessarily get into it myself. And I don't put it down either. Some of it, like "The Message" is really tasty. I like the ones that say something substantial and don't just talk about partying all the time. When I hear rap, I want to hear something like (Quincy Jones') "The Dude," a hip, sensible and classy rap. I think there's a market for it. Also, I like guys such as Melle Mel, who raps with serious conviction.

**MR&M:** Does it take a lot of musical chops to pull off making a good rap record?

**PL:** No. It takes a lot of technical chops.

**MR&M:** With all the sampling going on—and samples getting longer and longer, what do you think the legal ramifications will be? Will copyright infringement become an issue?

**PL:** I'm sure it will—especially if someone makes a lot of money doing it. I wouldn't want to hear somebody sample something I've done and make a million dollars off of it without sharing it.

**MR&M:** But if they take a piece of Freddie's vocal—say "rock" and you *know* it's yours, would you get upset at that?

**PL:** That's an interesting question. I don't really know if I'll go crazy trying to go to court on that. The steal would have to be obvious. Like what Chaka did on "I Feel For You" with Stevie. For that she got permission from Stevie, so that was okay. That was a long, very obvious passage from another record ("Fingertips").

**MR&M:** You're a composer, producer and now performer. What's most satisfying for you?

**PL:** The artist aspect is the really hard one. Producing isn't easy, but you could always hide behind the artist; there's a cushion. I would love for my first album to be a hit, but if it's not I wouldn't be discouraged. I didn't ride a trend, so it might take a while for it to click with the public. I don't think it's a piece of garbage, but I'm expecting people to hear it and say, "Where's he coming from?" That's O.K., because when you're doing what you want to do, it takes a succession of (similar) songs for people to see what you're doing—until finally they're into it.

**MR&M:** Tell me about the album.

**PL:** The album is...a little different from the things I've done in the past, not way out different. When you hear it you might say it's not different at all. There are some *real* songs on it. I didn't try to be a vocalist like Freddie because I'll be killed out there (laughs). I want to be viewed as the writer of his music, and not the singer.

There are some things on the album that I think artists have always wanted to say, but didn't for fear that the record company wouldn't release it. I said 'to hell with the rules.' There's one tune—a trio between Freddie, Lillo and me called "She's Not A Sleaze." It's about women who likes to dress "loosely"; it

doesn't mean she's a whore or a sleazy woman; she might just feel comfortable dressing that way. It's a song in defense of these women. When I was writing it, people would tell me "you're crazy."

**MR&M:** One song on Lillo's debut album, "Who Do You Think You Are," sounded like a slap on the back of Prince's Vanity 6. Lillo's character is simultaneously attracted/repulsed by a "nasty girl." Was it?

**PL:** Not really. It was written to be interpreted a lot of ways. You could see it as being transvestital; you could see it as being a song about a naive young man who has never really dealt with a woman before, always waiting for her to make the first move. Or you can interpret the lyric by seeing a woman trying to buy a guy. And he says, "You can't buy my love/Who do you think you are?"

**MR&M:** That brings me to a question about video. Wouldn't a video destroy individual perceptions?

**PL:** I think so. A video will present one dimension—unless it is an avant garde-type video, where there are a whole lot of confusing images. (On the broader canvas), I see video as

could go hang out and say 'Hey, have you heard that new Paul Laurence song? A guy meets up with his old lady/Raps with her about life without him/She does the same/Then he speculates about getting on once more'—never mentioning the hook. Do you write with an image in mind?

**PL:** Not with video per se. When I get stuck, I try not to approach the song with a video type concept. But I do visualize some of the things people, even me, have gone through. I try to stay close to the heart. Sometimes when I lose interest in a song, I just finish it without really thinking about it. Mostly, I take the lyrics very seriously.

Sometimes I use bad English. But that's okay because it's the only way I can express some emotion without using two or three sentences. Ideas come while I'm in my car, on my bike, while I'm sitting at home...

**MR&M:** Has technology been a great help for you in terms of efficiently transferring everything that's in your head to tape?

**PL:** Oh yeah! Thank God for drum machines and all the other technological wonders. It makes life so

**PL:** For Lillo and myself—AKG-414s; for Freddie—Neumann 89s; for Melba—an old tube mic whose name I forget. For backgrounds—AKGs all the way.

**MR&M:** How do you mix?

**PL:** I leave all of my mixing to the engineer, because I like an objective ear. I also can't see myself sitting behind a console for six or seven hours and then still being able to say 'it's a print' when it's done. I probably will be wasted. After he's done, I go in and say 'I don't like this' or 'I don't like that' and he changes it. I may be at the studio—but I'll be playing Ms. Pacman or sleeping.

**MR&M:** Do you attend mastering sessions?

**PL:** Yes. Just to make sure the things the engineer and I worked for aren't messed up. I rarely check reference disks against things I've done; I check 'em against things I like at the time.

**MR&M:** What do you like these days?

**PL:** I'm still into Chicago. I like Nile Rodgers' album (*B Movie Matinee*) from a musician's point of view, Tears For Fears' latest and Phil Collins' latest.

**MR&M:** What's your favorite musician's toy?

**PL:** It's eight DX-7s in a rack with a QX-1 sequencer. That's gonna be my favorite. Right now, it's the Kurzweil 250.

**MR&M:** What's a recording session like with you?

**PL:** I like closed sessions, because I'm basically shy. When I'm not sure about something, I feel uncomfortable when I have people watching me. I like to get the most out of artists. My job as producer comes in when they're stuck. I believe in trying anything.

**MR&M:** You produced your album yourself. Did you have a problem with objectivity?

**PL:** On tracks I didn't have a problem. The main problem was with lead vocals. On some tunes it took maybe two or three days to get, only because I kept doing it, coming back into the control room, listening, and on and on.

It got to the point where I said to myself 'It's either a hit...like it is now, or it isn't. Whether your vocals are the greatest or not will not make or break the record at this point—because the strong song foundation is already there. It's your first album; stop being Quincy Jones.'

---

***I leave all of my mixing to the engineer, because I like an objective ear. I also can't see myself sitting behind a console for six or seven hours and then still being able to say 'it's a print' when it's done.***

---

being terrific. It's a way for a song to sell more, and depending on how well it is made, it can solidify a wavering opinion about a tune.

A lot of videos have nothing to do with the song. That I can't understand. There seems to be a lot of those out there because of low budgets and the lack of time to develop (good) stories. A lot of times, an artist may have a good concept for his video, but by the time he goes to shoot, money and time become factors and the script suffers.

**MR&M:** Are you planning any videos for your album?

**PL:** At least one.

**MR&M:** I think your songs could make great videos. After listening to "Rock Me Tonight," for example, I

much easier. In a way it makes you lazy, too.

**MR&M:** How do you go about tracking a song?

**PL:** I usually don't mic anything but vocals. I sometimes mic guitars, but basically, everything goes direct. It's very rare that I track a live drummer, because I'm so used to a drum machine that keeps perfect time. Even though a drummer may be great, he may lose tempo. That edge, in contrast to the drum machine's stiff, mechanical nature sometimes creates a pleasing looseness and palpable mood. Because of this, I'll begin tracking live drummers in the future.

**MR&M:** What mics do you like using for vocals?



# Brian Battle's Ad Ventures

**B**y now your appetite for opportunities to work in the exciting world of commercial production has been whetted, so it's time to have a serious briefing session. We're going to find out who is going to pay you to make ads for them. There's nothing like scientific market research to take all the fun out of an endeavor, so let's say the heck with science and just stumble along guided by common sense. That'll at least put us a few steps ahead of our quarry, anyhow.

You've got to know whom you're going to approach. Here's a marvelous idea: listen to your radio. Not just your favorite station, you must twist that dial and find out who is being played everywhere (or at least on two or three stations). If you recognize one of the station's staff announcers over a clearly generic music bed the chances are very good that you're on a good hunt. You want the client that already advertises on radio, doesn't currently employ an advertising agency or production house, and spends a sufficient amount of money on broadcast spots to feel that your services are affordable. The sponsor who runs three or four spots a week on just one station isn't likely to engage your services—with a small budget it's nearly certain that your price will amount to a prohibitively high figure in proportion to the rest of the advertising outlay.

You see, the average radio advertiser is a "little guy." He uses radio because he believes in the exposure and type of audience radio attracts, but he lacks the resources to purchase television time. Furthermore, less affluent businesses are not often sought by professional, established agencies or consultants, so you may be the first person to propose this type of service to a particular firm. Up to now this small advertiser merely provides the station(s) with the facts he wants included in the commercial copy and then sits back to listen and criticize. The radio station's role is to take the money and information, write (or rewrite) the script, let the disc jockey choose suitable music and/or sound effects, and then record the thing. Stations

generally can't afford to offer much more in the way of creativity, and the sponsor has come to expect nothing more. Everyone hears fancy McDonalds and Coca-Cola jingles, but few people believe that they can compete with that kind of customized audio artistry. Here's where you fit in, you sharp little dickens. You're going to visit this advertiser's office or store and enlighten him. Explain how, for a remarkably small investment (don't say "price"; it bums 'em out), your state-of-the-art recording studio and horde of incredibly experienced professional musicians, composers, singers, arrangers, and producers will toil around the clock to put together a potential Clio award winning radio commercial. Never mind telling the client what a Clio is. I got nominated for one in 1982 and have yet to impress anyone but my wife, and she already thinks I'm swell.

Sure, this all sounds easy, but there's always a snag in the pantyhose of life. In this case it's your fee. "Hey," you'll be told, "I already pay through the beak for my spots on all these stations and their people do a good job. After all, they're professionals, too. Why should I pay you? And stop making faces at that picture of my wife and kids!" Here's where you unleash your potent sales tactics. You patiently explain that anybody who gets paid for what they do can be correctly called a professional, that disc jockeys who produce his ads don't have the time to bust their berries on fancy production jobs, that good custom-produced musical commercials sound more prestigious, make stronger impressions on listeners, increase retention in people's minds, elicit more responses, enormously improve the quality of the airtime he's already paying for, and will help you finance that new mixing console you're buying. After all, as long as the advertising medium is being used anyway, shouldn't it be as effective as possible? And isn't it obvious that one's one personal production company stands to gain by devoting more care and creativity to the task than an underpaid disc

jockey who just wants to finish his air shift, cut the half-dozen spots he's been assigned for the day, and go home and sniff cocaine? Doesn't original music project a stronger image than just an anonymous instrumental track from some dusty old album from the station's Production Library (i.e., the "reject" album rack—stuff that isn't good enough for the playlist or is incompatible with the radio station's format is tossed in the production studio. It's a sort of Purgatory, like The Island of Misfit Toys).

I'm not deliberately knocking disc jockeys and radio station production personnel, since I was a deejay and Production Director for years, but when you deal with dozens, even hundreds of commercials a week it's normally pretty difficult to get all excited working on any one ad. Those station-produced jobs do work, but often not as well as a top-notch outside piece of production. People who run their own businesses should understand that a company committed to creating their spots one at a time as their only major activity will unquestionably dedicate more time and effort to doing terrific work. It does entail a certain extra investment over the airtime itself, but as long as it's in proportion to the client's annual advertising budget it can be justified. Especially since you may only put together one or two spots a year (or ever), it'll just be a one-time charge. By the way, if your prospect uses a professional artist to design his print ads, T-shirts, signs, and such, he's probably quite familiar with the idea of a "one-time setup charge" which is, in effect, what you'll be looking for.

I hate to use examples because while they may well serve to illustrate a point, they can limit perspective to that particular situation. As a recording professional, however, you're creative and can use your imagination, so here's a fantasy—an ideal prospect:

You've heard this clown's ads on both of the town's top radio stations for months now, you know that the announcers on the spots are always disc jockeys from the station you hear the ads on, you recognize a Spyro Gyra tune in the background of the spot on one station and an old Crusaders number on the other station's version of the commercial. Both scripts seem to retain a common theme or slogan, but each station uses different wording and style of delivery.

Is this consistency? Does this improve the sponsor's status? If the advertiser is a rational, intelligent individual (remember, this is a fantasy) who is awed by the efforts of major national advertisers but hasn't any clear idea how custom jingles mysteriously appear on the airwaves, you just may be able to get a chance to cut a demo for him to evaluate. It's always risky to commit time and energy to writing a jingle and slapping together a rough tape on speculation, but most clients want some idea of what you'll deliver before you abscond with the loot. If you truly feel that you've found the person who can give your offer proper consideration I'd say it's worthwhile to go on to the "spec" phase. If you agree, be here next month to get some guidance that will help you plan your demo effectively. Relax, the impossible part is over; now the difficult part begins.



# don't be left out in the **COLD**



**Subscribe Now.**

**Modern Recording & Music can help you develop your talent.**

I wish to subscribe—\$18.00 for 12 issues—Save \$9.00. Plainview, NY 11803  
 \$31.00 for 24 issues—Save \$23.00. (516) 433-6530  
 \$45.00 for 36 issues—Save \$36.00

Check  Money Order enclosed for the amount of \$\_\_\_\_\_

My account number is:  Visa  Mastercharge 

--	--	--	--	--	--	--	--	--	--	--	--	--	--	--	--	--	--	--	--

Exp Date \_\_\_/\_\_\_/\_\_\_

Name \_\_\_\_\_

Address \_\_\_\_\_

City \_\_\_\_\_ State \_\_\_\_\_ Zip \_\_\_\_\_

(Foreign subscribers add \$3 for each year. Foreign subscriptions payable ONLY in U.S. funds by international draft or money order.)

# The Market Place

what's new in sound and music

## RECORDING INDUSTRY STUDIO FORMS

StudioForms, Inc. has developed a line of industry-standard forms and labels specifically designed for the recording industries. The complete line includes pressure sensitive box and reel labels, track sheets, tape inventory sheets, session log sheets, quote sheets, session proposals, work order forms, maintenance forms, credit/deposit slips, invoices and appointment cards, with new forms slated for a future release. These forms and labels were designed to help organize and standardize studio information while promoting the studio's image. They are available in different quantities and come printed with the studio's name, address and phone number. StudioForms are made to be used by professional studios, musicians' home studios, production houses, broadcast facilities and mobile recording studios.

Circle 40 on Reader Service Card



## NADY WIRELESS GUITAR

The Nady Systems Inc. Lightning™ wireless guitar is the world's first production wireless guitar. The Lightning has a built in VHF wireless transmitter for use with any of the Nady VHF wireless receivers, including the Nady 501 VHF, the 601 and the 701 VHF. The standard system includes a 501 VHF receiver. The Lightning's strat-style body is alder, with a neck through the body of maple—the ultimate combination of woods for strength and lightness. The fingerboard is ¼-in. ebony with jumbo frets and distinctive lightning bolt mother-of-pearl inlays. The guitar is finished in high-gloss black, with all fittings satin black. The Lightning is full scale at 25½-in with a fingerboard width of 1 and ¾-in. at the nut. The instrument's neck is uniquely sculpted to play fast and deep with molded cutaways to allow easy access to the 24th fret. The Lightning features specially designed high-output pickups, a custom tremolo and locking nut with string tree, and high ratio Gotoh tuning machines. Each set of pickups has a volume control, with the knurled knob of the lead control ideally positioned for pinky finger swell



effects. A three-way toggle switch selects between pre-set rhythm, lead, and combinations of the two. Unique to the Lightning is its transmitter on/off switch and LED indicating transmitter on. Power is provided by two 9V batteries which fit neatly into a bay with a hinged cover and magnetic latch. The batteries can be changed in seconds without using tools. Nady also provides a standard jack so the guitar can be played with a cord if desired. System range is 200

feet under adverse conditions and 1,500 feet line of sight. The receiver is AC powered and plugs directly into a mixing board or amplifier. A fold-down, retractable antenna is attached to the back of the unit. Five channels are available. Two 3-color 10 LED displays on the receiver indicate *received signal strength* and *audio level status*. The retail price on the Lightning guitar is \$1,500.

Circle 41 on Reader Service Card

## SHURE HOME RECORDING MIC

The new Prologue 8L from Shure Brothers Inc. is a low-impedance (600 ohms, compatible with home recording equipment), probe type microphone with an attached 15 foot cable that terminates in a mini-plug for easy interface to home audio and video recording gear. The 8L features the dependability, ruggedness and equipment compatibility required by home recordists, yet at an affordable price. The microphone features a specially tailored frequency response which produces an "alive," clear sound for accurate audio reproduction and a cardioid (unidirectional) polar pattern which controls annoying feedback and rejects unwanted noise. Each Prologue model features a metal, die-cast case for ruggedness and durability, and an on/off switch for maximum convenience. To insure the long life and easy serviceability of



the mics, each microphone incorporates a field-replaceable cartridge, grille, and switch. The mic comes with a mini-to-phone plug adapter, table top stand, and Shure's one year

guarantee. Suggested list price for the Prologue 8L is \$43.75.

*Circle 42 on Reader Service Card*

## SEQUENTIAL DIGITAL DRUM MACHINE

Sequential's TOM is a fully programmable drum machine featuring 8 digitally recorded instrument sounds and easy sound expandability. TOM lets you program volume, tuning and stereo pan individually for each of its digitally recorded drum and cymbal sounds. Programmable tuning "expands" your drum set to include the sounds of gongs, 32 tom rolls, gorilla claps and more. You can also play and record any of TOM's sounds in reverse. Plus, you can easily add entirely new sounds to TOM with any of Sequential's plug-in cartridges. You can record your rhythm patterns in real time, or enter parts in "single-step" mode one beat at a time. Up to 99 rhythm patterns can be programmed, and each one can be from one to 99 measures long. The total memory capacity of TOM is more than 3,000 notes. You define the measure and the time signature. Once you have a number of rhythm patterns recorded you can link them together (up to 99 different patterns) to create whole songs. Songs can be edited, copied, and appended in the same manner as patterns. TOM'S back-up battery retains memory when power is off. For permanent storage and repro-

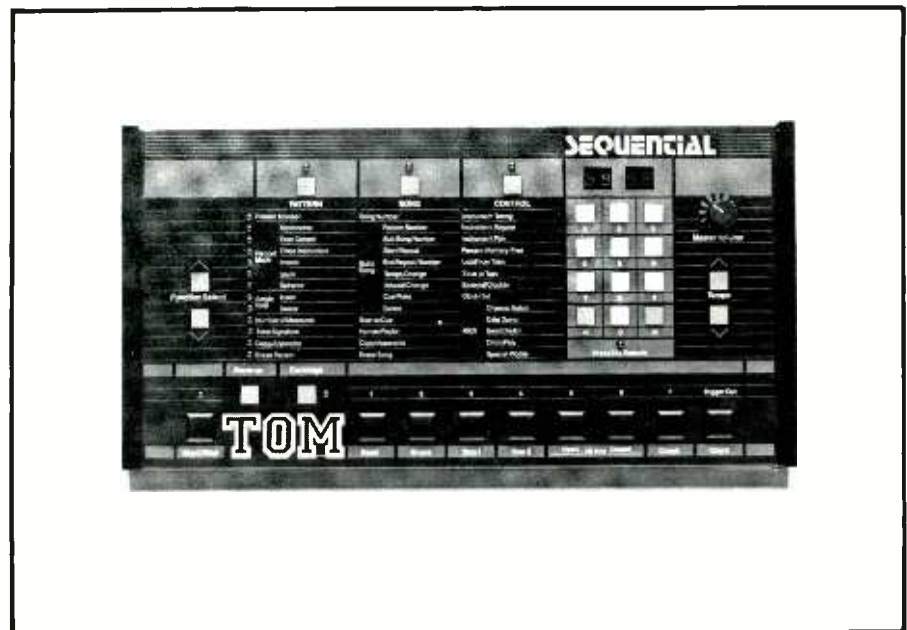

gramming, a cassette interface is provided. TOM can be interfaced with almost any basic sequencer system through its multi-mode clock input and output. TOM also features MIDI (Musical Instrument Digital Interface). Through MIDI, TOM puts the beat in your computer-based music system, or connects directly with any MIDI-equipped instrument.

MIDI also lets you program all of your drum parts, including volume and tuning, in real time from any velocity-sensitive keyboard instrument such as Sequential's Multi-Trak or Prophet T8. Suggested retail price is \$799.

*Circle 43 on Reader Service Card*

MODERN RECORDING & MUSIC

## AUDIO TECHNICA DIRECT BOXES

Two direct boxes which permit the direct connection of instruments to mixing consoles are available from Audio-Technica. The boxes are the AT8512, a passive direct box for use with electric guitar and bass, as well as for other electrical instruments; and the AT8511, an active direct box intended primarily for use with keyboard instruments: synthesizers, electrical and electronic pianos and organs. The AT8512 which features ground lift, can be used as an impedance matcher, balancer, and voltage pad—either with or without an instrument amplifier; or, the direct box can be fed from the instrument amp's line-out signal. It can also be used to route to the mixer the typical sound of the amp output stages—either with or without a separate amp output. The box accepts



inputs at up to 50 volts, RMS. The AT8511 active direct box, utilizing either batteries or phantom power, is intended chiefly for uses in which the passive AT8512 level is too low for the mixing console input. It can be used as an impedance matcher and balancer, either with or without an instrument amplifier, or for picking up sound after the tone controls and preamp stages, using the instrument

amp line-out. Both boxes have heavy die-cast walls, and utilize specially designed connectors and transformer coupling. The high degree of isolation not only minimizes hum, but prevents electrical shocks. Prices are \$79.95 for the AT8512 and \$95.50 for the AT8511.

*Circle 44 on Reader Service Card*

## OMNI CRAFT MODULAR NOISE GATES

Designed to fit into the two most common rack systems, the GTX(d) and GTX(K) noise gates from Omni Craft are slightly different in layout, but identical in function and performance. Extremely low noise and distortion have been retained by designing the new products around Omni Craft's optical control system. Inputs are balanced. In addition to the push button provided for switching the unit between "GATE" and "DUCK" functions and another for

choosing between either a "key" signal or the primary source as the activator of the gate. Two more provide the unique ability to insert a high- or low pass-filter (or both) into the trigger signal path, substantially reducing the chance of accidental triggering. Rotary pots are used for adjusting range, selecting the "GATE" and "DUCK" release times, and establishing the threshold. The suggested retail price for both GTX units is \$275.

*Circle 45 on Reader Service Card*

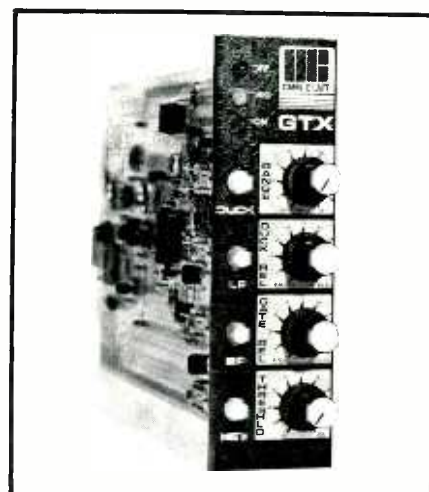

## TWELVE VOICE SYNTHESIZER

Oberheim/ECC Development's new twelve voice MIDI-equipped synthesizer is based on their popular XPANDER synthesizer voice. Dubbed the Matrix 12, it has twelve independently programmable voices, each of which are composed of two oscillators with simultaneously available square, sawtooth, and triangle waveforms, five envelopes, a fifteen mode filter, fifteen VCAs, five LFOs, four ramp generators, three tracking generators, frequency modulation, and a lag processor. The five octave keyboard has velocity and release velocity, and is divisible into six user-programmable zones. The Matrix 12 has 100 Single Patch memory locations, as well as 100 Multi-Patch Memory locations. The

suggested price of the Matrix 12 is \$4,995.

*Circle 46 on Reader Service Card*

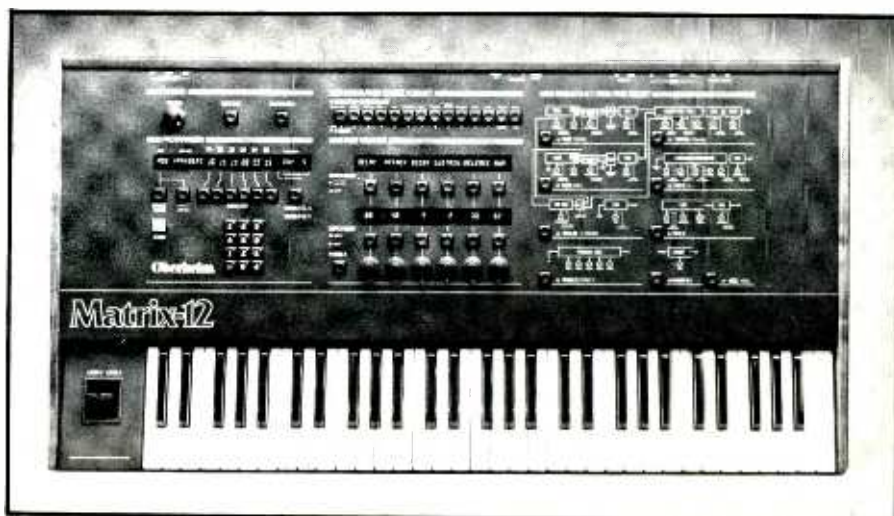

The June 22-25 NAMM (National Association of Music Merchants) Expo in New Orleans was an event every bit as spectacular as the pre-show publicity had indicated, setting a new record for number of exhibitors and display space as well as providing those who attended with great entertainment and educational attractions.

The number of exhibitors at Expo '85 increased significantly over last year's show. There were 583 exhibiting companies represented in New Orleans, while Expo '84 in Chicago had only 515 exhibitors.

Foreign exhibitors increased over previous Expos and numbered about 60. Countries represented included Germany, Britain, the Netherlands, Austria, Canada, China, France, Israel, Italy, Japan and Spain.

Total attendance for the four day Expo was a healthy 20,179. The use of two convention facilities—the New Orleans Convention Center and the Rivergate Expo Center—proved satisfactory to both exhibitors and buyers who were there.

"The flow of traffic at this show was a little different than usual, due to the use of two facilities,"

says NAMM show director John Vincent. "Exhibitors in both halls, however, reported excellent business. In the long run, neither hall was any more advantageous than the other, and the exhibitor satisfaction in both locations was high."

Attendance at Expo educational seminars reached a new peak, with a total of 3,270 persons participating. Seminars, sponsored by NAMM and various other industry organizations, focused on such topics as new product information, industry trends, sales techniques and retail management.

NAMM's popular Creative Merchandising Center and the new Computer/Video Resource Center, both located in the Rivergate, were visited by over 5,000 show attendees.

A number of Expo educational seminars were video taped and will be available this fall, in VHS format, from NAMM. The following is a photo session taken at NAMM as explained by Bob Buontempo and *MR&M's* roving photographer, Cheri Watchmaker, who were on location to give you an in depth look at NAMM '85...



1. The Roland MPS (Music Processing System).



2. Seymour Duncan (right) displays his new line of amps.



3. AKG was well represented with its full line of mics.

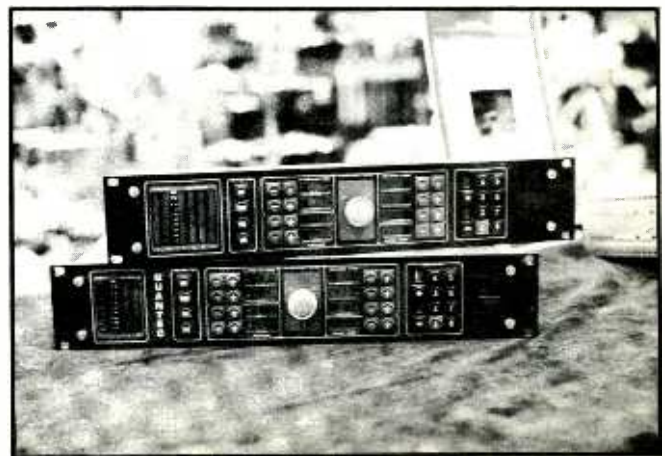

4. The Quantec Room Simulator adds space to any instrument or recording.

All photos by Cheri Watchmaker



5. Roger Powell of Utopia displayed Reasonable Alternative's Digital Clock Divider.



6. Soundcraft's producer system including the Series 1600 console would look nice in your basement.



7. DOD's DigiTech line of studio effects.

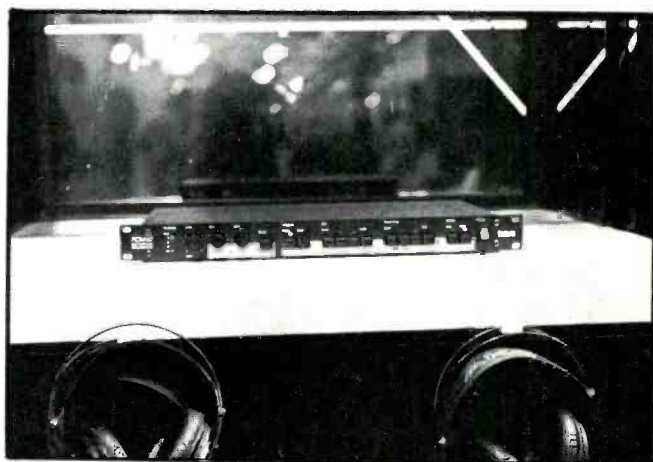

8. The Lexicon PCM-60 Digital Reverb.



9. Tascam made a big splash with their new model 246 Porta-Studio.



10. Delta Lab's CompuEffectron is a micro-processor based digital delay shown with Schecter guitar used for demonstration.



11. Audio Technica displayed their 6 input top of the line cassette recorder/mixer, model AT-RMX64.



12. AKAI debuted its new digital sampler with disc drive.

## 1/4 Notes

### LIVE AID

A very special event took place on July 13 that affected every citizen. Not only US citizens—world citizens. The Live Aid show in Philadelphia (JFK Stadium) and London (Wembley Stadium) was an event planned to try to put an end to world hunger, and was viewed by over one billion people throughout the world.

The plan was to have two colossal concerts on the same day, with some of the biggest names in the recording industry. The majority of the money was not to come from ticket sales. The shows were to be broadcast—via 16 satellites—around the world, and the music would be interrupted only by local commercials and inspirational messages from world leaders to motivate viewers to call an 800 number that had been set up. Donations from the calls and all profits from local advertising were to go into a fund. At the time of this writing—three days after the show—over \$50 million has been raised.

All of this was due to the efforts of one man, Bob Geldof, the founder of Band Aid, and the leader of the Boomtown Rats. He has been nominated for a Nobel Peace Prize for his work with Live Aid. His work is indeed noble—he was able to do the impossible by bringing together the big names necessary for such an event and getting all the logistics worked out with a minimum of problems.

The technologies involved allowed Live Aid to smoothly become the largest concert event of all time, with the largest amount of viewers ever for any broadcast—an honor that will probably stick with Live Aid for years to come. In both London and Philadelphia, large video screens were set up for concert goers that were too far or had an obstructed view of the stage. There were at least ten separate camera crews (not including news crews) to broadcast the show. The use of a rotating stage was employed to aid in the removal and set-up of each group—while one group played, another was set up.

We could go on and on, but with all the publicity this show has received, you've probably heard it all before and are bored silly with it.

Since the show was such a huge success, we here at *MR&M* would like to salute Bob Geldof and all the musicians that gave their time and sweat for this worthy cause. We would also like to salute the behind-the-scenes people—stage managers, stage hands, bands' roadies, camera people, broadcast engineers, maintenance technicians, security personnel, and anyone else we might have neglected to mention for their invaluable contributions to making the day's event a successful one:

.S.C.



# & MUSIC...



## PRINCE AND THE REVOLUTION: *Around the World in a Day*

[Produced by Prince and the Revolution, engineered by Susan Rogers, Prince, David Leonard, Peggy Mac, and David Tickle, recorded at Paisley Park, Sunset Sound, Mobile Studio and Capitol Records (no cities listed)] Paisley Park/Warner Brothers 1-25286.

Performance: **Psychedlic fun-k**  
Recording: **Painstaking clarity**

Prince Roger Nelson has been producing, composing arranging and performing most of the instruments on all of his albums, of which the more you listen, the more remarkable Prince's talents seem to be. By listening to *Around the World in a Day* just once or twice, the casual listener might reject the LP as psychedelic fluff since his most recent albums, specifically *1922* and to a lesser extent *Purple Rain*, were funk personified.

If the listener happens to like the Beatles' *Sgt. Pepper's Lonely Hearts Club Band* and *Magical Mystery Tour* and perhaps the Rolling Stones' *Their Satanic Majesties Request*, then he or she will feel more at home with *Around the World*. But Prince has crafted such an intriguing album that one does not have to be enamored with the aforementioned relics of the 60's to appreciate his magical mystery album.

The opening track, "Around the World in a Day," asks the listener to "Open your heart, open your mind/ And laughter is all u pay." Prince employs a cello along with a synthesized flute to get a raga-like feel, and with echoed voices, the trip has started. But then the voyage becomes a bit mysterious. Although the merry-go-round like "Paisley Park" is a park for fun loving people and where some of Prince's stereotypical funk is felt as an undercurrent, "Raspberry Beret" is about seduction, "Tambourine" suggests masturba-



tion, and the closing "Temptation" centers on sex and lust. And in the anthem-like "America," a patriotic song, Prince synthesizes a cross between a bagpipe and fiddle, later chugging into a rhythmic pattern.

Prince is apt to change tempos and moods in a song. "Conditions of the Heart," a love ballad which later picks up momentum, starts with a delicate intro. There is dense chording on "Temptation" along with some screechy, loud, out-of-context avant-garde saxophone lines plus a sermon on sexual temptation. "Pop Life," an anti-drug song accentuated with synthesized strings, has Sheila E on drums. And "The Ladder," which Prince co-wrote with his father, John L. Nelson, is a dirge-like track dealing with the salvation of the soul.

*Around the World in a Day* is masterfully produced, layer upon layer of sounds. By employing acoustic and country instrumentation textures, Prince has synthesized an unexpected fusion of psychedelia and funk. But by singing about "mushroom clouds" in "America" and sex in other songs, Prince has once again found controversy in his albums.

And just as Prince retired from the live stage by saying "I'm looking for the ladder," he closes this album by announcing "I have 2 go now. I don't know when I'll return."

bob grossweiner

## GO GO CRANKIN': *Various Artists*.

[Various producers; no recording studios, mastering studios or engineers listed] 4th & Broadway BWAY—4001.

Performance: **Energetic**  
Recording: **Dense with no electrosnap**

This past summer, hip folks in clubs everywhere did the Happy Feet and the Freeze to the vicious whomp of tunes such as "Movin' and Groovin'," "Good To Go," and "We Need Some Money"—call and response party chants seasoned with thick junkanoo-like street percussion. It's all about go-go, a brand of raw funk born and bred in Washington, D.C.'s black inner-city neighborhoods that's now going national. Touted by critics and Island Record's chief Chris Blackwell

as The Next Big Thing, its closest parallel is the progressive seventies funk of folks like James Brown and George Clinton, the kind of stuff I recall seeing black youths “breaking” to at the height of the disco boom. But, quite honestly, the go-go themes on *Crankin’*, the genre’s first ever LP, may have a tough time competing against hip hop’s (now commercial) slick domain. Will funk hungry B-Boys used to Emulators, “impossible” sounding drum patterns, and rapid fire edits spend money on go go? Or, more importantly, will radio programmers feel comfortable sandwiching “Good To Go,” for example, in between Grandmaster Flash’s “Larry’s Dance Theme” and Run-DMC’s “You Talk Too Much?” Eventually, yes, because the beat always wins—and go-go’s got lots of it.

Shunning high-tech synthesizers and studio gimmicks, the “chocolate city sound” combines layers upon layers of percussion, weaving a dense rhythmic cloth. Congas, roto toms, tambourines and congas occupy, quite unconventionally, the front of the mix—right alongside the kit and a heavy, loping bass. Guitars, keyboards and blaring horn sections pad the sides and are mixed just a notch lower. Even the vocals seem like accompaniment to the emphatic, syncopated rhythm patterns.

For all its urban toughness though, the go-go on *Crankin’* (which is typical)—except for one anti-drug message—doesn’t address any of the poor man’s frustrations: poverty, unemployment and violent crime. The track just exposes bitterness and rage. Thus, Go-go is escapism with balls.

havelock nelson

**MILES DAVIS: *You’re Under Arrest***  
 [Produced by Miles Davis and Robert Irving III, co-produced by Vince Wilburn, Jr., engineered by Ronald F. Lorman and Tom Swift, recorded and mixed at the Record Plant Studios, New York] Columbia FC 40023.

Performance: **Three surprising cover songs**

Recording: **Trumpet clarity**

Miles Davis’ post-retirement albums, from 1981’s *The Man With the Horn* to 1984’s *Decoy*, have generally been grinding fusion jams that have split the Davis fan club into sectors. Although there has been some in-



spirational blowing, most of the tunes are easily forgettable. Now *You’re Under Arrest* (actually *You’re Under Arrest You Have the Right to Make One Phone Call or Remain Silent So You Better Shut Up*) indicates a sense of humor lacking on most of Davis’ albums.

Even more surprising to the long time Davis aficionado has to be the three cover versions of popular contemporary hits. Davis previewed the exquisite “Time After Time” (Cyndi Lauper’s number one pop hit) at last year’s Kool Jazz Festival-New York, and even though it had a more everlasting effect live, Davis handles the delicate melody with justice. Michael Jackson’s “Human Nature” is really filler, but the little known “Something on Your Mind” (from the soul act D Train) has crystalline trumpet lines over a mildly percolating rhythm. The track is also surrounded by Davis compositions “M D 1” and “M D 2” to give the entity more of a Davis oeuvre.

*You’re Under Arrest* features other surprises, including the keynote “One Phone Call/Street Songs,” a song with dialogue about an arrest (Sting of the Police is the French policeman’s voice) with police voices and a “Polish” voice within a soundtrack-type arrangement. Guitarist

John McLaughlan, who first came to international prominence on Davis’s 1969 *In a Silent Way*, 1970’s *Bitches Brew* and 1971’s *A Tribute to Jack Johnson*, is featured on a few of the more fusion oriented tracks, including “Katia Prelude,” which ends the first side, and “Katia,” which kicks off the second side.

For the most part, Davis employed his current band. Guitarist John Scofield penned the title track but surprisingly enough did not play on it. Synthesist Robert Irving III co-wrote a few songs with Davis and co-produced the album with Davis as well. While some of Davis’ most recent albums have been loud and noisy in parts, *You’re Under Arrest* is his mellowest LP since the 60’s. But while his recent albums have also been more riveting, Davis has opted for variety on *Arrest*, which allows for the ballads and fast tempo numbers to play off and accentuate each other.

*You’re Under Arrest* is basically a Davis album with his trumpet front and center whereas in his recent albums Davis at times had to struggle and to find space to be heard in. *You’re Under Arrest* will appeal to Davis’ old straightahead fans as well as his recent fusion ones.

bob grossweiner

MODERN RECORDING & MUSIC

# Classified



- PRODUCTS
- EQUIPMENT
- SERVICES

## Classified Rates

**\$1.00 per word.**

**Minimum \$25.00.**

**Copy must be received at Modern Recording & Music, 1120 Old Country Road, Plainview, NY 11803 by the 15th day of the 2nd month prior to cover date (for example, the April issue closes February 15th). Payment must accompany order.**

**Phone numbers count as 1 word. Zip codes are free.**

## DISPLAY

## ADVERTISING

**\$40.00 per column inch.**

### Studio Forms

Get box labels, track sheets, invoices, etc., printed with your studio's name & address! **FREE Catalog** of specialized forms for the recording industry.

#### StudioForms, Inc.

186 Glen Cove Ave, Suite 201/MR1  
Glen Cove, NY 11542 • 516-671-1047

MCI 400 series 24 in/24 out recording console and MCI JH-100 24-track recorder. Good working condition. \$22,000 for package. (615) 577-5597.

SONGWRITERS RESOURCES and SERVICES is a non-profit organization dedicated to the education and protection of songwriters. For free information, write or all **SRS, 6772 Hollywood Blvd., Hollywood, CA 90028; (213) 463-7178.**

Write for **FREE discount catalog** of highest quality name brand Pro-Sound equipment. 20%-50% off! **RMS Recording & Electronics, Box 1075, Ames, Iowa 50010.**

GUITARS/FREE DISCOUNT CATALOG. Martin, Ovation, Guild, Dobro, Fostex Multitrak, mandolins, banjos, accessories. **Mandolin Bros., 629-MR Forest, Staten Island, NY 10310. (718) 981-3226.** Visit our showroom.

SEPTEMBER 1985

LOFT 400R Gate/Limiter new \$300.00.  
LOFT 603M Crossover new \$250.00.  
APHEX Exciter \$300.00. MXR Omni Guitar Effects Rack \$300.00. YAMAHA High End Stereo Components, JBL P.A. Components & Monitors. CALL for more info: **JIM SORAN (208) 733-4024, 423-4630, P.O. Box 657, Twin Falls, ID 83303.**

FREE your copy of yesterday's prices on the industry's leading Pro Audio and Stage Lighting Equipment and Accessories. Mixers, amps, equalizers, mics, lights, dimmers, lamps, gel and much more. Check our prices before you buy **All-Pro Audio and Lighting, P.O. Box 3992, Centredale, RI 02911.** Big Savings from the Smallest State.

**DX-7 OWNERS!**  
Get the "Right Sound" with

**RIGHTERSOUND™**

NOW AVAILABLE

16 custom DX-7 programs used in top studios across the country! Send SASE for complete information. **RIGHTERSOUND™ I Program Set—\$25.00**

Demo Tape with \$5 Rebate Coupon—**\$10.00**

note  
table  
software  
P.O. Box 1556—MR  
Philadelphia, PA 19105  
(215) 736-8355

**Advertiser's Index**

AKAI .....	9
ART .....	5
Audio Technica .....	17
Carvin .....	25
Casio .....	15
Connectronics .....	8
Crown .....	7
Innovation Specialties .....	12
LT Sound .....	16
Oberheim .....	19
Octave Plateau .....	21
Orban .....	4
Otari .....	Cover III
Peavey .....	Cover IV
Phoenix Audio .....	10
Phoenix System .....	14
Polyline .....	14
Reasonable Alternatives .....	16
Rocktron .....	6
Sequential Circuits .....	13
Shure .....	3
Steinway .....	11
Tascam .....	Cover II

# HAVE A RECORDING STUDIO PROBLEM?

Call **DataLine**  
**(213) 651-4944**

The Society of Professional Audio Recording Studios, a non-profit organization, offers SPARS members, and non-members referred by a SPARS member, a national telephone 'hot-line.'

recording studio operations including business practices, audio engineering, and technical maintenance will be answered by SPARS-approved sources at no charge.

Want a problem solved?  
Call SPARS—  
**(213) 651-4944**



Questions regarding any area of

**SPARS Board of Directors and Consultants**

- |   |   |  |   |
|---|---|--|---|
| <b>Murray R. Allen</b><br><i>Universal Recording Corporation, Chicago</i>         | <b>Larry Boden</b><br><i>JVC, Cutting Center, Los Angeles</i> | <b>Mack Emerman</b><br><i>Criteria Recording, Miami</i>      | <b>Christopher Stone</b><br><i>Record Plant, Inc., Los Angeles</i>  |
| <b>Jerry Barnes</b><br><i>United Western Studios, Los Angeles</i>                 | <b>Bruce Botnick</b><br><i>Digital Magnetics, Los Angeles</i> | <b>Bob Lufin</b><br><i>Regent Sound, New York</i>            | <b>Joseph D. Tarsia</b><br><i>Sigma Sound Studios, Philadelphia</i> |
| <b>Charles Benanty</b><br><i>Soundworks Digital Audio-Video Studios, New York</i> | <b>Nick Colleran</b><br><i>Alpha Audio, Richmond</i>          | <b>Lenard Pearlman</b><br><i>Editel, Chicago</i>             | <b>David Teig</b><br><i>New York</i>                                |
|   |   | <b>John Woram</b><br><i>Woram Audio Associates, New York</i> |   |

*Take this to heart*

**Have regular medical check-ups.**

WE'RE FIGHTING FOR YOUR LIFE

**American Heart Association**

**SUBSCRIBER SERVICE CHANGE OF ADDRESS**

Planning to move? Please let us know six weeks in advance so you won't miss a single issue of MODERN RECORDING.

Attach old label and print new address in space provided. Also include your mailing label whenever you write concerning your subscription to insure prompt service on your inquiry.

**MODERN RECORDING**  
1120 Old Country Rd.  
Plainview, NY 11803

Attach Label Here

▼ New Address Here ▼ Please print

Name \_\_\_\_\_

Address \_\_\_\_\_

City \_\_\_\_\_ State \_\_\_\_\_

Date \_\_\_\_/\_\_\_\_/\_\_\_\_ Zip \_\_\_\_\_

NO POSTAGE  
NECESSARY  
IF MAILED  
IN THE  
UNITED STATES



---

**BUSINESS REPLY CARD**  
FIRST CLASS PERMIT No. 47 DEER PARK NY

---

Postage will be paid by addressee

**MARDATA**  
P.O. Box III  
Deer Park, NY 11729

**Get The Most**  
from your instrument and  
recording equipment.  
Because you're creatively  
involved in music and not just  
a listener, subscribe now to  
**MODERN RECORDING & MUSIC.**

Send MODERN RECORDING & MUSIC For:

- \$18 for 12 issues—Save \$9.00    31.00 for 24 issues—Save \$23.00    \$45.00 for 36 issues—Save \$36.00
- Payment enclosed (Put form in envelope) \$ \_\_\_\_\_

Outside U.S. add \$3.00 for each year, U.S. funds ONLY.  
Drawn on a U.S. bank

Charge to my  Mastercharge    Visa account

My account number is

Exp. Date     \_\_\_\_\_

Name \_\_\_\_\_

Address \_\_\_\_\_

City \_\_\_\_\_ State \_\_\_\_\_ Zip \_\_\_\_\_

Signature \_\_\_\_\_

**Get The Most**  
from your instrument and  
recording equipment.  
Because you're creatively  
involved in music and not just  
a listener, subscribe now to  
**MODERN RECORDING & MUSIC.**

Send MODERN RECORDING & MUSIC For:

- \$18 for 12 issues—Save \$9.00    31.00 for 24 issues—Save \$23.00    \$45.00 for 36 issues—Save \$36.00
- Payment enclosed (Put form in envelope) \$ \_\_\_\_\_

Outside U.S. add \$3.00 for each year, U.S. funds ONLY.  
Drawn on a U.S. bank

Charge to my  Mastercharge    Visa account

My account number is

Exp. Date     \_\_\_\_\_

Name \_\_\_\_\_

Address \_\_\_\_\_

City \_\_\_\_\_ State \_\_\_\_\_ Zip \_\_\_\_\_

Signature \_\_\_\_\_

NO POSTAGE  
NECESSARY  
IF MAILED  
IN THE  
UNITED STATES



---

**BUSINESS REPLY CARD**  
FIRST CLASS PERMIT No. 47 DEER PARK NY

---

Postage will be paid by addressee

**MARDATA**  
P.O. Box III  
Deer Park, NY 11729

# Free Information Service

To receive manufacturer's information about products advertised or editorially mentioned in this issue.....Circle the numbers on the card to correspond with the key numbers at the bottom of the advertisement or editorial mention that interests you.

1	2	3	4	5	6	7	8	9	10	11	12	13	14	15
16	17	18	19	20	21	22	23	24	25	26	27	28	29	30
31	32	33	34	35	36	37	38	39	40	41	42	43	44	45
46	47	48	49	50	51	52	53	54	55	56	57	58	59	60
61	62	63	64	65	66	67	68	69	70	71	72	73	74	75
76	77	78	79	80	81	82	83	84	85	86	87	88	89	90
91	92	93	94	95	96	97	98	99	100	101	102	103	104	105
106	107	108	109	110	111	112	113	114	115	116	117	118	119	120
121	122	123	124	125	126	127	128	129	130	131	132	133	134	135
136	137	138	139	140	141	142	143	144	145	146	147	148	149	150
151	152	153	154	155	156	157	158	159	160	161	162	163	164	165
166	167	168	169	170	171	172	173	174	175	176	177	178	179	180
181	182	183	184	185	186	187	188	189	190	191	192	193	194	195
196	197	198	199	200	201	202	203	204	205	206	207	208	209	210

September

Please type or print

Card expires four months after cover date of issue.

Name \_\_\_\_\_

Address \_\_\_\_\_

City \_\_\_\_\_

State \_\_\_\_\_

Zip \_\_\_\_\_

**BUSINESS REPLY MAIL**

FIRST CLASS PERMIT NO. 2264, HICKSVILLE, N.Y.

Postage will be paid by addressee

MODERN  
RECORDING  
& MUSIC

1120 Old Country Rd.  
Plainview, N.Y. 11803



NO POSTAGE  
NECESSARY  
IF MAILED  
IN THE  
UNITED STATES

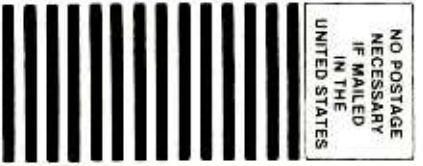

# Free Information Service

To receive manufacturer's information about products advertised or editorially mentioned in this issue.....Circle the numbers on the card to correspond with the key numbers at the bottom of the advertisement or editorial mention that interests you.

1	2	3	4	5	6	7	8	9	10	11	12	13	14	15
16	17	18	19	20	21	22	23	24	25	26	27	28	29	30
31	32	33	34	35	36	37	38	39	40	41	42	43	44	45
46	47	48	49	50	51	52	53	54	55	56	57	58	59	60
61	62	63	64	65	66	67	68	69	70	71	72	73	74	75
76	77	78	79	80	81	82	83	84	85	86	87	88	89	90
91	92	93	94	95	96	97	98	99	100	101	102	103	104	105
106	107	108	109	110	111	112	113	114	115	116	117	118	119	120
121	122	123	124	125	126	127	128	129	130	131	132	133	134	135
136	137	138	139	140	141	142	143	144	145	146	147	148	149	150
151	152	153	154	155	156	157	158	159	160	161	162	163	164	165
166	167	168	169	170	171	172	173	174	175	176	177	178	179	180
181	182	183	184	185	186	187	188	189	190	191	192	193	194	195
196	197	198	199	200	201	202	203	204	205	206	207	208	209	210

September

Please type or print

Card expires four months after cover date of issue.

Name \_\_\_\_\_

Address \_\_\_\_\_

City \_\_\_\_\_

State \_\_\_\_\_

Zip \_\_\_\_\_

# PLAY OTARI

The magic of creativity often happens in streams of musical ideas, and the nuances of this process are compromised by interruptions. The creation of music demands an audio machine that is in harmony with musicians, and their instruments.



Otari's Mark III-8 with Autolocator and Remote Control is a part of this often elusive synergy, like no other half-inch, 8-track can be. With the Mark III-8, you and the instruments are the magic, while the Otari supplies the unobtrusive flexibility and precision of fingertip control. And what you control is audio performance that rivals the best of the one-inch machines.

So when you strive for that essence of sound that is unmistakably professional, choose the Mark III-8 for those fleeting moments when perfection must be the rule. From Otari: The Technology You Can Trust.

Contact your nearest Otari dealer for a demonstration, or call Otari Corporation, 2 Davis Drive, Belmont, CA 94002 (415) 592-8311 Telex 9103764890

**OTARI**®

# THE PEAVEY CELEBRITY™ SERIES

## Designed to have everything... except competition.

At Peavey Electronics we're dedicated to our commitment to design and manufacture high performance products at realistic prices. We've underlined that philosophy with our Celebrity Series line of microphones.

The Celebrity Series feature large diameter diaphragm/voice coil structures for increased sensitivity with the ability to handle high sound pressure levels. These higher output levels allow for significantly less mixer gain and are a tremendous aid in maintaining good signal-to-noise ratios.

Perhaps the most important characteristic of any performing microphone is reliability. The design of our cartridge/shock mount system increases ruggedness as well as isolation capability to insure long-term performance under severe field conditions.

Our microphone screen utilizes extremely heavy gauge wire that has been "junction locked". Once the screen is formed, we do not stop there. The heavy wire screen is "fired" in an oven after forming, thus causing the plated wire to "fuse" at all

interconnecting points. The result is an unbelievably durable "brazed" wire windscreen that will hold together under the most severe abuse. After the ball windscreen is formed, brazed and coated, a precision urethane foam pop filter is fitted to minimize the undesirable proximity effects. This special acoustically transparent foam protects the entire sound system by breaking up explosive high SPL pressure waves created by close vocals or close miking

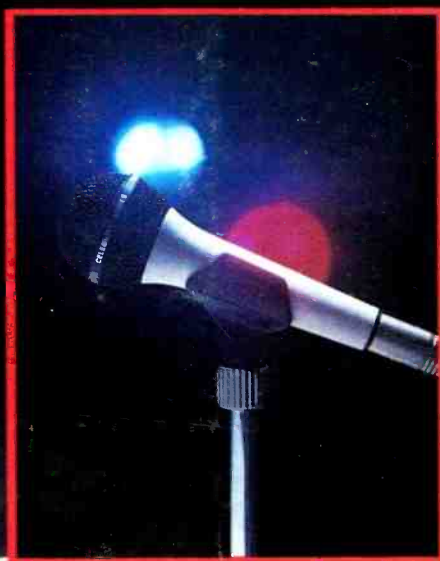

percussion instruments. For those applications requiring even more acoustic screen from wind noise, etc., Peavey offers special external colored wind noise filters that slip over the screen and internal pop filter.

While outwardly, the appearance of the Celebrity Series is somewhat conventional, the aspect of "feel" has been given heavy emphasis since our experience has shown that performers prefer a unit that not only sounds right and looks right, but must also have a comfortable balance, weight, and overall tactile characteristics.

Special "humbucking" coils (models CD-30™ & HD-40™) have been designed into the microphone element that effectively counterbalance any hum that might be picked up from external sources. Performers who play clubs where hum from light dimmer switches or other sources are a problem can appreciate this unique feature.

We invite comparison of our Celebrity Series with other cardioid microphones. You'll see why we feel that in terms of performance, features, and price, there is no competition.



DATE	TIME	BY	REVISION
DESIGNED BY	DATE	BY	REVISION
CHECKED BY	DATE	BY	REVISION
ES DRAWING			
TELEPHONE UNLESS SPECIFIED			
FOR INFO CALL			
FOR ORDER CALL			
FOR SERVICE CALL			
FOR REPAIR CALL			



For a complete catalog featuring the entire line of Peavey sound reinforcement equipment send \$1.00 to Peavey Electronics, Dept. A, 711 A Street, Meridian, MS 39301

Circle 12 on Reader Service Card