

Computers & Electronics

SEPTEMBER 1983

formerly Popular Electronics

\$1.75

Improving Timex/Sinclair Data-Tape Loading
Sony's New Personal Desktop Computer System
Computerized Video Drawings Made Easy
One-Shot Testing of Multiple Circuit Points



**A NEW
BREED OF
COMPUTER
PRODUCTS**

Also in This Issue:

- Digital TV Overview
- The Unix Operating System Simplified





BUY A BANANA.™ SAVE A BUNCH.

Meet the Banana,™ the very tough, versatile, portable, and reliable dot-matrix printer from Gorilla.™

At \$249.95 retail it's an ideal and inexpensive companion for personal computers like Apple® (or Apple "look alikes" such as Franklin® or Albert®), TI®, Commodore®, TRS-80®, Kaypro®, Timex®, Osborne®, etc.

After that, it's merely comparable to other printers that can cost up to three times as much: 10" carriages (to handle standard 9½" paper), 80 columns, graphics capability, 10 characters per inch (expandable to 5 cpi) draft-quality print (for perfectly acceptable form letters, data processing,

business reports, etc.) tractor feed (for precise alignment and quick loading), parallel or serial interface (take your pick), self-inking ribbon cassette (for long life and easy installation), 10 portable pounds in weight, and compatibility with so many of the most popular personal computers on the market.

Plus its printhead features a unique single-hammer design that eliminates a lot of moving parts, to eliminate a lot of annoying repairs.

That's the Banana: silly name, serious service. It's everything the expensive dot-matrix printers are . . .

Except expensive.

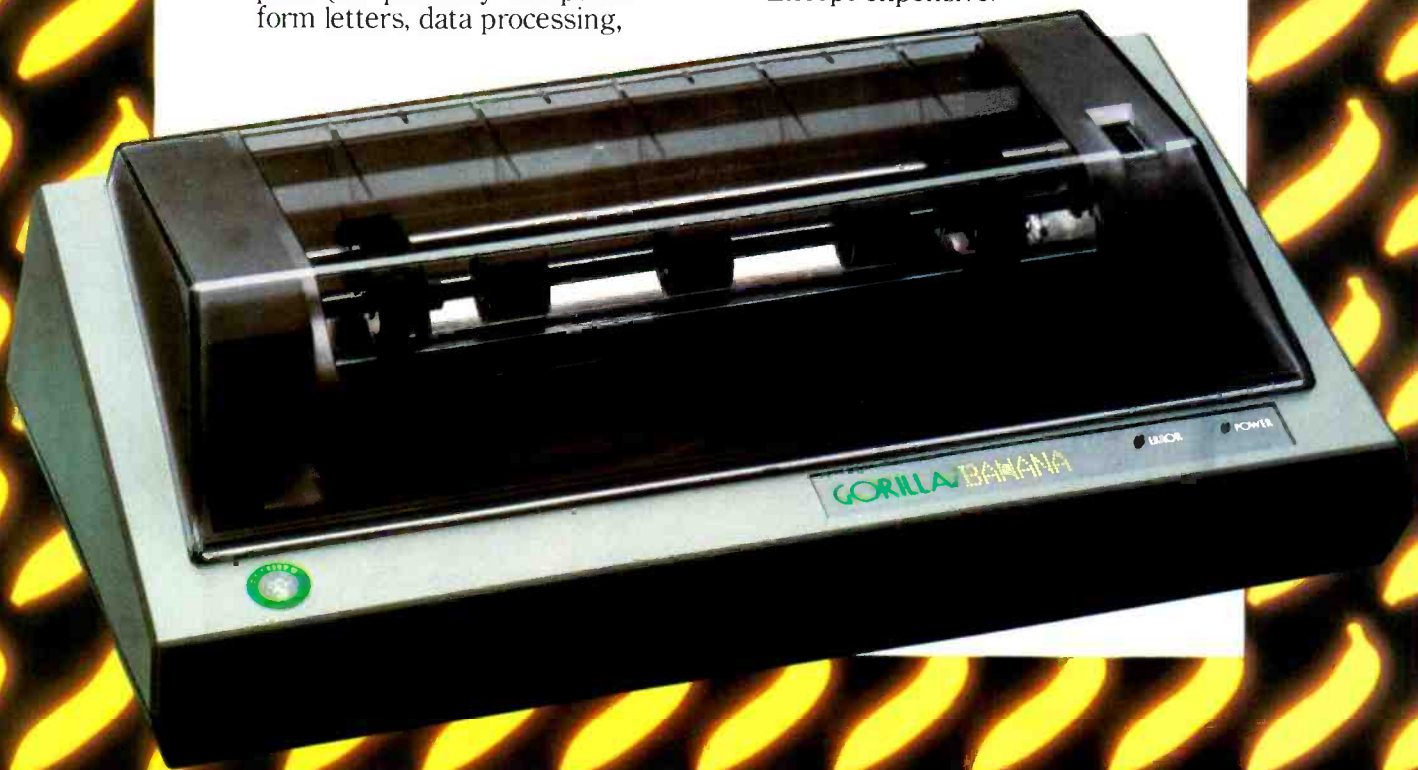

Leading Edge Products, Inc., 225 Turnpike Street, Canton, Massachusetts 02021
Toll-free: 1-800-343-6833; In Massachusetts (617) 828-8150. Telex 951-624.

CIRCLE NO. 20 ON FREE INFORMATION CARD

Here's why we're Number One.

When it comes to logic probes, more people purchase Global Specialties! Because you can spend twice as much and not get the speed, precision, flexibility and accuracy offered by our four logically-priced probes—including our remarkable new 150 MHz ECL Probe. Not to mention the versatility, reliability and durability we've become famous for.

But we don't stop there. When it comes to logic testing, Global Specialties does the *complete* job. With our DP-1 auto-sensing digital signal injector—for fast, easy stimulus-response testing at an economical \$83.00*. Plus a line of multi-channel Logic Monitors that provide an inside picture of circuit activity at up to 40 nodes simultaneously. And each product has an idea-filled applications manual—as well as an unmatched line of highly-functional accessories, to extend its versatility still more.

With Global Specialties, there's no need to compromise on performance. Or *value*. Discover for yourself why we're the number-one logical choice!



Easy-to-use Memory and Pulse functions

Full readout indications—HI, LOW PULSE

Overload and AC-line-protected high-impedance input
Linear input impedance eliminates errors due to non-uniform loading

Complete line of interchangeable probe tips and grounding wires, including easy clip, banana plug, alligator clip jumpers and variety of power cords

Compact, high-impact, human-engineered case

True multi-family performance: DTL, TTL, CMOS. Or ECL!

Interchangeable thin-profile power cords (instead of awkward, heavy or coiled cords)

Unsurpassed reliability—performance proven

All specs conservative and guaranteed

Half the price for equal (or better) performance

Circuit-powered with reverse-voltage protection

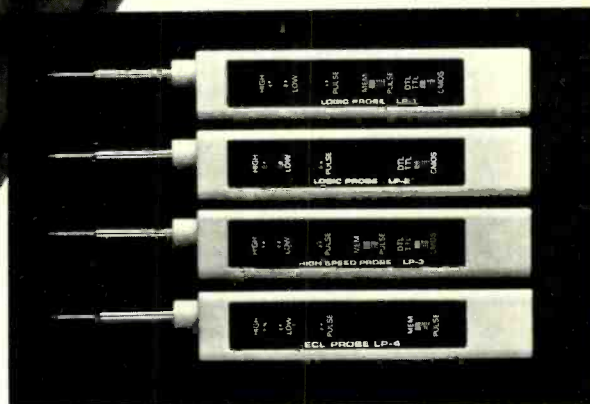

Standard LP-1, only \$50.00*, with latching memory—captures pulses as fast as 50 nsec, to 10MHz, guaranteed
Economy LP-2, \$32.00*, guaranteed to 50 nsec, 1.5 MHz
High-speed LP-3 with memory, only \$77.00*, guaranteed to 10 nsec (6 nsec, typical) and 50 MHz!
New ECL LP-4†, \$150.00; the new industry standard—with memory, guaranteed to 4 nsec (2 nsec, typical) at 150 MHz!
 †LP-4 probe exclusively for use with ECL. For DTL, TTL or CMOS, select LP-1, -2 or -3.

70 Fulton Terr., New Haven, CT 06509 (203) 624-3103, TWX 710-465-1227
 OTHER OFFICES: San Francisco (415) 648-0611, TWX 910-372-7992
 Europe: Phone Saffron-Walden 0799-27682, TLX 817477
 Canada: Len Finkler Ltd., Downsview, Ontario

GLOBAL SPECIALTIES CORPORATION

Call toll-free for details
1-800-243-6077
 During business hours

*Suggested U.S. resale. Prices, specifications subject to change without notice. © Copyright 1981 Global Specialties Corporation.
 Circle No. 46 on Free Information Card

Computers & Electronics

SEPTEMBER 1983

VOLUME 21, NUMBER 9

FEATURE ARTICLES

- 32 A NEW BREED OF COMPUTER PRODUCTS**
Joe Desposito/A roundup of recent innovative computers and related products.
- 43 UNIX THE EASY WAY**
David Fiedler/Fundamentals of the Unix operating system.
- 51 FAST AND EASY GRAPHICS WITH A LOW-COST TOUCH TABLET**
Joe Desposito/Enables computerists to bypass a computer keyboard, while creating drawings.
- 59 THE MODULARIZED COMPUTER—SONY'S NEW SMC-70**
Stan Veit/A hands-on look at a unique small computer system.
- 64 A COMPUTERIZED DIALING SYSTEM FOR THE TRS-80 MODEL II**
James Barbarello/Enhance utility of TRS-80 in office-type applications.
- 72 LEARNING 16-BIT MICROCOMPUTER TECHNOLOGY**
George Meyerle/Part 7: How to use the monitor to create software.
- 76 A MULTIPLE TEST-POINT MONITOR**
George Gooder/Measures volts at a number of circuit points simultaneously.
- 79 BEEP! BEEP!**
James Antonakos/Add a power-failure sensor to any ac digital clock.
- 80 IMPROVING TIMEX/SINCLAIR TAPE LOADING**
Tim Stoner/Reduce troublesome dropouts and noise problems.
- 84 A VIC-20 CASSETTE ADAPTER**
Bernard J. Sheehan/Interface for the VIC-20 allows any audio cassetter recorder to be used.

COLUMNS

- 22 COMPUTER VIDEO GAMES**

COVER ART BY A. DANIELS



- 26 LES SOLOMON ON COMPUTER HARDWARE**
Invisible Short Circuits in Digital Equipment.
- 27 COMPUTER SOURCES**
- 85 ENTERTAINMENT ELECTRONICS**
Len Feldman/Digital TV—How Soon?
- 90 THE ELECTRONICS SCIENTIST**
Forrest M. Mims, III/Homemade Electroscopes and Experimenting with a Geiger Counter.

DEPARTMENTS

- 6 EDITORIAL/Art Salsberg**
Compuphobia.
- 12 LETTERS**
- 16 NEW PRODUCTS**
- 103 COMPUTER MART/ELECTRONICS CLASSIFIED**
- 112 ADVERTISERS' INDEX**

COPYRIGHT © 1983 BY ZIFF-DAVIS PUBLISHING COMPANY. All rights reserved. Computers & Electronics (ISSN 0032-4485) September 1983, Volume 21, Number 9. Published monthly by Ziff-Davis Publishing Co., at One Park Ave., New York, NY 10016. Richard P. Friese, President; Selwyn Taubman, Treasurer; Bertram A. Abrams, Secretary. One year subscription rate for U.S. and Possessions, \$15.97; Canada, \$20.97; all other countries, \$23.97 (cash orders only, payable in U.S. currency). Second Class Postage Paid at New York, N.Y. 10016 and at additional mailing offices. Authorized as second class mail by the Post Office Dept., Ottawa, Canada, and for payment of postage in cash. POPULAR ELECTRONICS including ELECTRONICS WORLD trademark registered. Indexed in the Reader's Guide to Periodical Literature. Ziff-Davis also publishes Boating, Car and Driver, Cycle, Flying, Popular Photography, Skiing, Stereo Review, Electronic Experimenter's Handbook, and Tape Recording & Buying Guide. **POSTMASTER:** Send address changes to COMPUTERS & ELECTRONICS, Circulation Dept. P.O. Box 2774, Boulder, CO 80302. Please allow at least eight

HUGE ELEK-TEK DISCOUNTS

TI-99/4A COMPUTER KEYBOARD

by **TEXAS INSTRUMENTS**

TI-99/4A Keyboard 149.00
Less Mfr. Rebate 50.00

Price After Rebate 99.00
Limited Time Offer



EXTRA BONUS

SAVE \$180

FREE PHT200 PERIPHERAL EXPANSION BOX
with purchase of any 3 following items:

- PHP 1270 RS 232 Card
- PHP 1270 Disk Controller Card
- PHP 1270 Expansion System Disk Drive
- PHP 1260 Memory Expansion Card (32K RAM)
- PHP 1270 P-Code Card
- PHP 1113 Tractor-Ribbon Processing Pad
- PHP 1113 Ribbon Blotting / Spread Sheet

LIMITED TIME OFFER

Model	Name	Mfr. Sugg. Ret.	Elek-Tek Price	Model	Name	Mfr. Sugg. Ret.	Elek-Tek Price	Model	Name	Mfr. Sugg. Ret.	Elek-Tek Price
CONSOLE											
PHC 004A	TI-99/4A Home Computer (incl. PFD Modulator)	225.00	149.00	PHM 3028	Addition and Subtraction II (Solid State Speech™ Synthesizer is recommended)	39.95	32.00	PHD 5058	TI Invaders (32K Memory Expansion and Either Extended BASIC or Editor/Assembler Command Module are required)	14.95	5.00
PERIPHERALS											
PHP 1200	Peripheral Expansion Box	249.95	180.00	PHM 3029	Multiplication I (Solid State Speech™ Synthesizer is recommended)	39.95	32.00	PHD 5060	Munch Man (32K Memory Expansion and Either Extended BASIC or Editor/Assembler Command Module are required)	19.95	18.00
PHP 1220	RS-232 Card	174.95	100.00	PHM 3049	Division I (Solid State Speech™ Synthesizer is recommended)	39.95	32.00				
PHP 1240	Disk Controller Card (One Disk Manager module packed with each Disk Controller)	249.95	180.00	PHM 3050	Numerations I	39.95	32.00				
PHP 1250	Expansion System Disk Drive (Disk Drive Controller required)	299.95	285.00	PHM 3051	Numerations II	39.95	32.00				
WAB-11 Blank Disks											
PHP 1260	Memory Expansion Card (32K RAM)	249.95	215.00	PHM 3060	Scholastic Spelling—Level 4 (Solid State Speech™ Synthesizer is required)	59.95	45.00				
PHA 1950	Thermal Paper (2 Packs)	9.95	8.00	PHM 3061	Scholastic Spelling—Level 5 (Solid State Speech™ Synthesizer is required)	59.95	45.00				
PHP 1500	Solid State Speech™ Synthesizer	149.95	80.00	PHM 3062	Scholastic Spelling—Level 6 (Solid State Speech™ Synthesizer is required)	59.95	45.00				
PHP 1600	Acoustic Coupler Modem	224.95	165.00								
PHP 1850	Disk Memory Drive (External)	499.95	370.00								
PHP 2500	TI 80 Column Impact Printer	750.00	500.00								
PHP 2700	Program Recorder (Includes PHA 2622)	639.95	50.00								
PHA 4100	10" Color Monitor	399.95	320.00								
OPTIONAL ACCESSORIES											
PHP 1100	Wired Remote Controllers (Pair)	34.95	28.00								
PHA 1950	Thermal Paper (2 Packs)	9.95	8.00								
PHA 2000	Cassette Cable	14.95	12.00								
PHA 2010	Monitor Cable	19.95	15.00								
PHP 2700	Cassette Recorder	650.00	52.00								
APPLICATION PROGRAMS											
Home Management/Personal Finance Command Modules											
PHM 3006	Home Financial Decisions	29.95	24.00	PHM 3092	Multiplication*	39.95	32.00				
PHM 3007	Household Budget Management (Data storage system is recommended)	39.95	32.00	PHM 3093	Division*	39.95	32.00				
PHM 3012	Securities Analysis	54.95	32.00	PHM 3097	Computer Math Games II	39.95	32.00				
PHM 3013	Personal Record Keeping (Data storage system is recommended)	49.95	40.00	PHM 3098	Decimals*	39.95	32.00				
PHM 3016	Investment Record Keeping (Disk system is recommended)	69.95	58.00	PHM 3099	Number Readiness	39.95	32.00				
PHM 3022	Personal Rate Data (Data storage system is recommended)	69.95	58.00	PHM 3100	Law of Arithmetic Equations	39.95	32.00				
PHM 3044	Personal Report Generator (Data storage system is recommended)	49.95	32.00	PHM 3101	Measurement Formulas	39.95	32.00				
PHM 3111	TI Writer (32K Memory Expansion required)	99.95	75.00								
PHM 3113	Macroedit™ (32K Memory Expansion required)	99.95	75.00								
Disks											
PHD 5001	Mailing List	69.95	58.00								
PHD 5003	Personal Financial Aids	19.95	18.00								
PHD 5021	Checkbook Manager	19.95	16.00								
PHD 5022	Business Aids Library—Finance Management (Extended BASIC Command Module is required)	39.95	32.00								
PHD 5024	Business Aids Library—Inventory Management (Personal Record Keeping or Statistics Command Module is required)	69.95	58.00								
PHD 5027	Business Aids Library—Investment Management (Personal Record Keeping or Statistics Command Module is required)	69.95	58.00								
PHD 5029	Business Aids Library—Cash Management (Extended BASIC Command Module is required)	39.95	32.00								
PHD 5038	Business Aids Library—Lease/Purchase Decisions	69.95	58.00								
PHD 6038	Personal Financial Aids	14.95	12.00								
PHD 6039	Business Aids Library—Lease/Purchase Decisions	59.95	45.00								
Documentation Section for Young Minds											
PHA 2606	Creative Programming Computer Competency Series—Volume 1	9.95	8.00								
PHA 2607	Creative Programming Computer Competency Series—Volume 2	9.95	8.00								
PHA 2608	Creative Programming Computer Competency Series—Volume 3	9.95	8.00								
PHA 2609	Creative Programming Computer Competency Series—Algebra Projects	9.95	8.00								
Educational/Personal Enrichment Command Modules											
DLM Arcades											
PHM 3114	Alligator Minitest	39.95	32.00								
PHM 3116	Demolition Division	39.95	32.00								
PHM 3118	Manus Minitest	39.95	32.00								
PHM 3169	Word Invaders (4th quarter)	39.95	32.00								
PHM 3185	Word Reader (4th quarter)	39.95	32.00								
Texas Instruments Packages											
PHM 3002	Early Learning Fun	29.95	24.00								
PHM 3003	Beginning Grammar	29.95	24.00								
PHM 3004	Number Magic	19.95	16.00								
PHM 3005	Video Graphs	19.95	16.00								
PHM 3008	Video Chess	69.95	58.00								
PHM 3010	Physical Fitness	29.95	24.00								
PHM 3020	Musical Master (Data storage system is recommended)	39.95	32.00								
PHM 3021	Weight Control and Nutrition (Data storage system is recommended)	59.95	32.00								
PHM 3040	TI LOGO (Memory Expansion is required)	129.95	75.00								
PHM 3064	Touch Typing Tutor (Available for TI-99/4A only)	39.95	32.00								
PHM 3109	TI Logo II (32K Memory Expansion is required)	129.95	75.00								
PHM 3144	Logo Learning Fun	39.95	32.00								
PHM 3015	Scott, Foresman Reading and Math Packages (Developed by Scott, Foresman)	54.95	44.00								
PHM 3043	Reading Fun (Solid State Speech™ Synthesizer is recommended)	54.95	44.00								
PHM 3046	Reading On	44.95	44.00								
PHM 3047	Reading Round	44.95	44.00								
PHM 3048	Reading Rally	54.95	44.00								
PHM 3082	Reading Ring	54.95	44.00								
PHM 3027	Addition and Subtraction I (Solid State Speech™ Synthesizer is recommended)	39.95	32.00								
TI-PLATO® Courseware											
(Disk system, 32K mem., esp. and PLATO interpreter cartridge are required)											
			Availability Expected								
Elementary											
Grades 1-8	Mathematics	PHD 5201-PHD 5219	(December)								
Grades 1-8	Reading	PHD 5220-PHD 5247	(September)								
Grades 1-8	Grammar	PHD 5246-PHD 5264	(December)								
High School											
Grades 9-12	Writing	PHD 5265-PHD 5272	(October)								
Grades 9-12	Mathematics	PHD 5273-PHD 5280	(September)								
Grades 9-12	Reading	PHD 5281-PHD 5288	(September)								
Grades 9-12	Science	PHD 5289-PHD 5296	(December)								
Grades 9-12	Social Studies	PHD 5299-PHD 5308	(October)								
Each of the above ELEK-TEK priced at \$40.00											
PHM 3122	Plato Interpreter Cartridge		40.00								
PLATO is a trademark of Control Data Corp.											

Texas Instruments Compatible Supplies

Blank 5 1/4" Disks 2000

Blank 80 Minute Cassettes 300

Command Module or Cassette Storage File

File-Pro, dust-free Storage Box (holds 18 modules/cassettes) 1500

Ribbon Cartridges 4000

For TI PHP 2500 Printer: Epson MX-80 Printer 1500

For Epson MX-100 Printer: Disc Storage File 700

Advance Storage File Holds 50 5 1/4 Disks 1600

File N File: Stores 50 5 1/4 Disks 2000

Waco Z9794 Joystick 22.00

Adapter For Above Joystick 6.00

WE CARRY A LARGE VARIETY OF CABLES

Call for very special prices on EPSON and GEMINI Printers.

1111 Developed by DLM, Inc.
1112 Available only until replaced by peripheral card.
1113 UCSD, UCSD Pascal and UCSD p-System are all trademarks of the Regents of the University of California.
1114 Ohiolex is a trademark of Gabriel Industries.
1115 Course is designed to be used with Critical Analysis I textbook.

ELEK-TEK, Inc.
6557 N. Lincoln Ave., Chicago, IL 60645
(800) 621-1269 (312) 677-7660

CALL TOLL FREE 800-621-1269 (EXCEPT IL, AK, HI) MasterCard or Visa by mail or phone. Mail Cashier's Ck., Mon. Ord., Pers. Ck. (2 wks to clr). Add \$4.00 1st item. (AK, HI, P.R., Canada add \$10.00 1st item except large peripherals) \$1.00 ea. add'l shpg. & handl. Shipments to IL address add 6% tax. Prices subject to change. Write (no calls) for free catalog. 30 day return policy applies to defective merchandise ONLY and limited to U.S. shipments. Sorry, no other exchanges or refunds since ALL MERCHANDISE SOLD BY ELEK-TEK IS BRAND NEW, FIRST QUALITY AND COMPLETE.

Circle No. 73 on Free Information Card

ALL MINI DISKS COME ERROR FREE.

THE HA

A disk is built with certain safeguards. The technology is widely known. That's why most disk makers offer guarantees that the product you receive comes to you error free. We at Memtek Products are concerned that the minidisk remains error free, once put into use. *Every* time you use it. After exposure to dust, cigarette smoke, fingerprints, even wear caused by your computer. And so, we have built safeguards around the disk, as well.

The hub ring. Designed to prevent our minidisks from jamming in your machine.

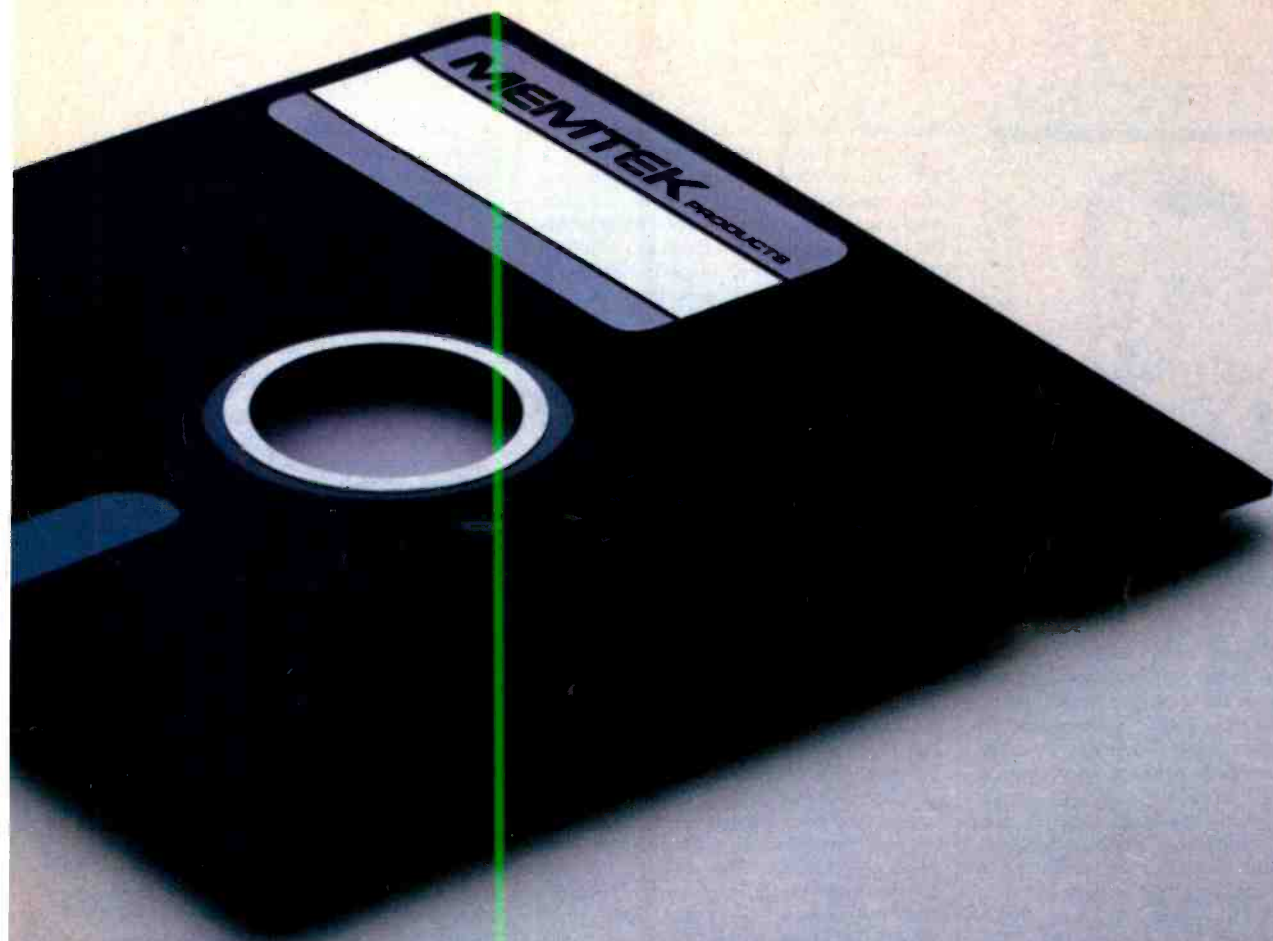

RD PART IS MAKING SURE THEY STAY THAT WAY.

Rigid. Durable. Reinforced. To maximize disk life and improve alignment.

Memtek Products' latest innovation... acknowledgment of a real world beyond the laboratory.

The coating. A critically-controlled coating of high-energy magnetic oxide particles that covers the disk's surface, which is then micro-polished to improve head to disk contact. This process not only helps prevent dropouts, it

also lowers head abrasion.

The lubrication system. A constant lubricant protects both the disk surface and the drive head from wear.

The sleeve. Comes with a soft liner that protects the disk while gently cleaning the surface of dust and debris that can damage drive heads.

The guarantee. Memtek Products will replace any minidisk if it fails to accurately store and retrieve data due to a defect in materials or workmanship for up to 5 years from date of purchase. Simply mail the disk back and we'll replace it, free.

The Memtek lineup. Includes premium double and quad density

minidisks as well as 10- and 15-minute computer cassettes and a 5 1/4" disk drive head cleaner.



WE PLAY FOR KEEPS™



Compuphobia

THE fear of using computers—compuphobia—is more widespread than many people imagine, particularly among more mature adults. There are a host of likely causes, led by fear of failure and the challenge presented by linguistics. Mix in poor documentation by manufacturers' sales jargon, a confusing array of competitive machines and software, questionable utility, cost, incompatibility between computers, and even fear and awe of a system that might replace the user.

Some of the foregoing hurdles are slowly being overcome. Too slowly. But "The Force" cannot be denied. Inexorably, computers are encroaching indirectly on virtually everyone today; and more and more people are already eyeball to eyeball with them at work, particularly in professional, executive, technical, educational, and clerical areas.

The tip of the iceberg is clearly in sight. For example, a new computer network planned by Travelhost Inc. is expected to

link hotel and motel rooms throughout the U.S., making available to guests a variety of information services such as videotext service, restaurant reviews, and computer data exchange using the hotel room's TV set. This was launched recently in Chicago's Midland Hotel with computer terminals in 100 rooms, according to a company spokesman. Another hotel system designed by HotelTech International, called "Suitetalk," consists of a color microcomputer system that offers word processing, business programs, and data communications, among other services, for about \$9 per hour at night and \$20 per hour during the day. Information is presented in magazine-page format, activated by the user pressing a letter or number on a keyboard. Function keys include GAMES, NEWS, STOCKS, HOME-OFFICE, MESSAGES, CALC, and AIRLINES.

For anyone not yet familiar with what a personal computer can do, a trip to a local computer store can be a fruitful outing, especially if he gets a helpful salesperson to demonstrate some software. There's a new in-store information center from Apple Computer, too, that can relieve people who have compuphobia. It consists of an interactive laser videodisc system with a touch-sensitive screen that gives answers to the most commonly asked questions about personal computer applications. For example, if one touches a spot on the screen next to the topic "Word Processing," a list of subtopics is displayed. Touching the screen again to choose a specific segment, say, making text changes or text search, the selected topic is played back on the 13" color monitor.

There are also some interesting efforts being made to demonstrate computer software. Buyers face a choice from among tens of thousands. One "creative" idea was rental of software, in much the same manner as recorded video cassette tapes are rented. How-

ever, software makers are more than displeased by this owing to the possibility of a customer's copying a program illegally. In fact, Micropro has filed suit against a software rental company, charging copyright infringement because consumers do not own their software. They are licensed to use it and lending it to others is prohibited.

Another interesting approach to researching software products is the establishment of the National Software Reference Library, a division of PC Telemart, Inc. in Fairfax, VA. This facility is reported to house thousands of microcomputer software programs and associated documentation, along with appropriate personal computer configurations. Members can operate software packages to aid them in purchasing the products (\$25 per day). The company plans to establish nationwide on-line data-base equipment for placement in computer and book stores.

Computers are not as easy as they could be to operate. But there is a growing trend to design them with humans in mind—built-in application ROMs, graphic screen menus, function keys, adjustable terminals, etc. The sooner the better, of course, since we are rapidly moving into an awesome information age where hardly anyone will be untouched by computer technology. This being the case, the smart move is to embrace computers as early as you can, not waiting for all the operating conveniences to be in place. Imagine what would have happened if people hadn't learned how to drive automobiles because shifting gears was too complicated.

Art Salsberg

Computers & Electronics

formerly Popular Electronics

WILLIAM S. DAVID
Publisher

ARTHUR P. SALSBERG
Editorial Director

LESLIE SOLOMON
Technical Director

JOHN R. RIGGS
Managing Editor

EDWARD I. BUXBAUM
Art Director

ALEXANDER W. BURAWA
Senior Editor

JOSEPH DESPOSITO
Technical Editor

JOSEF BERNARD
Technical Editor

ANDRE DUZANT
Technical Illustrator

CARMEN ROBLES
Production Editor

JEFF NEWMAN
Editorial Assistant

Contributing Editors:
Walter Buchsbaum, Len Feldman
Glenn Hauser, Julian Hirsch
Forrest Mims

Editorial and Executive Offices
One Park Avenue
New York, New York 10016
212 725-3500

Sales Offices
New York Office
Tom Ballou 212 725-3578
Ken Lipka 212 725-3580

Midwestern
Suite 1400, 180 N. Michigan Ave.,
Chicago, IL 60601 312 346-2600
Sales: Robert Vanek

Western
J.E.M. Associates
Francisco Bay Office Park
1750 Montgomery Street
San Francisco, CA 94111 415-989-4643
Joe Mesics

Representation in Japan
J.S. Yagi
Iwai Trading Co., Ltd.
603 Ginza Sky Heights Bldg.
18-13, Ginza 7-Chome
Tokyo, Japan 104

Consumer Computers & Electronics Magazine Division

Larry Sporn President
J. Scott Briggs Vice President, Marketing
Carole Mandel Vice President, Circulation
Eileen G. Markowitz Vice President
General Manager
Peter J. Blank Creative Director

Ziff-Davis Publishing Company

Richard P. Friesen President
Albert S. Traina President, Consumer Magazine Division
Executive Vice President
Marketing and Circulation Senior Vice Presidents
Phillip T. Heffernan Vice Presidents
Sidney Holtz
Edward D. Muhlfeld
Philip Sine
Baird Davis
George Morrissey
Selwyn Taubman Treasurer
Bertram A. Abrams Secretary

Editorial correspondence: COMPUTERS & ELECTRONICS, 1 Park Ave., New York, NY 10016. Editorial contributions must be accompanied by return postage and will be handled with reasonable care; however, publisher assumes no responsibility for return or safety of manuscripts, art work, or models submitted.

The publisher has no knowledge of any proprietary rights which will be violated by the making or using of any items disclosed in this issue.



wabash[®] diskettes for as low as \$1.29 each!

Now get Wabash Quality at a CE Price

For over 17 years, Wabash has been making high quality and dependable computer products. Wabash diskettes are made to provide error-free performance on your computer system because every diskette has been totally and hypercritically tested. Since you can now buy Wabash computer products directly from CE, the world's largest distributor of magnetic media, you can now get maximum savings on every order. You can even order toll-free.

New Wabash Six Year Warranty

The quality of Wabash diskettes is stressed throughout the entire manufacturing process. After coating, all Wabash diskettes go through a unique burnishing process that gives each diskette a mirror-smooth appearance. Wabash then carefully applies a lubricant that is specially formulated to increase diskette life. Then, to keep out foreign particles, a unique heat seal bonds the jacket and liner together to help prevent contamination. After 100% hypercritical testing and certification, Wabash then packages each diskette, (except bulk pack) in a super strong and tear resistant Tyvek[®] envelope. The final Wabash product is then shrink-wrapped to insure cleanliness and reduce contamination during shipment. Wabash diskettes are so very reliable that Wabash now offers a six year warranty in case of defects in materials or workmanship on all diskettes purchased directly from Communications Electronics.

New...Wabash Diskette Duplication Services

Communications Electronics has teamed up with Wabash to provide a single-source solution for the diskette duplication requirements of software developers, OEM's and distributors. All service is in-house, to give you fast, dependable service. In most cases, delivery can be completed in five days. Whether you require 100, 1,000, or 10,000 copies per week, call CE first for a no obligation price quote. For additional information, please write us on your letterhead with your requirements.

SAVE ON WABASH DISKETTES

Product Description	Part #	CE quant. 100 price per disk (\$)
8" SSSD IBM Compatible (128 B/S, 26 Sectors)	F111	1.89
8" SSSD Shugart Compatible, 32 Hard Sector	F31A	1.89
8" SSDD IBM Compatible (128 B/S, 26 Sectors)	F131	2.39
8" DSDD Soft Sector (Unformatted)	F14A	2.99
8" DSDD Soft Sector (256 B/S, 26 Sectors)	F144	2.99
8" DSDD Soft Sector (512 B/S, 15 Sectors)	F145	2.99
8" DSDD Soft Sector (1024 B/S, 8 Sectors)	F147	2.99
5 1/4" SSSD Soft Sector w/Hub Ring	M11A	1.49
5 1/4" Same as above, but bulk pack w/o envelope	M11AB	1.29
5 1/4" SSSD 10 Hard Sector w/Hub Ring	M41A	1.49
5 1/4" SSSD 16 Hard Sector w/Hub Ring	M51A	1.49
5 1/4" SSDD Soft Sector w/Hub Ring	M13A	1.79
5 1/4" Same as above, but bulk pack w/o envelope	M13AB	1.59
5 1/4" SSDD 10 Hard Sector w/Hub Ring	M43A	1.79
5 1/4" SSDD 16 Hard Sector w/Hub Ring	M53A	1.79
5 1/4" DSDD Soft Sector w/Hub Ring	M14A	2.69
5 1/4" Same as above, but bulk pack w/o envelope	M14AB	2.49
5 1/4" DSDD 10 Hard Sector w/Hub Ring	M44A	2.69
5 1/4" DSDD 16 Hard Sector w/Hub Ring	M54A	2.69
5 1/4" SSQD Soft Sector w/Hub Ring (96 TPI)	M15A	2.59
5 1/4" DSQD Soft Sector w/Hub Ring (96 TPI)	M16A	3.69
5 1/4" Tyvek Diskette Envelopes - Price per 100 Pack	TE5	12.00

SSSD = Single Sided Single Density; SSDD = Single Sided Double Density; DSDD = Double Sided Double Density; SSQD = Single Sided Quad Density; DSQD = Double Sided Quad Density; TPI = Tracks per inch.

CIRCLE NO. 19 ON FREE INFORMATION CARD

Quantity Discounts Available

Wabash diskettes are packed 10 disks to a carton and 10 cartons to a case. The economy bulk pack is packaged 100 disks to a case without envelopes or labels. Please order only in increments of 100 units for quantity 100 pricing. With the exception of bulk pack, we are also willing to accommodate your smaller orders. Quantities less than 100 units are available in increments of 10 units at a 20% surcharge above our 100 unit price. Quantity discounts are also available.

Order 500 or more disks at the same time and deduct 1%; 1,000 or more saves you 2%; 2,000 or more saves 3%; 5,000 or more saves 4%; 10,000 or more saves 5%; 25,000 or more saves 6%; 50,000 or more saves 7%; 100,000 or more saves 8%; 500,000 or more saves 9% and 1,000,000 or more disks earns you a 10% discount off our super low quantity 100 price. Almost all Wabash diskettes are immediately available from CE. Our efficient warehouse facilities are equipped to help us get you the quality product you need, when you need it. If you need further assistance to find the flexible disk that's right for you, call the Wabash compatibility hotline. Dial toll-free 800-323-9868 and ask for your compatibility representative. In Illinois or outside the U.S. dial 312-593-6363 between 9 AM to 4 PM Central time.

Buy Wabash Diskettes with Confidence

To get the fastest delivery from CE of your Wabash computer products, we recommend you phone your order directly to our Computer Products Division and charge it to your credit card. Be sure to calculate your price using the CE prices in this ad. Written purchase orders are accepted from approved government agencies and most well rated firms at a 30% surcharge for net 30 billing. For maximum savings, your order should be prepaid. All sales are subject to availability, acceptance and verification. All sales are final. All prices are in U.S. dollars. Prices, terms and specifications are subject to change without notice. Out of stock items will be placed on backorder automatically unless CE is instructed differently. Minimum prepaid order is \$50.00. Minimum purchase order \$200.00. All shipments are F.O.B. Ann Arbor, Michigan U.S.A. No COD's please. Non-certified and foreign checks require bank clearance.

For shipping charges add \$8.00 per case or partial case of 100 8-inch flexible disks or \$6.00 per case or partial case of 100 5 1/4-inch mini-diskettes for U.P.S. ground shipping and handling in the continental U.S.A.

Mail orders to: Communications Electronics, Box 1002, Ann Arbor, Michigan 48106 U.S.A. If you have a Visa or Master Card, you may call and place a credit card order. Order toll-free in the U.S. Dial 800-521-4414. In Canada, order toll-free by calling 800-265-4828. If you are outside the U.S. or in Michigan dial 313-994-4444. Telex anytime 810-223-2422. Order your Wabash diskettes today.

Copyright ©1983 Communications Electronics™

Ad #U12483



Order Toll-Free!
800-521-4414

In Michigan 313-994-4444

wabash
error-free
diskettes

COMMUNICATIONS
ELECTRONICS™

Computer Products Division

818 Phoenix □ Box 1002 □ Ann Arbor, Michigan 48106 U.S.A.
Order TOLL-FREE 800-521-4414 or outside U.S.A. 313-994-4444

Introducing A 16-Bit
Microprocessor System
Designed To Expand
Your Knowledge.



Encotek Educational Systems
ET100 LEARNING COMPUTER



Here's How You Can Learn 16-Bit Technology. And Graduate To One Of Today's Most Powerful And Advanced Microcomputers.

Now you can master 16-bit technology with an all-new Advanced Microprocessor course. And build hands-on experience with the only 16-bit microcomputer specifically designed for the hobbyist, working engineer and student.

Advanced Microprocessor Course

This all-new self-study course (EE-8088) provides in-depth coverage of 16-bit, state-of-the-art technology.

You will gain a thorough understanding of microprocessors from this 1200 page course. In 10 easy-to-understand units, starting with microcomputer basics, you'll cover all phases of 16-bit micro-processing. Assembly language. Program writing. Addressing modes. Dynamic and static RAM. And hardware interfacing.



And by using your 16-bit Trainer/Learning Computer for hands-on experiments (over 60 included), you'll gain actual circuit interface and software programming experience with an

8088 microprocessor system.

Trainer/Learning Computer

A unique combination of design features makes this versatile microprocessor system much more than a "teaching machine." Use it as a trainer with the Advanced Microprocessor course. Use it as an experimental design computer. And use it to run a wide variety of 16-bit software - including Z-Dos, Multiplan, Z-Basic, Condor File Manager, and much more.



In its most basic form, the Trainer/Learning Computer is a 16-bit, cassette-based microcomputer.

Its unique design features access ports and solderless breadboards to allow you to build interfaces, design and modify circuits, or simply experiment with the inner workings of the microprocessor system.

The basic system has an 8088 processor, 32K ROM (including assembler, editor and debugger) and 16K RAM.

The unit also features a serial I/O printer port, cassette interface and a detached 95-key keyboard (including 16 function keys and a numeric keypad) which generates a full ASCII character set. It's available either in kit form or factory assembled.

And you can take advantage of the system's H/Z-100 computer design heritage by easily upgrading it to a disk-based, 16-bit microcomputer that will run H/Z-100 series software and many other forthcoming programs.



Fully Upgradeable

The powerful upgrade package and variety of accessories allow you to make the basic 16-bit system more powerful and versatile. You can add 128K or 192K bytes

of RAM. Floppy disk controller. 48TPI double-sided, double-density, single or dual floppy disk drive. Bit-mapped video graphics or full-color graphics. Two RS-232 ports. Programmable timer. And a Centronics-compatible printer port.

Learn on it. Design with it. Use it as a 16-bit computer.

It's the only 16-bit microprocessor system specifically designed to integrate theory with a hands-on understanding of how 16-bit computers work. And it's from Heathkit/Zenith Educational Systems, the world-leader in problem-solving courses, trainers and accessories to help you learn state-of-the-art technology.

Heathkit
Heath
Company

A subsidiary of Zenith Radio Corporation

Circle No. 24 on Free Information Card



Get more information in the
**FREE
HEATHKIT CATALOG**

Mail to: Heath Company, Dept. 010-097
Benton Harbor, MI 49022

Name _____

Address _____

City _____

State _____ Zip _____

ED-199

FOCUS

The Largest Authorized Dealer in Brooklyn

Our 16th Ave. in Electronic

Our Policy: lowest prices, prompt service, satisfaction guaranteed

Computers Peripherals & Software

PRINTERS

Gemini 10X dot matrix
Epson MX-80 III call
Epson MX-80 Ft call
Epson FX-80 In Stock

Franklin Ace 1200
NEW! Mattel Aquarius

Call
Call

ATARI

Atari 1200 XL
after rebate 429.95
Intec 32K card (400/800) 69.95

CASIO

NEW! FX 902P w/printer 139.80
FX 702 pocket computer 74.95
FA-2 Cassette interface 36.90
FPI-10 computer printer 56.49

HEWLETT PACKARD

New HP 75C 5737.40
HP 41CV 204.95
HP 15C Programmer 87.80
82161A Digital Drive 339.95
82163 A/B Video int 179.95
Full HP Line in Stock

TEXAS INSTRUMENTS

NEW! TI CC 40 188.95
TI 99/4A low 219.95
32K RAM card (PMP 1260) 219.95
Full line of TI software in stock
Timex 1000 44.95
16K RAM Original Timex 39.95
Timex Printer 89.90
Full line of Timex software in stock

Commodore

Commodore 64 complete w/word processor, w/Disk Drive printer 14" color monitor pet emulator only 899.98

SHARP

PC 1500 8K module and CE 1507 298.95
CE 158 RS 232 Itr. 1500 159.95
CE 159 8K w/battery 119.95
NEW! PC1250 79.95
PC CE 125 Printer and micro cassette 109.95

TUNE INTO THE WORLD OF SHORTWAVE



GE World Monitor 8 Band 159.95
Sony ICF 6500 LCO 129.95
Sony ICF 7600 7 Band 68.95
Sony ICF 7600A 9 Bnd 79.95
Sony ICF 4800 Compact 59.95
Pan RF 2700 8 Band 128.95
Pan RF 7600 8 Band 108.95
Pan RF 2900 5 Band 198.95

MONITORS

Taxan 12" amber 149.95
Comdex Epson 12" green 99.98
Comdex Epson 13" color 299.98
Panasonic 13" RGB color 379.95
Sony KX-1901 Proteel 548.95

For information and all N.Y. State orders, please dial (212) 287-1600. All items subject to availability and price change. Mail and phone orders C.O.D. Master Charge, Visa O.K. Shipping extra. Everything Factory Fresh 10 day Money Back Guarantee (less shipping). FOCUS ELECTRONICS 4523 13th Ave. Brooklyn NY 11219

IBM * MATTEL * MIDATA * PACER * HEWLETT PACKARD * TIMEK * BSR * ATARI * SONY * RCA * VIDIACRAFT

EPSON * ANDER * APPLE * TI * SHARP * QUERTTI * COMMODORE * BARRIS * BSR * PANASONIC * PERMAL CONDER

FOR ORDERS ONLY TOLL FREE- 800-221-0828

Circle No. 18 on Free Information Card

Put Professional Knowledge and a COLLEGE DEGREE in your Electronics Career through HOME STUDY

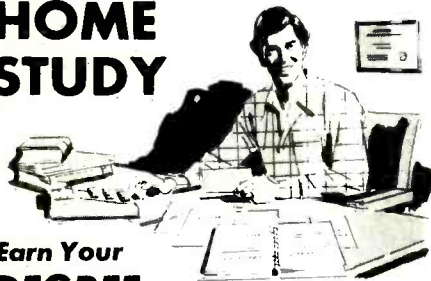

Earn Your DEGREE

No commuting to class. Study at your own pace, while continuing your present job. Learn from easy-to-understand lessons, with help from your home-study instructors whenever you need it.

In the Grantham electronics program, you first earn your A.S.E.T. degree, and then your B.S.E.T. These degrees are accredited by the Accrediting Commission of the National Home Study Council.

Our free bulletin gives full details of the home-study program, the degrees awarded, and the requirements for each degree. Write for Bulletin ET-83.

Grantham College of Engineering
2500 So. LaCienega Blvd.
Los Angeles, California 90034

LETTERS

UPGRADING T/S VIDEO

With regard to my article "Upgrading Timex-Sinclair Video" (May 1983), it should be noted that the article and the diagrams were based on the ZX-81, not the ZS-80. However, during the time between the article's conception and its publication, the computer underwent a layout change to accommodate discrete pull-up resistor instead of several single-in-line resistor packages. Schematically, the computer remained the same, but the positions of D9, R31, and R32 changed. They are still accessible, however, and must be removed as in the article. It has also been observed by some of your readers that bending and tearing may occur on some TV sets when inverse characters are displayed while the DVC-2 is operating in the normal mode. This is due to the TV's inability to clamp the horizontal sync pulses properly. Reducing the value of R7 to 3.9 kilohms or 4.3 kilohms will increase the ratio of the sync pulse to video signals and should solve the problem.—*Steve Pence, Phoenix, AZ.*

MORROW IS GREAT

The "Desktop Appliance Computers" (July 1983) review of the Morrow Designs and Cromemco micros was well done. Having just coordinated the purchase of 50 Morrow Designs MD-2 and MD-3 machines for our facility, I can vouch for the fact that they do everything that has been claimed for them. The computers, when delivered, actually included more software than advertised.—*Stephen R. Hample, Montana State University, Bozeman, MT 59717.*

COMPUTER PLACEMENT

I appreciated your article "Maximize Your Computing Comfort and Efficiency" (April 1983) and intend to recommend it to management and occupational physicians and nurses for aid in relieving employee complaints. I have seen computers set up against a west window so that the operator was facing the relatively low-level illumination of the video screen against the exceedingly bright background outside the window—a very difficult visual task!—*J.M. Krichbaum, Occupational Ophthalmologist, Lakewood, CO.*

KAYPRO AND MBASIC

The review of the Kaypro II (June 1983, p. 57) was a pleasure to read but was a little confusing as to the types of software that are available for the computer. The author correctly said that MBASIC comes with Kaypro and then went on to discuss the limitations of SBASIC for the Kaypro. To set the record straight, you should point out that MBASIC-80 from Microsoft now comes with the Kaypro at no extra cost.—*Betsy Wallace, Westminster, MD.*

OUT OF TUNE

In "Data Storage in a Nutshell" (July 1983), on page 48, in the second paragraph, the last few lines should read, "Thus, using semiconductor technology, $16 \times 64,000$ or 1.024×10^6 bits per square inch can be created. Compare this with the 10^8 bits per square inch of longitudinal recording and 10^{10} bits/square inch of perpendicular recording."

RECORDING WITH THE VIC-20

With regard to the discussion on using a cassette recorder with the VIC-20 (see "Computer Hotline," March 1983, and

"Letters," June 1983), I have been using the circuit below with my VIC-20 for several years and it works fine.—*Joe Little, Atlanta, GA.*

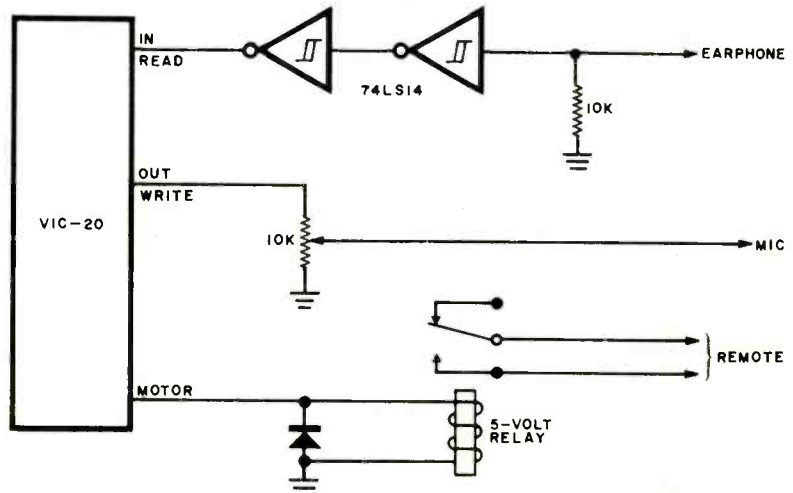



Memorable.

With 3M diskettes, your computer never forgets.

3M diskettes remember everything, every time. Because at 3M, reliability is built into every diskette. We've been in the computer media business for over 30 years. And we've never settled in. We're constantly improving and perfecting our product line, from computer tape and data cartridges to floppy disks.

3M diskettes are made at 3M. That way, we have complete control over the entire manufacturing process. And you can have complete confidence in the reliability of every 3M diskette you buy.

Look in the Yellow Pages under Computer Supplies and Parts for the 3M distributor nearest you. In Canada, write 3M Canada, Inc., London, Ontario. If it's worth remembering, it's worth 3M diskettes.



3M hears you...

3M

Circle No. 48 on Free Information Card

www.americanradiohistory.com

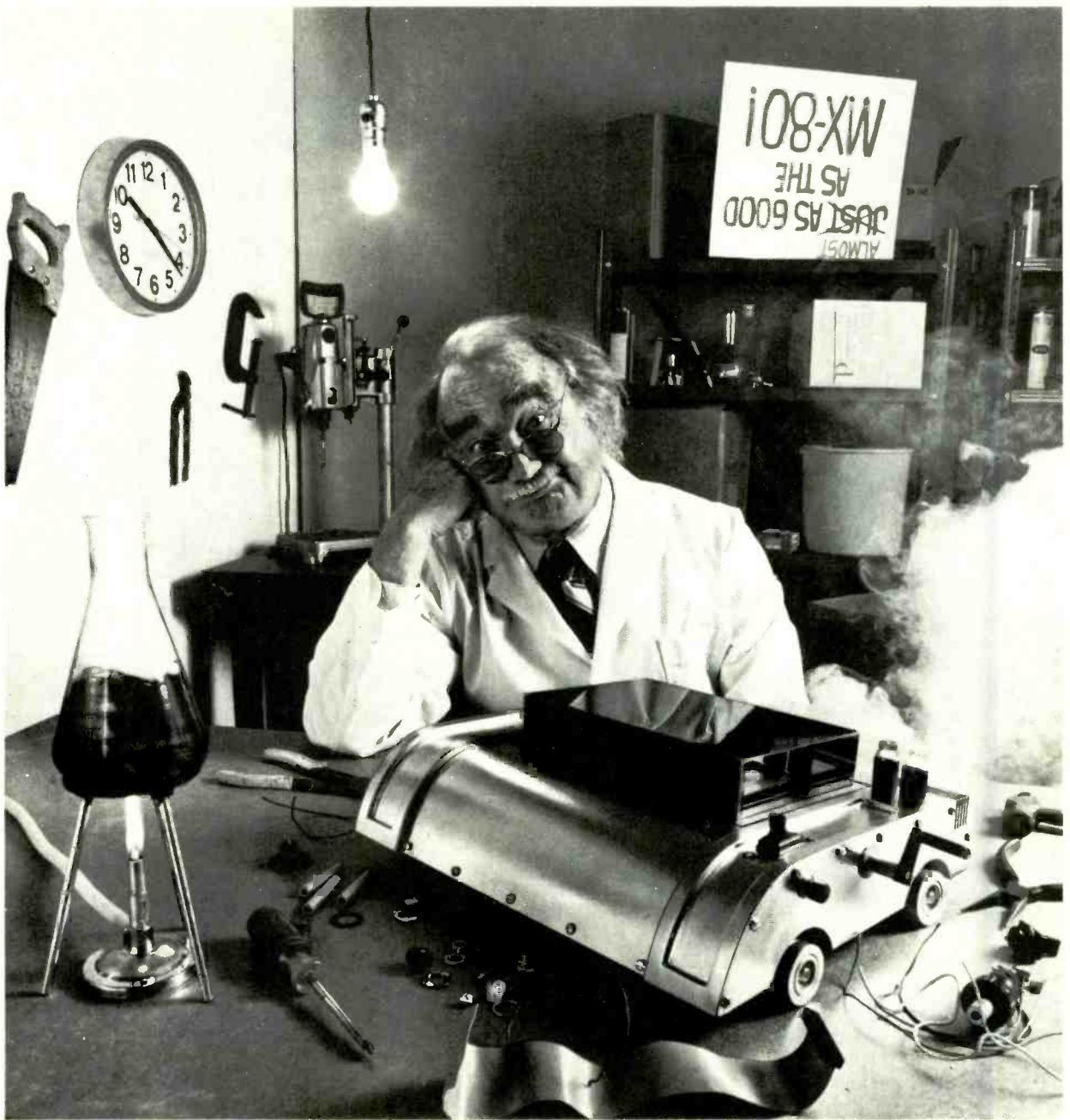

For everyone who's tried
to top the MX-80, bad news.
We just did.

Epson.

The Epson MX-80 is the best-selling dot matrix impact printer in the world. It has been since its introduction. And despite the host of imitators it spawned, no one has been able to top it. Until now.

FX-80: Son of a legend.

The new Epson FX-80 is far more than just doo-dads added on to last year's model. It's the most astonishing collection of features ever assembled in a personal printer.

For starters, it's fast: 160 CPS. And clean. All the print quality Epson is famous for in a tack-sharp 9x9 matrix.

But that hardly scratches the surface.

Create your own alphabet.

With the new FX-80, you aren't limited to ASCII characters. You can create your own. Any character or symbol that can be defined in a 9x11 matrix can be added to the FX-80's already impressive library of type styles and stored in its integral 2K RAM.

So you can create "Sally's Gothic" or "Tom's Roman" just by downloading and modifying standard characters. Or you can create a custom set from scratch. Either way, you can store up to 256 new characters. And if you don't need a new alphabet, the RAM functions as a 2K data input buffer.

Who knows graphics better than Epson?

Nobody, that's who. And if you don't believe it, witness the FX-80.

With a 12K ROM capacity, the FX-80 gives you a few things the others don't. For example, not one, not two, but *seven* different dot addressable graphic modes are program

selectable. And can be mixed in the same print line. Everything from 72 DPI (dots-per-inch) Plotter Graphics to the 640 dots per line resolution designed to match the remarkable monitor clarity of the Epson QX-10 personal computer.

And *that* is in addition to an astonishing array of 136 different user-selectable type styles including Proportional, Elite and Italic as well as the more conventional faces you get on other printers.

Hard-to-beat hardware.

The FX-80 has all the hardware features you've come to know and love on the MX Series: logic seeking, bidirectional printing, the by-now-famous disposable printhead, and more.

The FX-80 features an adjustable pin platen or optional friction/tractor feed, so you can use fanfold, roll or sheet paper ... backwards or forwards. The FX-80 even gives you reverse paper feed.

And if you're printing forms, the FX-80 has a feature you're gonna love: a function that allows you to tear off the paper within one inch of the last print position.

Be the first on your block.

We'd be willing to bet that the FX-80 — like the MX-80 — will have its share of imitators. Don't be fooled. To make sure you get the genuine article, rush down to your local computer store right now and let them show you everything the FX-80 can do.

And while you're there ... ask them to show you how it works with our computers.

The New
Epson FX-80.
See it at your
dealer now.



EPSON
EPSON AMERICA, INC.
COMPUTER PRODUCTS DIVISION

3415 Kashiwa Street
Torrance, California 90505
(213) 539-9140.
Outside California, phone
(800) 421-5426 for the
Epson dealer nearest you.

Circle No. 25 on Free Information Card

NEW PRODUCTS

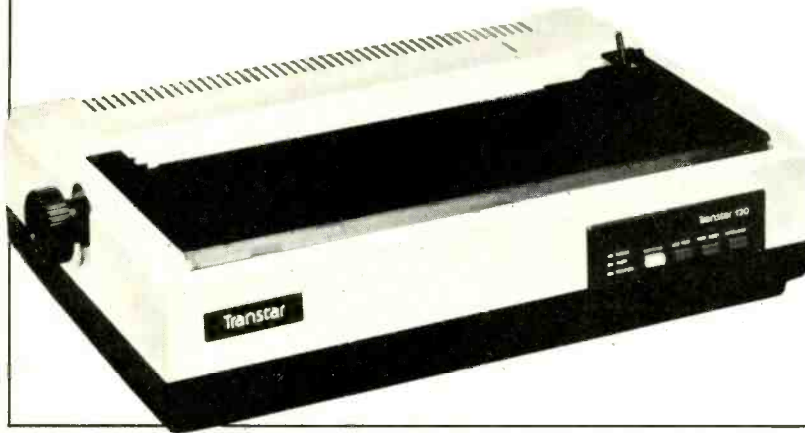

LOW-COST LETTER-QUALITY PRINTING

Transtar's Model 120, a \$599 daisywheel letter-quality printer, is compatible with major word-processing software using existing Diablo routines for boldface, underscore, superscript, and subscript. Printing speed is 14 cps, and a DIP switch selects 10, 12, or 15 cpi pitch. Automatic paper loader handles cut-sheet paper. Initial offering is with a Centronics-type, 8-bit parallel interface. A serial version will support the DTR protocol as standard ETX/ACK or XON/XOFF and at transmission rates from 300 to 9600 baud.

Circle No. 84 on Free Information Card

MULTI-USER MICROCOMPUTER SYSTEM

CompuPro's new MultiPro Model MP 10 is said to be the first four-user multiprocessor microcomputer offering simultaneous 8/16-bit operation at a price of less than \$1800 per workstation. At \$4995, excluding terminals, the system supports word/data-processing and communications functions through a shared database at high speed. Has 8-MHz 8088 16-bit CPU with 1M byte of main memory, 7 ports, 384K solid-state disk memory, and dual 5¼" mini-floppy drives; four Z80B 8-bit user CPUs, each with its own 64K of RAM.

Circle No. 85 on Free Information Card

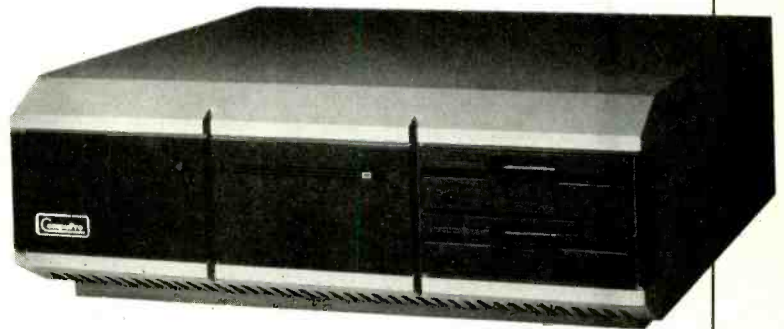

AM/FM SWEEP FUNCTION GENERATOR

Model FG-201 function generator from OK Industries has a 1-Hz to 1-MHz range, (in six steps) and sine, triangle, and square waveforms. Also, linear 100:1 FM modulation and 0 to >100% AM modulation. Square-wave output is independently variable, simultaneous and in-phase with the separate sine/triangle output for use as an individual signal source as well as a trigger or synchronizer. Source impedance, 50 ohms and switch-selectable < 5 ohms for sine/triangle; output level, ± 10 V p-p. \$250.

Circle No. 87 on Free Information Card

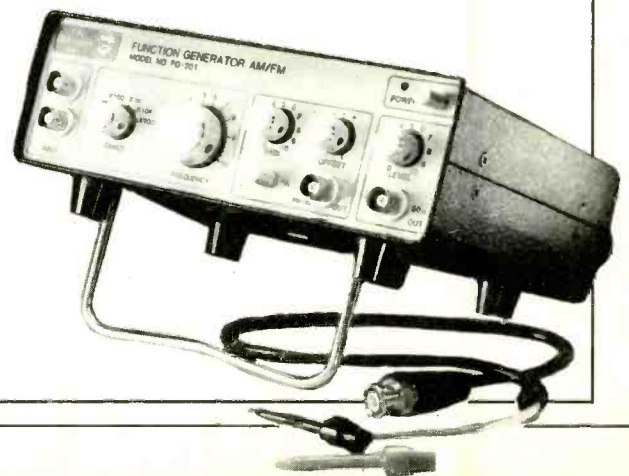

VIDEO INTERFACE

Texas Instruments' video interface gives the TI CC-40 a 450-char \times 24-line display on any TV receiver or TI video monitor. The HX-1100 attaches to the CC-40 through the hex-bus intelligent peripheral port, permitting operation in a text mode with limited graphics. Display modes include scrolling and paging. Both modes have top and bottom (first and last) lines protection. "Windowing" function permits viewing up to 80 char/line and display can highlight words by reversing colors. \$99.95.

Circle No. 86 on Free Information Card

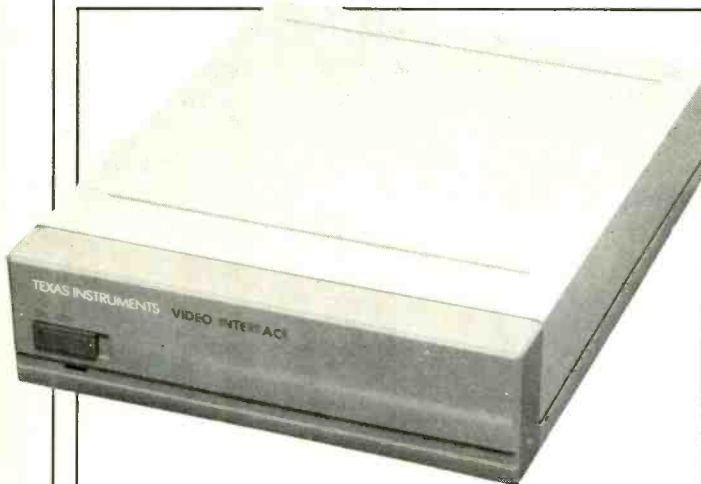

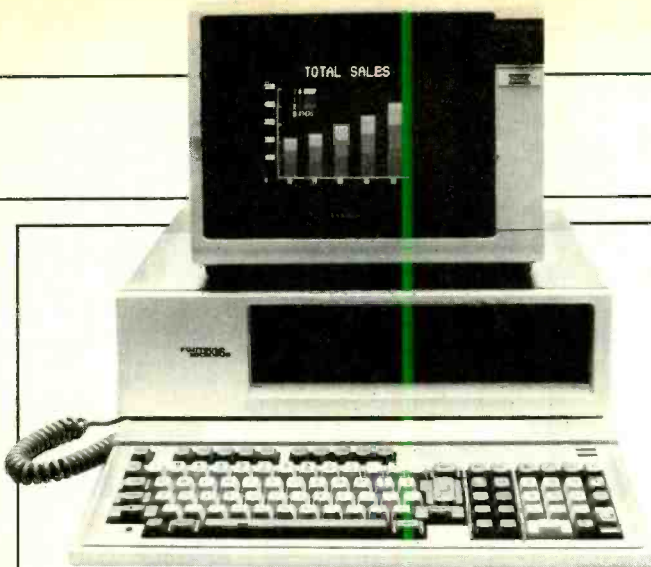

FUJITSU 8/16-BIT COLOR COMPUTER

Fujitsu's Micro 16s Personal Business Computer has both 8086 and Z80A processors for operation in the 16- and 8-bit worlds. Comes with 128K RAM, optionally expandable to 1M and 52K of video RAM; dual 320K-byte 5¼" disk drives; 300-to-19,200-baud serial and Centronics-type parallel I/O ports; four-channel A/D converter. Software includes CP/M-86, SuperCalc, and Wordstar word processing. Text display can be either 80 or 40 columns by 25 lines, while graphics mode offers 640 × 200-pixel resolution. \$3995.

Circle No. 88 on Free Information Card



LIGHT PEN FOR APPLES

The Gibson Light Pen from Micro D enables users to draw high-resolution graphics directly on the screen of an Apple II. Using a stylus the size of ballpoint pen, it works with machine-language software (included). Has area fill/refill, four complete HiRes drawing systems and a HiRes generator. \$349.

Circle No. 89 on Free Information Card

HIGH-POWER STEREO AMPLIFIER

Model PM-1.5 professional low-feedback high-headroom stereo amplifier from Carver has a rated output of 450 W/channel and weighs 21 lb. Specs: 0.1% THD full power into 8 ohms; <0.1% IM distortion (SMPTE); frequency response, -3 dB at 3 and 80,000 Hz; damping 200 at 1 kHz; noise better than 115 dB below 450 W A-weighted; 19" W × 10 13/16" D × 3 1/2" H.

Circle No. 90 on Free Information Card



INTELLIGENT SERIAL INTERFACE

The SC817 Smart Cable from IQ Technologies, Inc., is designed to solve the problem of RS232C interfacing. It connects any computer to any peripheral with the flick of a switch. On-board logic circuitry "looks" at the RS232C interfaces in the computer and peripheral and connects them for correct operation. An indicator light shows when a software problem exists. \$78.

Circle No. 91 on Free Information Card



AUTO-DIALER MODEM FOR IBM PC

Rixon's Model PC212A auto-dialer modem installs in any slot in the IBM PC and offers a choice of two transmission rates. Stores up to 10 telephone numbers and operates at up to 300 baud in the low-speed asynchronous mode or 1200 baud in the high-speed synchronous or character asynchronous mode. Also features an RS232C interface port and eliminates the need for an asynchronous communications adapter card and external modem cable. Internal microprocessor allows total control, operation, and optioning of the modem from the IBM PC. Modem is battery-protected. \$495.

Circle No. 92 on Free Information Card

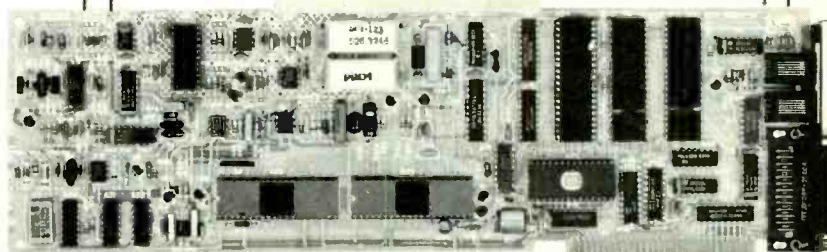

Now NRI takes you inside the new TRS-80 Model 4 microcomputer with disk drive to train you at home as the new breed of computer specialist!

NRI teams up with Radio Shack advanced technology to teach you how to use, program and service state-of-the-art microcomputers...

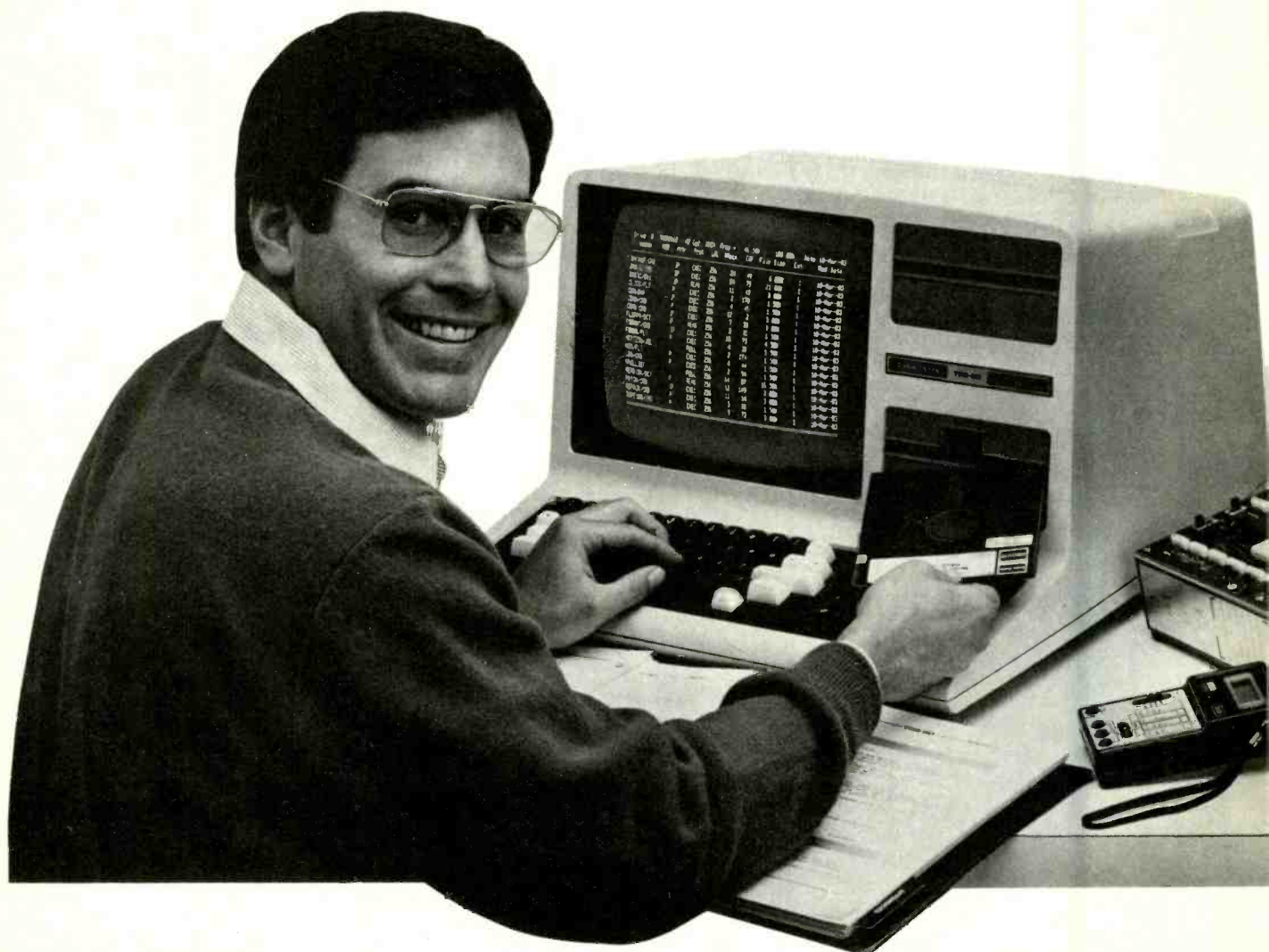

It's no longer enough to be just a programmer or a technician. With microcomputers moving into the fabric of our lives (over 1 million of the TRS-80™ alone have been sold), interdisciplinary skills are demanded. And NRI can prepare you with the first course of its kind, covering the complete world of the microcomputer.

Learn At Home In Your Spare Time

With NRI training, the programmer gains practical knowledge of hardware, to design simpler, more effective programs. And, with advanced programming skills, the technician can test and debug systems quickly and easily.

Only NRI gives you both kinds of training with the convenience of learning at home. No classroom pressures, no night school, no gasoline wasted. You learn at your convenience, at your own pace. Yet you're always backed by the NRI staff and your instructor, answering questions, giving you guidance, and available for special help if you need it.

You Explore the TRS-80 Model 4 Inside and Out

NRI training is hands-on training, with practical experiments and demonstrations as the very foundation of your knowledge. You not only learn to program your computer, you learn all about it... how circuits interact... interface with other systems... gain a real insight into its nature. Under NRI's carefully planned training, you even install a DISK DRIVE, verifying its operation at each step.



Now training includes either the TRS-80 Model 4 Microcomputer with Disk Drive or TRS-80 Color Computer with Computer Access Card; professional LCD multimeter; the NRI Discovery Lab; and hundreds of demonstrations and experiments.

You also work with a professional 4-function multimeter, featuring full portability and a 3½-digit liquid crystal display. Using it along with the exclusive NRI Discovery Lab® and your TRS-80, you perform over 60 separate experiments. You learn how to troubleshoot and gain greater understanding of any microcomputer from the information your testing procedures give you.

TRS-80 Model 4 With Disk Drive Is Yours To Keep

Since NRI is hands-on training, it's essential that you work with the right equipment. For this reason, NRI sends you the latest, most advanced model in America's most popular line of microcomputers: the new TRS-80 Model 4, with disk drive for greater memory capacity.

The TRS-80 Model 4 is a remarkably powerful and versatile machine that incorporates many performance features still available only as add-on options with other microcomputers.

What's more, the Model 4 is designed to accept all software developed for previous TRS-80 models, with no conversions

required. This means your computer will be compatible with thousands of existing programs — more software than with any other microcomputer on the market! So once you've learned the interdisciplinary computer skills the practical NRI way, you can use your TRS-80 Model 4 for a tremendous range of business, educational, and personal applications.

Along with your multimeter and the NRI Discovery Lab, the powerful TRS-80 Model 4 with double density disk drive is yours to learn with, yours to keep, and yours to use for all your future computing needs.

Same Training Available With Color Computer

NRI offers you the opportunity to train with the TRS-80 Color Computer as an alternative to the Model 4. The same technique for getting inside is enhanced by using the new NRI-developed Computer Access Card. Only NRI offers you a choice to fit your specific training needs.

The Catalog is Free. The Training is Priceless.

Get all the details on this exciting course in NRI's free, 104 page catalog. It shows all equipment, lesson outlines, and facts on other electronics courses such as Electronic Design, Industrial Electronics, TV/Audio/Video Servicing... 12 different career opportunities in all.

Send today. Prepare to take advantage of the incredible job and earnings possibilities of the microcomputer revolution as you learn on the world's most popular computer. If postcard has been used, write to NRI Schools, 3939 Wisconsin Avenue, Washington, DC 20016.

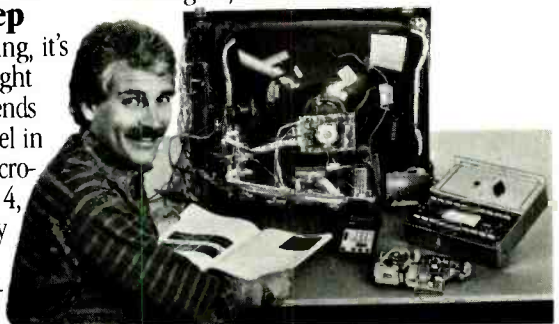

NRI Schools
McGraw-Hill Continuing
Education Center
3939 Wisconsin Ave.
Washington, DC 20016

We'll give you tomorrow.

(TRS-80 is a trademark of the Radio Shack division of Tandy Corp.)

Hands-On Reviews of Recently Released Game Software

EVERY so often, someone comes along with a really good idea. Such an idea was the Sony 3½" microfloppy diskette, which looked like a logical and sensible approach to computer storage.

This diskette is small enough to slip into a jacket pocket and has a rigid protective jacket and a metal cover that slips over the normally exposed parts that are read by the computer. In short, it's well protected and well designed for easy portability, mailing, and just plain carrying around.

The diskette runs in drives designed to work with the same controllers that operate 5¼" minifloppies, and this is an important area of compatibility. Computer systems don't have to be redesigned to use these new miniaturized diskettes.

What about storage space? In its basic format, the Sony microfloppy can hold more than the most densely packed 5¼" model—up to about 900K formatted. Now that's an awful lot to be able to put on a disk that small; but like all areas of technology, mass storage has been going through its own refinement and development stages.

With all this going for it, you'd think companies would be battering down the doors to sign up for this new format. Some have. But others have decided that they'd out-micro the microdiskette with their own designs. At last count, there were at least four different diskettes in the three-inch range vying for industry attention. The leading contender today is Maxell's 3"; and like Sony, Maxell has a lot of camp followers, including some of the industry's biggest guns.

In the meantime, Sony is very unquietly spearheading its drive for 3½" standardization. A special standards committee that includes Sony and Shugart, the latter being a giant O.E.M. manufacturer of disk drives, has established standards that all members have agreed to and can live with. Last summer, Sony signed a licensing agreement with Hewlett-Packard to use its microdiskettes, and this is the biggest single major manufacturer to go along with this development. A couple of new H-P computers use the microdiskettes, and it's certainly gratifying to see someone at least doing something sensible.

What of the other majors who've elected to go with other 3" formats? Most of them will make hardware and diskettes for whatever system will sell, but much of this hassle looks like the old multi-standards battle shaping up with proponents in each camp. There are no longer any 78-rpm records being made, but there are still plenty of both 33's and 45's being cranked out. Same is true of VCRs; not only do we have ¾" U-Matic, but also ½" Beta and VHS coexisting rather uncomfortably. And we also have laser discs along with CED video discs. (Now they've finally gone and introduced VHD video discs in Japan with an eye on the U.S. market.)

What's going to happen in the microfloppy diskette battle? We'll probably see at least two different sizes, and as many as four. We've also heard that there's a four-inch floppy. Just what the industry has been waiting for! For now, we're going to stick to our 5¼ inchers. At least with these the size is the same, even if you can't necessarily use a disk from one kind of computer on someone else's machine, and one is hard sector, another soft sector . . . but that's a whole other story.

A. E.

Diskette for Atari 400/800
Brøderbund Software, Inc., 1938 Fourth
St., San Rafael, CA 94901; 415-456-
6424. \$34.95

Graphics ****

Gameplay ****

Sustained Interest ***

Type: Joystick action game

Memory Required: 48K

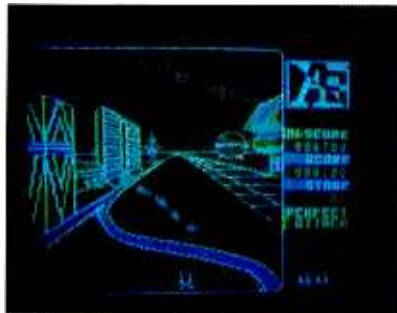

The jacket blurb explains that "A. E." is the Japanese word for "ray" as in Manta Ray or Sting Ray. In this case, the A.E. was designed as a pollution-fighting robot and some slipped through quality control at the Mitsubishihuku Company and are running loose in the universe—not destroying or damaging, but being extremely pesky.

Your mission is to destroy enough of the A.E. to drive them out of our corner of the universe. A ship-like cannon

moves horizontally (joystick control) and you try to shoot sections or preferably the head of the centipede-like A.E. as it snakes in and around and up and about your city and then your planet. To destroy the A.E. waves, you have to detonate your shooter's missiles directly in their path.

If you succeed in a perfect attack on the A.E. waves—destroying all waves in your play level, you move on to the next level—from the city to planetary orbit, and then beyond. There are five different screens (levels) of play, and if you get really good at this, you can make the game even more difficult by pressing Control H (H = hard) when the disk is booting up.

The game also offers the option of pausing during gameplay to answer the phone, or nature's call, or to get another cup of coffee. It can be controlled either by joystick or paddle.

At first, gameplay seems a little strange; these cruising serpentine A.E.s don't look all that menacing until they "clean up" your cannon, and knock you out of the game. Like other "twitch" type games, your own reflexes and learning ability count for a lot. It's an interesting, action-filled game, and while it's not as good as some others to come out of Brøderbund, it ranks among some of the better computer games we've seen recently.

Yes, it can keep you up late until you unlock the key to ridding the civilized universe of those pesky A.E. robots. And once the universe is safe for polluters once again, you can start all over—this time at the Hard level. Have fun!

RICOCHE

Cassette for Commodore VIC-20.
Epyx (Automated Simulations, Inc.,
1043 Kies Court, Sunnyvale, CA
94086. 408-745-0700.) \$19.95.

Graphics ****

Gameplay ****

Sustained Interest ****

Type: Keyboard strategy game.

Memory required: 8K

Plug in your 8K or 16K expansion module and go to town with this exciting and unpredictable strategy game. The instructions say there's nothing else to compare it to, and they're quite right. The screen display looks more like a double-ended bowling alley than anything else. Each of the two players (two humans or one human and the computer) has six targets at his end of the alley, arranged bowling-pin fashion. Behind the targets are up to four bumpers that give your opponent a ton of extra points

The First Shirt-Pocket TV With a PERFECT PICTURE!

Less Than an Inch Thick, Weighs Less Than 12 Ounces

The CASIO POCKET TV

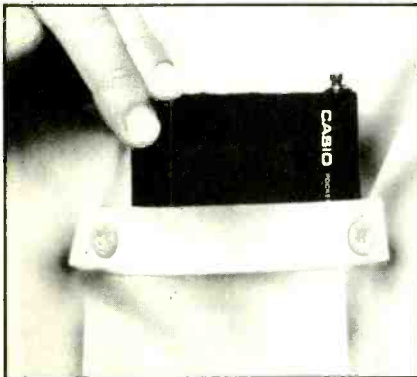

*Slips into your shirt pocket
or small purse.*

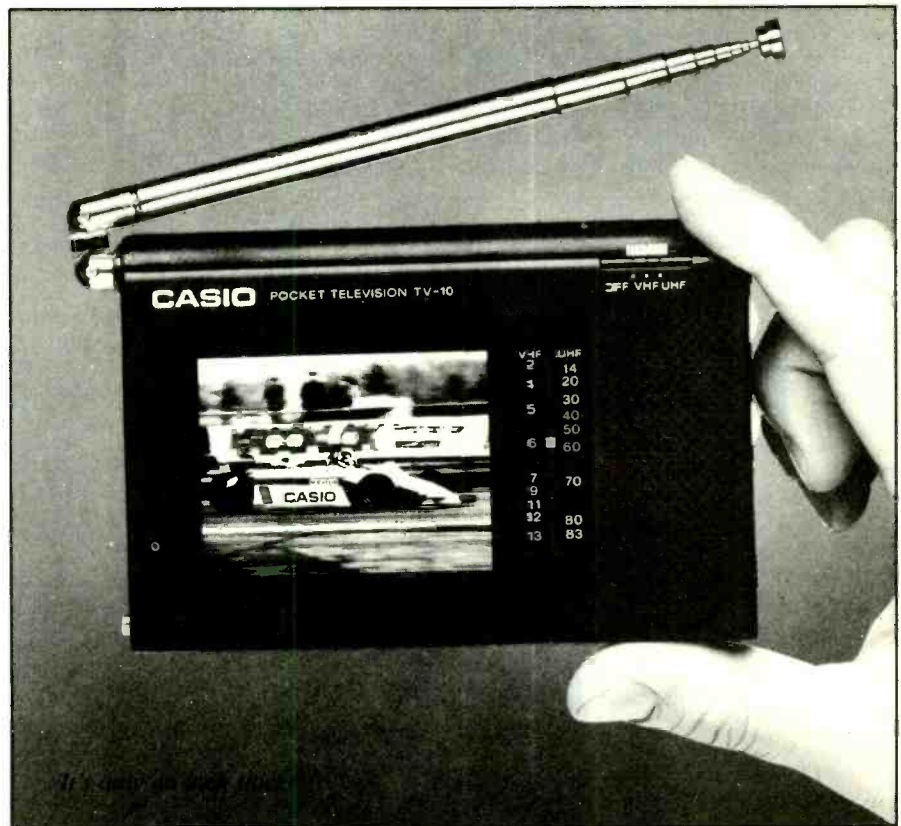

A whole new world of technology has made possible unbelievable picture quality on a TV set so compact it slips easily into your shirt-pocket.

Technically, it's **nematic liquid crystals** and **electroluminescence**. From your viewpoint, it's a sharp, brilliant black-and-white picture on every commercial channel, 2 to 83.

Outperforms Sony and Seiko

We didn't say we have the only miniaturized TV set; we said ours has the only **perfect picture**. Sony has a set for \$50 more, and Seiko has one for \$150 more, and in our opinion neither of them is within light-years of the picture quality ours has. Side by side, our set's picture, like our description, is absolutely clear.

We've picked up signals 75 miles and more away from a station, because the built-in antenna really grabs the signal. If you're near an antenna connection, in ten seconds you can connect the Casio Pocket TV to that antenna.

Watch and enjoy in complete privacy. We include an earphone jack. Plug it in and the speaker is bypassed; only you will hear the sound.

4-Way Power Supply System

Three tiny AA batteries will power this TV for hours and hours (power consumption is only one watt). Or use the rechargeable battery-pack, and after viewing, plug it in the wall to recharge overnight.

That isn't all. With an optional adapter you can plug the Casio Pocket TV into your car's cigarette lighter; it uses almost no power.

Or, with the optional AC adapter, you can watch TV forever with your set plugged directly into a wall outlet.

Sunlight or Pitch Dark - No Difference

Unlike old-fashioned conventional television sets that need a shadow-box in sunlight or a room light inside, the Casio Pocket TV delivers its perfect picture under any lighting conditions.

The picture is strong and easy to see even on the brightest sandy beach with the sun glaring right into the set. And it's equally clear in the dark.

An LCD brightness control guarantees perfect picture quality no matter where you are.

You Get All These

As "standard equipment" with your Casio Pocket TV, you'll get —

- test batteries (UM-3)
- earphone
- built-in VHF/UHF rod antenna
- wire antenna
- carrying strap and soft case

If you want the rechargeable battery-pack, the cigarette-lighter power adapter, or the AC power adapter, they're optional extras, but they aren't expensive.

Your Casio Pocket TV not only will be the talk of the neighborhood; you'll be able to watch your favorite shows no matter where you are.

WE ABSOLUTELY GUARANTEE!

Use your Casio Pocket TV for up to 30 days, entirely at our risk. If for any reason you decide not to keep it, return it for a 100% refund.

THIS HAS TO BE THE ELECTRONIC ENGINEERING ACHIEVEMENT OF THE DECADE!

The CASIO POCKET TV complete with test batteries, earphone, antenna, strap, and soft case **\$299.95** two for **\$275** each
Rechargeable Battery-Pack, **\$7.95**

Cigarette-lighter Power Adapter, **\$14.95**

AC Power Adapter, **\$14.95**

(+ \$3.80 per total order for shipping)

Order TOLL-FREE

For fast delivery on credit card orders call toll-free 24 hours a day, 7 days a week:

800-443-0100

Ask for Ext. 111

Or send check or money order. Please add indicated shipping cost.

The Casio Pocket TV is another electronic marvel from

NEW HORIZONS

Dept. CE9, 5-31 50th Avenue
Long Island City, NY 11101

© 1983 New Horizons

Circle No. 27 on Free Information Card

if his/her/its missile hits them.

You have two launch positions, top and bottom, and there are times when you may not be able to use one of these launchers. You may use your turn to rearrange the locations of your targets to provide the most advantageous strategy positioning. Figuring out those bounces (or ricochets) in advance can be very complex. The missile ball, projectile, or whatever travels totally free of friction

and can create some interesting and infuriating patterns before the turn is completed.

As long as the ball has something to hit, it will continue to ricochet. Each time it strikes a target, bumper or wall, it rebounds at a 45-degree angle and goes on to its next contact point. If there's nothing left to hit, it goes off the play field and the turn is over.

It's especially fascinating to watch

the strategy moves the computer makes when you're playing solo. You can't help but wonder what the computer knows that you don't.

There are a number of game variations and choices to make before starting the game. The computer keeps track of the scores and the matches played with unerring impartiality and accuracy, but it's awfully hard to figure out the scoring system itself. Rest assured, the computer won't cheat on this; but it plays an awfully tough game.

This is another of those super-intriguing games that can be habit forming. We've already seen an awful lot of sleep lost over it. So keep that coffee pot percolating. You'll need it.

THE NIGHTMARE

Diskette for Atari 400/800
Epyx (Automated Simulations, Inc.), 1043
Kies Ct., Sunnyvale, CA 94086; 408-
745-0700. \$29.95.

Graphics ★★★

Gameplay ★★★★

Sustained Interest ★★★★

Type: Joystick adventure/action game

Memory Required: 40K

We Made It Tick Now We've Made It Quick



Memotech now has instant access software for Timex-Sinclair computers. There's no loading problem nor waiting time to run Word Processing, Spreadsheet, Graphics Routines, or Assembly Language Software. That's because all Memotech software comes on EPROM cartridges. Simply plug the Memopak on the back of your Sinclair ZX81, Timex TS1000, or Timex TS1500 and you're up and running the most sophisticated software for your computer.

Memotext is a word processor with comprehensive editing features. If your need is spreadsheet analysis, Memocalc provides an extensive matrix for mathematical calculations and projections. And for learning assembly language, the Z80 Assembler allows you to write your programs in this language. Memotext, Memocalc, and the Z80 Assembler each sell for \$49.95. *

The HRG produces high resolution graphics (192 x 248 pixels). There are thirty built-in graphics subroutines which enables the user to work interactively at the dot, line, character, block and page levels. Priced at \$99.95 * inclusive.

Order at no risk (10 day money-back guarantee): Call 1-800-662-0949 (Colorado 1-303-986-1516). Or send your name, address, phone number and a check/money order/Visa or MasterCard number with expiration date to:

Memotech Direct Sales Division
7550 W. Yale Avenue, Denver, Colorado 80227

* Shipping/Handling \$4.95; Colorado Residents add applicable sales tax. Minimum 16K memory necessary to operate software.

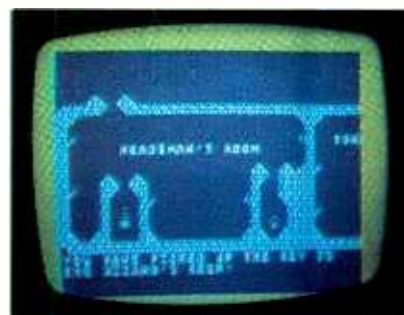

This one might well be called "Son of Escape from Vulcan's Isle" since it has a number of similarities to that earlier release from Epyx. As the player, you control the movements of a little man (or woman—it really has no gender) who runs around a castle trying to collect goodies and escape the various bad-dies who try to stop you.

Why is it called nightmare? The manufacturer says because it's so hard to tell reality from what could be simply a bad dream. But dreams should be made of more ethereal stuff; this game has definite characteristics, and urges you on to explore the many byways of the haunted castle while the computer scrolls merrily through one screen after another.

The instructions suggest that the first time you enter the haunted castle, you prepare a rough map to help you keep track of where things are. There are three floors plus a spooky dungeon to

explore, and when you bang into a wall or obstruction, there's a sharp clunking noise and the screen flashes the message, "Ouch!" But these bumps and bruises don't cost you points—just time and frustration over trying to negotiate a narrow passage.

You find yourself being pursued by the rat pack, the mistress, and the resident ghost—among others. You do battle with these creatures, and can kill them. It's just a little mind-boggling, though, to read a message such as, "You have killed the ghost." How can you kill a ghost?

This game is lots of fun, good for several evenings of engrossing adventure-type gaming, and best of all, you can save an unfinished game to resume at some future date. The program will only allow you to save *one* game, and the dyed-in-the-wool adventure gamer might find this just a bit constraining. The Nightmare is a good game, and we recommend it.

SUPER AMOK

Rom Cartridge for Commodore VIC-20 U.M.I. (United Microware, Inc.), 3503-C Temple Ave., Pomona, CA 91768; 714-594-1351. \$39.95

Graphics ***

Gameplay ****

Sustained Interest ****

Type: Joystick action game

Memory Required: Resident 3.5K RAM

If you remember U.M.I.'s earlier game, Amok, you'll recognize this one immediately. But it's much better in many ways. The original Amok—which somewhat resembles Atari's "Berzerk," was slower-moving, didn't have graphics as good as this later version, and the original was (and still is) on a cassette which can be super-slow getting loaded into the computer.

Because this is a ROM cartridge, you don't have to be too concerned about such niceties as memory expansion, and the like. Just plug it in and you're ready to go.

This joystick game can be played with one or two people—the latter made possible by the simple expedient of passing the single joystick back and forth between players. This method is needed because the VIC has just one joystick port, but it doesn't have to be a handicap.

Like its predecessor, the game makes you a little man in an uncomplicated maze, surrounded by angry robots who try to shoot you. You try to shoot them first. Then duck, because robots who shoot can miss you and their fire can hit and destroy other robots. They may

supposedly represent the pinnacle of technological achievement, but they're slow and dumb. Yet they can get in a lucky shot and zap you, so don't get overconfident. That's when other things start to happen.

Getting safely out of a screen starts you in the next screen and wave of robots, and they get harder as you go along. The robots move faster and you move slower, but you've got a pretty

good, fast set of legs and can get out of the way if you keep your wits and don't get flustered.

In general, Super Amok is a worthy successor to its predecessor, and the graphics seem to be much better. It's awfully hard to do a graphically excellent program for the VIC with its limited amount of memory and the very special way its ROM addresses the color video screen. ◇

The Direct Connection is Here . . .



... for your Timex-Sinclair computer. Memotech can now connect you to CompuServe with our new modem package. With this introductory offer you get a 300 Baud J-Car Modem by Novation, RS232 serial interface with built-in communications software and all connecting cables. PLUS, you get a CompuServe Demopak, password, I.D. and log on/off procedures for a free two hour demonstration of the CompuServe Information Service.

Memotech, the leader in add-on Timex products, introduces the modem package for only \$199.95 + \$6.95 shipping/handling. (Suggested value \$290.00).

Simply plug in our direct connect add-on products to the back of your Timex computer. The Memopak 16K sells for \$49.95*, 32K Memopak is \$99.95* and our best seller 64K Memopak is \$149.95*.

The Memotech keyboard is priced at \$99.95*. The Centronics parallel interface sells for \$74.95* including software, and the RS232 interfaces are \$99.95*. Printer packages are also low, low priced.

Order at no risk (10 day money-back guarantee); Call 1-800-662-0949 (Colorado 1-303-986-1516). Or send your name, address, phone number and a check/money order/Visa or MasterCard number with expiration date to:

Memotech Direct Sales Division
7550 W. Yale Avenue, Denver, Colorado 80227

* Shipping/Handling \$4.95. Colorado Residents add applicable sales tax.

LES SOLOMON ON COMPUTER HARDWARE



Finding Invisible Short Circuits in Digital Equipment

THERE are commercial test instruments for almost every type of electronic problem. However, as every computerist knows, there is one potential hardware problem for which there is no test instrument that can be of help.

This is the case where you are confronted by a pc board full of ICs, all soldered in, and the circuit does not work. The best that a logic probe, multimeter, logic analyzer, or scope can tell you is that a particular signal path is *kaput*. Unfortunately, you are left with some difficult decisions since none of these instruments can tell you whether it's the source IC that is not delivering an output, or if it's the IC (or one of the ICs) receiving the signal that has a short at its input, thus effectively removing the signal. All that these instruments can tell you is that there is no signal on a line that should have one. They cannot pin the blame (no pun intended).

Until this time, to hunt down this type of fault, you would have had to start unsoldering ICs, with the attendant possibility of damaging solder pads and slender foil traces. As you have probably found out by now, it does not take many solder/unsolder operations or very much soldering-iron heat to catastrophically destroy a foil pattern.

The short-hunter test circuit shown here can solve the problem of determining which IC is at fault, and there is no need to unsolder anything.

As an extra bonus, despite the fact that this novel instrument—for which there is no commercial counterpart—was originally designed for troubleshooting digital circuits, it can also be used to locate an inoperative IC or transistor in an analog circuit without unsoldering, junction testing, or otherwise removing the semiconductor from the

board. It works on the premise that, when a semiconductor is supplied with the proper operating power and input signal, and if the device draws no collector current, the likelihood is very good that the semiconductor is bad. Operation in this mode will be covered further along.

In almost all digital circuits, one IC usually drives one or more other ICs or transistors. When the driving IC is delivering a high and there is a short to ground at the input of one of the signal receiving devices, current will flow down the trace making the electrical connection between the two. However, a scope, logic probe, etc., will not show the presence of this current and, for all intents and purposes, will indicate that the line is "dead."

Since all conductors have some finite value of resistance, according to Ohm's Law, there will be a voltage gradient (though small in the case of low currents and a low-resistance path), between the current source and ground. If the source IC has failed, and will not deliver a high, then the line will still be dead, but there will be no voltage gradient.

What we need is a device that can respond to these minute voltages. Fortunately, this is the primary electrical property of a semiconductor device called an operational amplifier (op amp) whose differential inputs can respond to voltages down in the microvolt levels to cause the output to switch states depending on which of the differential inputs receives the higher voltage.

In the diagram, note that each differential input of the op amp is connected via a 10,000-ohm resistor to a color-coded probe, biased via 100,000-ohm resistors, with a centering network including a potentiometer provided for zeroing. This potentiometer is adjusted for a zero-type output when the two probes are shorted to each other. The output of the op amp is connected to a pair of inverters, each having a different colored

LED, and its associated-current limiting resistor connected at the outputs.

When you make up the probes, use sharp-tipped needles that can penetrate into the copper foil (or through insulation if point-to-point wiring is used in the circuit under test). Although only one inverter/LED combination is required for general-purpose troubleshooting, using two inverter/LED combinations allows you not only to find out which way current is flowing in a trace, but which end has the high polarity and which the low.

If the polarity of the voltage present at the red probe is higher than the voltage at the black probe, the RED-color LED glows. If the voltage at the black probe is higher than the voltage at the red probe, then the GREEN-color LED glows. These polarities can then be checked against the circuit schematic to make sure that they are correct.

Obviously, if the source IC is not delivering a high, the line being tested will not show a voltage gradient.

For testing analog circuits, insert the needle probes in the foil trace or lead feeding the collector of each transistor or the +V pin of each IC. If the operating power and the base signal are present, but no current flows, then that particular semiconductor should be suspect. Open ground connections to the IC or transistor can also be checked with the short hunter.

In a digital circuit, make sure that the clock is operating, then use the probe on each signal-carrying IC lead. If the signal source IC is good, then the short hunter will find the defective receiving IC. If the line is dead, then the source IC is not delivering a high.

You should experiment with tip spacing, and make tests on an operating board to get the "feel" of this new test device. Since no commercial equivalent is available, you can write your own manual on how to use the circuit. Drop me a line if you use this circuit for any unusual applications. ♦

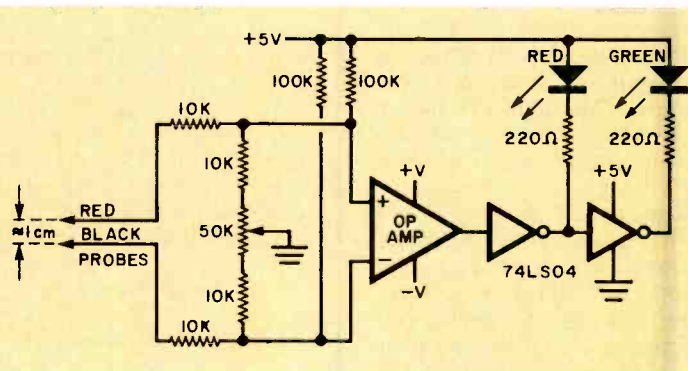

Hardware

Apple Modem. The Summa 300 is a single-slot, 300-baud, direct-connect modem for the Apple II and IIe computers. It contains the modem and communications circuitry on one card without the need for additional peripherals or software. It is also furnished with software that permits the screen image to be captured in the Apple Memory. \$119. Address: Zoom Telephonics, Inc., 207 South St., Boston, MA 02111.

IBM-PC Color Monitor. The RGB 12-inch color monitor for the IBM-PC will deliver 16 different colors using a special 31-mm dot pitch CRT that can produce 690 x 480 dots. Obviously, the monitor can be used with any type of video output from games to serious business applications. \$795. Address: Quadram Corp., 4357 Park Dr., Norcross, GA 30093 (404-923-6666).

Winchester Drive. The Hard Disk III is available as a 5M-byte (formatted) fixed or removable disk cartridge. It is also available in other configurations.



Adapters, which include hardware and software, are available for use with IBM-PC, IBM-XT, Apple II, Apple IIe, Franklin, TRS-80 Models I and III, LNW-80, and LNW-II. \$995. Address: VR Data, 777 Henderson Blvd., Folcroft, PA 19032.

Timex/Sinclair Expansion. The 32K-plus-I/O module adds four parallel I/O ports, and 32K bytes of RAM to the T1000 or ZX81 computers. When plugged into the rear apron connector, this module allows the use of external controls, A/D, temperature measurements, etc. \$155 plus \$4.95 shipping/handling. Address: Wisconsin Electronics, PO Box 332, Milton, WI 53563.

VIC-20 Memory Expander. The Ramex is a 27,648-byte switchable memory for the VIC-20 and has two ex-

tension connectors identical to the VIC Memory Expansion connector except for BLK-5. The memory is switchable in one 3K or three 8K sections. Also included are a reset switch, memory and connector safety fuse, operating manual, self-test program, and case. \$169. Romax Jr. with 19,456 bytes is \$139. Address: Apropos Technology, 350 Lantana Ave., Suite 821, Camarillo, CA 93010 (805-482-3604).

S-100 Weighing System. This load cell digitizing card is designed for S-100/IEEEE696 systems to enable weigh platforms, hoppers, and tank and truck scales to interface directly with compatible computers. The single-channel converter is compatible with all strain gauge transducers, providing excitation for up to eight 350-ohm bridges. In the high accuracy mode, 17-bit binary output is available four times per second

The Safe Video Head Cleaner is Dry.

Yes, dry!

The Discwasher® Video Head Cleaner is the only truly non-abrasive dry head cleaner on the market today.



Its superior cleaning action is the result of its textured fabric matrix, not the result of abrasive properties (like those often utilized in aluminum oxide cleaners). This exclusive matrix safely cleans not only the video heads, but the audio and sync heads as well.

This graph represents approximate hardness ratings of individual VCR components and various tapes and cleaners using the Temper scale, developed by industry to measure materials. A diamond, one of the hardest materials known, rates T-10.

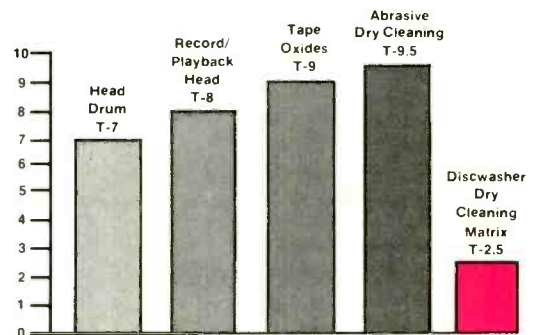

The Discwasher Video Head Cleaner is less abrasive than both the video head and video drum. In fact, it's even less abrasive than video tapes themselves.

And best of all ... it works. Easily, safely, and quickly.

For your free copy of "Guide to Video Care", write:

discwasher

1407 NORTH PROVIDENCE ROAD, P.O. BOX 6021, DEPT. CE, COLUMBIA, MO 65205 USA
A DIVISION OF JENSEN an ESMARK Company

while at 15 conversations per second, 15 bits are available, plus sign and overload. Accuracy is 0.01 percent. A programmable damping filter is provided to reduce vibration effects. \$495. **Address:** Scalar Electronix (1982) Inc., PO Box 0863, Champlain, NY 12919-083 (514-634-7026).

Apple Clock. The "dat-a-clock" is fully compatible with all versions of the Apple II. It maintains date, month, and year capability and its EPROM is accessible. An on-board battery ensures a two to three-year life. \$85 assembled and \$55 in kit form plus \$2 shipping/handling. **Address:** P&B Research Consultants, 231 East Grand Blvd., Detroit, MI 48207 (313-259-5951).

VIC Numerica Keypad. The Keypad for the Commodore VIC-20/64 comes as standard or hexadecimal. The 24-key keypad connects to the computer via a ribbon cable. The standard unit contains 0-9, +, -, *, /, shift, period, comma, colon, semicolon, space, delete, cursor down, cursor right, and return. The hexadecimal version contains 0-9, A-F, shift, period, comma, space, delete, cursor down, cursor right, and return. \$79.95. **Address:** Home Computer Corp., 154 Heard Rd., Kathleen, GA 31047 (912-987-0235).

Half-High Winchester. The Space Saver hard disk systems for the Apple and IBM-PC are available as fixed or removable cartridge systems. They are 2¼" high, 5¼" wide, 9½" deep and weigh five pounds. They feature dynamic volume allocation (DVA) for the Apple allowing one or 65K volumes. DOS volumes can be allocated as large as 400K bytes. The user can define the volume size. For the IBM-PC, the device is hardware compatible with the IBM hard file products and operates transparently with IBM-PC DOS 2.0. The fixed system is \$995 without controller, while the cartridge is \$1325 without controller. For the IBM, the controller is \$450. **Address:** Mountain Computer Inc., 300 El Pueblo Rd., Scotts Valley, CA 95066 (408-438-6650).

IBM-PC Speech. The PC-Mate Speech Master hardware and software provide synthetic voice output, text-to-speech conversions, and expanded native vocabulary while occupying a single slot. The Speech master provides two forms of speech synthesis: high-quality with a limited ROM-based vocabulary, and a lower-quality unlimited vocabulary using phonemes. The software operates

under PC DOS 1.10 and contains two programs—English that provides for text-to-speech conversion, and Speak which sends screen output to the speech synthesizer for simultaneous spoken output. The Speech Master board is \$395, and the Speech Master software support package is \$95. A Speech Master Auxiliary Vocabulary Unit is \$100. **Address:** Tecmar Inc., Personal Computer Products Div., 23600 Mercantile Rd., Cleveland, OH 44122 (216-464-7410).

Software

Plotting Package. The Prime Plotter is a comprehensive plotting package for business, technical, and scientific applications. Features include data management, statistical analysis, X-Y plotting, pie charts, graphics, and slide show/replay. Users can perform trend analysis and curve fit regressions on data

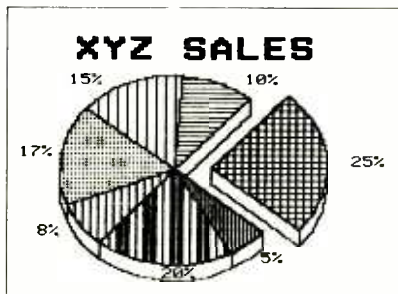

files. Then the data, fit, or any function/mathematical subroutine can be plotted. Screens can be saved or printed using a graphic printer interface such as the Grappler or Pkaso. Three disks come with the package: a master, a replay, and a user. \$240. **Address:** Primesoft Corp., PO Box 40, Cabin John, MD 20818 (301-229-4229).

Cribbage Player. Cribbage Master II features card graphics on the TRS-80 screen with the player's cards moving from his "hand" to the "table". All rules are observed, and although the program may make a mistake in playing, it never makes errors in counting hand or crib points. Some scoring is automatic, but pegging is up to the player. Score is kept on screen. For TRS-80 Model I and III disk systems. \$21.95. **Address:** Manhattan Software, PO Box 1063, Woodland Hills, CA 91365 (213-453-6943).

CP/M Communications. MITE allows CP/M based machines to appear

as intelligent data terminals for on-line services such as CompuServe or the Source. It also enables the computer to be used as a Western Union TWX or Telex terminal. The menu driven program supports many different protocols and provides full modem control with auto logon if required. Files can be transferred between any two CP/M computers with error checking. Pre-installed versions are available for most computers and installation is easy with other types of computer systems. \$150. **Address:** Wordmovers Inc., 15818 Hawthorne Blvd., Lawndale, CA 90260 (213-542-7351).

Commodore Inventory Manager. The Inventory Manager transforms any Commodore 64 or VIC-20 with Data 20 16K Video Pak into an inventory management system. It has a capacity of 2500 separate files with 99,999 items per file. The menu driven software offers sales posting, edit update, display, inventory, inventory master listing, daily and monthly sales listings, selected field listings (over 1000 vendor codes per vendor report, re-stocking reports, department classification reports, sales analysis reports, etc. Two back-up routines that allow saving data files on tape and restore disk from tape are also provided. \$99.95. **Address:** Electronic Strategies Inc., 23012 Del Lago, Laguna Hills, CA 92653 (714-770-3246).

Apple Children's Trainer. MATH FACTS LEVEL 1 is a self-paced instructional program for children from 4 to 7. It uses color drawings and large numbers and letters to teach the fundamental concepts of math. The program is formed from 16 units covering numbers from 1 to 20, number placement, number words, and addition and subtraction both with and without symbols. It also features a sound-off option for silent viewing in a classroom. Disk version is \$25 (DOS 3.2 or 3.3). **Address:** THESIS, PO Box 147-M, Garden City, MI 48135 (313-595-4722).

IBM-PC Management Utility. The Sales Manager is a professional management information tool for executives in sales, marketing, and general business. It handles the tracking and reporting for Customers, Prospects, Sales Representatives, Quota, Commissions, Planning, Forecasting, Expenses, Sales Analysis, and Personnel. It is menu driven and requires 128K of RAM. \$450. **Address:** Market Power, 11780 Rough & Ready Rd., Rough & Ready, CA 95975 (916-432-1200). ◇



LAST NIGHT, 39 MUSICIANS HAD A COMPUERVE CONFERENCE, SO DID 31 M.D.S, 49 SPORTS FANS AND 640 APPLE POLISHERS, AND NO ONE HAD TO LEAVE HOME.

The Electronic Forum, Cheaper than Long Distance and Much More Rewarding.

Every night on the CompuServe Information Service, professional and social groups discuss a wide range of subjects. From what's new in medical technology to what's nouvelle in continental cuisine.

And every day more computer owners who share a common interest are discovering this exciting new way to exchange ideas and even transfer hard copy data.

And besides electronic forums, they leave messages for each other on our national bulletin board, "talk" informally on our CB simulator, and communicate via CompuServe's electronic mail.

But best of all, in most cases, CompuServe subscribers get all of these state of the art communications options, plus a world of on-line information and entertainment for the cost of a local phone call plus connect time.

To become part of this flexible communications network, all you

need is a computer, a modem and CompuServe. CompuServe connects with almost any personal computer, terminal, or communicating word processor.

To receive an illustrated guide to CompuServe and learn how you can subscribe, contact or call:

CompuServe

Consumer Information Service, P.O. Box 20212
5000 Arlington Centre Blvd., Columbus, OH 43220

800-848-8199

In Ohio call 614-457-0802

Circle No. 60 on Free Information Card

An H&R Block Company

How to quickly re

If you'd like to turn the agony of small business bookkeeping into the ecstasy of total control, you've come to the right place.

Because even if you're starting with a shoe box full of invoices or a pile of checks hiding under a pile of deposit slips, we can tell you how to centralize, organize and monitor all that information, and manipulate it in ways that will make your business a

pleasure — all with an Apple® III Personal Computer.

Attain instant financial status.

An Apple III, teamed with the BPI General Accounting Package, can put every basic accounting function right at your fingertips.

Technically, that means

General Ledger, Accounts Payable, Accounts Receivable and Payroll — all in one package.

Meaningfully, that means you can turn numbers into answers.

With BPI, your Apple III can give you a snapshot of your company's financial condition,

an up-to-the-instant balance sheet. It

can also generate instant and detailed reports



gain your balance.

on your customers and vendors.

So you know who owes whom, how much, and how come.

And just how well your cash flow is flowing.

And where to give credit where credit is due (a customer inquiry

The BPI General Accounting Package also lets your income statements be coded by location, department or product line. So you know where your money's coming from.

And where it's not.

results will make an important statement to everyone you deal with—including your banker.

More ways Apples pay.

There are more people in more places doing more things with

Ichiban Fish Supply Company Consolidated Income Statement Current Comparative Periods Ending May 31, 1983 and May 31, 1982					
	May 31, 1983	%	May 31, 1982	%	
Income					
Contract Sales	52,818.82	91.3	44,176.52	92.7	
Retail Sales	3,816.08	8.7	3,569.88	7.3	
Total Income	57,634.90	100.0	47,746.40	100.0	
Cost of Sales					
Cost of Contract Sales	37,338.88	64.6	31,886.55	66.7	
Cost of Retail Sales	4,875.85	8.4	3,489.35	7.2	
Total Cost of Sales	42,214.73	73.0	35,375.90	73.9	
Gross Profit	15,420.17	27.0	12,370.50	26.1	

Ichiban Fish Supply Company Merchandise Purchased By Due Date As Of 05/31/83					
Date	Vendor No Name	Invoice Number	Acct No	Detail	Net Amt
05/02/83	1 Herring World Due 06/03/83	35278572	5010-01		501.23
05/05/83	2 Consolidated Cod Due 06/05/83	4562	5010-01		289.36
05/05/83	3 Lewy Sushi Fare Due 06/05/83	212	5010-01		459.00
05/05/83	4 Mussel Men, Inc Due 06/05/83	657	5010-01		68.26
	Total				1,237.85

Ichiban Fish Supply Company Accounts Receivable Ledger Page 1				
Customer No Name	FCIAO	Balance Forward	Current Month	Balance
1 Moser's Sole Food		892.75		
Invoice 1124			212.23	
Invoice 1159			156.62	
Invoice 1386			828.00	
05/15/83	5010-01		758.00	
				1,831.58

Your Apple can generate instant income statements (with expense ratios) or balance sheets, and let you compare them to last month's or year's, then print them out to suit your banker.

It can also allow you to take full advantage of merchandise discounts. So you'll know whom to pay, when to pay, how much to pay—and save a lot of jams in the process.

To avoid fishy transactions, you can instantly display customer's payments, charges and current balance. In this case, a few more cans of tuna would put Mr. Moser over his \$2,000 limit.

feature allows you to make credit decisions based on the most current information).

You can also list your purchases by discount dates. And take advantage of them in no uncertain net terms. You can even keep payroll records without paying more, because it's part of the same package.

Make a timely statement.

Add an Apple Dot Matrix or Daisywheel printer to your Apple III, and you can print out your entire balance sheet in minutes.

Or any number of reports, from cash receipts to payroll ledger to income. You can even print checks and customer statements.

The impressively professional

Apples than with any other personal computer in the world.

Because for one thing, there's more software for Apples than for any other personal computer in the world. So the same Apple that handles all your accounting needs can also handle financial spreadsheets, word processing and electronic filing.

You'll also find programs that are designed specifically for your kind of business. Be it dentistry, architecture or swine herding.

Of course, the best way to learn all the ways Apples can help you make better business decisions is to visit any one of over 1500 authorized Apple dealers.

So drop in. For a full account.

Profit from history.

In business as in life, experience is the best teacher. And the Apple/BPI system can provide you with instant comparisons of this-month-this-year vs. this-month-last-year, or this-year-to-date vs. last-year-to-date.

So you can quickly spot changing expense ratios and make decisions with 20/20 foresight.



Call (800) 538-9696 for the location of the authorized Apple dealer nearest you, or for information regarding our National Account Program. In Canada, call (800) 268-7796 or (800) 268-7637. Or write Apple Computer Inc., Advertising and Promotion Dept., 20525 Mariani Ave., Cupertino, CA 95014. © 1983 Apple Computer Inc.

Circle No. 35 on Free Information Card

A NEW BREED OF COMPUTER PRODUCTS

Manufacturers unveiled a host of new computers and related products at recent industry shows

By Joe Desposito

THERE'S a strange phenomenon that occurs at industry computer shows. As you walk up and down the aisles peering at a myriad of new products on display, some of them stop you in your tracks and compel you to investigate more closely. I call them the "eyepoppers"—a select group of products that generate real excitement at first glance.

Here are the ones I've seen at a host of recent shows that stretched from March to date. Most are just coming to market.

Computers

It's been said that Italians talk with their hands, so when I heard that you could "talk" to the Gavilan Computer in this manner, naturally I was interested. And sure enough, when Manny Fernandez, President of Gavilan Computer Corp., displayed his new machine, he held his hand in the air and said, "I am now going to choose an item from the menu." He placed his pointer finger on an area of the computer just above the keyboard, swirled it around, tapped the area, and a word processing program appeared on the screen. This "touchpad," controlled by Intel's 8051 computer on a chip, can be used to move a cursor around the screen and operate in a fashion similar to an electronic mouse.

But that's not all Manny did. He also took a 3" disk and, with a sleight of hand that rivaled a magician's, made the disk disappear into the side of the machine. Now this Gavilan computer is not very big. It's so small, in fact, that it easily fits inside a briefcase. So where did you put the disk, Manny? It seems

that there's a 3" disk drive built into this computer.

The screen display is also very intriguing. It had first appeared when Manny pulled at the top of his rather small computer package. Resting on an angle, this small LCD screen displayed 8 lines and more characters per line than I could immediately count (66 it turns out). With a tap of his finger on the touchpad, superb graphics were displayed. The Gavilan computer is truly a breakthrough in computer design.

Besides the touchpad, built-in drive, and LCD display, there is a printer (optional) that plugs right into the back of the computer. It adds just 4.9" to the Gavilan's 11.4" length and only 5 lb to its 9 lb weight.

The Gavilan uses an 8088 microprocessor and supports MS/DOS as well as its own operating system. Included standard with the computer is proprietary, integrated, multifunctional software with windowing capabilities. Software is available on plug-in cartridges called CapsuleWare™. The packages include CapsuleWord, CapsuleCalc, CapsuleOffice, CapsuleComm (communications and mail system), and CapsuleForm.

Other features of the Gavilan are a full typewriter keyboard and ten-key pad, built-in 300-baud direct-connect modem, 48K ROM, 32K RAM (expandable to 336K), video interface, I/O bus, rechargeable batteries (that operate for up to eight hours), and an ac adapter and quick recharger. Suggested retail price of the Gavilan is \$4000.

The Sharp PC-5000 is another briefcase-sized computer with outstanding



features. In particular, the computer comes with 128K of bubble memory. That's right, bubble memory is alive and well. The volatile memory can be used for storage in the same way as a disk drive. Besides the standard bubble memory, Sharp is planning to develop applications software on small bubble cartridges that can fit into one's pocket.

But like Lawrence Welk on a Saturday night, the PC-5000's whole show doesn't depend on bubbles. Exciting features abound in this portable. First there is an eight-line by 80-character liquid crystal display panel that folds flat over a typewriter-style keyboard when the computer is not in use. In the

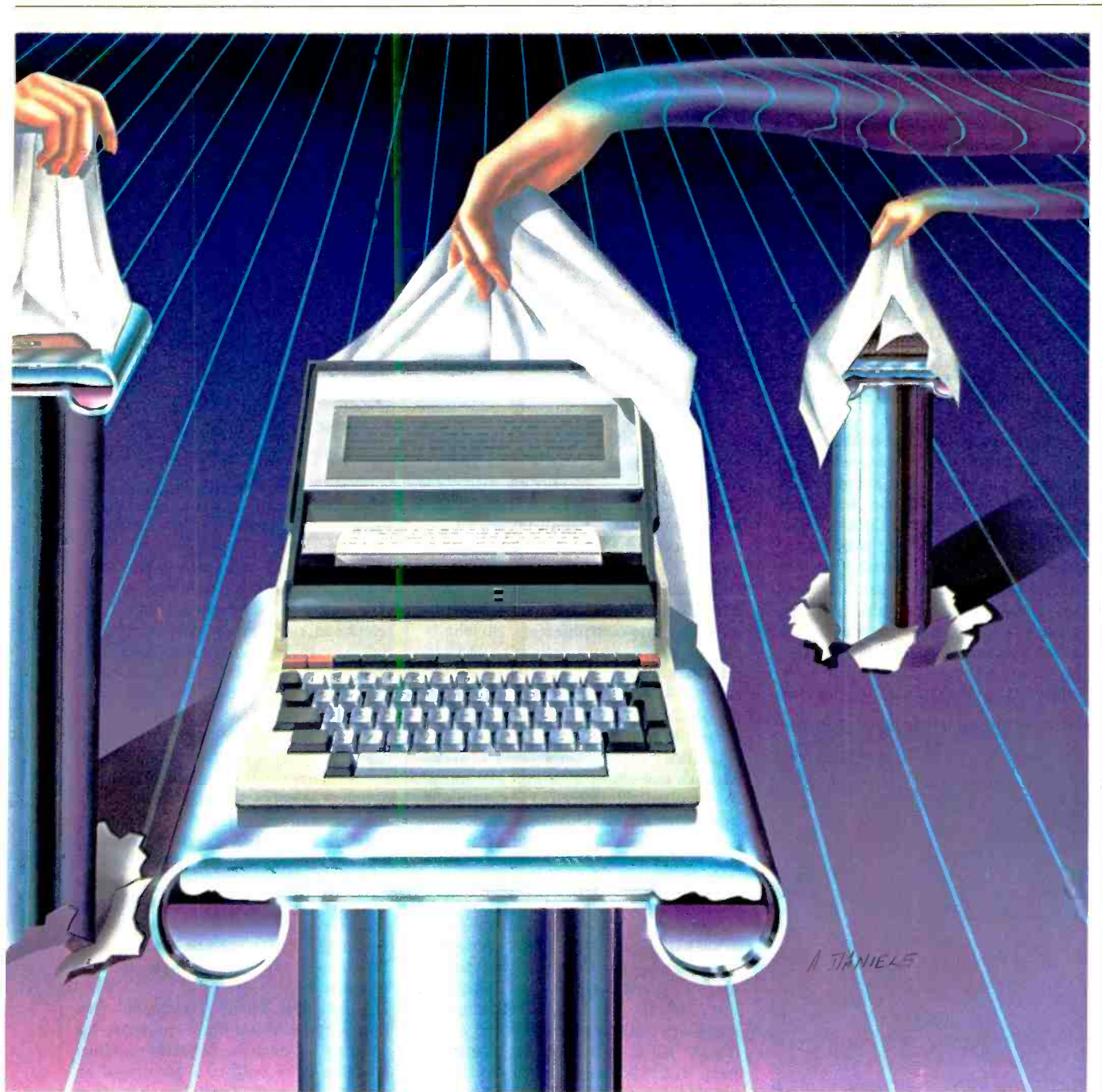

“A select group of ‘eyepoppers’ that generate excitement at first glance”

graphics mode, the display is 640 × 80 or 51,200 pixels.

Secondly, there is an optional printer available that plugs right into the back of the unit. The printer is a high-density dot-matrix thermal impact printer that uses thermal paper. However, a carbon ribbon can be inserted if you want to print on bond paper. Print speed is 37 characters per second.

Finally, an optional modem is available, which is both an attractive and

functional addition to the computer. Besides using it as a modem, it can be an auto-dial phone and calculator keypad, too! It has a built-in speaker and microphone for two-way conference calling, and can store up to ten numbers. Of course, when used with communications software, it can store many more numbers. The calculator keypad doubles as a pushbutton dialer and a numeric keypad for data entry into the computer. The modem can be stored right in

the case of the computer so that it adds nothing to overall size.

The PC-5000 uses an 8088 micro-processor and comes standard with 128K RAM (expandable to 256K). Also standard are word-processor and communications software. The computer weighs 11 lb and operates from a rechargeable battery that will run it for about 8 hr. (An ac adaptor is also supplied.) If needed, a 5¼" dual-head disk drive is available as an option. Target price is \$2500.

There's not a computer on the market that can be all things to all people, although the next machine goes as far to that end as anything I've ever seen. Apt-

...NEW BREED

ly named the Chameleon, it supports the two most popular operating systems in the 8-bit and 16-bit markets, namely CP/M-80 and MS-DOS. More the size of a suitcase than a briefcase, this transportable comes standard with 128K of RAM, dual 5 1/4" drives, a 9" green-phosphor display, one serial (RS-232) and one parallel port, an IBM-PC-compatible keyboard, and 320 x 200 color graphics capability. Software included with the unit are Perfect Writer and Perfect Calc. The Chameleon is manufactured by the Sequa Computer Corporation and has a suggested retail price of \$1995.

Lest you come to the conclusion that the only exciting new computers are portables, let me tell you about Adam. Adam is not just a computer, but a family computer system from ColecoVision. Standard features are an 80K RAM computer, a built-in digital data pak drive, whose plug-ins are said to have a data transfer rate comparable to a floppy disc's and can save up to 250 typewritten text pages. A full-travel 72-key plus numeric keypad keyboard, a letter-quality 10-cps daisywheel printer, two



Fig. 1. Caere type styles.

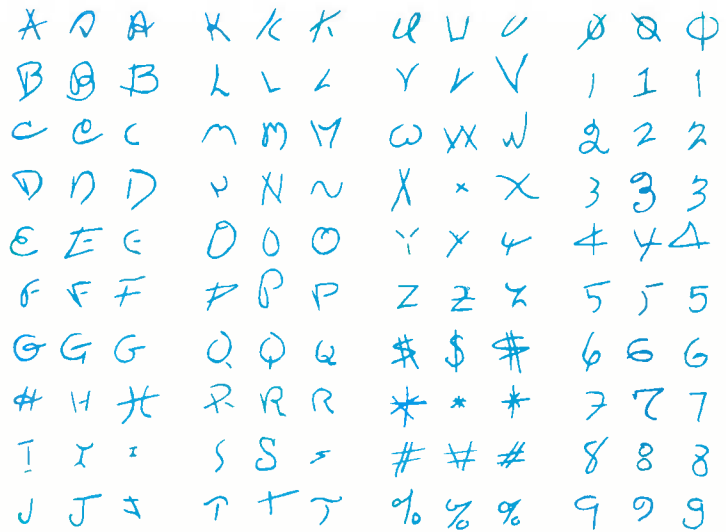

Fig. 2. Pencept recognizes a wide variety of characters.

game controllers, a built-in word processor called SmartWriter, Smart-BASIC (which is Applesoft source-code compatible), and the Buck Rogers Planet of Zoom video game that plugs into Adam's game cartridge slot. "So what's the big deal?" you might ask. The big deal here is price. Only \$599 suggested retail!!! Why, up until now, a low-cost daisywheel by itself cost that much.

And there's more! So that you can play those super games from ColecoVision's game player, Adam has something called the ColecoVision graphics operating system. This is not to be confused with the CP/M operating system that Adam is compatible with.

Furthermore, Adam comes up as a word processor. The display is 36 x 24, but an 80 x 24 "window" mode is also available. The SmartWriter program makes heavy use of graphics so that a user can easily learn how to operate it. For example, one of the screens shows a typewriter roller near the bottom and a margin guide at the top. As you type, your words scroll up from the roller, just as they would on a typewriter.

Software

Have you ever wished for a software package that you could use on your machine without having to read a lengthy manual first? Better yet, what if you couldn't speak or read English, but wanted to do word processing in your native tongue? Well someone out there is thinking about you. Commodore has introduced a software series called the Magic Desk. Magic Desk does not use words to convey ideas. Instead it uses graphic symbols (icons) exclusively. It's similar to using a cigarette with a line

through it to convey a "no smoking" message.

When the software is run, a picture of a desk with various items on it fills the screen. There is a typewriter, index file, telephone, calculator and financial journal. Alongside the desk is a file cabinet with an artist's easel and digital clock on top of it. Under the desk is a trashbasket.

To operate the program, an external device such as a joystick, trackball, or mouse is used to move a pointing finger to one of the objects on the screen. That object is selected by pressing a button on the device. If you choose the typewriter, a picture of a typewriter roller appears on the screen, and you may begin typing. As you type, the paper scrolls up, just as in a typewriter. The control device (joystick, etc.) can be used to move the paper up and down in the typewriter.

If you want to file a document, you return to the Magic Desk and move the pointing finger to the file cabinet. When you press the button, a picture of an open file cabinet appears on the screen complete with file folders. There is even a sound produced as you riffle through the stack of folders. There are three file drawers, with 10 files in each drawer and 10 pages in each file.

Although used with a disk drive, the Magic Desk will be sold as a plug-in cartridge for the Commodore 64. The first cartridge in the series will be entitled Magic Desk—Type and File with a suggested retail price of \$100. Other titles will also be available for Magic Desk at a similar price.

In a software breakthrough for small business and professional use, Quarterdeck announced the first multiwindow operating environment to integrate applications packages from different pub-

Radio Shack's Pocket Computers -Have One To Go!

TRS-80® PC-2
19995
26-3601



TRS-80 PC-4
6995
26-3650



TRS-80 PC-3
9995
26-3590

TRS-80 PC-2. A hand-held computer with power and speed that rivals many desktop micros, yet measures just $1\frac{1}{16} \times 7\frac{1}{16} \times 3\frac{3}{8}$ ". Ideal for engineers, business people, scientists— anyone with tough problems to solve on the go! Programmable in Extended Pocket BASIC. Fully-addressable 7×156 dot-matrix LCD for graphics, plus upper and lower case characters. Expandable 2640-byte memory. Add the PC-2 Printer/Plotter/Dual Cassette Interface (26-3605, \$219.95) to create spectacular four-color charts and graphs or to use our library of ready-to-run software.

TRS-80 PC-3. Perfect for students. The PC-3 is easily programmable in Pocket BASIC, and features 16 arithmetic and 8 string functions, 1.4K memory, 24-character display, two-digit exponents, multiple statements, arrays

and more. $\frac{3}{8} \times 5\frac{5}{16} \times 2\frac{3}{4}$ ". Add our Printer/Cassette Interface (26-3591, \$119.95) and choose from our large library of programs.

TRS-80 PC-4. Our lowest-priced pocket computer ever! Keep up to ten short programs in memory and enter BASIC commands with just two keystrokes. Features expandable 544-character memory and 12-character display (scrolls to 62 characters). Just $\frac{3}{8} \times 6\frac{1}{2} \times 2\frac{3}{4}$ ". Expand with the Cassette Interface (26-3651, \$39.95) and Printer (26-3652, \$79.95).

TRS-80 Computers Are Available Nationwide. Drop by any Radio Shack Computer Center, participating store or dealer and pick up your own TRS-80 Pocket Computer today.

Radio Shack®
The biggest name in little computers®
A DIVISION OF TANDY CORPORATION

Send me your free TRS-80 Computer Catalog today!

Mail To: Radio Shack, Dept. 84-A-675
300 One Tandy Center, Fort Worth, Texas 76102

NAME _____
ADDRESS _____
CITY _____ STATE _____ ZIP _____
TELEPHONE _____

Prices apply at participating Radio Shack stores and dealers.

At CIE, you get electronics career training from specialists.



If you're interested in learning how to fix air conditioning, service cars or install heating systems— talk to some other school. But if you're serious about electronics... even earning an Associate Degree... come to CIE — The Electronics Specialists.

Why trust your education and career future to anything less than a specialist?

You shouldn't. And you certainly don't have to.

If you talked to some of our graduates, chances are you'd find a lot of them shopped around for their training. They pretty much knew what was available. And they picked CIE as number one.

Be sure to shop around. Because, frankly, CIE isn't for everyone.

There are other options for the hobbyist. If you're the ambitious type—with serious career goals in electronics—take a close look at what we've planned for you at CIE. **What you should look for first.**

Part of what makes electronics so interesting is it's based on scientific discoveries—on ideas! So the first thing to look for is a program that starts with ideas and builds on them!

That's what happens with CIE's Auto-Programmed® Lessons. Each lesson takes one or two principles and helps you master them—before you start using them!

How practical is the training?

This is the next big important question. After all, your career will be built on what you can do—and on how well you do it.

Here are ways some of CIE's career courses help you get your "hands-on" training...

With CIE's Personal Training Laboratory...

you learn and review the basics—perform dozens of experiments. Plus, you use a 3-in-1 precision Multimeter to learn testing, checking, analyzing!

When you get your own 5MHz, solid-state oscilloscope, you take some real professional steps. You use it as a doctor uses an X-ray machine—to "read" waveform patterns...lock them in...study, understand and interpret them!

When you get your Digital Learning Laboratory, you'll

be into digital theory—essential training today for anyone who wants to keep pace with the state of the art of electronics. With CIE's Digital Lab, you'll be applying in dozens of fascinating ways the theory you've learned. For example, you'll compare analog and digital devices. You'll learn to make binary to decimal conversions and to work with semiconductor devices and circuits. You'll see how digital equipment is vital to today's exciting, growing fields such as security... where digital theory provides the brains for space-age alarm and protective devices.

You'll build your Microprocessor Training Laboratory, a working microcomputer—from "scratch." You'll also learn how to program and interface it with displays, memories, switches, and more.

Earn An Associate Degree from CIE.

One of the best credentials you can have in electronics—or any other career field—is a college degree. That's why CIE gives you the opportunity to earn an Associate in Applied Science

in Electronics Engineering Technology. Any CIE career course can offer you credit toward the degree...more than half of the number needed in some cases.

You can also prepare for the government-administered FCC (Federal Communications Commission) Radiotelephone License, General Class. It can be a real mark in your favor... government-certified proof of your specific knowledge and skills.

Shop around...but send for CIE's free school catalog first!

Mail the card. If it's gone, cut out and mail the coupon. If you prefer to write, mention the name and date of this magazine. We'll send you a copy of CIE's FREE school catalog—plus a complete package of independent home study information! For your convenience, we'll try to have a representative contact you to answer your questions.

Mail the card or coupon—or write: CIE, 1776 East 17th St., Cleveland, OH 44114.

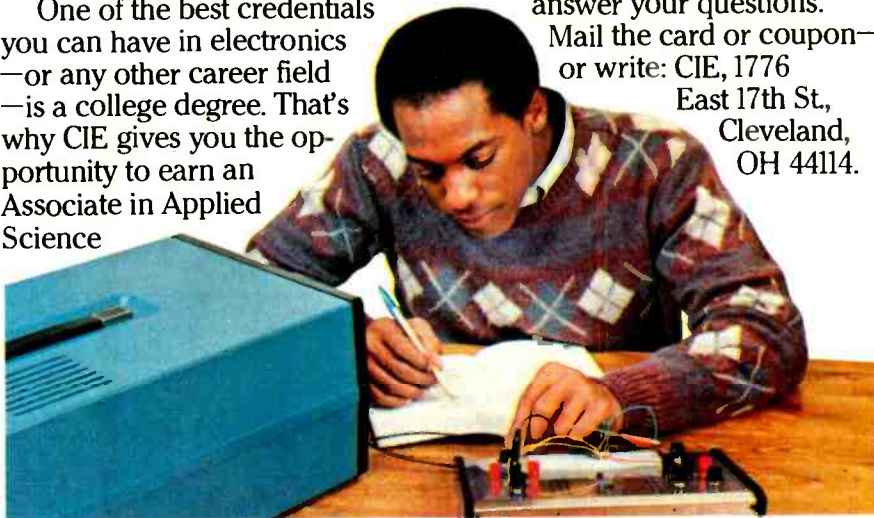

CIE Cleveland Institute of Electronics, Inc.

1776 East 17th Street, Cleveland, Ohio 44114

Accredited Member National Home Study Council

YES... I'm shopping around for the right kind of career training in electronics—and CIE sounds well worth looking into. Please send me my FREE CIE school catalog—including details about the Associate Degree program—plus my FREE package of home study information!

Print Name _____

Address _____ Apt. _____

City _____ State _____ Zip _____

Age _____ Area Code/Phone No. _____ / _____

Check box for G.I. Bill information: Veteran Active Duty

MAIL TODAY!

PE-94

lishers. Named DesQ™, the software package is designed for end-users, software developers, and systems integrators who want to upgrade personal computers into integrated, multi-windowing systems. DesQ, which is based on Quarterdeck's proprietary artificial intelligence-like development language, can be used with packages such as WordStar and dBase II. Several programs can be run at the same time, each in its own window on the video display.

The windowing feature enables a user to mark information in one window and then transfer it to another. For example, a user might mark a column of numbers in a MultiPlan spreadsheet and then transfer it to a specific place in WordStar monthly status report. The software can operate effectively with either a keypad or a mouse. The package is available for the IBM-PC with 256K of RAM, one floppy disk drive, one five-megabyte Winchester, and either a color or monochrome display.

Peripherals

Besides new computers and software, a flock of new peripherals made their debuts at the recent industry shows. Most of those that attracted my attention could be classified as alternate input devices. Alternate input devices were shown that used light, touch, and voice to enter data into a computer.

The Caere (pronounced like "care") Corporation manufactures an optical character reader (OCR) that reads the typefaces found on many familiar items such as electric bills and automobile licenses. Examples of the typestyles are shown in Fig. 1. The Caere OCR system is made up of two parts: the base control unit and either a handheld wand or slot reader. Both the wand and slot reader use a light-sensing photo diode array to "read" information and convert it into electronic impulses that are sent to the control unit. The information is then digitized and "recognized." The OCR devices are available for the IBM PC and Apple III. The Series 500 model for the PC uses a handheld wand and has a suggested retail price of \$1145.

If you're one who enjoys letting your fingers do the walking (or inputting in this case), you'll be interested in the Point-1 Monitor from MicroTouch. The Point-1 has an integrated touch-

At right, Gavilan's integrated touch panel.

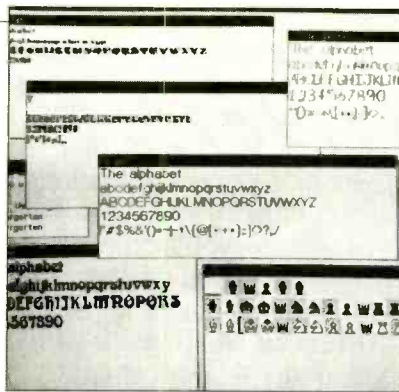

Multiple windows on Diser's Modula Computer.

sensitive screen that allows direct interaction with the computer by simply touching the display screen. For example, if you wish to make a menu selection, you just touch the number on the screen and the item is selected. The monochrome monitor comes in either amber or green and is priced at \$1295.

A less expensive fingertip input device is the Koalapad Touch Tablet. Available for the Apple II line, IBM-PC, Commodore-64 and VIC-20, and the Atari line of computers, its suggested retail price is \$125 including graphics software. The Koalapad has a 4" square drawing surface that's simple to use.

You just rub your finger along the pad and the drawing is displayed on the video screen. If you think this product is similar to the little device that's used on the Gavilan computer discussed earlier, you're right. The inventor of the Koalapad, Dr. David Thornberg, told me that Koala Technologies licensed the touchpad technology to Gavilan.

Another input device that responds to pressure (but with a pen) is Pencept, a product that accepts hand-printed information, for input into a computer. Using dynamic character recognition (DCR) techniques, Pencept allows you to fill out a form by hand and automatically enters the data into the computer. For example, a person in telephone sales could take information over the phone by hand, and Pencept would decipher the handwriting and send the information to the computer. You don't have to print perfectly either, as the Pencept's DCR techniques, can recognize a wide variety of character shapes (Fig. 2).

If you're not into OCR or DCR, and feel that you've lost the touch, you might be interested in talking your way into the computer. VoiceDrive by SuperSoft gives you the opportunity to

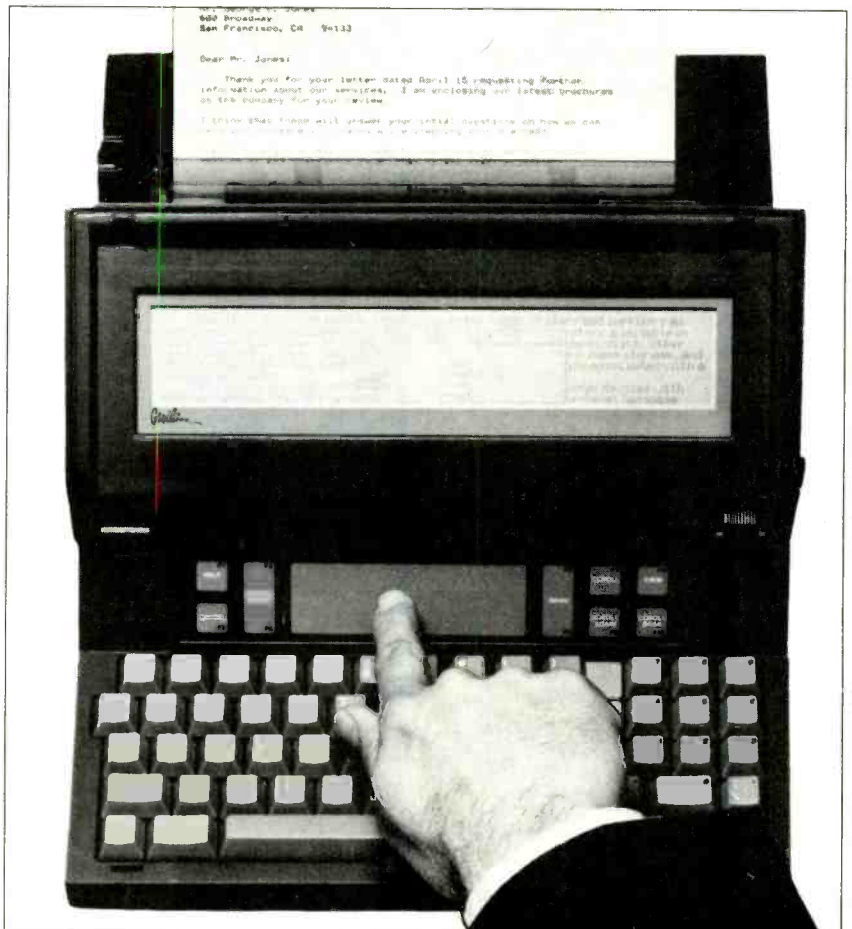



Shown above is Caere's new wand reader, which is compatible with the IBM PC.

The Sharp briefcase-sized PC-5000 (right) has 128K of bubble memory.

do this! VoiceDrive is a speech recognition software interface that's compatible with ScratchPad, a financial spreadsheet package from SuperSoft. To use VoiceDrive you need the Tecmar voice recognition card and an IBM PC. But you're not constrained to voice input since both keyboard and speech can be intermixed at the discretion of the user. SuperSoft plans to market more application packages in coming months, all utilizing the VoiceDrive software interface. Price of ScratchPad with VoiceDrive is \$495. (Bundled with the Tecmar board, it's \$995.)

Not all eye-popping peripherals were alternate input devices. Indeed, the following peripheral is an exciting output device. It's the CX4800 printer/plotter available from Leading Edge Products, Inc. What is so special about this printer/plotter? At first glance, the CX4800 might be mistaken for a dot-

matrix printer. However, as the copy emerges from the machine, there's no question that it's a four-color plotter. The secret is in the printhead, which consists of four colored pens rather than the usual matrix of pins.

Color changes can be made automatically under software control. The four standard colors are black, red, blue, and green, although other colors are available upon request. Plotting can be done at speeds of 120 mm/s for 0.1 mm depth (60 mm/s for 0.5 mm depth).

The CX4800 can also be used as a printer. It can print a standard 80-character line of a size comparable to pica type at a speed of eight cps. Single or fan-fold paper sheets of standard 9½"-wide sprocket-feed paper can be used with the unit. Suggested retail price is \$695.

For those who want colorful output, but need something more sophisticated than a printer/plotter, Sharp has introduced its IO-700 ink jet color image printer. It can reproduce, in seven colors, anything from graphs to detailed computer graphics. Roll paper that is 8-10 inches wide is needed to produce print areas up to 8½" wide. The unit will print a maximum of 120 dots per inch and, when printing characters,



SUPPLIERS

Caere Corporation
100 Cooper Court
Los Gatos, CA 95030

Coleco Industries, Inc.
945 Asylum Ave.
Hartford, CT 06105

Commodore
Computer Systems Div.
1200 Wilson Drive
West Chester, PA 19380

Diser Corporation
385 East 800 South
P.O. Box 70
Orem, UT 84057

Gavilan Computer Corp.
240 Hacienda Avenue
Campbell, CA 95008

Grid Systems Corp.
2535 Garcia Ave.
Mountain View, CA 94043

Koala Technologies Corp.
4962 El Camino Real
Los Altos, CA 94022

Leading Edge Products, Inc.
225 Turnpike St.
Canton, MA 02021

Microtouch Systems, Inc.
491 Massachusetts Ave.
Arlington, MA 02174

Pencept, Inc.
39 Green St.
Waltham, MA 02154

Quadram Corporation
4357 Park Drive
Norcross, GA 30093

Quarterdeck Software
1918 Main St., Suite 240
Santa Monica, CA 90405

Seequa Computer Corp.
209 West Street
Annapolis, MD 21401

Sharp Electronics Corp.
Systems Division
10 Sharp Plaza, P.O. Box 588
Paramus, NJ 07652

Supersoft
P.O. Box 1628
Champaign, IL 61820

Unitronics
2100 Livingston St.
Oakland, CA 94606

Vertimag Systems, Corp.
815 14th Ave.
Minneapolis, MN 55414

...NEW BREED

uses a 12×16 dot matrix. Price of the Sharp IO-700 has not been set but will fall into the \$1000-1500 range.

One peripheral that handles both input and output is a low-cost mass storage device for one of the most popular low-cost computers. Available from Unitronics, the Expander and Wafer-drive module is a high-speed wafer-tape drive plus 8K of RAM for the Commodore VIC-20 home computer. It plugs right into the expansion slot at the rear of the VIC-20 (and provides another slot at its rear). The module has a VIC floppy-disk look-alike operating system as well as a filing system. The unit, which uses 64K-byte data wafers, has a data transfer rate that is comparable to the speed of a floppy disk. Price is \$99.

Can a computer also be a computer peripheral? If it's Quadram's Quadlink, it can. This peripheral board, which fits into a slot on the IBM PC, is functionally equivalent to an Apple II computer. To run Apple software, you just pop an Apple disk into your IBM drive and press one key. Although not fully compatible, Quadram expects Quadlink to run about 90% of Apple software. Switching back to IBM operation is just another keypress away. Suggested retail price for the board, which comes standard with 64K of usable RAM, is \$680.

New Technologies

Computer shows are often a showcase for new technologies that may well drift into lower-cost products. Three companies—Diser, Grid Systems, and Vertimag—had some interesting examples of products based on new technologies.

Diser was showing the Modula Computer, which costs about \$22,500. Although priced beyond the range of most people, the interesting aspect of the computer was the language that it used. The language, Modula-2, is the final synthesis of Dr. Niklaus Wirth's widely used language, Pascal, and his research language, Modula.

The Modula Computer was designed to take full advantage of the power of the Modula-2 language. The language makes it much easier to handle complex programming problems. For example, Dr. Richard Ohran, vice-president of Diser, showed me a PacMan program that was developed by one of his computer science students in 80 hours using Modula-2. I played the game and it ran very much like the original. That's enhanced programmer productivity!

Another computer, the GRiD Compass portable computer, although priced at about \$9000 with software, is a showcase of state-of-the-art electronics technology. Most impressive is its amber-color, electroluminescent, flat-panel display. It has a 6" diagonal screen that can display 24 80-character lines. With a resolution of 320×240 pixels, the display also offers superb graphics.

The main processor is Intel's 16-bit 8080, which runs under MS/DOS 2.0 or CCOS (compass computer operating system). Another feature is Intel's 8087 80-bit arithmetic coprocessor. The computer has 256K of RAM Standard as well as 384K of bubble memory.

Packaged in a lightweight magnesium case weighing 10 pounds, the GRiD Compass measures just $15" \times 11\frac{1}{2}" \times 2"$. Some of the other features of this portable are a 1200-baud modem and integrated software for word processing, electronic spreadsheet, data base management, graphics, and communications.

Vertimag is working on ways to increase the storage capacity of floppy disks. Using vertical rather than longitudinal recording techniques, and a disk that is an alloy of chromium and cobalt, Vertimag expects to achieve capacities of 2.5M bytes per side (and more) on a floppy disk. According to the people at Vertimag, the drive will cost about the same as a conventional floppy drive, while the disks will run about \$20 each. Production begins in 1984.

Conclusion. As is evident, the recent industry computer shows have produced a plethora of exciting new products. Not all of them are on the market yet and some may never reach it but they should give you an idea of what the companies are trying to do and in which directions the computer industry is going.

Some products that could have been classified as "eyepoppers" may not have been highlighted here for a couple of reasons. A product may have been introduced at other than an industry show and already covered in this magazine; the excitement may have been generated not by an individual product but by a line of them. For example, Atari recently introduced four new computers (600XL, 800XL, 1400XL, and 1450XLD), plus a line of support peripherals and software.

All that's left now is to direct you to the list of addresses that I've included so that you'll know where to find out more information on any product that may have a peculiar attraction for you. ♦

UNIX

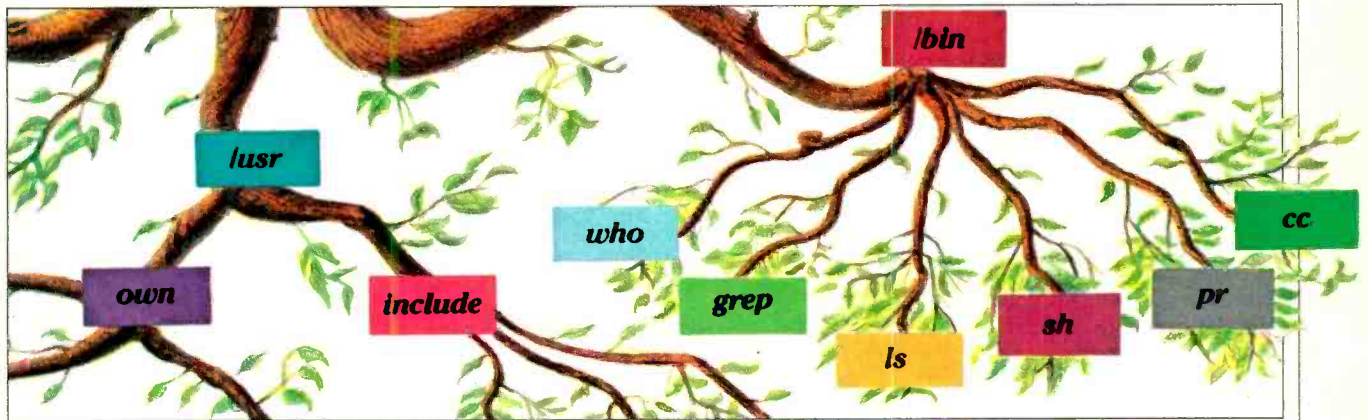

THE EASY WAY

This important and versatile operating system, programmed in C language, promises to become increasingly popular

By David Fiedler

THE Unix operating system originated at Bell Laboratories in 1969. Since its release to the general public in the early 1970s, it has gone through several major revisions, been transported to both microcomputers and large IBM mainframes, and has become an important force in the computer industry.

Unix was not developed as a general-purpose commercial operating system, nor even as a product. A Bell Laboratories scientist named Ken Thompson found a DEC PDP-7 (a small, but fairly powerful minicomputer) in a lab that was not being heavily used, and decided that it would be a good machine to implement an idea he had for a new type of file system. He used some innovations that were designed to provide what has been called by Dennis Ritchie "a pleasant environment in which to write and use programs." While any operating system is designed to allow people to use a computer more efficiently, Unix has proved especially "friendly."

Ritchie, one of Unix's earliest users at

Bell Labs, found it so fascinating that he began spending a great deal of his time helping Thompson refine it. While the Unix was originally written in low-level assembly language, they became dissatisfied with this approach, especially since they were considering putting Unix on other computers with completely different instruction sets. As a result, the C language was created as an "intermediate-level" language—one that was both highly efficient (fast execution of programs as well as low memory usage) and easily portable to other computers. With Unix largely rewritten in C, the operating system itself became portable. Consequently, widely different computers could run the same programs without the extensive rewriting that was previously necessary.

What's So Good About It? While transportability is important in itself, there are other aspects of Unix that make it increasingly popular. Some of these are described below.

Tree-like file system. Operating systems usually impose a predefined structure of some type on the way files are viewed by their users. In most cases, this structure is a simple "disk directory" that lets one access certain files when the system is used. In Unix, the structure can be viewed as an upside-down "tree" with its single "root" at the top as shown in the diagram. The root is the main directory in Unix; it leads down to all other files and directories. You can add to your own directory, usually located in the `/usr` directory by creating new files or even new sub-directories. This allows you to create whatever structure you need to manage your data effectively, much like being able to add new filing cabinets with ever more drawers and more file folders.

This is called a "hierarchical" file system because it resembles an organization chart, where the "big boss" (in this case, the root) is at the top. Like some organizations where one individual may have two responsible positions, a Unix

file can be accessed by several different names through different paths.

In Unix, every directory is actually just another file, which can be read by user programs. The only difference is that the information contained in a directory file consists of names of files and directions for where to find them on the file system.

I/O simplicity: The input and output devices attached to a computer are what allow humans to communicate with it. Unix permits any device—CRT terminal, printer, laser typesetter, or even main memory—to be accessed by simply reading, or writing a character at a time. This is aided by the Unix view that all files are just a sequence of bytes to be read or written. No external structure is expected by the operating system. Even when a device actually requires data in large blocks (such as a disk drive), Unix hides this dependency by taking care of these details internally.

In fact, all devices on a Unix system appear to the user to be ordinary files found as entries in the /dev directory). Therefore, a program intended for use with a disk file could easily be changed to work with a printer instead, but the process called “redirection” makes even this rewriting unnecessary.

Redirection and piping. Any program that normally “prints” to your terminal can have its output redirected to a disk file, printer, or another device. Similarly, a program’s input can be easily directed to come from a file, modem, or any device that can read characters. This allows the same program to serve many purposes. A text-editing program can get its input from a predefined set of instructions, for instance, eliminating errors in repeated complex editing sessions.

The concept of a program that simply operates on its input and transforms it into some output is important. In Unix, these types of programs are termed filters. Many programs in Unix are filters and perform one function only. The output of one can be connected to the input of another in a kind of “pipe” arrangement. By piping them together, it’s easy to use them as “building blocks” to perform much more complicated functions without having to write more programs.

One example of piping that is often used when running Unix involves backups. The disks used to store files on most Unix systems are very large in capacity. Thus, it takes a long time to save all the files onto tapes or floppy disks. To save time, a Unix system administrator will save daily only those files that were actually changed on that particu-

lar day or certain files known to be important. The following command line will save to tape all C source files on an entire system:

```
find -name "*.c" -print | tar c
```

The “find” command goes through the tree structure, looking for all files that fit the criteria. In this case, it finds all files ending in “.c”, and emits a list of filenames. This list is then handed off to the “tar” (or tape archiver) program, which can then go ahead and write each file listed to a new backup tape. (The “c” after tar means to create a new tape.)

The best part of pipes is not just that they are a convenient way of sending information from one command to the next, but that the commands actually run simultaneously. The find takes a long time to go through the tree, and tar

takes a while to write to tape. But as each filename is found, the pipe passes it along to be written out. Since both programs run at once, total run time is about halved. One wouldn’t want to wait until these programs were finished before using the Unix system, so they run by themselves in what is called the multitasking mode.

Multitasking. Did you ever have to wait for a program to run on your computer before you could do something else? In Unix, you can decide to run a program anytime (or several at once!) in “background,” while you continue using your terminal for another project. Just imagine writing a BASIC program, while at the same time a C program is compiling and its documentation printing out! You don’t even have to worry about compiler error messages cluttering your CRT screen provided you remembered to redirect those to the print-

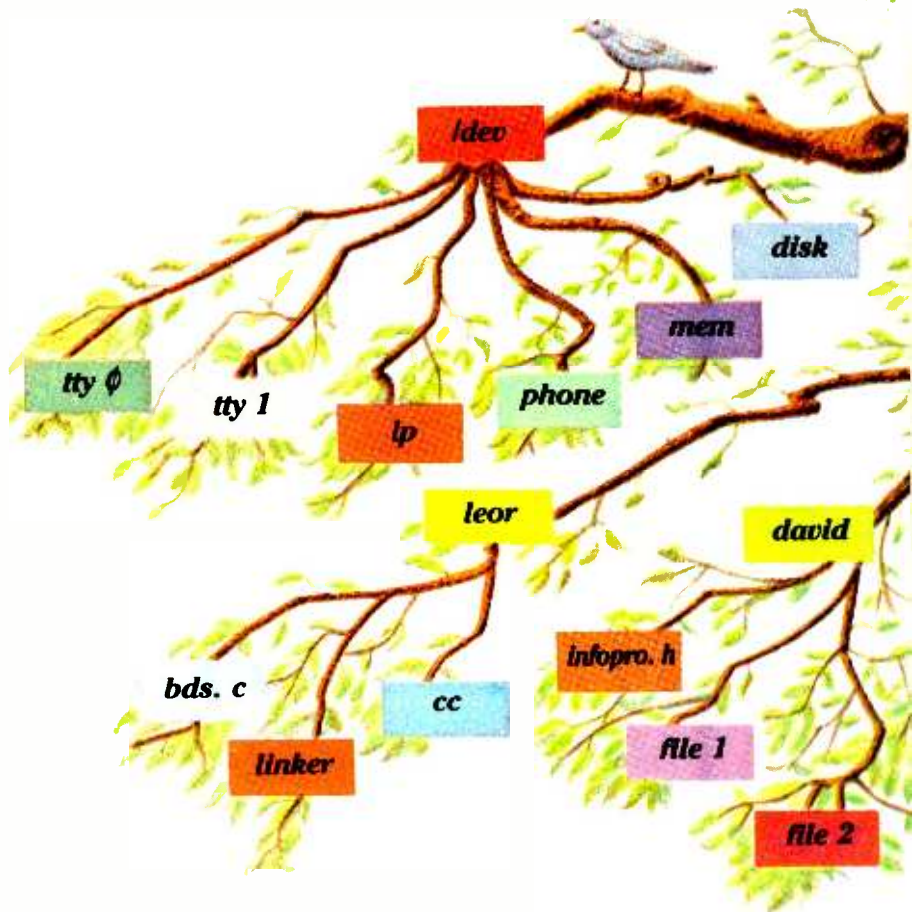

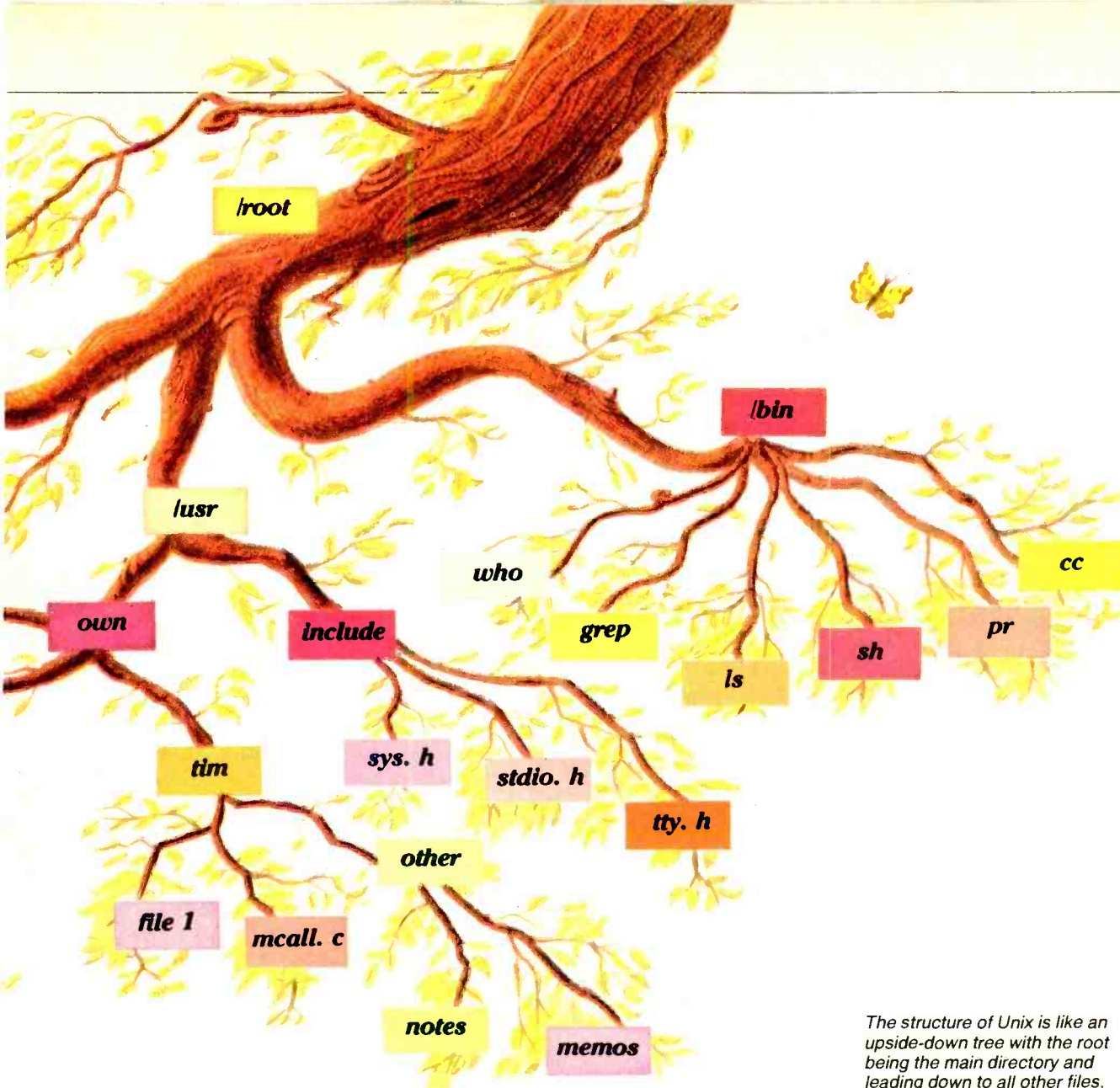

The structure of Unix is like an upside-down tree with the root being the main directory and leading down to all other files.

er as well. All you have to do is type a “&” at the end of any command line, and you immediately get the shell prompting you for your next command while your other project goes on its merry way.

- **Multuser.** On all but the very smallest Unix systems, several people can use the computer at once. Unix will take care of the details. If everyone wants to print simultaneously, the system sets things up so that data doesn't get mixed up in the printouts. It does this by automatically “spooling” or writing to disk files all output that is destined for the printer. It then prints it all in sequence, in background of course. To the user, it appears as if he has a 1,000,000-char/sec printer.
- Modems are supported, so people can call the system remotely. (Unix can change the baud rate to match the caller.) People can also send messages to

each other, either while they are logged on the system or as electronic mail files to be read at any time. Using the “uucp” package you can even send mail to people at other Unix systems. If your program directs, your machine will dial their machine when the phone rates are lowest, and transfer the message unattended.

Naturally, with all these people on one system, havoc could result if a program (or unfriendly user!) ran wild. So Unix provides various levels of protection by different mechanisms. The first comes when you initially log in to the system. If you don't enter the right password, you can't get in at all! The next level is by protection bits. Any user can set the protection on his own files and directories, so that other users or programs can be prevented from reading, writing, or executing them. The highest level is by actual encryption of data,

which is done easily on Unix by the inclusion of a special encoding program.

Development tools and languages. Unix boasts an impressive range of utilities, languages, and development tools that are either expensive add-ons or unavailable with other operating systems. Here are some examples.

- The “diff” program can show the exact differences between two text files, and can also help you change one file to match the other.
- A compiler for the C language and an assembler are included. There are also versions of FORTRAN, ratfor, Snobol, and a dialect of BASIC supplied as standard. Available for many systems are COBOL, Business BASIC, and Pascal. Cross-compilers and assemblers are common tools, allowing you to develop software for an entirely different machine.
- Powerful software tools such as

“yacc,” “lex,” and “M4” let you develop compilers for other languages or computers. You can develop your own language for a particular application. “Yacc” (Yet Another Compiler-Compiler) will generate a compiler for a new language once that language has been adequately described. “Lex,” a lexical analyzer generator, can virtually write a program on its own for transforming data in prespecified ways. M4 is used to add macro facilities to an existing language.

- Word processing and typesetting can be done with “nroff” and “troff” programs and the appropriate peripherals. Such devices as the Diablo series of precision printers, Tektronix graphics terminals, and Versatec plotters are supported, and can be used as easily as their more ordinary counterparts such as “dumb” terminals and line printers.

- Utilities such as “make” and the Source Code Control System allow programmers to keep track of changes to their files. The latest versions of their programs, or a specified older version can be made to compile and run automatically, even if the source code is spread out over many files managed by different people.

The Shell. The “command interpreter” is the program that you spend most of your time interacting with when you use an operating system. Much of the power of the system comes from it. It not only handles the I/O redirection mentioned above, but is actually a programming language in itself. Complex data management functions, testing, and file manipulation can be done with shell commands alone, without having to “write programs” in a more traditional way.

Shell programming features include loops, if-then-else, “case” constructs, error handling, and process synchronization. Since the shell interprets commands as they are typed in, often such a “shell program” is composed right at the terminal, and it can be easily saved for future use. The shell also permits you to “customize” the way Unix responds to your commands. You can change the prompt character, have the system search in particular places for commands, use your own favorite names for Unix commands, and run a predefined series of commands each time you log on to the system.

Is Anything Perfect? With all these attributes going for it, Unix seems like an idea system. But there are a few disadvantages that while relatively unimportant to a home user, could hamper

its acceptability as a general-purpose commercial operating system.

- **Security:** In theory at least, Unix prevents unauthorized users from accessing or destroying data that doesn't belong to them. In practice, a great deal of caution is necessary when running a Unix system to ensure file security. There are several fairly well-known ways of bypassing the usual Unix security checks. Also, the system does not adequately protect against runaway programs that can use up all available system resources and cause Unix to grind to a halt. An experienced Unix System Administrator is usually needed to watch over things.

- **Priority constraints:** It is presently impossible to ensure that an important program will have exclusive use of the machine if necessary for high-speed calculations. Further, system resources

“Its full power is within reach of most small business.”

such as memory or special devices cannot be reserved in advance, meaning a program that needs these resources will simply “bomb” (instead of waiting for the resource) if they are not available. Real-time response, critical for certain kinds of projects, is simply not there in standard Unix. Segments of code needed for high-speed access could be “swapped out” to disk at any time, making them temporarily unavailable.

- **Reliability:** Unix systems are generally thought of as “fragile,” a holdover from earlier versions that needed an expert available on an almost constant basis due to the complexity of the file system. Current versions are more robust and include programs to fix the file system automatically in case of a crash, but an expert will still be needed on certain occasions. Also, while a system might not be destroyed after a power failure, current state-of-the-art for commercial systems requires that all programs running before the failure pick up where they left off. This will not happen with Unix! While Unix may not be perfect in this regard, it's also a good deal smaller than those commercial operating systems. They are far too big to fit on a mi-

crocomputer and need a full-time team of experts to keep them running at all.

Owing to the way Unix implements its terminal interface, the practical maximum number of terminals usable on a Unix system is less than might be otherwise. Unix (designed as a time-sharing system for the purpose of efficient program development) is not always the appropriate choice for a large-scale applications-based computer center. However, the sheer power of some of the newer Unix computers on the market, and their low cost, ensures that many installations will be running Unix anyway!

What Machines Run Unix? The first machines to run Unix were the DEC PDP-7, PDP-11/34, and PDP-11/70. For this reason (also because they tend to be powerful yet, moderately priced) the DEC PDP-11 line of minicomputers has been most often associated with Unix. Larger minis such as the VAX are also popular, and Unix has even been “ported” or moved onto the IBM 370 series of mainframe computers.

By far the most exciting news for the greatest number of people is that Unix has now been ported to almost every 16-bit microprocessor on the market, thus bringing its full power within the reach of most small businesses and even some personal computer enthusiasts. Also, new operating systems (known as Unix “look-alikes”) developed by companies other than Bell Labs have come on the market, offering capabilities similar to Unix without the licensing headaches sometimes associated with the “real” Unix system. Yet since AT&T announced the new System III version of Unix, “binary” licenses (no source code included) to “real” Unix are available from systems houses for as little as a few hundred dollars.

The most popular microprocessor to use Unix at present is the Motorola 68000 due to its powerful instruction set, 32-bit internal data paths, and large addressable memory space. Typical of the many 68000-based computers that are now using Unix are:

- The Dual System 83: an S-100 machine which was one of the first micro-based Unix machines to be compatible with an industry standard bus.
- The Altos ACS68000, one of the most powerful machines on the market, dollar for dollar. It has a 40-megabyte hard disk and 512K of dynamic RAM, and supports 8 serial RS232 ports with an intelligent I/O controller.
- The Pixel AP/100, one of the fastest small machines around, with high-level

"I built this 16-bit computer and saved money. Learned a lot, too."

Save now by building the Heathkit H-100 yourself. Save later because your computer investment won't become obsolete for many years to come.

Save by building it yourself. You can save hundreds of dollars over assembled prices when you choose the new H-100 16-Bit/8-Bit Computer Kit – money you can use to buy the peripherals and software of your choice.

H-100 SERIES COMPUTER SPECIFICATIONS:

USER MEMORY:
192K-768K bytes*

MICROPROCESSORS:
16-bit: 8088
8-bit: 8085

DISK STORAGE:
5.25" disk drive,
8" disk drive
Winchester drive

KEYBOARD:
Typewriter style, 95 keys,
13 function keys,
18-key numeric pad

GRAPHICS:
Always in graphics mode.
640h/225v resolution; up to
eight colors are available**

COMMUNICATIONS:
Two RS-232C Serial
Interface Ports and
one parallel port

DIAGNOSTICS:
Memory self-test
on power-up

AVAILABLE SOFTWARE:
Z-DOS (MS-DOS)
CP/M®
Z-BASIC Language
Microsoft BASIC
Multiplan
SuperCalc
WordStar

MailMerge
Data Base Manager
File Manager
General Ledger
Accounts Receivable
Accounts Payable
Inventory Control
Sales Invoicing
Lotus 1,2,3
PeachText 5000
Fortran-86
Cobol-86
Pascal
Basic Compiler
Most standard
8-bit CP/M
Software

The H-100 is easy to build – the step-by-step Heathkit manual shows you how. And every step of the way, you have our pledge – "We won't let you fail." Help is as close as your phone, or the nearest Heathkit Electronic Center.†

And what better way to learn state-of-the-art computing techniques than to build the world's only 16-bit/8-bit computer kit? To run today's higher-speed, higher-performance 16-bit software, you need an H-100. It makes a big difference by processing more data faster.

Dual microprocessors for power and compatibility. The H-100 handles both high-performance 16-bit software and most current Heath/Zenith 8-bit software.

Want room to grow? The H-100's standard 192K Byte Random Access Memory complement can be expanded to 768K bytes – compared to a 64K standard for many desktop computers.

And the industry-standard S-100 card slots support memory expansion and additional peripheral devices, allowing your investment to grow.

High-capacity disk storage, too. The H-100's 5.25" floppy disk drive can store 320K bytes on a single disk. The computer also supports an optional second 5.25" and external 8" floppy disk drives. For maximum storage, an optional internal Winchester disk drive is also available.

For more information, circle the reader service number below. Better yet, visit your Heathkit Electronic Center for a demonstration!

*The H-100 gives me
the most for my
computer dollar!*

*192K bytes standard.
**Optional.
CP/M is a registered
trademark of Digital
Research.

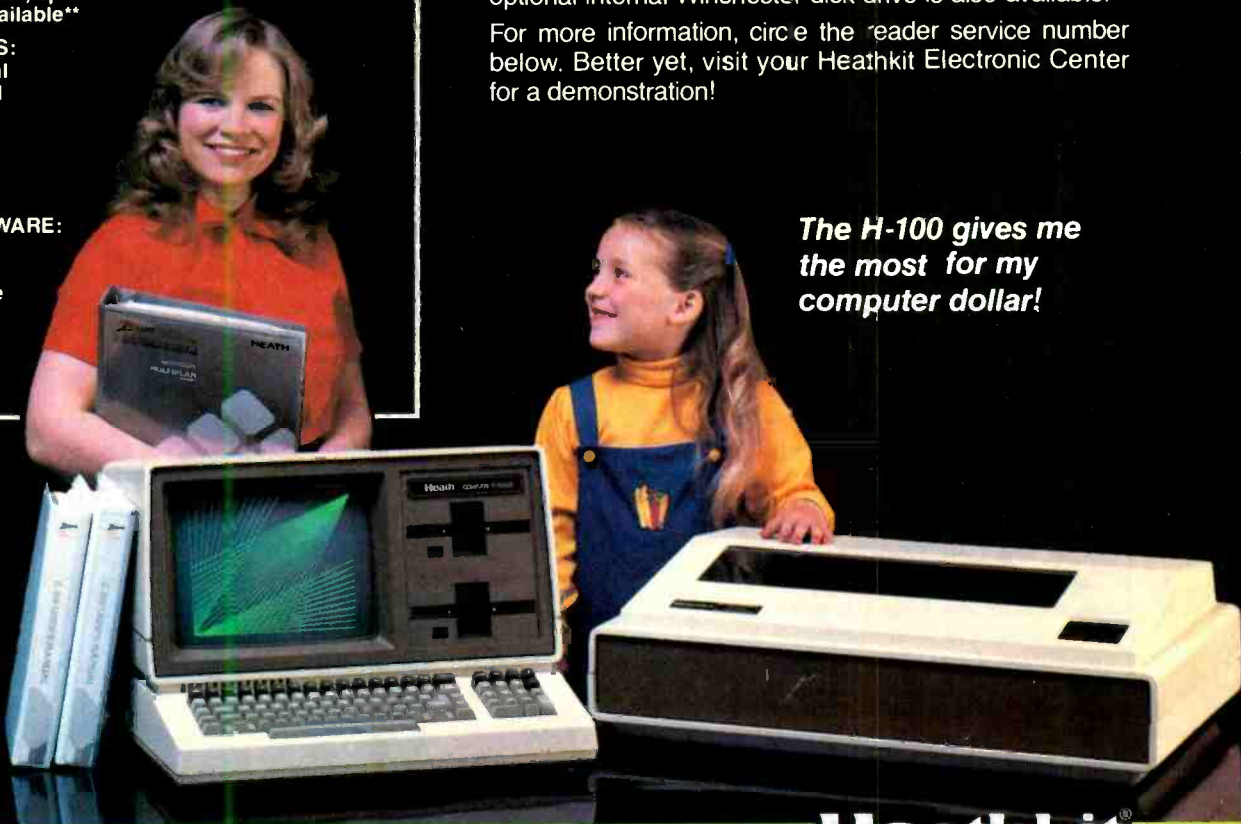

Heathkit
Heath
Company

A subsidiary of Zenith Radio Corporation

†Heathkit Electronic Centers are units of Veritechnology Electronics Corporation.

Circle No. 28 on Free Information Card

I/O controllers for virtually every device.

- The Fortune 32:16 has the distinction of being one of the smallest and least expensive (\$4995 with 1 limited floppy disk) Unix machines. It has a "user-friendly" menu system that makes operation easy, but hides most of the power of Unix.

- Radio Shack Model 16 with dual processors now runs Microsoft Xenix, which is a licensed Version of Unix.

Then there are Z8000 and 8086/88 computers. Zilog and Intel both sell their own Unix-based machines. Zilog, the first microcomputer maker to support Unix, has several high-performance Z8000-based computers available starting from around \$14,000. Intel's latest 86/300 series uses its standard Multibus, and is slightly more expensive. There are several other companies using these CPUs as well, including InterSystems' Z8000-based DPS-8000, which runs Coherent (a Unix look-alike from Mark Williams Co.).

Even the IBM Personal Computer can run Coherent for about \$500, or you can get a real Unix derivative, Venix, for \$900 from VenturCom, Inc., including several useful applications packages. The fastest-growing section of the market (after the 68000 onslaught) is expected to be in the 8086/8088-based desktop computers that can run MS-DOS, since Microsoft is attempting to make future versions of MSDOS compatible with its Xenix version of Unix.

What about 8-bit machines? A few enterprising companies such as Morrow Designs and Microware actually have Unix-like, multiuser, multitasking systems that run on Z80 and 6809 computers. Morrow's Decision I S100-based system features a Z80 CPU, 256K of RAM, a 10M-byte disk drive, and floppy backup. It can support several simultaneous users, and emulate CP/M at the same time. The Decision I runs the Micronix operating system (written at Morrow's company), which is compatible with Unix Version 6.

Several companies sell software that can simulate the Unix commands and shell on current 8-bit computers running CP/M. These are not really operating systems, but rather utility packages, although they can be quite useful. The most useful of these is possibly Microshell from New Generation Systems (\$150). Microshell can be called up at any time to actually replace the user interface of CP/M. This allows you to perform redirection, piping, automatic command search, and even shell programming, just like on Unix. The best

BUYERS GUIDE TO UNIX SYSTEMS

Vendor	Operating System	Real Unix?	CPU	Price	Comments
Advanced Digital Products Suite 205 1701 21 Ave., S. Nashville, TN 37212 615-383-7520	uNETix	No	8086/8088	\$350	IBM PC
AT&T Technology License Guilford Center PO Box 25000 Greensboro, NC 27420 919-697-2000	Unix System III	Yes	PDP-11, VAX	43,000	Source license only
Charles River Data Systems 4 Tech Circle Natick, MA 01760 617-655-1800	Unos	No	68000	3,000	Version 7 compatible, Real time extensions
Cromemco 280 Bernardo Ave. Mountain View, CA 94043 415-964-7400	Cromix	No	Z80, 68000	600	Not call compatible, CDOS emulation
Mark Williams Co. 1430 W. Wrightwood Chicago, IL 60614 312-472-6659	Coherent	No	Z8000, 8086	OEM only	Version 7 compatible, IBM PC
Microsoft Suite 819 10800 NE Eighth St. Bellevue, WA 98004 206-455-8080	Xenix	Yes	PDP-11, VAX, 8086, Z8000	1,000 and up	Version 7, System III
Microware Systems Corp. 5835 Grand Ave. Des Moines, IA 50312 515-279-8844	OS-9	No	6809	200	No bank switching needed
Morrow Designs 5221 Central Ave. Richmond, CA 94804 415-524-2101	Micronix	No	Z80	500	Version 6 compatible, CP/M emulation
Technical Systems Consultants, Inc. PO Box 2570 1208 Kent Ave. W. Lafayette, IN 47906 317-463-2502	Uniflex	No	6809	550	Needs only 96K RAM
VenturCom, Inc. 139 Main Street Cambridge, MA 02142 617-661-1230	Venix	Yes	PDP-11, LSI-11/2, 8066	900	IBM PC; includes DBMS, word processor, graphics package
Vortex Technology PO Box 2284 Culver City, CA 90230 213-645-7200	Marc	No	8080	175	Single tasking, CP/M emulation, not call compatible, runs on current BIOS
Whitesmiths, Ltd. 30 Lowell Rd. Concord, MA 617-369-8499	Idris	No	8080, 68000, PDP-11, VAX	2,200	Version 6 compatible

Is something wrong in your home?
You can listen from any phone in the world.

The SENSAPHONE Protects Your Home Whether You're There Or Not— And You Can Listen to What's Going On When You're Away!

New! From Gulf & Western

Connect the Sensaphone to your telephone and at once you have an alarm system, an environmental monitor, an ear that lets you listen to "live" sounds in your home or office, and an automatic dialer that dials any of eight pre-set numbers when you push one digit. Read on:

Sophisticated Alarm System

Your Sensaphone system never sleeps. If power fails, if the temperature rises beyond the pre-set limit or falls below the pre-set minimum, if an unusual sound occurs, or if any of three other conditions of your choosing develop, this remarkable system will dial automatically, and in sequence until someone answers, you, a neighbor, the fire department, the police, or whatever group of numbers you've entered. Your Sensaphone won't quit calling until someone answers or you turn it off.

"Call-In" Monitor

If you're away from home and are worried about the kids or about break-ins, call home from any phone. Your Sensaphone will report to you (privately, because your call will include a private code) on the monitored conditions. Then you can listen to the room sounds for yourself.

You can install a Sensaphone in your office too. At night, if you're driving by and see a light, call your Sensaphone. You'll quickly learn whether it's the cleaning service or an unwelcome intruder.

Automatic Dialer

Enter the eight numbers you call most frequently. Then, when you want to call one of those numbers (up to 16 digits each), press just one dial-key and your Sensaphone will call the whole number for you.

Your Sensaphone won't lose its memory if the power fails, because a battery backup protects it. What's more, the Sensaphone will call the preprogrammed numbers to warn that the power is off and it'll also warn you if the battery power is low.

- A product of Gulf & Western, made in U.S.A.
- Occupies only 7 $\frac{3}{4}$ " x 8 $\frac{5}{8}$ " of space.
- Connects to your phone in 10 seconds.
- "Standby" mode remembers information but prevents function.

SPECIAL PRE-HOLIDAY ALLOTMENT!

The Sensaphone wasn't supposed to be available until 1984. New Horizons has moved up the delivery date, so we can ship your Sensaphone immediately, unless the demand is even greater than we expect. A special note:

As an executive gift for someone "who has everything" - consider the Sensaphone. We guarantee, it's a gift he or she will use and appreciate for years to come!

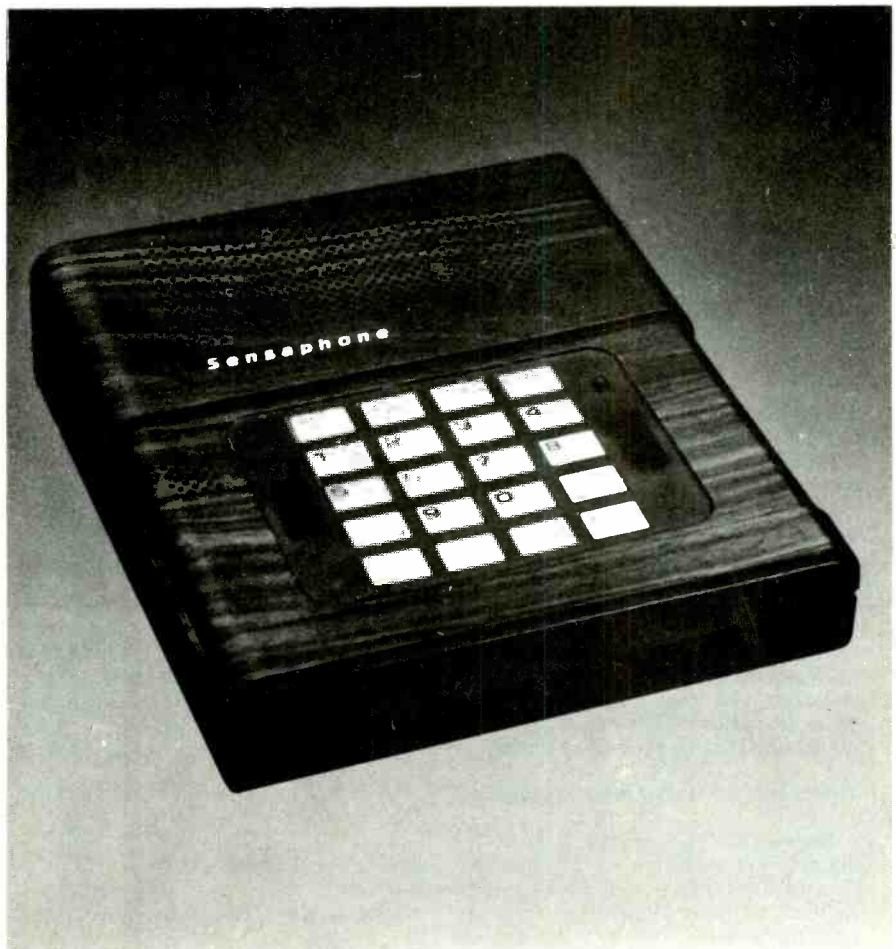

WE ABSOLUTELY GUARANTEE!

Plug your home or office phone (or both) into the Sensaphone. Use it for up to 30 days. If you decide for any reason you don't want to keep it, return it for a 100% refund.

The Sensaphone is
another electronic marvel from

NEW HORIZONS

Circle No. 17 on Free Information Card

THE SENSAPHONE \$249.95
(two for \$229.95 each)
add \$3.50 per total order for shipping

Order TOLL-FREE.

For fast delivery on credit card orders,
call toll-free 24 hours a day, 7 days a week:

800-443-0100

Ask for Ext. 111

Or send check or money order.
Please add \$3.50 per total order for shipping.

Dept. CE9, 5-31 50th Avenue
Long Island City, N.Y. 11101

REDIRECTION MADE SIMPLE

Let's say you have a simple program called "add" that reads two lines of text from your terminal, puts those lines together, and writes them back out. Here is how that might look on Unix. What you type is in *italics*, and Unix responds in **bold face**.

```
$add
This is a
short test of add.
This is a short test of add.
$
```

When Unix prompts with its "\$", you simply type the name of the program to be executed. Then Unix finds this program and begins to run it, with the results as shown. Now suppose you want to save the results of the program in a file instead of printing them out. Instead of rewriting the program to create the file, open it, then write to the file and finally close it (as would be necessary on almost any other operating system). Just let Unix do the work. Simply type:

```
$add > resultfile
This is another
test of the add program.
$
```

Notice that this time, Unix returned immediately with its prompt. A file called "resultfile" has been automatically created by the system. If we were to look at it, we would see its contents were simply

This is another test of the add program.

The notation ">", is clear in its meaning: send the results the way it points. The command line would usually be read aloud as "add, redirected to resultfile." This redirection of output can, as mentioned, be done to almost any device. The actual devices are accessed through their entries in the device directory, as if they were files. To send the output of the add program to the printer, for example, you could type

```
$add > /dev/lp
This is yet another
test of the add program.
$
```

If you went over to your printer ("lp" is the general term for the system printer, actually short for "line printer") at this point, you would see that

This is yet another test of the add program.

had been printed on the last line of the paper (though we have to print it as 2 lines here). Input can also be redirected. Suppose a file called "twolines" contained the two lines

```
Well, I'll be a
hog-tied varmint.
```

```
Then "add" could be used to show them
at your terminal by typing
$add < twolines
Well, I'll be a hog-tied varmint.
$
```

Of course, both input and output can be redirected at the same time by a line somewhat like this:

```
$add < twolines > resultfile
$
```

Notice that the prompt is again immediately returned, since we have taken the input from the file "twolines" and sent it to the file "resultfile." Suppose we had another filter-type program called "reverse," which reversed the order of space-separated words fed into it. If we gave it

```
useful amazingly be can towel a
```

we would get:

```
a towel can be amazingly useful
```

Now suppose a file named "towel" had the lines separate and backwards:

```
useful amazingly be
can towel a
```

By redirecting several times, we can get the final result:

```
$add < towel > temp
$reverse < temp
a towel can be amazingly useful
$
```

But on Unix, we don't need the temporary file "temp." By piping the output of add directly into the input of reverse, we can get the same result in a much cleaner fashion:

```
$add < towel reverse
a towel can be amazingly useful
$
```

Not only is this easier to understand, it is more efficient. A temporary file is not created by Unix as you might expect; rather, the programs are actually run *simultaneously*, with the second program getting its input only when the first program has generated its output. ◇

part is that all this takes place with your current software. Your programs don't have to be rewritten to use these features. Output intended for the printer can be diverted to a disk file for spooling off later. The power of this package is such that an entire user-friendly menu (written in shell commands, of course) is included just as a programming example. Such programs usually are sold as products on their own.

The Unica from Knowlogy (\$95) is a group of Z80 utility programs that emulate, as far as possible, some of the most often-used Unix commands. While in some cases they duplicate the functions of programs you probably already have (file copiers and the like), they tend to work in more logical ways. The Unica programs support full "wildcards" in most commands, and redirection and piping among themselves. They allow full use of the usually neglected "user area" feature in CP/M 2.2, permitting easy use of large-capacity hard disks.

It's not really necessary to have a CP/M machine, though, to get a flavor of these systems. If you have a terminal and a modem, you can access several computers for just the price of a phone call, that can give you experience with some of the Unix features. Among these are the following:

CNODES: These systems use Unix-style commands, and provide online libraries of software that can be downloaded into your system. The eventual goal of these systems is to provide inexpensive electronic mail transfer facilities between computer hobbyists. Most software on these is written in BDS C. The systems and phone numbers are: Denver CNODE (the original): 303-781-4937; 24 hr; Norman, OK: 405-364-1373; 8 a.m.-5 p.m. weekdays; State College, PA 814-238-4857; 24 hr, hard-disk storage.

The C Line: this system runs Microshell and some of the Unica programs, and has a bulletin board system and rumor "hot line" especially for Unix and C users, as well as providing some downloadable free software. Call 201-625-1797, 6 p.m.-9 a.m. weekdays, 24 hr on weekends.

Digital Research already feels the competitive pressure, and has put some Unix-style features in its new operating system CP/M-Plus. Quite a bit of competition will be seen as Unix migrates to smaller computers and CP/M moves up to larger computers. The eventual benefactors of this competition? You, as a computer buyer and user, will find better software and hardware for less money. ◇

Fast and Easy Graphics with a low-cost Touch Tablet

*The Koalapad and Micro Illustrator
team up to make sophisticated graphics a snap*

By Joe Desposito

ANYONE who uses a computer to create screen graphics probably has a keyboard bypass device on his most-wanted list. The new Koalapad Touch Tablet

from Koala Technologies Corp., Los Altos, CA, makes it easy for this to come true. At \$125, it adds a new dimension to computing for Apple, Atari,

Commodore, and IBM personal computer owners.

The Tablet comes with disk software called the KoalaWare Micro Illustrator

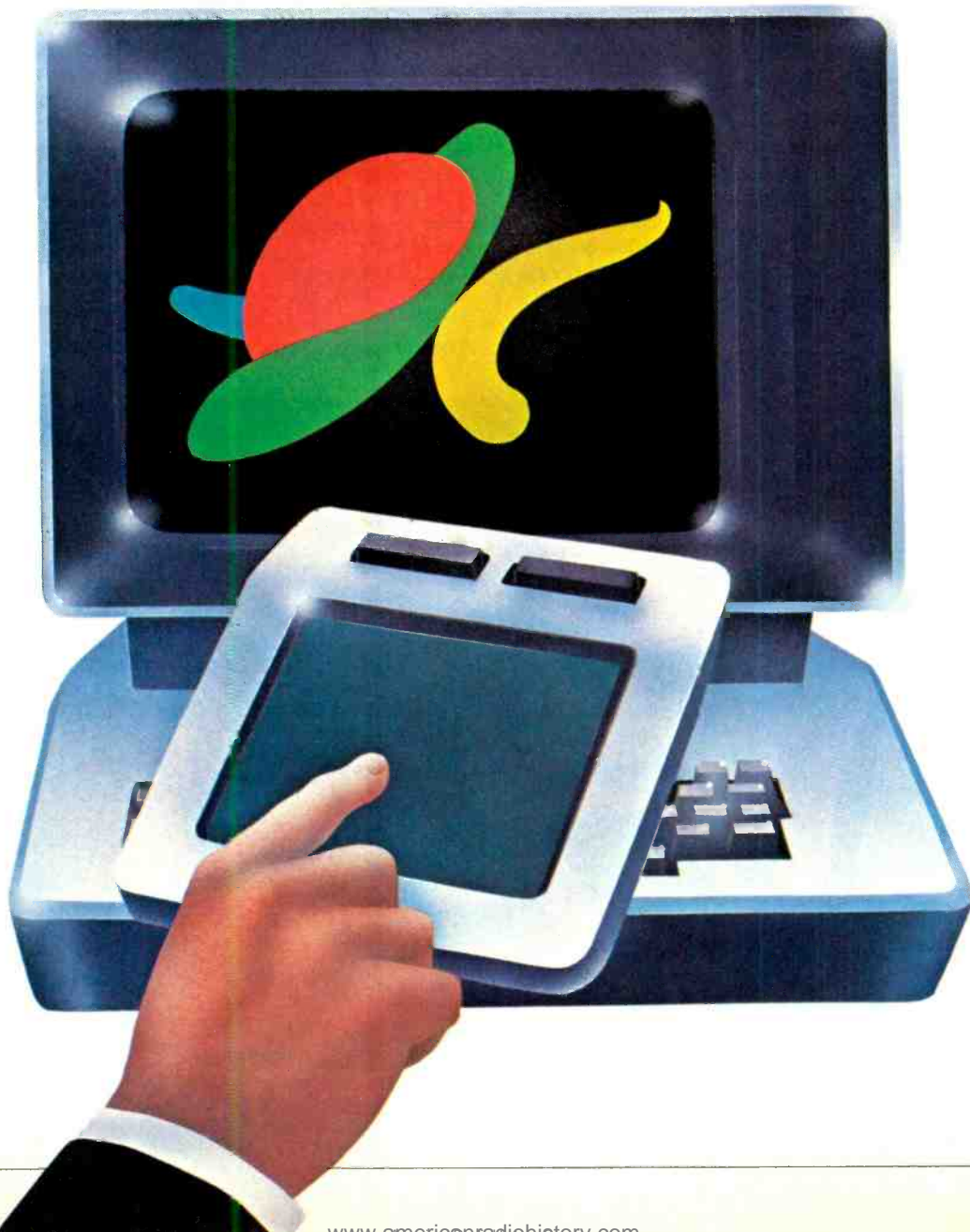

...TOUCH TABLET

to get one started, with other software packages priced at less than \$50 each. This ability to permit the user to draw and point to images on the video display while ignoring the keyboard is the Koalapad's forte.

The Tablet. The Koalapad is relatively small (8" × 6" × 1") and lightweight (1 lb) so a person using it naturally holds it in his hands. The active pad surface is a 4" square that's slightly recessed with two pushbuttons located above it. The unit is contoured in such a way that it can be grasped easily in the left hand with the left thumb pushing one of the buttons and the right forefinger or a stylus doing the drawing (or vice versa if the person is left-handed). The Koalapad is easy to interface with the Apple II+ (which is what I used it on). It plugs right into the game port.

Software. The software package reviewed here, the Micro Illustrator, is menu driven, though the menu is not the usual kind. Menu choices are accompanied by visual images and

each command occupies a rectangular area of the screen. Selecting an item from the menu is as easy as moving one's finger.

One rectangular box on the middle-left portion of the menu is labelled "Cursor." This is an automatic function. When the Koalapad is used and a finger is moved around the pad, the cursor follows it on the screen.

As an example of how other portions of the menu are used, consider the box labelled "Draw." To use it, the cursor is placed somewhere in the box, and a button on the tablet is pushed. The Draw mode is then in effect. With another push of the button, the screen goes blank and anything can be drawn just moving a finger around the pad surface.

Other commands can be selected in the same way. Two areas of the menu are not commands. One is for a "brush" set and the other for a "color" set. The brush set varies the width and shape of the lines drawn on the screen, while the color set permits varying the colors. There are two color sets. Each works well with colors from its own set; but if colors from different sets are mixed, peculiar color reactions may occur.

Let's review in more detail the com-

mands on the menu. "Draw" permits drawing straight lines and curves in any direction all over the screen. "Point" leaves a single dot on the screen each time the button on the pad is pressed. With "Line," a single straight line is drawn in any direction. "Lines" is for making continuous lines. In other words, after a line is drawn, the button on the tablet is pressed to indicate the endpoint of the line. When the cursor is moved to another spot, another line is drawn from the end of the first line. "Ray" gives a fan effect. If a line is drawn, the button is pressed, and the finger is moved again, a whole set of lines fans out from the original line.

The "Frame," "Box," "Circle," and "Disc" commands are for drawing squares, rectangles, and circles. For a rectangle or square, a button on the tablet is pressed to establish a corner point. Then the finger is moved away from the point. A rectangle begins to form and grows larger as the finger is moved farther away from the corner point. When the proper size is reached, the button is pressed again and there is a rectangle (or square).

A circle is created the same way except that the starting point is the center

A typical business application of the Koalapad.



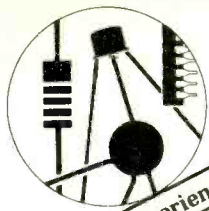

18 years experience

The ELECTRONICS BOOK CLUB

The latest *computer* and *electronics* titles for hobbyists and professionals!

State of the art technology . . . projects . . . troubleshooting and repair . . . even how to build your own microcomputer!

Select 6 Books for \$2⁹⁵
Save up to \$125⁷⁵



1409
List \$15.95

1183
List \$14.95

1539
List \$19.95



1499
List \$21.95

1513
List \$19.95

1486
List \$17.95

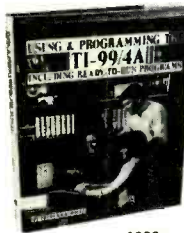

1620
List \$16.95

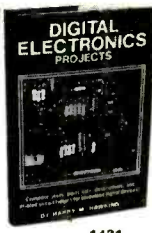

1431
List \$17.95



1479
List \$19.95

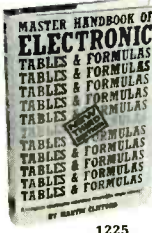

1225
List \$16.95



1473
List \$18.95



1337
List \$9.95



1160
List \$13.95



1490
List \$14.95



1466
List \$17.95



1493
List \$21.95



1453
List \$16.95



1531
List \$17.95

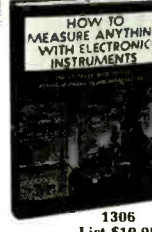

1306
List \$19.95



1533
List \$17.95



1451
List \$18.95



1423
List \$17.95

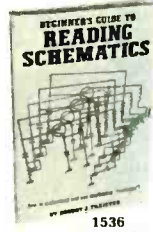

1536
List \$13.95

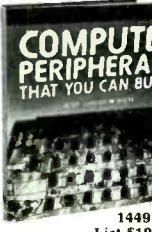

1449
List \$19.95



1529
List \$21.95



1406
List \$17.95

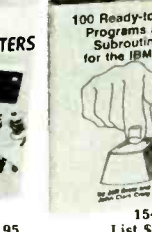

1540
List \$22.95

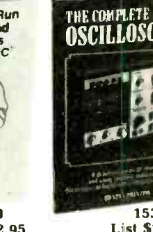

1532
List \$17.95



1506
List \$13.95



1218
List \$17.95

7 very good reasons to try Electronics Book Club

Blue Ridge Summit, PA 17214

- **Reduced Member Prices.** Save 20% to 75% on books sure to increase your know-how
- **Satisfaction Guaranteed.** All books returnable within 10 days without obligation
- **Club News Bulletins.** All about current selections—mains, alternates, extras—plus bonus offers. Comes 13 times a year with dozens of up-to-the-minute titles you can pick from
- **"Automatic Order."** Do nothing, and the Main selection will be shipped automatically! But . . . if you want an Alternate selection—or no books at all—we'll follow the instructions you give on the reply form provided with every News Bulletin
- **Continuing Benefits.** Get a Dividend Certificate with every book purchased after fulfilling membership obligation, and qualify for discounts on many other volumes
- **Bonus Specials.** Take advantage of sales, special events, and added-value promotions
- **Exceptional Quality.** All books are first-rate publisher's editions, filled with useful, up-to-the-minute information



ELECTRONICS BOOK CLUB

Blue Ridge Summit, PA 17214

Please accept my membership in Electronics Book Club and send the 6 volumes circled below, billing me \$2.95 plus shipping and handling charges. If not satisfied, I may return the books within ten days without obligation and have my membership cancelled. I agree to purchase 4 or more books at reduced Club prices (plus shipping/handling) during the next 12 months, and may resign any time thereafter.

1160 1183 1218 1225 1306 1337 1406
1409 1423 1431 1449 1451 1453 1466 1473
1479 1486 1490 1493 1499 1506 1513
1529 1531 1532 1533 1536 1539 1540 1620

Name _____ Phone _____

Address _____

City _____

State _____ Zip _____

Valid for new members only. (Orders outside U.S. or Canada must be prepaid in International Money Orders in U.S. dollars. Canada must remit in U.S. dollars.) This order subject to acceptance by Electronics Book Club. PE-983

NTS Electronics

Learn Robotics, Microcomputers, Microprocessors, Digital Video, Test Equipment and more with NTS INTRONIC™ home training. Courses include state-of-the-art equipment, lessons and texts to make your hands-on programs exciting and down-to-earth practical.

NTS Intronic Training is a carefully developed and tested learning system providing a thorough intergration of advanced electronic hardware with modern lesson texts. The relationship between theory and practical applications is made clear through the hands-on experience of building and assembling kits of state-of-the-art equipment. Courses include a wide variety of test instruments, both digital and analog, as well as other units not shown here. And, depending on the NTS program you select, you can earn up to 30 CEU credits for successful completion. Our full-color catalog has complete details. NTS has taught industrial skills for over 78 years—a record that has no equal.

HERO 1 is included in two courses, one basic and one advanced. You'll cover principles of industrial electronics, microprocessor troubleshooting, fundamentals of mechanics, and robotic applications in industry. You'll learn analog and digital skills, radio control, fluidic, pneumatic and servo-mechanisms, as well as computer interfacing and robotic programming. **HERO 1**, complete with arm, gripper and speech synthesis board, is a fully self-contained electro-mechanical robot—the featured unit in the most exciting training programs ever offered in home study.



Training.....

FIRST WITH TOMORROW'S TECHNOLOGY

1. **Advanced "Z Chassis" NTS/HEATH "Smart Set"** with computer space command remote control and space phone. Originate or receive telephone calls through this set and the number appears on the screen-store your police and other emergency numbers into memory which may be recalled and auto-dialed at any time. Traditional and incomparable picture quality. Unit has Quartz Controlled Tuning, 178 channel capacity, remote antenna switch accessory for reception of VCR, VDR, Broadcast, Cable, Video Games, and Personal Computer Input (no cable change) plus computer-controlled color. Featured in all-new Video Technology Course.

2. **NTS/HEATH HN89A Microcomputer** is included in two programs. This famous and reliable unit features Floppy Disc Drive, 48K Memory on Board, CRT Terminal with its own Z-80 Processor, and standard keyboard as well as Numerical Input Keyboard. The growing importance of computer knowledge and skills have made these programs increasingly significant. The experience gained in assembling these kits is invaluable in the understanding of computer troubleshooting skills.

3. **NTS Microprocessor Trainer** is included in our Industrial and Microprocessor Technology Course. It is a portable unit, contained in a convenient high-impact carrying case. Hardware/Firmware includes Monitor Operating System-Expandable User Memory-User Experimental On-Board Section-Breakpoint Editor-Single Step Trace-Cassette I/O.

Simulated TV Reception



NO OBLIGATION

NO SALESMAN WILL CALL

NTS NATIONAL TECHNICAL SCHOOLS

TECHNICAL TRADE TRAINING SINCE 1905
Resident and Home-Study Schools

4000 So. Figueroa St., Los Angeles, CA 90037

Use the mail-in card or fill out and mail the coupon. Indicate the field of your choice. (One, only please.) FREE full color catalog will be sent to you by return mail.

NATIONAL TECHNICAL SCHOOLS Dept. 205-093
4000 South Figueroa Street, Los Angeles, CA 90037

Please send FREE color catalog on course checked below:

- | | |
|---|---|
| <input type="checkbox"/> Robotics | <input type="checkbox"/> Computer Electronics |
| <input type="checkbox"/> Digital Electronics | <input type="checkbox"/> Video Technology |
| <input type="checkbox"/> Auto Mechanics | <input type="checkbox"/> Home Appliances |
| <input type="checkbox"/> Air Conditioning/Solar Heating | |

Name _____ Age _____

Address _____

Apt. _____ City _____

State _____ Zip _____

Check if interested in G.I. information.

Check if interested ONLY in classroom training in Los Angeles

of the circle. For a shaded rectangle or circle, the "Box" or "Disc" mode is used.

The "Fill" command will color any enclosed area. However, one must be careful and not leave an opening in the area or the color will "leak" out of the area and eventually fill the whole screen.

An "Erase" command permits erasing the whole picture on the screen, but not part of it. If a mistake is made and it is desired to erase just a small part, the color of the brush must be changed to the background color and the part to be erased must then be wiped out. It's like a typist using "White-Out" to correct a mistake on a letter. However, the procedure is not that simple since the finger is on the pad and the drawing is on the screen. There are no markings on the pad that will indicate a corresponding location on the screen.

What I found to be the easiest way to eliminate mistakes was to use the "Magnify" command. This enlarges the screen seven times. Thus, it's like looking at the drawing under a magnifying glass. There is also a large cursor that guides one to selected points.

The "Magnify" command is also useful when doing detailed work. For example, I drew a small box on the screen and wanted to put a letter in it. Using the magnified screen, I was able to create the letter dot by dot. When I entered "Normal" mode again, the letter looked perfect.

The "Storage" command permits saving artwork to disk. One of the problems I found with the Micro Illustrator is that it had no provision for a screen dump. Thus, if a file is saved, it can only be loaded back onto the screen again. (Screen dump software and hardware is available through other sources, however.)

Finally, the "Help" command gives assistance on screen so it is not necessary to refer to the manual. I thought this feature was rather poor, however, because it only referred to a few commands. So I used the manual to clarify any points about the program.

A short manual is included with both the Koalapad and the Micro Illustrator. The manuals are easy to read, direct and to the point. I still found it a little difficult getting used to working with the pad and the program (although my nine-year old son took to it more readily). However, after playing with it for a while, I became accustomed to it.

User Comments. My reaction to the Koalapad and Micro Illustrator was

very favorable. It gave me the opportunity to create graphics with the Apple II that I could do before only on a much more expensive graphics tablet. There were some problems, however. Every so often, while in the "Draw" mode, a line would jut out seemingly at random. I tried to discover if there was a flaw in the pad, but I couldn't duplicate the glitch at any specific point on the pad. This is annoying because, as I mentioned, it's not that easy to erase a part of a drawing. (I spoke to Dr. David Thornberg of Koala about this and found that the problem was in the software, which has been corrected.)

models. Besides its use with the Micro Illustrator and other packaged software, the Koalapad tablet data can be incorporated into your own programs using subroutines in the manual.

Koala expects to market a variety of software packages aimed at education and entertainment for the home market, as well as productivity enhancements for business and financial applications. In fact, the Koalapad has overlay locations that can turn the pad into a custom keyboard for certain applications.

The Koalapad and Micro Illustrator are a synergistic combination that produces a remarkable end result. I saw it

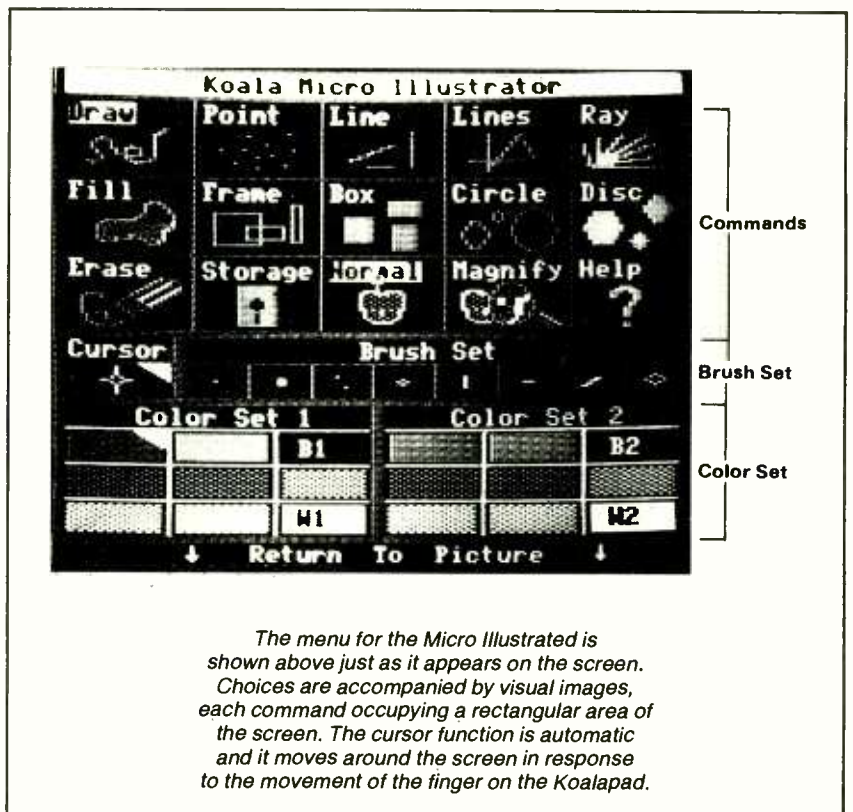

The menu for the Micro Illustrated is shown above just as it appears on the screen. Choices are accompanied by visual images, each command occupying a rectangular area of the screen. The cursor function is automatic and it moves around the screen in response to the movement of the finger on the Koalapad.

Also, I tried to determine the optimum speed for drawing on the pad. I discovered first that it is not necessary to keep a finger on the pad while drawing. If I lifted my finger off and moved it to another point, the line was drawn between the points.

What this means is that a straight line can be drawn as fast as desired (although there is some delay until the line catches up). However, I also tried drawing a Z for Zorro. Since a Z is made up of four points, it can't be drawn too fast or the lines will be in the wrong places.

The Koalapad Touch Tablet is available for the Apple II, II+, and IIe computers as well as the Commodore VIC-20, IBM PC and Atari 400 and 800

first at an industry show in April and was impressed with it then. When I got a review sample and worked with it a while, my initial impression was reinforced.

The combined package enables one to create sophisticated graphics in a matter of minutes. And for those who want to spend time creating detailed computer art without spending too much money, this package is the perfect tool. I recommend it highly. Others must share this view since the company, founded in 1981, is reported to have recently raised almost \$5 million in venture capital from a six-member group that includes Hewlett-Packard, Allstate Insurance, and Boston University. ◇

The Modularized Computer

SONY'S NEW SMC-70

By Stan Veit

SONY is certainly living up to a reputation as an innovative manufacturer with its new SMC-70 Z80A-based micro-computer (a 16-bit 8086-CPU adapter will reportedly be available soon). It's the most modularized system we've seen in a long time, in contrast to a trend toward all-in-one packages. Moreover, it uses 3½" disk systems, as well as having provisions for Winchester-type hard disks.

The SMC-70 system examined consists of a main computer unit that includes a keyboard (\$1475), a 3½" microdisk system (\$650 for one drive/

controller and \$1100 for two), a 12" composite/RGB color video monitor (\$875), and a 136-character-line dot-matrix printer (\$725). Software packages were CP/M extended for color and graphics (\$150), BASIC (\$150), Word Processor (\$495), and SuperCalc (\$295). Additionally, we had a 256K solid-state disk memory peripheral (\$875) and a battery backup unit (\$350).

General Description. The main computer unit consists of a rectangular housing containing 64K RAM of main memory, 32K system ROM, and 32K video RAM. The keyboard juts out the front as an appendage that fits into a slot, while the power supply mounts on the back of the main unit. Between the power supply and the main block is a telescoping slide with a ribbon cable and edge connectors mounted on it. Here is where the system expansion modules are plugged in. The Sony's keyboard is a stan-

dard 72-key QWERTY type with five function keys mounted on the top of the keyboard. There are also cursor control keys and INS (insert), DEL (delete), CLR (clear), and HOME keys on the top row of the keyboard.

There is also a hole in the keyboard with a red button beneath it for system RESET. To use it you must insert a pencil or stylus into the hole (your finger will not fit). This is to protect the system against accidental reset, though it's rather a stern measure.

There are two ways that an SMC-70 can be expanded. One or two boards may be mounted inside the main computer section by a dealer. In another method, expansion modules are installed between the main unit and the power supply on the plug-in bus. This type of installation can be done either by the user or dealer. However, it is somewhat more complicated than merely opening a cabinet and plugging in modules.

The color video display on the SMC-70 is what you would expect from Sony. I found it to be impressively good. To start, the characters are actually displayed in an 8 × 8 dot matrix, a somewhat unusual arrangement, but one that produces characters that are sharp and good looking. You have a choice of a screen display that is 40 characters by 25 lines or 80 characters by 25 lines, as well as eight colors that can be used for characters alone.



...SONY SMC-70

The graphic color display has four resolution modes of operation:

Mode 1: 160 by 100 dots, 16 colors, 4 pages.

Mode 2: 320 by 200 dots, 16 colors.

Mode 3: 640 by 200 dots, 4 colors.

Mode 4: 640 by 400 dots, B & W.

The border area has 16 colors.

Graphics and text have separate display planes, so you can superimpose characters, graphics, and the border areas! The display capabilities are therefore particularly impressive.

Sony has incorporated its 3½" disk system into the SMC-70. Like everything else in this building-block system, the disk system is an add-on. It can be added by the user, but it is strongly recommended that it be done by Sony or a dealer. The disk controller is sandwiched between the power supply and the main unit, while the disk unit mounts on the top of the main unit. There is also provision for mounting external drives.

The Sony 3½" drives use rigid diskettes that can store 280K bytes of data. The floppy disk inside the package is protected by a sliding metal cover. All you have to do to carry them around safely (say, in your pocket, where they fit) is to close the cover slide. They cost \$5 each in a "hard pack" box of ten.

Double-sided 5¼" diskettes, which hold about the same amount of data, cost the same price.

You can't help being impressed by the KX-121HG Trinitron 12"-diameter component color TV Monitor. It can display either a VCR/TV video signal or a video signal from the computer. This is done by switching signals from the computer if desired. Loudspeakers (8 to 16 ohms) have to be added to the 28.8 lb monitor if one wants sound. The company also makes available the CDP-120 12" green-phosphor tube Monitor that's as good in its own way as the color monitor.

Sony's SMI-7020 dot-matrix printer is a Centronics type parallel printer that is an 80-column machine with selection of type styles and modes from software. It's similar to imported printers sold under various brand names. Other options include a numeric key pad (\$90) and a light pen (\$175), both of which plug into inputs provided on the computer.

The SMI-7050 Cache disk unit is an interesting module that adds 256K of memory, which is equivalent to adding a super fast disk drive to the system. CP/M recognizes it as a disk drive.

The SMI 7080 Battery Backup Module option will switch to the battery supply to keep the memory alive if power fails. If the power loss is less than 0.5 seconds, the IN USE light comes on and

the power is drawn from the battery. If the loss is longer than 0.5 seconds, the beep tone sounds until the ac power is restored. The battery backup will keep the unit alive. However, if the loss exceeds 7 seconds, the backup dc supply will be cut-off. Then the beep will stop and all memory will be lost. This system is not, therefore, an uninterruptable power supply, but it does prevent loss of data when the electric company "blinks" as it often does.

User Comments. This highly flexible general-purpose microcomputer system worked beautifully (color and graphics were superb) once it was connected. Putting it all together, though, can be challenging. Using the computer revealed that the keys are too small and, therefore, somewhat uncomfortable to use as compared to larger, more conventional key designs.

Its expansion bus method, while neat in theory, is cumbersome in practice. Just getting the solid-state board to work took three tries.

Using the SMC-70 is simple enough. You insert the CP/M system disk and set a small switch on the left side to DISK position, and turn on the computer and the video monitor. The system does a self-check and the disk drives come on. The CP/M System Disk contains a few exceptional programs that are not found

Typical business configuration includes basic unit, dot-matrix printer, monitor and stand, numeric keypad, and two floppy disk drives mounted on the unit.



Is Your Cordless Phone Obsolete? YES — If It Doesn't Have a 1500-Foot Range! NEW HORIZONS Smashes the Distance Barrier with These Advanced Phones

The SuperFone 650 with TRUE TOUCHTONE®

Most cordless phones will work in Touchtone areas, but the phone itself won't generate a Touchtone signal.

The SuperFone 650 is a *true* Touchtone. From your pool, patio, or neighbor's home, you can use MCI, Sprint, PABX, or a computer code. Range is 1500 feet, *minimum*. Users report 1800 and 2000 feet. That's approaching half a mile. SuperFone 650 is a radiophone, not a gadget, and that's why the signal is crisp and strong even at distances that would leave most phones with nothing but a frustrated hiss.

A secret code system lets you choose from 512 combinations. No other signal can interfere. Change the code whenever you like.

Speakerphone, Intercom Features

The base station is a speaker phone. The base and unit have complete intercom capability, which means one person can roam the yard or warehouse and be in constant touch with the base.

A privacy button lets you hear the party on the other end of the line without his hearing you.

Automatic redial of the last number is a real convenience.

A security switch makes it impossible for anyone but you to make outgoing calls.

What else? A volume control for the speaker, a call-button to page the base from the cordless phone, and sound fidelity so good we challenge anyone to tell the difference between SuperFone 650 and a cord-phone.

How much for all this? \$239.95.



The Mini-SuperFone 620 — State-of-the Art Electronics

The SuperFone 620 is no bigger than a pack of cigarettes. It's the smallest high-performance phone in the world.

But it has a 1500-foot range. It also has private "security codes" — 512 of them. In fact, except for the speakerphone, paging system, and Touchtone® capability, it has all the features of its big brother, the SuperFone 650 — including incredible sound quality.

The SuperFone 620 is yours for \$159.95.



TRIPLE THE RANGE OF ANY CORDLESS PHONE!

The SuperAntenna will give your cordless phone, regardless of make or model, three times the range it has now.

If the range is 700 feet, it'll leap to over 2,000. If it's 1500 feet (the range of the phones on this page), it could be as far as one mile!

Easy to install. Only \$79.95 complete. Add \$4.50 for shipping.

The Tote & Talk Is a Decorator Cordless Phone with 1500-Foot Range and a 10-Phone-Number Memory

This extended-range cordless phone is absolutely gorgeous. Don't be misled by its beauty: it has a brain!

The Tote and Talk, made by Universal, is programmable. You can put ten of your most-called numbers into its memory, including a last-number redial. Then, by pushing two digits, you'll be able to dial any of those numbers.

Tote & Talk has a full intercom between the base station and the remote unit including a call button on each unit. It has the "Mute" privacy key, so you can hear the other party without his hearing you.

You'll be proud to display this phone. Put it on a countertop or hang it on the wall. The rich brown vinyl inset-panel matches any decor.

How much for this long-range decorator cordless phone? \$209.95 (if you don't need the 10-memory capability, it's even less — \$189.95).



The SuperFone 650, with True Touchtone dialing — \$239.95 (two for \$219.95 each)

The SuperFone 620, with 1500-Foot Range — \$159.95 (two for \$149.95 each)

The Tote & Talk, with 10 Memories — \$209.95 (two for \$199.95 each)

The Tote & Talk, without Memory Feature — \$189.95 (two for \$179.95 each)

The SuperAntenna, TRIPLES the Range of Any Cordless Phone — \$79.95

Please add \$4.50 per total order for shipping.

For instant service, if you have a VISA or MasterCard, call toll-free 24 hours a day, seven days a week.

800-443-0100

Ask for Extension 111

New marvels are what you expect from

NEW HORIZONS Dept. CE9, 5-31 Fiftieth Avenue
Long Island City, NY 11101

WE ABSOLUTELY GUARANTEE!

Use ANY of these wonder-phones, or the SuperAntenna, for up to 30 days. If for any reason you decide not to keep them, return them for a 100% refund.

Circle No. 53 on Free Information Card

AMAZING DEVICES

LASERS

RUBY LASER RAY GUN — Intense visible red beam. Burns and welds the hardest metals. HAZARDOUS device. Kits available. RUB3 PLANS includes part sources \$15.00

CARBON DIOXIDE BURNING AND CUTTING LASER — produces a continuous beam of energy. HAZARDOUS device — Kits available. LC5 PLANS includes part sources \$15.00

VISIBLE LASER LIGHT GUN — produces intense red beam for special effects and other various optical applications. Hand-held enclosure houses batteries. LGU3 PLANS \$10.00 LGU3K KIT/PLANS (minus tube) \$99.50

IR PULSED LASER RIFLE — produces 15-30 watt pulses at 9000A at 200-2000 per second. LRG3 PLANS \$10.00 LRG3K KIT/PLANS (minus diode) \$119.50

BEGINNER POCKET LASER — visible red simulated device. produces an excellent monochromatic source of light. LHC2 PLANS \$5.00 LHC2K KIT/PLANS \$24.50

HIGH ENERGY VARIABLE AND PROGRAMMABLE PAIN FIELD GENERATORS. REQUIRE NO CONTACT — Recently developed device produces directional fields of moderate to high SPL capable of producing intense pain and discomfort. HAZARDOUS IF NOT USED WITH DISCRETION. SOLO FOR ANIMAL CONTROL — MAY BE USED IN CERTAIN INSTANCES TO DISCOURAGE UNWANTED ENCOUNTERS. PPF1 PROG/VAR PLANS \$15.00 PPF1K KIT/PLANS \$175.00

PHASOR BURNING WAND — capable of burning flesh. generates 3500 volts of continuous DC power. PSW3 PLANS \$8.00 PSW3K KIT/PLANS \$59.50

PARALYZING SHOCKING WAND — produces 100,000 watt pulses of stunning power. PG1W PLANS \$10.00 PG1WK KIT/PLANS \$79.50

Above electrical devices are hand-held and may be used for PERSONAL DEFENSE.

SECURITY

SNODDER PHONE — allows user to call his premises and listen in without the phone ever ringing. SNP2 PLANS \$7.00 SNP2K KIT/PLANS \$49.50

LONG RANGE WIRELESS MIKE — miniature device clearly transmits over 1 mile. FBT9 PLANS \$7.00 FBT9K KIT/PLANS \$34.50

WIRELESS TELEPHONE TRANSMITTER — long range all automatic, undetectable. VWPM5 PLANS \$7.00 VWPM5K KIT/PLANS \$34.50

TALK AND TELL — clearly and automatically records both sides of a telephone conversation when phone is being used. TAT2K KIT/PLANS \$14.50 TAT20. READY TO USE \$24.50

Our order phone is available 24 HOURS. 7 DAYS A WEEK. Write for FREE catalog of our many products.

We accept Master Charge or Visa. Please allow 10% for shipping. On orders OVER \$50.00 WE PAY freight.

SEND TO: SCIENTIFIC SYSTEMS
DEPT 01, P.O. BOX 716 AMHERST, NH 03031
OR CALL FOR ORDERING ONLY: 1-603-673-4730

... SONY SMC-70

on the usual CP/M system disk. These include DIAG, a complete diagnostic check of the SMC-70 that includes all the peripherals. This is one of the most complete diagnostic programs I have ever seen in a user package. Then there is a BACKUP program. Selecting it from the directory enables the newest user to

ation. Not only that, but the power of this DBMS will match, or exceed any I have seen used with CP/M.

The SuperCalc implementation is not quite "standard" in that Sony has used color to enhance the spreadsheets so that they are easy to read and to use. This is one of the most imaginative uses



Expansion modules are installed between the main unit and power supply.

perform all of the disk format, system transfer, and backup functions, under the direction of the computer.

Another helpful program is SETUP. This presents a setup menu with programs selectable by number, including Time & Date Setting, Screen Attributes (such as color or monochrome with white letters), Disk Configuration (what drives are installed and active), and Automatic Program Execute.

These programs simplify using the SMC-70, especially when employed with the packaged applications programs supplied by Sony or other vendors.

We received a Word Processor and SuperCalc with our test machine as examples of the software being distributed by Sony. Calling major distributors of CP/M software to find out the extent of support for this computer, we learned that Lifeboat and most others will configure their complete catalog of CP/M-80 software in Sony format. A definite plus for Sony!

Of the programs supplied, we found the Word Processor very complete and thorough, but unwieldy to use and hard to learn. We suggest that a new owner buy one of the standard CP/M word processors in place of this one, unless he is very experienced with word processors. On the other hand, the DBMS (Data Base Management System) is first rate, and easy to use and to learn. It guides the user step-by-step through the system providing menus for every oper-

of color for business programming that I have ever seen. It is not restricted to the SuperCalc, either, since it is used throughout Sony's software. I am sure others will adopt these methods. Bravo Sony! When it comes to the use of color, it takes a back seat to none.

The documentation is really great, consisting of loose-leaf volumes of manuals protected by slip cases and illustrated with clear, understandable diagrams and photos.

Conclusions. What a strange beast this one is. Its very strength (flexibility) creates a great weakness (cumbersomeness). A complete setup is a klutzy-looking affair. The main computer section with a different-height power supply at its rear and an attached keyboard at its front that looks like it's a third element gives the setup disconcerting lines.

Top the foregoing off with a monitor that must be located on a stand that straddles the computer to get the proper viewing height and distance, coupled with a plug-in numeric keyboard that sits off to a side, and you get the picture.

The price marks aren't bad considering the obvious high quality and expandibility of the system, and the evident hardware and software support that Sony seems to be putting behind it. In sum, the technical side of the SMC-70 is super, while the modular going-their-own-way design offers great flexibility at the cost of some setup and appearance awkwardness. ◇



MAGIC "INPUT/OUTPUT" MUG

Let the world know when you're on a coffee break. When hot liquid is poured in, one message disappears and another takes its place on the computer screen. Fascinating to watch. Big 10 oz. size. Fine quality white English porcelain. 10 day money-back guarantee if not completely satisfied. \$8.95

Call Toll-Free Mon.-Fri. 9am-6pm
1-800-B-E-S-W-E-E-T
exc. Fla. or mail coupon.

sweet gum inc. CE093

15490 NW 7th Ave., N. Miami, FL 33169

Please send me the Magic "Input/Output" Mug.

Quant. ___ @ \$8.95 Add \$2 each for shipping & hand.

Fla. residents add 5% sales tax. Total \$ ___

Encl. is Check MO Charge my MasterCard

Visa Credit Card # _____

Exp. Date _____

★ Just send me your free COMPUTERMANIA Catalog for now. ★

Signature _____

Name _____

Address _____

City _____

State _____ Zip _____

Circle No. 16 on Free Information Card

COM-STAR F/T

Tractor Friction Printer

only **\$259**



- Lowest price quality tractor friction printer in the U.S.A. • Fast 80 characters per second
- 40, 46, 66, 80, 96, or 132 characters per line spacing • Prints labels, letters, graphs, and tables
- List your programs • Print out data from modem services

Deluxe COMSTAR F/T PRINTER — \$259.00

The Comstar is an excellent addition to any micro-computer system. (Interfaces are available for Apple, VIC-20, Commodore-64, Pet, Atari 400 and 800, and Hewlett Packard). At only \$259 the Comstar gives you print quality and features found only on printers costing twice as much. Compare these features.

• **BI-DIRECTIONAL PRINTING** with a LOGIC SEEKING CARRIAGE CONTROL for higher through-put in actual text printing. 80 characters per second.

• **PRINTING VERSATILITY:** standard 96 ASCII character set plus block graphics and international scripts. An EPROM character generator includes up to 224 characters.

• **INTERFACE FLEXIBILITY:** Centronics is standard. Options include EIA RS232C, 20mA Current Loop. (Add \$20.00 for RS232)

• **LONG LIFE PRINT HEAD:** 100 million character life expectancy.

• **THREE SELECTABLE CHARACTER PITCHES:** • 10, 12 or 18.5 characters per inch. 132 columns maximum. Double-width font also is standard for each character pitch.

• **THREE SELECTABLE LINE SPACINGS:** 6, 8 or 12 lines per inch.

• **PROGRAMMABLE LINE FEED:** programmable length from 1/144 to 255/144 inches.

COMSTAR F/T

ABCDEFGHIJKLMN O PQRSTUVWXYZ abcdefghijkl
lmnopqrstuvwxyz 1234567890
ABCDEFGHIJKLMN O PQRSTUVWXYZ abcdefghijklmnopqrstuvwxyz1234567890

SUPER-10"

ABCDEFGHIJKLMN O PQRSTUVWXYZ
ABCDEFGHIJKLMN O PQRSTUVWXYZ 1234567890

• **VERTICAL FORMAT CONTROL:** programmable form length up to 127 lines, useful for short or over-sized preprinted forms.

• **FRICTION AND TRACTOR FEED:** will accept single sheet paper.

• **224 TOTAL CHARACTERS**

• **USES STANDARD SIZE PAPER**

If you want more try —

Premium Quality COMSTAR F/T SUPER-10" PRINTER — \$299.00

More Features Than MX-80

For \$299 you get all of the features of the Comstar plus 10" carriage 120 cps, 9x9 dot matrix with double strike capability for 18 x 18 dotmatrix. High resolution bit image (120 x 144 dot matrix), underlining, backspacing, 2.3K buffer, left and right margin settings, true lower descenders, with super and subscripts, and prints standard, Italic, Block Graphics, special characters, plus 2K of user definable characters. For the ultimate in price performance the Comstar F/T Super 10" leads the pack!

80 COLUMN PRINTER \$189

Super silent operation, 60 CPS, prints Hi-resolution graphics and block graphics, expanded character set, exceptionally clear characters, fantastic print quality, uses inexpensive thermal roll paper!

Double Immediate Replacement Warranty

We have doubled the normal 90 day warranty to 180 days. Therefore if your printer fails within "180 days" from the date of purchase you simply send your printer to us via United Parcel Service, prepaid. We will IMMEDIATELY send you a replacement printer at no charge via United Parcel Service, prepaid. This warranty, once again, proves that WE LOVE OUR CUSTOMERS!

15 DAY FREE TRIAL OTHER OPTIONS

Extra Ribbons \$ 5.95
Roll Paper Holder 32.95
Roll Paper..... 4.95
5000 Labels 19.95
1100 Sheets Fan Fold Paper..... 13.95

Add \$20.00 shipping, handling and insurance. Illinois residents please add 6% tax. Add \$40.00 for CANADA, PUERTO RICO, HAWAII, ALASKA orders. WE DO NOT EXPORT TO OTHER COUNTRIES. Enclose cashiers check, money order or personal check. Allow 14 days for delivery, 2 to 7 days for phone orders, 1 day express mail available!! Canada orders must be in U.S. dollars.

PROTECTO ENTERPRISES (We Love Our Customers)

BOX 550, BARRINGTON, ILLINOIS 60010
Phone 312/382-5244 to order

Circle No. 69 on Free Information Card



Radio Shack

TRS-80

MODEL II
MICRO
COMPUTER

TRS-80 MICRO
CERTIFIED D

A Computerized DIALING SYSTEM FOR THE TRS-80 MODEL II

*Enhance the utility of this business machine
beyond billing, inventory,
and other office-type applications*

By James Barbarello

MOST TRS-80 Model II computers are used in a business environment. The utility of the computer in such cases can be expanded by adding the simple, inexpensive telephone dialer presented here. With a minor hardware addition and a little software, a TRS-80 Model II computer can "dial" any telephone number, maintain a phone book, and, when used in conjunction with the internal real-time clock, originate calls when desired. No modification of the Model II is required.

Phone Dialing. If you lift the handset of a conventional telephone and look at the cradle, you will see a pair of buttons that are normally depressed when the handset is in place.

When the handset is lifted from the cradle, these buttons automatically extend and close internal contacts (called the "hook switch") within the telephone body. If you could measure the dc voltage between the red and black leads attached to the telephone, you would note that about 48 volts will be present when the handset is in place. When the handset is lifted, current flows through the telephone and energizes a relay in the telephone office. This action also causes the dc voltage to drop to a low value. When the system in the phone office senses that "your" relay is operating, it searches for an idle dialing circuit to connect to your phone. When this occurs, you hear the familiar dial tone.

In a rotary telephone system, the dial acts as a short circuit until it is released and is spring returned to the rest position. As the dial rotates, it opens and closes the telephone lines as many times as the digit being dialed. Another switch contact within the telephone disconnects the earpiece until the dialing is finished.

Thus, for the purposes of dialing, a

telephone system represents a simple series circuit that is interrupted by the operation of the dial.

Since we are dealing with a series circuit, dialing can occur at any point on the line where it can be interrupted. The schematic for the computerized dialing system is shown in Fig. 1.

Circuit Operation. Prior to dialing, the computer signal to *J1* is a steady 5 volts dc. Since dc will not pass through capacitor *C1*, the voltage divider formed by *R1* and *R2* holds the trigger input of *IC1* (pin 2) above the trigger level, thus keeping the output at pin 3 close to ground. In this state, current flows through *R4*, *LED1*, and pin 3 to cause *LED1* to glow. Also, since no power is applied to the coil of relay *K1*, its normally closed contacts complete the dc circuit between PHONE jack *J3* and telephone LINE jack *J4*. In this state, the telephone works normally and is ready for everyday use.

When the computer signal drops from the +5-volt level to ground, the negative-going step passes through *C1* and triggers *IC1*. When this occurs, the output at pin 3 goes high to simultaneously turn off *LED1* while powering relay *K1* through *R5*. When the relay operates, it breaks the PHONE-LINE circuit in just the same manner as the rotary dialer. The time constant associated with *IC1* keeps pin 3 high for approximately 60 ms which is the same as the "break" time that is prescribed by the telephone company.

At the conclusion of the 60-ms interval, *IC1* times out, relay *K1* is de-energized, and *LED1* glows. Thus, by controlling the pulses coming from the computer, any number can be "dialed" just as is done when using the conventional rotary dialer. Power is provided by a 9-V, 100-mA dc plug-in supply through POWER connector *J2*.



...DIALING SYSTEM

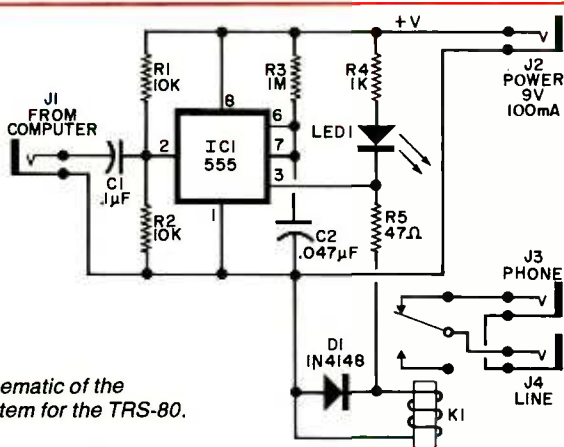

Fig. 1. Schematic of the dialing system for the TRS-80.

PARTS LIST

C1—0.1- μ F disk capacitor
 C2—0.047- μ F disk capacitor
 D1—1N4148
 IC1—555 timer
 J1— $\frac{3}{32}$ " phono jack
 J2— $\frac{1}{8}$ " phono jack
 J3, J4— $\frac{1}{4}$ " phono jack
 K1—spst subminiature relay (Radio Shack 275-216 or similar)
 LED1—Red light-emitting diode
 R1, R2—10-kilohm, $\frac{1}{4}$ -watt resistor
 R3—1-megohm, $\frac{1}{4}$ -watt resistor
 R4—1-kilohm, $\frac{1}{4}$ -watt resistor
 R5—47-ohm, $\frac{1}{4}$ -watt resistor

Misc.—9-volt/100-mA wall-mounted power supply, suitable cable, phono connectors, AP Products female header #929975, press-on type, suitable enclosure, mounting hardware.

Note: The following are available from J.J. Barbarello, R.D. #1, Box 241H, Tennent Rd., Englishtown, NJ 07726: diskettes containing all three programs (TRS-80 Model II, TRSDOS 2.0) at \$20, assembled interconnect cable that allows line printer and interface at the same time at \$15. NJ residents please add 5% sales tax.

Software. Three programs are required. Two, written in BASIC, maintain the computerized phone book and provide reports on phone usage, while the third is a machine-language program that controls the interface (Program 1). In this program, lines 110 and 120 turn off the real-time clock that would otherwise interrupt operation every 25 ms. Line 130 retrieves the digit to be dialed and stores it in the E register, while line 140 places a delay constant in the BC register pair for later use.

The actual dialing is performed in the loop of lines 150 through 200. Line 150 loads a 1 into the A register (this value is arbitrary), while line 160 sends this data to I/O port 0E1H the Parallel Printer Port (PPP) connector on the rear of the Model II. Whenever we send data to the "printer" via the PPP, we must inform the printer that valid data is on the lines. Pin 1 of the PPP connector (STROBE*) goes negative for an instant for this purpose. A special cable connects pin 1 of the PPP connector to J1 of Fig. 1. Thus, by sending "data" to the "printer," IC1 can be triggered. In Program 1, lines

170 and 180 use the delay constant previously loaded in the BC register pair (line 140) for a delay of 100 ms. (See the TRSDOS manual for an explanation of SVCs.) Line 190 decrements the number of times the phone line must be pulsed. If there are pulses remaining, line 200 returns operation to line 150 (loop); otherwise, line 210 returns to the BASIC program.

Program 2 contains the BASIC program that maintains a computerized phonebook. Line 10 clears 5000 bytes for string storage, and resets protected memory to EFE0H (one place below where the machine-language hardware controller will reside). It then loads "Phoner", the controller program. Line 15 gets the date entered when you started up the computer and converts it to a MM/DD/YY format, while line 20 opens the data file containing the phonebook entries and checks to see that it exists. If it does, it calls the subroutine at line 11000 to field buffer 1, which will be used to transfer data to and from the file. If it finds there are no entries, it initializes the file by placing blanks in all the records (line 30).

Lines 40 through 100 draw a graphic representation of a phonebook on the screen. Line 110 prompts you to press ENTER, whereupon lines 130 through 240 "open" the phone book to the first page which contains the instructions. Line 260 prompts you to press a letter key between A and Z to select that page in the phone book (both upper and lower case are accepted). When the selected letter is entered, lines 290 through 320 retrieve the data from the file and "turn" the page to that letter.

Line 330 calls a subroutine to print a prompt at the bottom of the screen. At this point the arrow keys are used to move the cursor to the row and column to be added to or modified. When the cursor is at the desired position, depressing "M" adds to, or modifies the data the cursor is pointing to. This takes place in lines 340 through 400.

When the "D" key is depressed to request dialing, line 580 draws an arrow in front of the number on the line the cursor is currently positioned on. You are then requested to depress ENTER when a dialtone is available, or ESC if you decide not to dial (or cannot get a

```

00010          00010          ;*****
00020          00020          ;* SOURCE=PHONER/ASM - - OBJ: PHONER *
00030          00030          ;* VERSION 1.0      13 JUNE 1982 *
00040          00040          ;* c 1982 by J.J. Barbarello *
00050          00050          ;* For use with Phone Dialing Hardware *
00060          00060          ;* *
00070          00070          ;*****
00080          00080          ;
00090          00090          ;
00100          00100          ORG 0E1EH ;In BASIC,use CLEAR 5000,4HEFE0
00110          00110          LD A,129 ;Use Register A contents to
00120          00120          OUT (255),A ; turn off Real-Time Clock.
00130          00130          EF5 5E ;Number of pulses into E register.
00140          00140          LD BC,15804;Delay to=.100 Sec (6.5*(BC-1)+22)
00150          00150          LD A,1 ;Load "1" into Register A.
00160          00160          OUT (0E1H),A;Send it to the "Line Printer".
00170          00170          LD A,6 ;Do DELAY Svc
00180          00180          RST B
00190          00190          EF0 1D ;One less pulse to do.
00200          00200          JR NZ,LOOP ;Go Back to LOOP unless E=0.
00210          00210          RET ;Return to BASIC calling program.
00220          00220          END
00000 TOTAL ERRORS
00000
LOOP EF59
    
```

Program 1. Machine-language program to control the interface.

The SINCLAIR TIMEX SINCLAIR Library

FROM CREATIVE COMPUTING PRESS

NEW!



The Best of Sync
Edited by Paul Grosjean

This new book is a must for all Sinclair and Timex Sinclair 1000 owners! Taken from the first six issues of *Sync* magazine, *The Best of Sync* covers: Games, Math and Math Graphics, Software Programming Techniques, Translation, Graphics, Machine Language, Hardware, Resources, Reviews, Glossary—and more! Get more from your computer with these hard-to-find programs, procedures and techniques—get *The Best of Sync!*

8½" x 11", Softbound, #6M \$9.95 (\$2.00)

The ZX81 Companion

By Bob Maunder



The ZX81 Companion follows the same format as the very popular *ZX80 Companion*, and assists the ZX81 or Timex Sinclair 1000 user in four applications areas: graphics, information retrieval, education and games. This practical guide contains scores of fully documented short routines plus complete programs and a disassembled listing of the ZX81 ROM Monitor. "Thoughtfully written, detailed, and illustrated with meaningful programs."—MUSE

5½" x 8", Softbound, #17P \$9.95 (\$2.00)

Getting Acquainted With Your ZX81

By Tim Hartnell

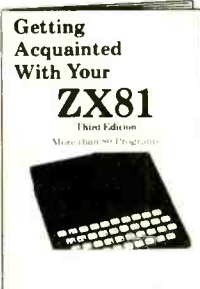

This informative volume for the new ZX81 or Timex Sinclair 1000 user contains more than 80 programs to help the reader get the most from his Sinclair computer. Game programs include Checkers, Alien Implosers, Blastermind, Moon Lander, Break-out, Star Burst and Derby Day. The book also shows programs for cascading sine waves, plotting graphs and tables, data sorting, equation solving, plus the use of PLOT, SCROLL, PRINT, TAB, PEEK, POKE and much more!

5½" x 8", Softbound, #15Y \$9.95 (\$2.00)

The Gateway Guide to the ZX81 and ZX80

By Mark Charlton

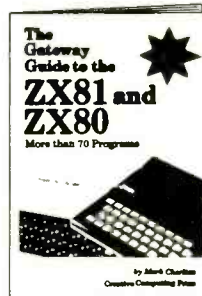

The Gateway Guide is a practical programming manual for the beginner that furnishes over 70 fully documented programs. The majority of the programs have been written for easy conversion from machine to machine (ZX81 or Timex Sinclair 1000, 4K ZX80 or 1K ZX80). *The Gateway Guide* describes each function and statement, illustrates it with a demonstration routine or program, and combines it with previously discussed material to help you understand your computer.

5½" x 8", Softbound, #160 \$9.95 (\$2.00)

Computers for Kids (Sinclair Edition)

By Sally Larsen

This new edition of *Computers for Kids* is written specifically to introduce children aged 8 to 13 to the ZX81 or Timex Sinclair 1000. The book requires no previous knowledge of algebra, variables or computers, and it enables a youngster to program a Sinclair in less than an hour. There's also a section for parents and teachers. "*Computers for Kids* is the best material available for introducing students to their new computer."—Donald T. Piele, Professor of Mathematics, University of Wisconsin-Parkside.

11" x 8½", Softbound, #12S \$4.95 (\$1.00)



CREATIVE COMPUTING PRESS

Dept. NF 1F, 39 East Hanover Avenue, Morris Plains, NJ 07950

Please send books listed below:

Book No.	Qty.	Title	Price Each	(P&H) Each	Total Price

CA, NJ and NY State residents add applicable sales tax

Postage and handling charges appear in parentheses () next to price of book.

TOTAL AMOUNT

PAYMENT ENCLOSED \$ _____ Outside USA add \$3.00 per order.

CHARGE MY: (Charge and phone orders \$10 minimum.)
 American Express MasterCard Visa

Card No. _____ Exp. Date _____

Signature _____

Mr./Mrs./Ms. _____ (please print full name)

Address _____ Apt. _____

City/State/Zip _____

Send me a FREE *Creative Computing* Catalog.

For Faster Service, PHONE TOLL FREE: 800-631-8112

(In NJ only: 201-540-0445)

Also available at your local bookstore or computer store.

```

1 REM**      HARDWARE/SOFTWARE PROJECT
2 NAME      PHONBOOK
3 REM**      LATEST UPDATE: #6, 9 OCT 19
4 REM**
5
6 CLS: CLEAR 5000, #HEF20: SYSTEM "LOAD PHONER": D
7 DEFSTR #HEF1: DEFSTR A-D: DIM A(21), I: DLN=STR
8 INGS(79, 150): DR=CHR$(26): DN=CHR$(25)
9 DTRE=MIDS(DATES, 16, 21)*"/": MIDS(DATES, 7, 2)*"/"
10 "MIDS(DATES, 11, 21): FOR I=1 TO 4: IF MIDS(DTE, I, 1)
11 = " THEN MIDS(DTE, I, 1) = "0": NEXT ELSE NEXT
12 OPEN "D", 1, "PHONBOOK/DAT", 48: FIELD 1, 48 AS A
13 DAT: IF LOP(1) <> 0 THEN GOSUB 11000
14 FOR I=1 TO 21: PRINT#(I, 10, 35), "INITI
15 ALIZING...": LET ADAT=SPACES(48): FOR I=1 TO 2
16 O 520: PUT 1, I: NEXT CLS: GOSUB 11000
17 FOR I=2 TO 21: A(I, 0)=SPACES(34): A(I, 1)=SPAC
18 ES(14): NEXT
19 PRINTCHR$(2); TAB(10); STRINGS(60, 155)
20 FOR I=1 TO 3: PRINT#(I, 10), DR; " "; DN; " ";
21 DR; " "; DN; TAB(68); DR; " "; DN; NEXT
22 PRINT#(4, 10), DR; " "; DN; " "; DR; " "; DN; TAB
23 (22); "A U T O M A T I C P H O N E B O O K
24 "; TAB(68); DR; " "; DN
25 PRINT#(5, 10), DR; " "; DN; " "; DR; " "; DN; TAB
26 (22); STRINGS(37, 150); TAB(68); DR; " "; DN
27 " "; DN; TAB(68); DR; " "; DN; NEXT
28 PRINT#(6, 10), DR; STRINGS(60, 152); DN
29 PRINT#(23, 33), "Press "; DR; " ENTER "; DN; CHR$(
30 1)
31 A=INPUTS(1): IF ASC(A) <> 13 THEN 120
32 PRINTCHR$(2)
33 PRINT#(4, 17), "      I N S T R U C T I
34 O N S
35 *****
36 PRINT#(6, 17), "
37
38 PRINT#(7, 17), "      The Automatic Phonebook
39 contains 26 Pages
40 PRINT#(8, 17), "      (A-Z). Each page may contain
41 up to 20 Names
42 PRINT#(9, 17), "      Phone Numbers. The last line
43 on the screen will
44 PRINT#(10, 17), "      always tell you what to do
45 next
46 PRINT#(11, 17), "      To use the Automatic P
47 honebook to dial a
48 PRINT#(12, 17), "      number, the AP hardware mu
49 t be connected, and
50 PRINT#(13, 17), "      you must have a dialtone.
51 PRINT#(23, 24), "Press a LETTER between A and
52 Z..."; CHR$(1)
53 A=INPUTS(1): A=CHR$(ASC(A)-"Z")+32+ASC(A): IF A<
54 "A" OR A>"Z" THEN 280
55 PRINT#(23, 0), CHR$(23); PRINT#(23, 28), "page
56 -"; A; "- selected. "; DR; " WAIT..."; DN; RN=(A
57 (A)-65)*20+1: J=2: FOR I=RTORN+19: GET 1, I: A
58 (J, 0)=LEFTS(ADAT, 34): A(J, 1)=RIGHTS(ADAT, 14)
59 J=J+1: NEXT I: CG#=#
60 PRINT#(1, 17), "      NAME....."; A; "
61
62 ..... NUMBER....."
63 FOR I=2 TO 20: PRINT#(I, 17), " "; A(I, 0); " "; A
64 (I, 1); " "; NEXT: PRINTCHR$(1)
65 GOSUB 10200
66 PRINT#(2, 18), " "; P=2: NC=18
67 A=INPUTS(1): NU=ASC(A): IF NU=9 THEN 350
68 IF NU=31 AND P<20 THEN P=P+1
69 IF NU=30 AND P>2 THEN P=P-1
70 IF NU=29 AND NC=18 THEN NC=53
71 IF NU=28 AND NC=53 THEN NC=18
72 IF A="M" OR A="m" THEN 530 ELSE IF A="D" OR
73 A="d" THEN 580
74 IF NU=1 THEN 430
75 PRINT#(P, NC); " "; GOTO 350
76 IF CG#=1 THEN PRINT#(23, 0), CHR$(23); TAB(12)
77 "Do you wish to SAVE the CHANGES you have
78 made Y(Y/N)..."; GOSUB 10010: GOTO 440 ELSE
79 PRINT#(23, 0), CHR$(23); PRINT#(23, 7), "No cha
80 nges made. "; GOTO 445
81 IF A="N" THEN PRINT#(23, 0), CHR$(23); " AL
82 L CHANGES CANCELLED. "; ELSE 480
83 PRINT#(23, 0), CHR$(23); TAB(30); DR; " F2 "; D
84 N; " TO CLOSE the book...";
85 A=INPUTS(1): A=CHR$(ASC(A)-"Z")+32+ASC(A): IF A<
86 "A" OR A>"Z" THEN 10050
87 IF A<"A" OR A>"Z" THEN 450
88 PRINT#(23, 0), CHR$(23); TAB(30); DR; " SAVING P
89 AGE..."; DN;
90 J=2: FOR I=RTORN+19: LET ADAT=A(J, 0)+A(J, 1)
91 PUT 1, I: J=J+1: NEXT I
92 PRINT#(23, 0), CHR$(23); TAB(10); "PAGE SAVED.
93 "; GOTO 445
94 REM**      MODIFY ENTRY **
95 PRINT#(23, 0), CHR$(23); "Type in New informat
96 ion, then press "; DR; " ENTER "; DN; " (or pre
97 ss "; DR; " ENTER "; DN; " for NO change)...";
98 PRINT#(P, NC), DR; A(P, (NC-18)+1): DN: PRINT#(P,
99 NC); "LINE INPUT A: IF LEN(A)=0 THEN 560
100 IF NC=18 THEN A(P, 0)=LEFTS(A, 34)+SPACES(34-
101 LEN(A)) ELSE A(P, 1)=LEFTS(A, 14)+SPACES(14-L
102 EN(A))
103 IF NC=18 THEN A(P, 0)=LEFTS(A, 34): IF LEN(A(P
104 , 0)) < 34 THEN A(P, 0)=A(P, 0)+SPACES(34-LEN(A
105 , 0))
106 IF NC=53 THEN A(P, 1)=LEFTS(A, 14): IF LEN(A(P
107 , 1)) < 14 THEN A(P, 1)=A(P, 1)+SPACES(14-LEN(A
108 , 1))
109 PRINT#(P, 18); A(P, 0); " "; A(P, 1): GOSUB 10210:
110 PRINT#(P, NC); " "; CG#=#: GOTO 350
111 REM**      DIAL PHONE NUMBER **
112 PRINT#(P, 50), DR; " "; DN; " "; PRINT#(23, 0), C
113 HR$(23); TAB(9); "Press "; DR; " ENTER "; DN; " w
114 hen DIALTONE is available, or "; DR; " ESC ";
115 DN; " to abort...";
116 A=INPUTS(1): IF ASC(A) <> 13 AND ASC(A) <> 27 TH
117 EN 590 ELSE IF ASC(A) = 27 THEN 640
118 PRINT#(23, 0), CHR$(23); TAB(35); "DIALING...";
119 CHR$(2);
120 NC=53: PRINT#(P, NC);
121 FOR X=1 TO 14: J=ASC(MIDS(A(P, 1), X))-48: IF J
122
123
124
125
126
127
128
129
130
131
132
133
134
135
136
137
138
139
140
141
142
143
144
145
146
147
148
149
150
151
152
153
154
155
156
157
158
159
160
161
162
163
164
165
166
167
168
169
170
171
172
173
174
175
176
177
178
179
180
181
182
183
184
185
186
187
188
189
190
191
192
193
194
195
196
197
198
199
200
201
202
203
204
205
206
207
208
209
210
211
212
213
214
215
216
217
218
219
220
221
222
223
224
225
226
227
228
229
230
231
232
233
234
235
236
237
238
239
240
241
242
243
244
245
246
247
248
249
250
251
252
253
254
255
256
257
258
259
260
261
262
263
264
265
266
267
268
269
270
271
272
273
274
275
276
277
278
279
280
281
282
283
284
285
286
287
288
289
290
291
292
293
294
295
296
297
298
299
300
301
302
303
304
305
306
307
308
309
310
311
312
313
314
315
316
317
318
319
320
321
322
323
324
325
326
327
328
329
330
331
332
333
334
335
336
337
338
339
340
341
342
343
344
345
346
347
348
349
350
351
352
353
354
355
356
357
358
359
360
361
362
363
364
365
366
367
368
369
370
371
372
373
374
375
376
377
378
379
380
381
382
383
384
385
386
387
388
389
390
391
392
393
394
395
396
397
398
399
400
401
402
403
404
405
406
407
408
409
410
411
412
413
414
415
416
417
418
419
420
421
422
423
424
425
426
427
428
429
430
431
432
433
434
435
436
437
438
439
440
441
442
443
444
445
446
447
448
449
450
451
452
453
454
455
456
457
458
459
460
461
462
463
464
465
466
467
468
469
470
471
472
473
474
475
476
477
478
479
480
481
482
483
484
485
486
487
488
489
490
491
492
493
494
495
496
497
498
499
500
501
502
503
504
505
506
507
508
509
510
511
512
513
514
515
516
517
518
519
520
521
522
523
524
525
526
527
528
529
530
531
532
533
534
535
536
537
538
539
540
541
542
543
544
545
546
547
548
549
550
551
552
553
554
555
556
557
558
559
560
561
562
563
564
565
566
567
568
569
570
571
572
573
574
575
576
577
578
579
580
581
582
583
584
585
586
587
588
589
590
591
592
593
594
595
596
597
598
599
600
601
602
603
604
605
606
607
608
609
610
611
612
613
614
615
616
617
618
619
620
621
622
623
624
625
626
627
628
629
630
631
632
633
634
635
636
637
638
639
640
641
642
643
644
645
646
647
648
649
650
651
652
653
654
655
656
657
658
659
660
661
662
663
664
665
666
667
668
669
670
671
672
673
674
675
676
677
678
679
680
681
682
683
684
685
686
687
688
689
690
691
692
693
694
695
696
697
698
699
700
701
702
703
704
705
706
707
708
709
710
711
712
713
714
715
716
717
718
719
720
721
722
723
724
725
726
727
728
729
730
731
732
733
734
735
736
737
738
739
740
741
742
743
744
745
746
747
748
749
750
751
752
753
754
755
756
757
758
759
760
761
762
763
764
765
766
767
768
769
770
771
772
773
774
775
776
777
778
779
780
781
782
783
784
785
786
787
788
789
790
791
792
793
794
795
796
797
798
799
800
801
802
803
804
805
806
807
808
809
810
811
812
813
814
815
816
817
818
819
820
821
822
823
824
825
826
827
828
829
830
831
832
833
834
835
836
837
838
839
840
841
842
843
844
845
846
847
848
849
850
851
852
853
854
855
856
857
858
859
860
861
862
863
864
865
866
867
868
869
870
871
872
873
874
875
876
877
878
879
880
881
882
883
884
885
886
887
888
889
890
891
892
893
894
895
896
897
898
899
900
901
902
903
904
905
906
907
908
909
910
911
912
913
914
915
916
917
918
919
920
921
922
923
924
925
926
927
928
929
930
931
932
933
934
935
936
937
938
939
940
941
942
943
944
945
946
947
948
949
950
951
952
953
954
955
956
957
958
959
960
961
962
963
964
965
966
967
968
969
970
971
972
973
974
975
976
977
978
979
980
981
982
983
984
985
986
987
988
989
990
991
992
993
994
995
996
997
998
999
1000
1001
1002
1003
1004
1005
1006
1007
1008
1009
1010
1011
1012
1013
1014
1015
1016
1017
1018
1019
1020
1021
1022
1023
1024
1025
1026
1027
1028
1029
1030
1031
1032
1033
1034
1035
1036
1037
1038
1039
1040
1041
1042
1043
1044
1045
1046
1047
1048
1049
1050
1051
1052
1053
1054
1055
1056
1057
1058
1059
1060
1061
1062
1063
1064
1065
1066
1067
1068
1069
1070
1071
1072
1073
1074
1075
1076
1077
1078
1079
1080
1081
1082
1083
1084
1085
1086
1087
1088
1089
1090
1091
1092
1093
1094
1095
1096
1097
1098
1099
1100
1101
1102
1103
1104
1105
1106
1107
1108
1109
1110
1111
1112
1113
1114
1115
1116
1117
1118
1119
1120
1121
1122
1123
1124
1125
1126
1127
1128
1129
1130
1131
1132
1133
1134
1135
1136
1137
1138
1139
1140
1141
1142
1143
1144
1145
1146
1147
1148
1149
1150
1151
1152
1153
1154
1155
1156
1157
1158
1159
1160
1161
1162
1163
1164
1165
1166
1167
1168
1169
1170
1171
1172
1173
1174
1175
1176
1177
1178
1179
1180
1181
1182
1183
1184
1185
1186
1187
1188
1189
1190
1191
1192
1193
1194
1195
1196
1197
1198
1199
1200
1201
1202
1203
1204
1205
1206
1207
1208
1209
1210
1211
1212
1213
1214
1215
1216
1217
1218
1219
1220
1221
1222
1223
1224
1225
1226
1227
1228
1229
1230
1231
1232
1233
1234
1235
1236
1237
1238
1239
1240
1241
1242
1243
1244
1245
1246
1247
1248
1249
1250
1251
1252
1253
1254
1255
1256
1257
1258
1259
1260
1261
1262
1263
1264
1265
1266
1267
1268
1269
1270
1271
1272
1273
1274
1275
1276
1277
1278
1279
1280
1281
1282
1283
1284
1285
1286
1287
1288
1289
1290
1291
1292
1293
1294
1295
1296
1297
1298
1299
1300
1301
1302
1303
1304
1305
1306
1307
1308
1309
1310
1311
1312
1313
1314
1315
1316
1317
1318
1319
1320
1321
1322
1323
1324
1325
1326
1327
1328
1329
1330
1331
1332
1333
1334
1335
1336
1337
1338
1339
1340
1341
1342
1343
1344
1345
1346
1347
1348
1349
1350
1351
1352
1353
1354
1355
1356
1357
1358
1359
1360
1361
1362
1363
1364
1365
1366
1367
1368
1369
1370
1371
1372
1373
1374
1375
1376
1377
1378
1379
1380
1381
1382
1383
1384
1385
1386
1387
1388
1389
1390
1391
1392
1393
1394
1395
1396
1397
1398
1399
1400
1401
1402
1403
1404
1405
1406
1407
1408
1409
1410
1411
1412
1413
1414
1415
1416
1417
1418
1419
1420
1421
1422
1423
1424
1425
1426
1427
1428
1429
1430
1431
1432
1433
1434
1435
1436
1437
1438
1439
1440
1441
1442
1443
1444
1445
1446
1447
1448
1449
1450
1451
1452
1453
1454
1455
1456
1457
1458
1459
1460
1461
1462
1463
1464
1465
1466
1467
1468
1469
1470
1471
1472
1473
1474
1475
1476
1477
1478
1479
1480
1481
1482
1483
1484
1485
1486
1487
1488
1489
1490
1491
1492
1493
1494
1495
1496
1497
1498
1499
1500

```

Program 2. BASIC program to maintain a computerized phonebook.

dialtone). Line 600 informs when dialing has begun, line 620 searches through the 14 positions in the number column, and disregards all but those containing digits 0 through 9, while line 630 makes the digit in question black on white (reverse video) to highlight which digit is presently being dialed. It then calls the subroutine at line 10100 to perform the actual dialing. When dialing is complete, line 635 passes execution to the Log Call subroutine, starting at line 12000. When the call has been completed, execution returns to line 350.

The Dial subroutine (line 10110) checks for a "0" and converts it to the decimal number 10. The routine then calls the controller program (via the USR command), passing the digit to be dialed (J%), and waits for approximately one second and returns.

The Log Call subroutine (Lines 12010 through 12130) starts by prompting you to press ENTER when the call begins, or ESC to abort logging. If you press ENTER (ASCII 13), line 12050 obtains the current time (HH.MM.SS.),

prints it as "START:", and asks you to press ENTER when the call is completed. Line 12050 also turns on the real-time clock display, which is shown in the upper right of the screen. This allows you to monitor how long the call is lasting. When you finish the call and press ENTER, line 12070 gets the current time, turns off the real-time clock presentation, and restores the graphics that were erased by the clock. Lines 12080 through 12130 calculate the call length, then store it, the start time, date, and the phone-book entries for the name and number of the person called. This information is stored in the Phonelog/Dat file for later access. At this point, execution continues through line 13010, which clears the command line and returns from the subroutine.

Phonelog Report Generator (Program 3) is a menu-driven program that retrieves the logging data and prints a report (to the screen or to a line printer). The three menu options are subroutines beginning at lines 1000, 2000, and 3000 respectively. The END option (starting

at line 3000) closes the file and ends the program. The remaining two options are essentially identical, except that one provides the data to the screen and the other to any 80-column line printer.

The report may include all data in the file, or you can select a range of months of logging data. In this way, you can maintain a full calendar year of data, printing only what you wish each time. To retain this data after the year's end, rename the data file (i.e. Phonelog/83) using BASIC's Name command (see your user's manual for details). Then a new Phonelog/Dat file will be automatically started the next time you use the Phonbook program.

To print data for a single month, enter the same month number for both Start and Finish. If you enter a Start number less than 1 or greater than 12 you will be informed that this is an *Invalid Input* and allowed to try again, or return to the menu. Similarly, if you enter a Finish number that is less than the Start or greater than 12, it will also be treated as an *Invalid Input*.



Call for Price & Information on
Franklin 1000, 1100, 1200 and
other NEW Franklin Hardware &
Software & Special System Pricing

MICRO-SCI

Apple & Franklin

A2	\$249.00
A40	\$349.00
A70	\$459.00
C2 Controller	\$79.00
C47 Controller	\$89.00

RANA

Elite I (Apple/Franklin)	\$279.00
Elite II (Apple/Franklin)	CALL
Elite III (Apple/Franklin)	CALL

PRINTERS

EPSON

MX80 FT. MX100	CALL
RX80	CALL
FX80, FX100	CALL

OKIDATA

82 83 84	CALL
92 93	CALL

STAR

Stx 80	\$169.00
Gemini 10	\$299.00
Gemini 15	\$479.00
Serial Board	\$75.00

SMITH CORONA

TP-1	\$469.00
TP-2	CALL
Tractor Feed	\$129.00

C.I.TOH

Gorilla	\$209.00
Prowriter 8510P	\$379.00
Prowriter 1550P	\$689.00
Starwriter F10.40P	\$1149.00
Printmaster F10.55P	\$1569.00
Tractor Feed	\$109.00

DIASYSWRITER

2000 Letter Quality	\$1149.00
2500 "NEW"	CALL
Tractor Feed	\$109.00

DIABLO

620	\$949.00
630	\$1769.00

IDS

Call for ALL Configurations on
IDS PRISM PRINTERS

NEC

8023	\$399.00
7710/7730	\$2149.00
3510/3530	\$1549.00

PC-1500A SHARP

POCKET COMPUTER \$169

PC-1250A \$89.00

125 Printer/Micro Cassette	\$129.00
150 Printer/Plotter/Cassette	\$172.00
151 4K RAM	\$55.00
152 Cassette Recorder	\$62.00
155 8K RAM	\$94.00
158 8K RAM Battery	\$129.00
161 16K RAM	\$139.00



east
800-233-8950
In PA call (717)327-9575, Dept. 907
Order Status Number: 327-9576
477 E. 3rd St., Williamsport, PA 17701



CBM 8032 \$599

CBM 64 \$229
VIC 20..... \$99

1520 Color Printer/Plotter	\$169.00
1525 80 Column Printer	\$219.00
1526	\$319.00
1530 Datasette	\$69.00
1541 Single Disk Drive	\$249.00
1600 VIC Modem	\$59.00
1650 AD/AA Modem	\$89.00
1701 14" Color Monitor	\$249.00

FLOPPY DISKS

MAXELL

MD-1	\$32.00
MD-2	\$44.00
FD-1(8)	\$40.00
FD-2(8 DD)	\$50.00

ELEPHANT

5 1/4 SS SD	\$18.95
5 1/4 SS DD	\$24.95
5 1/4 DS DD	\$29.95

VERBATUM

5 1/4 SS DD	\$26.00
5 1/4 DS DD	\$36.00

HEAD

Disk Head Cleaner	\$14.95
-------------------	---------

DISK HOLDERS

INNOVATIVE CONCEPTS

Flip-n-File 10	\$4.00
Flip-n-File 50	\$19.00
Flip-n-File 400, 800 Cart	\$19.00

MONITORS

AMDEK

300G	\$149.00
300A	\$159.00
310A	\$169.00
Color I	\$279.00
Color I plus	\$299.00
Color II	\$399.00
Color III	\$349.00
Color IV	\$999.00

ZENITH

ZVM 121	\$95.00
ZT1 Terminal	\$369.00

BMC

12" Green	\$85.00
9191 13" Color	\$299.00

TAXAN

12 N Green	\$129.00
12 A Amber	\$139.00

GORILLA

12" Green	\$89.00
-----------	---------

U.S.I.

Pi 1. 9" Green	\$99.00
Pi 2. 12" Green	\$119.00
Pi 3. 12" Amber	\$159.00
Pi 4. 9" Amber	\$139.00
1400C 14" Color	\$299.00

ATARI™ HOME COMPUTERS



16K
ATARI
400®



\$79.00 ATARI 400
- \$50.00 REBATE FROM ATARI
\$29.00

+ \$100.00 410 PROGRAM RECORDER
\$129.00 TOTAL PACKAGE PRICE

16K 600 XL..... \$149

CALL FOR PRICING ON THE
ENTIRE XL ATARI LINE!



DISK DRIVES FOR ATARI

AT88-S1	\$369.00
AT88-A1	\$299.00
AT88-S2	\$569.00
AT88-S1 PD	\$419.00
AT88-S2 PD	\$669.00
AT88-DDA	\$139.00
AT44-S1	\$579.00
AT44-S2	\$969.00
Texas Instruments Drive	\$369.00

JOYSTICKS

WICO

JoyStick	\$21.95
Famous Red Ball	\$23.95
Power Grip	\$21.95
Three-Way Deluxe	\$22.95
Atari/VIC Trackball	\$34.95
Apple Trackball	\$59.95

KRAFT

Atari Single Fire	\$13.00
Atari Switch Hitter	\$16.00
Apple Joystick	\$44.00
Apple Paddles	\$39.00

MDEMS

HAYES

Smart	\$219.00
Smart 1200 (1200 Baud)	\$519.00
Chronograph	\$199.00
Micromodem 100	\$309.00
Micromodem II	\$279.00
Micromodem II (with term)	\$299.00
Smart Com II	\$99.00
Smart 1200B	\$469.00

NOVATION

J-Cat	\$119.00
Cat	\$144.00
D-Cat	\$159.00
103 Smart Cat	\$189.00
Apple Cat II	\$279.00
103/212 Smart Cat	\$439.00
212 Apple Cat II	\$609.00
Apple Cat II 212 Upgrade	\$309.00

ANCHOR

Mark I (RS-232)	\$79.00
Mark II (Atari)	\$79.00
Mark III (T..I. 99)	\$109.00
Mark IV (CBM-PET)	\$125.00
Mark V (Osborne)	\$95.00
Mark VI (IBM-PC)	\$179.00
Mark VII (Auto Ans/Auto Dial)	\$119.00
Mark VIII	\$269.00
TRS-80 Color Computer	\$99.00
9 Volt Power Supply	\$9.00

\$29

*PACKAGE
PRICE
AFTER
REBATE

1010 Program Recorder	\$74.00
1020 40 Col. Printer/Plotter	\$249.00
1025 80 Col. Printer	\$449.00
1027 Letter Quality Printer	\$299.00
1050 Disk Drive	\$379.00
850 Interface	\$169.00
1030 Direct Connect Modem	CALL

MEMORY

Axlon 32K Ram	\$59.00
Axlon 48K Ram	\$99.00
Axlon 128K Ram	\$299.00
Intec 32K Board	\$59.00
Intec 48K Board	\$85.00
Intec 64K Board (400 only)	\$99.00

RANA

1000 Atari Disk Drive	\$319.00
-----------------------	----------



MBC-555	\$795.00
MBC-1000	\$1599.00
MBC-160 Drive	\$539.00
PR5500 Letter Quality Printer	\$699.00

TIMEX SINCLAIR \$39.95 1000

16K Memory	\$44.95
2040 Printer	\$99.95
Vu-Calc	\$17.95
Check Book Manager	\$13.95
Organizer	\$14.95
Budgeter	\$13.95
Stock Option	\$14.95
Loan & Mortgage Amortizer	\$12.95
Mindware Printer	\$109.00



HEWLETT PACKARD



HP 41CV... \$209.00

HP 75	\$749.00
HP 41C	\$146.00
HP 10C	\$52.00
HP 11C	\$69.00
HP 12C	\$92.00
HP 15C	\$92.00
HP 16C	\$92.00

For HP41/41CV

HPIL Module	\$99.00
HPIL Cassette or Printer	\$359.00
Card Reader	\$144.00
Extended Functions Module	\$64.00
Time Module	\$64.00



computer mail order west

800-233-8950

In PA call (717)327-9575, Dept. 907
Order Status Number: 327-9576
477 E. 3rd St., Williamsport, PA 17701

800-648-3311

In NV call (702)588-5654, Dept. 907
Order Status Number: 588-5654
P.O. Box 6689, Stateline, NV 89449

```

1 REM**      PHONELOG REPORT GENERATOR
2 REM**      NAME: PLOGRPT
3 REM**      LATEST UPDATE: 0 0, 9 OCT 1
4 REM**      982
10 CLS: CLEAR 1000: DEFSTR A-D: DLM=STRING$(79,15
0): DR=CHR$(26): DN=CHR$(25): ON ERROR GOTO 15
000
20 OPEN"D",1,"PHONELOG/DAT",72: FIELD 1,8 AS DT
E,8 AS STARTS,8 AS TTLS,34 AS NMS,14 AS NU
MBS
30 CLS: PRINT$(4,15),"PHONE LOG REP
OR T G E N E R A T O R": PRINTDLN
40 PRINT$(8,20),"TASKS":
50 PRINT$(10,25),DR;" 1. ";DN;" Print Report to
SCREEN"
60 PRINT$(12,25),DR;" 2. ";DN;" Print Report to
PRINTER"
70 PRINT$(14,25),DR;" 3. ";DN;" END."
80 PRINT$(18,24),"Press ";DR;" NUMBER ";DN;" o
f TASK desired...";
90 A=INPUT$(1): IF VAL(A)<1 OR VAL(A)>3 THEN 90
100 ON VAL(A)GOSUB 1000,2000,3000:GOTO 30
1000 CLS:PRINTTAB(22);"T A S K # 1: Print Repor
t To SCREEN":PRINTLN:Z=0
1010 GOSUB 11000:IF A="R" THEN RETURN
1020 GOSUB 10000:IF A="R" THEN RETURN
1030 CLS:PRINTTAB(15);"Phone Usage Report for Mo
ntha ";DR:SM:DN;" through ";DR:FM:DN:PRINTD
LN
1040 PRINT"DATE";TAB(10);" START";TAB(20);" USAG
E";TAB(30);" PHONE NUMBER";TAB(45);"PHONEBOO
K ENTRY FOR PERSON CALLED":PRINTLN
1050 FOR I=1 TO 60: GET I,1: IF VAL(DTE)<SM OR VAL
(DTE)>FM THEN 1080
1060 PRINTDTE;TAB(10);STARTS;TAB(20);TTLS;TAB(30
);NUMBS;TAB(45);NMS;Z=Z+1
1080 NEXT I:PRINT:PRINTZ;"ENTRIES FOUND. ";GOTO11
110
2000 CLS:PRINTTAB(22);"T A S K # 2: Print Repor
t to PRINTER":PRINTLN:Z=0
2010 GOSUB 11000:IF A="R" THEN RETURN
2020 GOSUB 10000:IF A="R" THEN RETURN
2030 PRINT$(2,0),CHR$(24);PRINT$(10,20),"PREPAR
E PRINTER. ";GOSUB 11110
2040 PRINT$(10,15),"PRINTING REPORT. Place print
er ";DR;" OFF LINE ";DN;" to Abort...";
2050 LPRINT TAB(15);"Phone Usage Report for Mont
h";SM;" through ";FM:LPRINTSTRING$(79,"-")
2060 LPRINT"DATE";TAB(10);" START";TAB(20);" USA
GE";TAB(30);" PHONE NUMBER";TAB(45);"PHONEBOO
K ENTRY FOR PERSON CALLED":LPRINT STRING$(
79,"-");LPRINT
2070 FOR I=1 TO 60: GET I,1: IF VAL(DTE)<SM OR VAL
(DTE)>FM THEN 2100
2080 LPRINTDTE;TAB(10);STARTS;TAB(20);TTLS;TAB(3
0);NUMBS;TAB(45);NMS;Z=Z+1
2100 NEXT I:PRINT:PRINTZ;"ENTRIES PRINTED."
2110 PRINT$(12,18),"REPORT COMPLETED. ";GOTO 11
110
3000 CLS:PRINTTAB(30);"T A S K # 3: END":PRINTD
LN
3010 GOSUB 11000:IF A="R" THEN RETURN
3020 PRINT$(10,35),DR;" WAIT...";DN;
3030 CLOSE:PRINT$(10,32),DR;" PROGRAM ENDED ";DN
:PRINT$(18,0);END
10000 PRINT$(3,0),"Enter START Month for Report (
1 - 12 )...";CHR$(23);LINE INPUT A
10010 SM=VAL(A):IF SM<1 OR SM>12 THEN PRINT$(3,50
),"INVALID INPUT":GOSUB 11020:IF A="R"THE
N RETURN ELSE 10000
10020 PRINT$(5,0),"Enter FINISH Month For Report
(";SM;"-";12 );...";CHR$(23);LINEINPUT A
10030 FM=VAL(A):IF FM<SM OR FM>12 THEN PRINT$(5,5
0),"INVALID INPUT":GOSUB 11020:IF A="R"TH
EN RETURN ELSE 10020
10040 PRINT$(10,10),"REPORT FOR MONTHS";SM;"THROU
GH";FM;" O.K. (Y/N)?...";
10050 GOSUB 11210:IF A="N"THEN A="R":RETURN ELSE
RETURN
11000 REM** CONTINUE/RETURN QUERY SUBROUTINE
11010 PRINT$(2,0),CHR$(24)
11020 PRINT$(22,0),CHR$(23);STRING$(21,150);">";
PRINT$(22,60),"<";STRING$(18,150);PRINT$(2
2,28),DR;" C ";DN;"continue, or ";DR;" R ";D
N;"Etcn...";
11030 A=INPUT$(1):IF ASC(A)>96 THEN A=CHR$(ASC(A)
-32)
11040 IF A<>"C" AND A<>"R" THEN 11020ELSE PRINT$(
22,0),CHR$(23);PRINT$(2,0);RETURN
11100 REM** PRESS ANY KEY UTILITY **
11110 PRINT"Press ANY key to continue...";
11120 A=INPUT$(1):RETURN
11200 REM** YES/NO ANSWER UTILITY
11210 A=INPUT$(1):NU=ASC(A):IF NU>96 THEN NU=NU-3
2:A=CHR$(NU)
11220 IF A<>"Y" AND A<>"N" THEN 11210ELSE PRINT A
:RETURN
11400 REM** LOWER/UPPER CASE SHIFT UTILITY - SH
IFT STRINGA **
11410 FOR X=1 TO LEN(A):NU=ASC(MID$(A,X,1)):MIDS(
A,X,1)=CHR$(NU-(MID$(A,X,1)>"Z")*32):NEXT
11420 RETURN
15000 REM** ERROR TRAPPING ROUTINE
15010 PRINT DR:CLS:PRINT$(9,25),"ERROR #";ERR;"OC
CURRED IN LINE #";ERR;
15020 IF ERR=56 THEN PRINT$(10,25),"(Printer Not
Available)"
15030 PRINT$(11,25),"Press ANY Key to Continue...
";
15040 A=INPUT$(1):PRINT DN:RESUME 30

```

Program 3. Phonelog report generator program.

Construction. Since there is nothing sensitive in the circuit and it is simple, any type of construction can be used.

The finished board is mounted within any type of enclosure with LED1, and the four jacks (J1 through J4) mounted on the front panel and suitably marked. Power can be obtained from any wall-socket supply that can deliver 9 V at 100 mA. The power comes through J2.

The interconnecting cable between the computer and dialer is fabricated from a 4-foot (approximate) length of shielded audio cable. One end is terminated in a phono plug that mates with J1, and the other end is terminated on a header that mates with the parallel printer port edge connector on the rear apron of the computer. Solder the braid to pin 24 of this connector and the center lead to pin 1.

This header uses an AP Products female header 929975, cut so that there is a double row of 19 contacts.

Loading Software. Enter Program 2 and save it under the name Phonbook. Then enter NEW and enter Program 3, saving it under the name Plogrpt.

The easiest way to load machine-language Program 1 is to use the TRSDOS utility Debug. Enter SYSTEM to enter

the TRSDOS Ready mode. Now enter DEBUG ON. When TRSDOS READY appears again, enter DEBUG. Next, press M, type EFE1, and then the F1 key (do not press ENTER). The top portion of the screen will appear similar to Program 4, with the cursor at the first position on the EFE1 and EFF1 lines (do not press the spacebar or ENTER key). Then check to see that all characters were entered correctly. If you find an error, use the arrow keys to position the cursor over the incorrect entry and type in the correct character.

When all characters are correct, press the F2 key to transfer the code to memory. Press O (letter) to turn Debug off. Now type DUMP PHONER (START=EFE1, END=EFF3) and press ENTER. When TRSDOS READY again appears, enter DIR

and note that you now have a new program named Phoner. Before proceeding, make a backup of the disk containing all three programs—just in case. Finally, enter the TRSDOS Ready mode and type Auto BASIC Phonbook -F:2 and press ENTER. This will cause the computer to automatically load BASIC and run the Phonbook program the next time you start up your Model II with this disk.

Using the System. Before using the system, you will have to prepare your phone line. This consists of cutting the tip (red) wire and connecting the two resulting ends to the tip lugs of two 1/4" phono plugs. All remaining wires in the incoming cable should remain intact. Whether to cut or not must be your decision, since there are many possibilities of phone hookups. If you have a modular plug system, you may wish to keep the cable intact, and use modular jacks wired into the interface. In any event, you must interrupt the tip (red) wire before it enters the phone, and connect the resulting wires to the J3-TIP and J4-TIP points.

When the J3 and J4 plugs (or connections) have been made, connect the interface cable to the Model II and the interface. Finally, connect the power supply cable to J2 and plug it into a 120-V ac outlet. If the power supply does not have a 1/4" phono plug on the dc end, you can either use a mating jack for J2 or connect a 1/4" phono plug to the dc end. If you modify the supply, be sure the +9-volt lead goes to the tip of the 1/4" phono plug, and the remaining wire goes to the phono plug's "plug" lug.

Run the Phonbook program. Then follow the directions that appear on the last screen line. Select a page in the book and enter some phone numbers. Save the new (modified) page, and continue on to other pages.

Now select a number to dial. Note that LED1 on the interface is glowing. Pick up your handset, and obtain a dialtone. Then press ENTER to begin dialing. You will note that LED1 pulses in unison with the dialing. Since you are not using the phone's dial, its muting

```

TRS=80 Model II DEBUG Program
EFE1 3E 81 03 FF 5E 01 BC 3D 3E 01 D3 E1 3E 06 CF 1D >.....>
EFF1 20 F6 C9 00 00 00 00 00 00 00 00 00 00 00 00 11 .....
F001 FF FF FF FF FF FF FF FF FF FF FF FF FF FF FF FF .....
F011 FF FF FF FF FF FF FF FF FF FF FF FF FF FF FF FF .....
F021 FF FF FF FF FF FF FF FF FF FF FF FF FF FF FF FF .....
F031 FF FF FF FF FF FF FF FF FF FF FF FF FF FF FF FF .....
F041 00 00 00 00 00 00 00 00 00 00 00 00 00 00 00 .....
F051 00 00 00 00 00 00 00 00 00 00 00 00 00 00 00 .....
PC SP S2HPNC AF BC DE HL LX LY AP BC DE HL
? P 280 21FE 000000 0000 0000 0009 0000 0000 0000 0000 0000 0000

```

Program 4. Debugging program.

THIS MONTH'S SUPER DEALS!



ATARI 800
•Home Computer
•8K RAM
\$479⁹⁵

ATARI COMPUTERS
ATARI 400 \$149.95
ATARI 1100XL (i540) \$499.95

ATARI HARDWARE
ATARI 1010 Program Recorder \$79.95
ATARI 810 Disk Drive \$429.95
ATARI 850 Acoustic Modem \$149.95
ATARI 850 Interface Module \$169.95
TARA C-32 12K Boot \$59.95
ALTRA GROUP AL5003 (Voice Box) \$99.95

SOFTWARE LISTED BELOW COMPATIBLE WITH ATARI HOME COMPUTER SYSTEMS
ATARI SOFTWARE
CX-4024 GALAXIAN \$34.95
CX-4022 CENTIPIDE \$34.95
CX-4023 PAC-MAN \$34.95
CX-4025 SUPERHERO \$34.95
DX-5048 PAINT \$34.95
DX-5050 MUCKEY IN THE GREAT OUTDOORS \$39.95
RX-8031 DONKEY KONG \$38.95
ATARI PROGRAM EXCHANGE SOFTWARE WORD PROCESSOR (Disk) \$44.95
EASTERN FRONT (Disk) \$77.95
747 LANDING SIMULATOR (Disk) \$19.95
MAPWARE (Disk) \$21.90
ON-LINE SOFTWARE
PROGGER (32K Disk) \$29.90
WIZARD & PRINCESS (Disk) \$27.95
THRESHOLD (Disk) \$29.95
MOUSE ATTACK (Disk) \$29.95

THORN BBS SOFTWARE
BRITISH HERITAGE PT II (Cassette) \$24.90
SUPERVICERS & SLIP \$24.95
HOME FINANCIAL MANAG. \$24.95
JUNBO JET PILOT (Cartridge) \$39.90
SUMMERHILL \$39.95
APPLE & FRANKLIN SOFTWARE
ADVENTURE INTERNATIONAL SOFTWARE
PREDATOR (Disk) \$22.95
SEA DRAGON (Disk) \$26.95
TUNNEL THROU (Disk) \$22.95
RECORDING SOFTWARE
STAR BLAZER \$24.95
TRACK ATTACK \$23.95
EDUWARE SOFTWARE
ALGEBRA \$29.90
COMPUSPELL LEVEL 4 \$17.90
ON-LINE SOFTWARE
PROGGER \$29.90
ULTRIA II \$36.90
WIZARD AND PRINCESS \$26.90

COMPUTER BOOKS
KIDS & THE ATARI \$16.95
KIDS & THE APPLE \$16.95
KIDS & THE VIC \$16.95
ATARI SOUND & GRAPHICS \$10.95
1001 THINGS TO DO WITH YOUR PERSONAL COMPUTER \$9.95

STEREO-TO-GO
SONY WMS (Cass. Stereo) \$177
SONY MAF (i8 Cass. Stereo) \$119.95
SANYO MC-100 (Cass. Stereo) \$29.95
SANYO MC-160 (Dobly/Cass) \$54.95
ARNA HSP-02 (Cass./Ster. Auto Rec) \$124.95
ARNA HSP-02 (FM/Cass./Ster.) \$124.95
TOSHIBA KTS-3 (FM/Cass. Stereo) \$59.95
TOSHIBA KTS-5 (AM/FM/Cass) \$64.95
PANASONIC RQ120X (Cass. Disk) \$124.95
PAC CO-1 (Cass. Dobly) \$74.95
PAC CO-2 (Cass./FM Stereo) \$94.95

TEXAS INSTRUMENTS T100/4A •16K RAM
\$169⁹⁵

TI HARDWARE
PMP 1500 Speech Synthesizer \$114.95
PMP 1600 Telephone Modem \$169.95
PMP 1200 Peripheral Expansion \$179.95
PMP 1230 8K/32K Card \$129.95
PMP 1850 Disk Memory Drive \$359.95
PMP 1260 128K RAM Card \$219.95

TIMEX SINCLAIR COMPUTER
TIMEX SINCLAIR HARDWARE
TIMEX SINCLAIR 1000 \$44.95
TIMEX TS-1500 (16K Computer) \$64.95
TIMEX 1018 16K RAM Expansion \$64.95
TIMEX SINCLAIR PRINTER 2040 \$89.95
MEMOTECH KEYBOARD II (TS-1000) \$64.95
TIMEX SINCLAIR MEMOPAK
MEMOTECH 16K Exp. for Timeo \$44.95
MEMOTECH 32K Exp. for Timeo \$79.95
MEMOTECH 64K Exp. for Timeo \$119.95
MEMOTECH PERIPHERALS DESIGNED TO FIT TOGETHER IN PROXY-BACK FASHION

TIMEX TS-1000 SOFTWARE
TIMEX Flight Simulator \$18.95
TIMEX Frogger \$16.95
TYBENT Adventure Baseball \$16.95
SOFTSYNC MotherShip \$14.95
TIMEXWORKS Outmaster \$13.95
XIBMAC Cubes \$11.95
XIBMAC Princess of Kraal \$11.95

SHARP COMPUTERS
SHARP PC-1500 \$199.95
PC-1250 (Pocket Computer) \$89.95
CE-122 (Printer) \$21.11
CE-150 (Printer for PC-1500) \$174.95
CE-151 (4K RAM Expansion) \$49.95
CE-155 (8K RAM Expansion) \$99.95

FLOPPY DISCS
MAXELL MD-1 (Box of 10) \$34.90
SCOTCH 7450 (Box of 10) \$39.90
ELIMINAT (Box of 10) \$34.90
BASF PD-10 (Box of 10) \$32.90
VERBATIM MD-525 (Box of 10) \$34.90

DEALER'S INSTITUTIONAL INQUIRES CALL (800) 221-3194
"OUR NAME MEANS A GREAT DEAL"

STAR MICRONICS GEMINI-10
•100 CPS
\$329⁹⁵

PRINTERS/TYPENRITERS

EPSON FX-80 (Print. Feed) 160 CPS CALL
EPSON MX 80-B CALL
EPSON MX 100-B CALL
NEC PC-8001A (32K RAM) \$699
NEC PC-8023 (Printion Feed) \$699
NEC PC-8031A (Dual Print. Disk Drive) \$685
SMITH CORONA Letter Quality Printer \$479.95
TP1-109 (10 Print) \$479.95
STAR MICRONICS GEMINI-15 \$489.95
100 CPS Full Size
SMITH CORONA
ULTRASONIC TYPEWRITER \$399

COLECO GEMINI VIDEO GAME CONSOLE
•Atari Software Compatible
\$79⁹⁵

VIDEO GAMES
ATARI CX-5200 Video Game \$169.95
VICITREX VIDEO GAME \$109.95
ATARI VIDEO GAME CX-2600 \$79.95
MATEL INTELLIVISION II \$149.95
MATEL INTELLIVISION \$44.95
COLECOVIDEOW (Video Game) \$109.95
ODYSSEY VIDEO GAME \$79.95

BLANK TAPES
MINIMUM ORDER 12 AUDIO TAPES
MAXELL DLOXL C 90 \$2.79
MAXELL DOLX S 90 \$3.39
SONY ULES 90 \$3.99
TOK SA-90 \$2.39
TOK SA-X 90 \$3.39

UNIX SOFTWARE FOR VIC-20
AMON (Cartridge) \$29.95
METEOR RUN (Cartridge) \$24.95
SATELLITES (Cartridge) \$34.95
SPIDERS OF MARS \$24.95
VIC 1937 Sea Moon
ALLEN PANGLOSS (Cassette) \$8.95
DEFENDER ON THE RUN (3K Expansion) \$11.95
KRAZY KONG (Cassette) \$9.95
DUEK (Cassette) \$8.95
SEARCH (Cassette) \$8.95
SPACE QUEST (Cassette) \$14.95
VIC MAN (Cassette) \$6.95

UNIX SOFTWARE FOR VIC-20
AGGRESSOR (Cartridge) \$29.95
HEMLOCK \$29.95
CARD RUNNER (Cartridge) \$24.95
PROTECTOR \$34.95
HESWRITR (Word Proc.) \$49.95

NEW FLOPPYS
TI PMA 6100 110" Color \$119
VIC C1701 16" Color \$59.95
OUASAR LP-1762 7" Color \$19
PANASONIC TR-120 112" Color \$179.95
PANASONIC CT-7771 8" Color \$349
PANASONIC CT-160 110" Color \$299.95
NEC C12202A 112" Color \$299.95



TOMY TUTOR 8000
•16K RAM
\$134⁹⁵

TOMY
TOMY 8020 Joy Controller \$11.95/ea
TOMY 8023 Joy Stick \$14.95/ea
TOMY 8021 Voice Synthesizer \$54.95
TOMY 8022 (Data Recorder) \$39.95

COMMODORE 64 HARDWARE
COMMODORE 64 (64K RAM) \$279.95
VIC 1211 Super Expansion \$49.90
VIC 1530 (Data Cassette) \$59.95
VIC 1541 (Single Disk Drive) \$59.95
VIC 1525 (Graphic Printer) \$219.95
VIC 1800 Telephone Interface \$69.95
VIC 1111 (16K RAM Cartridge) \$79.95
VIC 1011A (85-232 CARDBOARD & Disk Expansion) \$44.95
COMMODORE 64 SOFTWARE
AUS Temple of Aestral \$27.95
HES Hewitree \$16.95
PAC Business Inventory \$16.95
PAC Super Broker \$16.95
PAC Personal Finance \$38.95



COMMODORE VIC-20
•5K RAM
•Home Computer
\$89⁹⁵

VIC-20 SOFTWARE
VL 102 Intro to Basic Pt. 1 \$19.95
VL 103 Intro to Basic Pt. 2 \$19.95
VL 110 (Gortek & the Microchip) \$23.95
VIC 1910 Radar Rat Race \$14.95
VIC 1914 Adventure Land \$17.95
VIC 1916 Mission Impossible \$17.95
VIC 1919 Sargon (Chess) \$17.95
VIC 1923 (Golf) \$17.95
VIC 1937 Sea Moon \$14.95

UNIX SOFTWARE FOR VIC-20
AMON (Cartridge) \$29.95
METEOR RUN (Cartridge) \$24.95
SATELLITES (Cartridge) \$34.95
SPIDERS OF MARS \$24.95
VIC 1937 Sea Moon
ALLEN PANGLOSS (Cassette) \$8.95
DEFENDER ON THE RUN (3K Expansion) \$11.95
KRAZY KONG (Cassette) \$9.95
DUEK (Cassette) \$8.95
SEARCH (Cassette) \$8.95
SPACE QUEST (Cassette) \$14.95
VIC MAN (Cassette) \$6.95

UNIX SOFTWARE FOR VIC-20
AGGRESSOR (Cartridge) \$29.95
HEMLOCK \$29.95
CARD RUNNER (Cartridge) \$24.95
PROTECTOR \$34.95
HESWRITR (Word Proc.) \$49.95

function is not available. Therefore, you will hear loud clicks as the number is dialed. This is normal. When dialing is completed and you have reached your party, press ENTER to begin logging. When the call is completed, press ENTER again to end the logging. You may continue dialing, changing the phone number data, or you can "close" the book. In any event, the last screen line will always tell you what to do next.

You might have noted that, while dialing was taking place, as each digit was dialed it appeared in reverse video. If you had entered non-numeric data in the number column (such as dashes) you would have noted that such data was automatically skipped.

Note: You must advise your local telephone company that you plan to interface a device to their lines in the event they have certain requirements that must be met for the installation.

To obtain a report of phone usage, you must end the Phonobook program (by "closing" the book) and then enter RUN"PLOGRPT". This menu-driven program allows you to select all data or only data for a given month (or range of months). You can print the data to the screen (TASK 1) or to any 80-column printer (TASK 2). When finished, select the END task.

Modifications. Different phone lines will accept different dialing rates. If your interface dials too fast for your line (or, on the other hand, your line can accept faster dialing) you can modify the rate. This is a two-step process. First, you can change the pulse time by modifying the values of either R3 or C2. (The rate is approximately $1.1 \times R3 \times C2$ milliseconds, with R3 in megohms and C2 in microfarads.) If you change the pulse time significantly, you should also change the time between pulses so the ratio remains at about 60/100. To do this, change bytes EFE7 and EFE8 in the Phoner program per the formula Delay (μ s) = $6.5 \times (BC-1) + 22$. We originally loaded BC with 15804 (3DBC Hex). Calculate the new constant, and convert it into Hex notation. Then patch the Phoner program with the new values. As an example, to change the time between pulses to 90 ms (90,000 μ s), use a constant of 13844 (3614 Hex). Since the hex number is entered as Least Significant Bit, then Most Significant Bit, we would patch Phoner A = EFE7, F = BC3D, C = 1436.

McIntosh

STEREO CATALOG and FM DIRECTORY

Get all the newest and latest information on the new McIntosh stereo equipment in the McIntosh catalog. In addition you will receive an FM station directory that covers all of North America.

SEND TODAY!

McIntosh Laboratory Inc. CE
 East Side Station P.O. Box 96
 Binghamton, N.Y. 13904-0096

NAME _____
 ADDRESS _____
 CITY _____ STATE _____ ZIP _____

If you are in a hurry for your catalog please send the coupon to McIntosh. For non rush service send the Reader Service Card to the magazine.
 CIRCLE NO. 31 ON FREE INFORMATION CARD

16-BIT MICROCOMPUTER TECHNOLOGY

Part 7: How to use the monitor to create software

By George Meyerle

LAST month we introduced the ROM-based monitor and its entry commands. Here we will show how to use the monitor to create software.

All monitor commands require one or two character entries plus their optional address and/or iteration fields. Command lines are terminated by operating the carriage return key which starts execution of the command.

Following is a list of conventions used:

1. The > character is the monitor video prompt. When it is displayed, the monitor is waiting for a command entry.

2. The < character indicates that a carriage return must be initiated. This character does not appear onscreen, and is used here only to indicate carriage return.

3. Any values within parenthesis are optional. The parenthesis are not entered but appeared for clarity only.

4. The value "FA" represents the Full Address i.e.: an address that may contain both a segment and an offset address value. The segment and offset are always separated by a colon as in the form CS:IP (CS = segment register; IP = instruction pointer). The segment value is optional and if it is not used, then the current code segment is assumed to be operative.

5. The value "AD" represents an *offset* address value. No segment address is allowed within a "AD" field.

6. Any register pair designation may be used in place of an address.

7. All address fields must be separated by one or more spaces.

8. All entries are in hexadecimal with the exception of the iteration count which is in decimal.

9. The iteration count is entered by typing in an asterisk followed by a nu-

meric value. The default iteration count is 32.

The Command Set.

DISPLAY

The format is:

D (FA) (AD) <

D (FA) *nnnn <

Example:

D F000:E000 *5 <

In this example, F000 is the code segment start address (however, since we are dealing with a 16-bit processor, this is actually F0000), E000 is the offset address found in the instruction pointer), and 5 is the number of bytes required to be displayed.

The absolute hex address where the monitor will actually go to is found by adding the code segment and offset addresses as follows:

F000 code segment

E000 offset address

FE000 absolute hex address

Thus, if the command D F000:E000*5 were executed, the first five bytes of whatever started at address FE000 (1,040,384 decimal) would be displayed. In our case, this happens to be FA B4 D5 9E 73, first five bytes of the Explorer-88 ROM-based monitor program as shown in Fig. 19.

The same absolute address can be obtained by using any combination of code segment and instruction pointer values that, when added, equal the absolute value FE000

Being able to set the code segment value at 64K boundaries has the advantage of breaking up the 1 million memory addresses into sixteen 64K blocks which is convenient. Keep in mind though, that the flexibility of almost endless combinations of segment and offset addresses can be very useful. Because of its complexity, it would require

a small book on 8088 addressing modes to describe how this addressing scheme is employed. The reader should consult any of the currently available 8086/8088 books for details.

The "D" command, can also be used to display the following:

D SS:SP *2 < (SS is stack segment while SP is stack pointer) displays the first two bytes of the stack pointer.

D 0:0 FF < Displays the absolute locations

00000 to 000FF. Note that the first 32H bytes displayed are the interrupt jump vectors.

D DS:0 < Displays the first 32 bytes of the data segment (DS).

REGISTER

Format R <

Example R (RP)

This group of commands is perhaps one of the most important features of the monitor. To know what has happened in your program, you must be able to review what has happened to the registers inside the microprocessor.

The 8088 registers are shown in Fig. 20. The general registers are subdivided into two sets of four registers each. Each segment is separately addressable which means that one register can be used as one 16-bit, or two 8-bit registers. All other registers are 16 bits wide. In addition to the registers, nine status flags are available.

An R followed by a carriage return will cause a display of *all* the internal 8088 registers. An R followed by a register pair designator (RP) will cause the selected pair to be displayed and allow modification of that pair. If a change is required, enter the change followed by a < (carriage return). If no change is required, entering a < will terminate the review.

A typical register display might look like this:

```

DX   = 0000  SP   = 007E
CX   = 0000  BP   = 0000
BX   = 0000  SI   = 0000
AX   = 04FF  DI   = 0000
SS   = 0FFB  CS:IP = E8
ES   = 0000
DS   = 0FF0  FL   = 0000
CS   = F000  IP   = EDB7
    
```

E000	INIT	LABEL	NEAR	
E000	FA	CLI		INTERRUPTS MUST BE OFF
E001	B4 D5	MOV	AH,0D5H	SET FLAGS
E003	9E	SAHF		
E004	73 4E	JNC	ERR01	JUMP IF CF NOT SET
E006	75 4C	JNZ	ERR01	JUMP IF ZF NOT SET
E008	7B 4A	JMP	ERR01	JUMP IF PF NOT SET

Fig. 19. First five bits of the monitor program.

DISCOVER THE MAGAZINE THAT HELPED LAUNCH THE MICROCOMPUTER INDUSTRY

Incredible as it may seem, *Popular Electronics* helped launch the microcomputer industry. Back in 1975, we published plans for building the first powerful microcomputer based on the 8080 cpu. These plans generated incredible excitement—and started the world thinking about personal computing.

Since then, we've added more coverage of personal computing. Today, so much of the magazine is devoted to microcomputers that we've changed our name to...

Computers & Electronics

Computers & Electronics continues the *Popular Electronics* tradition of helping our readers experience the advances of the future—today. We do it with clearly written, in-depth articles explaining each innovation... plans for building useful, money-saving projects incorporating the newest technology... reviews of the latest mass-produced equipment. Whether it's microcomputer equipment, audio, video, or personal electronics, *Computers & Electronics* will make it possible for you to enjoy the newest, the most sophisticated, the most innovative technology around.

Helpful buying guides

Computers & Electronics compares and contrasts computers and other electronics gear in meaningful buyer's guide articles. We discuss features and options, what to look for, and how to get the best value. Recent buyer's guides have covered computer printers, pocket computers, sophisticated telephones, video cassette recorders and high-tech audio cassettes.

World-famous test reports

In every issue of *Computers & Electronics* you'll find our famous in-depth test reports. We take a new product, test it and analyze the results. Recently we've tested the Radio Shack TRS-80 Model III, the IBM Personal Computer, and the Sinclair ZX 81 Microcomputers by Apple, Atari, Hewlett-Packard, Intelligent Systems and Netronics. Plus an interactive data terminal, software,

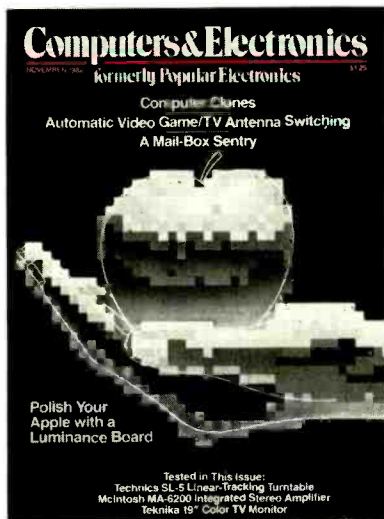

and a variety of audio, video and testing equipment.

Innovative construction projects

If you're a do-it-yourselfer, you'll love the construction projects in *Computers & Electronics*. Not only did we bring the world the first successful microcomputer kit, but also projects for building the first low-cost modem. The first computer keyboard integrated with the computer (SOL)

The first low-cost voice synthesizer. The first low-cost logic analyzer. The first 1802-based microcomputer (ELF). The first low-cost function generator. The first gas-laser communicator (awarded a place in the Smithsonian Institution). The first low-cost color graphics computer module. An interface to transfer narrow line listings from your TRS-80 Pocket Computer to either a printer or CRT screen....

As you can see, our construction projects, while not necessarily complex (thanks to multifunction IC chips), will keep you at the forefront of technological development—at remarkably low cost. And in the future, we'll be bringing you construction projects to help you make your microcomputer more useful—whether it's an enhancement, an application, or a merging of technology with external controls and products.

Get the leader in the field— at up to 33% off!

Computers & Electronics is the world's most widely read computer and personal electronics magazine. Now you can subscribe at big savings: up to 33% off. At our New Subscriber rates, a one-year subscription is only \$12.97. Take advantage of this offer—complete and return the coupon or postage-paid reply card today!

Computers & Electronics P.O. Box 2774, Boulder, Colorado 80322

- YES!** Send me one year (12 issues) of *Computers & Electronics* at \$12.97—I save 19%.
 I prefer two years for \$22.97—I save 28%.
 Make that three years for \$31.97—I save 33%.

Savings based on full one-year subscription price of \$15.97

Mr./Mrs./Ms. _____ (please print full name) 4N153

Address _____ Apt. _____

City _____ State _____ Zip _____

CHECK ONE: Payment enclosed Bill me later

Offer valid in U.S. and possessions only. Please allow 30 to 60 days for delivery of first issue.

BLOCK MOVE

The block move command is helpful to relocate a program/subroutine, or, if you want to fill a portion of memory with a constant. The formats are as follows:

```
B FA AD AD <
B FA AD *nnnn <
```

The first address is the beginning address of the block to be moved. The second address is the beginning address of where the block is to be moved to. The third address is the last address of the destination block which could alternatively be replaced by the iteration count designator which is simply the number of bytes to be moved.

The command: `B 0:0 500 5FF <` will move the data in locations 00000-000FF to 00500-005FF. The data in the source field is not changed.

The command `B 0:0 500 *1000 <` will fill 1000 locations starting from 00500 with the data value stored at location 00000.

MEMORY

The M command opens memory locations for display or modifications, and is used to enter programs. The format is:

```
M (FA) <
```

After inputting the M command, the designated memory location is displayed followed by a dash. If a space is entered the next sequential location will be displayed.

If a change is desired, enter the new data followed by a space. A carriage return will end the command. If a memory location cannot be changed (as would be the case if ROM or bad or nonexistant RAM were addressed) a bell or beep will be outputted.

INPUT

The I command inputs one byte from the specified I/O address to the Accumulator and displays the value on the terminal.

```
Format: I AD <
```

Entering `I 61 <` inputs and displays the state of the dip switch S1 on the mother board of the Explorer-88.

OUTPUT

The O command outputs one byte to the output device specified.

```
Format: O AD xx <
```

Where xx is the value of data outputted to port address AD

CASSETTE

The cassette read and write commands will not be discussed in any detail since the format used is the same as for the IPM PC.

TRACE

The T commands are perhaps the most important in the monitor. They allow you to single-step through a program tracing the execution of each instruction and observing the registers at every step. After execution, control is returned to the monitor and the new value of CS:IP along with the next instruction to be executed is displayed. Optionally, all registers may be displayed if the T command is followed by an R (TR command). This command also allows tracing more than one instruction at a time by entering an asterisk followed by the desired iteration count value. The formats are:

```
T FA <
T FA *nnnn <
TR FA <
TR FA *nnnn <
```

As an example of how to use the trace command, lets trace the P(ROM) test portion of the hardware test. Before we start the trace, we have to make sure that code, data, and stack segments are set to match the definitions established when the monitor program was written.

Using the register commands, modify the following registers.

```
CS= F000 DS=0FF0 SS=0FF8
```

Now enter

```
TR F000:ECDO *5 <
```

This command will begin tracing the first 5 steps of the ROM testing program which starts at the absolute address FECDO. Note that the next address to be executed is EDB7. To

complete the trace to the end of the test will require in excess of 16,000 steps because all 8K locations of the ROM are added together and checked for the proper result. Step through the first part checking the registers against the results you might expect.

GO

The G command starts program execution at the Full Address specified. If no address is specified, then execution starts at the current CS:IP location. There is an optional break-point address that can be entered to cause control to be passed back to the monitor if the break-point is entered, the monitor loses control of the system. A dash or hyphen entry must precede the break-point address. All registers may be displayed after the break-point is reached if the "GR" command is used. Format:

```
G (FA) (-AD) <
GR (FA) (-AD) <
```

Try the Go command by going to the beginning of the monitor hardware test which begins at F000:EDB7. Make sure that the CS, DS, & SS registers are set as described in the trace test. Enter

```
G F000:EDB7 <
```

The hardware tests should now be executed just as if they were called directly by the monitor. To test the breakpoint enter `GR F000:EDB7-EE05`. This will cause the program to break at the beginning of the cassette test.

HARDWARE TEST

The format is: `HT <`

The final test described is a complete hardware test to perform diagnostics.

1. Read only memory
2. Random Access memory
3. The cassette interface
4. The interrupt controller
5. The timer circuitry
6. The DMA controller
7. The RS 232 port (not tested in the IBM compatible version)

Enter:

```
HT <
```

Conclusion. Keep in mind that the 8086 and 8088 are almost "clones," although the 8088 has an 8-bit external data path to memory and I/O and the 8086 can transfer 16 bits at a time, the two processors are otherwise identical. Software written for one CPU can run on the other, without alteration.

What is more important is to experiment with the commands within the Explorer-88 monitor. There is no way you can cause physical harm to the system by issuing wrong or faulty commands. The worst thing that can happen is for the system to "hang up." In this case, simply reset and start over. ♦

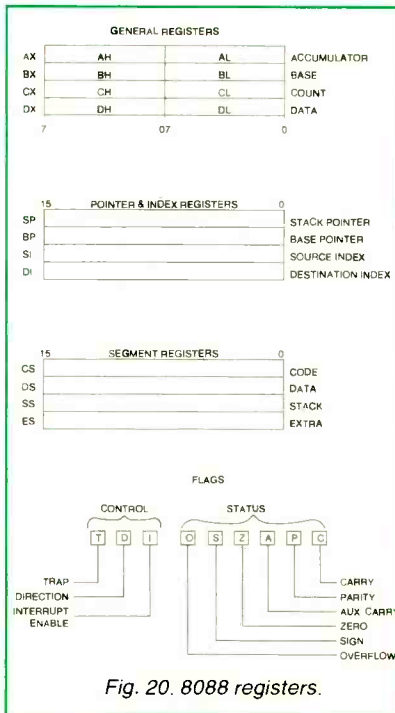

Fig. 20. 8088 registers.

COMMODORE 64

(more power than Apple II at half the price)

\$159.00*

• 170K DISK DRIVE \$199.00*

• TRACTION FRICTION PRINTER \$159.00* SERVICE

(* with software savings applied)

COMPUTER AND SOFTWARE SALE

WE
HAVE
THE
BEST

WE
HAVE
THE
LOWEST
PRICES

VIC-20

(a real computer at the price of a toy)

\$77.00*

• 40-80 COLUMN BOARD \$99.00

• VOICE SYNTHESIZER \$69.00

(* with Cassette and Gortek purchase)

COMMODORE 64 COMPUTER \$159.00

You pay only \$259.00 when you order the powerful 64K COMMODORE 64 COMPUTER! PLUS we pack the SPECIAL SOFTWARE COUPON with your computer that allows you to SAVE UP TO \$100 off software sale prices!! With these savings applied your net computer cost is only \$159.00.

170K DISK DRIVE \$199.00

You pay only \$299.00 when you order the 170K Disk Drive! Plus we pack the SPECIAL SOFTWARE COUPON that allows you to SAVE UP TO \$100 off software sale prices!! With these savings applied your net Disk Drive price is only \$199.00.

TRACTION FRICTION PRINTER \$159.00

You pay only \$259.00 when you order the Comstar F/T deluxe line printer that prints 8 1/2 x 11 full size, single sheet, roll or fan fold paper, labels etc. 40, 66, 80, 132 columns. Impact dot matrix, bi-directional, 80 CPS. PLUS we pack the SPECIAL SOFTWARE COUPON that allows you to SAVE UP TO \$100.00 off software sale prices!! With these savings applied your net printer price is only \$159.00.

80 COLUMN BOARD \$159.00

You pay only \$159.00 for this 80 Column Board when it is purchased with a COMMODORE 64 Computer or a Disk Drive or a Printer or a Monitor. If purchased alone the sale price is \$179.00. Included with this board is word processor pack, electronic spread sheet and mail merge data base on two tapes. List \$275.00. (Disk add \$10.00).

EXECUTIVE WORD PROCESSING PACKAGE

SCRIPT 64 EXECUTIVE WORD PROCESSOR is the finest available for the COMMODORE 64 Computer! THE ULTIMATE for PROFESSIONAL wordprocessing application. Featuring simple operation, powerful text editing with a customized word dictionary, complete cursor and insert/delete key controls, line and paragraph insertion, automatic deletion, centering, margin settings and output to all printers. Included is a powerful MAIL MERGE When used with THE COMPLETE DATA BASE PACKAGE. List \$99.00. Sale \$79.00. Coupon Price \$52.00. (Disk only).

COMPLETE DATABASE PACKAGE

A user friendly data base system that makes information easy to find and store. You can add, change, delete, and search for data. Print the information on a printer in any format desired. When combined with the word processor pack you have a powerful merge program that allows custom documents and personalized mailing lists. List \$69.00. Sale \$69.00. Coupon Price \$48.00. (Disk only).

SPECIAL SOFTWARE COUPON

We pack a SPECIAL SOFTWARE COUPON in very COMMODORE 64 COMPUTER-DISK DRIVE-PRINTER-MONITOR we sell! This coupon allows you to save up to \$100 OFF SALE PRICES and much more off list prices!!

PROFESSIONAL SOFTWARE COMMODORE 64

Name	List	Coupon
Executive Word Processor	\$99.00	\$52.00
Complete Data Base	\$99.00	\$48.00
Electronic Spreadsheet	\$89.00	\$46.00
Accounting Pack	\$89.00	\$32.00
Total 5.2 Word Processor—Plus		
Tape	\$60.00	\$37.00
Disk	\$79.95	\$42.00
Total Text 2.6 Word Processor—		
Tape	\$44.95	\$26.00
Disk	\$49.95	\$26.00
Total Label 2.6	\$24.95	\$12.00
Disk	\$29.95	\$15.00
Quick Brown Fox Word Processor	\$69.00	\$40.00
Programmers Reference Guide	\$20.05	\$12.50
Programmers Helper	\$69.00	\$40.00
Basic Tutor	\$29.95	\$15.00
Typing Tutor	\$29.95	\$15.00
Sprite Designer	\$16.95	\$10.00
Medicinenmen	\$19.95	\$12.00
Weather War II	\$19.95	\$12.00
Music-Maker	\$19.95	\$12.00
EDU-Pack	\$24.95	\$13.00
3D Maze Craze	\$24.95	\$13.00
Professional Joy Stick	\$24.95	\$12.00
Light Pen	\$39.95	\$20.00
Deluxe Dust Cover	\$ 8.95	\$ 4.60

Write or call for

Sample SPECIAL SOFTWARE COUPON!

COMPLETE ACCOUNTING PACKAGE

This general ledger program is perfect for small business as well as home. It utilizes a double entry bookkeeping system. You only need enter one transaction and the computer will handle the other. All accounts are user definable and will build for 1 year, resulting in a file of all transactions by account number, month and year to date. Each month a current months' transactions can be viewed at any time (99 accounts 187 entries per month). With this accounting program you will be able to monitor your financial growth as well as your expenses. List \$59.00. Sale \$49.00. Coupon Price \$32.00. (tape or disk).

VIC-20 COMPUTER \$77.00

You get the Commodore VIC-20 Computer for only \$77.00 when you buy at sale prices: The Commodore Data Cassette for only \$69.00 and the Gortek Introduction to Basic program for only \$19.95. TOTAL LIST PRICE \$302.95. SPECIAL PACKAGE SALE PRICE \$185.25.

VIC-20 COMPUTER \$88.00

When you buy 6 tape programs on sale for only \$59.00. These 6 programs list for \$100.00 to \$132.00. You can choose one of three packs: 6 game pack, 6 home finance pack, or 6 small business pack. TOTAL LIST PRICE \$360.00. SPECIAL PACKAGE SALE PRICE \$147.00.

40-80 COLUMN BOARD \$99.00

A fantastic price breakthrough for VIC-20 owners on this most wanted accessory!! "Now you can get 40 or 80 Columns on your T.V. or Monitor Screen." Plus we add a word processor with mail merge, electronic spread sheet, time manager and terminal emulator!! These PLUS programs require 8K or 16K RAM memory. (Disk add \$10.00).

VOICE SYNTHESIZER \$69.00

Votrax Based. Make your VIC-20 COMPUTER TALK! Has features equivalent to other models costing over \$370.00. You can program an unlimited number of words and sentences and even adjust volume and pitch. You can make adventure games that talk! A must for enhancing your programming creativity and pleasure. Includes FREE \$14.95 Editor.

60K MEMORY EXPANDER \$69.00

Sixslot — Switch selectable — Reset button — Ribbon cable. A must to get the most out of your VIC-20 Computer. Includes FREE \$29.95 adventure game.

8K RAM CARTRIDGE \$39.95

Increases programming power 2 1/2 times. Expands total memory to 33K (33,000 bytes). Memory block switches are on outside of cover! Includes FREE \$16.95 game.

16K RAM CARTRIDGE \$69.00

Increases programming power 4 times. Expands total memory to 41K (41,000 bytes). Memory block switches are an outside cover! Includes FREE \$29.95 adventure game!!

12" GREEN SCREEN MONITOR \$129.00

Excellent quality VIDEO MONITOR With anti-glare, a 12" Green Phosphorous screen — 1920 characters (80 characters x 24 rows). Perfect for word processing application. 12" AMBER MONITOR — 2000 characters, 800 lines. \$159.00. Plus \$9.95 for VIC-20 or COMMODORE 64 Cable.

• LOWEST PRICES • 15 DAY FREE TRIAL • 90 DAY FREE REPLACEMENT WARRANTY
• BEST SERVICE IN U.S.A. • ONE DAY EXPRESS MAIL • OVER 500 PROGRAMS • FREE CATALOGS

Add \$10.00 for shipping, handling and insurance. Illinois residents please add 6% tax. Add \$20.00 for CANADA, PUERTO RICO, HAWAII orders. WE DO NOT EXPORT TO OTHER COUNTRIES.

Enclose Cashiers Check, Money Order or Personal Check. Allow 14 days for delivery, 2 to 7 days for phone orders, 1 day express mail! Canada orders must be in U.S. dollars.

PROTECTO ENTERPRISES

(WE LOVE OUR CUSTOMERS)

BOX 550, BARRINGTON, ILLINOIS 60010
Phone 312/382-5244 to order

A MULTIPLE TEST-POINT

Measures volts at a number of circuit points simultaneously

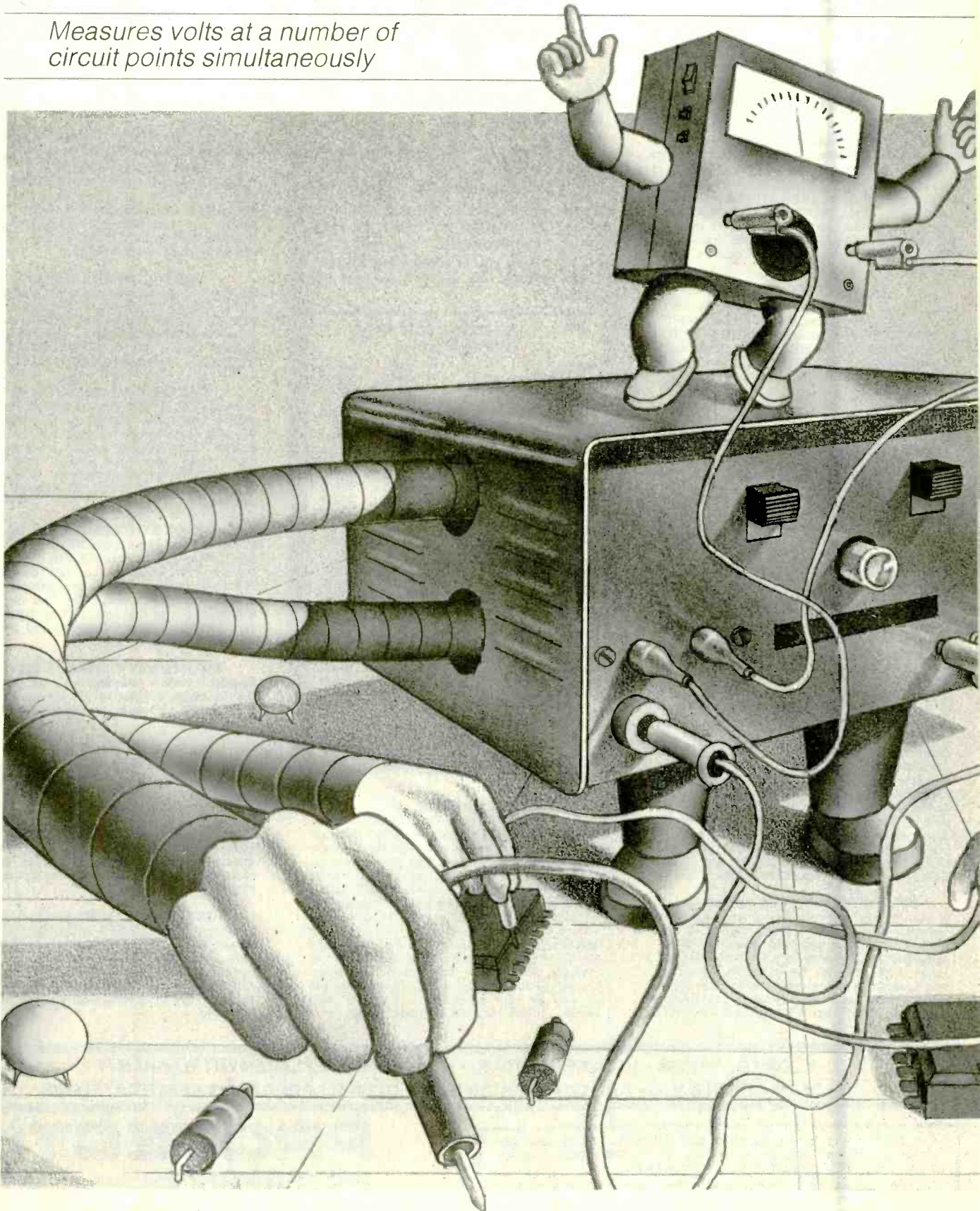

MONITOR

By George Gooder

HAVE you ever had a situation arise in troubleshooting or aligning an electronic circuit when adjustments of a potentiometer, capacitor, or coil caused two or more test point signals to vary simultaneously? When this happens, you must either move your test equipment inputs from one point to another or use several pieces of the same equipment to monitor each test point at the same time.

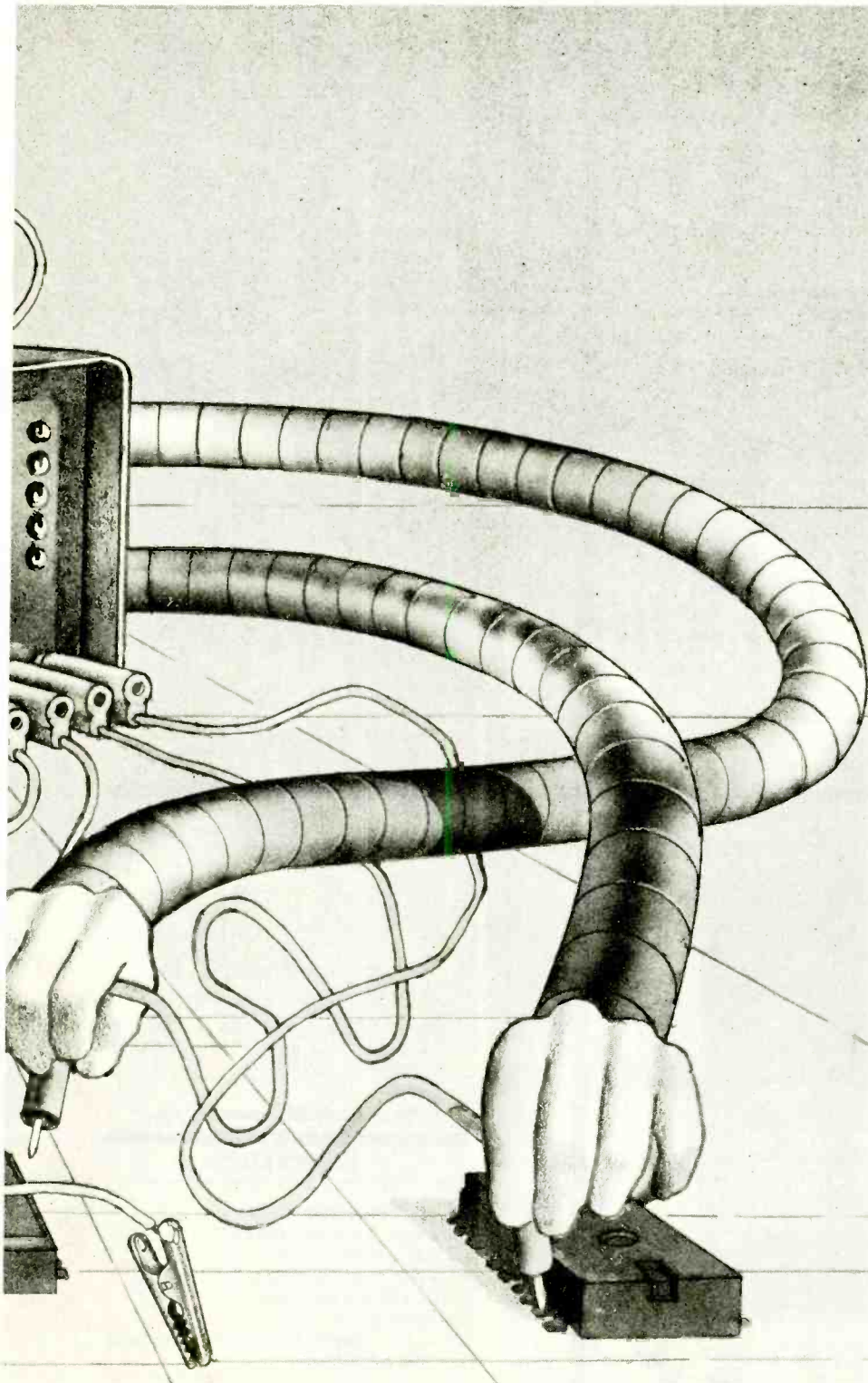

The Multiple Test-Point Monitor described in this article overcomes this problem. It can measure up to four test points at intervals of 1 to 10 seconds. All four test points can have the same polarity, or two can have positive polarity and the other two negative. The monitor can also be set to operate on two test points only or "look" at one preselected test point indefinitely.

Circuit Operation. As shown in Fig. 1, the circuit is based on IC2, a 4-bit shift register. The inputs to this register are loaded with a binary "1000" when pins 4, 5, and 6 are low, and pins 9 and 10 are high.

When pin 10 is forced low and the right shift is activated by a signal on pin 2, clock pulses from IC1 shift the 1 bit to the right thus changing the binary word at pins 12 through 15. After a 2- or 4-bit shift (whichever is selected by S2), the 1 bit returns to the A output (pin 15).

Switch S2 performs two functions. It initializes the IC2 ABCD inputs to binary 1000 and sets the system to shift 2- or 4-bit positions. When S2 is momentarily activated, it places a low at pin 1 of IC3A (a set-reset flip-flop) which forces its pin 3 high. This high is coupled to pin 10 of IC2. With pin 9 of IC2 tied to high, the next clock pulse will initialize IC2. The low-to-high transition at IC3A pin 3 is also fed to the clock input of IC6A to toggle this flip-flop. When IC6A is set, IC2 shifts 4 bit positions, and when IC6A is reset, IC2 shifts 2 bit positions. The shift is actuated by a closure of momentary switch S2 for one clock pulse.

Transistors Q1 and Q2 are driven by the A and B outputs of IC2, while IC4A and IC4B gate bits C and D from IC2 to transistors Q3 and Q4, with IC6A inhibiting or enabling the two gates. When IC6A is set, the gates are enabled, and when IC6A is reset, they are inhibited. Gate IC4B's output at pin 6 is also fed to IC5A to reenter the 1 back into the shift register A position after 4 shifts, while IC4C shifts the 1 back to the shift register when the system is in a 2-bit monitor position. Gate IC4C is enabled or inhibited by IC6A depending on whether the latter IC is set or reset. Gate IC5B puts bits A and B from IC2 through to one section of S3 to activate Q5. Transistor Q5 and relay K5 form a polarity-switching network that allows negative signals to be monitored at J1 and J2 without changing the voltmeter leads.

The clock signal generated by IC1 can be adjusted from one pulse per second to one pulse every 10 seconds by potentiometer R3. The clock output is fed to one input of AND gate IC4D, whose other input comes from the set-reset

TEST-POINT MONITOR

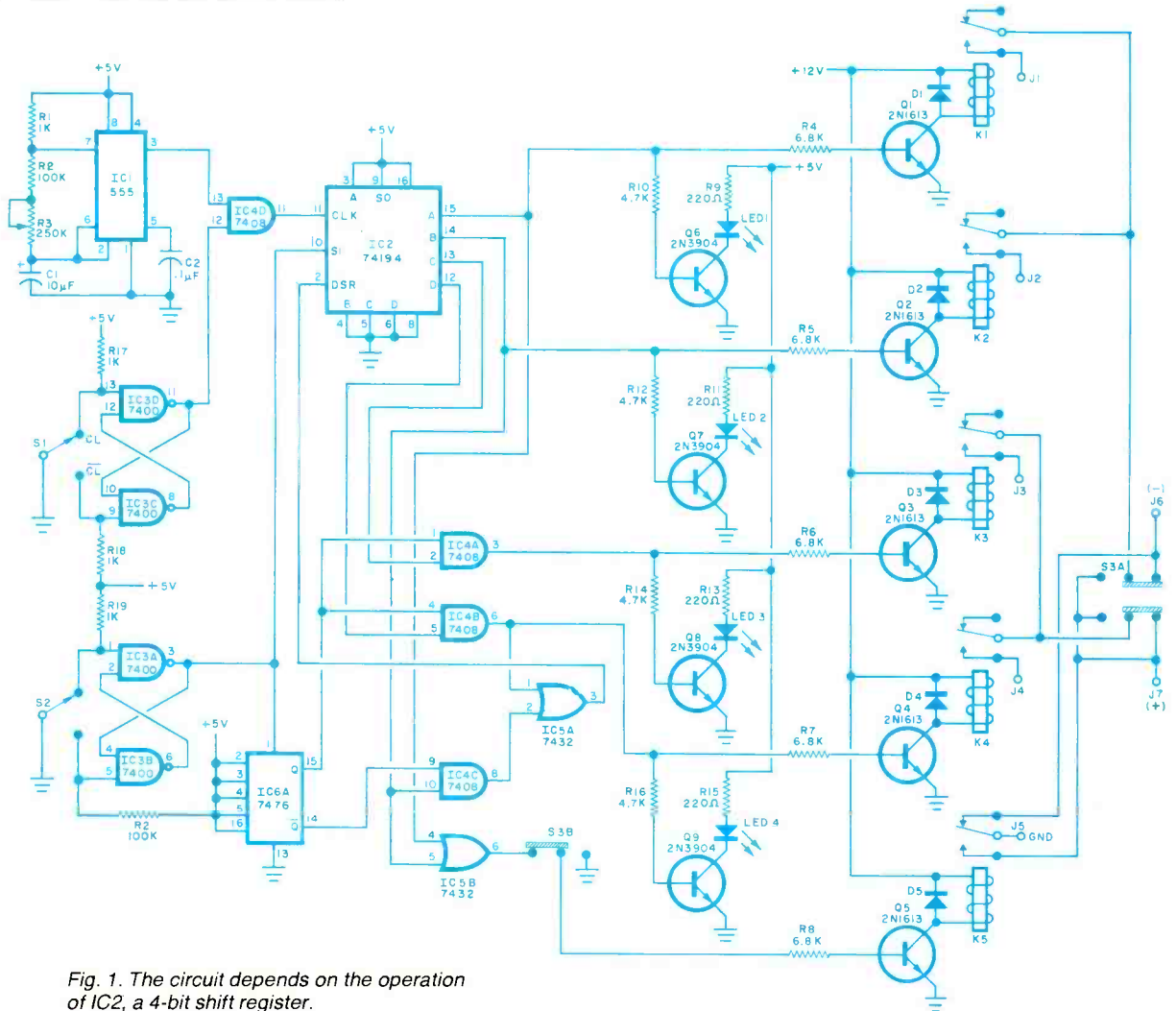
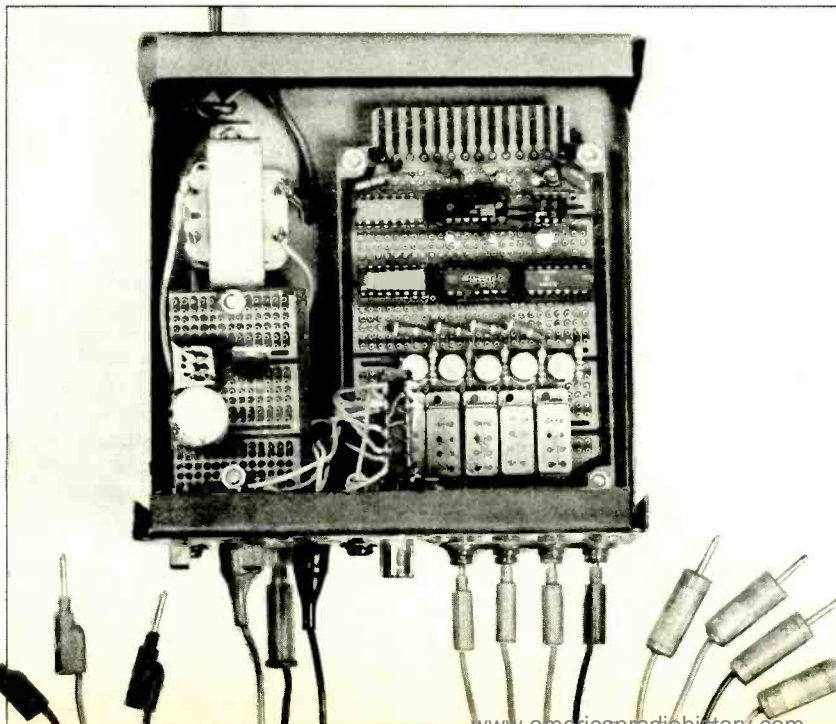

Fig. 1. The circuit depends on the operation of IC2, a 4-bit shift register.



At left is a view of the inside of the author's prototype.

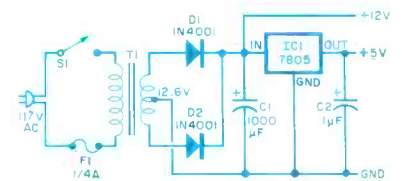

Fig. 2. A suitable power supply.

PARTS LIST

- C1—1000- μ F, 25-V electrolytic
- C2—1- μ F, 10-V electrolytic
- D1,D2—1N4001 diode
- F1— $\frac{1}{4}$ -A fuse with holder
- IC1—7805 5-V regulator
- S1—Spst switch
- T1—12.6-V center-tap transformer (Triad F-25X or similar)

PARTS LIST (Fig. 1)

C1—10- μ F electrolytic
 C2—0.1- μ F capacitor
 D1 through D5—1N914 diode
 IC1—555 timer
 IC2—74194 4-bit shift register
 IC3—7400 quad 2-input NAND gate
 IC4—7408 quad 2-input AND gate
 IC5—7432 quad 2-input OR gate
 IC6—7476 dual JK flip-flop
 J1 through J7—Banana connector
 K1 through K5—Spdt relay
 LED1 through LED4—Red light-emitting diode
 R1, R17 through R20—1-kilohm, 5%, 1/2-W resistor
 R2—100-kilohm, 5%, 1/2-W resistor
 R3—250-kilohm potentiometer
 R4 through R8—6.8-kilohm, 5%, 1/2-W resistor
 R9, R11, R13, R15—220-ohm, 5%, 1/2-W resistor
 R10, R12, R14, R16—4.7-kilohm, 5%, 1/2-W resistor
 S1—Spdt slide switch
 S2—Spdt momentary-contact switch
 S3—3pdt slide switch
 Q1 through Q5—2N1613 transistor
 Q6 through Q9—2N3904 transistor
 Misc.—Suitable enclosure, knob, press-on types, etc.

flip-flop formed by IC3C and IC3D.

The IC3 flip-flop is switched by the operation of S1 to either enable or inhibit the clock signal from reaching IC2. Stopping the clock signal allows indefinite monitoring of one selected test point.

The four lines driving relay drives Q1 through Q4 are monitored by transistors Q6 through Q9, each of which has a LED and associated current-limiting resistor as a collector load. When the line goes high, it activates both sets of transistors thus selecting one line and indicating it by the glowing LED.

Construction. Since parts placement is not critical, any type of construction can be used. Once a board has been constructed, it can be mounted with the associated relays and a power supply (see Fig. 2 for a circuit) in a convenient enclosure. The front panel should mount the four input banana connectors J1 through J4, the system ground connector J5, clock speed control R3, and the three switches (S1 through S3).

Input connectors J1 through J4 are connected to the signals of interest, while J5 is connected to the tested system's ground. Connectors J6 and J7 connect to the monitoring device being used (voltmeter, scope, etc.) in accordance with the polarity specified by J6 and J7. \diamond

BEEP! BEEP! BE...

Add a power-failure sensor to any ac digital clock

By James Antonakos

MOST digital clocks do not have the backup circuits (reserve power supply and oscillator) necessary to keep them running during a power outage. Thus, it is possible that someone glancing casually at a clock can be misled as to the time. One way to combat this problem is to install the "Power Out Sensor" in your digital clock. After a power failure, the circuit will "beep" until you reset the clock.

Circuit Operation. When power is first supplied to the circuit, a positive spike, produced by C1, is applied to the SET input of flip-flop IC1. This causes the Q output to go high and enables one half of the dual timer, IC2. The latter oscillates at about 5 Hz, alternately enabling the other half, a 1-kHz oscillator. The circuit will continue to oscillate until the flip-flop is reset by momentarily closing S1. This forces Q low

and disables the timer. The circuit will remain in this state because the inputs to the 4027 are grounded through R3. Therefore, the circuit is actuated only when power is shut off and then re-applied.

The output from IC2 is applied to emitter follower Q1, which drives the speaker through R10. The value of the latter resistor is selected for the desired audio level. If the clock is a radio alarm, its speaker can be used, or any small type of speaker can be added. If desired, the audio oscillator output from pin 9 of IC2 can be used to drive any external audio system.

Construction. Assembly is not critical. The prototype was built on a standard perf board cut to fit into the clock to be used. A printed-circuit board could be used but is not required and is time-consuming to prepare.

Because CMOS integrated circuits are used, the supply voltage can be any value between 5 and 18 V, a range suitable for most applications. The current drain for the alarm is only 30 mA and can be safely drawn from most clock power supplies. \diamond

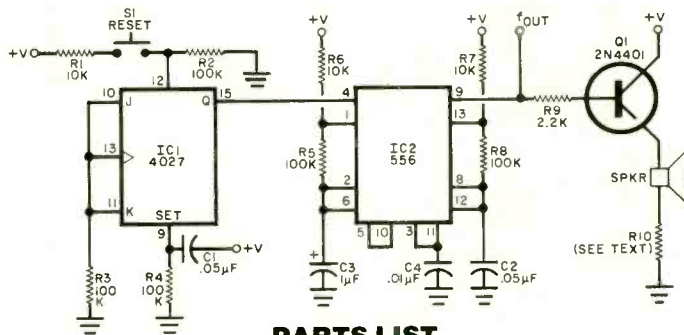

PARTS LIST

C1, C2, C4—0.05- μ F capacitor
 C3—1- μ F, 35-V electrolytic
 IC1—4027 CMOS dual JK flip-flop
 IC2—556 dual timer
 Q1—2N4401 transistor
 R1, R6, R7—10-kilohm, 1/4-W resistor
 R2 through R5, R8—100-kilohm, 1/4-W resistor
 R9—2.2-kilohm, 1/4-W resistor
 R10—See text
 S1—Normally open pushbutton switch
 SPKR—8-ohm speaker
 Misc.—Mounting hardware, perf board, IC sockets, etc.

Improving TIMEX/SINCLAIR Tape Loading

Reduce troublesome dropouts and noise problems

By Tim Stoner

THE Sinclair/Timex ZX81/1000 is an excellent computer for its price. However, as a result of design compromises made to keep the price low, there are some shortcomings. The most annoying of these is the delicate nature of the tape loading process. Frequently, a cassette has to be run several times before a good load occurs.

Although the tape SAVE/LOAD function within the computer is designed well, tape hiss, dropouts, and other forms of noise from low-cost tape can cause problems. The use of high-quality tapes may not solve the problem either since distortion produced by inexpensive cassette recorders can also make tape loading a frustrating experience. The purpose of the "Z-Dubber" described in this article is to improve tape loading and also allow the user to reliably copy a tape.

The Tape Signals. An idealized pulse train that drives the input of the cassette is shown in Fig. 1A. A sync pulse, or clock burst, consists of four pulses. If the data is a "one," the four pulses are followed by a "silent period" of approximately the same width as the series of four pulses. A "zero" consists of eight pulses, rather than four.

The purpose of this specialized waveform can be seen in Fig. 1B. When the pulses are played back into the computer, they are applied to a one-shot multivibrator within the multipurpose chip. This circuit modifies the input (as shown in Fig. 1B) by creating an "enve-

lope" of the pulse train. The four pulses become one clock pulse, which is used to synchronize the loading sequence. A gap after the clock pulse represents a "one." However, when eight pulses occur, the period following the clock stays at the same level as the clock and represents a "zero."

This scheme is said to be self-clocking, and is very tolerant of playback speeds that are faster or slower than the original recording speed. The data stream provides a series of evenly spaced clock pulses, each of which is followed by a data pulse. The synchronization circuit in the computer waits until the arrival of a clock pulse, then starts looking for a "one" or a "zero."

It would appear that missing or misinterpreted data bits are eliminated by the conservative save/load design. However, the preceding explanation gave no consideration to the distortion introduced by the cassette recorder.

One of the principal reasons for tape-loading difficulties is that Sinclair/Timex does not supply or recommend a particular cassette recorder for use in conjunction with its computer. As a result, virtually every conceivable make and type of cassette recorder is being used to save and load Sinclair/Timex program tapes.

The pulses shown in Fig. 1A are those applied to the cassette recorder. The ideal waveform from the earphone jack of the cassette shown in Fig. 2A was generated from the waveform shown in Fig. 2B, the one that was used to make

the recording. Unfortunately, these ideal waveforms are seldom seen. Inadequate high-frequency response can produce a distorted waveform such as that shown in Fig. 3A. Notice that the area where the one-zero information resides is predominantly positive. Depending at what level the computer makes its decision, the gap can become either a "one" or a "zero." If one single bit is wrong, a checksum error will occur at the end of the tape, and it's rewind time again.

Poor transient and high-frequency response combined can make the ideal waveform look like Fig. 3B. This is a very common type of distortion created by cassette recorders with a slow acting automatic volume control circuit.

Another form of distortion commonly encountered is poor low-frequency response that results in the tilt of the gap in Fig. 3C. This improper waveform can cause the circuit to make an improper one-zero decision.

The Mystery Buzz. Just before the computer starts to SAVE to a cassette, a 60-Hz "buzz" occurs for a few seconds. Some users have blamed this on "motor noise" from the cassette. Actually, this is the sound of vertical sync pulses leaking out of the computer into the tape recorder. The Z-Dubber circuit will filter this noise below the level where it is troublesome. However, when making copies of existing tapes, it is a good idea to fast-forward the tape past the point where the buzz ceases.

Circuit Operation. As shown in the schematic diagram on page 86, the circuit is designed around IC1, a quad operational amplifier. Only three sections of the device are used. This particular op amp was selected since it is able to operate efficiently when powered by ± 1.5 volts.

The input at P1, connects to the earphone jack of the cassette recorder. Resistor R1 provides a load for the recorder audio, while R2 couples the signal

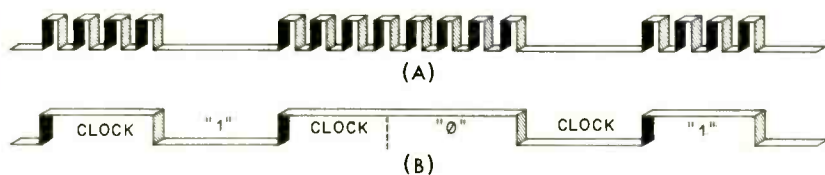
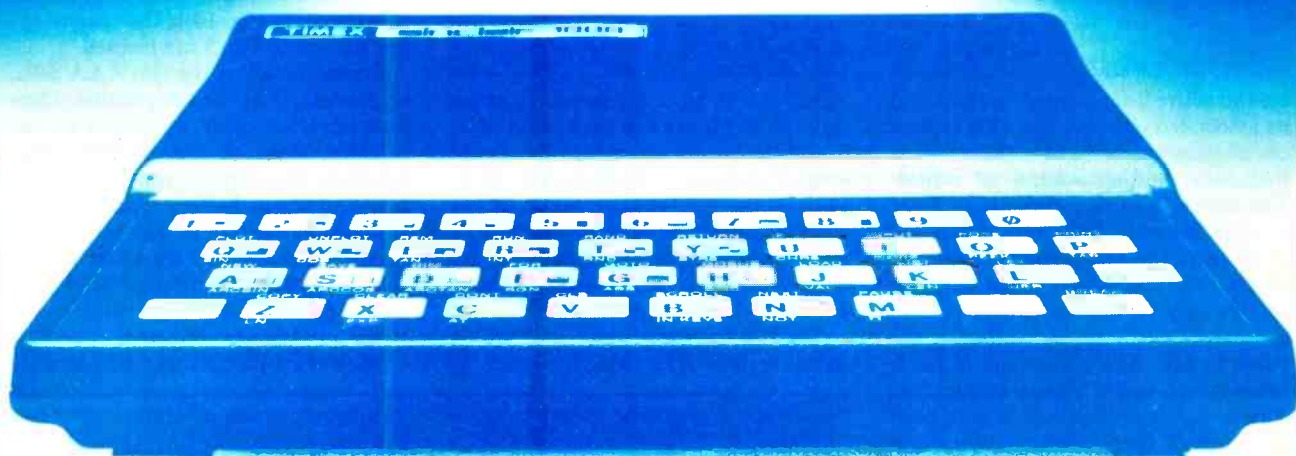

Fig. 1. Idealized pulse train representing zeros and ones.



“One of the principal reasons for tape-loading difficulties is that Timex/Sinclair does not supply or recommend a particular cassette recorder for use with its computer.”

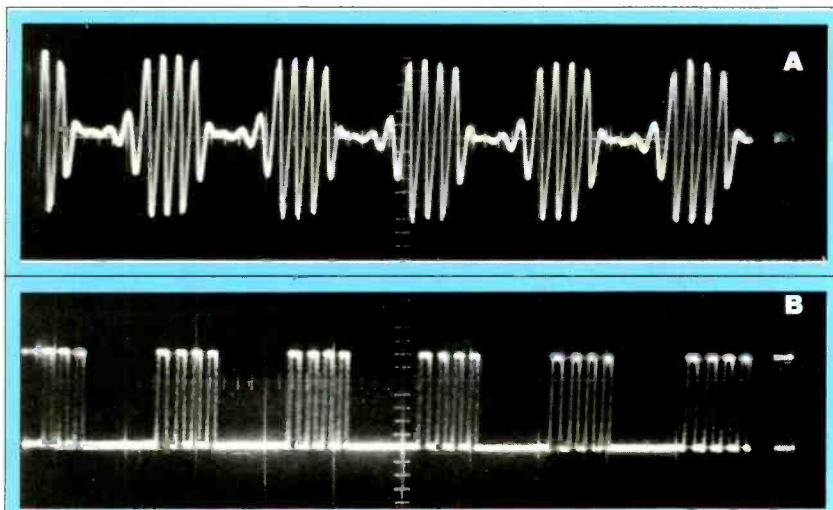

Fig. 2. Output of IC1A is shown at (A), which is amplified in IC1B, whose output is at (B).

into an active filter formed by IC1A and its associated components. This type of circuit passes and amplifies the resonant frequency, and attenuates all others. The center frequency of the IC1A filter is approximately 3000 Hz, which appears to be the approximate frequency of the recorded pulse bursts. This responds only to sine waves and ignores distortion which appears between the pulse bursts. The output of IC1A is nearly ideal and is shown in Fig. 2A. This is the signal that would have been produced if there were no distortion generated by the cassette recorder.

The output of IC1A, feeds the inverting input of IC1B and appears greatly amplified at the output of IC1B. A small amount of the output is fed back to the noninverting input through R8. The feedback provides a small amount of hysteresis, which causes the circuit to switch states slightly above and below the centerline. The hysteresis prevents this stage from switching at zero crossings and thus ignores "glitches" and noise pulses which might get through the active filter.

The output consists of a series of four or eight square waves (depending on whether a one or zero is present). The signal is shown in Fig. 2B and is an exact reproduction of the waveform which originally made the recording. This output is coupled to the computer input jack via C5 and P2.

Since the original waveform has been reproduced, it can be used to feed the microphone input (via PL3) of a second, or "slave," cassette recorder. This can be extremely useful for making backup copies of machine-language programs and other difficult-to-copy tapes. The

signal is fed to the "slave" recorder through R10 and C6, with R11 acting as a voltage divider to reduce the signal level. This is necessary to prevent overloading the microphone input of the slave recorder. The value of resistor R11 can be increased or decreased if the recording level for your cassette proves to be too low or too high.

The noninverting input of IC1C is pulled high by R12. Since the inverting

input is grounded, the output on pin 14 is also high. Thus, no current flows through LED1. However, when pulses appear at the output of IC1B, the cathode of D2 is brought low. This causes the output of IC1C to go low and allows current to flow through the LED, thus causing it to glow. When the pulses make the cathode of D2 go high, the relatively slow discharge of C4 keeps the noninverting input of IC1C low between data pulses. Thus, the output remains low as long as data is passing through and LED1 steadily glows. This is useful for setting the correct level of the playback cassette.

Testing and Using. The circuit can be wired point-to-point on perforated board, or a pc board using the foil pattern shown in Fig. 4 and the component installation of Fig. 5 can be used.

Before installing the two AAA cells, set switch S1 to the ON position. Connect one lead of an ohmmeter to the shielded braid of one of the cables (ground). Measure the resistance to the plus and minus battery terminals. The reading should be in excess of 1000 ohms. If it is not, look for solder splashes, semiconductors inserted backwards, and so on. Don't insert the batteries until the condition is corrected.

With the LED, B1 and B2 correctly

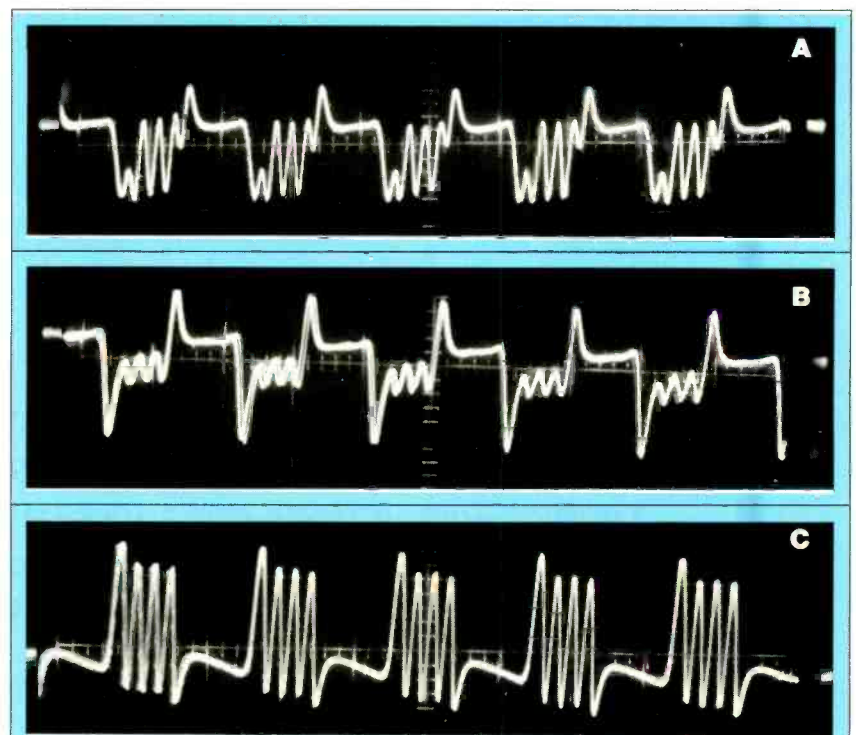

Fig. 3. Three forms of distortion involving poor transient and low- and high-frequency response.

inserted, the LED should glow when pins 1 and 11 of IC1 are temporarily jumpered.

Insert P1 into the earphone jack of the cassette with the tape to be loaded. Insert cable with P2 into the jack labeled EAR on the side of the computer. One half of the cable supplied with the computer can be used to connect the MIC jack to the microphone input of the cassette recorder for saving programs, if desired. It is not necessary to use this cable to simply load tapes. The remaining cable from the Z-Dubber (P3) can be left hanging until a second recorder is connected for copying.

Before attempting to load a tape, get the "feel" of the volume control. Even though the computer is not yet turned on, the LED should glow at some point as the cassette recorder volume is increased. Notice that as the volume is

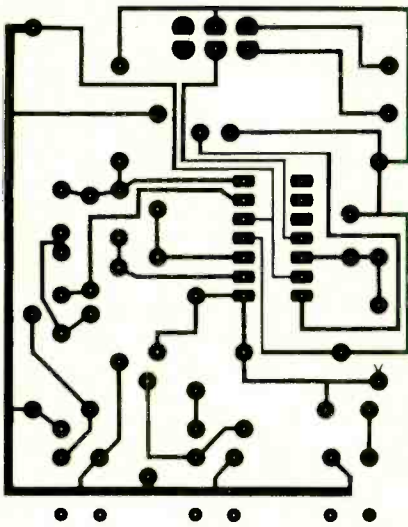

Fig. 4. Actual-size foil pattern for the circuit board.

raised and lowered, the LED goes on and off. The correct setting is 10-20 degrees past where the LED first illuminates. This will ensure that "weak spots" on the tape do not drop below the threshold level. If the volume level is advanced too far, the signal may overload the Z-Dubber.

Once you feel you have the correct setting, rewind the tape to the start of the program (where the musical buzz starts), power up the computer and follow the vendor's instructions for loading the tape.

Normally the LED should remain lit. If it flickers off and on, the volume is set too close to the threshold and should be slightly advanced. As the tape is load-

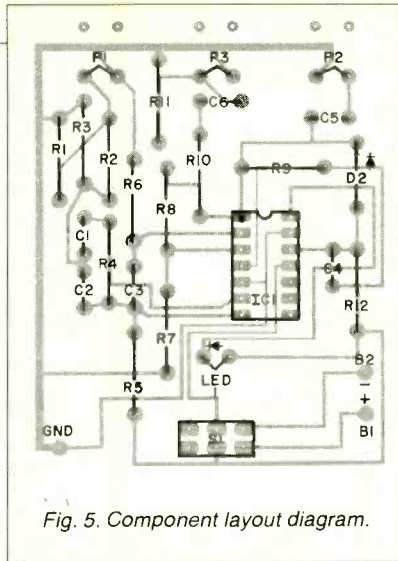

Fig. 5. Component layout diagram.

ing, evenly spaced black-and-white bars should be noted on the TV screen.

It should be possible to get a good load the first time the Z-Dubber is used. However, this may not occur until the user becomes familiar with the relationship between the volume control and the LED. Once the correct setting is found, note the amount of rotation beyond the point where the LED first glows. The correct setting depends on the volume level at which the program

was recorded and will vary from tape-to-tape. One will find that different tapes may require different settings of the volume control. Always add the few degrees of volume advance to that required to illuminate the LED.

Making Copies. The procedure for making tape copies is almost exactly the same as for loading tapes. In fact, to ensure a perfect reproduction, the tape should be loaded at the same time the copy is made. When the tape is loaded properly, the user can be assured that the copy is perfect. The signal to the "slave" recorder is essentially the same (except for a much lower level) as is fed to the input of the computer.

As mentioned earlier, the tape being copied should be advanced to just before the point where the buzz sound starts. This way, one can "edit out" the vertical sync noise that appears on some tapes. Always use good quality tape in the "slave" recorder and don't forget to leave a 10-second leader at the beginning of the new tape. This will eliminate plastic leaders, wrinkles, and so on. ◇

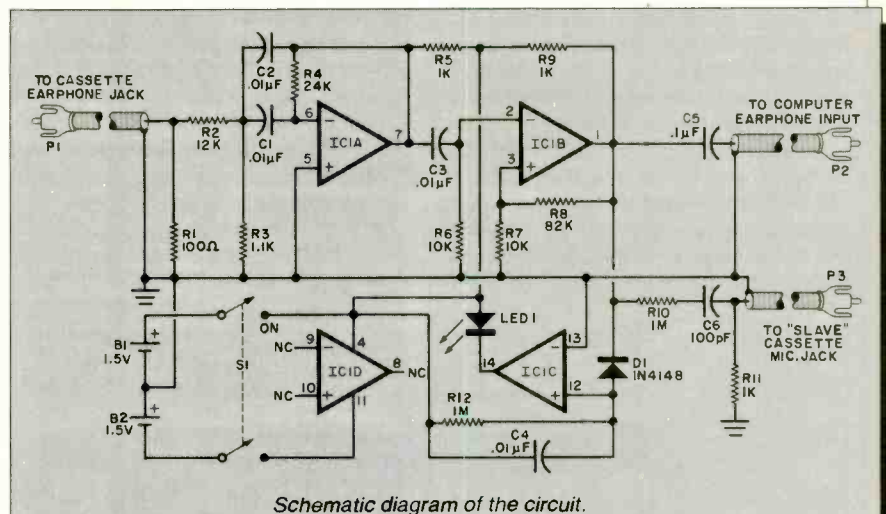

Schematic diagram of the circuit.

PARTS LIST

- B1, B2—1.5-V AAA cell
- C1, C2, C3, C4—0.01- μ F monolithic capacitor
- C5—0.1- μ F, 50-V disc ceramic capacitor
- C6—100-pF silver mica capacitor
- D1—1N4148
- IC1—LM324 quad operational amplifier
- LED1—MV50 or similar light emitting diode
- P1, P2, P3—12" shielded cable, terminated in miniplug
- R1—100-ohm, 1/4-W, 5% carbon resistor
- R2—12-kilohm, 1/4-W, 5% carbon resistor
- R3—1.1-kilohm, 1/4-W, 5% carbon resistor
- R4—24-kilohm, 1/4-W, 5% carbon resistor
- R5, R9, R11—1-kilohm, 1/4-W, 5% carbon resistor

- R6, R7—10-kilohm, 1/4-W, 5% carbon resistor
- R8—82-kilohm, 1/4-W, 5% carbon resistor
- R10, R12—1-megohm, 1/4-W, 5% carbon resistor
- S1—Dpdt slide switch
- Misc.—Suitable enclosure, perforated or printed circuit board, battery holder, for two AAA cells, tie wraps (3), double-sided "sticky" tape for securing pc board.

Note: The following is available from Bytesize Micro Technology, PO Box 12309, Seattle, WA 98111: kit of all parts and materials at \$22.95. Also available separately: pc board at \$8.50 punched and silk-screened cabinet at \$6.50. Postage and handling prepaid.

A VIC-20 CASSETTE ADAPTER

*Interface for the Commodore VIC-20
allows any audio cassette recorder to be used*

By Bernard J. Sheehan

No longer must one pay almost as much for the VIC "digital" cassette machine as for the VIC-20 computer itself. Frugal owners will be happy to learn that a simple, easily built, dependable circuit, costing about \$7, can be used to interface the VIC-20 with any commonplace audio cassette tape recorder.

Circuit Operation. The circuit, shown in Fig. 1, is based on IC1, a hex Schmitt trigger package. The main characteristic of such a trigger is that it will convert an irregular input waveform into a train of clean, square-edged pulses at TTL levels. Typical operation of a Schmitt trigger is shown in Fig. 2. Diode D1 prevents the cassette audio from applying a negative signal to the Schmitt.

As shown in Fig. 2A, the Schmitt has an upper and lower triggering threshold. When the input voltage level rises above the upper-trigger level, the output of the stage goes high and remains high as long as the input voltage level

exceeds the lower trigger level. When the voltage drops below the lower trigger level, the stage output drops to zero. This action is shown in Fig. 2B.

Note that, even if the varying input voltage drops below the upper trigger level, as long as it does not go below the lower trigger level, it will not affect the output signal. It is this "dead band" between the upper and lower triggering threshold that gives the Schmitt trigger the capability to ignore random fluctuations in the input signal level.

Since the circuit is not sensitive, any type of construction can be used (point-to-point wiring on perf board or a small pc board). Any pair of gates in IC1 can be used. Power is obtained from the B line of the VIC-20 cassette port connector (with ground coming from pin A).

To minimize chip current drain, ground the *input* of the four unused gates. The cassette interface is connected to the VIC-20 cassette edge connector through J1, which can be made from

any edge connector having 0.154" spacing.

Use. Connect J1, the cassette interface, to the VIC-20 cassette port, and connect the cassette recorder audio output to J2. Then connect J3 to the microphone input connector on the VIC-20 computer.

To store a program on cassette, type SAVE, with the computer responding by printing PRESS RECORD AND PLAY ON TAPE. At this point, the computer halts. Simultaneously depress the PLAY and RECORD buttons on the recorder, then close S1 on the interface. The computer sends data to the cassette recorder. The cassette volume control will have to be adjusted for the correct signal level. However, once this is done, the knob position should be marked and never moved.

To load a program from the cassette, type LOAD on the computer, then close S1. When the interface is not in use, open S1. ◇

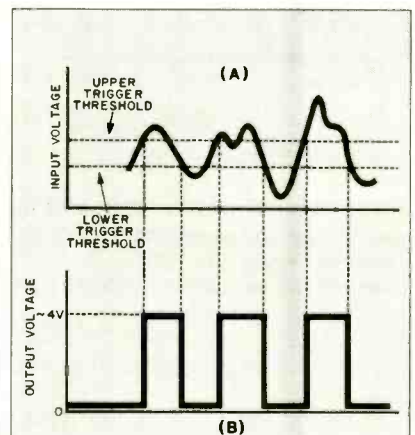
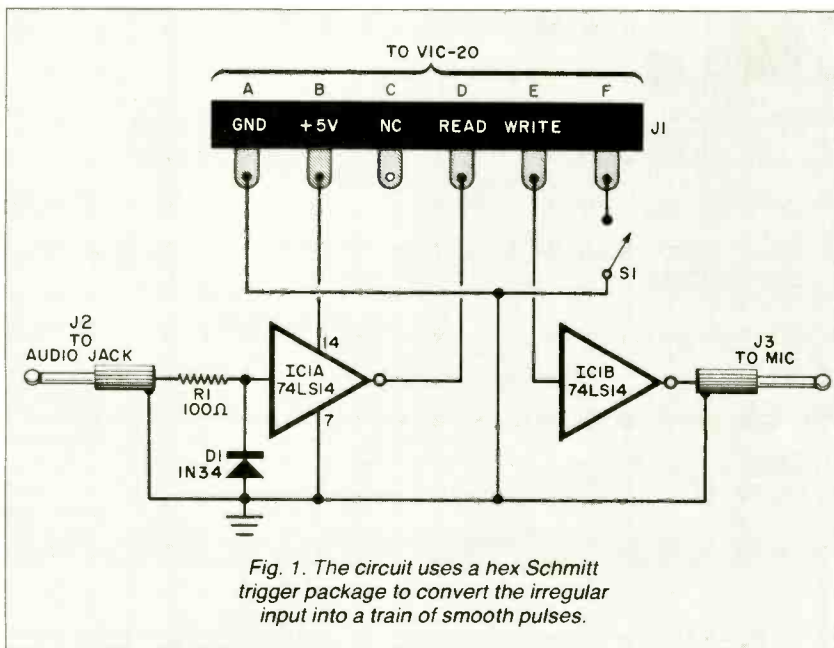

Fig. 2. As shown at (A), the triggering of the circuit is determined by the upper and lower levels of the input signal. Whether or not the circuit is triggered determines the output level at (B).

Digital TV— How Soon?

By Len Feldman

FOR some three years now, several high-tech consumer electronic companies such as Sony and Panasonic have been demonstrating what they call "high-definition" TV. The television pictures they have shown consist of between 1050 and 1150 lines per frame, or more than twice the number of lines currently in use in standard NTSC TV transmissions (used in the United States and Japan). European TV, which for the most part employs a 625-line format, offers far better definition or picture resolution than U.S. television, but still suffers by comparison with these experimental systems. In addition to the greater number of lines per frame employed in these systems, the aspect ratio (picture width to height) has been increased over the present standard of 4:3.

This was done to accommodate motion pictures that were filmed for wide-screen viewing, but are shown on TV with their sides chopped off.

Although high-definition TV is certainly a worthwhile achievement, there is currently no way for such superb-looking TV pictures to be transmitted over the air. Present TV frequency allocations, established in the "dark ages" of television, assign a bandwidth of just 6 MHz for each TV channel, for both vhf (channels 2 through 13) and uhf (channels 14 through 83) service. This 6-MHz bandwidth accommodates the present 525-line system, its associated color sub-carrier signal, and even currently proposed (but not yet approved) stereo or multi-lingual audio channels. But an increase in the number of lines per frame would mean an increase in each channel's frequency bandwidth. The FCC is not about to revamp the entire TV broadcasting frequency band at this time, what with more than 80-million households now owning one or more TV receivers.

There has been talk of developing a

new band of frequencies for high-definition TV, way up in the 12 gigahertz (GHz) region. In fact, some have proposed that the FCC make provisions in that "empty" and spacious frequency region not only for high-definition TV, but for *digital* high-definition TV. A digital system might require frequency assignment in excess of 30 MHz per channel, but such wide channel bandwidths are perfectly feasible up at 12 GHz. What's more, the 12-GHz frequency band is being proposed as a new satellite frequency band. This means that if the industrialized nations of the world could get together and agree upon a high-definition TV standard, we might finally have a single, standardized, high-quality TV service for the entire world.

One Form of Digital TV Is On The Way. While we wait for such a system, several manufacturers have been hard at work improving the picture quality of today's TV receivers. At least two of them have indicated that they intend to market "digital" television sets before

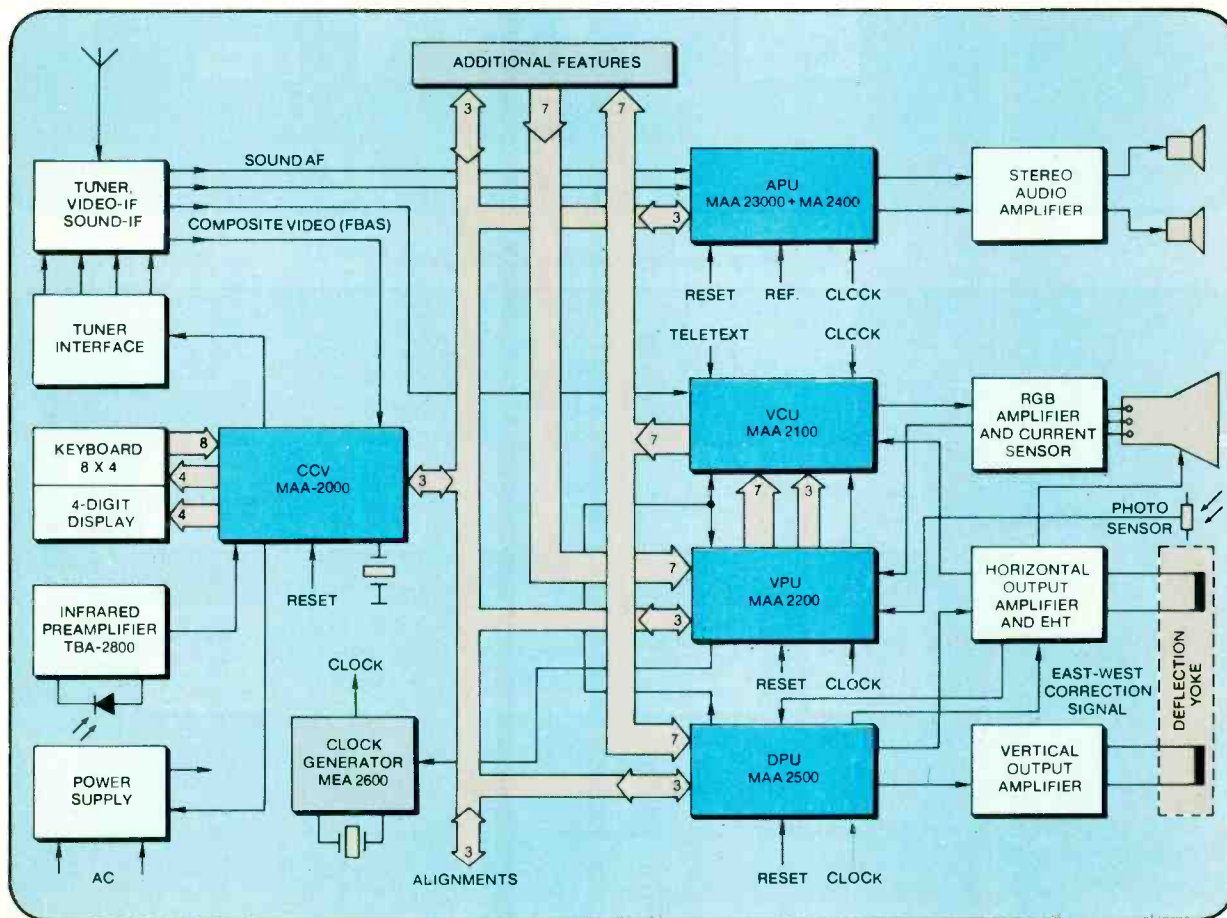

Fig. 1. Block diagram of ITT "digital" television receiver.

the end of 1983. However, these digital TVs will still have conventional (i.e. analog) front ends and I-f sections. The signals demodulated by the analog circuitry, which have a bandwidth of only 4 or 5 MHz, will then be digitized. The signal processing, including the analog-to-digital conversion, will be done by a set of eight chips that contain five VLSI (very large scale integrated) circuits. These chips, which were designed and produced by the International Tele-

phone and Telegraph Corp. (ITT), are said to perform the work of about 300,000 transistors. According to ITT, digital TV sets using this technology can provide better image quality than is now available, at about the cost of today's higher priced sets. Furthermore, the kind of digital signal processing performed by these circuits will allow for the introduction of additional features over the years, such as the ability to zoom in on part of a picture, simulta-

neous viewing of two station signals (with one picture inset in the other), and the ability to process teletext.

As for better picture quality, ITT claims that at least partial elimination of ghosts is possible. A digital TV set will be able to lock onto a sync signal to suppress interference from electrical appliances, passing aircraft, etc. Once a video signal is digitized, picture storage becomes possible. Such picture storage capability will provide a number of useful

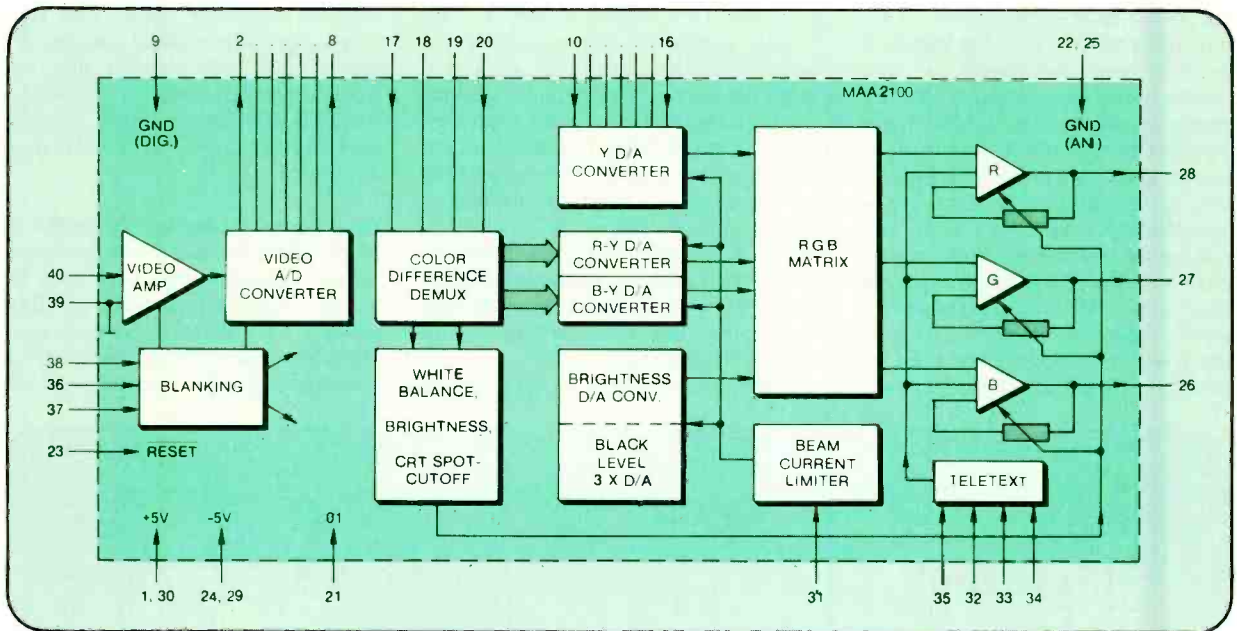

Fig. 2. Block diagram of the video CODEC chip.

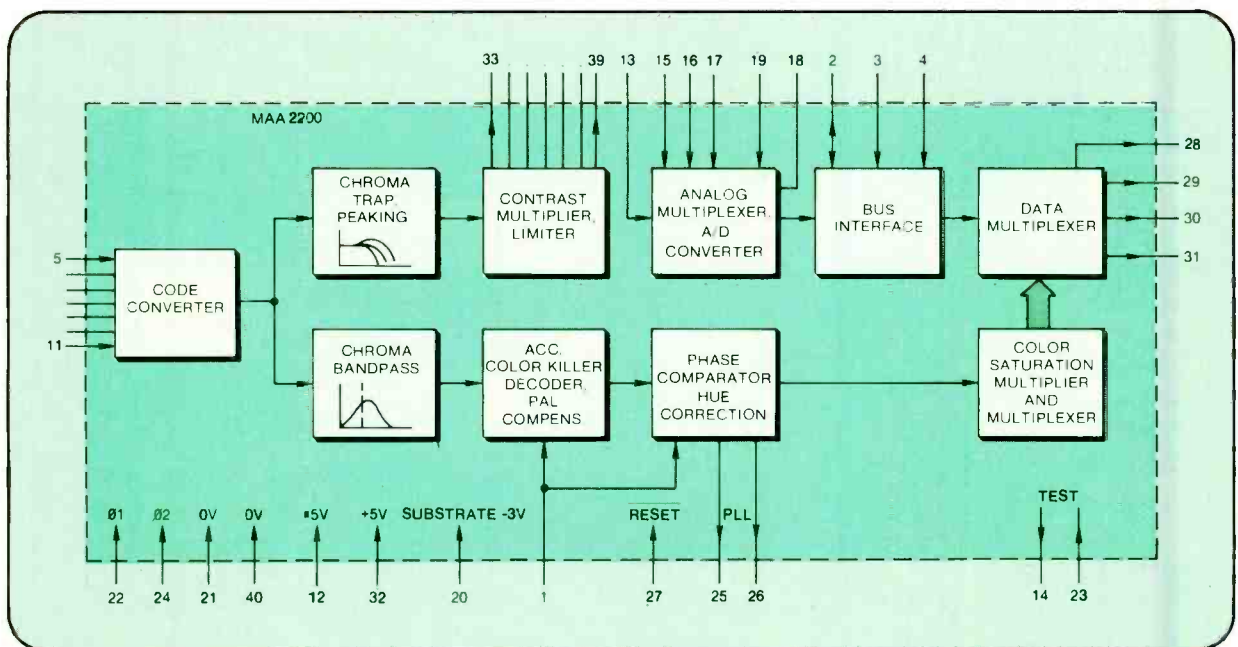

Fig. 3. How the video processor chip works.

features that are not possible using current analog technology. For example, it should be possible to provide a so-called pseudo high-resolution picture. The set would interpolate between scanning lines of a picture and produce additional scan lines that could be positioned between the original lines. This technique which would produce twice as many scan lines, would give the appearance of a high-resolution picture. Not only would a normal-sized picture seem much sharper, but the resolution or definition of pictures projected onto large screens would be greatly improved. If

digital TV circuitry should ever be applied to video cassette recorders, the ability to store images would allow the user to watch pictures in slow motion or freeze frame without the usual "noise bursts" now common on analog VCRs.

Digital TV is also expected to be of great importance in the development of DBS (direct broadcast satellite) transmissions. For one thing, it overcomes incompatibility problems between our own NTSC system and European PAL and SECAM color-TV transmission systems. Digital sets can be designed to handle all three types of transmissions.

In addition, digital TV would permit direct processing of satellite transmissions that are expected to include digital and multichannel sound transmission (bilingual and/or stereo audio). Normally, in the case of conventional receivers, such digital audio signals would have to be converted into analog form for further processing by analog circuitry.

How Digital TV Sets Work. A digital TV uses analog circuits until the incoming signal has been demodulated. Then both the video and audio demodulated signals are converted to digital form. Experience has shown that an 8-bit code is needed for proper resolution of the video luminance (brightness) signal; 6 more bits are required for the chroma (color) signal; 13 bits are needed, for the deflection signals; and 14 bits are required for the audio signal.

The digital processing is performed by five VLSI chips, aided by a clock generator, a digital amplifier, and a microcomputer that controls the process based upon the user's front-panel control settings. The five chips are a video "codec" (coder/decoder), which consists primarily of A/D and D/A converters for the video signal; an audio codec, which performs the same functions for the audio signals; a deflection control unit, which deals with the sweep synchronization signals; and video and audio processor units, which do the filtering and decoding of the video and audio signals. A block diagram of a com-

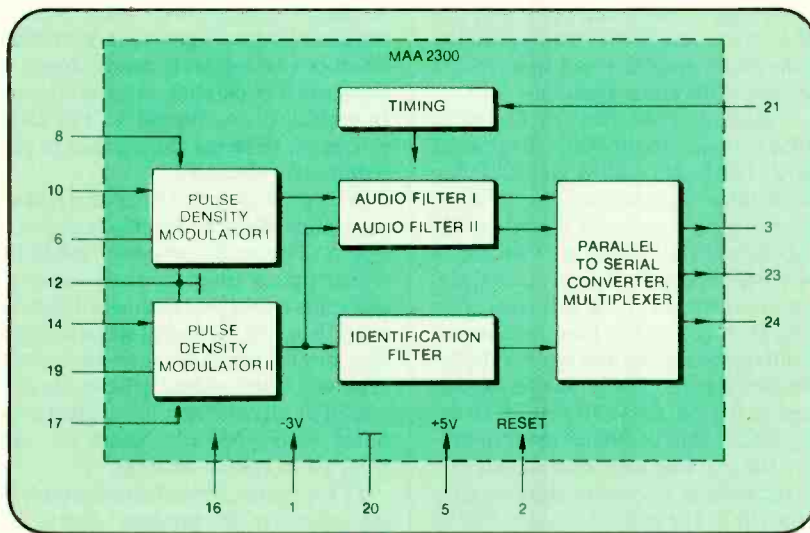

Fig. 4. Simplified diagram of the audio A/D converter.

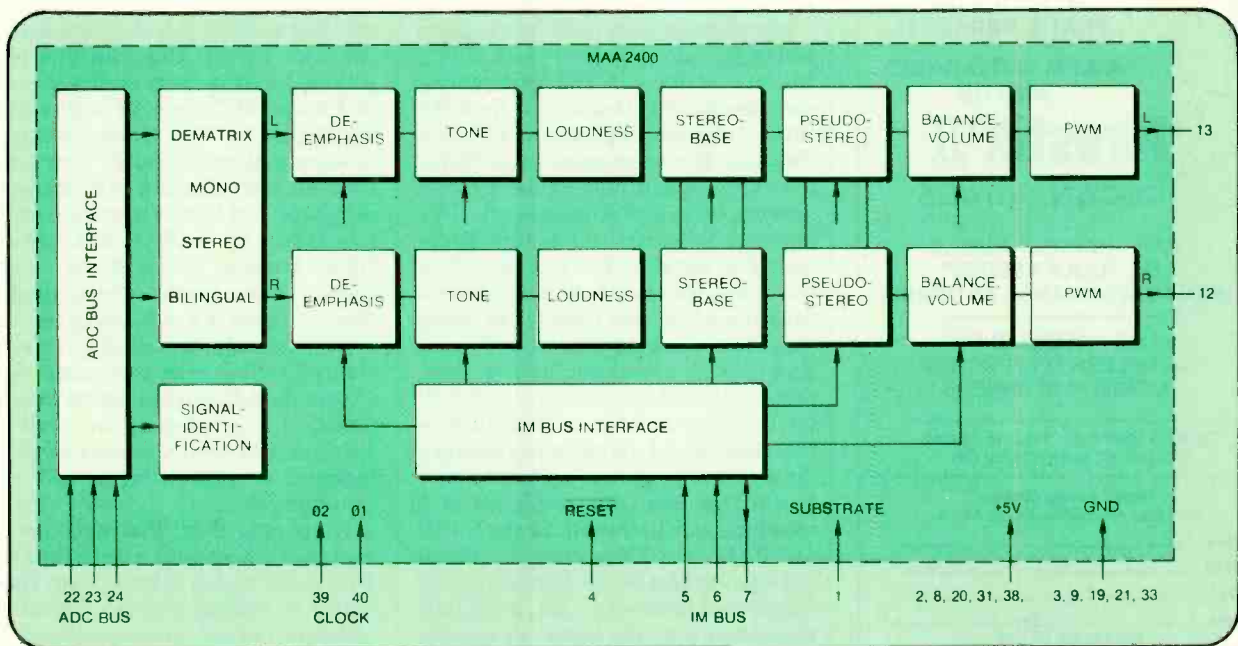

Fig. 5. Block diagram of the MAA2400 audio processor.

CREATIVE COMPUTING PRESS HAS THE BOOKS YOUR CUSTOMERS NEED!

Everybody who buys a computer needs information ... and looks to books for in-depth instruction. Creative Computing Press, one of America's largest computer book publishers, has a complete line of microcomputer books you can sell in your store. Send for our free book catalog today!



ROBERT GALES, Sales Manager
One Park Avenue, 12th Floor
New York, NY 10016
(212) 725-7006

SEE YOUR DEALER TODAY



FROM



HERE'S A TIP THAT'S PERFECT!

AM/FM AUTO RADIO AND CB

'Firestik' II

GOLDEN SERIES

BARE-HANDS TUNABLE
"NO TOOLS NEEDED"
HIGH PERFORMANCE ANTENNAS

ALSO ANTENNAS FOR
CORDLESS TELEPHONES
MONITOR SCANNERS

Dealer & Distributor Inquiries Invited
SEND FOR FREE CATALOG

'Firestik' Antenna Company
2614 East Adams/Phoenix, AZ 85034

Name _____
Street _____
City _____
State _____ Zip _____

Serving the CB and
Communications Market Since 1962.

5-YEAR REPLACEMENT WARRANTY

Circle No. 26 on Free Information Card

ENTERTAINMENT

plete TV receiver using these chips is shown in Fig. 1.

Demodulated signals from the IF amplifier, at the upper left of the diagram, are fed to the video and audio codec chips, which convert the analog signals into digital. The digital signals are then passed along to the audio and video processor units. These units are controlled by the central control computer, which also receives inputs from the user via a keyboard or an infrared remotely controlled hand-held module. Signals from the video and audio processor units are fed back through the converter where they are changed back to analog and fed to the color beam amplifiers and the CRT (in the case of the video signals) or to the audio amplifier and speakers (in the case of the audio signals).

A more detailed view of the video codec is shown in the block diagram of Fig. 2. This codec is a bipolar VLSI chip which takes signals from the i-f stage and converts them into digital in the A/D block. The signals are then fed to the video processor. The processed signals are converted back into analog by three D/A converters (two for the color-difference signals and one for the luminance signal). These analog signals are then fed into the RGB matrix, an analog circuit that combines them to produce the red, blue and green signals that are fed to their respective electron guns in the CRT. The process is controlled by brightness settings passed on by the control computer from the user. The electron circuits on the chip can also be activated by a teletext input.

Signal processing that takes place within the video processor block of Fig. 1 is detailed in Fig. 3. The video processor takes the digitized output from the video codec and separates it into two channels. The luminance channel is filtered to emphasize high-frequency components, using a peaking network. This improves sharpness and picture definition. The signal is then passed on to a multiplier, which sets the contrast, and from there it is sent back to the codec chip. The chrominance channel goes through a bandpass filter, an automatic color control circuit, a comb filter, the color decoder, and then back to the codec. In the chrominance channel, the signal is amplitude controlled by a circuit that keeps the amplitude of a reference signal constant. In the NTSC and PAL color-TV systems, the signal codings for blue-minus luminance and red-minus luminance are amplitude modulated onto the carrier in quadrature (90 degrees apart). In the SECAM system (used in France) frequency mod-

ulation is used, with red and blue signals sent during alternate horizontal sweeps.

Processing the Audio Signals. The audio chip has two parallel-processing channels and an arithmetic/logic unit that shares them to carry out the required filtering operations. A block diagram of the audio A/D converter is shown in Fig. 4. It uses a pulse-density modulator and digital converter. The circuit samples a 4-MHz input signal and produces a 1-bit data stream, which is then converted into a 16-bit resolution stream at a 35-kHz sampling rate. A digital identification filter extracts the identification signal that determines whether a broadcast is mono, stereo, or bilingual. The parallel-to-serial converter multiplies the output to the audio processor, reducing the number of pins required for the chip.

A block diagram of the audio processor section of the audio chip is shown in Fig. 5. The audio processor takes the digital signals from the A/D converter and splits it into two channels. Each signal is then sent through a series of filters that control stereo balance, tone, loudness, etc. Filter characteristics are controlled by signals from the control computer chip and are based on user front-panel control settings.

ITT is, so far, the only semiconductor manufacturer to produce digital TV chips. If the chips prove reliable and the yield makes them economical enough to use in consumer products, the company plans to follow up with two-chip and one-chip versions that should make digital color TV sets competitive in price with the least expensive present-day color TV sets. ITT's own TV manufacturing division in West Germany expects to begin making digital TV sets sometime this year. The sets, to be marketed in Europe, will be able to receive signals transmitted by the PAL, SECAM and NTSC systems. Zenith Radio, in this country, also expects to begin production of digital TV sets using the ITT chips, but as of now exact dates or availability have not been announced. Sony Corporation, Sanyo, and Sharp International, all of Japan, as well as Telefunken of West Germany have also indicated an interest in the ITT chip development.

It appears, then, that although we may have to wait quite a while for a new TV system that is digital "from transmitter to receiver screen," digital enhancement of our present system of TV broadcasting may make the wait more tolerable. ◇

Move up to Microsystems

**THE JOURNAL FOR SOPHISTICATED
MICROCOMPUTER USERS.**

Microsystems is not, in any sense, for beginners. Unlike "personal computer" magazines, *Microsystems* is written *exclusively* for expert users and designers in the software and support hardware field.

If you need a reliable, high-level, up-to-date journal devoted to CP/M,[®] MP/M,[®] MS-DOS,[™] UNIX,[®] XENIX,[™] OASIS and other operating systems, then *Microsystems* is for you. We feature tutorials on the modification and special use of systems, offer short-cut routines, show you debugging procedures, techniques for interfacing, and much more. Our one purpose is to keep the advanced microcomputer professional at the leading edge of DOS development and use.

In a few recent issues of Microsystems you would have seen:

- Reviews of four C compilers: BDS C, Small C, tiny c TWO[™] and Whitesmiths C.
- A programming style comparison: Digital Research PL/I-80[™] vs. Microsoft BASIC.
- Twenty-seven 16-Bit DOS compared.
- Virtual segment procedures under UCSD Pascal.
- An in-depth look at MP/M-80 II.[™]
- A simple 6-byte hexadecimal ASCII conversion routine.
- Using CP/M's undocumented "Autoload" feature.
- An explanation of double density disk controllers.

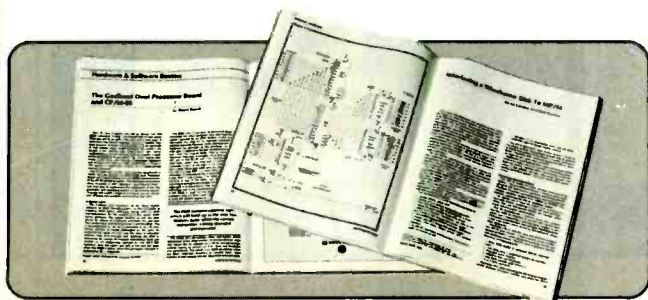

- A comparison of five popular S-100 disk controller cards.
- OS-1—a UNIX-like DOS with a CP/M adapter.

Every issue of *Microsystems* keeps you at the forefront of the industry in customizing software and adapting hardware to meet new requirements and standards. You'll also find industry news, book and new product reviews, plus our regular *Software Directory* listing newly available programs.

To get the high-level systems information you want, join the club of serious microcomputer professionals who subscribe to *Microsystems*. Use the coupon below to order, and save up to 33%!

PROFESSIONALS PLEASE NOTE:

*Your subscription to Microsystems
may be tax deductible. Check
with your accountant.*

Trademarks:

XENIX: Microsoft; tiny c TWO: tiny c assoc.;
PL/I-80, MS-DOS, MP/M-80 II: Digital Research.
Registered Trademarks:
CP/M, MP/M: Digital Research; UNIX: Bell
Laboratories.

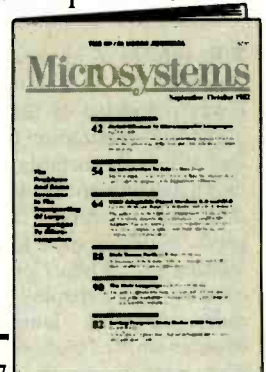

Microsystems CN 1987
Morristown, New Jersey 07960

YES, enter my subscription to *Microsystems* for:

- 12 issues at \$21.97—I save 19%
- 24 issues at \$40.97—I save 24%
- 36 issues at \$55.97—I save 31%

Savings based on full 12-issue subscription price of \$26.97

Mr. _____
Ms. _____
(please print full name) 8H38

Company _____

Address _____

City _____

State _____ Zip _____

CHECK ONE: Payment enclosed. Bill me later.
Offer valid in U.S. and possessions only. Please allow 30 to 60 days for delivery of first issue. Satisfaction guaranteed or a prompt refund for unmailed issues.

NEW SUBSCRIBERS ONLY



Homemade Electroscopes Experimenting with a Geiger Counter

By Forrest M. Mims, III

More About Radiation Monitors

THE subject of nuclear radiation often generates concern about human safety. I was reminded of this recently while gathering information for this column. I had taken a portable Geiger counter into a department store to search for radioactive materials. In the sporting goods department, I found what I was looking for. When I pushed the Geiger counter into a display of a hundred or more Coleman lamp mantles, the counter emitted a chorus of loud chirps. The saleslady was thoroughly alarmed. As you may know (she didn't), lamp mantles contain radioactive thorium.

This month we'll explore the topic of low-level radioactivity. We'll also build from common household materials a couple of electroscopes, a type of early voltage and radiation detector.

Recently I've heard from two manufacturers of radiation monitoring instruments in response to my coverage of this topic for this magazine (see "Solid-State Developments," April 1983). First, Mr. Al Zirkes, Marketing Manager of the Dosimeter Corporation (P.O. Box 42377, Cincinnati, OH 45242), sent a thick package of information about his company's wide ranging line of radiation measuring instruments and related products.

Among its electronic monitors is the MiniRAD-D (Fig. 1), a pocket-sized monitor that displays (on a 4-digit liquid-crystal readout) radiation levels up to 2000 milliroentgens per hour

(mR/hr). It includes an audible indication of the radiation level as well as a visual indication provided by flashing LEDs. The MiniRAD-D sells for \$375.

Another member of Dosimeter Corporation's family of compact electronic radiation monitors is the MiniCON®II (Fig. 2). It displays radiation levels on a conventional moving-coil meter and includes an audible output. A useful advantage of the unit is its cable-connected, external Geiger tube. This greatly simplifies some measurements since the tube can be placed in locations where instruments with internal tubes will not fit. The MiniCON II sells for \$450.

Dosimeter Corporation makes a complete line of electronic radiation monitors like the MiniRAD-D and the MiniCON II, but its best-known product is based upon an operating principle not included in my previous column. Noticing this omission, Mr. Zerkes wrote that I failed to describe "... the largest selling and lowest cost personnel radiation detection device, the Direct Reading Pencil Dosimeter, which outsells all of the instruments noted by a factor of at least 100."

I purposely omitted direct reading dosimeters from the previous article since they are not usually considered *electronic* devices. Other such devices include film badges, certain plastics, and phosphor screens.

In a very real sense, however, Dosimeter Corp.'s pocket dosimeters are indeed electronic devices. In fact, they are the modern version of one of the very first electronic instruments, the *electroscope*.

Since Dosimeter Corp.'s pencil dosimeters sell for as little as \$95, they are certainly economical. However, since they require a charger that costs another \$80 or more, they are not as economical as some competing devices.

For example, Mr. Dan Sythe of Solar Electronics International (156 Drakes Lane, Summertown, TN 38438), the second firm to respond to my earlier article, loaned me one of his company's Monitor 4 radiation detectors. This instrument, which I briefly described in the previous article, indicates alpha, beta and gamma radiation on a scaled moving-coil meter and with audible chirps—not bad for a device that sells for \$150. In its nonaudio mode, the Monitor 4, indicates individual counts with a flashing LED. While it lacks the ruggedized construction of its more expensive counterparts, it is compact and has a low power consumption.

Later in this column I'll describe how I've used the Monitor 4 to measure the radioactivity of several objects found in or around most homes. Meanwhile, let's find out more about the operating principles of direct reading dosimeters.

Direct Reading Dosimeters. The direct reading dosimeter is a modern form of the venerable electroscope, one of the first devices capable of indicating the presence of static electricity. The electroscope is based upon the well-known principle that unlike charges attract while like charges repel.

Traditional electroscopes are made by folding a rectangular piece of gold leaf into two equal halves and hanging it from a conducting support in a glass bottle. The electroscope is "charged" by touching a positively or negatively charged object or electrode to a metal sphere attached to the conductor emerging from the bottle. This applies an equal charge to both leaves of gold foil. Since like charges repel, the leaves will then fly apart and defy gravity until their charge gradually leaks away into the surrounding air or is intentionally shorted to ground.

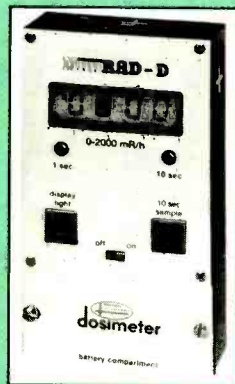

Fig. 1. Dosimeter's MiniRAD-D.



Fig. 2. MiniCON radiation monitor.

So how does the electroscope detect radiation? The charged leaves of the electroscope will gradually give up their charge by transferring electrons to or receiving electrons from the surrounding air. Unless it contains moisture, however, air is a poor conductor of electrons. Radioactive particles and rays have the ability to strip electrons from atoms that form air. These ionized atoms provide a conductive path for the charged leaves of an electroscope. Therefore, assuming no other leakage paths are present, the distance between the leaves of a charged electroscope is proportional to the cumulative radiation which has entered the space around the electroscope's leaves.

Figure 3 is a cutaway pictorial view of a typical pencil dosimeter made by Dosimeter Corporation. The device is prepared for use by first inserting the end containing the contact pin into the socket of a charger. The contact pin is mounted within a flexible metal bellows. When the dosimeter is pressed down into the charger's socket (Fig. 4), the opposite end of the contact pin makes contact with a metal member (the frame) inside the dosimeter. A charge of about 170 V is then transferred to the frame via the contact pin.

The charge is also applied simultaneously to a metal-plated quartz fiber suspended from and in electrical contact with a hinge on the frame. Since the frame and the fiber are given equal and like charges, the fiber swings away from the frame as illustrated in Fig. 3.

The sealed portion of the dosimeter that houses the quartz fiber and its frame is filled with dry air and is called an *ion chamber*. Radiation entering the chamber ionizes atoms of air, thereby providing a conductive path for some of the electrons on the fiber. As the charge

on the fiber is gradually diminished by a radiation field, the quartz fiber moves toward the frame.

The position of the fiber can be viewed against a scale inside the dosimeter by peering through the instrument's eyelens while pointing the contact end toward a light source. Light enters the instrument through a glass collar around the contact pin.

A key component of the dosimeter is the contact-pin/bellows assembly. Since the bellows pulls the contact pin away from the frame when the instrument is pulled from the charging socket, the charged quartz fiber is electrically isolated from the outside world. Consequently, a dosimeter typically loses only about 0.25% of its charge per day.

The pencil dosimeter is a very important radiation monitoring device. Unlike most electronic monitors, it is truly pocket-sized. And although, it doesn't provide an indication of the *rate* of incoming radiation, it does give an accurate measure of *cumulative* exposure. Note too, that although it requires an external charger, one charger can be used to service dozens of instruments.

A Homemade Electroscope. Figure 5 shows a simple electroscope you can make from homemade materials. For best results use a heavy-gauge copper wire for the conducting support. Round off both ends of the wire with a small file and fine sanding paper. This eliminates sharp edges and burrs that would otherwise serve as discharge points for the charged leaves. Insert the support wire through a cork and form it as shown in the figure.

Some hobby and craft stores sell gold leaf which you can use to make a traditional electroscope. But I've used both standard and heavy-duty aluminum foil

with good results. The standard gauge works best.

Prepare the foil by cutting it with sharp scissors to the size you plan to use. The finished size isn't critical so long as the leaves don't touch the sides of the bottle. Next, smooth the foil by placing it on a flat surface and stroking it a few times with a smooth pencil or your thumb. For best results, the foil should be as flat as possible. But this is not easy since it tends to curl when stroked.

After you smooth the foil, fold it in two equal sections over the edge of a piece of cardboard and hang the foil leaves over the support wired. Insert the cork with support wire and foil leaves into the jar as shown in Fig. 5. The leaves should be closely spaced and parallel to one another.

You can charge this homemade electroscope simply by touching the exposed end of the support wire with a comb you've stroked a few times through your hair. If both your hair and the comb are dry, the leaves will fly apart and remain extended for at least a



Fig. 4. Charging a dosimeter.

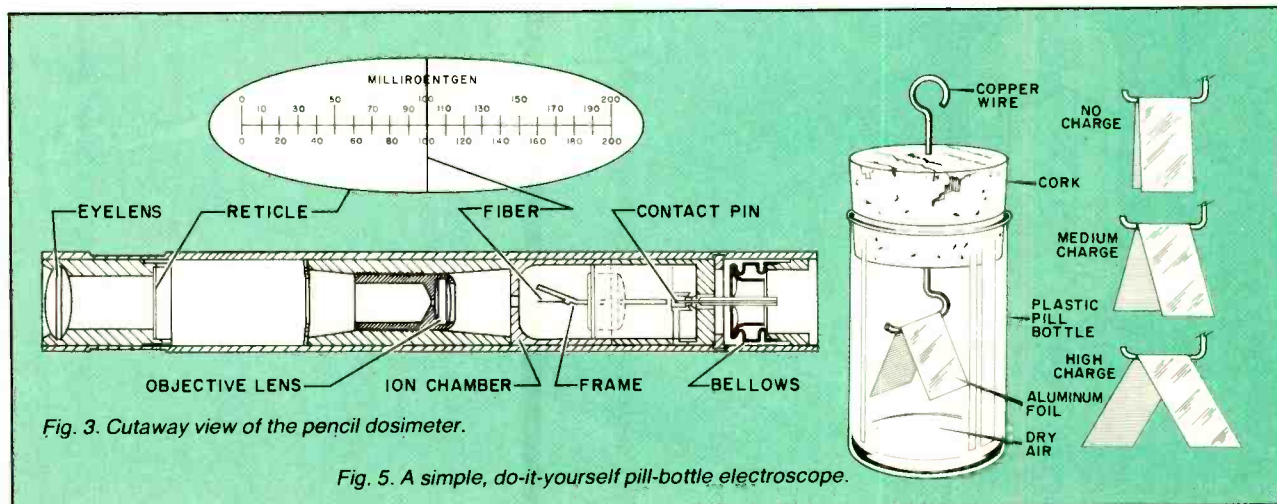

Fig. 3. Cutaway view of the pencil dosimeter.

Fig. 5. A simple, do-it-yourself pill-bottle electroscope.

few seconds. On a very dry day, they will stay apart for quite some time.

If the leaves appear to stick to the sides of the bottle, use a larger container or smaller leaves. If the leaves fail to diverge when the electroscope is charged, make sure they have not become attached to one another at any slight nicks or frayed edges along the edge of the foil.

Failure of the leaves to diverge may indicate moist air in the electroscope's bottle (its ion chamber). Assuming everything else checks out, but the leaves still fail to repel one another, it may be necessary to replace the air in the bottle with dry air.

Several companies sell cans of pressurized, filtered, dry air for blowing dust from photographic film and mechanical devices. I've had good results using such air in my homemade electroscopes. Just remove the cork and leaves, squirt a dose of dry air into the bottle, and quickly replace the cork and leaves.

When you place a radioactive sample (see below) near the exposed electroscope wire, the leaves will begin to collapse at a much faster rate than normal. Move the sample away and the leaves will stop falling. This proves that a charged electroscope, even one made with household materials, can indeed detect ionizing radiation.

A Better Electroscope. Figure 6 shows another homemade electroscope with which I've experimented. It differs from the first in that it has but one moving leaf. The second leaf had been replaced by a rigid rectangle of two-sided

copper-plated printed-circuit board.

The support member is a copper wire soldered to the back side of the pc board and bent around to the front side to form a support for the movable leaf. The leaf is a strip of smooth, flat aluminum foil. Shape the foil by wrapping one end of it around a wire with a diameter larger than that of the support wire. Then slip the resulting foil tube over the support wire to form a hinged leaf.

This electroscope can be installed in a plastic pill bottle much like the one in Fig. 5. I used, however, a small glass bottle of the type used to ship soft contact lenses. The bottle has a plastic cap into which you can easily insert the support wire. The cap provides a secure seal and is easily removed.

Note that this electroscope doesn't have a protruding wire contact. This greatly reduces the possible leakage paths and preserves the electroscope's charge for a longer time.

A Non-Electronic Electroscope Amplifier. You can amplify the motion of the leaves of an electroscope by reflecting a narrow beam of light from one of the leaves. If the reflected spot of light is directed toward a white card marked with an appropriate scale, you can easily measure movements of the leaf.

Figure 7 shows how you can use a helium-neon laser for this purpose. For best results, make sure the shiny side of the aluminum foil electroscope leaf faces outward.

If you place the white card a few feet away from the electroscope, the reflected spot of light may move 6" or more as

the leaf falls from its fully charged, extended position. Since the foil surface is not perfectly flat, the reflected spot of light will be fairly large and blurred around the edges. Nevertheless, by arranging the electroscope, laser and card in suitable positions, you should have little difficulty detecting very tiny movements of the electroscope's leaf when a sample of radioactive material is placed near its external electrode.

Radiation Sources. By now you may be wondering where to obtain a radioactive source to check out a homemade electroscope. One possibility is to purchase a source from a manufacturer or distributor of radiation monitors. For instance, Dosimeter Corporation sells a source containing 5-microcuries or cesium 137 for \$35.

You can obtain other sources for considerably less, though. The cheapest is probably a thorium impregnated lamp mantle made by Coleman, Aladdin and Gaz. These mantles contain thorium-232, an isotope that can be bred into uranium-233, the fissionable isotope used in nuclear reactors and weapons. Thorium-232 emits alpha particles, and decays through a series of ten *radio-daughters* (subsequent elements), the first being a beta emitter, radium-228.

Another reasonably low-priced radioactive source is the polonium-210 used in Staticmaster dust removers, a product of Nuclear Products Company (Box 5178, El Monte, CA 91734). The Staticmaster is a soft brush equipped with a replaceable cartridge containing a strip of metal coated with polonium-

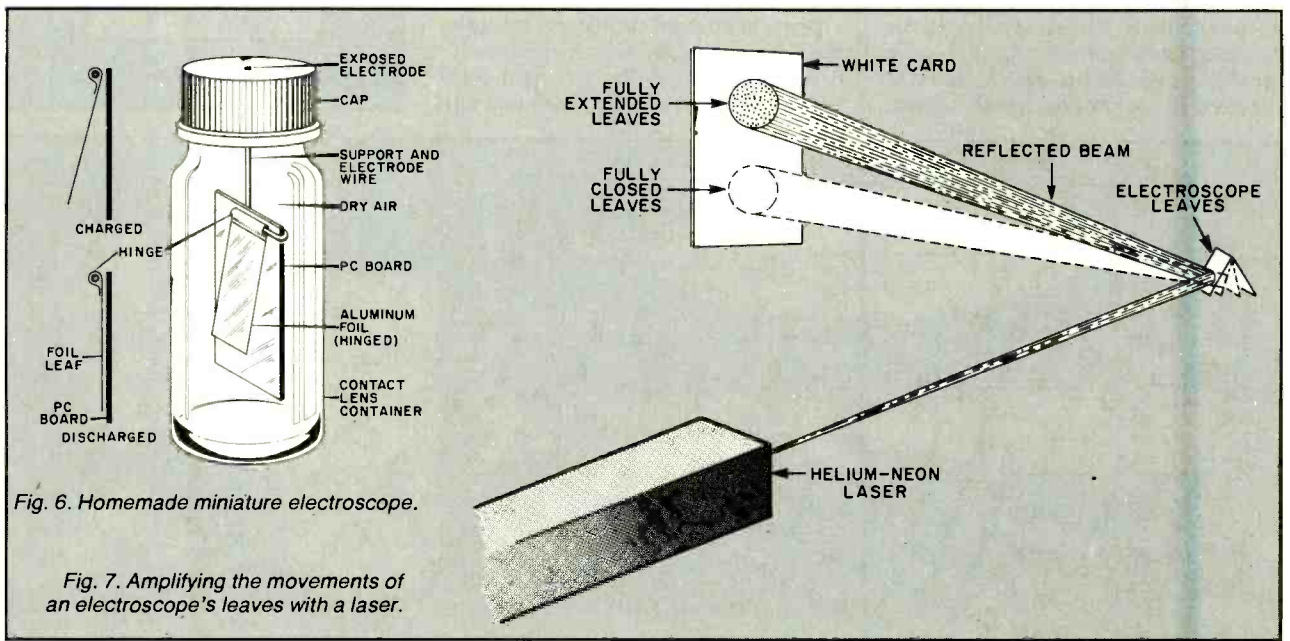

Fig. 6. Homemade miniature electroscope.

Fig. 7. Amplifying the movements of an electroscope's leaves with a laser.

210 permanently encapsulated in tiny ceramic beads. The polonium-210 emits a potent spray of alpha particles that ionizes the air near the brush. This provides a conductive path for the static charge that attracts dust particles to glass lenses, phonograph records, and photographic film.

STATICMASTER brushes (they come in two sizes) and replacement cartridges are available from some audio equipment and camera stores. If you just want a radioactive source, buy only a replacement cartridge. Be sure to comply with the safety precautions supplied with the cartridge!

Experimenting with a Geiger Counter. Solar Electronics International's Monitor 4 is a compact Geiger counter that indicates radiation levels by means of a moving-coil meter, flashing LED, and an audible chirp generator. The instrument incorporates CMOS circuitry and consumes only about 3 mW in a low radiation field. This provides a life of up to 2000 hours for the 9-V battery that powers the instrument, so long as the radiation level doesn't exceed a nominal background.

The Monitor 4 uses a Geiger tube having a mica end-window to permit the detection of alpha particles. The tube also detects beta particles and gamma and x-radiation.

I've used the Monitor 4 to detect radiation from several sources. For example, a Coleman lamp mantle lying on a flat surface produces a reading of 0.1 to 0.2 mR/hr when the Geiger tube's port is placed directly over the mantle. Rolling the mantle into a tight bundle and placing it next to the port gave a reading of 0.4 to 0.5 mR/hr.

When I placed a sheet of paper between the mantle and Geiger tube, the radiation level was only slightly lowered. Since alpha particles are stopped by paper, the bulk of the radiation appears to be beta particles emitted by the radium-228 byproduct of the thorium in the mantle.

I've also used the Monitor 4 to detect the alpha emission from the polonium-210 microbeads in a Staticmaster IC200 static eliminating brush. When the Geiger tube port is placed directly against the grid over the polonium-210 microbeads, the radiation level exceeds the Monitor 4's maximum detection level of 50 mR/hr. Alpha particles are blocked by only a few centimeters of air. When the grid over the polonium-210 is placed exactly 1-cm from the Geiger tube port, the radiation level is 10 mR/hr. At 2-cm, the level is too low to measure.

Since polonium-210 decays with time, Staticmaster cartridges are stamped with an expiration date. Therefore, the measurements you obtain may differ from those I obtained.

You can use the Monitor 4 and similar monitors to detect very low levels of radiation if you first determine the natural background count. The background

count can range from several to more than a hundred counts per minute, although the typical figure is between 10 and 25 counts per minute.

The background count is caused by cosmic rays, the natural radioactivity present in soil, and perhaps the building materials of your home or office. The background count can vary with atmo-

FREE CATALOG OF COMPUTER EQUIPMENT AND HARD-TO-FIND TOOLS

Jensen's new catalog is jam-packed with hard-to-find precision tools, tool kits, tool cases, test equipment and computer accessories used by electronic technicians, sophisticated hobbyists, scientists, engineers, laboratories and government agencies.

Call or write for your free copy today.



JENSEN TOOLS INC.

7815 S. 46th St., Phoenix, Arizona 85040 (602) 968-6231

Circle No. 79 on Free Information Card

CABLE TV

CONVERTERS

**Largest Selection
of Equipment Available**
\$ Buy Warehouse Direct & Save \$



36 channel
converter
\$45⁹⁵

36 channel
wired remote
converter
only
\$88⁹⁵



Send \$2 for complete catalog
of converters and equipment

Quantity Discounts • Visa • Master Charge
Add 5% shipping—Mich. residents add 4% sales tax

C&D Electronics, Inc.
P.O. Box 21, Jenison, MI 49428
(616) 669-2440

For Home or Business
WHAT...WHEN...HOW...

LEARN HOW TO USE A COMPUTER

Train at home in spare time! No previous experience needed! Now you can learn it all! Computer programming...computer applications...computer games...everything you ever wanted to know about computer operations! Write your own computer programs or use hundreds of programs already available...budgeting, real estate, bookkeeping, expenses, investments, interest, taxes, shopping lists, vacation planning, addresses, phone numbers, routing...even foreign languages and graphics.



You'll know what really happens when you have a computer problem with a bank, store, loan company, oil company, utility or anyone else. You'll be able to talk their language...understand why and how things happen...to be able to take the offensive when you're the victim of a computer error. Experts explain everything in easy-to-understand language with step-by-step directions.

- TIMEX COMPUTER INCLUDED WITH YOUR TRAINING • Plugs into any TV
- SEND FOR FREE FACTS!

ICS COMPUTER TRAINING, Dept. P0083
SINCE 1981 Scranton, Pennsylvania 18515

Please rush me free facts and color brochure that tells how I can learn computer applications, programming and operation at home in spare time. No cost. No obligation.

Name _____ Age _____
Address _____
City/State/Zip _____

ELECTRONICS SCIENTIST

spheric conditions. For instance, a tightly sealed home can collect a higher than usual accumulation of radioactive radon gas emitted by construction materials such as brick and tile.

After you measure the background count, you can proceed to check suspected low-level radiation sources. For instance, on a day when the background was 16 counts per minute (averaged over 5 minutes), the center of the screen of a color television set I use as a computer monitor gave a count of 28 per minute. While this figure is nearly double the background rate, it's still low.

Other radioactive sources around my home, checked on a day when the background averaged 11 counts per minute, include a glazed brick used as a step for a storage building (40 counts/minute) and a ceramic tile entryway (16 counts/minute). An ionization-type smoke detector with an internal radiation source produced no detectable radiation above the background count.

Other household radiation sources include older pieces of earthenware glazed with orange or red pigment containing uranium oxide. And though

they are no longer manufactured due to their hazardous properties, watches and clocks with hands and numbers coated with radium impregnated luminescent paint are still around.

Mr. Milo Voss, Manager of Safety, Health and Plant Protection at the Ames Laboratory of the U.S. Department of Energy, is one of many health physicists who have studied low-level background radiation. In a recent telephone conversation, Mr. Voss recounted how aerial surveys have spotted higher than usual radiation levels over some cemeteries and golf courses. Apparently the radiation sources are the granite headstones in the cemeteries and the phosphate fertilizer spread over the greens of the golf courses. Mr. Voss also observed that pilots and passengers of high flying aircraft are exposed to higher than usual levels of radiation.

Summing Up. The subject of nuclear fission always generates considerable controversy, particularly when so-called minimum acceptable exposure levels are discussed. Some health physicists believe no level of exposure can be

incurred without some risk to the population. Others feel this view is far too extreme, particularly in light of the naturally occurring background radiation to which we are all subjected.

Milo Voss, for instance, has studied thorium in some detail and concluded in a 1979 report that the material is relatively safe unless it is inhaled or ingested. On the other hand, Walter Wagner, a Veterans Administration health physicist, has filed a \$300 million class action lawsuit against the Coleman Company and other manufacturers of lantern mantles. Mr. Wagner is convinced that the thorium in the mantles constitutes a public health hazard.

Despite their divergent views regarding exposure levels, both sides agree that, for better or worse, naturally occurring radioactive sources abound. They are found in granite, bricks, grains, soils, and even in our bodies. The ceramic housing of a DIP integrated circuit can be slightly radioactive!

Another area of agreement is that radiation, no matter its source, is very difficult to accurately measure—much more difficult than measuring light. ◇

FIRST QUALITY COMPONENTS - NOT MAIL ORDER "SECONDS"

Send for Free Catalog - over 1100 parts.

ARIES ZERO INSERTION SOCKETS

cam actuated, true zero insertion - tin plated solder tail pins - capable of being plugged into dip sockets, including wire wrap.

Stock No.	No. of Pins	1-9	10-49	50
11055	24	4.98	\$4.35	\$3.90
11056	28	5.15	4.50	4.05
11057	40	6.81	5.95	5.35
11058	64	12.02	10.50	9.45

IC-COOLERS from UNITRACK™ dissipate over 2 watts of heat from IC's producing longer life and better performance. Just push IC-Kooler on heat is collected from top and bottom of IC and dissipated. Won't shake loose!

Stock No.	No. in IC	Price
22225	14	\$.29
22226	16	29
22227	18	29
22228	20	29

WILD ROVER Touch switch capsule. Operating motion is .005 without the use of a levered arm. Extremely fast on and off with low noise. Normally operated 1.5 VAC, 1.6 amp, 300 milliohm resistance - 615 radous by .160 inch.

Stock No.	1-9	10 & Up
12098	\$1.42	\$1.28



DIGITAL MULTIMETER Single rotary switch operation. Large easy to read 5 3 1/2 digit display. 800 hours operating life with single 9v battery. Seven functions: DC Volts, DC Amps, Ohms, AC Volts, AC Amps, Diode and Resistor Junction, Audible Continuity Check.

Stock No. 82503 \$79.95 Full 1 year warranty.

TI WIRE WRAP SOCKETS Tin plated phosphor bronze contact - 3 wrap

Stock No.	No. Pins	1-99	100-499	500
11301	8	\$4.40	\$3.36	\$3.30
11302	14	.59	.54	.45
11303	16	.64	.58	.48
11304	18	.73	.66	.55
11305	20	.99	.90	.75
11306	22	1.12	1.02	.85
11307	24	1.25	1.14	.95
11308	28	1.52	1.38	1.15
11309	40	2.05	1.86	1.55

TI LOW PROFILE SOCKETS

Tin plated copper alloy 688 contact pins with gas tight seal.

Stock No.	No. Pins	1-24	25-99	100-999
11201	8	\$1.0	\$0.9	\$0.8
11202	14	.14	.13	.12
11203	16	.16	.15	.14
11204	18	.18	.17	.15
11205	20	.20	.18	.16
11206	22	.22	.20	.18
11207	24	.24	.22	.20
11208	28	.28	.26	.25
11209	40	.40	.37	.33

ELPAC POWER SUPPLIES - DC/DC CONVERTERS

SINTEC Stock No.	ELPAC Part No.	Input Voltage (VDC)	Output Voltage (VDC)	Output Current (MA)	Dimensions (HxWxD) in Inches	Price
13825	CB3801	3.0-7.0	12±0.6	0.25	48x.51x3.05	\$5.75
13826	CB3811	3.0-7.0	12±0.6	0.25	48x.51x3.05	7.95
13827	CB3802	3.0-7.0	15±0.7	0.20	48x.51x3.05	7.95
13828	CB3812	3.0-7.0	15±0.7	0.20	48x.51x3.05	7.95
13829	CB3904	3.0-7.0	28±0.7	0.10	48x.51x3.05	7.95
13830	CB3814	3.0-7.0	28±0.7	0.10	48x.51x3.05	7.95
13831	CL3801	4.0-7.0	12±0.6	125	65x1.2x1.77	\$24.95
13832	CL3811	4.0-7.0	12±0.6	125	65x1.2x1.77	24.95
13833	CL3802	4.0-7.0	15±0.7	100	65x1.2x1.77	24.95
13834	CL3812	4.0-7.0	15±0.7	100	65x1.2x1.77	24.95
13835	CL3804	4.0-7.0	28±1.4	50	65x1.2x1.77	24.95
13836	CL3814	4.0-7.0	28±1.4	50	65x1.2x1.77	24.95
13825-1	DATA SHEET FOR DC/DC CONVERTERS 25					

Special of the Month!

USE YOUR OFFICE COPIER TO MAKE YOUR FORMS! SAVE TIME • WORK • MONEY

Stock No.	Description	Price
23001	Make your own graph & chart paper	ONLY \$7.50 each
23002	Make your own data & column sheets	
23003	Make your own memo & office forms	

MODUTEC

Miniclamp AC Volt-Ammeter allows singling one conductor out of many without disarrangement.

Stock No.	AC Amperes	Price
13730	0-25A	\$39.50
13731	0-50A	39.50
13732	0-100A	39.50

ACCESSORY LINE SPLITTER allows fast readings of AC power consumption of plug in equipment without separation of leads. Stock No. 13727 \$9.95

POCKET SIZED BATTERY TESTER for all types of small batteries from 1.35v to 4.5v. Stock No. 13733 \$13.95

VOLT-CATOR automotive diagnostic meter plugs into lighter socket and indicates battery condition and charging rates. Stock No. 13736 \$15.95

AC VOLTAGE TESTER plugs into any 110v service receptacle to check line voltage over 50-150 VAC. Stock No. 13735 \$14.95

VOM-MULTITESTER versatile Volt-Ohm-Milliammeter in small package. Stock No. 13729 \$13.95

ELPAC POWER SUPPLIES - SOLV SERIES FULLY REGULATED

SINTEC Stock No.	ELPAC Part No.	Output Voltage (VDC)	Output Current (MA)	Dimensions (HxWxD) in Inches	OVP	Price
13802	SOLV15-5	5	3.0A	4.7/16x4.2	Fixed included	\$39.95
13803	SOLV15-12	12	1.5A	4.7/16x4.2	Fixed included	39.95
13804	SOLV15-15	15	1.2A	4.7/16x4.2	Fixed included	39.95
13805	SOLV15-24	24	0.75A	4.7/16x4.2	Fixed included	39.95
13806	SOLV30-5	5	6.0A	5-5/8x7/8x3-1/16	OVP-4	59.95
13809	SOLV30-12	12	4.0A	5-5/8x7/8x3-1/16	OVP-4	59.95
13810	SOLV30-15	15	3.3A	5-5/8x7/8x3-1/16	OVP-4	59.95
13812	SOLV30-24	24	2.0A	5-5/8x7/8x3-1/16	OVP-4	59.95
13802-1	Data Sheet for SOLV Series 25					

PIN FORMING TOOL

puts IC's on their true row to row spacing. One side for 300 centers. Flip tool over for devices on 600 centers. Put device in tool and squeeze. NEW! Stock No. 10200 \$14.95 (ANTI-STATIC MODEL)

ONE TOOL DOES 8 thru 40 PINS! Stock No. 11059 \$12.95

OK MACHINE AND TOOL

IC INSERTION/EXTRACTION KIT Includes DIP-IC extractors and inserters to accommodate all IC's from .4 to .60 in. diameter. Features average conductive surfaces and CMOS safe and includes ground pins. Stock No. 13309 \$37.74

SOCKET WRAP ID DIP socket sized plastic panels with numbered holes in top edge. Sign onto socket before work. Wrapping to identify pins. Write or therm label location. IC part number function etc. Simultaneous. Initial use. Wasteful. Trouble shooting and repair. Stock No. 13302 per pack \$1.82

IC EXTRACTOR One-piece, spring steel construction. Will extract all LSI, MSI and SSL devices with 8 to 24 pins. Stock No. 13313 \$2.10

SINTEC CO. Drawer Q Milford NJ 08848-9990

TOLL 800-526-5960
FREE in NJ (201) 996-4093

We accept VISA, MC, C.O.D., CHECK, or M.O. *INCLUDE SHIPPING CHARGES - 0 to \$100 - \$3.00 \$100 to \$250 - \$4.00 over \$250 - \$5.00

TOLL FREE ORDERS • 1-800-826-5432
(IN CALIFORNIA: 1-800-258-6666)
INFORMATION • (213) 380-8000

MINIATURE 6 VDC RELAY

 SUPER SMALL SPOT RELAY: GOLD COBALT CONTACTS
 RATED 1 AMP AT 30 VDC. HIGHLY SENSITIVE. TTL DIRECT DRIVE POSSIBLE. OPERATES FROM 4.3 TO 6 V. COIL RES. 220 OHM. 1 3/16" x 13/32" x 7/16"
 AROMAT # RSD-6V
\$1.50 EACH
 10 FOR \$13.50

13 VDC RELAY

 CONTACT: S.P.N.C. 10 AMP @ 120 VAC
 ENERGIZE COIL TO OPEN CONTACT
 COIL: 13 VDC 650 OHMS
 SPECIAL PRICE **\$1.00 EACH**

KEY ASSEMBLY 5 KEY

\$1.00 EACH
 CONTAINS 5 SINGLE-POLE NORMALLY OPEN SWITCHES. MEASURES 3 3/4" LONG

6 KEY

\$1.25 EACH
 CONTAINS 6 SINGLE-POLE NORMALLY OPEN SWITCHES. MEASURES 4 1/4" LONG.

120V INDICATOR

 NEON INDICATOR RATED 120 V 1/3 W. MOUNTS IN 5/16" HOLE... RED LENS.
75¢ EACH
 10 FOR \$7.00
 100 FOR \$65.00

L.E.D.'S STANDARD JUMBO DIFFUSED
 RED 10 FOR \$1.50
 GREEN 10 FOR \$2.00
 YELLOW 10 FOR \$2.00

FLASHER LED 5 VOLT OPERATION RED JUMBO SIZE \$1.00 EACH



BI POLAR LED 2 FOR \$1.70

LED HOLDERS TWO PIECE HOLDER FOR JUMBO LED 10 FOR 65¢ 200 FOR \$10.00

METERS 1 MA

 2 5/16" SQUARE PANEL METER MOUNTS IN 2 1/8" HOLE
\$5.50 EACH

0 - 15 V.D.C.

 THIS 2-1/4" SQUARE METER MEASURES 0-15 VDC.
\$4.50 EACH

POWER SUPPLY W/ PRE-AMP

 THIS SUPPLY WAS USED TO POWER AN 8 TRACK/CASSETTE UNIT. IT WILL SUPPLY APPROX. 18 VDC AND INCLUDES A SMALL PRE-AMP TO BOOST SIGNAL LEVEL. RCA PLUGS FOR LINE IN/OUT.
\$4.50 EACH







FREE! SEND FOR NEW LARGER! 48 PAGE CATALOG

COMPUTER GRADE CAPACITORS

 1700 mfd. 150 VDC \$2.00
 2 1/2" DIA x 4 3/4" HIGH
3,600 mfd. 40VDC \$1.00
 1 3/8" DIA x 3" HIGH
6,400 mfd. 60 VDC \$2.50
 1 3/8" DIA x 4 1/4" HIGH
18,000 mfd. 75 VDC \$4.00
 2 1/2" DIA x 4 1/2" HIGH
22,000 mfd. 15 VDC 2" DIA x 2 1/2" HIGH \$2.00
22,000 mfd. 40 VDC 2" DIA x 6" HIGH \$3.00
24,000 mfd. 30 VDC 1 3/4" DIA x 4" HIGH \$3.50
31,000 mfd. 15 VDC 1 3/4" DIA x 4" HIGH \$2.50
72,000 mfd. 15 VDC 2" DIA x 4" HIGH \$3.50
180,000 mfd. at 6V 2 1/2" DIA x 4 1/2" HIGH \$1.50
 CLAMPS TO FIT CAPACITORS 50¢ ++

TRANSFORMERS 120 volt primaries

 5.6 VOLTS at 750 MA \$3.00
 6 VOLTS at 150 MA \$1.25
 16.5 V. at 3 AMPS \$6.50
 18 V at 650 MA \$3.50
 18 VOLTS at 1 AMP \$4.50
 18 V.C.T. at 2 AMP \$5.50
 24 VOLTS at 250 MA \$2.50
 24 VCT at 1 AMP \$4.50
 42 V.C.T. at 1.2 AMP \$4.50

WALL TRANSFORMER ALL ARE 115 VAC PLUG IN

 4 VDC at 70 MA \$2.50
 9 VDC at 225 MA \$3.00
 16.5 VAC at 10 VA \$3.50
 17 VAC at 500 MA \$4.00
 22 VDC at 60 MA \$2.50

MINIATURE TOGGLE SWITCHES ALL ARE RATED 5 AMPS @ 125 VAC

<p>S.P.D.T. (on-on)  P.C. STYLE NON-THREADED BUSHING 75¢ EACH 10 FOR \$7.00</p>	<p>S.P.D.T. (on-on)  SOLDER LUG TERMINALS \$1.00 EACH 10 FOR \$9.00 100 FOR \$80.00</p>	<p>S.P.D.T. (on-off-on)  SOLDER LUG TERMINALS \$1.00 EACH 10 FOR \$9.00 100 FOR \$80.00</p>
<p>S.P.D.T. (on-off-on)  NON-THREADED BUSHING P.C. STYLE 75¢ EACH 10 FOR \$7.00</p>	<p>S.P.D.T. (on-on)  P.C. LUGS THREADED BUSHING \$1.00 EACH 10 FOR \$9.00 100 FOR \$80.00</p>	<p>D.P.D.T. (on-on)  SOLDER LUG TERMINALS \$2.00 EACH 10 FOR \$19.00 100 FOR \$180.00</p>

ALL ELECTRONICS CORP.
 905 S. VERMONT • P.O. BOX 20406 • LOS ANGELES, CA 90006

- QUANTITIES LIMITED
- MINIMUM ORDER \$10.00
- USA \$2.50 SHIPPING
- NO C.O.D.
- FOREIGN ORDERS INCLUDE SUFFICIENT SHIPPING
- CALIF RES ADD 6 1/2%

QUALITY SERVICE AVAILABILITY



ACTIVE, YOUR NUMBER ONE CHOICE

Active Electronics

WE ARE THE LARGEST BECAUSE WE ARE THE BEST. Over \$40 million in stock. The world's most complete hobbyist inventory.

Active Electronics is your one stop source for the widest variety of top quality semiconductors, microprocessors, memories, microcomputer systems, peripherals and electronic components.

NOW AVAILABLE! Absolutely FREE



Active's Newly Revised 1983 Spring/Summer Catalog

Whether you're a serious hobbyist, experimenter, student or professional you shouldn't be without it. Call for your free copy today.

Circle No. 50 on free information card or write:
 P.O. Box 8000, Westboro, Mass. 01581
CALL TOLL FREE: 1-800-343-0874
 MASS. customers call (617) 366-0500

Circle No. 50 on Free Information Card

NOW!

GET IBM-PC Capacity at a Fraction of IBM'S Price!

New NETRONICS 16 Bit EXPLORER 88-PC Kit Starts at Just ~~\$399.95~~ - Accepts All IBM Peripherals.

It's true! Now you can enjoy the power of the Intel 8088—the same microprocessor which powers the IBM-PC—and run any program compiled for the IBM-PC...starting at only \$399.95!

- Take this easy, low cost way to learn 16-bit technology! Two-board system features:
- 8088 mother board with 5-slot expansion bus; accepts any hardware designed for IBM-PC; and
 - 64K memory board, expandable to 256K; with IBM compatible RS232 communications port.

Any disk-operating system which works on the IBM will work directly on the EXPLORER 88-PC, and all programs compiled for the IBM will run on it.

The system monitor ROM included in the Starter system features a user-friendly operating system that allows easy program generation and debugging. The commands include display/modify memory...display/modify registers...input/output data to I/O ports...block moves...single-step trace mode...go/run with optional breakpoint and register reports...cassette load/save with file labels...plus a complete system test program that tests and reports condition of ROM, RAM, cassette interface, timer, DMA controller, interrupt controller, and the communications port. These test programs not only allow easy debugging of software but they serve as hardware and software learning tools.

The EXPLORER 88-PC STARTER KIT includes a mother board, memory/I/O board, all components needed, sockets for IC's used, one 62-pin bus connector and complete assembly/test instructions. All you need is a soldering iron, solder, a power supply, and a standard RS232 terminal (Netronics has 2 low-cost ones to choose from):
 Explorer 88-PC Starter Kit... \$399.95 + 10.00 p&i

- wired & tested, add \$100.00
- Extra 62-pin connectors at \$4.25 ea. + 1.00 p&i.

Use your own terminal with the EXPLORER 88-PC or, if you plan to expand it to be fully IBM compatible, we offer our IBM compatible keyboard and an IBM compatible color graphics board (only available wired and tested).

- IBM compatible keyboard...\$299.95 + 10.00 p&i.
- IBM compatible color board...\$299.95 + 10.00 p&i.
- Additional ROM required...\$35.00

Set your own pace! Invest and learn, at the rate YOU want! Add to your EXPLORER 88-PC.

Deluxe heavy-duty steel cabinet that houses either two 5 1/4" floppies or a 5 1/4" hard disk with one floppy. This cabinet features a brush-finish front panel and a wood-grained sleeve.

- EXPLORER 88-PC Cabinet...\$199.95 + 18.00 p&i.

A heavy-duty open frame power supply with fan that can be used in your own cabinet or installed into the Netronics cabinet is available as follows:

- 10 amp power supply for system + 2 floppies...\$149.95 + 8.00 p&i.
- As above + extra power for 1 hard disk...\$169.95 + 8.00 p&i.

IBM compatible disk controller board. Controls four 5 1/4" floppy drives (w/2 drive cable). Available wired and tested only...\$250.00 + 8.00 p&i.

- Monitors and BIOS source listings: available on either disk or hard copy at \$35.00.
- Please specify format and system required.
- INTEL 8086/8088 user manual...\$15.00 + 1.50 p&i.
- THE 8086 BDDK by RECTOR & ALEX...\$16.00 + 1.50 p&i.

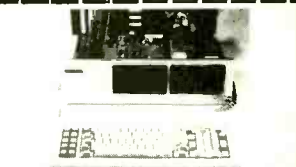

Special IBM compatible system: with keyboard, color graphics board, floppy disk controller, 64K RAM, cabinet, standard power supply and a single 5 1/4" floppy drive... \$1899.95 + 25.00 p&i.

IBM compatible hard disks, built-in modern board, eeprom burner, print buffer system plus more will be available shortly.

Over 100 EXCLUSIVE Products and Kits—including the 'Speak Easy' universal voice synthesizer, a Diagnostic card with built-in logic probe for the IBM-PC, terminals, monitors, the ELF and EXPLORER 85 computers, and much more, are described in our upcoming catalog. It's yours FREE if you check here



"p&i" stands for "postage and insurance".

CALL TOLL FREE 1-800-243-7428 for Charge Card Orders.
 In Conn., call 203-354-9375. Conn. res. add sales tax.
 TO ORDER BY MAIL, CHECK BOXES FOR PRODUCTS DESIRED AND MAIL ENTIRE AO TO:

NETRONICS R&D LTD.
 333 Litchfield Rd., New Milford, CT 06776

Amount enclosed OR Charge my VISA MASTERCARD
 Acct. No. _____ Exp. Date _____
 Signature _____
 PRINT NAME _____
 Address _____ City _____ State _____ Zip _____

Circle No. 3 on Free Information Card

JDR SUPER SPECIALS!

**THE LEADER IN
COMPUTER
COMPONENTS
BRINGS YOU THESE
FANTASTIC
SUMMERS-END
CLEARANCE BARGAINS**

OKI MSM5832RS

MICROPROCESSOR
COMPATIBLE
CLOCK/CALENDAR CHIP
3.95 100/3.25 ea.
32.768KHZ XTAL .95
OTHER CRYSTALS
3.579545MHZ .95
5.0688MHZ 1.95
18.432MHZ 1.95

78M05

VOLTAGE
REGULATOR
TI PART #UA78M05C
STANDARD TO-220 CASE
5 VOLT AT 500MA CAN BE
USED AS 7805T IN MOST
APPLICATIONS

.29 100/.25 EA.

**ORDER TOLL FREE
800 538-5000
800 882-8279
(CA Residents)**



CONNECTORS

IDP-16 IDC DIP-PLUG .95
IDE-34 IDC EDGE-CARD 1.95
ICC-14 DIP "HEADER" .49
ICC-16 DIP "HEADER" .59
44P-ST PC EDGE-CARD 1.95
DB25PC/P VERTICAL
PC-MOUNT 1.49
DB25PC/S VERTICAL
PC-MOUNT 1.69

TRANSISTORS

2N3904 TO-92 100/7.95
2N3906 TO-92 100/7.95
PN2222 TO-92 100/7.95

CERAMIC MONOLITHIC CAPS AT THE PRICE OF DISC!

.1UF-MONO 100/12.00
.047UF-MONO 100/11.00
.01UF-MONO 100/10.00

PRIME LED'S

JUMBO RED 100/ 8.00
JUMBO YELLOW 100/12.00
JUMBO GREEN 100/12.00
5082-7760 10/ 7.95

JDR MICRODEVICES

IS PROUD TO INTRODUCE
ARK ELECTRONIC ENTERPRISES
AS AN AUTHORIZED DISTRIBUTOR
SERVING THE MIDWEST WITH HIGH
QUALITY JDR MERCHANDISE
CALL OR STOP BY



ARK
ELECTRONIC ENTERPRISES
734 Phillips Avenue
Toledo, Ohio 43612
(419) 476-6727

MICROPROCESSOR

Z80A-CPU 3.95
Z80A-CTC 3.95
Z80A-PIO 3.95
Z80A-SIO/1 12.95
Z80A-DART 6.95
8086 16-BIT 5MHZ 19.95
68A00 CPU 1.5MHZ 2.95
68A10 RAM 1.5MHZ 1.95
68A21 PIA 1.5MHZ 2.95
68A50 ACIA 1.5MHZ 2.95
6520/6820 PIA 2.95

MEMORY

2102L-4 450NS-LP .55
2111L 450NS-LP 1.49
2112 450NS 1.99
2114 450NS .99
2114-25 250NS 1.09
TMS4027 250NS .99

SPECIAL TMS4060/2107

4096 x 1 DYNAMIC
RAMS TI OR INTEL .69
YOUR CHOICE

**SPECIAL THANKS
TO MATT FOR HIS
RECENT SOFTWARE
DEVELOPMENTS
WHICH WILL ENABLE
JDR TO BETTER SERVE
OUR CUSTOMERS**

LINEAR I.C.'S

LM1800 1.95
LM1310 .99
MC1330 .99
MC1350 .89
MC1358 .99

HARD TO FIND BLACK CONDUCTIVE FOAM

14" x 26" SHEET 12.00
12" x 13" SHEET 6.00

DISK CONTROLLERS

1771 11.95
1791 18.95
1793 18.95

CRT CONTROLLERS

DP8350 19.95
CRT5027 9.95
CRT5037 9.95

D-RAM CONTROLLERS

8202 17.95
8203 32.95
3242 5.95

**Visit Our
EXPANDED
Retail Store
NEW SATURDAY
HOURS 10-3**

VISIT OUR RETAIL STORE

HOURS: M-W-F, 9-5 T-Th., 9-9 Sat. 11-3

PLEASE USE YOUR CUSTOMER NUMBER WHEN ORDERING
TERMS: For shipping include \$2 for UPS Ground or \$3 for UPS Blue
Label Air. Items over 5 pounds require additional shipping charges.
Foreign orders, include sufficient amount for shipping. There is a \$10
minimum order. Bay Area and Los Angeles Counties add 6 1/2% Sales
Tax. Other California residents add 6% Sales Tax. We reserve the
right to substitute manufacturer. Not responsible for typographical
errors. Prices are subject to change without notice. We will match or
beat any competitor's price provided it is not below our cost.

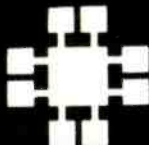

JDR Microdevices

1224 S. Bascom Ave. • San Jose, CA 95128

(408) 995-5430 • Telex 171-110

© 1983 JDR MICRODEVICES, INC.

4164

64K DYNAMIC 200 NS

\$595

TMM2016

2KX8 STATIC 200 NS

\$415

STATIC RAMS

2101	256 x 4 (450ns)	1.95
5101	256 x 4 (450ns) (cmos)	3.95
2102-1	1024 x 1 (450ns)	.89
2102L-4	1024 x 1 (450ns) (LP)	.99
2102L-2	1024 x 1 (250ns) (LP)	1.49
2111	256 x 4 (450ns)	2.49
2112	256 x 4 (450ns)	2.99
2114	1024 x 4 (450ns)	8/9.95
2114-25	1024 x 4 (250ns)	8/10.95
2114L-4	1024 x 4 (450ns) (LP)	8/12.95
2114L-3	1024 x 4 (300ns) (LP)	8/13.45
2114L-2	1024 x 4 (200ns) (LP)	8/13.95
2147	4096 x 1 (55ns)	4.95
TMS4044-4	4096 x 1 (450ns)	3.49
TMS4044-3	4096 x 1 (300ns)	3.99
TMS4044-2	4096 x 1 (200ns)	4.49
MK4118	1024 x 8 (250ns)	9.95
TMM2016-200	2048 x 8 (200ns)	4.15
TMM2016-150	2048 x 8 (150ns)	4.95
TMM2016-100	2048 x 8 (100ns)	6.15
HM6116-4	2048 x 8 (200ns) (cmos)	4.75
HM6116-3	2048 x 8 (150ns) (cmos)	4.95
HM6116-2	2048 x 8 (100ns) (cmos)	8.95
HM6116LP-4	2048 x 8 (200ns) (cmos)(LP)	5.95
HM6116LP-3	2048 x 8 (150ns) (cmos)(LP)	6.95
HM6116LP-2	2048 x 8 (120ns) (cmos)(LP)	10.95
Z-6132	4096 x 8 (300ns) (Qstat)	34.95

LP = Low Power Qstat = Quasi-Static

DYNAMIC RAMS

TMS4027	4096 x 1 (250ns)	1.99
UPD411	4096 x 1 (300ns)	3.00
MM5280	4096 x 1 (300ns)	3.00
MK4108	8192 x 1 (200ns)	1.95
MM5298	8192 x 1 (250ns)	1.85
4116-300	16384 x 1 (300ns)	8/11.75
4116-250	16384 x 1 (250ns)	8/11.95
4116-200	16384 x 1 (200ns)	8/12.95
4116-150	16384 x 1 (150ns)	8/14.95
4116-120	16384 x 1 (120ns)	8/29.95
2118	16384 x 1 (150ns) (5v)	4.95
4164-200	65536 x 1 (200ns) (5v)	5.95
4164-150	65536 x 1 (150ns) (5v)	6.95

5V = single 5 volt supply

EPROMS

1702	256 x 8 (1us)	4.50
2708	1024 x 8 (450ns)	3.95
2758	1024 x 8 (450ns) (5v)	5.95
2716	2048 x 8 (450ns) (5v)	3.95
2716-1	2048 x 8 (350ns) (5v)	5.95
TMS2516	2048 x 8 (450ns) (5v)	5.50
TMS2716	2048 x 8 (450ns)	7.95
TMS2532	4096 x 8 (450ns) (5v)	5.95
2732	4096 x 8 (450ns) (5v)	4.95
2732-250	4096 x 8 (250ns) (5v)	8.95
2732-200	4096 x 8 (200ns) (5v)	11.95
2764	8192 x 8 (450ns) (5v)	9.95
2764-250	8192 x 8 (250ns) (5v)	14.95
2764-200	8192 x 8 (200ns) (5v)	24.95
TMS2564	8192 x 8 (450ns) (5v)	17.95
MC68764	8192 x 8 (450ns) (5v) (24 pin)	39.95
27128	16384x8 Call	Call

5v = Single 5 Volt Supply

EPROM ERASERS

	Timer	Capacity Chip	Intensity (uW/Cm ²)	
PE-14		6	5,200	83.00
PE-14T	X	6	5,200	119.00
PE-24T	X	9	6,700	175.00
PL-265T	X	20	6,700	255.00
PR-125T	X	16	15,000	349.00
PR-320	X	32	15,000	595.00

Z-80

2.5 Mhz

Z80-CPU	3.95
Z80-CTC	4.49
Z80-DART	10.95
Z80-DMA	14.95
Z80-PIO	4.49
Z80-SIO/0	16.95
Z80-SIO/1	16.95
Z80-SIO/2	16.95
Z80-SIO/9	16.95

4.0 Mhz

Z80A-CPU	4.95
Z80A-CTC	4.95
Z80A-DMA	11.95
Z80A-DMA	16.95
Z80A-PIO	4.95
Z80A-SIO/0	16.95
Z80A-SIO/1	16.95
Z80A-SIO/2	16.95
Z80A-SIO/9	16.95

6.0 Mhz

Z80B-CPU	11.95
Z80B-CTC	13.95
Z80B-PIO	13.95
Z80B-DART	19.95

ZILOG

Z6132	34.95
Z8671	39.95

CRYSTALS

32.768 khz	1.95
1.0 mhz	4.95
1.8432	4.95
2.0	3.95
2.097152	3.95
2.4576	3.95
3.2768	3.95
3.579535	3.95
4.0	3.95
5.0	3.95
5.0688	3.95
5.185	3.95
5.7143	3.95
6.0	3.95
6.144	3.95
6.5536	3.95
8.0	3.95
10.0	3.95
10.738635	3.95
14.31818	3.95
15.0	3.95
16.0	3.95
17.430	3.95
18.0	3.95
18.432	3.95
20.0	3.95
22.1184	3.95
32.0	3.95

CRT CONTROLLERS

6845	14.95
68B45	19.95
HD46505SP	15.95
6847	11.95
MC1372	6.95
68047	24.95
8275	29.95
7220	99.95
CRT5027	39.95
CRT5037	49.95
TMS9918A	39.95
DP8350	49.95

KEYBOARD CHIPS

AY5-2376	11.95
AY5-3600	11.95
AY5-3600 PRO	11.95

8000

8035	5.95
8039	6.95
INS-8060	17.95
INS-8073	24.95
8080	3.95
8085	5.95
8085A-2	11.95
8086	29.95
8087	CALL
8088	39.95
8089	89.95
8155	6.95
8155-2	7.95
8156	6.95
8185	29.95
8185-2	39.95
8741	1.75
8748	24.95
8755	24.95

8200

8202	24.95
8203	39.95
8205	3.50
8212	1.80
8214	3.85
8216	1.75
8224	2.25
8226	1.80
8228	3.49
8237	19.95
8237-5	21.95
8238	4.49
8243	4.45
8250	10.95
8251	4.49
8253	6.95
8253-5	7.95
8255	4.49
8255-5	5.25
8257	7.95
8257-5	8.95
8259	6.90
8259-5	7.50
8271	39.95
8272	39.95
8275	29.95
8279	8.95
8279-5	10.00
8282	6.50
8283	6.50
8284	5.50
8286	6.50
8287	6.50
8288	25.00
8289	49.95

DISC CONTROLLERS

1771	16.95
1791	24.95
1793	26.95
1795	49.95
1797	49.95
2791	54.95
2793	54.95
2795	59.95
2797	59.95
6843	34.95
8272	39.95
UPD765	39.95
MB8876	29.95
MB8877	34.95
1691	17.95
2143	18.95

CONNECTORS

RS232 MALE	2.50
RS232 FEMALE	3.25
RS232 HOOD	1.25
S-100 ST	3.95

6800

68000	59.95
6800	3.95
6802	7.95
6808	13.90
6809E	19.95
6809	11.95
6810	2.95
6820	4.35
6821	3.25
6822	14.95
6840	12.95
6843	34.95
6844	25.95
6845	14.95
6847	11.95
6850	3.25
6852	5.75
6860	9.95
6862	11.95
6875	6.95
6880	2.25
6883	22.95
68047	24.95
68488	19.95

6800 - 1MHZ

68B00	10.95
68B02	22.25
68B09E	29.95
68B09	29.95
68B10	6.95
68B21	6.95
68B45	19.95
68B50	5.95

6800 - 2MHZ

6502	4.95
6504	6.95
6505	8.95
6507	9.95
6520	4.35
6522	7.95
6532	9.95
6545	22.50
6551	11.85

6500 1 MHZ

6502A	6.95
6522A	9.95
6532A	11.95
6545A	27.95
6551A	11.95

6500 3 MHZ

6502B	14.95
-------	-------

UARTS

AY3-1014	6.95
AY5-1013	3.95
AY3-1015	6.95
PT1472	9.95
TR1602	3.95
2350	9.95
2651	8.95
TMS6011	5.95
IM6402	7.95
IM6403	8.95
INS8250	10.95

GENERATORS BIT-RATE

MC14411	11.95
BR1941	11.95
4702	12.95
COM5016	16.95
COM8116	10.95
MM5307	10.95

FUNCTION

MC4024	3.95
LM566	1.49
XR2206	3.75
8038	3.95

74LS00

74LS00	.24	74LS173	.69
74LS01	.25	74LS174	.55
74LS02	.25	74LS175	.55
74LS03	.25	74LS181	2.15
74LS04	.24	74LS189	8.95
74LS05	.25	74LS190	.89
74LS08	.28	74LS191	.89
74LS09	.29	74LS192	.79
74LS10	.25	74LS193	.79
74LS11	.35	74LS194	.69
74LS12	.35	74LS195	.69
74LS13	.45	74LS196	.79
74LS14	.59	74LS197	.79
74LS15	.35	74LS221	.89
74LS20	.25	74LS240	.95
74LS21	.29	74LS241	.99
74LS22	.25	74LS242	.99
74LS26	.29	74LS243	.99
74LS27	.29	74LS244	1.29
74LS28	.35	74LS245	1.49
74LS30	.25	74LS247	.75
74LS32	.29	74LS248	.99
74LS33	.55	74LS249	.99
74LS37	.35	74LS251	.59
74LS38	.35	74LS253	.59
74LS40	.25	74LS257	.59
74LS42	.49	74LS258	.59
74LS47	.75	74LS259	2.75
74LS48	.75	74LS260	.59
74LS49	.75	74LS266	.55
74LS51	.25	74LS273	1.49
74LS54	.29	74LS275	3.35
74LS55	.29	74LS279	.49
74LS63	1.25	74LS280	1.98
74LS73	.39	74LS283	.69
74LS74	.35	74LS290	.89
74LS75	.39	74LS293	.89
74LS76	.39	74LS295	.99
74LS78	.49	74LS298	.89
74LS83	.60	74LS299	1.75
74LS85	.69	74LS323	3.50
74LS86	.39	74LS324	1.75
74LS90	.55	74LS352	1.29
74LS91	.89	74LS353	1.29
74LS92	.55	74LS363	1.35
74LS93	.55	74LS364	1.95
74LS95	.75	74LS365	.49
74LS96	.89	74LS366	.49
74LS107	.39	74LS367	.45
74LS109	.39	74LS368	.

2114

450 NS

8/\$995

2114

250 NS

8/\$1095

7400

'400	.19	74132	.45
'401	.19	74136	.50
'402	.19	74141	.65
'403	.19	74142	2.95
'404	.19	74143	2.95
'405	.25	74145	.60
'406	.29	74147	1.75
'407	.29	74148	1.20
'408	.24	74150	1.35
'409	.19	74151	.55
'410	.19	74152	.65
'411	.25	74153	.55
'412	.30	74154	1.25
'413	.35	74155	.75
'414	.49	74156	.65
'416	.25	74157	.55
'417	.25	74159	1.65
'420	.19	74160	.85
'421	.35	74161	.69
'422	.35	74162	.85
'423	.29	74163	.69
'425	.29	74164	.85
'426	.29	74165	.85
'427	.29	74166	1.00
'428	.45	74167	2.95
'430	.19	74170	1.65
'432	.29	74172	5.95
'433	.45	74173	.75
'437	.29	74174	.89
'438	.29	74175	.89
'440	.19	74176	.89
'442	.49	74177	.75
'443	.65	74178	1.15
'444	.69	74179	1.75
'445	.69	74180	.75
'446	.69	74181	2.25
'447	.69	74182	.75
'448	.69	74184	2.00
'450	.19	74185	2.00
'451	.23	74190	1.15
'453	.23	74191	1.15
'454	.23	74192	.79
'460	.23	74193	.79
'470	.35	74194	.85
'472	.29	74195	.85
'473	.34	74196	.79
'474	.33	74197	.75
'475	.45	74198	1.35
'476	.35	74199	1.35
'480	.59	74221	1.35
'481	1.10	74246	1.35
'482	.95	74247	1.25
'483	.50	74248	1.85
'485	.59	74249	1.95
'486	.35	74251	.75
'489	2.15	74259	2.25
'490	.35	74265	1.35
'491	.40	74273	1.95
'492	.50	74276	1.25
'493	.35	74279	.75
'494	.65	74283	2.00
'495	.55	74284	3.75
'496	.70	74285	3.75
'497	2.75	74290	.95
'4100	1.75	74293	.75
'4107	.30	74298	.85
'4109	.45	74351	2.25
'4110	.45	74365	.65
'4111	.55	74366	.65
'4116	1.55	74367	.65
'4120	1.20	74368	.65
'4121	.29	74376	2.20
'4122	.45	74390	1.75
'4123	.49	74393	1.35
'4125	.45	74425	3.15
'4126	.45	74426	.85
'4128	.55	74490	2.55

LINEAR

LM301	.34	LM340(see 7800)	LM566	1.49	LM1800	2.37
LM301H	.79	LM348	LM567	.89	LM1812	8.25
LM307	.45	LM350K	NE570	3.95	LM1830	3.50
LM308	.69	LM350T	NE571	2.95	LM1871	5.49
LM308H	1.15	LM358	NE592	2.75	LM1872	5.49
LM309H	1.95	LM359	LM709	.59	LM1877	3.25
LM309K	1.25	LM376	LM710	.75	LM1889	1.95
LM310	1.75	LM377	LM711	.79	LM1896	1.75
LM311	.64	LM378	LM723	.49	ULN2003	2.49
LM311H	.89	LM379	LM723H	.55	LM2877	2.05
LM312H	1.75	LM380	LM733	.98	LM2878	2.25
LM317K	3.95	LM380N-8	LM741	.35	LM2900	.85
LM317T	1.19	LM381	LM741N-14	.35	LM2901	1.00
LM318	1.49	LM382	LM741H	.40	LM3900	.59
LM318H	1.59	LM383	LM7417	.69	LM3905	1.25
LM319H	1.90	LM384	LM748	.59	LM3909	.98
LM319	1.25	LM386	LM1014	1.19	LM3911	2.25
LM320(see 7900)	LM387	1.40	LM1303	1.95	LM3914	3.95
LM322	1.65	LM389	LM1310	1.49	LM3915	3.95
LM323K	4.95	LM390	MC1330	1.69	LM3916	3.95
LM324	.59	LM392	MC1349	1.89	MC4024	3.95
LM329	.65	LM394H	MC1350	1.19	MC4044	4.50
LM331	3.95	LM399H	MC1358	1.69	RC4136	1.25
LM334	1.19	NE531	MC1372	6.95	RC4151	3.95
LM335	1.40	NE555	LM1414	1.59	LM4250	1.75
LM336	1.75	NE556	LM1458	.59	LM4500	3.25
LM337K	3.95	NE558	LM1488	.69	RC4558	.69
LM337T	1.95	NE561	LM1489	.69	LM13080	1.29
LM338K	6.95	NE564	LM1496	.85	LM13600	1.49
LM339	.99	LM565	LM1558H	3.10	LM13700	1.49

H - TO-5 CAN

T - TO-220

K - TO-3

RCA

CA 3023	2.75	CA 3082	1.65
CA 3039	1.29	CA 3083	1.55
CA 3046	1.25	CA 3086	.80
CA 3059	2.90	CA 3089	2.99
CA 3060	2.90	CA 3096	3.49
CA 3065	1.75	CA 3130	1.30
CA 3080	1.10	CA 3140	1.15
CA 3081	1.65	CA 3146	1.85
		CA 3160	1.19

TI

TL494	4.20	75365	1.95
TL496	1.65	75450	.59
TL497	3.25	75451	.39
75107	1.49	75452	.39
75110	1.95	75453	.39
75150	1.95	75454	.39
75154	1.95	75491	.79
75188	1.25	75492	.79
75189	1.25	75493	.89
		75494	.89

BI FET

TL071	.79	TL084	2.19
TL072	1.19	LF347	2.19
TL074	2.19	LF351	.60
TL081	.79	LF353	1.00
TL082	1.19	LF355	1.10
TL083	1.19	LF356	1.10
		LF357	1.40

CMOS

4000	.29	4527	1.95
4001	.25	4528	1.19
4002	.25	4531	.95
4006	.89	4532	1.95
4007	.29	4538	1.95
4008	.95	4539	1.95
4009	.39	4541	2.64
4010	.45	4543	1.19
4011	.25	4553	5.79
4012	.25	4555	.95
4013	.38	4556	.95
4014	.79	4581	1.95
4015	.39	4582	1.95
4016	.39	4584	.75
4017	.69	4585	.75
4018	.79	4702	12.95
4019	.39	74C00	.35
4020	.75	74C02	.35
4021	.79	74C04	.35
4022	.79	74C08	.35
4023	.29	74C10	.35
4024	.65	74C14	.59
4025	.29	74C20	.35
4026	1.65	74C30	.35
4027	.45	74C32	.39
4028	.69	74C42	1.29
4029	.79	74C48	1.99
4030	.39	74C73	.65
4034	1.95	74C74	.65
4035	.85	74C76	.80
4040	.75	74C83	1.95
4041	.75	74C85	1.95
4042	.69	74C86	.39
4043	.85	74C89	4.50
4044	.79	74C90	1.19
4046	.85	74C93	1.75
4047	.95	74C95	.99
4049	.35	74C107	.89
4050	.35	74C150	5.75
4051	.79	74C151	2.25
4053	.79	74C154	3.25
4060	.89	74C157	1.75
4066	.39	74C160	1.19
4068	.39	74C161	1.19
4069	.29	74C162	1.19
4070	.35	74C163	1.19
4071	.29	74C164	1.39
4072	.29	74C165	2.00
4073	.29	74C173	.79
4075	.29	74C174	1.19
4076	.79	74C175	1.19
4078	.29	74C192	1.49
4081	.29	74C193	1.49
4082	.29	74C195	1.39
4085	.95	74C200	5.75
4086	.95	74C221	1.75
4093	.49	74C373	2.45
4098	2.49	74C374	2.45
4099	1.95	74C901	.39
14409	12.95	74C902	.85
14410	12.95	74C903	.85
14411	11.95	74C905	10.95
14412	12.95	74C906	.95
14419	7.95	74C907	1.00
14433	4.18	74C908	2.00
4502	.95	74C909	2.75
4503	.65	74C910	9.95
4508	1.95	74C911	8.95
4510	.85	74C912	8.95
4511	.85	74C914	1.95
4512	.85	74C915	1.19
4514	1.25	74C918	2.75
4515	1.75	74C920	17.95
4516	1.59	74C921	15.95
4518	.89	74C922	4.49
4519	.39	74C923	4.95
4520	.79	74C925	5.95
4522	1.25	74C926	7.95
4526	1.25	74C928	7.95
		74C929	19.95

74S00

74S00	.32	74S163	1.95
74S02	.35	74S168	3.95
74S03	.35	74S169	3.95
74S04	.35	74S174	.95
74S05	.35	74S175	.95
74S08	.35	74S181	3.95
74S09	.40	74S182	2.95
74S10	.35	74S188	1.95
74S11	.35	74S189	6.95
74S15	.35	74S194	1.49
74S20	.35	74S195	1.49
74S22	.35	74S196	1.49
74S30	.35	74S197	1.49
74S32	.40	74S201	6.95
74S37	.88	74S225	7.95
74S38	.85	74S240	2.20
74S40	.35	74S241	2.20
74S51	.35	74S244	2.20
74S64	.40	74S251	.95
74S65	.40	74S253	.95
74S74	.50	74S257	.95
74S85	1.99	74S258	.95
74S86	.50	74S260	.79
74S112	.50	74S274	19.95
74S113	.50	74S275	19.95
74S114	.55	74S280	1.95
74S124	2.75	74S287	1.90
74S132	1.24	74S288	1.90
74S133	.45	74S289	6.89
74S134	.50	74S301	6.95
74S135	.89	74S373	2.45
74S138	.85	74S374	2.45
74S139	.85	74S381	7.95
74S140	.55	74S387	1.95
74S151	.95	74S412	2.98
74S153	.95	74S417	4.95
74S157	.95	74S472	4.95
74S158	.95	74S474	4.95
74S161	1.95	74S482	15.25
74S162	1.95	74S570	2.95
		74S571	2.95

IC SOCKETS

8 pin ST	1.99	100
14 pin ST	.13	.11
14 pin ST	.15	.12
16 pin ST	.17	.13
18 pin ST	.20	.18
20 pin ST	.29	.27
22 pin ST	.30	.27
24 pin ST	.30	.27
28 pin ST	.40	.32
40 pin ST	.49	.39
64 pin ST	4.25	call
ST = SOLDER TAIL		
8 pin WW	.59	.49
14 pin WW	.	

BUILDERS GET MORE AT RADIO SHACK!

Low Prices!

High Quality!

Wide Selection!

Replacement Transistors

Type		Cat. No.	Each
2N1305	PNP	276-2007	1.19
MPS222A	NPN	276-2009	.79
PN2484	PNP	276-2010	.89
MPS3904	NPN	276-2016	.69
TIP31	NPN	276-2017	.99
TIP3055	NPN	276-2020	1.59
MPS2907	PNP	276-2023	.79
MJE34	PNP	244-2027	1.49
2N3053	NPN	276-2030	.89
MPS3638	PNP	276-2032	.79
TIP120	NPN	276-2068	1.29
2N3055	NPN	276-2041	1.99
MJ2955	PNP	276-2043	2.19
2N4124	NPN	276-2057	.59
2N4401	NPN	276-2058	.59
MPSA06	NPN	276-2059	.59
MPSA13	NPN	276-2060	.59
MPSA42	NPN	276-2061	.69
MU4891	UJT	276-2029	.99
2SD313	NPN	276-2048	1.79
2SC945	NPN	276-2051	.79
2SC1308	NPN	276-2055	7.95
2N3819	N-FET	276-2035	.99
MPF102	N-FET	276-2062	.99

4000-Series CMOS ICs With Pin-Out And Specs

Type	Cat. No.	Each
4001	276-2401	.79
4011	276-2411	.79
4013	276-2413	.99
4017	276-2417	1.49
4023	276-2423	.99
4049	276-2449	.99
4066	276-2466	.99

TTL Digital ICs

With Pin-Out and Specs

Type	Cat. No.	Each
7400	276-1801	.59
7404	276-1802	.79
7408	276-1822	.79
7447	276-1805	1.19
7490	276-1808	.89

Operational Amplifiers

Type	Cat. No.	Each
741	276-007	.79
MC1458	(Dual) 276-038	.99
LM324	(Quad) 276-1711	1.29
TL082	(Dual) 276-1715	1.89
TL084C	(Quad) 276-1714	2.99
LM3900	(Quad) 276-1713	1.39
LM339	(Quad) 276-1712	1.49

Audio Power Amplifiers

Type	Cat. No.	Each
LM383/TDA2002	276-703	3.19
LM386	276-1731	1.09
TA7205AP	276-705	2.99
LM380	276-706	1.59

Voltage Regulator ICs

Type	Adjustable	Cat. No.	Each
LM723	0 to 40 VDC	276-1740	.89
LM317T	1.2 to 37 VDC	276-1778	2.79

Type	Fixed Output	Cat. No.	Each
7805	+ 5 VDC	276-1770	1.59
7812	+ 12 VDC	276-1771	1.59
7815	+ 15 VDC	276-1772	1.59
7905	- 5 VDC	276-1773	1.59
7912	- 12 VDC	276-1774	1.59

Computer Connectors

Type	Positions	Cat. No.	Each
ID Card Edge	34	276-1564	4.95
ID Card Edge	50	276-1566	4.95
Card-Edge Socket	44	276-1551	2.99
ID D-Sub Male	25	276-1559	4.99
ID D-Sub Female	25	276-1565	4.99
Solder D-Sub Male	25	276-1547	2.99
Solder D-Sub Female	25	276-1548	3.99
Hood	—	276-1549	1.99

Power Transformers 120VAC Primaries

Type	Volts	Current	Cat. No.	Each
Mini	6.3	300 mA	273-1384	2.59
Mini	12.0	300 mA	273-1385	2.79
Mini	24.0	300 mA	273-1386	2.99
Mini	12.0 CT	450 mA	273-1365	3.59
Mini	24.0 CT	450 mA	273-1366	3.99
Std.	6.3	1.2A	273-050	3.79
Std.	12.6 CT	1.2A	273-1505	3.99
Std.	25.2	1.2A	273-1480	4.39
H-D	12.6 CT	3.0A	273-1511	5.99
H-D	25.2 CT	2.0A	273-1512	6.29
H-D	18.0 CT	2.0A	273-1515	6.99

Tantalum Capacitors

• 20% Tolerance
• Standard IC Pin Spacing

µF	WVDC	Cat. No.	Each
0.1	35	272-1432	.49
0.47	35	272-1433	.49
1.0	35	272-1434	.49
2.2	35	272-1435	.59
10	16	272-1436	.69
22	16	272-1437	.79

Electrolytic Capacitors

Axial Leads

µF	WVDC	Cat. No.	Each
4.7	35	272-1012	.49
10	35	272-1013	.59
22	35	272-1014	.69
47	35	272-1015	.69
100	35	272-1016	.79
220	35	272-1017	.89
470	35	272-1018	.99
1000	35	272-1019	1.59
2200	35	272-1020	2.49
3300	35	272-1021	2.99
4700	35	272-1022	3.59
470	50	272-1046	1.59
1000	50	272-1047	1.99
2200	50	272-1048	3.49

PC-Mount Leads

µF	WVDC	Cat. No.	Each
220	16	272-956	.79
470	16	272-957	.89
1000	16	272-958	.99
4.7	35	272-1024	.49
10	35	272-1025	.59
22	35	272-1026	.69
47	35	272-1027	.69
100	35	272-1028	.79
220	35	272-1029	.89
470	35	272-1030	.99
1000	35	272-1032	1.59
100	50	272-1044	.89

1/4-Watt, 5% Resistors 39¢ Pkg. of 5

Ohms	Cat. No.	Ohms	Cat. No.
10	271-1301	10k	271-1335
100	271-1311	15k	271-1337
150	271-1312	22k	271-1339
220	271-1313	27k	271-1340
270	271-1314	33k	271-1341
330	271-1315	47k	271-1342
470	271-1317	68k	271-1345
1k	271-1321	100k	271-1347
1.8k	271-1324	220k	271-1350
2.2k	271-1325	470k	271-1354
3.3k	271-1328	1 meg	271-1356
4.7k	271-1330	10 meg	271-1365
6.8k	271-1333	—	—

Miniature PC-Mount Pots

1/8-Watt, Horizontal-Mount Type

Ohms	Cat. No.	Each
1k	271-333	.49
10k	271-335	.49
25k	271-336	.49
100k	271-338	.49
500k	271-339	.49

1/4-Watt, Vertical-Mount Type

Ohms	Cat. No.	Each
500	271-226	.59
1k	271-227	.59
5k	271-217	.59
10k	271-218	.59
50k	271-219	.59
100k	271-220	.59
500k	271-221	.59
1 meg	271-229	.59

Submini Toggle Switches

10A at 125VAC. Each includes 4 colored handle covers. 1/4" mounting holes.

Type	Cat. No.	Each
SPST	275-324	1.89
SPDT	275-326	1.99
SPDT Center-Off	275-325	2.19
DPDT	275-1546	2.39
DPDT Center-Off	275-1545	2.59

RF/IF Components

MC1330 Video Detector IC. 8-pin DIP with data. 276-1757 2.29
 MC1350 Universal IF Amp IC With AGC. 8-pin DIP with data. 276-1758 1.99
 MC1358/CA3065 FM Detector. 14-pin DIP with data. 276-1759 1.79
 SFE4.5MB. 4.5 MHz Ceramic TV-Sound Filter. 272-1304 69¢
 CDA4.5MD3 4.5 MHz Ceramic Discriminator. 274-1305 79¢

18-Range Multitester 1995

Big 3" Meter
With Color-Coded
And Mirrored Scale

Measures 0 to 1000 volts, AC and DC. 0 to 250 milliamps DC current. 0 to 2 megohms resistance. -20 to +62 decibels. 5 1/2 x 3 1/2 x 1 7/16". With test leads and manual. Requires "AA" battery. 22-201 19.95



OVER 8800 LOCATIONS WORLDWIDE

Radio Shack®

Prices apply at participating Radio Shack stores and dealers.

A DIVISION OF TANDY CORPORATION

Computers & Electronics Marketplace

CLASSIFIED RATES: Per Word, 15 Word Minimum. **COMMERCIAL:** \$4.00. **PERSONAL:** \$2.30, **EXPAND-AD*:** \$6.00. Ads set in all bold type @ 20% premium. Ads set with background screen @ 25% premium. **DISPLAY:** 1" x 2 1/4", \$485.00. 2" x 2 1/4", \$970.00. 3" x 2 1/4", \$1,450.00. **GENERAL INFORMATION:** Frequency rates and prepayment discounts available. Payment must accompany order except credit card—Am. Ex., Diners, MC, VISA (include exp. date)—or accredited ad agency insertions. Copy subject to publisher's approval; must be typewritten or printed. First word set in caps. Advertisers using P.O. Boxes MUST supply permanent address and telephone number. Orders not acknowledged. They will appear in next available issue after receipt. Closing date: 1st of the 2nd month preceding cover date (e.g., Mar. issue closes Jan. 1). Send order & remittance to: Classified Advertising, **COMPUTERS & ELECTRONICS Magazine**, 1 Park Avenue, New York, NY 10016. Direct inquiries to Rose Lynch, (212) 725-7686.

FOR SALE

GOVERNMENT and industrial surplus receivers, transmitters, sniperscopes, electronic parts, Picture Catalog 25 cents. Meshna, Nahant, Mass. 01908.

ELECTRONIC PARTS, semiconductors, kits. **FREE FLYER.** Large catalog \$1.00 deposit. **BIGELOW ELECTRONICS**, Bluffton, Ohio 45817.

BUILD AND SAVE. TV EARTH STATION. DETECTIVE ELECTRONICS. Video Recorders, Color Cameras, advanced Telephone Projects. **BROADCAST Electronics.** 50 page color catalog of unusual electronic projects **AIR MAILED \$3.00**; with 3 hour audio cassette dramatization of cur catalog \$5.00. Don Britton Enterprises, PO Drawer G, Waikiki, Hawaii 96815.

RECONDITIONED TEST EQUIPMENT \$1.00 for catalog. **WALTER'S TEST EQUIPMENT**, 2697 Nickel, San Pablo, CA 94806, (415) 724-0587.

ELECTRONIC CATALOG. Over 4,500 items. Parts, & components. Everything needed by the hobbyist or technician. \$2.00 postage & handling (United States Only), refundable with first \$15.00 order. T & M Electronics, 472 East Main St., Patchogue, NY 11772. (516) 289-2520.

PRINTED CIRCUIT BOARDS, your artwork. Quick delivery. Reasonable. Atlas Circuits, Box 892, Lincolnton, NC 28092. (704) 735-3943.

SATELLITE TELEVISION...HOWARD/COLEMAN boards to build your own receiver. For more information write...**ROBERT COLEMAN**, Rt. 3, Box 58-APE, Travelers Rest, S.C. 29690.

SOUND SYNTHESIZER KITS—Surf \$19.95, Wind \$19.95, Wind Chimes \$24.95, Musical Accessories, many more. Catalog free. PAIA Electronics, Box J14359, Oklahoma City, OK 73114.

RF MODULATORS for **SATELLITE TELEVISION, MICRO-COMPUTERS** CCTV. Also monitors, cameras, kits. **FREE VIDEO CATALOG.** Phone (402) 987-3771. Dealers Welcomed. **ATV RESEARCH**, 13-P Broadway, Dakota City, NE 68731.

CABLE TV CONVERTERS & EQUIPMENT. Plans and parts. Build or buy. For more information send \$2.00: **C & D ELECTRONICS INC.**, P.O. Box 21, Jenison, MI 49428.

FREE FLYER! IC's, resistors, capacitors, jacks, etc., plus **SSM** music synthesizer/audio IC's, power amp modules, analog delay IC's, computer books, and more. Also plans for analog delay/chorus unit! **PGS Electronics**, Route 25, Box 304, Terre Haute, IN 47802.

TELETYPE EQUIPMENT: Copy Military, Press, Weather, Amateur, Commercial Transmissions. Catalog \$1.00. **WEATHER-MAP RECORDERS:** Copy Satellite Photographs, National-Local Weather Maps. Learn How! \$1.00. Atlantic Sales, 3730 Nautilus Ave., Brooklyn, NY 11224. Phone: (212) 372-0349.

POLICE CODE UNSCRABLERS, lets you hear the coded messages of Police, Fire and Medical channels; plus other scanner accessories, satisfaction guaranteed. **DNE Inc.**, Rt. 7, Box 257-A, Hot Springs, AR 71901. (501) 623-6027.

FREE FLYER 99 cent kits. Parts. Bargains Galore! **ALLKIT**, 434 West 4th St., West Islip, New York 11795.

RESISTORS, 1/4W-1/2W-5% C.F., 3¢ ea., 1% Metallfilms. **NO MINIMUMS.** Quantity Discounts. Write: **JR INDUSTRIES**, 5834-A Swancreek, Toledo, OH 43614.

IF YOU ARE READY TO BUY OR SELL GAMES OR SOFTWARE, YOU NEED...

COMPUTER SHOPPER

Over 100 pages each month. Deal with individuals nationwide. Low ad rate, only 12¢ a word. Subscription, \$10/year. MC & VISA. Money back guarantee 407 S Washington P.O. Box F599, Titusville, FL 32780 (305) 269-3211

CABLE TV

CONVERTERS & EQUIPMENT

We have the largest selection of **JERROLD** and **OAK** cable converters and equipment. Such as: Jerrold SB-3, Oak N12 and Jerrold 61 channel remote control converter with **FULL** features **DRX3-DIC-105**. Plus others.

CABLE TV KITS

Cable TV Kit (Jerrold gated pulse) 39.95.

We also have a large selection of cable TV and kits including all parts, silk screen, PC board and complete instructions.

Send for informative catalogue \$2.00

J & W ELECTRONICS, INC.
P.O. BOX 61-K
CUMBERLAND, RI. 02864

PRINTED CIRCUIT BOARDS. "QUICK PROTOTYPES", production, design, reflow solder. Send print or description for quote to: **KIT CIRCUITS**, Box 235, Clawson, MI 48017.

CABLE TV SECRETS, the informative publication the cable companies are trying to ban. HBO, Movie Channel, Showtime converters, etc. Send \$8.95 to: **CABLE FACTS**, Box 711-CE, Pataskala, Ohio 43062.

WHOLESALE: MATV/CATV/VCR equipment. Antennas, Audio, Cables, Adapters, Original and Replacement Cartridges, Styl, Telephone Accessories, Radios, Cassette Recorders, Speakers, etc. Send letterhead for catalog, 212-897-0509, D&WP, 66-19 Booth, Rego Park, NY 11374.

FREE CATALOG. Large selection of electronic kits and parts. Chaney Electronics, Box 27038, Denver, Colorado 80227. (303) 781-5750.

SATELLITE ANTENNAS. Build wood or metal from \$60, send \$2. Prototype Engineers, Box 1812, Deming, NM 88030.

FREE Catalog of special function IC's and quality components. Goldsmith Scientific, Box 318M, Comrack, New York 11725.

SATELLITE TELEVISION INFORMATION \$4. Build or buy your Earth Station. Satellite Television, RD 3, Oxford, NY 13830.

ELECTRONIC KITS—Low cost Power Supplies, Amplifiers, Alarm Systems, etc. Catalog \$0.25. **CBBI**, Box 222, North Granby, CT 06060.

TELEPHONES and ACCESSORIES. FCC registered. Send \$2.00 for 72 page catalog (refundable). **UNIQUE COMMUNICATIONS, INC.**, P.O. Box 5234, Mansfield, OH 44901.

RELIABLE MICROWAVE ANTENNAS
2.1 to 2.6 GHz
Frequency Range

34db System Gain for Greater!
Complete System (pictured): \$119.95
Down Converter Probe Style
(Assembled & Tested) \$49.95
Power Supply (12V to 16V DC+)
(Assembled & Tested) \$39.95

PETERSON ELECTRONICS
4558 Auburn Blvd
Sacramento CA 95841
(916) 486-9071

SPECIAL QUANTITY PRICING
Dealers Wanted - CDD'S

1 YEAR WARRANTY
PARTS & LABOR

MasterCard VISA

CABLE TV PRODUCTS. Jerrold, Hamlin & Oak converters. Send \$3.00 for catalog. **ADDITIONAL OUTLET CORP.** 231 E. Commercial Blvd, Ft. Lauderdale, FL 33334.

LOW, LOW COMPONENT PRICES! Ask for free flyer. Write: **E.E.P.** 11 Revere Place, Tappan, NY 10983.

SUCKING SOLDER MADE EASY. Finally, one-handed desoldering with your gun. Superb results with surplus vacuum pump. Tip assembly \$14 postpaid. Complete instructions, free brochure. **Gerkman Engineering**, Box 28251, Detroit, MI 48228.

SATELLITE TV BREAKTHROUGH! Build your own Low Noise Amplifier now! Send for complete instruction manual today! Only \$10.00! **XANDI**, Box 25647, Dept. 22P, Tempe, AZ 85282.

PRINTED CIRCUIT BOARDS. Design and artwork. Professional, reasonable, fast! Printed Concepts, OEM inquiries invited. (414) 442-4548.

World's Most Remarkable Radar Jammer!



Causes speed radar guns and devices to read out your choice of either a percentage of your true speed when in automatic mode (example: Your speed: 76 mph, auto mode set for 75%, speed displayed — 57 mph), or the speed that you dial in when in manual mode. Transmits only in the presence of speed radar, or by manual override. Operates on both X and K bands. **WARNING:** The device described in this literature is not legal for use against police radar, and is not FCC approved.

For complete literature and plan package, send \$19.95 to:
Philips Instrument Design Co. Inc.
8135 S.W. Nimbus, Building #11, Suite #114 C
Beaverton, Oregon 97005

CABLE T.V. EQUIPMENT. Channel 36r4 notch filter \$20.00. Information \$1.00. Goldcoast, P.O. Box 63/6025A, Margate, FL 30363.

PICTURE your Expand-Ad in all **BOLD** type! Call (212) 725-3927 for more information.

CABLE TV
Buy Direct & Save

SUPER SPECIALS

40 CHANNEL CONVERTER \$29.95

Advanced Solid State design and circuitry allows you to receive mid & super band channels. Restores pre-programming to Video Recorders.

36 CHANNEL REMOTE CONTROL CABLE CONVERTER \$69.95

JERROLD 400 THE ULTIMATE CABLE TV CONVERTER

60 CHANNEL INFRARED REMOTE CONTROL \$129.95

Send \$5 for Complete Catalog

DIRECT VIDEO SALES
P.O. BOX 1329
JEFFERSONVILLE, INDIANA 47130
CALL
1-812-282-4786

FREE!
ALL NAME BRANDS
 Video • VCR • VHS • BETA • Telephones
 Home Computers • Car Stereos
 Video Tapes • Televisions • T.V. Games
 Accessories • ETC.

What to **BUY**  How to **CHOOSE**

FREE 32 PAGE CATALOG
WITH PRICES!
LOWEST PRICES IN THE USA
GUARANTEED!!

Send \$2.00 to cover postage and handling
 To: **HARMONY VIDEO**
 Dept. CE-9
 2357 Coney Island Avenue
 Brooklyn, N.Y. 11223
 or for immediate price quote call:
800-221-8927

COMPUTER EQUIPMENT/PARTS

SAVE 90% Build Your own Minicomputer. Free Details. Digatek, 2723 West Butler Dr., Suite 20C, Phoenix, AZ 85021.

APPLE SERIAL CARD. Communicate with MODEM or terminal. Switch selectable serial printer protocol. \$46.95/kit \$61.95/assm. Comprehensive manual, DB-25 connector, 6 month warranty. CHECK or C.O.D. B&D ELECTRONICS, Box 3651, Lawrence, KS 66044.

WANT A PLEASANT SURPRISE? Call or write for quotes: Atari, Commodore, Timex, T.I., Corona (IBM work-alike), Amdek, Anadex, Apple & IBM accessories, Hayes, More. GET SURPRISED! HARDWARE SOFTWARE ANYWARE CO., 10 Coles Street, Brooklyn, NY 11231, (212) 596-3592.

APPLE BUILDERS—Send stamp for our flyer of Apple parts. IC sets, ROM sets, component packages, Shugart—Apple modification kits, Apple 9-track tape drives etc. Electrovalue, P.O. Box 376-P, Morris Plains, NJ 07950.

HARD DISK DRIVE LIQUIDATION. Major OEM is liquidating inventory of unused Shugart 8" 5A 1002 5.33 megabyte hard disk drives. \$380 each. Western Digital's controller, \$350. Call: LIQUIDATORS, 803-877-9828, or send check/money order to: 105 S. Main St., Greer, SC 29651.

VIC-20. Add 16K RAM card \$53.50. Plugs into memory port. MassLogic, 47 Edgewood Rd., Westwood, MA 02090.

GRAPHICS TABLET/DIGITIZER, 16"x20". For VIC 20/64, Atari, TI or any Atari-paddle compatible computer. \$44.95. Persimmon Peripherals, Route 2, Box 2306A-CE, Clayton, GA 30525.

COMPUTER SOFTWARE

VIC-20 USERS GROUP, receive newsletter, programs, discounts and more. Send SASE for information. P.O. Box 459, Dept 7, Ladson, South Carolina 29456.

TIMEX-SINCLAIR USERS: Join the group of newsletter subscribers who receive free programs every month! Software discounts, Free program, issue and catalog. Z-WEST, Box 2411, Vista, CA 92083.

TI-99/4A MOON TRIP animated graphic program on cassette. Guide module through asteroid belt. Then land on moon. Speech synthesizer and joyst capability. \$12.00 postpaid. JAG Software, P.O. Box 2225, Dept 1CE, Ocean, New Jersey 07712.

DISCOUNT SOFTWARE—Available for Apple, TRS-80, IBM/PC and TI 99/4 personal computers. Professional applications for the doctor, dentist, attorney, school administrator, teacher, contractor and general office personnel. Catalog \$1.00. Write for MONTHLY SPECIAL OFFERS! Creative Discount Software, 256 S. Robertson Blvd., Suite 2156, Beverly Hills, CA 90211.

COMPUTER PAPER—SAVES\$\$; Lowest single carton prices. Free samples. Bob's Charts, 405 East Third, Long Beach, CA 90802.

ATARI, APPLE, IBM-PC: Extensive line educational, entertainment, business. FREE BROCHURE. New Dimension Software, 39010 Baroque, Mt. Clemens, Michigan 48044.

TI-99/4A PROGRAMMERS: Affordable Software! Catalog, only \$1. PROGRAMS SOFTWARE, 1435 Burnley Square North, Columbus, Ohio 43229.

QUALITY COMPUTER SOFTWARE, VIC-20, Commodore 64, Atari, Games, Home, Ham radio. Large list, SASE. Amateur Accessories, Harvest Court, Flemington, New Jersey 08822. (201) 782-1551.

FREE money saving bulletin on popular brand name programs and books for your small computer. Superior, Dept CE, 8030 Westchester Road, Westchester, OH 45069.

FREE VIC-20 Software-Hardware catalog. Lighthouse Sales, Dept. 1, P.O. Box 68, Trenton, MI 48183.

VIC-20 and C64 SOFTWARE: Special Eighty VIC-20 Programs on two cassettes, \$15.95. Postage \$1.50. Public Domain. SASE to: FANFARE SOFTWARE, 120 E. Main, El Cajon, CA 92020.

SOFTWARE—VIC-20, C64, ATARI, PET, ZX-81. Utility and Amateur Radio our specialty. Free catalog! RAK Electronics, Box 1585, Orange Park, Florida 32067.

VIC-20, Commodore 64 educational software by teachers. FREE CATALOG. ATHENA SOFTWARE, 727 Swarthmore Rd., Newark, DE 19711.

CUSTOM SOFTWARE FOR THE ZX81/TS1000. Brochure \$2.00. Scott Wolf, 4949 Webster Rd., New Haven, Indiana 46774.

TI-99/4A OWNERS. Send for free list of new and exciting, low cost software. D.E., Box 124, Hicksville, NY 11801.

FREE Timex/VIC-20/TI99-4A/Commodore-64 programs! SASEs bring catalogs. Inexpensive! EZRAEZRA, Box 5222-CS, San Diego, California 92105.

SEND NAME OF YOUR COMPUTER. We'll send you periodic data on software, books and tech sheets. SUPERIOR, Dept CE, POB M8002, Westchester, OH 45069.

TI PROGRAMS on cassette. Large selection and variety, over 700. 4 sample programs and catalog \$3.00. KS SOFTWARE, Box 27130, Cincinnati, OH 45227.

FREE VIC-20 and COMMODORE 64 USERS GROUP MEMBERSHIP with software purchase. Why pay to belong to a users group when you don't have to? Benefits: Newsletter, extensive club library, discounts, contests, questions hot-line and more! Free details—(803) 797-1533. Lords of Basic, P.O. Box 459, Dept. 102 Ladson, SC 29456.

TI-99/4A SOFTWARE: Math, Business, Games, Learning, 8 program cassette—\$9.95 p.p. or send for free list. V.S., 2709 Chollet, Tallahassee, FL 32303.

ZX81, TS1000, TI 99/4A Software. Send for FREE Catalog: Midwest Software Co., 9922 Harwich, Crestwood, MO 63126.

POSTER® Assists Income Tax Preparation, Budgeting, Bookkeeping, Check Book Summaries, Credit Card Summaries. Simple and Accurate. BASIC program in spiral bound pamphlet. \$20 postpaid. WOODSON Products, 4025 Ivystone Court, Matthew, NC 28105. Phone 704-542-3796.

COMMODORE VIC-20 OWNERS! Send \$3.00 for cassette with five new games: D. Radke, Box 25938, Chicago, IL 60625.

COMPUTER HARDWARE

COMPUTERS, PRINTERS, ACCESSORIES! Epson FX-80 printer, \$519.00. Gemini 10X printer, \$295.00. Okidata, Prowriters, etc. Lowest prices! Free catalog! Team Computers, (203) 288-5772, 170 Daniel Rd., Hamden, CT 06517.

COMPUTER PUBLICATIONS

INCREASE YOUR PERFORMANCE. Newest facts. Microcomputers/Managing Newsletter Details: Large SASE plus 1.00 (credited to order). Cox Business Service, Dept CE, 2727 Canterbury, Springfield, OR 97477.

YOUR MICROSYSTEM can offer you substantial tax credits and deductions. Detailed guide, \$4.25. Integrated Microsystems: Dept. 6, Rt. 2, Box 227F, Buffalo, MN 55313.

APPLE OWNERS! Having trouble getting into your computer? Booklet aiding starters in computer struggles, \$5.00. 3146 S. Geneva St., Denver, CO 80231.

AMATEUR RADIO

VIDEOSCAN 1000 Slow Scan TV — HIGH RESOLUTION (amateur, phone line, monitoring, teleconferencing). CODE★STAR — DECODE Morse, RTTY, ASCII. LARGE LEDs or connect computer/printer. MORSE-A-KEYER — CW Keyboard. TRI-VOLTAGE POWER SUPPLY. Kits/Assembled. FREE brochures. MICROCRAFT CORPORATION, Box 513-PE, Thiensville, WI 53092. (414) 241-8144.

RADIO AMATEUR CALLBOOKS: Directories of Radio Amateurs around the world. Write for FREE catalog. Radio Amateur Callbook, Dept. PE, 925 Sherwood Dr., Lake Bluff, IL 60044.

TIMEX/SINCLAIR

KROPK., STAR SEARCH, NOAH'S ARK, finest programs available. Machine Language action, graphics. SASE Brown Cottage, 5486 Bright Hawk, Columbia, MD 21045.

"MUST-HAVE"! Utility SOFTWARE. Cassettes-relocatable machine language. SASE for information. SIRIUS WARE, 6 Turning Mill Rd., Lexington, MA 02173.

ANTI-SLIP COMPUTER CUSHION. Insures accurate, vibration free typing. \$4.95 complete. EDCOMPCO, 998 Farmington Ave., West Hartford, CT 06107.

CAD PROGRAMS: others for Timex-Sinclair Computers. Send SASE for brochure. SOFTEC, P.O. Box 432, Fairport, NY 14450.

FREE TS/1000-ZX81 MEMORY MAP. Send S.A.S.E. to: Delta Technical Services Inc., 565-9th St., Brooklyn, NY 11215.

TOP NAME BRAND PROGRAMS and Games. Try before you buy! Don't get burned, info: SEMI-Z, R.D. #4, Box 69, Danville, PA 17821.

FREE CATALOG for ZX81/TS1000. More than 60 different programs from \$9.95-\$14.95. Discount Software, P.O. Box 2530, New York, NY 10185.

SOFTWARE CHEAP! FREE special programs plus catalog. Send large SASE. Aleck, Box 493, Groves, TX 77619.

C.B. EQUIPMENT

IMPROVE CB PERFORMANCE! Modification hardware, books, plans, Catalog \$2. CBC INTERNATIONAL, Box 31500PE, Phoenix, AZ 85046.

CABLE TV

CHANNEL 3—60db notch filter. 63.5MHz. \$32. Crosley, Dept. 607, Box 840, Champlain, NY 12919.

PLANS AND KITS

HIGH PERFORMANCE AUDIO KITS. Phono, Equalizers, Delay and more. Send for FREE catalog. PHOENIX SYSTEMS, 91 Elm Street, Manchester, Connecticut 06040, (203) 643-4484.

8080 COMPUTERS, build your own for as little as \$30. Get two complete plans for \$9.95 plus 95¢ postage. Atlas Engineering, Box 943, Department 12, Skokie, Illinois 60076.

FREE KIT CATALOG contains test equipment. Phone (209) 772-2076. DAGE SCIENTIFIC, Box 144, Valley Springs, CA 95252.

PROJECTION TV... Convert your TV to project 7 foot picture... Results comparable to \$2,500 projectors... Total Cost less than \$30.00... PLANS & LENS \$19.95... Illustrated information FREE. Macrocoma-ca, Washington Crossing, Pennsylvania 18977. Creditcard orders 24 Hours, (215) 736-3979.

ALARM SYSTEM, battery powered. Professional features. Complete kit w/o chassis \$59.95. Free info. Silicon Machines Co., P.O. Box 1536, Wahiawa, HI 96786.

SATELLITE TV—Build your own commercial system for under \$500.00. A complete set of plans and patterns for a 12-16 foot antenna and polar mount. Schematics, P.C. board layouts and full assembly instructions for a low noise amplifier, down converter and receiver, \$55.00. Further information \$2.00. VIDEO SPECIALTIES, 2040 Polk Street, San Francisco, California 94109.

MAILING LISTS

COMPUTER SHOW ATTENDEES N.Y., N.J.: 15,000 NAMES. \$30/M. P/S labels. For info, (201) 297-2526.

ALARMS

BURGLAR-FIRE ALARMS for home, business, auto. Install yourself and save. Installation manual/catalog shows how. Shows latest equipment, accessories. Lowest prices. Send \$1.00 (refundable). BURDEX SECURITY, Box 82802-CEI, Lincoln, NE 68501.

DRIVEWAY ALARMS, wireless optional brochure \$1.00 (refundable). Paxton Enterprises, RR1, Box 313C, Fortville, IN 46040.

HIGH FIDELITY

DIAMOND NEEDLES and STEREO CARTRIDGES at DISCOUNT PRICES for SHURE, PICKERING, STANTON, EMPIRE, GRADO, AUDIO TECHNICA, ORTOFON, ADC, SONUS, MICRO-ACOUSTICS and LAST. Send S.A.S.E. free catalog. LYLE CARTRIDGES, Dept. P., Box 69, Brooklyn, NY 11218. For fast COD service Toll Free 800-221-0906. N.Y. State (212) 871-3303. 9AM-8PM except Sunday.

WANTED

GOLD, electronic, circuit board scrap, silver, platinum, tantalum, mercury. Ores, metals assayed. Samples evaluated. Wholesale Terminal, toll free 1-800-932-1010, (617) 326-3442 in Mass.

GOVERNMENT SURPLUS

IS IT TRUE YOU CAN BUY JEEPS FOR \$44 THROUGH THE U.S. GOVERNMENT? Get the facts today! Call (312) 742-1142 Ext. 4649.

TUBES

TUBES: "Oldies", Latest. Supplies, components, schematics. Catalog Free (stamp appreciated). Steinmetz, 7519-PE Maplewood, Hammond, Ind. 46324.

HUGE INVENTORY! Thousands of types. Wholesale prices. FREE CATALOG! ETCO Electronics, DEPT. 290, Plattsburgh, NY 12901.

COLOR PICTURE TUBES: \$55-\$75 exchange. Year warranty. ATOLL TUBES, 6425 Irving Park, Chicago, IL 60634 (312) 545-9667.

PERSONALS

MAKE FRIENDS WORLDWIDE through international correspondence, illustrated brochure free. Hermes-Verlag, Box 110660/Z, D-1000 Berlin 11, W. Germany.

CORRESPONDENCE FOR FRIENDSHIP IN PHILIPPINES, MALAYSIA. Free information. AAWS-(PE), Box 2777, Orcutt, California 93455-0777.

SCANDINAVIAN LADIES, sincere, seek correspondence for friendship. Details—Send stamp: Scannaclub, Box 4-(CE), Pittsford, NY 14534.

FREE: WORLD'S LARGEST PARTNER-PHOTO-CATALOG for friendship and marriage. Personalized introductions. INTERCONTACT, Box 12, Toronto, Canada M4A 2M8. U.S. Inquiries.

CLASSICAL MUSIC LOVERS' EXCHANGE—Nationwide link between unattached music lovers. Write: CMLE, Box 31, Pelham, NY 10803.

SUNBELT SINGLES looking for a person of quality. Check our group. Details Box 83395, Oklahoma City, OK 73148.

UNIVERSITY DEGREES BY MAIL! Bachelors, Masters, Ph.Ds. Free revealing details. Counseling, Box 317-EP9, Tustin, California 92680.

INSTRUCTION

LEARN WHILE ASLEEP! HYPNOTIZE! Astonishing details, strange catalog free! Autosuggestion, Box 24-ZD, Olympia, Washington 98507.

MEDICAL ELECTRONICS TECHNOLOGY, home study. Troubleshoot medical instruments. WTI, P.O. Box 3124, Fresno, CA 93650-3124.

UNIVERSITY DEGREES BY SPECIAL EVALUATION of existing credits and Job Experience. Fast, inexpensive. Call (614) 863-1791. Or write: EVALUATION, Box 13151-A9, Columbus, Ohio 43213.

REPAIR ELECTRONIC ORGANS—Revised home study course covers all current makes and models. Free booklet. Niles Bryant School, P.O. Box 20153, Sacramento, CA 95820.

F.C.C. COMMERCIAL RADIOTELEPHONE LICENSE. Home Study. Fast, Inexpensive! Free details. COMMAND, D-100 Box 2223, San Francisco 94126.

UNIVERSITY DEGREES without classes. Bachelors, Masters, Doctorates. Accredited, inexpensive, fast. Dr. John Bear, P.O. Box 11447-C9, Marina Del Rey, CA 90291.

YOUR OWN RADIO STATION AM, FM, Cable, licensed, unlicensed, low cost transmitter! Free information. BROADCASTING, Box 130-A9, Paradise, CA 95969.

UNIVERSITY DEGREES BY MAIL! Bachelors, Masters, Ph.D.s... Free revealing details. Counseling, Box 317-PE9, Tustin, California 92680.

ELECTRONIC TECHNICIAN EMPLOYMENT EXAMS from Silicon Valley. Prepare for a high paying job. 400 questions with answers. Send \$9.95 to: Advanced Learning Publications, 1348 Yosemite Drive, Milpitas, CA 95035.

BUSINESS OPPORTUNITIES

FREE CATALOGS. Repair air conditioning, refrigeration. Tools, supplies, full instructions. Doolin, 2016 Canton, Dallas, Texas 75201.

MECHANICALLY INCLINED individuals desiring ownership of Small Electronics Manufacturing Business—without investment. Write: BUSINESSES, 92-K9 Brighton 11th, Brooklyn, New York 11235.

ERASE DEBTS with little-known law—create wealth! Details FREE—Wealth Kit, No. EE9, Billings, NY 12510.

MAILORDER OPPORTUNITY! Start profitable home business without experience or capital. Information free. Mail Order Associates Inc., Dept 778, Montvale, NJ 07645.

ONE MAN CRT FACTORY. T.V.'s, Business machines. Monitors, Scopes, VDT's. \$3.00 rebuilding nets \$100-\$500 each tube. Higher profits overseas. New/used. FACTORY, 1909 Louise, Crystal Lake, IL 60014. (815) 459-0666.

BORROW \$300-\$30,000 INTEREST FREE! Keep indefinitely! Free Details. Write: American, 1601 Main, Plainfield, Indiana 46168.

BORROW \$30,000 without interest! All eligible. Repay anytime. Free details! Infohouse—508CE, 533 Sutter, San Francisco, CA 94102.

BE A LOCKSMITH



"Have seen other Locksmith courses but none compared to yours. I have a successful mobile service of my own. My earnings are good each month." Keith Hamil, Toronto

You'll enjoy your work as a Locksmith because it is more fascinating than a hobby—and highly paid besides! You'll go on enjoying the fascinating work year after year, in good times or bad because you'll be the man in demand in an evergrowing field offering big pay jobs, big profits as your own boss. What more could you ask!

Train at Home—Earn Extra \$\$\$\$ Night Away!
LOCKSMITHING INSTITUTE
Div. Technical Home Study Schools
Dept. 473-093 Little Falls, N. J. 07424

BUMPER STICKER PRINTING DEVICE. Cheap. Simple. Portable. Free details, Bumper, POB 22791 (PE), Tampa, FL 33622.

MAKING MONEY WITH PERSONAL COMPUTERS! 3 cassette package \$19.95, with book \$25.00. Computer Resources, 1659 Mills Street, Chula Vista, CA 92010.

LCD WATCH \$2.50, Penwatch \$3.60. Catalogue \$1.00. Reliant Engineering Company, P.O. Box 33610, Sheungwan, Hong Kong.

THE BEST HOME INCOME OPPORTUNITY IN HISTORY!!! The #1 computer-age, remote marketing, multi-level company seeks persistent people for member/brokerage. No inventory or meetings! Free information: AFP (CE3), Box 6232, L.I.C., NY 11106.

100 UNIQUE PERSONAL COMPUTER BUSINESSES. 40 page descriptive catalog \$1.00. C.B.I.E.E., P.O. Box 4759, Santa Barbara, CA 93103.

BIG MONEY fixing ATARI Video Games. Details \$2. JW Electronics, POB 133, Horseheads, NY 14845.

EARN \$200-\$500+ monthly part-time! HOME BURGLAR ALARMS Sales-Installation. E-Z learn. Information package, SEI, P.O. B 1456-BJ, Grand Rapids, Michigan 49501.

ATARI REPAIR BUSINESS. Start your own. Send \$5.00 for "Getting Started" manual: BEST ELECTRONICS, 4440 E. Sheena, Phoenix, AZ 85032.

MULTI-LEVEL HARDWARE/SOFTWARE SALES FROM YOUR HOME. Send \$3 for details & application. Alpha Byte, 2434 Madison Ave., Baltimore, MD 21217.

PROJECTION TV... MAKE \$\$\$'s assembling Projectors... Easy... Results comparable to \$2,500 projectors... Your total cost less than \$20.00... PLANS, LENS & Dealers information \$17.50... Illustrated information FREE... Macrocmax, Washington Crossing, Pennsylvania 18977. Credit-card orders 24 Hours. (215) 736-2880.

FOR INVENTORS

INVENTORS! IDEAS HAVE VALUE!

Ever think of an idea, forget it and see it later on the market? Many people don't forget, act quickly and are rewarded by American industry. Write down your idea! We offer free disclosure registration and initial consultation regarding your idea's potential value. Call or write without delay for your free information package.

AMERICAN INVENTORS CORPORATION
82 Broad St., Dept. CE
Westfield, MA 01086
(413) 737-5376

A fee Based Marketing Company
Offices Coast to Coast

EMPLOYMENT OPPORTUNITIES

ELECTRONICS/AVIONICS EMPLOYMENT OPPORTUNITIES. Report on jobs now open. Details FREE. Aviation Employment Information Service, Box 240E, Northport, New York 11768.

JOBS OVERSEAS - Big money fast. \$20,000 to \$50,000 plus per year. Call 1-216-453-3000, ext. 4608.

GOVERNMENT JOBS—Thousands of vacancies must be filled immediately. \$17,634 to \$50,112. Call 716-842-6000, Ext 3905.

BOOKS & MAGAZINES

PUBLISHERS' OVERSTOCKS. BARGAIN BOOKS 2,000 titles, all subjects! Free catalog: Hamilton's, 98-85 Clapboard, Danbury, CT 06810.

OUT-OF-PRINT Books Found. Send Wants. Booklook, Dept. C, 51 Maple Ave., Warwick, NY 10990.

SATELLITE, MICROWAVE, VIDEO, Audio Components and Equipment. Send \$1 for 1983 catalog. DSCO, Department B, 3110 Evelyn Street, Roseville, MN 55113.

FLYING RADIO CONTROL. Avoid hassles and pitfalls. New booklet tells how. \$2.00, St. Croix, P.O. Box 279C, Park Falls, WI 54552.

RECORDS/TAPES

RECORDS—TAPES! Discounts to 73%. All labels; no purchase obligations; newsletter; discount dividend certificates. 100% guarantees. Free details. Discount Music Club, 650 Main St., PO Box 1000, Dept. 5-0983, New Rochelle, NY 10801.

REAL ESTATE

NEW...FREE CATALOG! Top real estate values coast to coast! Please specify types, property and location desired. UNITED FARM AGENCY, 612-EP West 47th, Kansas City, MO 64112.

RUBBER STAMPS

RUBBER STAMPS, BUSINESS CARDS. Free catalog 1-800-851-4945, Jackson's, E-100, Brownsville Rd., Mt. Vernon, Ill. 62864.

RETAIL ROSTER

ALASKA

JUNEAU ELECTRONICS—1000 Harbor Way, 99801, (907) 586-2260. Apple, Osborne Hardware/Software/Peripherals. Full service and support.

CALIFORNIA

P.C. COMPUTERS, 10166 San Pablo Ave., El Cerrito 94530. (415) 527-6044. Commodore 64, VIC-20, Pet Specialists. In-House Maintenance.

CONNECTICUT

C&E DISTRIBUTING—Edgewood drive, Jewett City 06351, (203) 427-0657. Retail outlet and wholesaling for dealers.

NEW HAMPSHIRE

COMPUTER MART OF NEW HAMPSHIRE, 170 Main Street, Nashua 03060. 603-883-2386. THE APPLE SPECIALISTS. Full line Hardware/Software. Training/Service.

OHIO

COLUMBUS—HEATHKIT ELECTRONIC CENTER, 2500 Morse Rd., (614) 475-7200. Heath/Zenith Computers, Software, Peripherals, Robotics, Training.

PENNSYLVANIA

MARKETLINE SYSTEMS INC., 975 Jaymor, Southampton 18966, 215-355-5400. Microcomputers, terminals, printers, supplies, monitors, modems, diskettes, etc.

WISCONSIN

MILWAUKEE—HEATHKIT ELECTRONIC CENTER, 5215 W. Fond du Lac, (414) 873-8250. Heath/Zenith Computers, Software, peripherals, robotics.

FREE CATALOG!

Send for your FREE *Creative Computing* Catalog of books, buyer's guides, and more! Write to
Creative Computing Catalog
Dep NALX39 East Hanover Ave
Morris Plains, NJ 07950

Radio Shack and TDP-100

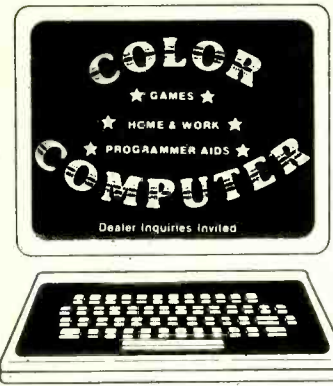

COMPUTERWARE®
 Box 668 *
 6809 Specialists Encinitas, CA 92024
 (619) 436-3512
Computerware is a trademark of Computerware.

VIC		
VIC 20	\$219	\$100.00
VIC 64	\$595	\$397.00
DATASETTE		\$69
VIC PRINTER		\$380
GORF		\$36
SNAK MAN		\$18
SERPENTINE		\$36

AND MUCH MORE!

- Discounts on Large Orders
- MasterCharge and VISA 1-a Accepted

FREE CATALOG

Name _____
 Address _____
 _____ Zip _____

Cougar Computer Systems
 1319 Bailey Ave. Add 3%
 Buffalo, NY 14206 for
 (716) 895-0672 Shipping

CIRCLE NO. 98 ON FREE INFORMATION CARD

GET THE MOST FROM YOUR VIC-20/C64

CASSETTE INTERFACE

- USE ANY STANDARD CASSETTE RECORDER
- CONNECTS TO THE CASSETTE PORT
- CONTROLS THE CASSETTE MOTOR
- NEEDS NO BATTERIES
- COPY FROM RECORDER TO RECORDER
- THIS IS THE BEST ONE FOR LESS \$\$\$ ONLY \$34.95 POSTPAID ADD \$2.50 FOR SHIPPING OUTSIDE US. CANADA, MEXICO



THE MODEM INTERFACE

- CONNECTS TO THE USER I/O PORT
- NEEDS NO BATTERIES/SOLDERING
- CONNECTS ANY STANDARD MODEM
- USE MODEM AUTODIAL/ANSWER FEATURES
- COMES WITH A FREE TYPE IN BASIC TERMINAL PROGRAM
- ONLY \$24.95 POSTPAID ADD \$2.50 FOR SHIPPING OUTSIDE US. CANADA, MEXICO



CHARGE OR COD ORDERS CALL
1-800-227-3800

ASK FOR OPERATOR 225

BYTESIZE PO BOX 12309 DEPT CJ
 MICRO TECHNOLOGY SEATTLE, WA 98111
 (206) 236-8YTE

CALL OR WRITE FOR DEALER INFORMATION

CIRCLE NO. 99 ON FREE INFORMATION CARD

PROTECT YOUR COMPUTER FROM DESTRUCTIVE POWER LINE SURGES

Surges momentary variations of thousands of volts strike daily on your home AC power line. Unchecked surges can disrupt normal computer operation and damage hardware.

Now, CUTS Company offers surge protectors engineered specifically for personal computers.

- Both models protect your system from losing memory, misregistering programs, and blowing out components.
- Both models contain a unique three-stage filter that clamps, limits, and dissipates incoming surges instantaneously for reliable and effective surge protection.
- Both models are compatible with all makes of computers and accessories.

DON'T DELAY—PROTECT YOUR INVESTMENT NOW. ORDER TODAY:

SURGE-SOCK-IT Protected dual outlet that replaces any existing grounded outlet for permanent on-site protection. 125V, 15A \$19.95

SURGE BLOCK (shown) Portable protected dual outlet that plugs into any 3 wire outlet. Includes neon light that monitors protector and ground path. 125V, 70A \$29.95

12 Month Warranty on all Products

Specify model, send name, address and check or M.O. to include \$2 postage (NY Res. add sales tax) to

P.O. Box 691A
 SYOSSET, NY 11791



CIRCLE NO. 100 ON FREE INFORMATION CARD

SAVE 90%

YES you can save up to 90% on a computer system for home or office.

68000 microsystem (8MHz) with 128KB & three RS-232C ports, \$252.00

8086 microcomputer with 128KB & three RS-232C ports, \$204.00

Floppy Interface as little as \$60.00

Also Z80A-8080A systems, CRT's Monitor Roms & parts

FREE CATALOG

DIGATEK CORPORATION
 Suite 7
 2723 West Butler Drive
 Phoenix, Az. 85021

ROLL-YOUR-OWN TECHNOLOGY AND SAVE A BUNDLE

CIRCLE NO. 101 ON FREE INFORMATION CARD

TRS-80+ MQD I, III, COCO, T199/4a
 TIMEX 1000, OSBORNE, others

GOLD PLUG - 80

Eliminate disk reboots and data loss due to oxidized contacts at the card edge connectors. GOLD PLUG 80 solders to the board edge connector. Use your existing cables. (if gold plated)

GOLD PLUG 80 Mod I (6)	\$54.95
Keyboard/EI (mod I)	18.95
Individual connectors	9.95
COCO Disk Module (2)	18.95
Ground tab extensions	1.00
Disk Drives (all R.S.)	9.95
Gold Disk Cable 2 Drive	29.95
Four Drive Cable	39.95
GOLD PLUG 80 Mod III (6)	54.95
Internal 2 Drive Cable	29.95
Mod III Expansion port	10.95
USA shipping \$1.45	Can/Mex \$4.
Foreign \$7.	TEXAS 5% TAX



E.A.P. CO.
 P.O. BOX 14
 KELLER, TEXAS 76248

(817) 498-4242

+ trademark Tandy Corp



MC/VISA

CIRCLE NO. 102 ON FREE INFORMATION CARD

IT'S HERE!!
 The keyboard you have been waiting for!

A LARGE 80 KEY TACTILE FEEL KEYBOARD (MEASURES 10" x 4") THAT PLUGS INTO THE SAME CONNECTORS AS EXISTING KEYBOARD ON YOUR ZX81 OR TIMEX SINCLAIR 1000. IT HAS ALL SILKSCREENED LEGENDS IN 3 COLORS ON THE BASE. MOLOED LEGENDS & GRAPHICS ON KEY TOPS. 8 AUTOMATIC SHIFT KEYS (NO SHIFTING REQUIRED) FOR EDIT, DELETE, SINGLE & DOUBLE QUOTES, COLON, SEMI-COLON, FUNCTION & STOP, 5" SPACE BAR, 2 SHIFT KEYS, NUMERIC KEY PAD.

ONLY \$84.95

MASS. RESIDENTS ADD 5% SALES TAX
 SHIPPING & HANDLING \$4.00/UNIT

DELIVERY 4 - 6 WEEKS. QUANTITY DISCOUNTS. WE WILL ACCEPT MC/VISA. PLEASE INCLUDE #'S, EXP. DATE AND SIGNATURE FOR MORE INFORMATION. SEND SASE. SEND INQUIRIES, CHECK OR MONEY ORDER TO:

E-Z KEY

SUITE 75 E. 711 SOUTHERN ARTERY
 QUINCY, MASSACHUSETTS 02169
 (617) 773-1187

CIRCLE NO. 103 ON FREE INFORMATION CARD

TIMEX-SINCLAIR
 ZX81 1000



1983 Directory

* Where to find: Disk Drives, RAM Extensions, Printers, Modems, Keyboards, Game & Serious Software, Books, Periodicals, Programming Aids, and other Exciting Accessories!

* Articles on: Special applications like Control Circuitry, Enhanced Graphics, Voice Generation, Music Synthesis, Video Inversion, Light Pens, Joysticks, etc.

* Complete Descriptions: We'll tell you what it is, what it does, how much it costs, and where to buy it.

* Jam-packed w/photographs: We knew you'd want to see what these products look like. So, we got pictures and put them in!

Only \$5.95 ... Postpaid!

Sent First Class in the U.S.A.

To Order: Send check, money order, or VISA/MC number and expiration date. MN residents add 6% sales tax.

Dealer Inquiries Welcome.

E. Arthur Brown Company
 Dept. TC-7 1702 Oak Knoll Drive
 Alexandria, MN 56308 Ph: 612/762-8847

TRS-80

COLOR COMPUTER

Quality Software on:

- DISK
- CARTRIDGE
- CASSETTE

Send for our free catalog

----- clip and mail -----



Box 10234
 Austin, TX 78766
 (512) 837-4665

Name _____

Address _____

Zip _____

CIRCLE NO. 104 ON FREE INFORMATION CARD

**GOT A TS-1000 ?
GET STARTED WITH
BOSS SOFTWARE**

DISCOUNT

**CASSETTE PROGRAMS FOR THE
TIMEX 1000/1500 COMPUTERS
GAMES, BUSINESS, EDUCATION, TUTORIAL**



START YOUR OWN SOFTWARE COMPANY ON A SHOESTRING
DUPLICATE 1 TO 50 CASSETTES WITH THE DIGITALIZER
AMPLIFIED CLEAN COPY OUTPUT, INEXPENSIVE, PROFESSIONAL
CASSETTE DUPLICATING EQUIPMENT
AND WE SHOW YOU HOW!

WRITE FOR FREE CATALOG

EULYN ENTERPRISES
4N 650 RIDGEWOOD
BENSENVILLE, IL., 60106
(312) 832-1599

CIRCLE NO. 105 ON FREE INFORMATION CARD

2-Bit Software

FREE CATALOG

**2-K CASSETTES FOR
TIMEX/SINCLAIR COMPUTERS**

2-BIT™ SOFTWARE, P.O. Box 2036
Dept. CED4 Del Mar, CA 92014
(619) 481-3629

DEALER INQUIRIES INVITED

CIRCLE NO. 106 ON FREE INFORMATION CARD

**Home Control System
for the VIC 20**

Control up to 256 lights & appliances
ON, OFF, ALLON, ALLOFF Commands
9 levels of Brightness
Manual & Time Control Software
Uses BSR remote switches
Plugs into User Port

\$59.95
only

MasterCard or VISA Accepted
Call 215-861-0850 to Order

GENESIS COMPUTER CORP.
1444 Linden Street
Bethlehem, PA 18018

VIController

CIRCLE NO. 107 ON FREE INFORMATION CARD

COMMODORE OWNERS!

New Releases From Home Software Co.

Nutridata - food value program
The Wizard - 5 level math tutor
Mediguide - home health aid
The Black Book - phone list
Compucise - exercise guide

13.95-Tape 17.50-Disk
FREE BROCHURES

Home Software Co.
P.O. Box 206
Bridgewater, VA
(703) 434-8418

for useful home software

CIRCLE NO. 108 ON FREE INFORMATION CARD

64K INSIDE!!

T/S1000 ZX81

No wobbles!
No bulky add-ons!
No fear of crashing if bumped!

The 64KT and 64KZ are 64k of user transparent memory which mount INSIDE the TS1000 or ZX81 (respectfully).

Installs in amnute with NO soldering, and easy to follow instructions. Or, if you prefer get the memory you want in a kit that you can put together, all the parts needed are included.

The 64KT = TS1000 with ser. no. prefix F or P
The 64KZ = TS1000 with ser. no. T or D or ZX81

64KT or 64KZ 115.00
64KTK or 64KZK (kit) 90.00

To order, send the part number you need, and check or money order (add 4.00 for shipping and handling) to:

INDEPENDENCE RESEARCH
P.O. BOX 1497
OREM, UTAH 84057

CIRCLE NO. 109 ON FREE INFORMATION CARD

POWER LINE PROBLEMS?

SPIKE-SPIKERS™... The Solution!

Minimize equipment damaging spikes and conducted RF noise to or from sensitive equipment. Transient surge protection plus low pass RFI hosh filtering. All units 120V 15A.

MINI II \$44.95
Wall Mount
3-stage filter
2 sockets

QUAD II \$59.95
Wall mount. Dual 3-stage filter
4 sockets & light

DELUXE \$79.95
Dual 5-stage filtered cts. 8 switch sockets
main switch, fuse, light

Kaligo Electronics Co., Inc. Order Factory Direct
65 B4 Ruch Rd., Dept. C/E
Bethlehem, PA 18017 **215-837-0700**

DEALERS INVITED
PA Res. Add 6% • COD add \$3.00 + Shipping

Out of State
800-523-9685

CIRCLE NO. 110 ON FREE INFORMATION CARD

LEO ELECTRONICS, INC.
8921 S. Sepulveda # 208
Los Angeles, CA. 90045
(213) 641-3101 (800) 421-2418
TLX: 664-688 Interline LSA

LOOK!!

LOW PRICES

RAMS		EPROMS	
4116 (200ns)	1.10	2708	2.50
4116 (150ns)	1.25	2716	3.20
4164 (200ns)	4.65	2716-1	5.00
4164 (150ns)	4.85	TMS 2716	4.75
2114 (200ns)	1.50	2732	3.95
6116P-3	4.25	2532	4.50
		2764	8.00

MICROPROCESSORS		REGULATORS	
Z-80A	4.50	ALL	.75
8080A	2.75	TO-220	
8085A	6.00		

TERMS: Check, Visa, Mastercard. Call for C.O.D.
U.S. Funds only. California residents add 6% sales tax.
SHIPPING: Add \$2.00 for Ground and \$5.00 for Air.
ALL MAJOR MANUFACTURERS
ALL PARTS 100% GUARANTEED
Prices subject to change without notice

CIRCLE NO. 111 ON FREE INFORMATION CARD

**Put 64K CP/M 2.2
in your TRS-80
Model III.**

Our plug-in Shuffleboard III comes with 16K and gives you the full power of 64K CP/M 2.2, the industry standard operating system.

Tap into over 2,000 off-the-shelf business programs such as dBASE II, SuperCalc, WordStar, etc.

READ/WRITE and RUN software from Osborne, Xerox, Superbrain, Kaypro II, HP 125 and TeleVideo. You can even READ/WRITE IBM PC software for CP/M 86.

Simple to install. Shuffleboard III plugs into two existing sockets inside your Model III. No permanent modifications, no cut traces, no soldering. You'll be up and running in minutes. For only \$299. Includes MBASIC Interpreter, a software manual and a first class user's manual. Coming soon: an 80 x 24 Video Board and a Floppy Disk Controller.

See the Shuffleboard at your local computer store or order directly from us. Credit card orders shipped directly from stock. Sorry, no COD's. Free 12 page brochure. Call (415) 483-1008

\$299.

mamory Marchant
1866 Dogville Drive San Leandro, CA 94577

CIRCLE NO. 112 ON FREE INFORMATION CARD

**Get more out of your
Apple with the MICRO
on the Apple Series**

Vols. 1, 2, & 3 **\$24.95**
+ \$2.00 shipping each volume

Each book includes more than 30 programs —
all on DISKETTE

Machine Language Aids
I/O Enhancements
Runtime Utilities
Graphics & Games
Hardware & Reference Information

To order toll free:
1-800-345-8112
In PA 1-800-662-2444
MICRO INK, Dept. CE
P.O. Box 6502
Amherst, NH 03301
603-889-4330

CIRCLE NO. 113 ON FREE INFORMATION CARD

Now we can make any computer sing as well as talk, for only \$219.



As featured in Garcia's Circuit Cellar, "BYTE" Magazine, September, October 1982.

Microvox.

MICROVOX is a completely self contained professional voice quality text-to-speech synthesizer. MICROVOX may be easily interfaced to any computer, modem, RS-232C serial or parallel output device.

- 6502 Microprocessor based text-to-speech algorithm
- SC-01A phoneme based speech synthesizer
- 64 crystal controlled inflection levels
- 3000 character buffer
- RS-232C and parallel port interfaces
- On board power supply
- Music and sound effects capability

MV01 Microvox Assembled & Tested \$299.00
MV02 Microvox, complete kit \$219.00

To Order: Call Toll Free 1-800-645-3479
In N.Y. 1-516-374-6793

MICROMINT, INC.
561 Willow Avenue
Cedarhurst NY 11516



CIRCLE NO. 114 ON FREE INFORMATION CARD

I WILL BEAT ANY COMPETITOR'S PRICE PROVIDED IT IS NOT BELOW MY COST. TRY TO BEAT THESE IC PRICES:

DYNAMIC RAM

64K	200 ns	\$5.35
64K	150 ns	5.35
64K	120 ns	5.90
16K	200 ns	1.40

EPROM

2764	250 ns	\$6.35
2732	450 ns	4.05
2716	450 ns	3.25
2532	450 ns	4.60

STATIC RAM

6264LP-15	150 ns	\$60.00
6116P-3	150 ns	5.00
2114	200 ns	1.45

Z80A FAMILY

CPU, CTC, or PIO	\$3.39
DART	7.99
DMA or SIO/O	12.50

MasterCard/VISA or UPS CASH COD
Factory New, Prime Parts

MICROPROCESSORS UNLIMITED

24,000 South Peoria Ave
BEGGS, OK 74421
(918) 267-4961

Phone 6/15/83

Prices subject to change. Call for volume prices. Subject to available quantities. Shipping & Insurance extra. Cash discount prices shown.

CIRCLE NO. 115 ON FREE INFORMATION CARD

VIC-20

NEW

VIC-20 INTERFACING BLUE BOOK

Did you know that your VIC can be used to control a 99c toy motor so effectively that it runs like a precision machine? Or that you can build an accurate digital thermometer using the VIC and four parts costing less than \$5?

These and other 28 interfacing projects selected for usefulness, ease of construction and low cost are detailed in the VIC-20 Interfacing Blue Book, a veritable gold mine of practical information on how to build a variety of interfaces for your computer.

Projects include: Connecting VIC to your stereo; Pickproof digital lock; Capacitance meter; Liquid level sensor; Telephone dialer; Voice output; 8K/16K RAM/ROM expansion; 128K RAM expansion; 8-bit precision D/A; 8-bit A/D converter; MX-80 interface and more.

Written by a college professor in a friendly and informative style, the Blue Book gives you theory of operation, schematics, program listings, parts list, construction hints and sources of materials for each one of the 30 projects.

If you want to get the most out of your VIC this book is a must. Cost is \$14.95 (less than \$0c per project!) Price includes postage.

microsignal Dept 9

P.O. BOX 22
MILLWOOD NY 10548

VIC-20

VIC-20 VIC-20 VIC-20 VIC-20 VIC-20 VIC-20 VIC-20 VIC-20 VIC-20 VIC-20

VIC-20 VIC-20 VIC-20 VIC-20 VIC-20 VIC-20 VIC-20 VIC-20 VIC-20 VIC-20

TRUE 16 BIT PROCESSING



Z8001 Microprocessor (upgradable to Z8003)

- 2 Kx16 Eprom with Monitor Program (E'Rom Optional)
- 16 Vectored Interrupts
- Full IEEE-696 (S100) Compliance
- All Z8001 Features available
- Battery backup time of day clock
- Requires RAM capable of word transfers
- CP/M8000 Coming Soon

*Model M8000 CPU Board \$425.00
*Model M8000 EE with E'Rom \$500.00

Memory Management Companion Card available 3rd Quarter 1983
*6 month limited warranty

NEW!!

2 Serial / 2 Parallel I/O Card

- 2 Async serial ports
- 1 Centronics parallel port
- 1 General purpose parallel port
- 3 16 bit counter/timers
- Uses Zilog 8531/8536

Introductory Price \$225.00

To Order: Call 1-800-821-8858, In NM, 1-505-523-0975 or write:

MICRO SOLUTIONS INC.

Suite 191 A - 1608 El Paseo Rd. - Las Cruces, NM 88001
Include Ck., M.O. or use MasterCard or Visa. NM res. add 4.5% tax

CIRCLE NO. 116 ON FREE INFORMATION CARD

TS1000 ZX81



3-Color Keyboard Symbols with Conversion Instructions

- Plastic TS1000-ZX81 keyboard symbols in Black, Red and Blue. Opaque background. Will fit all standard-size keys. Adhesive backing for easy application.
- Simple Illustrated Instructions will show you how to convert a cheap (about \$20) surplus keyboard to a full-size TS1000/ZX81 console. "...as easy as stringing wire on a fence."
- Do's and Don'ts for selecting a surplus keyboard.
- Bonus for the "pro" - Schematic Diagram of Computer.

MULE Electronics \$995*

Dept. 310
444 Lincoln Blvd.
Venice, California 90291

*Add \$1.50 P&H. California residents add 6.5% tax. Money-back guarantee, of course.

CIRCLE NO. 117 ON FREE INFORMATION CARD

VIC-20 SOFTWARE

Did you know that you can transfer just about any software on expansion ROM cartridges for the VIC-20 onto cassette tape or disc for your own use?

Well, with our board, which plugs into the VIC-20 expansion port and 8k or 16k of expansion RAM, you can copy games (Sargon Chess™), music, word processors, and just about anything else on expansion cartridges, for about the price of one cartridge!

only **\$34.95** (postage paid in cont. us)
Calif. Res. add sales tax.

nimrod computer

3823 OCEAN VIEW BLVD.
MONTROSE, CA 91020, SUITE 433

CIRCLE NO. 118 ON FREE INFORMATION CARD



RADIO SHACK TRS-80's™

We offer Special Discounts, Free Shipping and a Toll Free Order Number

1-800-531-7466 TOLL FREE

Pan American Electronics

Dept. P.E. - 1117 Conway Avenue
Mission, Texas 78572
(512) 581-2766 Telex 767339

CIRCLE NO. 119 ON FREE INFORMATION CARD

THE PEOPLE'S COMPUTER SUPPLY



YOUR TIMEX SINCLAIR Z8001 IS A FOOLER! IT LOOKS LIKE A TOY, BUT DON'T LET LOOKS FOOL YOU! TRY SOME OF OUR AD ONS & SEE WHAT YOU CAN REALLY DO WITH THE FOOLER!

HERE ARE JUST A FEW OF OUR HARDWARE ITEMS MEMOTECH PRODUCTS

1. 64K MEMOPAK \$44.00
2. 32K MEMOPAK \$35.00
3. 16K MEMOPAK \$28.00
4. HIGH RESOLUTION GRAPHICS \$5.00
5. FULL SIZE DIRECT CONNECT KEYBOARD \$99.00
6. MAKE IT TALK TO YOU WILLIAM STUART SYSTEMS SPEECH SYNTHESIS \$99.00

WE ALSO SELL MONITORS & PRINTERS FOR THE TIMEX SINCLAIR Z8001
VISA, MASTER CARD & AMEX Foreign Orders Please Add \$5.50
& MONEY ORDERS U.S. Orders Please Add \$3.00
PERSONAL CHECK Printer & Monitor Orders add \$7.50
ALLOW 2 WEEKS

THE PEOPLE'S COMPUTER SUPPLY
P.O. Box 664, Sidney, Nebraska 68162
Order Phone: Tel. 308-254-3208

CIRCLE NO. 120 ON FREE INFORMATION CARD

\$1,295.00

Z-80-6502

COMPUTER SYSTEM
DISK DRIVE, DRIVE CARD, MONITOR

SYSCOM*	\$550.00
ORANGE*	\$650.00
FRANKLIN	CALL
GEMINI 10	\$375.00

Hayes Micromodem	\$275. Incredible Jack	\$100.
Slimline Drive	\$255 Regular Drive	\$245.
80 Col. Card	\$110Z-80 Card	\$100
Cooling Fan	\$55 Syscom* Bare Board	\$55.
Disk Drive Card	\$6516K Card	\$65
Parallel Printer Card		\$65.

!! WE WILL BEAT ANY PRICE!!

Softsell Systems
9600 Roosevelt Blvd., Suite 100, LL
Philadelphia, Pa. 19115
(215) 665-5639

CIRCLE NO. 121 ON FREE INFORMATION CARD

COMPUTERS

**TELEMARKETING
Works For You**

1-800-841-0860

**Call For Your
Discount Prices**

Write For Free Price List

commodore • EPSON

SMITH-CORDONA

FRANKLIN • OKIDATA

EAGLE • TRS-80

MICRO MANAGEMENT SYSTEMS

TELEMARKET DEPT. 12

2803 Thomasville Rd. E. • Cairo, Ga.
912-377-7120

CIRCLE NO. 122 ON FREE INFORMATION CARD

COMPUSETTE

- Precision 5 Screw Cassette
- Premium Quality Tape
- Labeled Both Sides
- Individually Boxed
- Freight Paid On All Orders
- Guaranteed Against Defects

	COMPUSETTE (5 MIN. PER SIDE)	COMPUSETTE + (10 MIN. PER SIDE)
25	\$20.00 (80')	\$22.50 (90')
100	\$70.00 (70')	\$80.00 (80')
500	\$330.00 (66')	\$365.00 (73')

OUT OF STATE (800)527-1227

TEXAS (214)349-0081

C.O.D.



EACH CASSETTE INCLUDES A NORELCO CONTAINER
TEXAS RESIDENTS ADD 5% SALES TAX

BUY NOW SAVE 10%

IF CHECK OR MONEY ORDER COMPANIES ORDER (GOOD ONLY IN THE CONTINENTAL UNITED STATES)

P.O. BOX 38651 DALLAS, TX 75238

CIRCLE NO. 123 ON FREE INFORMATION CARD

TOROIDAL POWER TRANSFORMERS

Small size • Low noise • Easy mounting



Ideal for audio amps, CRT monitors and computers where low hum is required.

Includes mounting washer with center hole for screw.

Examples of 117V-60Hz transformers in stock:

Size-Weight ODxH	Secondaries* Volts/Current	Unit price 1	in qty 2-4
40VA-1.1 lbs 2.8"x1.3"	2x8.5V/2.3A 2x12V/1.67A 2x15V/1.33A 2x24V/83A	\$29.00	\$24.40
100VA-2.2 lbs 3.7"x1.4"	2x8.5V/5.8A 2x12V/4.1A 2x15V/3.3A 2x18V/2.7A	\$33.00	\$28.60
340VA-3.3 lbs 4.5"x2.3"	220V/1.55A 2x24V/7.1A 2x30V/5.7A	\$53.60 \$56.50	\$46.50 \$46.50

*May be used separately, in parallel, or in series.

Call to order or write for listing of off-the-shelf toroidal transformers 20VA-600VA

Terms: C.O.D., VISA, MASTERCARD or Money Order

Shipping: Add \$1.00/lbs for UPS (+\$1.50 for C.O.D.)

TOROID CORPORATION OF MARYLAND
(301) 459-8898
4720-Q Boston Way, Lanham, MD 20706

CIRCLE NO. 124 ON FREE INFORMATION CARD

★MICROCOMPUTER★ BUSINESS SOFTWARE

MEDICAL MGMT...
DENTAL MGMT...
INSURANCE AGENT
LEGAL BILLING.....
PROPERTY MGMT..
AND MUCH MORE !

UNIVAIR INTERNATIONAL

9024 St. Charles Rock Road
ST. LOUIS, MISSOURI U.S.A. 63114

(314) 426-1099

CIRCLE NO. 125 ON FREE INFORMATION CARD

MICROSETTE

5 1/4-inch DISKETTES

- Single or double sided, all double density (SSDD, DSDD).
- Soft sector, reinforced hub.

CASSETTES

- Error-free computer grade.

ITEM	10 PACK	50 PACK
SSDD	\$25.00	\$100.00
DSDD	35.00	150.00
C-10	7.50	32.50
C-20	9.00	39.00
C-60	11.00	50.00
C-90	15.00	70.00

UPS SHIPPING INCLUDED
in Continental USA
CA Customers add taxes

MICROSETTE CO.
475 Ellis St., Mtn. View,
CA 94043 (415) 968-1604

CIRCLE NO. 126 ON FREE INFORMATION CARD

Full Size Keyboard Conversion

10 3/4 x 7 1/4 x 2 1/8

For
Your
**ZX81/
TS1000**

SUN KD-81
\$69.95



Easy To Install

No Soldering - No Modifications

41 Keys with Full Size Space Bar - Allows Touch Typing
Same Key Layouts as Sinclair - Two Color Keytops
Keyboard Case Holds Both Keyboard and Computer
Commands and Graphics Spelled Out on Keytops
Rear Cutout for Any RAM or Expansion Modules

16K Piggyback RAM Module P.N. MX-16 \$49.95

SUNTRONICS CO., INC.

In Calif Call **213-644-1149**

Outside Calif Call **1-800-421-5775**

Or send Check or M.O. to

P.O. Box 1957 Hawthorne CA 90250

California residents add 6 1/2% sales tax

Add \$4.00 ship/handling; VISA/Mastercard include expiration date



CIRCLE NO. 127 ON FREE INFORMATION CARD

Texas Instruments

Atari 400, 800, and the new 1200XL
Commodore 64, Vic 20,
Eagle, ACE 1000, Hewlett
Packard, Kaypro II Osborne,
Sanyo, Otrona, NEC, Columbia,
Data, Altos, Amdek, Okidata

- Call us toll-free for low prices and friendly service.
- Full line of hardware and software.
- Fast service — most orders shipped within 24 hours.

Toll-free **800-327-8133**

In FL **305-266-5981 9AM - 6PM EST**

InterContinental Computer

5724 SW 20 Street, Miami, FL, 33155

All our products are new warranted equipment. Please call for handling charges or C.O.D. Non certified checks allow 1 to 2 weeks to clear.

CIRCLE NO. 127 ON FREE INFORMATION CARD

EE/EPROM PROGRAMMERS & UV ERASERS

AFFORDABLE ★ RELIABLE ★ AVAILABLE



PROMPRO-7 - \$489.00
PROMPRO-8 - \$689.00

UV ERASERS
QUV-1811 \$49.95
HOBBY

QUV-1822N \$68.95
INDUSTRIAL

QUV-182T \$97.50
WITH TIMER & SAFETY SWITCH

GANGPRO-8 \$1,295.00
(GANG PROGRAMMER)

RS-232 serial, STAND ALONE, INTELLIGENT

*EASY DUPLICATION *USER FRIENDLY *128K BUFFER
SUPPORTS MOST 8K, 16K, 32K, 64K, 128K, 256K EPROMS
PROMPRO-8: KEY PAD OPTION, EPROM SIMULATION MODE
Microcomputer Chips: 8748 (H), 8749H, 8750, 8751, 8741, 8742, 8755A
SOFTWARE DRIVERS: MDS ISIS, TEKTRONICS 8002, IBM PC, ATARI
APPLE II, CPM, FLEX, TRS-80
DIRECT HOOK UP TO ANY DUMB TERMINAL OR COMPUTER

DISTRIBUTOR INQUIRY WELCOME

LOGICAL DEVICES INC.

1231E N.W. 85 Place, Ft. Lauderdale, FL 33309
Phone Orders (305) 974-0967 TWX 510-955-9496

CIRCLE NO. 128 ON FREE INFORMATION CARD

CONVERT ANY TV TO A HIGH QUALITY MONITOR



Kit permits Dual Mode operation on B&W or Color sets
• Hi-resolution • Up to 80 characters per line • Wide bandwidth • Direct Video • Safe-Easy installation

34.95
ACVM

A full line of low cost Monitors and Receiver/Monitors available.

Send for complete Audio/Video equipment catalog.

V.A.M.P. Inc.

Box 411, Los Angeles, CA 90028
(213) 466-5533

CIRCLE NO. 129 ON FREE INFORMATION CARD

EXPAND THE USE OF YOUR TIMEX SINCLAIR 1000

Full line of Software and Peripherals for TS1000 Computers. For more information and FREE color brochure please write or call:

IC INTERCOMPUTER, INC.

PO Box 90
Prudential Center
Boston, MA. 02199
Tel: (617) 437-1190

Att: PROGRAMMERS

We pay better royalties for your high quality software for COMMODORE VIC 20, TI99-4A and TS2000 Computers. Please write or call.

COMING SOON: A full line of Software and Peripherals for VIC 20, TS2000, TI99-4A, and BBC ACRON.

CIRCLE NO. 13 0 ON FREE INFORMATION CARD

TIMEX/SINCLAIR ZX/81

GEMEX INT'L

P.O. Box 50
Utica, MI
48087

Full Size
43 Key
Keyboard with



Single Key Selection of FUNCTION, SHIFT LOCK and GRAPHIC MODES. 2 LED Mode Indicators

• Simple Plug In Installation
• Fully Enclosed . . . Only **'59.95**
64 K RAM PACK . . . **'99.95**
16 K RAM PACK . . . **'39.95**

Keyboard (case & numeric pad) **'89.95**

Seiksha GP 100 printer and interface for Sinclair . . . **'369.00**

Hi Res Graphics Board . . . **'49.95**

16 K SOFTWARE . . . **'9.95**

Horse Master Panzer SS

Bill Master Budget Master

Appointment Planner

Check or Money Order. Add \$5.00 s/h

Michigan Residents Add 4% Tax

CIRCLE NO. 131 ON FREE INFORMATION CARD

MAKE BIG MONEY!

★ **SELL VIDEO GAME SOFTWARE** ★

...Spare Time to Friends and Neighbors
Make \$50-\$100-\$200 Per Week

NO MONEY NEEDED TO START

No Minimum Order • No Risk • No Age Limit

Become a Part-Time Video Game Dealer. Buy all the new Video Game Software at Low Dealer Wholesale Prices. (Example: WIZARDRY, retail price \$49.95, your cost is \$29.95. You sell at \$34.95 and make \$5.00 a game — your customer saves \$15.00). No money needed to start! Sell ATARI VCS, 5200 400/800, COLECO, INTELLIVISION, APPLE, COMMODORE, TRS-80, T.I., etc. Be the first Dealer in your area.

Limited Offer—**ACT NOW** for Special Dealer Kit — only \$4.85. Dealer Kit includes everything you need to get started — Order Forms, Confidential Dealer Prices, Sales Manual, Ad Kit and much more! **UNCONDITIONAL GUARANTEE** or Full Refund.

MAIL \$4.95 T-O-D-A-Y TO:

GAMES
CLEANINGHOUSE, INC.

DEPT. CE, BOLTON, MASS. 01740

OR CALL:

(617) 897-5555



HAVING LOADING PROBLEMS ?

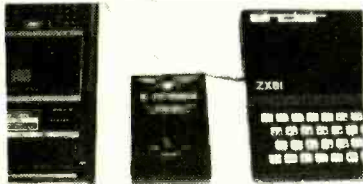

GET A Z-DUBBER

Because of the great variation in cassette recorders used with the ZX80/81/TS1000 (some in very poor shape) you may be having a hard time loading cassette programs. The Z (Dubber) connects between the cassette recorder and the computer and its circuitry produces a much better signal for the computer to read. The Z (Dubber) also allows you to connect two cassette recorders together to make perfect backup copies. The Z Dubber can be yours for \$31.95 post-paid. Add \$2.50 for shipping outside the US, Canada or Mexico.

CHARGE OR COD ORDERS CALL

1-800-227-3800

ASK FOR OPERATOR 225

BYTESIZE MICRO TECHNOLOGY
PO BOX 12309 DEPT. CJ
SEATTLE, WA 98111
(206) 236-BYTE

CALL OR WRITE FOR DEALER INFORMATION

CIRCLE NO. 132 ON FREE INFORMATION CARD

64K for VIC 20™ SELECT-A-RAM™



SELECT-A-RAM

STANDARD FEATURES

- 8K BLOCKS SELECTABLE FROM THE KEYBOARD OR BY SOFTWARE COMMAND
- TWO EXPANSION SLOTS
- WHITE PROTECTION
- RESET SWITCH
- EXPANDABLE TO 128K WITH ADDITION OF TWO EXPANSION MODULES
- COMPATIBLE WITH ROM CARTRIDGES
- ONE YEAR WARRANTY ON PARTS AND LABOR
- 15 DAY MONEY BACK GUARANTEE

SELECT-A-RAM . . . \$195

8K EXPANSION MODULE . . . \$148

TRADE-INS ACCEPTED

36.95 - 98.50 - 198-920

VIC 20 IS A TRADEMARK OF COMMODORE ELECTRONICS LIMITED



APS-52A

52K MEMORY FOR ATARI 400/800 . . . \$119.00

The APS 52A memory expansion board is

come furnished and tested with a 90 day

warranty covering material and workmanship.

Boards come with complete documentation,

including operation and installation instructions

and a memory test program.

16K TRADE-INS ACCEPTED . . . \$16.00

ATARI 400 AND 800 ARE TRADEMARKS OF ATARI INC.

512-441-3202 PO BOX 43006 Austin, Tx. 78745-0001



CIRCLE NO. 133 ON FREE INFORMATION CARD

CHADWELL'S SOFTWARE

#230, 4144A 97 St.
Edmonton, Alberta
Canada T6E 5Y6

ZX81

16K RAM Expansion **'40.95** U.S. + P & H

High Resolution Graphics

Cartridge (Reg. 8K RAM) **'89.95** U.S. + P & H

114 plot modes, mixed text and graphics including

print at graphics cursor, user defined graphics

screen copy to print.

VIC-20

16K RAM Expansion **'69.95** U.S. + P & H

32K RAM Expansion **'89.95** U.S. + P & H

3 Slot Expander+8K RAM **'77.95** U.S. + P & H

IC Chip Toolkit **'19.95** U.S. + P & H

IC Chip Mach. Code Mon. **'19.95** U.S. + P & H

IC Chips are built into RAM packs order with RAM

packs only.

6 MONTH WARRANTY

Send cheque or money order including \$2.50 per item/IC

50¢ per item postage & handling.

Mode switch and battery connector fitted with 3 slot

expander + 8K, switchable to Vic+3K, +8K, +16K.

DEALER INQUIRIES WELCOME

U.S. ORDERS WELCOME

CIRCLE NO. 134 ON FREE INFORMATION CARD

YORK 10™ CASSETTES

• LOWER PRICES
• LONGER LENGTHS

DATA TRAC C-06, C-12, C-24

From the leading supplier of Computer Grade Cassettes, new, longer length C-12's (6 minutes per side) provide the extra few feet needed for some 16K programs.

• Premium 5-screw shell with leader — BASF tape

• Error Free • Money back Guarantee

ITEM	1 DOZ	2 DOZ
C-06	7.00	13.00
C-12	7.50	14.00
C-24	9.00	17.00
Hard Box	2.50	4.00

FOR IMMEDIATE SHIPMENT USE YOUR VISA OR MASTERCARD CALL 213/710-1430

YORK 10™ Computerware
24573 Kittridge St., P1 Canoga Park, CA 91307

CIRCLE NO. 135 ON FREE INFORMATION CARD

STEP UP!

Quality Software for Apple II, Apple III, IBM PC.

Medical, Dental, Office And Educational Software

For further information call (619) 365-6668

Mediware
COMPUTER SERVICE
Village Data Center, P.O. Box 803
Joshua Tree, California 92252

CIRCLE NO. 136 ON FREE INFORMATION CARD

SPEECH SYNTHESIS NEW! SAVE \$\$\$ ONLY **\$69** KIT

16K ZX81
TIMEX
VIC20
APPLE II

• UNLIMITED VOCABULARY \$89 BUILT
• AMPLIFIER + SPEAKER INPUT FOR CAS - MUSIC UNITS

SMART EARS! SPEECH RECOGNITION **\$99**

FOR ABOVE LISTED COMPUTERS & OTHERS CALL (SOME NEED I/O)

Hugely successful Speech Recognition System, complete with microphone, software and full instructions BUILT TESTED & GUARANTEED

MUSIC SYNTHESIS STEREO + 16 LINE CONTROL PORT PLAY 3 PART MUSIC, EFFECT, DRUMS ETC 1/0 PORT TO CONTROL ROBOT **\$49.95** HOME SECURITY EARS ETC BUILT \$59

AUDIO VISION 1279 N. NORMANDIE LOS ANGELES, CA 90027 **SPEECH CHIP SX-01 \$38 AND SHIPPING \$4.95 ATAX (213) 6888217**

CIRCLE NO. 137 ON FREE INFORMATION CARD

ATARI 2600* GAME DEVELOPERS

VIDEO GAME DEVELOPMENT BOARD

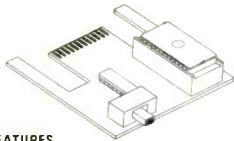

FEATURES

- CONVENIENT ZIF SOCKET BY AMP
- SWITCH SELECTABLE FOR 2716/2732
- FULLY ASSEMBLED AND TESTED
- HIGH QUALITY FIBERGLASS PC BOARD
- GOLD EDGE CONNECTOR
- RF NOISE SHIELD (PROM NOT INCLUDED)

SEND CHECK DR. M.O. FOR \$16.96 PLUS \$1.50 FOR POSTAGE AND HANDLING TO

VIDEO DEVELOPMENT CORP.
BOX 539
GLENCOE, MD. 21152
301-428-0605

MD. RESIDENTS ADD 5% SALES TAX
DEALER INQUIRIES INVITED
ALLOW 4 WEEKS FOR DELIVERY

*ATARI AND 2600 ARE TRADEMARKS OF ATARI INC.

CIRCLE NO. 138 ON FREE INFORMATION CARD

R.I.S.T. INC. ANNOUNCES

**LABOR DAY SALE
SPEECH SYNTHESIZER**

***ACT NOW: \$59.95 SALE ENDS 9/30/83**
Receive
Phrase Finder Program "\$5. VALUE FREE"
Speech Synthesis Manual "\$10. VALUE FREE"

- TIMEX/SINCLAIR - VIC-20 Speech Synthesizer plug-in module. ~~89.95~~ FREE
- Phrase Finder Cartridge, Speech Manual +4.5h
- T/S Speech Synthesizer Kit compl. with PC Board & all components. ~~59.95~~ 44.95
- APPLE II, II+; TRS80 I, III, Color; VIC-20 Speech Synthesis Starter Kits. ALL KITS include FREE: +2.5h
- Speech Manual, Phrase Finder List.
- 9v, 2amp POWER SUPPLY for the T/S ~~24.00~~ 21.95
- SURGE FREE transient absorber, eliminates destructive surges. 2 socket ~~60.95~~ 49.95, 6 socket ~~80.00~~ 69.95, 10 socket ~~99.95~~ 74.95 - Add \$3.5h
- TALKING POKER - Poker game ~~16.00~~ 12.95
- accentuated with speech +1.5h
- VOXCOMP - Speech Dictionary ~~15.95~~ +1.5h

*** 10 Day Money-Back Guarantee ***

Send check or M.O., COD add \$1.50 to: R.I.S.T. Inc., Dept. CE983, P.O. Box 499 Ft. Hamilton Station, Brooklyn, NY 11209 212-259-4934.

N.Y.S. RESIDENTS ADD 8 1/4% TAX.

CIRCLE NO. 139 ON FREE INFORMATION CARD

ATTENTION APPLE LOVERS

100% APPLE COMPATIBLE

- DISK DRIVE \$199.
- DUAL DISK CONTROLLER \$ 49.
- Z-80 BOARD \$ 85.
- 80 COLUMN BOARD \$159.

MONITORS

- ZENITH ZVM 121 12" Green Screen \$ 89.
- AMDEK COLOR I+ 13" Color \$289.

FREE BROCHURE

!!CALL US FOR LOWEST PRICES ON OTHER ACCESSORIES!!

XICOM COMPUTER PRODUCTS
414 B. West Fifth Street
Naperville, Illinois 60566
(312) 961-1616

MC, Visa

CIRCLE NO. 140 ON FREE INFORMATION CARD

Shelf Conscious?

Now you can organize your copies of

Computers & Electronics

Now your magazines can be a handsome addition to your decor, well organized, and easy to find, thanks to these durable library-quality cases or binders. They're made of luxury-look leatherette over high-quality binders board. And both styles are custom-designed for this or any magazine you save, with size, color, and imprint selected by the publisher. FREE transfer foil included for marking dates and volumes.



Magazine binders

hold your issues on individual snap-in rods, combining them into one volume. \$7.95 each; 3 for \$22.50; 6 for \$42.95. Mixed titles OK for quantity prices.



Open-back cases

store your issues for individual reference. \$6.95 each; 3 for \$19.75; 6 for \$37.50. Mixed titles OK for quantity prices.



CHARGE ORDERS ONLY—
for your convenience PHONE 24 HRS.
TOLL-FREE 800-526-0790.
In NJ only 201-540-0445.

USE THIS COUPON

Computers & Electronics

P.O. Box 5120, Philadelphia, PA 19141

Please send: Cases Binders

TITLE _____ QUANT. _____

Computers & Electronics: _____

(Other): _____

ENCLOSED IS \$ _____ * Add \$1.00 per order for post. & handling. Outside USA add \$2.50 per unit ordered. Send U.S. funds only.

CHARGE (Min. \$10): VISA

American Express Master Charge

Card # _____

Exp. Date _____

Signature _____

Print Name _____

Address _____

City/State/Zip _____

City/State/Zip _____

*PA residents add 6% sales tax.

Computers & Electronics

ADVERTISERS INDEX

RS no.	ADVERTISER	PAGE no.
50	Active Electronics	95
3	All Electronics Corp.	95
35	Apple Computer	30-31
	C & D Electronics	93
	Classified Advertising	103-112
	Cleveland Institute of Electronics, Inc.	36-39
29	Commodore Computer	Cover 4
19	Communications Electronics	7
60	CompuServe	29
11	Computer Mail Order	69
14	Digi-Key Corp.	100-101
66	Discwasher	27
73	Elek-Tek, Inc.	3
25	Epson America	14-15
26	Firestik Antenna Corp.	88
18	Focus	12
46	Global Specialties	1
	Grantham College of Engineering	12
24,28	Heath Co.	8,11,47
	ICS	93
21	Jameco Electronics	96
22	JDR Microdevices	97,98,99
23	J & R Music World	71
79	Jensen Tools	93
20	Leading Edge	Cover 2
48	3M Company	13
31	McIntosh Laboratory, Inc.	71
	Memotech	24,25
	Memtek	4,5
	National Technical Schools	54-57
27,17	Netronics, R & D Ltd.	95
53	New Horizons	23,49,61
	NRI Schools	18-21
40,69	Protecto Enterprises	63,75
	Radio Shack	35,102
	Scientific Systems	62
36	Sintec Co.	94
16	Sweet Gum Inc.	62
39	Tab Books	53
82	Tektronix	Cover 3

Now 60 MHz or 100 MHz Tek quality is just a free phone call away!



Tek has expanded its best-selling 2200 scope line up to 100 MHz. And brought it all as close as your phone. Tek's revolutionary, reduced-component architecture brings unprecedented quality, reliability and affordability to the 60 MHz 2213 and 2215, and now, the 100 MHz 2235.

All three of these lightweight (13.5 lb.) scopes feature 2 mV/div vertical sensitivity and 5 ns/div sweep speeds, plus a complete trigger system for stable triggering on digital, analog or video waveforms.

Scopes with a comprehensive 3-year warranty*... probes...and expert advice. One free call gets it all! You can order, or obtain literature, through the Tek National

	2213	2215	2235
Bandwidth	60 MHz	60 MHz	100 MHz
No. of Channels	2	2	2 + Trigger View
Alternate Sweep	—	Yes	Yes
Vert/Trig B/W Limit	—	—	Yes—20 MHz
Single Sweep	—	—	Yes
Accuracy: Vert/Horz	3%	3%	2%
Delay Jitter	1:5,000	1:10,000	1:20,000
Trigger's Sensitivity	0.4 div at 2 MHz	0.4 div at 2 MHz	0.3 div at 10 MHz
Input R-C	1M Ω -30pf	1M Ω -30pf	1M Ω -20pf
Variable Holdoff	4:1	4:1	10:1
Price	\$1200†	\$1450†	\$1950†

Marketing Center. Technical personnel, expert in scope applications, will answer your questions and expedite delivery. Direct orders include operating and service manuals, two 10X probes, 15-day return policy, and worldwide service back-up.

**Order toll-free:
1-800-426-2200
Ext. 27**

In Oregon call collect:
(503) 627-9000 Ext. 27

†Price F.O.B. Beaverton, OR.
*3-year warranty includes CRT and applies to 2000 family oscilloscopes purchased after 1/1/83.
Scopes are UL Listed, CSA and VDE approved.

Tektronix[®]
COMMITTED TO EXCELLENCE

Circle No. 82 on Free Information Card

IF PERSONAL COMPUTERS ARE FOR EVERYBODY, HOW COME THEY'RE PRICED FOR NOBODY?

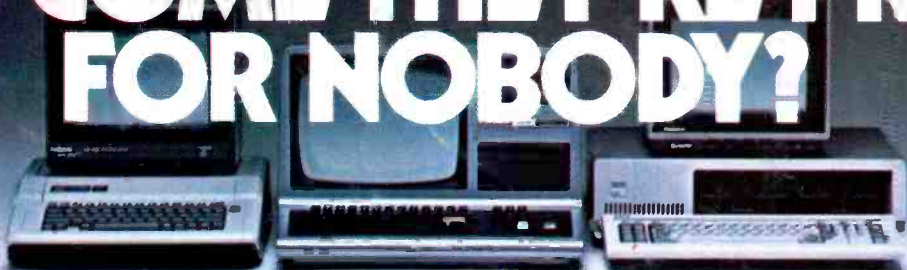

A personal computer is supposed to be a computer for persons. Not just wealthy persons. Or whiz-kid persons. Or privileged persons.

But person persons.

In other words, all the persons whom Apple, IBM, and Radio Shack seem to have forgotten about (including, most likely, you).

But that's okay. Because now you can get a high-powered home computer without taking out a second mortgage on your home.

It's the Commodore 64. We're not talking about a low-priced computer that can barely retain a phone number. We're talking about a memory of 64K. Which means it can perform tasks most

\$1395*
APPLE® IIe 64K

\$999*
TRS-80® III 16K

\$1355*
IBM® PC 64K

other home computers can't. Including some of those that cost a lot more. (Take another look at the three computers above.)

By itself, the Commodore 64 is all the computer you'll ever need. Yet, if you do want to expand its capabilities some day, you can do so by adding a full complement of Commodore peripherals. Such as disk drives. Modems. And printers.

You can also play terrific games on the Commodore 64. Many of which

will be far more challenging than those you could ever play on a game machine alone. And as great as all this sounds, what's even greater-sounding

is the price. It's hundreds of dollars less than that of our nearest competitor.

So while other companies are trying to take advantage of the computer revolution, it seems to us they're really taking advantage of something else:

Their customers.

*Manufacturers' suggested list prices. Monitor included with TRS-80 III only. Commodore Business Machines—P.O. Box 500R, Cowshohocken, PA 19428; Canada—3370 Pharmacy Avenue, Agincourt, Ont., Can. M1W 2K4.

commodore
COMPUTER

Apple is a registered trademark of Apple Computer, Inc. TRS-80 is a registered trademark of Tandy Corp. IBM is a registered trademark of International Business Machines Corp.

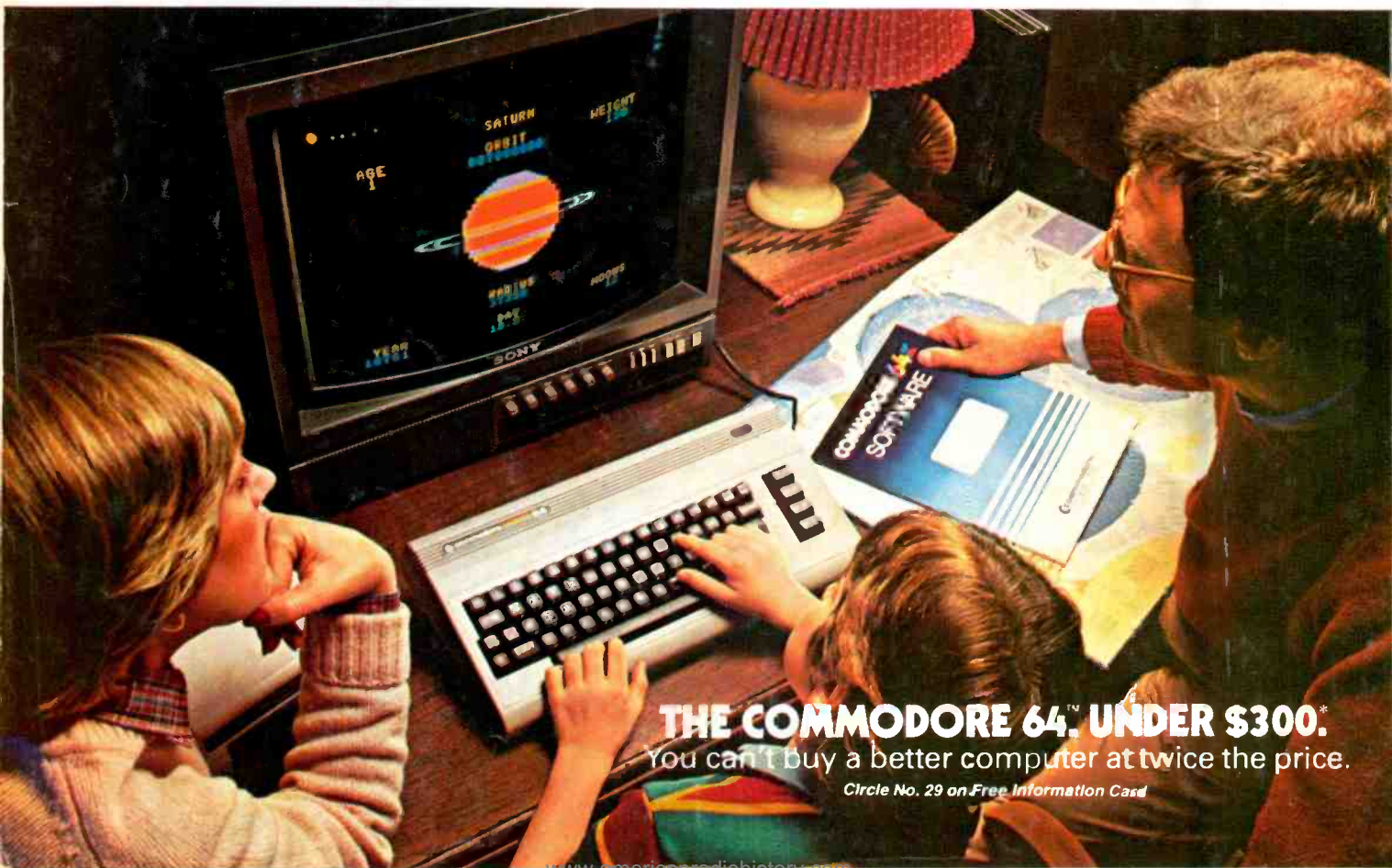

THE COMMODORE 64™ UNDER \$300.*
You can't buy a better computer at twice the price.

Circle No. 29 on Free Information Card