

New Wave Traps; Reflex Neutrodyne Circuit

# Radio Digest

EVERY WEEK

Illustrated

TEN CENTS

REG. U. S. PAT. OFF. & DOM. OF CANADA

Vol. VIII

Copyright 1924  
By Radio Digest Publishing Co.

SATURDAY, FEBRUARY 9, 1924

No. 5

## CLAIM R.C.A. MONOPOLY



Above is Dolores Cassinelli, the "Cameo Girl" of the screen; as Queen Isabella in "Columbus." She sang recently from WGR, Buffalo, winning a flood of applause. Below, Nancy Welford, of "Up She Goes," who pleased WDAR with her songs.

### WBAP GOES 6,500 MILES TO SAMOA

Fort Worth Plant Is Heard for Second Time in Distant Islands

FORT WORTH.—Station WBAP, Star-Telegram, has been heard for the second time in Apia, Samoan islands, an airline distance of 6,500 miles, according to a government Radio message received from Quincy F. Roberts, American consul at Apia. Only one station in the United States has been heard at a greater distance, this was by especially arranged tests on special power.

The Radiogram from Roberts came by way of San Francisco and the Fort Douglas station of the army.

Interest in Radio is mounting rapidly in the south seas, according to Roberts. Several good receiving stations are in operation throughout the Samoan group.

Static conditions and a large volume of ship traffic are handicaps to fans there, which handicaps fail to dampen the enthusiasm of the fans.

### DEAF MAN PUTS ON PHONES AND HEARS

Affliction Is Overcome by Ether Waves After 26 Years

DAVENPORT, IA.—More evidence that Radio aids the deaf to hear was received recently by Station WOC, Palmer School of Chiropractic, of this city, which made known a newspaper report that Levi Bullard of Lexington, Mo., who had been deaf more than 26 years, had been enabled to enjoy a concert broadcast by the station here.

Bullard, while in a shop in Lexington, was induced to don a pair of earphones. Soon there came to his face first a look of consternation, then of amazement, then of pleasure and amusement. He shouted that he could hear. Bullard held onto the earphones until the end of the program and then announced that he was going to buy a Radio set at once.

## GOVERNMENT SAYS FIRMS ACT ILLEGAL

### Unfolds Patent Exchange Big Five Combined and Conspired According to Sweeping Complaint of Federal Trade Commission

(By L. M. Lamm, Special Correspondent)

WASHINGTON, D. C.—Illegal monopoly not only in the manufacture and sale of Radio apparatus, but in Radio broadcasting and communication, both domestic and transoceanic, is the sweeping charge, long awaited and finally made by the Federal Trade Commission against the Radio Corporation of America and its parent companies, which are no other than the General Electric Company, Westinghouse Electric & Manufacturing Company, American Telephone & Telegraph Company (which controls the Western Electric Company), International Radio Telegraph Company, Wireless Specialty Apparatus Company and the United Fruit Company.

Firms Named Have "Combined and Conspired"

The charge was made in a complaint brought by the commission under its (Continued on page 2)



Lela Johnstone, soprano of San Francisco Opera Company, who sings from KPO, Hale Brothers.

# NEW REVENUE GRAB "MUSIC TRUST" AIM

## PIN PAN ALLEY BUNCH TO SUE MANY STATIONS

### Shall American Society of "Composers" Eke Income from Broadcasters? Case in Court Now

CHICAGO.—Another legal onslaught which observers believed would be the last in the desperate attempt of the American Society of Composers, Authors and Publishers to compel broadcasters in the United States especially to pay license fees for the use of copyright music and the like, was begun here recently when E. S. Hartman, general counsel for this district, of the organization, filed suit in federal court against the Chicago Board of Trade, owner and operator of Station WDAP, Drake hotel, charging infringement of the copyright law.

And that which caused the suit was the song, "Last Night on the Back Porch I Loved Her Best of All," published by the Skidmore Music company of New York city.

### Both Sides Determined to Finish Fight

So determined apparently were both parties to the suit to fight to a finish that it appeared likely the issue would become national in aspect, involve decisions of the United States supreme court, enter perhaps the halls of Congress.

The plaintiff in the suit asked monetary damages of not less than \$250 for each alleged violation of the statute and an injunction against the further broadcasting of copyright music by the station. Papers in the suit were served to the assistant secretary of the Board of Trade.

Henry S. Robbins, attorney for the Board of Trade, has asked the organized broadcasters that a defense fund of \$10,000 be raised at once to carry the case if need be to the highest court, and to Congress for remedial legislation.

### But Two Questions Involved

"Every broadcaster in this country is affected, theoretically at least, by this suit," said Mr. Robbins, for the defense. "It is a national, a vital issue which must be determined.

"There are only two questions involved—Does the copyright law of 1909 include radio broadcasting? Does Station WDAP or any other broadcast for profit?" The need for an immediate conference of broadcasters was emphasized by Robbins.

### Radio Cuts Sale of Songs?

"The success of any broadcasting station," Hartman said, "is due to its music. The more a song, for instance, is broadcast, the less are its sales. Some of our members who are publishers complain that radio has cut the sale of certain songs from 3,000,000 to 5,000,000 copies each to 500,000. That condition prevails also in the sale of phonograph records and player-piano rolls.

"Radio broadcasting, we are prepared to prove, is not philanthropic. It is one of the most intensive forms of advertising and as such produces profit. That was and is the aim of the Chicago Board of Trade and of all other broadcasters."

### "Most" of Broadcasters Licensed," Hartman

Hartman said that "most" of the broadcasters had signed contracts with the American Society of Composers, Authors and Publishers entitling them, for fees ranging upward from \$250, to place copyright music and like productions on the air. Among the broadcasters who had thus become "good," Hartman included stations in St. Louis, Kansas City, Mo., Detroit, Minneapolis and Cleveland. He refused to name the stations specifically.

Hartman declared that the American Society of Composers, Authors and Publishers numbered more than 250 members. A printed list showed, after hasty scrutiny, only 18 names widely known as those of composers of music. Further examination failed to reveal the names of noted authors but showed a few notable lyricists.

### Would Advertise A. S. C. A. P.

A blank contract or license to broadcast, issued by the society, read in part as follows: "This license is not transferable. The licensee agrees to make the following announcement upon the commencement of each program in which special numbers from the repertory of the society are broadcast—by special arrangement with the American Society of Composers, Authors and Publishers." If required, by the society the licensee agrees to furnish it, upon forms to be supplied, a list of the musical numbers contained in the society's repertory used in each program.

### WDT Paid License; Now off Air

The attorney for the society did not cite the report that Station WDT, Premier Piano corporation and Shipowners' Radio Service, New York city, had been compelled to quit broadcasting because of what were termed excessive license charges imposed by the society.

The consensus of broadcasters and of the Radio industry in general in relation to the contention of the American Society of Composers, Authors and Publishers

that broadcasting injured the business of music publication, phonograph record manufacture and that of player piano rolls, was that the opposite was true. One of the most influential Radio business factors, who asked that his name be not made known, declared that the cry of "Radio hurts my business" was inspired by the "music trust." "And of course," he said, "the 'trust' doesn't realize that it was its demands for license fees that hurt the sheet music business. The broadcasters refused to be 'bled' by the 'trust.' They refused to broadcast 'trust' music; the result was that 'trust' music lost the advertising or 'sales plugging' given by Radio and the volume of sales dropped."

### Record Makers Now Go On Air for Ad

Similar conditions obtained in the phonograph industry, he maintained. "Makers of phonographs are linked in a sense with the 'music trust,'" he asserted, "in that they make records of 'trust' music. Radiophans, unacquainted with the phonograph records of 'trust' music, called for records they had heard by Radio. Of course that hurt the sale of the other kind of record. And that's why two of the largest phonograph companies, the Victor and the Columbia, have become allied with Radio broadcasting. The latter concern now rents Station WEAJ, New York, at regular intervals to broadcast its latest records. Why? Good advertising, of course. The Victor is installing a station at its Camden, N. J., plant."

### "Music Trust" Chain of Coins

The latest suit of the American Society of Composers, Authors and Publishers is a link in the chain it has forged to bind the broadcasters of the United States, it is said, to place on the air only that music or like creation which it controls. The chain (Continued on page 8)

# SANDWICHES GIVEN COLUMBUS STATION

## Basketful Is Answer When Announcer Asks for Word from Fans

LONDON, O.—An announcer from a Columbus station recently told his listeners that the station once in a while wished to hear from all sections reached and mentioned that they had not heard from London for some time, and at the same time stated that several other places had been missed.

The next night, the announcer stated that the station still had received no word from London or vicinity and asked that someone send in word if the programs were being heard there.

The local Radiophans heard this. Thirty minutes later they were surprised to hear the announcer state that he had heard from London with a vengeance; that one London enthusiast had called the Deshler hotel, Columbus, by long distance telephone and ordered a basket of sandwiches sent to the broadcasting station. The announcer stated that the response was most gratifying and pleasing to the station.

### Boom Daylight Broadcasts

MINNEAPOLIS.—Records now being compiled by the Twin City Radio central, WLAG, are believed to indicate that the practicability of daylight broadcasting is to be demonstrated shortly and that one of the big developments in the near future will be the increase of daytime programs.

# CONTENTS

Radio Digest, Illustrated, Volume VIII, Number 5, published Chicago, Illinois, February 9, 1924. Published weekly by Radio Digest Publishing Company, 123 West Madison Street, Chicago, Illinois. Subscription rates, yearly, Five Dollars; Foreign Postage One Dollar additional; single copies Ten Cents. Entered as second-class matter at the postoffice at Chicago, Illinois, under the Act of March 3, 1879.

"All the Live News of Radio".....	1 to 7
Listening In in the North Woods.....	6
Wave Traps Now on the Market.....	7
How to Make a Lighthouse Keeper's Receiving Set, Part I—Portable Set Suitable for Everyday Use, by S. R. Winters.....	11, 12, 13
Operating and Trouble Shooting for Owners of Standard Receiving Sets.....	14
An Evening at Home with the Listener In.....	15, 16, 17
Advance Programs for the Current Week.....	18
Radiophone Broadcasting Station Directory.....	19
King Miloplex Turns Out New Trick Circuit, by the Mystery Man.....	19
Editorials; Indi-Gest; Condensed, by Dielectric.....	20
How and Why of Super-Heterodyne Receiver, Part IV—Loop Aerial and Circuit, by H. J. Marx.....	21
Simple Explanation of Radio for Everybody, Chapter X, Part II—Loud Speakers, by M. W. Thompson.....	23
The Interference Problem in Radio.....	24
Reflex Four-Tube Neutrodyne Receiver, by H. J. Marx.....	25
Modified Form of a Green Regenerative Receiver, Part II—Accessories, Assembly and Operation, by Myron P. Green.....	27
Weagant Receiver Hook-Up.....	28
Single Circuit Tuner Changed to Reflex.....	29
Reviews of Books.....	30
Questions and Answers.....	31
Radio Illustrated, a Page of Pictures.....	32

# Looking Ahead

**Super-Regeneration and the Super-Heterodyne Combined—How?** Read the story next week how George Eltz, famous New York Radio engineer, has experimented to combine the benefits of both circuits without the disadvantages of either. The combination circuit is presented for further experimenting by Digest readers.

**Wave Traps? See the Mystery Man's "Let Eat" Eliminator—**He'll tell you about it next issue. The King of Miloplexes says—as usual—"It's a knockout."

**A Neutrodyne with Still Less Tubes than that described herein, will be diagrammed next week.** How many tubes? Three, with reflex stages.

**Trouble Finding and Set Operation Isn't Difficult—**It's just an idea most beginners develop. Read the continuation of this series next issue.

**Dry Cells and Storage Batteries Are Usually Neglected—**until finally the set goes on a strike and won't work. Then the set is dissected first. Batteries are examined last. Read M. W. Thompson's article next week.

**More Details Regarding the Lighthouse Keepers' Set will also be a part of the February 16 edition.**

Newsstands Don't Always  
Have One Left  
WHEN YOU WANT

# Radio Digest

YOU WANT IT!  
BE SURE OF YOUR WEEKLY COPY  
BY SUBSCRIBING NOW

SEND IN THE BLANK TODAY

Publisher Radio Digest,  
123 West Madison St.,  
Chicago, Illinois.

Please find enclosed check M. O. for Five Dollars  
(Six, Foreign) for One Year's Subscription to  
Radio Digest, Illustrated.

Name .....

Address .....

City..... State.....

# CALL R.C.A. MONOPOLY

(Continued from page 1)  
organic act prohibiting unfair competition in trade.  
In the language of the complaint, which is called a sweet morsel to every Radiophan and independent Radio manufacturer, "The respondents (firms named) have combined and conspired for the purpose and with the effect of restraining competition and creating a monopoly in the manufacture, purchase and sale in interstate commerce, of Radio devices and apparatus and other electrical devices and apparatus, and in domestic and transoceanic Radio communication and broadcasting."

### How Radio Monopoly Grew

In explaining how the present alleged control of Radio had reached its powerful and what is called dangerous magnitude of today, the Federal Trade Commission recites that the firms named:

- (1) Acquired collectively patents covering all devices used in all branches of Radio, pooled the rights to manufacture, use and sell Radio devices covered by these patents, and then allotted certain of the rights exclusively to certain of their firms.
- (2) Granted to the Radio Corporation of America the exclusive rights to sell the devices controlled, and required the Radio Corporation to restrict its purchases to certain of the firms named.
- (3) Restricted the competition of certain of the companies in the fields occupied by other companies in the agreement.
- (4) Attempted to restrict the use of Radio apparatus manufactured and sold by themselves (the respondents).
- (5) Acquired existing essential equipment for transoceanic communication and flatly refused to supply to others necessary equipment for such communication; also excluding others from the transoceanic field by preferential contracts.

### Combine Sews Up Vacuum Tubes

From the series of contracts referred to in the trade commission's complaint, it appears that the Radio Corporation of America, long criticized by Radio Digest for its policies, has the right to use and sell under patents of the various firms in the combine which relate to the Radio art. It has also given the various respondents the right to manufacture under these patents.

Thus, by a series of manipulations which would reflect great credit on the brains of their makers were it not for the public menace they are believed to have become, there has been combined in the hands of the chosen few corporations not only the patents covering vital improvements in the vacuum tube, but also many other important Radio patents or inventions supplementary to this keystone device, the three element tube.

### Guess Who Controls Radio Corporation?

The report of the Federal Trade Commission shows that the gross income of the Radio Corporation of America in 1922 was \$14,830,856.76 and that its total capital stock on December 31, 1922, was \$33,440,033.56. The total capital stock is made up of 3,955,974 shares of preferred and 5,734,000 shares of common, or a total of 9,689,974 shares of stock. Who owns this stock?

The table below showing the holdings in the R. C. A. of but several of the respondents named in the federal complaint should answer the question. The holdings reported are:

Respondent's Name	No. of Preferred Shares	No. of Common Shares
General Electric Company	620,800	1,876,000
Westinghouse Elec. & Mfg. Co.	1,000,000	1,000,000
Amer. Telep. & Teleg. Co.	400,000	None
United Fruit Company	200,000	160,000
Total	2,220,800	3,036,000
Grand total shares controlled by respondents		5,256,800

In other words, the four firms named in the table and also named by the Federal Trade Commission as parties to an illegal monopoly, hold more than 51 percent of both common and preferred individually and consequently, more than 51 percent of the total.

### How E. C. A. Sold 5,509,487 Tubes

The report of the commission also finds that up until 1922 (when the Fleming Valve patent expired and allowed DeForest to make and sell his own invention, the three element tube), the Radio Corporation had an absolute monopoly in the manufacture of vacuum tubes.

It was therefore able to sell 5,509,487 such tubes during the first nine months of 1923. The DeForest company sold but 94,100 tubes during that period.

### E. C. A. Has World in Hand

In the commercial Radio communication field, while the R. C. A. still has a little competition in ship-to-shore communication, it has a virtual monopoly in transoceanic service. The R. C. A. controls all the high power stations in this country except those owned by the United States government.

In addition agreements of an exclusive character have been entered into with the (Continued on page 19)

# "HELP!" CRIES FAN TO "PAPA" HOOVER

TEMPER SHATTERED BY DAMPHOOL SPARKS

"I've Helped Russia," He Writes, "And Now I want Relief Myself"

WASHINGTON.—Complaints relating to Radio interference are received daily by Secretary of Commerce Hoover, who has become a sort of "fosterfather" of the Art, now regulated under the 1912 law by his bureau of navigation. A recent and unique communication from a fan located on the Florida peninsula, where ship traffic is heard almost constantly, has caused amusement in high official circles.

The letter, which follows, voices a pathetic appeal from an apostle of Hooverism and demonstrates the need for definite regulatory laws:

"My dear Sir:  
"Help! !!!  
"When you called upon me to conserve, I conserved. When you asked me to sweeten my food with the milk of human kindness, I got indigestion using Florida cane syrup in my coffee. When you asked me to come across, I stepped on the gas. When you asked for help for the Near East, I went the limit. When you asked for help for Russia, I sent over a few safety razors and barber shears.

**Now He Wants Relief**

"I have been for you in your every endeavor. I have Hooverized until I didn't know 'hooves-who.'

"Now I want RELIEF.

"I have \$700 invested in a Radio set. It functions perfectly but every program is deadened or the fine passages lost by the damnable interference.

"And this not for one night but every night for a year back, and from any time in the day until I quit in disgust.

"Night after night I try until my patience is exhausted to get decent reception and, may be for a minute, sometimes two minutes, a song or music comes in as clear as a bell, and then some deep throated spark begins to shatter the atmosphere. Then the amplifier takes it up and another station is lost. Some damp-ool is playing with the keys of his transmitter—or telling some buddy or some other rumrunner that he has a date when on shore with some calico.

**Florida, Worse Than Dante's Inferno**

"There must be some relief. Were there periods of ten minutes even when one could listen in to lectures, songs or music without interference I would have no complaint. But it is incessant.

"Dante's Inferno can be no worse than the noises that come to us here in the peninsula of Florida. In relief work, in drives, in everything, you have accomplished the seemingly impossible—let us have relief."

Mr. Hoover's answer to the Florida fan has not been made known, but it is understood that he realizes keenly the need for more authority to regulate Radio, both ashore and afloat, even though the voluntary agreement laid down by past Radio conferences has greatly modified the interference.

Legislation defining his duties and setting forth rules and regulations as to amateur, commercial, private and other forms of Radio communication is urgently desired by the secretary, as well as additional appropriations and personnel for better and more frequent inspection of stations causing interference.

## Wendell Hall Sings His "Blue" Songs for WEA F

NEW YORK.—"Blues," not of the sulphurous nor of the lugubrious kind, featured the recent programs of Station WEA F, American Telephone and Telegraph, this city. They were the sapphire songs of Wendell Hall who, through Station KYW, Westinghouse, Chicago, has won fame. While in this city Hall arranged with a leading phonograph company to make four "blue" records.

## SHOWS RADIO VALUE IN RESCUING MINERS

HAZELTON, PA.—Opposition to the theory that Radio could be utilized in mine-rescue work was upset in a sense near here recently when John Fritz of Audenried, who had installed a set in an anthracite mine 200 feet from the surface, afterward reported that he had heard almost every broadcasting station ordinarily heard above ground.

## BLIND YOUTH LEARNS MUSIC BY AIRWAVE

ELK CITY, KAS.—A blind boy musician of this town recently wrote to Station WEA F, New York City: "Radio helps me learn new pieces and keep pace with popular songs." The lad asked WEA F to help him find a job at the piano or drum in theater, cafe or dance hall. The station said it would forward such information to the lad.

## KANSAS CITY OPENS ITS PURSE STRINGS

CONTRIBUTE TO BUY SETS FOR CITY'S INVALIDS

Mayor Gives His Sanction and a Check—Merchants Join Movement

KANSAS CITY, MO.—Had Jean Wurmser, 16 years old, been able to get out and play like normal boys, Kansas City might never have opened its pocketbook to provide Radio sets for the several such invalid children here.

Jean has been an invalid since birth, paralyzed in both legs. He never told anyone except his mother about his desire for a set to lift the gloom that is necessarily the lot of one who must always remain within the confines of his home. Mrs. Wurmser had found such difficulty in keeping up the home and in supporting herself and two children that she could never quite set aside enough from her \$12 a week to purchase even the simplest receiving set for Jean.

**Money Saved for Set Needed for Coal**

At one time this winter she did have four dollars put away toward the set, saving a nickel or dime at a time, but then it turned unusually cold and stayed cold so long she was forced to use the reserve to purchase coal.

The little mother was faithful—she didn't complain. It was just a chance bit of conversation that caused her to reveal to a friend that the severe weather had beat Jean out of the Radio set he had been looking forward to for so long.

But that was sufficient. The friend passed the word along and that same day a movement was organized to provide sets not only for the Wurmser boy, but for every other invalid in the city. Many merchants, catching the spirit of the movement, offered to accept contributions from the public which each day would be turned in to the fund headquarters.

**Movement Takes City by Storm**

Two days after the birth of the movement four crystal sets and an extra pair of phones had been contributed in addition to the pecuniary gifts.

Magnetically the spirit spread. Everyone seemed to be eager to assist in providing pleasure for the city's unfortunates. Certain Radio dealers agreed to furnish sets at cost, volunteers offered to install aerials and other outside wiring without remuneration and the contributions have shown no indication of ceasing to pour in.

Mayor W. W. Gordon has given the movement his indorsement and a check. Other city officials were among the first to contribute, children brought their pennies, business men usually made the offering one dollar. Kansas City, long noted for its generosity to the needy, again had responded to call.

## SWEETER VOICES ARE BROADCAST RESULT

New Vocal Technique Developed Says Music Leader

MINNEAPOLIS.—Radio is developing an entirely new type of vocal artists with voices surpassing in sweetness and technique those of concert and theatrical stage stars, it is declared by Miss Eleanor Poehler, music educational leader of the Northwest, one of the few women executive directors in complete charge of a large Radio broadcasting station.

Miss Poehler, as director of the Cutting and Washington Radio corporation's station, WLAG, popularly known as the Twin City (Minneapolis and St. Paul, Minn.) Radio central, has for some time been experimenting with these "Radio voices" and developing them.

"This extraordinary invention—Radio—is opening a field that is epochal for new artists and giving the public the benefit," said Miss Poehler.

Before taking charge of Station WLAG, Miss Poehler was prominent in western musical circles as a soprano soloist.

## FOLLIES QUEEN LOVES HER RADIO



Merry Ann Pennington, of Ziegfeld Follies fame, is ever happy with her Radio set, but here the camera man has caught her with a particularly pleased expression, and even if she has been "left out in the cold," as the furs seem to indicate, she evidently harbors no grudge against this old world of ours. Foto Topics Photo

## BAND REHEARSES AT KHJ TO HONOR SOUSA

Famed Musician and His Men Also in Concert

LOS ANGELES.—That there is something new under the sun was revealed throughout a great part of Radioland recently, when Hiner's Los Angeles Band was presented in a Radio rehearsal over Station KHJ, the Los Angeles Times, as a tribute to Lieut. Com. John P. Sousa, and his band of 100 musicians, who were the guests of Los Angeles.

It was the desire of Dr. E. M. Hiner in presenting his concert four days earlier to inspire the listeners in of Radioland to a desire for "better" music.

Fifty musicians of the band produced beautiful music which, with the aid of the transmitter of KHJ, was able to fill the great auditorium of ether. Under the guidance of Dr. Hiner, the band was directed through two hours of difficult compositions, each of which was interspersed with one of Sousa's stirring marches.

Always keep the plate and grid leads far apart. If they must be run close, have them run at right angles to each other. This will reduce howling.

## THE ANTENNA BROTHERS

Spir L. and Lew P.

## A Broadcast from China

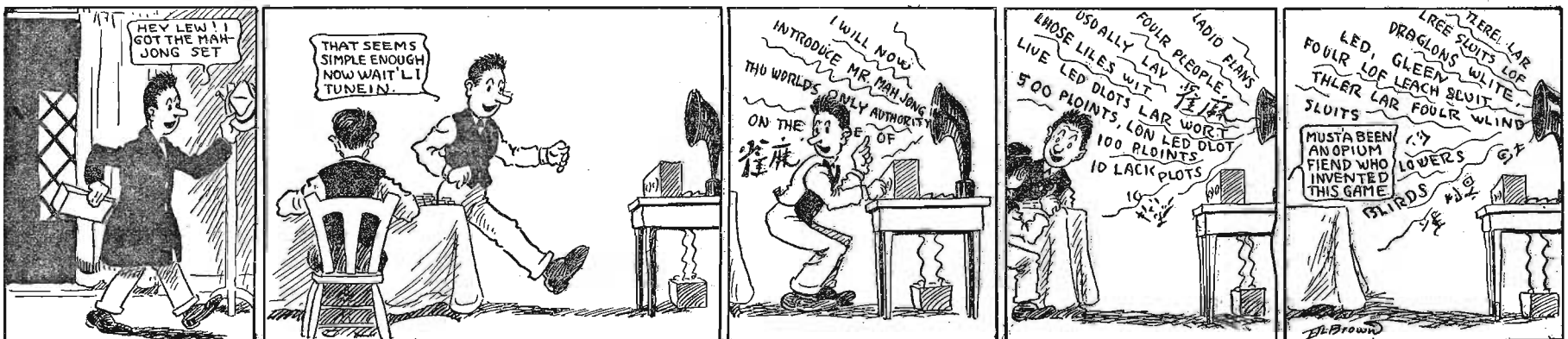

## SUGGEST SPECIAL SERVICE FOR WEST

### BROADCASTS AT LATER HOURS IS PLAN

Difference in Time Moves Station Officials to Consider Early Morning Programs

NEW YORK.—A suggestion that the National Association of Broadcasters arrange a schedule of its members for broadcasting late programs for the benefit of Pacific coast listeners, is being seriously considered and may be put in effect. Inasmuch as there is a difference of three hours between Eastern standard and Pacific coast time, and two hours between Central standard and Pacific coast time, an eastern station signing off at 10:30 eastern time would be stopping its program at 7:30 on the Pacific coast, and a midwest station signing off at 10:30 central time would be stopping its program at 8:30 on the Pacific coast. The N. A. B. stations are being asked if they believe that special early morning broadcasts for Pacific coast listeners would be a desirable project. If the suggestion is acted on it will mean putting on programs approximately between the hours of 1 and 3 o'clock in the morning.

#### N. A. B. Would Arrange Schedule

If such a plan is found desirable, the Association will arrange a schedule, so that each station which considers this service advisable, can go on the air one night a week, or if a sufficient number are favorable, perhaps once in two weeks. An argument given in favor of the proposed plan is that Pacific coast listeners now have little reason to buy long distance sets, because all eastern stations have signed off before interference from their local stations has ceased. Another argument is that performers could extend their publicity to the Pacific. Stations wishing to express themselves on the plan are requested to communicate with Paul B. Klugh, secretary of the National Association of Broadcasters, 1265 Broadway, New York.

## CHARLES SCHWAB IS FAN TOO



Charles M. Schwab, steel master and shipbuilder, is just as human as the poorest of us when it comes to Radio. His spare moments are spent landing the distant stations and the magnate says he finds relaxation therein. He keeps a set (pictured above) on his desk to be sure it's handy when he wants to tune in.

#### Radio Sets in Denmark

WASHINGTON.—Denmark now has 3,109 private Radio receiving sets officially licensed. School pupils rank first with

473; commerce, shipping, and industry second with 448; office and store employees have 354; artisans 341; electrical contractors 334; laborers 324.

## BROADCAST UPKEEP CONFRONTS CANADA

### CONSIDER SUBSIDIZATION AS ONE ANSWER

Dominion Sees Need of Supplying Her Own Service for Listeners

OTTAWA.—To be or not to be subsidized is a question which is engaging the attention of broadcasters throughout Canada, and which may soon require from the Dominion Government a definite "Yes" or "No." There are over 100,000 listeners in Canada and broadcasting is the life of the Radio world. Again, it is of importance to Canadians that as much as possible of this should be of home origin.

Encouragement of some form to the broadcasters would be one means, but if this were carried out the Dominion Government might be open to the accusation of subsidizing instruments of propagation in its favor, such as newspapers which have installed broadcasters. It is now being done in Manitoba, where the Provincial Government is operating a broadcaster through the Telephone Commission's facilities. That installation is subsidized by the Dominion Government in this way: Half of every Radio license fee of \$1 paid by citizens of that Province to the Dominion is turned over to the provincial government to aid in maintaining the broadcasting system.

# Radio Circuits

The Most Popular American Radio Circuits

50 Diagrams and Illustrations

- Flewelling Hook-ups
- Single Tube Reflex
- Spiderweb Coil Circuits
- Radio Frequency Amplifier
- Ultra Reinartz Receiver
- Grimes Inverse Duplex
- Honeycomb Coil Circuits
- Three Tube Reflex

#### ORDER NOW

Send Only Money Orders  
No Checks or Stamps  
Cash at Your Own Risk



RADIO DIGEST PUBLICATIONS  
123 West Madison St. - CHICAGO, ILL.



Type CR-14—A 3-tube dry cell Regenerative Receiver . . . \$110.00  
(Accessories extra)

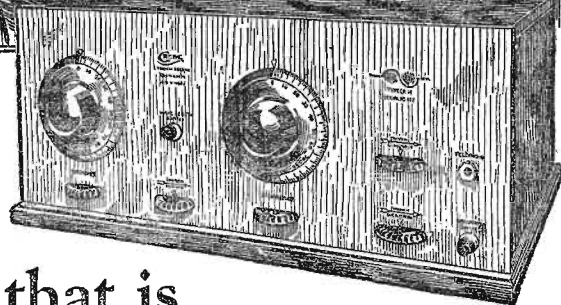

Music that is Clear and True!

WHEN you tune in your favorite jazz band or orchestra, each note comes clear and undistorted through your dependable

# GREBE Broadcast Receiver

Built in two highly efficient types, each an easily operated Instrument that adds grace and charm to any room. The beautiful walnut cabinets have concealed compartments for all necessary dry batteries.

Ask your dealer to demonstrate.

A. H. GREBE & CO., Inc.  
RICHMOND HILL, N. Y.  
Western Branch  
451 East 3rd St. Los Angeles, Calif.

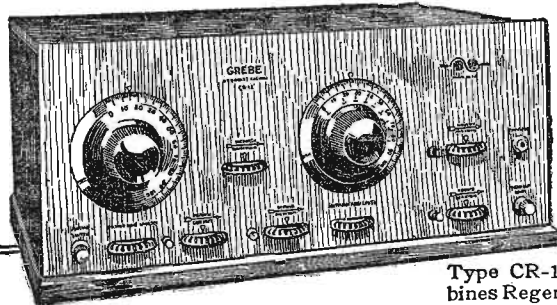

Type CR-12—4 tubes. Combines Regeneration and Tuned R. F. \$175.00  
(Accessories extra)

Licensed under Armstrong U. S. Pat. No. 1,113,149

# BOY SCOUTS BECOME BROADCASTERS

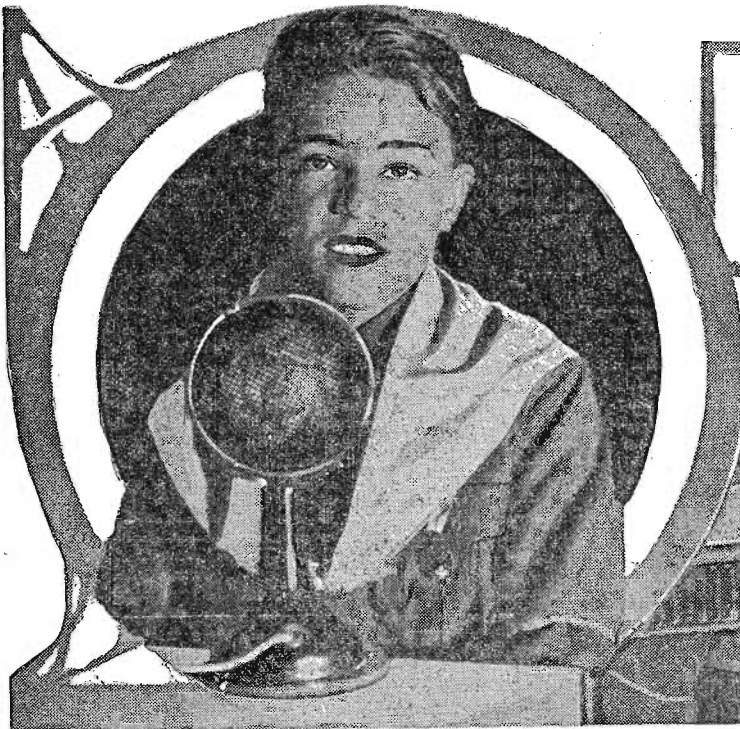

"This is Station WJZ, manned by the Boy Scouts of America," says Michael Salucka, age 13 (circle inset), as he helped other Boy Scouts recently to run the big eastern station as an aid to recruiting. "Mike" at the "Mike" you will note, wears a decoration for saving a woman's life. Below, left to right, are Michael Salucka, Robert De Groat, George Kutzelman, Harry Galland, Leon Moler and Herb Saranson. Photo Topics Photo



## BOY SCOUT TUNES 32 IN 150 MINUTES

**B**ROOKLYN.—Andrew S. Bostwick, Boy Scout of this city, recently reported he had tuned in Station 6AND, J. Kennedy, Hawaii, thus breaking, he said, his own record of receiving 32 amateur stations in the United States and Canada in two and one-half hours, a few nights ago. During three and one-half hours of the same night Bostwick said he copied 144 stations in code.

## ETHER TRAFFIC COP STOPS WAVE JAMS

Radio traffic policeman O'Keefe of the Bureau of Standards, keeping tab on broadcasting and transmitting stations. This work supplements that of the Radio Inspection Service of the Department of Commerce. © U. & U.

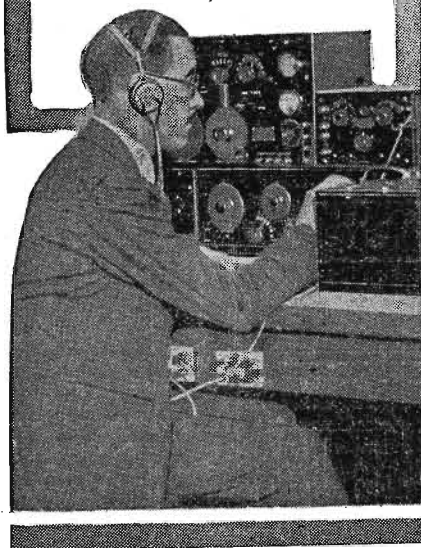

## Caribbean Cruisers to Ride Waves with Phones

Will Listen In to Home Station at Fort Worth

FORT WORTH, TEX.—One of the special amusement features of the Caribbean Cruise to be conducted by the Star-Telegram, March 20 to April 9, will be Radio programs on board the S. S. Cartago, of the United Fruit Company line, the ship on which the cruise will be made.

A special receiving set will be installed and passengers will listen in to programs from WEAP, the Star-Telegram here, and other stations in the United States. Special efforts will be made to insure clear reception of programs.

## RADIO NAMES SONG; OTHER MEANS FAIL

PUBLISHERS IN NEW YORK RECEIVE 5,000 TITLES

Owners of Hit Offer Royalty to Winner After Tin Pan Alley Admits Defeat

NEW YORK.—For many months Charles Tobias and Louis Breaux, publishers of songs, widely known as pioneers in broadcasting "hits," tried to find an appropriate title for a fox trot whose rhythm, they said, was novel. Finally, after every other means had failed, they appealed to the Radio audience of Station WHN, Loew's State theater, 45th and Broadway, and found not one but many suitable names. The publishers who, during the last two and one-half years, have broadcast songs from Stations WJY, WJZ, WEAJ, KYW, WOR, WHN, WDAP, WMAQ, WAAM and others, appealed at first to the professional lyricists of "Tin Pan Alley" where most of the popular ditties of the nation are conceived. But nothing suitable was found.

**Radio Brings 5,000 Names**  
For two weeks or more the song lay in the publishers' office, a thing of regret and irritation. A few nights ago, the publishers fell upon what they at first thought was a "wild" idea—they determined to let the Radiophans, the listeners in, try to name the new melody.

The announcer for WHN, Nils T. Grandlund, put the publishers' plight on the air. Shortly afterward more than 5,000 suggestions for names were received by mail, telegraph and telephone. Many fitting titles were among these, according to the publishers, but to give thousands of other listeners in opportunity to compete, the contest was continued three weeks. The name of the winner will appear on the title page of the song and he or she will be given opportunity to write the lyric under a royalty contract.

## Away Up in Canada WTAS Wins Aid for Griffis Fund

CHICAGO.—Although Mr. M. Ercury wings his feet so fast 'way up North that during the winter he usually arrives near the bulb of the little glass tube which makes weather seem real, he didn't, a few days ago, drop so low as to prevent the warmth of the appeal for funds to release Griffis from a German prison to reach at least one Canadian.

It was Radio which defeated M. Ercury; Radio as broadcast from Station WTAS, Elgin, Ill. In a letter to those in charge of the fund in this city, C. L. Pickering of Cochrane, Ontario, said that WTAS's plea had induced him to send money to effect the freedom of Griffis, who had tried to kidnap Bergdoll, fugitive slacker. Station WJAZ, Edgewater Beach hotel, and several theaters here also broadcast appeals for Griffis.

The French deny that the pilotless airplane is an American invention, and furnish conclusive proof that in September of 1918 a pilotless plane was successfully controlled from the Eiffel Tower.

## Yukon Miners Dance to Music from Portland

Best Orchestras of Continent Heard in North

DAWSON, YUKON.—Denizens of the Yukon are dancing this winter to music played by the best orchestras of the continent through the medium of the Radiophone. Now that the period of the shortest daylight is reached, Radiophans receive good results from their instruments. Miners at Miller Creek and Keno Hill have experimented, and found they can

tune in on Radio concerts for their dance music. Concerts broadcast from Calgary, Alberta, Portland, Ore., Los Angeles and San Francisco compete with music from distant Eastern cities these nights to beguile the unbroken twilight of the sub-arctic winter.

## Greece to Have Radio

WASHINGTON.—Radio communication will be established throughout Greece by the British Marconi company under an agreement which has just been signed with the Greek department of communications, according to a report received by the United States department of commerce. Stations will be erected in the principal cities.

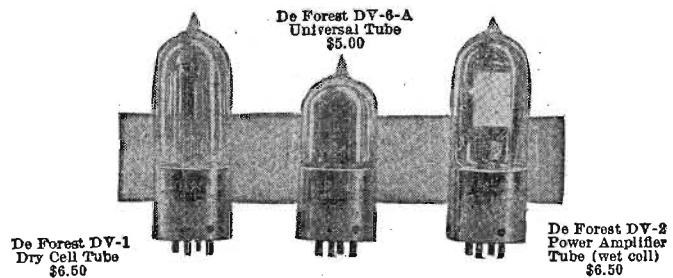

## The More You Know About Radio The More You Rely on De Forest

Without Lee De Forest's discovery of the vacuum tube there would be no radio today. All radio broadcasting, all radio receiving by means of tube sets, rests on De Forest patents.

De Forest has been a pioneer in radio since 1900 and De Forest is a pioneer today. That is the reason for the great success of the De Forest Reflex Radiophone. That is the reason for the success of the new De Forest tubes—DV-1 Dry Cell Tube, DV-6-A Universal Tube, DV-2 Wet Cell Power Amplifier Tube.

If you want a radio receiving set with a range on indoor loop of from 1,500 to 3,000 miles, depending on atmospheric conditions; if you want simplicity of control, clear reception without distortion and without extraneous noise; if you want operation on either wet or dry cells—see the De Forest Reflex Radiophones at the De Forest agents today.

The D-7A Reflex Radiophone is a three-tube set at \$125.00; the D-10 Reflex Radiophone has a drawer in its cabinet for dry batteries and is a four-tube set at \$150.00. No matter what you pay, you can't get greater radio satisfaction.

Whether you buy your set complete, or build your own from the laboratory-tested De Forest parts, you can rely on De Forest, the greatest name in Radio.

De Forest Radio Tel. & Tel. Co. Dept. R. D. 6 Jersey City, N. J.

De Forest Portable Reflex Radiophone type D-10, which operates on wet or dry cells, has a reception range of from 1,500 to 3,000 miles on indoor loop; has drawer for all necessary A and B dry cells. Price \$150.00, plus approximately 6% for transportation in territories west of Rocky Mountains.



Radio Catalogs Free Send a postcard for De Forest's Free Radio Catalog with full details and prices on sets, tubes, and parts.

De Forest products are sold only through exclusive agents direct to the public for your protection. The De Forest Company will be glad to hear from representative dealers in various communities who wish to become exclusive De Forest agents.

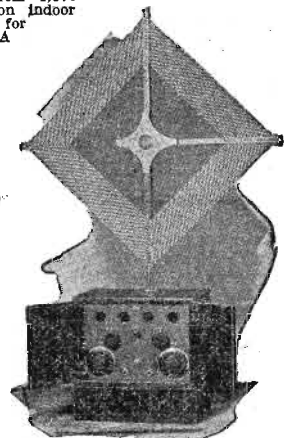

## KANSAS OPENS FARM STUDY TO ALL FANS

STATE U COURSE BEGINS ON FEBRUARY 11

First School of Kind Offers Written Quiz—President Sees Radio as Necessity

MANHATTAN, KAS.—Kansas State Agricultural college of this city will join the ranks of the universities communicating college courses to a widely separated student body by Radio, when on February 11, a complete course in agriculture will be opened to everyone in the United States; it has been announced by President J. M. Jardine.

In order that the farm course may bring material results, President Jardine has asked Radiophans throughout the country to apply for enrollment in any or all of the courses on the extension Radio schedule. The most important agricultural subjects will be included, it was said.

At the completion of the course a written examination will be given all students. A passing grade will entitle the Radio student to a certificate of graduation from the first school of its kind.

### School Will Influence Farm Life

The entire course will be broadcast on 286 meters from the university station, WTG.

"Radio's greatest contribution to the advancement of civilization may lie in the influence it will have upon the life and action of the farm population," President Jardine said in announcing his school's unique plan.

"The great new science is to become an imperative necessity of the economic, spiritual and intellectual life of the farm. It will mean the delivery of the farmer from the sense of isolation by keeping boys and girls on the farm and by making possible a system of agricultural education."

President Jardine has asked all Radiophans interested in the course to communicate with him before the "school of the air" is opened.

## RADIO TELLS HER OF PERIL TO SON

Mother of Sailor on Ill-fated Tacoma Learns of Danger by Airwave

CEDAR RAPIDS, IOWA.—To be "listening in" on a set and suddenly hear that the ship on which your son was a sailor had been wrecked, was the experience of Mrs. John Patterson, 313 Twelfth avenue west, on a recent evening about 10:30 o'clock.

Mrs. Patterson had tuned in on Station WFFA, Dallas, Texas, when she heard the announcer tell that the old cruiser Tacoma, which had gone aground near Vera Cruz, Mexico, was battered to pieces and would soon go down.

Mrs. Patterson screamed when she heard the news, attracting the attention of her husband. She told him of the announcement when he rushed into the room and they worried and wondered what had been the fate of their son, Robert, 24 years old, who had been a water tender on the vessel. Neither had read of the mishap to the ship as announced in the newspapers until they heard of it through the Radio receiving set in their home.

Mr. Patterson was relieved next morning when at the office of a local newspaper, he learned that there were only four of the crew dead and his son was not among these. The rest of the crew had been saved in the face of a heavy storm by Mexican rebel boats.

## WLAG Reception Good, Is MacMillan Message

Twin City Radio Central Wins Explorer's Praise

MINNEAPOLIS, MINN.—WLAG, Twin City Radio Central, Minneapolis and St. Paul, announces that it has recently joined the list of stations to receive the applause of Capt. Donald MacMillan's North Pole expedition.

Through Jack Barnsley, Prince Rupert, B. C., the station has received the following message from Capt. MacMillan:

"WLAG very good here occasionally. Please extend New Year's greetings to D. D. Davis of Washburn Crosby Flour Co."

The message was communicated to Mr. Barnsley by the Schooner Bowdoin at Refuge Harbor, Greenland, at 2:28 a. m. WLAG is about 2,800 miles from the position of the Bowdoin at latitude 78.30 N., long. 72.30.

A high power wireless station is about to be erected at Ruysselede, near Bruges, Belgium, and a workshop has already been established on the site. This station will be in operation within two years.

## LISTENING IN FROM WAY UP NORTH

By Vera Brady Shipman

SLEIGHBELLS coming over the hills; prancing horses frisking with the cold; a long drive from town; the lookout light shows afar; it gets dark early in winter. Wonder how it would feel to get lost?

Come inside while they put up the team. The log fire welcomes. It's far below zero tonight. Wish KYW would put on the setting up exercises now instead of 7 in the morning. It's too cold then to enjoy it. Wish we could telegraph some of those Radio stations we hear so well, but central in our little town closes at 9 o'clock. That's what comes of preferring to live in the country. Serves me right, you say? It's time to tune in. Sit down in the sleepy hollow chair, with your feet just comfortably up; get out your Radio Digest time-table and we're off.

WMAQ broadcasting the Chicago Theater revue from atop the theater. The announcer parodies the famous Rollo travel books of childhood. He is showing his little nephew, Rollo, around the broad-

casting studio. He insists if he says a word out loud he will throw him off the Municipal Pier! The music is lovely, Jesse Crawford at the organ, the symphony directed by Finston and Roy Dietrich's perfect enunciation.

Just tuned in on WSAI, Cincinnati, hearing Israel Zangwill in a witty discourse on Judaism from the Gibson hotel banquet. He spoke of his "friend Galsworthy saying: 'You Americans are all right. You have so much thunder.' Guess he's right after all! The orchestra from WFAA, Dallas, is playing, "I'm Here—You're There." Now, doesn't he know we know that?

WOS of Jefferson City has a new magnetic attachment on its piano which clarifies its music. A new fox trot, "Norma," dedicated to Norma Talmadge, is played by their Novelty Six, and the announcer is sure that Norma is listening in from Hollywood tonight.

A 300-piece orchestra from WOA-W playing "My Sweetie Went Away," but never mind, don't feel so bad, according to Vincent Lopez' orchestra from WEAF, New York City, "The Girl I Love Belongs to Somebody Else." The Bellevue Stratford orchestra of WFI, Philadelphia, is playing, "Last Night on the Back Porch," and a police report from Station

WBAA, Harrisburg, Pa., state police department gives a weather and roads report for the Quaker state. WOI, Iowa State college at Ames, is putting on its own orchestra, and the Shrine band comes from WLW, Cincinnati. WMC, Memphis, has a midnight revue. Did you hear Joyce White of Al Jolson's show, dance on the table at KYW, midnight Wednesday?

WGY players are playing "The Truth;" KDKA sends out an urge to own your own home. WHAZ of Troy gives us a tenor "Goodbye," of Tosti. Kansas City Athletic association at WDAF, and then, too, on close meter on the tuner, Minneapolis Athletic association orchestra at WLAG. My how athletics do take to Radio.

"Sunshine of Mine" and "Marcheta" hand in hand.

WDAR's Dream Daddy, with a toot-toot of the train going to Dreamland, taking his regular load of youthful passengers. The Harmony club of Fort Worth giving its monthly program from WBAP, and a tenor there sings Massenet's "Elegy." WHAS, Louisville, is sending the Rigoletto quartette clear to Springfield, Massachusetts. Here's hoping, WHAS.

WSB triangle bells, signing off, ring cold across the snow.

Winter is King.

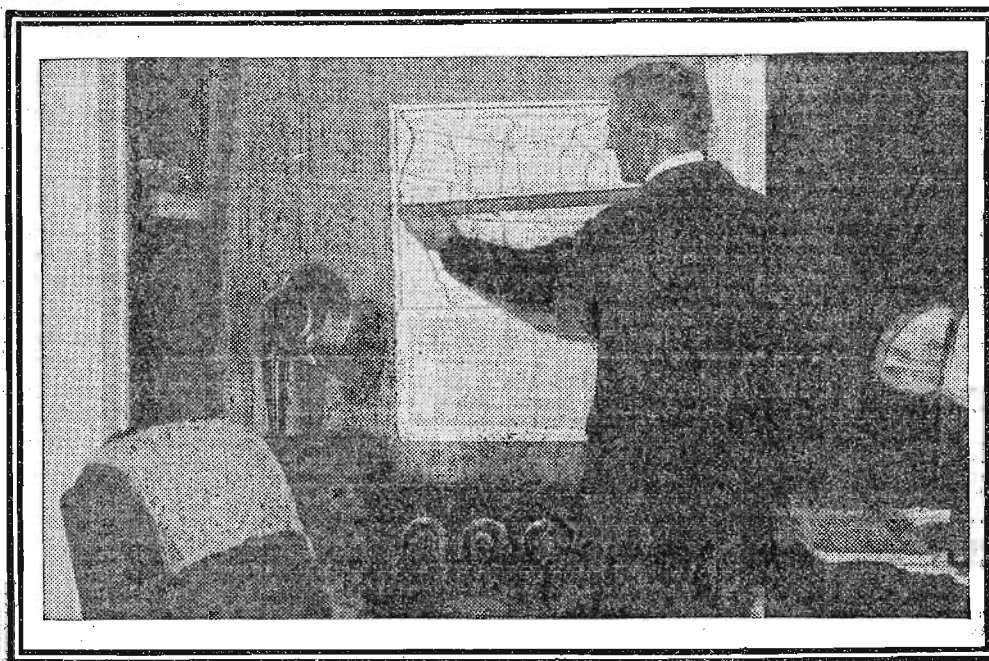

FADA "ONE SIXTY" NEUTRODYNE RADIO RECEIVER

## Distance

The real thrill of radio is in listening to voice or music on the loud speaker from broadcasting stations located in cities a hundred or a thousand miles away.

To tune them in almost at will is a feature that has made hosts of enthusiastic friends for the FADA "One Sixty" radio receiver. Here is a four-tube Neutrodyne receiver combined with the craftsmanship and experience that have made the name FADA synonymous with quality in radio. It is a receiver that is

the equal of any five-tube set of any type or make.

Selectivity, volume, distance and clarity are outstanding features of the FADA "One Sixty" radio receiver. Once the dial readings of any station are recorded, that same station can always be tuned in again by returning to the same settings—and almost always, with loud-speaker volume, no matter where the station may be located. Price, \$120 at dealers. Extra for tubes, batteries and phones.

F. A. D. ANDREA, INC., 1581 Jerome Avenue, New York City

# FADA

## Radio

# WAVE TRAPS NOW ON THE MARKET

## Manufacturers Meet Demand for Interference Eliminators with Two New Models

### Tests Made on Two Types

#### Malone-Lemmon Control-O-Meter and Metro Wave Selector Explained for Benefit of Fans

IN AN effort to locate and test various standard wave traps, selectors or whatever name they might be known by, it was found that there were not as many on the market as might be anticipated. Undoubtedly in various cities there are numerous traps available at dealers which are only produced for local trade. The idea, however, was to describe a few that have a more national distribution. Evidently the demand has been great because manufacturers were not in a position to deliver instruments for testing purposes.

Two were available, but details of other instruments will follow later. The first one shown in the illustration is the "Control-O-Meter," a Malone-Lemmon product. The instrument is well made, having a sloping panel with two binding posts and one control dial.

A card accompanies each instrument on which is given the calibration for eliminating specific wave lengths. On the one tested this is given as follows:

Undesired Wave Length	Dial Setting
300 meters.....	22
350 meters.....	29
400 meters.....	38
450 meters.....	49
500 meters.....	65

The instructions on this card should be of interest.

1. Set the instrument in a convenient location alongside the receiving set. Avoid having the connecting wires too long.

2. Disconnect the antenna lead wire from the set and attach it to one binding post of the meter. Now connect the other post on the meter to the antenna binding post on the receiving set.

3. Each instrument is tested and calibrated before shipment, results being noted on the "Factory Record."

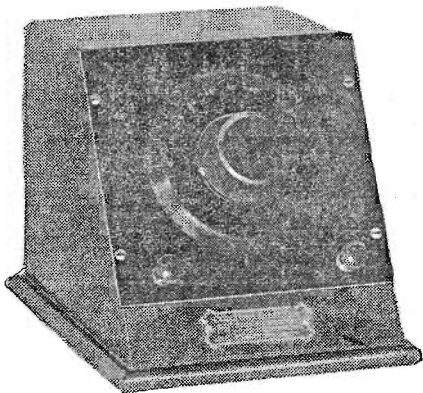

Malone-Lemmon "Control-O-Meter."

#### Setting of Instrument

The method of setting the instrument is as follows: Assume that WJZ (455 meters) is interfering with a concert from WEAF (492 meters). To eliminate WJZ, refer to calibration table on back of the instruction card and note that the wave length of 455 meters lies between 450 and 500. In column "Dial Setting" under "Factory Record" are the figures corresponding to 450. Slowly rotate dial between the figures corresponding to 450 and 500 until the point is noted at which interference diminishes. By advancing or retarding the dial a few degrees from this position a point will be found at which WJZ is completely eliminated.

4. It will be found that when the interfering station is once eliminated by a careful setting of the instruments, a further readjustment of the main receiver will not again bring back the interference.

5. The adjustment of the Control-O-Meter to completely eliminate interference is quite sharp, loud signals disappearing within a few degrees on the dial. In exceptional cases, supersensitive receiving sets located alongside of a powerful broadcasting station may require an additional instrument inserted in the ground lead.

#### The Wave Selector

Another instrument, shown in the second illustration, is the "Wave Selector" manufactured by the Metro Electrical

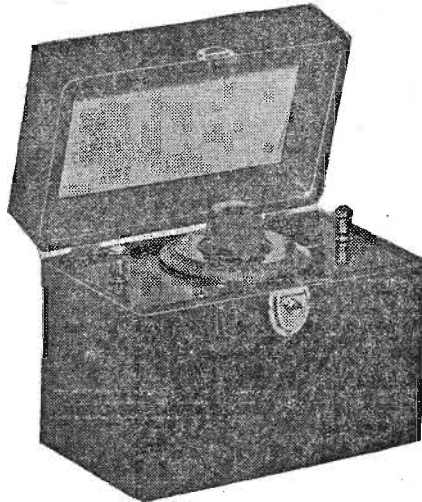

Metro "Wave-Selector."

Company. This instrument is enclosed in a very neat compact case with a hinged cover. Instructions are pasted in this cover and are as follows:

1. Binding post marked "Aerial" should be connected directly to the aerial.

2. Binding post marked "Set" should be connected to receiving set where the aerial usually connects.

3. Before adjusting main receiving set, the dial on the selector should be set approximately at 90.

4. The main receiving set is now adjusted in the usual manner in order to bring in the desired station to the greatest signal strength, regardless of interference.

5. To eliminate the interfering station, the dial on the instrument should now be slowly turned either to the right or left until the undesired station is at its minimum strength.

6. If the undesired station is still present, it will be necessary to again adjust the main receiving set, with a final very slight adjustment of the selector.

7. Remember that every adjustment of the selector affects the tuning of the main receiving set and every adjustment of the

latter affects the tuning of the selector. It is only by the careful adjustments and re-adjustments of both in combination that the two circuits can be absolutely balanced and the undesired station entirely eliminated.

## AH, WOE! ANOTHER ONE'S WED, GIRLS

### Pheemine Phans Lose Second Idol at WGR, Buffalo

BUFFALO, N. Y.—Alas and alack! Here is more bad news for pheemine phans. After L. B. Weller got married and ceased forthwith to be chief announcer for WGR, the no less dulcet accents of Edward Stanko began to be heard from Maine to California as chief spokesman at the Buffalo station.

Some of those same pheemine phans who used to send Mr. Weller mash notes are beginning to get keyed up over Mr. Stanko's voice and now along comes the news that he too is married.

The ceremony took place in Buffalo recently before City Judge Harry B. Lamson. Miss Fay Pepley of Hooversville, Pa., was the bride.

## Bryan's Talk—"Is Bible True?"—Is Sent by WMC

MEMPHIS, TENN.—What were deemed forceful arguments against modernism in the church were presented here recently by William Jennings Bryan by means of Station WMC, Memphis Commercial Appeal.

The "Commoner's" address, delivered to a large audience in a church, was relayed to the newspaper's Radio plant, whence it was put on the air. The title of Bryan's lecture was "Is the Bible True?" The applause which his points evoked indicated that most of those who heard him still believed in the spiritual verities.

Radio is described by a native of Africa as a powerful machine that can speak without mouth and hear without ears.

# Uninterrupted radio enjoyment for you is Federal's manufacturing policy

EVERY radio set and each of the 130 parts manufactured by the Federal Telephone and Telegraph Company carries a guarantee of absolute freedom from mechanical and electrical defects. This guarantee is made possible through the efforts and skill of 25 years' research by experts in the radio field.

When in the market for a radio set or parts it will pay you to investigate the unsurpassed services being rendered to millions of radio enthusiasts by Federal products.

Progressive dealers everywhere carry the Federal line and will be glad to tell you what the name Federal signifies on radio sets and parts.

Federal Telephone and Telegraph Company  
BUFFALO, N. Y.

Boston      New York      Philadelphia      Chicago      Pittsburgh  
San Francisco      Bridgeburg, Canada      London, England



Federal Head Sets are used by Radio Experts because they are Federal Standard.

Price

2200 OHMS

**\$7.00**

**Federal**  
Standard RADIO Products

# NEW REVENUE GRAB "MUSIC TRUST" AIM TIN PAN ALLEY BUNCH TO SUE MANY STATIONS

Shall American Society of "Composers" Eke Income from Broadcasters? Case in Court Now

(Continued from page 2)

is made of coins, according to recent data, which, in considerably less than a year, total more than \$500,000.

Research conducted during the last few months by broadcasters individually and as a national organization shows that, in the instance of a popular Radiophon contest under the auspices of Stations KYW, WJAZ and WDAP, Chicago, during a period of less than 12 days, more than 13,170,500 men, women and children heard the terms of the competition, that more than 240,000 answers were received and that the greatest number of these preferred "jazz" or "popular" music, showing how large was the audience which the organized publishers might have reached.

### Tests Show Radio Aids Music Sales

Further investigation revealed that the local and mail order sheet music sales of the Knight, Campbell company, Denver, Colo., were greatly increased by being broadcast by Station KFDL of that city. An "independent" sheet music publisher in New York City reported that Radio had raised the volume of his sales of one song to 25,000 in a short time. Another publisher in the same city, rather a partnership of publishers, told how, by means of Radio, Station WHN, they had received 5,000 suggestions as to a title for a song which "Tin Pan Alley," habitat of composers and authors, had failed to name appropriately. It became known that some of the music publishers paid as much as \$10,000 a year for "plugging" the sales of one of their songs.

### Hartman and Rosenthal Lie?

The question re-opened by the suit against the Board of Trade brought into conferences during 1922 and 1923, in Chicago and New York, representatives of the American Society of Composers, Authors and Publishers, and the broadcasters.

Delegates from the American Telephone and Telegraph company, Radio Corporation of America, General Electric, Westinghouse, and the United States depart-

ment of commerce attended the meeting in New York City. The assembly in that city ended in a deadlock. One of the meetings ended in an agreement to file a test suit in the federal courts.

During one of the later conferences in Chicago Hartman, attorney for the organized publishers (and composers and authors), and J. C. M. Rosenthal, their general manager, were asked to withdraw because, it is alleged, of a deliberate misstatement.

### Broadcasters Oppose Tactics of Society

A questionnaire under the auspices of the Drake hotel, Chicago, and Radio Digest showed that most if not all the broadcasters of the United States opposed the tactics of the society and favored the use of "independent" music. The National Association of Broadcasters, of which Paul Klugh was and is executive chairman, headquarters New York City, established a bureau for the cultivation of "independent" music. The Chicago Daily News, Station WMAQ, aided the association considerably in that respect.

Methods of the American Society of Composers, Authors and Publishers, as applied by some of its representatives, were condemned by broadcasters and thousands of listeners in.

### Is Fight of Millions of Listeners In

The repeated declaration by members of the society's legal staff that Station WEA, American Telephone and Telegraph company, New York City, had become a licensee was afterward proved a misstatement as was a similar assertion during the trial of the suit against Station WOR in Newark.

It is reported that some of the members of the American Society of Composers, Authors and Publishers on several occasions came over to the Drake station and attempted to get WDAP to broadcast their numbers by issuing a written "release." These members had no right to do this, it is obvious, considering the stand of the Society, and their attempts can only be credited, it is believed, to internal dissension or an organized effort to "frame" WDAP.

The fight of the National Association of Broadcasters, of its individual members, to retain the right to the freedom of the air, the right to place on it what they wish excepting that which conflicts with present Radio regulations, has become, it is said, the fight of millions of listeners in throughout the United States. On the outcome of the suit filed against the Chicago Board of Trade depends in a sense, it is predicted, the life of broadcasting in this country.

# BEAUTIFUL MAHOGANY NEUTRODYNE Brings in Everything

WHEN you get this magnificent looking set hooked up you will be able to hear all stations without interference. All the parts are standard the same as illustrated in the Radio Digest last week. The panel is mahogany with beautiful Tate dials—a set fitted for the most exclusive home.

Panel drilled, all parts mounted on panel and baseboard ready for wiring

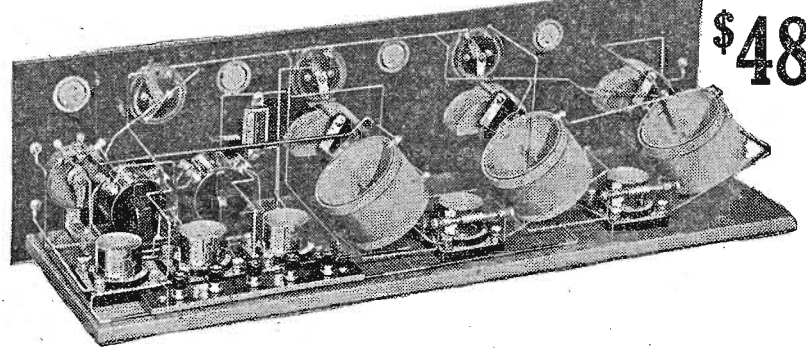

Only  
**\$48.50**

FREE  
BLUE  
PRINT

### It Works NEUTRODYNE All Standard Parts

3 Rheostats, 30 ohms.....	\$2.00	5 Sockets .....	\$5.00
1 Rheostat, 6 ohms.....	.90	2 Transformers .....	9.50
3 Air Core R. F. Transformers, mounted on condensers, and 2 balancing condensers.....	20.00	9 Readem Binding Posts.....	.85
1 Potentiometer, 600 ohms.....	1.85	1 8x26 Mahogany Panel.....	3.64
3 Jacks .....	2.70	4 Bezels .....	.80
1 Condenser .....	.40	3 Dials .....	4.50
1 Grid Leak .....	.65	1 Baseboard .....	.50
		24 ft. Square Brass Bus Wire.....	.60
		<b>Total \$53.89</b>	

ONLY  
**\$45.50**

With Blue Prints  
FREE

### The above Neutrodyne Complete with all the following parts:

5 Genuine DX Tron Tubes.....	\$25.00	1 45 Volt B Battery.....	\$ 5.50
1 110 Ampere Storage Battery.....	18.00	2 22½ Volt B Battery.....	6.00
1 DeLuxe Homecharger.....	18.00		
1 Genuine Baldwin Headset.....	12.00		\$86.00
1 Complete Aerial Equipment.....	1.50	1 Fultone Loud Speaker.....	9.50
		<b>TOTAL.....</b>	<b>\$95.50</b>

The above parts and equipment complete would cost you \$144.00!

**Our Price \$125.00**

### Special Offer

USING only the best materials in this wonder Neutrodyne set and appreciating its beauty we are willing for you to be the judge. You needn't send us any money, just pay the postman or expressman. If you don't say its the best appearing set you have ever seen and are not satisfied we will return your money within ten days on return of the set.

## SEND NO MONEY Just Pay the Postman

### Complete Parts—MILOPLEX—2-Step Amplifier

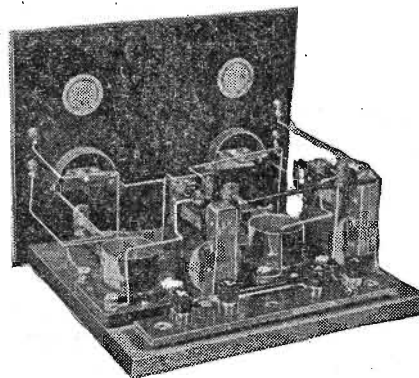

Mounted on baseboard and panel

LIST—\$21.06  
Our Price Only  
**\$16.50**

1 Panel 7x9x½".....	\$1.26	2 Sockets .....	\$2.00	1 Baseboard .....	\$0.25
2 Webster's 4-1 Transformers.....	9.50	2 Double Circuit Jacks.....	1.80	1 Cabinet Mahogany Finish .....	3.50
2 30 Ohm Rheostats.....	2.00	1 Set Readem Engraved Binding Posts .....	.75		

The above mentioned parts will include any Ohm Rheostat and All-American Transformers if desired.

### Complete Parts - MILOPLEX - Cabinet FREE

1 .0005 Variable Condenser, Vernier.....	\$6.00	1 Socket Bakelite Base.....	\$0.90
1 Estru Variometer .....	5.00	1 Bakelite Panel, 9x14x½.....	2.50
1 .00025 Variable Condenser.....	2.00	1 WD-12 Tube .....	6.50
1 Variable Grid Leak.....	.75	1 B Battery, large, 22½ volt.....	3.00
1 .00025 Mica Fixed Condenser.....	.40	3 Dry Cells .....	1.35
2 .002 Phone Condensers .....	.80	12 ft. sq. brass Bus wire.....	.30
3 3½-Inch Dials, each 75c.....	2.25	1 Set Readem Binding Posts.....	.75
1 Potentiometer, 1850 ohms.....	2.20		
1 Rheostat .....	1.00	<b>TOTAL .....</b>	<b>\$35.70</b>

ONLY  
**\$28.50**

Blue print FREE only with order for complete parts

## WAVE TRAP

You can now enjoy the comfort of selecting any station that you desire by hooking up one of our METRO Wave Traps with your set. Mounted in Mahogany Cabinet with the highest grade material. Regular List Price \$7.50. Our Price  
**\$6.50**

We Are Responsible Folks, Money Promptly and Cheerfully Refunded If You Are Not Satisfied

All Orders Mailed Promptly. Parcel Post Prepaid on \$5.00 or Over. No Stamps Accepted.

Every-thing in Radio Write Us

Quality Merchandise at Low Prices  
**Economical Radio House**  
4600 Lincoln Avenue, Chicago

We Personally Guarantee All Goods

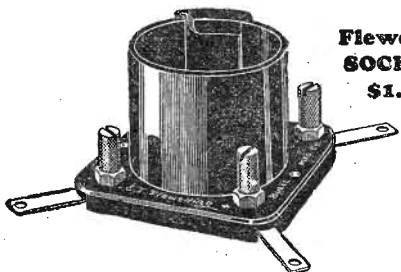

Flewelling SOCKETS \$1.00

# Genuine E.T. Flewelling PARTS

The names Dresden, Rembrandt and Sterling mean a lot when you are buying china, art and silver. But when Radio is considered, the name Flewelling is paramount. The careful buyer has learned that if it is a "genuine" Flewelling part it is right! E. T. Flewelling will not allow his name to be placed on a part that has not passed both laboratory and practical use tests. Genuine Flewelling parts are manufactured exclusively by

**BUELL MANUFACTURING COMPANY**  
2977 Cottage Grove Ave.  
CHICAGO

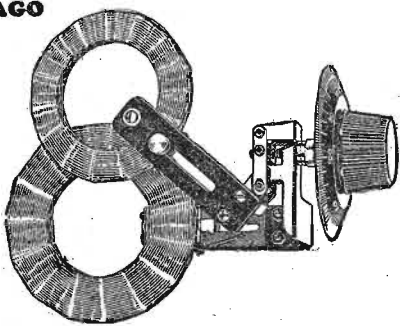

Flewelling TUNERS \$8.00



# How to Make a Lighthouse Keeper's Receiving Set

## Part I—Portable Set Suitable for Everyday Use

By S. R. Winters

A PORTABLE Radio receiver, representing a cash investment of only \$20, and so simple in structural details that a person with the slightest elemental knowledge of electricity can assemble the parts, has been designed by A. W. Tupper, assistant engineer of the Lighthouse Service, United States Department of Commerce. Furthermore, the set is compact, the cabinet, instruments, and dry-cell batteries weighing barely 15 pounds. A single vacuum tube is used, which, besides the headphones, is the only expensive unit used.

This receiving equipment was designed especially for keepers of lighthouses—those lonely guardians of property along our 44,000 miles of coast line. One of these lighthouses, for instance, is perched on a rock in the Pacific Ocean, miles from land. The installation of the receiving set about to be described on this rock, will dispel the isolation by bringing civilization—music, church services, financial reports, lectures, etc.—into mid-ocean by the magic of the invisible electromagnetic waves.

### Adapted for Universal Use

This compact Radio receiving set, perfected fortunately, is not limited in usefulness to the lighthouse. It is equally adapted to home, office or field, where inexpensiveness, simplicity, compactness, and long-distance reception are sought.

The opportunity for the farmer to display his mechanical skill in making and assembling the parts entering into the construction of the Radio telephone equipment is not to be discounted. The city dweller, too, who is swinging away from electric circuits involving cumbersome units and bulky storage batteries, will appreciate the possibility of building and assembling a set of such light weight that one person could easily carry cabinet, instruments, and batteries anywhere he might go.

The materials necessary for building this simple form of regenerative circuit have been so explicitly outlined by the Lighthouse Service that even the size and number of screws are specified. Fortunately, some of the materials are likely to be found around any home which houses a person with a mechanical turn. Moreover, the various parts indicated are

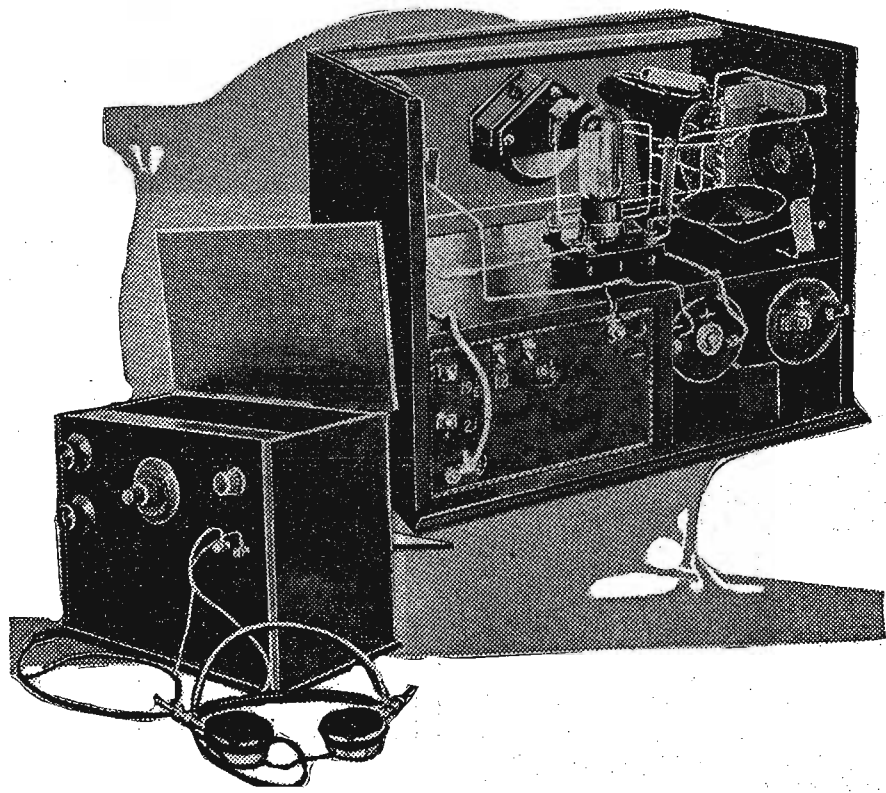

not suggested for use on mere theory, but these sundry units have been tested for several months and their suitability established beyond a doubt.

The simplicity of the assembly of the instruments is not likely to be marred except in one possible instance, namely, the making of the proper connections of the two spider web variometers or coils. This obstacle may be avoided, however, by faithful adherence to the diagram or hook-up illustrating one part of this series of articles.

### Materials Necessary

The materials required are the following: One 1½-volt vacuum tube for detecting the Radiophone signals; type WD-11 being used by the Lighthouse Service; one vacuum tube receptacle; one pair of headphones; one 22½-volt B battery; one dry-cell battery; one 23 or 43-plate variable condenser with vernier; one telephone condenser of .00025 mfd. capacity; one grid condenser of .0005 mfd. capacity; one grid leak; one piece of fiber or hard bristol board about ¼ inch thick and 8 inches

square; ¼ pound of number 24 gauge enameled magnet wire; 7 feet of tinned copper hook-up wire or heavy bell wire; one rheostat for controlling the filament of the vacuum tube; one piece ¼-inch diameter dowel stock, 5 inches long; one piece ¼-inch diameter dowel stock, 8¼ inches long; three or four pieces of tin-foil for covering back of panel; four binding posts; four machine screws No. 6, about ½ inch long, with nuts; one piece of brass, about ⅜ inch thick, ⅝ inch wide, and 6 inches long, for making end supports for coil shafts; three dozen copper or brass wire terminals; one dozen number 4 round-head brass wood screws, ⅝ inch long.

### Materials for Cabinet

This homemade Radio receiving set involves the building of the cabinet as well as assembling of the instruments contained therein. Therefore, the materials for making the container are quite specific. Obtain a piece of dry close-grained wood, about ¼ inch thick, 13 inches long, and 10¼ inches wide, for the front or panel. Bakelite or other insulating material may be used if preferred. The remainder of the cabinet may be of any kind of wood, although the model receiving sets built by the Lighthouse Service is of white pine, ⅝ inch thick.

The dimensions of the other pieces for the construction of the cabinet are as follows: Bottom and top, 14 inches by 8¼ inches; two ends, 8¼ by 10¼ inches; back, 13½ by 6 inches; hinged back or door to the compartment containing the batteries, 13½ by 4¼ inches; shelf, 7¼ by 12¼ inches. The other essentials for securing the cabinet in position include four pairs of small brass hinges and screws and some 1¼-inch wire brads; six brass screws, number 6, about ⅞ inch long, for securing the back in place; and soldering material.

### Making the Cabinet

The construction of the box or cabinet involves the making of a groove, ¼ inch wide and ⅝ inch deep, in each side-piece near the front into which the front board or panel is slipped. Any kind of wood, about ⅝ or ¾ inch thick, will do. The panel should, preferably, be a piece of close-grained wood ¼ inch thick.

(Continued on page 10)

# Complete Your Radio Outfit

## Bring Out the Best in Your Receiving Set with a Bristol

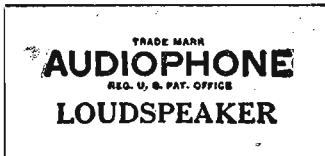
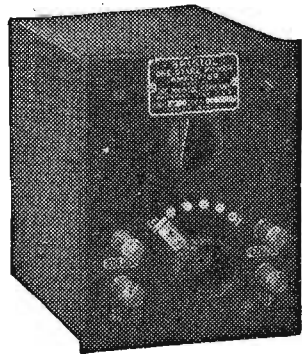

IT TOOK six years to develop and perfect the Audiophone. That is more time than the average person cares to spend on a Loud Speaker for his receiving set.

But here it is, all ready for you to use by simply connecting to the set.

No auxiliary batteries are necessary.

The tone is big, full, and rich, and without that scratchy, tinny noise so often heard in receiving. It can easily be heard all through the house, so

that your own family and friends can enjoy it with you.

The finish is a beautiful, dull gold bronze.

### Made in Three Sizes

- Senior Audiophone ..... Price \$32.50
- Junior Audiophone ..... Price 22.50
- Baby Audiophone ..... Price 12.50

When signals are not sufficiently loud to give good results with the loud speaker, Bristol One-Stage Power Amplifier is recommended to build up the power so that it can be heard even in a large hall. .... Price \$25.00

Ask for Bulletins Nos. 3006 and AY-3011

# THE BRISTOL COMPANY, Waterbury, Conn.

### LIGHTHOUSE RECEIVER

(Continued from page 9)

The rheostat and condenser are put on the board, in order to be certain that the holes are in their true positions, after which the instruments are removed and the panel is put into an oven. Heat should

may be attached to the panel by means of shellac. While the latter is in a moist condition, any tinfoil that may be dangling through the holes of the panel is cut away, in order that no metal parts of the condenser, rheostat, binding posts, or any of the wiring or wire terminals, may come in contact with it. The panel is

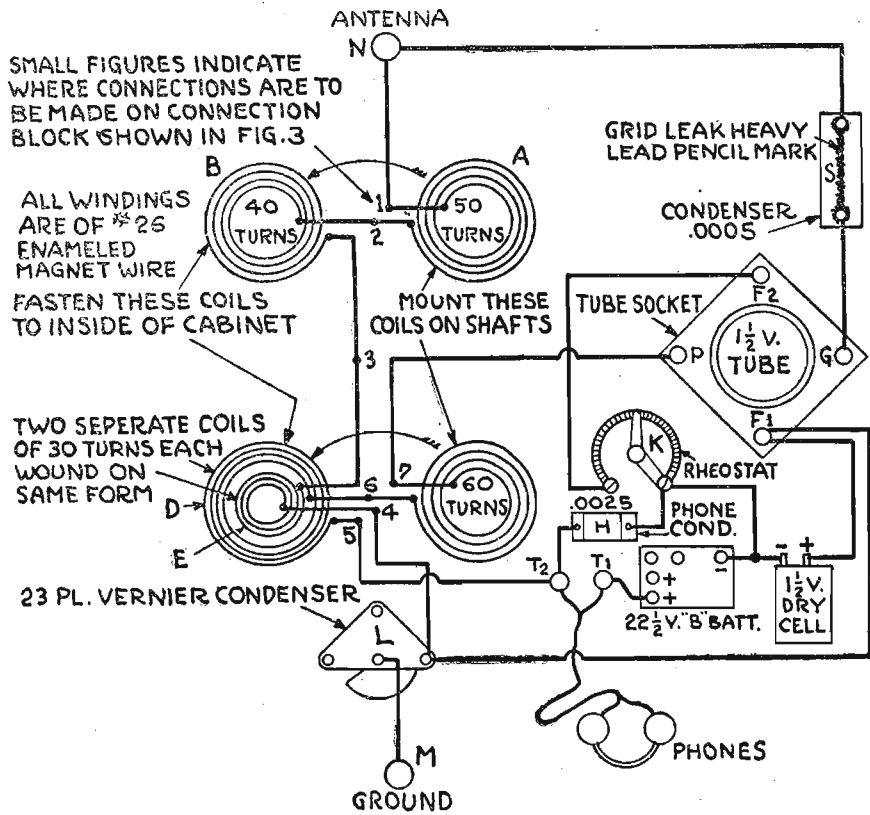

be applied thoroughly as a means of expelling moisture, but caution should be exercised lest the panel be scorched. While the panel is still hot, a coating of thin shellac is applied on both sides, to the edges and in the holes. The panel is permitted to dry for 24 hours, after which two more coats of shellac are applied at intervals of 12 hours. Positive instructions are issued not to paint this panel with ordinary paint; a spirit stain or water-color stain being applied if color is desired.

#### Applying Tinfoil

Once the third coat of shellac is dry, the inside portion of the panel that is above the shelf is covered with tinfoil, which

then placed in position, the instruments are properly fastened, the coil shafts are inserted with the coils mounted thereon, and the tube socket is secured to the shelf.

(TO BE CONTINUED.)

#### Open and Short Circuits

"Open" circuits (incomplete connections) may be due to broken wires, wrong connections, or poor contacts. "Short" circuits (where an undesired path for the current is provided in addition to the desired one) may be due to touching of bare connecting wires, wrong connections, touching condenser plates or some metallic object having fallen among the wiring.

**MAIL ORDERS**  
Address  
**DEPT. D-6**  
Chicago,  
Ill.

**MAIL ORDERS**  
Address  
**DEPT. D-6**  
Chicago,  
Ill.

**3-4-5 TUBE NEUTRODYNE**

Easy to Build  
Complete instructions for assembling and blueprints for wiring are included with each outfit. Instructions written so everyone can understand them.  
**FREE**  
Specially drilled panels are included with each of the sets illustrated and described below.

1 7x21x3/16 Drilled Formica panel  
1 Howard rheostat  
3 4-inch Radion dials  
3 John Firth bakelite sockets  
8 Binding posts  
**3 Tube \$28.60**

3 23 plate var. condensers  
1 Wave control neutroformer  
2 R. F. amp. neutroformers  
2 Grid neutralizing cond.  
1 .00025 micron grid cond.  
**4 Tube \$44.65**

1 Marco variable grid leak  
1 Baseboard for mounting  
25 feet tinned copper bus bar wire and complete instructions for assembling and wiring.  
**5 Tube \$46.25**

Complete parts for 3-tube set as follows:

<b>Complete Parts for All Receivers:</b>		<b>Got Your Copy Yet?</b>
Herald-Exam. Set	\$ 5.95	<p>Our new 48-page catalog lists, describes and illustrates 10 complete sets like that pictured above. It contains hundreds of bargains in parts that have not and can not be duplicated elsewhere. <b>SEND A DIME FOR YOUR COPY, TODAY!</b></p>
Cockaday Receiver	11.95	
Autoplex Hook-Up	16.45	
Short-Wave Tuner	10.50	
(Wood Parts)		
Short-Wave Tuner	14.95	
(Moulded Parts)		
Single Tube Erla	20.90	
Columbia Freak	39.95	
Haynes DX	10.95	
1-Tube Reinartz	11.45	
Wave Trap	5.25	
2-Stage Amplifier	12.95	
Power Transformer	16.95	
Supertuner	49.95	
Honeycomb Receiver	17.95	
Ultra Audion	8.95	

## Get the Thrill of Distance

### Armstrong Regenerative Set Receiving Radius 600 Miles

Order Direct From This Advertisement.

HERE is a money saving Radio Outfit that will bring the news of the world—concerts, lectures and stock reports—into your home. Sold complete with head set, tube, batteries, aerial and ground wires, for only \$23.25! Connections simple and plainly marked. Easy to tune. Order NOW! Shipping weight, 12 pounds. Shipped from CHICAGO or PHILADELPHIA store.

57RD9366.....\$23.25

Licensed under the Armstrong Patent No. 1113149 for amateur, experimental and scientific uses only.



#### Save on All Radio Supplies.

Save money on your Radio Supplies, and get guaranteed quality! Our big FREE Book shows hundreds of bargains in complete sets and parts. Many new hookups, complete list of broadcasting stations. Contains "How to Build an Aerial."

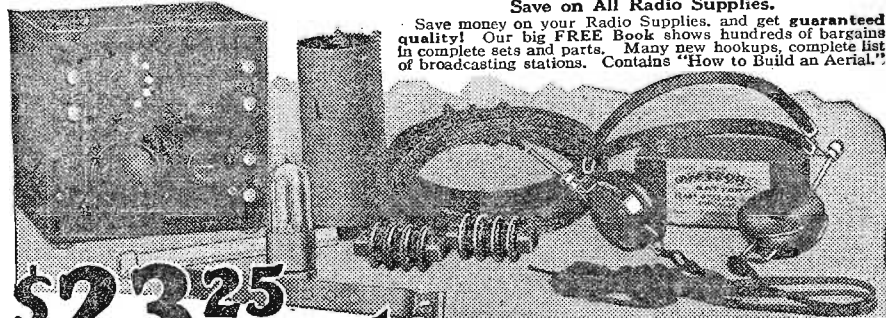

**\$23.25**

**FREE Radio Catalog**

Sears, Roebuck and Co.  
Chicago - Philadelphia

Mail coupon today to store nearest you for Free Radio Catalog.

Send me FREE Radio Catalog No. 60R01

Name.....

P. O.....State.....

Rural.....Box No.....

Street and No.....

# Sears, Roebuck and Co. Philadelphia

The World's Biggest Mail Order House

## WHOLESALE RADIO SERVICE COMPANY

39-41 Cortlandt St.  
New York City

**SERVICE**

Buying from us will save you both time and money—and all the while you are protected by a double guarantee, the manufacturer's and ours.

Orders are shipped the same day as received, and we'll pay the postage on orders above \$5.

We will gladly make C. O. D. shipments if you desire.

### 5 TUBE NEUTRODYNE

Just connect these guaranteed Neutrodyne parts together and you're ready to bring in the really distant stations. The Neutrodyne is the most talked-of set today because it gives unusual DX results—without squeals or distortion.

The complete parts, with All Accessories, everything carrying our usual guarantee, for.....**\$32.50**

All Fada Parts, if you wish, for \$49.50

<p style="text-align: center;"><b>TUBES</b></p> <p>Genuine R. C. A. Radion-tions, UV-201A, WD-12, WD-11, UV-199.....\$4.75</p> <p>Genuine Supertrons, types UV-201A and WD-12..... 3.50</p> <p>Genuine Telefunken 6v. Det. and Amp..... 4.50</p> <p>Each tube is tested for light and oscillation before it is shipped.</p>	<p style="text-align: center;"><b>SETS</b></p> <p>Crosley XJ.....\$ 57.50</p> <p>Freed-Eisemann NR5... \$27.50</p> <p>Grebe CR-12..... 155.00</p> <p>Crosley VI..... 27.50</p> <p>Westinghouse Sr..... 36.50</p> <p>Federal DX-58..... 105.00</p> <p>Cockaday 3 Tube..... 95.00</p>	<p style="text-align: center;"><b>PHONES</b></p> <p>Dr. Selbt, 6,000 ohms..\$5.75</p> <p>Brandes Superiof..... 4.75</p> <p>Federal..... 4.75</p> <p>Baldwin Original Type C..... 8.25</p> <p>Western Electric..... 9.50</p> <p>Ambassador 3,000 ohm.. 3.75</p>
<p style="text-align: center;"><b>MISCELLANEOUS</b></p> <p>5 Amp. Tungar &amp; Tube..\$23.50</p> <p>2 Amp. Tungar &amp; Tube. 15.00</p> <p>22 1/2 B Battery, small.. .95</p> <p>22 1/2 B Battery, large.. 1.65</p> <p>45 B Battery, large..... 2.35</p> <p>Columbia Inside Mounts 4.75</p>	<p style="text-align: center;"><b>VARIOCOUPLER SPECIALS</b></p> <p>Shamrock, all bakelite...\$2.35</p> <p>Sleeper No-Tap..... 4.75</p> <p>Columbia..... 3.75</p>	<p style="text-align: center;"><b>RHEOSTATS</b></p> <p>Cutler Hammer..... \$.85</p> <p>Cutler Hammer Vernier. 1.35</p> <p>Federal, 8 ohm..... .95</p> <p>Federal, 25 ohm..... 1.25</p> <p>Fillkostat..... 1.85</p>
<p style="text-align: center;"><b>LOUDSPEAKERS</b></p> <p>Brandes Table Talker.. \$ 9.50</p> <p>Music Master..... 27.50</p> <p>Magnavox, New Type.. 28.50</p> <p>Atlas Amphitone..... 20.00</p> <p>Baldwin Loudspeakers.. 21.50</p> <p>Western Electric 10-D.. 44.00</p>	<p style="text-align: center;"><b>TRANSFORMERS</b></p> <p>Federal No. 65.....\$ 5.25</p> <p>Acme Audio..... 3.95</p> <p>General Radio..... 4.50</p> <p>Jefferson Star..... 2.50</p> <p>Modern Push-Pull (set).. 11.00</p> <p>Amertrans..... 5.50</p>	<p style="text-align: center;"><b>CONDENSERS</b></p> <p>11 Plate, Bakelite Ends..\$1.30</p> <p>23 Plate, Bakelite Ends 1.45</p> <p>43 Plate, Bakelite Ends 1.55</p> <p>23 Plate Vernier..... 2.45</p> <p>43 Plate Vernier..... 2.95</p>

**WE SELL RETAIL AT WHOLESALE PRICES.**

# OPERATING AND TROUBLE SHOOTING

## For the Owner of a



## KENNEDY Model V

THE new receiving unit Model V combines an unusual degree of selectivity and precision with simplicity in tuning. But, even though simplicity has been attained, the observation of certain precautions named below will usually improve the operation and add to the enjoyment to be had therefrom.

also strengthened—sometimes to the point of being objectionable.

The simplest and most effective way to reduce such interference is to decrease both the length and the height of the antenna. This makes the set tune "sharper" although at the same time it reduces signal strength correspondingly.

It is therefore wise to choose a middle course. Best all-around results are usually obtained with an aerial consisting of a single bare copper wire, number 12 or 14, suspended at a height of 20 to 40 feet and from 100 to 200 feet long. Where greater signal strength is desired, lengthen or raise the aerial; where greater selectivity is desired, shorten or lower it, or use a wave trap.

In the absence of an outdoor aerial, any one of the interior types may be employed.

### Ground

A good ground system is desirable, the best practical method being to connect a ground wire number 12 or 14 gauge,

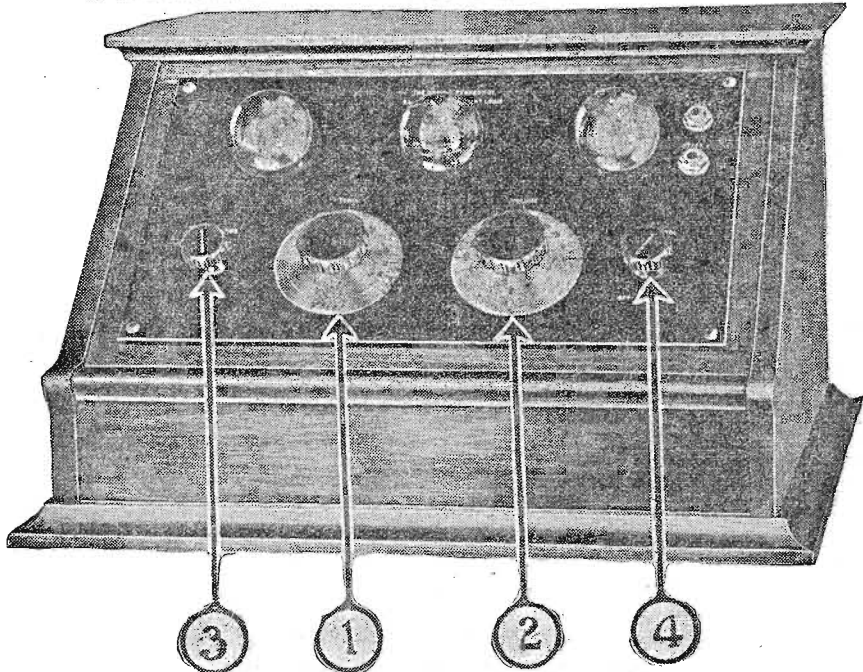

### Aerial

Almost any type of aerial is suitable, although a properly constructed outside antenna is to be preferred.

In general, it may be said that the strength of the received signal increases with the height and length of the antenna. While this is quite desirable, yet where static and other disturbing conditions are present, these disturbances are

either bare or insulated, to a cold-water pipe. Connection should be made through a ground clamp firmly fastened to pipe and soldered to the ground wire.

While a good aerial and ground system is recommended, it is interesting to know that this receiving unit operates quite well without a ground connection of any kind. It operates without an antenna, provided the ground wire is attached to the an-

"OPERATING and Trouble Shooting" is a Radio Digest feature whose purpose is to study the late models of various standard receiving sets and to show the newly initiated broadcast listener, who has purchased such a set, how he can operate it to get the best there is in it and how he can overcome minor difficulties which may be causing some trouble. On pages 11, 12 and 13 this week the Kennedy V and the Garod RAF are described. Radiophans with other kinds of sets will also find these articles worth reading, particularly the notes on trouble finding.

tenna binding post. In other words, it will give quite fair results if the ground binding post is left disconnected and either the antenna or ground wire is connected to the antenna binding post.

### Interference

While it has a high degree of selectivity, there are some instances where interference is so strong that it is practically impossible to eliminate it. In such cases, the following suggestions may be helpful:

Where code signals are the source of interference it will generally be found that these signals are being transmitted on special government wave lengths (within the authorized broadcast wave band) or else it may be that the signals are being transmitted above certain authorized wave lengths that could not ordinarily interfere with broadcast reception. This is almost certain to be the case if a slight movement of the tuning dial, either to the right or left, will lose or tune out the offending signal.

It is difficult to tune out a strong code signal, on any regularly authorized wave length, that is being transmitted at a distance of only two or three blocks from a receiver. Likewise, it is extremely difficult to tune out a powerful broadcasting station located within one or two miles of a receiver.

In quite a few cases where interference is present to an unusually marked

degree, it is possible to eliminate it by using a small wave trap connected between the antenna and the antenna binding post on the receiver. Such a wave trap consists simply of a coil having a variable condenser connected across it. The aerial is connected to one terminal of this combination, and the other terminal is connected to the aerial binding post on the receiver.

One striking fact about the use of a wave trap with the Kennedy Model V is that the wave trap does not in any way affect the regular dial settings or tuning operations.

### Special Caution

In a majority of cases where trouble is encountered in the operation of this receiver it is of external origin and can be traced either to the A batteries, B batteries, socket adapters or tubes. These will now be considered separately.

### A Batteries

Since faulty A batteries form one of the most frequent sources of failure to operate, the following suggestions are of particular importance:

When dry cells are employed their life ranges from three to six weeks, depending on the number of tubes used and the amount of service to which the batteries are subjected each night. For this reason this type of A battery should be tested frequently. When it is found that best (Continued on page 12)

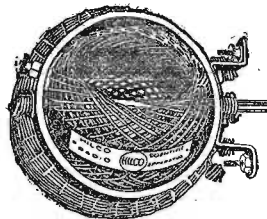

HILCO VARIOCOUPLER Type "E"

Contains primary and secondary winding of the HILCO Lattice Banked type, and is ideal for use in single, two and three circuit close adjustments in wave lengths of 200 to 600 meters; very selective, sharp tuning and variable thru wide range. Price \$7.00.

Specified as Standard Equipment in Erla Reflex and other well-known receiving circuits.

## What a Difference the HILCO Variocoupler Makes!

Put a HILCO variocoupler or variometer in your set and note the difference! The dominant and exclusive features of HILCO inductance coils are—1st, lattice-bank type of winding, which suspends the wire in air with the successive turns crossing each other at right angles. (This winding possesses much greater efficiency than honey-comb and dualateral windings, and should not be confused with them), 2nd, The unique design of mounting the winding, with minimum amount of insulating or energy-absorbing material employed.

These construction features make HILCO inductance coils very selective and sharp-tuning, enabling the most distant broadcasting stations to be brought in right thru nearby stations.

HILCO Radio Products are now sold by most dealers and jobbers. If your dealer or jobber can't supply you, send his name with order and we will see you are supplied.

DEALERS AND JOBBERS: HILCO Radio Products are profitable, satisfactory merchandise, with quick turnover. Write for literature and discounts.

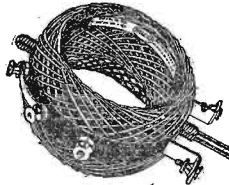

Type A Variometer, very selective and sharp-tuning thru a range of from 200 to 600 meters. Price \$6.00.



HILCO TYPE R1 Inductance Coil for Reinartz circuit; will tune to wave lengths of 200 to 600 meters. Price \$2.50.

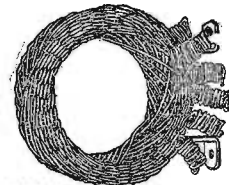

HILCO Krystkcoil—most efficient for crystal sets; winding tapped for tuning from 200 to 600 meters. Price \$1.25.

A. E. HILL MFG. CO., Atlanta, Ga., U. S. A.

# Thrills from Radio

No. 12 of a Series Featuring Experiences of "ALL-AMERICAN" Users

## No Others Equal the "All-American"

By T. J. Gehlert, Benton Harbor, Mich.

"I hooked up a two-stage radio detector and a two-stage audio frequency set using "All-American" transformers on both sides with first class results. The two r.f. transformers were identical.

"Hearing about it being better to have r.f. transformers that were made special for first, second and third stages, I obtained a set of these of another make but they didn't come

anywhere near brining in the results that the two "All-American" Radio Frequency Transformers produced.

"I have never been able to get, with other transformers, the good results that I get when I use "All-American."



All-American Radio Frequency Transformer for wave lengths 150 to 600 meters. Price \$4.75. The best—why pay more?

And over 500,000 other radio enthusiasts will readily agree with Mr. Gehlert on this. That is why All-Americans are the most popular and most widely used of all transformers.

### Special Offer

All-American Power Amplification diagram-circular and Book of 22 Tested Hookups sent for 4c in stamps to cover mailing.

All the better dealers sell the "ALL-AMERICAN"

RAULAND MFG. CO., 208 N. Jefferson St., CHICAGO PIONEERS IN THE INDUSTRY

Audio and Radio Frequency: Power Amplifying (input and output)

More than 500,000 in use Standard on the better sets



# ALL-AMERICAN AMPLIFYING TRANSFORMERS

Largest Selling Transformers in the World

SCIENTIFIC HILCO RADIO APPARATUS

# OPERATING AND TROUBLE SHOOTING

(Continued from page 11)

results are obtained only when the rheostat is turned completely to the right, it is necessary to renew the A batteries.

If a storage battery is used, see that it is always kept well charged and properly filled with distilled water. The battery solution should always be kept at a level 1/4 inch above the battery plates.

The ideal location for the storage battery and storage-battery charger is in the basement. Both battery and charger should be placed on a shelf supported from the first floor joists at such a height that hydrometer readings can be taken and distilled water added easily.

### B Batteries

B batteries are also a frequent source of trouble. This is indicated by severe crackling noises in the headphones, unsatisfactory amplification or the necessity of setting the volume dial abnormally high to produce oscillation (the hissing sound referred to under the paragraph devoted to tuning in distant stations).

Whenever these conditions appear, it is well to make a careful inspection of the B batteries and their connections, including a voltage test, which should be made with an accurate voltmeter across the battery terminals. Connecting the battery terminals with a wire to see if the battery "sparks" is very bad practice and quite injurious to the battery. If the voltmeter shows that the battery is much below the rated voltage, it is probably the cause of the trouble.

Be sure that both A and B battery leads are connected to the proper terminals, + or -, because if the leads of either are reversed, the set will function very poorly or not at all.

### Socket Adapters

When UV-199 or C-299 tubes are used, the socket adapters may not make good contact to the tube prongs. See that the tube prongs are clean, and, if necessary, bend the adapter contact springs upward to make good contact.

### Tubes

While all tubes are manufactured under strict supervision and inspection, it will be found that one of the three tubes used with the receivers is usually better as a detector than the remaining two.

For this reason it is always well to

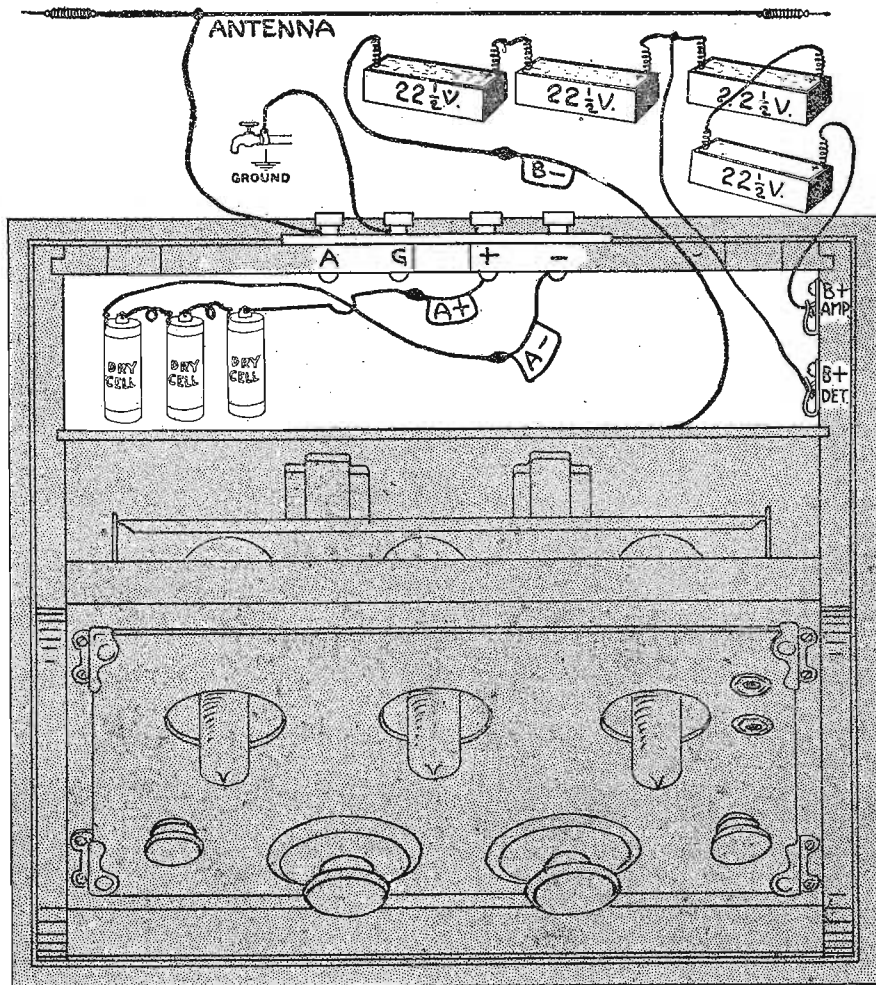

try each one of the three tubes, successively, as a detector and to choose for a detector that tube which functions more quietly and gives clearer reception in general.

Dry-battery tubes are designed pri-

marily to avoid the use of a storage battery, which in some cases may be impractical. However, dry-battery tubes do not give quite so great volume.

### Tuning

Tuning of the Model V is simple. The few operations required for nearby stations (within 25 miles) are: Plug in headphones on stage 1.

Turn tube control knob 4 clockwise until tubes light up. If you are using UV-199 or C-299 tubes, do not turn any farther than necessary to light tubes. If using WD-12 or C-12, turn knob until arrow points straight up. If using UV-201A or C-301A tubes, turn somewhat past this point. Set volume dial 2 at 30. Turn tuning dial 1 slowly until you hear voice or music. If signals are loud and distorted, turn volume dial 2 down. If clear, but not loud, turn volume dial up.

A small change of tube control knob 4 may now increase the volume or clear up the signal. Turn tubes no brighter than necessary for good reception. Plugging headphones in at stage 2 will, of course, give greater volume than when plugged in at stage 1.

For distant stations (over 25 miles), plug in headphones at stage 1. Set tuning dial 1 at 50. Turn tube control knob 4 to point previously found best for local reception. Turn volume dial 2 up until a hiss is heard in the phones. Leave volume dial at a point a few degrees above where the hissing occurs (usually about 40 to 45), and find the carrier wave whistle of a broadcasting station by turning the tuning dial 1 slowly in either direction. With the fine tuning knob 3, get as nearly as possible in the center of this whistle (where it dies out but will come back when fine tuning knob is turned in either direction). Reduce volume control 2 until signal is clear.

For best results it is desirable to work the volume and fine tuning controls together at this point, by turning one with each hand.

Plugging headphones in at stage 2 will, of course, give greater volume than when plugged in at stage 1, also in this case. Finally, it is often found that advancing volume dial 2 just a trifle will strengthen the signal somewhat—otherwise the volume dial is left alone.

## The RADIO-SHACK

58 Dey Street - New York City  
Goods shipped C.O.D.  
Just pay the postman

EVERY ARTICLE SOLD ON WRITTEN MONEY-BACK GUARANTEE

**1c SALE**

One of Six Large New York Stores

Send No Money. We'll Ship Anything C. O. D.

**1c SALE**

## MAKE 2 SETS FOR PRICE OF 1

<b>SUPERTRON TUBES</b> Type 201A uses 6 volts, type WD 12 uses 1 1/2 volts. Excellent as detector or amplifier. Draws 1/4 amp. Oscillate in all circuits. 1 FOR \$6.49	<b>"B" BATTERIES</b> 22 1/2 Variable Reg. \$1.75..\$1.29 Reg. 2.65.. 1.99 Reg. 3.00.. 2.19 45 Variable Reg. \$3.50..\$2.99 Reg. 4.00.. 3.49 Reg. 5.50.. 5.49	<b>PLUGS</b> Torpedo or Flat, easy adjustment for phone cords. High finish. Perfect contact. Reg. \$1.25. 1 FOR 69c.	<b>JACKS</b> Single or Double Heavy Springs—German Silver Contacts. Nickel finish. Reg. 90c. 1 FOR 59c.	<b>TUBE PROTECTORS</b> Impossible to blow your tubes if you attach these to end of socket for 1/4 or 1 amp. tubes. 1 FOR 49c.	<b>AERIAL WIRE</b> 7 Strand Tinned copper wire gives excellent results on DX work. Reg. \$1.00. 100 ft. 99c.	<b>KRONE PHONES</b> 2200 Ohms. Standard Make. Remarkable Clearness and volume. Can be used with horn. Reg. \$6.50. 1 FOR \$5.89.
<b>LIGHTNING ARRESTERS</b> Approved by Underwriters. You need these for your set. 1 FOR 89c.	<b>VARIABLE CONDENSERS</b> Moulded end plates, sturdy construction. Perfect alignment between plates. 11 Plate...\$1.79 23 Plate... 2.09 43 Plate... 2.69	<b>DIALS</b> DeForest Type Remarkable value. Knurled knob with heavy brass bushing. 3/4 and 1/2 shafts. 2 1/2 inch... 39c 3 inch... 54c 4 inch... 74c	<b>D. L. COILS</b> 35-50-75-100 Just the size for Three Circuit. 1 FOR 69c.	<b>TRANSFORMERS</b> Audio Frequency well known standard make. Ratio 4-1. Reg. \$5.50. 1 FOR \$5.49.	<b>HYDROMETERS</b> Very Accurate. Packed in wooden moisture proof box. Reg. 75c. 1 FOR 59c.	<b>NEUTRODYNE</b> No set has ever made the hit with the Radio fan that the Neutrodyne has. The reason is obvious—the Neutrodyne brings in the distant stations without squeals and without distortion. These are GENUINE NEUTRODYNE PARTS licensed under HAZELTINE PATENTS. Beware of unlicensed parts! 3 Workriteformers (Wound on Bakelite with silk wire) 1 7x24 panel 2 Workrite Neutrodons 5 Brunswick Sockets 2 Shanton Rheostats 2 Star Transformers 1 Single Closed Jack 1 Single Filament Jack 2 .006 Wostinghouse Fixed Leak 1 .00025 Mica with Grid Leak 3 Shanton Dials 3 23 pl. Brunswick Variables Look over this list of parts. Compare it with others. Then you will realize what a special price this is. <b>\$25.97</b>
<b>VERNIER CONTROL</b> For any Dial. Makes a Vernier out of any make condenser. Very efficient. Reg. 75c. 1 FOR 49c.	<b>SWITCH LEVERS</b> Adjustable Arm. Fada Type Knob. Heavy Nickel-plated arm and collar. Reg. 40c. 1 FOR 29c.	<b>VARIABLE GRID LEAK</b> Panel Type. Needed for proper results. No solder needed. 1 FOR 79c.	<b>MOULDED VARIOMETER</b> A remarkable buy. Green silk wire, pig tail contacts. Can be split. Heavy windings. Reg. \$6.00. 1 FOR \$5.49.	<b>RHEOSTATS</b> Any Resistance. Fada Type with tapered knob and secure wire. 6 ohms... 49c 30 ohms... 59c MORE	<b>VARIO-COUPPLERS</b> 180 Degree Wound on Genuine Bakelite tubing with green silk wire. Reaches 600 meters. Reg. \$5.00. 1 FOR \$3.89.	
<b>SOCKETS</b> Well made in detail. Extra heavy phosphor bronze contacts. Binding post nuts. Metal top... 49c All Moulded... 59c Wiping Contact... 69c.	<b>Vernier Condenser with Dial</b> A beautiful moulded end instrument with tapered dial and knob. Precision made. Delicate adjustment. 11 Plate...\$4.49 23 Plate... 4.99 43 Plate... 5.50	<b>LITZ WIRE</b> Most Efficient. A double silk covered wire with 37 strands of No. 38 wire, each strand enameled. Wonderful for Coils, Loops, etc. 1 FT. FOR 4c.	<b>GOLD BUS BAR</b> Most Efficient. Allows high frequency currents least resistance. Used in finest sets. Reg. 15c. 1 FOR 15c.	<b>POTENTIOMETER</b> Complete with knob and dial. 200 or 400 ohms. The most remarkable buy you ever made. 1 FOR 69c.	<b>VERNIER RHEOSTATS</b> The famous TECO complete with bakelite dial. Needed for your detector tube. 1 FOR 89c.	

### Special Shackdx Set Complete

Set includes all parts, drilled panel, phones, tube, batteries, aerial equipment, etc. Great for D.X. .... **\$15 00**

**RADIO SHACK SERVICE**  
The Radio Shack aims to give you better service than any other Radio House. New Customers are just as valuable to us as Old Customers, as we consider our New Customer an old one in the making. In the same way a small order is just as valuable as a large one, because our Service is so sure to please you that large orders are BOUND to follow. Write for our booklet of unsolicited testimonials from satisfied buyers all over the country.

**RADIO CONSTRUCTOR FREE WITH EVERY \$1 SALE**

### ERLA REFLEX

1 Erla Reflex No. 1  
1 Erla Audio  
1 Erla .001  
1 Erla .002  
1 Erla .00025  
1 Z and T Detector  
1 Erla Socket  
All other parts and panel included.

**Special \$19.75**

# OPERATING AND TROUBLE SHOOTING

## For the Owner of a GAROB RAF Receiver

THE neutrodyne receiver is essentially different from the more familiar types and the procedure to be used in tuning is also different.

### Tubes

This set is adjusted for three 201-A tubes and one type 200. These tubes should be used in the sockets as follows: Two 201-A's in both sockets next to the panel, and one in the rear left socket; the 200 in rear right socket.

### Better Connections

After inserting the tubes, the battery connections should be made as indicated by the markings on the panel. Ground and antenna connections should be made except when close to transmitting station. By plugging the phones in the detector jack the set is ready to tune.

### Tuning

As this set does not squeal it is necessary to tune to the signal wave length rather than to the carrier wave. The two right-hand dials 2 and 3 control the wave length to which the set is tuned and these two dials tune together. For example, if it is found that one station tunes in at 45 on the second or middle dial 2, and 49 on the third or right-hand dial 3, it should be noted that there will always be a difference of four points be-

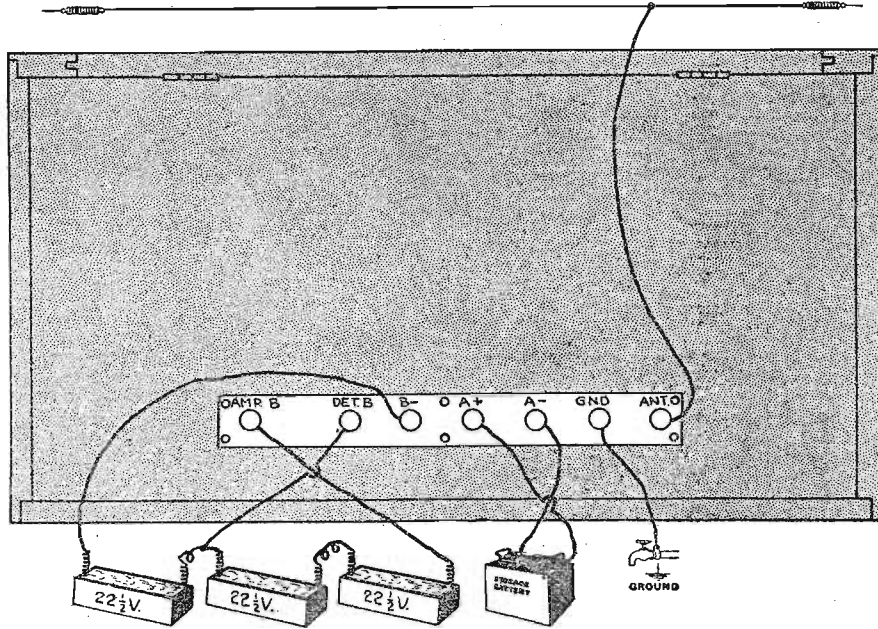

tween dials 2 and 3, it will be found a simple matter to tune in distant stations, by increasing or decreasing the adjustments of these two dials, one point at a time, and swinging antenna dial back and forth over about 10 points known to be near the correct adjustment. As soon as the station is picked up, it is a very simple matter to tune it in.

ages and different adjustments of rheostats 4 and 5 to determine the values best suited to the tubes used.

### Renewal of Tubes

If the directions for operating the set are carefully observed, the vacuum tubes will have exceptionally long life. When the filament of a tube does burn out, however, the tube should be replaced by a new one. Use same type when ordering spare tubes or replacements.

### Renewal of B Batteries

After B batteries have been in service from 8 to 12 months they become exhausted so that the signals are weak and disagreeable noises are produced. This condition may be remedied by replacing the battery by a new one.

### Possible Difficulties

Anything which tends to increase resistance or decrease insulation will cause poor operation. As the batteries grow

## How to Take Care of the Radio A Battery

See that the connections are clean and tight and scrape off the wire or terminal connections going out of the battery so that they are bright and will form a good contact.

See that there is no acid or water spilled upon the top of the battery which would cause voltage leakage between the cells. Keep the top of the battery dry.

Keep the plates covered with water at all times. The solution should come at least 1/4 inch over the top of the plates. Use only distilled water.

Do not permit the battery to stand completely discharged for any length of time. It should be recharged when hydrometer reading shows under 1,200. When fully charged hydrometer reading is between 1,280 and 1,300.

In using hydrometer, see that the float does not cling to the side of the glass tube. When taking reading also see that the rubber bulb is fully expanded and not indented, as otherwise suction would permit incorrect reading.

Remember that all new batteries are somewhat like a new automobile. They do not reach their full efficiency until they have been in service for a little while. A new battery will, therefore, not give as long service on a single charge as it will after it has been recharged a few times.

old, they decrease in voltage and increase in resistance. As the tubes grow very old, the filaments become less effective. Each fault, however, suggests its own remedy.

1. Poor connections in antenna or ground wires or defective insulation of antenna.
2. Rheostats not properly adjusted.
3. Batteries exhausted (indicated by low filament brilliancy, weak signals and distortion).
4. Battery connections improperly made, poor or broken.
5. Tuning controls not in correct adjustment.
6. Poor or broken connections in telephone cord or plug.
7. Inoperative vacuum tubes.
8. Glass tube resistances (grid leaks) fallen out of their mountings.

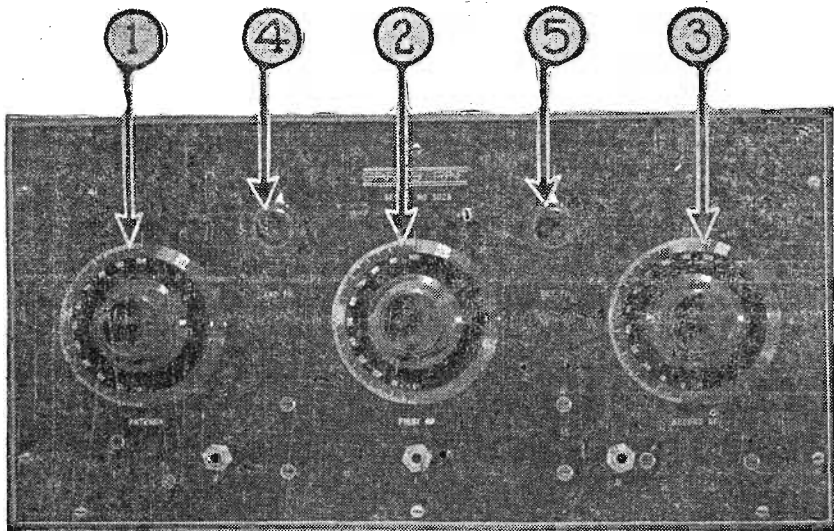

tween these two dials. Before endeavoring to tune in a distant station, this difference should be determined on a strong local signal. Dial 1 will be found to follow dials 2 and 3, but its tuning is affected by changes in the antenna.

If a log is kept of the readings it will be found that the same station always comes in at the same setting, unless, of course, the transmitting wave length is changed.

After the tubes have been installed, it is advisable to try different B battery volt-

After determining the difference be-

# Your Choice Free Limited Supply

Your prompt action gives you one bound volume with each annual subscription. New or renewal.

**Greatest Collection of Radio Information**  
A. B. C. Lessons for Radio Beginners.  
Two, Three, and Four Tube Reflex Circuits.  
The Famous Miloplex with Various Hook-ups.  
Reinartz Long Distance Circuits—Ultra Reinartz.  
Flewelling Popular "Fliver" Circuit.  
Single Tube Reflex Circuits—Super-Heterodyne  
Five Tube Neutrodyne, Special R. D. Hook-ups.

In addition to these features, the current issues give you all the live news in Radio. The popular Q. and A. Department, How to Operate Your Set, Advance Broadcasting Stations Programs, and a correct list of all Broadcasting Stations.



## 55 Copies

RADIO DIGEST, 123 W. Madison St. Chicago  
Check Offer Desired

- One year's subscription, and choice of one volume. Send Vol. .... Enclose...\$5.00
  - One year's subscription, and choice of two volumes. Send Vols. .... Enclose... 7.00
- Additional Bound Volumes at \$2.00 each.

Name .....

Address .....

City ..... State .....

Serving as a Radio Reference Library  
You receive 52 issues with your Subscription  
and 13 issues in each bound volume

Bound Volumes 3, 4, 5, and 6 now ready.  
Volume 7 ready about February 15.  
This offer good only in U. S. and Possessions,  
and Canada.

This offer not good through dealers or subscription agencies, but must be sent us direct with the full subscription price. Remittance must be by check, money order or draft.

## NOW YOU CAN GET THEM FROM YOUR DEALER



COMSCO

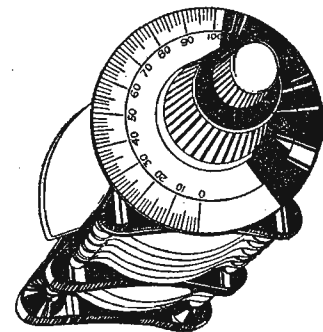

COMSCO

## COMSCO CONDENSERS

The most ingenious variable air condenser ever conceived  
No outside Spring Connections—True Capacities.

and Remember the Bronze Bushings!

Bronze Bushings for Permanent Contact—A Comsco Feature

11 plate plain .....	\$2.00	16 plate vernier .....	\$4.00
17 plate plain .....	2.25	26 plate vernier .....	4.50
23 plate plain .....	2.75	46 plate vernier .....	5.50
43 plate plain .....	3.50	All Tested Instruments	

YOU CAN DEPEND ON A COMSCO CONDENSER  
IT'S MADE BY THE MAKERS OF  
THE ORIGINAL AUTOMATIC  
BULL DOG GRIP TELEPHONE PLUG

For One Pair Phones  
\$1.00



For Two Pair Phones  
\$1.50

ASK FOR COMSCO AT YOUR DEALER  
Otherwise send purchase price direct to us and you will be supplied

## GENERAL INSTRUMENT CORP.

123 Liberty Street  
NEW YORK CITY



RADIO IS ALLY OF TALKING RECORDS

FANS TO HEAR PRODUCTS BEFORE RELEASE

Makers of "Canned Music" Suddenly Discard Old Attitude of Rivalry

CAMDEN, N. J.—Talking machine factories and record manufacturers seem to have changed their tactics and are now taking Radio as a profitable ally instead of a feared rival.

That is, Radio fans will be permitted to hear original records before they are released. When famous vocalists or musicians are about to perform for the reproduction on master phonograph records in the studio, a microphone will be placed alongside the recording apparatus and as the artist renders his piece for record the fans will hear it over the air.

The Columbia Graphophone Co., in co-operation with the A. T. & T. Co., Station WEAF, is already broadcasting its latest record releases.

The system is likened to "first nights" at operas and theatrical productions, seats at which are always sold at a premium or distributed to the elite and members of the press.

Mme. X Gives Fans a Stiff Guessing Contest

4,700 Telegrams Flood WJAZ to Tell Who She Is

CHICAGO.—Nearly five thousand listeners in joyously tackled a mystery recently when a star from the Chicago Civic Opera company sang from WJAZ, the Zenith-Edgewater Beach hotel station, under the Radio name of "Madame X."

"Who is Madame X? Guess and send us a telegram," the announcer requested after the opera star had sung "Annie Laurie," "The Last Rose of Summer," and, finally, "Caro Nome." The flood of telegrams that followed nearly paralyzed the telegraph companies. A total of 4,700

AN EVENING AT HOME WITH THE LISTENER IN (SEE INSTRUCTIONS FOR USE BELOW)

Table with columns: Station and City, Met., Monday, Tuesday, Wednesday, Thursday, Friday, Saturday, Sunday. Lists broadcast schedules for various stations across the country.

Instructions for Use.—All the hours above are given in Central Standard Time. If your city uses Eastern Time, add one hour to each of the periods stated; if your city uses Mountain Time, subtract one hour; if your city uses Pacific Time, subtract two hours. This table includes only the evening broadcasts, and on Sunday, the late afternoon program.

telegrams had arrived up to the time the broadcasting station lost count. They came from north, south, west and east—as far away as Portland, Ore. Forty-six percent of the guessers guessed right. The singer was Florence Macbeth.



This Radio Catalogue FREE

Save 1/3 on Guaranteed Radio Equipment

Write us a post card—Address Dept. 41-R

and we will send you free this 52 page catalogue of radio sets and parts. It also contains explanation of radio terms, map and list of broadcasting stations and much radio information, including an explanation of successful hook-ups and circuits.

You will be amazed at the low prices Ward's quote. A complete tube set having a range of 500 miles and more, including tube, head set, batteries, and antenna equipment, as low as \$23.50.

This catalogue contains everything for the expert and amateur. Complete sets and every improved part for building sets, all the most up-to-date devices—at the lowest possible prices.

Headquarters for Radio

Montgomery Ward & Co. is headquarters for Radio, selling everything direct by mail without the usual "Radio-profits." Why pay higher prices? Ward quality is the best and the prices will often save you one-third. Everything sold under our Fifty Year Old Guarantee—Your Money Back if You Are Not Satisfied. Write today for your copy of this complete 52-page Radio Book.

Write to our house nearest you Address Dept. 41-R

Chicago Kansas City St. Paul Portland, Ore. Ft. Worth Oakland, Cal.

Established 1872 Montgomery Ward & Co. The Oldest Mail Order House is Today the Most Progressive

Advertisement for THE "FORD" OF LOUD SPEAKERS, featuring a large image of a speaker and the text 'Special METRO Unit \$9.50'.

Standard Cord Ready To Use on Your Set \$9.50

BRINGS IN CLEARLY ALL MUSICAL TONES

THE Fultone Loud Speaker is full throated and brings in, in volume, both music and voice in their natural, full, rich tones, with no distortion or metallic noises.

Fultone is constructed of a non-metallic composition, in one piece, and is equipped with a special Metro Unit, together with standard cord all ready for attachment to the finest Radio set.

Quality at a Low Price Facilities for immense production have enabled us to quote you this moderate low price on the quality Fultone loud speaker.

All good dealers or SENT POSTPAID on Receipt of Price HALL & WELLS

Manufacturers' Representatives and Exclusive Distributors of FULTONE Loud Speakers and Metro Units 508 South Dearborn Street CHICAGO, ILL.

JOBBERS We have a money-making proposition on FULTONE DEALERS for you. This loud speaker, because of its quality at such a low price, is destined to be the biggest seller in Radio. Better wire today. Prompt and immediate delivery assured.



Advertisement for ALWELL soldering iron, featuring the brand name in a logo, the price '\$3.00', and the headline 'No More Shocks in Using the New ALWELL Wooden Handle Soldering Iron'.

THE Alwell soldering iron, with its handle made of wood, affords the greatest boon to the builder of sets from the sudden and ruthless electric shocks often received from metallic irons.

\$3.00 With Choice of Points Extra points 50c each

At all good dealers or SENT POSTPAID ON RECEIPT OF PRICE

HALL & WELLS Manufacturers' Representatives and Exclusive Distributors of ALWELL Soldering Irons 508 South Dearborn Street CHICAGO, ILLINOIS

JOBBERS Some territory is still open to live jobbers and dealers for this fast and popular Alwell soldering iron. Immediate delivery assured. Better wire.

# King Miloplex Turns Out New Trick Circuit

## Part XIX—Modified Wizard Miloplex Described

By the Mystery Man

*The wind is blowing,  
And it is snowing,  
And I am going  
HoEm.*

WHICH is proof positive that all you have to do in order to write heart-rendering poetry is try and sell it. But, really, truly, the above windlet came

Ever since the Wizard Miloplex came out in your magazine, I have been a strong advocate of the circuit. I originally built it as a one tube set and the results were better than I had hoped. I rebuilt it as a three tube circuit a couple of weeks ago after having heard over fifty stations on the one tube. My list then contained at least three in California, some 1,900 miles from here. Since the three tube set has been working I have raised my list to over eighty stations and am still gathering them in at the rate of four to six a night. Last silent night I was quite successful and up to midnight, when I "signed off," heard 35 stations, eastward to the Atlantic coast, westward to Denver, and from Texas to Ontario and Saskatchewan, Canada. My set is run on WD-11 tubes and is exactly like the original hook-up, except that I put a 1,000-ohm phone coil in series with the primary of the first transformer. It wouldn't oscillate correctly until I did. The wave length range of the stations received was from 254 to 545 meters. Could a neutrodyne beat it?

Yours very truly,  
Henry F. Dever, Wilmette, Ill.

ting the photo out for you, "My Gang"; you, now over 5,000 strong who wrote Maggie. Yes, and you fellows who sent her candy n'everything. Make him work, keep his nose to the grindstone; rope and hogtie him. Yes, all of them kind words and more, too, that's what you fellers wrote her.

'Course, as Maggie says, "It was awfully sweet of you," but man, oh, man, I said just fix it so I could still eat—not a banquet. Let's eat is my motto; then I'm sure, unless there's some company or a dude at the table whose chest measure is the same as mine but with a longer reach. . . Well, it's all there; why pass it and waste so much time? But, anyway, you fellows fixed it—I'll say you did! Can I stay home—can I eat? I'll say I can; listen, the very day your post cards reached the 3,000 mark she let a chicken wink at a pan of hot water and we had chicken soup—and it was fine. Then I brought home a chicken that I was going to teach how to wink, and Maggie nearly made soup of her (you know what I mean). Oh, well, it's all according to where you get your chicken. Certainly! Don't you 'spose I now know that the guy who wrote "Fine feathers make fine birds" never was a cook. He got all of his training listening or peeking at a lace counter.

I've noticed a slight change, though, in Maggie since she received, or got—no, it's received—all those cards, a sort of motherly tenderness, not quite so much rolling-pin attitude. Why, only yesterday at dinner—well, call it supper—anyway as we were eating at six bells, she said: "Don't you wish for another cup of coffee," and I told her I wouldn't.

Maybe I missed her, because she backfired by saying, "Pardon me, do you wish for another cup of coffee?" Well, I never knew you had to wish for it, so thought best to save my dome by playing telephone girl and not answering. Yes, I got by, but had to turn on the radiator to take the chill off the room. Really and truly, the more I think about it, the blacker seems the sky. Well, I'd rather

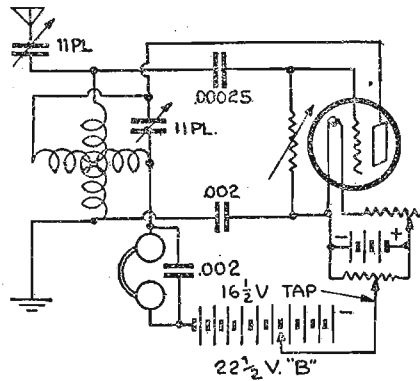

be right than president and she's both, so I guess this is going to be a bad year in our family—especially when you live in a stingy neighborhood and no cellars.

### Which is Best Miloplex Circuit?

And now that you know just how things are at home, please permit me for the first time to step out of the "Mystery Man" character for a moment to answer a most insistent question—sort of from-the-ridiculous-to-the-sublime change.

Hundreds of letters have come to me asking which of my three circuits is the best for the average fan to build who cares nothing about experimenting and who wants to be cock-sure that the circuit will stack up as "A number 1," not a trick circuit exactly but one that is stable and has enough refinements in it to make it well worth while building for keeps.

Friends, listen! If I was going to build one just to please everyone, I'd build two—one of them a three-tube regenerative, the

other a four-tube power amplifier Radio frequency set—which means I would add one more real circuit to my original three. But you insist on only one, so supposin' we run the first diagram today, showing my pet of the three-tube regenerative circuits for everyman's use. Then, next week, two stages of audio amplification; then rest a while, and if enough of you want a real "He" four-tube circuit that has a power amplifier idea in it, I will see that you get it. But build this one anyway; it will well be worth your time and make a lot of sets sit up and take notice. What is it? Nothing more or less than the "Wizard"—yes, the one some of you passed up—the real Wizard Miloplex with one or two slight modifications.

### The Wizard Miloplex Modified

Same old split variometer—and you know now, I don't like moulded ones—same old socket, rheostat, potentiometer and everything. But, it's got more kick than—well, build it you fellows who passed it up because it was too easy. Refining some of the "old liam" timers very often gives you a surprise on volume and DX.

I've made a very important B battery change, also a doubly important variable condenser change, and if you will cut your five-ton aerial down to a single wire around 100 feet long, I am quite certain you will be surprised.

Note particularly that the variable condenser in the antenna is an 11-plate affair, though you may in a pinch use a 21-plate but no larger. While the 11-plate is better, again watch very carefully and note that the connection from the center post of the potentiometer goes to the 16-volt + tap on your B battery; the 22 1/2-volt + connection on your B battery goes to phones, and be certain to try first one, then the other of your phone cord terminals on this + 22 1/2-volt tap. Considerably greater signal strength will result from the proper terminal and besides, you will also avoid the possibility of slowly demagnetizing your phones. Be certain to connect the rotating plates of antenna condenser to antenna side, and make your lead from grid condenser short, yes, very, very short. Don't make square

(Continued on page 22)

### QUIZ R.C.A. MONOPOLY

(Continued from page 2)

following countries, or with concerns in control of the situation in those countries: Norway, France, Germany, Poland, Sweden, Netherlands, South America, Japan and China.

Arrangements have also been "perfected" by the R. C. A. with the land telegraph companies (Western Union and Postal Telegraph) whereby messages will be received at their offices.

#### How R. C. A. Was Born and Nursed Along

A summary of the contracts between the respondents as recited in the Federal complaint is (1) the organization of the Radio Corporation of America in 1919, under the supervision of the General Electric Company which company received large holdings in the stock of the R. C. A. for capital supplied and for its service in connection with the acquisition of the American Marconi Company.

(2) An agreement entered into between these companies granted to the Radio Corporation an exclusive license to use and sell apparatus under patents of the General Electric Company until 1945; and the Radio Corporation grants to the General Electric Company the exclusive right to sell through the Radio Corporation of America only, the corporation agreeing to purchase from the General Electric Company all Radio devices which the General Electric Company could supply. (Later this arrangement was extended to in-

clude the Westinghouse Electric & Manufacturing Company, the business of the Radio Corporation being apportioned between the General Electric Company and the Westinghouse company; 60 percent going to the General Electric and 40 percent to the Westinghouse company.)

(3) Meanwhile, in July, 1920, the General Electric Company and the American Telephone & Telegraph Company made an arrangement for mutual licensing on Radio patents owned by each. This provided for certain traffic regulations. The terms of this agreement were then extended to the Radio Corporation of America and the Western Electric Company, and thereafter to the Westinghouse company.

#### How United Fruit Was Invited In

The Radio Corporation in March, 1921, made an agreement with the United Fruit Company (which operated a number of commercial Radio stations in Central and South America), by which licenses under the Radio patents of the Radio Corporation and of the United Fruit Company (and its subsidiary, The Wireless Specialty Apparatus Company of Boston) were exchanged and arrangements made for the exchange of traffic facilities. The definition of the respective fields of the Radio Corporation and the United Fruit Company was adopted and provisions of the agreements between the R. C. A., the General Electric, American Telephone & Telegraph and the Western Electric companies were also extended to the United Fruit Company.

## Acousticola Grand

\$35<sup>00</sup>

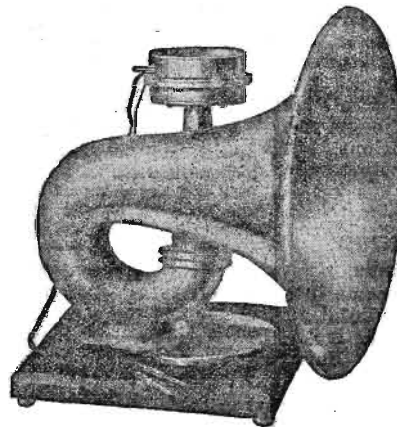

Highest quality Loud Speaker made. CAST ALUMINUM vibrationless horn, extra large and sensitive unit. Adjustment lever tones down local stations and strengthens weak signals from distant stations just like focusing a camera.

## Acousticola

STANDARD \$22<sup>50</sup>  
MODEL

Same wonderful unit, with same lever for instantly increasing or decreasing distance between poles and diaphragm. Fitted with non-metallic horn 21 1/2 inches high with bell 10 inches wide.

### Acousticola Phonograph Attachment

Same giant size unit with coupling to make a high grade loud speaker of any phonograph. . . . . \$10.00

### TRIMM HEADSETS

Dependable . . . . . \$5.00  
Professional . . . . . 7.65

Lifetime guarantee with every Trimm product. Write for folder.

## TRIMM RADIO MFG. CO.

Dept. 63, 24 S. Clinton St.

CHICAGO, ILL.

# VOLTRON TUBES



### LEADERS IN TUBE ECONOMY

Voltrons set a mark of highest quality in tube manufacture. Only the most skilled workers were employed, the most scrupulous tests resorted to. Yet Voltrons sold for considerably less than other tubes. They led in price reduction. They will continue to lead in quality and economy.

All Tubes One Price

Type	Volts	B Battery Amp	Voltages
O. H. 12	1 1/2	.25	15 to 90
O. H. 501-A		.25	15 to 90

\$5

Either from your dealer or sent direct C. O. D. Begin saving NOW—order TODAY!

O. HERSCHKOWITZ, 92 Branford Place, Newark, N. J.  
Dealers and Jobbers—Write for Attractive Proposition

# Radio Digest Illustrated

REG. U. S. PAT. OFF. AND DOM. OF CANADA

Published by the Radio Digest Publishing Company, Inc.  
123 West Madison Street  
Telephone: State 4843, 4844, 4845  
Chicago, Illinois

E. C. RAYNER, Publisher  
Chas. F. Smisor, Editor Evans E. Plummer, Managing Editor  
H. J. Marx, Technical Editor M. W. Thompson, Associate Editor

Eastern Representative, Jacob Miller, Times Bldg., Times Square,  
New York; Telephone Bryant 4909

Member of the Audit Bureau of Circulations

PUBLISHED WEEKLY

SUBSCRIPTION RATES  
Yearly in U. S. and Possessions and Canada, \$5.00.  
Foreign postage, \$1.00 additional. Single copies, 10 cents.

Vol. VIII Chicago, Saturday, February 9, 1924 No. 5

## Powerful Set Wanted

Simple Hook-Ups Desired but Are Not Heart of Set

EVEN the mightiest of the mighty is threatened by newcomers in Radio. Revolutions in this science are occurring so fast that the bystander can do nothing but give way and have patience for the final outcome. There is no use in taking part, no advantage in deciding on a certain receiving set for one's own amusement. For tomorrow that set may be overthrown by another, simpler and better. Such are the uncertainties of a revolutionizing science.

That Radio is in a state of turmoil, of constant change and uncertainty, has never been so attested as it is now. Today a "super set" is hailed as the latest achievement. Tomorrow it may be out of date.

The simple hook-up will come, but only through those necessary parts which cannot be made by persons that can just solder a wire.

## Operations Must Be Learned No Definite Instructions Can Be Given

NO definite laws regarding Radio communication can be laid down by the scientist and authority, as a great many fans have learned by experience. There are too many factors, of which little is known, involved in the operation of this newest science. The questions of static, fading of signals and interference, each of these a problem in itself, are always present to handicap the authority when he attempts to set down certain rules and laws for the fan to follow.

There is nothing definite for the fan to go by in Radio communication at the present time. The only way he can tell is by installing a receiver and experimenting with his antenna and ground system until he achieves perfect reception. It is entirely useless for him to write to an expert hundreds of miles away and ask him how far a certain type of receiving set will reach when installed. The expert cannot tell him. He may advise how to install the set properly to get the best results possible under the local conditions, but that is as much as he can do. The rest is up to the elements.

## Amplification and Interference Necessary Things for the Future of Radio

WHEN the telephone and telegraph first came into use their advent was hailed as "annihilating space." Yet we realize that we never knew the meaning of the term until Radio broadcasting began. Radio has proved the real space annihilator.

Radio telephone conversations have been held between New York, Paris and Honolulu. News of the greatest disaster of modern times, the Japanese earthquake, came to the rest of the world by Radio.

In 1897 Marconi made the statement that dispatches by voice could be sent 20 miles and said he was speaking within practical limits. The distance depends upon the amount of exciting energy and the dimensions of the conductors from which the waves proceed.

But amplification has upset all his calculations. The range of modern Radio communication is the result of amplifying or multiplying millions of times the electrical energy at the broadcasting station and again at the receiving station when it is changed back to sound energy.

In all probability, the biggest development in Radio in the immediate future will be among the farmers and those living in small villages and towns. Putting these families in touch with what Radio has to offer will enrich and expand rural life to a greater degree than even the automobile or the telephone.

Every family in the land contains potential Radiophans, and two factors especially point to the possibility of a Radio development which may eventually mean a set per family in the United States. One is the fact that amateurs need not buy expensive sets, but by a little ingenuity can build their own sets. They get good results, save money, and have a lot more fun building their own than in buying them. Their chief need is caution to buy only reliable apparatus. The transformer is the heart of the set, and this must be of reliable manufacture. We have interference to contend with at present, but progress is being made in this direction and soon this will not retard development.

## RADIO INDI-GEST

### Our Own Idiotorial

NOW WE want an inning. We demand an inning. We must have one so we will take one. All our contemporary column conductors take an inning now and then, so, "Why not I with thine?" Let's consider. Up to the time of going to press, 1,793,485,026 cartoonists have abundantly filled the daily press of this country with cartoon strips featuring two jokes.

It wouldn't be so bad if they'd vary it just a little bit and hop on a couple more of the old standbys, but why in the name of Marconi must these strip artists continue their incessant repetition? But WE will have revenge! We shall BAR the two offending, malodorous so-called jokes. They shall not pass!

Hear ye, hear ye, ye aspiring literati who contribute to our column—the story relating to the man with the ear muffs being taken for a Radiophan by a child and the pun coupling up the opening of a window and cold air with a Radiophan having received a South American republic, are hereby irrevocably barred from appearing in our column. We DARE you to send us anything based on similar premises. INDI.

### When We Had the "Willies"

When Willie was a little boy,  
He had such fiendish ways.  
If we had company at our house,  
'Twas one of his off days.

He'd be so good and play so nice,  
When we were all alone,  
But just when folks were sittin' 'round,  
That boy we could disown.

Time went on and it came to pass,  
Another "Willie" came to us,  
Who ran absolutely true to form,  
With howl and wall and fuss.

When all alone we'd tune in fine,  
And get all stations clear,  
But when strange folk would call at night,  
There wasn't one we'd hear.

So both we called by that same name,  
A contrary pair were they,  
But now a good set we have got,  
And son's outgrown his way.

H. K. C.

### Static Aid from Switzerland

Dear Indi: All this hokum pokum about wave traps hasn't even a butter knife's edge on my Shure Shot Static Trap. For the benefit of humanity I will disclose the details of my brain child to the world through your valued medium. Photograph is given herewith. The cheese not only attracts the static, but has been known to set up its own atmosphere, thus preventing the external atmospherics from atmospherizing.

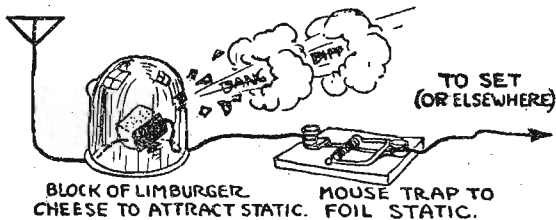

Then as a side issue, the holes often intrigue the static noises into the puzzling myriad of their complexities, thus losing them forever. The mouse trap, when the cheese falls, pins the sky crackles to the base, at the same time it opens the antenna circuit wide, in fact too wide for any self-respecting static to jump. Your welcome. V. L. J.

### Whereto? Galena, Illinois?

Dear Indi: Noting the unceasing inquiry as to my whereabouts and the untiring demand for my souper touch to valuable kinks, I feel duty bound to send in another, so here goes. The subject of my lecture this evening will be, "How to Make Your Crystal Set Cover Any Distance You Desire." Lecture.—Hop a train and take your set there.

CAPACITY JACK.

P.S. Am sending you hunk of coal which at present market prices is worth well over \$001.00. Handle it carefully so as not to get dirty. C. J.

### Here's One 3,000 Years Old

Dear Indi: Howzis?

King Tut had a Radio set,  
It cost him fifty annas  
But all the music he could get  
Was "Yes We Have No Oranges."

PHIL A. MINT.

### But Did He Get Cuba?

Dear Indi: A fellow in our town (the usual way to start) was robbed the other night as he sat at "Old Faithful," his Radio set. The newspaper reporter found that the following conversation had taken place:

Burglar: "Stick 'em up! No fooling, now, or—"  
Radiophan (frantically): "Sh-h-h-h! I've just tuned in Havana, I think. Take anything you want, but SHUT UP!"  
MAMA HAYMES.

### But They Were Martyrs to Science, C. M.

Dear Indi: When the Shenandoah lost her nose thousands of Radio sets lost their "innards." When the great ZR1 sent its Radio SOS, broadcasting ceased without warning, except at ten-minute intervals when announcements were made concerning the big dirigible's position. Hundreds of thousands of sets were being used. One man I know went to sleep with the headphones on depending on the announcements to awaken him.

BUT

think of the thousands of poor, innocent Radio sets that were tuned in during one of the silent intervals. Many a silent set was placed on the operating table that night and dissected mercilessly to locate an absent trouble.

C. M. P.

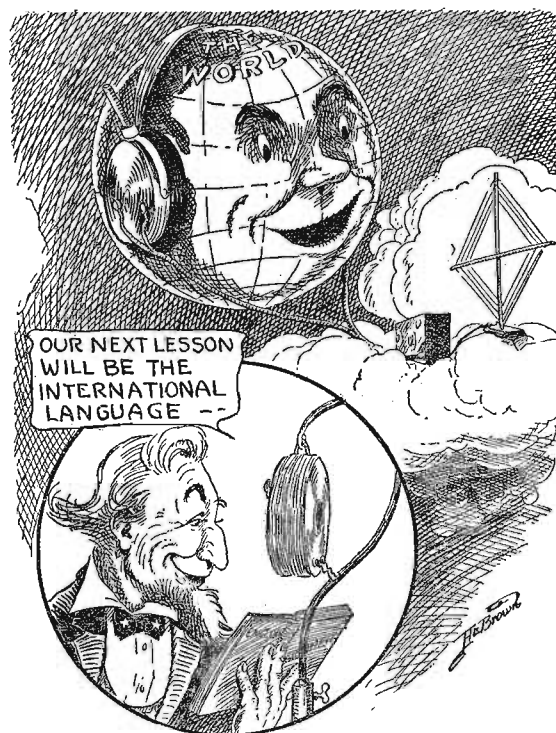

## Condensed

By DIBLECTRIC

Since the special attempt was made to reach across the Atlantic via Radiophony by England and the United States, a greatly increased interest has been manifested on the part of British listeners in to distant reception. They are equipped with several relay stations the business of which is to rebroadcast programs from other countries for the benefit of local fans. Many of our stations are heard with considerable regularity over there and by a large part of the Radio audience, due to this means. Why could not a similar stunt be put on for American listeners at some specified time, just to let them hear what is going on over there?

In conversation with a nurse recently I was informed that her observations of patients having access to a Radio receiver convinced her of its efficacy in relieving sufferers, particularly in cases of mental distress. In this instance a receiving set had been given the hospital where she is employed. Take, for example, the Arnold home for aged men in Detroit, Mich., where the installation of a receiver has brought new life to men whose outlook must be dreary at best. Is there any reason why those who through affliction must spend a part, or all, of their time in an institution would not appreciate hearing all the things that only Radio can bring? What are you doing in your community?

No matter to what political party you vow allegiance, Republican or Democratic, the proceedings of a national convention. May be we won't want to again, but this is to see how few men can pick the candidate you and I shall vote for. Of course, if the newspapers give you all you care to know of what takes place among the hundreds of delegates chosen (ostensibly) to represent you, perhaps the news of both parties contemplating broadcasting their big meetings will not make your dials more alluring. It is very likely, however, that immense audiences of listeners in will be all set to catch every sound coming from the "mike" set up in Public Hall, Cleveland, and from Madison Square Garden, New York City. Lots of us never heard a political convention. May be we won't want to again, but this is something entirely new in Radio.

"It's the same old thing no matter what station you tune to, songs, jazz and crop reports!" Is it? I will readily admit that some of the popular songs have become less popular, due to much repetition; jazz—well, you read the verdict rendered by the listening Radio public; as for the crop reports, they are given but seldom through the day and then not from all broadcasting stations. Was the battle in the air between the ZR-1 and the elements, so dramatically described through WOR, another of those commonplace features? To anyone listening to the announcer asking his unseen auditors for information about the huge airship and, later, giving location and proffers of aid to those on the dirigible, certainly thrills were not lacking. It is the unexpected which makes Radio reception so fascinating a thing.

If you have not too recently joined the clan of Radiophans it will be easy for you to recall the time when colleges had not realized the contribution they might make to educational advance in broadcasting lectures given by members of the faculty. Now, this Radio specialty has found a place in the regular programs of many studios and transmitting apparatus has been installed in a number of the colleges of the country. I know of one instance where the rapid strides in mastering correct use of English, by the aid of a professor's broadcasted lectures, enabled one listener to advance more quickly than would otherwise have been the case. An effort is now being made to have the authorities include the study of Radio in the scientific curriculum of the University of Pennsylvania. It would seem entirely logical to have all educational institutions including scientific courses of study adopt Radio as a subject.



# How and Why of Super-Heterodyne Receiver

## Chapter IV—Loop Aerial and Circuit

By H. J. Marx

WITH the completion of the super-audible transformers and the oscillator, the fan is prepared to start work on the assembly of his set. Many are no doubt wondering why there are three input terminals on all the cir-

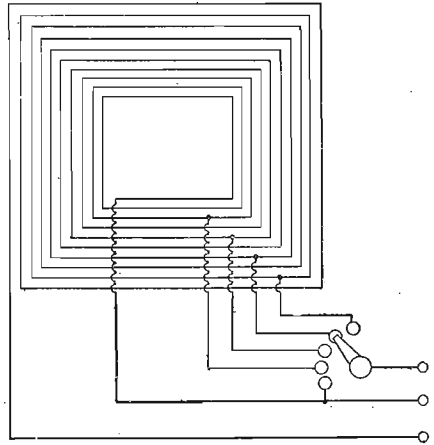

cuit diagrams and how the connections are to be made. With super-heterodyne circuits, owing to their ability to pick up weak signals, it has not been necessary to use an outdoor antenna. The loop aerial is amply efficient and by its directional effect makes the best type of energy collector.

### Loop Aerial Details

In the illustration is shown the connection details of a loop aerial. This loop consists of 10 turns of wire, stranded preferred, wound in the form of a single-layer inductance, on a framework 2 feet square. The turns should be spaced 1/2 inch apart. The two outer ends are connected to the two lower terminals, as shown in the diagram. This shunts the .0005-mfd. variable condenser in the input circuit across the loop for tuning. The tapped switch is connected to the top or grid terminal of the circuit. This tapped connection is made at every second

turn and permits a variation of the actual energy thrown on the grid. This variation of energy thrown on the grid is of decided importance in improving the efficiency of reception.

### Outdoor Antenna

For cases where the use of outside aerials are desired, the usual method of connecting the tapped secondary of an air core neodyne transformer is recommended. This method is shown in the

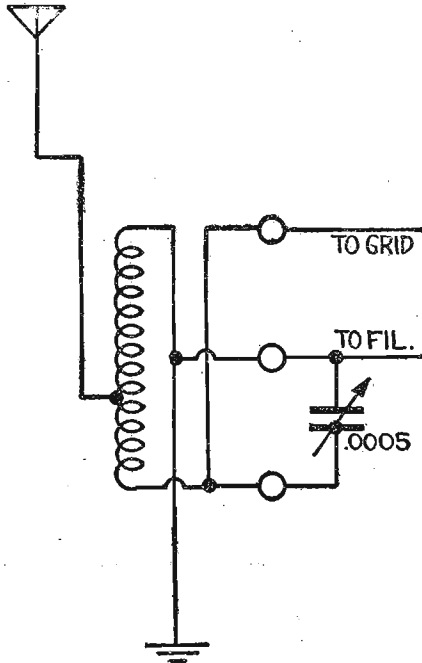
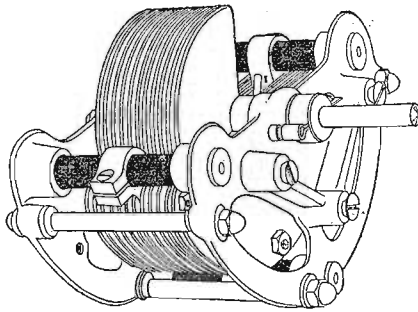

illustration. It is a decided improvement over an aperiodic primary and also avoids the addition of another control if a variocoupler were used.

### Condenser Efficiency

The problem of condenser efficiency is of prime importance. All condensers should



be of the highest quality obtainable, with low leakage losses and also low resistance value. Naturally the minimum capacity should be as low in value as possible. Two condensers of this type are shown in the illustration. These are by no means the only ones available; a number of others are about to be placed on the market. The two illustrated, however, show to best advantage the type of construction which is characteristic of high efficiency design.

### Seven-Tube Circuit

The large illustration shows a seven-tube super-heterodyne circuit using two stages of neutralized Radio frequency,

(Continued on page 26)

## RECHARGE YOUR OWN BATTERIES

Save Your Batteries, Time and Money

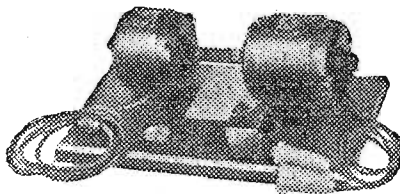

## OHIO Motor Generator CHARGER

A REAL Motor Generator Set

Designed and perfected to fill the need for an outfit that will give positive, dependable, lifetime service. It will quickly recharge any three-cell automobile or Radio "A" battery, even when completely exhausted or badly sulphated. Operates quietly, recharges in one-third time usually required and cannot charge in wrong direction, no matter how connected.

### SPECIFICATIONS

Capacity, 6-10 volts, 3-20 amperes; automatic; needs no watching while charging. Cannot be injured by accidentally short-circuiting generator leads. Ball bearing Ohio Motor and Generator will run quietly and smoothly thousands of hours without further oiling. Equipped with ammeter and rheostat to con-

trol charging rate. Long leads permit plugging in practically anywhere. Made of best materials; well finished; mounted on substantial base; weighs 60 pounds. Regularly equipped with 110 v., 60 cycle A. C. Motor; 6-10 volt Generator. Equipped for other service if desired; prices on application.

WRITE For Full PARTICULARS

Ask us why a good motor generator set is the only real way to charge and keep your batteries in condition and how it will save you money, time and trouble.

Made by one of the leading electric motor manufacturers of the country.

The Ohio Electric & Controller Company  
5910 Maurice Ave. CLEVELAND, O.

# RADIO AT N.Y. PRICES

Via Daily Parcel Post

The Prices Quoted Below Deliver Goods to Your Door

HOW TO ORDER—Write your order plainly; state number, description and price of items wanted. Send Post Office or Express Money Order, personal check or bank draft. REFERENCES: R. G. Dun, Bradstreet, or Corn Exchange Bank, New York City.

- ### BAKELITE TUBE SOCKETS
- Moulded of brown bakelite; Binding Post Connections.
- D99 Standard Type for 201A, 301A, W.D.12.....39c
  - D100 For U.V.199, U.V.299, Socket.....39c
  - D101 For W.D.11, C.11.....39c

- ### FILAMENT CONTROL RHEOSTATS
- Highest grade of material used, tapered knob.
- D104—6 ohm.....\$0.39
  - D105—30 ohm......49
  - D106—300 ohm Potentiometer. .79
  - D107—400 ohm Potentiometer. .79

- ### RADIO SOLDERING IRON
- Indispensable for the man who builds his own sets.
- D109.....\$2.50
  - D133—Soldering Paste, tube......25

- ### AMPLITONE LOUD SPEAKERS
- This speaker will give efficient results when used with any pair of Head Phones; highly nickel plated; 18 inches high.
- D117.....\$3.95

- ### COCKADAY CIRCUIT COMPLETE
- Consisting of
- 1 Cockaday coil and 7 pigtail connections
  - 2 .0005 Variable Condensers
  - 1 Socket
  - 1 Panel 7x12
  - 2 Dials, 3 in.
  - 1 Grid Leak and Condenser
  - 1 Rheostat
  - 1 Switch Lever
  - 1 Base Board
  - 12 Ft. Bus Bar
  - 7 Switch Points
  - 7 Marked Binding Posts
  - 1 Jack
- Wiring Diagram and Instructions
- D-178—Our Price.....\$9.95

- ### WOOD CABINETS
- Highest grade Mahogany finish Cabinets. Hinged top. These cabinets are being sold at less than one-half regular value.
- D57 Wood Cabinet; panel size 7"x10", Ea.\$2.50
  - D58 Wood Cabinet; panel size 7"x12"..... 2.75
  - D59 Wood Cabinet; panel size 7"x14"..... 3.00
  - D60 Wood Cabinet; panel size 7"x18"..... 3.50
  - D61 Wood Cabinet; panel size 7"x21"..... 3.75
  - D62 Wood Cabinet; panel size 7"x24"..... 4.00
- Baseboards (Mahogany Stained) for use with above cabinets
- 7x10.....25c
  - 7x12.....30c
  - 7x14.....35c
  - 7x18.....40c
  - 7x21.....45c
  - 7x24.....50c

- ### MISCELLANEOUS
- D163 Spaghetti Tubing, per yd.....\$0.09
  - D164 Synthetic Crystal......30
  - D165 Ground Clamps......17
  - D166 Black Rubber Binding Posts......05
  - D167 Nickel Plated Binding Posts, 2 for......05
  - D168 No. 18 Annunciator Wire, half pound coil. .39
  - D169 6 ft. Phone Cord with Tips......79
  - D170 20 ft. Extension Cord with Tips.....1.95
  - D171 Wall Insulators, Porcelain......05
  - D172 Tubular Porcelain Lead-in Insulators, 6-in. .10
  - D173 Reinartz Coil.....1.45
  - D174 Cockaday Coil.....2.42
  - D175 2 in. Dial and Knob......25
  - D176 3 in. Dial and Knob......35
  - D177 4 in. Dial and Knob......49

- ### PLATE CIRCUIT "B" BATTERIES
- The highest grade of battery made at prices lower than they ever were sold before.
- D80—22 1/2 Volt Small.....\$1.15
  - D81—22 1/2 Volt Medium.....1.45
  - D82—22 1/2 Volt Large.....1.95
  - D83—45 Volt Medium.....1.95
  - D84—45 Volt Large.....2.50
  - D85—45 Volt Extra Large.....3.50
  - D86—360 Hour 1 1/2 Volt Twin Double Duty "A" Battery......75

## 2-LO, LONDON, ENGLAND ON ONE TUBE

Another Record for the

# ELGIN SUPER-REINARTZ

Tuesday, November 27, during the test period between 9 and 9:30 P. M., Rev. E. A. Cole in the residence of J. A. McIver, of Roodhouse, Ill., while operating a set made of materials and in accordance with the hookup furnished by the ELGIN RADIO SUPPLY CO., tuned in 2-LO, London, England, using receivers and but one tube. Later another tube was lighted and the loud speaker used, so that four people could hear the program and concluding announcement. The numbers, time, and the order in which they were played were

### Officially Confirmed

by the St. Louis Post Dispatch in conjunction with the National Association of Broadcasters, who had charge of the tests. (See page 34, St. Louis Post Dispatch, Dec. 2, 1923.) This same hookup has been advertised extensively as the one which brings in stations 2000 miles overland on a loud speaker and one tube; and this has been demonstrated so often as to need no repetition.

Send a two-cent stamp for circular giving one, two, and three tube hookup, and price list of parts for this remarkable circuit. Address the

**ELGIN RADIO SUPPLY CO.**  
207 Chicago St. ELGIN, ILL.

ESTABLISHED 1899

71 Cortlandt Street  
NEW YORK, N. Y.

America's Greatest Radio Mail Order House  
ELEVEN NEW YORK STORES

ADVANCE PROGRAMS

(Continued from page 17)

WLW, Cincinnati, Ohio (Central, 399), 9:30 a. m., Sunday School Editorial Staff of Sunday School Publications of the Methodist Book Concern; 11:00, Services, Church of the Covenant, Dr. Frank Stevenson, minister; 7:45, Service, Church of the Covenant, Dr. Frank Stevenson, minister.

Monday, February 11

CKAC, Montreal, Can. (Eastern, 425), 1:45 p. m., Rex Battle and his Mt. Royal Hotel Concert Orchestra; 4:30, Joseph C. Smith and his Mt. Royal Dance Orchestra.

Portingall, saxophone and vocal solos; 9:00-9:15, Sam Coslow, tenor; 9:15-9:45, "Broadway Melodies"; 10:00-10:15, Alfred Dulin, pianist; 10:15-10:45, Chic Winter's Empire State Theatre.

Phantom Circuit

The hook-up shown has proved very satisfactory. It gives louder signals on CW and phone transmission than by using the regular antenna and coupler.

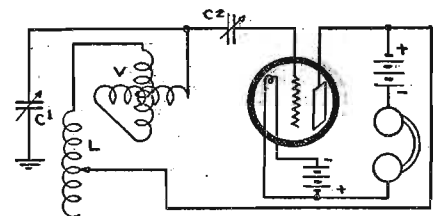

used, but a variable one is much better. The coil L is about 54 turns of Number 22 wire, tapped in nine places, or every six turns. The tuning is done with the switch and C1, while C2 controls the oscillations.

KING MILOPLEX

(Continued from page 17)

turns in your wiring. The shortest distance between two points is a straight line. Run your wiring as short as possible—never mind how it looks.

Operation of Wizard

In operating, turn on filament rheostat just to the ragged edge of the hiss point, then throw the dial out the window—well, all right, keep it if you will promise not to go beyond that very slight hiss point.

Ground Connections

What is the best ground connection? Using tubes, the ground is perhaps more important than the aerial. Many sets will operate on ground alone.

(TO BE CONTINUED.)

lators until it reaches the pipe. The actual ground is where the pipe enters the earth, not where the wire touches the pipe.



Use the ANTENNELLA

attached to any lighting socket, eliminating the inconveniences in Radio such as unsightly outdoor aerials, insulators, lightning arresters, lead-ins, etc.

Hundreds of unsolicited letters from satisfied users are on file in our office, showing that the

ANTENNELLA

is not only a real distance getter, but also successfully overcomes static annoyances.

ANTENNELLA

The complete, efficient and inexpensive aerial.

Price Only \$1.25

At your dealers—otherwise send purchase price and you will be supplied postpaid.

Chas. Freshman Co. Inc. Radio Condenser Products

106 Seventh Avenue NEW YORK

BLUE PRINTS



Make Your Own Sets

Miloplex

- Three Tube Receiver Detector and Two Stage Audio Frequency Amplifier Assembly Details Tuning Instructions Blue Prints

Reflex De Luxe

- Three Tube Receiver Full Details for Assembly Blue Prints Tuning Instructions How to Make a Loop Aerial De Luxe

Price Only 50c Each

Send Only Money Orders. No Checks or Stamps. Coins at Your Own Risk.

RADIO DIGEST PUBLICATIONS 123 West Madison St., Chicago

Reinartz

- Three Tube Receiver Detector and Two Stage Audio Frequency Amplifier Assembly Details Tuning Instructions Blue Prints

Flewelling

- Three Tube Receiver Detector and Two Stage Audio Frequency Amplifier Assembly Details Tuning Instructions Blue Prints

RADIO DIGEST PUBLICATIONS 123 West Madison Street, Chicago, Ill. Check Books Desired

- REFLEX DE LUXE.....50c Miloplex.....50c Reinartz.....50c Flewelling.....50c

I am enclosing M. O. for \$.... Name Address City State

2-2-24

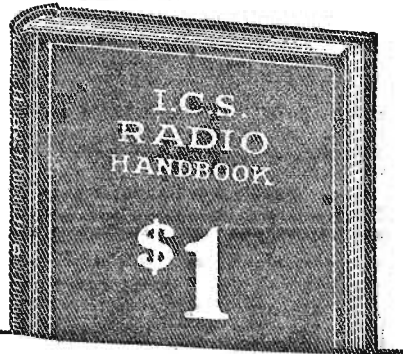

This RADIO BOOK will save you money!

Compiled by HARRY F. DART, B.S.E.E. Formerly with the Western Electric Co., and U. S. Army Instructor of Radio Technically edited by F. H. DOANE

JUST off the press! The greatest book on radio ever written. Price only \$1. Filled with sound, practical, tested information for every radio fan, from beginner to hard-boiled owl.

Every page tells you something useful. And there are 514 pages! More than 150 illustrations and diagrams!

You may dip into this I. C. S. Radio Handbook at random, or hunt up special information you want, or read it right through. Different types of receiving and sending hook-ups are explained; proposed insurance regulations; lists of broadcasting stations; radio compass stations; interesting experiments; definitions; codes and symbols; technical data; and thousands of suggestions for getting more pleasure out of radio.

Send \$1 to-day and get this 514-page I. C. S. Radio Handbook before you spend another cent on parts. Money back if not satisfied.

INTERNATIONAL CORRESPONDENCE SCHOOLS Box 8275-F, Scranton, Penna.

I enclose One Dollar. Please send me postpaid—the 514-page I. C. S. Radio Handbook. It is understood that if I am not entirely satisfied I may return this book within five days and you will refund my money.

Name Address

For Transmission or Reception! 'FRESHMAN SELECTIVE' Mercury Variable Condenser

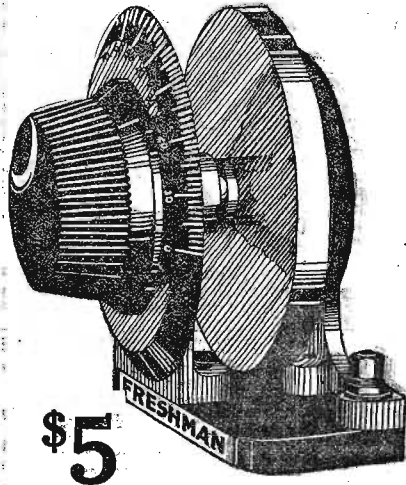

It has been conceded by the Foremost Radio Engineers that a Variable Condenser with Mercury plates is the most efficient for fine adjustment and selective tuning. Our engineers, after exhaustive experiments and research work, have developed a Variable Condenser with Mercury plates separated by heavy Mica dielectric.

- No Leakage Absolutely quiet No plate vibration Will stand 5,000 volts Compact and attractive Plates cannot collect dirt Cannot become short circuited

.0003 m.f. (equivalent to 17 plate) All Types \$5 .0005 m.f. (equivalent to 23 plate) .001 m.f. (equivalent to 43 plate)

All Molded Parts and Dial of the Finest Bakelite

At your dealer, otherwise send purchase price and you will be supplied postpaid. Ask your dealer or write us for free diagrams on Neutrodyne, Tri-Flex, Kaufman and other circuits.

Chas. Freshman Co. Inc. Radio Condenser Products

106 SEVENTH AVE. NEW YORK

# Simple Explanation of Radio for Everybody

## Chapter X—Part II—Loud Speakers

By M. W. Thompson

THE following article is the twentieth of a series for Radio beginners, written by Marvin W. Thompson, well known in air-phone circles for his understandable style of approaching his subject. The remaining chapters will be:  
Chapter XI—Dry Cells and Storage Batteries.  
Chapter XII—Radio Frequency Amplification.

THE perfect diaphragm, or one that would be sufficiently good for most of us, would have an intensity curve like that shown in Figure 78. For notes below 50, the efficiency would be gradually rising and it would reach maximum on notes around 100. The intensity line would be flat to notes around 5,900, after which it would drop to zero at 6,000. True, some of the higher harmonics of the upper fundamentals would be lost, but reproduction would be most satisfactory. Unfortunately, due to the increasingly di-

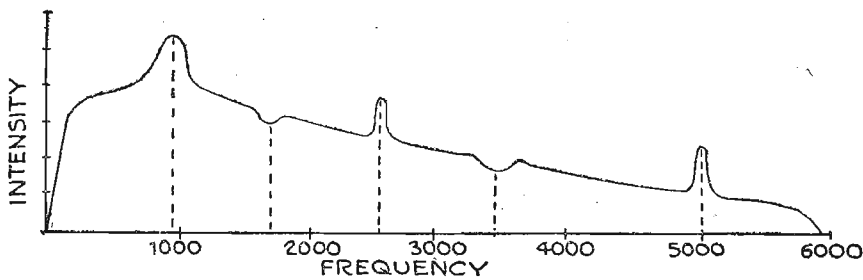

Figure 79—The diaphragm response is usually as shown here, the natural period being at 990 cycles.

other means of setting the air in vibration is essential.

The small chamber behind the diaphragm receives but little consideration in most loud speakers, although it can play quite an important part in the faith-

reinforce the vibrations which enter it due to the resonance properties of the body of air inclosed by it. The quantity and quality of this resonance depends mainly upon the volume of the inclosed air and somewhat upon its shape. Con-

stant to any of the frequencies found in the musical scale, is not completely dead and lifeless.

Unusually rigid material, such as stone or thick metal or compositions made of wood fiber, gives the best results. If the walls of the horn are smooth and rigid, they produce no appreciable effect upon the tone. If, on the other hand, they are rough or flexible (resonant), they may absorb or rapidly dissipate the energy of the air vibrations at certain frequencies and thus, by subtraction of certain harmonic overtones, have a marked influence upon tone quality. This would inject depressions or valleys into our curve of Figure 79 and make it appear as in Figure 80. A resonant point on the 1,750 notes will give the depression noted at that point and also a marked weakening on the first multiple, or 3,500.

### Shape of the Horn

The shape of the horn also affects that which comes out. Every curve and corner, twist and surface on the inner side

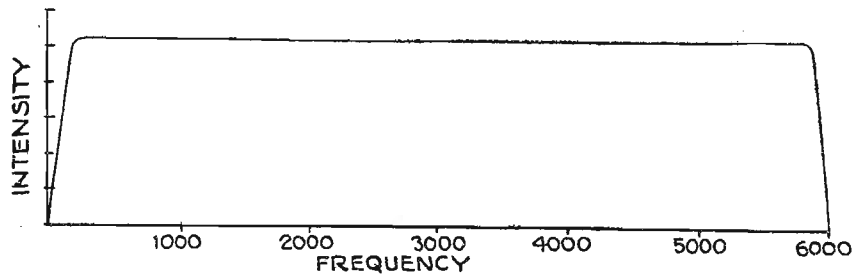

Figure 78—The efficiency curve of a perfect loud speaker would show equal response at all frequencies.

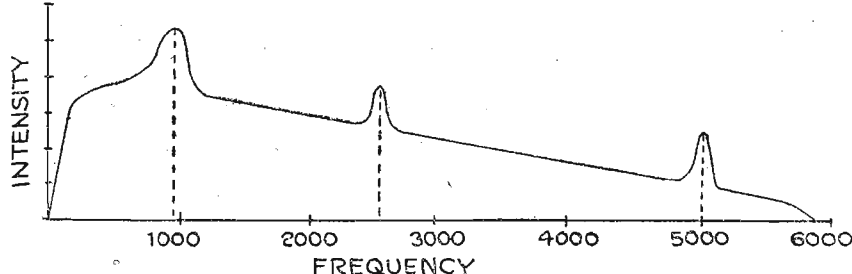

Figure 80—Many horns dissipate energy at certain frequencies, causing dips in the curve.

vided response on higher notes, the curve for even the best present-day loud speakers looks much like Figure 79. The peak at about 990 is due to the natural frequency of the diaphragm; those at 2,500 and 5,000 are due to certain harmonics at which the diaphragm vibrates well. The intensity, for the reasons given above, falls off and there is a pleasure-wrecking weakness of the high notes and a flat shrillness to them due to the elimination of their harmonics. The elimination of the diaphragm with the necessary substitution of some

fulness of the reproduction. It is, as a rule, air-tight, and the air within it must expand and contract with the diaphragm. This air has a natural resonant point. Both of these factors react on the diaphragm, adding more bumps to the reproduction curve, which mean distortion.

### The Horn Part

This brings us to the horn. Contrary to the general impression, the amplifying action on sound waves is not due to the horn vibrating and acting as a sounding board. The effect of the horn is to

changes the direction of the outpouring waves. The flare of the horn has a great influence upon the response; widening the

(Continued on page 26)

## THORDARSON

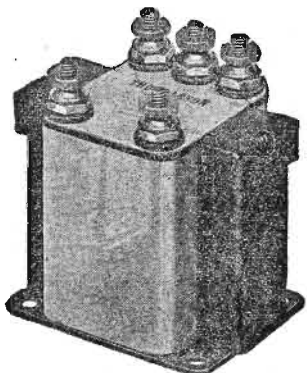

**POWER AMPLIFYING TRANSFORMERS**  
Price per pair, \$13.00

The new Thordarson Power Amplifying Transformers (push pull) are designed for use as third stage audio frequency amplifiers, to provide high power amplification for operating loud speaking devices.

With power amplification, not only is it possible to increase volume, but, since two tubes replace the usual one, the distortion and howling which usually accompany the overloading of a single tube on the third stage is done away with entirely.

The Thordarson Power Amplifying Transformers are well constructed electrically and are capable of indefinitely carrying the additional load without breaking down.

In tonal purity these transformers equal the Thordarson Super Audio Frequency transformer whose rich quality and even amplification has made it the popular transformer of the day.

**THORDARSON ELECT. MFG. CO.**  
500 W. Huron St. CHICAGO

### CLEAR RECEPTION ASSURED

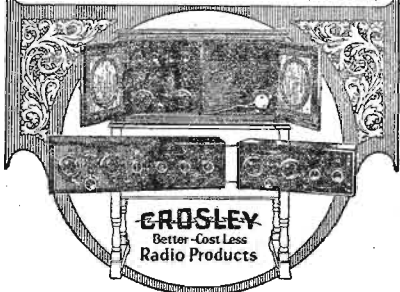

A Crosley brings in distant Stations Easily.

Listen to Crosley Broadcasting Station WLW.

NO MATTER which Crosley Receiver you choose, you can be assured of unexcelled performance at the lowest price. The Model X-J has proven especially popular. With it, Stations in all parts of the United States and Canada may be clearly heard. Even Honolulu has been frequently brought in from the eastern seaboard.

### Compare These Prices

- Crosley Model VI—a Two Tube Set .....\$ 30
  - Crosley Model X-J—a Four Tube Set .....\$ 65
  - Crosley Model X-L—a Four Tube Console .....\$140
  - Special Mahogany Stand for Model X-L, \$25
- For Sale by Good Dealers Everywhere.

Write for free Catalog.

### The Crosley Radio Corporation

Powel Crosley, Jr., President  
Formerly The Precision Equipment Company and Crosley Manufacturing Company  
2492 Alfred St., CINCINNATI, OHIO  
The Largest Manufacturers of Radio Receivers in the World

## World's Biggest Battery Bargain



Hydrometer and "B" Battery FREE

Proof of Performance 2-Year Written Guarantee

### READ THIS SPECIAL NEW YEAR'S OFFER. THEN ACT!

Thousands of Radio Digest Readers will profit by this amazing offer. They will buy the famous 2-year guaranteed World Battery at the lowest price ever quoted. They will get a hydrometer and a "B" Battery FREE. And they get the best battery built. It is "World" quality that makes possible our 2-year ironclad guarantee. It is "World" quality that makes "World" owners "tell their friends." That's the best proof of performance any product can have.

### SEND NO MONEY

You need not send a penny. Just clip this ad and attach your name and address. The battery will be shipped to you the day your order is received. When the battery arrives, inspect it—read our 2-year guarantee before you pay one penny. Convince yourself you are protected from every angle—that the World battery price saves you 50%. Get the "B" Battery and hydrometer FREE. Order today.

### COMPARE THESE PRICES: Special 200-hour Rechargeable Storage Batteries

- 2 Volt for WD-11 and 12 Tubes.....\$ 5.00
  - 4 Volt for UV-199 Tubes..... 8.00
  - 6 Volt 60 Amp..... 8.50
  - 6 Volt 80 Amp..... 10.00
  - 6 Volt 100 Amp..... 12.50
  - 6 Volt 120 Amp..... 14.50
  - 6 Volt 140 Amp..... 16.00
- 5% Discount for Cash with Order.

Special New Year's Offer

World Battery Co., Dept. L, 60 E. Roosevelt Rd., Chicago, Ill.

Clip and mail this ad with your World battery order and get this hydrometer and "B" battery FREE.

# World

Send your order today.

## Coto

"Built First to Last"

## Coto Special Audio Frequency Transformer \$2.50

A MARVEL of manufacturing economy brings this remarkable audio transformer to you at a popular price.

Turn ratio is 3 to 1. Gives you ample volume and full, rich tone. Finest of materials. Coto quality throughout.

If your Dealer cannot supply you write us giving his Name

### COTO-COIL CO.

87 Wilford Ave., Providence, R. I.  
BRANCHES  
Los Angeles: 329 Union League Building;  
Minneapolis: Geo. F. Darling, 705 Plymouth Building;  
Atlanta: C. P. Atkinson, Atlanta Trust Co. Building.  
CANADA: Perkins Elec. Co., Ltd., Montreal, Toronto, Winnipeg.

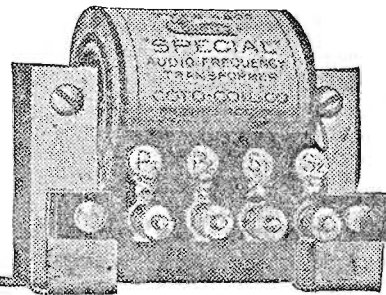

# The Interference Problem in Radio

By E. F. McDonald, Jr., President of the National Association of Broadcasters

**I**N ANALYZING the Radio interference situation at the present time, it should always be remembered that while broadcasting is of paramount importance to millions of people throughout the country, there are other phases of the Radio industry which must be considered and upon which depend much of the commerce of the world. Trans-Atlantic and ship-to-shore Radio traffic are of vital importance.

The work of the serious Radio experimenter is also of the highest value in furthering the advancement of the Radio art. In order that the broadcast listener may get the most out of his receiver, a thorough knowledge of the causes of the interference which he occasionally experiences, together with the various means available for their reduction or elimination, is essential.

### Two Most Frequent Causes of Trouble

There are, of course, various types of interference occasioned by different causes. The two most annoying at the present time are telegraph code interferences from ship and shore stations working on low wave lengths of around 450 meters, and the re-radiation of receivers of improper design or improperly operated by unskilled users. It is to the interest of all participating in the Radio industry to assist in correcting these conditions as well as the other causes of interference.

The National Association of Broadcasters have conferred with Secretary of Commerce Herbert Hoover on the subject of ship interference, and through his efforts and co-operation are arranging for international regulations providing for the carrying on of ship-to-shore traffic on wave lengths outside the broadcasting band. This article, therefore, deals only with the interference created by re-radiation from Radio receivers.

### Legislation Cannot End Bad Conditions

It is a popular fallacy that all that is necessary to put a stop to any undesirable condition is the passing of legislation. Unfortunately this idea has occasionally taken root and grown into something that constitutes a real menace at the heart of our American civilization. There is nothing more detrimental to the morale of a nation than the adoption of legislation which is obviously impossible of enforce-

ment and which, through the ease with which it may be ignored, teaches wholesale disrespect not only for the law but the authorities that make laws.

We have, at the present time, no better example of an "iron-clad" law which, so far at least, has been impossible to enforce, and which has possibly worked a greater evil than that which it was designed to eliminate—than the prohibition amendment.

### Patriotism Only Successful Force in War

During the war the navy department undertook through its intelligence service to prohibit the use of transmitting and receiving apparatus throughout the country. The prohibition on transmitting was comparatively easy to enforce, but, notwithstanding every effort to eliminate reception, in the final analysis it came down simply and squarely to reliance on the loyalty and patriotism of the individuals which go to make up our great nation.

Obviously the individuals who really desired to use Radio for ulterior purposes had no such sense of loyalty, and as a consequence, to a great extent, all that was accomplished was the prohibition of the use of receivers in the hands of those who would not use them in any case to the disadvantage of the country, whereas it was practically impossible to stop the use of such apparatus in the hands of those intent on serving their own ends.

### Adopted Legislation Could Not Be Enforced

For these reasons, the adoption of legislation prohibiting the use of receivers which feed back energy into the antenna is obviously absurd. The adoption of an act of this kind would be comparatively easy, but the enforcement would require a greater force of officers and special agents than we have at the present time attempting to enforce prohibition. Certainly our government cannot afford such an expenditure even if it were possible to completely eliminate re-radiation by such means.

It should be remembered that, in the first place, the locating of the offending receivers which feed back into antennae would be comparatively difficult, and even were they located, it would be a simple matter for the user of a set of this kind to disconnect the tickler coil, or whatever means was used to feed back the energy, while the inspector was present, and at-

tach it the moment he left. The enforcement of any such act would also be rendered extremely difficult because of the statutes prohibiting the entrance of private dwellings without proper search warrants.

### The Solution to the Problem

Granting that the feed back from receiving sets is harmful and that preventive legislation, if not impossible, at least is impractical, what is to be done?

Obviously the solution to the problem is constructive action on the part of the Radio manufacturer. At the present time the laboratories of eight of the largest manufacturers of receiving apparatus are at work night and day on the production of a simple device to be connected ahead of receivers feeding back, which will not allow the passing of this energy out to

the antenna. Such a device, when developed and perfected, will be put on the market by the manufacturers, according to an agreement among them, at practically actual cost, so that the users of all types of sets will have the benefit of the device without undue expense.

It is not fair or reasonable to expect the users of feed back receivers to junk and throw away apparatus representing the investment of many hundreds of thousands of dollars, when by the addition of some simple device the re-radiation can be entirely removed and reception improved.

The public will not be hard to persuade to use a device which will cost little and which will not only through reciprocity eventually eliminate all feed back howls,

(Continued on page 30)

**SUPER VALUES**

**NEW COCKADAY FOUR CIRCUIT RECEIVER**  
**ALL PARTS** As specified by Mr. COCKADAY OUR PRICE **\$59.00**  
 LIST PRICE, \$75.00

Solid Mahogany Cabinet for above set, \$7.50 Extra  
**GENUINE FOR 5 TUBE SET**

**Fada-Hazeltine** List Price .....\$65.60  
**Neutrodyne Parts** Our Price .....\$50.15  
 You Save \$15.45 by Buying Through Us

**RESISTANCES—Genuine P. L. Original Lavite**  
 48,000 OHMS .....\$1.00 100,000 OHMS .....\$1.00

We Are Prepared to Supply Dealers. Write for Our Proposition.

We Have Just Received a New Shipment of **OUR PRICE**  
**THE NEW MODEL D. N. K. & K. PHONES \$6.50**  
 MADE IN GERMANY

WE GIVE A 20% DISCOUNT On All Standard Radio Apparatus Not Listed Above  
 ALL MAIL ORDERS SHIPPED PROMPTLY. SEND MONEY ORDER, INCLUDING POSTAGE.  
 The RADIO MAIL ORDER HOUSE—Known for Low Prices. Write for Our Catalog B

**HANES-ZENER**  
 3 WEST 29TH STREET, NEW YORK CITY



**UV-201-A**

Radiotron UV-201-A is a high-power vacuum tube which, while suitable for a detector, is intended primarily to be used as an amplifier, at either radio or audio frequency.

It is famous for volume, for clearness and for economy of service—drawing but .25 ampere.

**Price \$5.00**

Be sure that every vacuum tube you buy is marked **RADIOTRON.**

**Radio Corporation of America**

Sales Offices—Dept. 312  
 233 Broadway, New York

10 South LaSalle St., Chicago, Ill. 433 California St. San Francisco, Cal.

**Radiotrons**  
 REG. U. S. PAT. OFF.

An Absolute Guarantee with every instrument made them famous!

**SHAMROCK** FOR SELECTIVE TUNING

**180° Vario-Coupler** list price \$3.50 each

**DOUBLE DUTY PIG-TAIL Variometer**

**SHAMROCK MFG. CO.**  
 318 E Market St. Newark N.J.

Standard Merchandise Only	S. HAMMER RADIO CO. 303 ATKINS AVE. BROOKLYN, N. Y. All Sales on a MONEY BACK GUARANTEE	Anything and Everything in Radio
<b>BLUE PRINT FOR THE IMPROVED COCKADAY 4 CIRCUIT RECEIVER.....\$1.50</b>		
<b>\$65.00 GENUINE FADA PARTS FOR 5 TUBE NEUTRODYNE SET.....\$54.00</b>		<b>A 5 TUBE NEUTRODYNE set with Genuine Fada parts, wired complete in Mahogany Cabinet without tubes or batteries.....\$85.00</b>
List	Our Price	List
\$ 2.25 Filkostat.....\$ 1.90		\$71.00 AMPLEX KIT.....\$56.50
2.00 Bradleystat.....1.75		1.80 11 Plate Variable Condenser.....1.65
2.00 Bradleyteak.....1.75		2.30 17 Plate Variable Condenser.....2.05
<b>PHONES</b>		2.50 23 Plate Variable Condenser.....2.25
\$ 5.00 Turney 3000 Ohms.....\$ 2.75		3.50 43 Plate Variable Condenser.....3.00
12.00 Western Electric.....10.50		4.00 11 Plate Vernier with Bakelite Dial.....3.50
6.00 Brandes.....4.75		4.50 23 Plate Vernier with Bakelite Dial.....3.95
12.00 Baldwin.....7.95		5.00 26 Plate Vernier with 4-in. Bakelite Dial.....4.75
7.00 Federal.....4.95		5.00 43 Plate Vernier with Bakelite Dial.....4.45
6.00 Potter Precision.....4.15		1.00 8 Ohm Rheostat with knob......95
<b>TRANSFORMERS</b>		1.25 30 Ohm Rheostat with knob.....1.10
\$ 7.00 Federal No. 65.....\$ 5.45		1.25 6 Ohm Rheostat with dial.....1.10
5.00 Acme.....3.85		1.50 30 Ohm Rheostat with dial.....1.35
5.00 All-American.....3.85		1.50 400 Ohm Potentiometer with knob.....1.30
7.00 Amertran.....5.75		1.75 400 Ohm Potentiometer with dial.....1.55
5.50 Thorlarsen.....4.50		2 inch Bakelite Dials......40
12.50 Como Duplex Pushpull, pair.....10.50		3 inch Bakelite Dials......60
5.09 Altracy.....3.95		4 inch Bakelite Dials.....1.00
5.00 Modern.....3.95		Lavite Resistances, 48,000 ohms.....1.25
5.00 Erla.....4.25		Aplex Grid-densers.....1.25
5.00 Amplex.....4.25		5.50 Cockaday Coils, Genuine Precision.....4.50
<b>BATTERIES</b>		Tube Socket, table mount.....1.00
\$ 5.50 45 Large Eveready or Cyclone.....\$ 4.25		Tube Socket, panel mount.....1.25
2.75 45 Small Eveready or Cyclone.....2.45		<b>LOUD SPEAKERS</b>
2.75 22 1/2 Large Eveready or Cyclone.....2.45		\$30.00 Music Master.....\$24.00
1.50 22 1/2 Small Eveready or Cyclone.....1.35		35.00 Magnavox.....29.00
<b>CONDENSERS</b>		25.00 Dictogrand.....18.00
\$ 2.00 Signal 11 plate.....\$ 1.40		55.00 Western Electric 10-D.....45.00
2.50 Signal 23 plate.....1.60		30.00 Stromberg Carlson.....24.00
2.75 Signal 43 plate.....1.65		<b>VARIOCOUPERS</b>
2.50 Admiral 11 plate.....1.45		\$ 3.50 Fisher 180 deg. or straight.....\$ 2.50
2.75 Admiral 23 plate.....1.65		3.50 Workrite 180 deg.....2.95
3.25 Admiral 43 plate.....1.80		3.00 Gilfillan.....6.00
6.00 Hammarlund Vernier 11 plate.....4.95		4.00 Simplex 180 deg., silk wound.....2.60
6.50 Hammarlund Vernier 23 plate.....5.65		3.25 Shamrock.....3.50
7.00 Hammarlund Vernier 43 plate.....6.25		4.00 Sleeper Fixed.....3.25
4.50 U. S. Tool Vernier 11 plate.....3.50		7.00 All Wave.....5.50
5.00 U. S. Tool Vernier 23 plate.....3.75		
5.50 U. S. Tool Vernier 43 plate.....4.25		

ALL MAIL ORDERS SHIPPED PROMPTLY. Orders over \$5.00 will be shipped prepaid. Money orders or C.O.D. Write for Price List. Not insured, unless insurance charges included.

**WEIGHS ONLY 8 OZ**

**The Scientific**

**SEND NO MONEY!**

20,000 TURNS EQUIVALENT TO 3,000 OHMS

**Order TODAY by Postcard and Pay Postman on arrival**

**LOUD SPEAKER UNIT \$1.95**

**THE PHONE IT TOOK A SOLID YEAR TO DESIGN**

**\$2.95**

**POST PAID**

**We Guarantee** The Scientific Headset to be the greatest value on the market. Try it for five days. If not satisfactory send it back and your money will be refunded immediately. Circular on request. Dealers wanted.

**THE SCIENTIFIC ELECTRIC WORKS**  
 98 Brookline Ave. DEPT. W. BOSTON, MASS.  
 Agents for New York and Vicinity—AMBASSADOR SALES CO.,  
 74 Cortlandt St., Phone Cortlandt 6296

# Reflexing Four-Tube Neutrodyne Receiver

## Inserting a Crystal in the Popular Circuit

By H. J. Marx

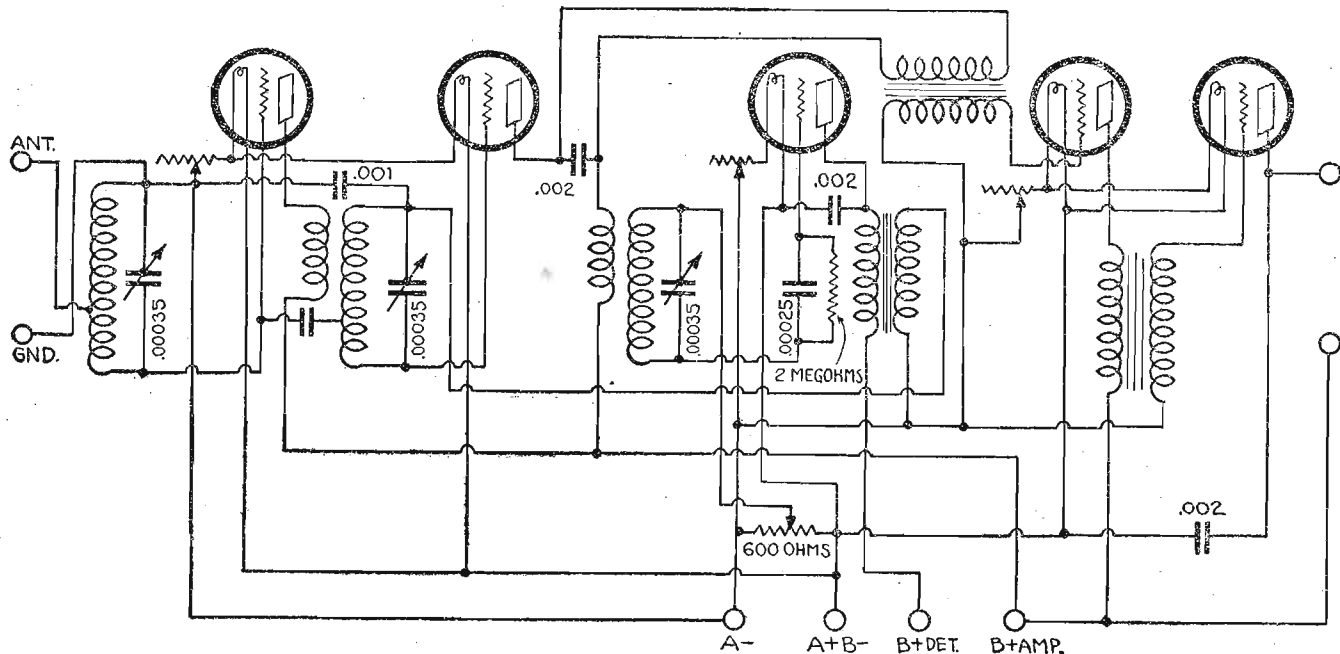

**T**HERE have been a number of efforts to discredit the possibility of using the reflex type of circuit in conjunction with the neutrodyne principle. No real reason exists, however, why the neutrodyne circuit should not be reflexed, and this without loss of efficiency but retaining the gain accruing from the elimination of one tube.

### More Volume

A number of fans have stated that they would like a little more volume from their five-tube neutrodynes. This article is primarily intended to detail the changes necessary for reflexing one stage of the audio frequency and then using the fifth tube for an additional stage of audio frequency amplification.

The additional parts required are one audio frequency transformer and a few by-pass condensers. Jacks can be added if desired.

Naturally, if only one stage is reflexed, the fan will have no trouble in construction and operation. It is only when two stages are reflexed that we meet the more serious problems of tube efficiency, proper by-pass condenser values, interference in leads, oscillation control of the tubes, and the ratios of the transformers. Few fans have had trouble with single-tube reflex circuits; it's the multi-tube reflexes that cause the gray hairs.

### Making Change on Five-Tube Set

In making the change on a five-tube set, the lead between the plate of the second

tube and the third neutroformer is opened and the primary of the extra audio transformer is connected in series, with a .002 condenser across it. The secondary of this transformer is connected to the grid and filament of the fourth tube. The secondary of the audio transformer, after the detector tube, is connected in series with the grid return of the secondary of the second neutroformer. A by-pass condenser is then added from the neutroformer filament terminal to the negative battery lead. This then completes the alterations for reflexing one stage.

### Four Tube Set

For those fans who want a four-tube set the last tube can be eliminated. This gives a very efficient receiver that meas-

ures up well with any five-tube neutrodyne.

### Heavy Wire Used

In circuits where a single turn of wire constitutes the primary inductance, heavy wire should be used, preferably number 12 or 14. A strip of copper ribbon, 1/4 inch wide and properly insulated from the secondary, will serve very well.

## RADECO Safety Fuses

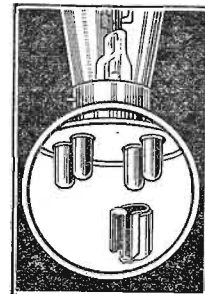

Are protecting countless Radio Tubes

### DEALERS

Add this profitable sales maker to your line and make satisfied customers. If you are not handling this fast selling specialty, write us at once.

## Radio Equipment Co.

New England's Oldest Exclusive Radio House

20 Stuart St. BOSTON, MASS.

## FAHNESTOCK'S LATEST RADIO HELP

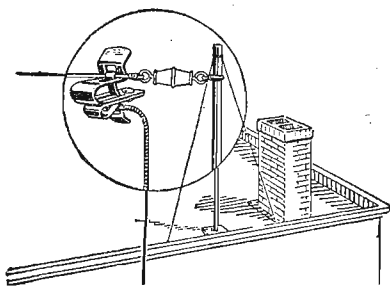

No. 31

## The Antenna Connector

Price 10c

Snap larger connector over Antenna Wire; insert Lead-in Wire into smaller clip and a perfect connection is the result.

## IMPROVED GROUND CLAMP

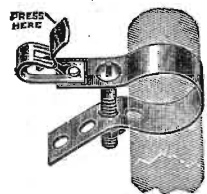

Equipped with Fahnestock Patent Wire Connectors Easily Attached

No Soldering—For Radio Use Only

## FAHNESTOCK ELEC. CO.

Long Island City, N. Y.

Dealers can obtain Fahnestock Products from following distributors:

Special New York distributors: SPARTAN ELEC. CORP.

BOSTON Wetmore-Savage Co. F. D. Pitts Co.

DETROIT Detroit Electric Co.

CHICAGO Barawik Co.

MILWAUKEE Julius Andrae & Sons Co.

PHILADELPHIA H. C. Roberts Elec. Supply Co.

PITTSBURGH Ludwick, Hommel Co.

WESTERN DISTRIBUTORS Marshall & Co., Los Angeles, Cal.



Smallest In Size Greatest In Results

Actual Size

## PREMIER AUDIO-FREQUENCY TRANSFORMER

**\$3.50** The wonder of the Radio world. A more efficient transformer than you could ever buy before. And the smallest, most compact instrument of its kind. About the size of an English walnut and yet "HEGEHOG" is a wizard for reproduction value, tone quality and consistent performance. Less distortion. No foreign noises. The secret is in its patented construction. It is shielded 100%. Fully guaranteed. Ratios 1 to 3, 1 to 4, 1 to 5, \$3.50; 1 to 10, \$4.50. You'll want "HEGEHOG" in your next "hook-up," so get all the facts NOW. Our Free Bulletin No. 92 gives them fully. Send for it. Ask for and insist on "HEGEHOG" at your dealer's.

Premier Electric Company 3810 Ravenswood Ave. CHICAGO

## Try This New One If You Want Efficiency

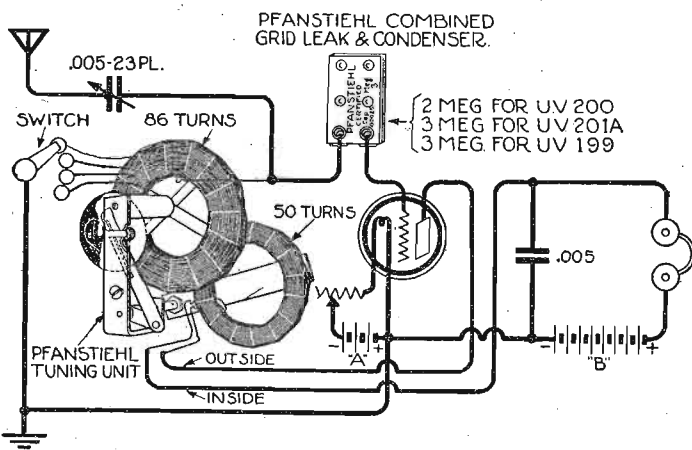

Try this newest efficiency hook-up, using the Pfanstiehl Tuning Unit

## PFANSTIEHL RADIO SERVICE CO.

Highland Park, Ill.

## Bring your set up-to-date

Switch points have passed out of date. They are uncertain and unsatisfactory. Walnut Inductance Switch 1-10 points, permits of better soldering and insures positive contact. Only one hole to drill. Simply and quickly installed.

ASK YOUR DEALER

Catalog of complete line of Walnut parts on request

## WALNART ELECTRIC MFG. CO.

1249 W. Van Buren St., Dept. 421 CHICAGO

In Canada: WRIGHT RADIO CO., Overbrook, Ottawa, Canada, Canadian Distributor

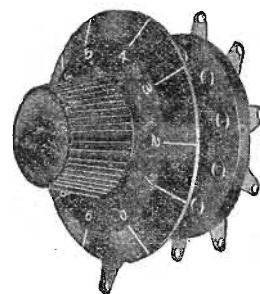

\$1.25 WITH DIAL

The base of this instrument is Condensite Celoron, the perfect dielectric insulation (licensed under Bakelite patents).

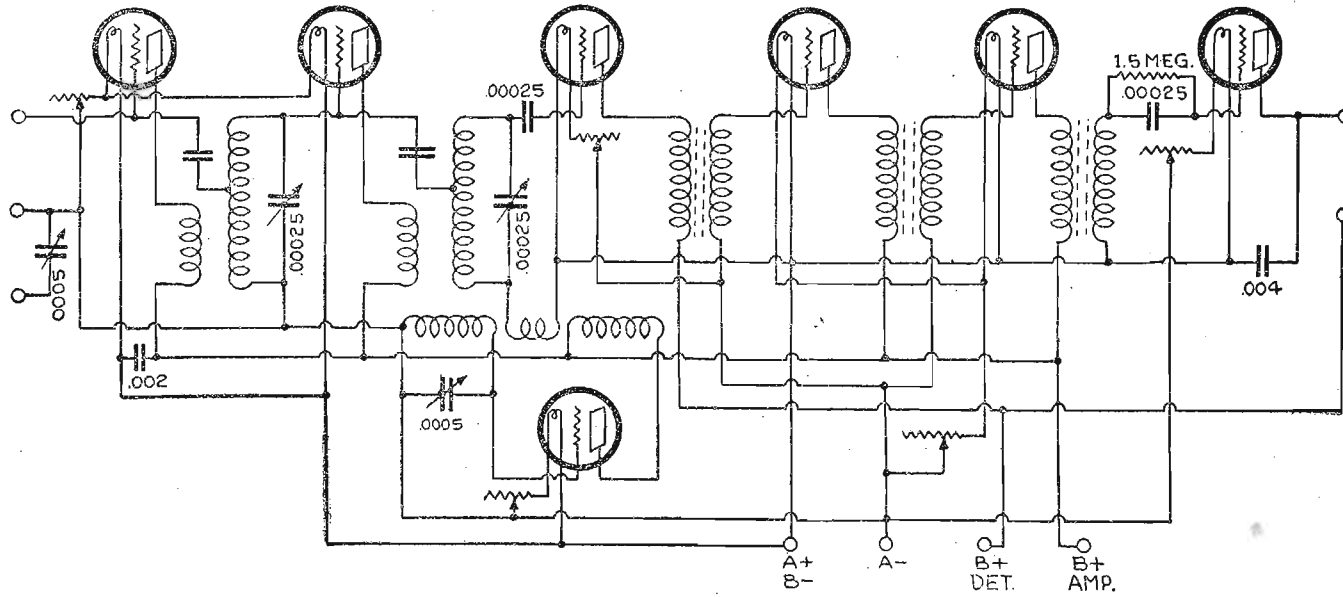

**SUPER-HETERODYNE**

(Continued from page 21)

two stages of super-audible amplification, two detectors and the usual oscillator.

The oscillator should be shielded from all the remaining parts of the circuit. The grid and plate leads should avoid all proximity and parallel runs to any other leads in the circuit. Shielding should be of brass or aluminum plates. The super-audible amplifying stages should likewise be well shielded from each other and the remainder of the circuit. Their grid and plate leads need careful attention to avoid losses and uncontrollable oscillation of the tubes.

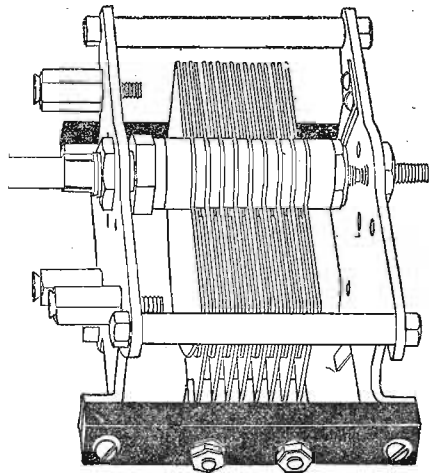

If a lead must run in some direction where interference is obvious, cover the lead with spaghetti and slip some copper or brass tubing over it, then ground this tube. Be careful that the tubing does not touch the lead, however.

Shielding reduces the volume but eliminates interference and improves the clarity of reception. When properly applied, it eliminates all capacity effects. The slight loss in volume can be restored by the addition of audio frequency amplification if necessary.

An ideal panel size for a set of this description would be about 12 by 30 inches. The cabinet should be about 12 inches deep. The cabinet and panel can be entirely lined with metal shielding. Metal partitions can then be used to further subdivide the interior for the various stages.

Condensers should be set back about 2 inches from the panel, and shaft extensions added.

Consistent coast-to-coast reception can be expected from a properly designed, well constructed and efficiently operated super-heterodyne receiver. But the fan may rest assured that he has a big job on his hands when he starts one.

(THE END.)

**Efficient Variocoupler**

A good variocoupler should not have a big surplus of wire. It should be constructed to efficiently receive a limited band of wave lengths, such as 200 to 600 meters.

It is not advisable to have one instrument cover a broad range such as from 200 to 3,000 meters, for in such a tuner losses occur, due to "dead" ends.

A variocoupler, in order to cover the broadcasting stations' wave lengths, should have about 80 turns of number 24 wire on a primary, or stator, 3 1/2 inches in diameter. The rotor should have about 40 turns of number 26 wire.

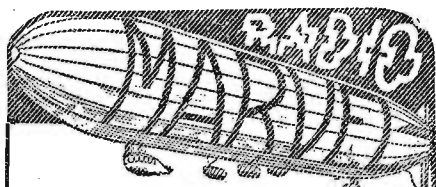

**Dealers! We offer you merchandise at prices below competition! Write now for our amazing offer!**

- FADA NEUTRODYNE PARTS for 5 Tube Set, \$50.15
- NEUTRODYNE Parts, Standard, for 5 Tube Set 46.75
- Set of 3 Neutrodyne Transf. with neutralizing Condensers ..... 14.70
- \$5.00 ACME Audio and Radio Frequency Transformers
- Globe High Ratio Transformers, quality unequalled ..... 3.45
- 7.00 Federal No. 65 Transformers ..... 5.55
- 5.50 13 pl. Vernier Ameco Condensers ..... 2.65
- 6.00 23 pl. Vernier Ameco Condensers ..... 3.50
- 6.50 43 pl. Vernier Ameco Condensers ..... 4.00
- 1.00 SATURN AUTOMATIC PLUG ..... .80
- 3.00 Electrahot Soldering Iron, small tip ..... 2.50
- 7.00 Pioneer Bakelite Variocoupler ..... 4.95
- 2.50 180 degree, 1200 meter, Variocoupler ..... 1.92
- 6.50 Pioneer Bakelite Variometers ..... 4.85
- 1.75 32 1/2 V. small B Batteries, highest quality ..... .75
- 3.00 22 1/2 V. large B Batteries, highest quality ..... 1.45
- 4.75 45 V. med. B Batteries, highest quality ..... 2.00
- 5.50 45 V. large B Batteries, highest quality ..... 2.90
- Ambassador Phones ..... 3.45
- Nereo Phones ..... 2.50
- 8.00 Brandes Phones ..... 4.75
- 5.50 Improved Cockaday Coils ..... 4.75

REMITTANCES MUST INCLUDE POSTAGE  
Send for Our Free Monthly Price List  
**MARVEL RADIO CO**  
132 NASSAU ST., NEW YORK

**Insulate Lead-In**

It is always good practice in bringing a lead-in into the house not to let it touch anything. If the lead-in touches any metal, some of the signal strength will be absorbed. In some cases where the lead-in touches wood there is not much difference in the signals; however, when it rains the wood has the same effect as a metal object.



**Five-Tube FADA Parts!**

**HAVEN'T** you often wanted a REAL Neutrodyne? Everyone is using this King of Circuits to enjoy trans-continental and trans-oceanic programs!

Having specialized in the Neutrodyne since its inception, we unqualifiedly guarantee astounding results using the ORIGINAL FADA Neutrodyne parts. 2,000 miles on a loud speaker! 500-mile stations only "locals"! Hundreds of our clients praise the PERFECTION-FADA receiving outfit. All the parts are yours at \$69.50—in addition we give you a beautiful mahogany cabinet—FREE!

Mahogany Cabinet **FREE**  
**\$69.50**  
Built For You **FREE**

Don't hesitate! Own a Neutrodyne now! If you are afraid of tackling the job, we will build it for you—and without charge of any kind, at the same price, \$69.50! Everything guaranteed!

Our Six-Store Organization Guarantees You Satisfaction  
**PERFECTION RADIO CORPORATION**  
24 Murray Street NEW YORK CITY

*Genuine*  
**Miller-B-Metal**  
Crystal

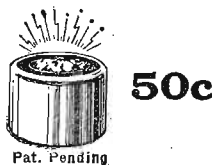

The loud-speaker of the crystal set bringing in reception so clearly you can enjoy every minute of entertainment—that is true night after night with Miller-B-Metal Crystal.

Loaded with the famous B-Metal and with new improvements Miller-B-Metal is fast becoming the choice of Radio Fans.

We are so sure you will like Miller-B-Metal that we will refund your money without question at your request.

Send money order or write for folder.

**DISTRIBUTORS**

If you want a live, fast-selling item—wire today for our distributors' proposition.

**A. H. Miller Radio Co.**  
1222 20th St. DETROIT, MICH.

**RADIO FOR EVERYBODY**

(Continued from page 23)

mouth increases the amplification in a general way; the bell flare makes the natural periods less sharp, but heaps up the efficiency on the low notes near the fundamental, diminishing that for the higher notes.

The loud speaker, it will be seen, is a very difficult unit to design and construct, and it is to be hoped that very soon someone will bring one out that gets away from both diaphragm and horn.

(TO BE CONTINUED.)

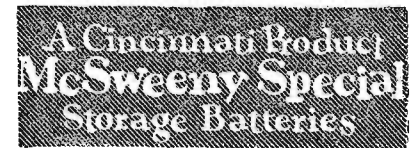

On account of tremendous production and lower overhead, we are able to quote the lowest prices on quality batteries. These batteries are designed especially for radio work.

**6-Volt Batteries**

60 AMP. <b>\$7.95</b>	80 AMP. <b>\$9.95</b>
100 AMP. <b>\$11.95</b>	120 AMP. <b>\$13.95</b>



**Two-Year Guarantee**

These batteries are guaranteed to give two years of satisfactory service. Your order, accompanied with this advertisement, will entitle you to a 22 1/2 Volt B Battery FREE. Send No Money—we ship C. O. D., subject to inspection, or allow 5% for cash with order.

**McSweeney Battery Co.**

105-108 Ninth Street CINCINNATI, OHIO

**Ask Your Dealer for Kellogg Radio Parts**

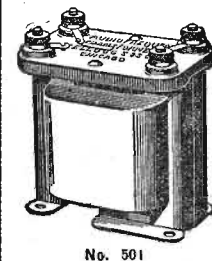

No. 501

**Transformers**

Built and designed correctly, delivering maximum amplification with minimum distortion. Connections clearly marked. Properly designed brass shield permits close mounting.  
No. 501 Ratio **\$4.50**  
4 1/2 to 1 .....  
No. 502 Ratio **4.50**  
3 to 1 .....

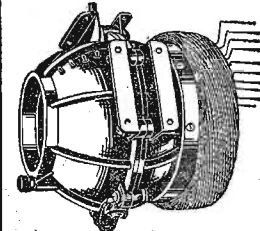

No. 501 with 502 Tuner Coil

**Variocouplers**

Furnishes efficient coupling. No sliding contacts. Bakelite shells. High induction, low distributed capacity.  
No. 501 Variocoupler **\$9.00**  
No. 502 Tuner Coil ..... **3.00**

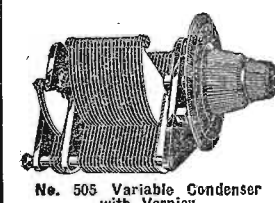

No. 505 Variable Condenser with Vernier

**Variable Condensers**

Decimeter type, 11, 23 and 43 plate with and without 3 plate vernier. Arranged for panel mounting.  
No. 605, 43 plate with vernier **\$8.75**



No. 69A Head Set

**Head Sets**

Extremely sensitive. Small in size. Easily adjusted. Thoroughly efficient.  
No. 69A Head Set, 2400 ohms ..... **\$10.00**  
No. 74A Head Set, 1000 ohms ..... **5.00**

**KELLOGG SWITCHBOARD & SUPPLY COMPANY**

1066 W. Adams St. CHICAGO, ILL.

**B-METAL**

**LOUD TALKING CRYSTALS 50c**

**RADIO CRYSTAL**

**B-METAL TUBE DETECTORS**

Have stood the test of time and are best by every test. **\$1.50**

At All Dealers and Jobbers

**B-METAL REFINING CO.**  
3134 Trumbull Ave., Detroit, Mich.  
Chicago Branch, 53 West Jackson Blvd.

**RENUOX DETECTOR**

# Modified Form of a Green Regenerative Circuit

## Part II—Accessories, Assembly and Operation

By Myron P. Green

**T**HERE are a few ideas that will, perhaps, be worth while to you when constructing the Green circuit. While some of these instructions are old to many of you it is well to be sure before you go ahead.

Primarily, I suggest the use of bakelite

### RECEIVED 2LO, LONDON

Dear Sirs:

I wish to thank you for publishing the two variometer hook-ups in the December 1st issue. I am using the hook-up as published with the addition of a 7-plate variable condenser in the aerial, and a 23-plate in the ground. In exactly two weeks I have heard 71 stations, and 2LO, London, on the morning of December 25th at 2:45 a. m., broadcasting from Westminster Abbey. I have written to them to verify this.

I get Los Angeles regularly and Ft. Worth, Tex., comes in as loud and clear as the local station on a crystal set. I can tune out powerful local station WTAM and tune in Ft. Worth, Tex., Chicago, Ill., Kansas City, Mo., etc. I can tune from 180 meters to 600 meters. Everyone who has heard this set in operation says it is the best he ever saw. I am using one WD-12 tube. This set acts like a super. I can use it without a ground or without an aerial, but am using ground.

What I want to know is how do you account for the unusual performance of this set and how could I add one stage of Radio frequency? Would it improve it much, or not?

I get a copy of your wonderful paper every week. Am enclosing a list of stations I heard in exactly two weeks' time. You may publish this if you wish and tell others of this good hook-up performance.

E. H. Richards, Cleveland, Ohio.

Editor's Note.—The Green circuit is the one mentioned.

should be taken that the shaft of each part has ample room to turn in its hole and yet fit snugly. This is important for if the shafts do not abut on a straight line, the dials will not fit properly and will turn on an angle. After each part has been properly mounted you are ready to begin wiring, preferably with number 18 copper wire covered with a good grade of spaghetti. This wire is easy to handle, is easily bent and serves the purpose fully as well as busbar. The efficiency of the set does not depend on how prettily each wire is bent to make sharp corners. To my way of thinking it is an unnecessary procedure. Before each wire goes into place, attach small copper lugs to each binding post and terminal of each instrument unless they are equipped with proper connections.

Scrape the ends of each wire and also each lug, to remove any accumulation of dust or grease. Use very little flux and very little solder. Hold the iron on the terminal until the solder begins to flow and form in a little pool. If these directions are followed you will have an absolutely perfect connection.

### Accessories to Be Used

It is not necessary to use a grid leak with this circuit if you use a UV-200 tube, but it is essential that the grid condenser be of .0005-mfd. capacity. When using the UV-199 tube I recommend a variable grid leak, as very often each tube even of the same make requires a different resistance.

An excellent socket for all standard bases is the one having a porcelain housing with metal top.

A good variocoupler is one that is made of fiberlike material with a wooden rotor. I have discarded all moulded tubes constructed of bakelite or rubber as I believe them responsible for a good deal of body capacity and possessing far too much rebound.

The same holds good of the variometers. They can be of the wooden variety as long as they are well made and wound to receive reception on high wave lengths.

As this circuit is very selective and critical it is a good idea to equip each variometer with a vernier type dial. It will be a 50 percent help in tuning.

It is not necessary to use a phone jack

in this set. The writer has used the small phone-tip jacks with better success. They eliminate the phone plug entirely.

The variable condenser occupies an important place in this circuit and should be chosen with care—a good strong type, with bakelite insulation, having the extra vernier plate. This extra plate is absolutely essential. It helps wonderfully on DX work.

If the UV-200 tube is used, the best rheostat is the one using carbon discs as a means of resistance. Control of the filament is one of the greatest helps in tuning in distant stations. Here is where this type of rheostat performs best, as an infinitesimal turn of the knob may regulate the filament resistance and place it in perfect accord with some far distant station.

### Cabinet for the Set

This set can be housed conveniently in a 7 by 18-inch cabinet, although I have used 7 by 24-inch largely when making these sets, as I believe plenty of space is far better than congestion of parts and wires.

If a grain is desired on the panel, a fine grade of sandpaper or emery cloth number 00 may be used to rub down with. Rub only in one direction, preferably from left to right the long way. After the panel has been rubbed well and no bright spots show, dust with a soft cloth, wash off with a little 3-in-1 oil. This oil should be rubbed into the panel hard and consistently until you get that dull grained finish so much desired.

If you use a shelf attached to your panel, place it low enough down on the panel so that when you slide the outfit into the cabinet, this shelf just engages the floor of the cabinet. Screw the shelf down to the floor of the cabinet using two long screws, one at each end. This eliminates the use of four or more screws on the face of your panel.

### Operation

The important part in tuning this set is the manipulation of the two variometers. The adjustment should be by micrometer in its entirety. One calibra-

tion means much on each dial, and it is well to remember that the more care that is taken in tuning, the more satisfaction will be obtained in the results.

It isn't good policy to jump at the set haphazard, for it will not respond to indifferent treatment. It can, however, be depended upon to produce excellent results, if the operator remembers to coax instead of command. Too much is expected of Radio sets by an unthinking public, and if you would only pause to consider upon how many different things depends the quality of reception you get, it would be much better for all concerned. The weather, largely, has much to do with the working of any and every set, whether crystal or super-heterodyne; the condition of your antenna, your insulation, your ground, and a dozen other factors that many times are not taken into consideration.

However, there is really no limit to what may be achieved with a Radio set properly made, dielectrically perfect, in conjunction with ideal Radio weather.

This circuit has proved itself under ideal and adverse conditions and I see no reason why you shouldn't be pleased with it.

(THE END.)

### Range of Reception

The range of transmitting and receiving Radio messages depends upon the nature of the territory lying between the transmitting and the receiving stations, the greatest range for a given power being obtained over water. Any metal, particularly iron or steel, lying between the stations, will cause loss of signal strength. Such metal may either be in the form of artificial structures such as building frameworks or tin roofs, or may be in the form of ore deposits. Some regions of the country are noted for their poor location for Radio reception. In many places it is possible to receive effectively from all directions but one, and it is usually found that in this direction a metallic structure or metal deposit is responsible for the lack of reception.

or any similar insulating material, as it possesses more tensile strength and is less likely to chip. Follow the old, and still best, plan of making a template before you start, drawing the panel plan on a sheet of ordinary paper slightly longer and wider than the panel. Paste it over the panel where it overlaps, center everything just as you wish the finished panel to appear and then drill all holes.

### Mounting of Instruments

After removing the template, you are ready to mount your instruments. Care

**NAZELEY'S**

# PORTENA

## Folding Loop

Patent Pending



*Folds up like an umbrella— Works like a charm.*

Spread 23 inches

Genuine Bakelite Facings; 85 ft. green covered wire; rich mahogany finish. In an individual morocco covered tube.

**List \$7 each**

One Dozen to a Case

**J. NAZELEY CO.**  
571 Hudson St. NEW YORK CITY



## Regal Radio Apparatus

Favored and demanded by "those who know" in Radio

**New "Regal" No. 162 Double Arm Inductance Switch**  
A 15 Point Switch complete in one unit. No more messy soldering. No more drilling of holes. No more chipped panels. Complete with hard rubber Knob and Dial.  
\$1.50

**New "Regal" No. 120 Vernier Rheostat**  
For fine filament control of tubes, and superfine tuning, the Regal Vernier stands alone. Nothing just like it on the market.  
Complete with Knob  
6-ohms ..... \$1.25  
30-ohms ..... 1.25

**New "Regal" No. 200 Audio Frequency Amplifying Transformer**  
For clearness of tone, amplification of voice and music from nearby and distant broadcasting stations, is unequalled by any Transformer on the market.  
3 1/2 to 1 Ratio.....\$4.25  
5 to 1 Ratio.....4.50

At your dealer's—otherwise write for our folder No. 25 showing complete line of Regal Radio Products

**AMERICAN SPECIALTY CO.**  
115-220 Holland Ave., Bridgeport, Conn.

## The Battery Charger Without a Weakness

Portable **Sterling** Rectifier

In line with recent developments in the radio battery field a number of improvements have been made in the design of this useful device. A five-ampere maximum charging rate has been adopted. The number of contacts has been reduced to one, affording greater simplicity and ease of adjustment without loss in efficiency. The quietness of operation, the almost total absence of sparking and the consequent free action and durability of the contact points mark a big advance in rectifier design.

**AS EASY TO USE AS AN ELECTRIC IRON**  
No Danger of Wrong Connections or Possibility of Overcharging

**THE STERLING MFG. CO., 2829 Prospect Ave., Cleveland, Ohio**

### The Best Rectifier Ever Built

**ONLY \$16<sup>00</sup>**  
Add \$1.00 West of Rockies.

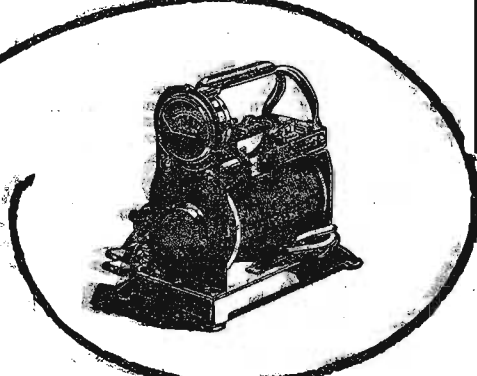

## STA-RITE RADIO BATTERIES SAVE YOU 60%

And Guarantee You in Writing 2 Years of Better Battery Performance

STA-RITE RADIO BATTERIES are made especially for Radio and the big saving is made possible by coming direct to you instead of thru distributors, dealers, etc. Boxes are made of oak, finished in mahogany and the plates very thick and will give a steady discharge over a long period. No premiums, just good, honest battery value.

**TRY TO BEAT THESE PRICES**

2 Volt for W. D. 11 and 12 .....	\$4.00	6 Volt .60 Amphr. -	\$ 7.50
4 Volt for U. V. 199 Tubes .....	7.00	6 Volt .80 " -	8.50
<b>RADIO BATTERY STORAGE</b>		6 Volt 100 " -	10.00
Glass Jars, Heavy Plates—		6 Volt 120 " -	12.10
Case of 12 Cells, 24 V.....	4.90	6 Volt 150 " -	14.00
		6 Volt 200 " -	17.00

**Get Yours Today—NOW—Send No Money**

The batteries are fully guaranteed in writing and shipped subject to examination on the day your order is received. You pay on delivery or deduct 5 per cent if full cash accompanies order. You may deduct 10 per cent if two or more are ordered at one time.

**STA-RITE BATTERY CO.**  
Department 5  
LOUISVILLE, KY.

# Weagant Receiver Hook-Up

## Simple Regenerative Fool-Proof Set

THE FOLLOWING is neither an excerpt from the Arabian Nights nor the brilliant discovery of a new-fangled receiver that will bring in signals when none exist. On the contrary it is the account of a simple regenerative set that is almost fool-proof, and which has given uniformly excellent results on arc, spark, phone and amateur waves since it was first published in 1918.

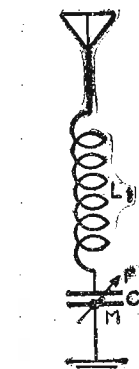

Figure 1.

means of circumnavigating the famous Armstrong patent. But while he legally failed to do so, he nevertheless gave to the Radio world a substitute that for simplicity, universality and performance can hardly be "beat."

A glance at Figure 1 will acquaint the Radio enthusiast with the circuit. A little energy will suffice to provide the broadcast or amateur listener with a set of which he can justly be proud.

### Parts of the Circuit

Getting down to a description of the parts of the circuit, the primary circuit, composed of  $L_1$  and  $C_1$ , is the same as any standard regenerative set. It consists of a 50-turn coil in series with a .001-mfd. variable condenser. The secondary circuit is the typical inductance with capacity in parallel. The inductance value is a 50-turn coil and the condenser in shunt is of the order of .0005 mfd. The tertiary, or tickler circuit as it is commonly known, consists of an inductance of 50 or 75 turns with a .0005 condenser in series, the whole placed in parallel with

the plate and filament circuits. Any Armstrong circuit, by the addition of a variable condenser, may be revamped into a Weagant without the slightest hesitation on the score of efficiency.

On account of the great variation in phone wave lengths, the desire of many fans for the arc and spark wave lengths, together with the experimenters who desire going down to 100 meters, a honey-comb coil mounting with three plugs is recommended to give the greatest versatility to this receiver.

### Inductance Values

As a rule in the Weagant circuit the inductance value of  $L_3$  is a trifle greater than that of  $L_2$ . For example, if the secondary coil is of 50 turns, then best

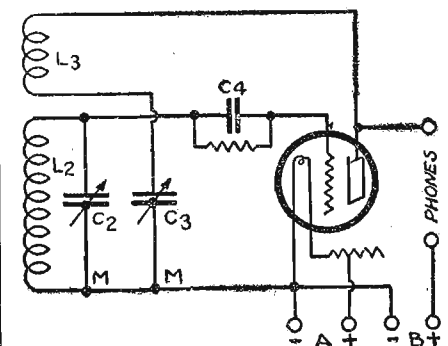

Figure 2.

results will probably be found with a tickler coil of about 75 turns, although many sets have given excellent results with a coil the same size as that of the secondary. The reason, apparently, is on account of the series capacity in the tickler circuit contrasted with the parallel capacity in the secondary.

For broadcast waves the reader should use a 50-turn coil for the primary, a 50-turn for the secondary and either a 50

or a 75-turn for the tickler. Experience has taught a great number of the fraternity that Giblin-Remler coils are best

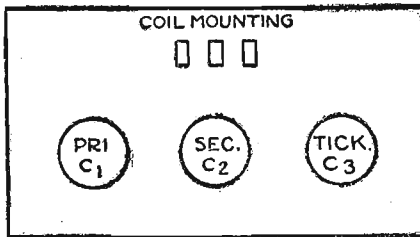

Figure 3.

suited. For 100-meter work it is necessary to wind single layer coils of the dimensions given later in this article.

### Hook-Up

After hooking up your apparatus, as shown in Figure 2, if the set fails to oscillate, reverse the two leads going to the back of the coil mounting on the tickler side so as to reverse the polarity of the winding. Sometimes, with a given value of tickler inductance a set will oscillate on high waves when the tickler is in one direction, and will oscillate on short waves when it is in the opposite direction. It will take only a moment to find the proper direction of winding. Also make sure that the series capacity  $C_3$  is not shorted. This will discharge your B batteries as this circuit is in parallel from the plate to the filament.

### Tuning

Tuning is accomplished by means of the secondary and tickler condensers, the primary, secondary and tickler inductances being set in one position. In the ordinary regenerative sets, regeneration is obtained by altering the inductive relationship of the coils, whereas in the Weagant circuit regeneration is brought about by chang-

ing the capacities of the secondary and tickler circuits, a method that is smoother and less troublesome. The tickler coil can as a rule be left close coupled to the secondary and all oscillation and regeneration changes affected by means of the series condenser  $C_3$ .

(Continued on page 30)



# KEYSTONE

## RADIO LIGHTNING ARRESTERS

**\$2.00**

Should be on every aerial the year 'round. Provides highly efficient lightning and static protection for the home. Fully approved by Fire Underwriters. Can be installed outdoors. Has no vacuum to lose. Install one in your aerial lead now—be safe. This pioneer radio arrester is backed by 31 years' experience in lightning arrester design. For sale by Dealers everywhere, or sent postpaid for \$2.00. Write for circular.

**Electric Service Supplies Co.**  
178 Cambria Sts.  
Philadelphia  
Monadnock Bldg., Chicago  
50 Church St., New York

# Infinite Adjustment

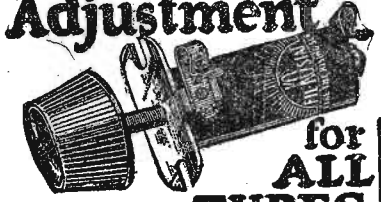

**for ALL TUBES!**

DESIGNED to permit infinite adjustment of currents used in vacuum tube. Gives absolute control of electronic flow and finest tuning possible. Fil-Ko-Stat will bring in DX you never heard before and shut out noise.

30 ohms full resistance. No adjustment to puzzle. No discs to break. No Carbon Powder.

**2 AT ALL DEALERS!**

# FIL-KO-STAT

Made and Guaranteed by  
DX Instrument Co. Harrisburg, Pa.  
Radio Stores Corp., 218 W. 34th St., New York  
Sole International Distributors

# WE REPAIR THE FOLLOWING RADIO TUBES

Dealers and Agents write for Special Discount Mail Orders Solicited and Promptly Attended to

WD-11	OUR SPECIALTIES	5 WATT TRANSMITTERS
UV-199	.....	\$3.50
UV-200	.....	2.75
UV-201	.....	3.00
UV-202	.....	3.50
UV-201A	.....	3.50
WD-11	.....	3.50
DV-6	.....	3.00
UV-299	.....	3.50
C-299	.....	\$3.50
C-300	.....	2.75
C-301	.....	3.00
C-302	.....	3.50
C-301A	.....	3.50
C-299	.....	3.50
DV-6A	.....	3.00

**H. & H. RADIO COMPANY**  
P. O. Box 22-A  
Clinton Hill Station NEWARK, N. J.

# Improved again!



The MAGNATRON DC-201A—even better than it was before! It and the MAGNATRON DC-199 are the two outstanding performers among tubes today.

At the new list price of \$5, these tubes are also outstanding values. You can no longer afford to use inferior tubes.

Your Dealer Has Them!

**CONNWEY ELECTRIC LABORATORIES**  
309 Fifth Avenue NEW YORK CITY

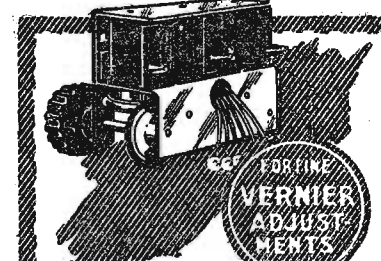

# Columbia Radio Corporation

## Inside Coil Mounting

Newer, Neater, Better

Here is an inside coil mounting made for the radio owner who wishes to keep bulky coils out of sight. It is friction geared and fine "vernier" adjustments are possible. Nothing shows outside panel except knob and pointer. Only \$6.00 at all good dealers.

DEALERS—Responsible distributors all have Columbia Radio products. It pays to give your customers the best. No other radio products have this name—insist on it.

**Columbia Radio Corporation**  
155 N. UNION STREET, CHICAGO

It's Columbia—So It's Good!

# DISTANCE on ALL wave lengths



**SENSITIVE!**

TRI-COIL Radio Frequency Transformers are sensitive; they reach out for distance on all wave lengths.

For reflex or straight radio—TRI-COIL should be your choice! And the list is \$2 only

FREE—"How To Build the TRI-COIL Reflex" free at your dealer's or direct from us.

**BROOKLYN METAL STAMPING CO.**  
718 Atlantic Ave.  
Brooklyn New York

# A REMARKABLE GRID LEAK—Says AMRAD



**\$1.85 EACH** **35¢ FOR 000252 CONDENSER**

The chief radio engineer of Amrad says, "The Bradleyleak is, without doubt, the best grid leak and condenser now on the market, and it is remarkably free from noise." What better evidence is needed that the Bradleyleak is different from other grid leaks?

Remember, the Bradleyleak is not affected by atmospheric conditions. It is noiseless and has a smooth range of control from 1/4 to 10 megohms. Try one, tonight.

**ALLEN-BRADLEY CO.**  
290 Greenfield Ave. Milwaukee, Wis.  
Manufacturers of the Universal Bradleystat

**Bradleyleak**  
THE PERFECT GRID LEAK

# Burned Out or Broken RADIO TUBES REPAIRED

All Tubes Guaranteed to Work Like New

Mail Orders Given Prompt Attention

**24 HOUR SERVICE—All Tubes returned P.P. C.O.D.**

RADIOTRONS	CUNNINGHAMS
WD-11 or 12.....\$3.50	C-11 or 12.....\$3.50
UV-200 ..... 2.75	C-300 ..... 2.75
UV-201 ..... 3.00	C-301 ..... 3.00
UV-202 ..... 3.50	C-302 ..... 3.50
UV-201A ..... 3.50	C-301A ..... 3.50
UV-199 ..... 3.50	C-299 ..... 3.50
DV-1 or 2..... 3.50	DV-6 or 6A..... 3.00

**RADIO TUBE CORP.**  
70 Halsey St. Newark, N. J.

SEND TO NEAREST REPAIR BRANCHES

"RADIO TUBES" 39 West Adams St. Chicago, Ill.	RADIO TUBE SPECIALISTS 137 Market St. Phila., Pa.
GLOBE ELECTRIC CO. 609 Cham. of Com. Bldg. Pittsburgh, Pa.	WELLSTON RADIO CO. 1479 Hodiadmont Ave. St. Louis, Mo.

# Why JUNK YOUR SET?



The new TWITCHELL AUXILIARY TUNER connected to your present set will enable you to bring in the long and short wave stations which your present set cannot get. It also cuts out all local stations so you may bring in distance any time without local interference. Copyrighted diagram of this tuner 50c, or with all parts \$9.00. Complete instrument in walnut cabinet, ready to use, \$15.00. Transportation prepaid.

MY HIGHLY IMPROVED REINARTZ brings in all important stations on this Continent loud, clear and without distortion. We dance to music from Atlanta and Los Angeles.

Build one of these wonderful 3 tube sets from my blueprint and specifications, price 50c, or with a complete and perfect double-wound spiderweb coil \$3.00 by mail. Picture of this set on a glass panel with every order. This copyrighted circuit is the most successful of any Reinartz modification yet produced, and is limited the most. Thousands are in use.

My W. D. 11 Circuit is especially designed for use with the "Pickie" tube and brings out the full value of that little tube as no other broadcast station 1000 miles away come in clearly on one tube. This set is small, complete, portable. For the man who wishes the highest efficiency, this is the set to build. Price of blueprint and specifications, 50c, or with complete and perfect windings, \$3.00. Photo of set with every order. Sets built from these copyrighted plans will receive all broadcasting stations operating under the new laws. Their wave length range is from 170 to 800 meters.

All goods prepaid. These instruments are easy to build, easy to operate. Everything clearly shown.

**S. A. TWITCHELL**  
1925 Western Avenue Minneapolis, Minn.



# Single Circuit Tuner Changed to Reflex

## Make Use of Old Set to Construct Reflex

In attempting to try the reflex circuits, the amateur hesitates about tearing down his present tuner. If he has a single circuit tuner, as shown in the diagram, he can convert it into a reflex circuit at very little

### WORKSHOP KINKS? EARN A DOLLAR—

**T**HERE are many little kinks worked out at home that would aid your fellow Radio worker if only he knew about them. There are new hook-ups, new ways of making parts and various unique ways of operating sets that are discovered every day. Radio Digest is very much interested in obtaining such material. Send them in with full details, including stamped envelope, so rejected copy may be returned. The work must be entirely original, not copied.

RADIO KINKS DEPARTMENT,  
Radio Digest,  
123 W. Madison St., Chicago

expense and at the same time retain his set in its present form by simply throwing one switch and changing the grid leak.

The change from single circuit regenerative to reflex is made by throwing the D.P.D.T. switch to the right, as shown in the diagram, and by removing the grid leak cartridge and in its place inserting a cartridge which connects the secondary of the audio frequency transformer across the grid condenser. This special cartridge may be made from a small fiber rod the same size as the variable grid leak with brass ends; the secondary wires being soldered to these ends. Do not use a D.P.D.T. switch in the grid circuit as the capacity and leak will be spoiled and will not be under good control.

The filament adjustment is very critical, hence a vernier rheostat should be used. The capacity of the fixed condensers is not critical with the exception of the grid condenser which should be .00025 mfd. Mica condensers should be used. The variometers have 38 and 36 turns each on their stators and rotors respectively. Twelve extra turns are on the stator of the second or plate variometer for inductive regeneration. The tube is a WD-11 with plate voltage of from 45 to 90. High voltage is required for loud signals. A galena detector gives loudest signals but is slightly unstable.

The reflexed signals are much louder than is possible to obtain by inductive feedback, and the tone is purer. When the contact on the crystal detector is lifted from the crystal the set will either break into violent oscillations or the signal will become very faint. However, stations can be tuned in very sharply and the signal strength will be about as loud as when inductive feedback is used, by having the cat whisker raised from the crystal and tuning the plate circuit to bring it in resonance with the aerial or grid circuit, thus getting capacity feedback.

Regeneration with reflexing was tried but did not increase the signal strength and made the set much harder to tune, hence a double-throw switch was used as shown. With some tubes it will be found that the grid leak and the secondary of

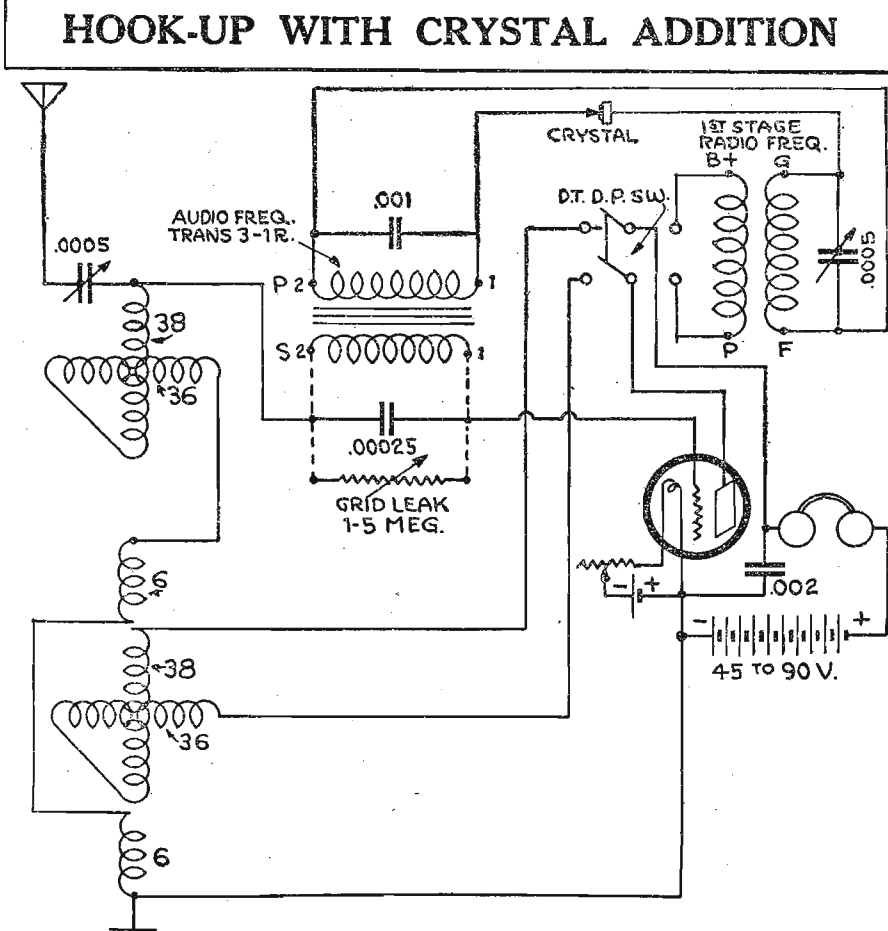

the audio frequency transformer can be left in the grid circuit permanently, but for best reflexing and inductive feedback they should be changed as mentioned.—Wm. S. Schmidt, Johnstown, Pa.

A counterpoise should always be lower than the aerial.

**Workman Radio Service**  
"THE ACCENT IS ON SERVICE."  
14-16 Vesey St. NEW YORK

VARIOCOUPPLERS	
\$3.50 Workrite 180° Silk Wound.....	\$2.95
3.50 Fisher, Large, 90°.....	2.75
2.75 Fisher, 180°.....	2.25
VARIOMETERS	
\$3.50 Workrite.....	\$2.95
5.00 Pathé Moulded.....	2.25
3.50 Fisher, Large.....	2.85
CONDENSERS	
\$2.00 R. C. 11 plate.....	\$1.05
2.35 R. C. 23 plate.....	1.35
2.75 R. C. 43 plate.....	1.65
VERNIER CONDENSERS	
\$4.00 R. C. 23 plate.....	\$2.25
5.00 B. C. 43 plate.....	2.95
PHONES	
\$18.00 DR. SEIBT IMPORTED "SUPER" HEADSET.....	\$5.90
\$12.00 N. & K., Imported.....	\$5.90

We specialize in the FAMOUS AMBASSADOR LONG DISTANCE CIRCUIT. Write for list of parts for this set. Either single or three tube set. Price of parts for single tube set..... \$15.00  
Price of parts for THREE TUBE SET..... 28.90  
Mail orders promptly attended to. All orders amounting to \$5.00 or more will be shipped prepaid. Will ship C. O. D. unless remittance accompanies order.  
The above items are just a few of our numerous attractive priced articles, which are contained in our BULLETIN OF RADIO PARTS. Gladly sent to you upon request.

**Jog Storage Battery**  
Some lead cell storage batteries, owing to the irregularity of action, give off bubbling noises. A sudden jar given the battery will usually stop this trouble.

**Electrad Indorarial**  
NOW! \$1.50  
**A Practical Indorarial**  
Ideal for sharp tuning, reduces static to a minimum. Cuts out interference, gives wonderful directional effects. Hang it on door or wall, behind portieres, lay under rug. One used as antenna and one as ground gives remarkable coupling effect.  
On sale at most good dealers, or direct. Price \$1.50.  
Satisfaction guaranteed or money back.  
**ELECTRAD**  
A Name Stamped Only on Superior Radio Products  
**ELECTRAD, Inc., Dept. "L"**  
428 Broadway, NEW YORK

## Recharging, Testing and Care of Radio Batteries

A Radio battery is operated at extremely low discharge rates, one, two or three amperes. It is not advisable to allow the battery to become more than three-quarters discharged, for this increases the formation of lead sulphate which is difficult to remove by recharging. Testing with the hydrometer is very easy and probably the best method. The solution is drawn up in the hydrometer by means of a bulb and the specific gravity of the electrolyte may then be read by means of a graduated scale on the small float inside. The various stages of charge and discharge are seen at a glance.

Long distance stations ordinarily can not be heard with a crystal detector set.

**The Stars Are Out**  
Price \$1.25  
THE STAR is a FIXT CRYSTAL DETECTOR for REFLEX OR CRYSTAL SETS.  
It is a marvel of efficiency and its gold tipped filament is so secured that it may be thrown against a wall without danger of dislocation.  
Try it with a horn on any good crystal set and you will have a crystal loud talker, if within five miles of any broadcasting station.  
Sent on ten days' approval, postage paid, and you pay us when satisfied. All we ask that you send us the name of your dealer with your request.  
**PERPETUAL GUARANTEED**  
  
For Reflex and Crystal Sets  
**Star Crystal Company**  
525 Woodward Avenue, Detroit, Michigan  
53 West Jackson Boulevard, Chicago, Illinois

**EASTERN COIL SETS FOR THE COCKADAY CIRCUIT**  
Are they STANDARD and in UNIVERSAL USE  
  
(4 Circuit Tuner)  
DUE TO THEIR PROVED EFFICIENCY IN THIS WONDER CIRCUIT  
Made as per specifications of Mr. Cockaday. "D" Coil bank-wound.  
Complete Assembled Set B, C and D Coils on GENUINE BAKELITE tubing, wound with No. 18 Double Silk \$4.25  
Covered Wire.....  
The same on guaranteed treated tubing, wound with No. 18 Single Cotton \$2.75  
Covered Wire.....  
Original and new improved hook-ups with material lists FREE with each set of coils.  
Either set may be used for original or new improved hook-up.  
Mail Orders Filled—Dealers Communicate  
**EASTERN RADIO MFG. CO.**  
22 Warren Street, Dept. R. D., NEW YORK, N. Y.

**TEN REAL BIG REASONS WHY YOU, Yes, YOU Should TODAY ORDER and ALWAYS USE WHERE I GO BY RADIO**  
The New Radio Record Book Now Being Used Every Night Everywhere

1. It is Handy, Complete, Convenient.
2. Shows at a glance When, Where, How and What You Heard.
3. Every line a complete record, giving Date, Hour, Weather Conditions, Station, Call Letters, Location, Kind of Program, "Tuning In" Combinations, etc.
4. How to Measure Distances and Get Best Service.
5. Accurate Official List of Broadcasting Stations corrected to November 15th.
6. Special copyrighted symbols make recording easy.
7. Enable you to keep permanent records of everything interesting you hear, such as when Lloyd George, Woodrow Wilson, President Coolidge spoke, etc.
8. Supplies at small cost what every "Ra-Owl" has long been wanting.
9. Endorsed and used by both amateurs and professionals Everywhere.
10. New, Unique Radio Record System, with an idea that appeals. It's the idea and not just the number of pages, each 8x11 inches, that makes it worth while.

Now "Listen In" on This. The names and addresses of the First Person from each of the First Ten States, and the Last Person from each of the Last Ten States, received by us to February 9th, inclusive, sending \$1.00 for one Holiday, or two copies Popular Edition of Radio Record Books "Where I Go by Radio," will be published later in this Paper. This is a test of the "pulling power" of this advertisement. Why Not Be First and see YOUR name in print?  
**RADIO BOOK DEPT.**  
PROGRESS PRESS  
Union, South Carolina, U. S. A.

**Guaranteed Head-Sets**  
"RED-HEADS" are guaranteed radio phones. You run no risk when you buy them. Money back if, after 7 days' trial, you're not satisfied that they're the best receivers on the market at the price. Why not act right now and get a pair? It'll mean getting the maximum from broadcasting from the day you put them into use.  
  
**RED-HEAD RADIO RECEIVERS**  
NOW READY  
The new 1924 Model F Per Pair Complete \$6.50 | The new "Red-Head" Jr. Per Pair Complete \$5.00  
"Red-Heads" sent prepaid on receipt of price if you are unable to get them at your dealer's.  
**THE NEWMAN-STERN COMPANY**  
Dept. R. D., Newman-Stern Bldg., Cleveland

**EVEREADY Radio Batteries**  
—they last longer  
Conspicuous for vitality and endurance —the right batteries by test and proof for every radio use.  
**NATIONAL CARBON CO., INC.**  
Headquarters for Radio Battery Information  
New York San Francisco  
CANADIAN NATIONAL CARBON CO., LIMITED  
Factory and Offices: Toronto, Ontario

**Don't Waste Your Time**  
Looking for stations you already had. When you get a station simply copy the readings in a KASPER RADIO RECORD BOOK, then when you want it—IT'S THERE. This book can be used with any set and it is so arranged and printed that each day's broadcastings are kept separate; also contains full illustrations and instructions HOW TO RECORD STATIONS. 25 cents —or 6 for \$1.00, postage paid—don't send stamps.  
Write Today  
**KASPER BROTHERS COMPANY**  
317 Lorain St. Bank Building  
Cleveland, Ohio  
Dealer or Agents Wanted Everywhere

### WEAGANT RECEIVER

(Continued from page 28)

For long waves, take the coils you have been accustomed to using and you will find they work as well as on your old set.

For short waves, 100 to 250 meters, the author uses a 35-turn coil; a secondary of 17 turns of number 22 d.c.c., wound on a 2 1/4-inch coil fitted with honeycomb plug, and a tickler of 25 turns wound on a 2 1/4-inch tube (same size of wire). The tickler is placed inside the secondary, and its relationship fixed and forgotten. The same precaution of getting the proper polarity on the tickler coil should be observed. A honeycomb plug with about 6 inches of wire can connect from the tickler coil inside the secondary to the tickler receptacle on the coil mounting. The panel layout is shown in Figure 3.

In shifting from 100 meters to higher waves, simply pull out your two home-made coils and plug in the larger-sized coils.

As to the types of tubes, with the Navy VT-1 and 2, or almost any oxide coated filament tube, the grid leak will not be extraordinarily critical, and the set will oscillate with almost any B battery potential, giving good signals; with the gas content tube, such as the UV-200, the grid leak is a bit more critical and should be of a variable type. The UV-200, on account of its great sensitivity, gives the most volume on phone wave lengths, while for continuous wave work the Navy tubes (J's) are fine.

Unlike the Reinartz (a single circuit Weagant, after all) the Weagant is not an excessive radiator. The coupling between the primary and secondary prevents this to a marked degree. Selectivity gained with a Weagant receiver cannot be approached by any other receiver, even the three-circuit Armstrong, so far as the writer has been able to ascertain.

Another advantage of the Weagant over the Armstrong is the fact that the telephone cords (in the case of a single tube set) are not directly in the oscillating circuit and therefore will not be productive of body capacity.

It would be well for the Radio enthusiast, regardless of the type of circuit which he intends using, to arrange all his variable connections on the condensers so there will be no potential in the circuit. This also obviates body capacity. In Figure 1 the condensers show a marking of M for movable plate which should go to low potential part, while the marking F should go to point of high potential.

Summing up the Weagant, the outstanding advantages it possesses are: selectivity, universality, simplicity of control and lack of body capacity. Despite the abundance of trick circuits with which the Radio fraternity has been deluged in the past two years, it is refreshing to contemplate the Weagant as peer of them all, despite its five year age. Broadcast listeners and amateur operators, who have used the Weagant after trying all others, are in accord with the opinion ventured above.

### Review of Books

**222 Radio Circuit Diagrams.** A complete and up-to-date collection of modern receiving and transmitting hook-ups. The book includes 234 diagrams and illustrations. Price, \$1.00.

**Within the Atom.** By John Mills. May be read by the Radiophan with interest for it deals with that infinite particle as associated with electrons, and all chemical and all electrical phenomena. Price, \$2.00.

**How to Retail Radio.** A new book telling of tested plans and methods and policies for the dealer in Radio. Financing, location, store equipment and arrangement. Price, \$2.00.

**An Introduction to Radio.** A real book for the amateur. This treatise comes in two volumes. 96 pages in each volume, fully illustrated, with flexible leather covers. Price two volumes, \$1.

**Experimental Wireless Stations.** By P. E. Edelman. Simple directions are given in this book for making Radio equipment for the transmission of messages over long distances. Price, \$3.00.

**Vacuum Tube Receivers.** By O. F. Heslar. A book that tells how to make a simple set. How to make the cabinet. It includes a 27 by 36-inch layout blueprint. Price, 75 cents.

**The Armstrong Super-Regenerative Circuit.** By George J. Eitz, Jr., E. E. This is a De Luxe edition of this famous circuit. Profusely illustrated and fully explained. Fifty-two pages. Price, \$1.00.

**Elements of Radio Communication.** By Ellery W. Stone. A splendid, well connected, complete, accurate and up-to-date discussion of every phase of Radio telegraphy and Radiotelephony. Written in simple language. The subject is presented from the physical rather than from the mathematical standpoint, avoiding the use of higher mathematics. Price, \$2.50.

The book department of the Radio Digest is prepared to send you any of the books on Radio published whether listed in our Book Review or not. Let us know

### RADIO INTERFERENCE

(Continued from page 24)

but will also improve reception and increase the selectivity of a receiver with which it is used.

**Sees Opportunity for "One-Way" Valve**  
It is often said that one of the most interesting phases of Radio to the novice is its possibility of original experiment. Many of the more important developments in the Radio field have been made by novices. From this standpoint, then, the development of a "one-way" valve to prevent radiation from receivers certainly offers wonderful possibilities.

With the general public interested in the development of a universal attachment of this kind, as well as with the well-equipped laboratories of the larger manufacturers of Radio apparatus earnestly working on the problem, it is safe to pre-

dict that not much time will elapse before there is available a universal radiation preventer adaptable to all types of receivers and which will not only end the present annoyance but, through uniform retail price and its advantages from the selectivity standpoint, will be desirable for general public use. Let's have no more unenforceable legislation!

Don't be disappointed if an occasional storm interferes with your summer Radio evening. There are many fine concerts coming. You can't expect to find a pearl in every oyster, nor to receive a record breaking concert every night.

### Superdine Tuners

FROM MANUFACTURER STRAIGHT TO DEALERS ONLY

NO CUT PRICE COMPETITION  
VERY LIBERAL DISCOUNTS  
VERY SMALL ORDERS WANTED  
STANDARD PARTS ONLY NEEDED TO COMPLETE SET  
DIAGRAM WITH EACH TUNER

THE SKELTON CORP.

Randolph 6760, 20 E. LAKE ST., CHICAGO

### DEALERS PROMPT SHIPMENTS LIBERAL DISCOUNTS

"ERLA"  
New Type  
Reflex  
Transformers

All Erla reflex parts in stock including Hilco Variocouplers and Rathbun Condensers.

Dealers send for Catalog and discounts

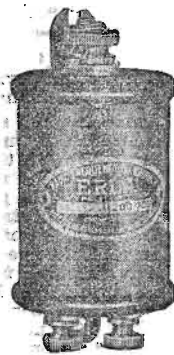

Note!!  
We are the largest exclusive Radio Jobbers in the Middle West

HUDSON CROSS  
123 W. Madison St., Chicago

### BETTER TUNING with BREMER-TULLY VERINER TUNER

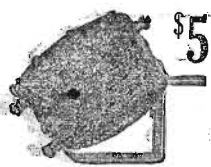

Paul Jiricks, St. Louis

"Being an amateur of the first order I am surprised at the wonderful results obtained in the past ten days with your B-T hook-up No. 2. I have tried hundreds of different hook-ups in past years but I haven't found any as good as yours."

**Better Tuning B-T**  
Price 10c

BREMER-TULLY MFG. CO.  
532 South Canal Street CHICAGO

# Duo-Reflex

Tube for Tube—the Most Powerful Circuits Ever Built. Write for free Bulletin No. 16

Electrical Research Laboratories  
CHICAGO  
ERLA

Variable Grid Leak

Resistance can be varied smoothly and without steps from 1/2 to 5 megohms, making it easy to obtain the correct leakage from any grid for maximum signal strength.

The resistor is a strip of fabric impregnated with a high resistance compound. Changing the area of contact between this strip and a curved phosphor-bronze spring increases or decreases the flow of electrons depending upon which way the knob is turned.

Enables you to tune a little sharper and kills many of those annoying "squeals."

No. 106 (without condenser) . . . \$1.50  
No. 107 (with condenser) . . . 1.85

Central Radio Laboratories  
312 16th Street, Milwaukee, Wisconsin

### FanSteel BALKITE BATTERY Charger

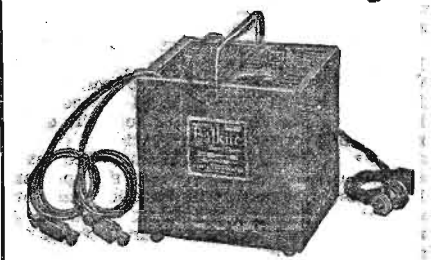

DEALERS - GET THIS

It's a fast seller—a new type of electrolytic rectifier for "A" Batteries. FanSteel Balkite is a rare metal developed for this purpose—acts as a valve—allows current to flow in but not out. Best charger made—no moving parts—can't get out of order. We can make prompt shipments. Price \$18.00—liberal dealer discounts.

Dealers only write for catalog A1001

WAKEM & McLAUGHLIN INC.  
225 E. ILLINOIS ST., CHICAGO

### Instruments of Excellence

- Langbein & Kaufman Variocouplers and Variometers . . . \$ 7.00
- Malone-Lemmon Condensers . . . 7.50
- Control-O-Meters . . . 12.50
- Ballantine Tuned Radio Frequency Transformers . . . 9.60
- Units . . . 15.00
- Curcoids—The Supreme Inductance by Means of Precision Coupling Coils. . . 7.50

### PARTS FOR ACMEDYNE NOW IN STOCK

- Amperites . . . \$1.10
- Meyers Hi-Mu Tubes . . . 4.35

Radio and Mechanical Trading Corp.  
23 Warren St. New York City

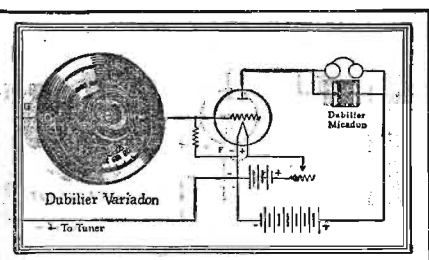

How the Dubilier Variadon is used with a fixed grid-leak to control the capacity of a grid-circuit.

### The Dubilier Variadon—A Variable Grid Control

It is difficult to control the resistance of a grid-circuit with the average variable grid-leak, but certain and easy to control the capacity with a fixed grid-leak and a Dubilier Variadon, the new compact variable mica condenser. Volume and selectivity are thus increased.

The Duratran will fit inside any cabinet, because it is no thicker than a dial. Price \$2.50.

Dubilier Condenser and Radio Corp.  
44-50 West Fourth Street New York

### CARTER Jack Switch

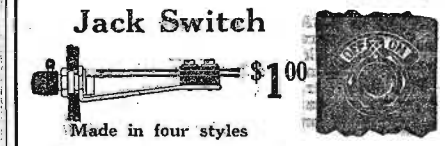

Two springs—three springs, four springs—six springs.

Nonreliable sliding contacts. All connections positive. Leads soldered. Mounts like a Jack.

There is no switch on the market to equal the Carter Jack Switch.

Positive—Reliable—Convenient.

Made from best materials by skilled workmen.

Write for catalog of other well-liked Carter Radio Products.

Carter Radio Co.  
CHICAGO

### We Want Agents to sell RADIO SETS and Supplies

(Part or Whole Time)  
Standard, well advertised merchandise—the kind everybody knows and wants. Make handsome profits representing us. \$5 a day easy in spare time. \$10 to \$20 a day made by many. Buy parts wholesale, sell them at retail. Assemble sets and sell at big profits—or sell our complete sets. Planagin of Keokuk, Iowa, picked off

Big Pay! \$50.00 A Week Up!

Write for agency in your locality.

OUTFIT FREE

WAVELAND  
Radio Co., Inc., 1027 N. State, Chicago

# Questions and Answers

**Radio Frequency**  
(05735) WPM, Cleveland, Ohio.  
I wish to thank you for your answer to my letter Number 05539 in regard to adding Radio frequency amplification to

ing will be fine at first; then the sound will vanish and return, vanish and return, so we only get half of what we want to hear. Could you suggest what might be the trouble? We got our set in May, 1923.

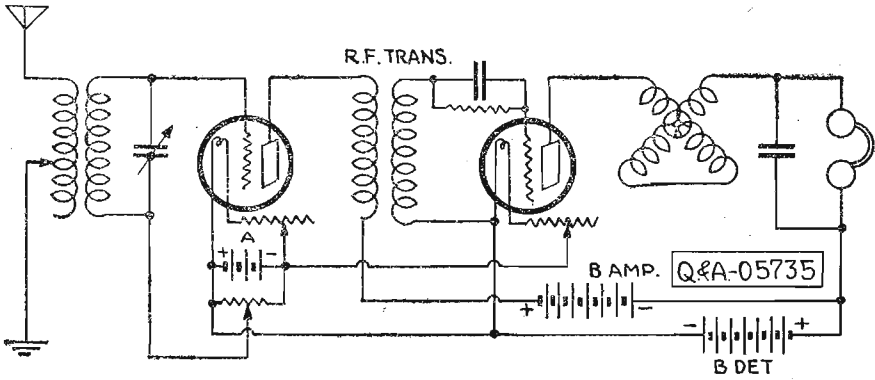

my set. I followed your advice and consulted the diagrams referred to, but it seems I can't figure out a way to hook it in, so again I must appeal to you for assistance.

If it isn't too much to ask I would like to know if you can furnish me with a diagram employing one stage of Radio frequency in conjunction with my set, diagram of which I am enclosing with this letter.

A.—We are giving a diagram showing method of connecting Radio frequency amplification to your circuit and trust it will solve your difficulties.

### Fading Signals

(06259) EC, Buffalo, N. Y.

We have a set on the Neutrodyne plan. Now we find it very difficult to reach eastern cities, as New York, Boston, etc., and when we get in tune with them the tun-

There are two large B batteries and a 6-volt Westinghouse A battery; the tubes light up nicely, but we are disappointed that the sound waves are so variable.

A.—While the details offered are insufficient to determine accurately the source of limitations encountered in operation of your Neutrodyne circuit, your description of action points quite definitely to "fad-

GOOD Radio Tubes CHEAP; American Radio Tube Works, Blum Street, Newark, N. J.

**BROADCAST ANNOUNCERS AND OPERATORS EARN BIG MONEY.** We will prepare you for a wonderful position in new field; unusual opportunities for ambitious young men. Catalog free. Dodge's Morse and Radio Institute, Valparaiso, Indiana. Established fifty years.

## Neutrodyne Sets

**BUILT and REPAIRED USING LICENSED PARTS**  
PANELS DRILLED  
R. WEISENMAYER  
421 W. 65th St.  
CHICAGO, ILL.

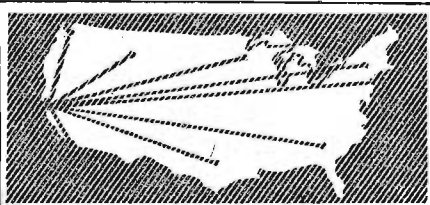

### ON ONE TUBE

Broadcasting from Atlantic Coast, Mexico, Hawaii, Canada and Cuba heard in California by users of CROSS COUNTRY CIRCUIT. Range due to simplicity of set and only one tuning control. Easily and cheaply built by any novice. Dry cell tubes may be used. All instructions, blueprint panel layout, assembly photo, etc. Postpaid, 25c. Stamps accepted.  
VESCO RADIO SHOP  
Box D-117 OAKLAND, CALIF.



**Reception Louder Clearer More Natural**

Functions with any conductor. No Cat Whisker necessary. Will not burn out..... **50c**

Celerundum "DE-TEX-IT" A perfect fixed detector..... **\$1.25**

Celerundum Products carry a MONEY BACK GUARANTEE  
Celerundum Radio Products Co.  
170 Summer Street Boston Standard Radio Corp. Chicago

### RADIO BY MAIL

- UV200, UV201-A, UV199, WD11, WD12. Genuine RCA. RADIOTRON TUBES..... \$4.24
- \$3.00 "COCKADAY" set of coils..... \$1.95
- \$5.00 "ACME" Audio or Radio transformers. 3.94
- \$12.50 "COMO" Push-Pull transformers (Pr.) 9.35
- All American Push-Pull transformers..... 9.87
- \$5.00 "ERLA" Audio or Reflex transformers..... 3.89
- All American Audio or Radio Transformers... 3.79
- 3 AMP. BATTERY CHARGER..... \$9.38
- \$6.00 BRANDES "Superior" phones..... \$4.69
- \$19.00 BRANDES "Table Talker"..... 8.29
- "Gold Plated" Square bus wire (2 ft.)..... .09
- \$3.00 Size 2 1/2 Volt "B" Battery..... 1.49
- \$5.50 Size 45 Volt "B" Battery..... 3.19

- VARIABLE CONDENSERS**
- 11-Plate..... \$0.94 Vernier With Dial \$1.89
  - 23-Plate..... 1.19 Vernier With Dial 2.19
  - 43-Plate..... 1.34 Vernier With Dial 2.49
  - \$3.50 "Teshoh" 3 to 1 & 5 to 1 Transformers 2.79
  - \$25.00 Set "FADA" Neutrodyne parts..... \$19.95
  - \$65.00 Set "FADA" Neutrodyne parts..... \$51.95
  - \$18.00 "G. E." TUNGAR 3-Amp. Battery Charger..... 15.69
  - \$28.00 "G. E." TUNGAR 5-Amp. Battery Charger..... 22.95
  - \$5.00 Bremer-Tully VERNIER TUNER..... 3.94
  - Bremer-Tully NEUTRODYNE Transformers (set of 3)..... 4.76
- CASH OR C. O. D.—SEND FOR COMPLETE LIST  
SIMPLEX RADIO SALES CO.  
1806 Lafayette Ave. ST. LOUIS, MO.

"ing," a natural phenomenon, as responsible for variable signals. The cause, being outside of your receiver, is impossible to combat. It is at this time little understood, and more or less prevalent at all times.

### Miloplex

(06226) FJG, New York City, N. Y.  
Send me a hook-up of the famous Miloplex using five UV-199 tubes, two audio transformers, two Radio transformers, two neutralizers, homemade, one loud speaker, etc.

Would you advise me to use three spider web coils or split variometer? If so, how? I have tried all of your Miloplex hook-ups and I find one to be as good as the other.

A.—We are not at this time prepared or disposed to advise the addition of Radio frequency amplification to the Miloplex circuit. We do not lose sight of the fact that this type of amplification is by no means as simple as audio frequency circuits, and it is our purpose to prove the

## CODE MADE EASY

Just Published **\$1.** Radio Alphabet

in THREE simple and fascinating FIVE MINUTE PICTURE LESSONS which you cannot forget.

A boy of eight learnt ten consecutive letters in five minutes. \$1.00 buys complete confidential course from Dept. D., KWIKKODE, 724 Beresford Avenue, Winnipeg, Man.

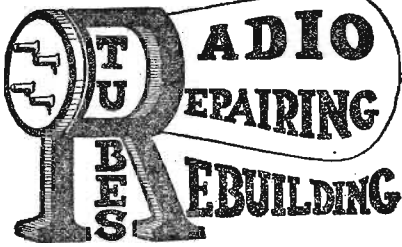

**ALL TUBES REPAIRED**  
Guaranteed Like New  
Detectors or Amplifiers **\$2.85**  
One Amp., 6 Volt Tubes Changed to 1/2 Amp. Tubes  
Agents Wanted—Free Circular

AMERICAN RADIO TUBE WORKS  
55 and 57 Blum St., NEWARK, N.J., U.S.A.

## \$140 NEUTRODYNE \$89.50 Set Only

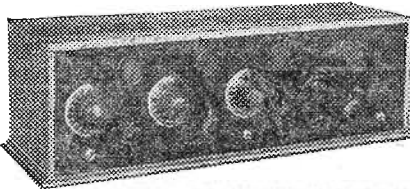

A \$140 Neutrodyne set while they last for \$89.50. High-grade parts are used exclusively in the manufacture of this set. Wherever possible the connections and wires are underneath a bakelite panel, where they cannot be seen. The cabinet is genuine walnut with a mahogany panel gold engraved. Four rheostats insure finer tuning, the detector rheostat being a vernier. Stations over 1500 miles distant have been received in tests made. Each set is thoroughly tested before leaving the factory. This is your opportunity to buy a high-grade Neutrodyne for a lower price than what the parts would cost you. We guarantee satisfaction. Send money order, draft or check. C.O.D. orders must be accompanied by \$20.00. Balance payable on delivery. Send in your order today before our limited supply is exhausted.

JACKSON RADIO COMPANY  
Dept. 21A, 639 W. North Avenue, Chicago, Illinois  
Send for our radio bulletin

## Edson Radio Headsets

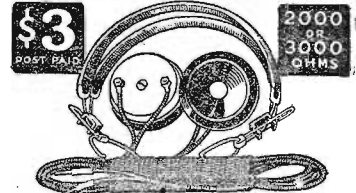

YOU can afford to have several at this price. Our guarantee protects you. Equal to any headset on the market in perfect reception of broadcasting. Send \$3.00 by registered mail or money-order. We will ship C. O. D., if you prefer. Prompt shipment—we pay postage. Ask for our

Free Catalog of Radio Parts  
EDSON RADIO SALES CO.  
6 Elmwood, Providence, R. I.

plan effective before offering it to the average novice. However, from the experimenter's viewpoint we may say that the method is the standard connection which can, generally speaking, be applied to any circuit.

The split variometer is much to be preferred to any other type of inductance.

### Miloplex

(06108) REC, Kansas City, Mo.

I am very much interested in your Miloplex hook-up. I would like to know if it is possible to use a variocoupler instead of the variometer, and what the results would be and if it would be as efficient as the variometer hook-up.

A.—The variometer of specifications for the Miloplex circuit is preferable to a variocoupler, and will give much better results.

## NASSAU NOCKDOWN CABINETS

SOLID MAHOGANY

- 14x7x7 ..... \$2.50
  - 21x7x7 ..... 3.50
  - 26x7x7 ..... 4.50
  - 36x7x7 ..... 5.50
- Length ANY Height Depth

All other sizes, odd or standard, at corresponding prices. Minimum \$2.50 complete with screws and hinges. Sent C. O. D. Prompt Deliveries.

Assembled and Waxed Finish 50% Extra  
NASSAU CABINET CO., 20 Nassau St., N. Y.



## SPECIAL (IMPROVED MODEL)

Direct From Manufacturer to Consumer  
**LOUD SPEAKER**

Genuine Wood Fiber Horn (With Unit and Cord)  
Entirely eliminates that annoying metallic sound. Positively the only WOOD FIBER HORN on the market today. 10-inch Bolt with Standard Attachment. Complete. Height 24 inches. Colors, Black, Mahogany and Olive Green.

Price **\$9.50**

Delivered to any part of the United States and Canada

### EMIL DECLYNE

15 Park Row, Room 612, NEW YORK CITY  
Send M. O. or C. O. D. Dept. R. D., Barclay 6298

# YOU DON'T NEED TUBES

to hear concerts from out of town. If you want to get new stations

### ON YOUR CRYSTAL SET

write me today. I get new records every day from people using my plans who hear programs on Crystal from stations 400 TO 1000 MILES AWAY

No tubes, batteries or amplifying apparatus necessary. I hear KDKA (Pittsburgh Pa.) on Galena. You may already have everything you need and just have it connected up wrong. Send self-addressed envelope for picture of my set, and reasons why you need my plans.

LEON LAMBERT

501 South Volusia, Wichita, Kan.

## Here Is The Cabinet You Have Been Looking For

Highest Quality CORBETT'S Latest Designs

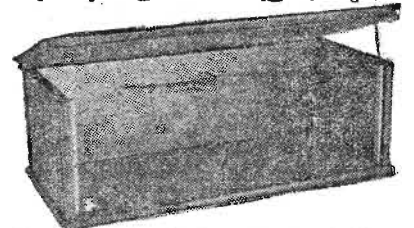

This cabinet is hinged to base with loose pin hinges, permitting entire clearance or removal for convenience. Top and base slanted, later being raised to allow clearance for wiring and screws underneath. Panels to be fastened to base, and no sub-base required.

Panel	Depth	Price	Panel	Depth	Price
6x10 1/2"	7"	\$2.60	7x18"	8"	\$3.60
8x21"	7"	3.85	7x21"	8"	4.35
7x10"	8"	3.15	7x24"	8"	4.90
7x12"	8"	3.30	7x26"	8"	5.10
7x14"	8"	3.50	12x14"	10"	4.35

All sizes, also furnished in old style hinged top and grooved front; no screws required. Price 10% off above list.

Genuine oak, dark finish, or hand rubbed mahogany finished hardwood. Odd sizes to order. Discounts to jobbers and dealers—our cabinets will sell over the counter. Guaranteed to please or money promptly refunded. Shipped C. O. D. Plus Postage

Corbett Cabinet Mfg. Company  
5323 N. Carlisle St. Philadelphia, Pa.  
5814 Forbes St. Pittsburgh, Pa.  
Plant—St. Marys, Pa.

## CATALOG E19-100 PAGES FREE

Latest Reflex and Neutrodyne Circuits  
**EVERYTHING IN RADIO**  
One of the largest complete stocks in the world. 40 diagrams of latest Hookups.  
**DEALERS ALL OVER THE U.S.**  
Making big profits handling our supplies. 24-hour service. Goods shipped same day order received.



WHOLESALE RADIO DISTRIBUTORS  
Dept. V, 6 W. 14th St., Kansas City, Mo.

# Radio Illustrate

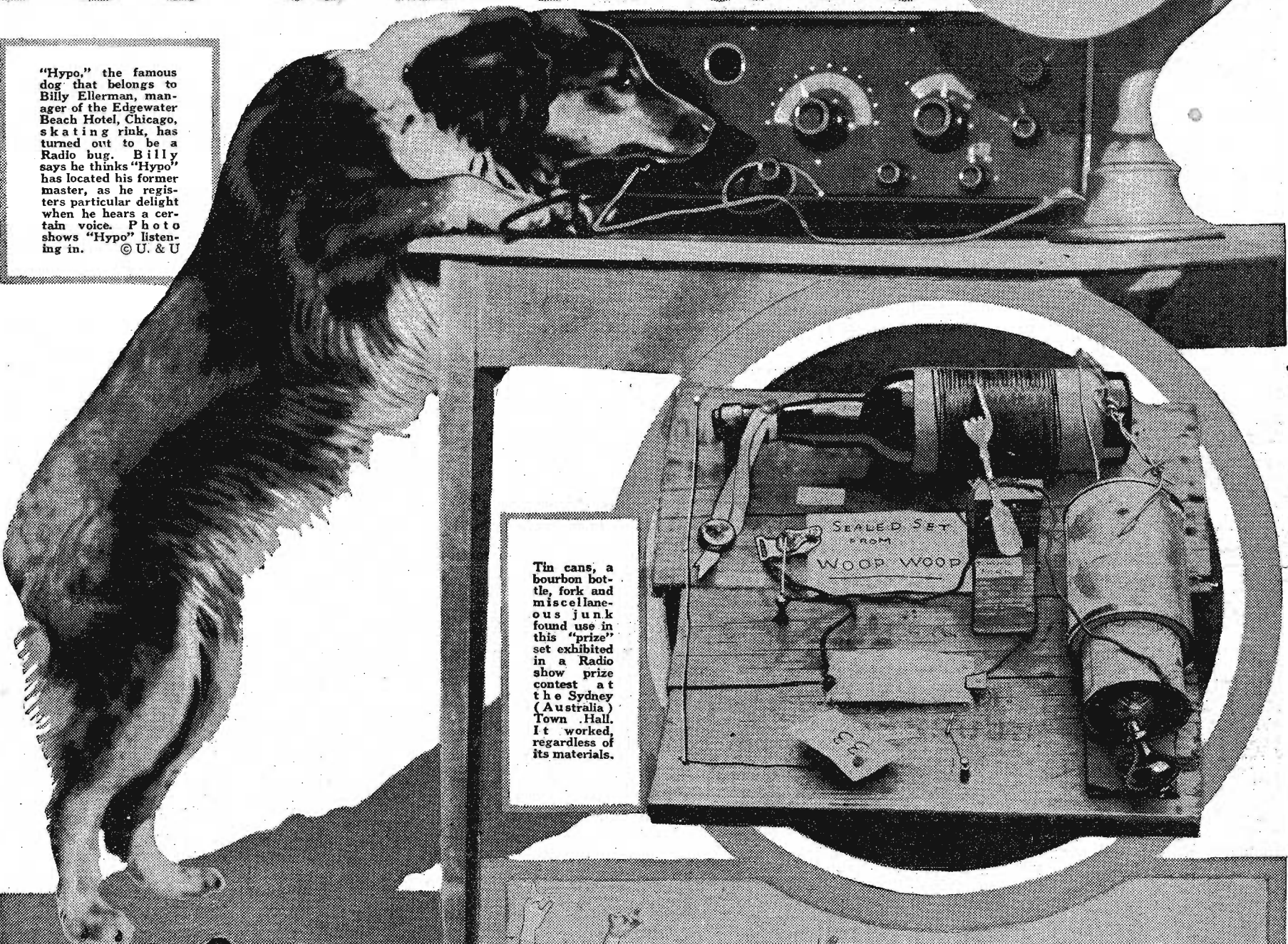
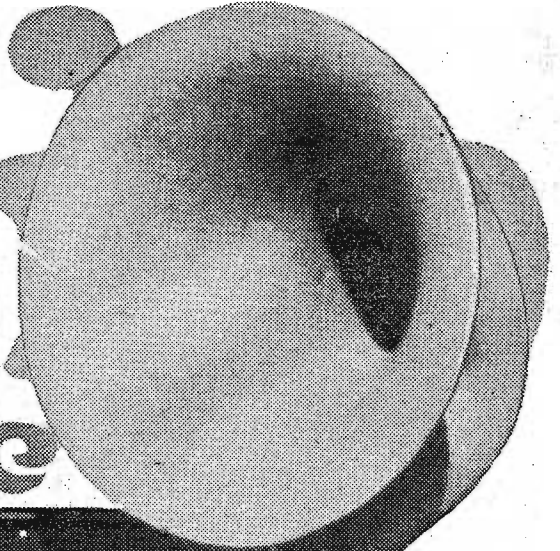

"Hypo," the famous dog that belongs to Billy Ellerman, manager of the Edgewater Beach Hotel, Chicago, skating rink, has turned out to be a Radio bug. Billy says he thinks "Hypo" has located his former master, as he registers particular delight when he hears a certain voice. Photo shows "Hypo" listening in. © U. & U

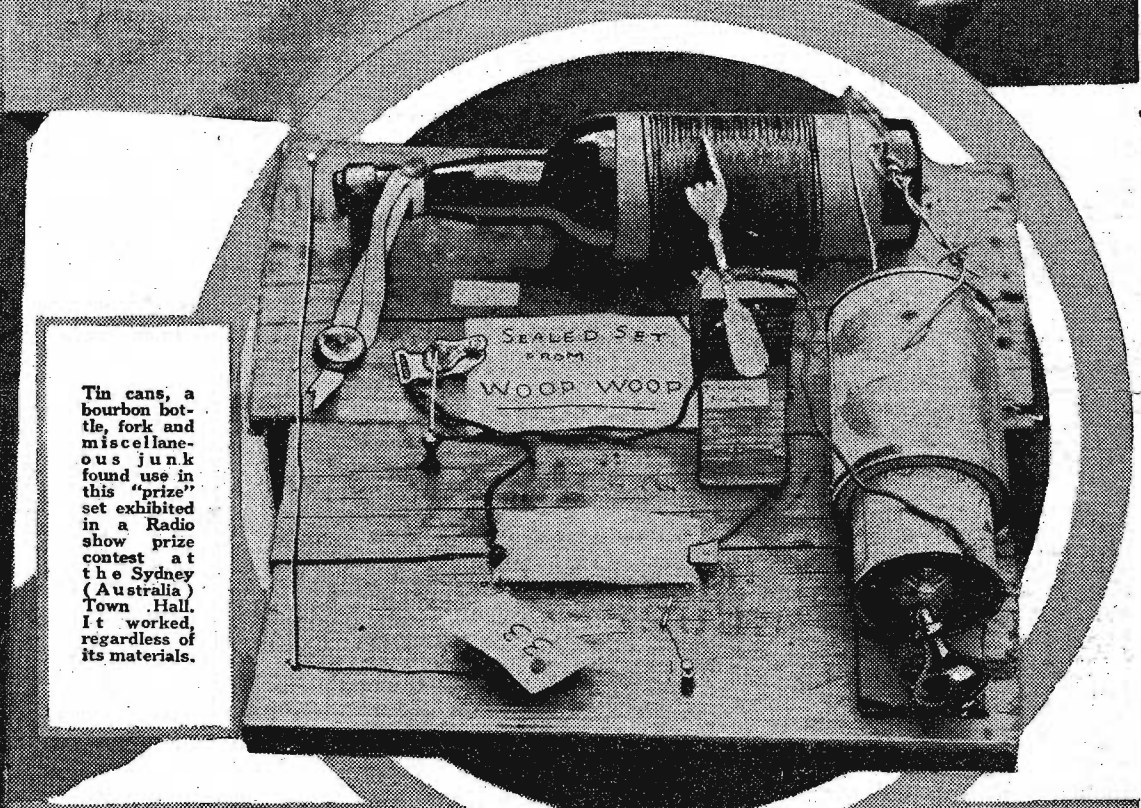

Tin cans, a bourbon bottle, fork and miscellaneous junk found use in this "prize" set exhibited in a Radio show prize contest at the Sydney (Australia) Town Hall. It worked, regardless of its materials.



Radio as a pain-killer is being tried by a Chicago dentist. He has installed an elaborate receiving outfit in his office and puts the headset on his patients while he works on them. Wide World Photo



A peep at the "Pony Ballet" of André Chariot's "English Revue of 1924," rehearsing to Radio music at Selwyn theater, New York. At the receiver are standing E. F. McDonald, Jr., (left) and "Sport" Herman (right). Pictorial Press Photo