

“Bloopers” Spoil International Tests

# Radio Digest

EVERY  
WEEK

PROGRAMS  
Illustrated

TEN  
CENTS

REG. U. S. PAT. OFF. & DOM. OF CANADA

Vol. XVI

Copyright 1926  
By Radio Digest Publishing Co.

FEBRUARY 6, 1926

No. 5



*Wendell Hall Tells of European Trip; Billy B. Van Beams Joy; Schedule of Sports; Florida Sunshine Reaches Alaska; Molliformer Chemical B Eliminator; Women's Programs*

# SUB-COMMITTEE NOW MOOTING RADIO BILL

## HOUSE WANTS ACTION ON MEASURE EXPEDIATED

Majority of Witnesses Endorse Proposed Bill at Hearings—Senate Delays on Dill Measure

WASHINGTON.—Hearings have been concluded by the committee on merchant marine and fisheries of the house of representatives on the White Radio bill, designed to secure legislative control of the Radio industry, and the measure has been referred to a subcommittee with instructions to expediate its action and report the measure back at the earliest possible date. Representative White of Maine, framer of the bill, is chairman of the subcommittee. It is believed that the full committee realizes the necessity and soundness of the White bill and will report it to the house at no distant date.

### Majority Favor Bill

In the majority of instances, the witnesses brought before the committee have endorsed the bill and it is considered quite possible the committee will accept the testimony of Radio experts in regard to the bill and will present it to the house with but few recommendations for major changes.

David Sarnoff, manager of the Radio corporation, told the committee that his organization feels that Radio needs proper legislation, and the White bill is satisfactory to it. He expressed himself as certain the bill would benefit both the industry and the listener.

### Master Radio Bill

Charles H. Stewart, representing the American Radio Relay league, and Herman Levinsky of Station WNJ, Newark, N. J., both held the White bill as a masterpiece among proposed Radio measures.

Judge Stephen Davis, solicitor of the department of commerce, expressed the opinion that the small station would be afforded more protection under the proposed bill than they now have, stating that a commission of technical men with a general knowledge of the whole Radio situation should be appointed.

### Endorsed by Fessenden

Sherman L. Whipple appeared before the committee on behalf of Prof. R. A. Fessenden, who has a damage suit for \$60,000,000 against the Radio corporation. Mr. Whipple told the committee that he endorses the White bill and that he considers it well adapted to regulate Radio.

Boyd B. Jones, also a representative of Prof. Fessenden, suggested that a commission or the secretary of commerce should say whether a corporation is a monopoly or not, if there is any doubt, before issuing a license.

### Senate Bill Lags

Senator Watson of Indiana, chairman of the senate committee on interstate commerce, is of the opinion that it will probably be several weeks before his committee will continue the hearings on the Dill and Howell Radio bills, which also provide for legislative control of the industry.

## Station Changes

Florida announces a new 1,000-watt station at Miami, Fla. The station is owned by Charles G. Fisher, Inc., and will operate on 247.8 meters or 1,210 kilocycles.

Two stations announce changes in call letters. WAAM, Newark, N. J., a pioneer station, will now be known by the call, WBPI. WEBK, Grand Rapids, Mich., has the call, WOOD.

Since the fourth national Radio conference there has been a big increase in applications for increased power among stations. The policy of the department in dealing with these applications is to grant an increase of power when it would be beneficial to the public and not result in interference. In large cities where there are a number of stations of high power already in operation, the power increase is not likely to receive favorable consideration unless experiments definitely prove that interference would not result.

### License Evaders Fined

LONDON.—The first batch of summonses under the new Radio Telegraphy act were heard in court here recently. Counsel for the postmaster-general declared each of the defendants had installed crystal sets and worked them without a license.

One evader's defense was that although he had installed the set he was unable to make it function, but he intended to get a license when he got results. The judge decided not to confiscate his set, but fined him \$2.50.

## GEORGE KUHN'S DIES; BUILT STATION WHO

DES MOINES, Iowa.—George Kuhns, known nationally as the president of the Bankers Life Insurance company of this city, owners of Station WHO, passed away here recently after a brief illness.

Mr. Kuhns, whose counsel in Radio matters will be sorely missed, was father of the Corn Sugar movement and was the starter of the campaign to better conditions for the farmer.

As a mark of respect for the deceased, WOC, at Davenport, the B. J. Palmer station, observed a one-minute silence period on the day of Mr. Kuhn's death. The Davenport announcer, in his remarks, paid a high tribute to the WHO founder.

Mr. Kuhns was one of the world's greatest fishermen and had a wonderfully complete exhibit of fish and sea creatures on display in one of the Des Moines hotels.

## Station Dedicates One Hour Every Week for Its Artists

NEW YORK.—Station WBPI, Warner's theater here, has recently inaugurated a form of Radio presentation as a means of honoring artists who appear before its microphone. An hour's program each week is dedicated to various prominent artists for their own use. The hour is

## MARIE PREVOST IS OUR COVER BEAUTY

THAT the beach costume is not alone responsible for the charm of a bathing beauty is manifest by the face enshrouded in ostrich feathers on the Radio Digest cover this week. The face belongs to Miss Marie Prevost who graduated from the role of a bathing beauty to a cinema star with the Warner Brothers studio in Hollywood. Her voice frequently is heard over Radio Station KPWB.

known under the name of the artist, who assembles his or her own talent for the special program.

The first to be honored was Joseph Turin, tenor. His hour was Friday night, January 15.

## KYW's Hawaiian Swede Is Back with New Repertoire

CHICAGO.—Cy Berg, the "Hawaiian Swede" and president of the I. O. O. S. Y. S. L. I. is back at KYW, to exploit a lot of new things to the Radio fans, who tune in the Congress carnivals at midnight each Saturday.

For those who are not acquainted with the long string of symbols above mentioned, it all means "International Order of Sky Yumpers, Snuse Chewers and Lutefisk Inhalers."

# CONTENTS

Radio Digest, Illustrated, Volume XVI, Number 5, published Chicago, Illinois, February 6, 1926. Published weekly by Radio Digest Publishing Co., (Incorporated), 510 N. Dearborn Street, Chicago, Illinois. Subscription rates yearly, Five Dollars; Foreign Postage One Dollar additional; single copies Ten Cents. Entered as second class matter at the post office at Chicago, Illinois, under the Act of March 3, 1879.

All the Live News of Radio.....	1 to 11
Wendell Hall Tells of European Trip.....	4
Billy B. Van, "The Sunshine Man," Gives a Cure for the Blues.....	5
WGHB Radiates Florida Sun to Alaska.....	7
Women's Page; Index to women's Programs.....	11
An Evening at Home with the Listener In; A Chart in Eastern Time, showing when to listen in for stations.....	12
Advance Programs for the Week.....	13 to 21
Editorials, Indi-Gest and Condensed by Dielectric.....	22
A. B. C. Fundamentals for Everybody, Part V—The Detector or Converter, by Milo Gurney.....	23
Operating and Trouble Shooting for the Owner of an Erla Circloid 5 Receiver.....	25
Readers' Views.....	26
Construction of B Current Power Supplies, Part II—The Molliformer Chemical Rectifier Type, by George Walters.....	27
Unitrola: Single Dial Phonograph Receiver, Part IV—Adjusting and Tuning, by Carl Patterson.....	29
Directory of Radiophone Broadcasting Stations, Part I (Revised).....	31

## Looking Ahead

**Whose Voice Was First to Cross the Atlantic Ocean?** Harold Robinson, New Jersey Boy Scout, presents evidence that indicates his amateur phone transmission was heard in Scotland at a date previous to the time accepted by Radio authorities as official. Hints are made that recognized tests were unfair. Details and evidence is the next issue of Radio Digest.

**Henry Ford's Old Fashion Dance Orchestra** has aroused a national interest in the fiddlers who were in the height of their glory forty or fifty years ago. A score of challengers have questioned the championship of Mellie Dunham of Maine. A survey of old-time fiddlers as they are today in coming Radio Digest.

**Did You Ever Tune in Station WKAQ?** A corking DX thrill is promised to those who have not yet logged this station of the Antilles—San Juan, Porto Rico. Mr. Agusty, WKAQ announcer, has written an interesting story to appear in one of the early releases of Radio Digest. There'll be pictures, too, of course.

**Globe Trotting with Vincent H. Percy**, organist at WEAR, Cleveland, has been one of the favorite pastimes with his listeners. Mr. Percy organized a world series which he called a "Trip Around the World" by organ music, which consisted of native classics from the various countries around the well-known earth. Other details of interest about this Ohio station in a near issue of Radio Digest.

**The Most Unusual Thompson Minuet Receiver** is scheduled to appear soon in the Operating and Trouble Shooting series. This neodyne looks nothing like the ordinary receiver, and has a built-in loud speaker of the cone type.

**A Power Supply Using the UX-213 Tube** will be presented in the next issue as the third of the series being described by Mr. George Walters. These tubes can be obtained anywhere and now a transformer is available which lights the filament and supplies high voltage, both windings being center tapped.

**M. Gurney's Series for Beginners Arrives**, with his next installment, at a discussion of the grid leak and the grid condenser, their functions and how to get the most out of them. Unless you understand their purpose thoroughly you cannot expect to adjust them for maximum efficiency.

## Newsstands Don't Always Have One Left

WHEN YOU WANT

# Radio Digest

YOU WANT IT!

BE SURE OF YOUR WEEKLY COPY BY SUBSCRIBING NOW

SEND IN THE BLANK TODAY

Publisher Radio Digest, 510 N. Dearborn St., Chicago, Illinois. Please find enclosed check M. O. for Five Dollars (Six, Foreign) for One Year's Subscription to Radio Digest, Illustrated.

Name .....

Address .....

City..... State.....

# NEWS BRIEFS FROM THE BROADCASTERS

## "HILL BILLIES" COME BACK TO WRC, WASHINGTON

Arctic Talk at WJAZ—Boston Tech. Dramatic Club at WTIC—Helen MacKellar at WOR

A return engagement of the "Hill Billies," whose program of hill country music was broadcast by Stations WRC and WJZ early in January, is being arranged for the middle of February. Included in the ranks of the "Hill Billies" are Charlie Bowman, champion fiddler of East Tennessee; Elvis Alderman, widely-known fiddler; John Rector, North Carolina banjoist, and the Hopkins Brothers, Al, John, Joe and Elmer, who hail from the Blue Ridge mountains of Virginia.

When Commander Donald B. MacMillan gave an Arctic talk at WJAZ, Chicago, recently, he told the story of Admiral Peary's discovery of the North Pole. Many people who have questioned Peary's discovery of the Pole, were convinced by this talk that he was successful.

Popular songs from "Too Many Brothers," the new show being presented by the members of the Dramatic club of the Massachusetts Institute of Technology, were broadcast by members of the company from WTIC, Hartford, last Monday.

At eight o'clock Helen MacKellar, star of "Open House," now playing in New York city, was talking before the microphone of WOR to millions of Radio fans. At 8:30 p. m., she was ready for the curtain to rise at the theater. Miss MacKellar was compelled to rush from studio to stage. Gilbert Miller and E. Ray Goetz, two leading Broadway theatrical managers, were listening in at the Ritz hotel, London, for her talk.

The American Lady quartet, recently returned from an Alaskan tour, is the new feature at WBBM, Chicago. Every Friday between the hours of 8 and 10 p. m. Central time the quartet will sing.

Three popular dance orchestras, Broadmoor Rhythm Rustler, Harmony Peerless orchestra, and Scheuerman's Colorado orchestra, are vying for popularity at KOA, Denver. Everything from symphonic jazz to blues and rapid-fire syncopation is played by these three orchestras.

"Stung" is the name of the comedy to be broadcast by the KGO players, Thursday night, February 11, at 8 p. m. Mountain time. The piece was written for the stage by Lydia Le Baron Walker, and adapted to Radio by Wilda Wilson Church, director of audio players.

The Yale band, familiar to football fans, will take part in the anniversary program which is being broadcast by WTIC on February 10. All the songs of old Eli and many other college tunes will be heard by Radio fans on that evening.

In the search for new music at WRC, Washington, D. C., the director of the U. S. Marine band orchestra discovered a new concerto for the violin composed by Robert Cary Stearns, a well-known Washington musician. The violinist will be William F. Santelmann, son of the marine band orchestra leader. This concert of the U. S. Marine band symphony orchestra will also be broadcast by WJZ, WGY.

Frederick D. Weaver, one of the foremost organists in the East, has been appointed staff organist of WBAL, Baltimore. He will give bi-weekly recitals from the new James Wilson Leakin organ which has recently been added to the broadcasting attractions of this station.

Clarence Dickinson, director of the Friday noon programs at WJZ, New York, will present each week an unusual sequence of music of the nations which first colonized America—England, Belgium, Holland, France and Spain. One country will be featured each Friday. Noted soloists have been secured to participate in these programs.

Beasley Smith and his orchestra will give a special frolic of popular dance tunes every Tuesday night from 10 to 12 o'clock, Central time, for WSM, Nashville, Tenn. WSM has added this frolic to the regular schedule. Heretofore the station has been silent on Tuesday night. Lovers of the Charleston will have their wishes for the dance gratified at that time.

The Apollo club with fifty-four years of public appearances behind it has arranged a series of programs to be given by members of the club at WLS, Chicago.

# WAR AGAINST "BLOOPING" BEGINS

## CLAIMS SUCCESS IN STATIC ELIMINATION

### PROF. DANA DEMOREST IS INVENTOR OF DEVICE

Ohio State University Scientist Has Applied for Patent—Large Manufacturer Reported Interested

By M. M. Carothers

COLUMBUS, Ohio.—Another promise has been made to solve the greatest problem of the Radio listener in. What may turn out to be a real static eliminator is claimed to have been invented by Prof. Dana Demorest of the department of metallurgy, Ohio State university here.



Prof. D. Demorest

If Professor Demorest's claims are true, and his device is simple enough for attachment to all receiving sets in use today, one of Radio's greatest stumbling blocks, atmospheric electrical disturbances, have been conquered. Professor Demorest has had the device in the national patent office for more than a year and since the word of his invention has spread, Radio manufacturers throughout the country have become interested. No public demonstrations have been made, pending the issue of a patent, but negotiations are now being made to exhibit the ability of the device to one large manufacturer.

#### No Outside Current

"The eliminator operates solely on impulses coming in over the antenna, requiring no outside current," Demorest said. "We do know that it greatly cuts down the static in reception and makes it far sweeter and clearer. We also believe it very practical since it can be made cheaply and attached to any set. Static is not grounded, as may be the popular belief. It merely is intercepted and carried into discard before the interference can reach the head phones or loud speaker. The principle is the same as that of a farmer's threshing machine, which separates the chaff from the grain. In Radio, clear reception is the grain and my invention is the machine that bears off the chaff."

#### Inventor Static Expert

Although Professor Demorest has worked with collaboration of others, whose names he would not state, he has been experimenting with static elimination since Radio was introduced. He has a very high standing locally, and comes from a family of scientists. He has done original and successful research work along other lines, and although he admits his extensive knowledge of metals and minerals helped him in making the discovery, rare or unusual metals are not employed.

Your correspondent has investigated the device but has not witnessed a demonstration.

The first "static eliminator or drain" was perfected at the army headquarters in Pershing road three years ago by Major General Squier and Major Mauboygne. So far as is known the device has not been commercially perfected.

## STRIKING OF CLOCK HINDERS RECEPTION

NEW YORK.—The next prohibitory amendment will probably be directed against striking clocks. WEAH recently received a letter from a New Hampshire listener which requested with considerable fervor that programs start at some other time than on the hour, because the striking of the clock interfered with the announcer's introductory remarks ushering in a new program.

## RADIO DIGEST ASKS PLEDGES TO HELP PREVENT RADIATION

### Broadcasters and Public Asked to Cooperate and End Unnecessary Noises Which Contributed to Failure of International Week Tests

## HUSBAND AND WIFE BEHIND WKAF

Robert F. Hall and his wife, Anita DeWitt Hall are the two motive forces behind WKAF, the Kesselman-O'Driscoll-Hotel Antlers station at Milwaukee. He announces and directs. She is hostess and accompanist. The two are very pleasing and both have good theatrical background.



Warfare against bloopers is declared! With the terrific demonstration of blooming fresh in the minds of all listeners who attempted to receive foreign stations during the International Radio Week tests just concluded, the campaign against radiating receivers thus announced by the Radio Digest should meet with instant success.

The method to be used by Radio Digest in its war to clear the ether for decent broadcast reception will depend chiefly upon pledge cards issued to listeners and filled in by them. It is the duty of every Radio listener to pledge himself, first of all, to operate his receiver to reduce radiation or blooming to a minimum. If his set will not operate without blooming, it is his duty to pledge himself to so arrange it so it will not bloop, or as an alternative, replace the receiver with one that will not broadcast squeals and howls into the already crowded ether.

#### Situation Now Intolerable

The silence periods of International Radio Week afforded an ample opportunity for listeners to recognize the situation as one that needs immediate correction. Everywhere reports were heard that radiating receivers spoiled the foreign tests.

If a listener turned his dials anywhere near the settings at which the overseas stations were supposed to be heard, an ear-splitting series of whistles, screeches and howls greeted his ears. Foreign reception was almost hopeless for anyone not living in the country or in a sparsely populated area.

American, Canadian and Mexican broadcasters were off the air. A few cases of these stations not observing the silence period were reported, but these were accidental for the most part. On the whole the air was clear—for reception of foreign stations and bloopers.

The result was that radiating receivers of every kind and description filled the air. In the larger cities practically no foreign reception was to be had. Poorly operated receivers were largely responsible. Regenerative sets were not alone to blame. Regenerative sets are easy to make bloop, but other sets are likewise offenders when not handled properly by the owner.

#### Stations to Aid Warfare

It is the earnest desire of Radio Digest to secure as many pledges as possible from its readers and all other Radio listeners. These pledges will be distributed by broadcasting stations and published in Radio Digest. The principal broadcasting stations of the country are being enlisted in the campaign to clear the air of radiation.

It is believed that entirely too often interfering "carrier waves of neighboring stations" are simply oscillating receivers of neighboring listeners. The broadcasters are blamed, regardless of the underlying cause for the interference.

#### Progress Is Chief Hope

If every listener earnestly pledges whole-hearted cooperation in the Radio Digest war to clear the ether of radiation (Continued on page 30)

## SPORT SCHEDULE

### Basketball

#### Saturday, February 6

WSUI (483.6m-620kc) Minnesota-Iowa, 7:30 p. m., Central time.

KOAC (280.2m-1070kc) Oregon Agricultural college-University of Idaho, 7:15 p. m., Pacific time.

KFMQ (299.8m-1000kc) University of Arkansas-University of Texas, 7:30 p. m., Central time.

#### Tuesday, February 9

WOI (270m-1110kc) Grinnell-Ames, 9:30 p. m., Central time.

KFKU (275m-1090kc) University of Kansas-Drake University, 7:30 p. m., Central time.

#### Thursday, February 11

KFKU (275m-1090kc) University of Kansas-Oklahoma A. & M. college, 7:30 p. m., Central time.

### Hockey

#### Tuesday, February 9

WBZ\* (333.1m-900kc) Boston Bruins-New York, 8 p. m., Eastern time.

## Fessenden Charges Not Clear, Say Defendants

### Corporations Assert Damages Are Not Outlined in Suit Action

NEW YORK.—Defendants in the \$60,000,000 suit for damages filed by Reginald Fessenden, Newton inventor of Radio appliances, asserted in demurrers filed in the federal court here recently that neither the way in which Mr. Fessenden had been damaged nor to what extent had not been made clear in his action.

The inventor charged eight corporations with infringement of patent rights, mostly on Radio devices. The defendants filing demurrers included the Radio Corporation of America, the American Telephone and Telegraph company, Western Electric company, United Fruit company, Wireless Safety Apparatus company, Westinghouse Manufacturing company, and the International Radio and Telegraph company.

## Newcastle Celebrates Birthday

LONDON.—The third anniversary of the opening of the Newcastle station of the British Broadcasting company (5NO) has just been celebrated by the opening, by the Lord Mayor, in the presence of Lord Gainford, chairman of the B. B. C., of the station's new premises, formerly a hospital. The transmitter, to which they are connected by the post-office land line, will remain in the old site. Some months ago 2LO moved its aerial but maintained its premises in the same location.

## PLEDGE CARD Radio Digest I WON'T BLOOP CLUB

I pledge myself to operate my Radio set to reduce radiation or blooming. If I am unable to make my present set operate properly, I further pledge myself to replace it with a receiver that will create less interference.

Make of my set:	Signature .....
Number of tubes is:	Address .....
	City and State.....

I am cooperating in this campaign with Station.....

# Wendell Hall Reflects on 2LO

**W**ENDELL HALL, the Red-Headed Music Maker, dropped in the office the other day before continuing his itinerary westward to fill a series of bookings in some of our best known broadcasting stations beyond the Mississippi.

It was the first time he had been in since his return from Europe. He stood in the doorway for a moment, his blue eyes sparkling with that peculiar Scotch twinkle that somehow finds its way into the songs he sings to Radio listeners. A long coonskin coat hung regally from his broad shoulders. I inquired as to his ramblings amidst the heather and whether he had uncovered any moss-

crowds and the fan letters and the cheers of the blase Frenchmen. Here was a poor little fellow in a back street of the old town of Canterbury whistling a tune that I had written far away across the Atlantic, in the heart of America. It had swept on the tides of the air all this way and was coming back to me in this wee corner of the world on the lips of this rain-soaked little boy. I tell you, that sure did give me a kick I'll never forget."

Wendell Hall wrote "It Aint Gonna Rain No Mo'" four years ago and first sang it over KYW, Chicago, where he began as a staff artist at \$25 a week. Over a million copies of that song have

**C**ANTERBURY Boy Whistling in the Rain Gives Red-Headed Music Maker Greatest Thrill on European Trip. American Singer Breaks Through British Barriers. "Aint Gonna Rain," Called "Bad English" by Irritated Letter Writer

"**H**E HAD a good laugh when I related my experiences in getting to his office. 'You should have called up from your hotel first,' he said. And he was right. But he soon fixed things nice for me by writing an order on the back of his card. Afterward I found this card a magic sesame to every door connected with the British Broadcasting company throughout the entire system.

"Then we took up the proposition of my not signing up before leaving the states. It seems this is a very rigid rule. Captain Eckersley, one of the most powerful authorities on broadcasting in Great Britain, went to see every-

fore the directors before you are finally passed upon and dated for a performance. I entered the rehearsal room and while there saw a troop of chorus girls in theatrical costumes rehearsing their songs before going on the air.

"**I** TOOK my turn at the rehearsal and apparently gave satisfaction as I was promptly booked for a feature for the following week. In the meantime I was asked to go up to Daventry and try out locally from that station.

"The rain song seemed to be especially popular over there so I sang that. It brought a quick reply and apparently there were a great many persons who had never heard it before. One man wrote a very indignant letter in 100 per cent pure English. He was terribly shocked that I had managed to get before a microphone at all as he supposed that the dialect in the song 'It Ain't Gonna Rain No Mo'' was my best understanding of the English language. He said it was the most terrible crime against the mother tongue he had ever heard.

"That gave me a hint what to do when I got to London again. I prepared a brief announcement of my own in which I explained what the dialect of the song was and after that the letters



Upper picture shows Wendell Hall, serenading his bride aboard ship as they sailed for Europe on their honeymoon. Mr. Hall is playing his famous tarpatch ukulele. Below the bridal pair are shown waving farewell to friends ashore.

At left Mr. Hall is playing into the Marconi microphone in famous 2LO station, London England.



grown tombstones with Hall marks that he could claim.

"Yeh," he said dropping into an armchair and draping one of his spindling legs over the other. "Yep, and I met Johnny Walker, himself. He was not of my clan but I got a thrill from him."

"Was that your greatest thrill, abroad?"

"No, the greatest thrill happened in a little English town, the old town of Canterbury. It was just a skinny, little kid in the rain—"

**A** SUDDEN earnestness came over the face of the Red-Headed Music Maker as he leaned forward. He had forgotten Scotland with the recollection of his greatest thrill and was back in England waiting for the slow unwinding of British red tape before he could do his stuff at the famous 2LO, London. He had neglected the little detail of registering at the English consul's office in New York with the declaration that he was going to London to broadcast. This he related in preface to the story he told of his greatest thrill.

"So Marion and I started out for short junkets about the old town while waiting for Captain Eckersley to find a way of hurdling that troublesome oversight," (Marion, it may be explained, is the bride of the famous singer). "We were in historic Canterbury. The rain was pouring a deluge. I was sloshing down a by-street when I met a boy, a weazened little fellow, sauntering along under the fragment of a wind-torn umbrella. He seemed utterly unmindful of the weather. His soggy clothes clung to his body but he whistled a tune. The tune that he whistled was 'It Aint Gonna Rain No Mo'."

"You know that meant more to me than all the applause of the London

been sold and it is still going strong. Mr. Hall can well afford "million dollar" coonskin coats for he has also produced other songs that have been almost as successful.

"**B**UT how did you get around that obstinate British rule?" I asked.

"Obstinate is right," answered the Red-Headed Music Maker with a wry smile. "It's like going through stone walls, utterly unlike anything in America. We registered at the Savoy and after we had our things straightened out and had written a few post cards for folks back home I thought I would stroll around to the British Broadcasting company and see Captain P. P. Eckersley with whom I had corresponded before leaving the states.

"It was all understood by Captain Eckersley, with whom I had correspondence, that I was to come and sing from 2LO. I never imagined there would be anything to it than just to walk in and say 'Hello.' But they don't do things that way in England.

"First I had to give my name and pedigree to a doorman who had the dignity and bearing of a man in command of an army. He regarded me with cold skepticism and finally condescended to take my card, memoranda, miscellaneous information and other matters pertaining to my family history to his superior. After a half hour I was taken to see this important individual to whom I verified all that I had told the doorman and he condescendingly decided to lay the matter before one of the secretaries of the 'on high.' Then I took another degree and finally reached the secretary of Captain Eckersley who seemed to understand things much better and in a few minutes more I was ushered into the inner sanctum of Captain Eckersley who greeted me cordially.

body that could possibly have any influence to make an exception in my behalf. But nobody would take the responsibility of breaking the rule.

"At last he found a way. It was quite formal and involved fine technical decisions, I suppose. The inside of it is as much of a mystery as ever, so far as I know. Anyway I discovered that I had been enrolled as an employe of the British government and one of the functions of my office was to be present in the 2LO studio and while there I was to test the reactions of the British public to Negro folk songs from the American Southland.

"Broadcasting is a tremendously serious performance over there. No matter how experienced you are before the microphone you have to rehearse be-

were very gratifying and there were many thousands of them during the three weeks which I appeared on the Wednesday program of the 2LO chain."

The English are more prone to write than are the Americans, Mr. Hall explained. The letters are characteristic for their analysis and comment in regard to details. He said his letter responses ranked third in the record of the London station.

Mrs. Hall, formerly was Marion Martin of the Chicago Tribune. Her father was a very well-known editor before his death some years ago. The honeymoon trip of the Hall's across the Atlantic was the occasion of considerable newspaper notice. Mrs. Hall now arranges Wendell's business engagements.

# Billy B. Van Beams Sunshine

By JACK FORREST

*OLD SOL Gets Plenty of Puff From This Humorous Philosopher and There's a Reason. It Saved His Life When He Was In a Tight Pinch.*

**G**OD'S GREATEST gift to the human race is sunshine! If you don't believe it, tune in some night to Station WHN, New York, and listen to Billy B. Van. His name may not be familiar, but the name that he is given by thousands of people may perhaps identify him. He is called "The Sunshine Man." As the apostle of good cheer he has established a growing doctrine of faith that has become almost a religion to thousands who have followed his precepts.

"Good evening, ladies and gentlemen," is his opening greeting. "Lovely weather we're having. Regardless of the nature of the weather we get, it is good weather. When it is stormy and rainy, the umbrella and raincoat manufacturers are happy. Look at the world—everything is for the best.

"People want to know where I came from and why I believe in sunshine. I came from a little town called Newport, N. H., where the sun shines on both sides of the street at the same time. It's a little town of about 6,000 inhabitants, and everybody is happy. There is no poor district, for everybody works. "We have four banks in the town and everyone owns their own home. There are no labor troubles. It is the biggest little town in the world."

**G**OING back a little, an insight into the trials that beset Billy B. Van in his earlier days may give you an insight into why he is so cheerful today.

Some years ago, the doctors told him that he would have to make a trip to Arizona and die there, as he had weak lungs. Having about twenty-four dollars to his name, he decided that if he was going to die, he wouldn't starve to death. A thing that he would do if he went to Arizona. He made a trip into New England and came to the little town of Newport, N. H. After a few years sleeping outdoors among the fragrant odor of the pine trees, he recovered his health, and opened a dairy.

"For years," he said, "I supplied the town with milk. And I contend to this day that the cow is the foster-mother of the world. When I see the crowds on Broadway pushing, rushing and scrambling, they remind me of a can of worms I carry when I go fishing. Each one pushing and shoving, yet none of them getting anywhere.

"Then I think of a contented cow, peacefully chewing it's cud who is responsible for those crowds. For without milk, 75 per cent of them would not be there. That is why I say a cow is the foster-mother to the world. With more people coming into the world all the time, it is necessary to produce more milk. But how?

**I**N ORDER to produce more finished products through machines or human energy, the machine must be well oiled and the humans must be contented and happy.

"To give more milk, a cow is likable to a human being. It must be contented and happy. That is why I have a sign up in my barn in New Hampshire reading: 'Speak to a cow as you would to a lady.' In order that cows can be contented and happy, I have invented a system whereby the cow receives a slight electrical treatment, the same as is applied to a human being. It is so slight that the cow doesn't notice it, but it soothes its nerves and makes her contented—thus making her give more milk.

"The sunshine that God has given us is a reflection of his goodness. It makes things grow; the flowers beautiful. Without sunshine, the trees and flowers would die; we could have no grain; no growth from which we get food, and in fact, our entire existence.

"It is up to us to reflect what sunshine comes to us and give it to others. That's why I am known as the 'Sunshine Man.' I have asked numerous people to contribute towards helping spread sunshine, and I have received 100 per cent cooperation.

**T**HERE are 110,000,000 people in this country. If you talk to them right, they are 110,000,000 good fellows. Daily I receive hundreds of letters all calling me the 'Sunshine Man.' They tell me I bring happiness and sunshine into their homes and lives. If what they say is right—and I believe them—I would rather be who I am, than who the Kaiser thought he was.

"My one great wish before I leave this earth is to be able to open a broadcasting station in the mountains of New Hampshire. I would call it the 'Sunshine Station' and its only object would be to spread sunshine and happiness to everybody."

Billy B. Van is on the air every Tuesday and Thursday at 6:40 p. m., Eastern Standard time, from Station WHN. Tune in and you will readily see why they call him the "Sunshine Man."

When "Gay Paree" hit Broadway, Billy B. Van gleamed forth as the leading comedian. This afforded him the

opportunity to present his sunshine talks in New York as he had previously done in Boston.

"And in Boston he was just wonderful," said Miss Jean Sargent, announcer at WNAC when Billy appeared there at that time. "He aroused tremendous enthusiasm, appealing first to the children and then to the older folks with his limerick contest.

"I should say he received 50,000 letters during his series of talks at our station. These letters included answers to the contest and messages of appreciation for what he had to say.

"All that he did was so innocent and wholesome and you could see that he was really sincere in his great idea of

sunshine. It was more than just a pose. He actually lived it."

Tools and a workbench, where he assembles Radio sets, afford him recreation. The sets are given to hospitals and orphan asylums.

Virtue may be its own reward, but there are other compensations when real goodness is genuine and altruistic. Billy may have had a lean pocketbook when he started out to regain health through a more intimate acquaintance with Old Sol, but it isn't lean now. He cast his bread on the waters and it came back to him in carloads. The more he gave away the more it seemed to come back and today he is ranked as one of the wealthiest in the actor's profession.

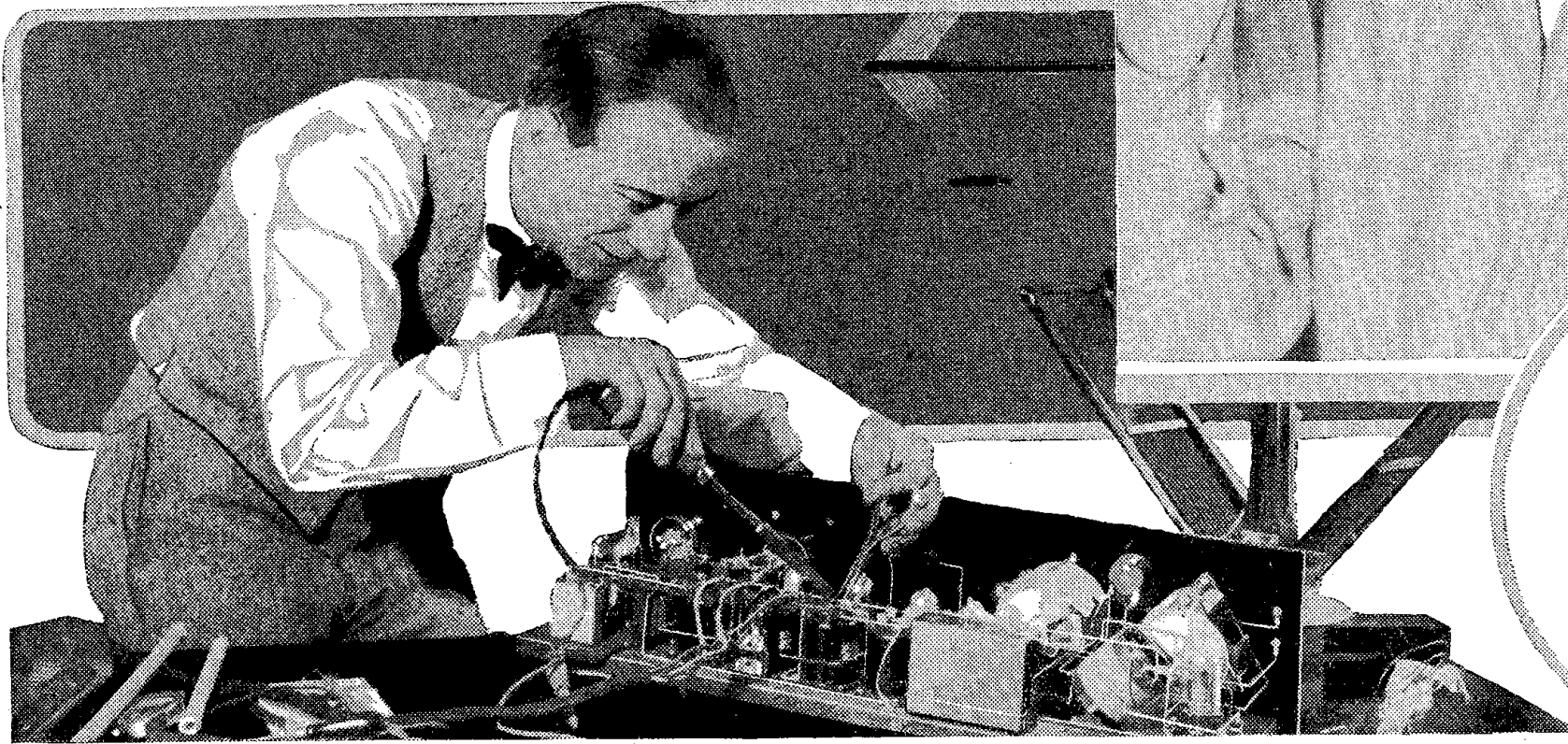
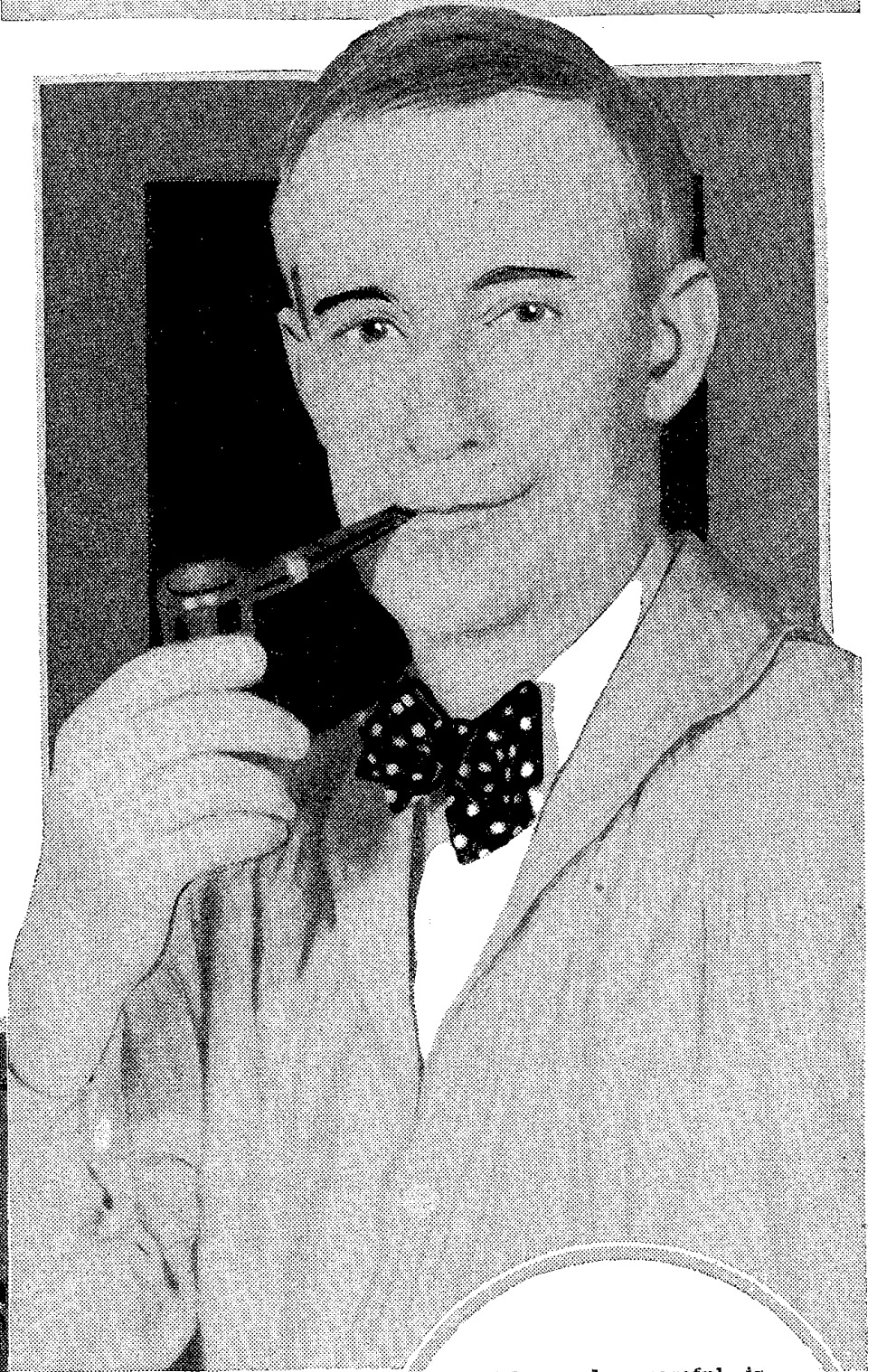

Calm and reposeful is this typical expression of Billy B. Van (above), the Sunshine Man, as he appears before the microphone in New York. Billy's favorite text is the Golden Rule, and he practices what he preaches by building Radio receiving sets (left) which he afterward presents to the invalids in hospitals. He is an adept workman.

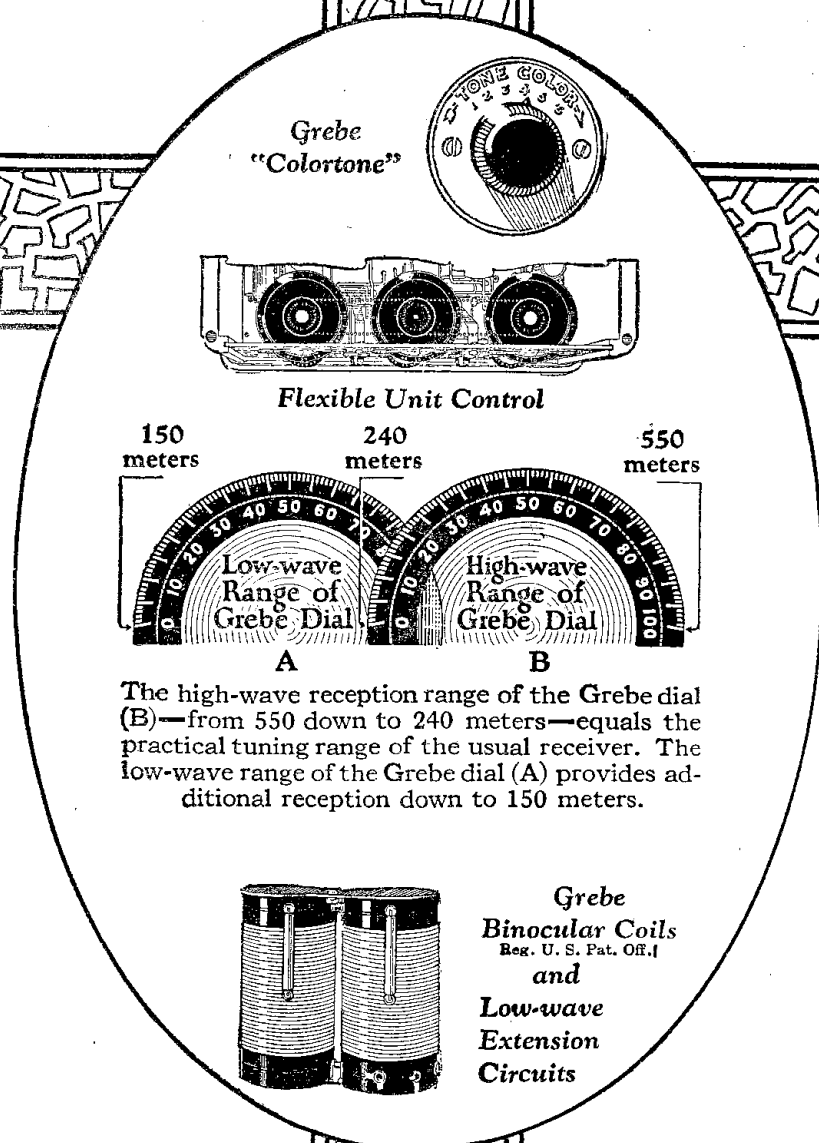

# Always Well in Advance

THE Synchronphase, as usual, is fully a year in advance of other receivers. This is due to those Grebe developments which have contributed so much to the improvement of radio reception. As past experience will show, these advances may be adopted, perhaps next year, on sets of other manufacturers.

So, in buying a Synchronphase now, you are assured of a receiver well in advance of others, and a quality of reception which they will take some time in equaling, if ever.

*A demonstration by your dealer will convince you.*

**A. H. Grebe & Co., Inc., 109 West 57th St., N. Y.**

*Factory: Richmond Hill, N. Y.*

*Western Branch: 443 So. San Pedro St., Los Angeles, Cal.*

*This company owns and operates stations WAHG and WBOQ; also low-wave re-broadcasting stations, mobile WGMU and marine WRMU.*



*It is written:*  
 "It is foolish to try to graft a bamboo shoot on a cherry tree."  
 The adding of Grebe developments to other receivers does not put Synchronphase quality into them. Only Grebe can do that.

*Doctor Myer*

# THE GREBE SYNCHROPHASE

TRADE MARK REG. U.S. PAT. OFF.



All Grebe apparatus is covered by patents granted and pending.

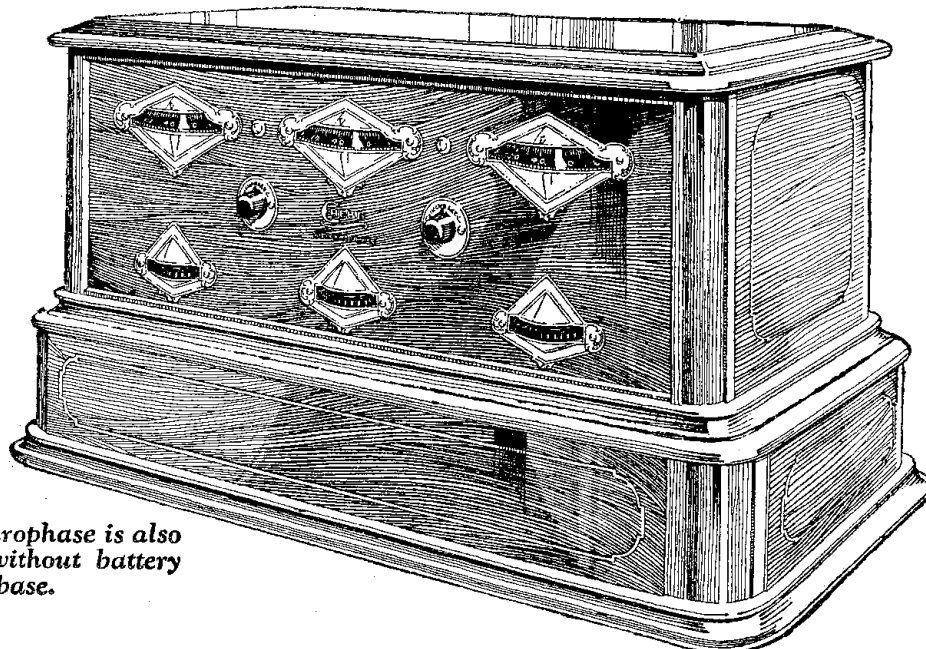

The Synchronphase is also supplied without battery base.

# Florida to Bering Sea via WGHB

## TISON Follows His "Baby" to Clearwater and Puts It Over with a Wow, Pleases G. H. Bowles and Brings Alaskan's Praise

**F**IGURE it out in miles and it's a long hop from Clearwater, Florida, to the Bering sea. Yes, yes indeed, it's SOME step from the land of alligators and humming birds to the habitat of the polar bear and the walrus! But to a little 266 meter Radio wave, traveling at the rate of 186,000 miles a second, it is nothing—almost less than nothing.

On a fisherman's island off the icy coast of Alaska, in the Bering sea, is the home of Dr. George H. Lescher. And when winter comes on St. Paul island 'tis a very dreary place. Evening diversifications consist of melting holes through the frost on the tiny window panes to see whether the drifts are over the roof. Sometimes the doctor must burrow a tunnel through the snow to call on his nearest neighbor. The nights are long. You blow out the light in the morning and before the chimney is cold you must light it again. Social amusements are impossible. Only the slinky polar bear and the water creatures ramble about. Home fires grow monotonous. At least they WERE that way until, until—

**B**UT this story has little to do with St. Paul island. It pertains particularly to the new Radio station, WGHB, located on the Fenway hotel, Clearwater, Florida. They brought it down from Atlanta last November and set it up here among the palms and orange trees.

Mr. George W. Bowles is the sole owner and proprietor of Radio Station WGHB and—you guessed it, of course—he's a real estater (speaking broadly, although the letter head calls it "Developments"). Florida real estate dealers think nothing of buying and installing a mere Radio broadcasting station. In the course of a motor jaunt over the shell roads that traverse the world's

greatest subdivision from the oldest city to the keys, Mr. Bowles ran across the new Biltmore where workmen were erecting the towers of a Radio station.

He pulled up beside the road and gazed at the proceedings earnestly. Brushing through a row of young palmettos, he approached the engineer in charge and announced himself. Clearwater never had a Radio station. Where might one be obtained?

"Well, I don't know," said the engineer, looking up from a torn blueprint that he held in his gloved hands. "They are going to put in a thousand watter at WSB, the Atlanta Journal, and you might buy the 500 watt transmitter they are taking out—"

The young palmettos swished in the trail of Mr. Bowles, making fast return tracks to his speedster. It took but a few minutes for him to reach the nearest telegraph station and a wire burned a brief, compelling inquiry into the office of the Atlanta Journal a few moments later.

**M**R. W. WALTER TISON, engineer at WSB, felt no thrill as he watched the slow dismantling of his "baby" to make room for the "big boy" in the Atlanta station. He had played with that little 500 watter until he knew its every whim, every resource and he had faith in it that transcended any new born expectations for the device that jumped to a thousand watts. He had been with the "baby" for four years, lived with it and loved it. Now it was OUT, and shoved aside!

In the midst of his gloomy reflections, he was summoned to a conference over a hot wire just received from Clearwater, Florida. Would he go down and see this man, Bowles? He was on the next train.

"Do you think that 500 watts will get

anywhere?" asked Mr. Bowles, doubtfully.

"Say, don't worry," smiled Mr. Tison, with a confident nod of his head. "We'll have it up in time to invite Santa Claus down from the North Pole to help celebrate Christmas at the Fenway hotel."

**F**REIGHT jams, embargoes, tie-ups, "preferred cargoes" and all the traffic rules melted away before the powerful influence of Mr. Bowles, and, true to his promise, Mr. Tison had his station ready for the first formal announcement the night of December 5. It had been assigned to call letters "WGHB," which was quite gratifying to Mr. G. H. Bowles.

Miss Caroline Lee, known to WSB

listeners as the "Virginia Girl," had come down for the occasion of the opening and signed up to remain as a staff artist to play her Spanish guitar and the big grand piano, in the spacious new studio on the Fenway hotel. She could sit on the veranda and watch the pelicans flopping awkwardly their lazy way along the gulf coast line—and that helped to make it inviting. Mr. Tison had arranged for the Radio Ramblers orchestra to help make the nights merry and then there were many other pleasing program features.

"I think everything is just about perfect for one of the sweetest little broadcasting stations in the country. And I'm sure you'll be proud of it," said Mr. Tison to Mr. Bowles, in the course of the afternoon. "I wouldn't be surprised if some of our (Continued on page 12)

Below may be seen the luxurious studio of WGHB, located on the Fenway hotel, Clearwater, Florida; W. Walter Tison, director-announcer, at the desk and Caroline Lee, at the piano. Miss Lee, who was known to WSB listeners as the "Virginia Girl," at right with her Spanish guitar.



# The Newest Achievements of POWEL CROSLLEY JR.

*Industrialist—Pioneer Radio Builder—Master of Mass Production*

## Four Entirely New 4 and 5-tube Radio Sets—Also the Crescendon

Never before has Crosley engineering and manufacturing genius been so brilliantly demonstrated as in this group of new Crosley sets.

Here, at prices so low as to be literally revolutionary, are three 5-tube sets and one 4-tube set—entirely new in principle, design, circuit, and appearance—entirely unique in the results they give on distant and local stations—entirely unprecedented in the values they now introduce.

On two of these sets is offered the Crescendon, a new and exclusive Crosley feature—an extra volume control by which average incoming signals can be built up or modified in a manner nothing short of amazing. Introduced on the new, 4-29 and 5-38, the Crescendon principle makes its first appearance in the low price field, its use having hitherto been restricted to one set costing several times as much.

Particular emphasis is directed to the new Crosley RFL receiving sets that utilize an entirely new and patented circuit which provides true cascade amplification and closely approaches the theoretical maximum of efficiency per tube. Non-oscillating at any frequency and absolutely non-radiating, the RFL Crosleys are specifically recommended for use in congested areas and for satisfactory performance in the hands of inexperienced operators.

In addition to their truly marvelous selectivity, sensitivity, and purity of tone, these new Crosleys have been given a new order of beauty that cannot help but win the highest admiration.

We do more than urge you to go to the nearest Crosley dealer for a demonstration! We ask you to go prepared for the most startling revelation in radio ever announced in the entire history of the industry—and predict that your expectations will be more than satisfied!

*Crosley manufactures radio receiving sets which are licensed under Armstrong U. S. Patent No. 1,113,149, or under patent applications of Radio Frequency Laboratories, Inc.*

**THE CROSLLEY RADIO CORPORATION, CINCINNATI, OHIO**

*Owning and Operating WLW first remote control super-power broadcasting station in America*



**The Crescendon**

—an amazing new volume control exclusive to Crosley sets. Hear it!

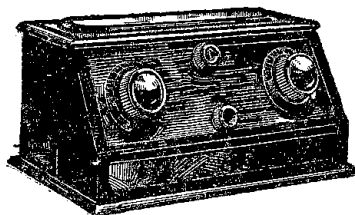

**The Crosley 4-tube—4-29**  
in which the Crescendon is equivalent to one or more additional tubes of tuned radio frequency amplification **\$29**

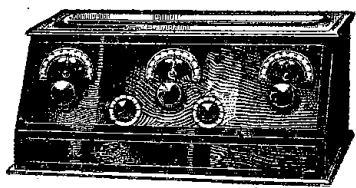

**The Crosley 5-tube—5-38**  
All the volume, selectivity, sensitivity and purity of tone available in the best 5-tube set—plus the Crescendon . . . **\$38**

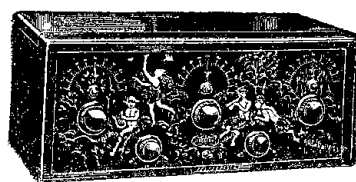

**The Crosley 5-tube—RFL-60**  
A set so marvelous in performance that its appearance on the market is bound to create a new standard of comparison . . . **\$60**

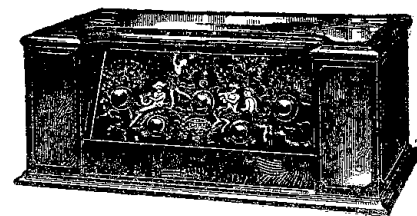

**The Crosley 5-tube—RFL-75**  
For simplicity and speed in tuning, fidelity of tone, and decorative beauty—it stands unchallenged at twice the price . . . **\$75**

*West of the Rocky Mountains all prices as published are 10% higher*

# CROSLLEY RADIO

B E T T E R • C O S T S L E S S



# Here Are 1926 Wampas Stars—Like Them?



## CANADA CAR SQUAD WILL AID TORONTO

### EXPERTS TO INVESTIGATE POWER INTERFERENCE

Apparatus Has Been Taken 4,000 Miles Over Dominion Improving Conditions for Good Reception

By A. H. Munday

TORONTO.—The Radio branch of the department of marine and fisheries has detailed a Radio inductive interference squad for the city of Toronto and district, and the staff and the car reached Toronto a few days ago.

For the past two years the Radio branch has been carrying on considerable research work of ways and means of dealing with this particular type of interference and as a result has developed special apparatus for its location and suppression.

This car has recently completed a 4,000-mile tour of eastern and central Ontario investigating and clearing up many cases of interference in about ninety towns and villages. During the trip the squad has been successful in eliminating seventy-five per cent of the cases investigated, and it is hoped that many of the remaining twenty-five per cent of the cases investigated will be shortly eliminated as a result of the experiments which are now in hand.

#### Listeners' Licenses Provide Funds

From the preliminary survey of the situation in Toronto recently made by the inductive interference section, it is found that the question is very much more involved here than in smaller towns, largely owing to the multiplicity of power lines and the great amount of electrical apparatus in use.

Inductive interference, which originates generally in some fault in electrical apparatus, whether in the power house or the consumer's premises, will travel along the power lines in the form of an electric surge, and will then radiate therefrom, causing interference to all Radio receivers in a district, possibly for a distance of two or three miles from the source.

This work of clearing the air is being carried on by the Canadian Radio branch from the funds available from the sale of Radio listeners' licenses, and it is the intention to extend this work according to the increase of the number of licenses sold.

## Dallas Station Will Receive Reports on Sports in Studio

DALLAS, Tex.—Station WRR, here, "The City of Achievement," has adopted a system that will enable this station to receive returns direct from football and baseball games by wire on the telegraph ticker and broadcast play by play at a great saving of time, giving the results as received without losing time for copying reports in a different room.

A noiseless telegraph ticker has been equipped and installed in the same room with the microphone, and the operator will use head pieces for receiving and a noiseless typewriter. The announcer stands back of the operator and announces the results word by word as the news flashes over the wire.

Motion picture fans will know many of the above girls, who have been picked as the 1926 Wampas stars. As this issue speeds to press, the plans for the annual Wampas ball and frolic, scheduled for February 4, will have been completed. In fact, the ball will be over before many readers see this picture. KNX, Hollywood, had the girls before its microphone on Tuesday, February 2. The thirteen new screen favorites are, left to right, Dolores Costello, Vera Reynolds, Mary Astor, Marcelline Day, Edna Marion, Mary Brian, Fay Wray, Janet Gaynor, Sally Long, Joyce Compton, Dolores del Rio, Sally O'Neill and Joan Crawford.

By G. L. King

THE Wampas Stars of 1926! To be one of the thirteen lucky ones is the dream of every extra girl in Hollywood, the hope of every girl who is not yet an extra.

Every year, just about Christmas time, The Wampas club (which officially is known as the Western Association of Motion Picture Advertisers, and whose membership embraces practically every press agent and advertising man connected with the movie industry in the West), holds an election in its California bungalow clubhouse at the corner of Las Palmas and Sunset boulevard in Hollywood. The result of it all is that the club as a whole pledges its efforts for the following year to the advancement of thirteen young women of the screen.

After the votes have been counted by the chaplain of the Wampas and the results announced to the anxious candidates, plans are launched for the most spectacular annual event in moviedom—the Wampas frolic and ball.

#### Producers Bid for Stars

This year the frolic was held in the new Al Malikah Shrine Temple in Los Angeles, one of the most magnificent buildings of its kind anywhere, and as usual the house was packed.

The selection of stars by the Wampas is an event. In years past, producers have entered into spirited bidding contests for the winners, as experience has shown that the Wampas make few mistakes and practically all of their selections have risen to real stardom. To enumerate a list of Wampas stars in the past, now stars in their own right, would

be to list a great many of the leading feminine players of the screen.

#### KNX Official Wampas Station

Radio, of course, plays its part in Wampas proceedings, for what publicity man does not recognize the value of broadcasts in connection with the promotion of popularity of a screen player? The Wampas club for the past two years has been on the air one hour a week over KFI. More recently it has switched over to the Los Angeles Express station, KNX, which is located right in the heart of Hollywood and more suited to movie studio convenience.

The Wampas club programs are now on KNX every Tuesday between the hours of 10 and 11 p. m., Pacific time. On their last Radio program before the big annual ball, all of the thirteen lucky Wampas stars were presented to the audience of the air. Most of them had been on the air before and all of them undoubtedly will appear at Los Angeles and Hollywood microphones many times during 1926.

#### Dolores Costello Knows "Mike"

Some of them, Dolores Costello for instance, are microphone-broke and enjoy appearing on the air. Dolores Costello is a Warner Brothers player who, although short of experience, has already appeared in the picture, "The Sea Beast," with John Barrymore. She has appeared over the Warner Brothers station, KFWE, many times, acting as guest announcer for the Warner frolics.

So, when you pick up a Los Angeles or Hollywood station on your set next time listen for the voice of one or more of the pretty girls pictured above.

## INLAND EMPIRE HAS GROUP TO AID RADIO

### NON-PROFIT, NON-BUSINESS ORGANIZATION FORMED

To Assist Financially and Otherwise in Maintaining Station KFCF at Walla Walla, Wash.

SPOKANE, Wash.—Articles of incorporation were forwarded recently to Olympia by the Blue Mountain Radio association, a non-profit, non-business organization, formed to promote more widespread interest in Radio and particularly to help Station KFCF at Walla Walla, Wash.

Objects of corporation include: To assist, financially and otherwise, in maintaining and operating a Radio broadcasting station in Walla Walla, and in establishing, maintaining and operating broadcasting stations elsewhere within the Inland Empire.

To obtain material for broadcasting programs and to promote and encourage improvement of Radio programs and the use of Radio in exploiting communities and community advantage, and to organize Radio patrons in the Inland Empire, are also announced as objectives.

Membership certificates are to be issued to chambers of commerce, business firms and individuals. There will be no capital stock and no shares will be issued. Trustees for the first six months are Benjamin J. Stone, M. L. McMurtry, H. L. Bendix, John Cameron, L. R. Hoagland, R. E. Allen and J. D. Moore.

## PRIEST, RABBI AND MINISTER AT MIKE

Three Religionists Attend Brooklyn Dinner and Speak on Same Subject Over WAHG

BROOKLYN.—Monsignor John H. Belford and Rabbi Alexander Lyons and the Rev. Dr. F. Parkes Cadman recently faced the microphone at WAHG, the Grebe station, Richmond Hill, broadcasting a dinner by the Parents' and Preachers' association of the Adelphi Academy, Brooklyn.

Station WAHG carried the speeches on three wave lengths, 316, 236 and 63. Reports have been received that France, Peru and Alaska heard the three prelates tell about religious instruction in the home. A consensus of opinion of the three religionists seemed to be that a home is a home, whether it is a Catholic, Jewish or Protestant home, and that the latent desire of all is that the fatherhood of God and the brotherhood of man are of the greatest importance.

While the three prelates were seated at the dinner, a battery of lamps blazed in their faces while photographers from all of the big news services of New York were present to make pictures of a priest, a rabbi and a protestant minister breaking bread together. The scene seemed to be too much for the "juice" of the Hotel Bossert, for a fuse blew out and left the big hotel in total darkness. Repairs were made, however, and the pictures were completed.

## ONE TUBE STAR GETS POLICE DOG

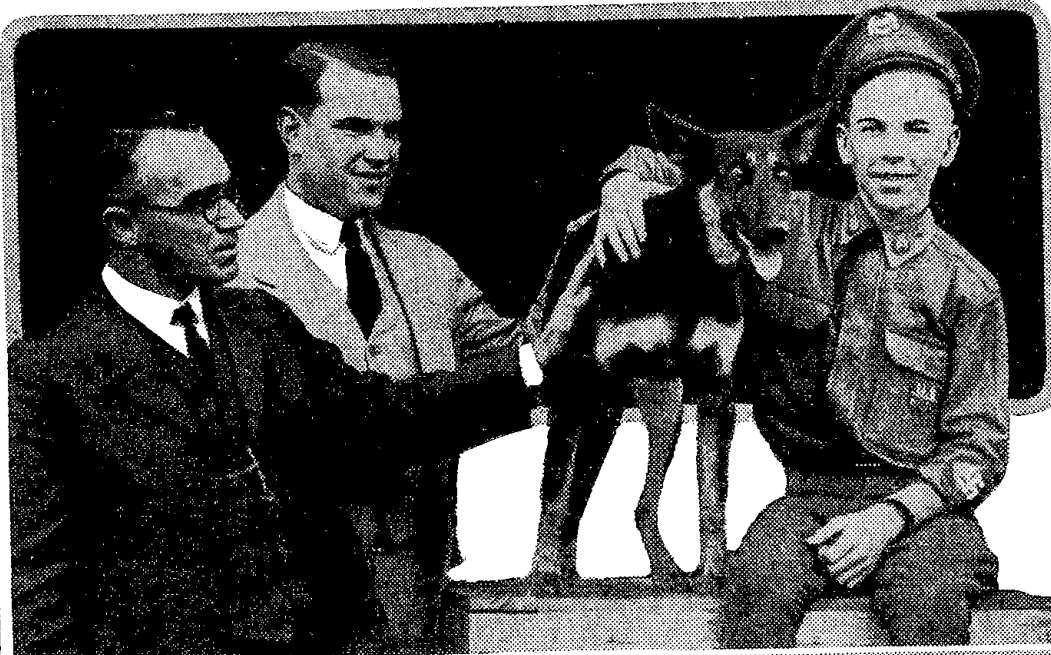

Otto Glasser, Jr., (right) of San Antonio, Texas, is one young member of the R. O. T. C. who knows how to tune in the stations on a one tube set. "Nigger," the dog, is the prize Otto received for winning first place in the first month of the Crosley Radio corporation one tube set receiving contest. "Miss Nigger," however, we should call her ladyship, for she is the charming daughter of two famous German shepherd dogs of very fine pedigree.

# RADIO 'RITHMETIC

"A" batteries + "B" batteries  
+ RECTIGON =  
clear radio reception



© 1925  
W. E. & M. Co.

## How to Prove this Result

Complete your set with a Rectigon! Keep your batteries so full of life that every turn is a tune, every adjustment of the delicate knobs a means of furthering your radio joys.

It's a simple thing with a Rectigon. Just snap the cords into place and your "A" and "B" batteries—and your automobile

battery—will surprise you with their old-time pep.

There's no muss or fuss with a Rectigon. No acids or chemicals. No moving parts and no noise.

It's a handsome, bright, maroon-enameled helper that will get the best out of your radio—and continue to do so.

*No storage-battery radio is complete without a Rectigon.*

WESTINGHOUSE ELECTRIC & MANUFACTURING COMPANY, SOUTH BEND, INDIANA

Westinghouse manufactures, also, a complete line of Micarta radio panels, Micarta tubes and instruments.

# The Westinghouse Rectigon Battery Charger

# WAMD TRAFFIC SQUAD TO CLEAR AIR

## Sunday, February 7

**KFAB, Lincoln, Nebr. (340.7m-880ke),** 12-2 p. m., orchestra entertainment; 4-5:30, vesper service; 9-11, Sunday evening musicale.

**KFNF, Shenandoah, Iowa (263m-1140ke),** 10:45 a. m., morning worship, First M. E. church; 2:30 p. m., Golden Rule song service; 3, Methodist Sunday school; 6:30, Golden Rule Circle, regular services; 7:30, Christian church, services.

**KFRU, Columbia, Mo. (499.7m-600ke),** 7:30 a. m., sunrise program, Nellie Lee Holt; 9:20, Bural Bible class, Jessie L. Bural; 7:30 p. m., student service, First Baptist church, Luther Wesley Smith, minister.

**KFUO, St. Louis, Mo. (545.1m-550ke),** 4 p. m., "Weep Not"—Comfort Against Death and the Grave, Rev. A. P. Pedersen; 9:15, "I Know That My Redeemer Liveth," Rev. P. Hansen.

**KLDS, Independence, Mo. (440.9m-680ke),** 11 a. m., studio service; ladies quartet, Mrs. John Watkins, soprano; Mrs. James Gault, soprano; Mrs. Mark Siegfried, contralto; Mrs. Madge Kuefer, contralto; Irene Burroughs, violinist; 3, sacred program, Watson Memorial M. E. church; Watson Memorial choir; ladies' quartet; Edward Schwegender, baritone; Hazel Cook, organist; Mrs. F. W. Rucker, soprano; sermon, Rev. W. E. Brown; 6:30, vesper service; Madge Nesbitt, soprano; Velma Nunn, contralto; O. C. White, tenor; Albert Brackenbury, basso; Wesley Brocaw, saxophonist; sermon, Evangelist U. W. Greene; 9:15, Stone church chorus choir; Stone church male chorus; Elizabeth Smith, harpist; Margaret Armstrong, soprano; sermon.

**KMA, Shenandoah, Iowa (252m-1190ke),** 4-5 p. m., men's gospel team; 5-6, Bible class, G. H. Van Houten.

**KOIL, Council Bluffs, Iowa (278m-1080ke),** 11 a. m., First Congregational church; 1 p. m., Pontenelle orchestra; 7:15, The Steep "Time Girl"; 7:30, Monday Musical club; 11, Casino club orchestra.

**KPRC, Houston, Tex. (296.9m-1010ke),** 3 p. m., Christian Science lecture; 7:30, South End Christian church; Coralie Gregory, director of music; 9:30, Victor Alessandro and his first band.

**KSD, St. Louis, Mo. (545.1m-550ke),** 6:15 p. m., St. Louis Dispatch concert orchestra; 8:15, Atwater Kent Radio hour.

**KTHS, Hot Springs National Park, Ark. (374.8m-800ke),** 11 a. m., First Baptist church; 9-10 p. m., Meyer Davis' grand ensemble; Edward Richter, cellist; 10-11:30, Arkansas Traveler special train frolic, Benny Ford and his musical train crew; 11:30-12:30, Lawson Reid, organist.

**KYW, Chicago, Ill. (536m-560ke),** 11 a. m., Central church service; 2:30 p. m., Chicago church federation; 4:30, studio concert, Edwin Harper, director; 7-9:15, Sunday evening club concert; Dr. Robert E. Speer, speaker.

**WAFD, Port Huron, Mich. (275m-1090ke),** 10-11:30 a. m., church service; 6-7 p. m., organ recital.

**WAMD, Minneapolis, Minn. (244m-1230ke),** 10:30 a. m., First Unitarian church services, John Dietrich, pastor; 7:01 p. m., Arthur H. Faust; 9:30, Gayle Wood, Harmony Hurricane.

**WBBM, Chicago, Ill. (226m-1330ke),** 12:30-2 p. m., William Zimmer, tenor; Kantor A. Kriz; Sandy Meek and Harry Sosnik; Edna Wheeler Ballard, harpist; Moulou Rouge operatic quartet; 4-6, Shayne's Melody Monarchs; Lavergne and Shayne, xylophonists; Pete Kules; Tip trio; Ziegler, Harold Anderson; 8-10, Sunset male quartet; WBBM string trio; Moulou Rouge orchestra; 12-2 a. m., Natty club; Moulou Rouge orchestra.

**WBCN, Chicago, Ill. (266m-1130ke),** 10:30 a. m.-12 noon, morning service, People's Liberal church; talk, Rev. Rufus A. White; 4-5 p. m., Dain & Son classical hour; Velma Cook, soprano; Oriental quartet; male harmony group; Robert Stronach, pipe organist; 7:45-9:15, evening services, Thoburn M. E. church, 40-piece Thoburn semi-symphony orchestra, 80-voice choir, special vocal soloist, speaker.

**WCAL, Northfield, Minn. (336.9m-890ke),** 8:30 a. m., Norwegian church services; 9:15, speaker, Dr. Martin Hegland.

**WCCB, Zion, Ill. (344.6m-870ke),** 8 p. m., junior choir; mixed quartet; cornet quartet, assisted by Chester Bagg, baritone; Miss Reynolds and Mr. Bagg, soprano and baritone; Mrs. Beatrice Been, soprano; Mrs. Kathryn Crowe, contralto; Messrs. Newcomer and Stewart, cornet duet; Erwin Rendall, flute; readings and piano duets.

**WCCO, Minneapolis-St. Paul, Minn. (415.4m-720ke),** 10:50 a. m., Hennepin Avenue M. E. church, Rev. Lucius H. Bugbee, pastor; 4:10 p. m., House of Hope Presbyterian church, Rev. H. C. Svearinsen, pastor; 6:20, Second Church of Christ, Scientist; 8:15, Atwater Kent program, WEAF; Charles Hackett, tenor.

**WDAF, Kansas City, Mo. (365.6m-820ke),** 4-4:45 p. m., WDAF's Sabbath vespers, Church of Our Redeemer, Lutheran, Rev. H. Dierks, pastor.

**WDD, Chattanooga, Tenn. (256m-1170ke),** 7:30-9 p. m., services.

**WEBH, Chicago, Ill. (370.2m-810ke),** 10:45 a. m., Seventh Church of Christ, Scientist; 7-8 p. m., artists' program.

**WGES, Oak Park, Ill. (250m-1200ke),** 7:40 p. m., Moody Bible institute program; 11-12 midnight, organ, sacred, classical.

**WGN, Chicago, Ill. (302.8m-990ke),** 10:45-11:45 a. m., Uncle Walt; 11:45-1 p. m., Chicago theater organ recital; 1-2, Chicago theater feature program; 2-3, Lyon and Healy organ recital; 3-4, Chicago Philharmonic orchestra, North Side Turner hall; 4-5, Chicago Musical college concert; 8:15-9:15, Atwater Kent program, WEAF; 9:15-10, popular program.

**WHAD, Milwaukee, Wis. (275m-1090ke),** 3:15 p. m., Turner's symphony orchestra.

**WHAS, Louisville, Ky. (399.8m-750ke),** 9:57 a. m., organ prelude; 10, Fourth Avenue Presbyterian church; 4:30-5:30 p. m., Evenson choral service.

**WHO, Des Moines, Iowa (526m-570ke),** 11 a. m., church service; 4-6 p. m., Christian Science lecture, First Church of Christ, Scientist, William W. Porter; 7:30-8:30, Reese-Hughes orchestra, Hotel Fort Des Moines.

**WHT, Chicago, Ill. (399.8m-750ke),** 12-10:30 p. m., Paul Rader.

**WIBO, Chicago, Ill. (226m-1330ke),** 2-4 p. m., Chester Newman, baritone; Mildred Perlin, reader; WIBO string trio; 6-8, sacred songs, Walter Preston; Fred Nobel, cornetist; Earl Bigelow, pianist; WIBO trio.

**WJAZ, Chicago, Ill. (329.5m-910ke),** 7-9 p. m., symphony orchestra.

**WJJD, Mooseheart, Ill. (370.2m-820ke),** 7:45-8:45 a. m., Catholic services; 9:40-10:30, Protestant services; 3-4 p. m., Mooseheart Sunday concert.

**WKAF, Milwaukee, Wis. (261m-1150ke),** 4-6 p. m., Jean Hammond and her Tune Tinkers; Orpheum male quartet.

**WKRC, Cincinnati, Ohio (422.3m-710ke),** 6:45 p. m., Walnut Hills Christian church services, Rev. J. J. Castleberry; 10, classical program, vocal and instrumental numbers; 11, Marlon McKay and his orchestra, dance music.

**WLIB, Chicago, Ill. (302.8m-990ke),** 5:15-8:15 p. m., studio program, mixed and male quartets; string trio; Correll and Gosden.

**WLS, Chicago, Ill. (344.6m-870ke),** 6 p. m., prelude; 7-7:55, WLS Little Brown Church in the Vale; Little Brown church choir; Ralph Emerson, organist.

**WLW, Cincinnati, Ohio (422.3m-700ke),** 9:30 a. m., Sunday school, Editorial Staff of Sunday School Publications of the Methodist Book concern; 11, morning worship, Seventh Presbyterian church, Jesse Halsey, pastor; 3 p. m., organ recital, John J. Fehring; 7:30, services, First Presbyterian church of Walnut Hills, Dr. Frederick McMillan, pastor; 8:30, concert program, H. & S. Pogue company orchestra, Walter Esberger, director.

**WMBB, Chicago, Ill. (259m-1200ke),** 3-5 p. m., Trianon

orchestra, Dell Lampe, conductor; Woodlawn theater orchestra, Armin F. Hand, conductor; Lucille O'Hara, Bob Duffy, Earl Smith, popular concert; 7:40-9, Fifth Church of Christ, Scientist, services; 9-11, Trianon orchestra, Dell Lampe, conductor; Woodlawn theater orchestra, Armin F. Hand, conductor; J. T. Carney, Bob Bennett, popular program.

**WOAI, San Antonio, Tex. (394.5m-760ke),** 11 a. m., services, First Presbyterian church; 7:45, Central Christian church.

**WOAN, Lawrenceburg, Tenn. (282.8m-1060ke),** 9-10 p. m., C. S. T. male quartet, sacred songs.

**WOAW, Omaha, Nebr. (526m-570ke),** 9 a. m., chapel service; 1:30 p. m., matinee program; 6, Bible study period, Mrs. Carl R. Gray; 9, chapel service.

**WOC, Davenport, Iowa (483.6m-620ke),** 1-2 p. m., Palmer Little symphony; 6:30-7:30, St. John's Methodist Episcopal church; 8:15-9:15, Atwater Kent Radio artists, WEAF; 9:45-11:45, Palmer Little symphony.

**WOL, Ames, Iowa (270m-1110ke),** 10:45 a. m., college chimes; 11, chapel services, Dr. Ben H. Hibbard.

**WOK, Chicago, Ill. (217.3m-1390ke),** 6 p. m.-1 a. m., Tearney's Town Club orchestra; Carl Lorraine's Pershing Palace orchestra; Husk O'Hare's Coconut Grove orchestra; Capitol theater complete musical program; studio program; 1-2, Tearney's Town Club orchestra; Carl Lorraine's Pershing Palace orchestra; Husk O'Hare's Coconut Grove orchestra; studio program.

**WQQ, Kansas City, Mo. (278m-1080ke),** 11 a. m.-12:30 p. m., services; 7-7:45, services.

**WORD, Batavia, Ill. (275m-1090ke),** 10 a. m., sacred songs; 2:30 p. m., Chicago Rapid Transit company; 3:30, address, O. R. Moyle; 7, I. B. S. A. choral singers; 9, Milwaukee I. B. S. A. choral singers.

**WQJ, Chicago, Ill. (447.5m-670ke),** 9:30-11:30 a. m., People's church; 3-4 p. m., Sunday concert, Resurrection church choir; 8-10, Balboa Gardens orchestra; Fontella duo; Sheppard Levine, tenor; Pierson Thal, pianist; Grace Wallace, soprano; Madeline Ruff, pianist; Herman J. Techtentine, baritone; Jean Carlson, soprano.

**WRR, Dallas, Tex. (246m-1220ke),** 10-11 p. m., light opera.

**WSAI, Cincinnati, Ohio (325.9m-920ke),** 3-4:30 p. m., address, Dr. S. Parkes Cadman, pastor, Central Congregational church; music, Gloria Trumpeters; George Betts, chimer; 7:45, chime concert, Robert Badgley; 8, sermonette, Rev. John D. Christie, pastor Mt. Auburn Presbyterian church; 8:15-9:15, Atwater Kent hour, WEAF; featuring Charles Hackett, tenor; accompanied by Myron Jacobson; 9:15, orchestra, Sigmond Culp, director, Union Central Life.

**WSB, Atlanta, Ga. (428.3m-700ke),** 5 p. m., Second Baptist church.



"Yo Ho and a Bottle of Rum." We are afraid the prohibition officers will censor this picture, but here is Bloody Bill McDonnell, Captain of the Pirate Ship which sails the ether waves at WBCN, Chicago, on Tuesday nights. "Ukulele Kitty" Throckmorton, left, is one of the most popular entertainers at WRC, Washington.



**WSM, Nashville, Tenn. (282.8m-1060ke),** 10:30 a. m., First Presbyterian church services, Dr. James I. Vance, pastor.

**WSUI, Iowa City, Iowa (483.6m-620ke),** 9:15 p. m., familiar hymns, Mrs. L. G. Lawyer.

**Mountain Time Stations**

**CFAC, Calgary, Can. (435.8m-688ke),** 7 p. m., First Baptist church, Rev. Dr. H. H. Bingham.

**KOA, Denver, Colo. (322.4m-930ke),** 10:55 a. m., Trinity M. E. church service, Dr. Loren M. Edwards, pastor; Shad J. Tinsley, organist; Ina Rains, soprano; Mrs. Hazel Engle Youngs, contralto; Frank W. Farmer, tenor; Everett E. Foster, baritone; 3 p. m., afternoon music hour; recital, Trinity M. E. church, Shad J. Tinsley, organist; 7:30, Trinity M. E. church service.

**KXKF, Colorado Springs, Colo. (250m-1200ke),** 7:30-9 p. m., First Methodist church services.

**Pacific Time Stations**

**KFI, Los Angeles, Calif. (468.5m-640ke),** 6:30 p. m., Nightly doings; 7-8, Norman Kobler and his dance orchestra; 8-9, Angelus string trio, Emma Kimmel, soprano; 9-10, Mabelle Hein and her Blue Bird band; 10-11, Packard Six dance orchestra.

**KFON, Long Beach, Calif. (233m-1290ke),** 2:30-4 p. m., Long Beach Municipal band; 6-6:30, organ, Brayton's theater; 6:30-7, amusement information; 7:45-9, service, First Church of Christ, Scientist.

**KFWB, Hollywood, Calif. (252m-1190ke),** 9-11 p. m., late news followed by Warner Brothers' Sunday night movie frolic, Lake Arrowhead dance orchestra and entertainers.

**KGO, Oakland, Calif. (361.2m-830ke),** 11 a. m., First Unitarian church; 3:30 p. m., KGO little symphony orchestra; 8, First Unitarian church.

**KGW, Portland, Ore. (491.5m-610ke),** 11-12 noon, The Church of Our Father, services, Unitarian; 7:25-9 p. m., First Presbyterian church services; 9-10, concert, Chevrolet symphony orchestra.

**KHJ, Los Angeles, Calif. (405.2m-740ke),** 4-5 p. m., Masonic service; 6:30-7, Leighton's Arcade cafeteria orchestra, Jack Cronshaw, leader; 7-7:30, First Methodist Episcopal church, Arthur Blakely, organist; 8-

10, program, Martin music company; Ruth Pitts, soprano, John Martin, concert pianist.

**KNX, Hollywood, Calif. (336.9m-890ke),** 2-4 p. m., Park Board program, Westlake park; 6:30-7, Unitarian church service; 7-8, First Presbyterian church of Hollywood; 8-9, Ambassador hotel concert orchestra, Joseph Rosenthal, leader; 9-10:30, program, Beverly Hills Nurseries, Calmer Lubovitch, concert violinist.

**KPO, San Francisco, Calif. (428.3m-700ke),** 9:45-10:45 a. m., Undenominational and Nonsectarian church services; talk, Dr. J. W. Payne; Mabel Turner Payne, soprano; Uda Waldron, organist; 5-6 p. m., organ recital, Marshall W. Giselman; 6-6:30, Waldemar Lind and the States Restaurant orchestra; 8:35-8:55, Palace hotel concert orchestra, Cyrus Trobde, director; 8:35-10, Rudy Seiger's Fairmont hotel orchestra.

**KPSN, Pasadena, Calif. (315.6m-950ke),** 6:45-8:45 p. m., Presbyterian church service; 8:45-9:45, Maryland artists' ensemble, Henri J. Van Praag, director.

**KTAB, Oakland, Calif. (240m-1250ke),** 9-9:30 a. m., Bible lecture, Prof. E. G. Lintsey; 11-12:30 p. m., church service; 7:45-9:15, church service; 9:30-11, after-service concert.

## Monday, February 8

**Headliners Today**

Eastern	Central	Mountain	Pacific
7:30 p. m.	6:30 p. m.	5:30 p. m.	4:30 p. m.
WAMD (244m-1280ke)	Traffic Squad.		
8	7	6	5
WHAZ (379.5m-790ke)	Troy Elks' night.		
8:30	7:30	6:30	5:30
WBZ (333.1m-900ke)	Quartet of fretted instruments.		
9	8	7	6
KDKA (309.1m-970ke)	Rudd light opera hour.		
WDAP (365.6m-820ke)	Ivanhoe band.		
WNYC (526m-570ke)	Shorthand contest.		
9:15	8:15	7:15	6:15
WTIC (475.9m-630ke)	Rolling sea songs.		
10	9	8	7
KTHS (374.8m-800ke)	Musical comedy hour.		
WEAF (491.5m-610ke)	WOO, WJAR, WCAP, WTAG, WCAE, WSAI, Grand opera, "Thais."		
WPG (299.8m-1000ke)	Galen Hall trio.		
10:30	9:30	8:30	7:30
KWSC (348.6m-860ke)	Special piano program.		
WTIC (475.9m-630ke)	Travelers' symphonic ensemble.		
11	10	9	8
KOA (322.4m-930ke)	Voice culture.		
12	11	10	9
KFI (468.5m-640ke)	Special program.		
KHJ (336.9m-890ke)	Old-time minstrel show.		

**Eastern Time Stations**

**CKNC, Toronto, Can. (356.9-840ke),** 8-10 p. m., Chamber music hour; Toronto conservatory instrumental trio; Frank Blackford, violinist, Leo Smith, cellist, Alberto Suerrero, pianist; Arthur Blight, baritone.

**KDKA, Pittsburgh, Pa. (309.1m-970ke),** 7:15, 8 a. m., exercises, O. Shannon; 5:45 p. m., children's period; 6:30, dinner concert; 8:15, University of Pittsburgh address; 9, Rudd Light Opera hour.

**WABQ, Haverford, Pa. (261m-1150ke),** 11 p. m., Ardmore theater organ; William Stewart, pianist; Horace Hustler, organist.

**WAHG, Richmond Hill, N. Y. (315.6m-950ke),** 12:03 p. m., Grebe matinee trio; 7:30, piano recital; 8, Synchro-phase hour; 9, travel talk, Major Dent Atkinson; musical classes, A. W. Bennett; 9:30, musicale; 10:03, studio program; 10:20, Joe Zimmerman's orchestra; 12, popular program.

**WBAL, Baltimore, Md. (246m-1220ke),** 6-6:30 p. m., children's program, "The Children Lost in the Woods," Hazel Knox; 6:30-7:30, dinner program, WBAL dinner orchestra, Robert P. Lina, conductor; 7:30-8, organ recital, Frederick D. Weaver, organist; 8-9, musical program, Mary Muller Fink, harpist; Evelyn Upp, violinist; Helene Broemer, cellist; 9-9:10, Swenson Earle, conservation commissioner; 9:10-10, musical program, Edith Reinhardt, soprano; Helen Welshamp, pianist.

**WBBR, New York, N. Y. (273m-1100ke),** 8 p. m., Jubilee entertainers; 8:10, news digest; 8:20, Jubilee entertainers; 8:30, Bible instruction; 8:40, Jubilee entertainers.

**WBZ, Springfield, Mass. (333.1m-900ke),** 6:30 p. m., Little Symphony orchestra, KDKA; 7, theatrical gossip, Samuel Wren; 7:30, organ recital, Rene Dagenais; 8, Capitol theater orchestra; 8:30, quartet of two mandolins, tenor mandola and piano, Hercules Zenopoulos, director; 9, concert, Aleppo Drum Corps; 9:30, movie club, George Fecke, director.

**WCAP, Washington, D. C. (468.5m-640ke),** 6:45-7:45 a. m., tower health exercises, WEAF; 6-11 p. m., Washington Post hour; health talk, A. and P. Gypsies, opera, "Lucia di Lammermoor," WEAF.

**WCAU, Philadelphia, Pa. (278m-1080ke),** 7:30 p. m., recital, N. Snellenburg and company; 8, Carolyn Thomas, soprano; Ella Jaquette Kratz, pianist; 8:45, Ruppert and McCullough, barjo duets; 9, Al Wing and his Sugar Cane orchestra; 9:30, Carl Smith's Monday Nighters; 10, Arline R. Smith, soprano; Kathryn Flighthorne, contralto; Sarah Snyder, pianist; Virginia Kleib, pianist; 10:30, Parvians dance orchestra.

**WCX, Detroit, Mich. (516.9m-580ke),** 6 p. m., Gold-kette ensemble; 8-9, studio program.

**WEAF, New York, N. Y. (491.5m-610ke),** 6:45-7:20 a. m., tower health exercises; 4-5 p. m., Edward E. Holle, bass; Marguerite Welte, soprano; 6-12, dinner music, Hotel Waldorf-Astoria; Theophilus Alban, tenor; Columbia university lecture; lullaby lady; coal miners' trio; tower health talk; music, A. and P. Gypsies; grand opera, "Thais," WEAF; Ben Bernie and his Hotel Roosevelt orchestra.

**WEAO, Columbus, Ohio (293.9m-1020ke),** 1:30 p. m., music.

**WEAR, Cleveland, Ohio (389.4m-770ke),** 7 p. m., Allen theater orchestra.

**WEEL, Boston, Mass. (348.6m-860ke),** 6:30 p. m., Joe Rines and his Hunters' Cabin orchestra; 7:30, Black Iron Shiners; 8, Boy Scout music, program, Dan Beard, Baden Powell; 8:45, Tower health talk; 9, A. & P.



# COST OF ECONOMIES MAY BE PROHIBITIVE

## CHECK YOUR THRIFT, SAYS NOTED KITCHEN EXPERT

### Betty Crocker Outlines Principle of Determining False Savings—Suggests Taking Inventory

Have you heard, and do you regularly listen for Betty Crocker's Radio talks? Miss Crocker is nationally known as a home food specialist who is broadcasting from a dozen of the country's largest stations. By special arrangement Radio Digest has secured a series of exclusive articles by Miss Crocker dealing with her current Radio talks. These broadcasts are made through WEEL, WEAJ, WCAE, WGR, WEAR, WWJ, WDAF, WJAB, WHT, WFL, KSD, KFI, and WCCO, the Gold Medal station at Minneapolis-St. Paul. All of Miss Crocker's recipes and discussions are based upon actual investigations and work of herself and her assistants in model kitchens.—Editor's Note.

By Betty Crocker

"NOW is the time," the walrus said, "to talk of many things," and among the many things the question of economy bobs up repeatedly. In discussing the big subject of economy, there are indeed many things to talk about. Pet economies are funny things. A real economy in one family or one community may be sheer extravagance in another. What is your pet economy? Is it a real economy or does it cost more than it is worth?

Every housekeeper should do a little detective work and investigate the character of her economies. For example, do you economize by buying a large quantity of food and then serve it so often that your husband not only refuses that food, but demands more expensive food by way of reaction? Do you economize by using eggless recipes and buying less milk and then pay high-priced specialists to tell you why your little boy is underweight and your little girl so pale?

### Use of Cheap Meat

Do you buy a cheap cut of meat and then pound it and chop it and add quantities of vegetables and butter and use a great deal of time and fuel trying to make it palatable? Figure the cost of the finished product, and see if a more tender cut would not be just as cheap in the end.

On the other hand, do you "buy a few chops for dinner" at 30 cents a pound without realizing that these same chops will cost all the way from 53 cents to 85 cents a pound by the time they are ready to serve—and the bone (at 30 cents a pound) is reposing in the garbage can?

### Air Your Pet Economies

It might be worth while to bring some of your pet economies out into good light to look them in the face. Find out whether they are real economies, or only luxuries in disguise.

A woman on our street orders a sack of flour from the grocer without stating

# SHE TELLS MOTORISTS HOW TO GO



Motor touring has taken on a new aspect of safety and surety since broadcasting stations became the vogue. Many of these are now giving road conditions and directions for best routes for their automobile owning listeners. One of the best of such services is conducted via WBBM by the Stewart-Warner company, and the young lady above, Miss Nina Baker, is the voice behind the service.

what brand she wants. I often hear her say, "I can't understand what happened to my Devil's Food cake this morning." Her Devil's Food cake is her prize recipe, and she is always surprised when it turns out to be a failure. A kitchen-tested flour, guaranteed to always act the same way in the oven, would not only be a real economy to this woman, but also a very great satisfaction.

A woman once told me that for years and years she had spent her precious strength and had worn out clothes by rubbing them to pieces in order to save soap—common, every-day soap. What is soap compared to a woman's strength and happiness?

### Question of Quantity and Quality

Economies can never be measured by those of your next door neighbor, because no two families have the same need. It is extravagance for one family to buy all the expensive out-of-season fruits and vegetables, but it may be a real economy to the mother whose big task is to tempt the appetite of her anaemic child.

Buying in large quantities may be the best plan in a family of seven with a

large basement store room, but it would be most absurd for a family of two living in a small apartment.

A mother from a small town was visiting her daughter in the city and thinking she would help. She made a gorgeous bread pudding to use up the stale bread, scolding her daughter all the while for her extravagance. Her daughter carefully figured the cost of the eggs, milk, sugar and gas used for the pudding as compared with the cost of the simple fruit gelatine that seemed so expensive to her mother.

### Reclassify Your "Economies"

If eggs are cheap a bread pudding may be very inexpensive, but at city prices in the winter it is apt to be a luxury. There is no set formula or rule by which economy may be judged. It is an individual problem to be solved by each one of you. It will require some figuring and a whole lot of common sense to decide just what is the best plan for spending your money and time and energy in such a way that your family can secure the greatest returns in health and happiness. I am neither posing as a teacher nor as a wise (Continued on page 30)

# SHORT WAVES

By Marcella

Talk about the male microphone stars getting mash notes! I, Marcella, received one myself last week. Clifford, I won't divulge, his last name, wrote me a beautiful poem about my beautiful eyes. Clifford, I fear you are a naughty, naughty boy and entirely too curious. Alas, my eyes must continue to remain a mystery to you. This column is reserved for Radio artists only. Poor Marcella mus. remain just an obscure little writer, unseen by the wicked world.

"I'll bet the answer men in the movie magazines don't get any more mail than the Radio stars," says Mary L., in requesting facts about "The Merry Old Chief," Leo Fitzpatrick. She continues, "though you are disillusioned sometimes when you see what they really look like." But Mary might as well write Mr. Fitzpatrick off the date book, for Leo is very much married to a most charming young lady. His looks? Well, he is handsome, judging from the average standard of masculinity, is heavily built but not fat, and is of average height.

G. W. S. of WOA-W, or just "Gus," is pretty new to me. I have his picture, and answering May's question, I think (from the picture) that he is married. Of course, I may be wrong. Gene Rouse is no longer there, but why he is interested in Gene—he has a "cover-girl" wife that is so good looking that when the two stand side by side, all of Gene's homeliness, if I can be so brutal as to call it that, stands out. And they have a baby, too.

Pat Barnes, of "Your Hour" and WHT fame, is certainly a question producer. My, my, but we girls must admire him! He is a handsome fellow, brunette, 32 years old, six feet tall, not fat, not thin—168 pounds exactly. Why shouldn't we admire him? His eyes are brown and he is SINGLE.

That deep-voiced chap you've been hearing over WJAZ lately is E. F. McDonald, Jr., who owns the broadcaster. He's a peach and has a wonderful personality. Somebody'll get him if you don't, for he is a wealthy bachelor. Get out the postage stamps and writing paper!

Gladyce liked our first reply to her note and therefore sends another. Replying punctually, according to our boss' order, we hereby reply that Fred Jeske is free and footloose, 26 years young, a ladies' man, and that he steps out every Monday night (silent night for WBBM). He happens to be very handsome and is one of the Two Jays. Charlie Garland, likewise of WBBM, ad- (Continued on page 30)

## Index to Women's Programs

### Saturday, February 6

Eastern	Central	Mountain	Pacific
9:30 a. m.	8:30 a. m.	7:30 a. m.	6:30 a. m.
WWJ (352.7m-850kc)	Tonight's dinner.		
11	10	9	8
WEAR (389.4m-770kc)	Home service talk.		
WHT (399.8m-750kc)	Women's club.		
12 n.	11	10	9
WGN (302.8m-990kc)	Household hints.		
WQJ (447.5m-670kc)	Cheating the Baby. Stories About Famous Pictures.		
1 p. m.	12 n.	11	10
KMA (252m-1130kc)	Domestic science topics.		
12:30	11:30	10:30	9:30
WGN (302.8m-990kc)	Discussion of fashions.		
12:35	11:35	10:35	9:35
KYW (535.4m-560kc)	Table talk.		
4	3	2	1
KJR (384.4m-780kc)	Tonight's dinner.		

### Monday, February 8

Eastern	Central	Mountain	Pacific
9:30 a. m.	8:30 a. m.	7:30 a. m.	6:30 a. m.
WWJ (352.7m-850kc)	Tonight's dinner.		
10	9	8	7
WJZ (454.3m-660kc)	Women's hour.		
WRC (468.5m-640kc)	Women's hour.		
10:45	9:45	8:45	7:45
WEAF (491.5m-610kc)	Home service talk, Betty Crocker.		
WFI (394.5m-760kc)	Gold Medal talk, Betty Crocker.		
11	10	9	8
WEAR (389.4m-770kc)	Home service talk.		
WHT (399.8m-750kc)	Women's club.		
WNYC (526m-570kc)	Women's program.		
11:45	10:45	9:45	8:45
WTIC (475.9m-630kc)	Fashion talk.		
11:30	10:30	9:30	8:30
KFAB (340.7m-880kc)	Amusing the Convalescent.		
WTIC (475.9m-630kc)	Housewife's forum.		
11:45	10:45	9:45	8:45
WCCO (416.4m-720kc)	A Gold Medal Valentine Party, Betty Crocker.		
WDAF (365.6m-820kc)	A Gold Medal Valentine Party, Betty Crocker.		
12	11	10	9
WGN (302.8m-990kc)	Household hints.		
WQJ (447.5m-670kc)	Where Do You Get Your Perfumes.		
12:15	11:15	10:15	9:15
KYW (535.4m-560kc)	Talk.		
12:35 p. m.	11:35	10:35	9:35
KYW (535.4m-560kc)	Table talk.		
2:30	1:30 p. m.	12:30 p. m.	11:30
KFNE (263m-1140kc)	Mothers' hour.		
WGY (379.5m-790kc)	Cooking lesson; Household talks. Stamping Out Diphtheria and Small-Pox.		
3	2	1	12 n.
WCCO (416.4m-720kc)	Women's hour.		
WSOE (246m-1220kc)	Cooking chats.		
4	3	2	1 p. m.
WIP (508.2m-590kc)	Market hints for housewives.		
WOC (483.6m-620kc)	Home Management schedule, Aunt Jane.		
10:45	9:45	8:45	7:45
WEAF (491.5m-610kc)	Home service talk, Betty Crocker.		
WFI (394.5m-760kc)	Gold Medal Service talk, Betty Crocker.		
WTAG (268m-1120kc)	Talk to Housewives.		

### Tuesday, February 9

Eastern	Central	Mountain	Pacific
9:30 a. m.	8:30 a. m.	7:30 a. m.	6:30 a. m.
WWJ (352.7m-850kc)	Tonight's dinner.		
10:45	9:45	8:45	7:45
WTAG (268m-1120kc)	Talks to Mothers.		
11	10	9	8
WEAR (389.4m-770kc)	Home service talk.		
WHT (399.8m-750kc)	Women's club.		
WMA (340.7m-880kc)	Home makers' hour.		
12 n.	11	10	9
WGN (302.8m-990kc)	Household hints.		
WQJ (447.5m-670kc)	How to Shop.		
12:35 p. m.	11:35	10:35	9:35
KYW (535.4m-560kc)	Table talk.		
1	12 noon	11	10
KPO (428.3m-700kc)	Domestic science talk.		
4	3 p. m.	2 p. m.	1 p. m.
WIP (508.2m-590kc)	Menu talk.		
WOC (483.6m-620kc)	Home Management schedule.		
WQJ (447.5m-670kc)	Sunday Night Suppers.		
4:30	3:30	2:30	1:30
WLIT (394.5m-760kc)	Household helps and hints.		
5	4	3	2
KJR (384.4m-780kc)	Home helps.		
5:30	4:30	3:30	2:30
KOA (322.4m-930kc)	Housewives matinee.		
6	5	4	3
KOA (322.4m-930kc)	Culinary hints.		
6:15	5:15	4:15	3:15
KOA (322.4m-930kc)	Fashion review.		
7	6	5	4
KFOA (454.3m-660kc)	Today's recipe.		
8	7	6	5
WPG (299.8m-1000kc)	Fashion Flashes.		
8:30	7:30	6:30	5:30
KGO (361.2m-830kc)	As a Woman Thinketh.		

### Wednesday, February 10

Eastern	Central	Mountain	Pacific
9:30 a. m.	8:30 a. m.	7:30 a. m.	6:30 a. m.
WWJ (352.7m-850kc)	Tonight's dinner.		
10	9	8	7
WIP (508.2m-590kc)	Menu.		
WJZ (454.3m-660kc)	Women's hour.		
WRC (468.5m-640kc)	Women's hour.		
10:45	9:45	8:45	7:45
WEAF (491.5m-610kc)	Home service talk, Betty Crocker.		
WFI (394.5m-760kc)	Gold Medal Service talk, Betty Crocker.		
WTAG (268m-1120kc)	Talk to Housewives.		

### Thursday, February 11

Eastern	Central	Mountain	Pacific
9:30 a. m.	8:30 a. m.	7:30 a. m.	6:30 a. m.
WWJ (352.7m-850kc)	Tonight's dinner.		
10	9	8	7
WIP (508.2m-590kc)	Menu talk.		
WJZ (454.3m-660kc)	Women's hour.		
WRC (468.5m-640kc)	Women's hour.		
11	10	9	8
WEAF (491.5m-610kc)	Talks. Cookery lecture.		
WEAR (389.4m-770kc)	Home service talk.		
WHT (399.8m-750kc)	Women's club.		
12 n.	11	10	9
WGN (302.8m-990kc)	Household hints.		
WQJ (447.5m-670kc)	Unusual Sunday Night Supper Dishes. Relationship Between Employer and Employee.		
12:35 p. m.	11:35	10:35	9:35
KYW (535.4m-560kc)	Table talk.		
1	12 n.	11	10
KPO (428.3m-700kc)	Domestic science.		
2	1 p. m.	12 n.	11
WGY (379.5m-790kc)	Training Pre-Kindergarten children.		
4	3	2 p. m.	1 p. m.
WOC (483.6m-620kc)	Home Management schedule, Aunt Jane.		
WQJ (447.5m-670kc)	Washington's Birthday Plans. Foot Troubles—Their Home Treatment.		
5	4	3	2
KFOA (454.3m-660kc)	Home helps.		
RSD (545.1m-550kc)	Women's hour.		

### Friday, February 12

Eastern	Central	Mountain	Pacific
9:30 a. m.	8:30 a. m.	7:30 a. m.	6:30 a. m.
WWJ (352.7m-850kc)	Tonight's dinner.		
10	9	8	7
KDKA (309.1m-970kc)	Domestic science and Arts for the Housewife.		
WJZ (454.3m-660kc)	Women's hour.		
WRC (468.5m-640kc)	Women's hour.		
10:45	9:45	8:45	7:45
WTAG (268m-1120kc)	Food hints.		
11	10	9	8
WHT (399.8m-750kc)	Women's club.		
11:30	10:30	9:30	8:30
KFAB (340.7m-880kc)	The Family Dinner Table.		
WTIC (475.9m-630kc)	Housewives' forum.		
11:45	10:45	9:45	8:45
WCCO (416.4m-720kc)	A Gold Medal Pie, Betty Crocker.		
WDAF (365.6m-820kc)	A Gold Medal Pie, Betty Crocker.		
WEAR (389.4m-770kc)	Home service talk.		
12 n.	11	10	9
WGN (302.8m-990kc)	Household hints.		
WQJ (447.5m-670kc)	Sunday Dinner Menu.		
12:30 p. m.	11:30	10:30	9:30
WGN (302.8m-990kc)	Discussion of fashions.		
12:35	11:35	10:35	9:35
KYW (535.4m-560kc)	Table talk.		
1:45	12:45	11:45	10:45
WOAW (526m-570kc)	Sunshine Sunday dinner menu.		
3	2 p. m.	1 p. m.	12 n.
WCCO (416.4m-720kc)	Women's hour.		
4	3	2	1
WOC (483.6m-620kc)	Home Management, Aunt Jane.		
WQJ (447.5m-670kc)	Lincoln's Birthday. Fifth Radio Lesson. Proper Use of Cosmetics.		
5	4	3	2
KJR (384.4m-780kc)	Home helps.		
KYW (535.4m-560kc)	Woman's hour.		
5:15	4:15	3:15	2:15
WMAQ (477.5m-670kc)			
5:30	4:30	3:30	2:30
KOA (322.4m-930kc)	Housewives matinee.		
WFAA (475.9m-630kc)	Women's hour.		
6	5	4	3
KOA (322.4m-930kc)	Culinary hints.		
6:15	5:15	4:15	3:15
KOA (322.4m-930kc)	Fashion review.		

# Who Wins the Gold Award for Foreign Tests?

AS THIS issue goes to press the reports of foreign reception are being submitted to Radio Digest for entry in the \$100.00 Gold Award competition. The communications must be in the judges' hands not later than Thursday midnight, February 4. Watch the next few issues of the Radio Digest for announcements of the winners of this unique contest. Confirmation programs for all foreign stations will be given next week.

## 1,200 VOICES WILL SING ON PROGRAM

### WEAF to Broadcast the Third Annual Concert of the Associated Glee Clubs

NEW YORK.—On Saturday, February 6, WEAF will broadcast direct from the Seventy-first Regimental Armory, Thirty-fourth street and Park avenue, this city, at 8:30 p. m., Eastern time, the third annual concert of the Associated Glee clubs which will be held under the direction of Walter Damrosch, the famous conductor of the New York Symphony orchestra. The concert will last two hours. The glee club concert has been broadcast from New York city and several other nearby cities with a combined membership of 1,200 voices, all of whom will take part. The soloist of the occasion will be Miss Annie Fitzu of the Metropolitan and Chicago Opera companies. Several of the selections which will be rendered by this mammoth male chorus will be Baldwin's "Hymn Before Action," a special arrangement of Handel's "Where'er You Walk," Speaks-Gaines' "Sylvia" and Mark Andrews' "The Clock."

## Boston Symphony to Be Broadcast Over WEEI

### Winfield S. Quinby Gives \$1,000 for Each of Twelve Concerts

BOSTON.—For the first time in its history, and after a long series of attempts to secure permission, concerts of the Boston Symphony orchestra are to be broadcast from Station WEEI through the generosity of a Boston business man, Winfield S. Quinby. Mr. Quinby has given \$1,000 for each of the twelve concerts to pay for the privilege of having them broadcast from the regular Saturday afternoon programs of the orchestra at Symphony hall. The first two concerts were broadcast January 23 and 30, and one thereafter will be given each Saturday for ten additional weeks. It is possible that the concerts will be relayed to other stations in New England, particularly WTAG, Worcester, and QCSH, Portland, Me. This feature is dependent upon the arrangements that WEEI officials can make with other stations and with the telephone company. Arthur F. Edes of the WEEI announcing staff, known to listeners as EFA., is to have charge of the microphone at all the twelve concerts.

## KSL Broadcasts Education

SALT LAKE CITY, Utah.—The University of Utah has announced the beginning of a series of lectures over Station KSL. They are of an educational nature and deal with health subjects, literature, science, history, etc.

## To Hunt Cause of Static This Week

### National Tests Will Be Made by 4,000 Observation Stations; Will Aid in Survey

CHICAGO.—Dates for the national tests of Radio reception to determine the causes of static and fading have been announced after 4,000 of the 4,500 designated observation stations had expressed a willingness to take part in the survey, which is being conducted by the Stewart-Warner Speedometer corporation here, in cooperation with the Northwestern university. The first test will be held on Tuesday night, February 9, from 8 to 11 o'clock, Central time. The second and third tests will be on the two succeeding nights at the same hours. Subsequent trials will be held throughout the winter, should the data obtained indicate that real progress in a search for the causes of these two major Radio annoyances is being made. Most of the observations will be made by broadcast listeners using standard receiving sets and depending for the accuracy of their reports upon their own ears. To insure the scientific accuracy of the result, however, twenty control stations equipped with electrical measuring devices and automatic recorders have been placed in strategic points about the country.

## FLORIDA TO BERING SEA

(Continued from page 7)  
frostbitten Canadian friends would be listening in when WGHB goes on the air tonight. Mr. Bowles looked hopeful, but the merest shadow of a doubt still lingered. It was a clear night and Clearwater never had been clearer. There was nary a thing to go amiss. The little 500 watter did her stuff to Mr. Tison's entire satisfaction. Telegrams and phone calls came in with a flood that fairly deluged Mr. Bowles. But the best message did not get in until the next day. And this is what it said: "Congratulations, new station. Songs, orchestra whole program came through loud speaker like next room. What power do you use?—Dr. George H. Lescher, St. Paul Island, Alaska."

## Gus Swanson Is Member of WOAW's Announcing Staff

OMAHA.—Station WOAW has recently added to their announcing staff Mr. Gus Swanson, possessor of a deep bass voice, with unusually clear enunciation. Already he has become very popular with the Radio audience. Mr. Swanson is well known in the musical circles of Omaha and is a leader in choral and community singing. He is a bass soloist at the Kountze Memorial Lutheran church and an active club worker.

## AN EVENING AT HOME WITH THE LISTENER IN IN EASTERN TIME

Call	Location	Met.	Saturday	Sunday	Monday	Tuesday	Wednesday	Thursday	Friday
AT9	Fort Bragg, N. C.	435	Silent	6:00-7:00	Silent	Silent	Silent	8:00-9:55	Silent
CFCN	Calgary, Alta.	434.5	12:00-2:00	Silent	Silent	Silent	Silent	10:00-11:00	Silent
CJCA	Edmonton, Can.	516.9	11:00-1:00	9:30-10:30	9:30-11:30	9:30-10:00	8:00-10:00	11:00-1:00	10:00-1:00
CKAC	Montreal, Que.	410.7	7:30-11:00	Silent	Silent	7:30-11:00	Silent	7:30-11:00	Silent
CKNC	Toronto, Ont.	356.9	8:00-10:00	Silent	8:00-11:00	Silent	Silent	Silent	Silent
CKY	Winnipeg, Man.	384.4	9:00-12:00	8:00-11:00	9:00-1:00	Silent	8:30-12:00	9:30-12:00	Silent
CNRO	Ottawa, Ont.	434.5	8:30-1:30	Silent	Silent	Silent	8:30-1:30	Silent	Silent
CYL	Mexico City, Mex.	480	Silent	10:24-11:54	Silent	10:24-11:54	Silent	Silent	10:24-11:54
CZE	Mexico City, Mex.	350	9:24-10:24	Silent	Silent	9:24-10:24	9:24-10:24	9:24-10:24	9:24-10:24
KDKA	Pittsburgh, Pa.	309.1	6:30-9:55	4:00-8:45	6:30-9:55	6:30-12:35	6:30-9:55	6:30-12:00	6:30-9:55
KFAB	Lincoln, Nebr.	340.7	6:30-10:30	5:00-12:00	6:30-11:30	6:30-11:30	6:30-11:30	Silent	6:30-11:30
KFI	Los Angeles, Calif.	299.8	9:00-6:00	7:00-2:00	9:00-2:00	9:00-2:00	9:00-2:00	9:00-2:00	9:00-2:00
KFKX	Haystack, Nebr.	288.3	6:30-7:30	Silent	10:00-12:00	Silent	8:00-9:00	8:00-9:00	10:00-12:00
KFMQ	Fayetteville, Ark.	299.8	Silent	Silent	Silent	8:30-9:30	9:00-10:00	Silent	Silent
KFMX	Northfield, Minn.	336.9	Silent	8:00-9:00	Silent	10:30-11:00	10:00-11:00	Silent	11:00-12:00
KFNF	Shenandoah, Ia.	263	8:00-10:00	8:30-9:30	8:00-10:00	8:00-10:00	8:00-10:00	8:00-10:00	8:00-10:00
KFOA	Seattle, Wash.	454.3	11:30-2:30	Silent	9:45-1:00	9:45-1:00	9:45-1:00	Silent	9:45-2:30
KFUO	St. Louis, Mo.	545.1	Silent	5:00-11:15	9:00-10:00	Silent	10:15-11:15	Silent	Silent
KFVE	Univ'ty City, Mo.	240	10:15-11:15	Silent	10:15-11:15	10:15-11:15	Silent	Silent	10:15-11:15
KFWB	Hollywood, Calif.	252	10:45-9:00	12:00-2:00	10:00-3:00	10:00-3:00	10:00-3:00	10:00-3:00	10:10-3:00
KGO	Oakland, Calif.	361.2	11:30-3:00	6:30-12:30	9:00-1:00	9:00-2:00	9:00-10:00	11:00-2:00	9:00-10:00
KGW	Portland, Ore.	491.5	9:00-3:00	10:25-1:00	9:00-12:00	9:00-3:00	9:00-2:00	9:00-11:00	12:00-1:30
KHJ	Los Angeles, Calif.	405.2	9:00-2:00	9:30-1:00	Silent	9:30-2:00	9:00-2:00	9:00-4:00	9:30-2:00
KIAP	Shtipok, Minn.	421	Silent	3:00-4:00	8:00-9:00	Silent	8:00-9:00	Silent	8:00-9:00
KJR	Seattle, Wash.	384.4	11:30-1:00	10:15-12:00	10:00-2:00	11:30-1:00	10:00-1:00	11:30-3:00	11:30-3:00
KLDS	Independence, Mo.	440.9	9:00-10:00	7:30-11:00	Silent	9:00-12:59	Silent	9:00-10:00	Silent
KLX	Oakland, Calif.	508.2	10:00-10:30	Silent	7:00-10:30	10:00-2:30	Silent	10:00-10:30	7:00-10:30
KNX	Hollywood, Calif.	336.9	9:15-5:00	5:00-1:30	9:15-3:00	9:15-3:00	9:15-3:00	9:15-3:00	9:15-3:00
KOA	Denver, Colo.	322.4	11:00-1:00	5:00-10:45	8:30-12:30	8:30-10:30	8:30-2:00	8:30-9:30	8:30-11:00
KOB	State College, N.M.	348.6	Silent	Silent	9:30-10:30	Silent	Silent	Silent	Silent
KOIL	Council Bluffs, Ia.	278	6:00-2:00	8:00-1:00	7:00-1:00	7:00-1:00	7:00-8:15	7:00-1:00	7:00-1:00
KPO	San Francisco, Cal.	428.3	9:35-3:00	8:00-2:00	9:40-2:00	9:15-2:00	9:15-2:00	9:15-2:00	9:30-2:00
KPRC	Houston, Texas.	296.9	8:30-1:00	8:30-11:30	8:30-11:30	8:30-10:30	8:30-1:00	8:30-1:00	8:30-1:00
KSD	St. Louis, Mo.	545.1	7:45-11:00	7:15-10:15	7:55-12:00	7:55-11:00	8:00-10:00	7:55-11:00	8:30-10:00
KSL	Salt Lake City, Ut.	299.8	10:00-1:00	11:00-1:00	10:00-1:00	11:00-1:00	10:00-1:00	10:00-1:00	11:00-1:00
KTAB	Oakland, Calif.	240	Silent	10:45-2:00	11:00-1:00	11:00-1:00	Silent	12:00-3:00	11:00-3:00
KTBI	Los Angeles, Calif.	295.9	Silent	10:15-12:30	Silent	11:00-12:00	Silent	11:00-12:00	Silent
KTGL	Seattle, Wash.	305.9	Silent	12:10-9:10	10:00-11:00	11:00-12:00	Silent	Silent	10:00-3:00
KTHS	Hot Springs, Ark.	374.8	10:00-12:00	10:00-12:30	10:00-12:00	10:00-12:00	10:00-12:00	10:00-12:00	10:00-12:00
KTW	Seattle, Wash.	455	9:30-10:30	Silent	Silent	9:30-10:30	Silent	9:30-10:30	Silent
KWKH	Shreveport, La.	261	10:00-1:00	6:00-10:00	9:00-10:30	10:00-1:00	Silent	9:00-10:30	Silent
KWSG	Pullman, Wash.	348.6	Silent	Silent	10:30-12:00	Silent	10:30-12:00	Silent	10:30-12:00
KYW	Chicago, Ill.	535.4	8:00-11:00	5:00-9:00	Silent	8:00-1:30	8:00-2:30	8:00-1:30	8:00-2:30
NAA	Radio, Va.	434.5	Silent	Silent	7:45-8:00	7:45-8:00	7:25-8:40	7:45-8:00	7:45-8:00
PWX	Havana, Cuba.	400	8:30-11:00	Silent	Silent	Silent	8:30-11:00	Silent	Silent
WAHG	Richmond, N. Y.	315.6	12:00-2:00	Silent	8:00-2:00	Silent	7:30-12:00	Silent	8:00-11:00
WBAL	Baltimore, Md.	246	Silent	6:30-7:30	6:30-9:00	6:30-9:00	Silent	6:00-10:00	6:30-9:00
WBAP	Fort Worth, Tex.	475.9	10:30-12:00	10:30-12:00	8:30-1:00	8:30-12:00	Silent	8:30-1:00	8:30-1:00
WBAR	Sisith, Wis.	406	Silent	11:00-12:00	10:00-11:00	Silent	9:00-10:00	8:30-9:30	Silent
WBBM	Chicago, Ill.	228	9:00-2:00	9:00-3:00	7:00-8:00	9:00-1:00	9:00-3:00	9:00-1:00	9:00-11:00
WBBR	Staten Island, N.Y.	272.6	8:00-10:00	9:00-10:15	8:00-9:00	Silent	8:00-9:00	Silent	Silent
WBCN	Chicago, Ill.	260	6:00-2:00	6:00-1:00	Silent	10:00-2:00	9:00-1:00	10:00-3:00	10:00-2:00
WBZ	Springfield, Mass.	333.1	6:30-8:30	8:00-9:00	6:30-11:05	6:30-10:02	6:30-9:45	6:30-10:00	6:30-11:05
WCAE	Pittsburgh, Pa.	461.3	8:30-9:30	6:30-8:20	6:30-12:00	6:30-11:00	6:30-10:00	9:00-11:00	8:00-9:30
WCAP	Washington, D. C.	468.5	Silent	4:00-10:15	7:00-11:00	Silent	6:45-12:00	Silent	6:00-12:00
WCAU	Philadelphia, Pa.	278	Silent	5:00-11:30	8:00-11:30	6:45-12:00	6:45-12:00	6:30-12:00	7:30-11:30
WCBD	Zion, Ill.	344.6	Silent	9:00-11:30	Silent	9:00-11:30	Silent	9:00-11:30	Silent
WCCO	Minn.-St. P., Minn.	416.4	7:15-12:05	5:10-9:15	7:00-11:00	7:15-11:00	8:00-1:30	8:00-12:05	7:15-12:05
WCX	Detroit, Mich.	516.9	6:00-7:00	7:15-8:15	6:00-9:00	6:00-11:00	6:00-9:00	6:00-9:00	6:00-11:00
WDAF	Kansas City, Mo.	365.6	7:00-2:00	5:00-5:45	7:00-2:00	7:00-2:00	7:00-2:00	7:00-2:00	7:00-2:00
WDBO	Winter Park, Fla.	240	9:00-10:30	5:00-6:00	9:00-10:30	9:30-11:00	9:00-10:30	9:00-10:30	9:00-10:30
WDWF	Providence, R. I.	440.9	Silent	Silent	Silent	8:30-9:30	Silent	Silent	Silent
WEAF	New York, N. Y.	491.5	6:00-12:00	2:00-10:15	6:00-12:00	6:00-12:00	6:00-12:00	6:00-12:00	6:00-12:00
WEAO	Columbus, Ohio.	285.9	Silent	Silent	Silent	7:00-9:00	8:00-9:00	8:00-11:00	Silent
WEAR	Cleveland, Ohio.	389.4	7:00-1:00	7:00-10:15	8:00-12:00	7:00-11:00	8:00-8:00	7:00-11:00	7:00-11:00
WEBH	Chicago, Ill.	370.2	8:00-3:00	6:00-10:00	Silent	8:00-1:30	8:00-1:30	8:00-1:30	8:00-1:30
WEBJ	New York, N. Y.	272.6	Silent	Silent	Silent	8:00-9:00	8:00-10:00	Silent	7:00-9:00
WEEI	Boston, Mass.	348.6	Silent	7:20-10:20	8:30-10:00	8:00-11:00	8:00-10:00	8:00-11:00	8:30-11:00
WENR	Chicago, Ill.	260	7:00-3:00	3:00-12:30	Silent	7:00-11:00	7:00-3:00	7:00-11:00	7:00-3:00
WFAA	Dallas, Tex.	475.9	9:30-1:00	7:30-12:00	7:30-10:30	7:30-1:00	Silent	7:30-1:00	7:30-1:00
WFBH	New York, N. Y.	272.6	11:30-2:00	5:00-8:00	11:30-2:00	11:30-2:00	11:30-2:00	11:30-2:00	11:30-2:00
WFI	Philadelphia, Pa.	394.5	8:00-9:30	7:30-8:30	Silent	8:00-12:00	Silent	8:00-11:00	Silent
WGBS	New York, N. Y.	315.6	6:00-11:30	8:00-9:00	7:00-7:15	6:30-11:30	6:00-8:30	6:00-8:45	Silent
WGBU	Fulford, Fla.	278	6:30-1:00	9:30-12:00	6:30-1:00	6:30-1:00	6:30-1:00	6:30-1:00	6:30-1:00
WGCP	New York, N. Y.	252	Silent	8:00-11:15	8:00-11:00	Silent	8:00-11:15	Silent	8:00-11:00
WGES	Oak Park, Ill.	250	11:30-3:00	11:30-3:00	Silent	11:30-3:00	11:30-3:00	11:30-3:00	11:30-3:00
WGHV	Clearwater, Fla.	266	6:30-1:00	Silent	6:30-1:00	6:30-1:00	6:30-1:00	6:30-1:00	6:30-1:00
WGHF	Detroit, Mich.	270	Silent	Silent	7:00-9:00	7:00-9:00	7:00-9:00	9:00-11:00	9:00-11:00
WGN	Chicago, Ill.	302.8	7:30-11:00	4:00-10:15	Silent	7:30-12:00	7:30-12:00	7:30-12:00	7:30-12:00
WGR	Buffalo, N. Y.	319	Silent	7:45-10:15	8:30-1:00	8:00-11:00	8:00-1:00	8:00-1:00	8:45-1:00
WGY	Schenectady, N. Y.	379.5	9:00-12:00	6:30-10:00	6:30-8:30	7:00-11:00	Silent	6:45-11:30	7:15-10:30
WHAR	Atlantic City, N. J.	275	7:30-10:30	7:50-1:15	7:30-10:00	7:30-1:15	Silent	7:30-11:00	7:30-1:15
WHAS	Louisville, Ky.	399.8	8:30-10:00	6:00-6:00	Silent	8:30-10:30	8:30-10:00	8:30-10:00	8:30-10:00
WHAZ	Troy, N. Y.	375.5	Silent	Silent	9:00-12:00	Silent	Silent	Silent	Silent
WHB	Kansas City, Mo.	365.6	Silent	9:00-2:30	8:00-9:00	8:00-11:00	8:00-9:00	8:00-11:00	8:00-9:00
WHN	New York, N. Y.	361.2	7:30-10:00	5:00-5:30	8:00-12:00	9:30-10:00	10:00-11:30	8:00-10:00	7:30-12:30
WHO	Des Moines, Ia.	528	Silent	5:00-9:30	8:30-1:00	8:30-1:00	8:30-1:00	8:30-1:00	8:30-1:00
WHT	Chicago, Ill.	399.8	8:00-2:00	1:00-11:30	Silent	8:00-2:00	8:00-2:00	8:00-2:00	8:00-2:00
WIBO	Chicago, Ill.	226	7:00-9:00	7:00-1:00	Silent	7:00-4:00	7:00-4:00	7:00-4:00	7:0

# ADVANCE PROGRAMS FOR THE WEEK

Saturday, February 6

## Headliners Today

Eastern	Central	Mountain	Pacific
7:55 p. m.	6:55 p. m.	5:55 p. m.	4:55 p. m.
WNAC (280.2m-1070kc)	Chicago Civic opera		
8	7	6	5
WSM (282.8m-1060kc)	Barn dance		
8:30	7:30	6:30	5:30
WBZ (333.1m-900kc)	Three Red Heads		
WIP (508.2m-590kc)	Vice-President's talk		
WJZ (454.3m-660kc)	WRC (468.5m-640kc)	Philharmonic society	
8:45	7:45	6:45	5:45
CNRO (434.5m-690kc)	Sleigh ride		
9	8	7	6
WFI (394.5m-760kc)	Ave Maria mandolin club		
9:30	8:30	7:30	6:30
WBZ (333.1m-900kc)	Ruthstrom family band		
10	9	8	7
KFI (468.5m-640kc)	Mexican music		
WSAI (325.9m-920kc)	Jack Little, Wendell Hall		
10:50	9:50	8:50	7:50
KTHS (374.8m-800kc)	South Seas frolic		
12	11	10	9
KPRC (296.9m-1010kc)	The Phantoms, Ghosts of the Air		

Saturday, silent night for: CFAC, CFCA, CNRA, CNRC, CNRE, CNRM, CNRR, CNRT, CNRV, CNRW, KFDM, KFEQ, KFKX, KFKU, KFMX, KFVO, KFXF, KLY, KMA, KOAC, KOB, KQP, KSAC, KSO, KTAB, KWSC, WABQ, WCX, WOOD, WEAQ, WEBJ, WEBW, WEEL, WGCP, WGST, WHAD, WHAZ, WGR, WHN, WHO, WIP, WJAR, WJAZ, WKAG, WKAR, WLIT, WLWL, WQAI, WOC, WOS, WRVA, WTAG, WTIC, WWJ.

## Eastern Time Stations

**CKNC, Toronto, Can.** (356.9m-840kc), 4 p. m., CKNC Chamber orchestra, Charles E. Bodley, director; Elsie White, soprano; Bert Petch, reader.

**KDKA, Pittsburgh, Pa.** (309.1m-970kc), 7:15-8 a. m., exercises; 9 Shannon; 5:45 p. m., Daddy Winkum; 6:30, dinner concert, T. J. Vastine, conductor; 8:30, concert, Westinghouse band, T. J. Vastine, conductor; Harry M. Hopkins, tenor.

**WAHG, Richmond Hill, N. Y.** (315.6m-950kc), 12:03 p. m., Rosalin Pass, pianist; 12, Weinzauff's concert orchestra.

**WAIU, Columbus, Ohio** (293.9m-1020kc), 12-1 p. m., music; 9:15-11, dance music, Allen Hale orchestra.

**WBBR, New York, N. Y.** (273m-1100kc), 8 p. m., Dr. Hans Haag, violinist; 8:20, L. Marion Brown, soprano; Bible discussion; 8:40, Dr. Hans Haag, violinist.

**WBZ, Springfield, Mass.** (333.1m-900kc), 7:15 p. m., income tax problems, Thomas McCarty; 8, McEnelly and his Victor Recording orchestra; 8:30, program, three "Red Heads," Hotel Brunswick studio; 9:30, concert, Ruthstrom family band.

**WCAE, Pittsburgh, Pa.** (461.3m-650kc), 3 p. m., music, Nixon cafe; 6:30, dinner concert, William Penn hotel; 7:30, address; 8, Youngstown artists.

**WCX, Detroit, Mich.** (516.9m-580kc), 6-7 p. m., Goldkette ensemble.

**WEAF, New York, N. Y.** (491.5m-610kc), 6:45, 7, 7:20 a. m., Tower health exercises; 4-5 p. m., dance program; 6-12, dinner music, Hotel Waldorf-Astoria; Ross Gorman and his orchestra, Monte Carlo; Chamber musicale, Grace Leslie, contralto, and Carl Rollins, baritone; Marie Samuel, pianist; Glee clubs, 71st Regiment armory; Hughie Barrett and his orchestra, Hotel Commodore; Vincent Lopez and his orchestra from Casa Lopez.

**WEAR, Cleveland, Ohio** (389.4m-770kc), 7 p. m., Hotel Statler concert orchestra, Maurice Spitalny, director; 12, Wormack's singing syncopators, Far East restaurant.

**WFI, Philadelphia, Pa.** (394.5m-760kc), 1 p. m., Tea Rogin ensemble; 3, Bill Marshes Collegians; 8:30, Bellevue Stratford concert orchestra; 7, Bellevue Stratford dance orchestra; 8, talk, auspices Philadelphia County Medical society; 8:10, Trinity Presbyterian church quartet; 9, Ave Maria mandolin club; 9:30, "Abraham Lincoln," Dr. Clarence E. Macartney; 9:45, Mirella Cianci, soprano; 10, WFI concert orchestra.

**WGBS, New York, N. Y.** (315.6m-950kc), 3 p. m., Ben Goldman and his Boy Scout entertainers; 6:30, Bill Hines and his orchestra; 7, international film arts guild talk, Bill Hines; 7:20, Tommy Tucker, tenor; 8:30, Joe Kahn, tenor; Ruth Friedman, pianist; Michael Saltpeper, violinist; 9, Irish program, Maura Channing, contralto; 10:30, Arrowhead Inn orchestra.

**WGFP, New York, N. Y.** (252m-1190kc), 3 p. m., Al Sussman's college club orchestra; 4, Southampton entertainers; 8:30, Southampton entertainers; 9:30, Bob McDonald, ukulele soloist; 9:45, June Lee; 10, Yama Yama Boys; 10:30, Strickland's orchestra.

**WGY, Schenectady, N. Y.** (379.5m-790kc), 6:30 p. m., dinner program, Hotel Onondaga; 7:45, bridge lesson, No. 7; 8:25, New York Philharmonic society student symphony series, Willem Mengelberg, conductor; 10:30, dance program.

**WHAR, Atlantic City, N. J.** (275m-1090kc), 2 p. m., Seaside hotel trio; 7:30, lecture period; 8, Seaside hotel trio.

**WIP, Philadelphia, Pa.** (508.2m-590kc), 1 p. m., organ recital, Germantown theater; 3, Dal Ruch and his Arcadians; 6:05, Benjamin Franklin hotel concert orchestra; 7, Uncle Wip's bedtime stories; Walter Baker, pianist; Arthur Conn, violinist; Henry Dorneman, cornetist; 8, sports corner, Dr. Francois D'Eliseu; 8:15, "The Sign of the Skull and Cross Bones," Prof. Ivor Griffith; 8:30, dinner tendered to Vice-President Chas. E. Dawes; 10:05, Benjamin Franklin El Patio dance orchestra; 11:05, organ recital.

**WJR, Pontiac, Mich.** (454.3m-660kc), 7 p. m., Jean Goldkette's Petite symphony orchestra; 9, Jean Goldkette's serenaders; 10, Jean Goldkette's Victor Recording orchestra; 11:30, Jewett Radio Jesters.

**WJZ, New York, N. Y.** (454.3m-660kc), 11 a. m., Philharmonic children's concert; 1 p. m., Irwin Abrams' Knickerbocker Grill orchestra; 2:02, discussion of National Republican club; 4:30, Hotel Lorraine Grill orchestra; 7, Bernhard Levitov's Hotel Commodore dinner concert; 8, Cosmo Hamilton's Radio novel; 8:15, James Keith, tenor; 8:25, Philharmonic society's student concert; 10:20, James Keith, tenor; 10:30, George Olsen's Hotel Pennsylvania Grill orchestra.

**WLIT, Philadelphia, Pa.** (394.5m-760kc), 12:02 p. m., daily almanac; Stanley theater organ recital; Arcadia cafe concert orchestra; 2, Rose Tree cafe dance orchestra; 4:30, Ed. Matthews' entertainers; 7:30, Benjamin Franklin hotel concert orchestra.

**WMBF, Miami Beach, Fla.** (384.4m-780kc), 7-9 p. m., Fleetwood Radio orchestra; 10-1 a. m., Gene Fosdick and his orchestra; Fleetwood Radio orchestra.

**WMCA, New York, N. Y.** (349.7m-880kc), 6-6:30 p. m., Olcott Vail and his Hotel McAlpin string ensemble; 6:50-7, Club Caprice orchestra; 7-7:30, The Amphons; 10:30-11, Norman Pearce, readings; 11-12 midnight, Ernie Golden and his Hotel McAlpin orchestra.

**WNAC, Boston, Mass.** (280.2m-1070kc), 6 p. m., The Smilers, Clyde McArdle, conductor; 6:30, Shepard Colonial dinner dance, Billy Lossez, director; 7:55, Chicago Civic Opera company in "Il Trovatore," Claudia Muzio, Augusta Lenka, Antonio Cortis, Richard Bonelli.

**WNYC, New York, N. Y.** (526m-570kc), 7 p. m., song recital; 7:35, Seville trio; 8, studio program; 9:30, annual dinner, Real Estate Board of New York.

**WOOD, Philadelphia, Pa.** (508.2m-590kc), 11 a. m., organ recital; 12:02 p. m., Golden's Crystal Tea Room orchestra; 4:45, organ recital; 7:30, A. Candelieri's Adella orchestra.

**WPG, Atlantic City, N. J.** (299.8m-1000kc), 1:30 p. m.,



This pretty young lady proves that Louisville has at least one beauty. Her name is Myrtle G. Stinger and her sweet voice has been heard countless times from WHAS.

## High Lights of the Week

CHICAGO fans were denied the privilege of hearing the Chicago Civic Opera company during its season in this city, but Boston listeners will hear the entire company give "Il Trovatore." Among the artists appearing are, Claudia Muzio, Augusta Lenka, Antonio Cortis and Richard Bonelli. Another headliner Saturday, is a speech by Vice-President Dawes from WIP, Philadelphia. He is the guest of the Manufacturers' club. If you have not had an old-fashioned sleigh ride this year, you will tune in for CNRO, Ottawa, this same evening and leave for the annual sleigh drive at 8:45 p. m. Eastern time. Stop-overs for old-time square dances will be enjoyed by all.

The opera star featured at WEAF this Sunday, is Charles Hackett, tenor. Fans may hear him at 9:15 p. m. Eastern time on the WEAF chain. The assisting artist with the Copley Plaza orchestra at WBZ, Springfield, is Theresa Sprague.

A traffic squad recruited by Earle Buell is the new feature at WAMD. No word has been received as to what this squad will do, but it is expected that the air will have no squeals nor howls on Monday evenings at 6:30 p. m. Central time, when this group is on the air. Troy Elks expect to meet in the studio of WHAZ between 8 and 9 p. m. Eastern time, for their regular Elks club frolic, Monday.

The Provincetown players are well known in New York for their selections of unusual plays of literary

value. They will appear before the microphone of WGBS Tuesday night in "The Dream Play" by August Strindberg. A gay program is scheduled for KOIL, Council Bluffs, Ia., when the Nautical dance orchestra "Seamen without a Ship" embark on the air.

From 6:30 p. m. to 1 a. m. Eastern time Wednesday, a gala program will travel etherways from WTIC, Hartford. Among the special features are the Yale band, the New York Philharmonic ensemble, Arthur Middleton, baritone, and Jeanne Laval, contralto. For those who prefer lighter music, the midnight frolic presents Sherman and Ryan and three young ladies called the Harmony entertainers.

A piano recital of Chopin compositions and a talk "Chopin and His Works" by J. Austin Springer from WGY Thursday, will give Radio fans a better idea of this composer's skill. "Stung" is the amusing title of the dramatic offering of KGO for this same evening. Eight of the famous KGO players will appear before the microphone.

The fifteenth great artist organ recital will be given Friday evening from WAHG. William Edward Zuech is the artist this week. Lincoln programs are popular for this evening. The Department of English at the U. of Pittsburgh will officiate at KDKA with the KDKA Little symphony orchestra playing civil war melodies. Drinkwater's famous play "Lincoln" will be given by the WMAQ players.

Hotel Morton music; 3, Atlantic City auto show; 6:45, Arthur Scott Brook, organist; 7, Hotel Ambassador dinner music; 7:30, dance orchestra; Atlantic City auto show; 8:15, "Swimming," lesson; 8:30, Haverford college musical clubs; 10, Nick Nichols' dance orchestra; 10:45, Grace Brewer Allen, vaudeville star; 11:30, dance orchestra.

**WRC, Washington, D. C.** (468.5m-640kc), 11 a. m., children's concert; 12:15, organ recital, Homer L. Kitt studios; 1, Hamilton hotel orchestra, Daniel Chwalow, director; 8, Lee House trio, Sam Udren, director; 7, Irving Boernstein's Hotel Washington orchestra; 8, Bible talk; 8:30, student's concert, Carnegie hall; 10:30, Crandall's Saturday Nighters; 12-1 a. m., The Spanish Village orchestra.

**WREO, Lansing, Mich.** (285.5m-1050kc), 6-7 p. m., dinner concert, Speed-Wagon Serenaders; Gold Standard ensemble; 10-12 midnight, special dance program; Speed-Wagon Serenaders, Carl Hall Dewey, director.

**WTAG, Worcester, Mass.** (268m-1120kc), 10:30 a. m., musical selections; 12:05-2, noonday luncheon music, WTAG orchestra, Will Hardy, director; 3-5, Tea Dantant music; 5:15, "The Twinkle Twinkle Story Teller."

**WTAM, Cleveland, Ohio** (389.4m-770kc), 12:30-1:30 p. m., lunch hour program, Austin Wylie's Vocalion Recording orchestra; 6-7, dinner hour music, Carl Rupp and his Hotel Hollenden orchestra; 8-9, Hollenden hour, Carl Rupp and his Hotel Hollenden orchestra; 9-12, novelty program, Er Jones and his Gang.

**WTIC, Hartford, Conn.** (475.9m-630kc), 6:30 p. m., Skinny and his gang; 6:50, dinner music, Hotel Bond trio; 8, Sunday school period; 8:20, familiar hymns; 9, Helen Virginia Cain, contralto; Estelle Crossman, pianist; Morris Krosnick, violinist; 10:30, Emil Heimberger's Hotel Bond orchestra.

**WWJ, Detroit, Mich.** (352.7m-850kc), 12:05 p. m., Jules Klein's Hotel Statler orchestra; 3, Detroit News orchestra.

## Central Time Stations

**CKY, Winnipeg, Can.** (384.4m-780kc), 8 p. m., University lecture, Prof. W. F. Osborn; 9, concert, J. A. Banfield Limited.

**KFAB, Lincoln, Nebr.** (340.7m-880kc), 8:30-10:30 p. m., Schmoller and Mueller musicale.

**KFMQ, Fayetteville, Ark.** (299.8m-1000kc), 7:30 p. m., University of Arkansas vs. University of Texas basketball game.

**KFNF, Shenandoah, Iowa.** (263m-1140kc), 7 p. m., concert, Forest City, Lenis R. Glass, director.

**KFVE, University City, Mo.** (240m-1250kc), 9:15 p. m., amusement review, Romaine Fielding; dramatic readings, Romaine Fielding; special KFVE organist; Solan Nealy; harmonica duo.

**KLDS, Independence, Mo.** (440.9m-680kc), 8 p. m., concert, Amy E. Winning, organist; Mrs. Otto Grasse, contralto; Mrs. Norma Troje Miller, violinist; Thusnelda Birsak, pianist; August Zander, basso; 9, request program.

**KMA, Shenandoah, Iowa** (252m-1190kc), 6-7 p. m., bedtime stories; 9-11, William Howie, organist.

**KOIL, Council Bluffs, Iowa** (278m-1080kc), 5 p. m., Randall's Royal Fontenelle orchestra; 5:30, McCrory's popular music, Leo Kearsse; 6:15, Mona Motor oil entertainers; 6:30, Randall's Royal Fontenelle orchestra; 7:15, U. of Omaha; 7:30, Omaha Conservatory of Music; 11, Hugo Heyn and his Happy Hollow club orchestra; 12 midnight, Indian Pow-Wow.

**KPRC, Houston, Texas** (296.9m-1010kc), 12 noon, Jack Willich and his orchestra; 7:30, Bible class, Rev. Claude L. Jones; 8, Frank Tilton, pianist; 11, Phantoms, "Ghosts of the Air."

**KSD, St. Louis, Mo.** (545.1m-550kc), 7 p. m., Grand Central theater; 8:30, Y. M. H. A. orchestra.

**KTHS, Hot Springs National Park, Ark.** (374.8m-800kc), 9-9:45 p. m., Curtis W. Fish and his old-time fiddler band; 9:45-9:50, Phantom Voice; 9:50-10:45, South Seas frolic; 10:45-11:30, New Arlington orchestra.

**KYW, Chicago, Ill.** (536m-560kc), 6:30-7 a. m., exercises, Paul A. Leonhardt; 7:30, morning family worship; 12:05 p. m., noonday concert; 1, luncheon concert, Congress hotel; Coon-Sanders' Original Night-hawks; 4, Saturday frolic; 6, dinner music, KDKA; 7:05, bedtime story, Walter Wilson; 7:30, home lovers hour; 11, Congress classic; 11:30-1 a. m., Congress carnival; 1-2, Insomnia club, Coon-Sanders' orchestra.

**WAMD, Minneapolis, Minn.** (244m-1230kc), 12 m., popular musical program, Charles Cloud, xylophone; Walter Stachell, pianist; Paul Curtis, saxophone; John Hardy, accompanist; "Blowdowns" orchestra; 6:15 p. m., dinner concert, George Osborn and his orchestra; 7:05, talk, "What Prominent Outsiders Think of Minneapolis and the Great Northwest"; 7:10, popular musical program; Harmony Twins, Fred and Bob; Ruth Hokans, contralto; Jerry Harrington, tenor; Bernice Hayeck, accompanist; 11, Skyrocket frolic, George Osborn's orchestra; 12, organ recital, Jack Malerick.

**WBBM, Chicago, Ill.** (226m-1330kc), 4-6 p. m., Harry and Sandy; Valentino Inn; Jack Penewell; 8-9:30, musical comedy; 9:30-11, Sandy and Harry; Moulin Rouge orchestra; Sy Berg; Fred Jacobson; 11-2 a. m., Sunset male quartet; George Thurn; Two Jays; Lew Russel; Romeo Vincent Moulin Rouge orchestra.

**WBCN, Chicago, Ill.** (266m-1130kc), 10-10:30 a. m., shopping talk, Penny Wise; 3-5 p. m., tea time martine; Clarence Jones, pianist, and song writer; Cecile and Johanna Arends, violinist and pianist; Marie Wright, soprano; 10-11:15, jazz jamboree; Midway Dancing Gardens orchestra; Cameron and Pelt, "The Harmony Wizards," harmony duo; Albert Blaha, concertinist; Johnny Special, harmonica acrobat; Elizabeth Emmett Malone, soprano; Jack Parker, tenor; 11:15-12 midnight, King Statie's court, Frank H. MacDonald, "King Statie," Mary Williams, "Queen Olive," Harry A. Zook, Jr., "Prime Minister"; "Big Boy" Yagle, "Court Jester."

**WGAL, Northfield, Minn.** (336.9m-890kc), 8:30 p. m., "With the Great Masters," Dr. Carl A. Mellby, St. Olaf college music faculty.

**WCCO, Minneapolis-St. Paul, Minn.** (416.4m-720kc), 12:30 p. m., concert, Emma Long's Golden Pheasant orchestra; 2:30, afternoon concert; 6:15, dinner concert, Emmet Long's Golden Pheasant orchestra; 8, "Flreside Philosophies," Rev. Roy L. Smith, pastor Simpson M. E. church; 8:15, musical program; 10:15, dance program, Willie Erikson's Coliseum orchestra.

**WDAF, Kansas City, Mo.** (365.6m-820kc), 3:30-4:30 p. m., The Star's string trio; 6-7, address, "Things Our Army Does Besides Fight," H. Edmund Bullis; address, "Water Supply and Hydraulic Engineering," Wynkoop Klersted; organ music, Pantages theater; music, Trianon ensemble; 11:55-1 a. m., Plantation players; Billy Adair's Kansas City club orchestra; Eddie Kuhn's Kansas City Athletic club orchestra.

**WEBB, Chicago, Ill.** (370.2m-810kc), 3-4 p. m., special features; 7-8, Oriole orchestra; Howard Neumiller, pianist; 9, Oriole orchestra; 9:45, James Murray, tenor; Marie Kelly, reader; 11-12, Oriole orchestra; Wayne Myers, Frank Greif; 1-2 a. m., Marie Kelly, reader; Kay Ronayne, songs.

**WFDA, Dallas, Texas** (475.9m-630kc), 3:30-4 p. m., Tom Fowler, violinist; 4:30-5, Cloyd Griswold, songs; 6:30-7:30, Don Bestor's orchestra; 6:55-7, "History of Our Coins," W. A. Philpott, Jr.; 8:30-9:30, program, Commerce, C. E. Conway, director; 11-12 midnight, Jack Gardner's orchestra.

**WGES, Oak Park, Ill.** (250m-1200kc), 5-7 p. m., basso, tenor, organ; pianist, organ, orchestra; 11-1 a. m., Coyne Serenaders orchestra; Remington Welsh, organist; Eddie Adams, the girl with the uke.

**WGN, Chicago, Ill.** (302.8m-990kc), 10-10:20 a. m., good health and training; 10:20-11, entertainment for shut-ins; 12:40-2:30 p. m., luncheon concert, Drake concert ensemble; 2:30-3, Lyon and Healy artists' series; 3:30-4:15, tea time music, Marshall Field's tea room orchestra; 5:30-5:57, Skeezix time; 6:30-7, dinner concert, Drake concert ensemble; 8-9, music hour; 9-10, popular program; 10-10:10, Sam 'n Henry; 10:10-10:20, old-time favorites; 10:20-11, dance program, featuring Drake hotel dance orchestra.

**WHAD, Milwaukee, Wis.** (275m-1090kc), 11 a. m.,

# VICE PRESIDENT TO SPEAK AT WIP



Cincinnati fans have known and loved Waldene Johnson for the past two years. She will be the soloist of the Cincinnati community program Monday at WSAI. To the right is a young comedian, who between law classes at the University of Oklahoma, entertains with Scotch jokes of one kind and another at WNAD, the college station. Meet W. H. Thompson, baritone.

## Saturday, February 6

planologue, Andy Hertel; story for children, Faye McBeath; Margaret Cunningham, pianist; Willard Kaleibe, tenor banjo soloist.

**WHAS, Louisville, Ky.** (399.8m-750ke), 1-2 p. m., Benson trio; 3-3:30, Mrs. Myrtle Fuiks Zahn, Jr., organist; 4-5, music box; Martha Pope Robinson, reader; 7:30-9, Arthur Findling, baritone.

**WIBO, Chicago, Ill.** (226m-1330ke), 10-11 a. m., shoppers' bureau; 2-4 p. m., popular program for shut-ins; 6-8, dinner concert, WIBO trio; Ruth Buhl Fliak, reader; North Shore line quartet.

**WJAZ, Chicago, Ill.** (329.5m-910ke), 9-2 a. m., Opera club dance orchestra.

**WJJD, Mooseheart, Ill.** (370.2m-820ke), 6-7 p. m., instrumental hour; Howard L. Peterson, organist; the Palmer symphonic players; Palmer House Victorians.

**WKAF, Milwaukee, Wis.** (261m-1150ke), 8:30-10 p. m., Tricie Ann Troy and her Royal Hawaiians; Hi Coleman's dance orchestra.

**WKRC, Cincinnati, Ohio** (422.3m-710ke), 10 p. m., Marion McKay and his orchestra, Jack Tilson, singer; 11, violin solos, Eugene Perazzo; 11:15, Marion McKay; 11:45, request piano program.

**WLS, Chicago, Ill.** (344.6m-870ke), 12-12:45 p. m., Junior R. F. D. roundup program; talk, "Windbreaks and Shelterbelts," Paul C. Porter; talk, "With Our Boy Trappers," Johnnie Muskrat; 7, lullaby time, Ford and Glenn; 7:20, WLS national barn dance; Cornhuskers; WLS barn dance trio, Tom Owens, caller; Ruth Etting, Ford and Glenn; 10:30-1 a. m., WLS Twin Wheeze, Ford and Glenn, and Ralph Emerson.

**WLW, Cincinnati, Ohio** (422.3m-700ke), 7 p. m., popular organ concert, Johanna Grosse; 7-9, Secretary Hawking Radio club; 8, Annual banquet and dance, Engineers' association; address, Garrett Burgers; Thomas Thurston, editor of the Nat'l. Eng.; music, Walter Esberger's orchestra; 9:30, dance program, Castle Farm.

**WMAQ, Chicago, Ill.** (447.5m-670ke), 12 noon, harmonica lesson; 6 p. m., Chicago theater organ; 6:30, Hotel La Salle orchestra; 8, Frederick Daw and Russell Pratt; 8:30, Radio photologue, Harry Hansen; 9, Chicago theater revue; 9:55, University of Chicago chimes.

**WMBB, Chicago, Ill.** (250m-1200ke), 7-8 p. m., Trianon Duo, Neva Carlson, mezzo-soprano; M. Norris, violinist; Vella Cook, contralto; semi-classical program; 9-11, Trianon orchestra, Dell Lampe, conductor; Woodlawn theater orchestra, Armin F. Hand, conductor; Jack King, Harriette Seelye, popular program.

**WMC, Memphis, Tenn.** (499.7m-600ke), 7:15 p. m., bedtime stories; 8:30, concert, Dr. George L. Powers, director.

**WOAW, Omaha, Nebr.** (526m-570ke), 7 p. m., after-dinner hour; 9, classical; 10:30, Frank Hodek and his

Nightingale orchestra; 11, Arthur Hays and his organ jubilee.

**WOC, Davenport, Iowa** (483.6m-620ke), 9-10 p. m., musical program, Mrs. John Malloy, soprano; Norine Murray, soprano; William F. Vesley, trombonist; Louis Crowder, guitarist; 11-12, Le Claire hotel orchestra, Peter MacArthur, baritone.

**WOI, Ames, Iowa** (270m-1110ke), 12:30 p. m., college chimes.

**WOK, Chicago, Ill.** (217.3m-1380ke), 4:30-7 p. m., Tearney's Town Club Willight Dansant; Capitol theater organ; Howard Will, tenor; 10-11 a. m., Tearney's Town Club orchestra; Carl Lorraine's Pershing Palace orchestra; Husk O'Hare's Coconut Grove orchestra; Capitol theater program; studio program.

**WOQ, Kansas City, Mo.** (278m-1080ke), 8-9 p. m., musical program; 10-11, musical healing service.

**WORD, Batavia, Ill.** (275m-1090ke), 8 p. m., Webster hotel program; trio; speaker.

**WQJ, Chicago, Ill.** (447.5m-670ke), 3-4 p. m., coffee klatsch; 7-8, Rainbo Gardens orchestra; Prof. Ascan W. Kittner, baritone; 10-3, Rainbo Skylarks; Rose Vanderbosch, soprano; Clarence Theders, tenor; Oxford Girls; Brundage and Kraemer; Thelma Pefferle, soprano.

**WRR, Dallas, Texas** (246m-1220ke), 12-1 p. m., "Pair of Jacks"; 6-7, Jack Gardner's orchestra; 8-9, novelty program, A. Harris and company; 12-1, George Perfect, organist; Melba theater.

**WSAI, Cincinnati, Ohio** (325.9m-920ke), 7 p. m., Freda Sanker's orchestra; 7:30, children's stories, Mrs. Ethel Knapp Behrman; 7:50, chime concert, Robert Badgley; 8, international events, Allison F. Stanley; 8:15, The Bicycle Playing Card sextet; 9, Jack Little; Ray-O-Vae Twins.

**WSB, Atlanta, Ga.** (428.3m-700ke), 8 p. m., Atlanta Atwater Kent hour; 10:45, Hired Help Skyline.

**WSM, Nashville, Tenn.** (282.8m-1060ke), 6:30 p. m., concert, Francis Craig's orchestra; 7, bedtime story interlude; 8, Uncle Jimmy Thompson and others, in barn dance program.

**WSOE, Milwaukee, Wis.** (246m-1220ke), 8:30 p. m., Sunday school lesson; 9, Lakefront studio program.

**WSUI, Iowa City, Iowa** (483.6m-620ke), 7:30 p. m., Minnesota-Iowa basketball game.

**Mountain Time Stations**

**KFWA, Ogden, Utah** (261m-1150ke), 4-5 p. m., organ recital, Paramount theater; 5-6, Ogden Radio Dealers' program; 9-10:30, music, Paramount theater; 10:30-12, Olie Reeves and his orchestra.

**KOA, Denver, Colo.** (322.4m-930ke), 12:15 p. m., Rialto theater musical; 9, dance program, Harmony Peerless orchestra; 10:30, dance program, Scheuerman's Colorado orchestra.

**Pacific Time Stations**

**KFI, Los Angeles, Calif.** (468.5m-640ke), 5:30-6 p. m., Owen Fallon's Californians; 6, Nightly doings; 6:15, KFI's Seeing California; 6:30, rest-pocket program; 6:45, Radiotorial period; 7-8, hour of Mexican music arranged by Felipe Delgado; 8-9, All-American

string quartet; 9-10, vocal pupils, Edith Lillian Clark; 10-11, Packard Radio club, featuring popular songs; 11-5 a. m., KFI midnight frolic, Don Meaney, master of ceremonies.

**KFOA, Seattle, Wash.** (454.3m-660ke), 4-5:15 p. m., afternoon at home program, The Times; today's recipe; 5:15-5:30, around the town; 9:30-11, Rhodes department store; Jackie Souder's Club Lido Serenaders.

**KFON, Long Beach, Calif.** (233m-1290ke), 6-6:30 p. m., organ, Brayton's theater; 6:30-7, KFON gossip and amusement information; 7:30-8, Long Beach Municipal band; 8-9, Press-Telegram program; 9-11, Echophone entertainers frolic.

**KFWB, Hollywood, Calif.** (252m-1190ke), 8-9 p. m., Warner Brothers' Syncopators; Eunice Wynn, soprano; Ray Kellogg, Bill Hatch, the jazz twins; Ashley sisters in vocal duets; 9-10, Frank Stever, baritone; Gertrude Redman, soprano; Le Roy Kullberg and his banjo; 10-11, Warner Brothers' frolic, direction Charlie Wellman.

**KGW, Portland, Ore.** (491.5m-610ke), 10-11:30 a. m., town crier; music; 12:30-1:30, concert, Oregon Radio Trades association; 6-7, dinner concert, Oids Wortman and King company; 9-12, dance music, Multnomah hotel; piano solos, Curt Kremer.

**KHJ, Los Angeles, Calif.** (405.2m-740ke), 6-6:30 p. m., Leighton's Arcade cafeteria orchestra, Jack Cronshaw, leader; 6:30-7:30, history story, Prof. Hertzog; Dollie Wright, David Durand, Henrietta Poland and Uncle John; 8-10, program, Motor Transit company.

**KJR, Seattle, Wash.** (384.4m-780ke), 1:30-3 p. m., organ recital, Columbia theater; 8:30-10, L. C. Warner company program, featuring artists; 10-12, Henry Halstead's Victor Recording orchestra.

**KLX, Oakland, Calif.** (508.2m-590ke), 7-7:30 p. m., news.

**KMTR, Hollywood, Calif.** (238m-1260ke), 6-7 p. m., Starr Piano company studio; 8-10, the Turner orchestra, Loren Powell, director; Neil Russell, baritone.

**KNX, Hollywood, Calif.** (356.9m-890ke), 5-5:30 p. m., Sunny Jim's talk; 5:30, First Presbyterian church organ; 5:55, Town Tattler; 6:15, travel talk, W. F. Alder; 6:30-7, Atwater Kent concert orchestra; 7, stories of insect life, H. W. McSpadden; 7:15, church announcements; 7:30-8, half-hour of musical gems; 8-9, program, Broadway Department store; 9-10, KNX feature program; 10-11, Ambassador hotel dance orchestra; 11-2 a. m., Filmland frolicers.

**KOAC, Corvallis, Ore.** (280.2m-1070ke), 7:15 p. m., University of Idaho-Oregon Agricultural college basketball game.

**KPO, San Francisco, Calif.** (428.3m-700ke), 7, 7:30, 8 a. m., daily dozen exercises, Y. M. C. A.; 10:30, "Ye Towne Cryer"; 12 noon, scripture reading; 1-2 p. m.,

Sunday, silent night for: CFAC, CHIC, CKNC, CNRA, CNRC, CNRE, CNRM, CNRO, CNRR, CNRT, CNRV, CNRW, KFAB, KFAU, KFAX, KFBU, KFMB, KFOA, KFVE, KFWA, KKAU, KMA, KMTR, KOAC, KOB, KSAC, KSO, KWSC, PWX, WABQ, WAHC, WCAD, WCX, WDAF, WEAQ, WEBJ, WEBW, WFI, WGES, WGH, WGST, WHAD, WHAS, WHAZ, WIP, WJAZ, WJJD, WKAF, WKAQ, WKAR, WNAQ, WNYC, WOI, WRC, WRVA, WSB, WTAM.

## Eastern Time Stations

**KDKA, Pittsburgh, Pa.** (309.1m-970ke), 11 a. m., services; 4 p. m., organ recital, Dr. Charles Heinrich; 4:45, vesper service, Shady-side Presbyterian church, Rev. Hugh Thomson Kerr, pastor; 6:30, dinner concert; 7:45, services.

**WBAL, Baltimore, Md.** (246m-1220ke), 6:30-7:30 p. m., twilight program; WBAL, concert orchestra, Gustav Klemm, conductor.

**WBBR, New York, N. Y.** (273m-1100ke), 10 a. m., Watchtower instrumental trio, M. Carment, C. Park, G. Twaroschik; 10:15, Sunday school lesson, S. M. Van Sipma; 10:35, Watchtower instrumental trio; 10:45, I. B. S. A. choral singers; 11, Bible lecture, "The Holy Spirit—Is It a Person?" W. L. Pelle; 11:30, I. B. S. A. choral singers; 2 p. m., Watchtower orchestra; 2:30, L. Marion Brown, soprano; 2:40, Watchtower orchestra; 3, Bible lecture, "World-wide Peace at Hand," W. L. Pelle; 3:30, L. Marion Brown, soprano; 3:40, Watchtower orchestra; 9, Watchtower string quartet; 9:15, Bible questions and answers; 10, L. Marion Brown, soprano; 10:15, Watchtower string quartet.

**WBZ, Springfield, Mass.** (333.1m-900ke), 10:55 a. m., South Congregational church services, Rev. James Gordon Gilkey, pastor; music, Prof. Wilson P. Moos, organist and choir of 24 voices; quartet, Mrs. Grace R. Donovan, soprano; Mrs. Nora Gladden Winton, contralto, William L. Spital, tenor; Albert Edwards, bass; 7 p. m., concert, Copley Plaza orchestra, W. Edward Boyle, director; assisting artist, Theresa Sprague, soprano; 8, "Canada in the Empire," Sir George E. Foster.

**WCAP, Washington, D. C.** (468.5m-640ke), 11 a. m., services, Central Presbyterian church of Washington, Rev. James H. Taylor, pastor; 4 p. m., service, Bethlehem chapel; 6:20-7:20, chamber musicale, vesper string ensemble; 7:20-9:15, Capitol theater program, WEAF; 9:15-10:15, Atwater Kent hour, Charles Hackett, tenor; Myron Jacobson, accompanist.

**WCAU, Philadelphia, Pa.** (278m-1080ke), 5 p. m., recital; 5:15, Undenominational church services; 5:25, "Appearance of Animals and Man on the Stage," Rev. John W. Stockwell; 5:35, recital; 5:45, "Nothing Hidden," Rev. John W. Stockwell; 6:45, Clarence Seaman and his Hotel Pennsylvania orchestra; 7:45, Cathy concert orchestra; 8:30, Bonwit-Teller light opera company; 9, Putash and Perimutter.

**WCX, Detroit, Mich.** (516.9m-580ke), 7:15 p. m., church service.

**WEAF, New York, N. Y.** (491.5m-610ke), 2 p. m., Sunday Radio service, Greater New York Federation of Churches, Rev. Herbert F. Latham, presiding; Mildred Bryar, contralto; Albert Miller, tenor; Arthur Billings Hunt, baritone; musical program, Mendelssohn's "Elijah"; address, Rev. Frederick W. Evans, pastor Harlem-New York Presbyterian church; 3-4, young people's conference, Marble Collegiate church; 4-5, men's conference; address, Dr. S. Parkes Cadman; music, Gloria Trumpeters; George Betts, chime soloist; Mr. and Mrs. Howard Wade Kinsey, song leader and pianist; 7:20-9:15, special musical program, Capitol theater; 9:15-10:15, Atwater Kent hour.

**WEAR, Cleveland, Ohio** (389.4m-770ke), 3:30 p. m., Goodyear concert orchestra; 7, Park theater orchestra; 7:45, Fireside hour; 8:30, Vincent Percy organ recital; 9:15, Atwater Kent hour.

**WEEL, Boston, Mass.** (348.6m-860ke), 10:50 a. m., Old South church; 2 p. m., Golden Rule hour; 3, Chamber of Commerce organ recital; 4, Y. M. C. A., WEAF; 6:20, Ecker concert group; 7:20, Major Bowes and his Capitol family; 9:15, Atwater Kent Radio hour.

**WFI, Philadelphia, Pa.** (394.5m-760ke), 10:20 a. m., services, Arch Street M. E. church; 4:30 p. m., services, Central Y. M. C. A.

**WGCP, New York, N. Y.** (252m-1190ke), 7 p. m., Dulcementans; 7:30, Milton Yokeman, tenor; Madeline Freeman, soprano; 8, Bernard Share, violinist; Bernard Retskin, pianist; studio program; 8:55, health talk; 9, Strickland's orchestra.

**WGY, Schenectady, N. Y.** (379.5m-790ke), 10:30 a. m., services, First Lutheran church, Rev. Herbert D. Shimer, pastor; 3 p. m., musical program, Syracuse, N. Y.; 5, organ recital, Dr. Frank Still Rogers, T. Roy Keefer, violinist; 7:30, service, First Lutheran church; 9, WJZ studio program; 10, Godfrey Ludlow, violinist, WJZ.

**WHAR, Atlantic City, N. J.** (275m-1090ke), 10:45 a. m., morning service, Chelsea Baptist church; 2:15 p. m., sacred recital, Seaside hotel trio; 2:45, sermon; 7:50, Chelsea Baptist church.

**WHN, New York, N. Y.** (361.2m-830ke), 11:30-12:30 p. m., Calvary morning services; 12:50, Lexington organ recital; 2-3, Queens County Christian Endeavor program; 3-4:30, Radio Bible class; 5-5:30, Roseland dance orchestra; 7:30-9:45, Calvary evening service; 10:15-10:45, Anatol Friendland; 10:45-11:15, Janssen's Hofbrau orchestra; 12-12:30, Harry Richman and his entertainers.

**WIP, Philadelphia, Pa.** (508.2m-590ke), 10:45 a. m., services, Holy Trinity church; 4 p. m., "You Americans," Ada Ward.

**WLIT, Philadelphia, Pa.** (394.5m-760ke), 2 p. m., Arcadia cafe concert orchestra, Prof. Feri Sarkoziz, director; 6:30, Benjamin Franklin hotel concert orchestra; 7, Benjamin Franklin hotel organ recital.

**WMAK, Buffalo, N. Y.** (266m-1130ke), 10:25 a. m., morning service, First Presbyterian church, Rev. Stewart M. Robinson, pastor; 7:30 p. m., evening service, Church of the Redeemer, Rev. Clinton Churchill, pastor.

**WMBF, Miami Beach, Fla.** (384.4m-780ke), 7-9 p. m., Fleetwood Radio orchestra; 10-11 a. m., Gene Fosdick and his orchestra; Fleetwood Radio orchestra.

**WMCA, New York, N. Y.** (340.7m-880ke), 11-12 noon, services, Fifth Church of Christ, Scientist; 5:30-6 p. m., Lou Gold's Woodmanster Inn orchestra; 6-7, Roemer's Homers; 7-7:30, Ernie Golden and his Hotel McAlpin orchestra; 7:30-8, Olcott Vail and his Hotel McAlpin string ensemble; 9:30-10, Donald Flamm's frolicers.

**WOO, Philadelphia, Pa.** (508.2m-590ke), 2:15 p. m., musical exercises, Bethany Sunday school; 6, organ recital, Clarence Bawden; 9:15, Atwater Kent hour of music.

**WPG, Atlantic City, N. J.** (299.8m-1000ke), 3:15 p. m., Arthur Scott Brook, organist; Mrs. Fred Plum, soprano; 4:15, St. James' Episcopal church; 9:15, Hotel Ambassador concert orchestra; 10, Arthur Scott Brook, organist.

**WREG, Lansing, Mich.** (285.5m-1050ke), 10 a. m., chimes, Betty Plymouth Congregational church; 10:30, services, First Baptist church, Rev. Ralph W. Hobbs, pastor; Mrs. Henry Chambers, organist; 7 p. m., services, Central M. E. church; Rev. Frank Kingdon, pastor; James Tillotson, organist.

**WTAG, Worcester, Mass.** (268m-1120ke), 4-5:30 p. m., men's conference; address, Dr. S. Parkes Cadman; questions answered; music, Gloria Trumpeters, George Betts, chime soloist, and Mr. and Mrs. Howard Wade Kinsey, baritone and accompanist; 7:20-9:15, musical program, Maj. Edward Bowes and Capitol family; vocal and instrumental artists; 9:15-10:15, Atwater Kent hour, WEAF.

**WTIC, Hartford, Conn.** (475.9m-630ke), 9 p. m., Weyland Echols, tenor; Fred Patton, baritone.

**WVJ, Detroit, Mich.** (352.7m-850ke), 11 a. m., St. Paul's Episcopal cathedral; 2 p. m., Detroit News orchestra; 7:20, Capitol theater family; 9:15, operatic stars.

**Central Time Stations**

**CKY, Winnipeg, Can.** (384.4m-780ke), 7 p. m., service, Knox United church; 9, studio program.



Rudy Seiger's Fairmont hotel orchestra; 2:30-3:30, Victor Lichtenstein and his violin ensemble; 3:30, Palace hotel concert orchestra, Cyrus Trobbe, director; 6:30, "Ye Towne Cryer"; 6:35-7:30, Waldemar Lind and the States Restaurant orchestra; 8-12, Fairmont hotel dance orchestra, Reg Code, director.

**KPSN, Pasadena, Calif.** (315.6m-950ke), 8-9 p. m., Star-News concert; 9-10, dance orchestra, Maryland hotel.

**KTAB, Oakland, Calif.** (240m-1250ke), 9-9:30 a. m., prayer service, Rev. E. L. Spaulding; 12-1 p. m., luncheon concert program.

## Sunday, February 7

### Headliners Today

Eastern 7 p. m.	Central 6 p. m.	Mountain 5 p. m.	Pacific 4 p. m.
WBZ (333.1m-900ke) Theresa Sprague.	8:30 7:30	6:30	5:30
WCAU (278m-1080ke) Bonwit Teller Light Opera company.	9	8	7
WTIC (475.9m-630ke) Concert.	9:15	8:15	7:15
WEAF (491.5m-610ke), WEEL, WCAP, WJAR, WGR, WCAE, WSAL, WOO, WCCO, WGN.	10	9	8
WEAR, KSD, WTAG, WVJ, Atwater Kent program, Charles Hackett, tenor.	10	9	8
WJZ (454.3m-660ke), WGY (379.5m-790ke) Godfrey Ludlow, organist.	11	10	9
KTHS (374.8m-800ke) Arkansas Traveler Train frolic.	12	11	10
KFWB (252m-1190ke) Movie frolic.	12:30 a. m.	11:30	10:30
KNX (336.9m-890ke) Calmon Luboviski, violinist.			9:30
KTHS (374.8m-800ke) Organ classic.			





# WTIC GIVES FIRST BIRTHDAY PARTY

## Tuesday, February 9

music; address, "National Characteristics of the Drama of Today"—"The Hungarian Influence," Mrs. Russell Sage; 2:30, organ recital, Stephen E. Boisclair; 3:30, dinner program, Porter E. Potts' Hotel Van Curler orchestra; 7:30, "What Is Matter Made Of?" Charles B. Hurd; 7:45, Marine band, WRC; 8:30, Edison hour, WJZ; 9:30, "Progress of Broadcast Development by General Electric Company," C. J. Young; 9:40, WGY orchestra; 10, "The Grand Tour—Southern France," WJZ; 10:30, dance program.

**WHAR, Atlantic City, N. J.** (275m-1090ke), 2 p. m., Seaside hotel trio; 7:30, talk; 8, Seaside hotel trio; 11:15, Strand theater organ recital.

**WHN, New York, N. Y.** (361.2m-830ke), 6:30 p. m., Everglades orchestra; 7, Vincent Lopez Iceland orchestra; 7:30, Will Oakland's Chateau Shanley; 11, Circo orchestra; 12:12:30 a. m., Club Kentucky orchestra.

**WIP, Philadelphia, Pa.** (508.2m-590ke), 6:45 a. m., setting-up exercises; 7, setting-up exercises; 1 p. m., menu talk, Mrs. Anna B. Scott; 2 p. m., organ recital; 3, Ada W. Craig, soprano; Ruth Rile, contralto; and artists from Myrtle C. Kaver Piano studio; 6:05, Al Lentz and his Versatile entertainers; 7, Uncle Wip's bedtime stories; songs by Helen Jefferies; 8, Elliott Lester, dramatic critic; 8:15, recital, Mary Molle, dramatic soprano; Alice M. Crossley, coloratura soprano; Augusto M. Fabrizi, flutist; 9, Kaufmann instrumental trio; 10:05, movie talk, Eli M. Orowitz; 10:30, Pagoda Cafe dance orchestra.

**WJR, Pontiac, Mich.** (516.9m-590ke), 7 p. m., Jean Goldkette's Petite symphony orchestra; 7:30, old-time dance music, Glover-Watson organization; 8, Storm-feltz-Loveley company; 9, Michigan night.

**WKAR, Lansing, Mich.** (285.5m-1050ke), 7:15-8 p. m., veterinary, poultry and animal husbandry courses.

**WLIT, Philadelphia, Pa.** (394.5m-780ke), 11 a. m., organ recital; 12:02 p. m., daily almanac; Stanley theater organ recital; Arcadia cafe concert orchestra; 2, Arcadia cafe concert orchestra; 4:30, Household Helps and Hints, Richard S. Bond; 7:30, Dream Daddy's bedtime stories; 7:50, play review, Allyn C. Sauer.

**WMAK, Buffalo, N. Y.** (266m-1130ke), 6:15-7:15 p. m., dinner music, Hotel Lafayette orchestra; 7:15, daily news.

**WMBF, Miami Beach, Fla.** (384.4m-780ke), 7-9 p. m., Fleetwood Radio orchestra; 10-11 a. m., Gene Fosdick and his orchestra; Fleetwood Radio orchestra.

**WMCA, New York, N. Y.** (340.7m-580ke), 11-12 noon, Ida Bailey Allen's Homemakers' hour; 12:15-12:30 p. m., American School association talk on private schools; 12:30-1, beauty talk, Lucille Buhl; 6-6:30, Olcott Vail and his Hotel McAlpin string ensemble; 6:30-7, Club Caprice orchestra; 7:45, Hugo Zeller, "Laquer and Laquer Finishing"; 7:45-8, Tyrrell's health talk; 8-8:15, Pace institute program; 8:15-9:15, Landy hour; 9:15-9:45, Palmer pen lesson; 9:45-10:30, "How to Drive Automobiles," Harry Raines; 11-12, Ernie Golden and his Hotel McAlpin orchestra.

**WNYC, New York, N. Y.** (526m-570ke), 7 p. m., the Canadians; 8, violin recital; 9, male quartet; 9:30, dance quartet.

**WOD, Philadelphia, Pa.** (508.2m-590ke), 11 a. m., organ recital; 12:02 p. m., Golden's crystal tea room orchestra; 4:45, organ recital; 7:30, A. Candelieri's Hotel Adelphia orchestra.

**WPG, Atlantic City, N. J.** (299.8m-1000ke), 6:45 p. m., Arthur Scott Brook, organist; 7, Hotel Morton dinner music; 8, Ethel Rattay Fowler's fashion fashies; 8:15, Cedie Steiner, violinist; Margaret Irwin, pianist; Louise K. Richards, soprano; 9, Chalfonte-Haddon hall dual trio; 10, studio program; 10:30, Karl Bonawitz, pianist; 11, Silver Slipper supper club.

**WRO, Washington, D. C.** (468.5m-640ke), 12 m., George P. Ross, organist; 1 p. m., Hotel Washington orchestra; 6, Hotel Hamilton orchestra; 7, "Show Shopping," Leonard Hall; 7:10, Radio school of international relations; 7:30, U. S. Marine band orchestra, WJZ, WGY; 8:30, New York Edison hour, WJZ, WGY; 9:30, to be announced; 10:30, W. Spencer Tupman and his Mayflower orchestra; 11:30, Gertrude Smallwood, organist; 12, Meyer Davis' Le Paradis band.

**WREO, Lansing, Mich.** (285.5m-1050ke), 6-7 p. m., dinner concert; Speed-Wagon serenaders; Gold Standard ensemble; 8:15, Reo Motor Car company band, Carl Hall Dewey, conductor; Reo Motor Car company band glee club, Fred Killeen, director; vocal and instrumental solos; Beulah Clark Northrop, pianist.

**WTAG, Worcester, Mass.** (288m-1120ke), 10:30 a. m., musical selections; 12:05-2 p. m., noon-day luncheon music; WTAG, Will Hayes, director; 5:15, Twinkle Twinkle story teller; 7:45, Prof. G. H. MacCullough; 9-10, Eveready hour, WEAF; 10-10:30, moment musicale, WEAF; 10:30-11, Vincent Lopez and his orchestra.

**WTAM, Cleveland, Ohio** (389.4m-770ke), 12:15-1 p. m., lunch hour, Guy Lombardo and his Royal Canadians; 6-7, Carl Rupp and his Hotel Hollenden orchestra.

**WWJ, Detroit, Mich.** (352.7m-850ke), 12:05 p. m., Jules Klein's Hotel Statler orchestra; 3, Detroit News orchestra; 6, dinner concert; 8, concert, WEAF.

### Central Time Stations

**KFAB, Lincoln, Neb.** (340.7-890ke), 8:05-10:30 p. m., Univ. of Nebraska program.

**KFKU, Lawrence, Kan.** (275m-1090ke), 7:30 p. m., Kansas Univ.-Drake basketball game.

**KFMQ, Fayetteville, Ark.** (299.8m-1000ke), 8 p. m., choir of First Presbyterian church.

**KFNC, Northfield, Minn.** (336m-890ke), 9:30 p. m., "Moroco," Prof. Keith Clark.

**KNF, Shenandoah, Iowa** (263m-1140ke), 7 p. m., concert, Retail Merchants, Shirley Leavitt, director.

**KFRU, Columbia, Mo.** (499.7m-600ke), 8:45 a. m., convocation program; music, students of Stephens Conservatory of Music; 9, educational talk; 4:30-5:30 p. m., Bella Vista Quadrangle orchestra; 6:15, dinner music; 6:45, children's hour; 7, Radio school; talk, E. A. Trowbridge.

**KFUO, St. Louis, Mo.** (545.1m-550ke), 8 p. m., "The Young People and Their Money," Rev. Herman H. Hohenstein.

**KLDS, Independence, Mo.** (440.9m-680ke), 6:30 a. m., morning, devotional service, 8 p. m., "Problems of Society," Prof. M. A. Eitzenhauser; 8:15, program; Thelma Steele, pianist; Mrs. Blanche King Park, soprano; Virginia Drane, violinist; Mary Lindfoot Drane, violinist; Mrs. Edna Thompson, contralto; Margaret Logan, accompanist; 11:59, weekly midnight program; organ requests, Herbert Johnson.

**KMA, Shenandoah, Iowa** (252m-1190ke), 6-7 p. m., May Flower trio; May's Flower lady; 9-11, May's mandolin musicians.

**KOIL, Council Bluffs, Iowa** (278m-1080ke), 6:15 p. m., Dorothy Hurd, pianist; 6:30, Fontenelle orchestra; 7:15, Izaak Walton league; 7:30, Rainbow Post No. 2; 11, Nautical dance orchestra.

**KPRC, Houston, Tex.** (296.9m-1010ke), 7:30 p. m., Billie Mae's dance orchestra; 8:30, Ruth Burr, pianist; 9, bridge.

**KSAC, Manhattan, Kans.** (340.7m-880ke), 9-9:25 a. m., music, inspirational talks, agricultural primer, calisthenics; 9:35-10:25, readings, backyard gossip, question box; planning today's meals; 12:35-1:05 p. m., readings, question box; 4:30-5, program for women's clubs; 6:30-7:30, better speech; etiquette; Extension Credit course, Economics.

**KSD, St. Louis, Mo.** (545.1m-550ke), 6:55 p. m., WEAF chain.

**KSO, Clarinda, Iowa** (242m-1240ke), 12:30-1:15 p. m., concert; music; garden club; Sunday school lesson; dinner concert; 7-8, music; 8-9:30, Berry Radio orchestra, J. D. Palmer, director.

**KTHS, Hot Springs National Park, Ark.** (374.8m-800ke), 9-9:30 p. m., Eastman hotel orchestra; 9:30-10, Meyer Davis' 10-piece orchestra; 10-11, Hot Springs Kiwanis club.

**KYW, Chicago, Ill.** (536m-560ke), 11:35 a. m., table talk, Mrs. Anna J. Peterson; 12:05 p. m., Joska De-

Barbery's orchestra; 4, afternoon frolic; 6-7, dinner music, KDRA; 7:05, bedtime story, Uncle Bob; 7:35, speeches, American Farm Bureau federation; address, A. D. White; Walter B. Remley; 8, musical program, Edwin Borroff, director; 9, hour of music; 10, evening at home, Coon-Sanders' orchestra.

**WAFO, Port Huron, Mich.** (275m-1090ke), 10-11:30 a. m., Ironing club.

**WAMD, Minneapolis, Minn.** (244m-1230ke), 12 m., organ recital, Jack Malerick; 12:55 p. m., news bulletins.

**WBBM, Chicago, Ill.** (226m-1330ke), 4-6 p. m., Valentine Inn orchestra; artists; 8-9, Moulin Rouge orchestra; Phil Fleming, tenor; Jean St. Anne, French baritone; 9, Ziegler sisters; Jeanine St. Anne orchestra; Claire Matthews, artists.

**WBCN, Chicago, Ill.** (266m-1130ke), 10-10:30 a. m., Penny Wise, the shopper's ready helper; 7-8, Ballantine Electric company classical hour; Robert Sansome, cellist; Gordon A. Nelson, tenor; Ann Kelley, soprano; Pearl Fairchild, pianist.

**WCBD, Zion, Ill.** (344.6m-870ke), 8 p. m., mixed quartet; Hire string quartet; assisted by Emma Reynolds, soprano; William Dunn, euphonium; Paul Stewart,

**WHAS, Louisville, Ky.** (399.8m-750ke), 12-1 p. m., Trinity Methodist church; 1-2, Benson trio; 3-3:30, Mrs. Myrtle Fuks Zahn, Jr., organist; 4-5, editorials; 7:30-9, Eddie Rosson and his orchestra.

**WHIO, Des Moines, Iowa** (526m-570ke), 7:30-8 p. m., Raleigh quintet, Savory hotel; 8-9, Bankers Life trio, Helen Birmingham, director; 11-12, Bankers Life Little Symphonic orchestra; Leon A. Dashoff, director.

**WHT, Chicago, Ill.** (399.8m-750ke), 6 p. m., Al Carney, organist; Grayling's string trio; Loftis half-hour of music; 7:45-9:15 (238), Alamo and Chez Pierre orchestras; 9:35 (399.8), Kitchen Klenser entertainers; 9:50, Howard Serhson, tenor; Al Carney, organist; 10:10, U. S. L. half-hour of dance music; 12, Pat Barnes, Al Carney.

**WIBO, Chicago, Ill.** (226m-1330ke), 10-11 a. m., shoppers' bureau; 2-4 p. m., program for shut-ins; 6-8, dinner concert, popular American ballads, Walter Preston; WIBO trio; Bernice Taylor, soprano; Ruth Buhl Flike, reader; 12-2 a. m., midnight jamboree.

**WID, Mooseheart, Ill.** (370.2m-820ke), 4-5 p. m., Mooseheart hour, music, younger Mooseheart children; daily assembly of 1,250 children; faculty talks; 6-7,

**WMAZ, Macon, Ga.** (261m-1150ke), 8-9 p. m., religious services.

**WMBB, Chicago, Ill.** (250m-1200ke), 7-8 p. m., Trianon duo; Genevieve Barry Burnham, operatic soprano; Eleanor Kaplan, violinist; Preston Graves, concert pianist, semi-classical operatic program; 9-11, Trianon orchestra, Dell Lampe, conductor; Woodlawn theater orchestra, Armin F. Hand, conductor; Matts and Donovan, Axel Christensen, popular program.

**WMC, Memphis, Tenn.** (499.7m-600ke), 7:15 p. m., bedtime stories; 8:30, Hofstad Bible class quartet; 9, auction bridge; 11, Britling cafeteria orchestra.

**WOAI, San Antonio, Tex.** (394.5m-780ke), 8:30 p. m., Gebhardt musicians.

**WOAN, Lawrenceburg, Tenn.** (282.8m-1060ke), 9-9:30 p. m., Walter B. Seale and orchestra; 9:30-10, quartet and orchestra.

**WOAW, Omaha, Neb.** (526m-570ke), 6 p. m., entertainment; 6:50, orchestra; 9, classical; 10:10, Radio review, Neal Jones; 10:30, Herb Felerman and his Omadala orchestra; 12, Rialto alarm.

**WOC, Davenport, Iowa** (483.6m-620ke), 5:45-6 p. m., chimes; 6:30-6:50, Sandman; 7:30-8, Gold Dust Twins; 8-9, Eveready hour; 9-10, travel talk; 10-11, Heuer's Whizz Bang orchestra.

**WOL, Ames, Iowa** (270m-1110ke), 12:30 p. m., college chimes; 7:15, basketball game, Grinnell vs. Ames.

**WOK, Chicago, Ill.** (217.3m-1380ke), 4:30-7 p. m., Tearney's Town Club Twilight Dancers; Capitol theater organ; Pat Hoster, tenor; 10-1:30, Tearney's Town club orchestra; Carl Lorraine's Pershing Palace orchestra; Husk O'Hare's Coccanut Grove orchestra; Capitol theater program; studio program.

**WOQ, Kansas City, Mo.** (278m-1080ke), 8-9 p. m., devotional musical program.

**WORD, Batavia, Ill.** (275m-1090ke), 7 p. m., Public Service Company of Illinois; 7:45, Bible questions and answers; 9, program, W. A. Sheehy, Pen company; 9:45, good reading; 11, Public Service company; 11:45, address, Ernest G. Wylam.

**WQJ, Chicago, Ill.** (447.5m-670ke), 7-8 p. m., Rainbo Gardens orchestra; Puntella girls; 10-11 a. m., Rainbo Skylarks; Gertrude Wolf Quentini, soprano; Jerry Sullivan; Rose Vandenberg, soprano; Merrill Carder, baritone; Ila Shannabrook, soprano; Mary Wade, soprano; Romo Vincent, boy baritone; 1-2, Ginger hour.

**WRR, Dallas, Tex.** (246m-1220ke), 6-7 p. m., Jack Gardner's orchestra; 8-9, program, Montgomery.

**WSAI, Cincinnati, Ohio** (325.9m-920ke), 5:30 p. m., twilight musicale; 6:30, musical program; 7, Mabley and Carey orchestra; Ruben Lawson, director; 8, Eveready hour, WEAF; 9-9:30, auction bridge; 9:30-10, musical program, featuring Hawaiian music; 12, Freda Sanker's orchestra.

**WSB, Atlanta, Ga.** (428.3m-700ke), 8 p. m., concert; 10:40, concert.

**WSM, Nashville, Tenn.** (282.8m-1060ke), 10 p. m., frolic, Beasley Smith's orchestra.

**WSUI, Iowa City, Iowa** (483.6m-620ke), 12:30 p. m., Mrs. Geraldine Mars Ristine; address.

### Mountain Time Stations

**CFAC, Calgary, Can.** (435.8m-688ke), 8 p. m., recital, Jean Gilbert.

**CNRR, Regina, Can.** (476m-640ke), 8 p. m., bedtime story, Aunt Jenny; vocal and instrumental numbers, Mr. and Mrs. Edward Franklin, Vera Geddes.

**KFWA, Ogden, Utah** (261m-1150ke), 4-5 p. m., organ recital, Paramount theater; 5-6, Ogden Radio Dealers' program.

**KFXF, Colorado Springs, Colo.** (250m-1200ke), 8:30-10 p. m., Freeman Dust Absorber musical program.

**KOA, Denver, Colo.** (322.4m-890ke), 12:15 p. m., Rialto theater musicale; 8:15, relaxing and corrective exercises; 6:30, dinner concert, Brown Palace string orchestra, Howard Tillotson, director.

### Pacific Time Stations

**KFI, Los Angeles, Calif.** (468.5m-640ke), 5:30-6 p. m., Norman Harvey's orchestra; 6, nightly doings; 8:15, KFI's Seeing California; 6:30, vest pocket program; 6:45, Radiotrial period; 7-8, program arranged by Clarabelle Patten Wallace; 8-9, Al Wesson and his dance orchestra; 9-10, Louise Kios string trio; Virginia Flohri, lyric soprano; 10-11, Packard ballad hour with usual favorites in popular song numbers.

**KFOA, Seattle, Wash.** (454.3m-660ke), 6:45-8:15 p. m., Hooper-Kelly company; 8:30-10, Times studio program; 10-11, orchestra.

**KFON, Long Beach, Calif.** (233m-1290ke), 6-6:45 p. m., organ, Bratton's theater; 6:45, amusement information; 7-8, investors' hour; 8-9, program, William Conrad Mills; 9-11, Long Beach Aero club hi-jinks.

**KFWB, Hollywood, Calif.** (252m-1190ke), 5-5:30 p. m., children's hour, Big Brother of KFWB; 7:30, health talk, Dr. W. I. Schuster; 8-9, Hazel Thomas, soprano; Jack Smith's dance orchestra; Blanche Kamliner, pianologues; 9-10, Joe Martin's California serenaders; Bill and Tom Moseley, banjo duets; Henry Kaplan, pianist; Bill Blake, tenor; 10-11, Warner Brothers' frolic, direction Charlie Wellman.

**KGO, Oakland, Calif.** (361.2m-830ke), 4-5:30 p. m., concert orchestra, Hotel St. Francis; 6:45-6:55, twilight concert; 8-9, Eveready hour, Metropolitan male singers; Carolyn Cone Baldwin; James Gerard, tenor; Albert Gillette, bass; Jeannette Shearer, clarinetist; 9-9:30, Y. M. C. A. concert orchestra; Alice Emma Hansen, soprano; 9:30, bridge; 10-12, Girvin-Deuel's California Collegians.

**KGW, Portland, Ore.** (491.5m-610ke), 10-11:30 a. m., town crier; music; 12:30-1:30 p. m., concert, Oregon Radio Trades association; 6-7, dinner concert, Olds, Workman and King company; 7:45-8, talk, courtesy Union Savings and Loan association; 8-10, educational program; book review, courtesy J. K. Gill company; auction bridge lesson; health talk; music, McElroy quartet; 10-12, dance music, Multnomah hotel; intermission piano solos, Cur Kramer.

**KHJ, Los Angeles, Calif.** (465.2m-740ke), 6-6:30 p. m., Leighton's Arcade cafeteria orchestra; Jack Cronshaw, leader; 6:30-7:30, history story, Prof. Hertzok; weekly visit of Queen Titania and the Radio Fairies; Lenore Killian, contralto; Charles Leslie Hill, readings; 7:30, talk on dogs, H. M. Robertson; 8-10, program, Frank Meline company, Collegiate night.

**KMTR, Hollywood, Calif.** (238m-1260ke), 5-6 p. m., home hour, Mammy Simmons with Boy Scouts and Campfire Girls; 6-7, Starr Piano company studio; 7, talks about diamonds, E. P. Barclay; 8-10, the Turner orchestra, direction Loren Powell.

**KNX, Hollywood, Calif.** (336.9m-890ke), 5-5:30 p. m., Sunny Jim's talk; 5:50, First Presbyterian church; 5:55 town tatter; 6:15, travel talk, W. W. Alder; 6:30-7, Atwater Kent concert orchestra; 7-7:45, studio program; 7:45-8, health talk, Dr. Robert F. Williams; 8-9, program, Globe Ice Cream and Weber Quailty Bread companies; 9-10, program, Western Auto Supply company; Optimist male quartet; 10-11, Ambassador hotel dance orchestra.

**KPO, San Francisco, Calif.** (428.3m-700ke), 7, 7:30, 8 a. m., daily dozen exercises; 10, domestic science talk, Virginia Tappan; 1-2 p. m., Rudy Seiger's Fairmont hotel orchestra; 2:30-3:30, matinee program; 3:30-4:30, Cyrus Frobb's Palace hotel concert orchestra; 5:15-6:15, children's hour stories, "Big Brother"; 6:40, Waldemar Lind and the States restaurant orchestra; 7-7:30, Rudy Seiger's Fairmont hotel orchestra; 8-9, Elks glee club, Maynard Jones, director; 9-10, Mona Motor Oil trio; GYDSY and Marta, harmony team; 10-11, Palace hotel dance orchestra, Gene James, director.

**KPSN, Pasadena, Calif.** (315.6m-950ke), 8-9:30 p. m., varied instrumental and vocal program.

**KTAB, Oakland, Calif.** (240m-1250ke), 9-9:30 a. m., prayer service, Rev. G. W. Phillips; 9:30-9:40, "Proper Care of Household Pets," Ansel W. Robinson; 12-1 p. m., luncheon concert; 8-10, studio program.

## Index to Classical Concerts

Saturday, February 6			
Eastern	Central	Mountain	Pacific
6 p. m.	5 p. m.	4 p. m.	3 p. m.
WVX, WFAE, WMCA, WREO.			
7	6	5	4
KGO, KYW, WEAR, WENR, WMAQ, WNYC.			
8	7	6	5
WOAW, WOK, WRC.			
9	8	7	6
KDKA, KFNP, KOIL, KSD, KYW, WBBR.			
10	9	8	7
WGN, WMBB, WNYC, WOAW, WQJ.			
11	10	9	8
KFOA, KPRC, KHJ, KYW, WHAS, WIP.			
12	11	10	9
WLW, WORD, WSAI, WSOE.			
1	2	1	0
KNX, KYW, WEAF, WMAQ, WMC, WOAW.			
2	1	0	0
WOC, WORD.			
3	2	1	0
KGO, KMA, KPO, KTHS, WCAE, WLS.			
4	3	2	1
WLW, WOC, WSAI.			
5	4	3	2
KGW, KPO, KTHS, WCAE, WLS.			
6	5	4	3
WLW, WOC, WSAI.			
7	6	5	4
KGW, KPO, KTHS, WCAE, WLS.			
8	7	6	5
WLW, WOC, WSAI.			
9	8	7	6
KGW, KPO, KTHS, WCAE, WLS.			
10	9	8	7
WLW, WOC, WSAI.			
11	10	9	8
KGW, KPO, KTHS, WCAE, WLS.			
12	11	10	9
WLW, WOC, WSAI.			
1	0	0	0
KGW, KPO, KTHS, WCAE, WLS.			
2	1	0	0
WLW, WOC, WSAI.			
3	2	1	0
KGW, KPO, KTHS, WCAE, WLS.			
4	3	2	1
WLW, WOC, WSAI.			
5	4	3	2
KGW, KPO, KTHS, WCAE, WLS.			
6	5	4	3
WLW, WOC, WSAI.			
7	6	5	4
KGW, KPO, KTHS, WCAE, WLS.			
8	7	6	5
WLW, WOC, WSAI.			
9	8	7	6
KGW, KPO, KTHS, WCAE, WLS.			
10	9	8	7
WLW, WOC, WSAI.			
11	10	9	8
KGW, KPO, KTHS, WCAE, WLS.			

# CHOPIN PROGRAM THURSDAY AT WGY

## Wednesday, February 10

### Headliners Today

Eastern	Central	Mountain	Pacific
8 p. m.	7 p. m.	6 p. m.	5 p. m.
WEEB (273m-1100kc) Bronx night	8:05	7:05	5:05
WGY (379.5m-790kc) Opera presentation	8:30	7:30	5:30
KDKA (309.1m-970kc) Wall Paper Pierrots	9	8	6
WTIC (475.9m-630kc) Gala First Anniversary program	9	8	6
WKRC (422.3m-710kc) Everfresh hour	9:15	8:15	6:15
WBZ (333.1m-900kc) Concert series	10:15	9:15	7:15
KOA (322.4m-830kc) Hawaiian folk songs	11	9	8
KFI (468.5m-640kc) Ventura string quartet			

Wednesday, silent night for: CHIC, CKNC, CNRA, CNRC, CNRE, CNRW, CNRR, CNRT, CNRV, KFAU, KFDK, KFEE, KFKU, KFMQ, KFXF, KGO, KLDS, KOB, KTA, WABQ, WBAE, WBBR, WCAD, WCBW, WEA, WFAA, WGBS, WGPC, WGST, WHAR, WHAZ, WIP, WJAZ, WJAZ, WLWL, WMC, WOAI, WOAW, WOI, WPG, WRC, WREO.

### Eastern Time Stations

**CNRO, Ottawa, Can.** (434.5m-690kc), 7 p. m., children's half hour; 8, Chateau Laurier concert orchestra; 8:45, Madame Maud Pouget, soprano; Gladys Ewart, pianist; James McIntyre, violinist; Helen Langdon, cellist; Chateau Laurier dance orchestra.

**KDKA, Pittsburgh, Pa.** (309.1m-970kc), 7:15, 8 a. m., exercises; 8, Shannon; 5:45, Postman Dan; 8:15, "Chemistry and Human Progress—Speeding Up That Process," Dr. Carl J. Engelder; 8:30, Wall Paper Pierrots; 9, concert, First Presbyterian church quartet.

**WAHG, Richmond Hill, N. Y.** (315.6m-950kc), 12:03 p. m., Eida Treulich, pianist; 7:30, studio features; 8, special program, "Olds Folks at Home," Michael Lamberti, James Sayell, Jean McGregor, Jerva Bliz, James McKinley Rose, Maury Price, Boone, Madeline Hulsizer; Sterling male quartet; Jean Davison, Branfield trio and others; 10:03, special program; 10:15-11:30, special program, "Young Folks Abroad," Frank Lapeire's Collegians, "Mickey," Walter Looss, artists.

**WBZ, Springfield, Mass.** (333.1m-900kc), 6:30 p. m., Little Symphony orchestra, KDKA; 6:45, Hotel Kimball orchestra, Bob Patterson, director; 8, concert, Crook's band; 9, "Browning's Philosophy," D. M. Staley; 9:15, concert, Gibbs Piano company, presenting Springfield string ensemble; Lloyd Stoneman, pianist; Milton Aronson, violinist; Arnold Janser, cellist.

**WCAP, Washington, D. C.** (468.5m-640kc), 6:45-7:45 a. m., health exercises; 6:45-12 p. m., "Facts About the Capital," Charles W. Darr; "Matters Before the House"; concert, U. S. Army band, Capt. William Stannard, leader; Davis saxophone sextet, WEA; Ipana Troubadours, WEA; Roxy and his gang, WEA; dance music.

**WCAU, Philadelphia, Pa.** (278m-1080kc), 6:45 p. m., Parodians dance orchestra; 7:30, recital, M. Snellensburg and company; 8, "Tuberculosis Can Be Cured," talk by Dr. Ward Brinton; 8:10, Let Kane's Musical Adventures; 9, Rigo's Royal Gypsy band; 9:30, Jones' Jolly Four; 10, Lew Chapman's Inter Fraternity orchestra; 10:45, Frank Cook, songs of yesterday; 11, Artie Blittong's Cheer-Up clubs.

**WCX, Detroit, Mich.** (516.9m-580kc), 6-7 p. m., Goldkette ensemble; 8-9, studio program.

**WEAF, New York, N. Y.** (491.5m-610kc), 6:45-7, 7:20 a. m., tower health exercises; 10:45-12 noon, health talk; 4-5 p. m., Ray Nichols' recording orchestra; Henretta Mayer, soprano; children's hour, Annie Carroll Moore, story teller; 6-12, dinner music, United States army band; synagogue services; concert, Ipana Troubadours; Davis saxophone octet; Hughie Barrett and his Hotel Commodore orchestra.

**WEAO, Columbus, Ohio.** (293.9m-1020kc), 1:15 p. m., VFAO string quartet; 4:10, story hour, Prof. Sada Harburger; 8, "The Attention and Interest—How Controlled," Hayes Yeager; 8:15, Ach Bar Grotto chorus; Harry Apple, director; 8:30, "Investments," Prof. Milton Nelson; 8:45, Ach Bar Grotto chorus.

**WEAR, Cleveland, Ohio** (389.5m-770kc), 7 p. m., Hotel Cleveland orchestra.

**WEEB, New York, N. Y.** (272.6m-1100kc), 8-10 p. m., Bronx night, special program, Civic organizations.

**WEEI, Boston, Mass.** (348.6m-860kc), 6:30 p. m., Joe Rines and his Hunters' Cabin orchestra; 7:30, musicale; 8, musical skit; 8:30, Davis saxophone octet; 9, Ipana Troubadours; 10, Roxy and his gang.

**WFI, Philadelphia, Pa.** (394.5m-760kc), 1 p. m., tea room ensemble; 3, Josh Sandler's dance orchestra; 6:30, Bellevue Stratford concert orchestra; 7, Bellevue Stratford dance orchestra.

**WGBS, New York, N. Y.** (315.6m-950kc), 1:30 p. m., Evelyn Laska, songs; Hanson and Howard; 3, special program, Blind Girls; 6:30, Jersey Collegians.

**WGPC, New York, N. Y.** (252m-1190kc), 3 p. m., Lillian Rubin, pianist; 3:20, Bobby Grey, songs; 3:45, J. Vincent Moore, tenor; 4:15, Haines Good News party; 4:30, Jeanne D'Arce, soprano; 4:45, Frasey and Mohr; 7, orchestra; 7:30, Kennedy concert orchestra; 8, Tobias Brothers; 8:15, Charol de Thome, pianist.

**WGY, Schenectady, N. Y.** (379.5m-790kc), 6:30 p. m., program for children; 7, dinner program, Eastman theater orchestra; 7:30, "Book of Knowledge," program; 8:05, opera presentation, Rochester American Opera company.

**WHN, New York, N. Y.** (361.2m-830kc), 7 p. m., Parody club orchestra; 7:30, Akadyne entertainers; 10, Roseland dance orchestra; 10:30, Anatol Friendland; 11, Silver Slipper orchestra; 11:30, Ben Brown and Sidney Claire; 12, Cotton Club orchestra; 12:30, Harry Richman and his entertainers.

**WIP, Philadelphia, Pa.** (508.2m-590kc), 6:45 a. m., setting-up exercises; 7, setting-up exercises; 10:30, reducing exercises; 1 p. m., Gimbel tea room orchestra; 3, "Has Physics Anything to Say About Religion," talk by Dr. J. G. Rodgers; 3:15, recital, students Ada Turner Kurtz studio; 6:05, Benjamin Franklin concert orchestra; 7, Uncle Wip bedtime stories.

**WJR, Pontiac, Mich.** (516.9m-590kc), 7 p. m., Jean Goldkette's Petite symphony orchestra; 7:45, Good Will Oakland, harmonic balancer; 9, Radio hour, Haven Villa corporation; 11:30, Jewett Radio Jesters.

**WKAA, San Juan, P. R.** (340.7m-880kc), 6-8 p. m., municipal band.

**WKAR, Lansing, Mich.** (285.5m-1050kc), 7:15-8 p. m., horticultural course.

**WLIT, Philadelphia, Pa.** (394.5m-760kc), 12:02 p. m., daily almanac; Stanley theater organ recital; sermon, auspices Philadelphia Federation of Churches; Arcadia cafe concert orchestra; 2, Arcadia cafe concert orchestra; 4:30, recital; 7:30, Dream Daddy's bedtime stories; 9, P. H. B. band and orchestra; 10, Arcadia cafe concert orchestra; 10:30, El Patio dance orchestra.

**WLV, New York, N. Y.** (288.3m-1040kc), 9 p. m., "Accountancy," K. of C.; 9:15, entertainment; 9:45, McEvoy concert; 10:15, talk; 10:30, string music.

**WMAK, Buffalo, N. Y.** (266m-1130kc), 7:15 p. m., daily news; 7:30-8, song recital, Helen Minchen; 8-9, musical, Clef string trio; 9-10, dance program, Clark Light orchestra, Ray Jersey, director.

**WMBF, Miami Beach, Fla.** (384.4m-780kc), 7-9 p. m., Fleetwood Radio orchestra; 10-11 a. m., Gene Posdick and his orchestra; Fleetwood Radio orchestra.

**WMCA, New York, N. Y.** (349.7m-880kc), 6:30 p. m., Olcott Yal chant; his Hotel McAlpin string ensemble; 6:30-7:30, Ernie Golden and his Hotel McAlpin orchestra; 7:30-8:20, Prof. Curtina's Spanish lesson;

8:20-9, talk on "Securities"; 11-11:30, Hofbrau Haus entertainers; 11:30-12, Jack Denny and his Frivolity orchestra.

**WNYC, New York, N. Y.** (526m-570kc), 6:20 p. m., piano selections; 6:30, Spanish lesson; 7:35, Bernardas New York Six; 8:30, recital; 9:30, instrumental trio; 10:10, Board of Education lecture.

**WOO, Philadelphia, Pa.** (508.2m-590kc), 11 a. m., organ recital; 12:02 p. m., Golden's Crystal tea room orchestra; 7:30, Hotel Sylvania dance orchestra; 8, U. S. Army band; 8:30, Davis Saxophone octet; 9, WOO American male quartet; 9:25, address, Rev. Forest Dager; 10, Fox theater studio program; 10:30, Hotel Sylvania orchestra.

**WRC, Washington, D. C.** (468.5m-640kc), 12 noon, Gertrude Smallwood, organist; 1, Lee House trio; 4:15, Meyer Davis' Le Paradis band; 5, musical program.

**WREO, Lansing, Mich.** (285.5m-1050kc), 6-7 p. m., dinner concert, Speed-Wagon Screamers; Gold Standard ensemble.

**WRVA, Richmond, Va.** (256m-1170kc), 8:10 p. m., one-act play, Little Theater league; 8:50, instrumental program; 9:30, prologue opera, "Tannhauser," Elmer G. Hoelzle, director; 10:30, instrumental program; 11, "Carry Me Back to Old Virginia."

**KSO, Clarinda, Iowa** (242m-1240kc), 12:30-1:15 p. m., concert, music; garden club; Sunday school lesson; dinner concert; 7-7:30, music; 7:30-9, schools, Prescott, Iowa.

**KTHS, Hot Springs National Park, Ark.** (374.8m-800kc), 9-9:30 p. m., Meyer Davis' artists; 9:30-9:45, Eastman hotel orchestra; 9:45-10, Lawson Reid, organist; 10-10:45, Southern's Majestic hotel orchestra.

**KYW, Chicago, Ill.** (536m-560kc), 11:35 a. m., table talk, Mrs. Anna J. Peterson; 12 m., Commonwealth talk, Mrs. Joska De Babary and his orchestra; Edison company; 1 p. m., Joska De Babary and his orchestra; Coon-Sanders orchestra; 6-7, dinner music, Uncle RDKA, WBZ, KYW, KFKX; 7, bedtime story, Uncle Bob; 7:05, bedtime music; Uncle Bob; 7:30 half hour of music; 8, Congress hotel musicale; 10-12:30 a. m., midnight revue; Paul Ash and his orchestra; Coon-Sanders' orchestra; 1, Insomnia club.

**WAFD, Port Huron, Mich.** (275m-1090kc), 8-10 p. m., studio program; 1-2 a. m., studio program.

**WAMD, Minneapolis, Minn.** (244m-1230kc), 12 m., classical program, Hazel West, soprano; Beatrice Wilson, accompanist; Beata Hanson, violinist; Mrs. Hanson, accompanist; Oscar Bellman, pianist; 7:05 p. m., talk, "What Prominent Outsiders Think of Minneapolis and the Great Northeast"; 7:10, classical program, W. E. Peterson, baritone; Margaret Arnold,

ist; Harry Lewis, popular songs; artists, Capitol theater; 9-12, dance program.

**WHT, Chicago, Ill.** (399.8m-750kc), 6-7:30 p. m., Jean Carlson, Peter Porstner, Howard Will, Grayling's string trio; 7:45-9:15, Alamo orchestra; 9:30 (399.8), Borden request organ recital; Ray-O-Vac hour; 11:15, Chez Pierre orchestra; 11:30, Pat Barnes; 12, Your Hour league with presidents.

**WIBO, Chicago, Ill.** (226m-1330kc), 10-11 a. m., shoppers' bureau, Grace Viell Gray; 2-4 p. m., popular program for shut-ins; 6-8, dinner concert, Walter Preston; WIBO trio; Florence Osterman, contralto; Christopher Hendra, tenor; Hicky and Johnson, Marie Wright.

**WJAZ, Chicago, Ill.** (329.5m-910kc), 9-2 a. m., Opera club dance orchestra.

**WJJD, Mooseheart, Ill.** (370.2m-820kc), 4-5 p. m., Mooseheart hour; music by younger children; daily assembly of 1,256 children; faculty talks; 6-7, instrumental hour, Howard L. Peterson, playing Geneva organ; Palmer symphonic players; Palmer House Victorians; 8-9, Mooseheart children's hour, Mooseheart concert band; solos, talk, Matthew P. Adams; 10-11, Senator Harold Kessinger; Jean St. Anne; 12:30-1:30 a. m., setting-up hour, Howard L. Peterson playing Geneva organ; Palmer House Victorians.

**WKAF, Milwaukee, Wis.** (261m-1150kc), 10-11 p. m., Campus Skylarks; Michael Swedish, baritone; Spencer Reuter, tenor.

**WKRC, Cincinnati, Ohio** (422.3m-710kc), 6 p. m., dinner program, Alvin Roehr's orchestra; 8, book review, Alice B. Coy, xylophone solos; Oliver Plunkett, tenor; 9, Everfresh hour, concert orchestra, Robert Visconti, director; 9:30, Ben Alley, tenor; 12, Wesley Hevey and his La Vista clubhouse orchestra.

**WLIB, Chicago, Ill.** (302.6m-990kc), 7-8 p. m., dinner concert; 11-1 a. m., popular and dance program.

**WLS, Chicago, Ill.** (344.6m-870kc), 12 m., R. E. D. hour program, Ford and Glenn; 6:40 p. m., Ralph Emerson, organ recital; 7, Ford and Glenn; lullaby time; 7:15, WLS string trio; 7:45, Univ. of Chicago choir of 30 voices; 8:15, Ford and Glenn; songs; 8:30, Thurlow Lieurance, composer of Indian music, with assisting artists; 9, Little symphony orchestra; 10:30, Toney Corcoran, Irish baritone; 11, circus; 2 a. m., Ford and Glenn; Ruth Eiting; orchestra music.

**WLW, Cincinnati, Ohio** (422.3m-700kc), 7:30 a. m., healthful exercises, William Stradman of Physical department of Y. M. C. A.; 8, morning devotions, auspices of Parkway Y. M. C. A.; 12:05 p. m., musical novelties, Irene Downing, player-roll artist; 3, Kroger cooking class, Judith Anderson; 4, program for shut-ins, directed by William Downing; 7, dinner hour concert, Hotel Gibson; 7:30, address, representative of Ohio Farm Bureau federation; 10, Pep concerts, fraternities from Univ. of Cincinnati; 10:30, reading, "The Uncommon Commoner," Charles Meade; 10:40, Crosley male quartet; 11, La Vergne Sims, soprano, accompanied by Elizabeth Jones; 11:15, Crosby musical news, Johanna Grosse, editor and organist; 11:40 pianologues, "Newport" Carl Bamberger.

**WMAQ, Chicago, Ill.** (447.5m-670kc), 12:45 p. m., Radio farm school; 1, Chicago Association of Commerce luncheon; 2, shut-in program; 4, recipes, Mrs. E. O. Hiller; 4:30, pupils of Cosmopolitan School of Music; 5:15, Georgene Faulkner, story lady; 6, Chicago theater organ recital; 6:30, "Lincoln," Mrs. Eleanor Gridley; 8, lecture, Northwestern university; 8:30, Whitney trio; 9, University of Chicago lecture; 9:55, University of Chicago chimes.

**WMAZ, Mason, Ga.** (261m-1150kc), 11-12 p. m., fraternally musicale, S. A. E.

**WMBB, Chicago, Ill.** (250m-1200kc), 7-8 p. m., Trianon duo; Sascha Corado, concert baritone; Elizabeth Moritz, pianist; Veronica Krebs, contralto, semi-classical program; 9-11, Trianon orchestra, Dell Lampe, conductor; Woodlawn theater orchestra, Armin F. Hand, conductor; Cecil and Esther Ward, Hawaiian guitars; Billie Allen Hoff, Nina Smiley, Wilson and Davis, popular program.

**WOAI, San Antonio, Texas** (394.5m-760kc), 3 p. m., Radio Trades association concert; 8:30, army night, Fort Sam Houston.

**WOAN, Lawrenceburg, Tenn.** (282.8m-1060kc), 9-10 p. m., male quartet and orchestra.

**WOC, Davenport, Ia.** (483.6m-620kc), 4-4:45 p. m., St. Joseph's symphony orchestra; 9-9:30, Erwin Swindell, organist; 9:30-10:30, Augustana college.

**WOI, Ames, Iowa** (270m-1110kc), 12:30 p. m., college chimes.

**WOK, Chicago, Ill.** (217.3m-1380kc), 4:30-7 p. m., Tearney's Town Club Twilight Dancers; Capitol theater organ; Lillian Knowles, contralto; 10-10:30 a. m., Tearney's Town club orchestra; Carl Lorraine's Pershing Palace orchestra; Husk O'Hare's Coconut Grove orchestra; Capitol theater program; studio program.

**WORD, Batavia, Ill.** (275m-1090kc), 7 p. m., North Shore line; 7:45, Hays of God; 9, Webster trio; I. B. S. A. choral singers.

**WQJ, Chicago, Ill.** (447.5m-670kc), 7-8 p. m., Rainbo Gardens orchestra; Everett G. Mitchell, baritone; Maude Shapton Couse, soprano; Lavina Price, pianist; 10-1 a. m., Rainbo Skylarks; Dorothy Paxton, contralto; Christian A. Grimm, pianist; Jean St. Anne, baritone; Jessie Pringle, pianist; Melodians; Clarence Theaders; J. Edwin Peterson; George Thurn, kazoo soloist; Oxford girls; Thelma Pfefferle, soprano; 1-2, Ginger hour.

**WSAI, Cincinnati, Ohio** (325.9m-920kc), 7:15 p. m., art talk, Mary Alexander; 7:30, Davis saxophone octet, WEA; 8, Ipana troubadours, WEA; 9, program; 10, talk, Dr. L. B. Chisworth; 10:15, Congress Playing card string quartet.

**WSB, Atlanta, Ga.** (428.3m-700kc), 10:45 p. m., Billmore hotel orchestra.

**WSM, Nashville, Tenn.** (282.8m-1060kc), 6:30 p. m., concert, Francis Craig's orchestra; 7, bedtime story interlude; 8, program, Mrs. Meredith Plautt, contralto, Mrs. Robert L. Alexander, pianist; 8:30, program, Margaret Fry, soprano; 10, Dutch Erhart and his syncopators.

**WSUI, Iowa City, Iowa** (463.6m-620kc), 9 a. m., high school assembly program, music, address; music and address; 12:30 p. m., Prof. Frank Estes Kendrick, violinist; address; 7:30, College of the Air.



Character songs and popular ballads find new meaning when sung by Gladys Rice of the Capitol Family of WEA. This talented young songster comes from a theatrical family. Her father was John C. Rice, one of the greatest of American comedians, and her mother was Sally Cohen.

**WTAG, Worcester, Mass.** (268m-1120kc), 10:30 a. m., musical selections; 12:05-2 p. m., noonday luncheon music, WTAG, Will Hardy, director; 3-4:45, Tea music; 4:45, talk, Herbert K. Shaw; 7:15, Twinkle Twinkle story teller; 7:45, Spanish lesson, Mrs. John de la Parra; 8:30-9, Davis saxophone octet, WEA; 10-11, Roxy and his gang, WEA.

**WTAM, Cleveland, Ohio** (389.4m-770kc), 12:15-1:15 p. m., lunch hour music, Austin Wylie's Vocal Recording orchestra; 6-7, dinner hour music, Guy Lombardo and his Royal Canadians; 8:15, City of Cleveland program; 11-1 a. m., dance music, Guy Lombardo and his Royal Canadians.

**WTIC, Hartford, Conn.** (475.9m-630kc), 6:30 p. m., Hotel Bond trio; Mrs. Gertrude McAuliffe, contralto; 7:30, Yale band; 8:30, New York Philharmonic ensemble; Scipione Guido, violinist; New York Philharmonic Woodwind ensemble; Arthur Middleton, baritone; Jeanne Laval, contralto; 11, Edward Wittstein's dance orchestra; 12-1, Sherman and Ryan, Harmony entertainers.

**WWJ, Detroit, Mich.** (352.7m-850kc), 12:05 p. m., Jules Klein's Hotel Statler orchestra; 3, Detroit News orchestra; 6, dinner concert; 8, News orchestra; 9, dance program; 10, Roxy and his gang.

### Central Time Stations

**CKY, Winnipeg, Can.** (384.4m-780kc), 7:30 p. m., Canadian National Railway's program, Fort Garry hotel orchestra; 7:30 p. m., hotel.

**CNRW, Winnipeg, Can.** (384.4m-780kc), 7:30 p. m., hotel and time story, Aunt Grace; 7:30, Irvine Plumm and his Fort Garry hotel orchestra; 8:45, Florence Verrinder, pianist; Lewellyn Plumm and his Fort Garry hotel orchestra; 10, Irvine Plumm and his Fort Garry hotel orchestra; selections, Al Kilgour.

**KFAB, Lincoln, Neb.** (340.7-880kc), 8:30-10:30 p. m., Belshaw's orchestra; Olive Fletcher and Ruby Teater, double piano selections; Ralph Hall, banjo, uke and vocal numbers; Lincoln guitar orchestra; Slick Merriam, vocal and pianist.

**KFNF, Shenandoah, Iowa** (263m-1140kc), 3:30-4 p. m., flower talk, Mrs. Helen Fischer; 7, concert, Henry Field Seed company.

**KFRU, Columbia, Mo.** (499.7m-600kc), 4:30-5:30 p. m., Bella Vista Quadrangle orchestra; 6:30-7, religious news service, Rev. Cunningham; 9-11, musical program.

**KFUD, St. Louis, Mo.** (545.1m-550kc), 9:15 p. m., "Is Man's Destiny Sealed at the Time of His Death?" Prof. J. T. Mueller.

**KMA, Shenandoah, Ia.** (252m-1190kc), 6-7 p. m., domestic science talk, June Case; 9-11, Bobbie and Babe Riddle; program, Henry Adams.

**KOIL, Council Bluffs, Iowa** (278m-1080kc), 6:15 p. m., Mona Motor Oil entertainers; 6:30, Fontenelle orchestra.

**KPRC, Houston, Tex.** (296.9m-1010kc), 7:30 p. m., Fatty Martin's End of Main dance orchestra; 8:30, Rice Institute band; 11, popular concert.

**KSAC, Manhattan, Kans.** (340.7m-880kc), 9-9:25 a. m., music, inspirational talks, agricultural primer, callisthenics; 9:55-10:25, readings, backyard gossip, question box; planning today's meals; 12:35-1:05 p. m., readings, question box; 4:30-5, basketball lectures; 6:30-7:30, sports, inventions; Extension credit course, Agricultural Journalism.

**KSD, St. Louis, Mo.** (545.1m-550kc), 7 p. m., fur hour, Hotel Statler orchestra; 8, Ipana Troubadours.

soprano; Ida Sorenson, contralto; Irving Winslow, violinist; 11, Skyrocket frolic, George Osborn and his orchestra.

**WBBM, Chicago, Ill.** (226m-1330kc), 4-6 p. m., Valentino Inn orchestra; artists; 8, string trio; Moulton Rouge orchestra; Sunset quartet; 12-2 a. m., artists; Two Jays; Moulton Rouge orchestra; Hawaiian quartet.

**WBCN, Chicago, Ill.** (266m-1130kc), 10-10:30 a. m., Penny Wise, shoppers' ready helper, shopping talk; 7-8 p. m., classical hour; Emily Stone, violinist; Alice Ada Mae, tenor; Ethel Eaves Price, soprano; Alice McMahon Stone, accompanist; Lemmyon Amoureux, French tenor; Ethel Eaves Price, soprano; Alice McMahon, contralto; Margaret McArthur, pianist; John Williams, baritone.

**WCCO, Minneapolis-St. Paul, Minn.** (416.4m-720kc), 2:30 p. m., afternoon concert; 4, readers' club, Eleanor Poehler; 5:30, children's hour; 7, midweek church service, Rev. H. L. Maunder, pastor Hobart Memorial M. E. church; 8, program, WEA, Ipana Troubadours; 9, musical program, Nash-Finch concert orchestra; 10:05, dance program, Marigold Garden orchestra; 11:30, Eddie Dunstedt, organist.

**WDAF, Kansas City, Mo.** (365.6m-820kc), 6-7 p. m., addresses; The Trianon ensemble; 8-10, varied musical program; 11:45-1, Ted Weem's Victor Recording orchestra; Eddie Kuhn's orchestra.

**WDDO, Chattanooga, Tenn.** (256m-1170kc), 6:30-7 p. m., organ music, Tivoli theater; 7-8, Hotel Platten orchestra; 8:15, special features and program.

**WEBB, Chicago, Ill.** (370.2m-810kc), 7-8 p. m., Emerson Military band; 9, Oriole orchestra; 9:45, Florence Behrend, soprano; Eugenia Dolberg, pianist; 11, Oriole orchestra; Irene Beasley; Frank Bordner, revue.

**WFAA, Dallas, Tex.** (475.9m-630kc), 2:30-3 p. m., J. J. Sandler, pianist.

**WGES, Oak Park, Ill.** (250m-1200kc), 5-7 p. m., basso, pipe organ; 8-9, orchestra, contralto; 11-1 a. m., Coyne serenaders, comedian, organ, tenor, piano, orchestra.

**WGN, Chicago, Ill.** (302.8m-990kc), 10-10:20 a. m., good health and training; 10:20-11, entertainment for shut-ins; 12:01-12:30 p. m., "Concerning the Use of Needlepoint in Furniture," Walter Murray; 12:40-2:30, luncheon concert, Drake concert ensemble; 2:30-3, Lyon and Healy artists' series; 3-3:30, auction, bridge game; 3:30-4:15, tea time music, Marshall Field's tea room orchestra; 5:30-5:57, Skeezix time; 6:30-7, dinner concert, Drake concert ensemble; 8-9, music hour; 9-10, Roxy and his gang, WEA; 10-10:10, Sam 'n' Henry; 10:10-10:20, old-time favorites; 10:20-11, popular and dance program.

**WHAD, Milwaukee, Wis.** (275m-1090kc), 11 a. m., pianologue, Andy Hertel; the Housewife; 4 p. m., "With the Humorists," John R. Wolfe; Mrs. Marie Weiss, pianist; Linda Hering, saxophone; 6:15-7, Arthur Richter, organist; 10:30-11:30, popular dance hits, Dexter's Wisconsin and Elger's Creole orchestra; 11:30-12:30 a. m., Edmund Fitch, organist; 1-2 p. m., Mrs. M. J. Morrison, Mrs. Myrtle Fulk's Zahm, Jr., organist; 4-5, Music Box; 7:30-9, Jake Seligman and his Kentucky Night Owls.

**WHO, Des Moines, Iowa** (526m-570kc), 6:30-7:30 p. m., Reese-Hughes orchestra, Hotel Fort Des Moines; 7:30-9, Kate Miller, whistler; Maude Hughes, accompanist;

### Mountain Time Stations

**CFAC, Calgary, Can.** (435.8m-688kc), 4 p. m., Red Cross address.

**KFWA, Ogden, Utah** (261m-1150kc), 4-5 p. m., organ recital, Paramount theater; 5-6, Ogden Radio Dealers' program; 9-10:30, music, Paramount theater; 10:30-12, dance music, Olie Reeves and his orchestra.

**KOA, Denver, Colo.** (322.4m-930kc), 12:15 p. m., Rialto theater musicale; 6:30, dinner concert, Brown Palace string orchestra, Howard Tillotson, director; 7:30, book of knowledge; 8, instrumental program, Scheuerman's Colorado orchestra; 8:15, studio program; guitar duets featuring Hawaiian folk songs and Spanish numbers, Paul Parker and W. O. Bradbury; German folk songs, Arion; banjo duets, southern melodies, Charles H. Spencer and Charles McLaughlin; piano solos, Dorothy Secret; contralto solos, Laura Kemp Anderson; baritone solo, "The Rosary," D. Gross; vocal duet, Margaret Fell, soprano, Paul Parker, tenor; saxophone trios, Earl Fraser, L. R. Simmons and V. Schilling; miscellaneous quartet selections, Margaret Fell, soprano; Frances Joseph, contralto; Paul Parker, tenor and Ross Ruckstater, bass; 10-12 midnight, dance program, Broadmoor Rhythm Rustlers, Eber Grubb, leader.

**KSL, Salt Lake City, Utah** (299.8m-1000kc), 7:35 p. m., "The History of Economics," Prof. E. C. Lorenzen.

### Pacific Time Stations

**KFI, Los Angeles, Calif.** (468.5m-640kc), 5:30-6 p. m., musical matinee; 6, nightly doings; 6:15, KFI's Seeing California; 6:30, vest-pocket program; 6:45, Radioditorial period; 7-7:20, Nick Harris detective story; 7:20-8, Al Wesson's dance orchestra; 8-9, program, Ventura Refining company; Ventura string quartet; 9-10, Dorothy Conant Tildan, trio; 10-11, Patrick Marsh dance orchestra; Betty Patrick, soloist.

# FAMOUS ORGANIST PLAYS AT WAHG

## Wednesday, February 10

**KFOA, Seattle, Wash. (453.3m-660ke), 7-8:15 p. m.**, Sherman Clay and company, studio program; 8:30-10, Times studio program.

**KFON, Long Beach, Calif. (233m-1290ke), 6-6:45 p. m.**, organ, Brayton's theater; 6:45-7:15, amusement information; 7:30-8, Long Beach Municipal band; 8-9, Press-Telegram program; 9-10, KFON Artists' frolic.

**KFWB, Hollywood, Calif. (252m-1190ke), 5-6 p. m.**, children's hour, Big Brother of KFVB; 7-7:30, Mutual Motors, joke contest; 8-9, program, John Wright, The Right Tailor; John Wright orchestra; Sol Hoopii's Hawaiians, Frank Stever, baritone; 9-10, Bill Hatch's Oakland Country club dance orchestra, Esther White, blues singer; 10-11, Warner Bros. frolic, direction Charlie Wellman.

**KGO, Oakland, Calif. (361.2m-830ke), 11:30-1 p. m.**, Sherman Clay and company luncheon concert; 3-4, speaker, Williams institute; Eleanor Pierson, soprano; Manuel Alvarez, pianist; Jack Holworthy, tenor; 4-5:30, concert orchestra, Hotel St. Francis.

**KGW, Portland, Ore. (491.5m-610ke), 7:15 a. m., Y. M. C. A. physical culture exercises; 9:45-11:30, town crier; music; 12:30-1:30 p. m., concert, Oregon Radio Trades association; 6-7, dinner concert, Olds, Wortman and King company; 8-9, concert, Western Auto Supply company; 9-10, concert; 10-11, concert, Sherman, Clay and company.**

**KHJ, Los Angeles, Calif. (405.2m-740ke), 6-6:30 p. m.**, Leighton's Arcade cafeteria orchestra, Jack Cronshaw, leader; 6:30-7:30, history story, Prof. Hertzog; Dick Winslow, juvenile reporter; Mickie McBan and Vivian Marle, screen starlets; Uncle John; S. Dr. Mars Baumgardt, scientific lecturer; 8:30-10, program, Owensmouth Chamber of Commerce.

**KLX, Oakland, Calif. (508.2m-590ke), 5-5:30 p. m.**, Aunt Elsie's sunset matinee; 6:30-7, Adams Athletic club orchestra; 7-7:30, news; 8-9, educational program, Roy Harrison Danforth, Ad Schuster, Harry Noyes Pratt, Nadine Shephard, Prof. E. R. de Ong and others; 9-10, program.

**KMTR, Hollywood, Calif. (238m-1260ke), 5-6 p. m.**, Home hour, Mammy Simmons and the neighborhood children; 8-10, the Turner orchestra, direction Loren Powell; 10-11, Starr Piano company studio.

**KNX, Hollywood, Calif. (336.9m-890ke), 5-5:30 p. m.**, Sunny Jim's radio; 5:30, First Presbyterian church organ; 5:55, Town Talker; 6:15, travel talk, W. F. Adler; 6:30-7, Atwater Kent concert orchestra; 7-8, Ambassador hotel concert orchestra; 8-9, program, Security Trust and Savings bank; 9-10, Riviera program, John A. Vaughn corporation; 10-11, dance orchestra.

**KOAC, Corvallis, Ore. (280.2m-1070ke), 7:20 p. m.**, musical selections.

**KPO, San Francisco, Calif. (428.3m-700ke), 7-7:30, 8 a. m.**, daily dozen exercises; 10, sewing talk, Betsy Ebers; 1-2 p. m., Rudy Seiger's Fairmont hotel orchestra; 2:30-3:30, matinee program; 3:30, "Breath of the Avenue"; 5:15-6:15, children's hour stories, Big Brother; 6:40-7, Waldemar Lind and the States Restaurant orchestra; 7-7:30, Rudy Seiger's Fairmont hotel orchestra; 8-9, Atwater Kent artists; 9-10, Goodrich Silvertown Cord orchestra; Reg. Code, director; 10-11, Waldemar Lind and the States Restaurant orchestra.

**KTAB, Oakland, Calif. (240m-1250ke), 9-9:30 a. m.**, prayer service, Rev. G. W. Phillips; 12-1 p. m., luncheon concert.

**KWSC, Pullman, Wash. (348.6m-860ke), 7:30-9 p. m.**, Women's Glee Club quartet; Margaret Amundson, pianist; Harriette Metz, banjoist; special program, Garfield county students.

## Thursday, February 11

### Headliners Today

Eastern	Central	Mountain	Pacific
8 p. m.	7 p. m.	6 p. m.	5 p. m.
KFN (263m-1140ke) Old-time music.	7:15	6:15	5:15
WIP (508.2m-590ke) Etude hour.	7:30	6:30	5:30
WPG (299.8m-1000ke) Sylvano trio.	7:30	6:30	5:30
WJZ (454.3m-660ke), WRC (468.5m-640ke) Radio movie.	7:30	6:30	5:30
WBAL (246m-1220ke) Lady Negro jubilee singers.	7:30	6:30	5:30
WCBD (344.6m-870ke) Mandolin and Guitar club.	7:30	6:30	5:30
WJZ (454.3m-660ke), WGY (379.5m-790ke) Royal hour.	7:30	6:30	5:30
KPRC (296.9m-1010ke) Old fiddlers' contest.	7:30	6:30	5:30
WBZ (333.1m-900ke) Lincoln's Birthday program.	7:30	6:30	5:30
KNX (336.9m-890ke), Concert cellist.	7:30	6:30	5:30
WGY (379.5m-790ke) Piano recital, Chopin compositions.	7:30	6:30	5:30
KGO (361.2m-830ke) "Stung," three-act comedy.	7:30	6:30	5:30
KFWB (252m-1190ke) Sol Hoopii's Hawaiians.	7:30	6:30	5:30
WLW (422.3m-710ke) Venetian trio.	7:30	6:30	5:30

Thursday, silent night for: CHIC, CKNC, CNRA, CNRE, CNRO, CNRR, CNRT, CNRV, CNRW, KFAB, KFAU, KFDM, KFEQ, KFMX, KFOA, KFOW, KFWB, KFWA, KGW, KKL, KOA, KOAC, KOB, KWSC, PWX, WABQ, WAFD, WAHG, WCAP, WCEE, WDD, WEAO, WEBJ, WEBW, WHAD, WHAZ, WJJD, WQAI, WOR, WSM, WSUI, WTAM.

### Eastern Time Stations

**CNRM, Montreal, Can. (410.7m-730ke), 8:30 p. m.**, French Composers' night; address, Paul E. Joubert.

**KDKA, Pittsburgh, Pa. (309.1m-970ke), 7-7:15, 8 a. m.**, exercises, O. Shannon; 5:45 p. m., music; 6:30, dinner concert, Little symphony orchestra, Victor Saudek, conductor; 8:15, farm program; 8:30, with famous composers—Nikolai Andrejevitch Rimsky-Korsakov, Little symphony orchestra, Victor Saudek, conductor; 9, concert, Little symphony orchestra, Victor Saudek, conductor; quartet; 11, Pittsburgh Post midnight revue.

**WAHG, Richmond Hill, N. Y. (315.6m-950ke), 12:03 p. m.**, Grebe matinee trio.

**WBAL, Baltimore, Md. (246m-1220ke), 6-6:30 p. m.**, children's program, "Lincoln—The Little Boy Who Grew Big," Hazel Knox; 6:30-7:30, dinner program, WBAL dinner orchestra, Robert P. Lula, conductor; 7:30-8, organ program; recital, Frederick D. Weaver, organist; 8-9, instrumental selections, Baltimore Mandolin orchestra, Conrad Gebelien, director; 9-10, vocal selections, female negro jubilee singers.

**WBRR, New York, N. Y. (275m-1000ke), 8 p. m.**, George Twarosch, violinist; 8:10, Stanley Gohlinghorst, baritone; 8:20, Bible lecture, "The Unknown God," R. S. Emery; 8:40, Stanley Gohlinghorst, baritone; 8:50, George Twarosch, violinist.

**WBZ, Springfield, Mass. (333.1m-900ke), 6:30 p. m.**, Little Symphony orchestra, KDKA; 7, Hotel Kimball dance orchestra, Bob Patterson, director; 7:45, Massachusetts Aggie Radio forum; 8, musical program, Leo Reisman's orchestra; 9, concert, Ely May Burdick, soprano; Hazel Prentice, reader; Pearl Leahy, pianist and accompanist; 9:30, program commemorating Lincoln's birthday.

**WCAP, Washington, D. C. (468.5m-640ke), 6:45-7:45 a. m.**, health exercises.

**WCAU, Philadelphia, Pa. (278m-1080ke), 6:30 p. m.**, Billy Hayes and his orchestra; 7:30, Snellenburg Symphony orchestra; 8, The Mitchell Gondolier; 8:15, Elizabeth Lapetina, coloratura soprano, Michael Fonticelli, operatic tenor, Virginia Klein, pianist; 8:45,

The Kandy Kids; 9, Barry O'Moore, tenor; 8:30, Musical Chords; 9:45, burlesque lesson, Prof. Doolittle; 10, Sequi Centennial Hour; 11, Parodians orchestra; 11:30, Club Cadix revue.

**WCX, Detroit, Mich. (516.9m-580ke), 6-7 p. m.**, Goldkette ensemble; 8-9, studio program.

**WEAF, New York, N. Y. (491.5m-610ke), 6:45-7, 7:20 p. m.**, tower health exercises; 11-12, musical program; 4-5, play; Frank C. Doblin, baritone; "Some Polar Bears and Dogs," Anthony Flala; 6-12 midnight, dinner music, Hote Waters; Astoria; midweek hymn singing; the Smith Brothers; Larkinites; Hires Harvesters; Clicquot Club Eskimos; Silvertown Cord orchestra, Joseph Knecht, director; Vincent Lopez and his orchestra.

**WEAO, Columbus, Ohio (293.9m-1020ke), 1:15 p. m.**, Robert Coleman, pianist; 4:10, Mrs. Harvard Vallance, soprano; Charlotte Vallance, pianist; "Separation of Atoms into Units of Positive and Negative Electricity," Prof. A. W. Smith; 8:50, music; 10, Hotel Fort Hayes hour of music.

**WEAR, Cleveland, Ohio (389.5m-770ke), 7 p. m.**, Hotel Statler concert orchestra; 8, Larkinites Four; 8:30, Wokrite Radio artists; 9, Clicquot club, WEAF; 10, Vincent Percy, organist.

**WEEI, Boston, Mass. (348.6m-860ke), 6 p. m.**, Dok Eisenberg and his Sinfonians; 7, Big Brother club; 7:30, Cecilia and Robert Gomberg, violinists; 8, Larkinites; Hires Harvesters; Clicquot Club entertainers; Silvertown Cord orchestra.

**WFI, Philadelphia, Pa. (394.5m-760ke), 1 p. m.**, Tea room ensemble; 3, New Century Club of Chester; 6:30, Bellevue Stratford concert orchestra; 7, Bellevue Stratford dance orchestra; 8, The Larkinites; 8:30, Hires Harvesters; 9, Clicquot Club Eskimos; 10, Silvertown Cord orchestra; 11, dinner dance by Philadelphia Club of Advertising Women; Pat Riley and his orchestra.

**WGBS, New York, N. Y. (315.6m-950ke), 1:30 p. m.**, Rambler's trio; 3, women in the home program; 6:30, Palmer-Oliver orchestra; 8:30, "Footlight and Lamp-light," Oliver Saylor; 9, Five Brothers Lincoln program; 9:30, old-time minstrel.

**WGCP, New York, N. Y. (252m-1190ke), 3 p. m.**, Elvira Rose Geiger, pianist; 3:20, Nat. Osborne and Tommy Tucker; 3:45, Davis; 4:15, studio program; 4:45, Jack Davis; 5:10, Sylvia Schatz, pianist; 8:30, Strickland's orchestra; 9, Piotti and Val; 9:15, Eva Rothenberg, pianist; 9:30, Tracey and Moh, singers; 9:45, Max Merrit, violinist; 10, Strickland's orchestra.

**WGY, Schenectady, N. Y. (379.5m-790ke), 2 p. m.**, music; talk; "Training Pre-Kindergarten Children," Pauline Parke; 6:30, dinner program, Ten Eyck concert trio; 7:30, WGY book chat, William E. Jacob; 7:45, program, Syracuse University; 9, Royal hour.

**WJZ, 10, piano recital of Chopin compositions, J. Austin Springer, "Chopin and His Works"; 11:30, organ recital, Stephen E. Boisclair.**

**WHAR, Atlantic City, N. J. (275m-1090ke), 2 p. m.**, Seaside hotel trio; 7:30, lecture period; 8, Seaside hotel trio; 9, studio concert; 11:30, dance orchestra.

**WHN, New York, N. Y. (361.2m-830ke), 12:30-1 p. m.**, organ recital; 3:15-4:30, Lexington orchestra; 7, Vincent Lopez Iceland orchestra; 7:30, Ciro's orchestra; 8, Will Oakland's Chateau Shanley; 10:30, Club Kentucky orchestra; 11, Joe Ward's Swanee entertainers; 11:30, Everglades orchestra; 12-12:30, Parody club orchestra.

**WIP, Philadelphia, Pa. (508.2m-590ke), 8:45 a. m.**, setting-up exercises; 7, setting-up exercises; 10, menu talk, Mrs. Anna B. Scott; 1 p. m., Gimbel tea room orchestra; 3, Celesta trio; Margarita Parkinson, violinist; Ethel Dorr McKinley, cellist; Mildred H. Ackley, pianist, assisted by Iris Virginia Gruber, soprano, Flora Ripka, accompanist; 6:05, Pagoda Cafe orchestra; 7, Uncle Wip's bedtime stories; Banjo Collegians; 8, The Sequi Centennial; Harry A. Mackay; 8:15, Etude hour, direction James Francis Cooke; 9, John B. Oram, boy soprano; 9:20, negro spirituals, Theodor Liedend, violinist; 10:05, real estate talk; 10:15, Al Lentz and his versatile entertainers.

**WJR, Pontiac, Mich. (516.9m-580ke), 7 p. m.**, Jean Goldkette's Petite symphony orchestra; 7:30, Ide and Meginnity; 9, Jean Goldkette's serenaders; 11, Jean Goldkette's Victor Recording orchestra.

**WKAQ, San Juan, P. R. (340.7m-880ke), 6-8 p. m.**, Rialto theater musicals.

**WKAL, Lansing, Mich. (285.5m-1050ke), 7:15-8 p. m.**, daily course.

**WLIT, Philadelphia, Pa. (394.5m-760ke), 12:02 p. m.**, daily alternate; Stanley theater organ recital; Arcadia cafe concert orchestra; 2, Arcadia cafe concert orchestra; 4:30, concert; 7:30, Dream Daddy's bedtime stories.

**WLWL, New York, N. Y. (288.3m-1040ke), 9 p. m.**, announced; 9:15, "Rhea Leddy and William Flusk, duettists; 9:30, "Bogus Religions," Dr. James J. Walsh; 10, Rhea Leddy and William J. Flusk, duettists; 10:15, religion and science, Rev. John M. Cooper; 10:35, musical program.

**WMAK, Buffalo, N. Y. (266m-1130ke), 6:15-7:15 p. m.**, dinner music, Hotel Lafayette orchestra; 7:15-7:30, daily news.

**WMBF, Miami Beach, Fla. (384.4m-780ke), 7-9 p. m.**, Fleetwood Radio orchestra; 10-11 p. m., Gene Fesdick and his orchestra; Fleetwood Radio orchestra.

**WMCA, New York, N. Y. (340.7m-880ke), 6-7 p. m.**, Olcott Vail and his Hotel McAlpin string ensemble; 7-7:15, Hugo Zeller, lacquer and lacquer finishing; 7:15-7:45, Pace institute program; 7:45-8:15 p. m., Tyrrell's health talk; 10:30-11, Jack Smith, whispering baritone; 11-12, Ernie Golden and his Hotel McAlpin orchestra.

**WNYC, New York, N. Y. (526m-570ke), 7:10 p. m.**, dance program; 9, dinner, Steuben county society, Hotel Roosevelt.

**WOO, Philadelphia, Pa. (508.2m-590ke), 11 a. m.**, organ recital; 12:02 p. m., Golden's crystal tea room orchestra; 4:45, organ recital; 7:30, Hotel Adelphia French room orchestra.

**WPG, Atlanta City, N. J. (299.8m-1000ke), 1:30 p. m.**, Fleet Morton luncheon music; 4:30, tea music; 6:45, Arthur Scott Brook, organist; 7:15, Hotel Ambassador dinner music; 8, world wonder excursions, Alfred James P. McClure; 8:15, concert, Atlanta City Board of Education; Sylvano trio; Hilda Reiter, soprano; 10, Atlantic City Estates' dance orchestra; 11, Silver Slipper supper club.

**WRC, Washington, D. C. (468.5m-640ke), 12 m.**, organ recital; 1 p. m., Hotel Mayflower orchestra; 6:45, Smithsonian talk; 7, New Willard hotel orchestra; 7:20, U. S. army band, WJZ; 8:30, Radio-movie presentation, WJZ; 9, Royal Salon orchestra, WJZ, WGY, WCAD; 10, "The Political Situation in Washington Tonight," Frederick William Wile; 10:15, Rec'd Boys, WJZ; 10:30, Meyer Davis' Swanee orchestra; 11:30-12:30, Otto P. Beck, organist.

**WREO, Lansing, Mich. (285.5m-1050ke), 6-7 p. m.**, dinner concert, Speed-Wagon Serenaders; Gold Standard ensemble; 8, University of Marquette vs. Michigan State College, basketball game; 9:15, varied musical program, Reo Broadcasting orchestra; Carl Hall Dewey, director; Reo string quartet; Leland C. Cooke, clarinetist; Accelerator male quartet; vocal and instrumental solos.

**WTAG, Worcester, Mass. (268m-1120ke), 10:30 a. m.**, musical selections; 12:05-2 p. m., noon-day luncheon music, WTAG, Will Hardy, director; 4:30, entertainment for members of WTAG indoor sports club; 5:15, Twinkle Twinkle story teller; 8-8:30, Larkinites, WEAF; 8:30-9, travel talk; 9-10, Clicquot Club Eskimos, WEAF; 10-11, Silvertown Cord orchestra, Joseph Knecht, director.

**WTAM, Cleveland, Ohio (389.4m-770ke), 12:15-1:15 p. m.**, Austin Wylie's Vocalion Recording orchestra; 6-7, dinner hour music, Carl Rupp and his Hotel Hollenden orchestra.

**WTIC, Hartford, Conn. (475.9m-630ke), 6:30 p. m.**, children's period; 8:50, Hotel Bond trio; 7:35, "The United States Form of Government," Prof. Lane W. Lancaster.

**WVJ, Detroit, Mich. (352.7m-850ke), 12:05 p. m.**, Jules Klein's Hotel Statler orchestra; 3, Detroit News orchestra; 6, dinner concert; 8, concert, WEAF.

### Central Time Stations

**CKY, Winnipeg, Can. (384.4m-780ke), 10 p. m.**, dance program, Venetian Gardens, Cliff Menzies and his Collegians.

**KFKU, Lawrence, Kans. (275m-1090ke), 7:15 p. m.**, musical numbers, School of Fine Arts, Fiske Moun- tain, Vol. 1st; 7:30, K. U.-Oklahoma, A. & M. college basketball game.

**KFMQ, Fayetteville, Ark. (299.8m-1000ke), 8 p. m.**, University Extension lectures: "The Healthy Pessimist—Business Optimism Not Always a Good Thing," D. H. Baker; "English Gothic Architecture," W. B. Allen; "Diet and Pellagra," J. W. Read; "Play as a Basis of Education," G. N. Cade; "Hydraulic Records," W. N. Gladson; 8:45, program of piano music, Loraine Allen.

**KFNH, Shenandoah, Iowa (263m-1140ke), 7 p. m.**, concert, old time music, A. L. Thomas, director.

**KFRU, Columbia, Mo. (499.7m-600ke), 8:45 a. m.**, musical program, students of Stephens College Conservatory of Music; 9, educational talk; 4:30-5:30 p. m., Bella Vista Quadrangle orchestra; 6:15, dinner music; 6:45, children's hour, Grace Pemberton; 7, Radio school.

**KIDS, Independence, Mo. (440.9m-680ke), 8 p. m.**, "Problems of Society," Prof. M. A. Etzenhauser; 8:15, program, Mrs. William DeBernard; Thelma Martensen, soprano; Margaret Land, pianist; Gladys Clardy, contralto; Bonnie Ruth Hampton, reader; Christine Mears, reader; Verlyn Webb, baritone; Max Dohler, tenor; Jefferson Davis, reader; Helen Lee Hicks, pianist; Emmett Foltz, violinist; Doris Timmons, pianist.

**KMA, Shenandoah, Iowa (252m-1190ke), 6-7 p. m.**, popular musical numbers; 9-11, Delmonico Dreamers. Maria Imperial dance orchestra; 7:15, Sleepy Time Girl, Bernice Clizbe; 7:30, Harry M. Cooper, baritone; Albert Newquist, tenor; 8, Harmon-jazz orchestra; 11, Woodson's Collegians.

**KPRC, Houston, Tex. (296.9m-1010ke), 7:30 p. m.**, Blanchard's dance orchestra; 8:30, old fiddlers' contest.

**KSAC, Manhattan, Kans. (340.7m-880ke), 9-9:25 a. m.**, music, inspirational talks, agricultural primer, callisthenics; 9:55-10:25, readings, backyard gossip, question box; planning today's meals; 12:35-1:05 p. m., readings, question box; 4:30-5, Botany; 6:30-7:30, music, Extension credit course, Educational Psychology.

**KSD, St. Louis, Mo. (545.1m-550ke), 6:55 p. m.**, WEAF chain; 7:30, Esmeralda Berry Mayes, pianist; 8, WEAF chain; Good Will program.

**KSO, Clarinda, Iowa (242m-1240ke), 12:30-1:15 p. m.**, concert; music; garden club; Sunday school lesson; dinner concert; 7-7:30, music; 7:30-9:30, band concert; Dr. Rotton.

**KTHS, Hot Springs National Park, Ark. (374.8m-800ke), 9-9:30 p. m.**, Eastman classical orchestra; 9:30-9:45, Joe Kuntz and his accordion; 9:45-10:15, New Arlington hotel orchestra; 10:15-10:45, Elmer Menard, pianist.

**KYV, Chicago, Ill. (536m-560ke), 11:35 a. m.**, table talk, Mrs. Anna J. Peterson; 12:05-1, noonday concert, Commonwealth Edison company; I. Joska DeBary's orchestra; Coon-Sanders' orchestra; 2:35-4, afternoon frolic; 6, dinner music, KDKA; 7:05, bedtime story, Uncle Bob; 7:33-7:53, "The Forestry Clubs," A. L. Ford; More Adventures of Paul Bunyan, E. W. Meeker; 8, Twenty Minutes of Good Reading," Rev. C. J. Perrin; 8:25-9, musical program; 9, an hour of music, Commonwealth Edison company; 10-11:30, evening at home, Coon-Sanders orchestra; 1, Insomnia club.

**WAMD, Minneapolis, Minn. (244m-1230ke), 12 m.**, popular program, Norvy Mulligan, pianist; Ray Covett, tenor; Roy Nowack, banjo; Jack Leeman, clarinet; Katherine Grill, contralto; 6:15, dinner concert, George Osborn and his skyrockets.

**WBBM, Chicago, Ill. (266m-1130ke), 4-6 p. m.**, Valentine Inn orchestra; singers; 8-10, Tip trio; Ziegler sisters; Moulton Rouge orchestra; 10-12, Moulton Rouge orchestra; artists and stars.

**WBCN, Chicago, Ill. (266m-1130ke), 10-10:30 p. m.**, Penny Wise, the shopper's ready helper, shopping talk; 7-8 p. m., classical hour; Emily Stone, violinist; Ada Mae Stone, accompanist; Lemmyon Amoureux, French tenor; Ethel Eaves Price, soprano; Alice McMahon, contralto; Margaret McArthur, pianist; John Williams, baritone; 11-1 a. m., Elmer Jordan and company, Owl matinee.

**WCAL, Northfield, Minn. (336.9m-890ke), 8 p. m.**, sacred program, Rev. L. A. Vigness.

**WCCB, Zion, Ill. (344.6m-870ke), 8 p. m.**, mixed quartet; mandolin and guitar club, assisted by Mrs. Mayfield and Mrs. Reed, soprano and baritone; Mrs. Bird and Miss Donovan, Ralph Reed, baritone; Florence Farrar and Mr. Paxton, contralto and baritone; Alice Peters violinist; readings.

**WCCO, Minneapolis-St. Paul, Minn. (416.4m-720ke), 12 m.**, noon concert, Donaldson's orchestra; 2 p. m., "Among the Musicians," H. A. Bellows; 4, readers' club, Eleanor Poehler; 5:30, children's hour; 6, Boy Scout program; 7, program, WEAF; The Larkinites; 7:30, musical program; 8, program, WEAF; 8-9, Clicquot Club Eskimos; 9-10, Silvertown Cord orchestra; 10:05, traffic safety talk, George H. Herrold; 10:20, dance program, Oxford theater orchestra.

**WDAF, Kansas City, Mo. (365.6m-820ke), 3:30-4:30 p. m.**, the Star's string orchestra; 6-7, the Tell-Me-A-Story lady; address, Bonnie Victor Recording orchestra; organ numbers, Ted Ween's Victor Recording orchestra; Ted Meyn; Billy Adair's orchestra.

**WEBH, Chicago, Ill. (370.2m-810ke), 7 p. m.**, Oriole orchestra; 8, special recital; 9, Oriole orchestra; 9:45, Belle Forbes Cutler, soprano; Ruth Buhl Flick, contralto; soprano; Ruth Buhl Flick, reader; Rita McEwen, baby Bieber.

**WFAA, Dallas, Texas (475.9m-630ke), 12:30-1 p. m.**, Edgar Norris, pianist; 3:30-4, M. H. Bolack, pianist; 4:30-5, Marion Ginn, soprano; 6:30-7:30, Baker hotel orchestra; 8:30-9:30, Southbound Life Insurance company; 11-12, Emmett B. Peck, violinist; Edwin Lisman, bass.

**WGES, Oak Park, Ill. (250m-1200ke), 5-7 p. m.**, pipe organ, classical program; 8-9, orchestra, pipe organ; 11-1 a. m., mezzo-soprano, violin, orchestra, Evans Lloyd, composer; Tiffin organ, pianist, others.

**WGN, Chicago, Ill. (302.8m-930ke), 10-10:20 a. m.**, good health and training; 10:20-11, entertainment for shut-ins; 12:40-2:30, luncheon concert, Drake concert ensemble; 2:30, Lyon and Healy artists series; 3:30-4:15, tea time music, Marshall Field's tea room orchestra; 5:30-5:57, Skeezix time; 6:30-7, dinner concert, Drake concert ensemble; 8-9, Clicquot Club Eskimos, WEAF; 9-10, Silvertown orchestra, WEAF; 10-10:10, Sam 'n' Henry; 10:10-12:20, old-time favorites; 10:20-11, dance program.

**WHAD, Milwaukee, Wis. (275m-1090ke), 11 a. m.**, pianology, Anita Mertz; 4 p. m., Mrs. Ferne Medley Hanson, vocalist; I. E. Clayton, baritone; 6:15-7, Bill Benning's Milwaukee Athletic club orchestra.

**WHAS, Louisville, Ky. (399.8m-750ke), 1-2 p. m.**, Benson trio; 3-3:30, Mrs. Myrtle Fulk Zahn, Jr., organist; 7:30-9, concert, Mrs. J. E. Harmon, Jr., director.

**WHO, Des Moines, Iowa (526m-570ke), 7:30-8 p. m.**, Raleigh quintet, Savery hotel; 8-9, Bankers Life Little Helen Birmingham, director; 11-12, Bankers Life Little symphonic orchestra, Leon A. Dashoff, director.

**WHT, Chicago, Ill. (399.8m-750ke), 6 p. m.**, Al Carney, organist; 6:30, Genevieve Barry Burnham, soprano; Grayling's string trio; 6:45, Swedish program; 7:45 (238), Alamo and Chez Pierre orchestra; 9:30 (399.8), Kitchin Klezzer Classics; 10:30, Jack Turner, popular singer; 10:10, U. S. L. entertainers; 12, Your hour league.

**WIBO, Chicago, Ill. (226m-1330ke), 10-11 a. m.**, shoppers' bureau, Grace Viall Gray; 2-4 p. m., shut-in program; 6, dinner concert, Walter Preston; WIBO trio, Chester Newman, baritone; Helen Snyder, soprano; Harriet Hebert, contralto; 7:30-8, Swedish program; 12-2 a. m., midnight jamboree.

**WIAZ, Chicago, Ill. (322.4m-930ke), 10 p. m.**, chimes; Eva Polokoff, violinist; Gladys Petersen-Harless, mezzo-soprano; Bess S. Sondel; Norma Kittson, soprano; Betty Choven, pianist; Eva Polokoff, violinist; Gladys Petersen-Harless, mezzo-soprano; Norma Kittson, soprano; Betty Choven, pianist; Eva Polokoff, violinist; 11, chimes; Bess S. Sondel; Gladys Petersen-Harless, mezzo-soprano; Norma Kittson, soprano; Betty Choven, pianist; Eva Polokoff, violinist; Gladys Petersen-Harless, mezzo-soprano; Bess S. Sondel; 12 midnight, midnight chimes.

**WJJD, Mooseheart, Ill. (370.2m-820ke), 4-5 p. m.**, Mooseheart hour, music, younger children; daily assembly of 1,256 children; faculty talks; 6-7, instrumental hour; Howard L. Peterson, playing Geneva Victorians; 8-9, Mooseheart children's hour; music by children of all ages, solos, bands, etc.; talk, Matthew P. Adams; 10-11, Oliver Chaplin, tenor; Ruth Allanson, pianist; 12:30-1:30 a. m., setting-up hour, Garod studio, Palmer House; Palmer House Victorians.

# ABC Radio Fundamentals for Everybody

## Chapter V—The Detector or Converter

By Milo Gurney

VERY often truly great inventions revert to the commonplace early in their life, through association with previous methods, which refuse to step aside, other than very slowly, because of a lack of understanding of the invention's inherent greatness. Such seems to be true of the triode or three-element vacuum tube, whose function in a Radio receiver detector or converter circuit will be the subject of this article.

In order that the discussion may be made clear, figure 11 of last week's article is repeated, while figure 14 pictures the same arrangement, with the addition of a detector tube, together with the batteries and head phones required to complete an audible circuit.

Recall, if you will, the method of tuning outlined in last week's article and note with the addition of the vacuum tube, wires are connected to the coil which run to terminals G (or grid), and plus F (or filament). (The latter wire is also connected to minus filament, though never in a detector circuit.) The purpose of the wire connections is to act as conveyers to the detector tube for the radio frequency currents or inaudible frequencies of the station selected. At the detector they are to be converted into audible frequencies.

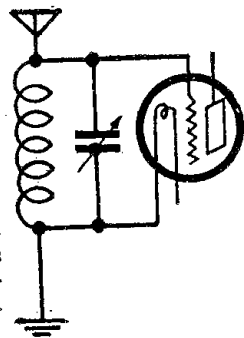

Figure 11

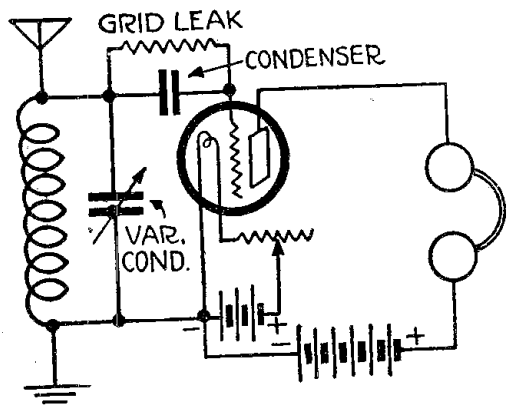

Figure 14

It is this conversion, which so mystifies those not versed in Radio technique, and which the author hopes will, following his explanation, create a profound respect for the inventors of the vacuum tube, Dr. J. A. Fleming, an English inventor, and our own Dr. Lee De Forest.

### Structure of Tube

Figure 15 is diagrammatic of such a tube, comprising an evacuated glass bulb, together with its internal elements, and their respective locations within the bulb. -F and +F represent the terminals of a continuous wire, termed a filament, somewhat similar to the filament of an

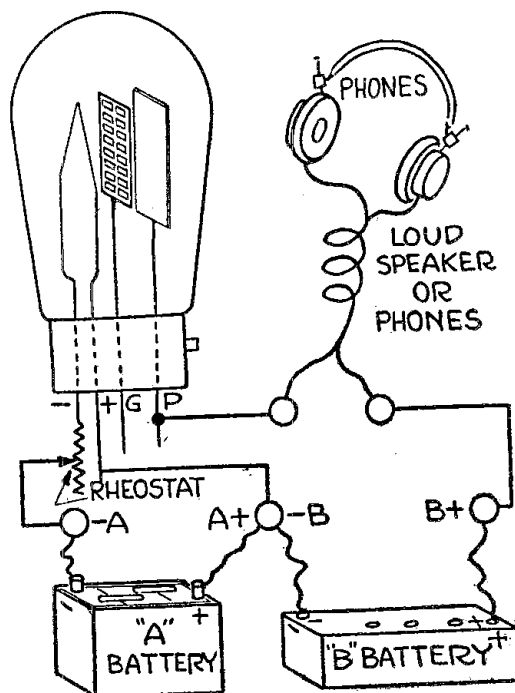

Figure 15

ordinary electric lamp; a plate (P), which as the name implies, is but a plate or sometimes a circular disc of metal, with its connecting terminal; and a grid (G), which is also of metal, but provided with several ladder-like openings in its structure. The grid is placed between the filament and the plate, the filament terminals are connected to a battery, with one arm directly connected and the other in series, with a resistance, to the opposed terminal of the battery.

Since the function of this battery, which is known as the A battery, is to supply current to heat the filament, the resistance, or rheostat is made variable in order that the current from the battery may be so regulated as to heat the filament to the desired temperature.

For a great many years prior to the invention of the vacuum tube it was known that a metallic filament or wire, when heated within a vacuum, would give off minute particles, or negative charges of electricity. These negative charges are known as electrons, and are boiled out of the filament in much the same manner as water particles are shot out from boiling hot water.

It was discovered by Dr. Fleming that

if a metallic plate, such as P in figure 15, was introduced into this vacuum and connected to a positive charge of electricity, then following the law that opposites attract, while likes repel, the negative electrons which were emitted from the filament under heat would be attracted to this positively charged plate. It was also found that the mass flow would be equivalent to a current passing over this space between filament and plate. It is this current flow which is known as the space charge. It was further noted that, while a considerable space charge would flow in the direction indicated, little if any could be made to flow in the opposite direction. Following this discovery, it was but a step in appli-

cation, to realize that the final result was a true one-way valve which, if placed in series with an alternating current, one-half of the alternations would be suppressed, thus converting it into a pulsating direct current. Such converted current is analogous to the current explained in a previous article as being used in wire telephony. An example of the space charge is given in figure 16.

### De Forest Invents Control

It is now apparent to the careful reader that the above result, of itself, would be of doubtful value, unless some means were provided to control the electron flow. Dr. Lee De Forest, America's wizard physicist, stepped into (Continued on page 24)

## The Best Radio Affords!



"A Wonder" says user:-

"The Loud Speaker is a wonder. I never heard anything like it. I put it to a little test a few nights ago and it was heard clear and loud nearly one-half mile from my place through an open window."

Burton W. Cooswell, Brockton, Mass.

# \$1.00 down!

With the Radiotone all the family can enjoy your radio at the same time!

# FREE

**Hydrometer and Voltmeter**

As an extra special offer to those who hurry their order for the Radiotone Loud Speaker offered below, we shall include absolutely free a highest grade Hydrometer to test your "A" battery and a guaranteed accurate Voltmeter to test your "B" batteries. You need these two accessories if you want to keep your radio always at its best efficiency. A genuine \$3.00 value—and given free on this special sale, while it lasts. So act quick!

## Radiotone Loud Speaker

Only \$1.00 with the coupon below brings this Genuine Radiotone loud speaker to your home on approval for 30 days! No radio is complete without a good loud speaker. Here's a first class loud speaker at an astounding rock-bottom price, direct—and on easy, monthly payments besides! Special now—Hydrometer and Voltmeter, \$3.00 value, included FREE, if you send at once.

### Makes Your Radio Complete

The Radiotone is super-sensitive, brings in distant stations with full volume so every one in the room can hear distinctly and easily. Wonderful clearness and absolute purity of tone. No distortion.

The Radiotone has a 14-inch horn made of Thorite in one piece without seam or joint, acoustically correct. This eliminates the metallic clang you often hear in other loud speakers. The reproducing unit is entirely enclosed at the base of the horn. The well balanced construction does away with all vibrations. The Radiotone has a graceful shape with a beautiful black florduline finish. It stands 23 inches high and weighs only 15 lbs. No extra batteries needed for the Radiotone—just plug it in as you do your head set. Nothing to wear out or get out of order. Sent complete with cord and plug.

## 30 Days Trial—\$3.00 a Month

**Straus & Schram, Dept. R9412 Chicago, Ill.**

Enclosed find \$1. Ship special advertised Radiotone Loud Speaker. I am to have 30 days free trial. If I keep the Radiotone, I will pay you \$3.00 monthly, total price \$25. The Radiotone is to become my property as soon as you receive the final payment. If not satisfied, I am to return it within 30 days and you are to refund my money and any express charges I paid. Hydrometer and Voltmeter FREE

Radiotone Loud Speaker No. Y8726A—\$25.00.

My Name \_\_\_\_\_ (Head of the family must sign this order. If you are not of age, have your parent or guardian order for you.)

My Street Address \_\_\_\_\_ My State \_\_\_\_\_

My Post Office \_\_\_\_\_ My City \_\_\_\_\_

My Shipping Point \_\_\_\_\_ I have lived in this Town \_\_\_\_\_ years

And before that I lived in \_\_\_\_\_ Town \_\_\_\_\_ State \_\_\_\_\_ for \_\_\_\_\_ years

Occupation is \_\_\_\_\_ Age \_\_\_\_\_ Married \_\_\_\_\_ or Single \_\_\_\_\_

Give names of merchants who know you personally

Name \_\_\_\_\_ Town \_\_\_\_\_ State \_\_\_\_\_

Name \_\_\_\_\_ Town \_\_\_\_\_ State \_\_\_\_\_

If you have ever bought goods on credit by mail, tell us from whom. If there is anything else you wish to tell us about yourself, write on a piece of paper and enclose it with this coupon. But the coupon alone, fully filled out will do.

That's all we want to know and we're ready to ship the goods at once. No formalities. No C.O.D. We trust rich and poor alike when they merely show us that they are honest.

When the Radiotone comes, there's nothing to pay. Use it freely at our risk, on trial for 30 days. See how loud, clear and distinct the Radiotone brings in all stations—better than any other loud speaker that you have ever heard, giving you the best that is in your set. After 30 days trial if you think you can get along without the Radiotone, return it to us and we will refund your dollar plus all transportation charges. No red tape. The trial costs you not a cent. But if you decide to keep the Radiotone, pay only \$3.00 a month until you have paid the total rock-bottom direct price—only \$25.00. See if you can equal this offer anywhere on such amazingly liberal terms. You'll scarcely feel those small monthly payments.

## Send Coupon NOW!

Only \$1.00 with the coupon brings the Radiotone on 30 days' trial, satisfaction guaranteed, your dollar refunded if not satisfied. Send the coupon now while this special offer lasts. Hydrometer and Voltmeter FREE, if you act quick.

**STRAUS & SCHRAM**  
Dept. R9412 Chicago, Ill.

### ABC'S OF RADIO SETS

(Continued from page 23)

the tube development at this stage, through discovering that if an additional valve, now known as the grid (G) was introduced into the tube and was placed between the plate and filament so that

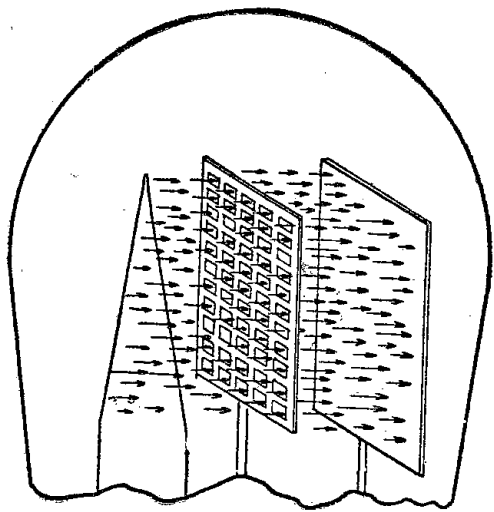

Figure 16

it would intercept and cause the electrons to pass through it on their journey to the filament, it could be made to function as an automatic gate to regulate the flow of electrons to the plate. This discovery and its application almost revolutionized the possibilities previously attributed to the vacuum tube and made ready a paved road to wonders of achievement.

The subject is much too important to

pass over without a detailed explanation of the grid element and its associated grid leak and condenser, but space demands that it be taken up in next week's article.

#### Uses of Vacuum Tube

I desire, however, to impress upon the reader's mind that, while many consider the vacuum tube as a one purpose device, its total limitations are far from realization. Its principle uses at the present time may be enumerated as follows:

1. As a detector, to rectify high frequency oscillations.
2. As an audio frequency amplifier, to magnify the feeble voice currents after they have passed the detector output transformer.
3. As a radio frequency amplifier, to build up the weak antenna signals in order that they may be rectified.
4. As an oscillator, to generate high frequency currents for both receiving and transmitting.
5. As a modulator, to mould or modulate the voice currents impressed upon the high frequency currents.

And last, but surely not least, it plays a most important part in modern surgery, diagnostic surveys of heart murmurs and lung disorders. Transcontinental, or extreme long distance telephony would be impossible were tubes not used as boosters at intervals along the line to maintain voice volume.

When a device secures such universal application, one wonders how it can be considered by the populace as "but a bulb." Surely the world moves rapidly.

(Next week Mr. Gurney will explain the fundamentals of the grid leak and condenser, which should prove very interesting for those who do not know why or how their receiver functions.—Editor's Note.)

## Radio Restores Hearing of Young Lady Who Knew World as Place of Silence

For Twenty-Two Years, Miss Elsie Hayes, Winnipeg Girl, Could Not Distinguish Sound Until Ear Phones Brought Music and Awakened the Aural Sense

WINNIPEG, Man.—For twenty-two years, Miss Elsie Hayes, 25-year-old book bindery worker of Winnipeg, knew the world as a place of silence. Today, due to Radio, she has begun to hear some of the things that are going on about her, and has hopes that gradually the nerves of her ears, long in disuse, will begin to function again.

Radio, the miracle science, is credited with responsibility for at least the beginning of Miss Hayes' return to hearing, for it was when induced to listen to music broadcast from Station CNRW, the Canadian National Railway's station at the Fort Garry hotel, Winnipeg, that Miss Hayes first was able to distinguish the sound of orchestral selections and later solo numbers which were on the program.

#### Sickness Caused Deafness

When 3 years old, Miss Hayes was stricken with bronchitis and pneumonia, followed by pleurisy. These attacks left in their wake paralysis of the nerves of the ear, and the little girl who had previously been "brimful of music," according to her mother, was found to be deaf. Gradually she lost also the power of speech, except for an occasional sound.

#### Distinguishes Program

Having read of many experiments wherein it was claimed Radio had assisted deaf persons in recovering their hearing, H. J. Metcalfe, a friend of the Hayes family, arranged for Miss Hayes and her mother to visit his home when Station CNRW was broadcasting a special program. As the broadcast proceeded, the deaf girl began to beat time and move with the rhythm of the numbers. It was obvious that Radio had penetrated the veil of silence which had hung over her life for two decades. Then, as the program closed, Mrs. Hayes spoke to her daughter. The girl turned at the sound of a human voice and nodded her recognition, then she uttered a sound which was very close to the word "mother."

On the following morning, as she left her home to go to work in the book bindery of a Winnipeg publishing establishment, Elsie Hayes heard the rumble of a passing street car for the first time.

#### Hope to Train Nerves

Her next sound of music came when friends played a phonograph with a loud needle and the girl was able to distinguish the sound of the records. After carrying on her conversations for twenty-two years by means of words written on a pad of paper, her friends have hopes that in time her aural nerves may be trained to function again; at least well enough that she may hear some of the things going on about her.

Scientists and local ear specialists say there is no reason why this should not have occurred, but to them it is no miracle; it is a combination of concentration and psychology. With the Radio headsets over her ears, Miss Hayes was concentrating on her hearing in a way

that she had not done for years, and since the aural nerves had not gone, but hearing was really possible, she received the necessary vibrations to allow her to distinguish sounds again.

#### Second Case on Same Set

WINNIPEG, Man.—J. A. Bennett, a composer, deaf since childhood, heard Radio for the first time recently when he listened in to CKY at the home of H. J. Metcalfe. This is the second experiment which has been tried by a deaf person on Mr. Metcalfe's Radio. Miss Elsie Hayes has had a similar experience; though she had been deaf since 3 years of age. Mr. Metcalfe is a photographer by profession and an amateur Radio fan. His set is a three-tube, one he assembled himself.



## Learn to Play a Harmonica via Radio

To stimulate interest in good music by teaching people to play instead of merely listen, a series of harmonica programs and lessons, known as the "Hohner Harmony Hour," are being broadcast through Stations WEAJ, New York; WJAR, Providence; WEEI, Boston; WOO, Philadelphia; WCAP, Washington; WGR, Buffalo; and WWJ, Detroit.

In addition to the musical numbers, ranging from the "bluest" of jazz selections to classical and operatic compositions, a series of harmonica lessons are broadcast by a well-known instructor.

If you want to enjoy one of the most popular features "on the air" and learn to play a harmonica for pleasure or profit, procure a copy of the Free Instruction Book and "tune in" for the "Hohner Harmony Hour." If your dealer cannot supply you Address M. Hohner, Inc., Dept. 233, 114 East 16th St., New York.



# Photogravures of Your Favorite Artists GALLERY of RADIO STARS

Suitable for Framing or Placing in Your Album

BY SPECIAL arrangement, Radio Digest is able to offer its readers a great opportunity to secure fine photogravures of their favorite Radio stars at practically no cost.

Radio fans will be able now, by this very special offer, to have pictures of their favorite artists and announcers before them when they listen in.

All that is necessary to secure photogravures from the Gallery of Radio Stars is to send the coupon published each week in Radio Digest, accompanied by ten cents to cover the cost of mailing and postage. Where a series of three photogravures is desired, it will only be necessary to send twenty-five cents and three consecutively numbered coupons clipped from Radio Digest. Remittance must accompany the coupon. Cash at your risk. Add 5 cents to personal checks for exchange.

WITH COUPONS Only 10c Each -- 3 for 25c To cover cost of mailing and postage



Size Eleven by Fourteen Inches

## Select Your Favorites from the Gallery of Radio Stars

- |  |  |
|--|--|
| 1 Wendell Hall, king of ukulele ditties                  | 26 Correll and Gosden of "Kinky Kids Parade" fame, at WEBH and other stations. |
| 2 Graham McNamee, 1925 Gold Cup announcer                | 27 Norman Brokenshire, popular at WRC, WJZ                                     |
| 3 Jack Little, popular wandering balladist               | 28 Indiana Male Quartet, popular at WEBH                                       |
| 4 Paul Small, who won fame through Radio                 | 29 Jane Novak, Blues Singer of Twin Cities, WCCO                               |
| 5 Coon-Sanders' "Nighthawks" at KYW                      | 30 Jean Sargent, the original, now at WHT                                      |
| 6 George Hay, 1924 Gold Cup announcer                    | 31 Ralph Emerson, popular organist at WLS                                      |
| 7 Harmony Girls, Edith Carpenter, Grace Ingram           | 32 Edna Adams, "Sweetheart of the Air" at KPRC                                 |
| 8 Ford and Glenn, Lullaby Boys of WLS                    | 33 Pat Barnes, vaudeville announcer at WHT                                     |
| 9 "Roxy" Rothafel of WEAJ chain fame                     | 34 R. V. Haller of KGW Hoot Owls fame  |
| 10 The Hired Hand, famous "Substitute Announcer" of WBAP | 35 Henry L. Dixon, ukulele wizard of KYW                                       |
| 11 Britt and Finch, popular songsters                    | 36 Quin Ryan, WGN's Uncle Walt and sports announcer                            |
| 12 Bob Emery, Big Brother of WEEI                        | 37 "Willie the Weeper," Ernest Rogers, WSB                                     |
| 13 "Bill" W. G. Hay, ex-KFKX, now of WLIB                | 38 Walter Wilson, "Uncle Bob" of KYW   |
| 14 Happiness Boys, jovial singers of WEAJ                | 39 Jack Chapman of Drake hotel repute  |
| 15 Lambdin Kay, "Little Colonel" of WSB                  | 40 Ray-O-Vac Twins, known country-wide   |
| 16 Leo Fitzpatrick, "Merry Old Chief," WJR               | 41 Art Linick, KYW's Mrs. Schlagenhauer  |
| 17 Henry Field, 1925 Gold Cup runner-up                  | 42 Fred Hamm of WTAS, now WLIB, fame   |
| 18 Al Carney, organ favorite at WHT                      | 43 Meyer Davis' Le Paradis orchestra of WRC                                    |
| 19 Aunt Jane, ladies' adviser at WOC                     | 44 "Senator Schultz, WLW's illiterate comic                                    |
| 20 Vincent Lopez, No. 1 Pennsylvania orchestra           | 45 "Uncle John" Daggett of KHJ   |
| 21 E. L. Tyson, pleasing voice at WWJ                    | 46 D. R. P. Coats, 1925 Silver Cup announcer                                   |
| 22 S. W. Barnett, ex-WOC, now WBAL                       | 47 Gene Rouse, WOAW's popular announcer  |
| 23 Art Gillham, "The Whispering Pianist"                 | 48 Freda Sanker, WKRC jazz orchestra director                                  |
| 24 Paul Greene, announcer at WSAI, "bridge voice"        | 49 Irish Ruth Payey, KOA's invisible stage beauty                              |
| 25 Harry Ehrhart, "Dream Daddy" of WLIT                  | 50 Queen Titania, star of KHJ Fairyland  |

If your favorites are not in this list, send in a request to have them included in the Gallery of Radio Stars.

### COUPON Numbers 6 and 7

This coupon entitles the holder to one photogravure selected from the Radio Digest Gallery of Radio Stars when accompanied by ten cents to pay the cost of mailing and postage, or two photogravures when accompanied by 20 cents.

This coupon together with either coupon number 5 or 8 will entitle the holder to three photogravures when accompanied by 25 cents. Remittance must accompany the coupon. Cash at your risk. Add 5 cents to personal checks for exchange.

Order by Number.....  
Radio Digest Publishing Co., 510 N. Dearborn St., Chicago

# SPECIAL LINCOLN PROGRAMS FRIDAY

## Thursday, February 11

**KHJ, Los Angeles, Calif. (405.2m-740kc), 6-6:30 p. m.,** Leighton's Arcade cafeteria orchestra, Jack Cronshaw, leader; 6:30-7:30, history story, Prof. Hertzog; Dickie Brandon, screen juvenile, Jeanne de Bard, Sunny Jane Hughes and Uncle John; 7:45, health talk, Dr. Philip M. Lovell; 8-10, program, Builders' Finance association.

**KMTB, Hollywood, Calif. (238m-1260kc), 5-6 p. m.,** movie hour, Mammy Simmons and pupils of Carter Weaver in continuity program; 6-7, Starr Piano company studio; 7:30, bridge lesson, Bertie D. Hill and; 8-10, the Turner orchestra, direction Loren Powell, Mrs. Edward Crossman, contralto.

**KNX, Hollywood, Calif. (336.9m-890kc), 5-5:30 p. m.,** Sunny Jim's talk; 5:30, First Presbyterian church organ; 5:55, Town Tattler; 6:15, travel talk, W. F. Adler; 6:30-7, Atwater Kent concert orchestra; 7-8, program, H. L. Crockett company, Ilya Bronson, concert cellist; May McDonald Hope, pianist and Corinne Reed, soprano; 8-9, program, Willys-Overland dealers of Southern California; 9-10, courtesy program; 10-11, Ambassador hotel dance orchestra.

**KPO, San Francisco, Calif. (428.3m-700kc), 7, 7:30, 8 a. m.,** daily dozen exercises; 10, domestic science, Virginia Tappan; 1-2 p. m., Rudy Seiger's Fairmont hotel orchestra; 2:30-3:30, matinee program; 3:30-4:30, Cyrus Trobber's Palace hotel concert orchestra; 5:15-9:15, children's hour stories, Big Brother; 6:40-7, Waldemar Lind and the States Restaurant orchestra; 7-7:30, Rudy Seiger's Fairmont hotel orchestra; 8-9, program, Frederick C. Nodder and the Radio Eight symphony orchestra, George Von Hagel, director; 9-10, program, Folsom Craig duo, male quartets, duets; 10-11, Cabrera cafe orchestra, Jack Coakley, director.

**KPSN, Pasadena, Calif. (315.6m-950kc), 8-9 p. m.,** Star-News program, Pasadena Chamber of Commerce.

**KTAB, Oakland, Calif. (240m-1250kc), 9-9:30 a. m.,** prayer service, Rev. G. W. Phillips; 12-1 p. m., luncheon concert; 8-10, program.

## Friday, February 12

### Headliners Today

Eastern 8 p. m.	Central 7 p. m.	Mountain 6 p. m.	Pacific 5 p. m.
WAHG (315.6m-950kc) Famous organist.	WBAL (246m-1220kc) Scottish Rite choir.	8:15 7:15 6:15 5:15	
KDKA (309.1m-970kc) Lincoln's Birthday program.	WPG (299.8m-1000kc) Wildwood glee club.	8:30 7:30 6:30 5:30	
KPNF (263m-1140kc) Patriotic program.	KOHL (278m-1080kc) Lincoln's Birthday program.	9 8 7 6	
WJZ (454.3m-660kc), WBZ (333.1m-900kc) Victor hour.	WMAQ (447.5m-670kc) Drinkwater's play, "Lincoln."	9 8 7 6	
WNYC (526m-570kc) American Composers recital.	10 9 8 7		
KTHS (374.8m-800kc), Best loved ballads.	WGY (379.5m-790kc) "For Love of Country," melodrama.	10 9 8 7	
WLIT (394.5m-760kc) Morning Glory club concert.	10:15 9:15 8:15 7:15		
KOA (322.4m-930kc) Lincoln's Birthday program.	10:30 9:30 8:30 7:30		
KTHS (374.8m-800kc) Jack-o-Lantern night club frolic.	11 10 9 8		
KHI (405.2m-740kc) Lincoln's Birthday program.	KPO (428.3m-700kc) Lincoln's Birthday program.	11:45 10:45 9:45 8:45	
WSB (428.3m-700kc) American Georgia program.	1:30 a. m. 12:30 a. m. 11:30 10:30		
KGW (491.5m-610kc) Hoot Owl frolic.			

Friday, silent night for: CFAC, CHIC, CKNC, CKY, CNCR, CNRM, CNRO, CNRR, CNRW, KFAU, KFEO, KFKU, KFMQ, KFWA, KFXF, KGO, KFAU, KPRC, KUOM, PWX, WBBR, WCAD, WCBD, WEAO, WEBW, WGBS, WGST, WHAZ, WIP, WJAZ, WKRC, WLW, WLWL, WNAD, WRC, WREG, WRVA, WSAI, WSUI, WSMB, WTAM.

### Eastern Time Stations

**CNRT, Toronto, Can. (356.9m-840kc), 6:30 p. m.,** Luigi Romanelli and his King Edward hotel concert orchestra; 8, address, R. H. Fish; 9, Ye Olde Tyme Village quartet; Pearl Carter, reader; Evan O. Withrow, violoncellist; 11, Luigi Romanelli and his King Edward hotel dance orchestra.

**KDKA, Pittsburgh, Pa. (309.1m-970kc), 7:15, 8 a. m.,** exercises, O. Shannon; 5:45 p. m., Auntie Jim's letter from across the sea; 6:30, dinner concert; 8:15, Lincoln's Birthday program; "Lincoln's Second Inaugural Address," W. M. Parrish; Little Symphony orchestra, Victor Saudek, conductor, Civil war melodies; 9, Teaberry time.

**WABQ, Haverford, Pa. (261m-1150kc), 11 p. m.,** Ardmore theater program; William Stewart, pianist, Horace Hustler, organist.

**WAHG, Richmond Hill, N. Y. (315.6m-950kc), 12:03 p. m.,** music; 7:30-7:45, Lincoln's Birthday program; Prof. R. E. Mayne; 8-8:45, Fifteenth Great Artist organ recital; William Edward Zouch, organist; 9, Shackley ensemble; 10:03, studio program; 10:30, Bernice Fletcher's orchestra.

**WBAL, Baltimore, Md. (246m-1220kc), 6:30-7:30 p. m.,** WBAL dinner orchestra, Robert P. Lutz, conductor; 7:30-8, WBAL male quartet; 8-9, musical program; concert, Scottish Rite choir, male and female ensemble, Edgar T. Paul, conductor.

**WBZ, Springfield, Mass. (333.1m-900kc), 6:30 p. m.,** Little Symphony orchestra, KDKA; 7, music story hour, Helen S. Leavitt; 7:30, "Appreciation of Music," Prof. John A. O'Shea; 8, concert, Edwin J. McInelly's orchestra; 8:30, concert, Boston, Samuel Seiner, director, with group from Boston symphony orchestra; 9, Victor hour of music, WJZ, WGY; 10:35, McInelly's orchestra.

**WCAP, Washington, D. C. (468.5m-640kc), 6:45-7:45 a. m.,** health exercises; 6-12 p. m., dinner hour concert, Mozart string quintet; Sir Hobgoblin story, Blanche Elizabeth Wade, story-teller; talk; dance music.

**WCAU, Philadelphia, Pa. (278m-1080kc), 7:30, recital,** N. Shenelberg and company; 8, concert; 8:15, chiro-practic talk; 8:30, Singing Grounds; 8:45, The Bryan Girl; 9, novelty songs; 9:15, Dwight Strickland, the "poetician"; 9:30, The Sea Gulls; 10, Willie Horowitz, songs and jests; 10:30, Jack Myers' Musical Architects.

**WCX, Detroit, Mich. (516.9m-580kc), 6-7 p. m.,** Gold-kette ensemble; 9-10, studio program; 10-11, Gray-stone ballroom; Jean Goldkette's Breeze Blowers and his Victor Recording orchestra.

**WEAF, New York, N. Y. (491.5m-610kc), 6:45-7, 7:20 a. m.,** tower health exercises; 10:45-12, musical program; 4-5 p. m., Mary Killoran, soprano; William Scott and his Club Florida orchestra; 6-12 midnight, dinner music, Hotel Waldorf-Astoria; Gene Ingraham's Great Notch Inn orchestra; Thomas Hughes, pianist; "Sir Hobgoblin" talk, Blanche Elizabeth Wade; "Happiness Candy Boys"; Eagle Neutrodyrn trio; Douglas Harmony quartet; Issay Lukashevsky, violinist; Chamber musicale with Grace Leslie, contralto and Carl Rollins, baritone; Ben Bernice and his Hotel Roosevelt orchestra.

**WEAR, Cleveland, Ohio (389.5m-770kc), 7 p. m.,** Wornack's Singing synopsators; 7:30, children's program; 7:45, talks; 8:15, studio program; 9, Cities service program, WEAP; 9:30, studio program; 10, Wornack's singing synopsators.

**WEBJ, New York, N. Y. (272.6m-1100kc), 7-7:30 p. m.,** Astoria Collegians, Bill Enersen, director; 7:45, Edna Josephs, concert pianist; 8, A. B. Jacobsen, baritone; 8:15-8:30, Leon H. Fox, concert violinist; 8:45, Henryetta Turner, ukulele girl.

**WEEI, Boston, Mass. (348.6m-860kc), 6:30 p. m.,** Joe Rines and his Hunters' Cabin orchestra; 7, Big Brother club; 7:30, Whiting's Grand A entertainers; 8, Sager's half hour of hospitality; 8:30, Neapolitan Ice Cream company program; 9, music; 9:30, Carter's Inca; 10, Imperial marimba band.

**WFI, Philadelphia, Pa. (394.5m-760kc), 1 p. m.,** Tea room ensemble; 3, address, Hon. Albert W. Johnson, federal judge; 3:15, de Keller Stoney, reader; 6:30, Bellevue Stratford concert orchestra; 7, Bellevue Stratford dance orchestra.

**WGBS, New York, N. Y. (315.6m-950kc), 1:30 p. m.,** special school children's program; 3:15, Joseph Lewis; A. G. Robyn, theory lessons; 6:30, Anzell's orchestra.

**WGCP, New York, N. Y. (252m-1190kc), 3 p. m.,** Samuel Weber, pianist; 3:20, Sherman and Neal; 3:45, Charol Thome, pianist; 4:15, Ruby Cowan, songs; 4:30, Ora Welsh, pianist; 5:10, Clarence Profit, pianist; 7, orchestra; 7:30, studio program.

**WGY, Schenectady, N. Y. (379.5m-790kc), 2 p. m.,** Asia Restaurant orchestra; 2:30, music, health notes; one-act play, "Sold," Kitty Cambridge, WGY matinee players; 6:30, International Sunday School lesson; 7, dinner program, Eastman theater; 7:30, health talk; 7:35, French lesson, Leon A. Huguemont; 8:15, "An Interpretation of Lincoln, the Great Emancipator," Rev. Lincoln Caswell; 9, Victor hour of music, WJZ; 10, melodrama, "For Love of Country," WGY players, Ten Eyck Clay, director.

**WHAR, Atlanta City, N. J. (275m-1090kc), 2 p. m.,** Seaside hotel trio; 8, Seaside hotel trio; 11:15, Strand theater organ recital.

**WHN, New York, N. Y. (361.2m-830kc), 6 p. m.,** Littman's dinner music; 6:30, Daddy Dingle and His Jingle Machine; 6:45, Littman's dinner music; 7, Harry Richman and his entertainers; 7:30, Lew Brown and Sidney Claire; 10, Roseland dance orchestra; 10:30, Anatol Friedland; 12-12:30, Silver Slipper orchestra.

**WIP, Philadelphia, Pa. (508.2m-590kc), 6:45 a. m.,** setting-up exercises; 7, setting-up exercises; 1 p. m., Ghubel tea room orchestra; 3, "The Determination of Celestial Distances," Dr. Samuel G. Barton; 6:05, Benjamin Franklin concert orchestra; 7, Uncle Wip's bedtime stories; songs by Mary and Helen Leedom.

**WJR, Pontiac, Mich. (516.9m-580kc), 7 p. m.,** Jean Goldkette's Petite symphony orchestra; 7:30, Artie Condon trio; 8, Jean Goldkette's serenaders.

**WKAQ, San Juan, P. R. (340.7m-860kc), 6-8 p. m.,** talks, Porto Rican Athenaeum.

**WKAR, Lansing, Mich. (285.5m-1050kc), 7:15-8 p. m.,** farm crops course.

**WLIT, Philadelphia, Pa. (394m-760kc), 12:02 p. m.,** daily almanac; Stanley theater organ recital; Aradia cafe concert orchestra; 2, Aradia cafe concert orchestra; 4:30, recital; 7:30, Dream Garden's bedtime stories; 8, sports talk; 8:30, recital; 10, Morning Glory club concert; Aradia cafe dance orchestra; 10:30, Rufus and Rastus; 11, continuation of Morning Glory club concert.

**WMAK, Buffalo, N. Y. (266m-1130kc), 7:15 p. m.,** daily news.

**WMBF, Miami Beach, Fla. (384.4m-780kc), 7-9 p. m.,** Pleetwood Radio orchestra; Al Wohlman and Dave Bernie.

**WMCB, New York, N. Y. (340.7m-880kc), 6-7 p. m.,** Oleott Vail and his Hotel McAlpin string ensemble; 7:30-8:30, Sach's Musical Monarchs; 8:50-9, Broadway association; 9, Harman hour of music; 10:10-10:30, Donald Flamm, dramatic critic and Mr. Zero; 11:30-12, Jack Denny and his Frivolity orchestra.

**WNYC, New York, N. Y. (526m-570kc), 6:20 p. m.,** piano selections; 6:30, French lessons; 8, Bernard Baslow, pianist; 8:30, Rudolph Joskowitz, violinist; 9, American composers' recital; 10:10, "Books That Everyone Should Know," Prof. Carter Tropp.

**WOO, Philadelphia, Pa. (598.2m-590kc), 11 a. m.,** organ recital; 12:02 p. m., Golden's crystal tea room orchestra; 7:30, "Sir Hobgoblin," Blanche Elizabeth Wade; 7:45, address; 8, WOO concert orchestra; 9, concert; 9:30, Fox theater orchestra; 10, organ recital; 10:30, Sylvania dance orchestra.

**WPG, Atlantic City, N. J. (299.8m-1000kc), 6:45 p. m.,** Arthur Scott Brook, organist; 7, Hotel Morton dinner music; 8, Lincoln's birthday address, Hon. Frank Smith; 8:15, Wildwood glee club; 9, Hotel Traymore concert orchestra; 10, James Salt Water Taffy Boys' dance orchestra; 11, Jean Wiener, organist.

**WRC, Washington, D. C. (468.5m-640kc), 12 m.,** Otto F. Beck, organist; 1, Meyer Davis' New Willard hotel orchestra; 3:30, U. S. Marine band, WJZ; 6, W. Spencer Tuppen's Hotel Mayflower orchestra; 5:45, book review, Alice Hutchins Drake.

**WREG, Lansing, Mich. (285.5m-1050kc), 6-7 p. m.,** m. dinner concert, Speed-Wagon serenaders; Gold Standard ensemble.

**WTAG, Worcester, Mass. (268m-1120kc), 10:30 a. m.,** musical selections; 12:05-2 p. m., noonday luncheon music, WTAG, Will Hardy, director; 3-5, Tea Dance music; 7:10, Twinkle Twinkle story teller; 7:30-7:45, stories, Blanche Elizabeth Wade, WEAP; 7:45, "Mechanics of Speech," Meta B. Wade; 8, current events for the blind and shut-ins, Gwendoline Albee.

**WTAM, Cleveland, Ohio (389.4m-770kc), 12:15-1:15 p. m.,** lunch hour music, Guy Lombardo and his Royal Canadians; 6-7, Austin Wylie's Vocalion Recording orchestra.

**WTC, Hartford, Conn. (475.9m-630kc), 12:05 p. m.,** Travelers club orchestra; 6:30, Harrio; 7:45, Anita Bird, soloist; 8, "Dress of the Soldier," T. G. Blakeley; 8:15, Anita Bird, soloist; 8:30, "Noah's Ark Follies," Junior league; 11, Le Bal Tabarin orchestra.

**WWJ, Detroit, Mich. (352.7m-850kc), 12:05 p. m.,** Jules Klein's Hotel Statler orchestra; 3, Detroit News orchestra; 6, dinner concert; 8, News orchestra; 9, dance program.

### Central Time Stations

**KFAB, Lincoln, Nebr. (340.7-880kc), 8:30-10:30 p. m.,** Doane college school of music.

**KFNF, Shenandoah, Iowa (269m-1140kc), 7 p. m.,** discussion, Sunday school lesson; 7:30, patriotic program, Mr. Pearson, director.

**KFRU, Columbia, Mo. (499.7m-600kc), 4:30-5:30 p. m.,** Bella Vista Quardrange orchestra; 6:15, dinner program, students of the Stephens college conservatory; 7, Radio school; talk, E. M. Harmon; 12-2 a. m., musical program, faculty of the Stephens college of music; Bella Vista Quardrange orchestra.

**KLDS, Independence, Mo. (440.9m-680kc), 6:30 a. m.,** morning devotional service.

**KMA, Shenandoah, Iowa (252m-1190kc), 6-7 p. m.,** How-do-you-do-Boys; 9-11, Maryville State Teachers' college.

**KOIL, Council Bluffs, Iowa (278m-1080kc), 6:30 p. m.,** Fontenelle orchestra; 7:15, Jack Mellotone, poet; 7:30, Lincoln's Birthday, Eleanor S. Smith, director; 11, organ recital; 11:30, entertainers.

**KSAC, Manhattan, Kans. (340.7m-880kc), 9-9:25 a. m.,** music, inspirational talks, agricultural primer, callisthenics; 9:55-10:25, readings, backyard gossip, question box; planning today's meals; 12:35-1:05 p. m., readings, question box; 4:30-5, Lessons in Color and Design; 6:30-7:30, travelogue; Extension credit course, Vocational Education; Extension course, "The Return of the Towns"; "Types of Radio Receiving Sets."

**KSD, St. Louis, Mo. (545.1m-550kc), 7 p. m.,** fur hour, Blanche Herriek Hopkins, contralto; 7:30, commerce hour, Dorothy Coates Coe, harpist; 8, Cities Service program, WEAF.

**KSO, Clarinda, Iowa (242m-1240kc), 12:30-1:15 p. m.,** concert; music; garden club; Sunday school lesson; dinner concert; 7-7:30, music; 7:30-9, Bankers' music makers; 9-9:30, Baker and Anderson.

**KTHS, Hot Springs National Park, Ark. (374.8m-800kc),** 9-9:30 p. m., best loved ballads, Meyer Davis' orchestra; 9:30-10:30, Phil Baxter, Jack-o-Lantern night club frolic; 10:30-10:45, Eastman hotel orchestra.

**KYW, Chicago, Ill. (536m-560kc), 11:35 a. m.,** table talk, Mrs. Anna J. Peterson; 12:05-1 p. m., concert, Commonwealth Edison company; 1, Joska DeBabary and his orchestra; Coon-Sanders orchestra; 4-5, woman's hour, Mary Casey, director; 6, dinner hour, KDKA, WBZ, KYW, KFKX; 9, hour of music, Commonwealth Edison company; 10-12:30, midnight revue, Paul Ash and his orchestra; Coon-Sanders orchestra; Henri A. Keates, organist; 1, Insomnia club.

**WAFD, Port Huron, Mich. (275m-1090kc), 8-10 p. m.,** old-time dance music.

**WAMD, Minneapolis, Minn. (244m-1230kc), 12 m.,** musical program, Dorothy Vanesek, soprano; Hazel Stageberg, pianist; Cornelius Schwarbel, violinist; Joseph Rudolf, accompanist; 7:10, music, Ruth Anderson; 8, Reception Five program; 11, Skyrocket frolic, G. Osborn and his orchestra.

**WBBM, Chicago, Ill. (226m-1330kc), 4-6 p. m.,** Valentine Inn orchestra; artists; 8-10, Tip trio; Moulin Rouge orchestra; artists; Verdi trio.

**WBCN, Chicago, Ill. (266m-1130kc), 10-10:30 a. m.,** Penny Wise, the shopper's ready helper, shopping talk; 11:15 p. m., police bulletins; 7-8, fireside hour; WBCN hobby club; George H. Cleveland, "Big Boy" Yagle, pianist; Will Rosstter, "Daddy of Song Publishers," tenor and songwriter; Harold Johnson, boy xylophonist; 11-12, request program; Midway Dancing Gardens orchestra; Eddie Matts and Billy Donovan, tenor and pianist; West End Harmony boys, instrumental duo; Ed Dempsey, "Silken-Voiced Tenor"; Alice McMahon, contralto; "Big Boy" Yagle, pianologist.

**WCAL, Northfield, Minn. (336.9m-890kc), 8:30 p. m.,** "The Life of Abraham Lincoln," Dr. George Weida Spohn.

**WCCO, Minneapolis-St. Paul, Minn. (416.4-720kc), 12 m.,** noon concert, Dick Long's Dayton trio; 2:30 p. m., afternoon concert, Dick Long's Nankin cafe orchestra; 4, readers' club, Mrs. Walter Stevens; 6:15, dinner concert, Wesley Barlow's Nicollet hotel orchestra; 8, health talk; 8:15, musical program; 10:05, dance program, Dick Long's Nankin cafe orchestra.

**WDAF, Kansas City, Mo. (365.6m-820kc), 6-7 p. m.,** "The Tell-All Story," address; The Trianon ensemble; 8-9:30, Baker university founders' day program; 11:45-1 a. m., Ted Woem's Victor Recording orchestra; Eddie Kuhn's orchestra.

**WDD, Chattanooga, Tenn. (256m-1170kc), 6:30-7 p. m.,** organ music, Tivoli theater; 7-8, Hotel Patten orchestra; 8:15, special features and program; 11, popular request.

**WEBH, Chicago, Ill. (370.2m-810kc), 7 p. m.,** Oriole orchestra; 8, Pauline Sachs, soprano; Eleanor Kaplan, violinist; 9-9:45, WEBH Light Opera company; 11, Oriole orchestra; 12:30, Irene Beasley, Jack Penewell, Fred Palmister.

**WFAA, Dallas, Tex. (475.9m-630kc), 3:30-4 p. m.,** program; 4:30-5, Joe Strother, pianist; 6:30-7:30, Ford's Texas trumpeters; 8:30-9:30, George T. Cobb.

**WGES, Oak Park, Ill. (250m-1200kc), 5-7 p. m.,** duo, mezzo-soprano, quartet, organ; 8-9, orchestra, pipe organ, soprano, tenor, pianist; 11-1 a. m., banjo friends, organ, Coyne orchestra, comedian, "Uke Girl."

**WGN, Chicago, Ill. (302.8m-990kc), 10-10:20 a. m.,** good health and training; 10:20-11, entertainment for shut-ins; 12:40-2:30 p. m., luncheon concert, Drake concert ensemble; 2:30-3, Lyon and Healy artists' series; 3:30-4:15, tea time music, Marshall Field's tea room orchestra; 5:30-5:57, Skeezix time; 6:30-7, dinner concert, Drake concert ensemble; 8-9, music hour; 9-10, popular program; 10-10:10, Sam 'n' Henry; 10:10-10:20, old-time favorites; 10:20-11, dance program.

**WHAD, Milwaukee, Wis. (275m-1090kc), 11 a. m.,** pianologue, Andy Hertel; 4 p. m., Ira Schnell, baritone; 6-7, Arthur Richter, organist; 7, Bill Juhrer's Radio cartoon game; 8:30-10, Wisconsin theater revue; 35-piece Wisconsin theater concert orchestra; Dexter's Wisconsin radio orchestra.

**WHAS, Louisville, Ky. (399.8m-750kc), 1-2 p. m.,** Royal Peacock orchestra; 3-3:30, Mrs. Myrtle Bulks Zahn, Jr., organist; 4-5, Music Box; 7:30-9, Louisville Music and Radio company.

**WHO, Des Moines, Iowa (526m-570kc), 7:30-9 p. m.,** program, Des Moines Credit Men's association; 11-12, Bankers Life Corn Sugar orchestra.

**WHT, Chicago, Ill. (309.8m-790kc), 6 p. m.,** Al Carney, organist; Grayling's string trio; Lillian Knowles, Ruth Rauh, pianist; 6:50, Ray-O-Vac program; 7:45-9:15 (238), musical features; 9:30 (399.8), Dutch Master entertainers; 10:05, Loftis half-hour of dance music; 12, Your hour league.

**WIBO, Chicago, Ill. (226m-1330kc), 10-11 a. m.,** shopper's bureau; 2-4 p. m., popular program for shut-ins; 6-8, dinner concert, Walter Preston; WIBO trio; Rae McKay, Otis Pike, jester.

**WJJD, Mooseheart, Ill. (370.2m-820kc), 4-5 p. m.,** Mooseheart hour; music, younger children; daily assembly of 1,256 children; faculty talks; 6-7, instrumental hour, Howard L. Peterson playing Geneva organ; Palmer symphonic players; Palmer House Victorians; 8-9, Mooseheart children's hour, music, children of all ages, solos, band, etc.; talk, Matthew P. Adams; 11-11:30, R. V. Thom, bass; John Rankel, tenor; 12:30-1:30 a. m., setting-up hour, Garod studio, Palmer House; Palmer House Victorians.

**WKAF, Milwaukee, Wis. (261m-1150kc), 10-11 p. m.,** Seventh Day Adventists' quartet; Mrs. E. A. Keppler, violinist; Mrs. A. J. Werner, pianist.

**WLIB, Chicago, Ill. (302.8m-990kc), 7-8 p. m.,** dinner concert; 11-1, popular program, Correll and Gosden and the Drake hotel dance orchestra.

**WLS, Chicago, Ill. (344.6m-870kc), 12 m.,** Ford and Glenn; 6, R. F. D. school program; Ford and Glenn; 7, Ford and Glenn lullaby time; 7:15, studio trio; 7:15, Wallace Bruce Amshary in poems of "Lincoln"; 8, Rodeo hour presents chorus of 42 voices; 8:30, Ford and Glenn; 9, Ruth Etting; 9:15, Thurlow Luriance, composer of Indian music, with assisting artists; 10, Ford and Glenn; music shop; 11, Paul Ash and his gang; 12, Ralph Emerson surprise program.

**WLW, Cincinnati, Ohio (422.3m-700kc), 7:30 a. m.,** healthful exercises, Y. M. C. A.; 8, morning devotions, auspices of Parkway Y. M. C. A.; 12:05 p. m., organ concert, Lincoln's Birthday program; 12:30, Hotel Gibson orchestra.

**WMAQ, Chicago, Ill. (447.5m-670kc), 12:25 p. m.,** Y. M. C. A. forum; 1, Radio farm school; 2, shut-in program; 4, "The Preschool Child"; 4:15, health talk, Charlotte Walls; 4:30, "Follies of the Moment," Mrs. Graham Aldis; 4:45, Child-life stories; 5:15, Topsy-Turvy time; 6, organ; 6:20, Family Altar league; 6:30, Wide-Awake club; 8, "Drinkwater's play, "Lincoln," WMAQ players.

**WMAZ, Macon, Ga. (261m-1150kc), 8-9 p. m.,** morning music club; 9-10, Pilot club; 10-11, Wesleyan college student night.

**WMBB, Chicago, Ill. (250m-1200kc), 7-8 p. m.,** Trianon duo; Frank Borden, baritone; "Old Virginia Colonel," Frank Chaplin; Preston Graves, pianist; 9-11, Trianon orchestra, Dell Lampe, conductor; Woodlawn theater orchestra, Armin F. Hand, conductor; Eddie Matts and Billy Donovan, William Lightfield, Walter Duffy, Earl Smith, popular program.

**WMC, Memphis, Tenn. (499.7m-600kc), 7:15 p. m.,** bedtime stories; 8:30, Cooper's Hawaiians; 11, midnight frolic, Bob Miller.

**WOAI, San Antonio, Tex. (394.5m-760kc), 8:30 p. m.,** San Antonio Express-Evening News program.

**WOAN, Lawrenceburg, Tenn. (282.8m-1060kc), 9-10 p. m.,** male quartet and orchestra, Y. M. Cornelius, director.

**WOAW, Omaha, Nebr. (526-570kc), 6 p. m.,** music review, Hester Bronson Cooper; 6:20, Francis Potter's banjo orchestra; 6:50, Gilbert Jaffy and his Little symphony; 9, classical; 10:15, Frank Hodek and his Nightingale orchestra.

**WOC, Davenport, Iowa (483.6m-620kc), 8-9:30 p. m.,**

Davenport Industrial commission program; 9:30-10:30, travel talk.

**WOI, Ames, Iowa (270m-1110kc), 12:30 p. m.,** college chimes.

**WOK, Chicago, Ill. (217.3m-1380kc), 4:30-7 p. m.,** Tearney's Town Club Twilight Dancers; Capitol theater organ; studio program; 10-1:30 a. m., Tearney's Town club orchestra; Carl Lorraine's Pershing Palace orchestra; Husk O'Hare's Cocomat Grove orchestra; Capitol theater program; studio program.

**WORD, Batavia, Ill. (275m-1090kc), 7 p. m.,** North Shore line; 7:45, Uncle Dan; 9, Glenn Dillard Gurn School of Music; 11, program, W. A. Sheaffer Pen company; 11:45, Golden Age.

**WQJ, Chicago, Ill. (447.5m-670kc), 7-8 p. m.,** Rainbo Gardens orchestra; Henrietta Nolan, violinist; "Before Jehovah's Awful Throne," H. W. Bundy; Willard O. Johnson, accompanist; Margaret Cade, soprano; Madeleine Ruff, accompanist; 10-1 a. m., Rainbo Skylarks; Dr. H. Lucille Long, harmonica player; Eleanor Terry, Marie Pollette; Melodians; Dean Herrill, baritone; Merrill Carder, baritone; Mary Wade, soprano; Romo Vincent, boy baritone; 1-2, Ginger hour.

**WRR, Dallas, Tex. (246m-1220kc), 6-7 p. m.,** Jack Gardner's orchestra; 8-9, Mabel Bush, violinist; 11-12, George Perfect.

**WSB, Atlanta, Ga. (428.3m-700kc), 8 p. m.,** concert; 10:45, American Georgia program.

**WSM, Nashville, Tenn. (282.8m-1060kc), 6:30 p. m.,** concert, Francis Craig's orchestra; 7, bedtime story interlude; 8, Columbia Military Academy orchestra; 10, sextet of Tio Handlers.

**WSUI, Iowa City, Iowa (483.6m-620kc), 12:30 p. m.,** Dr. Jacob Kwalwasser, pianist.

### Mountain Time Stations

**CFAC, Calgary, Can. (435.8m-688kc), 7-8 p. m.,** special salon program.

**KFWA, Ogden, Utah (261m-1150kc), 4-5 p. m.,** organ recital, Paramount theater; 5-6, Ogden Radio dealers program; 9-10, musical program, J. G. Read and brothers.

**KLX, Oakland, Calif. (508.2m-590kc), 5-5:30 p. m.,** Aunt Elsie's sunset matinee; 7-7:30, news; 8-9:45, studio program; 9:45-10:30, Athens Athletic club orchestra.

**KOA, Denver, Colo. (322.4m-930kc), 12:15 p. m.,** Rialto theater musicale; 3:15, relaxing and corrective exercises; 6:30, dinner concert, Brown Palace string orchestra, Howard Tiltotson, director; 7:30, Sunday school lesson review; 8, instrumental program, Scheurman's Colorado orchestra; 8:15, special program; organ selections, Royce H. Mintener; address, "Lincoln's Gettysburg Address," Stanley C. Warner; contralto solos, Lucile Fowler; address, "Abraham Lincoln," Rev. Loren M. Edwards; violin solos, Mrs. Della Hoover; Francis; vocal quartet selections; vocal trio selections, Mrs. Agnes Clark Ghalster, soprano; Mrs. Bessie Dade Hughes, contralto; Robert H. Edwards, tenor.

**KOB, State College, N. Mex. (348.6m-860kc), 7:30-8:30 p. m.,** student recital.

**KSL, Salt Lake City, Utah (299.8m-1000kc), 7:35 p. m.,** "The Story of Political Science and Lincoln," Prof. E. D. Thomas.

### Pacific Time Stations

**KFI, Los Angeles, Calif. (468.5m-640kc), 5:30-6 p. m.,** Kenneth Morse and his orchestra; 6, nightly doings; 6:15, KFI's Seeing California; 6:30, vest pocket program; 6:45, Radiatorial period; 7-8, Carlyle Stevenson's El Patio ballroom orchestra; 8-9, Aeolian residence pipe organ, Dan L. McFarland, organist; 9-10, Wm. MacDougal, Scotch comedian and Mutual Motors mirth contest; 10-11, Screen Artists string quartet.

**KFOA, Seattle, Wash. (454.3m-660kc), 12:30-1:30 p. m.,** program; 4-5:15, Wm. F. Hoffman's orchestra; today's recipe; 6-6:45, Hoffman concert orchestra; 6:48-8:15, program; 8:30-10, Times studio program; 10-11, serenaders.

**KFON, Long Beach, Calif. (233m-1290kc), 6-6:30 p. m.,** organ, Brayton's theater; 6:30-7, amusement information; 7-7:30, studio program; 7:30-8, Long Beach Municipal band; 8-9, Press-Telegram hour; 10-11, Long Beach Elks No. 888 frolic.

**KFWB, Hollywood, Calif. (252m-1190kc), 7:10 p. m.,** safety first talk, Officer E. G. Brown; 7:20, Jack Boaz, hunting and fishing scout; 7:30, eve-logue, Dr. Marshutz; 7:45, microphone brevities; 8-9, Warner brothers synopsators; Lois Woody, soprano; Frank Steyer, baritone; Estelle Shake, blues singer; 9-10, Mrs. Vivian Kidson, soprano; Tom Brennan, baritone; Geo. Wilson, popular songs; Jean Johnson, pianist; 10-11, Warner brothers frolic, direction Charlie Wellman.

**KGO, Oakland, Calif. (361.2m-830kc), 3-4 p. m.,** "Lincoln in Literature," Joseph Henry Jackson; Dorothy Clute, mezzo-soprano; Mrs. Kleo Orand, mezzo-soprano; Anna Lucchesi, pianist; Alice Davies Endris, violinist; 4-5:30, concert orchestra, Hotel St. Francis; 5:30-6, girls' half hour.

**KGW, Portland, Ore. (491.5m-610kc), 7:15 a. m.,** Y. M. C. A. physical culture exercises; 12:30-1:30 p. m., concert, Oregon Radio Trades association; 6-7, dinner concert, Olds, Wortman and King company; 8-9, concert; 9-10:30, concert, Sherman, Clay and company; 10:30-12, Hoot Owl frolic.

**KHJ, Los Angeles, Calif. (405.2m-740kc), 6-6:30 p. m.,** Leighton's Arcade cafeteria orchestra, Jack Cronshaw, leader; 6:30-

# Radio Digest Illustrated

Reg. U. S. Pat. Off. & Dom. of Canada

Published by the  
**RADIO DIGEST PUBLISHING CO.,**  
(Incorporated)  
510 North Dearborn Street  
Chicago, Illinois

Telephones: Superior 7323, 7324, 7325, 7326, 7327

E. C. RAYNER, Publisher

Eastern Office, Park-Lexington Building, 247 Park Ave.,  
New York. Telephones: Ashland, 8144, 8145, 8146

Member of the Audit Bureau of Circulations



241  
PUBLISHED WEEKLY

SUBSCRIPTION RATES

Yearly in U. S. and Possessions and Canada, \$5.00  
Foreign postage, \$1.00 additional. Single copies, 10 cents.

Vol. XVI Saturday, February 6, 1926 No. 5

## The "Piracy" Case of WJAZ

NEWS accounts throughout the country have carried vivid stories telling how WJAZ, the Zenith station in Chicago, has "taken" the wave length of 329.5 meters. The wave is reserved, without treaty, for Canadian use. Undoubtedly everyone by now has read about the matter, so there is no need to go into a detailed rehearsal of the news.

What can the U. S. government do about the matter? If unsuccessful, will the air be crowded to the point of pandemonium by others who strive to duplicate WJAZ's success?

We believe that no harm can result from the test case inaugurated by the Zenith station. E. F. McDonald, Jr., is placing his resources and his station in the balance to determine really just what the status of Radio is in the United States.

If the secretary of commerce is shown to have abused his discretionary powers by granting favors to certain firms and not to all, then we must remedy the situation.

Congress must take Radio away from Secretary Hoover and his successors in that event.

Perhaps the solution will be to form a non-partisan, representative body such as the interstate commerce commission, this body to handle with full discretionary powers (with the courts for appeal) all matters pertaining to Radio, the distribution of wave lengths, the division of time by broadcasters, etc. The new body might well be called the interstate communications commission, and besides Radio, it could handle wire telegraph and telephone affairs.

Other countries have such bodies, and have had them for some time. Witness the ministry of telephones and telegraph of France. This ministry also has charge of the administration of Radio. In Great Britain the post office department is the administrative head of all Radio and communication services.

Whether or not Mr. Hoover is shown to have abused his powers as chief of the Radio service, the commission suggested should be formed. No one man can assume, without being called partial, the responsibility that now rests upon the shoulders of the secretary of commerce.

The Radio bills now before the senate and house of representatives would give Mr. Hoover, or his successor, even more power. If these bills are passed unamended, the secretary of commerce will be czar of a vital means of propaganda.

Will this czar always be honest with this dangerous weapon in his hand?

The WJAZ case may bring much to light that will interest the senators and representatives now engaged in the study of bills which will determine the future method of Radio administration.

## "Program Coming in Fine"

WE SPOKE recently concerning the cost of broadcasting. In our editorial we advised that the better class of broadcasters were worthy of our good will, or quoted, "It is our duty to support them with our good will."

As a result, one of our consistent readers begs to challenge.

"If my conception of the phrase is at fault," this reader remarks, "I offer my humble apologies, but nevertheless, the situation has actually assumed serious proportions. I have heard people remark that they do not care to buy a receiving set in order to hear nothing but telegrams and other messages."

He is quite right. We did not mean to say that people should telegraph and telephone stations to show their good will. A silent good will, or bad will, is more effective.

If a station violates good broadcasting ethics by making up its evening's entertainment of telegrams and letters received, it is our duty to quit writing and telegraphing that station. That is where the "silent bad will" will begin to take effect.

It is not our duty to list the numerous "telegram-program" stations. There are entirely too many, suffice to say.

We have recommended many means of clearing the air of its present congestion. Perhaps one very effective manner would be to cancel the license of every broadcaster found reading telegrams.

## RADIO INDI-GEST

### THE RADIO BUILDERS

Whether the light comes from the sun or incandescent glow,  
We toil and think in factory bright to make your Radio.  
No task is so world wide as ours—all craftsmen play a part  
We make of Nature's giant powers the slaves of Radio art.

For us Montana miners toil the copper ore to dig,  
That we may make the Mystic coils and all your "aerials" rig.

Steel workers grim with blast on blast, make up our sheets and bars,  
Their furnace roars the whole night through, so bright it fades the stars.

Down south below the equator's line, in jungles of Brazil,  
The Indians smoke the milky sap to feed our rubber mill.

No task is so world wide as ours, all craftsmen play a part,  
For you we spend our working hours and search out every mart.

In China, worms on Mul'bry trees, the silk cocoons do spin;  
In Singapore the coolies toil to send us precious tin.

For us a thousand ships now sail with metals, ores and gums,  
Through seven seas in storms and calm, while our machinery hums.

For us a thousand freight trains roar, with felt and wood and glass,  
And metallurgists make alloys of Tungsten, chromium or brass.

From trees in far off India, the Hindoo strips a wax  
Which insects laid to hold their eggs—it makes our best shellacs.

For us from Georgia's trees of pine, the rosin gum is stealing,  
For us the mills in Caroline, the cotton spools are reeling.

No task is so world wide as ours, all craftsmen play a part,  
We tame electrons in the "lab" and use them in our art.

The miners, sailors, smelters, all who toil from morn till late,  
Are listening to the Radio call, their labor helped create.

Is romance dead? From countless throats, we hear a mighty NO!

For all do either build or hear, our country's Radio.

By Charles M. Ripley and Frederick A. Hull  
Schenectady, N. Y.

### Should Have Been Harmonicas

Dear Indi: Ha! Zenith is right. Mr. Hoover and his department of commerce are attempting to put Radio on the fritz. The following headline, taken from the latest "Radio Service Bulletin" of the commerce department, proves our contention. Here 'tis:

BROADCASTING STATIONS EQUIPPED SO AS TO SUPPRESS HARMONIES.

GUM SHOE

### Jah Wohl, Er Hat Narrheit

Dear Indi: I gott a ledder from Coussin John who iss inn Germany de odder day. He sez dey are macking Wernier controlls fawr gass stoffs and stoff pipe dahmpfers.

HERR WALT

Was ist los mit Ihnen, meiner freund? Wissen sie nicht dass it is nach dem Deutschen law Wernier knobs und controls on den gas range auch stove pipes zu put? Deiner Freund hat ein screw loose in his kopf geworden sein, nicht wahr?

### Paging King Tutt

Dear Old King Tutt: Had pleasant feeling reading your poem, "You Mean Hearing." There are no more cats fighting and panthers yelling in my set. I twist the dials of a good 8-tube super under a beautiful blue sky and Havana and Chicago come nicely like Heaven. Yours sincerely,

JUAN DEL RIO H.

There you are, King Tutt, a post card for you from Cuba. If you will send in your address to me I will deliver to you a beautiful picture of Parque Marti, Manzanillo Oriente, and a little more of the love note from Juan.

### Might Grow Whiskers

Dear Indi: There is a Radio problem in our town. A local barber has a Radio receiver in his shop and when we want a shave, he turns on the set and starts jazzing to the music. We want to get a shave but are afraid to, and as he is the only barber in town, we are in a rotten fix. Can you help us out of this predicament?

One day this barber was listening to a prize fight and hit one of the customers on the jaw, putting him unconscious.

Hoping you are the same, yours truly,

JUSTIN TIME

It was really unfortunate, Walt, that Indi got your letter on pay day or you might have found him the same. Must be conscious on that occasion. Probably your tonsorial artist has been tuning in on "The Barber of Seville" and thinks he is like the surgeon who bled his customers as readily as he shaved them. Suggest he get Ford and Glenn or the Harmony Girls with their barber shop chords, or the Smith Brothers over WEA. Anyway, whad'ya kickin' about? You want a close shave when you go in there, don't you?

### Ours Broke Our Window

"Striking of clock hinders reception" is a headline on one of the stories in this week's Digest. Bloopers says that's nothing compared to what the ringing of an alarm clock hinders.

## Hoover Tunes in 329.5

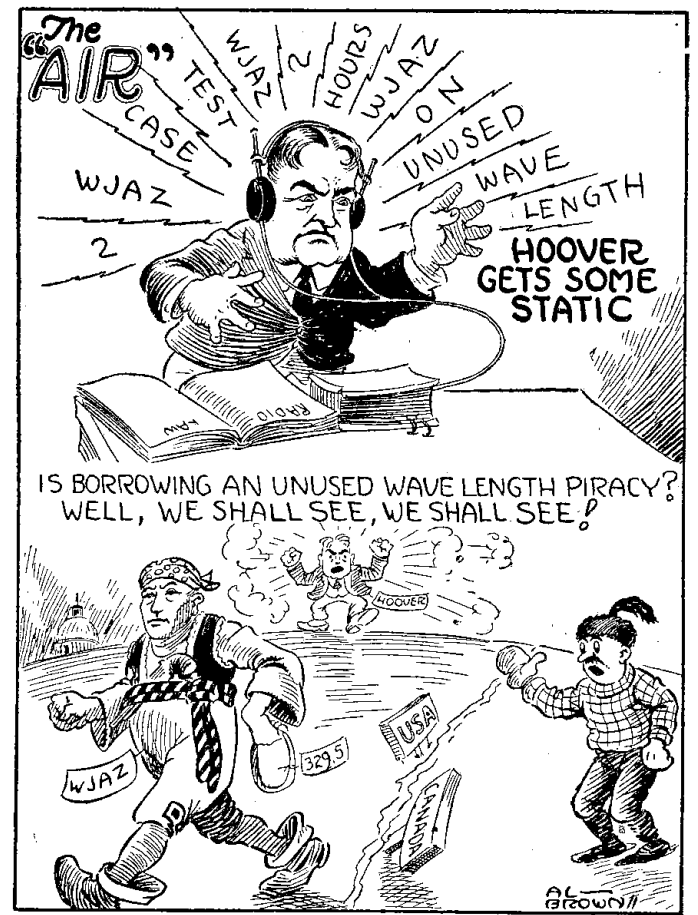

## Condensed BY DIELECTRIC

They certainly do take to dancing in Florida, if the preponderance of dance numbers on the programs of broadcasters there are fairly indicative. And such playing! As listeners heard one after another of the modern selections played by an orchestra through WMBF, Miami Beach, their consensus of opinion would have been that those players attacked the music with all the enthusiasm of brand new works, with none of the faltering unfamiliarity might have produced. And the announcements are clear and sufficiently slow to be understood by all.

It is possible with some orators addressing us in a foreign tongue to catch the drift of their remarks, though this is less likely to happen than where the words are set to music. Given Norse songs, with their fire and adventure, sung by Norwegians with trained voices and an expert leader, no one stops to note the unintelligible words. This experience was had by those tuned to WOAW, Omaha, not long ago, and a repetition of such a program should prove popular.

Instances of broadcasting from the stage of some theater in the large cities of this country are becoming more numerous—possibly more entertaining. Few features of the kind excell in general interest the broadcasting by Station WEBH, Chicago, from the Uptown theater in that city, where one may listen to a very good little symphony orchestra in a variety of musical presentations. Transmission is good.

Station WCAU, Philadelphia, presented a quartet of male voices known as the Jolly Four which supplied as much entertainment as that station can be credited with for some time past. Not all of their numbers were selected from among those songs heard almost nightly, but included a few new ones. More particularly one feels inclined to commend the pleasing blending of the four voices, none of which predominated nor marred the uniform effect of unity—both tone and expression.

Once more we feel obliged to the Victor company for an evening of almost unalloyed pleasure; "almost" appears, due to rather poor modulation during the singing of the famous Prologue by Titto Ruffo. However, we have no regrets for having offered us such artists and especially the Flonzaley quartet, to which there is no equal. When one may listen to the playing of these four men there is nothing to wish further. Again I suggest our commendation would not be amiss.

These community concerts are attracting attention not only to the cities sponsoring them but to the possibilities within them of providing musical talent and entertainment well worth a hearing. It may develop a national contest of community choruses with the listening public as judges, thus promoting a friendly rivalry by Radio and at the same time increase knowledge of choral music. WSAI, Cincinnati, had one such concert with piano selections including some of the best musical literature for the instrument, as well as vocal solos chosen from such composers as Grieg, Rachmaninoff etc.

A midnight dance program fostered by Station KDKA, Pittsburgh, had little to make it stand out above a host of other dance features presented at the same time, yet many fans remained to imagine themselves a part of the interfraternity ball given under the auspices of the University of Pittsburgh. It's probably the audiences present and audible to listeners which make such an event attractive.



# OPERATING AND TROUBLE SHOOTING

**OPERATING** and Trouble Shooting, is a Radio Digest feature, the purpose of which is to give practical information on the operation, care and cure of simple troubles in every kind of receiver. Standard Radio receivers of wide distribution and use are studied from the standpoint of instructions for installing and connecting, tuning and operating, and remedying little difficulties. The suggestions below, if executed faithfully, will make winter broadcast listening yield all there is to yield to the reader and give your set a fair chance to show its worth.

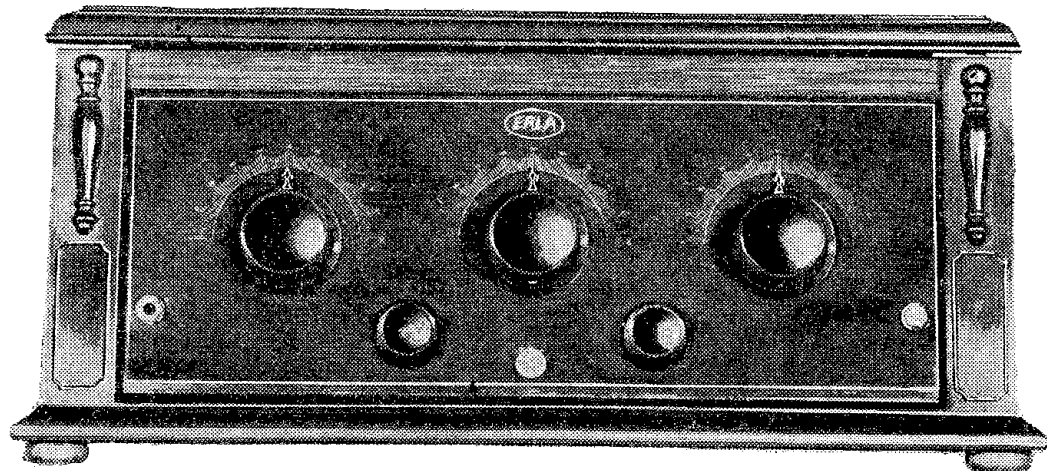

favor with several manufacturers, not only because of its efficiency in radio frequency amplifiers, but primarily because such amplifiers require no balancing for the elimination of coil interaction, and are practically immune toward the influence of nearby broadcast stations.

**The Panel**

One's attention is at once attracted to the symmetry and balance of the sloping front panel of etched bronze, upon an antique background, upon which is mounted the operating dials, together with the loud speaker and filament controls.

Many detail conveniences are provided within the cabinet to insure not only the avoidance of error in connecting the receiver, but to also insure its most efficient operation upon a variety of lengths of antenna. A commendable part of the interior assembly is the provision of a cable of wires connected to the proper binding posts, together with a blue print drawing which indicates the exact connections to the operating batteries.

**Laboratory Test**

Our laboratory test upon this receiver included a careful inspection of the total assembly, the quality of the materials used, and whether the workmanship indicated that repeated inspection tests had been made. In addition to the above, the usual tests for selectivity and quality of reproduction over the broadcast wave

band were made. In each instance the high average which we expected, because of the well-known reputation of the manufacturer, was well maintained, as evidence of the apparent "team-work" idea in design, through building each part to work in harmony with the whole.

**Antenna and Ground**

As this receiver is provided with antenna posts for both short and long aeri-als, our experience indicated that a single copper wire not exceeding 80 feet in length should be used, and connected through its lead-in wire to either the post marked L—Ant or S—Ant, according to the degree of selectivity one desired. This antenna should be well insulated from the ground and surrounding objects, and placed as high above the earth as possible within the limits of 45 feet. The ground connecting wire should run as direct as is convenient and be fastened by a ground clamp to a cold water pipe, which has been thoroughly scraped. If this is not possible, a like connection to a six-foot length of galvanized pipe which has been driven in moist earth should be made. Both the antenna and ground wire used should be No. 14 copper wire, while the lead-in to the receiver from the antenna may be made with the same gauge wire but well insulated.

**Tuning**

Three dials are provided for tuning, the smaller knobs, just below, acting as radio

frequency control and rheostat control for the detector filament. After connecting the batteries and placing the tubes in their respective sockets (five 201-A or 301-A being recommended), the battery switch at the bottom of the panel should be pushed in to light the filaments of the tubes. Set the lower right hand knob with the arrow in a vertical position if the A battery is new or a little beyond this point if not fully charged. Turn the three large operating dials to their zero position. Turn the detector rheostat, which is the small knob on the right, until a slight hissing noise is heard, then retard it just below this point, or until the hiss disappears. The receiver will then be ready for operation.

To tune in a station, first turn the lower left knob to the right until a rushing sound is heard, being careful not to turn this knob too far or this sound will stop and it will have to be retarded. Next, rotate each of the larger dials forward from their zero reading slowly and with each in step, or at approximately equal setting. When a station is heard, each dial should then be individually adjusted for volume. Very often one will find that after a station is tuned in, a slight readjustment of the lower left knob will be of benefit. It doubtless is not necessary to caution the operator to shut off the receiver, by pulling the filament switch out when through operating. Failure to do this means but an added expenditure of battery current and shortening of the tube life.

**Trouble Shooting**

While this receiver is so designed as to be practically foolproof, there may, at times, occur minor troubles which are annoying, but which are not defects within the receiver. Assuming that your antenna is well insulated and strung tight enough that it does not swing, also that your ground connection is well made, and your batteries in good condition (the A battery should register between 1250 and 1300 with a hydrometer and each block of B battery should register not less than 38 with a reliable voltmeter), the incidental troubles and their remedy may be classified as follows:

(Continued on page 26)

## For the Owner of an Erla Circlloid 5 Receiver

**R**ADIO receivers of the present season portray in a marked degree manufacturers' realization that artistry in cabinet design is of equal importance with that of Radio reception efficiency as a graceful and appropriate fitting for the home beautiful. A most worthy example of such forethought is the cabinet housing the Erla Circlloid 5 receiver.

There could not be any division of opinion regarding this point as the outstanding feature of this receiver, with its two-tone mahogany finish, ornamental carved panels and top, were it not that a glimpse of its interior reveals a striking example of the application of the now popular balloon type Circlloid coils as the media for radio frequency amplification. This type of inductance has found

# Big Price Reduction

## FULTONE LOUD SPEAKER FOR YOUR PHONOGRAPH

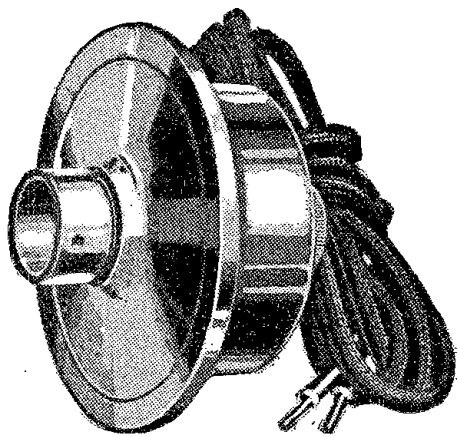

**Fultone**  
TRADE MARK

LOUD SPEAKER UNIT  
**\$3.00**

wire are protected from injury by a heavy nickel-plated case through the back of which adjustment is made by means of a special key. The pole pieces are not made from a solid piece of iron but are assembled from 15 laminations of carefully chosen steel.

**Use on Your Phonograph**

- Edison Adapter.....25c
- Columbia or Pathe.....20c
- Brunswick .....30c

**HALL & WELLS, Inc.**  
4600 Lincoln Ave. Chicago, Ill.

*Fits Any Make*

Now Only  
**\$3.00**

The unit will be shipped on a satisfaction or money back basis on receipt of price in money order or currency.

This unit is the secret behind the unparalleled success of Fultone Speaker. Its large diaphragm and bobbins of fine

**Tear Off, Fill in, Mail Now**

HALL & WELLS, Inc., 4600 Lincoln Avenue, CHICAGO, ILL.  
Enclosed is \$..... for which ship me.....  
( ) Fultone Unit at once, my money to be refunded if I am not satisfied and return this merchandise within 5 days.

NAME .....

ADDRESS .....

CITY AND STATE .....

Now In Its Second Year!  
Described in this issue of Radio Digest

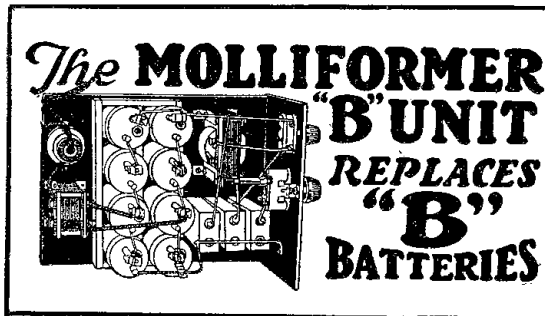

NO HUM

## BUILD YOUR OWN

Here is the B-ELIMINATOR your set needs and you can save money by building it yourself. The Molliformer B Unit is guaranteed to operate any set from one to ten tubes with a vast improvement in the quality and tone, and a big increase in volume.

It is absolutely noiseless—all A. C. hum being banished forever due to exceedingly high inductance. No expensive rectifying tubes are used—employs only improved electrolytic full wave rectifiers.

The MOLLIFORMER B UNIT will furnish you with ideal B-current for years to come.

Model FW4 is designed especially for 5 or 6 tube receivers, requiring no more than 100 volts on the amplifiers. This and model FW8 can be readily assembled by the home builder with every assurance of perfect results.

FREE—Write for Mr. Jacobs' complete description of the Molliformer B Unit

**PRICES**

The kits listed below include all the essential parts necessary to assemble the unit complete.

- Model F W 4—complete kit, 60 cycle A C . . . . . \$17.00
- Model F W 8—complete kit, 60 cycle A C . . . . . 22.50
- Model F W 4—Assembled complete . . . . . 24.50

25 and 40 cycle transformers \$2 additional  
Kits include rectifiers. Parts sold separately.

DEALERS write for DISCOUNTS.

**C. E. JACOBS, MFR.** SOLE 2802 N. Kedzie Ave. CHICAGO

### OPERATING THE ERLA

(Continued from page 25)

Have you closed the battery switch? Are the connections to your A and B batteries secure? Are these connections made correctly—that is, not reversed? Do all of the tubes light? If not, remove the offending one and bend up the socket springs slightly. If the receiver gives a sharp click in the head phones or loud speaker when the attachment plug is inserted in the jack, this indicates the B battery connections are correct. If not, their connections may be reversed, or one of the wires broken.

#### Noisy Reception

A continuous low-toned hum is usually due to your antenna running parallel rather than at right angles to a power line or electric light wires. Leaky transformers also will create this effect. After changing direction of antenna, if this hum still obtains, report your trouble to the lighting company.

If this hum is high pitched, the grid connection has become loose or the grid leak is not in its position. Also look for loose connections. In place of a high pitched note, this trouble is sometimes noted as a knocking or tapping sound.

A scraping sound when the large dials are turned as a rule indicates dust between the condenser plates, which may be removed with a pipe cleaner.

Howling and shrieking is usually caused because the rheostats are turned too high, while scratchy, rasping noises indicate a run down B battery, accumulation of dirt or moisture upon the surface of the batteries, or loose connections.

### The Reader's View

#### Truly It's a Nuisance

Can't you impress every week that this cheap broadcasting is not listened to? Also this cheap singing; this cheap hollering to one another; this cheap banjo playing. Just as soon as we get a few notes of it, we all tune out and get some real music elsewhere. Further, after a few times we all avoid that station. Some of it is dreadful. Truly it's a nuisance.—A. S. B. Huntington, W. Va.

#### Speaking of Single Circuits, Wow!

I am a regular reader of the Digest and would like to express myself as to present day reception of the fine programs broadcast by most of our generous broadcast stations. I have been a B. C. L. for eight years and few are the stations to whom I have not sent a few lines of appreciation.

However, I have often wondered if all this effort and expense was not mostly a waste of time and money on the part of both the broadcaster and the B. C. L., for this reason: We all know what a tremendous effort is made to transmit and also to receive distortionless music and speech. Why should all this be offset by the contemptible dim-wits who still persist in using, and continually twisting the dials of, the disgusting squealer set, or single-circuit, for the reason that he has not the brains to construct a present day receiver of the non-radiating type nor the ability (or is to lazy) to accumulate enough money to buy one? Why does not our government, that displays so much interest in Radio in some re-

spects, also show a little reason on this point and banish, into the discard, this type of would-be receiver along with other undesirables? I have heard the old gag about the heroic (?) place this hook-up deserves because of its usefulness in the early days. How about the old-time outhouse?

I must add that I consider a person a degenerate that would prefer to listen to nothing but squeals and howls (only reproduced this side of H— by the d— single-circuit) than to the beautiful musical and vocal selections that are the result of such painstaking effort on the part of station operators and lost to the majority of B. C. L.s because of a moron or two in every locality.—R. McB. M., Mansfield, Ohio.

#### Form For Announcers

I want to add my voice to the protest against unsatisfactory announcing. May I suggest the following as a model form for announcers to use?

"Radiophone XYZ, Chicago. You Have Heard So & So Play 'Normandy.' (\*) The Next Number Will Be 'Roses of Picardy' By Whosis. XYZ, Chicago."

Now I will explain why I think the above is the ideal. I have often noticed that in cutting from the performers "mike" to that of the announcers the first letter and sometimes the first two letters of the call are lost. Hence the suggestion that the announcement be started with "radiophone" or some other suitable word. The asterisk (\*) indicates the place in the announcement where it would be convenient to acknowledge requests and communications, if customary at the station. I have placed the station call letters both at the beginning and at the close because, very often a station is tuned in during the announcement, and if the following number is not cared for, the station is tuned out without its identity being disclosed.—R. W. L., Atchison, Kan.

#### Plagues Only One

In your issue of December 26, you published a letter from one, "W. A.," Covington, La., in which letter W. A. deplors the fact that WSMB at New Orleans, was handed the razz by one of your critics. More power and long life to this critic.

The announcer at any Radio station who reads into the microphone telegrams received from various listeners in, deserves to be hung, shot, electrocuted, razed, or what have you.

It is my opinion that the only person who gets any kick out of hearing a telegram read from a broadcasting station is the person who sends that telegram. When one stops to consider the fact that out of the large audience of most any broadcasting station, only one or two persons are entertained when the announcer broadcasts a telegram received by the station, it is quite evident that the broadcasting station is serving only a fraction of a per cent of its listeners.—J. B. S. Florence, Ala.

#### Interference Troubles and Mr. V-63

On recently returning home from a trip, I found several copies of Radio Digest, including one of November 21, 1925, on page 24, of which appears a letter from one V-63 (evidently a "Cadillac owner") of Pittsburgh, Pa., which interested me.

It appears that Mr. V. has a very poor receiving set or he would experience absolutely no trouble from the high power short wave telegraph stations along the coast. I am only 100 miles farther,

by airline distance, from WIR and WIZ than he is, yet on any receiver in this vicinity which makes any pretense towards selectivity, no trouble is had at all from this source. On the other hand, many local users of the famous "Eastingbarn Audiola 553" get not only these two stations, but KDKA's 62.5-meter transmitter, all over their dials at times. The only remedy for this is to substitute properly designed radio frequency input apparatus for the criminally inefficient and broad tuning equipment usually supplied on low priced receivers. Methods of adding tuned or untuned primary coils to this type of single circuit receiver have been described from time to time in Radio Digest.

Mr. V-63 also mentions the interfering (?) stations "mixing up" with harmonics of broadcasting stations. Well, broadcasting stations have no business smearing harmonics all over the short wave bands. To show you how bad these are, the first time I ever heard WHGP of Detroit, was one day when I picked up his 4th harmonic, coming in very strong. KDKA and some other stations use some mysterious harmonic suppressor circuits which seem quite effective. A broadcasting station is licensed to transmit on, say, 300 meters, but this license does not authorize the radiation of signals at the same time on 150, 75, 37.5 and 18.75 meters. Yet many stations are doing just this thing right now. Such harmonics not only "bring in" interference, but they are also liable to cause much trouble in commercial Radio-telegraph and relay broadcasting. About a week ago I was listening to KDKA's 62.5-meter wave and some other station on the broadcast band was radiating on a harmonic just a few kilocycles off KDKA's frequency, causing a bad heterodyne squeal, made worse by the fact that the interfering station's wave was "wabbling" badly. One can easily understand the effect that this would have on any attempt at retransmission from KDKA's short wave signal.

No. Mr. V-63, the remedy lies not in suppressing everything but broadcasting, it lies in cutting out some of these broadcasting stations which radiate on all harmonics, and also the elimination of the single circuit tuner and the crude and sloppy variety of super-heterodyne.—H. G., Kitchener, Ont., Can.

#### Popular Music for Majority

A reader of your publication almost since the birth of Radio broadcasting, I am influenced to write a word of indorsement to what a communication signed L. F. W. had to say in regard to popular music from the broadcasting stations. Classical music, for those who can appreciate it and who know enough of music to understand it, is no doubt a great thing.

But Radio, like a newspaper, must serve the majority—the masses of its listeners. And the great majority of those possessing Radio sets do not have the

gift of talent with which to truly appreciate classical music.

A popular tune is enjoyed by nearly everyone. By this I do not mean, necessarily, "popular" in the sense of jazzy orchestral music, but the popular lyrics of both our own day and that just passed.—J. H., Waco, Texas.

#### We Are Trying to Help

At the Radio convention, called by Mr. Hoover, it was affirmed by the Radio interests present, that in future all rules concerning broadcasting were to be made for the benefit of the listener.

This being true, is there any chance that the air is to be cleared up by taking some of the stations off the congested wave lengths?

Has it been suggested that if each broadcasting station were restricted as to the time it might be on the air, and each assigned such periods of time as would not conflict with others on the same wave length, the listener might profit?

Why, we wonder, don't station owners and advertisers realize that when the air is a mess of conflicting programs no program comes through clearly and all are lost? And that when one powerful station on any wave length broadcasts almost continually, others on that wave length are practically never heard by listeners in the range of the powerful station mentioned?

My set brings in stations of 500-watt power as far as 2,500 miles away; yet, because nearer ones are never at rest, I get only a very limited number of stations with my good set, and many who would profit by presenting their advertising programs to me are never heard, while I regret not hearing them.

Poor announcing is an aggravation; power noises are worse; howling sets in the hands of careless owners are anathema, but of all the patience destroying woes of the Radio receiving mortal, the overcrowded spots in the air are the limit. The worst of it is that apparently the trouble could be remedied for the benefit of all concerned, and without great effort. Can the Radio Digest go into the matter and explain why it is not done?—E. A. C., Spokane, Wash.

Corrosion in aerial and lead-in contacts is a common cause of poor reception.

Send for this **RADIO BOOK FREE**

**1926 Catalog of Everything New in RADIO**

at a Big Saving in Price



The World's Largest Exclusive Radio Mail Order House Will Send You This Wonderful Book FREE

64 illustrated pages containing thousands of bargains in radio sets, semi-finished sets and radio kits of all styles, sizes and approved circuits. Beautiful models of the very latest designs and types. Elaborate console models with loud speakers built right into cabinets of genuine mahogany and walnut. ALL SETS GUARANTEED.

Our line includes all popular sets, such as Superheterodyne, Neutrodyne, Ultradyne, Reinartz, Regenerative, Radio Frequency, Browning-Drake, Reflex and all other latest circuits. Kits, sets and parts manufactured by all well known manufacturers, such as: Frost, Howard, Baldwin, Brandes, Western Electric, Columbia and others.

**Our Guarantee**  
Every article exactly as represented. Every article is tested before shipping. Complete satisfaction or money cheerfully refunded.

**Don't Buy Anything in Radio Until You Get Our Big Money Saving Catalog**

**RANDOLPH RADIO CORPORATION**  
The Largest Exclusive Radio Mail Order House in the World  
159 N. Union Ave., Dept. 253, Chicago, Ill.

**Our Catalog**  
Includes complete list of broadcasting stations and general information and facts about our free service division. Our radio engineers will help you solve all your radio problems. Send your name and address on a card or in a letter. We will send catalog FREE.

**FREE**  
62 Page Revisable  
**LOG**  
and Radio Book of Knowledge

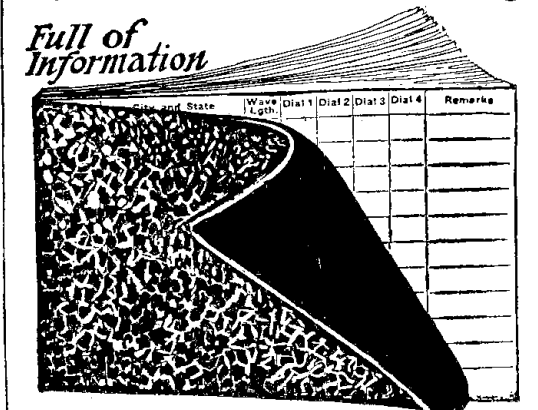

Full of Information

New 62 page Log and Radio Book. Loose leaves for inserting revised pages. We publish corrected sheets as changes in calls, wave lengths, owners and addresses, etc., occur and as new data comes out. 468 stations. 4 dial settings, remarks, etc. Tuning suggestions. Stations lists numerical by wave lengths (meters, also kilocycles)—alphabetical by states—by cities, etc. Trouble aids. Dictionary Radio Terms. Repair Hints. Trouble Preventers. Questions and Answers. Other valuable information necessary to enjoy YOUR radio. 10 Radio volumes bound as 1. Beautiful flexible cover (gold letters). So convenient. Get clearer programs. Increase your selectivity. Eliminate your troubles. Enjoy your radio more. For limited time, we will send latest \$2 edition elaborate 62 page Log and Radio Information Book absolutely FREE to those ordering revision service till Jan. 1, 1927 only, \$1.

**Send No Money** Pay postman \$1 for service till Jan. 1, 1927, after FREE Book arrives. Postpaid if pay with order. Money refunded if not delighted. Send order today—right NOW. A postal will do.

Radio Printers, Dept. 4412, Marengo, Ill.

**4 Big Improvements in Amplification!**

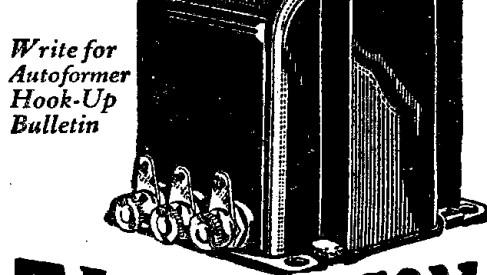

**THORDARSON**  
Autoformer  
Trade-Mark Registered

All Frequency Amplifier  
It Gives You

- 1 Full amplification of those bass notes hitherto largely "lost"
- 2 Greater clarity on all notes
- 3 Improved reception of distant programs
- 4 Better volume control

Latest development of the world's oldest and largest exclusive makers of transformers. For those who wish the finest reproduction of programs to be had. May be used with any set in place of regular audio hook-up. Autoformers are \$5 each at dealers'.

**THORDARSON ELECTRIC MFG. CO., CHICAGO**

# Construction of B Current Power Supplies

## Part II—Molliformer Chemical Type

By George Walters

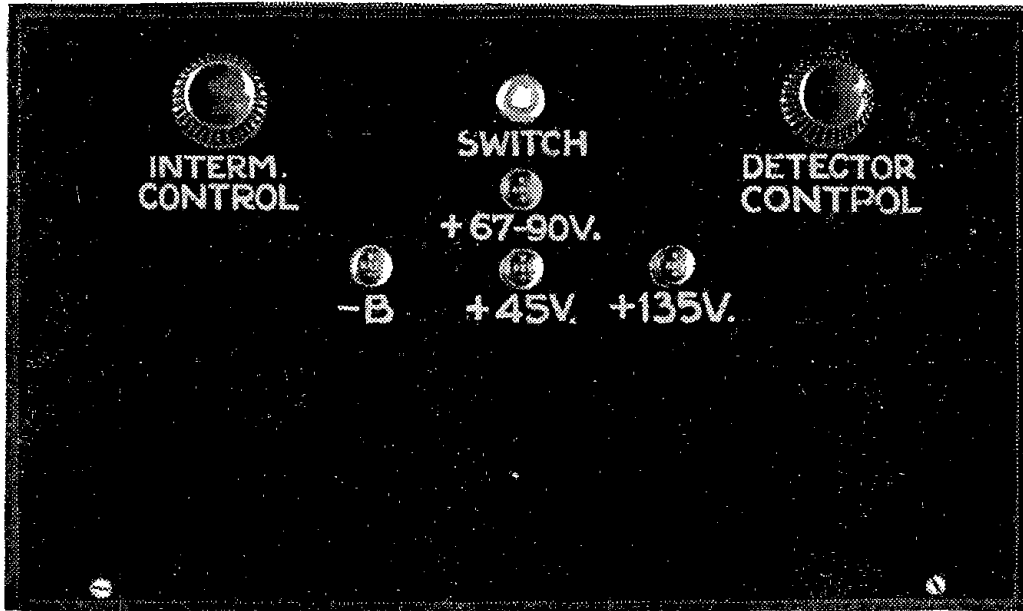

Figure 1. Front view of completed Molliformer B eliminator. The binding posts for the various voltages are indicated.

IN THE first article of this series, presented last week, the writer stated there were four types of rectifiers, and the construction of that using a no-filament tube was described. We will now consider that type which uses a chemical solution in jars to change alternating light current into direct current. This unit will supply current to the largest super-heterodyne as a four-jar model was used by the writer all last season on one of Jacques Fournier's four-filter supers, and the present model has eight jars. This second power supply is so arranged that three different B voltages are available, with the lower two variable. Thus if your super or tuned radio frequency must have 40 to 50 on the detector, 60 to 90 on the radio frequency amplifiers and 100 to 140 on the audio frequency stages you have these voltages.

### Chemical Rectification

It has been found that if a jar is filled with a solution of water and any of several substances, one of which is borax, and in this jar we place a piece of aluminum and a piece of lead, current can pass through this solution in only one direction. If, therefore, alternating current is connected to such a jar and a device which requires direct current, every other alternation or one-half of each cycle will pass through, but the other half of each cycle will be cut off. This is called "half wave rectification" and there are sev-

eral B power supplies available using this principle. Some have a jar as described, some use a tube, but only half the cycle is made use of.

So that a large set of six to nine tubes can be supplied, it is, in the writer's opinion, essential that a B power supply be so constructed that both halves of the cycle are used and all the pieces of apparatus made large enough to pass 50 to 60 milliamperes of current. Accordingly, eight jars are used, with four on each side of the output leads of the transformer, and both halves of the cycle are put to work without overheating and with the ability to pass plenty of current. Each jar contains a solution made up from powder (supplied by the manufacturer of the Molliformer kit) which is dissolved in water, an aluminum rod and a rod made of either lead or graphite.

### Filter

When the current leaves the jars it is direct current but pulsating to an extent that would produce a most undesirable hum in the loud speaker. To remove or smooth out this pulsating, or "ripple," as it is called, several pieces of apparatus are provided to form what is called a filter. A large coil on an iron core is provided with the kit which has a value of 125 henries, and three comparatively large fixed condensers are used with it. One is used before the choke coil, one immediately after it, and a third must be

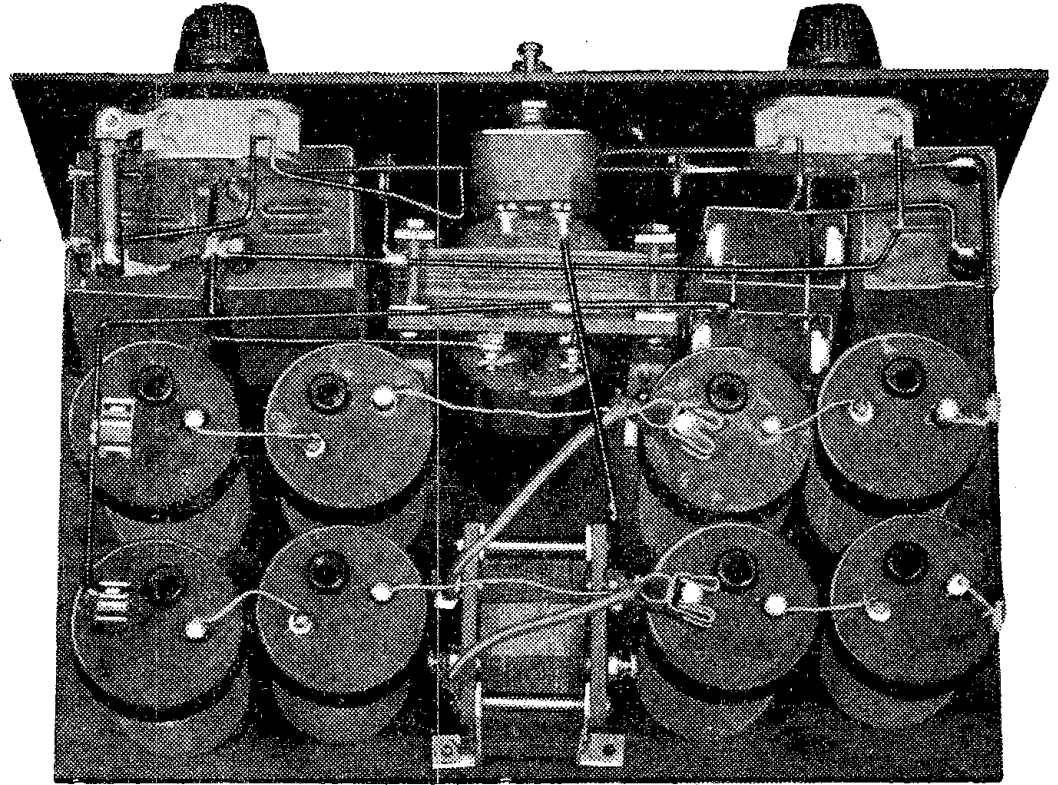

Figure 2. Rear of panel and baseboard view. The wiring and the arrangement of the various parts is clearly shown.

used across the detector supply output. Since the writer has added somewhat to the design intended by the maker of this outfit, we must have, also, a Tobe 2.0 mfd. condenser for use across the intermediate voltage output.

When assembling each jar it will be noted that each aluminum rod is provided with a rubber sleeve. This should be adjusted on the rod so that about 1 inch of the rod is exposed at the lower end and the upper end of the tube comes flush up against the underside of the rubber cap on each jar. The aluminum

rod goes in the hole marked plus on each cap and the graphite or lead rod goes in the negative hole. In placing the jars as shown in the photograph, the last jar to the right in both the front and back rows is turned so that the aluminum rod is to the right. All jars are then placed this way so that the last jar to the left in each row has its lead plate to the left.

The transformer is set with primary terminals to the left and secondary to the right. The large choke coil is set (Continued on page 28)

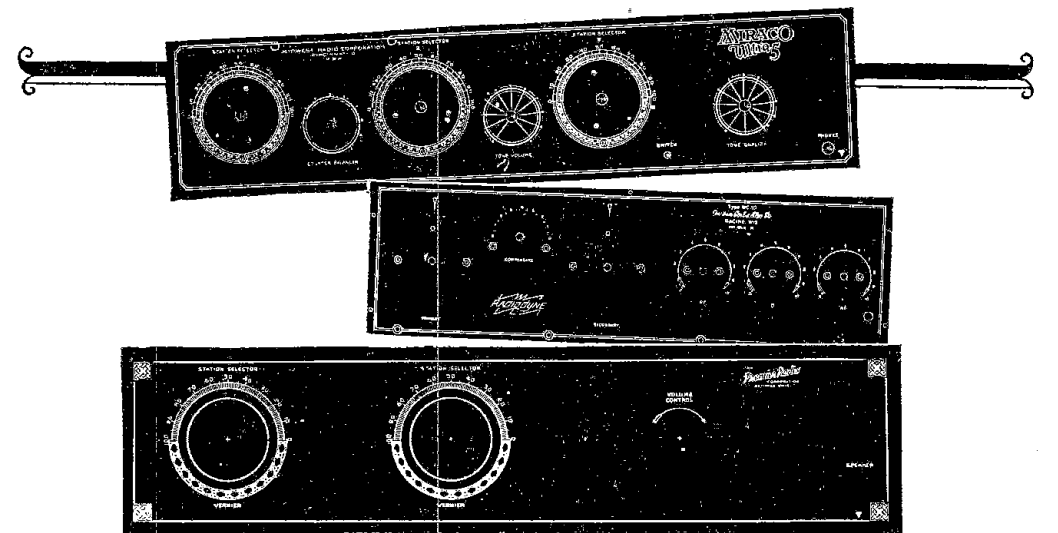

## Now Formica Offers Complete Panel Service!

FORMICA has improved its service to American radio manufacturers by offering completely decorated and finished front panels. The decorations are done in gold, silver and other colors by the Veri Chrome process. They are by far the most handsome panels in use in radio today—and the panels with the most permanent finish and surface.

those amateurs who wish to assemble certain well known kits.

Dealers and jobbers are stocking and supplying kit buyers with the following decorated Formica panels: Bremer-Tully No. 1; Bremer-Tully Counterphase; Bremer-Tully Nameless; two sizes of Best's Superheterodyne put out by Remler; the Four Tube Browning-Drake of the National Company, and Marco-Browning-Drake and General Radio Universal Receivers.

This service is now extended to

Formica panels in all the usual standard sizes are sold by most good dealers. Each panel is packed in a neat individual envelope.

Write for booklet "What Formica Is"

THE FORMICA INSULATION COMPANY  
4667 Spring Grove Avenue Cincinnati, Ohio

# FORMICA

Made from Anhydrous Bakelite Resins  
SHEETS TUBES RODS

## FREE

# You save 50%

**Approved!**  
Listed as Standard by  
Leading Authorities  
including Radio News  
Laboratories, Popular  
Science, Institute of  
Standards, Popular  
Radio Laboratories,  
Radio Broadcast Lab-  
oratories, Radio in the  
Home and  
Lex-  
inc.

WORLD "A" Batteries are famous for their guaranteed quality and service. Backed by years of successful manufacture—thousands of satisfied users. Built of finest materials possible to obtain from raw material producers of national reputation. Equipped with solid rubber one-piece containers, an insurance against acid leakage and breakage. You save fifty per cent and get a

**2-Yr. Guarantee Bond in Writing**  
with each Radio "A" and Auto Battery. WORLD Battery owners "tell their friends." That's our best proof of performance and is chiefly responsible for the tremendous growth of the Company. Compare these prices—then send your order in TODAY.

Solid Rubber Case Radio Batteries	Solid Rubber Case Auto Batteries
6-Volt, 100-Amperes . \$11.25	6-Volt, 11-Plate . . \$11.25
6-Volt, 120-Amperes . 13.25	6-Volt, 13-Plate . . 13.25
6-Volt, 140-Amperes . 14.00	12-Volt, 7-Plate . . 16.00

**SEND NO MONEY!**  
Just state battery wanted and we will ship day order is received, by Express, C. O. D., subject to your examination, on arrival. FREE "B" Battery is included.  
**EXTRA OFFER**—Five per cent discount for cash in full with order. Buy NOW and get a guaranteed battery at fifty per cent saving to you.

**WORLD BATTERY COMPANY**  
1219 S. Wabash Ave., Dept. 48 Chicago

**Radiocast Station**  
**W S B C**

Set your Radio Dials at 210 meters for the 1000-watt World Storage Battery Station, W S B C, Chicago. On the air nightly, between 8:30 P. M. and 8:30 P. M. and 10:00 P. M. and 1:00 A. M., with intensely interesting programs for your approval and enjoyment.

World Batteries for Radio

MOLLIFORMER CHEMICAL TYPE B CURRENT UNIT	
List of Parts	
1 Molliformer B Unit	C. E. Jacobs, Chicago, Ill. \$17.00
1 Tobe Condenser, 2 mfd.	Tobe Deutchmann Co., Boston, Mass. 1.75
4 Ensign Binding Posts	H. H. Eby Mfg. Co., Philadelphia, Pa. .60
1 C-H Filament Switch (110 v.)	Cutler-Hammer Mfg. Co., Milwaukee, Wis. .60
1 Formica Panel 7" x 12"	Formica Insulation Co., Cincinnati, Ohio 1.70
4 Feet Twin Conductor	Any Electrical Dealer .40
1 Light Socket Plug	Any Electrical Dealer .25
1 Baseboard 7" x 11½"	Local Lumber Yard .30
Screws, bus bar, solder, etc.	
<b>Total Cost</b>	<b>\$23.20</b>

**CHEMICAL ELIMINATOR**

(Continued from page 27)

with terminals to the rear and the Allen-Bradley resistors are turned so that terminals are upward. The number 10 Bradleyohm goes to the right. While the writer used two Tobe 1.0 mfd. condensers, only one condenser of 2.0 mfd. is preferable and specified; connections would be the same. Wiring is done with stiff bus bar at all points except between jars, which will support the upright fixed condensers and make a better looking job.

**Wiring**

The long wire which connects the lead rods at the left end of each row comes forward and then across the front terminals of all four of the condensers, can be put in first. Then the wire connecting the two aluminum rods at right end of each row is put in and bent to the left down to the rear terminal of the Tobe 2.0 mfd. condenser which is C1 in the diagram. An offshoot from this goes to the left terminal of the choke coil. A wire now connects the right terminal of choke coil to the rear terminal of the fixed condenser to right of choke which is C2.

This rear terminal of condenser C2 is a starting point for the three different voltages. From it we first run a wire across to left and up to left terminal of the special Bradleyohm in upper left corner of panel. An offshoot from this wire goes forward to the binding post at the right end of the row of three and this is the high voltage tap. From the right terminal of the special Bradleyohm, put

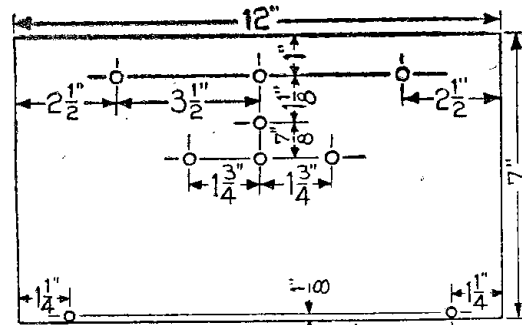

Figure 3. Panel drilling layout.

in one wire to rear terminal of fixed condenser at front left corner of baseboard, and from this same terminal of the Bradleyohm run a wire down to the single binding post just below the switch. This binding post will be the intermediate voltage tap if needed.

The fixed resistor which comes with the kit is supplied with two clips. Put a short 6-32 machine screw through the hole in each clip, slip on a long soldering lug and then a hex nut. Study of the photograph will show that the front clip is upside down with the soldering lug pointing to the left and secured under the right terminal of the number 10 Bradleyohm. The rear clip is right side up with its soldering lug also pointing to left and connected to the rear terminal of condenser C2. This leaves the left terminal of number 10 Bradleyohm open. Connect one wire from it, down to right to rear terminal of condenser in front right corner which is C3, and another wire from it to center binding post in row of three on panel. This gives us our detector voltage, around 45.

**Mixing Solution**

A wire about 1 inch long can now be inserted from the left binding post of the row of three up to the long wire connecting the front terminals of the four fixed condensers and this is negative B. At this point it would be a good idea to mix the solution and pour it into the jars. This should be done in a large, clean glass or earthenware bowl or dish and the solution should be stirred with a clean glass or rubber rod. Using one of the jars to measure with, put in 6½ full jars of cold distilled water. Then add the quantity of white powder furnished with the kit and stir well until all is dissolved. Each jar is to be filled three inches deep with solution.

Now place jars in position as shown and turn until rods are all in line, with lead to the left in each case. Then in each row connect aluminum of left jar to the lead of second from left jar and aluminum of second from right end jar to lead of right end jar. Now connect rear secondary terminal on transformer up to aluminum of second from left end jar in rear row and at same time bring over wire from lead rod in second from right end jar to this aluminum. Then the front secondary terminal is connected to the

aluminum of second from left end jar in front row and wire from lead rod of second from right end jar in this row is brought over to that aluminum.

**Connecting and Adjusting**

The final connection is from the front primary terminal of transformer to left terminal of switch. If entire unit is to be placed in a cabinet, it should now be placed in cabinet and a hole drilled in rear of cabinet for the twin or twisted conductor from light socket. One of these two wires is connected to right terminal of switch and the other to rear primary terminal of transformer. The

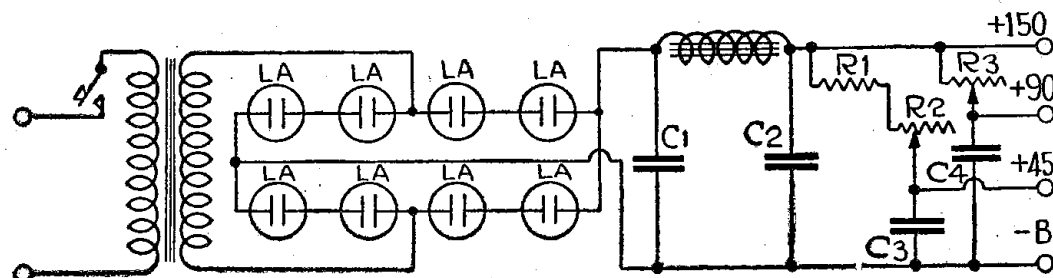

Figure 4. Circuit diagram for B eliminator.

light socket plug is connected to the other ends of this twin cord and unit is ready for operation. Check over all connections once more and connect to your receiver. Then pull switch on front of B power panel and turn switch of receiver to on position. You will hear nothing for a few minutes, then a few snatches of music very ragged and "growly." This happens only on first installation as the rectifiers have to work up a gas film. Pretty soon, if you leave set tuned to a good program, the raggedness will disappear and then the hum. Remember, the Bradleyohm to left controls the intermediate voltage and that to the right, the

detector voltage and these should now be adjusted for clearest reproduction. Slight change in the adjustment of the rheostats on your receiver may be necessary with this unit, from those settings to which you are accustomed when using B batteries.

At this point the writer wishes to give you an important fact in connection with all these B eliminators. The voltages from them cannot be measured with the ordinary B battery voltmeter. To get the exact voltage one should use a milliammeter and known fixed resistances. By multiplying the reading of the milli-

(Continued on page 30)

# No More "B" Batteries on Your Radio

At last, a practical reliable "B" battery eliminator for your radio. Does away with "B" batteries; no charging; no replacing. Always 100% efficiency in "B" current. The most revolutionary development in radio.

**Genuine Fansteel Balkite "B" Eliminator Sent for Only**

**\$1.00 Down**



U.S. PAT. MAY 27, 1924

The Balkite "B" is connected to your radio just like "B" batteries and attached to an ordinary electric light socket. Replaces "B" batteries entirely and furnishes "B" current direct from regular house lighting current. Always gives current equal to four new and fresh 22½ Volt dry "B" batteries. For sets of five tubes or less. Simplifies radio receiving. More convenient, more economical and more efficient than dry or wet "B" batteries. Operates storage battery or dry cell tubes and gives tubes longer life. Entirely noiseless. Creates no disturbance in reception. Has no bulbs, nothing to break, wear out, replace or get out of order. Requires no change in your set, no extras to buy. Operates from 110-120 AC, 60 cycle current. Measures 8 3-16 inches by 8 inches by 3¼ inches. Current costs only 1-20 of a cent per hour.

## \$5.00 a Month, if satisfied after trial

Only \$1.00 with the coupon below brings the Balkite "B" to your home on trial. Try it out thoroughly before you pay another penny. See how it improves reception. See how much more convenient than using batteries. Judge for yourself how it will save you money and make your radio set more enjoyable. Then, if not satisfied, send it back at our expense and we'll refund your \$1.00 plus all transportation charges. If you decide to keep the Balkite "B," start paying only \$5.00 a month until you have paid the total price of only \$35.00. That's the price others ask for spot cash. We give you the lowest cash price on easy monthly payments you will never feel.

### Send Coupon

Don't miss this opportunity to get the genuine Balkite "B" at the rock-bottom cash price on easy monthly payments. Send coupon now while this offer lasts. Order by No. Y-8578A, \$1.00 with coupon; \$5.00 a month; total price \$35.00.

**STRAUS & SCHRAM**  
Dept. R4412 Chicago, Ill.

**STRAUS & SCHRAM, Dept. R4412 Chicago**

Enclosed find \$1.00. Ship special advertised Balkite "B" Battery Eliminator. I am to have 30 days free trial. If I keep it, I will pay you \$5.00 monthly. If not satisfied, I am to return it within 30 days and you are to refund my money and any express charges I paid.

**Balkite "B" Battery Eliminator, No. Y8578A, \$35.00**

Name.....

St., R. F. D. or Box No.....

Shipping Point.....

Post Office.....State.....

# Unitrola: Single Dial Phonograph Receiver

## Part IV—Adjusting and Tuning

By Carl Patterson

**I**N PART III, published last week, the Unitrola was taken through the wiring and final assembly and was ready for operation. We are now ready to slide it into the phonograph, connect it up and bring in stations. If you choose to rest this receiver on the bottom of the record compartment, nothing further is necessary, but if you prefer to have the batteries in with it a shelf will have to be figured out. The writer handled this situation by putting in 1/2-inch by 1/2-inch strips on each side of the compartment with the upper surface of each 8 inches from the top. A light wooden shelf was then made, just the width and depth of the compartment and the completed receiver was secured to it, so that the lower edge of the front panel was 1/2 inch from the front edge. This 1/2 inch was allowed because the rheostat knobs protrude slightly and the doors on the front were to be closed when the set was not in use. A hole was then drilled through the shelf directly behind each of the battery binding posts so the wires could go down to their respective battery clips.

### The Speaker Cord

This arrangement left room below the shelf for a Philco glass case storage battery, a Balkite trickle charger, a Benjamin series two-way plug with lamp, and two large Eveready B units. Since each machine is different in the dimensions of this compartment you will have to do a little figuring on this part yourself. The cord for the speaker unit to be used on the machine is the next point. Here the writer lifted out the top panel in the phonograph, complete with its mechanism, and drilled a hole through, back of the horn, into the record compartment. Then, replacing the mechanism panel, a hole was drilled, above the first, in this panel, for the cord. Thus the cord comes up through the thin board forming the top of the compartment and through the panel above the works to the unit. Neither hole has to be very large, 3/16 inch should be enough.

The speaker cord tips are connected with the tip which has the tracer thread going to the fourth binding post from the left and the unmarked tip to the third. Antenna and ground are brought in through two 3/16-inch holes drilled either in the bottom or the back, about two inches apart. Antenna goes to number 1 binding post and ground to number 2 post. All these accessory connections should be made with the panel slid half way out of the compartment with the front edge resting on a chair or other support. The storage battery, or one of the so-called eliminators on the market, is then connected with its plus terminal going to binding post number 6 and its negative post to number 5. If you are not familiar with these terms it may be explained that the plus post on your battery is usually marked with POS., a + sign, or with a touch of red paint. The negative is, of course, the other terminal, and is marked with a — sign or NEG. The B battery units, whether dry or

wet, each have a plus and negative terminal. The negative of one is now connected to the third binding post from the right end of the strip, the positive of the same unit goes to the second from the right and also by a short length of wire to the negative of the second B unit. The plus of this second unit goes to the last binding post to the right. The last step is the insertion of the tubes. These new UX bases may be a little confusing at first if one has been used to the old UV type. Once you get used to this new arrangement though, you find it much more convenient with no question of springs touching pins or bayonet pin sticking in the socket.

Considering the sockets in the order in which they were numbered for wiring, turn the tube to go in socket 1 so that the two large pins in the base are toward the inside of the set, with the smaller pins to the left. Tip the tube into a vertical position and push down firmly and the tube will click into security. With socket number 2 turn the large pins to the front, with socket number 3 the small pins are to the right or outside of the set. When putting the tubes in sockets 4 and 5, the large pins are, of course, to the rear. Now see that each Amperite is securely in its mounting and the 2-megohm grid leak is in the Daven mounting. In operation 35, the last of article III, the copy read that the lead common to the F terminals of the Bodine coils was to be connected to the plus terminal of the left C battery. This should have read to the negative 4 1/2 of this C battery. This can be readily changed at this stage of the procedure.

### Preliminary Adjustments

Now slide the set back into position with rear edge of shelf against rear wall of compartment. The Pilot switch to the right is then turned to the "on" position and red lamp will glow. Then turn Dialite to right so its rays can light up the dial. The rheostats at the bottom should be turned clear to right as far as they will go and then back about 1/4 inch as a preliminary adjustment. Then turn left C-R-L unit to right to its limit and right C-R-L so that arrow is just to right of vertical. The small compensating knobs below and beside large dial are set so that each points outward. You are now ready to tune the set for initial tryout.

Turn the large dial, whether vernier or plain, through its complete scale and, if you are fairly near a large station operating at the time, it will be heard, though perhaps faintly at first. If nothing is heard, advance the right C-R-L and try it again. If still no results, advance both rheostats. The next suggestion, in case of no signals, is to set right compensator with arrow vertically and swing through scale. The next move would be to bring it back to horizontal, set left compensator at vertical and swing through range. One of these combinations will bring in signals if all work has been done correctly.

When program is heard, carefully set large dial for best results, then adjust each compensator, which will bring all three grid circuits into resonance. Then move the right rheostat back and forth until strongest and clearest reproduction is obtained but keep it no further to right than is necessary as this would burn up energy and shorten the life of the tube. The left rheostat can then come in for attention, after which adjust the left C-R-L. The left rheostat and left C-R-L may be adjusted together as they are interdependent on each other. For example, if the rheostat were turned back slightly and C-R-L adjusted to maximum, advancing rheostat would spill the tubes into oscillation, or tuning to a lower wave length would do the same. Find a position of the rheostat, probably just about 1/4 inch back of the limit, at which oscillation could be effected at any setting of the large dial by means of the C-R-L.

With a program brought in to maximum efficiency by means of rheostat, compensator and left C-R-L adjustments, turn the right C-R-L to the right until program starts to blur or distort. If distortion creeps in before you reach satisfactory volume, try switching the tubes around in their sockets to get the two best suited for radio frequency amplification in sockets 1 and 2, the best detector in 3 and that best suited to handle a lot of energy in socket 4. There is not likely to be trouble with the tube in socket 5.

### Trouble Shooting

There are two possibilities in connection with the operation of the compensators. In some cases, a position of each will be found that holds good throughout the tuning range of the large dial, while, in others there will have to be a slightly different position of each for the upper and lower range of the dial. This will depend, in the case of the right compensator, upon the antenna used. If by any chance you cannot bring this first grid circuit into resonance with the other

two at some portion of the tuning range, it will be necessary to insert a .00025 mfd. condenser (fixed) in the antenna lead-in wire, or possibly even a .0005 mfd., due to the great length and consequent influence of the antenna system.

The grid leak may possibly be changed for better results although due to detector having an individual rheostat and individual control this is not likely to be the case. If you happen to have several resistors between 1 megohm and 5 megohms you might try them. You will probably find, as has the writer, on tuned radio frequency sets, that lower values permit greater volume with clearness on local stations while higher values give slightly better results on DX work. Values of 2, 3 or 4 are usually good.

If you get into trouble think over the possibilities of where it might be, logically and carefully. Do not be afraid to try one or two things and remember that 80% of all Radio set troubles are in battery connections and oversights on the part of the user. Is the storage battery charged? Make sure. Do the B units test 38 to 45—with a good high resistance voltmeter? Borrow one and try it if you haven't one. Try your tubes in someone else's set to be sure you aren't trying to get 100% results on a poor tube or one that is worn out and cannot possibly deliver. Then check your wiring. Be sure that the connection passing through the hole at right lower end of condenser is not touching. Look out for that extra soldering lug on the rear end of condenser at left side, on the last stator. It fooled this writer and had us tearing the set apart, because it had gotten bent down against the end plate.

Did one of the wires in the coils come unsoldered from a terminal when you were putting on a connection? It might easily happen despite all care in manufacture. It may be, too, that one of the nuts on a transformer is a little loose. If you find this so, carefully loosen the lock (knurled) nut on top, remove solder-

(Continued on page 30)

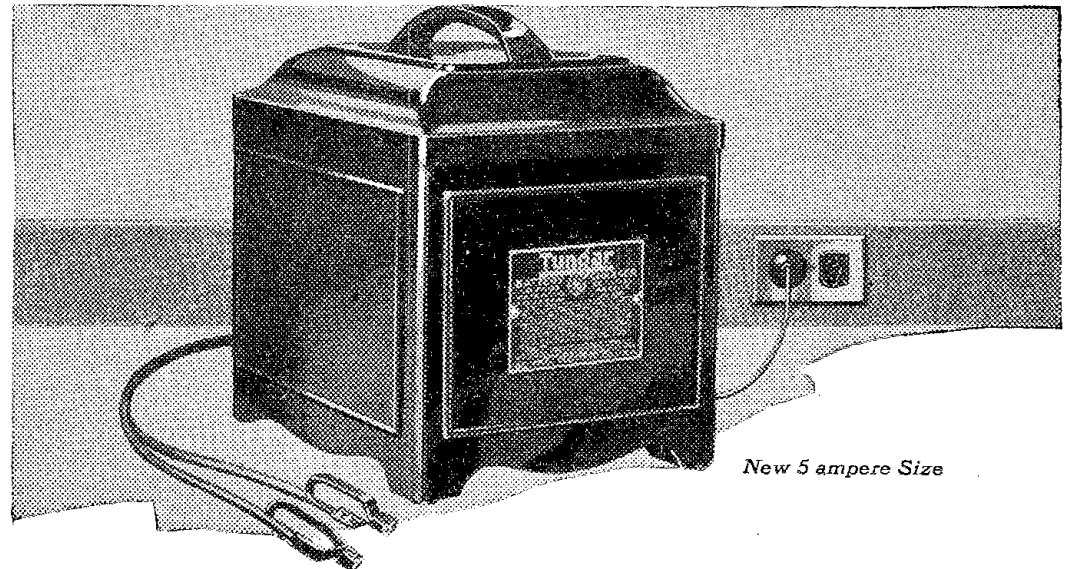

New 5 ampere Size

# Say Tungar

when you want the best battery charger



The Tungar is a G-E product, developed in the Research Laboratories of General Electric.

The new Tungar charges any make and size of storage battery: radio "A" and auto batteries, and "B" batteries as high as 96 volts in series.

East of Rockies

Two ampere size \$18.00  
Five ampere size \$28.00  
60 cycles . . . 110 volts

Merchandise Department  
General Electric Company  
Bridgeport, Connecticut

"Tungar" is fast becoming the word for battery charger. And no wonder!

Tungar is the trouble-proof, easy-to-use charger for all batteries. It's the original bulb charger. It's manufactured by General Electric. It makes no disturbing noise. It can't blow out Radiotrons and it cannot create radio interference.

# Tungar

REG. U.S. PAT. OFF.  
BATTERY CHARGER

Tungar—a registered trademark—is found only on the genuine. Look for it on the name plate.

# GENERAL ELECTRIC



Fred W. Stein.

# Steinite

Low Loss  
Interference Eliminator  
No Radio Set Complete Without It

Select stations at will. With music and voices crowding the air the average set fails to bring in the desired stations properly. The Steinite Interference Eliminator shuts out local and other interference. You get one station at a time, the one you want, and tune in loud and clear. Operates on any set—attach to aerial wire and to set—no changes—no extra tubes or batteries. Greatest Dollar Value in Radio Today.  
Over 150,000 Sold

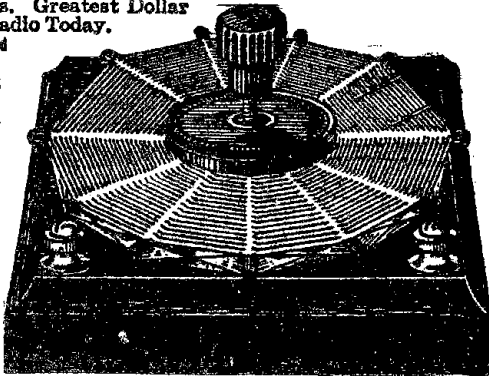

Improved Results with Tube or Crystal

Try entirely at my risk the wonderful improvement this inexpensive little device will make in the reception of your set. Improves results on both crystal and tube sets that use any kind of aerial except loop antenna. Clears up reception wonderfully, increases volume, and partially absorbs static. Money-Back Guarantee.

Mrs. Famous 1,500 Mi. Steinite 1-Tube Set, \$6; Long Distance Crystal Set, \$6; Steinite Crystal \$50—Three for \$1.

Steinite 5-Tube Set \$29.75

FREE Descriptive Literature on request.

\$1 Postpaid If you are not delighted with results you get your dollar back

Put this interference eliminator on your set and note amazing improvement. No tools needed—install in a moments time. Connect with set and follow simple instructions. Money back promptly if not delighted. \$1.00 postpaid anywhere in U. S. when cash with order.

References: Exchange National Bank, Atchison Savings Bank. Order today—a dollar bill will do.

STEINITE LABORATORIES, 161 Radio Bldg., ATCHISON, KANSAS

### SHORT WAVES

By Marcella

(Continued from page 11)

mits he is married and has a little boy 5 years old. Charlie is the fellow that barred sopranos from WBBM's microphones. As a result he is still receiving nasty letters from us ladies calling him on the carpet for his act. No, Mr. Garland is not the notorious Charles Garland of crime newspaper story fame. The latter is not even recognized as a relative.

We, meaning Radio Digest, located Jack Little last week. He was down at WSAI, Cincinnati. Incidentally, here is the real, honest-to-goodness low-down on this famous character. His dad tipped me off, so here 'tis:

His real name is Jack Leonard. He is the son of Mr. and Mrs. James Leonard of Waterloo, Iowa. He is really quite small, measuring only five feet three inches in height. He is 25 years old.

Those of you ladies who admire Henry Selinger, of the Drake concert ensemble heard over WGN, will be glad to know that he is handsome and unshackled. He started his career by reading a correspondence violin school ad, and graduated by going to the post office for his diploma. Since then he has become quite popular on the air, and he still uses the violin that came with his lessons.

Wendell Hall's charming wife was in to tea with Marcella not so long ago. "Do you mind the ladies' love letters your husband receives?" I asked. "Not at all," she replied, "I answer all of them myself."

What deep secret would you like to know about your favorite broadcast star? Drop me a note, girls and boys, and I'll do by best to answer here. **MARCELLA.**

### CHEMICAL ELIMINATOR

(Continued from page 28)

ameter with the value of the resistance one will get the exact value of the voltage. The ordinary B battery voltmeter will not show more than about 15 volts.

#### Final Suggestions

If the unit is used on a super-heterodyne, and two detectors are connected to the 45-volt binding post, it may be necessary to short circuit the fixed resistor in the clips identified as R1. As a rule there will be absolutely no hum with this unit. If there is, the trouble is usually that the B unit is placed too close to the receiver or the light line comes too close to it, and the receiver will pick up the hum from the light wires. Another cause of hum is too high a plate voltage on the radio frequency tubes. This can be cut down by the left Bradleyohm and the use of C battery in the grid return leads of the radio frequency tubes. If unit is put in a cabinet, it would be well to drill holes for ventilation. The writer drilled six 3/8-inch holes in each end near the bottom and seven 3/8-inch holes across the back about 1 1/4 inch from the top. This permits circulation of air around the jars and transformer which is desirable in summer time.

Should you have trouble getting any

### CLASSIFIED ADVERTISEMENTS

#### TELEGRAPHY

Telegraphy—Both Morse and Wireless taught thoroughly. Big salaries. Wonderful opportunities. Expenses low; chance to earn part. School established fifty years. Catalog free. Dodge's Institute, Sixth St., Valparaiso, Ind.

#### MISCELLANEOUS

Photos of Your Favorite Radio Stars. Ten cents and coupon appearing on another page of this issue will entitle you to one of the photos from Radio Digest gallery of stars. Radio Digest, 510 North Dearborn Street, Chicago.

#### BLUE PRINTS

Super-Het, Ryan's Simplest Possible 7-Tube Set. Complete instructions; actual size template. How to make a loop. All for 50 cents. Book Dept., Radio Digest, 510 North Dearborn Street, Chicago.

Six Tube Radio Frequency Set, employing three stages of perfect audio. Complete instructions, actual size templates and diagram. 65 cents. Book Dept., Radio Digest, 510 North Dearborn Street, Chicago.

#### SALESMEN WANTED

Make \$100 WEEKLY in spare time. Sell what the public wants—long distance radio receiving sets. Two sales weekly pays \$100 profit. No big investment, no canvassing. Sharpe of Colorado made \$955 in one month. Representatives wanted at once. This plan is sweeping the country—write today before your county is gone. **OZARKA, INC., 126-G, Austin Ave., Chicago.**

of the material locally, the address of C. E. Jacobs, maker of the Molliformer kit, is 2802 North Kedzie avenue, Chicago, while that of Tobe Deutschmann, maker of the extra condenser is Cornhill, Boston, Mass. Molliformer kits for 25, 40 and 50-cycle current are \$19.00. The other concerns can be reached from addresses given in list of parts.

(A third type of B power supply which incorporates a heated filament tube, the UX-213, will be described by Mr. Walters in next week's installment. A new Thor-darson transformer, type R-197, supplies the filament current and also the high voltage plate current.—Editor's Note).

### MAKING THE UNITROLA

(Continued from page 29)

ing lug and, with one pair of pliers hold the screw itself firmly. Then with another pair of pliers tighten the hex nut. If you do not hold the screw tightly, you may turn it and break off the connection inside. Do all these things, check all these things, no matter how sure you are or how silly they may seem, before you write in to the technical staff. They have a lot to do, answering essential questions by the hundred, working out new devices for you and writing them up.

### AVOID FALSE ECONOMY

(Continued from page 11)

woman telling you how you should economize. I can only suggest that you take stock of your economies, pigeon hole them where they belong, and if they do turn out to be extravagances, make them over or put them down as commendable luxuries rather than to fool yourself into thinking they are economies.

### OPEN "BLOOPER" WAR

(Continued from page 3)

interference, receiving conditions will be remarkably improved for everyone in the country.

Legislation, with penalties attached, is not believed by Radio Digest to be the way to solve the problem. Enforcement of such laws would be costly and almost impossible. It is the aim of Radio Digest to secure the cooperation, without legislation, of every listener.

Fill in and mail the pledge appearing on page three, TODAY.

To help pledging fans to carry out their promise, Radio Digest will begin, with the February 13 issue, a series of non-technical articles aimed to show if possible how one can make his receiver non-radiating. Hints and suggestions for the improve-

### ADDRESSES WANTED

THE Technical Editor wishes the present addresses of the following readers: Mr. Charles Ackerman of Philadelphia, Mr. Fred Bradley of Ann Arbor, Mich., Mr. Robert Harrington of Dayton, Ohio, and Mr. Jack Lenox, somewhere on the Orpheum circuit. If you know any of the above please call this to their attention, or write the Technical Editor giving the information.

ment of one's receiver, together with general, basic lessons in operating receivers properly, will be contained in this series of articles.

Simple rules in using a set, if followed, will stop a set from radiating. If the majority of listeners sign the pledge to do their best to prevent radiation, the problem will be more than half solved.

Join, and get your neighbor to join, the Radio Digest I WON'T BLOOP CLUB. Mail your pledge today.

### To Broadcast Frequencies

WASHINGTON. — Announcement is made by the Radio laboratory of the bureau of standards that standard frequency signals will be transmitted by the bureau laboratory (WV) and 6XBM, Stanford University, Calif., on the fifth and twentieth day of each month for the next three months, between 10 and 11-32 p. m., Eastern and Pacific times respectively. The frequency range to be covered will be between fifty and 2400 meters.

### \$1.50 for Your Old Radio Tubes

regardless make or condition, toward purchase of each new standard \$2.50 tube. Positively guaranteed. We do not sell re-built or bootleg tubes. Agents Wanted.

Super-Service Laboratories, Dept. 50 Room 58, 39 West Adams, Chicago, Ill.

### Big Money in Radio

Demand for high pay radio men is so great that a big Kansas City wholesale concern is now fitting men free to get into the radio business for themselves and make \$60 to \$200 a week without any capital invested. Select territory open. Send today for free catalog and amazing offer. Write direct to Mr. H. J. Saizow, Standard Radio Co., 1440 Walnut St., Kansas City, Mo.

### GET THIS BIG RADIO CATALOG FREE

Simply send name TODAY for big 64-page book explaining liberal proposition paying agents \$60 to \$100 a week, and how to make money from latest radio goods. Live dealers and agents wanted.

Standard Radio Co., 1442 Walnut St., Kansas City, Mo.

### Radio Results Improved 100%

Marvelous new scientific radio ground gives such amazingly improved reception you doubt your own ears. Stops all leakage. Doubles power and distance. Demonstrates full capacity of your set. Results you never dreamed possible.

### Yale Ground Hog "The Perfect Ground"

Has power to draw and hold moisture indefinitely. Highly sensitive to radiotelectric energy. To introduce we now offer for a limited time our Regular \$5.00 size for only \$2.00. SEND NO MONEY, simply pay postman \$2.00 plus 17c postage on delivery. If you prefer, send only \$2.00 with order and save postage.

SATISFACTION Guaranteed or Money Back FREE Complete description of Ground Hog, and new price lists on all radio supplies, sent free. Send name today.

YALE SPECIALTY SUPPLY CO., 1805 Grand Ave., Kansas City, Mo.

22 1/2 Volt un-acid everlasting rechargeable "B" STORAGE BATTERY \$2.95 Includes Chemical

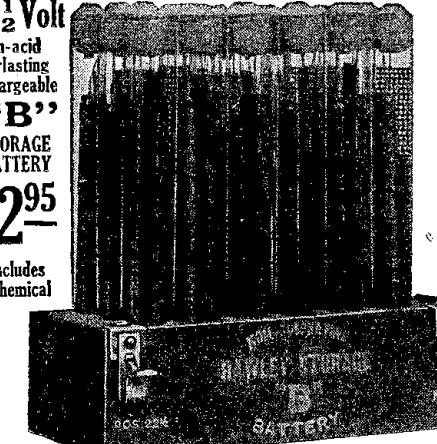

45 volts, \$5.25; 90 volts, \$10.00; 112 1/2 volts, \$12.50; 135 volts, \$14.75; 157 1/2 volts, \$16.80. Truly the biggest buy today. Easily charged on any current including 32-volt systems. Any special detector plate voltage had. Tested and approved by leading authorities such as Popular Radio laboratories. Over 3 years sold on a non-refundable 30-day trial offer with complete refund if not thoroughly satisfied. Further guaranteed 2 years. Knock-down kits at great savings. Complete "Hawley" "B" battery charger, \$2.75. Sample cell, 35c. Order direct—send no money—simply pay the expressman cost on delivery. Or write for my free literature, testimonials and guarantee. Same Day shipments. B. Hawley Smith, 817 Washington Ave., Danbury, Conn.

### CKAC Starts Own Capitol Hour

MONTREAL.—Canadian Radio fans will have their own Capitol theater hour from now on through the cooperation of CKAC, La Presse station here, and that of HARRY Dahn, manager of the million dollar playhouse located in the heart of the Canadian metropolis. This new departure, in Montreal, took place on a recent Sunday when a de luxe program was given by CKAC direct from the stage of the Capitol.

This broadcast from CKAC takes place every Sunday afternoon at 2:45 eastern time.

### LATEST "COAST TO COAST" FULLY GUARANTEED

**RADIO'S-10 DAYS FREE TRIAL** SAVE 1/3 TO 1/2



Users everywhere report Miraco Radios get programs coast to coast on loud speaker! Other form sets three times as costly. Many hear foreign countries. Radio's most amazing values in unconditionally guaranteed, factory-built long distance sets—let testimony of users convince you.

**MIRACO RADIO GETS EM COAST TO COAST**

Powerful New Multi-tube Miraco gets long distance on loud speaker. Set, ONLY \$27.35 retail

FREE! Literature on latest improved 1 to 6 tube models, new low prices, testimony of users and SPECIAL OFFER. Write: **MIDWEST RADIO CORP'N** Pioneer Builders of Sets 437-W E. 8th St. Cincinnati, O.

AGENT USERS WANTED Write for discounts.

New—Different The Beautiful, De Luxe Radio Log You've Always Wanted.

**The Wonder Radio Log**

Rich seal grain binding, stamped in gold; top edge gilt, 144 pages, size 5x7 1/2. Printed on heavy bond paper. A Log you will be proud of.

Lists the Broadcasting Stations three convenient ways—(1) by Call Letters; (2) by Locations and Owners; (3) by Kilocycles and Meters. Includes 24 page Wonder Radio Diary by months and days, and Wonder Radio Distance Map. Ample space for keeping complete Log and for changes, additions and revisions.

Sent post paid \$1.00. Order your copy now. You'll be delighted with it or money refunded.

**WONDER RADIO LOG CO., 711 South Dearborn, CHICAGO, ILL.**

**RADIO INVENTIONS** Protected by U. S. and Foreign Patents

**MASON, FENWICK & LAWRENCE** Patent and Trade Mark Lawyers Washington, D. C., New York, Chicago Established Over Sixty Years

References: LIFE SAVERS INC., PORT CHESTER, N. Y. STEPHEN F. WHITMAN & SON, PHILADELPHIA PACIFIC COAST BISCUIT CO., SEATTLE, WASH. LOFT, INC., NEW YORK CITY SPRAGUE WARNER & CO., CHICAGO THE WARREN CO., ATLANTA, GA. A. BALDWIN & CO., NEW ORLEANS, LA. JOSEPH BURNETT CO., BOSTON

Send Description and Sketch

Stop Tuning by Guess Use RADEX and get stations you never got before

RADEX shows—

- your dial positions for more than 600 stations
- the name of the station received without announcement
- the wave length to which your set is tuned at any time.

For any set that can be logged. Postpaid 25c. coin or stamp. \$2.00 des.

**THE RADEX PRESS** BOX 143-A CLEVELAND

**AMPLION** For Better Radio Reproduction



Product of nearly 40 years' experience

Hear this creation of the originators and oldest makers of loud speaking devices. Six models, with cords and panel plugs, \$12 up. Write for "Amplion Pedigree".

**THE AMPLION CORPORATION OF AMERICA** Suite A, 280 Madison Ave., New York Chicago Branch: 27-29 N. Morgan St. Burndepot of Canada, Ltd., Toronto

# Radiophone Broadcasting Stations

## Corrected Every Week—Part I

### United States

**AT9**, Fort Bragg, N. C. 434.5m-690kc. 750 watts. U. S. Government. Announcer, Lieut. James Y. LeGette. Slogan, "The Pioneer Broadcasting Station of the Army." Tues, Thurs, Sat, 8-9:55 pm, dance music, bands, fights. Sun, 8-9:55 pm, service. Eastern.

**KDKA**, E. Pittsburgh, Pa. 309.1m-970kc. 1,000 watts. Westinghouse Elec. & Mfg. Co. Announcer, George S. Ryan. Slogan, "The Pioneer Broadcasting Station of the World." Daily ex Sun, 9:45-11 am, 11:55, time, 12, market reports, weather, 2:30-5:30, music; 7, 9:55, time, daily except Sun, Sat; 12:15 pm, music; 7:45 pm, talks. Daily ex Sat, Sun, 8:30 pm; 8:45, concert; 9:55, time. Sun, 8:45 pm, concert; 9:55, time. Tues, Thurs, 10:30 pm, Sun, 9:45 am, 3 pm, 8:45, 6:45. Eastern.

**KDLR**, Devils Lake, N. Dak. 230.6m-1300kc. 5 watts. Radio Elec. Co.-Wilson Ins. Agency. Daily ex Sun, 12:10 pm, weather; 6:15, markets. Mon, 9:30-11:30 pm, Sun, 11 am, church, 4:30-6. Central.

**KDYL**, Salt Lake City, Utah. 245.8m-1290kc. 50 watts. Newhouse Hotel. Announcer, George S. Slogan, "Out on the Great Divide." Daily ex Sun, 3-4 pm, 6:30-8, news, music, entertainment. Sun, 11-11 am, Mountain.

**KDZB**, Bakersfield, Calif. 209.7m-1430kc. 100 watts. Pacific Siefert. Daily ex Sun, 8-9 pm, reports, music. Pacific.

**KFAB**, Lincoln, Neb. 340.7m-880kc. 1,000 watts. Nebraska Buick Auto Co. Announcer, Gayle Grubb. Daily ex Sun, 9:30-9:55 am, weather reports; 3-4 pm, Mon, Tues, Wed, Fri, 10:30-11 am, home economics; 1:15-1:30 pm, talks; 3:30-4 pm, 5:30-6:30, 8:05-8:30, college of agriculture; 8:30-10:30, Tues, Sat, 3-4 pm, Sat, 9:30-9:55 am; 5:30-6:30 pm, 8:30-9:30. Sun, 4-5 pm, 9-11. Central.

**KFAD**, Phoenix, Ariz. 272.6m-1100kc. 100 watts. Electrical Supply Co.-McArthur Brothers Mercantile Co. Announcer, Arthur C. Anderson. Slogan, "The Voice of the Atwater Kent Radio." Daily ex Sun, Mon, 6-7 pm, 8-9. Daily ex Sun, Wed, 6-7 pm; 9-11, concerts, news, stocks. Mountain.

**KFAF**, San Jose, Calif. 217.3m-1380kc. 50 watts. Alfred Fowler.

**KFAJ**, Boulder, Colo. 260.7m-1150kc. 100 watts. Univ. of Colo. Announcer, E. M. Orsborn. Tues, Sat, 9 pm, time, music, addresses by faculty. Thurs, 7:30 pm; Sat, 2:30-5 pm, sports. Mountain.

**KFAU**, Boise, Idaho. 280.2m-1070kc. 750 watts. Boise H. S. Announcer, Hoyt Cooper. Slogan, "Idaho Station." Daily ex Sat, Sun, 4-4:45 pm, markets, weather, news. Mon, 7:30-9 pm, concert. Thurs, 8-10 pm, concert. Sat, 7:30-8:30 pm. Sun, 7:30-8:30 pm, church service. Mountain.

**KFBB**, Havre, Mont. 275.1m-1090kc. 50 watts. F. A. Buttrey Co. Announcer, C. O. Boettger. Daily ex Sun, 12:45 pm, music, markets, weather, reports. Mountain.

**KFBC**, San Diego, Calif. 244m-1290kc. 100 watts. W. K. Azbill. Sun, 9-10 am, Bible lesson, sermon. Tues, Thurs, 8-9 pm, Pacific.

**KFBK**, Sacramento, Calif. 247.8m-1210kc. 100 watts. Sacramento Bee. Mon, Thurs, Sat, 7:30-10 pm, Pacific.

**KFBL**, Denver, Wash. 223.7m-1340kc. 100 watts. Lesse Bros. Daily, 7:30-8:30 pm. Pacific.

**KFBS**, Trinidad, Colo. 238m-1260kc. 15 watts. School District No. One.

**KFBW**, Laramie, Wyo. 270.1m-1110kc. 500 watts. Bishop N. S. Thomas.

**KFCB**, Phoenix, Ariz. 238m-1260kc. 100 watts. Nielsen Radio Supply Co. Announcer, E. A. Nielsen. Slogan, "When It's Winter in Michigan, It's Summer Time Down Here." Daily 7-7:30 pm, bedtime stories. Mountain.

**KOWW**, Walla Walla, Wash. 256.3m-1170kc. 500 watts. Blue Mt. Radio Association. Slogan, "The Valley They Liked So Well They Named It Twice." Mon, Thurs, Fri, 7-7:30 pm, 8-12. Wed, 12-1 pm; 7-7:30, 9-12. Sat, 2-7:30 pm; 8-12. Pacific.

**KFDD**, Boise, Idaho. 278.6m-1080kc. 500 watts. St. Michael's Episcopal Cathedral. Announcer, E. Mark Hanford. Sun, 11:15-12:30 pm, 7:30-9:15. Mountain.

**KFDM**, Beaumont, Tex. 315.6m-950kc. 500 watts. Magnolia Petroleum Co. Announcer, Magnolene Mike. Slogan, "Call for Dependable Magnolene." Tues, Fri, 12:30-12:55 pm, band concert; 7-7:30, children's hour; 8-10:30, concerts. Sun, 11-12 m, 8-9 pm, Central.

**KFDX**, Shreveport, La. 249.9m-1200kc. 100 watts. First Baptist church. Announcer, Hugh Claycomb. Sun, 10:50 am; 7:45 pm, Wed, 9-10 pm. Central.

**KFDZ**, Minneapolis, Minn. 230.6m-1300kc. 10 watts. Harry O. Iverson.

**KFEC**, Portland, Ore. 247.8m-1210kc. 50 watts. Meier & Frank Co., Inc. Daily ex Sun, 12 m, weather, reports; 4-5 pm, music; 6:30 pm, weather, crop, markets, reports. Sat, 11 am-12 m, children's hour. Pacific.

**KFEL**, Denver, Colo. 254.1m-1180kc. 50 watts. W. L. Winner. Inc. Announcer, Eugene P. O. Fallon. Daily ex Sun, 11 am, 2 pm, 4, 5. Tues, 9-10 pm; Thurs, 8-12 midnight. Mountain.

**KFEQ**, Oak, Neb. 267.7m-1120kc. 500 watts. J. L. Scroggin. Announcer, G. G. Scroggin. Daily ex Sun, 2-3 pm, orchestra. Sun, 4:30-6 pm, Central.

**KFEY**, Kellogg, Idaho. 292.4m-1290kc. 100 watts. Bunker Hill & Sullivan Mining & Con. Co. Announcer, Walter C. Clark. Slogan, "Voice of the Coeur d'Alenes." Mon, Wed, 6-7 pm. Sat, 9-11 pm. Sun, 6-7 pm. Pacific.

**KFFB**, Moberly, Mo. 241.8m-1240kc. 50 watts. First Baptist Church. Announcer, Granville Ray. Slogan, "The Gospel Messenger of the Air." Tues, Thurs, Fri, 7:30-8:30 pm; 9-10 pm, "Daniel Boone Station." Wed, 8-9 pm. Sun, 3-4 pm. Central.

**KFH**, Wichita, Kan. 267.7m-1120kc. 500 watts. Hotel Lassen. Daily ex Sun, 9-11 am; 9-10 pm; 9-10, Thurs, Sat, 12:15-1:15 am. Sun, 9:45 am, church; 9-9:45, quartet. Central.

**KFHA**, Gunnison, Colo. 252m-1190kc. 50 watts. West-ern State College of Colorado. Announcer, E. Russell Wright. Slogan, "Where the Sun Shines Every Day." Nightman. "Where the Sun Shines Every Day." Tues, Fri, 6:30 pm, bedtime story; 8 pm, music; 10:30, orchestra. Mountain.

**KFHL**, Oskaloosa, Iowa. 239.9m-1250kc. 19 watts. Penn College.

**KFI**, Los Angeles, Calif. 468.5m-610kc. 5,000 watts. Earle C. Anthony. Announcer, Robert Hurd. Slogan, "The Radio Central Station." Daily ex Sat, Sun, 5:30-11 pm. Sun, 10-11 am, 4-5 pm, 6:30-11, 11:30-12:30 pm, first and third Sunday of month. Pacific.

**KFIF**, Portland, Ore. 247.8m-1210kc. 100 watts. Benson Tech. School. 247.8m-1210kc. 100 watts.

**KFIO**, Spokane, Wash. 265.3m-1130kc. 100 watts. North Central High School.

**KFIQ**, Yakima, Wash. 256.3m-1170kc. 100 watts. First Methodist Church. Announcer, Dr. I. M. Miller. Wed, 7:30 pm, organ. Sat, 7 pm. Sun, 11 am, 7:30 pm. Pacific.

**KFIU**, Juneau, Alaska. 225.4m-1330kc. 10 watts. Alaska Elec. Light & Power Co. Announcer, O. E. Shoebell. Mon, Wed, Fri, 6-7 pm. Alaskan.

**KFIZ**, Fond du Lac, Wis. 272.6m-1100kc. 100 watts. Daily Commonweath and Wisconsin Radio Sales, Inc. Announcer, Albert Mayer. Daily ex Sun, 5 pm, music, news, markets, weather. Central.

**KFJB**, Marshalltown, Iowa. 247.8m-1210kc. 100 watts. Marshall Elec. Co. Announcer, E. N. Peak. Slogan, "Marshalltown the Heart of Iowa." Daily ex Sun, 10 am, markets. Tues, Fri, 8-9 pm. Central.

**KFJC**, Junction City, Kan. 218.8m-1370kc. 10 watts. R. B. Feagan.

**KFJE**, Oklahoma City, Okla. 260.7m-1150kc. 500 watts. National Radio Mfg. Co. Announcer, Hired Hand. Slogan, "Radio Headquarters." Daily ex Sun, 9:40 am, 12:15 pm, markets; 2:15, 6:30, weather am, 6:30-7:30. Mon, Thurs, Fri, Sat, 8:15-10:45 pm, Wed, 11-12 midnight. Sun, 2:30-4 pm; 10-11:45. Central.

**KFJH**, Astoria, Ore. 245.8m-1220kc. 10 watts. E. E. Marsh and Liberty theater. Announcer, E. E. Marsh.

Wed, 9-10 pm, organ. Sun, 12:30-1:30 pm. Sun, 10:30-11 pm, Pacific.

**KFJM**, Grand Forks, N. D. 277.6m-1080kc. 100 watts. University of North Dakota. Slogan, "Grand Forks, The Educational Center of the State." Daily ex Sun, Thurs, 6-7 pm. Central.

**KFJR**, Portland, Ore. 263m-1140kc. 50 watts. Ashley C. Dixon & Son. Mon, Tues, Wed, Thurs, 7:30-8 pm, Mon, 8-8:45 pm. Tues, Thurs, 9-10:30 pm. Wed, 8-8:30 pm. Sat, 1:30-3 pm. Pacific.

**KFJY**, Fort Dodge, Iowa. 245.8m-1290kc. 50 watts. Tunwall Radio Co. Announcer, Carl Tunwall. Daily, 5:30 pm, markets, news, weather, bulletins. Sun, 11 5:30 pm, church; 8:15 pm, orchestra. Central.

**KFJZ**, Fort Worth, Texas. 254.1m-1180kc. 50 watts. Southwestern Baptist Theological Seminary.

**KFKA**, Greeley, Colo. 272.6m-1100kc. 50 watts. Colorado State Teachers' College. Announcer, Charles F. Valentine.

**KFKU**, Lawrence, Kan. 275.1m-1040kc. 500 watts. University of Kansas. Announcer, John F. Patt. Slogan, "Up at Lawrence on the Kaw." Mon, Thurs, 6:55-8 pm. Central.

**KFKX**, Hastings, Neb. 288.3m-1040kc. 5,000 watts. Westinghouse Elec. & Mfg. Co. Slogans, "The Em-press of the Air." "The Pioneer Re-Broadcasting Sta-tion of the World." Daily ex Sun, 5:15-6:45 pm, 12:30 pm, markets. Daily ex Sat, Sun, 9:30 am, 10:30, 12:30 pm, markets. Mon, Wed, Fri, 9-11 pm, music. Sat, 9:30 am, 10:30, 12:30 am. Central.

**KFKZ**, Kirksville, Mo. 225.4m-1330kc. 10 watts. F. M. Henry. Mon, 8-9 pm, dance music. 1st and 3rd Mon, Radio plays. Sun, 3:30-4:30 pm, classical music. Central.

**KFLR**, Albuquerque, N. M. 254.1m-1180kc. 100 watts. U. & N. M. Announcer, Phillip S. Donnell. Slogan, "The Sunshine Center of America."

**KFLU**, San Benito, Texas. 236.1m-1270kc. 10 watts. Benito Radio Club. Announcer, R. W. Thacker. Slogan, "Heart of the Magic Valley." Mon, Thurs, Sat, 8:30-10 pm, concert. Sat, 8:30 pm, Sunday school lesson. Central.

**KFPM**, Greenville, Texas. 241.8m-1240kc. 10 watts. The New Furniture Co. Announcer, Dave Ablowich, Jr. Slogan, "The New Furniture Co., The Home of Good Furniture." Located at Greenville, Texas, Where You Find "The Blackest Land, the Whitest People." Daily ex Sun, 1 pm, music. Tues, Wed, Fri, 8 pm. Sun, 11 am, services; 7:30 pm, irregularly. Central.

**KFPB**, Los Angeles, Calif. 230.6m-1300kc. 500 watts. Los Angeles Co. Forestry Dept. Irregular schedule.

**KFPW**, Carterville, Mo. 258.5m-1160kc. 20 watts. St. John M. S. church, S. Slogan, "Keeping Face with Christ Means Progress." Tues, Fri, 8-10 pm, popular program. Sun, 1-3 pm, chapel service. Central.

**KFPY**, Spokane, Wash. 265.3m-1130kc. 100 watts. Symons Investment Co. Announcer, E. B. Craney. Daily ex Sun, Tues, 7-7:45 pm, Wed, 9-12. Thurs, 9-10 pm. Sat, 11-12 midnight. Sun, 9:45-10:30 am; 9-10 pm. Pacific.

**KFOA**, St. Louis, Mo. 260.7m-1150kc. 1,500 watts. The Principia. Thurs, 8 pm. Sun, 8 pm, church ser-vice. Central.

**KFOB**, Fort Worth, Texas. 263m-1140kc. 1,000 watts. The Searchlight Pub. Co.

**KFOD**, Anchorage, Alaska. 227.1m-1320kc. 100 watts. Chovin Supply Co.

**KFQP**, Iowa City, Iowa. 223.7m-1340kc. 10 watts. George S. Carson, Jr. Wed, 8-9 pm. Central.

**KFQU**, Alma, Calif. 217.3m-1380kc. 100 watts. W. Riker. Announcer, Arthur J. Landstrom. Daily ex Mon, 9-10 pm. Sun, 11-12 m, 9-10 pm. Pacific.

**KFW**, North Bend, Wash. 215.7m-1390kc. 50 watts. The Photo Radio and Elec. Shop. Announcer, Carl F. Kenner. Slogan, "At the Western Entrance of Snoqualmie Pass." Thurs, 8-9 pm. Sun, 8:45-10 pm. Pacific.

**KFQZ**, Hollywood, Calif. 225.4m-1330kc. 50 watts. Taft Radio Company. Tues, Fri, 9-11 pm. Pacific.

**KFRB**, Beaville, Texas. 247.8m-1210kc. 250 watts. Hall Brothers. Temporarily off the air.

**KFRG**, San Francisco, Calif. 267.7m-1120kc. 50 watts. City of Paris Dry Goods Co.

**KFRU**, Columbia, Mo. 499.7m-600kc. 500 watts. Steph-

**KFWA**, Ogden, Utah. 260.7m-1150kc. 500 watts. Brow-ning Brothers Co. Announcer, H. C. Mailander. Slogan, "Keeping Friends with All." Daily ex Sun, 4-5 pm, Zenith hour, stocks, markets, time. Mon, Wed, Fri, 9-10 pm, music. Mon, Wed, 10-11 pm, music. Mountain.

**KFWB**, Hollywood, Calif. 252m-1190kc. 500 watts. Warner Brothers.

**KFWC**, San Bernardino, Calif. 211.1m-1420kc. 50 watts. L. B. Wall.

**KFWF**, St. Louis, Mo. 214.2m-1400kc. 250 watts. St. Louis Truth Center. Slogan, "The Voice of Truth." Announcer, Rev. Charles H. Hartmann. Tues, 8 pm, Thurs, 7 pm; 7:45. Sat, 10 pm. Sun, 10:45 am; 7:45 pm. Central.

**KFWH**, Chico, Calif. 254.1m-1180kc. 100 watts. F. Wellington Morse, Jr. Slogan, "Kind Friends We're Here." Daily ex Sun, 10:30-11:30 am, 6:15-6:30 pm, news, music. Mon, Wed, Fri, 8-10 pm, 12-1:30 am; Sun, 9:30 am. Pacific.

**KFWI**, South San Francisco, Calif. 225.4m-1330kc. 500 watts. Radio Entertainments, Inc.

**KFWM**, Oakland, Calif. 206.8m-1450kc. 500 watts. Oakland Educational Society.

**KFWO**, Avalon, Calif. 211.1m-1420kc. 250 watts. Major Lawrence Mott-Signal Corp. Slogan, "Katalin for Wonderful Outings." Daily, 12:30-1:30pm, 7:30-9. Tues, Fri, Sun, 5-6 pm. Pacific.

**KFWU**, Pineville, La. 238m-1260kc. 100 watts. Louisiana, La.

**KFWV**, Portland, Ore. 212.6m-1410kc. 50 watts. Wil-ber Jernan. Daily ex Sun, 6-7 pm; 7-7:30; 8-11.

**KFXB**, Big Bear Lake, Calif. 202.6m-1480kc. 500 watts. Bertram O. Feller. Announcer, Charles Stillwell. Slogan, "Run of World Super Station." Mon, 5-5:30 pm; 9-11. Daily ex Sun, 8-9 pm. Pacific.

**KFXC**, Santa Maria, Calif. 209.7m-1430kc. 100 watts. Santa Maria Valley Railroad Company.

**KFXD**, Logan, Utah. 205.4m-1460kc. 10 watts. Service Radio Co.

**KFXE**, Colorado Springs, Colo. 249.9m-1200kc. 500 watts. Pikes Peak Broadcasting Company. Announcer, W. D. Pyle. Slogan, "The Pikes Peak Station."

**KFXH**, El Paso, Texas. 241.8m-1240kc. 50 watts. Bledsoe Radio Company. Announcer, Chuck Swann. Slogan, "The Voice of the Rio Grande." Mon, Wed, Fri, 8-10 pm. Mountain.

**KFXJ**, Colorado. 215.7m-1390kc. 10 watts. Mountain States Radio Distributors, Inc. (Portable.)

**KFXM**, Beaumont, Texas. 227m-1320kc. 10 watts. Neech Elec. Co.

**KFXR**, Oklahoma, Okla. 214.2m-1400kc. 15 watts. Classen Film Finishing Company.

**KFXV**, Flagstaff, Ariz. 205.4m-1460kc. 50 watts. Mary M. Costigan.

**KFYF**, Oxnard, Calif. 205.4m-1460kc. 100 watts. Carl's Radio Den. Announcer, Carl Newcomb. Slogan, "The Radio Voice from the Radio Den." Daily ex Sun, 5-6 pm, weather, crops, news, music. Pacific.

**KFYJ**, Houston, Texas. 238m-1260kc. 10 watts. Hous-ton Chronicle Pub. Co.

**KFYR**, Bismarck, N. D. 247.8m-1210kc. 10 watts. Hoskins-Meyer, Inc.

**KG**, Oakland, Calif. 361.2m-830kc. 4,000 watts. Gen. Elec. Co. Announcer, Howard I. Milholland. Daily ex Sun, 7:15-7:45, 8:15 am, exercises; 8:30, daily strength; 11:30 am, luncheon concert. Daily ex Sat, Sun, 1:30 pm; Sat, 12:30 pm, markets, weather. Mon, Wed, Fri, 3 pm, music. Daily ex Sun, Mon, 4-5:30 pm, concert orchestra. Mon, Tues, Wed, Fri, 6-7 pm, music. Mon, Tues, Thurs, Sat, 8-10 pm, lectures, music. Tues, Thurs, Sat, 8-12. Wed, Thurs, Fri, 7 Children's half hour. Mon, Tues, Wed, Thurs, Fri, 7 pm, stocks, markets, weather, news. Thurs, 5:30-6:30 pm, boys' hour. Fri, 5-5:30 pm, girl's half hour. Sun, 11-12 m, 8 pm, church services; 3:30-5 pm, Little Symphony orchestra. Pacific.

**KGTT**, San Francisco, Calif. 206.8m-1450kc. 50 watts. Glad Tidings Temple.

**KGU**, Honolulu, Hawaii. 270.1m-1110kc. 500 watts. Marlon A. Mulrony, The Honolulu Advertiser. Ann-ouncer, William Hoser. Daily, 7:30-9 pm. Tues, Thurs, Sat, special program. Sun, 11 am, 7:30 pm, 1:50 meridian. 2 1/2 hours earlier than Pacific.

**KGW**, Portland, Ore. 491.5m-610kc. 500 watts. Port-land Morning Oregonian. Announcer, Dick Haller. Slogan, "KGW, Keep Growing Wiser." Daily ex Sun, 10-11:30 am, Town Crier; Mon, Wed, Fri, 7:15-7:30 am, exercises. Daily ex Sun, 12:30-1:30 pm. Mon, Tues, Wed, Thurs, Fri, 7:30-7:45 pm, utility service; Mon, Tues, Wed, Fri, 8-9 pm. Mon, Tues, 9-10 pm. Tues, Sat, 10-12. Wed, 9-11 pm. Fri, 9-10:30 pm; 10:30-12, Hoot Owls. Sun, 10:30-12 m, 7:30-9. Pacific.

**KGW**, Lacey, Wash. 245.8m-1220kc. 50 watts. St. Martins College. Announcer, Sebastian Ruth. Slogan, "Out Where the Cedars Meet the Sea." Sun, Tues, Thurs, 8:30-9:30 pm. Pacific.

**KHJ**, Los Angeles, Calif. 405.2m-740kc. 500 watts. Los Angeles Times. Announcer, John S. Daggott. Slogan, "Kindness, Happiness, Joy." Daily ex Sun, Mon, 7 am, 7:30, 12 m, 1:30 pm, 2:30, 3:30, 5:30, 11. Mon, 7-7:30 am, 12-1:30 pm. Sun, 10-12:30 pm, 6-7:30, 8-11. Pacific.

**KHQ**, Spokane, Wash. 272.6m-1100kc. 500 watts. Louis Wasmer, Inc. Slogan, "In the Friendly City." 500 watts.

**KIAF**, Siltspete, Minn. 422.3m-110kc. 500 watts. Steele Co. Slogan, "Far from the Madding Crowd." Mon, Wed, Fri, 7-8 pm. Sun, 2-3 pm. Central.

**KIBS**, San Francisco, Calif. 220.4m-1380kc. 5 watts. Julius Brunton & Sons Co. Announcer, Edward Ludes. Dns ex Sun, 9-10:40 am; 2-2:30 pm. Mon, Wed, 8-10 pm. Fri, 8-11:30 pm. "Royal Order of Smoked Herring." Pacific.

**KIR**, Seattle, Wash. 384.4m-780kc. 1,000 watts. North-west Radio Service Co. Announcer, Ross W. Swift. Slogan, "Radio Headquarters." Daily ex Sun, 10:30-11:30 am, educational program; 1:30-3 pm, markets; 3-5 pm, stocks, time; 6-6:15 am; 7:30-8:30-10, 11-12:30. Sun, 11-12:30 pm, service; 5-6 pm, 7-9, 9-11:30. Pacific.

**KIS**, Independence, Mo. 440.9m-680kc. 1,000 watts. Reorganized Church of Jesus Christ of Latter Day Saints. Announcer, Arthur B. Church. Tues, 6:30 am, 11:59 pm. Tues, Thurs, Sat, 8 pm. Fri, 6:30 am. Sun, 11 am, 3 pm, 6:30, 9. Central.

**KLS**, Oakland, Calif. 249.9m-1200kc. 500 watts. Warner Bros. Radio Supplies. Announcer, S. Warner. Slogan, "The City of Golden Opportunity." Sun, 10-11 am. Pacific.

**KLX**, Oakland, Calif. 508.2m-590kc. 500 watts. Oak-land Tribune. Announcer, Charles H. Gabriel, Jr. Slogan, "Where Rail and Water Meet." Mon, Fri, 4-7:30 pm; 8-10:30. Tues, Thurs, Sat, 7-7:30 pm. Wed, 8-11:30 pm. Pacific.

**KLZ**, Denver, Colo. 265.3m-1130kc. 250 watts. Rey-nolds Radio Co. Announcer, Mrs. William D. Reynolds. Slogan, "Its a Privilege to Live in Colorado." Wed, Sat, Sun, 9 pm. Mountain.

**KMA**, Shenandoah, Iowa. 252m-1190kc. 500 watts. May Seed & Nursery Co. Daily ex Sun, 11:30-12:30 pm, 6-7, 9-11. Sun, 4-6 pm. Central.

**KMJ**, Fresno, Calif. 234.2m-1280kc. 50 watts. Fresno Bee. Mon, Wed, Fri, 7:15-9:15 pm. Pacific.

**KMK**, Clay Center, Neb. 228.9m-1310kc. 500 watts. M. M. Johnson Co. Daily ex Sun, Wed, 1:30 pm, 7:30. Central.

**KMO**, Tacoma, Wash. 249.9m-1200kc. 100 watts. As-sociation Station. (Love Electric Co.) Mon, Wed, Fri, 6-7 pm, popular program; 9-10, artist's program. Pacific.

**KMOX**, St. Louis, Mo. 280.2m-1070kc. The Voice of St. Louis. Announcer, Nate Caldwell. 238m-1260kc. 500 watts.

**KMTR**, Los Angeles, Calif. 238m-1260kc. 500 watts. K. M. Turner Radio Corp.

**KNRC**, Los Angeles, Calif. 208.2m-1441kc. 250 watts. Kierulff & Ravenscroft Co. Announcer, "Hastings." Daily ex Sun, 10 am. Mon, 1:30 pm. Tues, Wed, Thurs, Fri, 7-9 pm. Pacific.

(Note—The second part of the station data list will appear next week.)

## CHALLENGE!

ONE DOLLAR will be paid to the Radio fan submitting the most errors in any one station's listing in this directory. Letters must reach Radio Digest office not later than one week from date of issue corrected. Readers are not limited to correcting one station, but such corrections must be certified by the stations themselves, and NOT by comparison to other so-called accurate broadcasting directors and lists. Readers also must live in same state or province as stations corrected are located. Station verifications must accompany corrections.

That's just how sure Radio Digest is that this broadcasting station directory is correct! To make the challenge fair for everyone, broadcasting stations and their employees are barred from this offer. Why? Because the broadcasters are the source of all the data given herein. They are (or should be) interested enough to answer the inquiry sent them every time data on their station appears. This inquiry contains a proof of their last listing and must either be corrected or O K'd as correct and

returned to the Digest. Nevertheless, sometimes the stations are careless and mistakes are made. But Radio Digest is so sure of the exactness of this directory that this challenge is made unconditionally.

With reference to the directory: It appears in six parts, serially continuously; the first four parts are station data listings, arranged alphabetically; the fifth part is a state, city index of stations; the sixth part is a wave length index. The information contained in each station data listing is given in the following order: Call letters, city, state, wave length used, watts antenna input, owner's name, announcer's name, slogan used if any, name of listener in "club," schedule of operating hours, and kind of time used, as "Central," "Moun-tain," etc.

Six successive issues of Radio Digest will give one the most com-plete and accurate list of broadcast-ing stations obtainable. This service is original with this publication, and has been maintained from the start. Right of reproduction without permission of any or all of the data contained herein is denied.

**KFLV**, Rockford, Ill. 228.9m-1310kc. 200 watts. Swed-ish Evangelical Mission Church. Announcer, A. T. Frykman. Fri, 8:30 pm. Sun, 12:30 pm, service for shut-ins (Swedish); 9:30, service (English). Central.

**KFLX**, Galveston, Texas. 239.9m-1250kc. 10 watts. George R. Clough.

**KFLZ**, Anita, Iowa. 272.6m-1100kc. 100 watts. At-lantic Automobile Co. Operated by Walnut Grove Hog Remydy Co. Announcer, H. A. Marshall. Daily ex Sun, 11:50-12:30 pm. Central.

**KFM**, Fayetteville, Ark. 299.8m-1000kc. 750 watts. U. of Arkansas. Mon, 7:30 pm. Tues, Thurs, 8 pm. Central.

**KFMR**, Sioux City, Iowa. 260.7m-1150kc. 100 watts. Morningside College. Announcer, Jesse C. Ducommun. Wed, 9:15 pm. Central.

**KFMW**, Houghton, Mich. 263m-1140kc. 50 watts. M. G. Sateren (announcer). Sun, 3-4:30 pm.

**KFMX**, Northfield, Minn. 338.9m-890kc. 500 watts. Carlton College. Announcer, Merrill O. Bolen. Daily, 9:10-9:30 am, time. Tues, 9:30-10 pm, lecture. Wed, 7-8 9-10 pm, concert. Fri, 10-11 pm, organ. Sun, 7-8 pm, Central.

**KFN**, Shenandoah, Iowa. 263m-1140kc. 500 watts. Henry Field Seed Co. Announcer, Henry Field. Slogan, "Friendly Station in a Friendly Town." Daily ex Sun, 12:15-2 pm, 3-4 7-9 pm. Sun, 10:45 am, 2:30 pm, 3-4, services; 6:30-7:30, Golden Rule; 7:30-8:30, church service. Central.

**KFOA**, Seattle, Wash. 454.3m-660kc. 1,000 watts. The Rhodes, Dept. Store. Slogan, "The Gateway to the Orient." Daily ex Sun, 12:30-1:30 pm. Daily ex Sun, 10-10:30 am, homemakers hour, 3-4 pm, women's clubs; 5-15, Times Bulletins, concert. Daily ex Sun, Thurs, 8:30-10 pm. Times program. Mon, Wed, Fri, 6:45-8:15 pm, studio music. Tues, Fri, Sat, 10-11:30 pm, orchestra. Central.

**KFOB**, Burlingame, Calif. 225.4m-1330kc. 50 watts. Burlingame KFOB Inc. Tues, 8-11 pm. Thurs, 9-11 pm. Sat, 8-12. Pacific.

**KFOJ**, Moberly, Mo. 241.8m-1240kc. 10 watts. Moberly High School.

**KFON**, Long Beach, Calif. 232.4m-1290kc. 500 watts. Nichols & Warner, Inc. Slogan, "Where Your Ship Comes In." Daily ex Sun, Mon, 10-11 am; 2:30-5 pm; 6-11. Mon, 10-11 am; 6-11. Sun, 2:30-4 pm; 8-9. Pacific.

**KFOO**, Salt Lake City, Utah. 236.1m-1270kc. 250 watts. Latter Day Saints University. Announcer, Don C. McRae.

**KFOR**, David City, Neb. 225.4m-1330kc. 100 watts. David City Tire & Elec. Co. Slogan, "The Voice of David City." Mon, 7-9 pm. Central.

**KFOT**, Wichita, Kan. 230.6m-1300kc. 50 watts. Col-lege Hill Radio Club. Announcer, Leon Garnett. Slogan, "Radiocasting Church." Sun, 11-12:30 pm; 7:30-9, church services. Mon, 9-10:30 pm, music. Central.

**KFOX**, Omaha, Neb. 247.8m-1210kc. 100 watts. Board of Education. Technical High.

**KFOY**, St. Paul, Minn. 252m-1190kc. 50 watts. Beacon Radio Service. Thurs, 11-12 m. Sun, 3:30-4:30 pm. Central.

**KFPL**, Dublin, Texas. 252m-1190kc. 15 watts. C. C. Baxter, announcer.

**ens college**, Mon, Tues, Thurs, Fri, 6:15 pm. Fri, 12-2 am. Wed, 9-11 pm. Sun, 7:30 pm; 9:20, 7:30 pm. Central.

**KFRW**, Olympia, Wash. 218.8m-1370kc. 50 watts. "The Loy Memorial." United Churches of Olympia. Slogan, "Make the World a Brotherhood." Thurs, 9-10 pm. Sun, 11-12:15 pm. 7:30-9. Pacific.

**KFSG**, Los Angeles, Calif. 275.1m-1090kc. 500 watts. Angeles Temple. Tues, Thurs, Fri, Sat, 3:30-4:30 pm. Tues, 6:30-7:30 pm. Wed, 3:30-4:30 pm. Sun, 10:30-12:30 7:30. Thurs, Fri, Sat, 7:30-11 pm. Sun, 10:30-12:30 pm, 2:30-4:30, 7-9:30. Mon, silent. Pacific.

**KFUL**, Galveston, Texas. 258.5m-1160kc. 50 watts. Thomas Grossan & Bros.

**KFUO**, St. Louis, Mo. 545.1m-550kc. 500 watts. Con-cordia Theological Seminary (Lutheran). Announcer, Herm. H. Hohenstein. Mon, 8 pm. Wed, 9:15 pm. Sun, 4 pm, 9:15. Central.

**KFUP**, Denver, Colo. 234.2m-1280kc. 50 watts. Pitz-zsimons General Hospital, Educational and Recreational Dept.

**KFUR**, Ogden, Utah. 223.7m-1340kc. 100 watts. Peery Building Co. Tues, Thurs, Sat, 9:50-11:50 pm, dance music. Mountain.

**KFUS**, Oakland, Calif. 256.3m-1170kc. 50 watts. The Gospel Radio. Slogan, "The City of Opportunity."

**KFUT**, Salt Lake City, Utah. 260.7m-1150kc. 100 watts. University of Utah. Mon, Wed, Fri, 12-1 pm. Mon, 12 m. Wed, 12:20 pm. Mountain.

**KFUU**, Oakland, Calif. 229.4m-1360kc. 50 watts. Maripawson Motor Co. Announcer, H. C. Colburn. Slogan, "The Voice of Automobile Row." Daily ex Sun, 10:45-11:45 am; 6:30-7:15 pm. Tues, Thurs, 8-10 pm. Sat, 6:30-2 am. Sun, 8-9:30 pm. Pacific.

**KFVD**, San Pedro, Calif. 205.4m-1460kc. 50 watts. Me-Whinnie Elec. Co.

**KFVE**, University City, Mo. 239.9m-1250kc. 500 watts. Film Corp. of America. Daily ex Thurs, Sun, 9:15 pm. Central.

**KFVG**, Independence, Kan. 236.1m-1270kc. 10 watts. First Methodist Episcopal church. Sun, services.

**KFVH**, Manhattan, Kan. 218.8m-1370kc

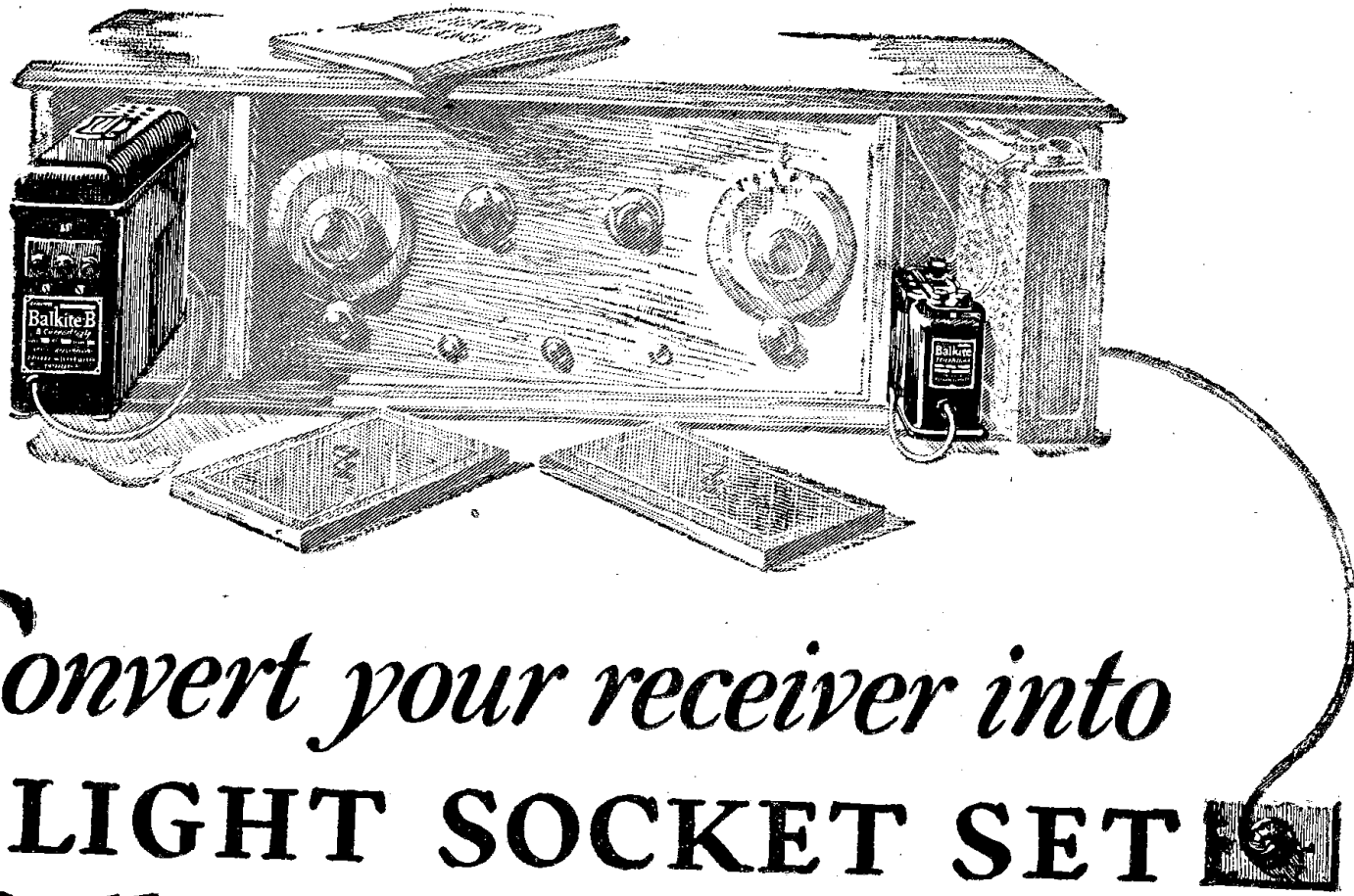

## Convert your receiver into A LIGHT SOCKET SET with Balkite Radio Power Units

Now you need wait no longer for a light socket set. Balkite Radio Power Units—the Balkite Trickle Charger and Balkite "B"—enable you to make a light socket set of your present receiver.

The Balkite Trickle Charger converts your "A" battery into an automatic "A" power unit that furnishes full "A" current from the light socket at all times. Balkite "B" replaces "B" batteries entirely and furnishes "B" current from the light socket. As an added convenience you may purchase from your dealer an automatic switch that cuts out the charger and turns on Balkite "B" during operation.

This popular light socket installation is the last word in radio convenience. It is extremely simple to install, economical both in initial cost and in operation, and is so compact it will fit in practically all present battery compartments. Revolutionary in the convenience it gives, yet it is composed entirely of units that have demonstrated their success over a period of time.

### Noiseless—No bulbs—Permanent

All Balkite Radio Power Units are entirely noiseless, have no bulbs, no moving parts, nothing to break or get out of order. All are permanent pieces of equipment. Their current consumption is ridiculously low. All operate from 110-120 volt AC current, with models for 50, 60 and other cycles. All are tested and listed as standard by the Underwriters' Laboratories. If you already own a receiver, equip it with Balkite Radio Power Units now. If you buy a new receiver, buy it Balkite equipped from your dealer.

*The Balkite Railway Signal Rectifier is now standard equipment on over 50 leading American and Canadian Railroads*

FAN STEEL  
**Balkite**  
Radio Power Units

MANUFACTURED BY FANSTEEL PRODUCTS COMPANY, INC., NORTH CHICAGO, ILLINOIS

SOLE LICENSEES IN THE UNITED KINGDOM: MESSRS. RADIO ACCESSORIES LTD., 9-13 HYTHE RD., WELLESDEN, LONDON, N. W. 10

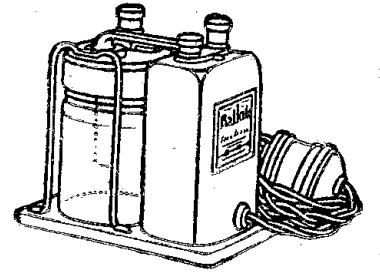

#### Balkite Trickle Charger

Converts any 6-volt "A" battery of 30 ampere hours capacity or more into an automatic "A" power unit that furnishes "A" current from the light socket. With 4-volt and smaller 6-volt batteries may be used as an intermittent charger. Or as a trickle charger if a resistance is added to cut down the charging rate. \$10. West of Rockies, \$10.50. In Canada, \$15.

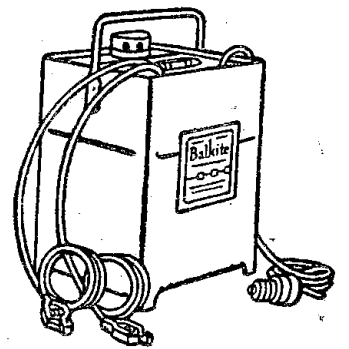

#### Balkite Battery Charger

The popular rapid charger for 6-volt "A" batteries. Noiseless. If your battery should be low you merely turn on the charger and operate the set. Special model for 25-40 cycles. \$19.50. West of Rockies, \$20. In Canada, \$27.50.



#### Balkite "B"

Eliminates "B" batteries and supplies plate current from the light socket. Keeps the "B" circuit always at full power. For sets of 6 tubes and less. \$35. In Canada, \$49.50.

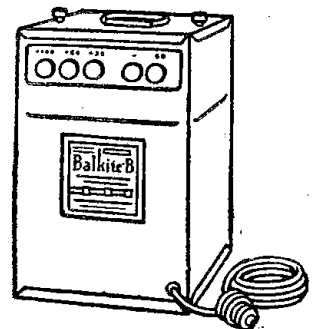

#### Balkite "B" II

Supplies plate current from the light socket. Will serve any standard set. Especially adapted to sets of 6 tubes or more. \$55. In Canada, \$75.