

RADIO — ELECTRONICS

K

IN THIS ISSUE
Radio-Controlled Bus
Antennas for Television

HUGO GERNSBACK,
Editor

formerly

**RADIO
CRAFT**

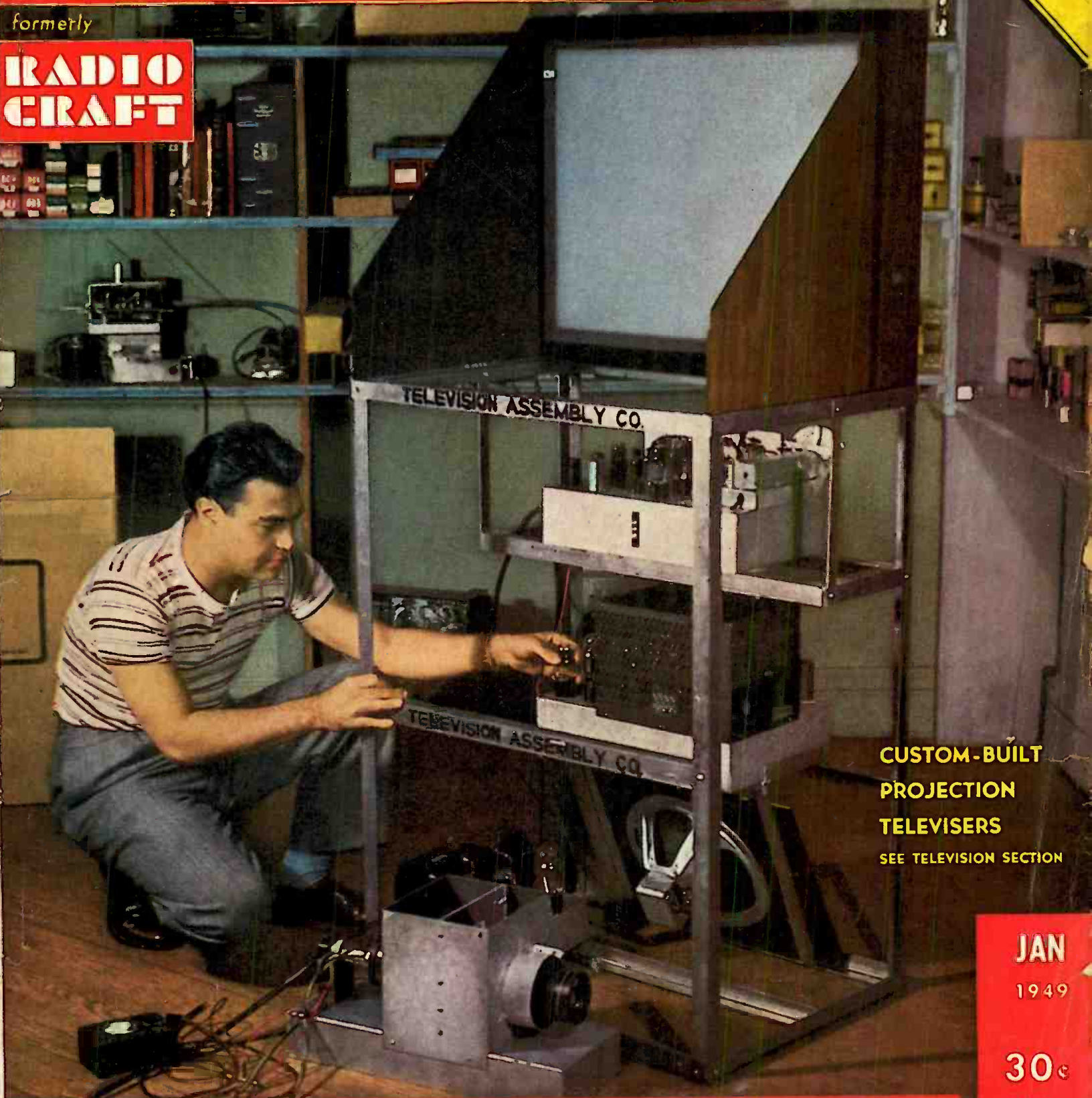

**CUSTOM-BUILT
PROJECTION
TELEVISERS**
SEE TELEVISION SECTION

JAN

1949

30¢

U.S. and
CANADA

LATEST IN RADIO — ELECTRONICS — TELEVISION

www.americanradiohistory.com

LOOK TO

McMurdo SILVER

FOR FM-TV SERVICE REQUIREMENTS

Here — at prices you can afford — are five Laboratory Caliber Electronic Test Instruments that you need to insure efficient and profitable AM - FM - TV servicing.



MODEL 900-A "VOMAX"

The new "VOMAX" is the truly universal v.t.v.m. — makes TV, FM and AM measurements accurately — at highest meter resistance. Giant meter, non-breakable glass; 45 ranges; new single probe for a.c., d.c., a.f., r.f., volts, ohms, db. and current measurements. "VOMAX" can be used for measuring TV power supply potentials up to 30 Kilovolts when used with our new High Voltage Adaptor Probe. Advancing far beyond its predecessor, choice of experts, "VOMAX" equips you with the world's newest and finest meter for only \$68.50 net.

**MODEL 911
TV/FM SWEEP GENERATOR**
2 thru 226 mc.; electronic sweep adjustable 0 to 10 mc.; high output adjustable 0 to 1/2 volt. Separate 1 mc. and 5 mc. precision crystal marker oscillators insure correct TV video i.f. curve shape and width; phasing control and 60 ~ sine-wave 'scope TV sweep voltage; 120 ~ saw-tooth FM 'scope sweep voltage. All this only \$78.50 net.

**MODEL 906
FM-AM SIGNAL GENERATOR**

Choice of the big engineering laboratories plus thousands of service technicians, 906 stands out as maximum value. 90 kc. thru 210 mc. in 8 ranges, $\pm 1\%$ accuracy; less than 1/2 microvolt, including strays to over shielding; adjustable 0 to 100% amplitude modulation, adjustable 0 to 1,000 kc. FM sweep. Price only \$116.50 net.

MODEL 905-A "SPARX"

Combining signal-tracer and universal test speaker, 905-A is amazingly sensitive yet free of usual tracer hum. Vacuum-tube prod. with r.f.a.f. switching; high-gain high-fidelity amplifier; 6" PM speaker; 18-watt output transformer gives wide choice of impedances. Two essential instruments in one, 905-A is a value far exceeding \$44.50 net.

904 C/R BRIDGE

A condenser resistor tester of precision caliber 1/4 mmfd./1000 mfd.; 1/4 Ω /1000 meg Ω ; variable d.c. polarizing voltage leakage current; 0/50% power factor. Laboratory accuracy of $\pm 3\%$. Measures all condensers with 0/500 V. rated d.c. volts applied. Only \$49.90 Net

MAIL POST CARD for new catalog showing complete line of Laboratory Caliber Electronic Test Instruments.

OVER 37 YEARS OF RADIO ENGINEERING ACHIEVEMENT

McMurdo Silver Co., Inc.

EXECUTIVE OFFICES: 1240 MAIN ST., HARTFORD 3, CONN.
FACTORY OFFICE: 1249 MAIN ST., HARTFORD 3, CONN.

I Will Train You at Home for Good Jobs RADIO & TELEVISION



1-49
98

**I Send You Many
KITS OF PARTS
for practical experience**

YOU BUILD THIS
MODERN RADIO

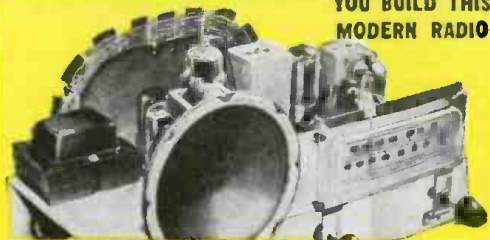

You build this complete, powerful Radio Receiver that brings in local and distant stations. NRI gives you ALL the Radio parts . . . speaker, tubes, chassis, transformer, sockets, loop antenna, etc.

YOU PRACTICE WITH SIGNAL GENERATOR

You build this Signal Generator for more valuable experience. It provides amplitude-modulated signals for many tests and experiments.



YOU USE TESTER
TO EARN
EXTRA MONEY

You build this Tester with parts NRI sends early in course. Soon help you fix neighbors' Radios and EARN EXTRA MONEY in spare time.



YOU BUILD MANY OTHER CIRCUITS

Practice FM experiments with Superheterodyne Receiver Circuit . . . build Vacuum Tube Power Pack . . . practice locating defects and repairing of still other circuits you build with MANY KITS OF PARTS I send.

VETERANS

GET THIS
TRAINING UNDER
G. I. BILL

Want a good-pay job in the fast-growing RADIO-TELEVISION Industry? Want a money-making Radio-Television shop of your own? Here's your opportunity. I've trained hundreds of men to be Radio Technicians . . . MEN WITH NO PREVIOUS EXPERIENCE. My tested and proved train-at-home method makes learning easy. You learn Radio-Television principles from illustrated lessons. You get practical experience building, testing, experimenting with MANY KITS OF PARTS I send. All equipment yours to keep.

Make EXTRA MONEY In Spare Time

The day you enroll, I start sending SPECIAL BOOKLETS that show you how to make EXTRA MONEY fixing neighbors' Radios in spare time. From here it's a short step to your own shop, or a good-pay Radio-Television servicing job. Or get into Police, Aviation, Marine Radio, Broadcasting, Radio Manufacturing or Public Address work. And think of getting in on the ground floor of the booming Television Industry. Trained men are already in demand . . . new stations are going on the air, manufacturers are building over 100,000 sets a month, more and more homes are getting sets. The man who prepares now will reap rich rewards.

I TRAINED THESE MEN



Extra Cash
In Spare Time
"Earned
enough spare
time cash to
pay for my
course by
time I grad-
uated. NRI training is
tops!" — ALEXANDER
KISH, Carteret, New
Jersey.

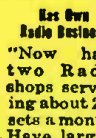

Has Own
Radio Business
"Now have
two Radio
shops serv-
icing about 200
sets a month.
Have largest
service establish-
ment in
Southeast Missouri."
— ARLEY STUDYVIN,
DeSoto, Missouri.



Good Job In
Radio Station
"Am Chief
Engineer of
Station
WORD, in
charge of 4
men. Owe all
I know about Radio to
NRI." — CLYDE J. BUR-
DETTE, Spartanburg,
South Carolina.

FREE ACTUAL LESSON

Act now! Send for my DOUBLE FREE OFFER. Coupon entitles you to actual lesson, "GETTING ACQUAINTED WITH RECEIVER SERVICING," absolutely free. Over 50 pictures and diagrams! You also get my 64-page book, "HOW TO BE A SUCCESS IN RADIO AND TELEVISION-ELECTRONICS." Tells more about YOUR opportunities, details of my Course, how quickly, easily you can get started. Send coupon in envelope or paste on penny postal. J. E. SMITH, President, Dept. 9AX, National Radio Institute, Pioneer Home Study Radio School, Washington 9, D. C.

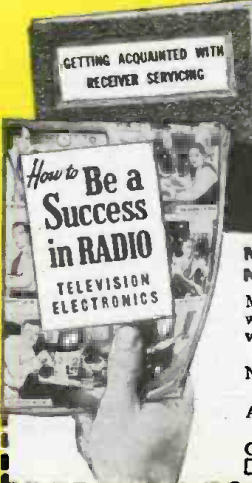

Good for Both - FREE

MR. J. E. SMITH, President, Dept. 9AX
National Radio Institute, Washington 9, D. C.

Mail me FREE Sample Lesson and 64-page book about how to win success in Radio and Television-Electronics. (No salesman will call. Please write plainly.)

Name..... Age.....

Address.....

City..... Zone..... State.....

Check If Veteran Approved for Training Under G. I. Bill

RADIO — ELECTRONICS

formerly RADIO-CRAFT

Incorporating
 SHORT WAVE CRAFT* TELEVISION NEWS*
 RADIO & TELEVISION
 *Trademark registered U. S. Patent Office

Hugo Gernsback, Editor-in-Chief
 Fred Shunaman, Managing Editor
 M. Harvey Gernsback, Consulting Editor
 Robert F. Scott, W2PWG, Technical Editor
 R. H. Dorf, W2QMI, Associate Editor
 I. Queen, W2OUX, Editorial Associate
 Angie Pascale, Production Manager
 Elmer Fuller, Shortwave Editor
 Wm. Lyon McLaughlin,
 Tech. Illustration Director
 G. Aliquo, Circulation Manager
 John J. Lamson, Advertising Director
 Alfred Stern, Promotion Manager

Contents — January, 1949

Editorial (Page 21)			
Future Transistor Uses.....	by Hugo Gernsback	21	
Construction (Pages 22-24)			
Radio-Controlled Bus.....	by M. Gordon Moses	22	
Broadcasting and Communications (Page 25)			
Rural FM Radio Network.....		25	
Television (Pages 26-30)			
Antennas for Television, Part I.....	by Edward M. Nall and Matt Mandl	26	
How to Get Television DX.....	by Lyman E. Greenlee	28	
Custom-Built Projection Televisers (Cover Feature).....		30	
Theory and Design (Pages 31-33, 85-87)			
Pocket Micro-Receiver.....	by Richard Henry	31	
Designing L-C Audio Filters.....	by Richard H. Dorf	32	
U.H.F. Noise Diode.....		85	
Multimeter Shows only Desired Scale.....		86	
Problems of Electronic Baking.....		86	
FM (Pages 34-37)			
Visual FM Alignment.....	by John B. Ledbetter	34	
Radio Set and Service Review (The Emerson Conqueror).....		36	
Amateur (Pages 38-40)			
V.F.O. From Surplus.....	by George F. Marts, WØDTH	38	
Wired Wireless Control Unit.....		40	
Test Instruments (Pages 41-46)			
Radio-Frequency Ammeter.....	by Rufus P. Turner, K6AI	41	
'Scope Aid Helps Audio Men.....	by Alfred Haas	42	
Tube Tester and Analyzer.....	by Harold Pallatz	44	
Audio (Pages 47-48)			
What is Supersonic Bias?.....	by Dr. Angelo Montani	47	
Foreign News (Page 49)			
European Report.....	by Major Ralph W. Hallows	49	
Servicing (Pages 50-59)			
Improving Supply to Test Car Sets.....	by Harry S. Leeper	50	
New York Servicemen Form State Federation.....		51	
Using Your Ohmmeter.....	by Herbert S. Brier, W9EGA	52	
The Impeded Double Cross.....	by Guy Slaughter	54	
Electronics			
Midget Atom Smasher.....		71	
Departments			
The Radio Month.....	12	Question Box.....	78
Radio Business.....	18	People.....	79
New Devices.....	60	New Patents.....	81
Technotes.....	64	Radio-Electronic Circuits.....	84
World-Wide Station List.....		Miscellany.....	88
by Elmer R. Fuller.....	68	Communications.....	93
Try This One.....	76	Book Reviews.....	97

ON THE COVER: Assembly of a projection-type television kit. See page 30. Kodachrome by Avery Slack

RADIO-ELECTRONICS, January, 1949, Volume XX, No. 4. Published monthly. Publication Office: Erie Ave., P. O. Box 200, Philadelphia 32, Pa. Entered as second class matter September 27, 1948, at the post office at Philadelphia, Pa., under the Act of March 3, 1879. **SUBSCRIPTION RATES:** In U. S. and Canada, in U. S. possessions, Mexico, South and Central American countries, \$3.50 a year; \$6.00 for two years; \$8.00 for three years; single copies 30c. All other foreign countries \$4.50 a year; \$8.00 for two years; \$11.00 for three years. Allow one month for change of address. When ordering a change please furnish an address stencil impression from a recent wrapper. **RADIO-CRAFT PUBLICATIONS, INC.** Hugo Gernsback, Pres.; M. Harvey Gernsback, Vice-Pres.; G. Aliquo, Sec'y. Contents Copyright, 1948, by Radio-Craft Publications, Inc. Text and illustrations must not be reproduced without permission of copyright owners.

EDITORIAL and ADVERTISING OFFICES: 25 West Broadway, New York 7, N. Y. Tel. REctor 2-9690. **BRANCH ADVERTISING OFFICES:** Chicago: 308 W. Washington Street, Telephone BRandolph 2-7363. Detroit: Frank Holstein, Room 402, Lexington Bldg., 2970 West Grand Blvd., Telephone TRinity 5-7026. Los Angeles: Ralph W. Harker, 606 South Hill St., Tel. Tucker 1793. San Francisco: Ralph W. Harker, 582 Market St., Tel. Garfield 1-2481.

FOREIGN AGENTS: Great Britain: Atlas Publishing and Distributing Co., Ltd., 18 Bride Lane, Fleet St., London E.C.4. Australia: McGill's Agency, 179 Elizabeth Street, Melbourne. France: Brentano's, 37 Avenue de l'Opera, Paris 2e. Holland: Trilectron, Heemsteedsche Dreef 124 Heemstede. Greece: International Book & News Agency, 17 Amerikla Street, Athens 56. Africa: Central News Agency, Ltd., Cor. Risak & Commissioner Sts., Johannesburg, 112 Louisa Street, Capetown; 389 Smith Street, Durban. Natal: Universal Book Agency, 70 Harrison Street, Johannesburg. Middle East: Steimatzky Middle East Agency, Jaffa Road, Jerusalem. India: Susil Gupta (Distributors) Co., Armita Bazar Patrika Lt., 14 Ananda Chatterjee Lane, Calcutta.

Editorial and Executive Offices:  MEMBER AUDIT BUREAU OF CIRCULATION
 25 West Broadway, New York 7, N. Y. ABC PAID CIRCULATION 6 MONTHS TO JUNE 30,
 1948-112,592. (Publishers Statement) PRINTED
 FOR JANUARY ISSUE-166,000

IRC Power Wire Wounds are better built every step of the way



Starting right from the winding form IRC Power Wire Wounds combine the best of materials, workmanship and resistor "know-how".

Highest grade alloy wire uniformly wound on sturdy ceramic tubes. Terminals spot welded for security; heavily tin dipped for easy soldering.



Climate-proof cement coating provides dark, rough surface—best for rapid heat dissipation, moisture protection and ability to withstand reasonable overloads.

Resistors cured at LOW temperature prevents damage to resistance windings, and loss of temper in terminals. Bands for adjustable types feature stainless steel springs and silver contacts. Cannot corrode to cause high resistance.

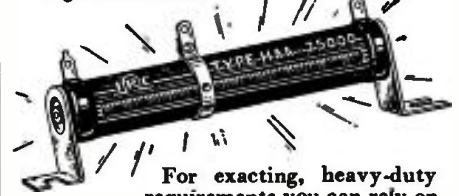

For exacting, heavy-duty requirements you can rely on IRC Power Wire Wounds for balanced performance in every characteristic. Being full-sized, they can operate continuously at full rating. Derating in high ranges is unnecessary. IRC Power Wire Wounds are available in a full range of ratings, sizes and terminal types. 91 new ranges have just been added. Next time you step up to your distributor's counter—stock up on IRC Power Wire Wounds.

IRC INTERNATIONAL RESISTANCE CO.

401 N. Broad Street, Phila. 8, Pa.
 In Canada: International Resistance Co., Ltd., Toronto, Licensee



YES! We're listed in the RED BOOK
 Looking for the correct IRC replacement controls for any receiver manufactured from 1938 to 1948? Just refer to the Radio Industry RED BOOK!



You receive all parts, including tubes, for building this fine, modern Superheterodyne Receiver. This and other valuable standard equipment become your property.

Learn RADIO

TELEVISION, ELECTRONICS
by
SHOP METHOD HOME TRAINING

Let NATIONAL SCHOOLS, of Los Angeles, a practical Technical Resident Trade School for almost 50 years, train you for today's unlimited opportunities in Radio

these two FREE books will tell you how



Good Jobs Await the Trained Radio Technician

You are needed in the great, modern Radio, Television and Electronics industry! Trained Radio technicians are in constant and growing demand at excellent pay—in Broadcasting, Communications, Television, Radar, Research Laboratories, Home Radio Service, etc. National Schools Master Shop Method Home Study course, with newly added lessons and equipment, can train you in your spare time, *right in your own home*, for these exciting opportunities. Our method has been proved by the remarkable success of National Schools-trained men all over the world.

You Learn by Building Equipment with Standard Radio Parts We Send You

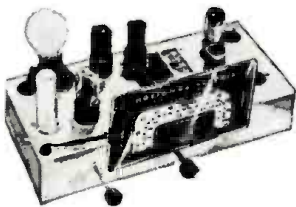

Your National Schools Course includes not only basic theory, but *practical* training as well—you *learn by doing*. We send you complete standard equipment of professional quality for building various experimental and test units. You advance step by step until you are able to build the modern superheterodyne receiver shown above, which is yours to keep and enjoy. You perform more than 100 experiments—build many types of circuits, signal generator, low power radio transmitter, audio oscillator, and other units. The Free Books shown above tell you more about it—send for them today!

Now! NEW PROFESSIONAL MULTITESTER INCLUDED:

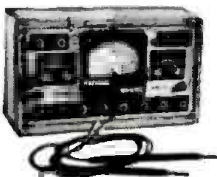

This versatile testing instrument is portable and complete with test leads and batteries. Simple to operate, accurate and dependable. You will be able to quickly locate trouble and adjust the most delicate circuits. You can use the Multitester at home or on service calls. It is designed to measure AC and DC volts, current, resistance and decibels. You will be proud to own and use this valuable professional instrument.

Lessons and Instruction

Material Are Up-to-date, Practical, Interesting

National Schools Master Shop Method Home Training gives you basic and advanced instruction in all phases of Radio, Television and Electronics. Each lesson is made easy to understand by numerous illustrations and diagrams. All instruction material has been developed and tested in our own shops and laboratories, under the supervision of our own engineers and instructors. A free sample lesson is yours upon request—use the coupon below.

You Get This and Other Valuable Information in the Free Sample Lesson:

1. Basic Receiver Circuits and How They are Used.
2. Construction of the Antenna Circuit.
3. How Energy is Picked Up by the Aerial.
4. How Signal Currents are Converted into Sound.
5. How the Tuning Condenser Operates.
6. How the R-F Transformer Handles the Signal, and other data, with diagrams and illustrations.

Both Home Study and Resident Training Offered

APPROVED FOR VETERANS

Check Coupon Below

NATIONAL SCHOOLS

LOS ANGELES 37, CALIFORNIA EST. 1905



MAIL OPPORTUNITY COUPON FOR QUICK ACTION

NATIONAL SCHOOLS, Dept. RC-1
4000 S. Figueroa, Los Angeles 37, Calif.

Paste on a postcard

Mail me FREE the books mentioned in your ad including a sample lesson of your choice. I understand in salesman will call on me.

NAME AGE

ADDRESS

CITY Zone STATE

Check here if Veteran of World War II

GET THE DETAILS—SEND THE COUPON →

Opportunity Ahead — but, for TRAINED MEN Only!



CREI Practical Home Study Courses in PRACTICAL TELEVISION Can Help You Advance in this Expanding Field!

You can make your own opportunity in Television, if you start preparing *now*. No need to tell you how fast this great new field is expanding—or, of the great number of jobs that are being created. If you are in Television now, expect to be, or wish to get in, CREI offers the very training you need to help accomplish your aims.

CREI can show you the way with convenient spare-time study at home that gives you the up-to-date technical background you *must* have for Television. CREI courses are designed to give you a thorough grounding in basic principles and take you step-by-step through the more advanced subjects of Television and its related fields. It must be remembered that all new electronic developments have their roots in past techniques. CREI training is basic and helpful in your daily work right from the start. You will learn about and understand such subjects as: Optics; Pulse Techniques; Deflection Circuits; RF, IF, AF and Video Amplifiers; FM; Receiving Antennas; Power Supplies; Cathode Ray, Iconoscope, Orthicon and Projection Tubes; UHF Techniques, Television Test Equipment, etc.

No matter how complete, or how limited your radio experience, CREI has a practical course of training for you based on twenty years experience in training professional radiomen. The facts about CREI, our courses, and what we can do for you, are described in our 32-page booklet. It is well worth reading. Send for it now.

VETERANS! CREI TRAINING AVAILABLE UNDER THE "G. I." BILL!

Capitol Radio Engineering Institute

An Accredited Technical Institute

DEPT. 141-A 16TH AND PARK ROAD, N. W., WASHINGTON 10, D. C.

Branch Offices: New York (7): 170 Broadway • San Francisco (2): 760 Market St.

1,000,000 Persons in TV Predicted Within 4 Years

—by one of industry's leaders

By 1953: 12,000,000 TV sets

By 1953: 50,000,000 Audience

By 1958: 40,000,000 TV sets

By 1958: 100,000,000 Audience

CAPITOL RADIO ENGINEERING INSTITUTE
16th & Park Rd., N.W. Dept. 141-A,
Washington, D. C.

Mail me ONE FREE sample lesson and your 32-page booklet, "Your Future in the New World of Electronics". I am attaching a brief resume of my radio experience, education and present position.

Check One PRACTICAL TELEVISION
Course: PRACTICAL RADIO-ELECTRONICS

NAME.....

STREET.....

CITY.....ZONE.....STATE.....

I am entitled to training under the "G. I." Bill.

RADIO-ELECTRONICS for

GET THESE 2 BIG BOOKS

FREE!

IF YOU WANT TO LEARN RADIO!



FRANK L. SPRAYBERRY
famous Radio teacher of hundreds of successful Radio men.

I TRAIN YOU RIGHT BY SENDING YOU 8 BIG KITS OF RADIO EQUIPMENT INCLUDING A POWERFUL 6 TUBE SUPERHET RECEIVER AND 16 RANGE TEST METER!

Radio job. Just mail the coupon for a FREE Sample Lesson and my big FREE book, "How To Make Money In Radio, Electronics, Television." It tells how I train you at home during spare hours by putting you to work building, testing, repairing Radio equipment. The Sprayberry Course teaches you Radio by working with 8 big kits of Radio parts I supply. You build a powerful 6 tube superhet Radio, a 16-range test meter, perform over 175 interesting, PRACTICAL experiments. My lessons are easy and interesting — you need no previous experience in Radio. I start you at the beginning... and give you valuable "bench" experience that sticks with you.

Soon after you start I send you my famous BUSINESS BUILDERS that help you earn EXTRA CASH getting and doing neighborhood Radio Service jobs while learning. You couldn't pick a better time to get into Radio. The Radio Repair Business is booming! Good Radio Service and Repair Shops are needed everywhere as millions of new sets are in use. Trained men are wanted for opportunities in Police, Aviation and Marine Radio, F.M. and Standard Broadcasting and Television. Manufacturers are looking for men who know Radio as production reaches new peaks. GET THE FACTS ABOUT YOUR FUTURE IN RADIO. MAIL THE COUPON TODAY for my FREE BOOKS!

LEARN HOW TO BUILD-TEST-REPAIR RADIOS By Working with YOUR HANDS!

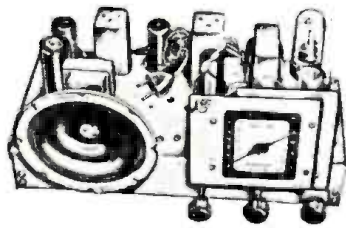

You really learn Radio the PRACTICAL way... when you build this big, powerful 6-tube Superhet Radio from parts I send you.

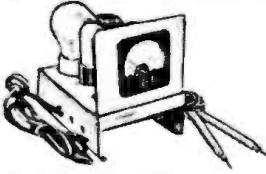

I give you a fine, moving coil type Meter — with parts for a complete analyzer and Circuit Continuity Tester. "Trouble-shoot" with professional accuracy.

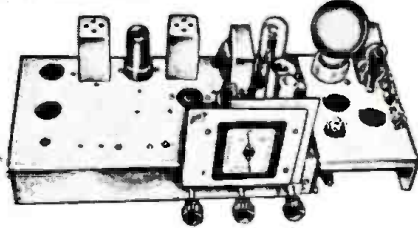

You don't have to buy expensive ready-made equipment. You get valuable experience building this Signal Generator and Multi-purpose Tester.

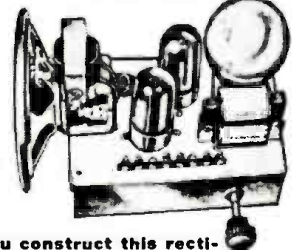

You construct this rectifier and filter, resistor and condenser tester, and really get on the Practical end of Radio.



Trained Radio men can step into their own profitable Radio Service Shop

LOW COST RADIO TRAINING STUDY AT HOME IN SPARE HOURS

Sprayberry Training costs surprisingly little! Easy monthly payments, if desired. Everything you need is furnished — nothing else to buy. With Sprayberry Training to back you up, you will be able to step into your own profitable Radio Service Business or go on to a big opportunity in Radio, Electronics or Television. The equipment I send you is yours "for keeps" — to use in your business or job. I have trained hundreds of successful Radio men — and I can help you too. Get the facts about Sprayberry Training — it's your first step to success, security and a bigger income in a field where you'll really enjoy your work. Fill out and mail coupon TODAY. I'll rush my two FREE books to you by return mail.

VETERANS: Approved for G. I. Training under Public Laws 16 and 346.

Sprayberry Academy of Radio, Dept. 20-N
Sprayberry Building or 20 North Wacker Drive
Pueblo, Colorado or Chicago 6, Illinois

RUSH COUPON Today!

SPRAYBERRY ACADEMY OF RADIO, Dept. 20-N
SPRAYBERRY BUILDING, PUEBLO, COLORADO or
20 NORTH WACKER DRIVE, CHICAGO 6, ILLINOIS

Please rush my FREE copies of "How To Make Money In Radio, Electronics and Television" and "How To Read Radio Diagrams and Symbols." No salesman will call.

Name _____ Age _____

Address _____

City and Zone _____ State _____

CHECK HERE IF A VETERAN
(Mail in an Envelope or Paste on Penny Postcard)

NOW!
Two Locations
TO SERVE YOU
BETTER
Mail Coupon To Location
Nearest Your Home

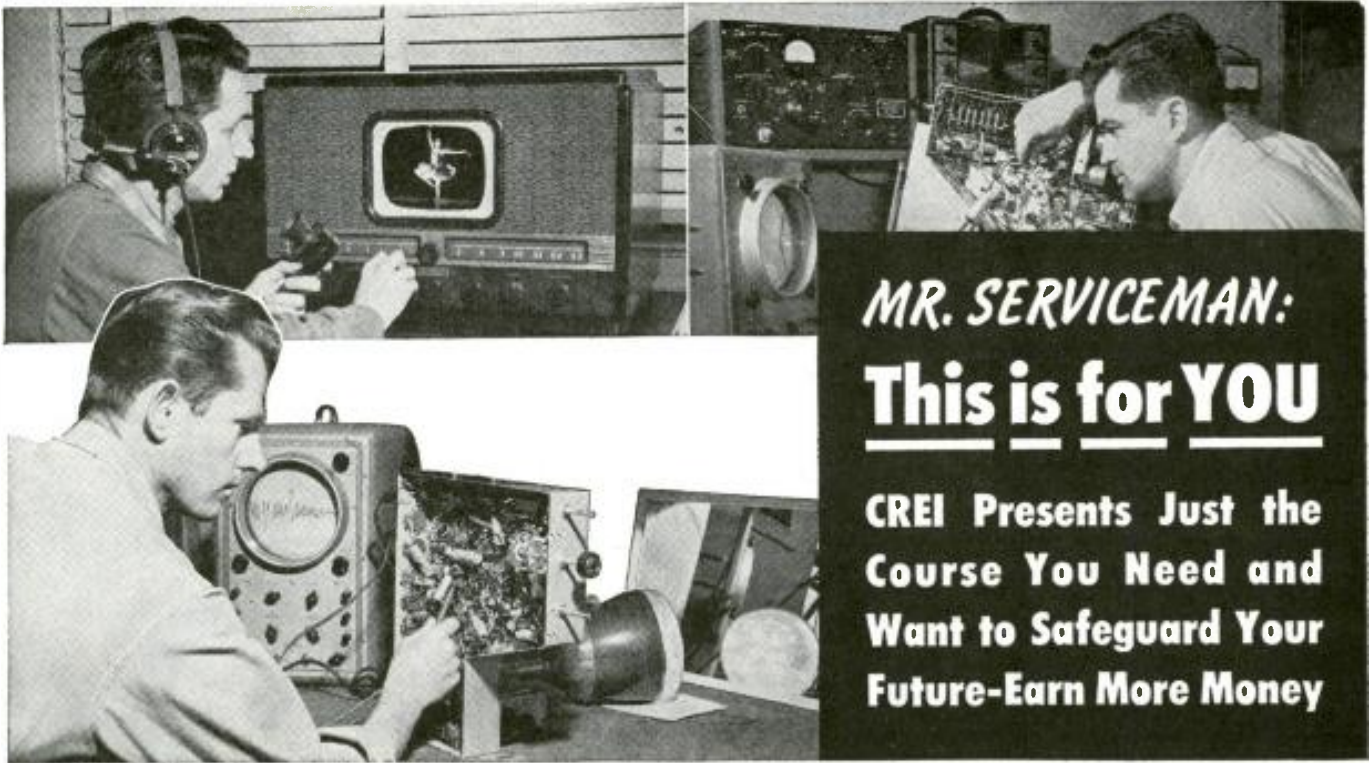

MR. SERVICEMAN:
This is for YOU

CREI Presents Just the Course You Need and Want to Safeguard Your Future—Earn More Money

"Television and FM Servicing"

Practical On-the-Job Training Program for the Better Serviceman Who Wants Greater Earnings and Security In This Expanding Field

THIS basic CREI Servicing Course paves the way to greater earnings for you. Since 1927 thousands of professional radiomen have enrolled for our home study courses in Practical Radio Engineering. Now, CREI supplies the answer to the need for a Practical Servicing Course. You do not have to be, or want to be, an engineer to benefit from this course. It is written for *you*—the average *good* serviceman! It's not too elementary for the experienced. It's not "over the head" of those who have limited experience—if they have real ambition and natural ability.

CREI developed this course at the request of several large industrial organizations. The urgent need of capable, trained servicemen is one of the big problems of the industry. Hundreds of thousands of Television

Receivers will be marketed in 1949. By 1951 two million TV units are expected to be flowing into American homes. With Television comes FM receivers and circuits. This new field demands a tremendous increase in the number of properly trained television and FM technicians to install and service this equipment.

CREI EQUIPS YOU TO INSTALL AND SERVICE ALL TYPES OF TELEVISION AND FM RECEIVERS

Now . . . with the help of this new CREI streamlined Service course you can move ahead to unlimited opportunities in your chosen field. CREI has again taken the lead by offering a course so entirely new that for the first time in our twenty-one year history we can offer a down-to-earth course of training for servicemen. In offering this course at a popular price, CREI is enabling thousands

of the "top third" now engaged in service work to enter the ultimate profitable field of television and FM installation and service.

This can be your big year! Don't waste another day. CREI has the answer to your future security in this new servicing course. Write today for complete information. The cost is *popular*. The terms are *easy*. The information is *free*. Write today.

Radio Service Division of
CAPITOL RADIO
ENGINEERING INSTITUTE

An Accredited Technical Institute

Dept. 151-A, 16th & Park Rd., N. W., Wash. 10, D. C.

Branch Offices: New York (7) 170 Broadway • San Francisco (2) 760 Market St.

MAIL TODAY

CAPITOL RADIO ENGINEERING INSTITUTE
16th & Park Road, N. W., Dept. 151-A, Washington 10, D. C.

Gentlemen:

Please send me complete details of your new home study course in Television and FM Servicing. I am attaching a brief resume of my experience, education and present position.

NAME _____

STREET _____

CITY _____ ZONE _____ STATE _____

I AM ENTITLED TO TRAINING UNDER G. I. BILL

RADIO-ELECTRONICS for

VIDEO HAMS!

SERVICE MEN!

ALL TELEVISION ENTHUSIASTS!

Here's Television's Greatest Thrill!

PILOT

CANDID T-V

PORTABLE TELEVISION

99⁵⁰

Plus \$1.55 Fed. Excise Tax



CANDID T-V
without magnifying
lens

OPTIONAL ACCESSORIES

Magnifying lens (shown in illustration above)—
actually triples picture area!.....\$6.95 and \$9.95

Leatherette carrying case (upper left)—with
built-in telescopic steel antenna enables you to
carry set everywhere.....\$24.50

Imagine! Television at its very finest—for less than \$100! That's the PILOT CANDID T-V . . . the newest national sensation! And—WHAT television! So clear, so bright—you couldn't buy a finer, sharper image if you paid TEN TIMES AS MUCH! So light, compact and handy (only 15 lbs!) you can easily carry it ANYWHERE . . . to living room, radio shack, playroom, den, office. Perfect for testing TV patterns on your regular service and installation calls. See and hear this sensational all-purpose television set at your nearest Pilot Radio dealer.

WRITE TO PILOT RADIO, Dept. RE, for name of nearest dealer. We will also send exciting details about new Pilot "Big Theatre" television console, featuring 16" x 12" viewing screen with famed Norelco "Protelgram" projection system.

FEATURES

- Powerful 17-tube chassis (plus 3 rectifiers and per-ray tube)
- Continuous tuning separate copper-plate, variable condensers for high and low bands
- High sensitivity—1 RF, 1 converter and 4 IF stages, providing full 4 mc band pass
- No drift
- AC operation
- Mahogany Masonite cabinet, with bakelite panel.

PILOT RADIO CORPORATION

, 37-06 36th ST., LONG ISLAND CITY, N. Y.

SYLVANIA ADVERTISING HELPS SERVICE DEALERS INCREASE THEIR SERVICE BUSINESS!

Read what these 3 dealers say about Sylvania's Dealer Campaign for Summer and Fall

ELECTRONICS Service Company

Recording Equipment
F. M. Radio
Phone 3-2842
Tulsa, Oklahoma
October 23, 1948

Advertising Department
Sylvania Electric Products Inc.
Emporium, Pa.

Gentlemen:

We would like to express our appreciation to Sylvania for its co-ordinated advertising campaign. It has, so far, resulted in a steady increase in our service business. During September our business increased 30 per cent and to date in October it has shown a 28 per cent increase. We feel that this increase is due to this campaign since we have used it exclusively during this time.

We have used the radio spot announcements over our local station and mailed the direct mail postal cards to our customers. We have also used the newspaper ad mats in our local paper upon occasion.

It is a great help to the radio service business to have this service provided so inexpensively. Thanks to you of Sylvania.

Very truly yours,
Vernor P. Rodgers, Jr.
Vernor P. Rodgers, Jr.
Manager and Prop.

VPR:ML

"September business increased 30%"

DAMON'S RADIO SERVICE
1006 E. 14TH ST SAN LEANDRO

RAPID Radio Service

Dial TR 4353
1006 East 14th Street
SAN LEANDRO, CALIF.

R. H. DAMON

Advertising Department
Sylvania Electric Products
Emporium, Pa.

Gentlemen:

Enclosed is my order for the second kit in the Sylvania co-ordinated advertising program.

I took over this business on July 1 and have been using the advertising material from your first kit. I have found that it really pays to advertise. The previous business was bankrupt and had no volume of service business.

With help from Mr. A. A. Hall, the local Sylvania salesman, and the advertising material furnished by him, my business now shows great promise. Mr. Hall works for C. C. Brown Co. of San Francisco, one of your distributors. Mr. Hall filled my rush order for a Sylvania Tube Tester which has already increased my sale of tubes.

I am enclosing a few copies of my ad using Sylvania ad mats which appear in the local paper. The San Leandro News Observer and the San Leandro Shopping News. These papers have a circulation of 18,000. This type of advertising brought in over 100 radio sets for repair during the month of July. I hope business grows like this every month from now on.

Sincerely yours,

R. H. (Bob) Damon
Damon's Radio Service
1006 E. 14th Street
San Leandro, Calif.

"Newspaper ads brought in over 100 radio sets for repair during July!"

216 FOURTH AVE. WEST
PHONE 1564
ASHLAND, WISC.

MYERS RADIO SERVICE CO.

Advertising Department
Sylvania Electric Products
Emporium, Pa.

Dear Sir:

I am writing to tell you how much your co-ordinated advertising has helped my business.

I have used the postal cards, the window display spot announcements to promote my business. The radio station. They are used seven times a week over our local radio station. They are used at various hours so I have contacted a large range of people.

I make my living entirely through service and the sale of used records, so anything which helps to increase my business is very valuable to me. Since I have been using your campaign my business has increased from an average of \$90.00 per week to about \$135.00 per week gross. My use of the campaign has cost me about \$12.00. Before I used the campaign I was spending an average of \$7.00 per week. For the extra expense I have certainly received a fair return.

I am very much pleased with the radio spots in your booklet.

Robert Myers
Myers Radio Service Co.

"Gross business increased from \$90.00 to \$135.00 per week"

SYLVANIA'S FEBRUARY, MARCH AND APRIL CAMPAIGN IS NOW READY

Here's what it contains:

- 3 Postal Card Mailings—one for each month.
- 3 Window Displays—one for each month.
- 3 Window Streamers—one for each month.
- 6 Newspaper Ad Mats—two sizes for each month.
- Radio Spot Announcements—several for each month.

SEND FOR FULL INFORMATION NOW!

Remember, this campaign designed for your use ties up directly with Sylvania's ad campaigns on a national scale. You pay only the postage on the government postal cards you mail. Sylvania supplies everything else free! Mail coupon today!

SYLVANIA ELECTRIC

RADIO TUBES; CATHODE RAY TUBES; ELECTRONIC DEVICES; FLUORESCENT LAMPS, FIXTURES, WIRING DEVICES; LIGHT BULBS; PHOTOLAMPS

Sylvania Electric Products Inc.
Advertising Department
Room R-1701
Emporium, Pa.

Gentlemen: Please send me full details on your February, March and April Service Dealer Campaigns.

Name _____
Company _____
Address _____
City _____ Zone _____
State _____

Our
GREATEST OFFER
in **17**
YEARS

Amazing New **EQUIPMENT** Helps

Prepare You **FASTER, EASIER** for . . .

TELEVISION

Radio...Electronics

Here's good news . . . big news . . . our **BIGGEST NEWS** in 17 years. The equipment pictured at left gives a partial idea of D.T.I.'s remarkable, new combination of shop-method training aids . . . to prepare you **AT HOME** for your start in Television-Radio-Electronics.

Get 48-Page Book FREE

Mail coupon today for D.T.I.'s big new 48-page **OPPORTUNITY GUIDE BOOK**. See how this amazing newer *method* helps you get started toward a **GOOD JOB** or your **OWN BUSINESS** in one of America's most promising, thrilling fields . . . that includes Television . . . F.M., Train, 2-Way Taxi, Aviation, and Broadcast Radio . . . Industrial Electronics . . . and other fast-developing branches.

In addition to well-illustrated lessons, you work over 300 instructive experiments from 16 shipments of Radio-Electronic parts. Among these projects you build and keep a commercial-type **CATHODE RAY OSCILLOSCOPE** . . . that helps you get practical Television circuit training. You also build and keep a double-range **R-F SIGNAL GENERATOR**, a jewel-bearing **MULTI-METER** and a quality 6-tube **SUPERHET RADIO**.

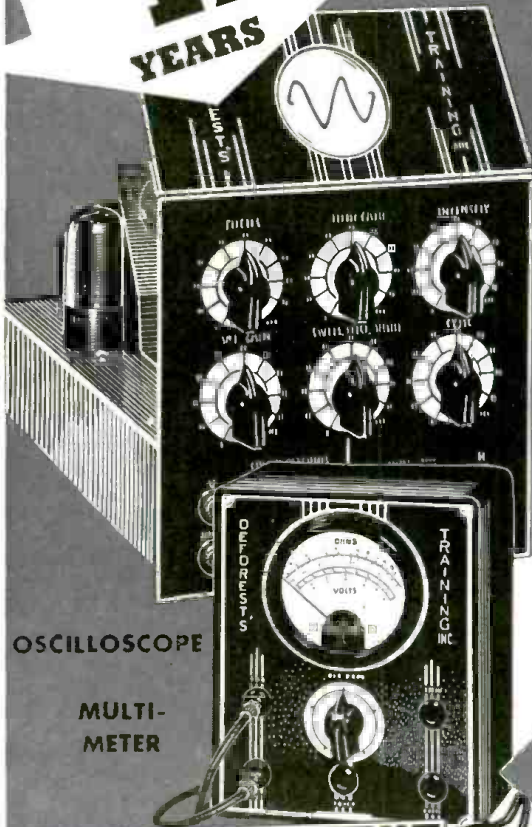

OSCILLOSCOPE

MULTI-METER

YOU BUILD AND KEEP ALL OF THE EQUIPMENT AT LEFT . . . MAKE OVER 300 HOME EXPERIMENTS!

MODERN CHICAGO LABORATORIES

If you prefer, you can get **ALL** your preparation in our new, Chicago training laboratories . . . one of the finest of its kind. Ample instructors . . . modern equipment . . . Write for details!

You also use **HOME MOVIES** . . . a **D.T.I. Exclusive!**

D.T.I. alone includes the modern, visual training aid . . . **MOVIES** . . . to help you learn faster, easier at home. You see electrons on the march and other fascinating "hidden action" — a remarkable home training advantage that speeds your progress.



You Get D.T.I.'s Effective **EMPLOYMENT SERVICE**

When you complete your training, our effective Employment Service is available to you without extra cost, to help you get started.

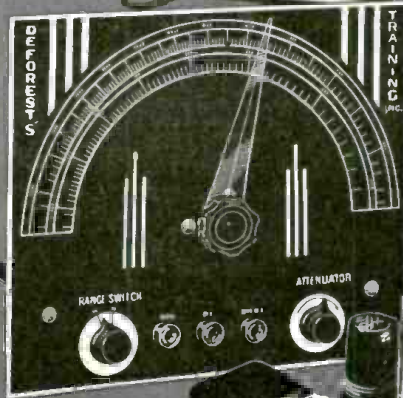

R-F SIGNAL GENERATOR

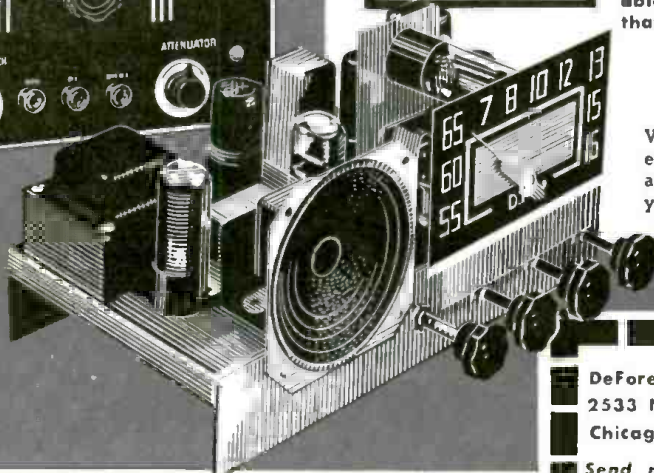

6-TUBE RADIO RECEIVER

MAIL TODAY!

DeForest's Training, Inc.
2533 N. Ashland Ave., Dept. RC-71
Chicago 14, Illinois

Send me **FREE** your 48-page **OPPORTUNITY GUIDE BOOK** showing how I may make my start in Television - Radio - Electronics.

Name _____ Age _____
Street _____ Apt. _____
City _____ Zone _____ State _____



DeFOREST'S TRAINING, INC.

CHICAGO, ILLINOIS

Affiliated with the De Vry Corporation
Builders of Electronic and Movie Equipment

**No More
Guesswork**



with
**OHMITE
Little Devil**

COMPOSITION RESISTORS

You never have to guess about the resistance and wattage of any Little Devil resistor. Every unit is not only color-coded but individually marked for quick, positive identification. Millions used in critical war equipment. Standard RMA values from 10 ohms to 22 megohms, in 1/2, 1, and 2-watt sizes. Tol. $\pm 10\%$. Also $\pm 5\%$ in 1/2 and 1-watt sizes.

Available Only Through OHMITE Distributors

Ohmite Manufacturing Co.

4894 Flournoy St., Chicago, Ill.



**EVERY UNIT
CLEARLY
MARKED!**

"SUICIDE ON WHEELS" was the description given to TV receivers in autos by the National Safety Council last month. "Keeping one's eye on the road ahead and on traffic behind and on both sides is the first essential of safe driving," a council statement said. The council said its staff would make a further study of TV installations visible to passengers only.



Auto tele installation of Robert Wright of Milwaukee, which brought a shower of criticism from safety officers of several states.

BLIND persons may be enabled to read ordinary print by a new device demonstrated for the first time last month by RCA Laboratories. It is an advanced letter-recognition system on which much work was done during the war and at the suggestion of Dr. Vannevar Bush.

A scanning device is moved along a line of type. A miniature cathode-ray tube explores each letter with eight spots of light arranged in a vertical line. When a spot hits a black portion, an impulse goes to a selector unit, where impulses are counted electrically. After each letter is scanned, the total number

of impulses—a different number for each letter—actuates a magnetic tape recording corresponding to the letter so that the reader hears the letter pronounced by the loudspeaker.

PREVENTIVE MAINTENANCE was the theme of a campaign carried out by radio repairmen of the Harrisburg, Pennsylvania, area during the month of November last. Sponsored by the Federation of Pennsylvania Radio Servicemen's Associations and put into action by the local Mid-State Radio Technicians Association, it stressed the advantages to the radio owner of having his set repaired *before* it breaks down, instead of after. The returns to the radio user, both in uninterrupted radio entertainment and lower repair bills, were emphasized in a month-long advertising campaign. Residents of the area were urged through the newspapers and over the air to bring their sets to their radio repairmen for preventive maintenance during the month of November; a special check-over rate and guarantee was offered for that month only.

National and local radio concerns both cooperated with the Harrisburg servicemen in the campaign. Large numbers of leaflets and display pieces stressing preventive maintenance were supplied by tube and set manufacturers. Several local distributors, including York Radio & Refrigeration Parts, the D & H Distributing Co., the Radio Distributing Co., and John Blessing & Co., alternated in running weekly ads featuring preventive maintenance in both morning and evening papers. These, with the Mid-State Association's weekly ad, brought the campaign to public attention several days each week. All ads featured the Code of Ethics of the Association (RADIO-CRAFT, March, 1948).



This device actually reads, pronouncing each letter as the phototube scanner moves over it.

RADIO-ELECTRONICS for

ULTRAFAX, a new method for high-speed transmission of pictorial or printed material, was demonstrated to the public for the first time last month by RCA. Feature of the demonstration was the sending in just two minutes and 21 seconds of the complete text of "Gone With the Wind," the famous 1,047-page novel.

A picture of each page is transmitted via television to a TV receiver and is copied on microfilm. Thirty of these pictures per second are sent. A war-developed system of high-speed photography delivers film ready for printing or projecting in 45 seconds.

A TALKING STOVE is the property of Mrs. Walter Sechrist, of York, Pa. Mrs. Sechrist's gas range picks up the voice of a neighbor who is a ham. An engineer told her that two unlike metals in the stove are probably acting as an imperfect-contact detector.

TELEVISION ANTENNAS within the sets are a major goal for research engineers, said Dr. W. R. G. Baker last month. The General Electric vice-president pointed out that many people do not want to disfigure their homes with large antennas and that installation costs are high. Eventually, he said, the engineers want to get the antennas right inside the sets, just as was done with standard radios.

COLOR TELEVISION is the subject of a patent granted last month to Dr. Lee de Forest, pioneer radio inventor. The system uses a pair of cathode-ray tubes and a multi-color filter. Dr. de Forest claims that the system eliminates all color flicker.

METAL-CERAMIC SEALING is made possible by a new method developed by General Electric, according to an announcement last month by the company's Dr. C. G. Suits. The seal is made by an alloy of silver and titanium. The process will be especially valuable in making microwave vacuum tubes. The sealing of glass and metal is now commonplace, but glass presents difficulties due to heat in the u.h.f. regions. Ceramic materials may now be used to replace the glass.

THREE TV ANTENNAS and an FM radiator may be placed atop the tower being constructed for Stromberg-Carlson's Rochester television station, WHTM. The new tower will reach 1,005 feet above sea level and will be sturdy enough to support four additional antennas. One will be used for FM station WHFM. Stromberg has offered to share the tower with one other FM and two more television broadcasters, since the location of the tower is the best available spot in the Rochester area. If the offer is accepted, the novel arrangement will be the first in TV history. Viewers will be able to beam their antennas to one spot and receive three stations free of ghosts.

PRESIDENT-ELECT of the Institute of Radio Engineers is Stuart L. Bailey, the IRE announced last month. Mr. Bailey is a partner in the firm of Jansky and Bailey, consulting engineers, as well as a Fellow of the Institute.



Stuart L. Bailey, new president of the IRE.

Arthur S. McDonald, chief engineer of the Overseas Telecommunication Commission, Sydney, Australia, was elected vice-president for 1949.

NEW CO-AXIAL CABLE linking the East with the Midwest will be ready for television use on January 12, the A. T. and T. Company announced last month. The eastern networks now link New York, Boston, Philadelphia, Baltimore, Washington, and Richmond, with Pittsburgh to be added shortly. The mid-western cities joined by cable are Chicago, Cleveland, Toledo, Detroit, St. Louis, Buffalo, and Milwaukee. Two other cities are connected to networks by privately owned relays, Schenectady and New Haven. All together, over 12.5 million families will be served by TV networks after January 12.

FM PERMITEES who surrender their construction permits would not be allowed to re-file for FM facilities within two years after the surrender, according to a regulation proposed to the FCC last month by the FM Association. Many CP holders have "sat on" their grants and then surrendered them "without prejudice," waiting for other operators to make FM a successful operation before spending money themselves. This, according to Leonard H. Marks, FM Association's general counsel, penalizes the conscientious broadcaster who constructs his station and serves the public, even though he makes no profit and may even sustain a loss.

TOWN MEETINGS of radio technicians will be held soon in Atlanta, Georgia, and in Los Angeles, the Coordinating Committee announces. The Atlanta meeting is being held in the Municipal Auditorium January 31 and February 1 and 2. The Los Angeles gathering will be at the Roger Young Auditorium on February 28 and March 1 and 2.

Keep posted on Electron Tubes

MAIL COUPON TODAY

RCA, Commercial Engineering Section 49AW, Harrison, N. J.

Send me the RCA publications checked below. I am enclosing \$_____ to cover cost of those books for which there is a charge.

Name _____

Title or Occupation _____

Address _____

City _____ Zone _____ State _____

Quick-Reference Chart, Miniature Tubes (Free). (A)

HE-3 Tube Handbook (\$10.00)*. (B)

RC-15 Receiving Tube Manual (35 cents). (C)

Receiving Tubes for AM, FM, and Television Broadcast. (10 cents). (D)

Radiotron Designers Handbook (\$1.25). (E)

Quick Selection Guide, Non-Receiving Types (Free). (F)

Power and Gas Tubes for Radio and Industry (10 cents). (G)

Phototubes, Cathode-Ray and Special Types (10 cents). (H)

RCA Preferred Types' List (Free). (I)

Headliners for Hams (Free). (J)

*Price applies to U. S. and possessions only.



Features
THAT MAKE

HEATHKITS

HEATHKIT FM and TELEVISION SWEEP GENERATOR KIT

A necessity for television and FM. This Heathkit completely covers the entire FM and TV bands 2 megacycles to 230 megacycles. The unit is 110V 60 cy power transformer operated. Uses two 6J6 tubes, two 6C4 tubes and a 6X5 rectifier. An electronic sweep circuit is incorporated allowing a range of 0 to 10 MC. A sawtooth horizontal sweeping voltage and phase control are provided for the oscilloscope.

The coils are ready assembled and precision adjusted to exact frequency. As in all Heathkits, the best of parts are supplied, Mallory filter condenser, zero coef. ceramic condensers, all punched and formed parts, grey crackle cabinet, 5 tubes, test leads, etc. Better get it built now and be ready for the FM and TV business. Shipping wt. 6 lbs.



\$24.50

Nothing ELSE TO BUY...

KITS THAT FIT

Heathkit chassis are precision punched to fit the quality parts supplied. The grey crackle aluminum cabinet and the two color panels are die punched to assure proper fitting. Many builders have written marveling of the ease with which assembly can be accomplished. The chassis are specially engineered for easy assembly and wiring—there are no small ends of the chassis which cannot be reached—the installation of parts and soldering can be done with both hands.

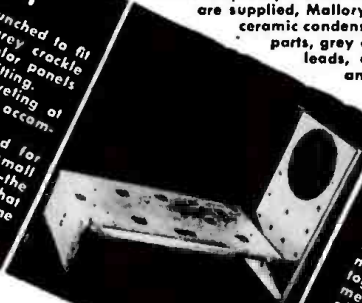

COMPLETE INSTRUCTION MANUALS

Everyone is pleased at the thorough instructions covering the assembly of each Heathkit instrument. Every detail of the assembly is covered, together with sections on the use of the instrument and trouble shooting instructions in case of difficulty. Actual photos of the assembled instrument enable fast and accurate assembly. Clear schematics and pictorial diagrams of the confusing parts such as rotary switches enable the wiring to be completed quickly.

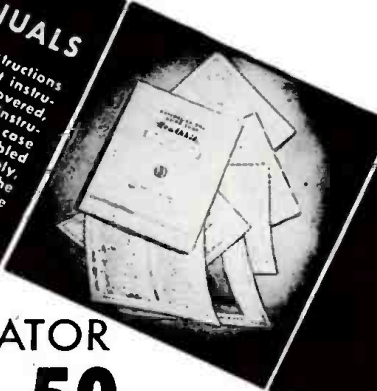

Heathkit SIGNAL GENERATOR KIT...

\$19.50

Nothing ELSE TO BUY

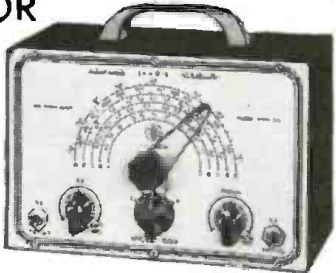

Every shop needs a good signal generator. The Heathkit fulfills every servicing need, fundamentals from 150 Kc to 30 megacycles with strong harmonics over 100 megacycles covering the new television and FM bands. 110V 60 cycle transformer operated power supply.

400 cycle audio available for modulation or audio testing. Uses 6SN7 as RF oscillator and audio amplifier. Complete kit has every part necessary and detailed blueprints and instructions enable the builder to assemble it in a few hours. Large easy to read calibration. Convenient size 9" x 6" x 4 3/4". Shipping weight 4 1/2 lbs.

Heathkit SINE AND SQUARE WAVE AUDIO GENERATOR KIT . . . \$34.50

The ideal instrument for checking audio amplifiers, television response, distortion, etc. Supplies excellent sine wave 20 cycles to 20,000 cycles and in addition supplies square wave over same range. Extremely low distortion, less than 1%, large calibrated dial, beautiful 2 color panel, 1% precision calibrating resistors. 110V 60 cycle power transformer, 5 tubes, detailed blueprints and instructions. R.C. type circuit with excellent stability. Shipping Wt. 15 lbs.

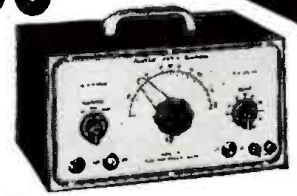

Nothing ELSE TO BUY

HEATHKIT HIGH FIDELITY AMPLIFIER KIT

\$14.95

Build this high fidelity amplifier and save two-thirds of the cost. 110V 60 cy transformer operated. Push pull output using 1619 tubes (military type 6L6's), two amplifier stages using a dual triode (6SL7), as a phase inverter give this amplifier a linear reproduction equal to amplifiers selling for ten times this price. Every part supplied; punched and formed chassis, transformers (including quality output to 3-8 ohm voice coil), tubes, controls, and complete instructions. Add postage for 20 lbs.

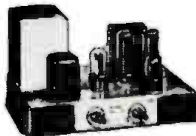

12" PM Speakers for above..... 6.95
Mahogany Speaker Cabinet 14 1/2" x 14 1/2" x 8" 8.75

110V A.C. MILITARY RECEIVER POWER SUPPLY KIT

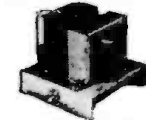

\$5.95

Ideal way to convert military sets. 110V 60 cy. transformer operated. Supplies 24 Volts for filament—no wiring changes inside radio. Also supplies 250V D.C. plate voltage at 50-60 MA. Connections direct to dynamotor input. Complete with all parts and detailed instructions. Shipping wt. 6 lbs.

110 V. A.C. TRANSMITTER POWER SUPPLY KIT

For BC-645, 223, 522, 274N's, etc. Ideal for powering military transmitters. Supplies 500 to 600 Volts at 150 to 200 MA plate, 6.3 C.T. at 4 Amps, 6.3 at 4 Amps, and 12V at 4 Amps. Can be combined to supply 3.6-9-12 or 24 Volts at 4 Amperes. Kit supplied complete with husky 110V 60 cycle power transformer, 5U4 rectifier, oil filled condensers, cased choke, punched chassis, and all other parts, including detailed instructions. Complete—nothing else to buy. Shipping Wt. 22 lbs.

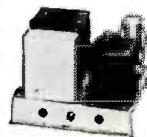

\$14.50

HEATHKIT CONDENSER CHECKER KIT

\$19.50

Nothing ELSE TO BUY

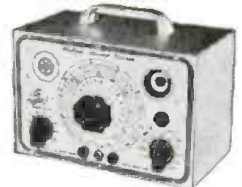

Checks all types of condensers, paper mica—electrolytic—ceramic over a range of .00001 MFD to 1000 MFD. All on readable scales that are read direct from the panel. NO CHARTS OR MULTIPLIERS NECESSARY. A condenser checker anyone can read without a college education. A leakage test and polarizing voltage of 20 to 500 volts provided. Measures power factor of electrolytics between 0% and 50%. 110V 60 cycle transformer operated complete with rectifier and magic eye tubes, cabinet, calibrated panel, test leads and all other parts. Clear detailed instructions for assembly and use. Why guess at the quality and capacity of a condenser when you can know for less than a twenty dollar bill. Shipping wt. 7 lbs.



The **HEATH COMPANY**

... BENTON HARBOR 20, MICHIGAN

IDEAL TEST INSTRUMENTS

HEATHKIT VACUUM TUBE VOLTMETER KIT

Everything you want in a VTVM. Shatterproof solid plastic meter face, automatic meter protection in burn-out proof circuit, push pull electronic voltmeter circuit assuring maximum stability. Linear DC and AC scales. Complete selection of voltage ranges starting with 3 Volts full scale up to 1,000 Volts. Isolated DC test prod for signal tracing and measurements of voltage while instrument is in operation. An ohmmeter section accurately measuring resistance of 1/10 ohm to one billion ohms with internal battery. Extremely high input resistance 11 megohms on all ranges DC and 6.5 megohms on AC. All these features and many more are the reasons hundreds of radio and television schools are using Heathkit VTVM's and recommending them to all students. Like all Heathkits, the VTVM kit is complete, 110V 60 cy power transformer, 500 microamp meter, tubes, grey crackle cabinet, panel, test leads, 1% ceramic precision divider resistors and all other parts. Complete instruction manual. Better start your laboratory now, and enjoy it all winter. Shipping Wt. 8 lbs.

*Nothing
ELSE TO
BUY!*
\$24⁵⁰

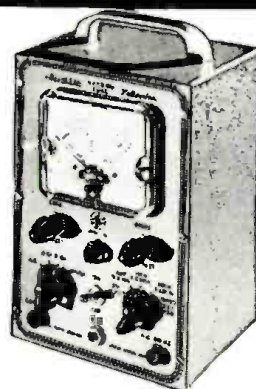

HEATHKIT SIGNAL TRACER KIT

Reduces service time and greatly increases profits of any service shop. Uses crystal diode to follow signal from antenna to speaker. Locates faults immediately. Internal amplifier available for speaker testing and internal speaker available for amplifier testing. Connection for VTVM on panel allows visual tracing and gain measurements. Also tests phonograph pickups, microphones, PA systems, etc. Frequency range to 200 MC. Complete ready to assemble. 110V 60 cycle transformer operated. Supplied with 3 tubes, diode probe, 2 color panel, all other parts. Easy to assemble, detailed blueprints and instructions. Small portable 9" x 6" x 4 1/4". Wt. 6 pounds. Ideal for taking on service calls. Complete your service shop with this instrument.

\$19⁵⁰

Nothing ELSE TO BUY

HEATHKIT 3-TUBE ALL-WAVE RADIO



\$8.75

An ideal way to learn radio. This kit is complete ready to assemble, with tubes and all other parts. Operates from AC. Simple, clear detailed instructions make this a good radio training course. Covers regular broadcasts and short wave bands. Plug-in coils. Regenerative circuit. Operates loud speaker. Add postage for 3 lbs. \$8.75
HS 30 Headphones per set. \$1.00
2 1/2" Permanent Magnet Loudspeaker 1.95

INTERPHONE 2-WAY CALL SYSTEM KIT



\$14.50

Ideal call and communication system for homes, offices, factories, stores, etc. Makes excellent electronic baby watcher easy to assemble with every part supplied including simple instructions. Distance up to 1/5 mile. Operates from 110V A.C. 3 tubes, one master and one remote speaker. Shipping Wt. 5 lbs.

Heathkit ELECTRONIC SWITCH KIT DOUBLES THE UTILITY OF ANY SCOPE

An electronic switch used with any oscilloscope provides two separately controllable traces on the screen. Each trace is controlled independently and the position of the traces may be varied. The input and output traces of an amplifier may be observed one beside the other or one directly over the other illustrating perfectly any change occurring in the amplifier. Distortion—phase shift and other defects show up instantly. 110 Volt 60 cycle transformer operated. Uses 5 tubes (1—6X5, 2—6SN7's, 2—6SJ7's). Has individual gain controls, positioning control, and coarse and fine sweeping rate controls. The cabinet and panel match all other Heathkits. Every part supplied including detailed instructions for assembly and use. Shipping weight 11 lbs.

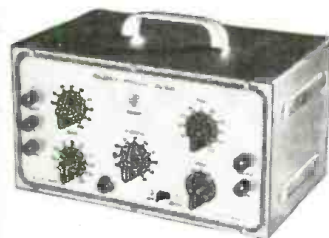

\$34⁵⁰

*Nothing
ELSE TO
BUY*

COMPLETE KITS

When you receive your Heathkit, you are assured of every necessary part for the proper operation of the instrument. Beautiful cabinets, handles, 2 color panels, all tubes, test leads where they are a necessary part of the instrument, quality rubber line cards and plugs, rubber feet for each instrument, all scales and dials ready printed and calibrated. Every Heathkit is 110V 60 cy. power transformer operated by a husky transformer especially designed for the job.

New 1948

HEATHKIT 5" OSCILLOSCOPE KIT

A necessity for the newer servicing technique in FM and television at a price you can afford. The Heathkit is complete, beautiful two color panel, all metal parts punched, formed and plated and every part supplied. A pleasant evening's work and you have the most interesting piece of laboratory equipment available.

Check the features—large 5" 5BP1 tube, compensated vertical and horizontal amplifiers using 6SJ7's, 15 cycle to 30 M cycle sweep generator using 884 gas triode, 110V 60 cycle power transformer gives 1100 volts negative and 350 volts positive.

Convenient size 8 1/2" x 13" high, 17" deep, weight only 26 pounds.

All controls on front panel with test voltage and ext. syn. post. Complete with all tubes and detailed instructions. Shipping weight 35 pounds. Order today while surplus tubes make the price possible.

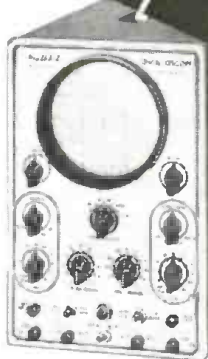

*Nothing
ELSE TO BUY*
\$39⁵⁰

ORDER DIRECT FROM THIS AD.
WE WILL SHIP C. O. D.
Add Postage for Weight Shown

BEST OF PARTS
You will find many famous names on the parts in your Heathkit. Mollory switches and filler condensers, Chicago Transformer Corporation and Electrical Assembly Transformers, Centralab Patentmeters, Belden Cable, IFC and Allen Bradley resistors, G. E. tubes, Cinch and Amphenol sockets with silver plated contacts, Deffiance variable condensers, Eby plated parts and many other quality parts. The finest of parts are used to assure long trouble-free service from Heathkits.



The **HEATH COMPANY**

... BENTON HARBOR 20, MICHIGAN

Buy HEATH SURPLUS Now!

ALL QUANTITIES LIMITED SUBJECT TO PRIOR SALES

APN/1 RADIO ALTIMETERS



\$34.50

NO. 200. The last chance to get a complete new 14 tube radio altimeter. Contains 420 Mc. transmitter and receiver, power supply, range switches, two antennas, meter indicator, all plugs and instruction manual. This unit makes excellent amateur station as it is right in the band. Shipped in original export crate. Weight 87 lbs.

G.E. BC 375 TUNING UNIT

NO. 203. Model TU10B covers 10 Mc. to 12.5 Mc. New complete with aluminum cabinet. The best buy of surplus. Over \$30.00 worth of new variable condensers, coil, dials, switches, etc. Add postage for 20 lbs.



\$2.49

G.E. 50 AMP CIRCUIT BREAKER NO. 204. New General Electric 50 Amp 220 Volt AC circuit breakers. 100 Amp when used on 110V. Add postage for 4 lbs.



\$2.95
EACH
3 FOR
\$7.50

BC 347 AIRCRAFT INTERPHONE AMPLIFIER

NO. 205. Interphone amplifier contains 6F8 tube, Ouncer transformers, diagrams, etc. in aluminum cabinet. Add postage for 4 lbs. **\$2.95**

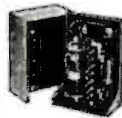

274N COMMAND SET ACCESSORIES

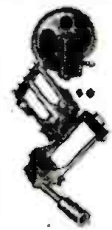

NO. 238. 5" PM Speaker with output transformer matching headphone output. **\$2.80**
NO. 239. Dual receiver rack FT277A with connecting plugs. **\$1.00**
NO. 240. Single transmitter rack FT234A **\$1.00**
NO. 241. Spline shaft for tuning command receivers. Allows use of regular tuning knob on 8C 453-4-5 receivers **\$.39**

BC 451 CONTROL BOX NO. 236. Control box for 274N transmitters. Contains proper cw-voice switch, 4 channel switch, power switch, mike jack and telegraph key. Add postage for 2 lbs. **\$1.95**

METER SPECIAL

NO. 237. Brand new DeJur Model 312 0-800 M.A. D.C. Square 3" 0-10 M.A. basic meter with built in shunt. Probably the best buy ever offered in a surplus meter. Shipping Weight 1 lb. **\$2.95**



A-62 ARMY PHANTOM ANTENNA



NO. 206. Contains tuning condenser, coil, resistors, tuning dial, tuning indicator, binding posts, steel case, useful for building amateur transmitter. Add postage for 8 lbs. **\$1.95**

BENDIX MR9C COMPASS CONTROL UNIT

NO. 207. Tuning and control unit for Bendix MN 26 radio compasses contains tuning dial, band switch, crystal switch, AVC switch, volume control, fuses, phone jacks, etc. Shipping Weight 5 lbs. **\$9.50**

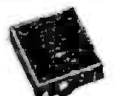

BC731 CONTROL BOX



Weston Model 476 AC Voltmeter NO. 208. Excellent buy in motor control box. Size 8"x10"x5 1/2". Contains Weston 0-150V. AC 3/2" voltmeter, motor starting switch, 28 fuses all 30 Amp 110V. and 8 fuse holders. Fuses and holders alone worth the price. Shipping Weight 18 lbs. **\$7.95**

BC 645 GENERAL ELECTRIC TRANSCEIVER



NO. 201. Complete 15 tube transmitter-receiver. Ideal for new citizens band 460 Mc. for communication between office and car, home, boat, etc. Conversion article in August ELECTRONICS Magazine. Brand new in original G.E. cartons with tubes. Add postage for 25 lbs. **\$19.50 . . . 2 for \$35.00**

ACCESSORIES FOR BC 645
PE101C Dynamotor for car use. **\$ 3.95**
110V 60 Cycle Power Supply for home or office use. **\$14.50**

T32 TABLE MICROPHONE

NO. 210. One of the Army's best. Built by Kellogg, ideal for factory call system, public address, amateur use. Brand new in original cartons. Add postage for 5 lbs. **\$2.95**



MINIATURE ELECTRIC MOTOR



NO. 211. Tiny Delco motor only 1" x 1 1/4" x 2". 10,000 RPM. Operates from 6 to 24 V. Excellent for models. Add postage for 1 lb. **\$2.95**

P. E. 103
6 VOLT

DYNAMOTOR

NO. 212. Dynamotor only from PE 103 power supply. Input 6 or 12 Volts, output 500 Volts at 160 MA. Brand new original cartons. Shipping Weight 29 lbs. **\$5.95**



G. E. 1,000 VOLT 350 MA DYNAMOTOR

NO. 213. An ideal dynamotor for mobile operation in taxicabs, police cars, sound systems and amateur stations. Supplies above voltage from 12 Volts or 500V. at 350 MA from 6 Volts. Complete with starting relay, and fuses. New. Our Dynamotor A. Shipping Weight 72 lbs. **\$5.95**

DM-36 DYNAMOTOR NO. 215. Western Electric 24 Volt input, 220V. or 60 MA out. With filter assembly. Shipping Weight 6 lbs. **\$2.95**

G.E. BC 306 ANTENNA TUNING UNIT



NO. 231. Matches any aerial to 150 Watt transmitter, used on BC 375. Brand new. Add postage for 20 lbs. **\$2.95**

W.E. BC 456 MODULATOR

NO. 217. Modulator from 274N command transmitters contains 3 husky relays, 3 tubes, VR150, 12J5 and 1625. Brand new. Add postage for 11 lbs. **\$3.95**



BE 77 TELETYPE TEST SET

NO. 218. Contains zero center volt-milliammeter, switches, relays, voltage divider resistors, neon indicator, etc. Excellent foundation for radio tester. Shipping Weight 10 lbs. **\$7.95**

BENDIX MN 20E DIRECTION FINDER LOOP

NO. 219. Ring type loop excellent for use on boat or aircraft. Extremely rugged construction. Low impedance manual type. Add postage for 8 lbs. **\$9.95 EACH**



LP 18C DIRECTION FINDER LOOP

NO. 220. Motor driven streamline pod type loop used on automatic direction finders. Has Selsyn transmitter and motor, fits most military direction finders. Add postage for 20 lbs. **\$14.50 EACH**



KIT SPECIALS

POTENTIOMETERS NO. 232. Kit of 10 excellent shaft type potentiometers good variety. **\$1.95**
SOCKETS NO. 233. Kit of 20 high quality sockets several different types. **\$1.00**

RCA NAVY COMMUNICATION RECEIVER

NO. 202. The last of these beautiful RCA sets. Covers 195 Kc. to 9.1 Mc. continuously. Supplied complete with tubes, control box, tuning unit, 24 Volt dynamotor, band change motor, plugs and circuit diagram. Superheterodyne circuit covers aircraft, broadcast, short wave, marine, foreign broadcasts. Has sharp or broad I.F.'s B.F.O., etc. Shpg. Wt. 30 lbs. **\$29.50**



PE 125 TRANSMITTER POWER SUPPLY



NO. 223. Operates from 12 to 24 Volts and supplies 500 Volts at 160 MA. Extremely rugged construction used in Army tanks. Complete with fuses - relays - filters, etc. Ideal for boats. Shipping Weight 73 lbs. **\$12.95**

FM PUSH BUTTON TUNER

NO. 224. Brand new ten push button tuning assembly from Army FM receiver. Contains 4 gang 100 MMF silver plated tuning condensers. Add postage for 10 lbs. **\$2.50 EACH**



RG 8/U FLEXIBLE COAXIAL CABLE NO. 225. Standard television lead in 52 ohm. Any length up to 1,000 feet. Add for postage. **4¢ PER FOOT**

POWER TRANSFORMER Specials

NO. 226. Primary 117V. 60 cycle. Secondaries supply 746 V. CT at 220 MA, 6.3V. at 4.5 A., and 5V. at 4A. Will handle 13 tube radio receivers. Supply is limited, order early. Shipping Weight 11 lbs. each. **\$3.95 . . . 3 for \$9.95**

OUTPUT TRANSFORMER

NO. 227. Push pull 6V6's to 6-8 ohm voice coil excellent characteristics. **3 for \$1.95**

TRANSFORMER TRANSFORMER

NO. 228. The transformer for Transmitter Power Supply, 600 Volt at 200 MA and 4 Amp. filaments of 3 to 24 Volts. Also 5 Volts at 4 amperes for rectifier. Shipping Weight 12 lbs. **\$9.50**

MILITARY POWER TRANSFORMERS

NO. 229. Convert your military receivers without rewiring the filament. "A" type supplies 500 VCT at 50 MA, 5V. at 2A. and 24V. at 1/2 A. "B" type supplies 500 VCT at 50 MA, 5V. at 2A. and 12V. at 1 Amp. State whether A or B type desired. Shipping Weight 4 lbs. **\$2.95**

HOME WORKSHOP GRINDER KIT

NO. 230. Easily assembled 110V AC or DC ball bearing fully enclosed motor from Army surplus dynamotor. Purchaser to make simple changes and shaft extensions, detailed instructions and all parts supplied. Motor approximately 5,000 R.P.M. Ideal for tool-post grinder, flexible shaft tool, model drill press, saw. Shipping Weight 6 lbs. **\$3.95**



HEARING AID HEADPHONES

NO. 216. The Army's best - eliminate flat ears and outside noise. Complete with transformer for conversion from low to high impedance. With cord and plug complete. Add postage for 1 lb. **\$1.00**

TELEVISION CONDENSERS

NO. 221. Tobe triple 2 MFD 4000 V.D.C. Filter used on Army radar. Ideal filter for H.V. television set. Add postage for 3 lbs. **\$3.95**
NO. 222. G.E. Pyranol capacitor 25 MFD 6000 V.D.C. Porcelain insulated, an outstanding buy for high voltage filters. Add postage for 3 lbs. **\$3.95**

HOW TO ORDER . . . GIVE PART NUMBER AND DESCRIPTION . . . ADD POSTAGE FOR WEIGHT SHOWN. NO ORDERS UNDER \$200 . . . WE WILL SHIP C.O.D.

The HEATH COMPANY
BENTON HARBOR 20, MICHIGAN

ELECTRONIC BARGAINS for EXPERIMENTERS and HOBBYISTS

ALL QUANTITIES LIMITED SUBJECT TO PRIOR SALES

STANCOR FILAMENT TRANSFORMER
 NO. 242. Heavy duty Stancor No. 5T355 supplies 5V at 6 Amps, 5V at 3 Amps and 5V at 3 Amps from 220V 60 Cy. primary or 1/2 above from 110V. Cased type. Ship. Wgt. 7 lbs. Each **\$1.50**

G.E. THYRATRON TRANSFORMER
 NO. 243. New G.E. Transformer supplies 2.5V at .100 KVA, has 3KV insulation 100V 60 cy. primary. Shipping Wgt. 13 lbs. Each **\$9.50**

RCA SATURABLE REACTOR TRANSFORMER
 NO. 246. New RCA No. CRV30531 AC current 750 MA DC current 2 Amperes. Rated 1.75 henries. Shipping Wgt. 4 lbs. Each **\$1.00**

12.6V POWER TRANSFORMER
 NO. 247. New cased 110 V 60 cy. Power Transformer. Supplies 440V Ct. at 60 MA, 6.3V at 2A. and 12.6V at 1 Amp. Excellent for military sets. Shipping Wgt. 6 lbs. Each **\$1.95**

RCA INPUT TRANSFORMER
 NO. 248. Heavy duty RCA No. CRV-30529. Input has primaries 600 to 200 and 25 ohms secondary 250,000 ohms C.T. Shipping Wgt. 2 lbs. Each **\$1.00**

REPLACEMENT POWER TRANSFORMER
 NO. 251. Excellent value transformers made by one of largest transformer companies. 110V 60 cy. Primary supplies 746 V Ct. at 150 MA. 5V at 4A and 6.3V at 4.5 Amps. Shipping Wgt. 7 lbs. Each **\$2.95**

FEDERAL POWER TRANSFORMER
 NO. 252. New cased 110V 60 cy. Power Transformer. Supplies 480V Ct at 50 MA and 6.3 V at 2.1 Amps. A beautiful transformer. Shipping Wgt. 4 lbs. Each **\$1.50**

HEAVY DUTY 6-12-24 VOLT VIBRATOR
 NO. 253. A husky vibrator used on army transmitter. Rated 30 amperes at 6 Volts 220 cycle with contacts for 12 and 24 Volts. Synchronous type, has many industrial applications. Ship. Wgt. 3 lbs. Each **\$1.50**

4 CHANNEL PUSH BUTTON TUNER
 NO. 254. Permeability tuner from BC 728 containing RF, first detector, and oscillator coils. Covers 2 to 5 MC. Complete circuit diagram furnished. Shipping Wgt. 2 lbs. Each **\$2.50**

CONDENSER SPECIAL
 NO. 255. An ideal oil filled power supply filter used in army 16 tube unit, has 2.5, 2.5 and 5 MFD all at 600V D.C. rating. Shipping Wgt. 3 lbs. Each **\$1.50**

TELEVISION CONDENSER
 NO. 256. Aerovox Myval .05 MFD at 7500V. rating. Excellent television coupling condenser with mounting bracket. Shipping Wgt. 3 lbs. Each **\$3.50**

BC 746 TUNING UNIT
 NO. 257. Plug in transmitter tuning unit from army Walkie Talkie. Contains antenna and tank coils, tuning condenser, transmitting and receiving crystals. Ideal transmitter foundation. Shipping Wgt. 1 lb. Each **\$1.00**
 (Same as above except transmitter crystal in 80 meter amateur band. \$2.50 each)

T30 THROAT MICROPHONE
 NO. 258. Makes excellent contact microphone for musical instrument or vibration pick-up. Shipping Wgt. 1 lb. \$1.00 each
 Extension cord with switch far above **\$.50 each**

BRAND NEW ARMY AIR FORCE ASTROGRAPH

NO. 259. The case of this unit makes the finest tool and service kit ever designed. Ply-wood construction, 14 x 11 x 10" high, with 8 covered compartments in the bottom for repair parts, leather handle, steel reinforced covers, hinged lid. Also excellent as case for radio phonograph, movie projector, camera, shell case, fishing kit, picnic kit, etc. The astrograph itself, (which cost the government \$125.00) makes an excellent contact printer, and can be used for a foundation for enlarger, strip map holder, etc. The case alone worth twice the give-away price of **\$3.95**

AN27/ARNS ANTENNA
 NO. 260. Standard blind landing antenna system. Brand new in original crate. Ship. Wgt. 14 lbs. **\$9.50**

AS114/APT ANTENNA SYSTEM
 NO. 261. New blade type antenna complete with case assembly, in original carton. Shipping Wgt. 9 lbs. **\$7.50**

AS115/APT ANTENNA SYSTEM
 NO. 262. New blade type antenna complete with case assembly, in original carton. Ship. Wgt. 11 lbs. **\$7.50**

AT38A/APT RADAR ANTENNA
 NO. 263. New radar dome type antenna with mounting base and connections, in original carton. Ship. Wgt. 11 lbs. **\$14.50**

AN104A BLADE ANTENNA
 NO. 264. Standard blade antenna used on many military fighting planes with coaxial connection at base. Shipping Wgt. 3 lbs. **\$1.50**

BENDIX MT51C TRANSMITTER CONTROL BOX
 NO. 235. Contains channel switch, emission switch, send receive switch, power switch and indicators for Bendix aircraft transmitters. Ship. Wgt. 3 lbs. **\$5.50**

BC 670B REMOTE CONTROL BOX
 NO. 265. Motor starting control box has starting and stopping switch, indicator, cable and plug. Wooden case. Ship. Wgt. 6 lbs. Each **\$1.95**

BK 22 RELAY ASSEMBLY
 NO. 266. Used on SCR 269 Radio Compasses. Contains stepping and control relays - junction box of aluminum. Brand new. Ship. Wgt. 7 lbs. Each **\$3.95**

HEINEMANN CIRCUIT BREAKER
 NO. 267. Heavy duty type 7 Amp. 24 Volt D.C. Many uses around shop. Shipping Wgt. 2 lbs. Each **\$1.00**

CUTLER HAMMER MOTOR FIELD CONTROL
 NO. 285. Rated 10 ohms. 3.2 Amps. Maximum. 6 1/2" diameter with knob and mounting feet, can be used to regulate generator output voltage. Shipping Wgt. 5 lbs. Each **\$2.50**

PENN THERMO RELAY
 NO. 268. Thermo Relay with a range of 45° to 100° complete with 5 Ft. flexible cable to immersion bulb. Shipping Wgt. 6 lbs. **\$3.50**

B & W 11 to 14 MC TANK COIL
 NO. 281. Plug in type used on BC 610 Transmitter. New, original cartons. Shipping Wgt. 2 lbs. Each **\$1.50**

DM 64A 12 VOLT DYNAMOTOR
 NO. 269. Input 12V at 5 Amps. Output 275 Volt 150 MA. New. Shipping Wgt. 7 lbs. Each **\$5.50**

DM 32A COMMAND SET DYNAMOTOR
 NO. 270. Part of 274N Command Receivers. Input 28 Volts, output 250V at 60 MA. Shipping Wgt. 4 lbs. Each **\$5.50**

DM 21 12 VOLT DYNAMOTOR
 NO. 271. Used in Army BC 312 Communication Receiver. Input 12 Volts at 3.3 Amps. Output 235 Volts at 90 MA. New, original cartons. Shipping Wgt. 8 lbs. Each **\$5.50**

PE94C SCR 522 POWER SUPPLY
 NO. 272. Complete dynamotor power supply for the SCR 522, operates from 28 Volts. Complete with controls, filters, etc. Original carton. Shipping Wgt. 34 lbs. Each **\$8.75**

PE101C BC645 POWER SUPPLY
 NO. 273. Complete power supply for BC 645. Operates from 12 or 24 Volts. Supplies both AC and DC required. Shipping Wgt. 13 lbs. Each **\$3.95**

DM 35 12 VOLT DYNAMOTOR
 NO. 274. New input 12 Volt at 18.7 Amperes. Supplies 675V at 275 MA or 1/2 above voltage from 6 volts. Excellent for auto use. Shipping Wgt. 11 lbs. Each **\$7.50**

PE 86 DYNAMOTOR
 NO. 214. A popular 28 Volt receiver dynamotor used on present military equipment. Supplies 250V at 60 MA. Shipping Wgt. 4 lbs. Each **\$5.50**

GN 58 HAND GENERATOR
 NO. 275. Makes excellent home lighting plant, operated by wind propeller, waterfall, gas engine, or hand crank. Reduction gear allows full output at slow speed; supplies 6 volts at 2.45 amp., 425 volts at .115 amp. New. Add postage for 28 lbs. Each **\$7.95**
 Handles for GN 58. \$.50 each
 Connecting cord for GN 58 with plugs CD1086. \$1.50 each

COLLINS AUTOTUNE CONTROL HEAD
 NO. 278. Brand new controls used on the ART/13, 100 Watt, Transmitter. Types 7, 8, 10, and 11 available. Get a spare while available as new cost is over \$22.00 each. Shipping Wgt. 3 lbs. Price any type (mention when ordering). Each **\$4.50**

MC 432 VHF ANTENNA LOADING UNIT
 NO. 279. Contains 2 pole, 5 position rotary switch with silver ceramic variable condensers, and coils for matching VHF Transmitter to AN109 antenna with 50 ohm line. Many useful parts. Shipping Wgt. 2 lbs. Each **\$1.50**

148 OUTDOOR TELEGRAPH KEY
 NO. 280. Rugged enclosed type for outdoor use, built for army to withstand hard usage. Complete with card and PL55 plug. Shipping Wgt. 2 lbs. Each **\$2.00**

ONE KILOWATT ADJUSTABLE ANTENNA LOADING COIL
 NO. 282. Huge porcelain coil 4" diameter 8 1/4" long, has 5 sliders for adjustments. Shipping Wgt. 5 lbs. **\$3.50**

300 MA SELENIUM RECTIFIERS
 NO. 209. Rated 300 MA at 36 Volts, complete with mounting brackets. Shipping Wgt. 1 lb. **3 FOR \$1.00**

DUAL SELENIUM RECTIFIER
 NO. 283. Two units mounted on single bracket, each section rated 15V. at 1/2 Amp. Shipping Wgt. 1 lb. **2 FOR \$1.00**

HOW TO ORDER • • • GIVE PART NUMBER AND DESCRIPTION • • • ADD POSTAGE FOR WEIGHT SHOWN. NO ORDERS UNDER \$2.00 • • • WE WILL SHIP C.O.D.

The HEATH COMPANY
 BENTON HARBOR 20, MICHIGAN

WHY BUY OVERHEAD?

START 1949 THE "SENCO WAY"

For low prices . . . for high quality . . . for immediate service go the "Senco Way"! Our policy of eliminating all unnecessary expenses enables us to pass along large savings to you.

THOUSANDS OF TUBES!

ALL BRAND NEW! R.M.A. GUARANTEE!
Immediate Delivery! Individually Cartoned!

Type	Each	Each	Type	Each	Each
024	69	59	6VSG	59	49
1A3	45	39	6V6GT/G	45	39
1CSGT	69	59	6W4GT	69	59
1D7G	69	59	6X5GT/G	49	39
1LC6	69	59	7A4	53	43
1LD5	69	59	7A7	59	49
1LH4	69	59	7B6	49	44
1LN5	69	59	7B8	69	59
1Q5GT	55	49	7C5	55	49
1R4	69	59	7F8	61	54
1R5	55	49	7J7	54	49
1S5	59	55	7N7	49	44
1T4	69	55	7Q7	69	59
1U4	49	39	7X7 (XXFM)	44	35
1U5	36	30	7Y4	44	35
IV	45	39	12A	79	69
2A5	54	43	12A6	29	25
2A6	45	35	12A8GT	35	28
2A7	32	25	12AT6	50	45
2X2/879	35	29	12AT7	69	59
3A4	49	39	12AU6	65	55
3B7/1291	59	49	12BA6	50	45
3Q5	55	49	12BE6	50	45
3S4	55	45	12F5GT	35	27
3V4	79	69	12H6	39	34
5U4G	50	40	12J5GT	25	19
5W4GT	39	34	12J7GT	45	39
5X4G	39	35	12K8Y	35	25
5Y3G	42	37	12SA7GT/G	40	32
5Y3GT/G	40	33	12SC7/1634	49	39
5Z4	59	49	12SF5GT	40	32
6A7	50	45	12SG7	55	45
6AC5	69	59	12SJ7GT	55	49
6AC7/1852	65	60	12SK7GT/G	45	35
6AH6	49	39	12SL7	49	43
6AL5	49	38	12SN7	49	43
6AL7	69	59	12SQ7GT/G	40	32
6AN5	65	55	12SR7	35	32
6AQ6	59	55	14A7	65	55
6AQ7	65	59	14B6	59	49
6AT6	49	39	19T8	89	79
6AU6	49	39	24A	49	39
6BA6	49	39	25A6G	69	59
6BE4	49	38	25L6GT	55	45
6BG6G	99	89	25Z5	49	45
6BH6	79	69	25Z6GT/G	45	39
6BJ6	59	49	26	32	25
6B7G	55	49	27	49	44
6C4	29	25	32L7GT	52	48
6CSGT	40	35	35L6GT/G	45	39
6F6GT	45	39	35W4	43	40
6F7/VT70	39	29	35Y4	43	40
6H6GT/G	45	39	35ZSGT/G	43	39
6J5GT/G	45	39	35Z6G	43	39
6J7GT	42	38	36	35	29
6K6GT/G	45	39	42	47	41
6K7	55	45	45Z5	59	49
6K7G	50	41	46	59	49
6K7GT/G	49	39	50	1.49	99
6L5G	69	59	50B5	42	32
6N4	49	38	50L6GT	50	45
6P5GT	55	49	56	55	45
6R7GT	59	49	57	45	39
6S7G	49	45	58	45	39
6SA7GT/G	44	37	76	49	45
6S87	55	45	77	35	27
6SH7GT	40	32	78	49	39
6SJ7GT	44	37	80	40	38
6SK7GT/G	49	39	81	1.49	99
6SL7GT	49	47	82	69	59
6SN7GT	49	47	83V	79	69
6SQ7GT/G	44	37	84/6Z4	49	39
6SR7	43	36	85	49	45
6SS7	59	49	99V	35	25
6SV7	55	49	99X	35	25
6T8	89	79	117L7	52	48
6U5/6G5	69	59	117Z6GT/G	89	76
6U6GT	40	29	1231	39	29
6U7G	35	25	1644	29	19

Dividend of the Month!

TUNG SOL J.A.N. TYPE 39/44

Individually Boxed. Take advantage of this terrific saving now! ONLY 14c ea. 50 for \$5.00

OUTPUT 50L6 39c ea.
TRANSFORMERS 6V6 PUSH PULL 49c ea.

WRITE FOR OUR CATALOG!

MINIMUM ORDER \$1.00

WHEN ORDERING—Send 25% deposit for all C.O.D. Shipments. Include sufficient postage—excess will be refunded. Orders without postage will be shipped express collect. All prices F.O.B. New York City.



Stewart-Warner Corporation reports net earnings of \$2,609,725, or \$2.02 per share of capital stock, for the first nine months of 1948. The statement was unaudited and subject to year-end adjustments. In 1947, net earnings were \$1,938,851, or \$1.49 a share, for the first three quarters.

Sales for the first nine months of 1948 were \$55,993,599, down 1.6% when compared to sales of \$56,926,546 for the same period of last year. Sales for the third quarter of 1948 were \$18,124,114, up 8.2% over 1947 third-quarter sales of \$16,748,250.

Hallcrafters Company of Chicago announces that it will place on the market an automobile television set. The set will have a tamper-proof device which automatically cuts off the power when the car is in motion so that the driver will not be distracted from his job; however, a second unit not affected by the shut-off device can be installed in the back seat.

Sentinel Radio Corporation of Evanston, Ill., has announced the manufacture of a portable television set which can be carried from one room to another, to be plugged in wherever an a.c. outlet is available.

The Radio Parts and Electronic Equipment Conference and Show of 1949 will be held at the Stevens Hotel, Chicago, from May 17 to 20. The Show is sponsored by the Association of Electronic Parts & Equipment Manufacturers, The Sales Managers Club (Eastern Division), The Radio Manufacturers Association, The West Coast Electronic Manufacturers Association and The National Electronic Distributors Association.

RCA Communications, Inc., New York, announces that a new radiophoto circuit has been opened between Portugal and the United States. All types of pictorial matter will be transmitted over this circuit, linking New York and Lisbon.

Howard W. Sams & Company, Inc., Indianapolis, Ind., publisher of Photofact folders, reports that the first series of ten meetings on the West Coast, consisting of lectures on television installation and circuitry, has been held under the co-sponsorship of local distributors of Photofact publications.

Over 4,000 radio technicians registered for these meetings to hear Mr. A. C. W. SAUNDERS of the staff of Howard W. Sams & Company. A series of lectures on the same subject will be held in all major centers of the country during the fall and winter.

Stromberg-Carlson Company of Rochester, N. Y., has announced price raises on its radio and television receivers, to take effect immediately. The increases range from \$10 to \$55. The company stated that the price adjustments resulted from increases in the cost of materials and labor.

Westinghouse Home Radio Division of Mansfield, Ohio, announces the production of a new dual-speed record changer which will be able to play more than four hours of record music. Either conventional or long-playing Microgroove records can be used.

Emerson Radio & Phonograph Corporation of New York has just put on the market the lowest-priced FM set. It will retail at \$29.95. (See page 36.)

Tele-Video Corporation, Upper Darby, Pa., announces acquisition of two electronic products manufacturing companies as subsidiaries. They are Air-design, Inc. of Upper Darby, and Electronic Controls, Inc., East Orange, N. J.

Radio Corporation of America's consolidated statement of income for the third quarter of 1948 and the first nine months of the year, with comparative figures for the corresponding periods of 1947, has been issued by GENERAL DAVID SARNOFF, President and Chairman of the Board of RCA. It included earnings of subsidiaries.

Total gross income from all sources amounted to \$256,968,537 in the first nine months of 1948, compared with \$224,982,605 in the same period in 1947, an increase of \$31,985,932.

Net income, after all charges and taxes, was \$15,128,783 for the first nine months of 1948, compared with \$12,233,758 in 1947, an increase of \$2,895,025. After payment of preferred dividends, net earnings applicable to common stock for the first nine months of 1948 were 92¢ per share, compared with 71.1¢ per share in the first nine months of 1947.

Earnings of Admiral Corporation, Chicago, and its subsidiaries for the third fiscal quarter ending September 30, 1948, hit an all-time high despite vacation periods and steel shortages which were responsible for temporary shutdowns in several Admiral plants, according to ROSS D. SIRAGUSA, president.

Net sales for the third quarter totaled \$15,128,165, compared with \$11,120,436 for the corresponding period last year, an increase of 36%.

Electronic Sound Engineering Company of Chicago announces a Polyphonic Sound Store Broadcasting System, to be used in large stores, restaurants, industrial plants, bus stations, etc. A timer device automatically turns the set on and off and increases or decreases the volume, adjusting the output to the expected crowd at various hours.

The Solar Manufacturing Company, Paterson, N. J., has filed a petition in the United States District Court, to initiate proceedings under Chapter 11 of the Bankruptcy Act. Reporting a deficit of \$670,687 from its 1947 operations, the company proposes to submit a plan of debt arrangement with its creditors to make payment in full on a deferred basis.

NOW! The Famous \$500 Photofact TELEVISION COURSE in Book Form!

Previously available only to Photofact subscribers—now published to answer the insistent demand of the entire Radio Industry

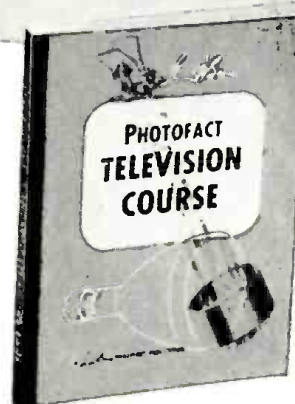

Now you can own the book that gives you a complete, clear understanding of modern TV principles, operation and practice. Previously available only in PHOTOFACT Folder Sets, this superb course has been bound in unified book form to meet an overwhelming demand from radio men in every branch of the industry. Written in clear, easy-to-follow language, profusely illustrated, packed with valuable up-to-the-minute data. Covers every phase of television—gives you the groundwork you must have to become a successful TV service technician. Bring your television knowledge up-to-date this easy, economical way. The PHOTOFACT Television Course is available at your jobber—order your copy today! Over 200 pages; fully illustrated; \$300 sturdy binding, 8½ x 11". Only..

A "Must" for Everyone in Radio!

NEW! 1948 Automatic Record Changer Manual

New Volume 2 covers 45 models made in 1948, including new LP and dual-speed changers, plus leading Wire and Tape recorders. It's easy to service record changers when you have the PHOTOFACT Record Changer Manual handy. Complete, accurate data—based on analysis of actual equipment. Gives full change cycle data, information on adjustments, hints and kinks, complete parts lists, exclusive "exploded" diagrams. Have this time-saving, money-making book in your shop. Over 400 pages; de luxe \$675 bound, 8½ x 11". Only.....

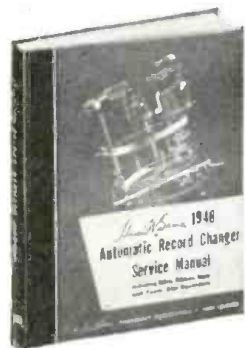

1947 EDITION. Volume 1, Automatic Record Changer Manual. Covers more than 40 different post-war changer models manufactured up to 1948. Includes full hard-to-get data on leading Wire, Ribbon, Tape and Paper Disc Recorders. 400 pages; fully illustrated; 8½ x 11", hard cover. Only.....\$4.95

NEW! Specialized Photofact Volumes



POST-WAR
**AUDIO
AMPLIFIERS**
and
Associated
Equipment

This is the book that's wanted by custom-builders, audio men and sound engineers. Covers a wide variety of well-known audio amplifiers and FM and AM tuners, plus data on important wire and tape recorders. Presents a complete analysis of each unit. A "must" for custom-installers and for sound service specialists. 352 pages; fully illustrated; in sturdy binding, 8½ x 11". Only..... \$395



POST-WAR
**COMMUNICATIONS
RECEIVER
MANUAL**

New! Invaluable to Amateurs and Short Wave Listeners. Complete technical analysis of more than 50 of the most popular communications sets on the market. An invaluable service aid, a perfect buying guide for purchasers of communications receivers. All data based on actual examination and study of each unit. 264 pages; profusely illustrated; durably bound, 8½ x 11". Only..... \$300



NEW! Photofact Volume 5

Latest addition to the famous PHOTOFACT Volume series—brings your file of post-war receiver service data right up to December 1948! Most accurate and complete radio data ever published—preferred and used daily by thousands of Radio Service Technicians. Everything you need for faster, more profitable servicing. Order Volume 5 today—keep ahead with PHOTOFACT—the only Radio Service data \$1839 that meets all your needs! In deluxe Binder...

- Vol. 5. Models from July 1, 1948 to Dec. 1, 1948
- Vol. 4. Models from Jan. 1, 1948 to July 1, 1948
- Vol. 3. Models from July 1, 1947 to Jan. 1, 1948
- Vol. 2. Models from Jan. 1, 1947 to July 1, 1947
- Vol. 1. All post-war models up to Jan. 1, 1947

FREE Photofact Cumulative Index

The easiest way to own the world's finest Radio Service Data is to subscribe regularly to PHOTOFACT Folder Sets. Send for the FREE Cumulative Index to PHOTOFACT Folders covering all post-war receivers up to the present. Helps you find the Folders you want in a jiffy. Get this FREE Index at your Jobber or write for it now.



ORDER THESE BOOKS FROM YOUR LOCAL JOBBER

Radio Industry Red Book

The RED BOOK tells you in one volume what you need to know about replacement parts for approximately 17,000 sets made from 1938 to 1948. Includes complete, accurate listings of all 9 major replacement components—not just one. Lists correct replacement parts made by 17 leading manufacturers—not just one. Covers original parts numbers, proper replacement numbers and valuable installation notes on: Capacitors, Transformers, Controls, IF's, Speakers, Vibrators, Phono-Cartridges. Plus—Tube and Dial Light data, and Battery replacement data. 448 pages, 8½ x 11", \$395 sewed binding. ONLY.....

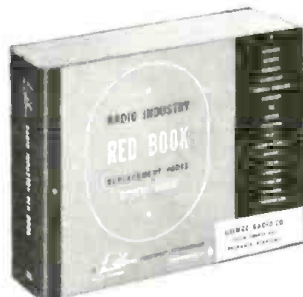

TUBE PLACEMENT GUIDE. Shows you exactly where to replace each tube in 5500 radio models, covering 1938 to 1947 receivers. Each tube layout is illustrated by a clear, accurate diagram. Saves time—eliminates risky hit-and-miss methods. 192 pages; handy index. ONLY..... \$1.25

DIAL CORD STRINGING GUIDE. The book that shows you the one right way to string a dial cord. Here, in one handy pocket-sized book, are all available dial cord diagrams covering over 2300 receivers, 1938 through 1946. Makes dial cord restringing jobs quick and simple. ONLY..... \$1.00

HOWARD W. **SAMS** & CO., INC.
INDIANAPOLIS 7, INDIANA

Which Do You Want?



Better Pay



A Nice Home



A New Car



Greater Security



Happy Vacations and Travel

Get Your FCC Ticket Jobs worth \$3,000 to \$7,500 are opening up right now for FCC Licensed Radiomen

Add Technical Training to Your Practical Experience and

Get Your FCC COMMERCIAL RADIO OPERATOR LICENSE in a Few Short Weeks



It's EASY if you use CIRE Simplified Training and Coaching AT HOME in SPARE TIME

Get your license easily and quickly and be ready for the \$3000 to \$7500 jobs that are open to ticket holders. CIRE training is the only planned course of coaching and training that leads directly to an FCC license.

YOUR FCC TICKET IS RECOGNIZED IN ALL RADIO FIELDS AS PROOF OF YOUR TECHNICAL ABILITY.

CIRE Graduates Find FCC License Pays Off

"Transmitter engineering is great, especially in the job I am on. Thanks again for all you have done, and you can take credit for the fact that my "ticket" is now posted on the wall of a 1000 watt broadcast station."

Student No. 3478N12

"I now hold ticket P-10-3787, and holding the license has helped me to obtain the type of job I've always dreamed of having. Yes, thanks to CIRE, I am now working for CAA as Radio Maintenance Technician, at a far better salary than I've ever had before. I am deeply grateful."

Student No. 3319N12

"I was issued license P-2-11188 on November 4. The next day I was signed on board a tanker as Radio Operator-Purser. Besides radio operating, I handle the payrolls, etc., which is all over-time and brings my monthly pay up to between \$500 and \$650."

Student No. 2355N12

CLEVELAND INSTITUTE OF RADIO ELECTRONICS
Desk RE-1, 4900 Euclid Building Cleveland 3, Ohio
Approved for Training under "G.I. Bill of Rights"

GET THIS AMAZING NEW BOOKLET

1. TELLS OF THOUSANDS OF BRAND-NEW, BETTER-PAYING RADIO JOBS NOW OPEN TO FCC LICENSE HOLDERS.
2. TELLS HOW YOU WILL BENEFIT BY HOLDING AN FCC COMMERCIAL LICENSE.
3. TELLS HOW YOU CAN GET YOUR FCC COMMERCIAL RADIO OPERATOR LICENSE IN A FEW SHORT WEEKS—EASILY AND QUICKLY, BY USING CIRE SIMPLIFIED TRAINING AND COACHING AT HOME IN YOUR SPARE TIME.
4. TELLS OF HUNDREDS OF OUR SUCCESSFUL STUDENTS WHO NOW HAVE LICENSES AND NEW, BETTER-PAYING JOBS.
5. TELLS HOW WE PREPARE YOU TO PASS THE NEW FCC COMMERCIAL LICENSE EXAMINATIONS, WHICH NOW INCLUDE FM AND TELEVISION.
6. TELLS HOW WE GUARANTEE TO TRAIN AND COACH YOU UNTIL YOU GET YOUR LICENSE.
7. TELLS HOW WE HELP YOU TO GET A BETTER-PAYING, LICENSED JOB, WITH OUR FREE AND EXCLUSIVE SERVICE, WHICH PREPARES AND MAELS YOUR EMPLOYMENT APPLICATION TO HUNDREDS OF EMPLOYERS, INCLUDING FM, AM AND TELEVISION BROADCAST STATIONS, RADIO MANUFACTURERS, POLICE RADIO STATIONS, AND RADIO-EQUIPPED TAXI, BUS AND PUBLIC UTILITY COMPANIES.



Get All 3 FREE Send Coupon Now!

CLEVELAND INSTITUTE OF RADIO ELECTRONICS
DESK RE-1, 4900 Euclid Bldg., Cleveland 3, Ohio
(Address to Desk No. to avoid delay)

I want to know how I can get my FCC ticket in a few short weeks by training at home in spare time. Send me your FREE booklet "Money Making FCC License Information", as well as a sample FCC-type exam and free booklet, "How to Pass FCC License Examination", (does not cover exams for Amateur License).

Name _____
Address _____
City _____ Zone _____ State _____

____ Veterans check for enrollment information under G. I. Bill.
NO OBLIGATION—NO SALESMEN

FUTURE TRANSISTOR USES

Transistors will play an increasingly important role in the future . . .

By HUGO GERNSBACK

WHEN we look back upon the humble crystal detector of the early radio days, long before the vacuum tube was invented, we must marvel at the spectacular comeback which it recently has staged in the form of the new *Transistor*.*

The crystal always was a fascinating device, the more because clear and strong signals could be obtained without either A or B batteries. This feature not only intrigued the experimenter, but the technician and scientist as well. It is therefore not too surprising that the new Transistor was evolved. A tremendous amount of work by the Bell Laboratory scientists went into its development. While the engineers have formulated a theory how the new device works, it is still too early to say just exactly what happens and why it works as it does. The explanation is a highly technical one and we will not review it here—simply for lack of space.

Those of our readers who are acquainted with some of our fanciful predictions—via our annual April Fool joke—will remember the “Crystron Lapel Radio” in the April, 1947, issue, which closely parallels the Transistor in many respects.

Like the Transistor the Crystron had a “grid.” It too used no A-battery, and in one instance a circuit was shown which also disposed of the B-battery entirely—a completely batteryless amplifying crystal device. Another fanciful diagram in the same article, labeled “A capacitive-grid crystal tube” probably came as close to the Transistor as anything published up to that date.

These remarks are not made to detract from the great work of the Bell engineers, but are made simply to show that when many people think along identical lines something is bound to evolve.

Inasmuch as the Transistor is an electronically operated device it would be interesting to know what happens, when and if someone applies a radioactive-tipped cat-whisker to the Transistor, as was suggested in the Crystron article in April 1947.

Will this be the avenue to the abolition of the high-tension B-battery voltage? It seems a foregone conclusion that at some time in the future the Transistor—or a similar allied device—may be evolved in which no outside voltage will be required.

Many questions are asked by our readers about the Transistor—the most common being: Will the Transistor supplant the vacuum tube *entirely*?

Personally we doubt it. There are too many uses for the present-day vacuum tube and wherever *power* is required the Transistor may not be able to compete with the vacuum tube. In high-power amplification, transmission, and many other instances the vacuum tube is likely to be dominant for many years to come.

Yet, it seems certain today that the new and revolutionary Transistor will supplant our present vacuum tube in many instances. Its development is so recent that it is difficult to foresee all its many uses. From our present knowledge it should not be too difficult to make certain prognostications based upon our knowledge of the radio art.

The Transistor is a radio and audio-frequency amplifying device paralleling its forerunner, the electronic tube. It differs from the latter in a most important point, in that

it does not require the usual A-battery. For this reason many appliances—particularly those where space and weight are at a premium—will be the ones that come under immediate consideration. These are chiefly hearing aids and vest pocket radio sets, both of which can now be made exceedingly small—thanks to the Transistor.

In a humorous-fanciful article in the April 1946 issue of *RADIO-CRAFT*, we predicted the “Radio Pen”—a radio set so small that it would take the shape of a somewhat large fountain pen. Such a radio set is now no longer so fanciful. Indeed, it would surprise us very much if one is not manufactured during the next few years.

Pocket recording instruments whereby voice or sounds may be recorded in an instrument small enough to slip into your pocket also now become possible.

For military purposes the Transistor will assume new proportions in equipping ground troops with small receiving instruments which weigh only a few ounces and therefore do not encumber the soldier with extra weight.

Proximity fuses already much in evidence in World War II—where small radio sets were embodied in the nose of a shell—can now be still further reduced in size and weight and be made much more efficient. It was the A-battery that was particularly troublesome in World War II proximity fuses.

Every aviation pilot prays for the day when he will be able to get radar into his plane to safeguard him from dreaded collisions with other planes, mountains, and building obstructions. Only the large size and great weight of present radar installations are in the way. The Transistor will certainly help to bring this achievement about in the near future.

One of our pet peeves for a long time has been the cumbersome microphone which actors, singers and speakers use on the stage, in cabarets and halls. Such a microphone which pops from beneath the stage—or the type with the heavy base, that must be lugged around—is totally unnecessary in this electronic age. These microphones constantly get in the actor's or speaker's way. If he steps away from the microphone the fading voice effect becomes grotesque.

In the future all this will be done away with. No longer will these unesthetic microphones be allowed on the stage or floor. Instead, half of the entire public address system will be carried by the actor or speaker. A concealed lapel microphone will be used, while a miniature radio transmitter weighing but a few ounces will be in his pocket. Now he *will be a walking broadcast station*. A pick-up wire underneath the stage or a metal strip underneath the rug or linoleum picks up the radio impulses and leads them to the public address system of the theater or hall. In this way the actor, speaker or singer will have free use of the hands with no cumbersome microphone to hide the face. He can walk anywhere on the stage or podium—he is no longer chained to a fixed mike. He will speak in a normal voice which will be broadcast from his pocket radio transmitter and sent out over the public address system of the auditorium.

These are just a few of the future uses of the Transistor. There are, of course, hundreds of others which will come about not only for personal use but also for the home, in the factory, in the stores, in the car—yes, and in television to reduce the size of our television receivers, too.

*See September, 1948, issue *RADIO-CRAFT*.

RADIO- CONTROLLED BUS

By M. GORDON MOSES



BUILDING radio-controlled models is perhaps the most fascinating, and certainly the most specialized, of model-making hobbies. Radio control is fairly commonly used by builders of model boats and airplanes, but it is seldom applied in model automobiles and similar vehicles.

This control system was developed for use in a model bus, but can be applied to almost any project where there is sufficient space and where weight is not an important factor. The control system, installed in a model bus 22 inches long and 9 inches high, enables it to perform many of the operations of a full-size bus. The operator can start, stop, reverse, turn the vehicle right or left, open and close the doors, operate the windshield wiper and stop signals, and turn lights on and off—all by radio.

The vehicle was assembled from a kit, such as is available at most hobby shops, for a *working-model* bus. Seats and other interior fittings were left out to provide space for the control mechanism.

The Control Circuit

The control system consists basically of a 6-meter transmitter and receiver. The transmitter (Fig. 1), using a 3A5

push-pull oscillator, is small enough to be held in the operator's hand. The receiver, a superregenerator using an RK-61 with a 10,000-ohm sensitive relay in its plate circuit, is in the bus. The circuit is illustrated in Fig. 2.

The heart of the control system is a special, motor-driven, 2-circuit, 12-point selector switch. Its contacts are arranged in concentric circles. The movable arms are on a piece of insulated material mounted on the shaft of the motor. Concentric circles and wiping

contacts provide a continuous circuit to the arms of the switch. The switch is shown in the photographs and in Fig. 3. The outer ring and the inner circle of contacts control colored indicator lights atop the bus so the operator can tell the position of the switch arm. The inner ring and the outer circle of contacts handle the various controls.

The master control circuit is shown in Fig. 4. When the transmitter key is closed, the plate current of the RK-61 in the receiver decreases and the sensitive relay RY1 closes the circuit to the power relay RY2. This completes the circuit to the selector motor, which continues to turn as long as the transmitting key is pressed. The operator knows the position of the rotating selector switch by watching the lamp indicators atop the bus. If the selector is stopped in the FORWARD position, solenoid SD1 pulls the forward-reverse switch S1 to the forward position, connecting the battery B2 to the driving motor so that it propels the bus for-

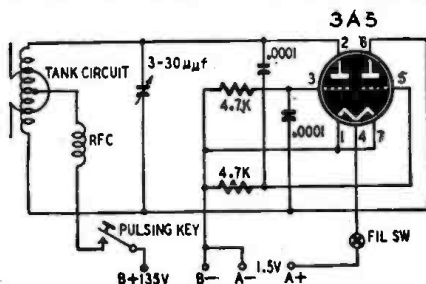

Fig. 1—Simple transmitter controls the bus.

ward. The motor is connected to the rear axle with 1 to 1 gears. The bus will continue to run forward until the selector is turned to REVERSE.

Setting the selector at LIGHTS ON causes solenoid SD3 to pull S2 toward it, closing the circuit between the 3-volt battery, the headlights, and running lights. When the selector is stopped at LIGHTS OFF, SD4 pulls S2 toward itself, opening the light circuit. To perform other operations with the lights on, al-

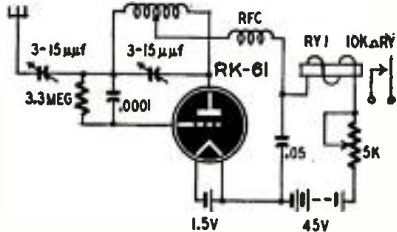

Fig. 2—The receiver is a superregenerator.

low the selector to pass over LIGHTS OFF without stopping. This is possible because the current to operate the solenoids is taken from B1 through the normally closed contacts on RY2.

The doors are opened independently by solenoids and closed by return springs when the selector is moved to another position. When either door is opened, the return spring contacts two metal strips and closes the circuit to the stop- and well-light circuits. The lights go out when the doors close. The construction of the door-opening mechanism and lighting circuit is shown in Figs. 5 and 6.

A bell and buzzer simulating the "getting-off" signals that passengers give the driver are powered by a 3-volt battery. The circuit is completed through RY2 when the selector switch comes to rest on BELL or BUZZER.

The windshield wiper uses a solenoid SD6, a return spring, and a thermostatic switch S3 to provide a slow reciprocating action. Current from B1 heats the bimetallic element, causing it to bend and open the heating circuit and close the circuit between the solenoid and the battery. SD6 pulls the windshield wiper in one direction. When the bimetallic element cools, it again closes the circuit to the heating element and the spring returns the wiper to its normal position. The cycle repeats as long as the selector is set on WINDSHIELD WIPER.

Steering is controlled by a 22½-volt motor geared to the front axle as shown in Fig. 7. When the axle is turned approximately 30 degrees to right or left, the steering motor is cut off by limit switches, as shown in Figs. 7 and 4. The wheels can be stopped in any intermediate position by moving the selector to a new position before the circuit is opened by the limit switches. The circuit is wired through RY3 so the motor normally turns to the right. RY3 reverses the circuit for a left turn.

Turn indicators are connected to blink when a turn is being made. Fig. 8 shows the connections to the blinker circuit. When the wheels are

turned to the right, the motor circuit is closed through the axle and contact A. Switch B closes the circuit to the right-hand indicators. This circuit is completed intermittently by the commutator and contacts E-E'. During a left-hand turn, the motor circuit is completed through the axle and C and the indicator circuit through D. The circuit is opened and closed by the commutator and contacts G-G'.

Two operations are required to reverse the bus: Set the selector to REVERSE. This causes SD2 to pull S1 toward it, reversing the connections between the driving motor and B2. In this position the circuit to the motor is completed through the auxiliary revers-

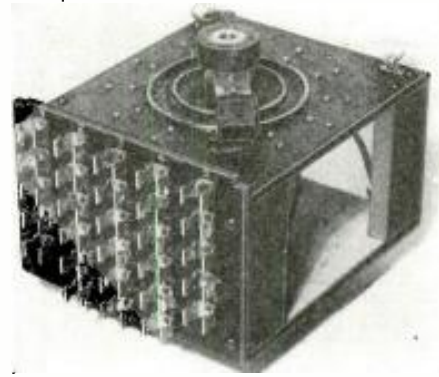

A motor drives this special selector switch.

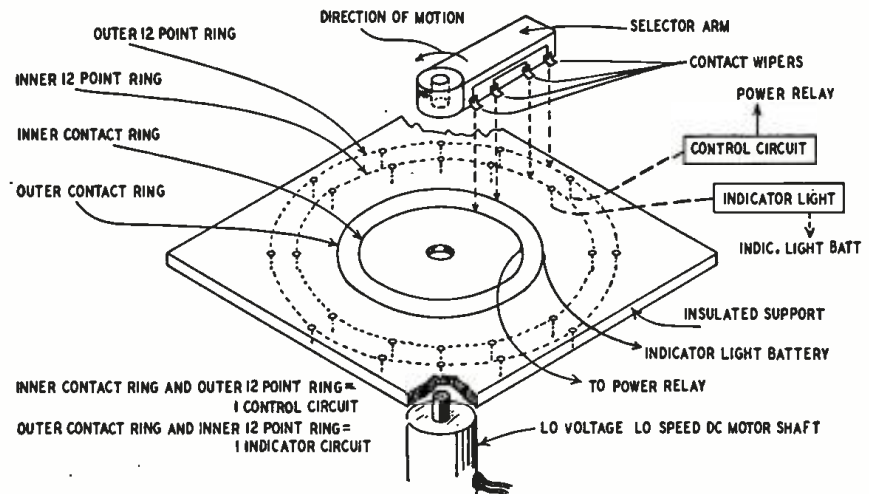

Fig. 3—This switch is the heart of the control system. View shows how it is constructed.

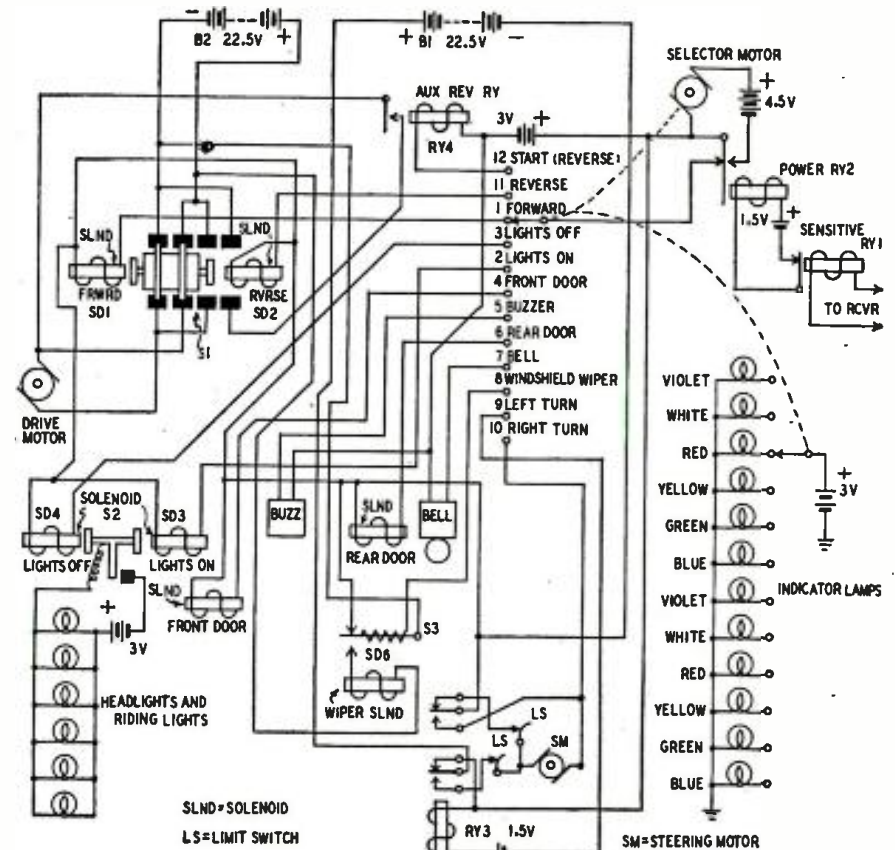

Fig. 4—The master control diagram. Other figures show the auxiliary actuating mechanisms.

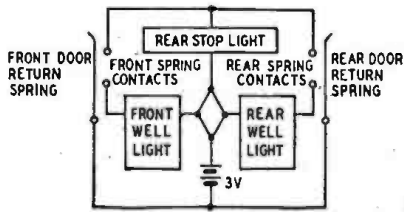

Fig. 5—Stop- and well-light wiring layout.

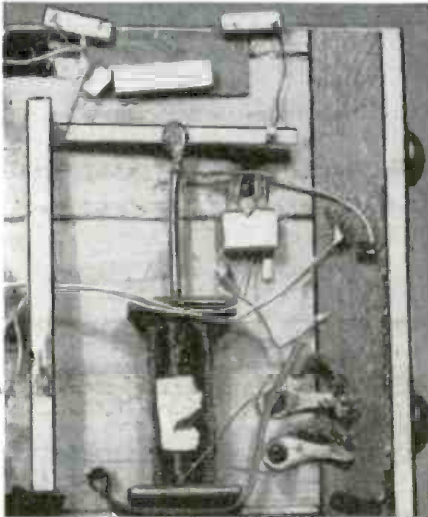
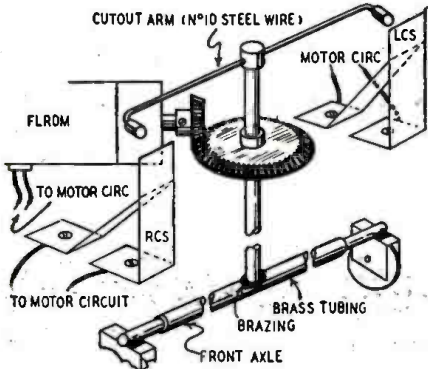

Fig. 6—Door solenoid and lighting switch.



FLRDM = FRONT LEFT-RIGHT DRIVE MOTOR
RCS = RIGHT CUTOUT SW LCS = LEFT CUTOUT SW
BOTH SWITCHES SPRING BRASS

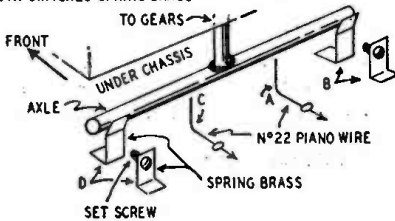

Fig. 7—Special switches operated by axle.

ing relay RY4. Moving the selector to REVERSE-START closes RY4 and completes the circuit to the motor. The bus is stopped by moving the selector to an intermediate position.

The construction of the reversing switch S1 can be seen in Fig. 9.

Many of the problems of construction are left to the ingenuity of the individual builder because of the particular problems of each project. Two types of solenoids were used in this model. Both types are wound with No. 28 enameled magnet wire on 3/32-inch inside diameter aluminum tubing. The door-oper-

ating solenoids are 1 1/2 inches long with enough wire added to give an over-all diameter of 1/2 inch. Those used to operate the windshield wiper, lights, and reversing switch are 5/8 inch long and wound to an over-all diameter of 3/8 inch. The cores are made of 1/16-inch soft iron rod. Steel machine screws are inserted in one end of the aluminum forms to adjust the pull of the solenoids. See Fig. 10 for construction details.

The steering, driving, and selector motors are 27 1/2-volt d.c. Alnico-field units rated at 250 r.p.m. The Delco type 5069600 driving motor runs at about 80 to 85 r.p.m. when loaded by the bus, which weighs about 9 1/2 pounds complete with batteries. The blinker motor is a Delco type 5068751, rated at 27 1/2 volts d.c. and 10,000 r.p.m. This unit turns at about 300 r.p.m. with a 3-volt battery. Both motors are available on the surplus market.

The thermostatic switch is made by the Lionel Train Corp. for use with automatic crossing signals.

Construction projects such as this one can be undertaken by anyone, although no radio-control system should be operated by anyone not holding an amateur radio operator's license.

A similar control system can be worked out by wired remote control, and the operator can control the power relay by inserting long flexible leads running to the operating position. Closing the circuit to RY2 by wire will give the same results as radio control.

Bill of Materials

Transmitter: 2—4,700-ohm, 1/2-watt resistors; 2—.0001-uf. mica capacitors; 1—3-30-uf trimmer; 1—u.h.f. choke or 35 turns No. 32 wire, close-wound on 1/4-inch low-loss form; 1—3A5; 1—6-meter tank coil (5 turns No. 14 with 1/2-inch inside diameter, turns spaced diameter of wire and center-tapped).
Receiver: 2—3-15-uf trimmers; 1—3.3-megohm, 1/2-watt resistor; 1—.0001-uf mica capacitor; 1—.05-uf, 150-volt paper capacitor; 1—5,000-ohm potentiometer; 1—10,000-ohm relay (with normally open contacts); 1—RK-61 tube, 1—u.h.f. choke or 35 turns No. 32 wire, close-wound on 1/4-inch form; 1—6-meter tank coil (10 turns No. 14 wire with 1/2-inch inside

diameter, spaced to 1/8 inch, tap near center, positioned for best results).
Model: 1—kit for working-model bus; 1—Lionel thermostatic switch; 1—buzzer, 1—bell; 3—27 1/2-volt d.c. Motors (Delco type 5069600); 1—27 1/2-volt d.c. motor (Delco type 5068751); 12—3-volt pilot lamps with sockets; 12—"grain of wheat" lamps; sockets; magnet wire; spring brass; assorted tubing; incidental hardware.

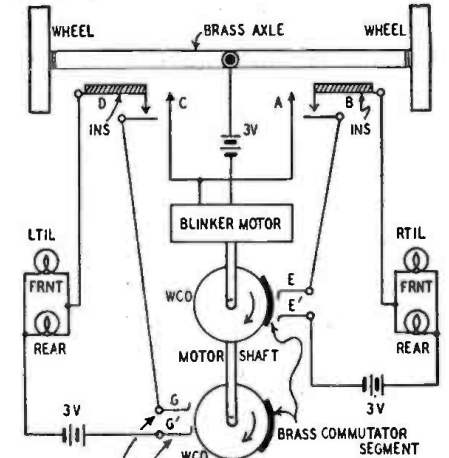

COMMUTATOR WIPERS (#28 BRASS WIRE)
INS=INSULATION ON AXLE SIDE (TAPE)
WCD=WOODEN COMMUTATOR DRUMS
LTIL - RTIL = LEFT AND RIGHT TURN INDICATOR LIGHTS

Fig. 8—Wiring of the turn-indicator circuit.

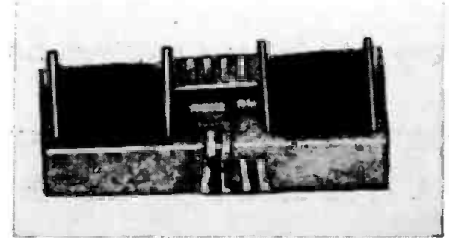

Fig. 9—Forward-Reverse switch and solenoids.

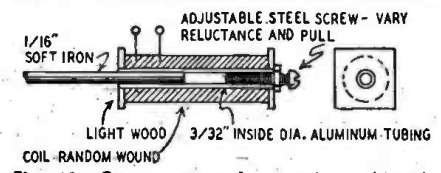
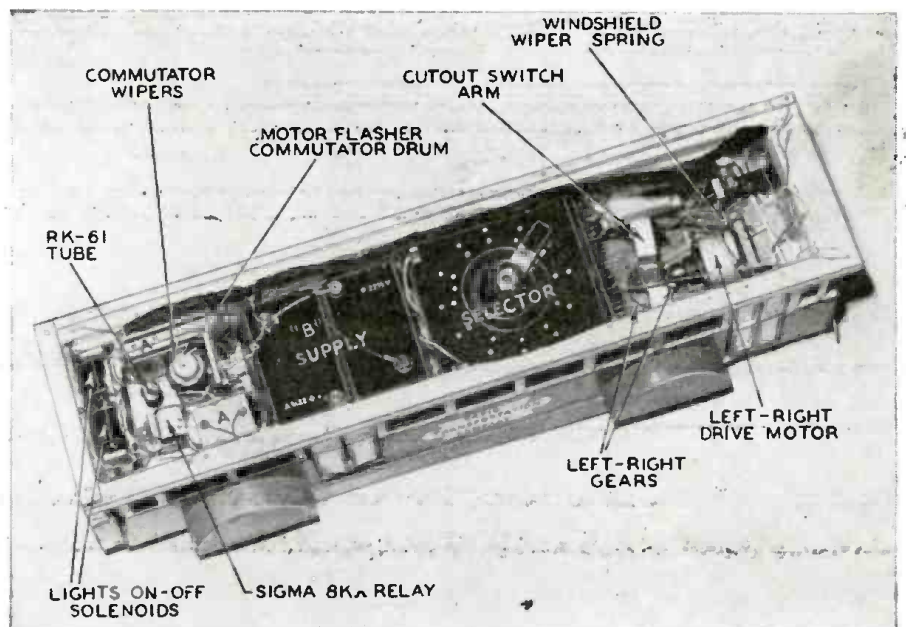
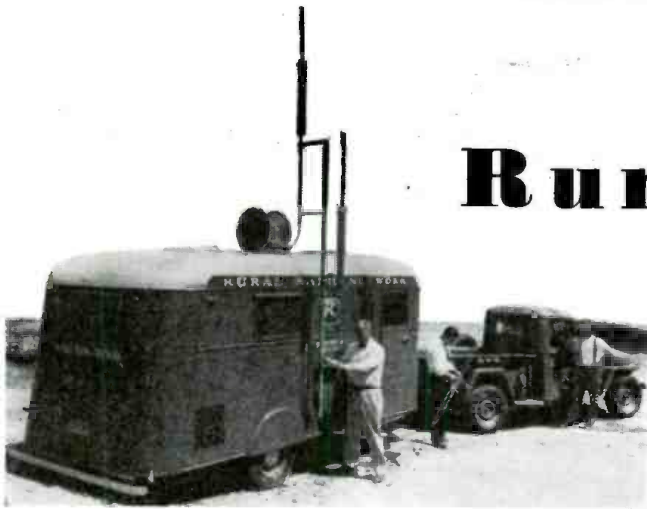

Fig. 10—Construction of actuating solenoids.



Top of the bus and indicator lamp leads are removed to show placement of the components.



Rural FM Radio Network

FM chain serves farmers

THE first cooperatively owned farmers' radio system in the world, the Rural Radio Network, serves 118,000 farms in upper New York State with programs, news, and reports especially designed and timed for farm families.

The network consists of six FM stations, wholly owned by ten farm organizations. Stations are linked only by radio. Sites for the transmitters were so chosen that each station would be able to receive the next one's signals, in addition to providing the desired local coverage. An affiliation with New York City's WGHF adds the facilities of a big-city outlet.

A mobile unit (above) originates programs from rural spots. Main origination point for most programs is Ithaca; a studio is shown below. In the control room is master-control equipment and

on the roof is the antenna (in circle) which beams signals from the ST-link transmitter (right photo) to the Ithaca transmitter, 9½ miles away. All transmitters are 250-watt units and resemble the one at bottom right.

A large service area is desired, and to that end the sponsors of the network had a special receiver designed for extra sensitivity. This was engineered by North American Philips and is being distributed to the listeners by the co-operatives whose members own the broadcast stations.

Farmers of other states are observing methods and results of RRN.

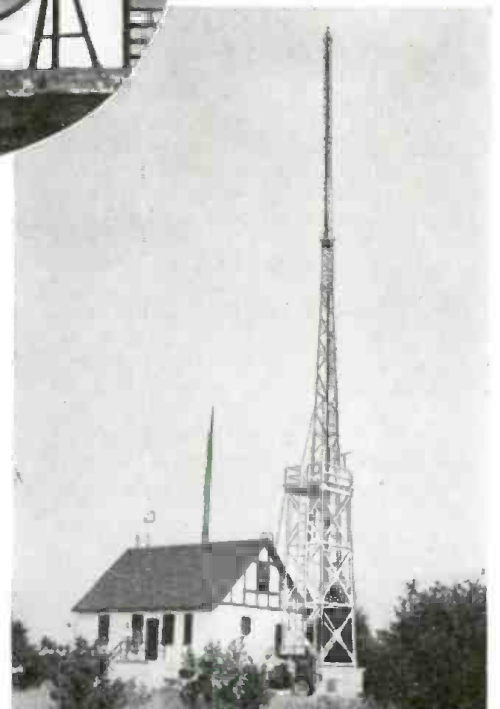
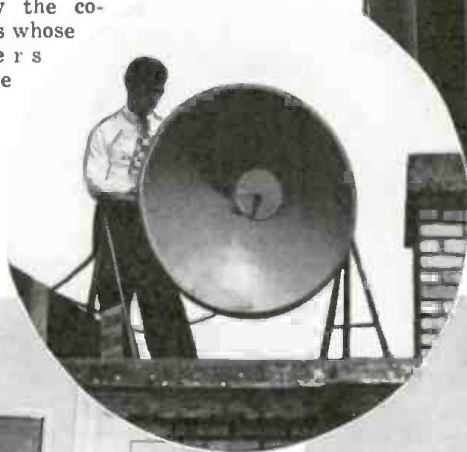

RRN broadcasters originate programs in Ithaca studio (left), through the window of which Ithaca master control room can be seen. Station engineer tunes the ST-link transmitter (upper right). Parabolic microwave antenna (circle) beams programs to the main Ithaca transmitter, thence to listeners in area. All RRN transmitter plants resemble the one shown at lower right. A weather vane is atop the antenna.

Antennas for Television

TELEVISION reception can be improved to a marked degree by correct installation of a well designed antenna. A good antenna system will do much to reduce snow effect, ghosts, poor contrast, and other picture defects which detract from the enjoyment of television programs.

Most present TV aerials fail to take advantage of the high gain which can be achieved by utilizing fully the properties of transmission lines and orientation and propagation characteristics. This can be traced directly to the misinformation and contradictory theories which daily confront the television repairman. To add to his confusion, his own experience with antennas seems to indicate that almost all he has been told is unreliable and cannot be depended upon to give predictable performance. Too often he runs across instances where the same antennas and receivers in adjacent homes give far different results—yet one installation seems a duplicate of the other.

Eventually the television technician comes to the conclusion that time consumed in trying to sort out all the conflicting ideas on television antennas is just wasted energy. In consequence he is firmly convinced that results are haphazard and uncontrollable. He chooses an antenna which seems to give fairly good results in most places, and makes that model his standard installation. If results are below what they should be, he feels that it is a matter of locality and nothing can be done about it.

To clarify this situation, the authors undertook an exhaustive investigation of every typical television antenna in common use. Experimental antennas, arrays, and transmission lines were set up to affirm or disapprove existing theories and ideas. Duplicate tests were made in different localities, at both low and high signal levels. Propagation and terrain characteristics were checked to verify all findings fully.

Receivers with different input systems were also employed to get complete data concerning their effects on transmission lines and antenna sensitivity. Comparisons were made with dipoles, folded dipoles, stacked arrays,

*Television Instructors—Technical Institute, Temple University

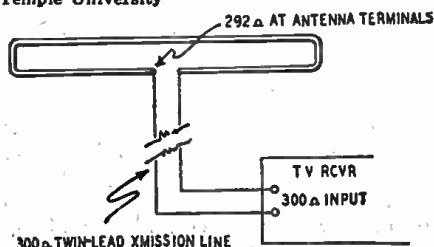

PART I

A simple and inexpensive way to boost signal input and cut down interference without using vacuum tubes or altering antennas

By EDWARD M. NOLL
and
MATT MANDL*

and reflectors, to note what difference each made in the received signal.

Originally it was intended merely to give practical proof of accepted theory by considering all the factors which might change reception under certain conditions. The results and observations, however, brought to light a number of startling factors completely unknown or ignored to date. Unorthodox methods for greatly increasing the received signal were evolved, and many pet theories long taken for granted were disproved.

Applied to typical installations, these procedures improved reception to a remarkable degree—contrast increased, interference and snow decreased, and fringe-area performance was brought to a level often comparable with that of better reception regions. In many instances improvement was over 10 db greater than that obtained with typical boosters.

To secure such results, changes must be made which differ radically from what is normally encountered in typical home installations. Full benefits are obtained only when consideration is given to each item along the line—receiver, transmission line, antenna, orientation, and propagation characteristics.

For instance, the accepted theory with regard to the popular twin-lead so much in use today is that this line represents an untuned or nonresonant transmission characteristic. As will be seen, this concept must be modified. Such a line has a characteristic impedance (Z_0) which results from the size of the two conductors, the spacing between them, and the dielectric constant of the insulating material. Most twin-

leads have a characteristic impedance of 300 ohms.

A transmission line will transfer a maximum amount of energy if it is terminated at each end in an impedance equal to Z_0 . A 300-ohm line, for instance, should be attached to a receiver whose impedance is 300 ohms. This line should also be attached to a 300-ohm antenna. This condition is approached with a folded dipole, which has a radiation resistance of about 292 ohms. (See diagram.)

Theoretically, a maximum of energy will be transmitted to the receiver and the transmission line can be of any length—though line loss does increase with length (300-ohm twin-lead has a loss of about 0.75 db per 100 feet).

In actual practice, however, this ideal condition is rarely achieved, and cutting the twin-lead to a random length may result in a considerable decrease in signal strength. In order to understand how this comes about and how to correct for it, a brief comparison between the twin-lead (untuned) and a resonant line is necessary.

A resonant (tuned) line should be some multiple of a quarter-wavelength long. Such a line, when open-circuited at one end, will not transmit or receive any energy. Radio waves sent along it will be reflected back to create standing waves.

Standing waves on a transmission line mean that there are voltage and current peaks standing along it, with a half-wavelength separation between each peak. The ratio of these voltage peaks to voltage nodes (low-voltage points) is the standing-wave ratio. When such a line is a multiple of a

RADIO-ELECTRONICS for

quarter-wavelength and is terminated in its characteristic impedance, all of the energy sent through it is utilized. Under such an ideal condition there would be no reflected waves, and no standing waves. However, the farther the termination from the correct value, the greater the standing-wave ratio. The same holds true if the line is shorter or longer than a multiple of a quarter-wavelength, since this will add capacitance or inductance to a line which is supposed to be purely resistive.

In television receiver installations the preference is for untuned (non-resonant) transmission lines because of their simplicity. In such a line we shouldn't have to worry about length and our only consideration would be a proper match at each end. If, however, a mismatch occurs due to line characteristics or incorrect termination, standing waves develop. In such cases our twin-lead acts like a resonant line which is either improperly matched or not cut to the right length. When this happens, signal intensity is decreased enormously because much of the energy is reflected instead of being absorbed by the input system of the receiver.

Thus, it can readily be seen how important it is that the nonresonant twin-lead act in the manner it should—that is, like an untuned line having no standing waves. Actually, however, this is never achieved when using any of the standard types available at the present time. Of the numerous installations checked by the authors, it was found that in every instance there definitely were standing waves on the line.

If the line happened to be cut near a multiple of a quarter-wavelength long for a certain channel, reception was fairly good and the standing-wave ratio low; but it still acted very much like a resonant line.

A simple and quick method for checking the presence of standing waves is to grasp the transmission line firmly at intervals of every 6 inches, with the receiver tuned to some channel between 7 and 13. If the line has a high unbalance, the picture will get dimmer when the hand is in some places and brighter when in others. If the line happens to be close to a multiple of a quarter-wavelength, the results will not be so pronounced but will still be evident.

If the contrast is decreased until the picture is barely visible and the line is held with the hand at a place where it results in signal *increase*, the difference will be more noticeable, because on highly unbalanced lines it will bring the picture up to almost normal contrast.

This can be rechecked at high signal level. Advance the contrast control until the picture is just on the verge of tearing. Now grasp the twin-lead at a place previously determined for signal increase; the picture will tear, showing much greater signal input to the receiver. (Excessive signal will tear the picture if the gain of the i.f. stages has

been increased to a high level by adjustment of the contrast control.)

On the lower channels the spacing between high and low points along the lines will be correspondingly greater, due to the longer wavelength. However, since some channels are harmonically related, an adjustment of this standing-wave condition often results in improvement for several channels.

Several methods of minimizing standing waves result in a much better signal and a reduction of the snow effect on weak stations. Because the maximum results are realized when adjusting for a certain channel, it is best to correct for the weakest station. Thus, if channel 10 is not received well, the twin-lead can be adjusted to favor this station and bring its level up.

The procedures used to aid reception are based on the fact that the line is actually resonant. When there are standing waves on a transmission line, reflections along the line begin at the termination (television receiver input) because the antenna acts as the generator of the signal and the receiver as the energy-consuming device. If all the energy is not utilized by the receiver, some is sent back along the line to the generator (antenna) with resultant standing waves. If the line is not a multiple of a quarter-wavelength, not all the energy will be utilized. Remem-

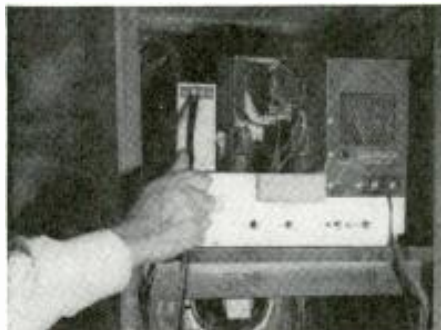

Grasp line and note whether picture changes.

ber that we are dealing with a resonant line, despite the fact that it was originally designed to be nonresonant.

The only way to match a resonant line is to make it a multiple of a quarter-wavelength—despite the apparent 300-ohm match at receiver and antenna.

Any one of several methods can be utilized to tune the line for maximum reception. A small variable capacitor can be placed across the twin-lead at the antenna posts of the receiver, and the capacitance adjusted for maximum picture signal. Another method is to keep cutting small sections from the lead-in until the signal is at a maximum. The third, perhaps the most economical and convenient method, consists of adding a section of twin-lead to the line. This is attached right to the antenna posts of the receiver (see photo).

It is preferable to start with about 40 inches of line and cut off an inch or two at a time. Close the end of the line by twisting together a small section of the stranded conductors at the free end. This shorted stub will nullify the effects

of either inductance or capacitance present in the line and will aid in bringing it back to a pure resistance. As this condition is approached, there will be a decided change in the picture on the viewing tube.

Not only does the procedure materially aid picture signal, but it results in a decrease of noise because an approach to a perfect balance will eliminate the possibility of stray pickup in either conductor.

The inability of twin-lead to act as a truly nonresonant line is also caused by the composition of the dielectric used. Under tests in good signal areas, it was found that the line would pick up a station even when disconnected from an antenna and terminated in a 300-ohm resistor. With such a termination, no pickup should have been possible. When, however, it is properly cut and matched, it still remains the most simple and economical low-loss line for television and FM reception.

In the next article co-axial cable will be discussed and comparison will be made with twin-lead. Gain considerations will be analyzed and methods for improving signal strength given.

(Amateurs and others who deal with transmitters are familiar with the power-wasting effects of standing waves. However, most servicemen have never met them before, professionally. In view of the fact that twin-lead is never non-resonant, the importance of the material in this article cannot be over-emphasized.

The Editors, for example, were most interested to note that a very snowy picture on channel 13 could be greatly improved merely by sliding the hand down a portion of the transmission line until best picture point was found.

Television installation and service men might do well to carry with them several sections of line, each of a different length, shorted at one end and terminated in alligator clips at the other. Clipping these, one at a time, to the receiver would soon indicate what stub length is optimum. A permanent stub could then be cut.—*Editor*)

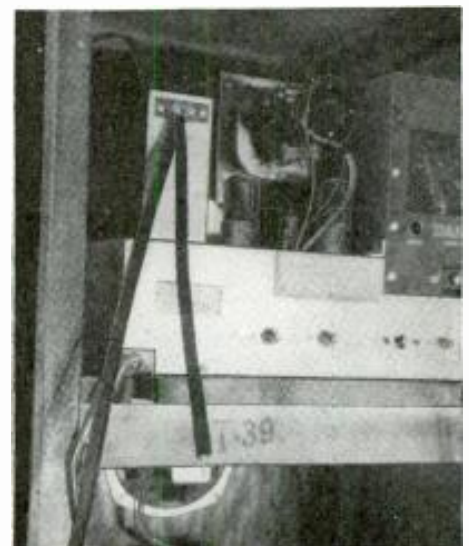

A stub of the correct length tunes the line.

HOW TO GET TELEVISION DX

Experimenters in fringe areas are picking up satisfactory television programs with the help of multiple boosters, very high antennas, and careful adjustment

By LYMAN E. GREENLEE



This Workshop Associates array, 90 feet in the air, is the antenna of Elmer Taflinger.

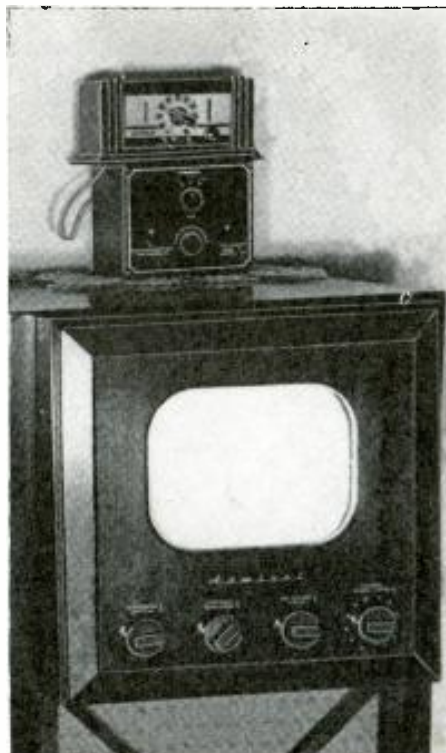

Multiple boosting is necessary for reception.

AROUND Indianapolis, Indiana, set owners are picking up TV programs from Chicago, about 190 airline miles away. Reception is, at times, equal to that from Cincinnati's WLWT, approximately 90 miles distant. Both pictures and sound are being received; although frequently the picture comes in without the audio, while at other times the video is lacking but sound is perfect. Inability to receive both sight and sound simultaneously is usually due to the narrow bandwidth resulting from the use of preselectors or boosters in series. Most marginal installations are using *two or three boosters in cascade* to build up the gain sufficiently to swing the video end of the receiver. Consequently, the bandwidth is often narrowed to the point where either the picture or the sound may be lost. Considerable care in peaking the boosters is necessary to avoid this difficulty, but it cannot be altogether avoided in marginal installations. One very good solution for the trouble is to use a separate receiver for the audio.

How good is reception?

TV set owners in the Indianapolis area are also reporting reception of signals from Milwaukee, St. Louis, Cleveland, and Detroit. There is often a lot of interference between stations on the same channel. Such interference is particularly bad between WLWT at Cincinnati and WBKB at Chicago, both stations being on channel 4. There are times when you get the picture from one transmitter and the audio from the other. At other times both pictures mix together to form a garbled mess; and, as reception conditions vary, the stronger signal is the one that predominates. Frequently we have seen a program suddenly shift from one station to the other with no adjustment of the controls on the TV receiver. Reflections from shifting cloud banks are particularly annoying and are probably responsible for such freak effects. They vary in direction and intensity from day to day and hour to hour. It is virtually impossible to eliminate entirely this type of interference. Rotation of the antenna is probably the best and most effective remedy. Often a stronger signal can be picked up by tuning to a reflection, but it is likely to be very erratic and difficult to hold.

All kinds of freak results can be expected in marginal areas—including some good reception that would almost lead you to believe the transmitter was about two blocks down the street. We have seen good, clear test patterns from WLWT (Cincinnati) when the weather was very hot and there was not a cloud in the sky—airline distance to the transmitter about 90 miles! Usually, however, results are better on a cloudy day with relatively high humidity such as occurs either before or after a thunder shower.

Most marginal installations are made in homes of people who know quite a lot about radio or electronics—amateurs, servicemen, engineers, and so on—but a surprising number of sets are being installed for professional people, such as doctors and lawyers. A few taverns have installed projection TV, even though the nearest transmitter is beyond the normal range of satisfactory reception. Since it has been the policy of set manufacturers in general to discourage marginal TV installations, most of the sets have been privately installed by their owners. Maintenance has been left entirely to the owners, and the manufacturer or distributor assumes no responsibility whatever for the results.

Are owners satisfied with their sets and with the reception they have been getting? The answer, surprisingly, is a very definite "yes." A few owners did not know what to expect, and they have been very much disappointed. They are the ones who were expecting to get pictures like home movies, something that just can't be done yet, at least not in marginal areas. Not all locations will give satisfactory reception, and an owner who installs a TV set in a particularly bad location may never be able to pick up a recognizable test pattern. Would-be viewers must be warned of possible complete failure, or unsuccessful installations will create bad will toward the installer.

Which is the best set?

The question is often asked: "What type or brand of television receiver should I purchase to get reasonably good reception in areas like this one, far from television broadcast stations?"

Any of the standard receivers now on the market will work in marginal areas if properly installed. Several kit

receivers have been as successful as standard makes. There is some difference in stability and performance between various sets; but, generally speaking, no special set is required for a marginal installation. Regardless of the type of set or make selected, it is very important to check it carefully (or to have it checked) to be sure it is properly aligned and in tip-top shape to deliver its maximum performance. Usually, the cheaper sets employing a minimum of tubes will require a larger input signal to drive the video channel successfully. If the location is in a low-noise area, the signal can be built up to the level required by any set on the market; but if there is noise and interference, that will also be amplified by the boosters and results will be unsatisfactory.

All marginal installations require the use of from one to three preamplifiers or booster stages. You can buy several good ones on the market, or one can be built. (See RADIO-ELECTRONICS, October, 1948, page 60, and November, 1948, page 48.) It is generally necessary to use two or three stages of preamplification. To avoid oscillation due to coupling, many users prefer to employ factory-made boosters in cascade. If trouble is encountered because of oscillation, instability, or failure to secure a tunable peak, it can often be corrected by making changes in the input or output lines. Of course, some boosters may be inherently unstable; in many cases it will be simpler to try another one when tracing down the source of trouble. Usually two different makes work better than two of the same make when connected in series because there is less chance for interaction between the two units.

Get a good antenna

To get any reception in a marginal area, you must bring the maximum signal into the set, so the antenna installation is the most important thing to consider. Several antenna systems now on the market give good results in marginal areas, and most users have preferred to buy a ready-cut antenna system. Decide what station you want to receive and then either get an antenna cut for that particular channel, or get one you can definitely tune to the desired channel. Properly spaced directors and reflectors are a necessity. Remember that straight dipoles have better directional characteristics than the folded types. Usually, a multiple array is the only answer to the problem of getting a signal into the set, and the only type of antenna that will give any usable results. The so-called "broadband" types that cover all channels are no good for use outside the line of sight of the transmitter. If the set is really far away from the transmitter, there will be trouble from all kinds of interference and stray noise pickup—automobile and airplane ignition systems, cloud reflections, static, random noise, tube noise—so the antenna must be tunable and highly directional to mini-

mize unwanted pickup and at the same time put the maximum signal into the TV receiver.

Get the antenna up as high as possible, preferably on a utility pole that is climbable or on a good pipe or fabricated mast that can be lowered for repairs and adjustments. The antenna *must be rotatable*, either by hand (turning the pipe column with a wrench) or with a motor. Keep the over-all height under 100 feet to avoid having to install a flasher beacon on top of the mast in compliance with CAA regulations.

Most marginal antenna installations run from 50 to 95 feet over-all height. It is important to get above trees and surrounding objects, but excessive height means increased length of transmission line, with increased losses. Use a minimum length of co-axial cable or transmission line to make the installation. Use co-ax for noisy locations and twin line for residential or country jobs. If a purchased antenna system is installed, directions for installation and matching to the set will be furnished. It is a good idea to do some experimenting when it comes to matching inputs; there is often a very great mismatch which results in a very poor transfer of signal. A little patient trial-and-error may make a big difference in the input signal. Keep the lead-in away from metal objects. Support it on a minimum of stand-off insulators and avoid sharp bends or turns.

Where to get a mast

For lightning protection, it is advisable either to ground the pipe mast or to run a separate ground wire to the top, as is done to protect utility poles. Follow the National Electric Code. Frequently your local power and light company will set a pole at a very reasonable price, as they have all the necessary equipment and can do the work in a minimum of time. You can mount your antenna on this pole, which is climbable and requires no guy wires for its support. Several marginal installations we visited had used this service with considerable satisfaction. Over a period of several years, such a pole should be a very good investment.

It takes a lot of work and patience to get a marginal installation to function properly. Do not expect consistently good pictures or uniform results. Television is here to stay, and it now appears that good reception may be possible at distances far beyond those at first established by the engineers as the maximum at which a satisfactory picture could be received.

After becoming thoroughly familiar with a particular setup, the operator can anticipate the times of best reception. Marginal TV is just beginning to open up on a national basis, and there are plenty of problems yet unsolved. Those who are now out on the fringe are having an unusual opportunity to assist in solving those problems by actually trying for reception under the varying atmospheric and climatic conditions encountered from day to day.

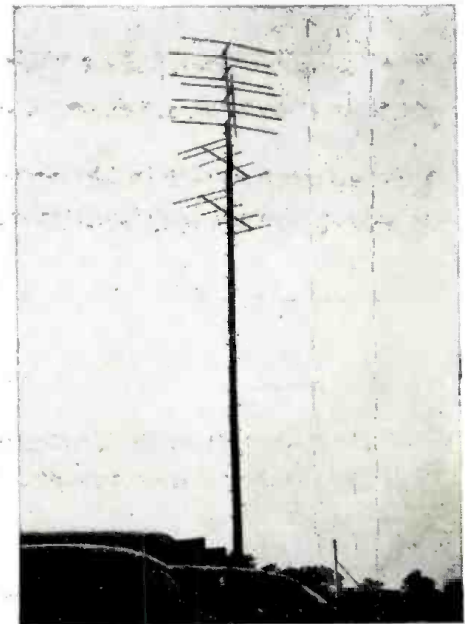

The upper array on this 90-foot-high mast is beamed on Cincinnati, lower toward Chicago.

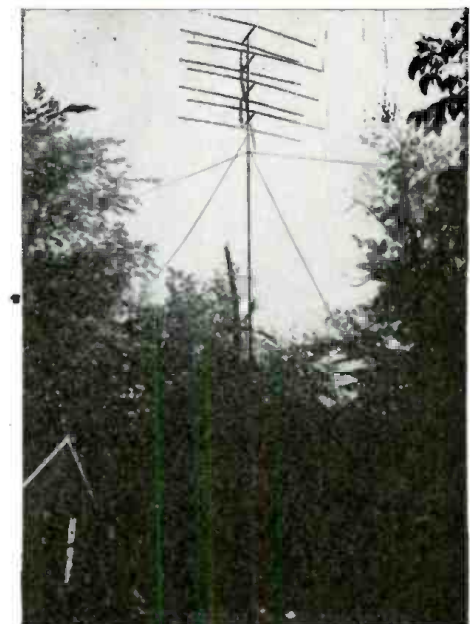
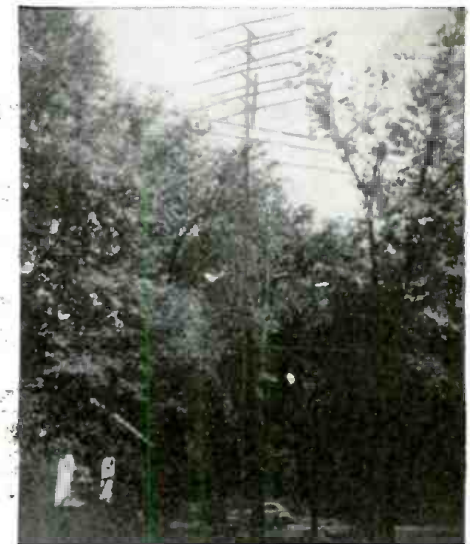

Two photos of another marginal installation.

CUSTOM-BUILT Projection Televisers

TELEVISION kits are becoming a new and important factor in the radio technician's life. Hampered in many cases by franchising systems, the kit is in many cases the wedge with which he can pry open the rich television field. The would-be televiewer buys his kit from the serviceman, who assembles and installs it for a fixed fee.

Advantages of the system are threefold. The kit manufacturer knows that his equipment will perform better if assembled and installed by a skilled technician than by even the cleverest amateur constructor. The customer has a wide range of choice in cabinet selection—or may even have his set built into a wall-space or an existing piece of furniture. And the servicing problem—doubly troublesome in kit-built receivers—is solved to the satisfaction of manufacturer, televiewer and serviceman.

Manufacturers are orienting themselves more and more toward the serviceman as television kits become more complex. Projection-type televisers, whose extra-high-voltage power supplies and optical systems add to the difficulties of the inexperienced constructor, are a natural for the skilled technician, and their manufacturers are not slow to realize it. Television Assembly Co., whose new projection job is the subject of this month's cover, is aiming

its sales efforts on the new model exclusively at radio servicemen. Other companies have been following a parallel course. This is a sharp break with former practices in television kit distribution.

The technician finds kits reasonably available, the public clamoring more and more for televisers, and the assembly work not too difficult. There are new problems, but they tend to follow definite patterns, and once licked in one receiver, are easily recognized and overcome in the next. If the radioman charges an assembly fee sufficient to meet these unexpected difficulties, he will find himself in a profitable as well as interesting field of radio work.

Among the alert radio technicians who have taken advantage of the opportunities in custom television assembly and installation are Irving Glassman and Leonard Mendelsohn, proprietors of Hi-Q Radio of Brooklyn, N. Y. The two partners appear in the photos at the bottom of the page, Glassman in the striped sweater and Mendelsohn in the white shirt. Organized a little less than two years ago, Hi-Q has assembled and installed more than 200 television sets, as well as numbers of special sound jobs. Specializing in custom-work, they welcome jobs out of the ordinary line, such as closet, wall, and fireplace television installations or special radio-

recording-television combinations to harmonize with fine furniture. Their slogan is: "Any cabinet or any installation."

Wiring up an ordinary kit, they find, takes a little more than a day, unless bugs are encountered. For this a fee of \$50 is charged the owner of the televiewer. This rate seems moderate, and is partly explained by the skill of the technicians, who are at home with practically any type of kit, and thus run into fewer difficulties than might be expected. It is certainly far less than the factor which must be charged to wiring in the price of a commercial televiewer.

The projection jobs were a trifle new at the time our photos were taken, but Glassman and Mendelsohn find that in spite of their greater size and complexity, they can be assembled in about 50% more time than the older direct-viewing kits. In the Television Assembly receiver, this is partly explained by the semi-ready condition of the kit, which has the front end (a Du Mont Inputuner), the i.f. strip, and the high-voltage power supply already wired. Fees for assembling projection receivers have not been fixed, but would probably run a little more than 50% higher than those charged for the small kits.

Assembly naturally leads to installation and servicing. The man who has put the set together is the logical one to repair it. Hi-Q makes a contract for installation and a year's servicing. The yearly contract rate of \$65—which includes installation and high- and low-frequency antennas with separate leads—represents a cut-to-the-bone figure due to the competitive situation in New York. The partners justify it on the basis that they can make money at that figure if they have more than 200 contracts, and that renewal service contracts will represent a greater margin of profit than original installations.

The partners have a strict cost-accounting system, and know that at present they have eight service calls per year per set, and that each call costs \$4.11, including all overhead. It is on this that they base their figure of a minimum of 200 contracts for a profitable business.

The example of Glassman and Mendelsohn is being followed—and is worth following—by radio technicians in all television areas. To repeat and emphasize what has previously been said: if the radioman charges enough to meet unexpected difficulties and reverses—as well as his straight labor—he will find an excellent new field in projection television kit assembly and installation.

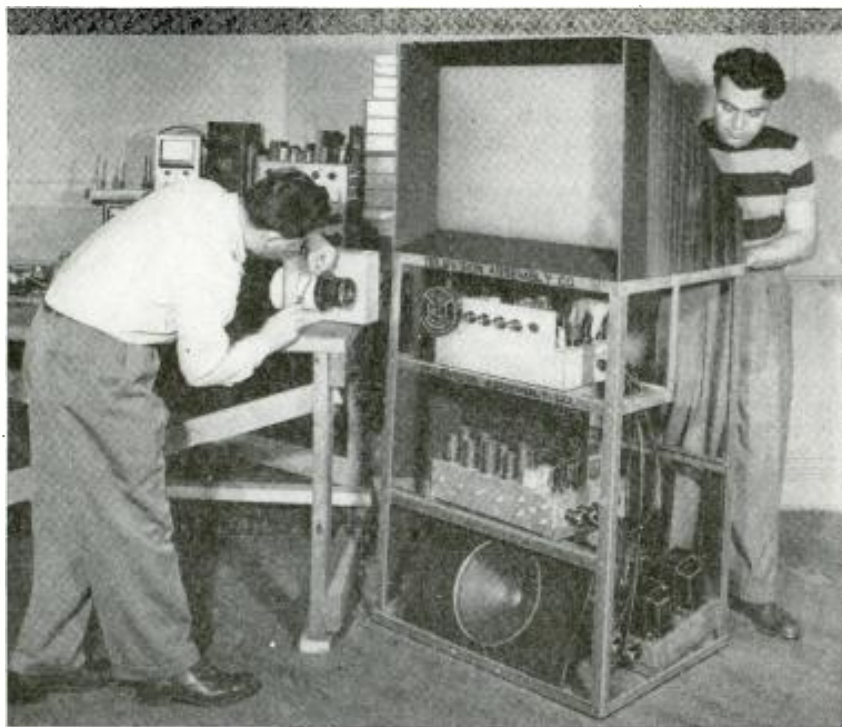

The Hi-Q partners, Glassman (in rear) and Mendelsohn (working on projection lens)

Pocket Micro-Receiver

By RICHARD HENRY

A NEW receiver put on the market by Micro-Electric Products, Inc., appears to be very near the smallest size possible for a three-tube set. Mounted in a brown plastic case approximately one-third larger than a standard package of cigarettes, the Micro receiver is even smaller than many hearing aids. Placed in a shirt pocket, it slips down out of sight, the only evidences of its existence being a slight bulge and the flesh-colored antenna and earphone wires.

Despite its miniature dimensions, the receiver contains three Raytheon sub-miniature tubes. CK512AX's are used as detector and first audio amplifier, and a CK522AX is in the output stage. The resistors and capacitors, as well as the output transformer, are miniature components, such as those used in hearing aids. As the photograph indicates, all the parts are mounted on a fiber chassis.

The circuit is a fairly standard regenerative. A departure from usual practice, however, is the tuning arrangement. The antenna, grid, and tickler coils are all wound on a single form. A powdered-iron core running through the form is terminated on a threaded rod bent at a right angle. This projects through a slot on the front of the case and a very small knob is screwed onto it. Sliding the knob up and down tunes the receiver.

There are calibration marks on the case but no numbers, presumably because, like all regenerators, the oscillator changes frequency so readily due to changes in the setting of the regeneration control and hand capacity that numbered marks would not be very helpful.

The tickler coil is not wound directly over one end of the tuning inductance in the usual manner. Part of it is spread out along the tuning coil to keep regeneration as even as possible over the whole tuning range.

The regeneration control is a miniature hearing-aid potentiometer. The knob projects slightly from the side of the case. The earphone, a crystal unit, is fitted with a clear plastic ear plug designed to fit the ear comfortably.

Considering the fact that the circuit is a simple regenerative, results are adequate, certainly unusual for the physical size. Distant (suburban) reception was very poor, but in downtown New York City there was satisfactory reception from several local stations with no antenna other than the 2½-foot clip-lead attached to the set. Clipping the

The Micro radio receiver as compared with a package of cigarettes. Earphone and its plug are in the foreground.



lead to a metal filing cabinet or typewriter brought in additional signals, although too good an antenna damaged reception because of the set's lack of selectivity.

One point concerning the receiver's mechanical arrangement is of interest. The tuning knob, as mentioned, slides up and down in a slot. The tension of the small spring placed under the panel is not sufficient to hold the tuner's setting at all times. When placed in a shirt pocket, for instance, the cloth rubs against the knob, detuning the set. Though it was not tried, replacing the

spring with a slightly longer one may cure this condition.

Anyone who is not used to a regenerative radio may have some trouble with this set. Critical regeneration control and body capacity both affect the receiver. These points will be quite familiar to the ham or shortwave experimenter, who will find operation quite simple.

The set is an interesting experiment in adapting old principles in new design. It remains to be seen whether the listener will accept a regenerative portable radio.

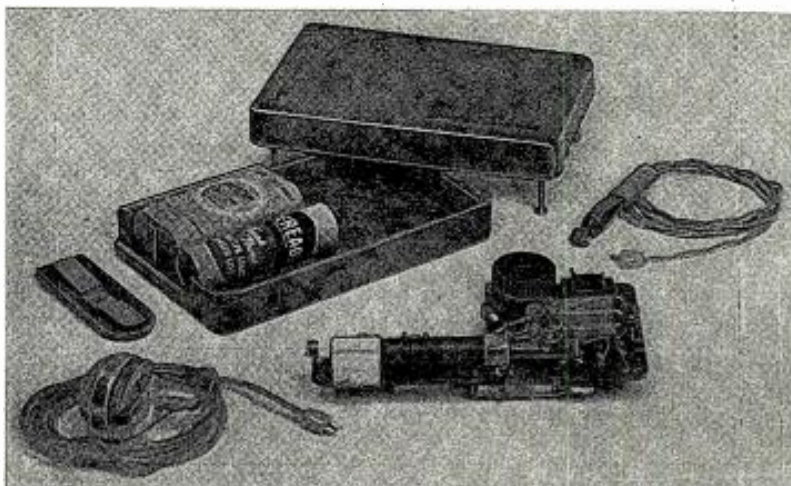

Exploded view reveals construction. The tuning slug is just ahead of the tubes.

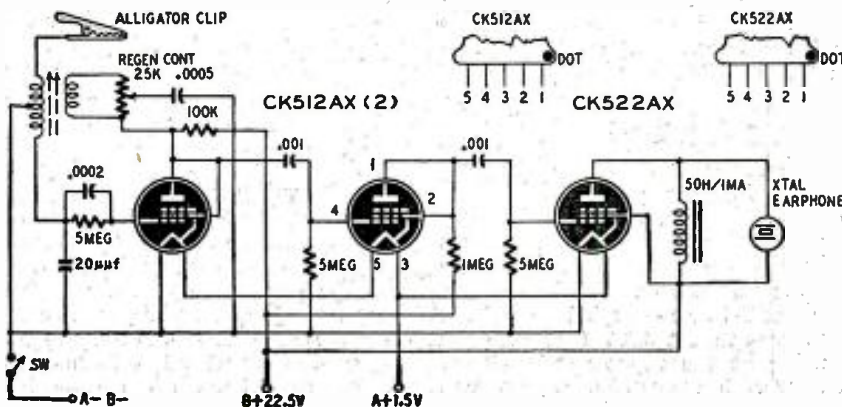

The schematic. Circuit is regenerative—using a shunt-fed tickler—with two audio stages.

Designing L-C Audio Filters

A nomogram eliminates all math in designing filters

By RICHARD H. DORF

WITH the two nomograms on page 33 you can design your own audio filters without tedious mathematical calculations. The nomograms are for the constant- k filter, a simple but effective type of L-C circuit. The cutoff slopes you will get with them will be almost as sharp as the ideals shown in Fig. 1, depending on the d.c. resistance of the coils you use. For sharpest cutoff use low-resistance coils.

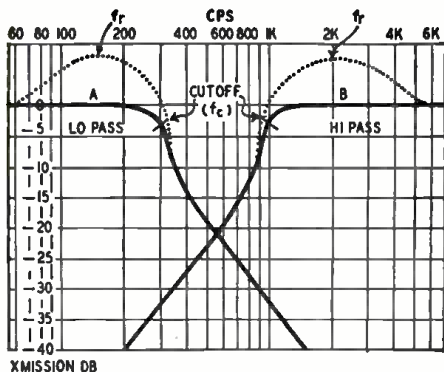

Fig. 1—Dotted lines show how response peaks if terminating resistance is high or absent.

To use the nomograms, first decide what kind of a filter you need. For a phonograph scratch filter, for instance, you might want a low-pass filter which would cut off at 6,000 cycles, leaving all lower frequencies practically untouched. Having decided on a fairly sharp cutoff, choose one of the full-section filters shown in Fig. 2. For a cutoff only half as steep as Fig. 1 indicates, you would choose a half-section, as in Fig. 3.

Either of the low-pass filters shown in Fig. 2-a, the T or pi, could be used, so you can decide on the basis of economy. A filter with only one choke being cheaper than one with two chokes, the pi filter would be selected.

First determine where the filter is to be placed. It could be in a low-impedance line if one is used, but suppose in this case you decide to place it in the amplifier between two tubes. The only important thing to know here is the resistance load the filter will face.

A filter will work with any load resistance as long as the resistance across the filter's input is equal to or greater than the output load. But it will work best when inserted in a line of uniform impedance—one terminated in the same resistance at both ends.

The resistance-coupled amplifier chart shows that a 6SJ7 (the tube you are using at the input to the filter) will work with a 100,000-ohm plate load resistor and a 100,000-ohm following

grid resistor. Because the plate resistance of the pentode is high, its shunting effect on the plate load resistor is negligible and the line between the 6SJ7 plate and the following grid is, in effect, a 100,000-ohm line. If a triode, such as the 6C5, were used with the same resistors, the low plate resistance shunting the plate resistor would bring the net resistance at the input of the filter down far below 100,000 ohms. The circuit is shown in Fig. 4.

To find the values for the coil and capacitors, find a straightedge (transparent plastic rulers with a black line down the center work best) and turn to Nomogram 1. The cutoff frequency you have decided on is 6,000 cycles, and the terminating resistance R (or the nominal impedance of the line) is 100,000 ohms. Place the straightedge, as shown by the dashed line, so that it touches 6,000 cycles in the f_c column and 100,000 ohms in the R column. Then read the value of L from the center scale. Since this is to be a low-pass filter, the calibrations at the right of the center column are used. The value found is 5 henries. Referring back to the original filter diagram in Fig. 2-a, note that the choke to be used is marked "L". Therefore, you assign 5 henries to L in Fig. 4.

To find the capacitances, use the same method with Nomogram 2. C , read again from the right center column, is approximately $.00055 \mu\text{f}$, or $550 \mu\mu\text{f}$.

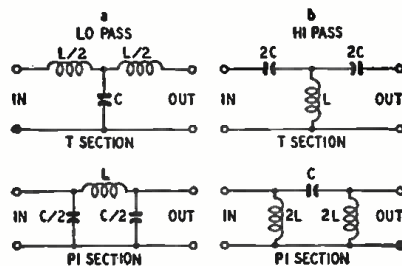

Fig. 2—These are basic constant- k filters.

However, the capacitors in the filter you are using (Fig. 2-a) are marked "C/2". Therefore you divide 550 by 2 and assign the value of $275 \mu\mu\text{f}$ to C_1 and C_2 in Fig. 4.

And there's your filter!

Constructing coils

The only real problem in making up filters is the inductors. Coils made for filter purposes can be obtained from transformer manufacturers; some even have an inductance which can be varied over a limited range. But these run to anywhere between \$5 and \$20 or more. A simpler and much less expensive solution is to dig into the junk-box for

old audio transformers and chokes.

To find a coil of a certain value, consult a resonance chart and choose a capacitor which will resonate with the desired coil at some audio frequency. For example, the 5-henry choke of Fig. 4 would resonate with a $.005\text{-}\mu\text{f}$ capacitor at 1,000 cycles. Try placing various

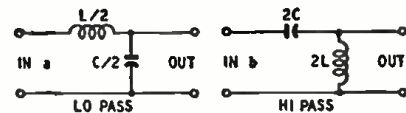

Fig. 3—Half-sections give less sharp cutoff.

coils in series with the capacitor across the output of an audio oscillator, with a vacuum-tube voltmeter also across the oscillator. Choose a coil which will cause the meter to dip at some frequency lower than the selected one (lower than 1,000 cycles, in this case). Then start removing core laminations or coil turns (or both) until the meter dip occurs at the desired frequency. To duplicate the conditions under which the coil will operate in the filter, it is a good idea to choose the same capacitors and resonant frequency for this trimming adjustment as will be used in the filter. The resonant frequency is one-half cutoff for a low-pass and twice cutoff for a high-pass filter. For that of Fig. 4, for instance, the 5-henry coil might be selected by placing it in series with $550 \mu\mu\text{f}$ and trimming for a meter dip at 3,000 cycles.

If it is possible, removing turns is the best plan, because the resistance of the coil will make the filter results depart somewhat from the ideal abrupt cutoff. Reducing the resistance by removing wire will raise the coil's Q and help lessen the effect.

If odd-value capacitors are specified, they can be made up by paralleling standard sizes. It should not be necessary to parallel more than two capacitors, since the greater precision obtained with more than two is not worth while.

After the filter is connected, it may be necessary to trim it slightly. This can be done by making further adjustments to the coil. If exact results are wanted, running a series of curves with an audio oscillator and output meter will show just what the filter does.

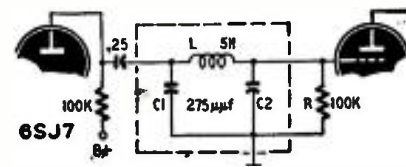
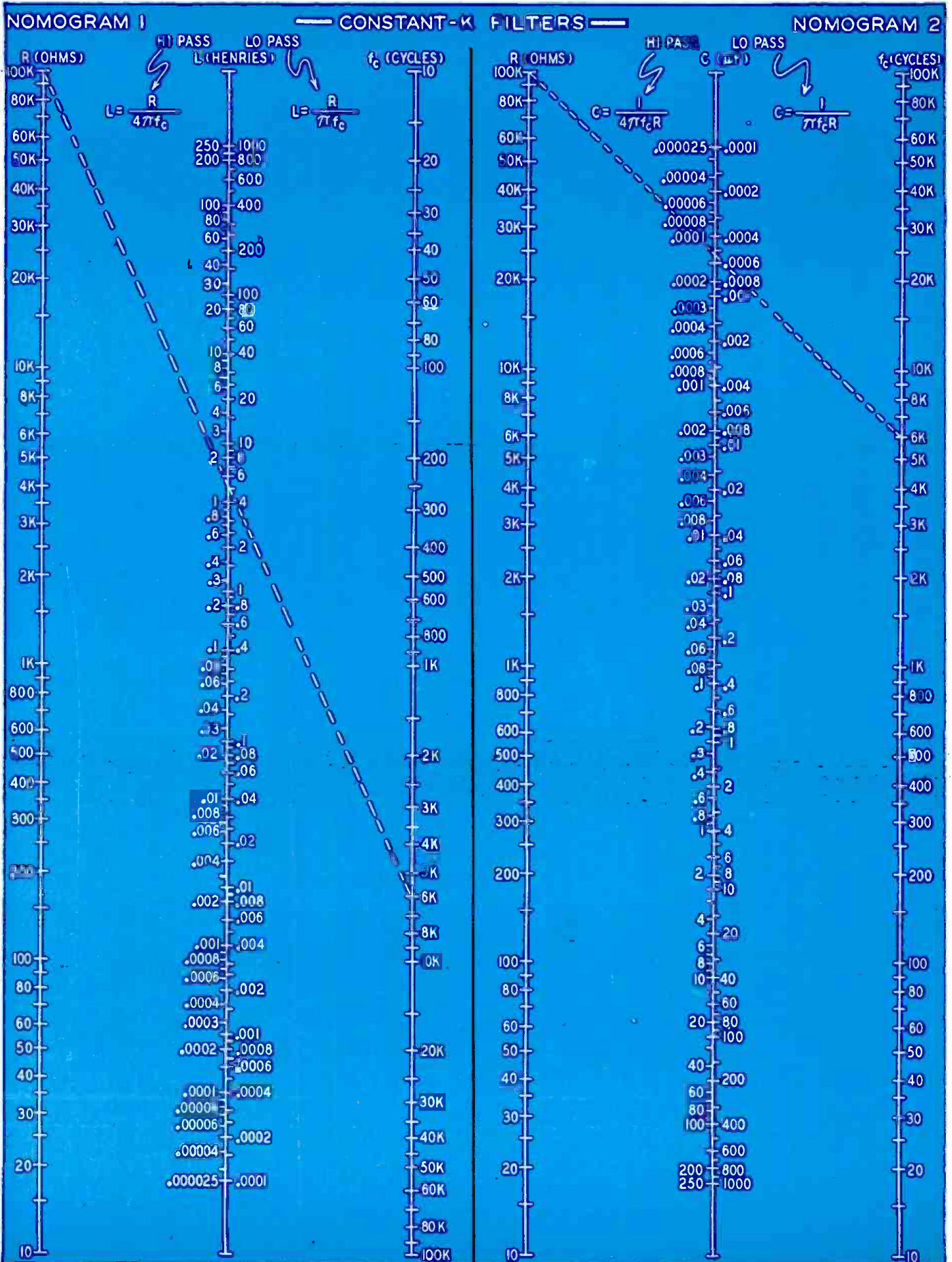

Fig. 4—Sample filter is shown in dashed box. RADIO-ELECTRONICS for



These nomograms make it possible for you to design audio filters without making calculations. Nomograms were derived from formulas shown. JANUARY, 1949

Visual FM Alignment

How to use an oscilloscope and FM signal generator to best advantage for rapid and accurate alignment

By JOHN B. LEDBETTER*

METHODS of aligning FM receivers accurately without the aid of an FM signal generator and oscilloscope have been described (RADIO-ELECTRONICS, November, 1948). While these methods do allow accurate adjustments to be made, it is always desirable to check the linearity of the FM detector visually. It is also very helpful to determine the alignment and response curve of r.f. and i.f. stages by eye. These checks of course can be made only with the aid of the above instruments and it is recommended that they be employed wherever possible.

Instrument requirements

Although the only instruments necessary for visual alignment are an oscilloscope and FM signal generator, a d.c. vacuum-tube voltmeter is helpful to determine the exact frequency at which the d.c. output of the discriminator is balanced to zero. (For this adjustment, the vacuum-tube voltmeter is connected in parallel with the vertical input terminals of the scope and the lowest possible meter range employed to indicate zero).

The oscilloscope can be of almost any type so long as provisions for connecting to an external source of sync voltage are included. This voltage in most cases is furnished by the signal generator. Although a scope with a 3- or 5-inch tube is more accurate and easily adjusted, satisfactory results may be obtained with a less expensive scope such as the Philco Model 7019 shown in the photograph. This particular model incorporates all the necessary features for visual analysis.

The FM signal generator should cover the 88-108-mc band and have an i.f. range of about 4 to 11 mc. Modulation capabilities of the generator should allow deviations of 75 to 100 kc on each side of center frequency, with the deviation rate adjustable from 30 to 15,000 cycles per second (sine wave). A built-in sweep is also desirable. Most

modern FM generators use reactance-tube modulators to provide an adjustable sweep width up to 200 or 250 kc. This sweep is synchronized with the oscillator time-base sweep to obtain an indication of the frequency response or overall characteristics of the circuit under test.

Aligning the i.f.

Generally speaking, i.f. alignment of FM receivers closely follows the procedure used in alignment of TV sound channels. (See "Video Alignment" by Robert N. Vendeland in the September, 1948, issue). There are certain differences, however, especially in the various types of FM discriminator circuits. These must be taken into consideration when aligning a straight FM receiver.

As stressed by professor Vendeland, the manufacturer's alignment notes should be closely followed wherever possible. If no instruction manual or alignment data is available, the general alignment procedure as outlined herein is to be recommended.

First, frequency response of the i.f. system may be checked by setting the generator to the correct center fre-

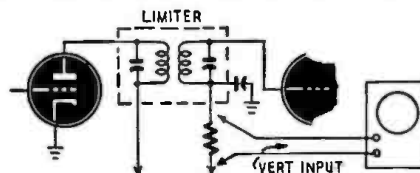

Fig. 1—Connection of scope vertical input.

quency and connecting its output leads through a 0.1 μf condenser to the grid of the converter tube. In receivers employing a Foster-Seeley detector, the vertical plates of the scope should be connected across the discriminator load resistor. In sets with a ratio or Philco detector, it will be impossible to obtain visual indication of the i.f. response curve unless an AM detector is used in conjunction with the scope.

If the receiver has a limiter stage, the vertical input circuit of the scope should be connected across the limiter load resistor as shown in Fig. 1. If it



has two limiters, the signal voltage for the vertical input of the scope should be taken from the load resistor of the first limiter stage as outlined above. The second limiter can be aligned after the i.f. stages have been adjusted.

With the scope FUNCTION control set for external sync, connect the sync input terminals of the scope to the sync terminals of the generator and adjust the horizontal sweep frequency of the scope until it is synchronized with the modulating frequency of the generator. The deviation is then increased until the response curve is spread across the desired portion of the scope screen. The signal voltage from the generator should be fairly low to prevent overloading and distortion in the i.f. stages; for this adjustment, the generator output should only be high enough to give good limiter action.

If the i.f. stages are properly aligned, a response curve similar to that in Fig. 2 should be seen. The pass-band should be 200 to 250 kc wide if the circuits are in proper alignment. The double-peaked curve shown in Fig. 2 is that normally obtained with i.f. transformers of the overcoupled type; single-peak transformers approach more closely the response curve in Fig. 3.

I.f. stages out of alignment may assume various forms of distorted response curves, usually similar to those shown in Fig. 4. Sometimes it is difficult to ascertain whether these distorted waveforms should be double-peaked (for overcoupled transformers) or single-peaked. Before attempting to align an i.f. stage, it is advisable to try to find out whether the transformers are of the overcoupled or single-peak type. Valuable time can be lost trying to "flat-top" a single-peak circuit which was not designed for it.

If the manufacturer's service notes are not available, the type of circuit may be determined quickly by connecting a loading network consisting of a 0.1- μf condenser in series with a 5,000-ohm resistor from plate to ground or

*Engineer, WKRC, WCTS-FM, WKRC-TV Cincinnati Ohio

from grid to ground of the last i.f. stage. If the transformer is over-coupled, the response curve will change considerably, usually straightening out on one side. If the transformer is single-peaked, little change will be noted.

Each i.f. stage must be able to pass the total bandwidth of 200 kc without introducing distortion into the system. To check this possibility, each stage must be aligned separately, beginning with the secondary of the last i.f. stage and working back progressively toward the converter. Each stage is "flat-topped" to give the symmetrical response curve of Fig. 2 or Fig. 3, depending on the circuit. For each stage, adjustments are made with the signal generator connected to the grid of the preceding i.f. stage. If any stage fails to peak properly there is trouble in that stage which must be corrected before going on with the alignment.

The deviation has already been set (as mentioned previously) so that the desired curve spread is obtained on the scope. As each successive stage is aligned, it may be necessary to decrease the signal generator output to maintain the desired height or size of the scope pattern and to prevent overloading. On the other hand, a comparative check on the gain of each stage may be made by leaving the generator output constant and noting the increase in image amplitude as each stage is aligned.

The second limiter may be aligned by increasing the output from the signal generator slightly and adjusting the limiter for minimum output. In some cases the d.c. vacuum-tube voltmeter may not read high enough to indicate the proper setting satisfactorily. This adjustment may be made quite satisfactorily by ear. The signal generator output may be reduced for the adjustment if necessary.

As mentioned before, a normal i.f. response curve cannot be obtained in receivers which have ratio or Philco-type FM detectors unless an AM detector is used with the scope. These cases can be aligned accurately, however, by observing the overall effect of the i.f. signal on the response curve of the FM detector, since the detector is extremely sensitive to any change in the i.f. response characteristics.

Detector alignment

First, connect the vertical input of the scope to the output of the discriminator and connect the scope sync-input terminals to the sync terminals of the generator. Then connect an output meter across the output of the audio amplifier or across the speaker voice coil. The response pattern of Fig. 5 should then appear. (The slope may face either way, depending on the phase relationship between the vertical input voltage and sync voltage).

Align in the same order as usual (first the secondary, then the primary of the discriminator transformer). Proper alignment is indicated by a maximum reading on the output meter and maximum linearity of the response

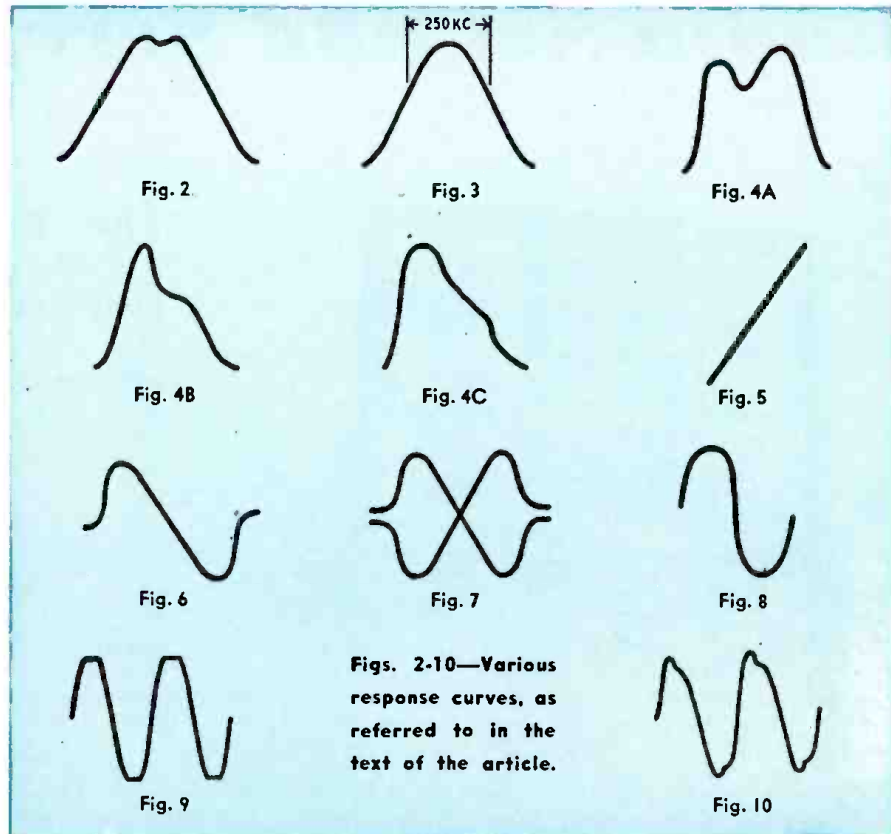

Figs. 2-10—Various response curves, as referred to in the text of the article.

curve, especially along the center portion. These two points of maximum indication should coincide.

An S-shaped discriminator response curve (Fig. 6) may be obtained by synchronizing the scope horizontal amplifier with the signal generator sweep voltage. Although this type of curve usually allows sufficiently accurate discriminator alignment, an X-type curve (Fig. 7) may be used for greater accuracy. With this type of response pattern, it is possible to double-check the entire curve for linearity.

The X curve may be obtained by using the same set-up as that employed for the S curve. The scope horizontal amplifier is then set to internal sweep and the sweep frequency adjusted for 120 cycles. The scope sync selector is then switched to external sync and the external sync voltage picked up from any source which supplies 120 cycles. (This frequency can be easily obtained by connecting the external sync leads across the input filter condenser of the receiver's power supply.)

Audio response

Hum, distortion, and frequency response characteristics in the audio system may be checked by connecting the vertical input of the scope across the output transformer and feeding a signal from an audio oscillator into the grid of the first audio tube. Sync voltage for the scope is taken in the usual manner from the generator. As the frequency is varied over the audible range, the waveform of each frequency should assume the shape of a sine wave (Fig. 8). Any distortion or hum pickup

will be noted in the departure of the waveform from its sine value. The flat-topped peaks in Fig. 9, for example, indicate overloading in a resistance-coupled amplifier or inability to handle normal signal voltage. The distorted curve in Fig. 10 indicates overload trouble in the output stage. For extreme accuracy in checking audio-frequency response, the voice coil should be disconnected and a resistor of the same value substituted, since reflected impedances from the voice coil will affect readings. Frequency response can be checked by noting the amplitude of each audio frequency on the scope. Waveforms should be essentially the same height for good response. For this test some sort of output meter must be connected across the output of the signal generator so that its output voltage can be kept the same for all frequencies.

Audio response can also be checked by using an output meter instead of a scope for response readings. A substantially flat response from 50 to 15,000 cycles should be present in the better audio systems. A drop in response at the higher frequencies is to be expected, but should not exceed 2 or 3 db in hi-fi systems.

While an inexpensive scope such as the one mentioned earlier in this discussion does necessarily have its limitations, it is quite satisfactory until a larger, more flexible scope can be purchased. To the serviceman just beginning or otherwise limited financially, these more inexpensive instruments will be welcomed as a means of doing the job right, while representing a minimum practical investment.

Radio Set and Service Review

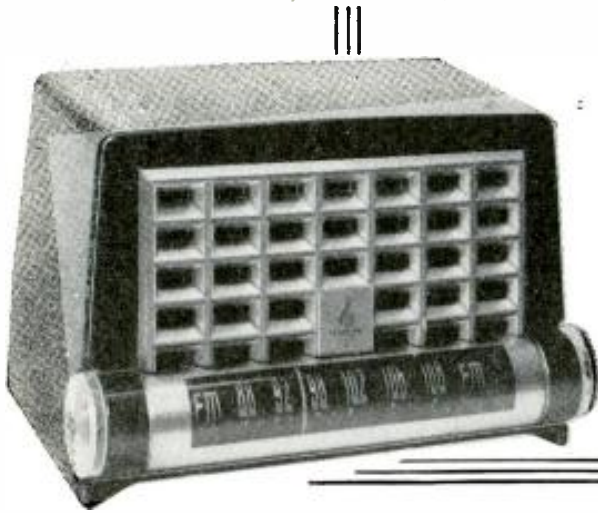

The Emerson Conqueror is lowest-priced a.c.-d.c. receiver for FM reception only

THERE was a time not so long ago when radio's wise men predicted that FM receivers could never be built to compete with AM table models on a price basis. That predictions are not always accurate was proved last November, not only by the election returns, but also by the Emerson Radio and Television Corporation.

Emerson's new a.c.-d.c. FM receiver sells for less than \$30, and is no bigger than an ordinary AM bedside set. It receives most local stations without an external antenna and has more pleasing tone quality than its typical AM counterpart. Designated Model 602, it is quiet when a station is tuned in—very little tube or r.f. noise is heard and hum is far enough down to be negligible. The prophets, in a word, have lost whatever honor they possessed in their own country or any other.

Just six tubes are used in the circuit—a converter, two i.f.'s, a combination discriminator and first audio, an output, and the power rectifier. All, with the exception of the 12S8-GT discriminator-audio, are miniatures. One, the 12BA7 converter, is being mass-produced for the first time especially for use in this receiver. Products of the first runs occasionally had loose

elements, so rubber grommets had to be used on either side of the tube to keep down microphonics. Now that the tube maker has hit his stride, Emerson engineers report that the new tubes are solid and the rubber grommets are no longer necessary.

The circuit, as the diagram shows, is extremely simple. The first three stages are completely conventional and a ratio detector, also standard, converts the r.f. to a.f. The 12S8 used for the purpose doesn't appear in most tube manuals. It is made, according to Emerson, by Tung-Sol. This information may prevent a harassed serviceman from thumbing through his books and concluding that "there ain't no such animal." There is. It may be a good idea to make a note of the pin numbers shown in our diagram and file it away.

Loop antennas don't seem to be practical for v.h.f.—at least as yet (why go out on a limb?)—so Emerson has provided a three-wire line cord. The third (center) wire is normally connected at one end to an antenna post on the rear of the receiver and is open at the other. Because it runs along the power cord for about 70 inches it is apparently capacitively coupled to

the line, and, as a piece of wire, it has a certain amount of direct pickup. In downtown New York it did just as well as a half-wave dipole of twin-lead hanging on the wall, picking up most of the local stations well enough for all practical purposes. If it is used in a poor-signal-strength area you can connect a standard antenna to the two terminals provided. Despite the lack of an r.f. stage, results ought to be satisfactory in most localities.

Though this is a small set and there is a reasonable number of parts, a look at the under-chassis photo ought to be heartening to servicemen. There has long been an impression in the service trade that a radio production line consists of a number of workers, each of whom solders in one component as the set goes down the moving belt. At the end of the line, the resistor and capacitor hookup rises up about a foot above the overturned chassis. The last man to work on the set, according to the theory, is a specialist, chosen for the large size of his feet. It is his sole duty to place the wired chassis, bottom upward, on the floor, and tread the parts and wiring into place.

You won't find much of that in the 602. Wiring is pretty well in the open

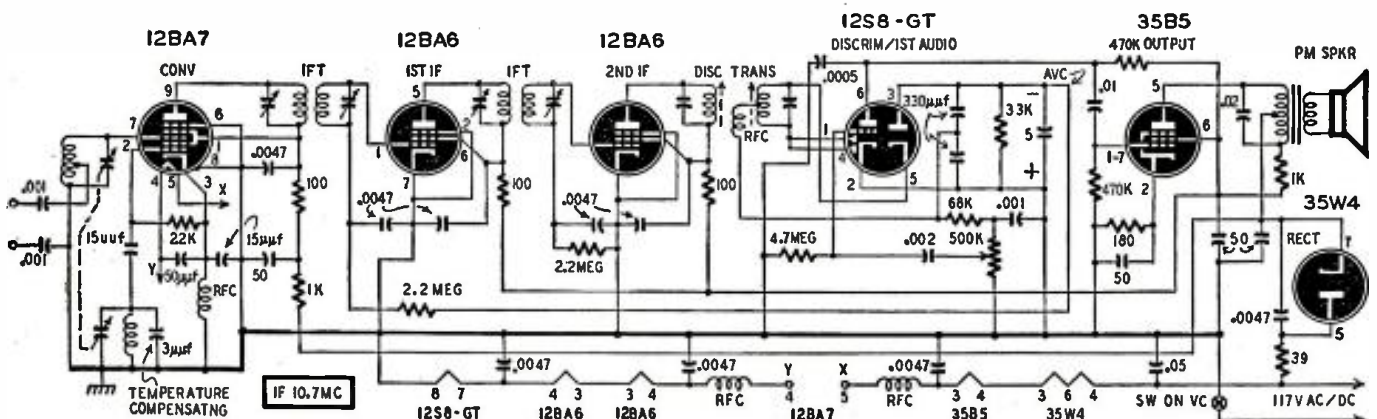

The Emerson Conqueror, Model 602, an a.c.-d.c. receiver which works on FM only. A standard circuit with a ratio detector is used.

and almost any component can be removed without an anesthetic and major surgery. All the capacitors except the electrolytics and a couple of micas are miniatures, so they take up very little room.

From the user's standpoint, this receiver is easy to operate and gives good results, though there are a few points that need comment. It wouldn't be realistic to expect concert-hall quality from the 4-inch speaker, but listening quality is judged to be more pleasing than that of a comparable AM model. That is due to two factors—the absence of noise under almost any conditions, and the peculiar "cleanness" of FM. Turning up the volume to maximum won't produce great waves of sound, but it won't make you cover your ears either. The distortion is much less than on similar AM sets (there wasn't any to speak of when a station was tuned in correctly) and the tonal range appears to be well-balanced.

The model examined showed frequency drift for some time after it was turned on. However, it was an advance model and didn't have the temperature-compensating capacitor across the oscillator coil which was added to all except the very first receivers off the production line. According to Emerson, the capacitor reduces drift to a slight change during the first few minutes of operation. The drift, even on the uncompensated set, isn't particularly annoying, especially as one can't expect a five-year lease on WWV for the price of a small FM receiver.

The dial scale is a semicylindrical strip of metal, in one end of which is set the volume control and in the other the tuning shaft. Two clear plastic knobs project slightly from each end. A dial cord turns the capacitor shaft and moves the frequency pointer. The stringing seems remarkably uncomplicated, but the pulleys are non-rotating, a factor that may possibly cause wear on the cord. The volume control mounting—on an angle bracket out in front of the chassis—makes replacing it easier instead of more complicated, as so many of the modern non-standard schemes do.

There are two points to which some objection may be legitimate. First, there is no pilot light. Though this means there is one less gadget to go bad, it also means that there is one more way to run up a light bill. (The between-station noise from the set is very low, especially when the volume is turned down, so it's easy not to realize the receiver is on.)

Second, one side of the power line is grounded right to the chassis. There are three exposed chassis screws underneath and two in the rear, so there is a definite shock hazard.

The 602 has just come out and alignment instructions are not available at this writing. The circuit, however, is so straightforward that it should be possible to follow any good set of general FM alignment instructions without trouble.

JANUARY, 1949

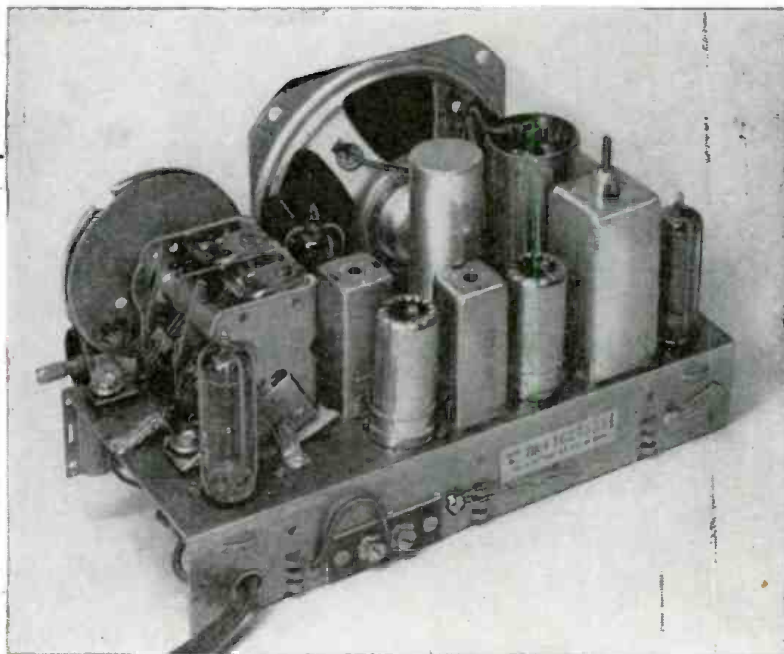

Emerson Model 602 from the rear. Attachment of the linecord antenna is shown.

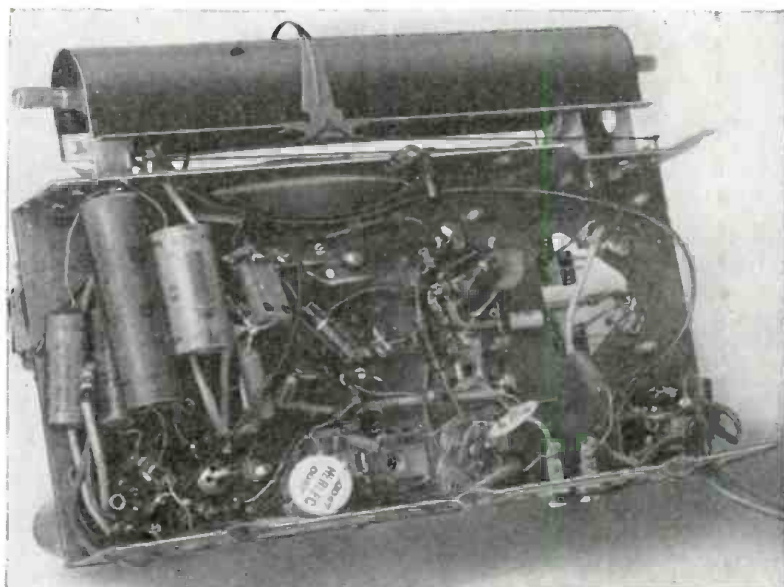

Underchassis, showing dial-cord assembly and control shafts. R. f. wiring at right.

SERVICEMAN'S RESISTOR QUIZ

Here are five questions which will show you whether you know as much about dealing with resistors as you thought you did. Write down your answers, then turn to page 90 and check your score.

1. Checking a dead receiver, you find that every circuit except the audio volume control is in perfect condition. Rotating the control has no effect whatever. Using nothing but an uninsulated screwdriver, how would you diagnose the trouble?
2. A circuit contains a 1-watt resistor and a 2-watt resistor in series. The resistance values are unknown. How many watts can the circuit dissipate? Don't decide this one too quickly.
3. Now the 1- and 2-watt resistors are placed in parallel. How many watts can the combination dissipate?
4. You have a volume control which is damaged beyond repair, but you can't find a replacement. How can you make a temporary repair with fixed resistors?
5. On your bench is a receiver in good condition. You want to find out whether the volume control is in the audio section or the r.f. section of the set. There are no stations on the air and your signal generator is out of order. How do you find out which stage the volume control is in without removing the set from its cabinet?

V. F. O. From Surplus

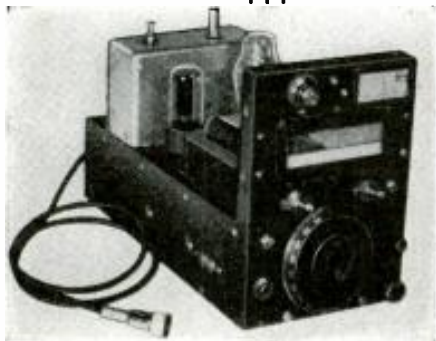

An excellent variable frequency control which can be constructed inexpensively from a 274-N surplus transmitter

By **GEORGE F. MARTS, W0T DH**

TO keep up with postwar competition in the congested amateur bands, some sort of variable frequency control is necessary. The W0T DH transmitter had a good crystal-controlled exciter using a harmonic-type 6V6-GT oscillator stage driving an 807 doubler-amplifier. This supplied enough drive for the medium-power final amplifier, making an elaborate v.f.o. exciter unnecessary. We decided on an external v.f.o. crystal substitute whose output could be plugged or switched into the crystal oscillator stage. It had to be inexpensive, compact, and self-powered, with good frequency stability.

One of the Army SCR-274-N (or its Navy twin, the ARC-5) aircraft transmitters makes an ideal foundation. The master-oscillator section is an excellent v.f.o., and there is ample space for a power supply after removal of the final amplifier components.

Each SCR-274-N transmitter consists of a master oscillator using a 1626 triode, (a 12J5 can be used) exciting two parallel 1625's (12-volt 807's) in the final amplifier. The oscillator and final tuning capacitors are ganged, and the dial system has an excellent worm-gear drive for vernier tuning. There is also a crystal and a 1629 (12-volt 6E5) electron-ray tube for frequency calibration.

Four transmitters in this series are available, each with a different tuning range. Either of two of them can be made to cover the 80-meter band, and either of the other two the 40-meter band. We chose the BC-458-A, which has a range of 5.3 to 7 mc, because it can be made to cover the 40-meter band by retuning the slug and padding condenser in the oscillator-coil assembly. The BC-459-A, which covers 7 to 9 mc, could have been used without re-

calibrating, but because of a difference in price the BC-458-A was chosen. Those favoring an 80-meter crystal substitute should choose one of the units that cover that band.

The modified circuit uses a 6J5 as the oscillator, exciting a 6AG7, which drives a 6F6. The 6J5 plugs into the original 1626 socket without any changes in the original wiring. All original wiring is removed from the crystal and 1629 tuning-eye sockets to accommodate the isolation stages. R.f. chokes are used instead of tuned tank circuits in the buffers, so that only one tuning control is necessary. Making the inductance of the r.f. choke in the 6AG7 plate circuit different from the other two r.f. chokes prevents coupling between grid and plate circuits. One

added stage would have provided the necessary isolation, but the second tube was put in to increase the power output.

The first step is to remove everything that will not be needed. All the final amplifier parts are removed, as well as the antenna components and relays and associated wiring. To retain the gear-drive dial system it was found necessary to use part of the framework of the p.a. tuning capacitor. The dial gear mechanism is fastened to the stator frame, which is needed to hold the gears properly for smooth dial movement.

Remove the rotor and stator plate assemblies and saw the stator frame in three places: saw off the two bottom strips, leaving the parts with the tapped screw holes, which are used to

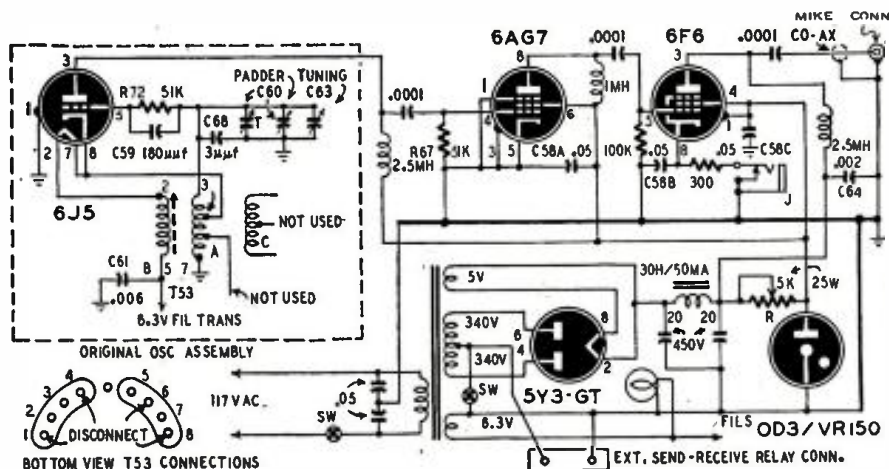

The SCR-274 as modified to make a v.f.o. Mike jack output connects to amplifier cathode.

1—SCR-274-N transmitter, frequency range as desired.
Resistors: 1—300-ohm, 1-watt; 1—5,000-ohm, 25-watt, adjustable; 1—100,000-ohm, 1/2-watt.
Capacitors: 3—100- μ f, mica; 2—0.5- μ f, 600-volt, paper; 2—20- μ f, 450-volt, electrolytic.
R.f. chokes: 2—2.5-mh; 1—1-mh.
Power transformer: 680-volt, center-tapped, 50-ma;

5-volt, 2-amp.; 6.3-volt, 1 1/2-amp.
Tubes: 1—6J5; 1—6AG7; 1—6F6; 1—5Y3-GT; 1—OD3/VR150.
Miscellaneous: 1—30-h, 50-ma filter choke; 2—s.p.s.t. toggle switches; 1—single-circuit, shorting phone jack; 1—single-circuit, cable-end microphone connector; 1—pilot-light assembly; hardware, terminal strips, etc.

RADIO-ELECTRONICS for

refasten it to the chassis, saw the left forward side of the frame close to the front frame plate. Remove the sawed portion by bending it backward and forward, forcing the right rear joint loose and leaving an L-shaped frame. Remount this in its original position. The gears can be easily refastened to the side of the frame and the flexible shaft coupling between the two worm gear shafts reconnected. The dial mechanism should operate as smoothly as before.

The p.a. (1625) tube sockets can be removed by inserting a knife or screwdriver edge under the lips of the aluminum shields and prying upward all along the edge. Push the sockets through the openings. We covered the openings with a piece of aluminum, using the many holes left by the previous removal of parts to bolt it to the chassis. Two holes are punched in the center of the openings to accommodate sockets for the rectifier and voltage-regulator tubes. They were placed there so as to be under the opening in the cover to make future replacement easy. Remove the filament resistor from across the 1629 socket. Remove, too, the chassis connector beside it and cover the opening with a piece of aluminum to complete the shielding.

From the front panel of the unit, remove the antenna coupling control, with its locking knob and the antenna inductance locking device. Enlarge the opening left by removal of the antenna coupling control to receive the shank of a s.p.s.t. toggle switch for the a.c. line. Mount a similar high-voltage off-on toggle switch symmetrically on the right side of the panel above the dial. Any remaining holes in the panel can be filled with suitable machine screws to improve appearance. The closed-circuit keying jack J is placed on the lower left, and the opening left by the antenna insulator is used for a pilot-lamp assembly.

In the oscillator section, leave the two mica condensers mounted on the side of the chassis behind the oscillator tuning condenser in their original positions. Remove the can containing the three .05- μ f condensers (C58A, C58B, and C58C) from the rear of the chassis and place it on the side to allow more freedom for soldering and mounting other parts. Leave the three octal sockets on the chassis rear in their original positions. Retain the connections on the oscillator tube socket except pin number 3 (plate), as shown in the diagram. The dashed box in the diagram encloses the remaining original components. The connections on the other two sockets must be removed to allow for wiring of the 6AG7 and 6F6 buffer stages.

In the original circuit the grids of the final amplifier tubes were excited through section C of the oscillator coil assembly. Heavy grid drive is unnecessary in the new circuit. To minimize frequency variations caused by loading of the frequency-control inductance, the grid of the 6AG7 was

capacitance-coupled to the plate of the oscillator, leaving coil section C unused. The bottom view of the coil connections shows which connections to retain. Also, the crystal calibration feed tap on coil A is not used.

The power supply is conventional, with a voltage-regulator tube connected across the output to provide a constant 150 volts. All circuits are operated at 150 volts, except the 6F6 which has the full supply voltage on its plate. No particular care need be taken in layout. The filter choke and filter condensers are underneath the chassis, with R mounted on top to allow its heat to be dissipated in the open.

Wiring problems

The wiring of the r.f. section may look difficult because of the small space available for mounting and soldering the parts, but it is really quite easy. Much time and work is saved because the oscillator coil is already mounted and wired. The filament wiring should be hooked up first. Note in the circuit diagram that the oscillator filament voltage is fed through the A and B sections of the oscillator coil T53. One side of the filament is grounded through the A section, and this connection should remain unchanged. The hot filament connection should be made from the ungrounded end of C61 since heater pin 2 is connected through coil B from that point.

Wire the midjet 100- μ mf coupling capacitors and the grid resistors next, using a small porcelain stand-off insulator as an anchor point for the last capacitor where it connects to the co-axial cable.

It is advisable to mount the r.f. chokes at different angles to keep their fields from coupling. A two-terminal strip was mounted on the side of the chassis nearest the power transformer to provide connections for an external send-receive relay. Four rubber feet were mounted on the bottom chassis cover to absorb shocks and vibration. As an added precaution the whole unit rests on a sponge-rubber kneeling pad when placed on the operating table.

A 3-foot length of 52-ohm RG-58/U co-axial cable terminated with a single-contact, pressure-type microphone connector is used to couple the v.f.o. output

to the oscillator stage of the transmitter. Approximately $\frac{1}{2}$ watt of power is obtained, enough to drive the transmitter's oscillator tube.

Final adjustments

Little adjustment is required before putting the v.f.o. in operation. The slider of the current-limiting resistor should be adjusted with the key closed

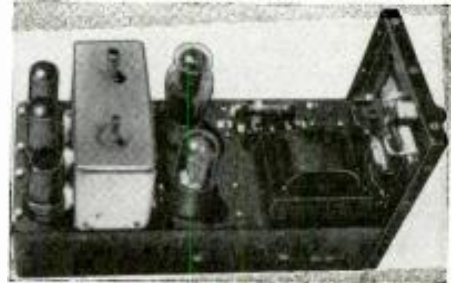

Parts layout atop the converted transmitter.

until the tube ignites with the familiar bluish glow. Since the top frequency of the BC-458-A just hits the lower end of the 40-meter band, it is necessary to shift the entire band lower on the dial by screwing the slug adjustment of the oscillator coil counterclockwise and making fine adjustments with the padding condenser C60. Of course, the direct reading of the dial was thrown off; but the dial can be used as a logging scale, or the correct frequency readings may be painted over the original readings. Building this v.f.o. with a BC-459-A, whose frequency range includes the 40-meter band, will enable you to retain the direct-reading calibration. Any frequency error due to changes in wiring can be compensated with the padding condenser, which can be reached with the chassis cover replaced, through an opening provided for it.

The v.f.o. was coupled to the regular crystal harmonic-type oscillator stage through a grounded-grid arrangement. The inner conductor of the co-axial cable is connected directly to the cathode of the tube, while the grid is grounded. Selection of crystal or v.f.o. operation can be simplified by the use of a switch in the transmitter.

This little unit will be found to facilitate quick, convenient frequency shift while maintaining excellent quality of the transmitter's emitted note.

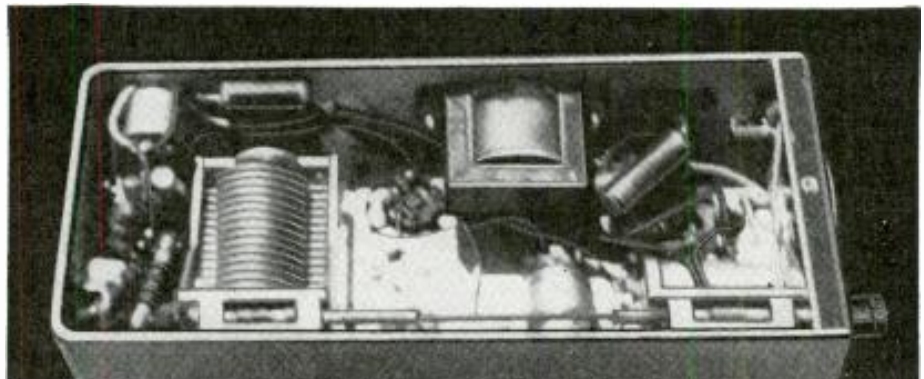

The filter choke is mounted on the side apron of the chassis. Main tuning capacitor at left.

Radio-Frequency Ammeter

An instrument occasionally needed but rarely available can be built with a 1-ma meter and 1N34 crystal

By RUFUS P. TURNER, K6AI

A RADIO-FREQUENCY ammeter suitable for use over a wide frequency range is frequently needed in ham shacks and experimental laboratories. It is usually needed most when unavailable. Thermocouple-type instruments are rather costly and sometimes are limited in frequency range.

A very satisfactory ammeter, usable at both audio and radio frequencies (including ultra-high frequencies), may be built with a regular 0-1 d.c. milliammeter, a 1N34 crystal diode, and a few other components from the spare-parts box. It can be calibrated very easily with an audio oscillator or filament transformer. It will indicate accurately 0-1 ampere, a.f. or r.f., so the regular 0-1-ma meter scale may be employed if the builder is unable to prepare a special one.

The milliammeter, crystal diode, rheostat, and bypass capacitor shown in the diagram comprise a simple wide-frequency a.c. voltmeter. When the calibration control is set to the proper value for a given crystal, 1 volt r.m.s. input will give full-scale deflection of the meter.

This rectifier-type voltmeter is connected, in the complete circuit, across a 1-ohm noninductive resistor, through which the unknown current flows. By keeping this resistance low, the drop in the circuit under test will be held to 1 volt.

From Ohm's law, the unknown current (I) flowing through the 1-ohm resistor, is equal to E/R, where E is the voltage reading of the rectifier voltmeter and R is 1 ohm. Thus the full-scale current value is 1 ampere. It is necessary only to calibrate the voltmeter for direct indications from 0 to 1 volt to have it indicate 0 to 1 ampere. The unknown current flowing through the shunt resistor may be either a.f. or r.f., since the frequency range of the 1N34 diode is 0 cycles to 100 mc.

Easy to construct

Construction of the instrument is entirely straightforward. The author's ammeter (see photos) is built around a 2-inch milliammeter mounted in a small sloping-front metal meter case 3 inches high and 3¼ inches deep.

The input terminals are insulated pin jacks mounted in the top edge of the case. To insure short leads the shunt

resistor is connected directly between these terminals inside the case, and the positive (anode) pigtail of the crystal diode is soldered directly to one input terminal. The negative pigtail is run directly to the positive terminal of the milliammeter. The calibration rheostat is mounted in a hole in the back of the case. The shaft of this rheostat is cut down and provided with a sawed slot for screwdriver adjustment.

The builder must observe carefully the proper polarities of both the crystal and milliammeter, as shown in the diagram.

Calibration

1. Temporarily disconnect one end of the 1-ohm resistor from the rest of the circuit.

2. Connect a variable a.c. voltage, adjustable from 0 to 1 volt, to the input terminals. A satisfactory source is an audio oscillator (with output control) set at any frequency between 100 and 1,000 cycles. Another convenient source is the 2½-volt winding of a filament transformer, with a potentiometer across it.

3. Connect a dependable a.c. voltmeter to the input terminals of the instrument.

4. Set the input signal to exactly 1 volt and adjust the 300-ohm rheostat for full-scale milliammeter reading. The rheostat ordinarily need not be touched after this adjustment unless the crystal diode or meter is replaced or calibration rechecked.

5. Reduce the input voltage in 0.1-volt steps from 1 volt to zero, noting the corresponding milliammeter readings. Make a calibration curve like the one shown. It is advisable to plot a complete curve, because individual crystal characteristics vary. However the graph given here may be employed as is, with tolerable error.

It will be easier to use the ammeter if a special direct-reading meter scale is prepared like the one in the photo. An examination of this photograph will show that currents as low as 0.1 ampere (100 ma) can be read easily.

MATERIALS FOR R.F. AMMETER

1—1-ohm, 2-watt, noninductive resistor; 1—300-ohm, wire-wound rheostat; 1—0-1-ma d.c. meter; 1—1N34 crystal diode; 1—.005-μf, mica capacitor; 2—terminals; 1—meter case.

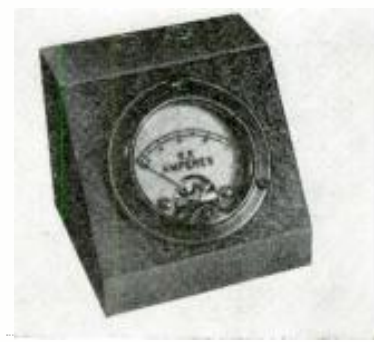

Front view of the meter. Input jacks on top.

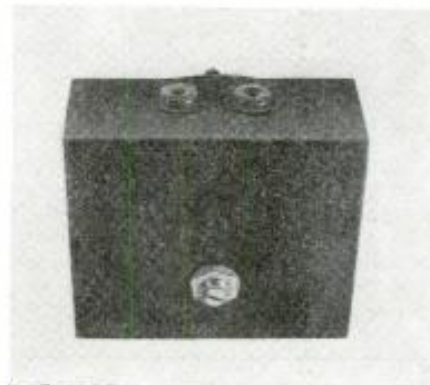

Calibration control is screwdriver-adjusted.

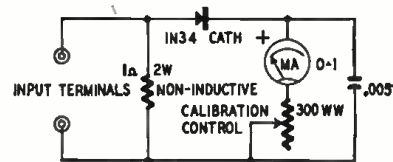

Hookup of the r.f. meter is simplicity itself.

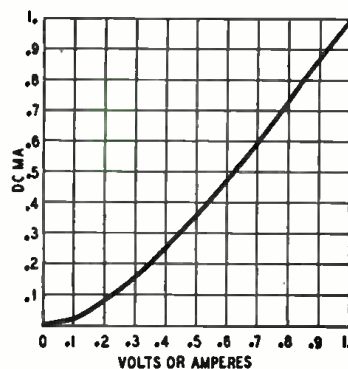

Calibration is roughly linear after 0.1 volt.

'Scope Aid Helps Audio Men

This electronic switch places two patterns on the 'scope at the same time for comparison

By ALFRED HAAS

THE cathode-ray oscilloscope, most interesting of all investigation instruments in the electronic field, is becoming more and more popular. Its cost is no longer a bar to its use for very good 'scopes are now available at reasonable prices. However, many experimenters ignore most of its possible uses. Some rather simple auxiliary equipment, for instance, the electronic switch, permits varied applications.

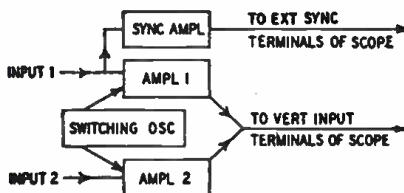

Fig. 1—A block diagram of electronic switch.

Suppose there are two waveforms to view simultaneously, for example, the input and output of an amplifier. The electronic switch makes such viewing possible by switching the two waves on the C-R tube so rapidly that the operator sees both of them at once.

Fig. 1 shows the basic block diagram of an electronic switch. There are two input amplifiers, one for each wave. The switching device is a multivibrator that produces a square wave which cuts off the two amplifiers alternately. In this way, one wave at a time is transmitted to the 'scope.

Difficulties may arise in synchronizing the 'scope's time-base oscillator. It is essential to hold this in step with the wave to be observed and not with the square wave of the switching device. For this reason, a synchronizing amplifier is provided. Its output is applied to the external sync terminals of the 'scope.

Fig. 2 shows the circuit of the electronic switch. No power supply has been provided, as the unit is to be powered by the oscilloscope it works with. (Unless the builder is sure his 'scope's filament and medium-voltage supplies will handle the extra load, it might be better to use a separate power supply.—*Editor*) Five tubes are used. V2 is a 6N7 in a cathode-coupled multivibrator circuit. The frequency-determining ele-

ments are the grid condenser and resistor. The switching frequency has to

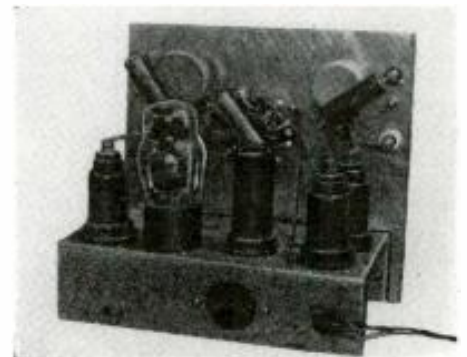

Fig. 3—Rear view of switch shows small size.

be variable; this is done by a potentiometer R8 and a rotary switch SW which selects C3, C4, or C5.

As the resultant wave is not sufficiently squared, another 6N7 (V3) is used as a squaring amplifier. The two triodes are cascaded without any bias, the plate resistors being of relatively high value. The well squared output of V3 is fed into the No. 3 grids of the two 6L7 input amplifiers V1 and V4. The

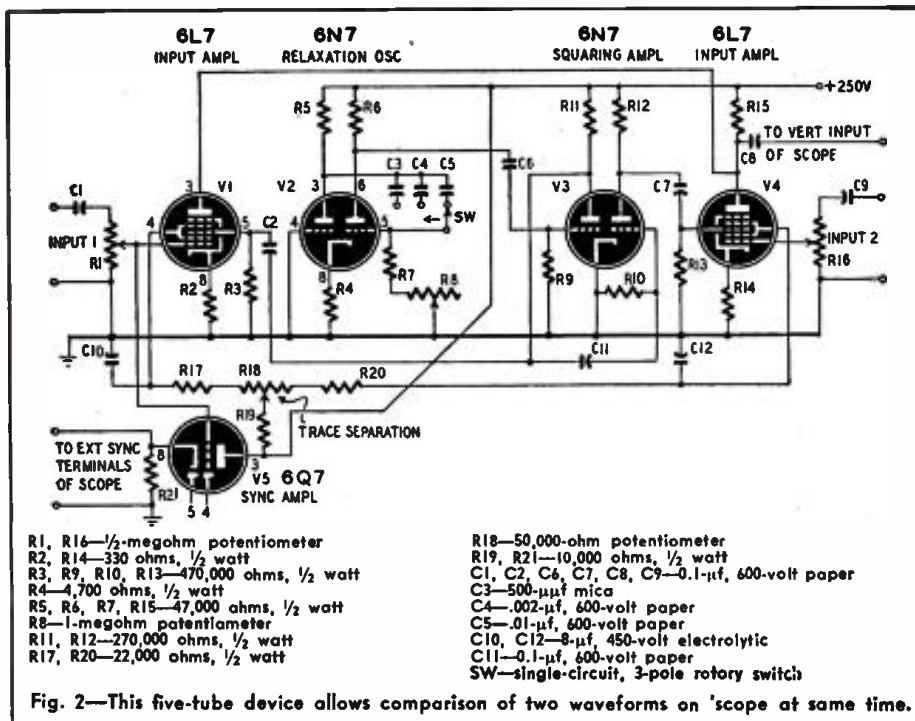

Fig. 2—This five-tube device allows comparison of two waveforms on 'scope at same time.

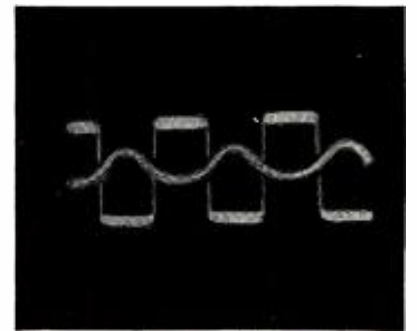

Fig. 4—Superimposed waves of same frequency.

control grids are coupled to the input potentiometers. The strong squared pulses on the No. 3 grids drive the tubes alternately to cutoff. As the plate resistor is common to both of them, the plate current of one tube at a time flows in it and the output voltage feeds the vertical plates (or amplifier) of the 'scope.

If V1 and V4 operate symmetrically, the outputs of both will appear at the same place on the screen, that is, the two waves will be superimposed. Some-

times—especially if they are almost identical—it is difficult to distinguish one from the other, so they must be separated. R18 is the separation control. When the arm is at the center, both 6L7 screens receive the same voltage and both tubes operate at the same point on their $E_r I_p$ curves. When the slider is moved to one side of center, the operating points of the tubes change so that one becomes higher as the other becomes lower. This causes the traces to appear one above the other on the C-R-tube screen. There is also, of course, some effect on the heights of the waves, but this can be corrected by

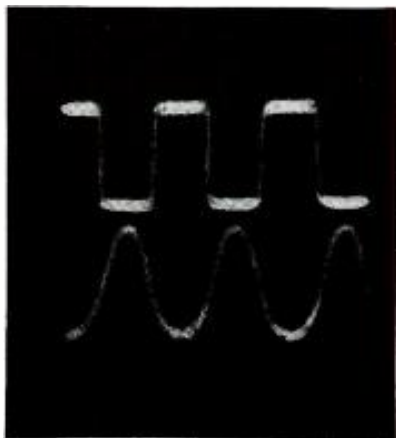

Fig. 5—Waves shown in Fig. 4 are separated.

resetting the input potentiometers R1 and R16.

The cathode-follower synchronizing amplifier V5 is a 6Q7 with the diode plates unused. Its grid is tied to that of V1 so that the time base is kept in step with signal E1. The cathode of V5 is to be coupled to the synchronizing input of the oscilloscope.

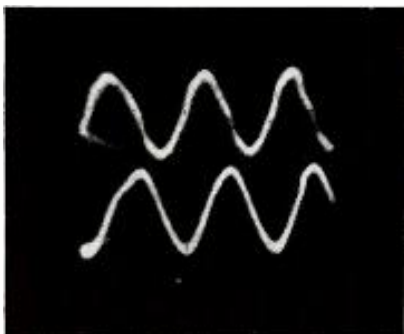

Fig. 6—These are two waves, same frequency.

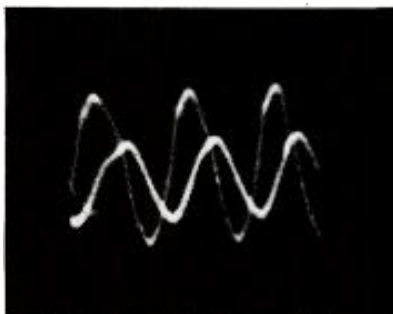

Fig. 7—Phase difference is now easy to see.

Fig. 3 shows the rear of the unit. The placement of parts is not critical.

This little unit is easily constructed, and should work immediately. However, here is some advice on getting best results. Suppose the switching frequency is exactly twice the signal frequency. The output of V1 will be coupled to the C-R tube for half a cycle, and to V4 for the other half. As the time base is kept in step with the signal and therefore with the switch, only half a wave of each will be seen. Therefore it is necessary to vary the switching frequency, and to avoid its being an exact multiple or submultiple of the signal frequency.

Low frequencies are best examined at a rather high switching frequency, say 5,000 to 10,000 cycles; for high frequencies, a low switching rate is best. That is why three frequency-determining condensers are provided in the circuit of V2. The 1-megohm potentiometer is for continuous tuning.

Figs. 4 and 5 show how the electronic switch permits comparison of two wave forms. Note how the traces are separated in Fig. 5. In Figs. 6 and 7 two waves of the same frequency but of different phase are compared. The phase difference is about 90 degrees. This time (Fig. 7) it may be more interesting to operate on a common base and to compare the superimposed traces.

Figs. 8 and 9 show how the electronic switch measures frequency. The wave composed of three cycles comes from the 60-cycle line. As there are three cycles, the time base is running at $60/3 = 20$ cycles. The other wave is

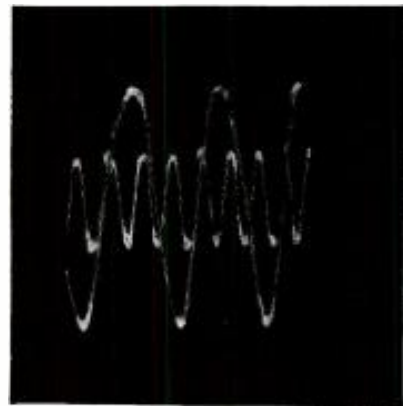

Fig. 8—Electronic switch measures frequency.

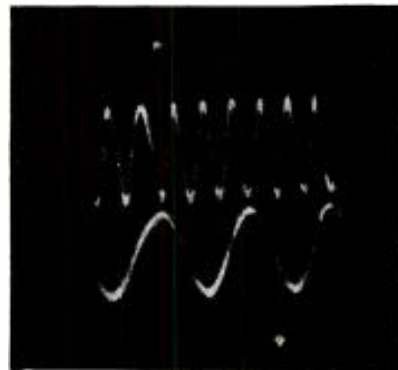

Fig. 9—Frequency relationships are obvious.

composed of eight cycles; its frequency is 8 times 20, or 160 cycles.

The repairman or research worker will find this switch increasingly valuable as he becomes accustomed to it.

MECHANICAL COUNTERS

ELECTRONIC circuits are not always better than equivalent mechanical devices. For example, mechanical relays are perfectly satisfactory for counting pulses and are much simpler than equivalent electron-tube circuits, if the pulse frequency is low enough to be followed mechanically and the pulses are strong enough to operate a relay without amplification.

Counting relays have been used for many years in telephone and signal work. The very simple and effective Molina counter is used in telephone communication. It was invented in 1911 by E. C. Molina* of the Bell Telephone Laboratories and has been in use ever since. It is shown in the schematic.

This is how the Molina counter operates: The pulsing key is alternately closed and opened (as in telephone dialing) to provide pulses. When it is closed, the M relay is grounded at one end. Since the battery is already connected to the other end, its contact is closed. The N relay remains as shown because it now is grounded at each end. When the key is released, however, this relay does operate, as it is across the battery in series with M. The net

result of a complete on-off pulse is the transfer of the F contact from one relay pair to the next.

Ordinarily there must be as many relay pairs as pulses to be counted. With a slightly more complicated sys-

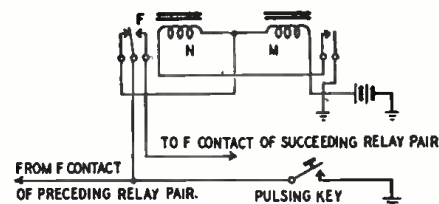

One pair of relays operates with each pulse.

tem the same relays may be used more than once, however. In telephone cross-bar circuits, for example, five relay pairs are used to count a maximum of ten pulses. At the sixth pulse, the first relay pair operates just as it did at the first pulse, etc.

At the end of the counting sequence, all the locked relays may be released by opening a switch in the battery circuit. Amateurs and experimenters can use this system for control-function selectors, instead of expensive rotary steppers.

* Bell Lab Record, July, 1948.

The two plate-current readings are then compared to the plate-current characteristic in the tube manual.

The circuit of the analyzer (Fig. 3) is simplified by omitting the wiring of all but one of the tube tester sockets. The unit includes all standard tube sockets. All socket pins having the same RMA pin number are tied together and connected to corresponding contacts on S16, S17, S18, S19, S20, one deck of S22, and the fixed contacts on S1 through S10. The nine-prong analyzer socket connects to contacts on the remaining deck of S22 and to the arms of S1 through S10. This system of switching provides for testing newly developed tubes, regardless of their pin connections.

A standard tube-tester transformer supplies filament or heater voltages for the tubes under test. Plate and screen-grid voltages are supplied by a 400-volt, 90-ma supply with a voltage divider. (The large tapped resistor, Fig. 4, has since been replaced with a network of series resistors R1 through R6 as

shown on the diagram.) The primary of the filament transformer (T2) is tapped for 105, 115, and 120 volts. Separate switches are used for each tap. The power transformer primary is across the 115-volt tap on the filament transformer. Autotransformer keeps input to the plate transformer constant.

The 50,000-ohm load resistor R10 is a compromise value, suitable for most tubes. To test a tube with a load resistance higher than 50,000 ohms, insert additional resistance in series with the positive side of the meter.

Construction

The analyzer is built in three sections: the switches, sockets, pin jacks, and indicators are on the panel; the power supply on a subdeck (Fig. 5); and the multitester fits in a hole cut in the panel before wiring the power-supply chassis. The miniature sockets are connected with fine wire, about No. 22 enamelled, and the other connections are made with push-back wire.

Use a minimum of flux on the connections because insulating surfaces are likely to break down when contaminated with flux. (Carbon tetrachloride and a small brush are handy for removing excess flux from soldered joints.—Editor)

Operating the tester

1. Plug the leads of the multitester into the A.C. VOLTS terminals and set the meter to the a.c. volts range corresponding to the filament voltage of the tube being tested.

2. Make sure that the D.C. VOLTS switch is in an off position and the ANALYZE—TUBE TEST switch is in the ANALYZE position. Refer to a tube manual and adjust the plate, cathode, screen-grid, control-grid, and filament switches to positions corresponding to the pin numbers of the elements. Be sure that both filament switches are not turned to the same number.

3. Plug in the tube and set the A.C. VOLTS switch for its correct filament voltage. (Continued on next page)

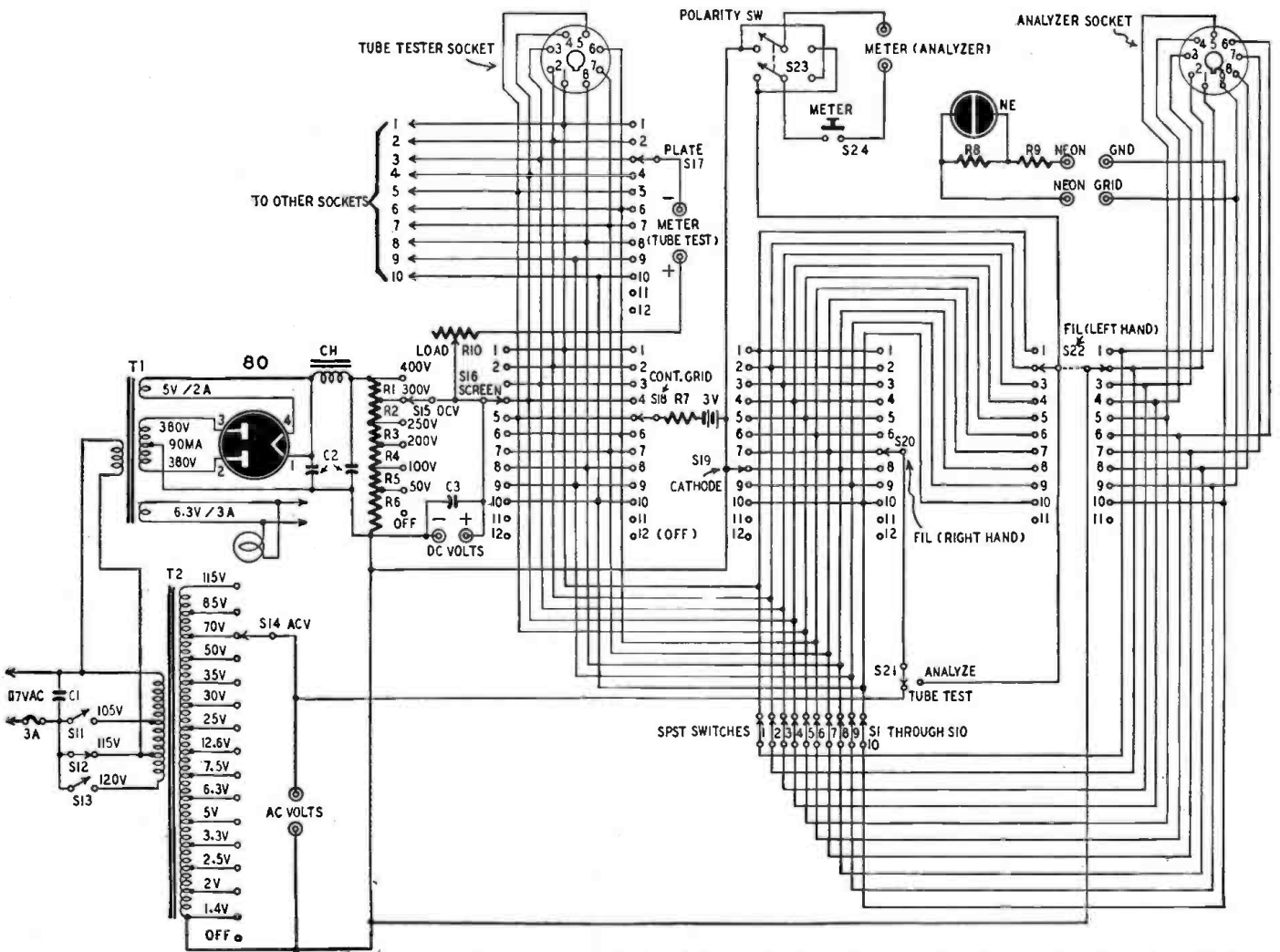

Fig. 3—Circuit of the tester and set analyzer sections. The meter circuit is not shown.

- C1—01- μ f, 600-volt paper
- C2—dual 8- μ f, 600-volt electrolytic
- C3—16- μ f, 600-volt electrolytic
- R1, R4—2,500 ohms, 10 watts
- R2, R3, R5, R6—1,300 ohms, 5 watts
- R7—22,000 ohms, 1/2 watt
- R8—470,000 ohms, 1/2 watt
- R9—100,000 ohms, 1/2 watt
- R10—50,000-ohm, 4-watt, wire-wound potentiometer
- S1, S2, S3, S4, S5, S6, S7, S8, S9, S10, S11, S12, S13—

- s.p.s.t. slide or toggle switch
- S14—24-point rotary tap switch, nonshorting
- S15—11-point rotary tap switch, nonshorting, with stop
- S16, S17, S18, S19, S20—12-point rotary switches, nonshorting type
- S21—s.p.s.t. toggle switch
- S22—2-gang, 11-point rotary switch, nonshorting
- S23—d.p.d.t. toggle switch

- S24—s.p.s.t. push-button switch
- T1—power transformer, 760 volts c.t., 90 ma, 5 volts, 2 amps., 6.3 volts, 3 amps.
- T2—filament transformer, 105-, 115-, 120-volt primary; secondary tapped at 1.4, 2, 2.5, 3.3, 5, 6.3, 7.5, 12.6, 25, 30, 35, 50, 70, 85, and 115 volts. May be Stancor P-1834-3 or equivalent
- CH—8 h, 100 ma
- NE—1/10-watt neon lamp

4. Turn on the power, using the switch corresponding to prevailing line voltage. If the filament voltage is too low, open the switch and close one marked for lower voltage. If too high, use a high-voltage switch. *Do not close more than one power switch at the same time.*



Fig. 4—The bleeder and acorn-tube adapter.

5. Remove meter leads from A.C. VOLTS terminals and insert them in the METER terminals on the left side of the panel. From the tube manual, determine the zero-bias plate current for a given plate voltage and load. Set the meter to a direct-current range that will pass this current safely.

6. Adjust the D.C. VOLTS switch and LOAD control to the desired voltage and load resistance. (Reading of the LOAD dial multiplied by 500 gives the value of the load resistance.) Note the plate current on the meter, then turn the CONTROL GRID switch to the off (No. 12) position. The new current reading is for zero bias.

7. Compare the two current readings with those listed on the characteristic curve in the tube manual. If the measured currents correspond to those in the manual, the tube is assumed to be good. The permissible deviation from normal values depends on the type of tube and its application. Plate current

of rectifiers and diode detectors can vary as much as 40% without making replacement necessary. Oscillator and converter tubes should be replaced when the current drops 10% or more. Discard amplifier tubes when the indication is 20% below normal.

Experience testing a few tubes with this unit will show when a tube has reached the end of its useful life.

Short tests are made by substituting the neon indicator lamp for the plate-current meter. Set the D.C. VOLTS control to 100 volts and turn the PLATE switch to the number corresponding to the cathode pin. Rotate the CATHODE switch to all positions. The indicator glows when there is a short between the cathode and one of the elements.

To check shorts between other elements, set the PLATE and CATHODE switches to pin numbers corresponding to the questionable elements. The PLATE switch is set to the element operating nearest cathode potential.

Transconductance tests can be made by dividing by 3 the change in current produced by removing grid bias and multiplying the resultant by 1,000,000. The product is the transconductance of the tube in micromhos.

Using the analyzer

Point-to-point voltage and current measurements can be made on a radio or amplifier without removing the chassis from the cabinet. Connections are made to the meter through the analyzer cable and the adapters. These measurements are confined to low-frequency radio circuits and audio and power circuits since the capacitance of the cable affects high-frequency circuits. To measure current:

1. Turn off the power and rotate all switches to the off position. Throw the ANALYZE-TUBE TEST switch to ANALYZE.

2. Remove the tube from the stage in the amplifier or radio where measurements are to be made, and insert it in the proper socket in the tester.

3. Plug one end of the adapter cable into the vacant tube socket and the other end into the nine-prong analyzer socket on the panel.

4. Set the multitester to the 300-ma range and plug the meter leads in the METER terminals in the center of the panel.

5. Open the toggle switch corresponding to the pin number of the circuit. Turn the left-hand FILAMENT switch S22 to the number of the circuit being metered.

6. Turn on the power in the set. Press the push-button METER switch to obtain a current reading. If the meter reads backward, throw the polarity switch in the opposite direction. If necessary, set the meter to a lower range so the current falls about mid-scale.

To measure voltage, use the CATHODE switch and the right-hand FILAMENT switch S20.

1. Turn all rotary switches to the OFF position.

2. Connect a jumper between the chassis, or B-minus, of the set and the ground terminal on the panel.

3. Set the right-hand filament switch to the number of the circuit being metered.

4. If the voltage measurement is made with reference to the cathode; set the CATHODE switch to the number of the cathode pin. If the voltage is made between an element and ground, set the CATHODE switch to 10.

5. Press the METER switch to read voltage.

(Note that no provisions are made for tubes with the suppressor brought out to a separate pin. With prevailing tube types the suppressor can be left floating. If it is desirable to connect the suppressor to the cathode or other element, plug a jumper into the cathode and suppressor pins on an unused socket.)

Other applications

Filament voltages are available for test purposes by plugging leads into the A.C. VOLTS terminals and setting the A.C. VOLTS switch to the required voltage. D.c. voltages are available at the D.C. VOLTS terminals. The voltage is determined by setting the D.C. VOLTS switch.

A special adapter is used for isolating a.c.-d.c. equipment from the line. The adapter is a female plug mounted inside a five-prong tube base. Terminals of the plug are wired to pins 1 and 5 on the tube base. Plug the adapter into the five-prong socket, set the filament switches to 1 and 5, and turn the A.C. VOLTS switch to 115 volts. Intermittents and faulty oscillators can be located by lowering or raising the voltage with the A.C. VOLTS switch.

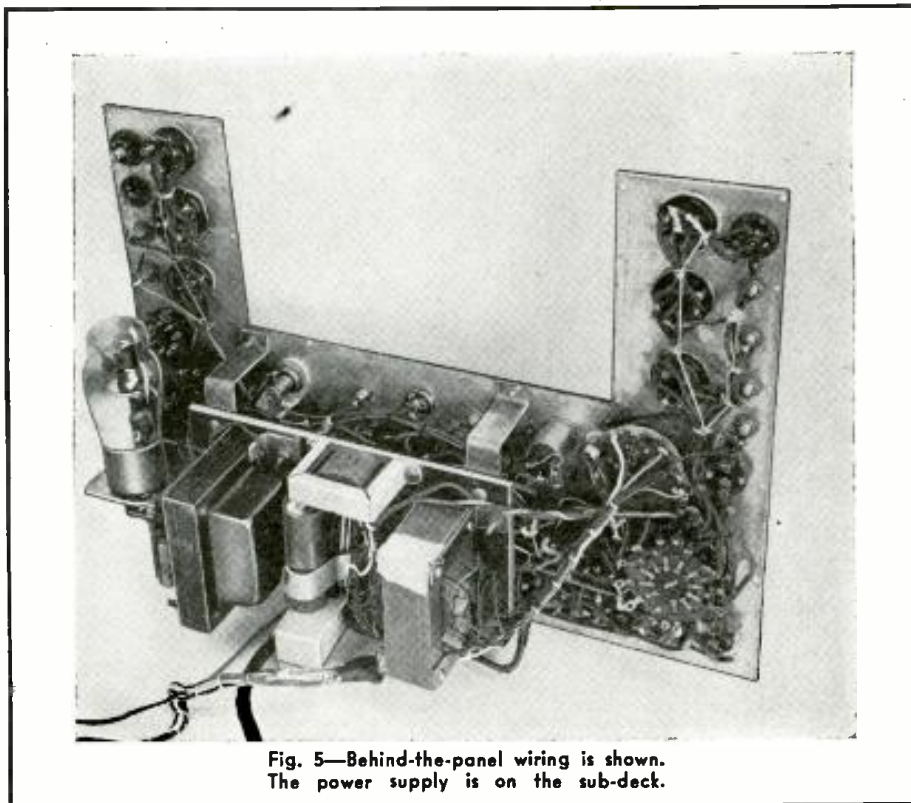

Fig. 5—Behind-the-panel wiring is shown. The power supply is on the sub-deck.

What is Supersonic Bias?

This clearly written article takes the mystery out of a common, but not well-understood, term

by DR. ANGELO MONTANI*

ALTHOUGH development of magnetic recording was started many decades ago, only recently is it proving to be a real threat to disc recording. Wire and tape recording are increasing in popularity so fast that every radioman—and especially every radio serviceman—should learn the fundamentals of the process as soon and as thoroughly as he can.

Supersonic bias is a familiar term today in the sound field because all mag-

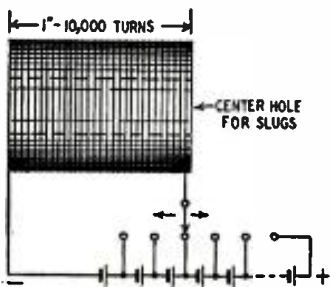

Fig. 1—Setup for experimental magnetization.

netic recorders use it. But do you know just what it is, why it is used, and how it works?

Every radioman knows that a steel needle, for example, can be magnetized permanently if it is touched to an ordinary bar or horseshoe magnet. It will also be magnetized if it is placed inside a coil energized by d.c.

Such a coil is shown in Fig. 1. The coil is 1 inch long and wound with 10,000 turns of thin copper wire. When a battery is connected to the coil, a magnetomotive force appears along its length. This force, measured in *ampere-turns*, is referred to as m.m.f. It is the product of the current through the coil (in amperes) times the number of turns.

In measuring and evaluating the magnetic characteristics of specific materials, a more convenient way to refer to magnetic field intensity is in *ampere-turns per inch*, represented by the letter H. This is the product of the coil current (still in amperes) and the number

of turns per inch.

If 0.1 ampere flows through the coil of Fig. 1, the value of H would be $0.1 \times 10,000 = 1,000$. (H is often referred to in textbooks as the magnetomotive force gradient.)

Suppose we take ten cylindrical steel-alloy slugs, each 1 inch long and of the correct diameter to fit inside the coil. We place one in the core and apply the battery voltage necessary to produce a current of .01 ampere. We remove the first slug and substitute the second. This time we energize the coil with .02 ampere. We continue the procedure with the remaining eight slugs, increasing the current each time by .01 ampere. At the end of the process we have ten permanent magnets.

Next we measure the residual magnetization, that is, the amount of permanent magnetism, left in each slug as the result of its exposure to the electromagnetic coil. We find that this *flux density* (represented as B_r) is not proportional to the current which caused it.

To determine the relationship between

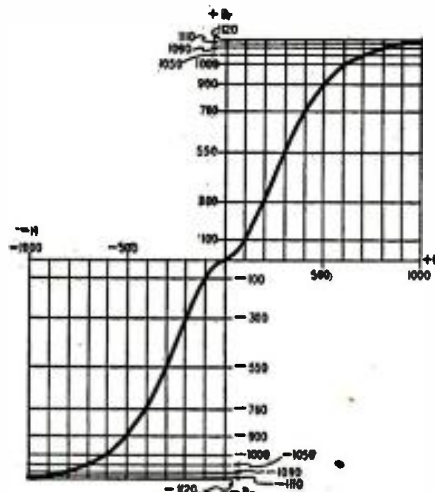

Fig. 2—Magnetization curve plots B_r versus H.

the coil current and the retained flux B_r of each slug, we assign an arbitrary value of 100 to the retained flux of the

first slug and compare all the rest to that. We find that the second slug, magnetized under a current of .02 ampere (when H was 200), has a B_r value of, not 200, but 300. Table 1 (next page) shows B_r vs coil current for all ten bars.

From Table 1 we make the upper right or positive portion of the graph of Fig. 2. The horizontal (X) axis is marked off in H units rather than current. The vertical (Y) axis shows the same B_r figures as the table.

If the current in the coil had been made to flow in the opposite direction, the slugs would have been magnetized to the same extent, though their polarities would be reversed—the north and south poles would have changed places.

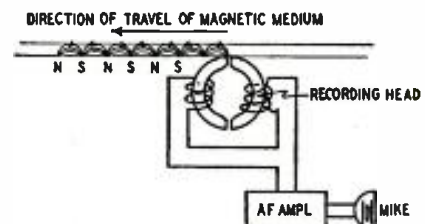

Fig. 3—How the signals are recorded on wire.

Because of this, we can reproduce the original positive curve in the negative direction, using the same figures, but preceded by minus signs. The symmetrical result, shown in Fig. 2, is known as the complete retentivity curve. It gives us sufficient data for an understanding of magnetic recording and supersonic bias (sometimes called radio bias).

In magnetic recording, H on the graph represents the instantaneous values of audio current flowing through the recording-head coil. The H signal is analogous to the grid signal of a vacuum tube. The corresponding B_r values represent the output—what is placed on the tape—and is analogous to a vacuum tube's plate current. This analogy between the magnetic B_r -H curve and the E_c - I_p curve of a vacuum-tube amplifier is very helpful in understanding supersonic bias.

Fig. 3 shows a magnetic recording

head schematically. The particular one pictured is the *split-ring* type, the most common. The gaps between the two half-rings are about .001 inch, and each half-ring is made of stacked laminations of high-permeability alloy. The magnetic medium (wire or tape) passes the upper gap at a constant speed. At each instant a .001-inch section of the tape

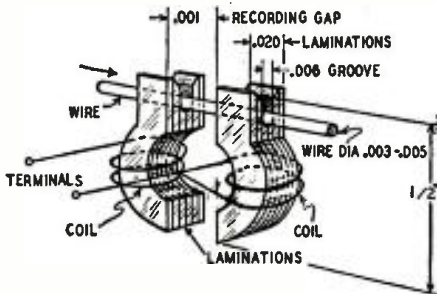

Fig. 4—View of a magnetic recording head.

or wire is across the gap and a tiny magnet is formed. The recorded sound consists of these minute longitudinal magnets, the flux and polarity of each depending on the current in the coil at the instant the magnet was made.

Fig. 4 gives a somewhat better idea of the construction of an actual recording head. To show the parts more clearly the dimensions in the drawing are much out of scale. This particular head is suitable for wire recording only; the top groove would be somewhat different for tape.

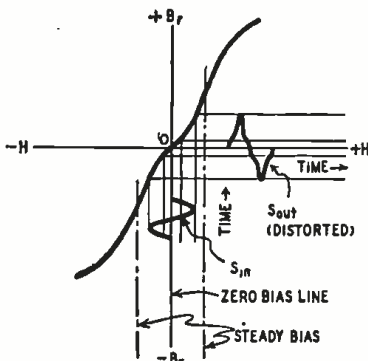

Fig. 5—Signal zeroed at center is distorted.

The arrangement of Fig. 3 can be used for making recordings, but the distortion would be very pronounced. Fig. 5 (the B_r - H curve is a copy of that in Fig. 2) helps to show the reason. This is where the analogy with the vacuum-tube E_c - I_p curve is useful. Employing vacuum-tube graphical technique, we draw a sinusoidal input signal S_{in} , and then construct a corresponding output signal S_{out} . S_{out} is obviously badly distorted, due to the curvature of the B_r - H characteristic in the vicinity of the zero point.

Early experimenters realized that the input signal should be centered, not at the zero point, as in Fig. 5, but somewhere on the straightest portion of the magnetic curve. A *steady magnetic bias* analogous to the d.c. grid bias of a vacuum tube had to be superimposed on the a.f. signal so as to shift its axis to

one of the points indicated by the dashed lines in Fig. 5.

Magnetic bias has disadvantages, and is now of purely historical interest. Any mechanical vibration is recorded as noise. And the linear portion of the curve is so limited that the dynamic range is insufficient for music.

Supersonic bias was first introduced about a quarter of a century ago. It consists of a current of supersonic frequency which is fed to the recording head along with the audio. The usual frequency is approximately 50 kc. Fig. 6 shows the audio, the supersonic, and the combined waves.

Note well that the audio *does not modulate* the supersonic signal, but combines with it, the resultant combined wave being a vectorial addition of the

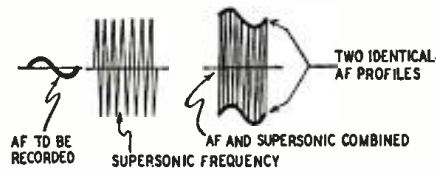

Fig. 6—Supersonic bias superimposed on a.f.

two. For this reason, two in-phase audio profiles are formed, one on either side of the supersonic frequency, rather than the familiar out-of-phase modulation envelope. We might say that the audio signal is split into two identical, in-phase audio signals. Actually, the original audio frequency is shifted back and forth with twice the amplitude of the supersonic frequency at the supersonic rate; but this is, of course, inaudible.

The composite wave is now applied to the magnetic retentivity curve previously described. The result is shown in Fig. 7. One audio profile is applied to the negative portion of the curve and the other to the positive portion. Each profile results in a distorted output. The two distorted output signals, however, are of opposite polarity and subtract from each other. The distortion components

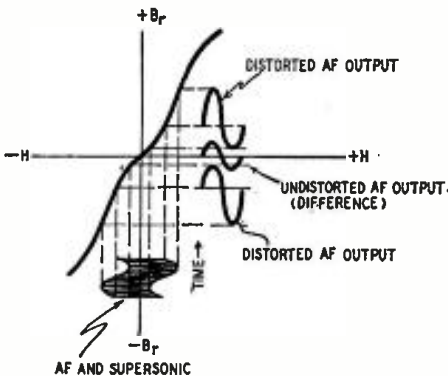

Fig. 7—Resultant output wave is undistorted.

in each output signal are equal and opposite in polarity, so they cancel, and the resultant is an undistorted signal. Though the resultant has lower amplitude than either of the distorted signals, it is not zero because the amplitudes of the two distorted signals are never equal

at any instant and therefore cannot cancel completely.

What remains on the wire or tape (the difference between the two distorted signals) is an undistorted signal of the same form and frequency as the original audio before the supersonic bias was added.

This last statement may sound as though it were "dragged in by the horns," but it can be proved by going back to simple mathematics. We stated that the algebraic difference between the two distorted recorded signals at any instant yields an undistorted wave. The statement is correct as long as the portion of the opposite branches of the magnetic curve to which we apply the two simultaneous a.f. profiles is either straight or parabolic. That is because the difference between the corresponding points of any symmetrically opposite parabolas (or straight lines) is a straight line.

This law is commonly used in class-B amplifiers, as shown in Fig. 8. The audio is applied to both tubes at the same time, producing two distorted outputs. Because the E_c - I_p curves of the two tubes are equally and oppositely nonlinear near the zero point, the resultant output is undistorted.

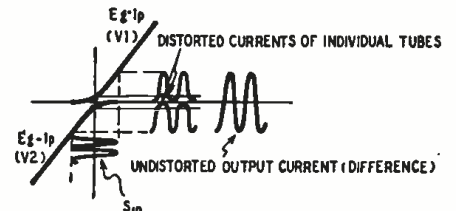

Fig. 8—Class-B amplifier distortion cancels.

In the class-B amplifier the over-all curve is already split at the zero point, since two tubes are used. In magnetic recording, the retentivity curve cannot, of course, be split, so supersonic bias is

Slugs	Coil Current (amps.)	Retained Flux (B_r)
1	.01	100
2	.02	300
3	.03	550
4	.04	760
5	.05	900
6	.06	1000
7	.07	1050
8	.08	1090
9	.09	1110
10	.1	1120

used to produce two audio signals. By controlling the amplitude of the supersonic bias, the two a.f. waves can be centered on the most parabolic sections of the curve.

We believe that the reader is now in the position of appreciating fully the neat trick performed with supersonic bias. It is without doubt a genial and elegant solution of the problem of obtaining a virtual or phantom transfer line which is straight, out of the crooked retentivity curve.

European Report

By Major Ralph W. Hallows

RADIO-ELECTRONICS LONDON CORRESPONDENT



IT'S not so very long since the only insulating materials from which molded or extruded radio parts, such as tube sockets, coil forms, and panels were made of bakelite and hard rubber. The use of higher and higher frequencies made new insulators with far superior qualities essential and the chemists gave us such wonderful stuff as polyvinyl chloride (P. V. C.) and the polyethylene family. The latest offspring of this family has just come into use in Britain. It is polytetrafluoroethylene—a pretty little name, but perhaps rather too long for general use in these busy days. We call it P.T.F.E. for short. It seems to have most high-frequency insulator virtues and few, if any, of the vices. Its properties are unaffected by oils, alkalis and most acids; it doesn't soften or warp when heated; it has a low coefficient of expansion; it has so much resilience that it doesn't tend to crack even under prolonged and severe vibration. At present it's being used mainly for coaxial and other r.f. cable connectors, for connectors for hermetically sealed components and for the sockets of miniature tubes. At the moment it's probably the best insulator available for a wide variety of purposes; but no doubt something with an even longer name and still more virtues will appear before we are much older.

Automobile Ignition Interference

Though all of us heartily cuss the effects of auto ignition interference on our reception of television and other v.h.f. transmissions, the amount of data obtained either in the U. S. and in Britain on the exact nature of this interference seems surprisingly small. We know by experience that it is usually imperceptible on the broadcast band, becomes a nuisance at frequencies above about 3 mc, and is something more than a nuisance above 30 mc. Has it a peak frequency? Is there a frequency above which, like natural static, it has negligible effects? Are its effects worse on horizontally or vertically polarized transmissions? Those are questions to which answers are needed and can't be found in the text books.

Two good bits of work have been

done here by the BBC and the British Electrical and Allied Industries Research Association—let's shorten that one to BEAIRA. Well, BEAIRA conducted two sets of tests on a range of frequencies between 40 and 100 mc, using a vertical dipole antenna for reception. The antenna was sited a few yards from a road along which vehicles of different kinds were driven. The results show that the interference has a sharp peak a little below 50 mc and that in the region of 90-100 mc it may be down by nearly 20 db. The latest BBC field tests largely confirm these findings and add other interesting details. It is found, for instance, that horizontally polarized v.h.f. transmissions are much less affected by ignition interference than those vertically polarized; that much smaller signal field strengths are needed at 90 than at 45 mc to override such interference; and that hardly any interference is caused by vehicles whose ignition systems have been suppressed with a resistor in the main distributor lead.

Another finding of interest to folk on both sides of the Atlantic is that interference with television signals on the 45-mc band (results on the 90-mc band are not available) is considerably more severe with horizontal polarization than with vertical. This surprised me a lot, for I know that many, if not all, American television transmissions have horizontal polarization, whereas ours have vertical. Yet I've seen very few references to this nuisance in U. S. journals, though it crops up constantly in British ones.

Listener-Interest Meter

The magazine published by the International Broadcasting Association reports the development in Denmark of an ingenious method of making direct measurements of listener response to broadcasts. The essence of the invention (which, whatever might be thought at first sight, does *not* belong to Mr. Gernsback's April First class) is this: when a receiving set is switched into an a.c. supply circuit, there is a slight distortion of the supply wave form, owing to the action of the rectifier of the radio. The distortion is small, but it is cumulative and the resulting harmonics introduced can be made to take the form of a voltage proportional to the number of radios in use at any time. By using a calibrated cathode-ray oscillograph, the number of receiving sets in action can be measured directly. The system isn't just a matter of theory; it has been in use for some months in Denmark. Photographic

records of the cathode-ray tube screens are made at regular intervals, and listener-response curves are easily prepared from these.

The scheme has, of course, several limitations. A separate recorder is required for the circuits served by each supply transformer; that, though, is not altogether a disadvantage, for it enables the response of particular districts to be metered. The recorder can't discriminate between the stations to which radios are tuned; all it can indicate is that so many are in use.

Wanted, an ECC

Would that we had in Europe a body as effective for the whole continent as your FCC is for the United States! The channels allotted to our stations are mainly a matter of international negotiation and agreement. There is nothing to compel all countries to come into line and even if all sign the terms of an agreement, such as that on which the new Copenhagen Plan (due to come into force March 15th, 1950) is based, no means exists of enforcing strict compliance in countries where broadcasting regulations are rather vague. The report on frequency measurements during a recent month, for instance, shows that though 181 European stations deviated by less than 5 cycles from their allotted frequencies, there were 84 whose frequency wanderings exceeded 25 *kilocycles!* In the first class there were 17 French stations and in the second 11. Realizing the chaos which such errings and strayings can and do cause, you'll see why I wish so fervently that there could be a European counterpart of the FCC armed with equal powers.





Photo 1—This is original battery eliminator.

Improving Supply To Test Car Sets

By HARRY S. LEEPER

MANY battery eliminators used in service shops to furnish 6 volts d.c. for testing car and some farm radios have no means of regulating the output voltage or checking the voltage applied to the set or the current it draws.

An eliminator with a copper-oxide rectifier is shown, as originally purchased, in photos 1 and 2. The original wiring of the eliminator is shown in the schematic.

This eliminator is rated at 6 volts output with a 15-ampere load. With the original arrangement the voltage would be too high with the light load of most radios.

After experimenting with various



Photo 2—Rear view shows original parts.

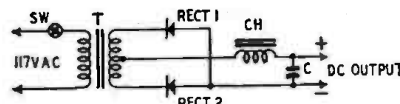

Photo 3—Drill holes in panel for new parts.

lamp bulbs in series with the primary of the eliminator transformer, a variable rheostat was installed in the primary circuit to control the output voltage. A voltmeter across the output was necessary. Since an ammeter in the d.c. circuit often gives clues to radio defects, one was added.

A wire-wound, 150-ohm, 150-watt rheostat was used in the eliminator primary circuit. A lower-wattage rheostat could probably have been used, but the ratings of all rheostats decrease when enclosed in a case. A lower resistance could have been used to drop the output to 6 volts with most radios, but the 150-ohm rheostat makes it possible to drop to 4 volts.

A 0-15-volt meter was used across the output and a 0-25-ampere meter was selected because the output circuit



Eliminator, when purchased, has this circuit.

is fused at 25 amperes. (Fuse is not shown in diagrams.)

A 117-volt pilot-lamp mounting was also obtained, as well as a spare switch for the input circuit. All this equipment was made ready for mounting on the top panel cover, or lid, of the eliminator case.

The parts are shown in photo 3, together with the top panel, which has been drilled and in which the required circular openings have been cut.

Photo 4 shows the panel with the parts assembled, while photo 5 is a rear view.

The wiring shown in the second diagram was then completed. Photo 6 shows the flexible wire used, making it easy partially to remove the top panel in case the fuse blows.

The spare toggle switch installed was not wired, but can be connected in place



Photo 4—New components are on panel.

of the original switch if desired, as the latter's location on one end of the case interferes with standing the case on end.

Photo 7 shows the revamped elimina-



Photo 5—Rear view shows parts ready to wire.

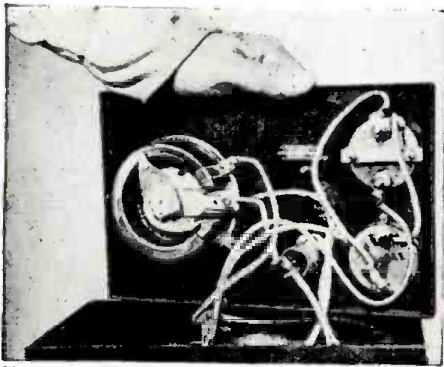

Photo 6—Flexible wire makes assembly simple.

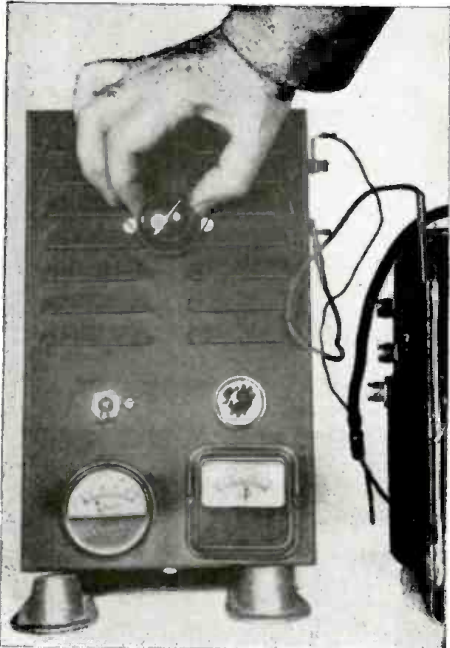

Photo 7—Supply is connected to a car radio.

tor in operation. It is connected to an ordinary car radio and the rheostat is adjusted for practically zero resistance. The closeup view in photo 8 shows that the output is around 9 volts and the

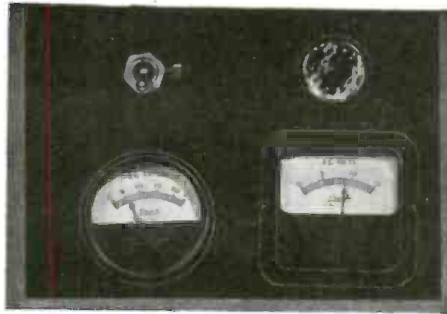

Photo 8—Output: 9 volts; current: 6 amperes.

current about 6 amperes. The rheostat was then adjusted as in photo 9 to give a normal output of slightly over 6 volts. The ammeter then shows less than 5 amperes.

With the rheostat thus adjusted, the radio's buffer condenser was bypassed with a resistor—to duplicate a partially shorted condenser—with the results shown in photo 10. High current with low voltage is indicated, information which makes the meters worthwhile.

Photo 11 illustrates a condition where the rheostat is adjusted—with the radio apparently normal—to place an extremely low voltage (about 4 volts) on the radio.

This treatment may often give an

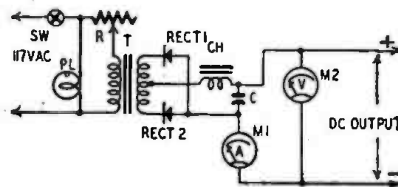

The complete, revamped circuit appears here.

- R—150-ohm, 150-watt rheostat
- PL—117-volt pilot lamp
- SW—S.p.s.t. toggle switch
- T—Step-down transformer
- RECT 1, RECT 2—Dry-disc rectifiers
- CH—Filter choke
- C—Filter capacitor
- M1—0-25-amp. meter
- M2—0-15-volt meter

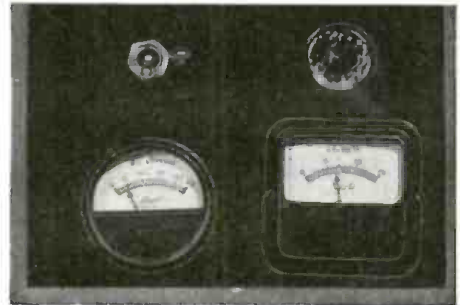

Photo 9—Output: 6 volts; current; 5 amperes.

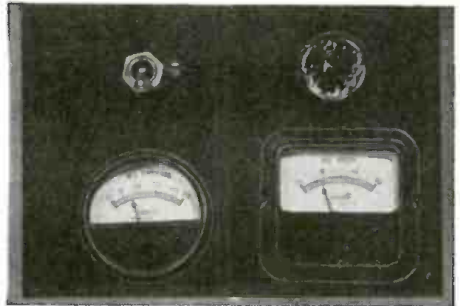

Photo 10—Readings show effect of bad buffer.

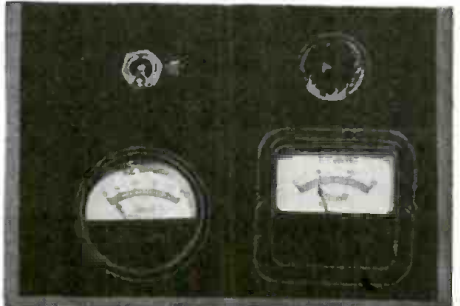

Photo 11—Reduced voltage tests the vibrator.

indication of the condition of the vibrator; one with worn points usually will not start on this voltage unless jarred. A weak 0Z4 rectifier tube may also be detected by lowering the voltage below normal, and other defects may be noted by raising or lowering the voltage and watching the meter indications.

NEW YORK SERVICEMEN FORM STATE FEDERATION

Radio and television service technicians of New York State met October 31 at Binghamton to establish the state federation of radio servicemen, which was formed temporarily at Rochester on October 10. The meeting was attended by about 35 persons, including representatives from Binghamton, Ithaca, New York City, Poughkeepsie, and Rochester. It was arranged by the Radio Servicemen's Association of Binghamton, which acted as host to the delegates from the various local groups.

A statement of aims and objectives was made and rules which will serve as the basis of a future constitution were laid down. The objectives of the new Empire State Federation of Electronic Technicians Associations are to promote fellowship and cooperation among servicing groups and better cooperation between the repair industry and the general public. Delegates pointed out

JANUARY, 1949

that their associations could, through a federation, act more effectively to raise the technical level of their membership by sponsoring lecture tours, and could act in matters concerning state legislation better than could any of the local associations acting alone. A state federation would also have advantages in carrying on educational campaigns among the public and is in a better position to encourage formation of new associations.

Each association will send two delegates to Federation meetings. At present, one of the two delegates also serves on the board of directors. Meetings will be held several times a year. Dues at \$20 a year for each association was set, and it was decided that meetings should be rotated among the various cities which have member associations.

Officers and a board of directors were elected. They will serve until the first

annual meeting, which is to be held in April, 1949. The first permanent officers are: Lawrence Raymo (president, Radio Technicians Guild, Rochester), president; Max Leibowitz (president, Associated Radio-Television Servicemen of New York City), vice-president; Wayne Shaw (president, Radio Servicemen's Association of Binghamton), secretary; Ben De Young (president, Central New York Radio Technicians Guild), treasurer; and Evert M. Holland (president, Hudson Valley Radio Servicemen's Association), Sergeant-at-Arms.

Federation headquarters was established at the address of the secretary, Wayne Shaw, 392 Chenango St., Binghamton, N. Y. The first efforts of the Federation will be to assist technicians or groups of technicians who wish to form their own local associations in any part of New York State.

Proper voltage at the rectifier and none at a tube element which the tube manual shows should have voltage indicates an open resistor or coil or a short-circuit, usually in the form of a blown bypass condenser. An open circuit reduces the voltage at the point it should feed to zero, with little effect on other points. Zero voltage at the plate of the output tube, for instance, and normal voltages at other points, would make the serviceman suspect the primary of the output transformer. In a.c.-

move and tap components while the receiver is playing until a suspicious part is discovered. Then the only sure test is to replace it and play the receiver for several hours. Loose elements in tubes are often the cause of intermittents; in fact, every part in the receiver is suspect and great patience may be required to locate the guilty one.

Do not use a screwdriver or other metal instrument for moving or tapping parts. There is too much chance for it to slip and cause a short.

When replacing defective parts try to duplicate the electrical characteristics of the original, but, with the exception of tuned-circuit components, a large variation may have little effect on performance. Space permitting, voltage and wattage ratings may always be increased. The capacity of bypass and filter condensers can usually be made larger, often with beneficial results. Resistance values are sometimes more critical, but often may be increased as much as 50% without much effect on performance. A study of the circuits and application notes in the tube manual will quickly acquaint you with the very few components whose values are critical.

Larger receivers

From the serviceman's viewpoint, the big differences between a.c.-d.c. midgets and more elaborate receivers are more tubes and higher voltages. Both mean additional points of possible trouble. More tubes mean more circuits, and higher voltages more dropping and decoupling resistors, with their bypass condensers. A systematic approach will locate the troubles in these receivers quickly. With the filaments in parallel, one tube's burning out does not affect the others. The bad one is easily detected because it is cold. Open resistors, which are relatively common, are quickly located with the ohmmeter (power off), or with the voltmeter (power on).

Personal three-way portables yield to the same treatment as the others. If the receiver works on commercial power, but not on the batteries, the batteries are probably dead. (Batteries should be replaced when their voltage has dropped one-third, measured under load.) If the receiver works on batteries and not on commercial power, the trouble is in the rectifier circuits. And if it works on neither, the trouble is one of those previously discussed.

Alignment methods

Aligning a receiver without a test oscillator seems a hopeless task; nevertheless it can be done with nothing more than a neutralizing tool and your ear. If the high-frequency oscillator is not disturbed the job is especially simple.

To align the i.f. amplifier tune in a weak signal, and, starting at the second detector, adjust each trimmer in the i.f. transformers for maximum deflection of the tuning indicator. If the receiver does not have a tuning indicator, simply adjust the trimmers for maximum audio output on a weak sig-

nal or noise. (This will work only on a receiver which has not been tampered with, and which brings in the stations on their correct dial markings. Even then, there is danger of misaligning instead of aligning.—*Editor*)

The mixer and r.f. stage (if any) trimmers are similarly adjusted, although it is doubtful that one setting will give maximum response over the entire band; so a compromise setting must be chosen to give best results over the most-used part of it. As a general rule these trimmers should be adjusted near the high-frequency end of the dial.

Earlier we put a "hands off" sign on the oscillator trimmers because they determine the accuracy of the dial calibration. However, if the calibration is incorrect it may be corrected if a little care is taken. If the receiver uses specially shaped oscillator condenser plates for tracking, tune in a station near 1450 kc and adjust the oscillator trimmer until the station comes in at the correct point on the dial.

In receivers using both series and parallel trimmers, the parallel trimmer (mounted on the variable condenser) is adjusted near 1450 kc and the series trimmer (padder) near 600 kc. The adjustments interact somewhat so they should be repeated for maximum ac-



A tube manual and multimeter are chief tools.

d.c. receivers all plate and screen voltages are obtained from a common point, so a short circuit anywhere causes a drastic reduction in all B-voltages.

No instruments are required to detect excessive hum. If an 8- μ f capacitor temporarily connected in parallel with one of the filter capacitors reduces hum level, the filter capacitors should be replaced.

As the tube manual will tell you, the best test of a tube's worth is how well it works in the piece of equipment concerned. Trying a doubtful tube in another receiver or replacing it with a new one will give all the information required. But there are indirect methods which may be used to obtain an approximate idea of a tube's condition without a tester. Measure the cathode voltage. If it is lower than the rated value, the cathode emission is probably low. Too high a reading may mean a shorted element or that a leaky coupling condenser is applying positive voltage to the control grid.

Touching a finger to the control grid of a good audio tube will produce a hum in the speaker. Touching the control grid of the first audio amplifier will immediately reveal whether a signal can get through the audio section.

The oscillator section of the mixer may be tested by putting the test meter between its control grid and B-minus, with an r.f. choke in series with the meter. If the tube is oscillating, the meter will read a few volts negative and touching the grid will cause the reading to decrease.

Those intermittents

Intermittent troubles take a perverse pleasure in not appearing while the receiver is being worked on. To find them,



Be sure set is off when measuring resistance.

curacy. After the oscillator is adjusted readjust the r.f. stage and mixer trimmers.

Receivers using permeability tuning are set on frequency by adjusting the oscillator padder near 1450 kc and the position of the slug in the oscillator coil near 600 kc. The r.f. and mixer stages are similarly adjusted for maximum output.

This method of correcting frequency calibration assumes that the i.f. is reasonably close to its original frequency, and that the calibration was correct when the set was new, both reasonable assumptions.

The aim of this article is not to belittle adequate test equipment, but to show that successful radio service work can be done with a minimum of it. Undoubtedly, a receiver can be serviced more rapidly with additional equipment, which should be acquired by anyone who intends to service receivers regularly.



He slams something down . . . with a vicious thud. It's a filter condenser, a cardboard-encased dual job, its pigtails waving.

The Impeded Double-Cross

Every radio serviceman will enjoy this piece of fiction,
which contains more truth than many a scientific article

By GUY SLAUGHTER

HE'S a big, flabby geezer in a natty overcoat and precisely creased felt hat, and I instinctively dislike him when he walks in the door and produces a claim check.

"My radio done yet?" he whines, his voice high and wheezy.

I glance at the stub and note the number.

"Sure is," I say, reaching the little three-way portable off the rack and laying it on the counter. "Good as new again."

I write him out an itemized ticket, he peels the six-buck charge off a thick roll, screws his fat face up into a leering grin, tucks the radio under his arm, and starts out the door.

"I'll be seeing you," he says. "Soon."

The way he says it it sounds like a threat, but I just nod, ring up the money on the register, and go back to the bench.

Pretty soon Pedro, the little Mexican kid who works for me, comes in, school being over for the afternoon.

"Hi, Herk," he says, walking back to the bench. "What's 'Z' mean?"

"'Z'?" I say absently, squirting carbon tet into a noisy volume control. "What're you talking about?"

"Physics," Pedro says, leaning his elbows on the bench and staring into the chassis I'm working on. "The prof says we got to remember 'I equals E over Z', but he don't say what 'Z' is."

"Impedance," I say shortly. "That's Ohm's law for a.c., and 'Z' is the impedance."

"What's impedance?" asks Pedro, poking a finger into the wiring and flipping a blob of dripped solder off a terminal lug.

So I grab a scratch pad and explain, in words of one syllable, the difference between resistance and impedance. Finally I run out of breath and break my pencil point, simultaneously.

"Thanks, Herk," Pedro says. He points to a resistor in the up-ended chassis. "That's a resistor," he indicates a condenser, "and that's an impededer, huh?"

I pack up some tools, disgustedly, collect a bunch of repaired chassis, and start out to the truck to make my rounds. It's late when I get back, and I find that Pedro has locked up and gone home.

Next afternoon Pedro comes in after school wearing a look of smug satisfaction. I can see he's got something on his mind, so I set down my soldering iron, and give him my full attention.

"Okay," I say. "Let's have it."

"You're wrong," he says gleefully, consulting a piece of paper on which he has apparently taken notes. "The prof says 'Z' is the algebraic sum of the inductive and capacitive reactances tending to resist the flow of current in an a.c. circuit." He grins at me triumphantly, and looks at his paper again. "And a device possessing capacitive reactance is known either as a condenser or a capacitor, never as an impededer."

I open my mouth to give him the business, but just then the door slams, and I see through my peephole that the fat boy with the overcoat is back, complete with reinforcements, so I thumb Pedro out front to take care of him.

"I wish to see the proprietor," the high voice wheezes. "In person."

I figure the portable has popped a tube, and I walk out resignedly. But he hasn't got a radio with him. His hands are flat on the counter, and a nasty smile is on his flabby face. Behind him, staring at the floor, is a short, thin guy in greasy coveralls.

"I'm afraid you're in trouble," Fatty starts off, still leering at me. "Remember the radio you fixed for me?" He accents the "fixed" heavily.

"Yes," I say. "I do."

"Allow me to introduce myself," he says, hands still flat on the counter. "I'm T. William Pearson." He pauses reverently, as though waiting for me to salaam, but the name doesn't mean a thing to me.

"So?" I say.

His red face turns a trifle redder, but he continues.

"I own and operate Pearson Motor Sales and Service, of which you have no doubt heard." He pauses again.

I nod, and repeat my question.

"So?"

By now his moon face is crimson.

"I also happen to be the newly-elected president of the MFBEA, and as such I am opening a newspaper campaign against sharp dealers like you."

"What's the MFBEA?" I break in. "And whattya mean sharp dealers?"

He pauses dramatically, lifts one hand, and waves it like a ham actor.

"Merchant's Fair Business Enforcement Association," he squeaks. His hand stops waving and moves toward me. He waggles a fat finger in my face, his voice rises to a shrill scream. "We're pledged to expose you sharp dealers who prey upon the public and suck the blood of unfair profits from the economic veins of our fair city. . . ."

RADIO-ELECTRONICS for

Get Your ALLIED Catalog Now

180 Value-Packed Pages Featuring

Everything New in Radio!

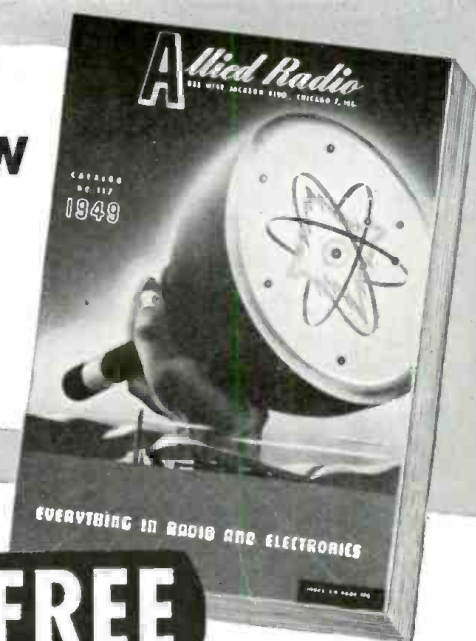

FREE

Send for the **ONE COMPLETE** Radio Buying Guide!

Get the Radio Buying Guide that's used by thousands of expert servicemen, engineers, amateurs, soundmen, builders and experimenters. Get every buying advantage at ALLIED—widest selection of equipment at money-saving low prices—speedy, expert shipment—personal attention—complete satisfaction on every order. Get your ALLIED Catalog today!



NEW! Projection Television by Hallicrafters—16" x 12" Screen

Amazing 192 Sq. Inch Picture!

Develops a brilliant, steady, optically correct picture; glare-free for comfortable viewing both at close range or distance, day or night. Optical system stays in perfect, stable adjustment. Includes following features: 2½" magnetic projection triode, sealed optical unit, 25 kv high voltage unit, 12 channel push-button selector, RF amplifier, 3 IF amplifiers, 2 video amplifiers, special synchronizing circuits, AGC and black level control, single picture control, inter-carrier FM system. Complete with 20 tubes, plus projection triode and 5 rectifiers. In handsome classic Chippendale mahogany cabinet. For 105-125 volts, 50-60 cycles AC.

T-68

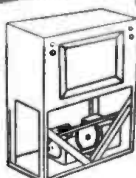

T-60

IMMEDIATE SHIPMENT FROM STOCK

- 97-805. Hallicrafters T-68 Projection TV in console. NET, f.o.b. Chicago..... **\$695**
- 97-801. Hallicrafters T-60 Projection TV in rack (less cabinet) for custom installation. NET, f.o.b. Chicago..... **\$595**



Hallicrafters 10" Direct View!

Here's an unbelievably sharp picture, with excellent stability and truly photographic contrast. Priced amazingly low for the quality. Features include: 12 channel push-button tuning, RF amplifier, 3 IF amplifiers, 2 video amplifiers, improved sync circuits, AGC, static-free FM. Complete with 19 tubes, plus 10" picture tube and 3 rectifiers. In rich mahogany table cabinet. For 105-125 volts, 50-60 cycles AC.

- 97-804. Hallicrafters T-67, 10" TV wood table model. NET, f.o.b. Chicago..... **\$299.95**
- 97-802. Hallicrafters T-61. As above, in black plastic cabinet. NET, f.o.b. Chicago **\$289.95**

Famous Hallicrafters 7" TV Receiver

An immensely popular TV receiver at low cost! Provides a brilliant 23 square-inch picture. Easy to operate; excellent sound; install it yourself.

- 97-803. Hallicrafters 505 in mahogany cabinet. NET, f.o.b. Chicago..... **\$199.50**
- 97-800. Hallicrafters T-54, as above, but in gray furniture-steel cabinet. NET, f.o.b. Chicago..... **\$189.50**

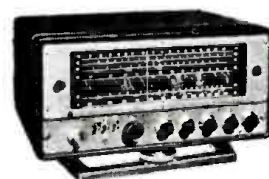

Short Wave Listeners! DX Fans! SX-62

HALLICRAFTERS' special SWL Receiver! Tuning range: 540 kc to 110 mc, continuous—world-wide Short Wave and special services; broadcast and all FM channels between 27 mc and 110 mc. Features: professional slide-rule dial; 500 kc crystal calibrator; single knob tuning, 60 to 1 ratio; bands illuminated separately; series type ANL; 4-position tone control; high-fidelity audio; 6-step filter; dual IF channels; crystal filter; 8 watts output, etc. In handsome steel cabinet. With tubes.

- 97-540. SX-62. NET, f.o.b. Chicago **\$269.50**
- 97-780. R-42 Speaker to match. NET .. **\$34.50**
- 97-568. B-42 Tilt-Base. NET **\$7.50**

Radio's Leading Buying Guide...



- ALLIED RADIO CORP., Dept. 2-A-9
- 833 W. Jackson Blvd., Chicago 7, Illinois
- Send FREE 180-Page ALLIED Catalog
- Enter order for Hallicrafters Model.....
- Full Payment Enclosed S..
- Part Payment (Bal. C.O.D.)
- Send ALLIED Easy Payment Plan details and order blank.

Name.....

Address.....

City..... Zone..... State.....

Everything in Radio and Electronics



"Wait a minute, Buster," I interrupt him, my plate current rising to saturation. "You come in here calling people names and making false accusations and you're going to lose a couple of those chins!"

He draws back a step, some of the color seeping out of his face, and throws a glance at his companion.

"False accusations, huh?" he bleats. "We'll see about that." He turns to the little guy, and waves a hand at him. "This is my chief mechanic, and he knows about radios, too."

The little guy looks up, catches my eye, and drops his head again, his pasty face turning a pale pink. Out of the corner of my eye I see Pedro looking from one to the other of us, obviously as mystified as I am. T. William continues his tirade.

"Jonas here cut a wire in my radio, one little wire mind you, and I brought it here to test your honesty. You charged me six dollars to fix it. Obviously you are a cheat and a fraud, and I intend to see to it that you are run out of business. The MFBEA shall state the facts in the paper for all to see, in a half-page paid advertisement." He pauses for emphasis, breathing heavily, one hand aloft.

I stand there with my mouth open, wondering what a lawyer can do for me. The words "libel" and "defamation of character" flash through the space between my ears, followed by "attorney fees" and "supreme court." After a minute I come to. The fat guy is still posing like the avenging angel, the pasty-faced mechanic is still looking floorward, and Pedro is regarding me, wide-eyed, somewhat as he would a cat whose disguise has just slipped, revealing instead a skunk.

I grab the card-index off the desk, and thumb through it until I find the job ticket labelled "Pearson, T. W." I lay the card on the counter, and read it to myself, and then aloud.

"Olympiad three-way portable," I read, my voice sounding strange. "Open second i.f. transformer replaced, set tracked and aligned. Total, six dollars." I look up, feeling kind of empty inside. "Look, Buster," I manage weakly. "That's a perfectly legitimate charge. The i.f. transformer was open, so I installed a new one, realigned the set, and you paid for time and materials used on the job."

T. William clears his throat triumphantly.

"There was just a cut wire," he wheezes. "That's all."

I turn to the mechanic, who is still looking at the floor.

"A cut wire?" I manage to ask him.

The little guy takes a deep breath, raises his eyes until they are fixed determinedly on my necktie, and reels it off as though it is memorized.

"I removed the chassis from the cabinet, peeled the insulation off a red wire, cut the wire, and replaced the insulation to cover the place where the wire was cut. Before I performed this operation the radio played nor-

mally." He licks his lips, casts a side-long glance at T. William, and drops his eyes back to the floor.

"Okay," I holler. "That wire must've been the hot lead to the i.f. transformer. The winding showed no continuity, so I replaced the whole transformer." Fatty is leering at me, all of his chins bobbing, and Pedro is squinting from one to the other of us, trying to decide which one to vote for. "Any radioman would have done the same thing," I argue. "It's a perfectly routine procedure."

T. William raises one hand to his mouth, blows idly at his fingertips, yawns, and leers at me again.

"I dare say," he says. "All that for one cut wire. It will make interesting reading in the paper, I'm sure."

"Look," I blurt, trying to keep my voice calm. "Mr. Pearson, you're making a mistake! A gimmicked radio is no test of a radioman's honesty or ability. In the routine of radio repair you just don't look for rigged-up defects."

Pedro has apparently made up his mind, and he slips quietly out the front door. I feel like a ship being deserted by her crew when it is needed most.

"A cut wire," the flabby one wheezes, "should be a cinch. Either you are incompetent to be trusted with people's radios, or you are downright dishonest." He smiles his nasty smile again. "Either way, you shouldn't be in business and the MFBEA will see to it that this fair community's citizens are made aware of that fact." He tips his natty hat at me disdainfully, and heads for the door, the pasty-faced grease-mon-

key dutifully at his heels. I stand there for a minute and watch them climb into a shiny black sedan out front; then I head for the bench and sit down dazedly to think it over.

In a few minutes the door opens, and Pedro strolls back and greets me with a big smile.

"Wanta see the fun?" he asks hopefully.

But I just wave my hand at him, and dig deeper into my gaze, so he wanders out front and leaves me alone.

After a while I rouse myself and go to the telephone. The lawyer on the other end of the line listens to my story in silence, and asks me whether T. William's radio did have just a cut wire wrong with it. I tell him yes, I guess so, he clucks his tongue disapprovingly, and hangs up.

"Should have seen it, Herk," Pedro says, coming away from the show window where he's been peering into the street. "He was so mad I thought he was going to kick the poor little mechanic." He chuckles appreciatively. "They finally towed it away."

"They did?" I say absently. "What?"

"T. William Pearson's car," Pedro says, eyeing me a bit apprehensively. "It wouldn't start."

"Good," I say, wondering how many people will see that half-page ad. "I hope somebody stole the engine."

"Nope," says Pedro thoughtfully. "Too much impedance."

"Yeah," I echo, wondering where I can find a nice town full of defective radios to open a shop in. "Too much impedance."

Pedro looks kind of disappointed, at

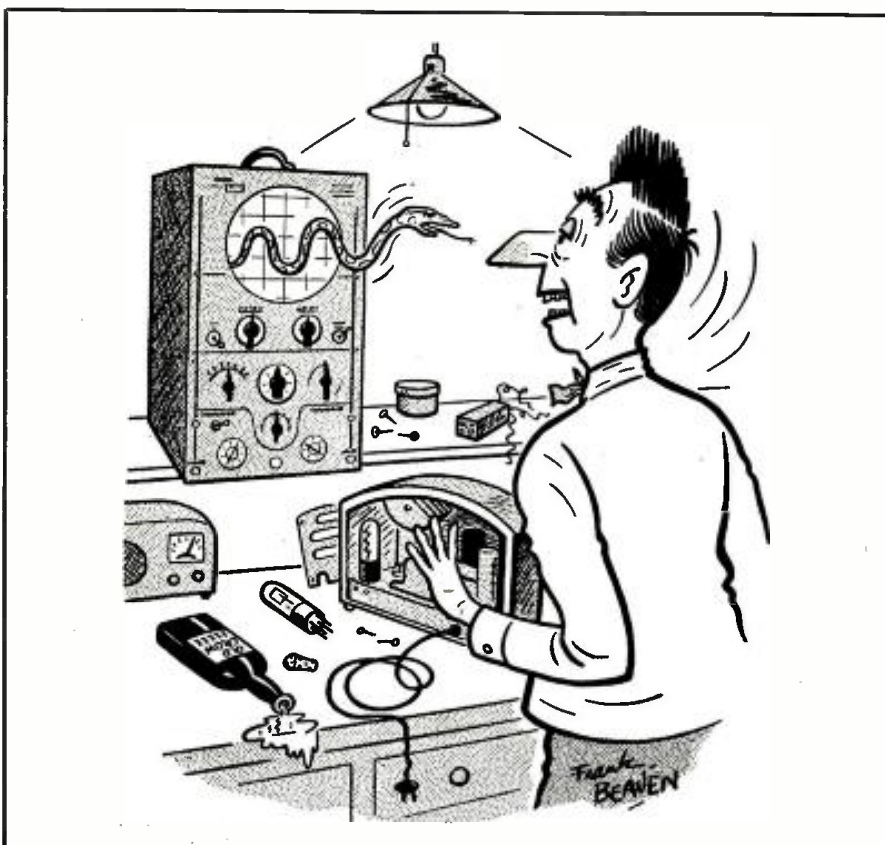

New 1948 TELEVISION Manual

INCLUDES EVERY POPULAR TELEVISION RECEIVER

In this giant volume of television factory data, you have everything you need to repair every modern television set. For only \$3, total price, you get complete service and alignment material on all popular T-V sets. You receive easy-to-understand explanations of circuits, 144 pages of alignment procedure, test patterns, T-V antenna data, response curves, oscilloscope waveforms, voltage charts, adjustment hints, many diagrams on mammoth 11x17-inch blueprints, everything to bring you up to date and make you an expert in television repairs.



Compiled by M. N. Beltman, radio engineer, teacher, author & serviceman.

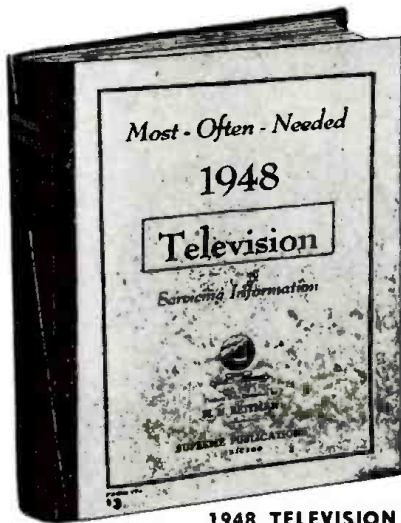

1948 TELEVISION

Contains material on all popular television sets, of Admiral, Belmont Radio, DuMont, Farnsworth, General Electric, Hallcrafters, Motorola, Philco, R.C.A., Sonora, Stromberg-Carlson, and others. Gives description of circuits, many pages of test patterns, response curves, oscilloscope waveforms, alignment tables, service hints, many diagrams in the form of giant double-spread blueprints, test points, voltage charts, etc. Large size: 8 1/2 x 11 in., manual style binding, flexible covers, priced at only **\$3.00**

FIND-FIX ALL TELEVISION FAULTS

Use this new practical "cyclopedia" of television servicing as your guide to quick fault finding and repair of any modern television set. Eliminates guesswork—tells you just where to look and what to do. Cuts hour-wasting jobs to pleasant moments. Use test patterns for quick adjustment, or look up probable cause of trouble in the pages of hints after simply observing fault of picture on screen. No equipment needed with these tests. Or use your volt-meter and compare values with many voltage charts included. Observe waveforms similar to hundreds illustrated using test points suggested and in a flash locate what used-to-be a hard-to-find fault. This manual will give you the know-how of a television expert and will repay for itself with time saved on the first T-V job. Order at our risk for a 10-day trial.

BIGGEST BARGAIN T-V TRAINING

For 15 years, radio servicemen expected and received remarkable values in Supreme Publications service manuals. The new 1948 Television Manual is a virtual treatise on practical television repairs. By normal standards, such a large manual packed as it is with practical data, illustrations, diagrams, charts, photographs, and expensive extra-large blueprints, should sell for \$10—but as another Supreme special value, it is priced to servicemen at only \$3, post-paid. Only a publisher who sold over one million of various radio manuals can offer such bargain prices based on tremendous volume-sales. Read about this new T-V manual at left. Find out about other radio manuals listed below. Use and save with Supreme Publications.

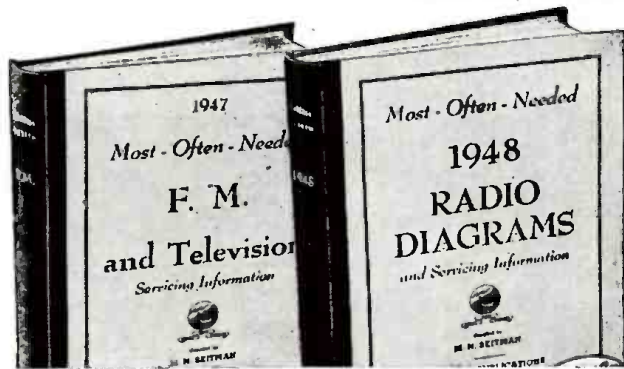

F. M. and Television

Use this extra-large manual of factory instructions for trouble-shooting, repairing, and alignment of all popular 1947 F.M. and Television sets. Covers every popular make, including F.M. tuners, AM-FM combinations, and all types of television receivers. Detail circuit diagrams, theory of operation, test hints, alignment data, including both meter and oscilloscope methods. Use this recent Supreme manual to save time and money on your very next F.M. job. Data presented on 192 large pages. 8 1/2 x 11 inches. Sturdy, manual-style binding. Tremendous value. Price postpaid, only..... **\$2.**

1948 Radio Diagrams

Be prepared to repair quickly all new 1948 radio receivers. In this big single volume you have clearly-printed, large schematics, needed alignment data, replacement parts lists, voltage values, and information on stage gain, location of trimmers, and dial stringing, for almost all recently released sets. Makes toughest jobs amazingly easy. Find all faults in a jiffy. A worthy companion to the 7 previous volumes used by over 120,000 shrewd radio servicemen. Will pay for itself on first job. Manual covers models of 42 different manufacturers. Giant size 8 1/2 x 11 inches. 192 pages. Index. Manual-style binding. Price only.... **\$2.**

RADIO DIAGRAMS AND F.M. SERVICE MANUALS

You can speed-up and simplify radio repairs with Supreme Publications Manuals. Service radios faster, better, easier, save time and money, use these most-often-needed diagram manuals to get ahead, earn more per hour. For the remarkable bargain price (only \$2 for most volumes) you are assured of having in your shop and on the job, needed diagrams and other essential repair data on 4 out of 5 sets you will ever service. Every popular radio of all makes from old-timers to new 1948 sets, including F.M. and Television, is covered. Clearly printed circuits, parts lists, alignment data, and helpful service hints are the facts you need to improve your servicing ability. Let these manuals furnish you with diagrams for 80% of all sets. There is no need to spend large sums for bulky, space-wasting manuals, or to buy additional drawings every few weeks; be wise, use SUPREME Manuals to get the most in diagrams and service data for the smallest cost. Select manuals at left and below. Check titles you want to examine and rush "no-risk" coupon today.



1947 1946 1942 1941 1940 1939 1926-1938

MOST-OFTEN-NEEDED RADIO DIAGRAMS

Each manual has between 192 and 208 pages of diagrams, alignment data, voltage values, and service hints, manual style, large size, 8 1/2 x 11". Price, each..... **\$2**

DIAGRAMS

240 Pages Price \$2.50

Record Changers

Post-War Manual

Service expertly all modern (1945-1948) record changers. Includes every popular make. Just follow simplified factory instructions to make needed adjustments and repairs. Hundreds of photographs and exploded views. Large size: 8 1/2 x 11 inches. 144 fact-filled pages. Price postpaid, only..... **\$1.50**

Radio Servicing Course-Book

Here is your practical radio course of 22 easy-to-follow lessons. Review fundamentals, learn new servicing tricks, all about signal tracing, oscilloscopes, recording, P.A., test equipment, and T-V. Just like a \$100.00 correspondence course. Everything in radio servicing. With self-testing questions and index. Large size: 8 1/2 x 11". Great value, only..... **\$2.50**



New 1948 Edition

NO RISK TRIAL ORDER COUPON

SUPREME PUBLICATIONS, 3727 W. 13th St., Chicago 23, ILL.

Ship the following manuals on trial under your guarantee of satisfaction or money-back.

Most-Often-Needed Radio Diagram Manuals

- New 1948 Television Manual.... \$3.00
- 1947 F.M. and Television Manual 2.00
- Post-War Record Changers..... 1.50
- Radio Servicing Course-Book.. 2.50

PRICED AT ONLY \$2. EACH

- 1948
- 1947
- 1946
- 1942
- 1941
- 1940
- 1939
- 1926-1938 — \$2.50

- I am enclosing \$...., send postpaid.
- Send C.O.D. I am enclosing \$... deposit.

Name:

Address:

Supreme Publications

Sold by all Leading Radio Jobbers

that, but I'm too busy thinking black thoughts to pay much attention. And after a little, from sheer force of habit, I collect some tools and start off in the truck to make my rounds.

I struggle through my bench work the next day, wiring filters up backwards and in general doing everything wrong, so I'm still hours behind schedule when, about the middle of the afternoon, Fatty shows up again. He's alone this time, and I can tell he's hopping mad even before I leave the bench and get out front to face him.

His pudgy hands are clenching and unclenching, his face is gassy-rectifier purple, and all the time gassy, popping sounds are being beamed from him to me.

I stand there a minute just watching him burn, and then I find my voice. "Now what?" I say wearily.

He slams something down on the counter with a vicious thud, and I see it's a filter condenser, a cardboard-encased dual job, its pigtailed waving.

"That yours?" he gurgles, exuding a purple mist.

"Could be. I use that brand. Why?"

"I'll sue," T. William screeches, waving his arms about. "I'll sue you for everything you've got. You can't get away with this."

"Huh?" I say, staring at him.

His squeaky voice oozes up toward the high-frequency limit of my hearing, and I think he's going to blow a fuse.

"It's sabotage," he wails. "I'll sue for every cent you've got."

Just then Pedro walks in, takes in the situation at a glance, stares for a minute at the filter condenser on the counter, and makes for the back room.

T. William spots him as he goes by, and points a shaking finger at his retreating back.

"He's your agent, the little monster," he wheezes. "You put him up to it. Contributing to the delinquency of a minor, they'll call it. You'll never get out of jail." By now he's spitting all over me as he mouths the words.

"What the devil are you shouting about?" I manage, grabbing his fat-stuffed hand as it waggles in front of my face. "Shut off that howling and tell me what goes on."

Fatty stands there breathing hard for a minute, not quite sure whether he's in bodily peril or not, and I take advantage of the fact.

"Speak up," I urge him, "while you're still in one piece."

He backs up a step, looks wildly about for a means of escape, and sees the door behind him. He retreats toward it, reaches it, and stops with his hand on the knob. That gives him courage.

"You had that little beast sabotage my car yesterday," he says, a little calmer now, beginning to get hold of himself. "My mechanics worked all night and most of today on my engine, and you're going to pay for it. They pulled the head, checked the valves, the head gasket, the ignition, carburetion, everything, and when they got

through it still wouldn't run. They just found it a few minutes ago, and I've been paying them time-and-a-half since five o'clock last night." He pauses, breathless, then waves his fist at me. "I'm suing you for the entire cost plus damages," he whines. Then he heaves the door open, stands in the doorway for a minute, and stalks out, muttering to himself in a high screech.

I watch him climb into the sedan at the curb, and pull away, his lips still moving, and scratch my head in sheer bewilderment. Then a blinding light flashes in my alleged brain.

"Pedro," I say, my voice rising ten decibels with each syllable. "Pedro, you come out here!"

The little guy strolls out, his face a mask of innocence, closely scrutinizing his fingernails.

"Pedro," I say, forcing myself to tone down a little. "What was that all about?"

He smiles half-heartedly.

"What d'ya mean, Herk?"

"You know what I mean," I say, trying to keep my voice calm. "I mean him!" I jerk my thumb in the direction of the front door.

"Oh," says Pedro blandly. "That."

I tap my foot menacingly, and eye him coldly.

"I just rammed that thing into the exhaust pipe, is all," he says innocently, pointing at the filter on the counter. "And then I guess his car wouldn't start." His eyes are very big and cocker-spanielish. "Too much impedance, huh?"

I stare at him for a full minute, and he starts to squirm.

"Looks like a good mechanic could find it in no time, Herk," he says, and he drops one eyelid in a slow wink.

Finally, at long last, I wake up. It takes me two minutes to dial the right number, and another two minutes to get T. William Pearson on the line.

"Hullo, Fatty?" I say. There is a gasp in the receiver, and I continue. "This is the radio shop, Fatty. What page is the MFBEA running that ad on?" I don't wait for an answer, but plunge ahead. "You see, Fatty, I want the other half of that page to tell the public that all the mechanics at Pearson Motor Sales and Service spent a good many man-hours on a dead engine that just had its exhaust plugged."

I pull the receiver away from my head and wait until the splutters subside a little. Then I listen.

"Oh well," I say. "Same thing, you know. Cut wire or plugged exhaust; a rigged-up defect is a good test of honesty and ability I've been told." I feel my smile spreading over my ugly face as I hang up. I'm still smiling when Pedro plucks my sleeve.

"Is it okay, Herk?" he asks.

I dig deep and hand him a buck.

"Yeah, Pedro," I say. "It's okay." My eye lights on the filter.

"And Pedro. You can tell your prof he's wrong." I pick up the filter and hand it to him. "Sometimes a condenser IS an impedor," I say, happily.

CONDENSERS—PAPER TUBULAR 600 WV—.001-.002, .005—.06; .01, .03—.06; 1—10e; 25—23e; .05—.35e; **ELECTROLYTICS:** 8mfid 200v—20e; 100mfid 35v—20e; 30mfid 150v—25e; 20/20mfid 150v—33e; 30/20 150v—48e; 50mfid 150v—43e; 8mfid 475v—34e; 16mfid 350v—65e; 01. **CONDENSERS:** 4mfid 600v—69e, 2mfid 600v—49e; 3X.1mfid 600v—29e.

SPEAKERS—These PM speakers are the finest that are available. All have heavy oversize Alnico V magnets.
3 1/2" \$1.15 6 for \$6.80
5" \$1.15 6 for \$6.80
6" \$1.15 6 for \$6.80
6"x4" Oval \$2.10 6 for \$10.80
7" (Car Radio Size) \$4.50 6 for \$21.50
8" \$3.95 6 for \$20.50
8" 21 oz. \$4.95 6 for \$26.50
10" 21 oz. \$5.50 6 for \$30.00
12" 21 oz. \$7.95 6 for \$42.00

AUTO-TRANSFORMER—Steps up 110v. or steps down 220v to 110v—\$2.95.

FIL. TRANSF.: 6.3v, 3 Amps.—\$1.35; Universal Output Trans. 8 Watt—89c; 18 Watt—\$1.29; 30 Watt—\$1.69. **AUDIO TRANSFORMER:** 8 Plate to 8 Grid—\$1.79; S. Plate to P.P. Grids—79c; Heavy Duty Class AB or B. P.P. inputs—\$1.49; Midget Output for AC-DC sets—69c; **MIKE TRANSFORMER** for T-17 Shure microphone, similar to UTC oncener type—\$2.00. Stancor SB or DB mike to line or grid—\$1.95.

POWER TRANSFORMERS—Half-shell type, 110V. 60 cycle. Center-tapped HV winding. Specify either 2.5 or 6.3V filament when ordering.

For 4-5 tube sets—850V, 40MA, 5V & 2.5 or 6.3V \$1.49

For 5-6 tube sets—850V, 45MA, 5V & 2.5 or 6.3V 1.75

For 6-7 tube sets—875V, 50MA, 5V & 2.5 or 6.3V 1.90

For 7-8 tube sets—700V, 70MA, 5V & 6.3 or two 2.5V 2.35

For 7-8 tube sets—700V, 70MA, 5V & 6.3 (25 Cycle) 3.60

For 8-9 tube sets—700V, 90MA, 5V-3A, 2.5V-3.5A, 2.5-10.5A 2.85

For 9-11 tube sets—700V, 5V & 6.3V-4A 2.85

For 9-15 tube sets—600V, 150MA, 5V & 6.3V 2.95

1000 CYCLE AUDIO FILTERS

Navy PD52010-1 low Pass audio filters as mentioned in the "Peaked Audio" article in June CQ, and designated by the above number, are the exact electrical and physical equivalent of commercial audio filter units selling for \$35.00 wholesale. They are infinitely better than the surplus "Radio Range Filters" being sold for reducing QRW, and at 2 KC off resonance for example, a 2 section filter using PD52010-1 is capable of twice the selectivity available in the use of the Q5 or (the BC453 section of the 274N which has provided the amateur's previous highest standard of interference elimination). **EXTRA SPECIAL—NAVY PD52010-1 with diagram** \$5.00

One hundred resistors \$1.95

Ten metal & Bakelite Knobs. (no wooden knobs) 39c

Six variable condensers, including butterfly types \$1.49

Ten R.F. Chokes, including high frequency types 35c

Four volume controls without switches 95c

Seven I.F. Transformers \$1.98

Five shield coils 69c

The above 7 assortments listed, can be purchased together as one lot at a super-special total price of only \$6.95. All merchandise guaranteed to be as advertised.

TUBES—ALL types in stock—Maximum discounts when ordered in lots of ten or more.

WORLD RENOWNED—700-page, tenth edition of the **RADIO HANDBOOK** in cloth binding and hard cover at the sensational reduced price, for a limited time only \$1.49

Book on **DRY DISC RECEIVERS** by H. B. Conant, nationally recognized authority on the subject. Theory and practical applications \$.25

\$10.95 TAKES ALL THREE BIG BARGAINS

1. **SENSATIONAL, FASCINATING, MYSTERIOUS SELSYNS.** Brand new Selsyns made by G. E. Company. Two or more connected together work perfectly on 110V AC. Any rotation of the shaft of one Selsyn and all others connected to it will rotate exactly as many degrees in the same direction, following unerringly as if the units were connected together by shafting instead of wire. This is true whether you twist the shaft of the master unit a fraction of a revolution or many revolutions. Useful for indicating direction of weather vanes, rotating directional antennas, or controlling innumerable operations from a distance. Complete with diagram and instructions. Per Matched Pair \$4.35.



2. **ALUMINUM GEAR BOX** 18x8x7 that contains two powerful electric motors and two matched gear trains. 62 gears in all varying in size from 1/4 to 4 inches in diameter. This unit is readily converted to rotate a beam antenna or any other similar use \$5.00

3. **HOME WORKSHOP AT BARGAIN PRICE.** Accurate and precise 2 speed guaranteed hobby lathe, the essential machine for the home workshop. Sturdy enough for light production work or factory standby service. Supplied with 56' of belting for connecting to any available electric motor or power take-off. Also included in this unbelievable offer are such accessories as a 3/4" drill chuck with specially hardened tool steel jaws, a 4" electric furnace high speed grinding wheel, a cotton buffing wheel with a large supply of buffing compound, and a 4" steel wire scratch brush. Your cost \$6.00. Sole export agent. Distributor inquiries invited.

BUFFALO RADIO SUPPLY

219-221 Genesee Street Dept. RE

Buffalo 3, New York

Please send 1949 Bargain Catalog

Name

Address

City Zone State

RADIO-ELECTRONICS for

RADIOMEN'S HEADQUARTERS + WORLD WIDE MAIL ORDER SERVICE !!

GENERAL ELECTRIC 150 WATT TRANSMITTER

Cost the Government \$1800.00 • Cost to You—BRAND NEW—\$100.00

This is the famous transmitter used in U.S. Army bombers and ground stations, during the war. Its design and construction have been proved in service, under all kinds of conditions, all over the world. The entire frequency range is covered by means of plug-tuning units which are included. Each tuning has its own oscillator and power amplifier coils and condensers, and antenna tuning circuits—all designed to operate at top efficiency within its particular frequency range. Transmitter and accessories are finished in black crackle, and the milliammeter, voltmeter, and RF ammeter are mounted on the front panel. Here are the specifications: **FREQUENCY RANGE:** 200 to 500 KC and 1500 to 12,500 KC. (Will operate on 10 and 20 meter band with slight modification for which diagrams are furnished.) **OSCILLATOR:** Self-excited, thermo compensated, and band calibrated. **POWER AMPLIFIER:** Neutralized class "C" stage, using 211 tube and equipped with antenna coupling circuit which matches practically any length antenna. **MODULATOR:** Class "B"—uses two 211 tubes. **POWER SUPPLY:** Supplied complete with dynamotor which furnishes 1000V at 350 MA. from either 112 or 24 volts. Complete instruction are furnished to operate set from 110V AC. **SIZE:** 2 1/4 x 23 3/4". Total shipping wt. 300 lbs., complete with all tubes, dynamotor power supply, seven tuning units, antenna tuning unit and essential plugs.

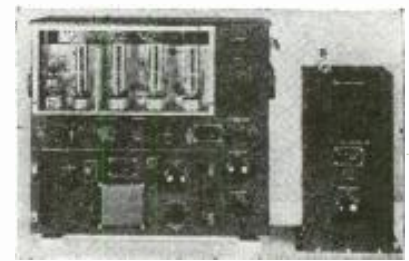

HEAT GUN

Streamlined pistol grip heat gun in virid red housing, that delivers a powerful 20 Cubic Ft. per minute blast of hot air at 160 Fahrenheit. Ordinary blowers have small fan motors, but this has a lifetime-lubricated AC-DC motor of the rugged vacuum cleaner type, that produces a hurricane of either hot or cold air. Perfect for blowing out dirt or dust from radio chassis, drying out ignition systems, warming up carburetors, quick-drying paint, blowing out radiators or water pipes, etc. **Warning:**—Keep this away from your wife, or she will be using it to dry her hair because it will do it in half the time of the ordinary hair dryer. To say nothing of her using it to dry stockings or clothing, or defrost the refrigerator instantly. Only \$12.95. Satisfaction guaranteed or money refunded if returned prepaid within 5 days.



Sensational Value in AC-DC Pocket Tester

This analyzer, featuring a sensitive repulsion type meter housed in a bakelite case, represents the culmination of 15 years achievement in the instrument field by a large company specializing in electronic test equipment.



Specifications of the AC-DC Model
 Volt-Ohm-Milliammeter:
 AC Volts—0.25, 50, 125, 250
 DC Volts—0.24, 50, 125, 250
 Milliamperes AC—0 to 50
 DC Milliamperes—0 to 50
 Ohms Full Scale—100,000
 Ohms Center Scale—20,000
 Capacity—95 to 15 Mfd.

Total Price, prepaid anywhere in the U.S.—\$7.00
 Similar DC Meter, lacking the AC operated ranges of above, \$5.50 prepaid.

RT-1655—11 tube crystal controlled superheterodyne receiver that cover the FM band. The ultra modern circuit uses the latest types of tubes including 7 miniature 6A15's. Beautiful chassis and aluminum cabinet. Tubes and schematic supplied—\$14.95

World renowned 700 Dase tenth edition of the Radio Handbook in cloth binding and hard cover at the sensational reduced price, for a limited time only, \$1.49
 RT111 Brand New 12 Tube, 110 Volt Receiver-Indicator-Oscilloscope complete with all tubes and power supply. Has telescoping hood over scope tube, which is equipped with a detachable calibrated screen. Has centering and amplitude controls and two video inputs. A natural for television..... \$39.95

Latest type PM Speaker in a fully-enclosed black crackle finished metal cabinet. This speaker and case match communication receivers, and in addition, make perfect intercom remote stations. Our price \$4.50, including output transformer..... \$4.95

Stupendous Value in 3 Section PERMEABILITY TUNER

The heart of one of this year's hottest radios. The entire variable tuning section of a deluxe car radio. Truly half of a radio. Shielded R.F. sections litz wire wound. All 3 tuned circuits adjustable at both low and high ends of dial. Amazingly tiny (4x3x2 1/2). Compact enough to be used to pep up any 2 or 3 gang superhet or 3 gang TRF. Will substitute for entire original tuning system including variable condenser or if desired the original tuning condenser can be connected to these coils, and the coils set to proper inductance (no instruments required), and the set tuned just as before, although much greater sensitivity and selectivity will result. Can be used as a multiple section variable that will cut out undesirable interference as with a knife, or if only a little bit better than average results with a slug-tuned wavecap are necessary, the unit can be split up in a couple of minutes into 3 coils that can be used on 3 different jobs. These coils, supercompact and really hot, can also individually replace any broadcast band RF, oscillator, or 1st detector coil with improvement in results in any set. After seeing one of these units, you'll order a dozen just for general repair or replacement work. Cost the manufacturer several dollars. Your cost \$1.49.

SELENIUM RECTIFIERS

(May be used at any voltage lower than rating)
 *1.2 ampere.....30 volt.....\$.90
 (above can be paralleled for battery charging)

25 MA.....	50 Volt.....	\$.48
75 MA.....	120 Volt.....	.75
100 MA.....	20 Volt.....	.75
150 MA.....	120 Volt.....	.80
200 MA.....	170 Volt.....	1.05
220 MA.....	120 Volt.....	1.25

METER RECTIFIER—Full wave, may be used for replacement, or in construction of all types of test equipment—\$1.25. Half Wave—90c.

CERAMIC INSULATED VARIABLE AIR CONDENSERS

350 mmfd, 5 gang—	\$1.95; 4 gang—\$1.49; 3 gang—\$1.28
10 mmf.	\$3.50—10 for \$2.90—100 for \$23.00
15 mmf.	\$3.50—10 for \$2.90—100 for \$23.00
25 mmf.	\$3.50—10 for \$2.90—100 for \$23.00
30 mmf.	\$4.50—10 for \$3.50—100 for \$28.00
50 mmf.	\$4.50—10 for \$3.70—100 for \$30.00
75 mmf.	\$4.50—10 for \$4.40—100 for \$38.00
100 mmf.	\$5.50—10 for \$4.50—100 for \$38.00
140 mmf.	\$6.00—10 for \$5.00—100 for \$46.00
160 mmf.	\$1.00—10 for \$8.50—100 for \$70.00
2 Gang 140 mmf.	\$1.60—10 for \$12.50—100 for \$100.00

Butterfly condensers, rotor has two ball bearings and a 9/4" shaft.
 15 mmf. per section \$5.50—10 for \$4.50—100 for \$40.00
 30 mmf. per section \$6.00—10 for \$5.00—100 for \$50.00
 50 mmf. per section \$7.00—10 for \$6.50—100 for \$60.00

Manufacturers and distributors write for prices on larger quantities. WE HAVE OVER 250,000 VARIABLE CONDENSERS IN STOCK.

MICROPHONES—Super Special—Highest quality all chrome bullet shaped CRYSTAL MIKE of tonight nationally known brand—\$5.95. Bullet DYNAMIC MIKE—\$7.95. MIKE Jr.—60c. HANDY MIKE with switch on handle—90c. LAPEL MIKES—(Specify whether carbon or magnetic)—93c.

Scoop-Brand new AERVOX CONDENSERS—40, 20, 20 Mfd. at 150, 150, and 25 W.V. Fully guaranteed. Ten for \$4.40.

GENERAL ELECTRIC RT-1248 15-TUBE TRANSMITTER-RECEIVER

TERRIFIC POWER—(20 watts) on any two instantly selected, easily pre-adjusted frequencies from 435 to 500 Mc. Transmitter uses 5 tubes including Western Electric 318 A as final. Receiver uses 10 tubes including 955's, as first detector and oscillator, and 3-7H's as IF's with a slug-tuned 40 Mc. IF transformers, plus a 7H7, 7E6's and 7F7's. In addition unit contains 8 relays designed to operate any sort of external equipment when actuated by a received signal from a similar set elsewhere. Originally designed for 12 volt operation, power supply is not included, as it is a cinch for any experimenter to connect this unit for 110 AC, using any supply capable of 400 DC at 135 MA. The ideal unit for use in mobile or stationary service in the Citizen's Radio Telephone Band where no license is necessary. Instructions and diagrams supplied for running the RT-1248 transmitter on either code or voice in AM or FM transmission or reception, for use as a mobile public address system, on 80 to 110 Mc. as an FM broadcast receiver, as a Facsimile transmitter or receiver, as an Amateur Television transmitter or receiver for remote control relay hookups, for Geiger-Mueller counter applications. It sells for only \$29.95 or (if for \$82.90 if desired for marine or mobile use the dynamotor which will work on either 12 or 24V DC and supply all power for the set is only \$15.00 additional).

COMPRESSED AIR INSTANTLY, Anywhere!!

Portable Air Compressor and storage tank. Ruggedly built of best materials using lifetime lubricated ball-bearing on connecting rod and oil impregnated main bearing on shaft. Unusual design forever eliminates valve trouble, the most common fault in air compressors. PATENTED unique air intake system increases efficiency tremendously over other compressors so that air output is much greater than that from larger compressors powered by heavier motors. Will deliver approximately 3500 cu. inches of air per minute at maintained pressure of 30 lbs., or will inflate a 90 lb. truck tire in less than one minute. Comes complete with 100 lb. gauge, although finger-tip adjustment allows setting of output pressure at any value, which will automatically be maintained. Works from any 1/4 H.P. motor. Useful for spraying paints or lacquers, disinfectants, insecticides, sandblasting or brazing with natural gas, inflating tires, etc. Price \$14.50 postage prepaid anywhere in the U.S. Efficient, completely adjustable siphon type spray gun complete with 12 ft. of 100 lb. tested hose, available for only \$7.75 with pint container, also prepaid. 25% required on all C.O.D. orders.



TERRIFIC VALUE— PORTABLE ELECTRIC DRILL



Only \$20.95 equipped with 1/2" Jacobs Geared Chuck and Key. Not an intermittent duty drill, but a full size rugged tool. Most convenient type switch, natural grip handle, and balance like a six-shooter. Precision cut gears—turbine type cooling blower—extra long brushes. No stalling under heaviest pressure because of powerful 110 Volt AC-DC motor and multiple ball thrust bearing. Other bearings self-aligning lifetime-lubricating Chrysler Oilite type. Made for toughest year-in and year-out service in Plant or on construction jobs. Amazing perpetual factory guarantee assures you of a lifetime of trouble-free use. 25% deposit on C.O.D.'s. Full refund if returned prepaid within five days.

Our PE-109 32-Volt Direct Current Power Plant

This power plant consists of a gasoline engine that is direct coupled to a 2000-watt 32 volt DC generator. This unit is ideal for use in locations that are not serviced by commercial power or to run many of the surplus items that require 24-32 Volt DC for operation. The price of this power plant tested and in good condition is \$79.95 F.O.B. Buffalo, or we can supply in strictly "as is" condition for \$58.95 F.O.B. New York City. These latter are exactly as received, in heavy steel-strapped gov't cases, and we are unable to determine if the individual units are new or used or what the condition is if used, while the \$79.95 units are some of the same that have been brought to Buffalo for testing and repair if necessary. We do not recommend gambling on the "as is" condition except for quantity purchasers. We can also supply a converter that will supply 110V AC from the above unit or from any 32V DC source for \$12.95.

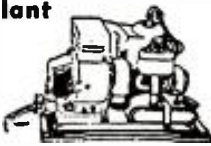

SCR-274N COMMAND SET

The greatest radio equipment value in history

A mountain of valuable equipment that includes 3 receivers covering 190 to 550 KC; 3 to 6 MC; and 6 to 9.1 MC. These receivers use plug-in coils, and consequently can be changed to any frequencies desired without conversion. Also included are two Tuning Control Boxes; 1 Antenna Coupling Box; four 28 V. Dynamotors (easily converted to 110 V. operation); two 40-Watt Transmitters including crystals, and Preamplifier and Modulator. 29 tubes supplied in all. Only a limited quantity available, so get your order in fast. Removed from unused aircraft and in guaranteed electrical condition. A super value at \$34.95, including crank type tuning knobs for receivers. Without these knobs the receivers can't be tuned, and are only useful for parts. Don't buy without knobs!

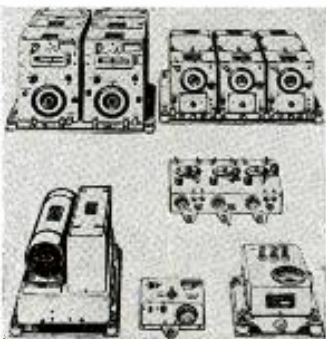

AUTO ANTENNA LEAD-IN

Federal Telephone and Radio Corp., East Newark, N.J.

A principal difficulty with automobile antenna lead-in wire has been the high capacitance, due to the shielding.



The new K-109 cable reduces capacitance to 8 μf per foot by surrounding the center conductor with air. This conductor is supported in a tube of polyethylene by being crimped into a saw-tooth form and pressing the points of the saw-tooth against the inside of the tubing. The shield and outside insulation surround the polyethylene tube.

RADIO TIMER

International Register Co., Chicago, Ill.

The RC-1021 timer is an electric clock which operates a switch. One operation of a setting is possible; if the radio is on, the clock will turn it off; and if it is off, the clock will turn it on.

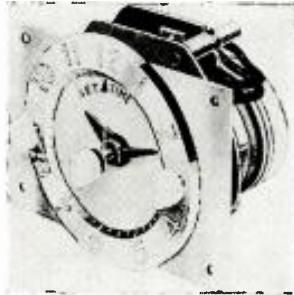

LIGHT A. C. GENERATOR

D. W. Onan & Sons, Inc., Minneapolis 5, Minn.

Series AAE gasoline-driven power plants furnish 350 watts a.c. and weigh only 77 pounds. They are small enough to fit into the trunk compartment of an automobile.



Suitable for use with outdoor PA systems, the generators are powered by 4-cycle, air-cooled, cast-iron engines. All models (including those made especially for battery charging) have electric push-button starting. One model may be hooked to any auto battery for starting; while it is running, a special 6-volt winding recharges the battery.

HIGH-FIDELITY TRANSFORMERS

Standard Transformer Corp., Chicago, Ill.

The new Stancor HF and WF series

high-fidelity audio transformers include a complete range of units for amplifiers, speakers, microphones, and pickups. Special coil and core construction results in the reduction of hum pickup and leakage reactance as well as of harmonic and intermodulation distortion.

The HF series, except for the HF-65 output transformer, has a frequency response of ± 1 db from 20-20,000 cycles. The HF-65 has a response of ± 1 db from 30-20,000 cycles. The WF series, except for the WF-21, has a frequency characteristic of ± 2 db from 30-20,000 cycles. The WF-21 input transformer has a response of ± 2 db from 50-10,000 cycles.



Both series are potted in gray enamelled cast cases with four tapped holes on both top and bottom for flush mounting. Stud-type terminals are provided on a phenolic panel.

TV ANTENNA

Tricraft Products Co., Chicago, Ill.

The model 500 TV-FM antenna covers both television bands and the FM band. The mounting bracket is designed to permit placement outside a window or in other places when a roof installation is not possible. It is

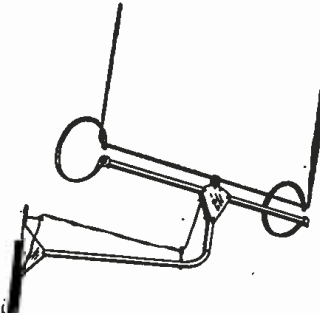

made for sets with a 300-ohm input and will match the line correctly.

TV ANTENNAS

Network Manufacturing Corp., Bayonne, N.J.

A new line of television receiving antennas features elements made of 1-inch-diameter aluminum tubing. Top item is a three-element stacked array. Others range from simple dipoles up. Units for both upper and lower bands are available. In all, the large di-

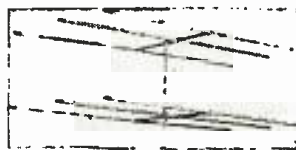

ameter of elements gives good band width, and mechanical installation problems are at a minimum.

The type LF-3E-D 3-element, double-stacked beam pictured is especially intended for use with receivers in fringe areas. The gain of the array is approximately 20.5 db. It covers channels 2 through 6.

TUBE SOCKETS

Yates Engineering Services, Cranford, N. J.

A combination tube socket and mounting strip is made of steatite or plastic. The socket is supplied mounted to the terminal board.

Resistors and capacitors associated with the stage can be soldered to the socket and strip before the unit is mounted in the chassis.

Breakdown of mass production into simple subassembly operations is made possible, and—especially in military equipment—rapid servicing can be done merely by removing the entire stage and replacing it with a new one.

SMALL STORAGE DRAWERS

Cincinnati Ventilating Co., Inc. Covington, Ky.

Every hom, serviceman, experimenter, and constructor early in his career runs into the problem of storing resistors, capacitors, screws and nuts, and a thousand other small parts. The new interlocking small parts drawers are made of steel. Each drawer and its housing is $2\frac{1}{4}$ x $2\frac{7}{8}$ x 5 inches. The housings are tongued and slotted so that they can be put together to form a rigid and durable cabinet of drawers of any size or shape. Starting with just a few, the buyer can obtain



more drawers in any quantities at any time and add them to the old ones to form a larger cabinet. Each drawer has a small handle and a holder for an identification card.

SMALL SOLDERING IRON

Transvision, Inc., New Rochelle, N.Y.

The Soldetron weighs only 3 ounces and has interchangeable heads. Push-button-controlled, it heats up in 20 seconds from a cold start. It is operated from a 117-volt a.c. line through a transformer, or from a 6-volt battery.



RADIO KITS

Eagle Electronics, Inc. Irvington, N. Y.

Pict-O-Graph kits include all the necessary parts for making any of several different receivers, amplifiers, and phono oscillators. Each kit is accompanied by a pictorial wiring diagram.

The manufacturer claims that no knowledge of radio is needed to construct the kits.

Receiver kits offered range from a 1-tube a.c.-d.c. set to a 5-tube superheterodyne. Also available are 3- and 4-tube amplifiers, as well as a crystal receiver, a code-practice oscillator, and a vacuum-tube voltmeter.

RADIO-INTERCOM

Setchell Carlson, Inc., Saint Paul, Minn.

The Radio Dor-A-Tone, Model 458RD, is a combination radio receiver and 2-station intercom. The receiver contains four tubes and a selenium rectifier, a loop antenna, and a 5-inch speaker. Quick-heating tubes are used in the device.

Four push-buttons atop the master unit serve as switching controls. The first turns the set off, the second feeds radio programs to the master speaker, the third feeds programs to both master and substation, and the fourth is used as a conventional talk-listen intercom switch.

The master is 7 inches wide, 7 inches deep, and $6\frac{1}{2}$ inches high. The substation measures $5\frac{1}{2}$ x $4\frac{1}{2}$ x 5 inches. A special weatherproofed substation is available for outdoor use when that is desired.

VIDEO BRIGHTNESS TESTER

Photovolt Corporation, New York, N.Y.

Model 205 video brightness tester measures the brightness of cathode-ray viewing tubes. It is designed for laboratory tests, production control, installation, and servicing. A photocell held against the face of the tube is connected to a meter by a short cable. The meter is calibrated in foot-lamberts up to 100, covering the highest brightness values found. The photocell has a filter so that brightness values are furnished in terms of visual perception.



HIGH-VOLTAGE TESTER

Richard Mattison Company, New York, N.Y.

A test probe designed for television servicing, the Hi-Volter contains a multiplier resistor. When used with any v.t.v.m. having an input resistance of 10 megohms, it will multiply the



normal range of the meter by 10. It may also be used with a microammeter by calibrating the meter scale directly in kilo-volts.

The probe is insulated for 25,000 volts and has a safety grip. The metal prod is cadmium-plated.

SOUND-EFFECTS KIT

Winslow-Wright, North Hollywood, Calif.

Intended for home recordists, the Recordo-Script Producer's Kit includes ten sound effects, such as bird calls, whistles, sleigh bells, etc.; three scripts; and a booklet on sound effects and how they are created.



TWO-SIDE RECORD PLAYER

Markel Electric Products, Inc.,
Buffalo, N.Y.

Both sides of each disc are played by the Markel Duo Playmaster. The pickup has a cartridge with two styli, one below and one on top. After play-

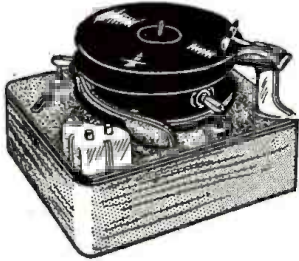

ing the bottom record, the pickup moves up and plays the underside of the next one. Three rubber-tired wheels spin the top record and then, moving aside, ease it down to the turntable.

ANTENNA CHIMNEY MOUNT

JFD Manufacturing Co.,
Brooklyn, N.Y.

The adjustable chimney antenna mount consists of an angle bracket which rests against a corner of the chimney and a metal strap which passes around the chimney. Two of these mounts may be placed any distance apart to support any mast from 1/2 inch to 1 1/2 inch in diameter.

DISC HOLE REPAIRER

Dunwel Sales Corp.,
Chicago, Ill.

Frequently-played records often develop an enlarged or chipped center hole, usually due to small maladjustments of the changer. The result is erratic changing and wavering pitch.

The Dunwel record repair kit consists of a two-part tool and a set of eyelets. The threaded end of one of the tool sections is passed through the rec-



ord hole and tightened into the other section. This enlarges the hole and makes it perfectly round. Then a pair of eyelets is placed in the hole and the other ends of the tool sections are used as before. This tightens the eyelets and leaves the record with a metal center hole.

MULTITESTER

Bradshaw Instruments Co.,
Brooklyn, N. Y.

Model 30 Multitester has a single rotary selector switch which controls all ranges. Meter sensitivity on the voltage ranges is 1,000 ohms per volt, and maximums are 1,250 volts a.c. and 1,000 volts d.c. Two d.c. milliampere ranges are provided, 0-1 and 0-100. Resistance may be measured in three ranges, with a maximum of 1 megohm. A decibel scale reading from -10 to +57 db is provided. Zero db equals 6 mw in 500 ohms.

JANUARY, 1949

COMBINATION TESTER

Radio City Products Co., Inc.,
New York, N. Y.

The Model 8573 Servishop is a tube tester, FM, AM and a.f. signal generator, and a 50-range multimeter. It consists of the Model 8058 combination tube and set tester combined with the Model 730 signal generator.

The tube tester is calibrated for over 800 types of tubes including those with acorn and sub-miniature type bases.

Readable scale on the ohmmeter is from 0.05 ohm to 25 megohms in 5 ranges. Other ranges are: 0-2.5-10-50-250-1000-5000 volts d.c.; 0-10-50-250-1000-5000 volts a.c.; 0-5-2.5-10-50-250-1000 ma d.c.; 0-10 amps. d.c.; -8 to

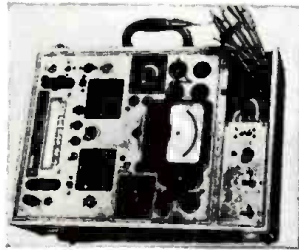

+15, 15 to 29, 29 to 49, 32 to 55 db; and output ranges corresponding to a.c. voltage ranges.

The unit's natural oak cabinet is 16 1/2 x 12 3/4 x 5 1/4 inches and its panel is hammertone gray. Weight 18 pounds.

PHONO AMPLIFIER

Langevin Mfg. Corp.,
New York, N. Y.

The Type 127-A amplifier is designed to operate with a radio tuner and a phonograph using LP microgroove, crystal, or variable-reluctance cartridges. It delivers 4 watts output with less than 5% total harmonic distortion over the range of 50 to 15,000 cycles. Separate bass, treble and volume controls are provided.

The unit is in a hammertone gray metal cabinet, small enough to fit into a bookcase or radio cabinet.

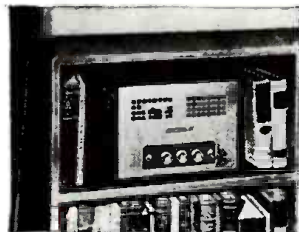

REMOTE CONTROL CONSOLE

General Electric Co.,
Syracuse, N. Y.

The Type EC-8-A remote control unit, designed to FCC specifications, permits remote operation of receivers and transmitters in land-mobile radio communications systems.

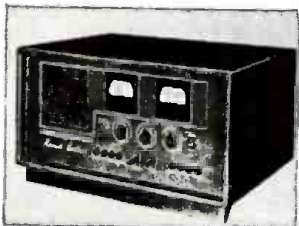

The unit is used to turn on plate power to the transmitter and mute a particular combination of station receivers. Voice signals are fed to the transmitter through a preamplifier with automatic level control. The line amplifier has two separately controlled inputs, one for station receiver monitoring and the other for monitoring auxiliary receivers.

The unit is 10 inches high, 14 inches deep and may be rack mounted.

db GAIN + + +

more signal strength for greater distance and the best picture

with

AMPHENOL

STACKED ARRAY

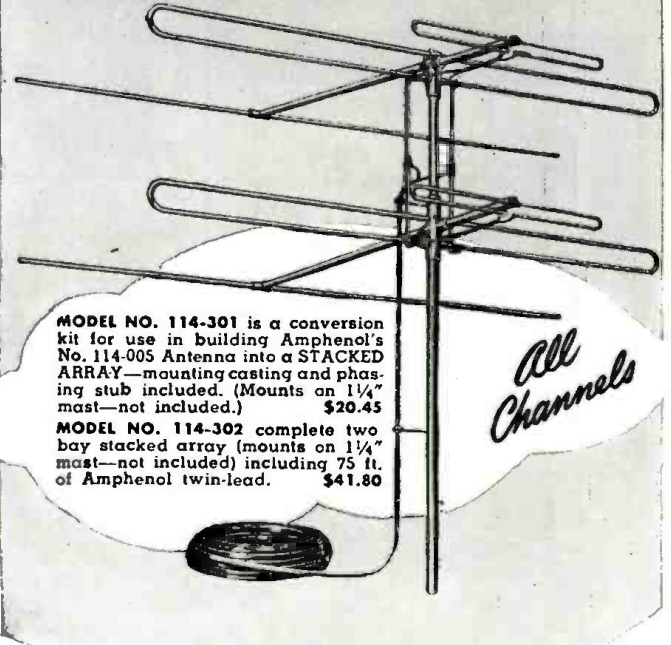

All Channels

MODEL NO. 114-301 is a conversion kit for use in building Amphenol's No. 114-005 Antenna into a STACKED ARRAY—mounting casting and phasing stub included. (Mounts on 1 1/4" mast—not included.) \$20.45

MODEL NO. 114-302 complete two bay stacked array (mounts on 1 1/4" mast—not included) including 75 ft. of Amphenol twin-lead. \$41.80

Stacked Array multiplies the universally acknowledged features of the Amphenol All-Channel TV Antenna (No. 114-005). Stack to provide reception at greater distances—Stack for picture brilliance and clarity—Stack for controlled TV reception. Provide the TV Receiver with the Best Antenna to Produce the Best Picture. Amphenol's Stacked Array is your assurance of top TV picture quality.

Performance Charts Available

If you are not now receiving the monthly AMPHENOL ENGINEERING NEWS — you will want to request the September issue which included pattern and gain charts for the Stacked Array. We will be glad to mail it and to place your name on our list to receive future issues—write Dept. 13D.



AMERICAN PHENOLIC CORPORATION

1830 SOUTH 54TH AVENUE CHICAGO 50, ILLINOIS
COAXIAL CABLES AND CONNECTORS - INDUSTRIAL CONNECTORS, FITTINGS AND CONDUIT - ANTENNAS - RADIO COMPONENTS - PLASTIC FOR ELECTRONICS

Introducing 1949

**TIME
DELAY
RELAY**

99¢

Start it Right

**Signal Corps
Jack Box**



Postpaid

24 volt, 200 ohms Resistance, approximately 1/50 of 1 second delay. Brand new type B-9 manufactured by Guardian Electric. Part No. 34464. Price, only 99c post paid.

COMMAND SET ACCESSORIES

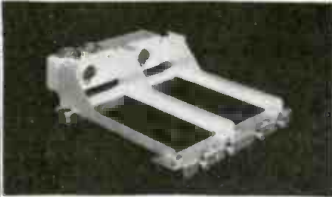

RACKS

Double Transmitter rack. Brand new in original carton. No. FT-226 only 99c postpaid.

Triple receiver rack. No. FT-220-A. Brand new in original cartons, only \$1.59 postpaid.

Antenna Relay \$1.95
Postpaid!

Antenna Relay Unit BC-442A or RE-2/ARC-5. Originally used on Command Set (SCR-274). Contains an antenna change-over relay, a 19 1/2 millivolt meter, with an external 3/4 amp. thermocouple. The meter scale reads R.F. current on linear scale calibrated 0 to 10. A truly sensational buy at only \$1.95



**BC 616
Control
BOX**

Originally used with the command set between Modulator BC456A and Control Box BC451A. Contains 3, 24 volt relays and other parts an excellent buy at only \$1.39 postpaid.



**BB
450**

Triple remote control box for Command Receivers (SCR 274 N Series). Equipped with 3 tuning dials, 3 volume controls, and 6 selector switches. Used, but in excellent condition, a steal at only \$1.50 ea. (Add 25c to cover postage and handling.)



BC-1366 or 366 Jack Box. Contains Mic. Jack, volume control, 5 position 2 gang rotary switch, 11 contact bayonet plug and receptacle. All nicely assembled in a neatly finished metal box 3 3/16" W x 4 3/8" H x 2 3/16" D. Lots of uses in the Ham shack, lab., or on mobile installations. A sensational buy at only 79c each, postpaid, or 10 for \$6.95 postpaid.



**2 volt
Battery
\$1.25**

Brand new, compact, spillproof built-in hydrometer, group several together to get higher voltages. Fully guaranteed. Shipped dry, add 35c to cover postage and handling.



**Loops
\$3.95**

Used primarily on aircraft & Marine ADF Systems, Loop LP-21-A contains an electric motor and selsyn. These loops have been removed from salvage aircraft, but are guaranteed to be in excellent working condition.

Shipped Express Collect

**PE-73-C
DYNAMOTOR \$3.95**

PE-73-C Dynamotor. Input 28 volts at 19 amps at 5000 RPM, output 1000 volts at .55 amps. Used but good.

(shipped express collect)

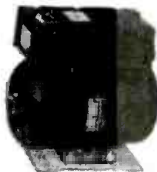

**NEW
METERS 77¢**

Brand new 3 0-3, DC voltmeter 2" round case. Meter has 450 ohms resistance (150 ohms per volt). (Add 15c each to cover postage and handling.)

Brand new Bowers D.C. Volt meter 0 to 9 volts in 2" case with 2 3/4" Flange ----- each .99c

Brand new Bowers D.C. Ammeter 0 to 100 amp scales (600 ma. movement with 100 amp shunt) same case as volt meter each .99c

Add 20c each to cover postage and handling



**Stainless Steel
Recording Wire \$1.95**
Postpaid

.006 Stainless Steel recording wire. New on original spools as used by Army and Navy recorders. Each spool contains at least 1/4 mile of wire. Can be used on standard wire recorders.



N. SILVERSTINE CO.

6532 EAST McNICHOLS ROAD DETROIT 12, MICHIGAN

Seven Acres of Surplus!

Take Advantage of These Bargains

The Smart Way

R-VARR-1 OR Similar Unit
\$4.95
 Postpaid



These units complete with four 954 acorn tubes, antenna relay, and control box. Three TRF stages and grid leak detector, tune 234-258 MC. Make FB converter or preslector for 1 1/4, 2, or 6 meter bands by changing coils.

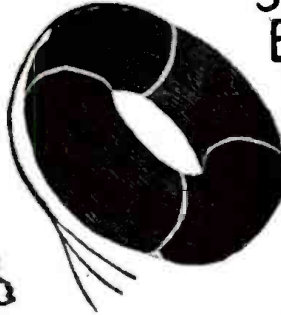

525 Feet Brand New Telephone Wire **\$ 2.95**

3 conductor braided insulated copper and steel telephone wire. It is of copper for conductivity and steel for strength. Worth at least 3c per foot, yet due to an exceptional buy we can now offer it at less than 1c per foot.
 (Shipped express charges collect)

Citizen Band Phantom Antenna
85¢



A transmitting antenna, for use on approximately 450 MC. Complete with standard coax connector. A weather-proof unit. (Add 25c to cover handling and postage.)

C.R. Tubes

3 CP 1 (Ind. Screen)	.95
3 DP 1-A (Ind. Screen)	.95
3 FP 7-A	1.35
3 HP 7	1.45
(Add 25c each to cover postage and handling)	
5 FP 7	1.75
5 CP 1	1.95
5 BP 1	2.45
5 HP 1	2.45
(Add 35c each to cover postage and handling)	
7 BP 7	2.65
7 CP 1	3.25
(Add 40c each to cover postage and handling)	
9 GP 7	3.50
(Shipped express, charges collect)	

Gibson Girl TRANSMITTER
\$4.95



Limited Supply

SCR578 Gibson Girl Transmitter complete with tubes, used but good, only \$4.95.
 (Shipped express collect)

COMPLETE SCR-578-B

New or good as new Transmitter. Complete with Kite, Balloon, Hydrogen Generator, Lamps and Instruction Book. \$29.50 each, F.O.B. Detroit. (Shipped Express or Motor Freight Charges Collect)

3/4 R.P.M. MOTOR



TUNING CONDENSERS

Brand New in cartons. 4 Gang-13-226 MMF/Sec. 99c (Postpaid)
 2 Gang as pictured (Postpaid) 69c

\$2.95



Ideal for a beam rotor, plenty of power. Originally designed for 24 volt DC operation, but easily converted, 110 volts AC. Complete instructions included. Excellent for other uses too. Brand new, surplus, guaranteed. (Add 40c each to cover postage and handling)

Surplus Tubes
 All New, All Postpaid

8012	\$1.69
1626	\$.35
705-A	\$1.19
211	\$.69



1300 FT. Heavy Duty Cable

\$18.00

New 4 conductor 16 gauge rubber covered cable. Color coded. Used by United States Government as Field Telephone Cable. 1300 feet on steel reel. F.O.B. Our warehouse Shipped motor freight or express shipping charges collect.

N. SILVERSTONE CO. 6532 E. McNichols, Detroit 12, Mich.

IMPORTANT!

All merchandise subject to prior sale, minimum order \$2.00, No C.O.D. orders accepted. Michigan residents must add 3% State sales tax.

Radio-Television-Electronic Parts & Equipment Specials

TELEVISION-CATHODE RAY HIGH VOLTAGE

2000 volt D.C. Power Supply.

For an unbelievably low price, we can supply a completely filtered television or cathode ray 2000 volt D.C. power supply. Why bother with bulky and dangerous 60 cycle supplies or expensive R.F. power supplies when you can purchase a complete 2000 volt D.C. unit (not a kit), ready to plug into the 110 volt A.C. power line. The ridiculously low price has been made possible by a fortunate purchase of high quality components. These units are brand new, completely tested and guaranteed.

Price \$7.95

4000-6000 VOLT TELEVISION SUPPLY

Similar to the unit above, but has a much higher D.C. output voltage suitable for use with the new 7" and 10" television tubes.

PRICE\$12.50

RADIO NOISE FILTERS

Eliminates extremely noisy radio reception due to power line disturbances caused by lights, refrigerators, washing machines, vacuum cleaners, elevators, oil burners, diathermy machines, etc.

Filters out man-made noises in the broadcast, short-wave, and ultra-high frequency bands. Designed for all radios, appliances, and electrical equipment consuming up to 1300 watts (12 amperes at 120 volts AC or DC).

Housed in a metal case 1 3/4" x 3" x 7 1/4" complete with male and female line connectors.

PRICE ONLY \$2.25

Industrial Type Radio Noise Filter—Will handle up to 50 amperes. Housed in shielded case 3 3/4" x 3 3/4" x 2 1/2".

PRICE\$3.95

EASILY ASSEMBLED RADIO KITS

5 Tube AC-DC superhet kit furnished in a brown plastic cabinet of artistic design, cabinet size (9"x5"x6")

Variable condenser tuned; with 2 double tuned I. F.'s.

Tubes used: 1 - 12SA7, 1 - 12SQ7, 1 - 12SK7

1 - 35Z5 and 1 - 50L6

PRICE \$11.95

including 8 standard tubes

6 TUBE 3 WAY PORTABLE KIT

• For operation on 110 volt AC or DC and battery

• Superheterodyne circuit

• Full vision dial

• High gain loop

• Cabinet of Blue Aeroplane cloth finish, size 13x9 3/4"x7"

• Tubes used 1A7, 1H5, 3Q5, 117Z6 and 2 - 1N5

PRICE \$13.75

Not including tubes

Extra for kit tubes \$3.75

6 TUBE, 2 BAND SUPERHET KIT

Bands covered BC 550-1600 KC and 6-18 MC

Power supply 105-125V AC, DC

Full vision dial

Variable condenser tuned, with two double tuned I. F.'s 455KC

Walnut veneer wood cabinet

PRICE \$15.75

A SCIENTIFICALLY DESIGNED PHONO SCRATCH FILTER

Resonated at approximately 4500 cycles effectively reducing objectionable needle scratch without altering the brilliancy of reproduction.

Contains a W-Q SERIES resonated circuit. Tested by means of an audio oscillator and an oscilloscope to give 22 db. attenuation with very low signal loss.

EASY TO ATTACH

Just two wires to clip on. Compact

Price\$1.98

THREE TUBE PHONO AMPLIFIER

An assembled unit ready for installation using tone and volume control and six feet of rubber

cord\$2.95

(Not including Tubes)

With Complete Set of Tubes\$3.95

PHONO OSCILLATOR

Wireless phono oscillator transmits recording for crystal pick-ups or voice from carbon mike through radio without wires. Can also be used as an intercom by using P.M. speaker as mike. Price

(excluding tubes)\$2.95

With Complete Set of Tubes\$3.95

SPECIAL! SPECIAL!

Mammoth assortment of radio and electronic parts, not less than TEN POUNDS of new transformers, chokes, condensers, resistors, switches, coils, wire, hardware, etc. A super-buy for experimenters, service-men, and amateurs for only

.....\$1.25

Satisfaction guaranteed on all merchandise.

All prices F.O.B. New York City

WRITE FOR FREE CATALOGUE

RADIO DEALERS SUPPLY CO.

154 Greenwich St. 'New York 6, N. Y.

New

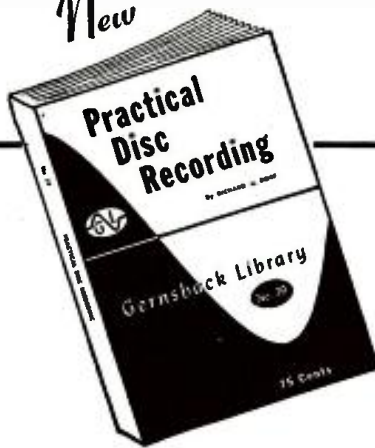

PRACTICAL DISC RECORDING

Answers Your Questions

LATEST INFORMATION

Here is the book that thousands of radio enthusiasts have been waiting for.

Whether you're interested in amateur or professional recording, you'll find PRACTICAL DISC RECORDING by Richard H. Dorf invaluable. It not only tells you how to make successful records, but in addition each important recording component is given a full chapter, explaining its purpose, and what features to look for when buying.

You'll like this book for many reasons. Without waste of words, it gets right down to business on the first page. It tells you what you need to make good records and how to do it by using any type equipment—from the simplest to the most expensive—depending on your purpose and pocketbook. You will find all the practical phases of recording covered as well as the underlying principles.

FILLED WITH FACTS

Chapter 1 discusses the various components which make up the complete system. Chapters 2 to 5 go into the practical details of the selection and use of discs, motors and turntables, feed mechanisms and cutters. Chapter 6 is a comprehensive explanation of constant amplitude and constant velocity recording, the two fundamental recording characteristics on which all recording is based. Chapter 7 covers stylus selection. In Chapter 8 the various sound sources (microphones, radio tuners, etc.) are discussed. A feature is the handy chart of characteristics of different types of microphones. Chapter 9 discusses the all-important amplifier. Circuits of several practical amplifiers are given. In Chapters 10 thru 13, you'll find explained the detailed techniques of making good records. All the fine points of adjustment, equalization, microphone placement and microphone technique, and a whole chapter on dubbing. Chapter 14 is a concise summary of common troubles in recording, and how to overcome them. The book ends with a comprehensive glossary of recording terms.

96 PAGES, 82 ILLUSTRATIONS

Only 75c

Postpaid.

See your radio parts jobber today or order direct.

SEE COUPON BELOW

CLIP AND MAIL

RADCRAFT PUBLICATIONS, INC.,
Dept. 1-49
25 West Broadway, New York 7, N. Y.

Send me PRACTICAL DISC RECORDING
I enclose 75c.

Your Name
(Print clearly)

Address

Jobber's Name

Address

.... RCA 66BX

A common trouble with this set gives all the symptoms of an open filter capacitor. If a check shows that the filters are good, replace the selenium rectifier with a new 100-ma unit.

TEDD FISHMAN,
Brooklyn, N. Y.

.... SILVERTONE 3351

The set was intermittent while in the case but was satisfactory when removed from the case. The trouble was a frayed antenna wire which was shorting to chassis. A short piece of spaghetti over the lead cured the fault.

ROBERT J. ZELLNER,
Menominee, Mich.

.... GE MODEL 140

If this set operates satisfactorily on batteries but not on a.c. or d.c., check the 3S4. When the switch is in the battery position, the two halves of the tube's filament are paralleled, so the set will operate even if one end of the filament is open. On the line, however, the filaments are in series, and the tube will not work with half of the filament open.

T. HORIUCHI,
Rock Springs, Wyo.

.... PHILCO AUTO RECEIVERS

When resistance or voltage measurements show an open i.f. coil, remove the assembly from the can and examine the lugs for broken-off leads frequently caused by vibration. A careful resoldering of the wire to the lug will make the transformer as good as new.

HURLEY D. ROBINSON,
Pullman, W. Va.

.... PHILCO 48-200

If one or several stations fade in and out on this set, replace the oscillator coil. If that does not entirely cure the trouble, install the ceramic trimmer sold by Philco for this purpose.

JOSEPH WOLK,
Brooklyn, N. Y.

.... RCA RECEIVERS

The condensers in certain RCA receivers were assembled with a compound in each end to hold the wires against the foil inside. This compound loosens, creating poor contact with the foil. The condensers that have failed in a receiver must be replaced, but cost usually prevents replacing the rest. I paint the ends of each condenser with service cement to prevent their failing during my guarantee period.

ALAN SMITH,
Shaftsbury, Vermont.

.... PHILCO 46-1201

Many of these sets develop a loud hum, either steady or intermittent. The radio-phonograph change-over switch has a metal snap-on cover which may be loose. Retighten and bond it to keep the shielding intact.

A. G. SANDERS,
Miami, Fla.

.... I.F. TRANSFORMERS

A resistance check across the i.f. coils of a weak receiver showed as much as 3,000 ohms. The transformers were found to have corrosion under the first winding layer. Replacement was necessary.

PETER KACAOURA,
Jamaica, N. Y.

.... TUNABLE HUM

Tunable hum in a.c.-d.c. receivers whose grounds are not connected directly to the chassis can often be traced to the a.v.c. bypass capacitor. If this capacitor is connected to the chassis, unsolder it and hook it to the circuit ground.

ALAN SMITH,
Shaftesbury, Vt.

.... 35Z6 REPLACEMENT

The 35Z6 rectifier used in several of the older makes of receivers is no longer being manufactured. Replace bad ones with a 25Z6 plus a 33-ohm, 5-watt series dropping resistor.

D. H. EBERT,
Chicago, Ill.

.... ADMIRAL 7C63

These sets are frequently brought in with a complaint of low volume. Sometimes the set is dead. Begin by checking the twin lead connecting the two halves of the loop antenna. It is fastened to the cabinet with staples, which, in some cases, short the loop. To prevent future trouble, remove the offending staples and replace them with ones small enough not to short the wires.

D. L. FUQUA,
Fairfield, Iowa

.... REMOVE OLD CONDENSERS

When installing new power-supply filter condensers in a receiver, it is very bad practice to leave the old ones in place. They may eventually break down and short out. Remove or disconnect them.

Removal of certain types of condensers benefits the serviceman in other ways. Old aluminum cans, for instance, are useful around the shop as r.f. probes, tube shields, night-light shades, and ballast housings.

R. P. BALIN,
Miami, Fla.

.... ZENITH 6MF080 FORD

I have serviced five of these auto sets, all with the same complaint of low volume and intermittent reception. Replacing the coupling capacitor between the 7B6 plate and the 7C5 grid with a 1,000-volt unit of the same value cured the trouble in each case. The sensitivity control usually needed adjustment, too.

DAVID H. HORN,
Grenada, Miss.

.... INTERMITTENTS

One cause of intermittents is ground lugs riveted to the chassis. These sometimes loosen up enough to cause resistance. To fix them permanently, solder them securely to the chassis.

L. E. MEYERS,
Ironton, Ohio

TRANSVISION



NEW Television Kits and Equipment

Important Advances in TV Reception and Servicing!

NEW 10" TV KIT at amazingly LOW PRICE!



MODEL 10A TV KIT

The new Transvision Model 10A electromagnet TV Kit gives a bright, stable 52 sq. in. picture. Has 10" picture tube, and **CONTINUOUS TUNING** on all 12 channels. Its high sensitivity makes for improved long-distance reception; especially good on high channels. Complete with all-channel double-folded dipole antenna and 60 ft. of lead-in wire.

MODEL 10A TV KIT, less cabinet Net \$199.00
MODEL 12A TV KIT, same as above, but has a 12" picture tube..... Net \$263.00

NEW STREAMLINED CABINETS

for Transvision Model 10A or 12A TV Kit. Made of select grain walnut with beautiful rubbed finish. Fully drilled, ready for installation of assembled receiver.

Walnut Cabinet for 10A or 12A (Specify)..... Net \$44.95
Mahogany and Blonde slightly higher.

TRANSVISION ALL-CHANNEL TELEVISION BOOSTER

To assure television reception in weak signal areas, or areas which are out of range of certain broadcast stations. Transvision engineers have designed this new booster. It increases signal strength on all television channels. Tunes all television channels continuously. Can be used with any type of television receiver. Unusually high gain in upper television channels.

Model B-1..... LIST \$44.95

TRANSVISION REMOTE CONTROL UNIT KIT

Will operate any TV receiver from a distance. Turns set on, tunes in stations, controls contrast and brightness, turns set off. Ideal for installations where the television receiver is inaccessible. Tuner unit is a high gain, all-channel unit with about 50 micro-volt sensitivity. Easy to assemble in about an hour.

Model TRCU, with 25 feet of cable..... NET \$69.00
Without cabinet..... NET \$65.00

TRANSVISION TELEVISION AND FM SWEEP SIGNAL GENERATOR

Complete frequency range from 0-227 MC with no band switching. Sweep width from 0-12 MC completely variable. Accurately calibrated built-in marker generator.

ADDITIONAL FEATURES: (1) Dial calibrated in frequency. . . (2) Self-contained markers readable directly on the dial to .5% or better. (No external generator required to provide the markers signals). . . (3) Crystal controlled output makes possible any crystal controlled frequency from 5-230 MC. . . (4) Plenty of voltage output—permits stage-by-stage alignment. . . (5) Output impedance 5-125 ohms. . . (6) Directly calibrated markers. 20-30 MC for trap, sound and video IF alignment. . . (7) RF for alignment of traps for IF channels when a DC volt meter is used as the indicating medium. . . (8) Unmodulated RF signal to provide marker dips simultaneously with the main variable oscillator. . . (9) Markers can be controlled as to output strength in the pip oscillator. . . (10) Power supply completely shielded and filtered to prevent leakage. . . (11) All active tubes are the new modern miniature type. . . (12) Phasing control incorporated in the generator.

MODEL NO. SG..... Net \$99.50



ALL-CHANNEL BOOSTER



REMOTE CONTROL UNIT KIT

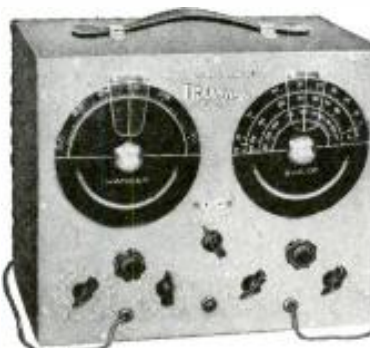

SWEEP SIGNAL GENERATOR

RADIOMEN . . . You Can GET INTO The
TELEVISION BUSINESS
IN A BIG WAY WITH THE
TRANSVISION DEALER PLAN
Write for FOLDER D-1

NEW 8-PAGE CATALOG showing complete Transvision line now available at your distributor, or write to:

TRANSVISION, Inc. Dept. RE New Rochelle, N. Y.

In Calif.: Transvision of California, 8572 Santa Monica Blvd., Hollywood 46.
All prices 5% higher west of Mississippi; all prices fair traded. All Prices Subject to Change Without Notice

TELEVISION
ASSEMBLY CO.

for the best in **TELEVISION**
for **CUSTOM-BUILT** installations

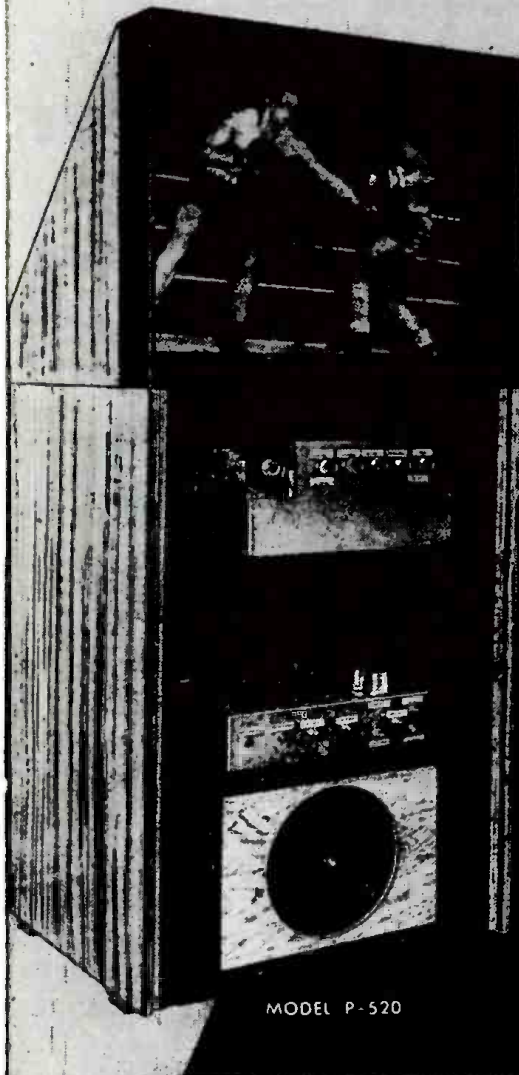

MODEL P-520

520 SQUARE INCH **PICTURE** 20 INCHES BY 26 INCHES
PROJECTION TELEVISION

Bausch & Lomb Optical Electronic System provides a contrasty sparkling picture projected onto the Eastman Kodak Glass Projection Screen, completely glare-proof. Every part of the entire set is designed, engineered and manufactured for the express purpose of bringing you the finest in television... ready for **CUSTOM-BUILT** installations in homes, schools, lodges, clubs, hospitals, taverns and other public places.

BAUSCH & LOMB F19 PROJECTION LENS

RCA 5TP4 PROJECTION C. R. TUBE
PRE-WIRED 27-30 KV TRIPLER FLYBACK
POWER SUPPLY

ALUMINUM COATED TOP PROJECTION MIRROR
EASTMAN KODAK GLASS PROJECTION SCREEN

PRE-WIRED, PRE-TUNED I. F. PICTURE & SOUND STRIP (PAT. PEND.)

DUMONT INPUTUNER
all channels — All FM Radio

RCA 12" HIGH FIDELITY PM SPEAKER
MANUAL OF INSTRUCTIONS & SCHEMATIC DATA prepared & edited by renowned **JOHN F. RIDER PUBLISHER, INC.**

COMPLETE WITH RACK, HOOD & PICTURE FRAME

10" 12" or 15" TUBE TELEVISION
in easy to install units

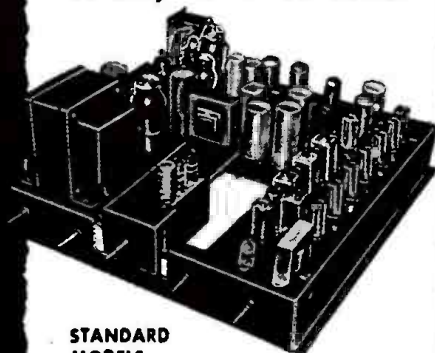

STANDARD MODELS

30-tubes, including the C.R. Tube. Supplied with 13-tube I.F. Picture and Sound Strip (Pat. Pend.) completely wired, tubed, tested and aligned. Has standard tuner pre-wired to handle 13 channels, ready to use with above unit.

Here's why Television Experts praise **T.A.C. Television**

Our products contain every new development, every new creation of television research. Our efforts are bent towards quality and this is particularly evident in the performance of our Assemblies. That's why men who know television are telling others about T.A.C. supremacy.

TELEVISION ASSEMBLY COMPANY GUARANTEE

All components are of the finest quality and are fully guaranteed under the Standard RMA Guarantee. All TAC Assemblies are guaranteed to operate when assembled according to directions.

T. A. C. CHAMPION MODELS WITH DUMONT INPUTUNER

Gives continuous tuning for all 13 channels plus all FM Radio. Available for all tube sizes.

TELEVISION
ASSEMBLY CO. 540 Bushwick Ave., B'klyn 6, N. Y.

Available only through
National Parts Distributors
Write us for list
Write for literature

Smart, Modern
Hand-Rubbed
Walnut & Blonde
Cabinets for 10"
12" or 15"
tube chassis



Our own exclusive designs, available for all T.A.C. models. Details on request.

Check this list for your nearest Television Assembly Co. Distributor

- CALIFORNIA**—Berkley
Dealers Supply Co.
Grove & Addison Sts.
- CALIFORNIA**—El Monte
El Monte Electronics Sup. Co.
992 E. Valley Blvd.
- CALIFORNIA**—Glendale
R. V. Weatherford Co.
6919 San Fernando Rd.
- CALIFORNIA**—Hollywood
Hollywood Radio Supply
5606 Hollywood Blvd.
- Pacific Radio Exchange, Inc.
1407 Cahuenga Blvd.
- CALIFORNIA**—Long Beach
Fred S. Dean Co.
969 American Ave.
Larry Lynde Radio Supply Co.
853 Pine Avenue
- Scott Radio Supply
266 Alamitos Ave.
- CALIFORNIA**—Los Angeles
Kierulff & Co.
820-830 W. Olympic Blvd.
Leo J. Meyberg Co.
2027 S. Figueroa St.
Radio Parts Sales Co.
5222 S. Vermont Ave.
Radio Products Sales Inc.
1501 S. Hill St.
Radio Specialties Co.
1956 S. Figueroa
Universal Radio Supply Co.
1404-06 Venice Blvd.
- CALIFORNIA**—Oakland
W. D. Brill Co.
10th & Jackson Sts.
Electric Supply Co.
149 12th St.
Wave Miller & Co.
188 12th St.
E. C. Wenger & Co.
1450 Harrison St.
- CALIFORNIA**—Palo Alto
Zack Radio Supply Co.
225 Hamilton Ave.
- CALIFORNIA**—Pasadena
Pasadena Radio Supply Co.
30 W. Colorado St.
- CALIFORNIA**—San Diego
Electronic Equipment Dist. Co.
1228 2nd Ave.
Shanks & Wright
1623 Fifth Ave.
- CALIFORNIA**—San Francisco
Associated Radio Distributors
1251 Folsom St.
Kaemper & Barrett, Inc.
1850 Mission St.
Leo J. Meyberg Co.
70 Tenth St.
San Francisco Radio & Supply
1282-1284 Market St.
Zack Radio Supply Co.
1426 Market St.
- CALIFORNIA**—San Jose
Frank Quement, Inc.
161 W. San Fernando St.
E. C. Wenger Co.
881 So. First St.
- CALIFORNIA**—Stockton
B. J. DeJornatt
515 N. Hunter St.
Dunlap Wholesale Radio Co., Inc.
12 N. Aurora St.
- CONNECTICUT**—Hartford
Hatry & Young
203 Ann St.
R. G. Scell & Co.
317 Asylum St.
- CONNECTICUT**—New Haven
Brown, Thomas H.
106 State St.
Hatry & Young
77 Broadway
- CONNECTICUT**—Stamford
Stamford Radio
562 Atlantic St.
- CONNECTICUT**—Waterbury
Hatry & Young
89 Cherry St.
- DELAWARE**—Wilmington
Almo Radio
6th and Orange
- WASHINGTON, D.C.**
Allied Electronics
#3 Thamos Circle
Capital Radio Wholesalers Inc.
2120-22 14th St. N.W.
Electronic Wholesalers Inc.
2010 14th St.
Kenyon Radio
2214 14th St. N.W.
Northwest Radio Wholesalers
3162 Mt. Pleasant St. N.W.
Rucker Radio Wholesalers, Inc.
1312 14th St. N.W.
Sun Radio
938 F Street N.W.
ILLINOIS—Chicago
Concord Radio
901 W. Jackson Blvd.
Newark Electric Co.
323 W. Madison St.
INDIANA—Indianapolis
Van Sickle Radio Co.
54 W. Ohio St.
INDIANA—Logansport
A. E. Conrad Co.
508 Broadway
IOWA—Des Moines
Radio Trade Supply Co.
1224 Grand Ave.
KENTUCKY—Louisville
P. I. Burks & Co.
911 West Broadway
MAINE—Portland
Radio Service Lab.
45A Free St.
MARYLAND—Baltimore
Acton Radio Labs
3218 Acton Rd.
Associated Distributing Corp.
Lombard & Charles Sts.
Berman, Henry
12 E. Lombard
Radio Electric Service Co.
5 N. Howard St.
A. R. Spartana Co.
239 N. Gay St.
Wholesale Radio Parts Co.
308-310 W. Redwood St.
MARYLAND—Cumberland
Cumberland Wholesalers
143 N. Centre St.
MASSACHUSETTS—Boston
DeMambo Radio Supply Co.
1111 Commonwealth Ave.
Hatry & Young
42 Cornhill
Herman, Louis M.
885 Boylston St.
A. W. Mayer
895 Boylston
Radio Shack Corp.
167 Washington St.
Radio Wire Television Inc.
110 Federal St.
MASSACHUSETTS—Brockton
Ware Radio Supply Co.
913 Centre St.
MASSACHUSETTS—Cambridge
Electrical Supply Corp.
1739 Massachusetts Ave.
MASSACHUSETTS—New Bedford
C. E. Beckman Co.
11-35 Commercial St.
MASSACHUSETTS—Roxbury
Gerber Radio Supply Co.
1900 Columbus Ave.
MASSACHUSETTS—Springfield
Springfield Radio Co.
405 Dwight St.
Springfield Sound Co.
147 Dwight St.
MASSACHUSETTS—Worcester
DeMambo Radio Supply Co.
729 Main St.
Radio Electronic Sales Co.
46 Candler St.
Radio Maintenance Supply
1925 Central St.
- MINNESOTA**—Minneapolis
Law Bonn Co.
1211 La Salle Ave.
- MONTANA**—St. Louis
Radionics
5040 Eastern Ave.
NEW HAMPSHIRE—Portsmouth
Electronics Lab. of N. H., Inc.
154 Congress St.
NEW JERSEY—Belleville
Wallace & Tiernan Co.
1 Main St.
NEW JERSEY—Camden
General Supply Co.
207 N. Broadway
Radio Electric Service Co.
513 Cooper St.
NEW JERSEY—Cliffside Park
Nidisco Cliffside Park, Inc.
658 Anderson Ave.
NEW JERSEY—Clifton
Eastern Radio Corp.
637 Main Ave.
NEW JERSEY—East Rutherford
Bergen Supply Co.
Route 17 & Stanley St.
NEW JERSEY—Jersey City
Nidisco Jersey City, Inc.
713 Newark Ave.
NEW JERSEY—Newark
Continental Sales Co.
195-197 Central Ave.
Krich-Radisco
422 Elizabeth Ave.
Radio Wire Television
24 Central Ave.
NEW JERSEY—Passaic
Nidisco Passaic, Inc.
205 Madison St.
NEW JERSEY—Red Bank
Monmouth Radio Supply
396 Shrewsbury Ave.
NEW JERSEY—Trenton
Nidisco Trenton, Inc.
126 S. Warren St.
NEW YORK—Albany
Fort Orange Radio Dist. Co.
642 Broadway
Taylor E. E.
465 Central Ave.
NEW YORK—Amsterdam
Adirondack Radio Supply
32 Guy Park Ave.
NEW YORK—Binghamton
Morris Distributing Co.
195-199 Water St.
NEW YORK—Bronx
Fordham Radio Supply Co.
2269 Jerome Ave.
Wilco Radio Dist.
383 E. 138th St.
NEW YORK—Brooklyn
Benray Distributing Co.
506 Coney Island Ave.
Electronic Equipment Co.
1460 Bushwick Ave.
Green Radio Distributors
482 Sutter Avenue
Hornbeam Dist. Co., Inc.
1638 Bedford Ave.
Hornbeam Dist. Co., Inc.
67-15 Fresh Pond Rd.
Hornbeam Dist. Co., Inc.
4123 Ft. Hamilton Pkwy.
National Radio Parts Dist. Co.
611 New York Ave.
Stan-Burn Radio & Electronics Co.
558 Coney Island Ave.
NEW YORK—Buffalo
Dymac, Inc.
2329 Main St.
Genesee Radio Parts Co.
205 Genesee St.
Radio Equipment Co.
326 Elm St.
Radio Electric Products
677 Michigan Ave.
NEW YORK—Crotton-on-Hudson
WRO Labs
6 Hamilton Ave.
NEW YORK—Douglaston
Eldico of N.Y., Inc.
44-31 Douglaston Pkwy.
- NEW YORK**—Flushing
Milo Radio & Electronics Corp.
160-13 Northern Blvd.
- NEW YORK**—Fredonia
C. R. Barker
45 W. Main St.
NEW YORK—Hempstead
Island Radio Distributing Co.
412 Fulton Ave.
Standard Parts Corp.
235 Main St.
NEW YORK—Jamaica
Harrison Radio Corp.
172-31 Hillside Ave.
Norman Radio Dist.
94-29 Merrick Rd.
Peerless Radio Distributors
92-32 Merrick Rd.
NEW YORK—Jamestown
Johnson Radio & Electronic Equip.
48-50 Harrison St.
NEW YORK—Middletown
L & S Radio Sales
NEW YORK—New York City
Arrow Electronics
82 Cortlandt St.
Federated Purchaser, Inc.
80 Park Place
Fischer Distributing Co.
118 Duane St.
Harrison Radio Corp.
12 West Broadway
Harvey Radio Co.
103 W. 43 St.
Leonard Radio Inc.
69 Cortlandt St.
Milo Radio & Electronics Corp.
200 Greenwich St.
Newark Electric Co.
242-250 W. 55th St.
Newark Electric Co.
212 Fulton St.
O. & W. Radio Co.
141 Cedar St.
Radio Wire Television
100 6th Ave.
Radionic Equipment Co.
170 Nassau St.
Stan-Burn Radio & Electronics Co.
1697 Broadway
Sun Radio & Electronics
122 Duane St.
Terminal Radio Corp.
85 Cortlandt St.
NEW YORK—North Rochester
Masalino Radio Supply Co.
192-96 Clinton Ave.
NEW YORK—Port Chester
Ratoc, Inc.
45 Westchester Ave.
NEW YORK—Poughkeepsie
Chief Electronics Inc.
104 Main St.
NEW YORK—Rochester
Beaucaire, Inc.
114 Monroe Ave.
Hunter Electronics
233 East Avenue
Rochester Radio Supply
114 St. Paul St.
NEW YORK—Schenectady
Electric City Radio Supply
158 Lafayette St.
M. Schwartz & Sons
710-712 Broadway
NEW YORK—Syracuse
Roberts & O'Brien
716 Park Ave.
Morris Distributing Co.
412 S. Clinton St.
NEW YORK—Utica
Electronics Laboratories & Supply Co.
608 1/2 Columbia St.
OHIO—Cincinnati
Chambers Radio Supply Co.
1104 Broadway
OHIO—Cleveland
Malz Electric Co.
6902 St. Clair Ave.
OHIO—Toledo
Warren Radio Co.
1320 Madison Ave.
- OREGON**—Portland
Portland Radio Supply Co.
1300 W. Burnside St.
United Radio Supply Co.
22 N.W. 9th Ave.
PENNSYLVANIA—Allentown
R. & M. Sales
1157 E. Livingston St.
PENNSYLVANIA—Alltoona
Kennedy's Radio Supply
1500 Seventh Ave.
PENNSYLVANIA—Erie
J. V. Duncombe Co.
1011 W. 8th St.
PENNSYLVANIA—Lancaster
The George D. Barbey Co., Inc.
29 East Vine St.
PENNSYLVANIA—Nerristown
Kratz Brothers
Cor. Kohn & Oak Sts.
PENNSYLVANIA—Philadelphia
A & G Radio Parts
3515 North 17th St.
Almo Radio
509 Arch St.
Herbach & Rademan Co.
522 Market St.
Pann Electronic Parts Co.
5303 Frankford Ave.
Radio Electric Service Co.
N.W. Cor. 7th & Arch Sts.
PENNSYLVANIA—Pittsburgh
Comeradio
963 Liberty Ave.
M. V. Mansfield Co.
937 Liberty Ave.
Radio Parts Co.
929 Liberty Ave.
Tydings Co.
632 Grant St.
PENNSYLVANIA—Reading
A & G Radio Parts
522 Schuylkill Ave.
The George D. Barbey Co., Inc.
2nd & Penn Sts.
PENNSYLVANIA—Scranton
Scranton Radio & Telev. Supply Co.
519-21 Mulberry St.
PENNSYLVANIA—Wilkes-Barre
Radio Service Co.
346 S. Main St.
PENNSYLVANIA—York
York Radio & Refrigerator Parts
265 W. Market St.
RHODE ISLAND—Providence
Dandrea, W.
129 Regent Ave.
De Mambro Radio Supply Co.
90 Broadway
TENNESSEE—Memphis
Bluff City Distributing Co.
905 Union Ave.
TEXAS—Dallas
Crobtree's Wholesale Radio
2608 Ross Ave.
VERMONT—Rutland
Rutland Radio Center
15 Merchants Row
WASHINGTON—Seattle
Radio Products Sales Co.
1214 1st Avenue
Radio Television & Appliance, Inc.
510 Westlake No.
Seattle Radio Supply
2117 Second Ave.
Western Electronic Supply Co.
2609 First Ave.
WASHINGTON—Tacoma
Wible Radio Supply
909 Tacoma Ave.
WEST VIRGINIA—Huntington
King & Irwin, Inc.
316 Eleventh St.
P.O. Box 1248
WISCONSIN—Madison
Radio Dist. of Madison
701 East Johnson St.
WISCONSIN—Milwaukee
Central Radio Parts Co.
1723 W. Fon du Lac Ave.

There's a Television Assembly Co. Distributor near you! Check this list

**TELEVISION
ASSEMBLY CO.**

for the best in
TELEVISION
for **CUSTOM-BUILT**
installations

- **STANDARD and CHAMPION MODELS**
with 10-inch, 12-inch, 15-inch Tubes
- **P-520 PROJECTION MODEL**
520 inch PICTURE

Distributed by



Island

**RADIO
DISTRIBUTORS**

**412 FULTON AVE.
HEMPSTEAD LONG ISLAND, NEW YORK**

In Buffalo, N.Y.

Here are the
2 GREATEST NAMES
in **TELEVISION**
for
**CUSTOM-BUILT
INSTALLATIONS**

**TELEVISION
ASSEMBLY CO.**

AND

**RADIO
ELECTRIC
PRODUCTS INC.**
677 Michigan Ave.
BUFFALO, N. Y.

DISTRIBUTORS for

**TELEVISION
ASSEMBLY CO.**

**CUSTOM-BUILT
TELEVISION**
in
SAN FRANCISCO
CALIFORNIA

**ASSOCIATED
RADIO
DISTRIBUTORS**

1251 FOLSOM ST. SAN FRANCISCO 3
TELEPHONE
HEMLOCK-10212

**World-Wide
Station List**

By **ELMER R. FULLER**

Location	Station	Freq.	Schedule
ALBANIA Tirana	ZAA	7.850	1300 to 1630
ALGERIA Constantine		11.830	0130 to 0315; 0630 to 0915; 1315 to 1400; 1430 to 1700
ANDORRA		5.980	0600 to 0830; 1300 to 1900
ANGOLA Benguela Louanda	CR6RB CR6RA	9.160 9.470	1300 to 1430 0115 to 0230; 0630 to 0745; 1400 to 1530
ARGENTINE Buenos Aires Buenos Aires Buenos Aires Rosario	LRSI LRYI LRAI LRR	5.980 6.890 9.680 11.880	1800 to 2300 0645 to 2300 0800 to 2200 0400 to 2100
AUSTRALIA Melbourne	VLH3	9.580	0345 to 0830; Sat., 0245 to 0900; Sun., 0330 to 0830
Melbourne Melbourne	VLG3 VLG3	11.710 15.230	0245 to 0345 2330 to 0045; 0100 to 0145; 2200 to 2300; Sat. and Sun., 2100 to 2300
Perth	VLW7	9.520	0530 to 1030; 1600 to 1900
Melbourne	VLR	9.540	0800 to 0915; 0930 to 1000; 1245 to 1415
Shepparton	VLC6	9.610	1000 to 1115; 1500 to 1615
Shepparton	VLC7	11.840	2330 to 0045; 1500 to 1615
Shepparton	VLC4	15.310	0245 to 0345; 0355 to 0730; 0800 to 1045
AUSTRIA Vienna Vienna	KWS4	7.160 9.560	2345 to 2930 0000 to 0200; 0400 to 0830; 1000 to 1000
Vienna Vienna		11.780 12.210	2345 to 1605 2345 to 1800
AZORES Ponta del Gada		11.090	1500 to 1600
BELGIAN CONGO Leopoldville Leopoldville Leopoldville	OQ2RC OTC OTC	6.010 9.480 9.740	1200 to 1300 0000 to 0200; 1100 to 1500 1530 to 1645; 1700 to 2300
Leopoldville Leopoldville	OTC OQ2RC	11.720 15.230	0530 to 0730 200 to 1100
Leopoldville	OTC	17.770	0500 to 0930; 1130 to 1215
BOLIVIA Cochabamba La Paz	CP40 CP49	6.510 6.770	1930 to 2200 0700 to 0900; 1100 to 1200; 1730 to 2100
BRAZIL Belem	PRC5	4.860	0600 to 0700; 0900 to 1100; 1230 to 2000 except Sundays
Fortaleza	PRE9	6.110	0100 to 1200; 1000 to 1900
Rio de Janeiro	ZYCG	9.610	1500 to 2200
Rio de Janeiro	PSH	10.220	1700 to 1800
Rio de Janeiro	PRL8	11.720	0345 to 0700
Sao Paulo	ZYB7	6.090	1600 to 2150
Sao Paulo	PBT2	7.410	except Saturdays and Sundays, 1800 to 2000
BRITISH GUIANA Georgetown	ZFY	6.000	0545 to 0745; 0945 to 1145; 1415 to 1945
BRITISH SOMALILAND Hargeisa	VQ6MI	7.130	0800 to 1030; 1200 to 1300
BRITISH WEST INDIES Jamaica Jamaica	ZQ1 ZQ1	3.480 4.950	1600 to 2200 1600 to 1730
BULGARIA Sofia		9.330	2300 to 0100; 0530 to 0700; 1100 to 1330; 1400 to 1545
BURMA Rangoon		6.040	0915 to 1015
CAMEROONS Douala		7.950	1300 to 1500
CANADA Calgary Edmonton Montreal Montreal	CFYP CJCA CFCX CBFW	6.030 9.540 6.000 6.090	0730 to 0100 0815 to 0200 0700 to 2315 0730 to 1945; 2000 to 2400
Montreal Montreal	CKLQ CKCX	9.630 15.190	1600 to 1800 0845 to 1100; 1820 to 1935
Montreal	CKNC	17.820	2345 to 0100; 0845 to 0630; 1820 to 2100
Toronto	CFCX	6.070	0600 to 0930
Vancouver	CKFX	6.080	0930 to 0300
Vancouver	FBRX	6.160	0900 to 0200
Winnipeg	CJRO	6.150	2200 to 0300
Winnipeg	CKRX	11.720	1000 to 2000
CANARY ISLANDS Santa Cruz	EAJ43	7.570	0730 to 0900; 1230 to 1700
CAPE VERDE ISLANDS Praia	CR5AA	6.400	1530 to 1700
CEYLON Colombo Colombo	SEAC ZOH	3.390 4.900	0730 to 1200 2100 to 2145; 0100 to 0330; 0630 to 1200
Colombo		6.070	1930 to 1200
Colombo	SEAC	9.620	1930 to 1200
Colombo	SEAD	15.120	1930 to 2300; 2330 to 0000; 0700 to 1200
Colombo	SEAC	17.770	2300 to 0730; 1100 to 1200
Colombo	SEAC	17.820	1930 to 0135; 0500 to 0700; 0715 to 1115

RADIO-ELECTRONICS for

Location	Station	Freq.	Schedule
CZECHOSLOVAKIA			
Prague		9.550	1215 to 1230; 1315 to 1330; 1400 to 1430; 1445 to 1500; 1515 to 1530; 1600 to 1630;
Prague		11.840	1645 to 1700
Prague		15.230	1030 to 1100; 1115 to 1130; 1200 to 1215; 1245 to 1300
CHILE			
Santiago	CE622	6.220	1900 to 2030
Santiago	CE1174	11.740	1700 to 2100
Santiago	CE1180	12.000	0600 to 0800; 1600 to 2300
CHINA			
Canton	XTPA	11.650	0400 to 0830; 2200 to 0930
Chungking	XGOY	7.150	0530 to 0730; 0745 to 0945; 1000 to 1045
Chungking	XGOY	11.900	0640 to 0530; 0745 to 0830; 0845 to 1045
Foochow	XGOL	10.000	0400 to 1000
Kwoiyang	XPSA	7.010	2330 to 0030; 0430 to 0900
Shanghai	XORA	11.680	0500 to 1000
COLOMBIA			
Armenia	HJFH	4.880	0600 to 2200
Barranquilla	HJAB	4.780	1700 to 2235
Bogota	HJCA	4.850	1900 to 2200
Bogota	HJCH	4.890	1800 to 2200
Bogota	HJCW	4.940	0645 to 1115; 1600 to 2315
Bogota	HJQC	4.950	1000 to 1400; 1700 to 2300
Bogota	HJXC	6.020	0700 to 0800; 1400 to 2315
Bogota	HJCD	6.160	0700 to 0800; 1600 to 2330
Bogota	HJCT	6.300	1000 to 1400; 1800 to 2315
Bogota	HJCF	6.240	1700 to 2300
Cartagena	HJAP	4.920	0600 to 1300; 1700 to 2300
Cartagena	HJAE	4.960	1600 to 2230
Call	HJED	4.820	1900 to 2300
Cucuta	HJBB	4.810	1700 to 2200
Medellin	HJDE	6.140	1100 to 2300
COSTA RICA			
San Jose	TIRH	6.130	2130 to 2400
San Jose	TIPG	9.610	0700 to 2330
CUBA			
Camaguey	COJK	8.720	2000 to 0030
Havana	COBF	6.040	0800 to 2300
Havana	COCD	6.130	0700 to 2400
Havana	COCW	6.330	0800 to 2400
Havana	COCO	8.700	0700 to 2330
Havana	COCQ	8.830	0330 to 0930
Havana	COBZ	9.810	0700 to 0100
Havana	COBQ	9.230	0800 to 1200; 1730 to 2330
Havana	COCX	9.270	0700 to 0030
Havana	COBL	9.830	0715 to 0045
Havana	COCY	11.740	0530 to 2330
Santa Clara	COHI	6.450	0630 to 2400
Santiago	COKG	8.950	0600 to 2300
CURACAO			
Willemstad		9.470	1400 to 1600
Willemstad	PJCI	7.250	1130 to 1230; 1630 to 2130
DENMARK			
Copenhagen	OZF	9.520	1145 to 1545
DOMINICAN REPUBLIC			
Ciudad Trujillo	H1Z	5.970	1900 to 2400
Ciudad Trujillo	H1IM	6.240	1600 to 2250
Ciudad Trujillo	H1IZ	6.310	1600 to 2255
Ciudad Trujillo	H1ZG	9.210	0530 to 0830; 1300 to 1530; 1700 to 1845
ECUADOR			
Ciudad Cuenca	HC5EH	3.930	1800 to 2230
Quito	H1B	4.190	1800 to 2230
Riobamba	HC5HC	4.950	1800 to 2300
Quito	HCJB	5.970	0900 to 0200
Quito	HCJB	6.280	1800 to 2400
Quito	HCJB	9.980	2230 to 2400 except Mon.; Mon., 2300 to 0300; Sun., 0800 to 2150
Quito	HCJB	12.440	2230 to 2230; Mon., 2230 to 2400
Quito	HCJB	15.110	0500 to 1200; 1330 to 2230
EGYPT			
Cairo	SUX	7.850	1400 to 1920
ENGLAND			
London	GRR	6.070	2300 to 0030
London	GSL	6.110	2300 to 0215; 1615 to 1745
London	GRW	6.150	1515 to 1600; 2000 to 2215
London	GRM	7.120	1145 to 1215; 1445 to 1715; 2330 to 2345
London	GSU	7.260	2315 to 2330; 2345 to 0130; 1000 to 1700
London	GSC	9.580	1330 to 1345; 1430 to 1530; 1600 to 1615; 1815 to 2030
London	GRY	9.600	2300 to 0100; 1315 to 1600; 1800 to 2245
London	GWD	9.620	1800 to 2300
London	GVZ	9.640	0100 to 0400; 0600 to 1045; 1615 to 1745
London	GRH	9.820	1830 to 2300
London	GVW	11.700	2300 to 0030
London	GSD	11.750	2000 to 0300; 1215 to 1745
London	GSN	11.820	0100 to 0500; 1230 to 1800; 1800 to 2030
London	GRF	12.090	2300 to 1615; 1700 to 2030
London	GWG	15.110	0400 to 1600; 1800 to 1930
London	GSF	15.140	0600 to 0715; 0915 to 1015; 1030 to 1200; 1300 to 1600; 1615 to 2015; 2300 to 0100
London	GSO	15.180	2300 to 1600; 1615 to 2015
London	GSI	15.280	0100 to 0500; 1615 to 1845
London	GWR	15.300	1200 to 1315
London	GSP	15.310	1045 to 1315; 2345 to 0030
London	GRD	15.450	0100 to 0500; 1700 to 2030
London	GVP	17.700	0600 to 0900; 1700 to 1800

IN PHILADELPHIA and WILMINGTON

it's *Almo* RADIO CO.

**509 ARCH STREET
PHILADELPHIA, PA.**

Corner SIXTH and ORANGE Streets
WILMINGTON, DELAWARE

● MODEL P-520
● 520 SQ. INCH
PROJECTION
TELEVISION

● 10", 12", 15"
PICTURE TUBE
STANDARD AND
CHAMPION MODELS

TELEVISION
ASSEMBLY CO.

TELEVISION ASSEMBLIES

for the best in TELEVISION for CUSTOM-BUILT installations

DISTRIBUTORS FOR

TELEVISION
ASSEMBLY CO.

LARRY LYNDE
RADIO SUPPLY CO.
853 PINE AVE.
Long Beach, Calif.

DIRECT-VIEW and PROJECTION ASSEMBLIES for CUSTOM-BUILT TELEVISION

for the Best in
TELEVISION
for CUSTOM-BUILT
installations

TELEVISION
ASSEMBLY CO.

**HEADQUARTERS for
PROJECTION and DIRECT VIEW
CUSTOM - BUILT TELEVISION**

RADIO PARTS SALES CO.
5220-22 So. Vermont Ave.
Los Angeles 37, Calif.

TELEVISION
ASSEMBLY CO.

10-12 and 15 inch Tube
and
520 Sq. In. Picture Projection
Assemblies

DISTRIBUTORS for

TELEVISION
ASSEMBLY CO.

Products in CALIFORNIA

E. C. WENGER CO.
1450 HARRISON ST., OAKLAND 12, CALIF.
981 SO. FIRST ST., SAN JOSE, CALIF.

ZACK
RADIO SUPPLY CO.

1426 MARKET ST., San Francisco 2, Calif.
225 HAMILTON AVE., Palo Alto, Calif.

**TELEVISION
ASSEMBLY CO.**

for the best in TELEVISION
for custom-built
INSTALLATIONS

MALZ PRESENTS the Famous T.A.C. Model P-520

**PROJECTION TELEVISION
ASSEMBLY (520 Sq. Inch Picture)**

and a Complete Line of TELEVISION ASSEMBLY CO. PRODUCTS

MALZ ELECTRIC CO.
6902 ST. CLAIR AVE. CLEVELAND, OHIO

TELEPHONE: EN-4808

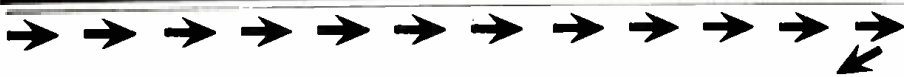

**FOLLOW THE ARROW FOR
TELEVISION AT ITS BEST!**

**TELEVISION
ASSEMBLY CO.**

**DIRECT VIEW
AND
PROJECTION**

**TELEVISION ASSEMBLIES
FOR CUSTOM-BUILT INSTALLATIONS**

ARROW ELECTRONICS
82 CORTLANDT ST., NEW YORK, N. Y.

Location	Station	Freq.	Schedule	Location	Station	Freq.	Schedule
London	GRA	17.710	0045 to 0400; 0600 to 0815; 0915 to 1115	Paris		11.840	0030 to 0130; 0145 to 0300; 1915 to 2245;
London	GVQ	17.730	0830 to 0900; 1700 to 1800; 2345 to 0630	Paris		15.350	0000 to 0015; 1700 to 1715; 1915 to 2015; 2030 to 2045
London	GSB	17.790	0545 to 0715; 0830 to 1030; 1100 to 1145	Paris		17.720	0700 to 0900; 1100 to 1230
London	GSV	17.810	0030 to 0300; 0400 to 1430	FRENCH EQUATORIAL AFRICA			
London	GRQ	18.020	0100 to 0500; 1100 to 1400	Brazzaville	FZI	9.410	0000 to 0130; 1100 to 2020
London	GVQ	18.080	1030 to 1600	Brazzaville	FZI	11.970	0445 to 0800; 0930 to 1030; 1100 to 2020;
London	GSB	21.170	0500 to 1215	Brazzaville	FZI	15.590	0000 to 0230
London	GSJ	21.530	0400 to 1215	Brazzaville	FZI	17.530	0445 to 0800; 0930 to 1030
London	GSB	21.550	0100 to 0400; 1230 to 1500	Brazzaville	FZI	17.530	0000 to 0130; 0445 to 0745; 1100 to 1700
London	GRZ	21.040	0600 to 0900; 1030 to 1230; 1300 to 1600	FRENCH MOROCCO			
London	GVT	21.750	0200 to 0715; 1030 to 1045; 1100 to 1130	Rabat	CNR3	16.670	0745 to 0830
London	GSK	26.100	0615 to 1500	FRENCH WEST AFRICA			
FINLAND				Dakar	FZK6	6.920	1330 to 1700
Lahti	O1X2	9.500	0100 to 0130; 0610 to 0740; 1000 to 1600	Dakar	FZK6	11.710	1330 to 1700
Lahti	O1X5	17.800	0130 to 0200; 0500 to 0545; 0800 to 1700	GERMANY			
FRANCE				Munich	MUNICH III	6.080	1100 to 1700
Paris		9.550	0000 to 0130; 0715 to 0845	Munich	MUNICH II	6.180	0530 to 0830; 1030 to 1730
				Munich	MUNICH I	7.250	1100 to 1700
						11.870	1100 to 1700

Location	Station	Freq.	Schedule
GOLD COAST			
Accra	ZOY	7.290	1045 to 1300
GUATEMALA			
Guatemala City	TG2	6.650	1800 to 2300
Guatemala City	TGWA	9.670	1830 to 2330
Guatemala City	TGWA	15.170	0730 to 1500
HAITI			
Port-au-Prince	HH2S	5.950	0600 to 0815; 1100 to 1300; 1730 to 2130
Port-au-Prince	HHCM	6.000	1200 to 1400; 1830 to 2100
Port-au-Prince	HHCM	6.160	0500 to 0830; 1100 to 1400; 1700 to 2145
HAWAII			
Honolulu	KRHO	15.250	0100 to 1005
Honolulu	KRHO	17.800	0230 to 0345 (off Mondays)
HONDURAS			
La Ceiba	HRD2	6.230	1200 to 1400; 1900 to 2300
San Pedro Sula	HRP1	6.360	1100 to 1415; 1800 to 2310
Taquigalpa	HRN	5.870	0800 to 1000; 1300 to 1500; 1800 to 2300
ICELAND			
Roykjavik	TFJ	12.260	Sundays, 0900 to 0930
INDIA			
Delhi	VUD3	3.340	1500 to 1240
Delhi	VUD3	6.100	1200 to 1245
Delhi	VUD3	7.290	0500 to 1100; 1730 to 1825; 2100 to 2300
Delhi	VUD5	9.590	0900 to 1230
Delhi	VUD11	15.200	2215 to 0030; 0125 to 0150; 0200 to 0400;
			0500 to 0700
Delhi	VUDIC	17.830	0430 to 0700; 0745 to 0800; 2215 to 0215
INDO-CHINA			
Saigon		11.780	1830 to 2000
IRAN			
Tehran	EQB	6.150	0930 to 1400; 2230 to 2315
Tehran	EQC	9.680	1200 to 1430
Tabriz		11.690	0500 to 0700
ITALY			
Rome		6.880	1400 to 1700
Rome		9.630	1400 to 1700; 1715 to 2015
Rome		15.120	1715 to 2015
JAMAICA			
Kingston	ZQ1	4.700	1830 to 1830
JAPAN			
Kure	WKLS	6.100	1830 to 2030
Tokyo	JLW	7.280	Home Service. 0300 to 0900; 1600 to 1800; 2200 to 0230
			0300 to 0830
KENYA			
Nairobi	VLG2	9.510	0500 to 0600; 0830 to 0915; 0945 to 1100
KOREA			
Seoul	JODK	7.030	0530 to 0715
LEBANON			
Beirut	FXE	8.030	0000 to 0115; 0515 to 0800; 1030 to 1600
LUXEMBOURG			
Luxembourg		6.090	0010 to 0030; 1400 to 1630
		15.350	0800 to 0800
MADAGASCAR			
Tananarive		6.060	1330 to 1400
MALAYA			
Singapore		4.780	0345 to 1000; 2330 to 0130
Singapore		6.770	0330 to 1200
Singapore		11.730	0330 to 0130
Singapore		15.270	0325 to 1300
Singapore		15.300	0300 to 1200
Singapore		15.300	0330 to 1200
MARTINIQUE			
Port de France		9.700	1780 to 1845; and later
MEXICO			
Guadalajara	XEJG	4.820	2200 to 2400
Mexico City	XEUW	6.020	0700 to 0100
Mexico City	XEUZ	6.130	1500 to 0030
Mexico City	XEWV	9.500	0800 to 0200
Mexico City	XETT	9.550	0700 to 0100
Mexico City	XEYU	9.600	sked unknown
Mexico City	XEQQ	6.680	0700 to 0045
Mexico City	XETW	6.040	0745 to 0045
MOROCCO			
Babat	CNR3	9.080	0145 to 0500; 1315 to 1900
MOZAMBIQUE			
Lourenca Marques	CR7BU	4.920	1330 to 1600; Sundays, 1000 to 1500
NETHERLANDS			
Hilversum	PGD	6.020	1745 to 2330; Tues., 0300 to 0430; Wed. and Sat., 1030 to 1200; 1600 to 1730
NETHERLAND-INDIES			
Bandaeng	PMC	4.790	0730 to 0800
Batavia	PMC	18.130	1100 to 1130
NEW CALEDONIA			
Noumea	FK8AA	6.200	0200 to 0400; 0430 to 0500
NICARAGUA			
Managua	YNDS	6.760	0800 to 1000; 1700 to 2300
Managua	YNOW	6.850	0800 to 2400
Managua	YNQW	6.910	sked unknown
NORWAY			
Ose	LKJ	9.540	0300 to 0315; 0500 to 0745; 1000 to 1700
NOVA SCOTIA			
Halifax	CHNX	6.130	0700 to 2300
Sydney	CJCX	6.010	0530 to 2200
PALESTINE			
Jerusalem	JCKW	7.220	2330 to 2000
PANAMA			
Colon	HP5K	6.000	0730 to 2300
Panama City	HP5K	6.030	1800 to 0030
Panama City	HP5H	6.120	0630 to 2400
Panama City	HP5A	11.700	0700 to 2300
Panama City	HP5G	11.780	0630 to 2230
PERU			
Lima	OAX4Z	5.890	1630 to 2330
Lima	OAX4V	5.910	1800 to 2400
PHILIPPINES			
Manila		11.890	Far East beam. 0400 to 1005
Manila		15.330	Indian-Pakistan beam, 0230 to 0345
POLAND			
Warsaw		6.100	1100 to 1800

RADIO-ELECTRONICS for

MIDGET ATOM SMASHER

An atom smasher no larger than a flower pot detects and counts neutrons, the vital building blocks in the structure of matter, Westinghouse announced last month. The neutron counter was developed jointly by Dr. William E. Shoupp, manager of nuclear physics and electronics at the Westinghouse Research Laboratories, and Dr. Kuan-Han Sun, research physicist.

Neutrons cannot be detected by ordinary means because they carry no electrical charge. They are instrumental, however, in splitting atoms, and Drs. Shoupp and Sun took advantage of this fact, constructing the atom smasher to make them reveal their presence.



Dr. Sun with world's smallest atom smasher.

In the new instrument a very small amount of uranium 235 is mixed with a special light-producing phosphor and the mixture is used to coat the surface of a phototube. The whole device is in a metal cylinder lined with two inches of paraffin, which slows down fast-moving neutrons.

When a neutron passes through the paraffin shield and strikes the uranium-phosphor mixture on the phototube, some of the uranium atoms are split. In the tiny explosion, nuclear fragments strike the phosphor, producing light rays. The light acts on the phototube cathode and liberates electrons.

The neutron-caused explosions can be observed directly on a fluorescent screen, or the electrons can be used to actuate recording devices which give an accurate count of the number of atomic explosions. The new detector can count the particles cast off by the exploding atoms at the rate of 100,000 a second—50 times faster than the standard Geiger counter.

Though all work so far has been devoted to neutron counting, Dr. Sun believes there is no reason the same instrument cannot be used to count the heavy mesons—components of cosmic rays—recently discovered in the upper atmosphere and artificially made in the giant cyclotron.

JANUARY, 1949

**A WIDE RANGE
HIGH QUALITY**

**...
INSTRUMENT**

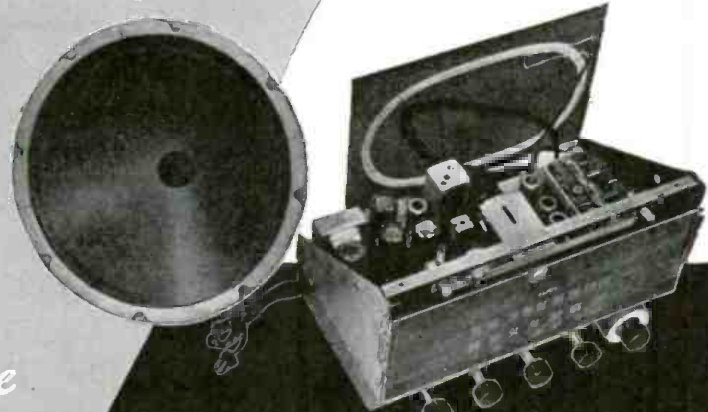

the
**new improved
ESPEY 511 AM-FM RADIO**

- Here is a fine radio, in chassis form, to please the most discriminating music lovers.
- Easy to install in any console cabinet old or new, the Espey 511 AM-FM radio chassis embodies the latest engineering refinements for lasting high quality and enjoyment at a price that defies competition.
- Features, 12 tubes plus rectifier and tuning indicator; drift compensated circuit for high frequency stability; tuned RF on AM and FM, high fidelity push-pull audio; 13 watts power output; wide range 12" PM speaker; smooth flywheel tuning; phono input provision; separate AM and FM antennas.

Other models available including 25 watt output.

Write Dept. K for your free catalog.

Makers of fine radios since 1928.

ESPEY MANUFACTURING COMPANY, INC.

528 EAST 72nd STREET, NEW YORK 21, N. Y.

TEL. BUTTERFIELD 8-2300

Custom
Built



EASY TO LEARN CODE

It is easy to learn or increase speed with an Instructograph Code Teacher. Affords the quickest and most practical method yet developed. For beginners or advanced students. Available tapes from beginner's alphabet to typical messages on all subjects. Speed range 5 to 40 WPM. Always ready—no QRM.



ENDORSED BY THOUSANDS!

The Instructograph Code Teacher literally takes the place of an operator-instructor and enables anyone to learn and master code without further assistance. Thousands of successful operators have "acquired the code" with the Instructograph System. Write today for convenient rental and purchase plans.

INSTRUCTOGRAPH COMPANY

4701 Sheridan Rd., Dept. RC, Chicago 40, Ill.

TWO WAYS

**to cut your
RECORDING COSTS!**

Find out about the MAGNETIC TAPE RECORDER that doubles your playing time, cuts your tape costs in half! Write today for technical literature.

AMPLIFIER CORP. OF AMERICA

398-10 Broadway, New York 13, N. Y.

MINE DETECTOR SCR-625 *Brand New*

**ATTENTION; LUMBERMEN, PROSPECTORS, MINERS, PLUMBERS,
OIL COMPANIES, etc.**



- ★ Below is a description of one of the finest metal detecting Mine Detectors ever built.
- ★ Operates in the manner of aural and visual method.
- ★ If you are looking for metal buried in logs, pipes in the ground, ore bearing rocks, underground cables, metallic fragments in scrap materials, metallic money buried or hidden in undetermined places this Mine Detector will probably surpass anything that was ever built. The United States Forestry Service has recommended procedure for using this detector to find concealed metal in tree logs and other timber products. Our government is reported to have paid several times the amount of our prices. They originally were sold by War Assets to jobbers for \$166.00

- ★ Unit consists of a balance-inductance bridge, a two tube amplifier and a 1000 cycle oscillator. The presence of metal disturbs the bridge balance resulting in a volume change of the 1000 cycle tone. Tubes used are low battery drain types such as 1G6 and 1M5. The circuit may be modified for control of warning signals, stopping of machinery, etc., when metal is detected.
- ★ Operates from two flashlight batteries and 103 v (B). However, a power supply operating for 100 v may be used.
- ★ This unit is brand new and comes complete with spare tubes, spare resonator and instruction manual—in wooden chest 8 $\frac{1}{4}$ inches x 28 $\frac{1}{4}$ inches x 16 inches. Weight in operation is 15 pounds. Packed in original overseas container.
- ★ We do not know exactly what the deepest possible penetration would amount to when this detector is used but we have had customers who have bought the detectors with the expectation that the detector would locate metallic objects buried several feet under the ground or under water and we have absolutely no complaints whatsoever regarding the detector not living up to the customers' expectations.
- ★ We can not overemphasize our belief that if an Army surplus mine detector could solve your problems in detecting metal that this detector should fill the bill.

NOTE: Batteries are not furnished, we can supply for \$4.50 extra.

our price
is **\$7950**
Shipping Weight 125 pounds

ESSE Radio Co
130 W. New York St.
Indianapolis 4, Ind.

Unless Otherwise Stated, All of
This Equipment Is Sold As Used
CASH REQUIRED
WITH ALL ORDERS
Orders Shipped F.O.B. Collect

RADIO-ELECTRONICS for

PRECISION TEST EQUIPMENT

(Government Surplus Release)

Low Voltage CIRCUIT TESTER Model 1-42

- ★ Here is an instrument that any mechanic that works on automobiles, boats, or airplanes would be proud to own and we offer it at a fraction of its original cost.
- ★ The low voltage circuit tester is a self-contained trouble-shooting device for making a complete and rapid check of the generator—battery circuit, including any current and voltage regulators which may be used. Battery voltage, regulator and cut-out settings, and generator performance can all be easily determined.
- ★ This tester is enclosed in a gray heavy-gauge metal box with a strong hinged top that, when opened, is supported by a slide rod and when closed, is latched by clamps. There is a carrying strap attached to the box.
- ★ This instrument was manufactured for the Quartermaster's Corps, United States Government Ordnance Department under the most rigid specifications. It is comparable in beauty and dependability to instruments made today that sell for many many more dollars than our price. Electric Heat Control Company, Cleveland, Ohio, or the Heyer Products Company, Inc., Belleville, New Jersey manufactured these for the Army. Although the unit you receive may be made by either of these companies, it will be practically identical to the unit made by the other company and all are made under Heyer Products Company's design and according to Government specifications.
- ★ This low voltage circuit tester is 11 3/16" wide x 9 9/16" deep x 7 1/2" high and can be used on either a 6 volt or 12 volt system. There is a metal chart attached to the lid of each unit which is easily readable while using the instrument. This chart shows settings of all controls and gives operation instructions to be used in conjunction with the operating manual which is included with the tester. One can quickly determine and correct trouble with this instrument. There are two battery leads with drive-in connectors (with spikes—lead coated) 8' long; ammeter lead (3-wire) complete with calibrated shunt, 6' long; voltmeter leads with alligator clip connectors and rubber insulators 8' long, and field rheostat leads with alligator type connectors and rubber insulators 5' long. The direct reading meter scale 4" in diameter with color-coded scales, along with the push-button



switch, voltage selector (3-circuit toggle switch), meter polarity switch, utility switch, volt-ammeter scale selector switch, field rheostat, regulator test selector switch, multisection load resistor, is used to control all operations and functions of this instrument. The master meter reads 0-60 volts and 0-60 amperes. One switch box indicator has following ranges: 0-9 volts and amperes, scale deviation—0-9 range in 1/10th of a volt, 0-18 in 2/10th's of a volt, 0-60 in 1 volt and ampere division, 0-9 in .05th of a volt and ampere.

- ★ They are brand new. Each weighs approximately 14 pounds. The price that we quote is only made possible because of the fact that they are Government surplus and this company bought them at a "steal". Remember, this is truly the finest of instruments and we cannot over-emphasize that we believe it is the best bargain ever offered.

PRICE

\$29⁷⁵

TERMS:
Cash with
Order

ESSE

Radio Co
130 W. New York St.
Indianapolis 4, Ind.

Unless Otherwise Stated, All of
This Equipment Is Sold As Used
CASH REQUIRED
WITH ALL ORDERS
Orders Shipped F.O.B. Collect

NEW!
Different!
Down to-
earth!

Cash in on

SERVICING PROFITS!



Just Published!

PRACTICAL TELEVISION SERVICING

By J. R. Johnson and J. H. Newitt
375 pages, 6 x 9, over 250 illustrations
Price only \$4

At last, you can get a book that really gives you the low-down on television servicing—one that tells step by step what to do and also guides you specifically on precautions to take and the mistakes to be avoided. PRACTICAL TELEVISION SERVICING is all the name implies—a complete, down-to-earth working manual for those who want to understand television servicing fully, get straightened out on the vast amount of MISinformation that is creeping into the television picture, and really be able to do television servicing work.

NOT a Book of Mere Theory

This isn't a book of theory, mathematics and general discussions. The authors—one a radio editor, the other a well-known engineer—actually owned and operated a television service shop to get the specific, how-to-do-it information they now pass along to you in easily understood form. In addition to a clear explanation of how television components, construction and operation differ from radio they show exactly how to perform all specific operations in troubleshooting, diagnosing and remedying television receiver troubles. You don't bother with needless theory. You are actually shown how to do the work!

MAKES TELEVISION REPAIR WORK EASY TO UNDERSTAND

Here are the subjects covered:

- | | |
|--|---|
| 1. Television is Here | 10. Test Equipment and Alignment |
| 2. Fundamentals of the Television System | 11. Wiring and Repair Techniques |
| 3. The Radio-frequency, Intermediate-frequency and Detector Sections | 12. Common Troubles in Television Receivers |
| 4. Video Amplifiers | 13. Troubleshooting |
| 5. Cathode Ray Tubes | 14. Servicing Hints and Case Histories |
| 6. Synchronizing and Sweep Circuits | 15. Color Television |
| 7. Power Supplies | A. Intermediate Frequencies of Standard Receivers |
| 8. Antennas and Wave Propagation | B. Receiver Layout Diagrams |
| 9. Television Receiver Installation | C. Glossary |

FACTUAL SERVICING DATA ON

- How to test for an intermittent peaking coil or transformer
- How to get a signal over a mountain
- What to do when the linearity of the picture is poor
- How to guy a mast properly
- Checking video response with a square wave
- When to use mica capacitors in place of other types
- . . . and scores of other practical problems

10 DAYS TRIAL

SEND NO MONEY JUST MAIL COUPON

Dept. RE-19, Murray Hill Books, Inc.,
232 Madison Ave., New York 16, N. Y.

Send me Johnson & Newitt's PRACTICAL TELEVISION SERVICING for 10 days' examination on approval. In 10 days I will send \$4, plus a few cents postage, or return book postpaid. Postage paid on cash orders: same return privilege. (Books sent on approval in U.S. only. Price outside U.S. \$4.50 postpaid).

Name

Address

City, Zone, State

Occupation



So we aren't the largest radio and parts distributors in the country. Just the same, we can supply anything and everything needed in the electronic field. And don't you overlook this fact—lower operating expenses mean savings to our customers. Let us know what you need. We're sure we can fill your needs . . . and our prices are always right. Drop us a line and get on our mailing list.

ADSON RADIO & ELECTRONICS CO.
221 Fulton Street New York 7, N. Y.

TELEVISION KITS

A real buy! A 7" television kit with all the features of the more expensive sets. 6000 Volt High Voltage Supply assures clear pictures at all times. Comes with factory built, precision-engineered thirteen channel tuner already aligned. Uses high-fidelity FM sound. Complete with illustrated instruction manual giving assembly data, alignment procedure, service notes and much helpful information. 18 tubes for this set can be furnished for \$39.50, cabinet for \$21.00. You can't go wrong at **\$59.50** this low price of **LESS TUBES**

10" TELEVISION KITS

For those who want the ultimate in TV kits, this 10" kit has everything: electromagnetic scanning and focusing, A.F.C. horizontal hold control, and many other fine features. 17 tubes for this set sell for \$57.30, cabinet for \$23.50. Worth many times more **\$99.50** than **LESS TUBES**

5-TUBE RADIO KIT

A real buy. Comes complete with 5" Alnico speaker for only **\$9.75**

Write for our new 1948 illustrated catalogue.

LAKE RADIO SALES CO.

615 W. Randolph Street, Chicago 6, Ill.

PEN-OSCIL-LITE

Extremely convenient test oscillator for all radio servicing! alignment • Small as a pen • Self powered • Range from 700 cycles audio to over 600 megacycles u.h.f. • Output from zero to 125 v. • Low in cost • Used by Signal Corps • Write for information.

GENERAL TEST EQUIPMENT

38 Argyle Ave. Buffalo 9, N. Y.

TINY METEORS HELP RADIO

Millions of tiny meteors entering the earth's atmosphere may be responsible for our ability to receive radio broadcasts from long distances during the night, states Dr. A. G. McNish of the National Bureau of Standards.

Radio waves, which travel in straight lines, must be reflected back to the earth if they are to be heard at any great distance. Tiny electrified particles in the ionosphere bounce the short waves back to earth.

The ions that compose this reflecting layer are produced mainly by the action of the ultra-violet in sunlight which splits electrons off the atoms and molecules high up in the rarefied air. Some of the electrical particles may also be produced by impact of tiny corpuscles shot off from the sun, others by cosmic rays and by meteors.

The lower portion of the ionosphere is rich in free electrons during the day, due to the action of sunlight, Dr. McNish pointed out. Directly after sunset most of the electrons are gone because they recombine with molecules.

"Yet—and herein lies the mystery—a sufficient number of electrons persist at this lower height all through the night to reflect radio waves," Dr. McNish said.

"Judging from the rate of electron-decay just after sunset, one would not expect to find any significant number beyond midnight."

Meteors may be the agency responsible for reflecting the radio waves at night. Astronomers estimate that more than a thousand billion of these particles, smaller than grains of sand, enter the earth's atmosphere during a 24-hour period. Traveling at speeds up to 200,000 miles per hour, they would smash violently into atoms and molecules of the upper air. These meteors would tear some of the electrons from these particles to which they belong and thus maintain the radio roof.

R. F. MASS SPECTROMETER

A new method of tracing chemical elements in certain parts of the body has been developed.

During radar research it was found that water vapor and oxygen absorbed ultra-high-frequency radio energy; their presence in air put an upper limit on the frequencies which could be used. Further research at M.I.T. and Columbia University showed that certain other gases and solid elements absorbed waves of particular frequencies.

The new spectroscopy transmits u.h.f. waves of frequencies in the bands which are absorbed by specific isotopes. Specimens of the skin, hair, or nails of animals which have been fed small quantities of the selected isotopes are placed in the path of the r.f. energy. A detection device records how much of the transmitted energy is received. The difference is the amount absorbed by the isotopes. From this information, the quantity of the given isotope in the specimen can be calculated.

A CHALLENGE—Order a model 247. Disregard the unbelievably low price and compare it on the basis of appearance, quality and performance to any other Tube Tester (ANY MAKE, ANY PRICE). If you are not completely satisfied with the model 247 after a 15 day trial, return it to us for full refund—no explanation necessary. The model 247 is not surplus nor is it a hashed over pre-war model. It is newly designed and incorporates new advances in Tube Tester design. Read the description below and order one today!



The New Model 247 TUBE TESTER

Checks octals, loctals, bantam jr. peanuts, television miniatures, magic eye, hearing aids, thyratrons, the new type H.F. miniatures etc.

Features;

- * A newly designed element selector switch reduces the possibility of obsolescence to an absolute minimum.
- * When checking Diode, Triode and Pentode sections of multi-purpose tubes, sections can be tested individually. A special isolating circuit allows each section to be tested as if it were in a separate envelope.
- * The Model 247 provides a super sensitive method of checking for shorts and leakages up to 5 Megohms between any and all of the terminals.
- * One of the most important improvements, we believe, is the fact that the 4 position fast-action snap switches are all numbered in exact accordance with the standard R.M.A. numbering system. Thus, if the element terminating in pin No. 7 of a tube is under test, button No. 7 is used for that test.

Model 247 comes complete with new speed-read chart. Comes housed in handsome, hand-rubbed oak cabinet sloped for bench use. A slip-on portable hinged cover is included for outside use. Size 10 3/4" x 8 3/4" x 5 3/4".

ONLY
\$29⁹⁰
NET

The Model 88



A COMBINATION

SIGNAL GENERATOR and SIGNAL TRACER

SIGNAL GENERATOR SPECIFICATIONS:

*Frequency range: 150 Kilocycles to 50 Megacycles. *The R.F. Signal Frequency is kept completely constant at all output levels. *Modulation is accomplished by Grid-blocking action which is equally effective for alignment of amplitude and frequency modulation as well as for television receivers. *R.F. obtainable separately or modulated by the Audio Frequency.

SIGNAL TRACER SPECIFICATIONS:

*Uses the new Sylvania 1N34 Germanium crystal Diode which combined with a resistance-capacity network provides a frequency range of 300 cycles to 50 Megacycles.

The Model 88 comes complete with all test leads and operating instructions. ONLY

\$28⁸⁵
NET

THE NEW MODEL 670

SUPER METER



SUPER METER. A combination VOLT - OHM - MILLIAMMETER plus CAPACITY REACTANCE, INDUCTANCE and DECIBEL MEASUREMENTS.

D.C. VOLTS: 0 to 7.5/15/15/150/750/1500/7500. A.C. VOLTS: 0 to 15/30/150/300/1500/3000 Volts. OUTPUT VOLTS: 0 to 15/30/150/300/1500/3000. D.C. CURRENT: 0 to 1.5/15/150 ma.; 0 to 1.5 Amps. RESISTANCE: 0 to 500/100,000 ohms. 0 to 10 Megohms. CAPACITY: .001 to 2 Mfd. .1 to 4 Mfd. (Quality test for electrolytics.) REACTANCE: 700 to 27,000 Ohms; 13,000 Ohms to 3 Megohms. INDUCTANCE: 1.75 to 70 Henries; 35 to 8,000 Henries. DECIBELS: -10 to +18. +18 to +38. +30 to +58.

The model 670 comes housed in a rugged, crackle-finished steel cabinet complete with test leads and operating instructions. Size 5 1/2" x 7 1/2" x 3".

\$28⁴⁰
NET

The New Model 770—An Accurate Pocket-Size

VOLT-OHM MILLIAMMETER



(Sensitivity: 1000 ohms per volt)

Features:

Compact—measures 3 1/4" x 5 7/8" x 2 1/4". Uses latest design 2% accurate 1 Mil. D'Arsonval type meter. Same zero adjustment holds for both resistance ranges. It is not necessary to readjust when switching from one resistance range to another. This is an important time-saving feature never before included in a V.O.M. in this price range. Housed in round-cornered, molded case. Beautiful black etched panel. Depressed letters filled with permanent white, insures legibility even with constant use.

Specifications: 8 A.C. VOLTAGE RANGES: 0-15/30/150/300/1500/3000 volts. 6 D.C. VOLTAGE RANGES: 0-7 1/2/15/75/150/750/1500 volts. 4 D.C. CURRENT RANGES: 0-1 1/2/15/150 Ma. 0-1 1/2 Amps. 2 RESISTANCE RANGES: 0-500 ohms. 0-1 Megohm.

The Model 770 comes complete with self-contained batteries, test leads and all operating instructions.

\$13⁹⁰
NET

Available for Immediate Shipment From Stock—20% Deposit Required on All C.O.D. Orders

MOSS ELECTRONIC DISTRIBUTING CO.

DEPT. RC-1, 229 FULTON ST.
NEW YORK 7, N. Y.

BUILD THE NEW MODEL TV-67 ALL CHANNEL TELEVISION BOOSTER

FOR YOUR OWN USE OR FOR RESALE



With the aid of our TV-67
INDUCTOR TUNER
Illustrated below.

only **\$3.50**

INDUCTOR TUNER comes complete with circuit and instructions for building the TV-67 TELEVISION BOOSTER. We will also include at no charge basic circuits utilizing the TV-67 INDUCTOR TUNER to build a Television and F.M. Signal Generator, a Television Interference Eliminator and front end for Television Receiver.

No need for switching when using the TV-67

INDUCTOR TUNER

Designed to Cover All Channels 2 to 13 Inclusive.

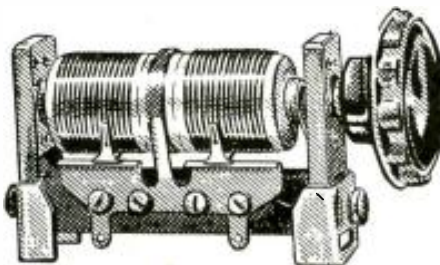

TV-67 Booster Features:

- ★ Permits use of Indoor Installations.
- ★ Reduces or eliminates interference including Amateur, F.M., Short Wave and Inter-Channel.
- ★ Permits TV reception in fringe areas.
- ★ Amplifies weak signals.
- ★ Provides brighter and clearer images.

Specifications:

- ★ The Model TV-67 employs 1-6AK5 as a high gain amplifier; 1-6C4 as an isolation amplifier and 1-6C4 as rectifier. Use of these highly efficient miniature tubes in conjunction with INDUCTOR TUNER results in maximum gain on all channels up to channel 13.
- ★ The Model TV-67 provides a 6 megacycle band-width reducing Video detail loss to absolute minimum.
- ★ The Model TV-67 is designed to operate with *any* antenna system indoor or outdoor—any impedance.
- ★ New INDUCTOR TUNER covers all television channels, 2 to 13, inclusive *without switching*.

INDUCTOR TUNER comes complete with circuit and instructions for building the TV-67 Television Booster. We will also include basic circuits utilizing the TV-67 INDUCTOR TUNER to build a Television and F.M. Signal Generator, a Television Interference Eliminator and front end for Television Receiver. *only*

\$3.50

GENERAL ELECTRONIC DISTRIBUTING CO.
98 PARK PLACE NEW YORK 7, N. Y. DEPT. RC-1

PANEL LETTERING

Designations can easily be printed on radio panels with a rubber stamp outfit, obtainable at most stationery stores. The choice of stamp pad ink is important. Volger's opaque ink, available in several colors, and special stamp pad are excellent for marking dark panels; mistakes can be wiped off with a rag moistened with benzene.

HAROLD PALLATZ,
Brooklyn, N. Y.

CONDENSER GROUND LEADS

Many of the new molded tubular capacitors have no mark to indicate which lead is connected to the outer foil. To determine which is which, connect the capacitor across the input of an audio amplifier and place your finger on the capacitor at the end from which the grounded lead emerges. Then reverse the capacitor connections and repeat the test.

When your finger induces the least hum, the grounded lead is the one connected to the foil.

ALAN SMITH,
Shaftesbury, Vt.

USE FOR SOCKET PUNCHES

Many people do not know that screw-type tube-socket punches (such as the Greenlee and others) will also work with Presdwood, Bakelite, and hard rubber.

NORRIS MCKAMEY,
Davenport, Iowa

CLEANING TOOL

Here is an interesting and useful tool which makes cleaning inaccessible parts, such as band switches and variable capacitors, much easier. Remove the head from an old vibrator-type electric shaver and attach a short fiber stick to the vibrating driver. The fiber is at right angles to the shaver so that when the shaver motor is turned on it vibrates lengthwise. A piece of cotton is glued to the other end of the fiber stick.

To use the gadget, dip the cotton in carbon tetrachloride, start the shaver, and apply the cotton to the dirty part. The vibration will make the cotton wipe off the dirt.

LLOYD O. WALTER,
Dillonvale, Ohio

DIAL POINTERS

To make a new pointer for a dial which has lost its original one, straighten a 12-inch length of solid tinned copper wire by fastening one end of it to a nail or screw on the bench and pulling on the other end with pliers until it breaks. Cut a piece the needed length, and fasten it to the dial shaft.

This is an excellent way to straighten wire for any purpose.

GEORGE L. GARVIN,
South Bend, Ind.

BC RECEPTION

Some surplus receivers, such as the BC-348, can be converted to broadcast-band reception with the aid of an a.c.-d.c. midget broadcast set to whose i.f. the surplus unit can be tuned.

INSTRUCTION MANUALS

DC 312, BC 342\$1.25
 SCR 281\$1.25 SCR 508 1.25
 Mark II 1.00 SX-32 1.00

VIBRATORS

TR 1210, 12 vdc, 5 pin\$1.00
 OAK V-6075, 24-32 vdc, 7 pin 1.00
 Mal. Type 534C, 12 vdc, 5 pin 1.00
 Mal. Type 6620-C, 12 vdc, 4 pin 1.00
 Radiant R2, 6 v. DC, 6-pin special... 1.00
 - Mfrs. quantities available.

XMTR TUNING UNITS

For BC 610; TU 48 (2-3 mc); TU 47 (2-2.5 mc); TU 46 (1.8-12 mc). Each...\$1.75
 For BC 223AX; TU 17 (2-3 mc); TU 18 (1-4.5 mc). Each...\$1.95
 BC 300-A, Antenna Loading unit for BC 375 & BC 191.....\$2.75
 400 vdc. originally used for Collins ART-13 xmr \$.59

ROTARY BEAM CONTACTOR ASSEMBLY

6 Heavy duty Contact Rings, 1/2" wide, 3 1/4" diam. mounted on low-loss form with bearings to fit 1 3/4" diam. shaft. An excellent unit for feeding that new beam. Each ring is brought out to a separate pin. New \$9.45 ea.

INVERTERS

PE 218: Input: 25-28 VDC @ 92 amps. Output: 115 volts @ 1500 volt-amps, 380-500 cycles.

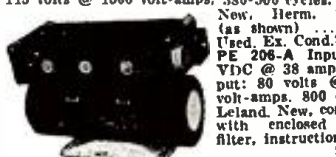

New, Herm. Sealed (as shown) ...\$49.95
 Used, Ex. Cond. \$35.00
 PE 206-A Input: 28 VDC @ 38 amp. Output: 80 volts @ 500 volt-amps, 800 cycles. Leland. New, complete with enclosed relay filter, instruction book \$12.50

HEADSETS

Dynamic mike and headset combination. A high quality, efficient unit. E-19 tank Xmtrs. Mike and phone complete. new\$2.75
 R-15 headsets: 8000 ohms impedance, rubber cushions. Comes with 8 ft. cord and plug PL 55. New \$2.95
HEADBANDS: HB-1, HB-4, HB-30. New .25 ea.

SCR 610 11-10 METER PORTABLE MOBILE RIG

SCR 610 portable transmitter-receiver. 27 to 38.9 mc crystal controlled, using FM for efficient operation. Unit consists of Xmr-rvr BC 659 and power supply PE 97. A. operating from 6 or 12 vdc. Slightly used, excellent condition. Less xials,\$25.00

Disconnect the secondary of the last i.f. transformer from the remainder of the broadcast-set circuit and attach leads of convenient length. Connect these leads to the antenna and ground posts of the surplus receiver. Now tune the surplus receiver to the i.f. of the midget, and tune the midget for which-ever station is desired.

This is a particularly valuable idea when the surplus receiver has a good audio end. The broadcast-band receiver from a 274-N, for example, was used to feed the input of a BC-779-B in one setup.

CURTIS M. EGGERS,
 Las Vegas, Nev.

USING KNIFE SWITCHES

In many applications requiring a single-throw knife switch, it is better to use a double-throw unit. The double-throw switch has a positive off position, keeping the blade in place so that the circuit is less likely to be closed accidentally.

CHARLES ERWIN COHN,
 Chicago, Ill.

WIRE STRIPPER

A pair of pocket fingernail clippers can be used as a wire stripper. Clamp the wire in the jaws and pull. If the pointed end of the depressor is filed off, it can be used as a small screwdriver.

CECIL HARRISON,
 Spencer, Okla.

DYNAMOTORS

Type	Volts	Input Amps	Output Volts	Output Amps	Radio Set	Price
WD 77KM	14	40	1000	.350	BC 191	\$20.00 N 14.00 LN
PE 73	28	19	1000	.350	BC 375	24.50 N
DM 21	14	3.3	935	.080	BC 312	3.45 LN
DM 21CK	28	1.8	935	.080	BC 312	3.45 LN
DM 28	12	2.3	930	.050	BC 367	2.49 LN
DM 28R	28	1.25	275	.070	BC 348	8.75 N
DM 33	28	7	540	.110	BC 456	5.50 N
DM 42	14	46	815	.110	SCR 506	6.50 LN
			1030	.050		
D-104	12		225	.100		14.95 N
			440	.200		
DA-3A*	28	10	300	.250	SCR 522	8.95 N
			350	.150		
			14.5			
5093	28	1.4	250	.080	AFN-1	3.05 N
DA-7A	30-5		400	.400	TA-2J	23.00 N
PE 58	12	25	500	.400	SCR 245	5.25 LN
PE 86	28	1.25	250	.080	RC 36	1.95 N
PE 101 C	13-26	6.3	800	.185	SCR 515	5.25 N
			800	.020		
			9 AC	1.12		
SD AR 93	28	0.25	375	.150		4.95 N
23350	27	1.75	285	.075		3.50 N
35X045B	28	1.2	250	.080		3.50 N
ZA-0515	12/24	4.2	500	.050		3.95 N
B-19 pack	12	0.4	275	.110	Mark II	
			500	.050		9.95 N

N-New. LN-Like New * Lens Filter Box & Relays

CROSS POINTER INDICATOR

Dual 0-200 micromD. movement in 3" case. Each movement brought out to 6-term receptacle at rear. Originally used in IIS equipment. New.....\$5.50



1619!! 1619!! 1619!!

Type 1619 vacuum tubes, octal based Pentode. . . . The most versatile high permeance tube at A New low price. \$21 ea. or 5 for.....\$100

TYPICAL OPERATION CHARACTERISTICS (Octal Base)

Class C RF Amp (Telco.)	Class A2Z Audio (2 Tubes PP)
Plate Volts 400	400
Screen Voltage 300	300
Plate Current 75 ma	75/150 ma
Screen Current 10.5 ma	6.5/11.5 ma
Grid Voltage -5	-16.5
Grid Current 3 ma	
Grid Drive .36 W	.4 W
Power Output 19.5 W	36 W

While they last.....\$21 ea. or 5 for \$100

131-C
 Liberty St.
 New York 7, N.Y.

All merchandise guaranteed. Mail orders promptly filled. All prices, F.O.B. New York City. Send Money Order or Check. Only shipping charges sent C.O.D.

COMMUNICATIONS EQUIPMENT CO.

MANUFACTURERS QUANTITIES AVAILABLE

GREAT TUBE VALUES

01-A	3.45	12A6	.35	860	15.00
1824	4.85	12AY7	.65	851	40.00
2C21	.68	12B7	.45	874	1.95
2C22	.69	12SR7	.72	876	4.95
2J21-A	25.00	18R	1.40	1005	.38
2J22	25.00	2B7	.75	1013	.95
2J26	25.00	30 (Spec.)	.70	1019	.21
2J27	25.00	48 (Spec.)	.89	1024	.85
2J31	25.00	39A	.72	1029	.35
2J32	25.00	35/51	.72	1961	5.00
2J38	25.00	227A	3.85	9002	.65
2J39	25.00	225	8.80	9004	.47
2J55	25.00	268-A	20.00	9006	.47
3J31	55.00	355A	19.50	CEQ72	1.95
3A4	.65	830	90.00	EF 50	.79
3A2/879	.69	417A	25.00	FC 271	40.00
3BP1	2.25	531	45.00	F.127	20.00
3C24	.60	532	3.95	FG 258A	165.00
3C30	.70	559	4.00	GL 562	75.00
3D6	.79	562	90.00	GL 623	75.00
3CP1	3.30	615	.89	GL 687	75.00
3D21-A	1.50	703-A	7.00	ML 100	80.00
3OP1	2.25	704-A	.75		
3EP1	2.95	705-A	2.95	QK59	65.00
3FP7	3.85	707-B	120.00	QK60	65.00
3SP1	3.50	714AY	25.00	QK61	65.00
3Q5	.79	715-B	12.00	QK62	65.00
5BP1	1.20	720BY	50.00	RC4 932*	.65
5BP4	4.85	721-A	3.40	VR 81	1.00
5CP1	3.75	723-A/B	12.50	VR 130	1.25
5FP7	3.50	724B	1.75	VR 135	1.25
5HP2	8.00	725-A	25.00	VR 137	1.25
5P20	39.50	728-A	12.00	VR 120	1.00
6G	2.00	800	2.25	WT 134	1.00
6L6GA	1.00	801-A	1.10	WL532	4.75
6X4	1.00	804	6.95	WM 150	3.00
7C4	1.00	815	2.50	WT 260	5.00
7E5	1.00	836	1.15		
7E6	.72	837	1.95		
10Y	.60	843	.59		

* Photocell. † With Cavity.

CARBON PILE VOLTAGE REGULATORS

Type "A": Coil current .105 to .115 amps, 80 volts. Leland Electric. \$3.00
 Type "C": Input: 22-30 v. coil, 30 amps. Output: 19 v. 5.7 amps. Spec. \$VR9000-2c. Leland Electric (as shown).....\$3.00
 \$35X045B: 22 v. 1 to 3 amps. for K-14B Gunsight. Webster.....\$3.00



PHONE DIGBY
 9-4124

AT LAST!! A LOW COST POWER UNIT FOR SERVICE WORK

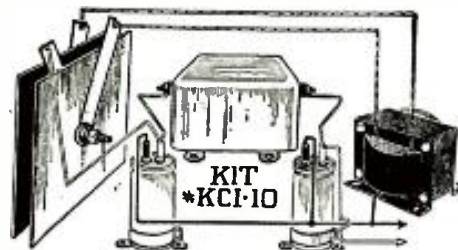

"A" ELIMINATOR KIT #KC 1-10

\$19.50

Including pictorial and schematic diagrams

For the first time, we are offering a well-engineered six volt direct current power unit for auto-radio and similar service work in kit form!!

This unit was formerly in the high priced range. Now, we have placed all the essential components necessary for construction in kit form, and are offering them to you at this low, low price.

These kits fulfill the long-standing need of every serviceman and technician. They are designed to operate from a 115 V.A.C. 50/60 cycle source, and deliver 6 V.D.C. well-filtered from three to eight amperes, with a peak rating of ten amperes. The A.C. ripple percentage is held to remarkably low values.

This unit charges a standard auto battery in one day!!

- Do away with bulky batteries!
- Do away with corroding fumes!
- Simplify your service operation!

Order this fine kit for your bench today!!

No C.O.D.'s. Full remittance with order. Shipping wt., 12 lbs.
 ATTENTION DEALERS! Write for quantity discounts

OPAD-GREEN COMPANY

71 Warren St. Phone: BEekman 3-7385 New York 7, N. Y.

INSTRUCTIONAL RECEIVER

? I would like to have a diagram of a one-tube radio to which a second (audio) stage can be added at some future time. The set is to be used for instructing students in the elements of radio.—G.E.J., Bedford Hills, N. Y.

A. The set you requested is shown in the diagram. The r.f. tube is the 1S5. When the 1S5 circuit is constructed, use the headphones in the position shown by the dotted lines in the diagram. When ready to build the 1S4 amplifier, connect the 1S4 grid in place of the phones, and use the phones at the output of the 1S4.

The receiver will have fairly low gain. To increase the gain, the 1S5 is made regenerative. Over a standard broadcast loop antenna wind 10 to 15 turns of No. 28 wire. You will have the

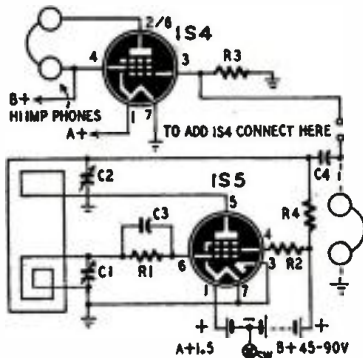

- R1, R3—2.2 megohms 1/2 watt
- R2—1 megohm, 1/2 watt
- C1—365- μ f variable
- C2—140- μ f variable
- C3—250- μ f mica
- C4—.01- μ f, 150-volt paper
- Broadcast loop antenna (see text)
- A—1.5-volt battery
- B—45- to 90-volt battery
- SW—s.p.s.t. toggle switch

correct number of turns when both volume and regeneration are easily controlled by C2.

If B is 90 volts, you may replace the headphones with a suitable output transformer and PM speaker.

CONVERTER FOR BC-312

? Please print a diagram for a broadcast-band converter to be operated with a BC-312 surplus receiver.—E.W.W., Jefferson, Ohio.

A. A two-tube converter is shown in the diagram. The two filaments should be connected in series to the 12-volt winding of the transformer in the BC-312. B-voltage and a.v.c. can be obtained from the receiver as well.

The tuning range of the converter is about 550-1500 kc. If you have a local station at 1500 kc, you will be unable to receive it unless you set the i.f. coil to about 1560 kc, connect a signal generator set to 1560 kc to the 6L7 grid cap, and tune the transformer for maximum receiver output.

To use the converter, connect its output to the antenna post of the BC-312, tune the receiver to 1500 (or 1560) kc, and tune in your station with the converter.

Questions Box inquiries are answered by mail. Those of general interest are printed on this page. A fee of \$1.00 is charged for questions requiring no research or schematics. Write for estimates on questions requiring research or schematics. Be sure to give full specifications and details. Due to nominal fees charged for this work, it must be handled as a part-time proposition. Therefore rapid service is impossible. Six to eight weeks is required to draw up answers involving large drawings or research.

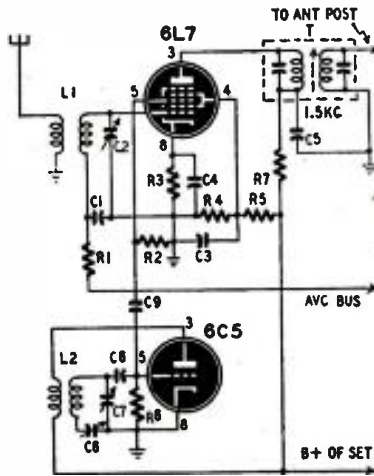

- R1—270,000 ohms, 1/2 watt
- R2, R4—47,000 ohms, 1/2 watt
- R3—470 ohms, 1/2 watt
- R4—22,000 ohms, 1/2 watt
- R5—15,000 ohms, 2 watts
- R7—3,300 ohms, 1/2 watt
- C1—.02- μ f, 450-volt paper
- C2, C7—2-gang, 365- μ f-per-gang, air variable
- C3, C4—0.5- μ f, 450-volt paper
- C5—.01- μ f, 450-volt paper
- C6—.001- μ f adjustable padder
- C8—100- μ f mica
- L1—broadcast antenna coil (Miller A-727-A or equivalent)
- L2—broadcast oscillator coil (Miller B-727-B or equivalent)
- T—i.f. transformer, 1500-kc (Miller 912-W1 or equivalent)

BAND-SWITCHING RECEIVER

? I am building a short-wave set with band switching. Please give me specifications for coils for 6, 10, 20, and 75 meters.—B.R.S., Vine Grove, Ky.

A. The front end of a typical receiver is shown in the diagram and coil data is given in the table. To get perfect tracking and the desired coverage it may be necessary to vary the coils slightly.

The coil values have been calculated for an i.f. of 1500 kc.

PHONO AMPLIFIER

? Please design a phonograph amplifier using a pair of 35Z4's as a voltage doubler, a 35L6 as output tube, and a suitable 12-volt tube as voltage amplifier. Provide a microphone input, too, please.—L.I.M., Milwaukee, Wis.

A. The amplifier you asked for is shown in the diagram. If you use a

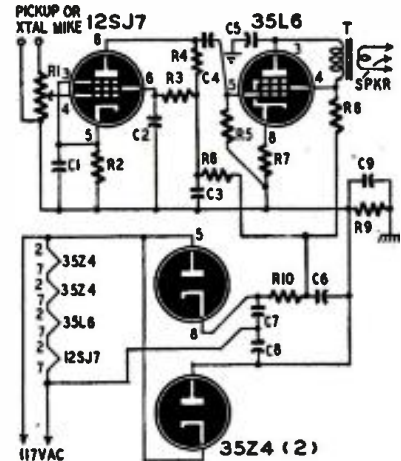

- R1—500,000-ohm potentiometer
- R2—560 ohms, 1/2 watt
- R3—4.7 megohms, 1/2 watt
- R4—100,000 ohms, 1/2 watt
- R5—470,000 ohms, 1/2 watt
- R6—15,000 ohms, 1/2 watt
- R7—150 ohms, 1 watt
- R8—3,000 ohms, 10 watts
- R9—270,000 ohms, 1/2 watt
- C1—10- μ f, 25-volt electrolytic
- C2—.05- μ f, 400-volt paper
- C3—8- μ f, 400-volt electrolytic
- C4—.01- μ f, 400-volt paper
- C5—.025- μ f, 400-volt paper
- C6—20- μ f, 450-volt electrolytic
- C7, C8—20- μ f, 150-volt electrolytic
- C9—0.25- μ f, 400-volt paper
- T—output transformer, 5,000 ohms to voice coil
- SPKR—PM speaker

microphone, you may not get as much volume as you want unless a high-output crystal is used. In any case, the output will be higher from a crystal phonograph pickup.

Band	COIL TABLE			Tap	C1 (μ f)
	Coils	Wire (AWG)	Turns Length		
75 meters (4 mc)	L1, L3	28 13	close-wound		
	L2, L4	28 53	1 inch		
	L5	28 39	1 inch	14	.006
20 meters (15 mc)	L1, L3	22 6	close-wound		
	L2, L4	22 11	1/2 inch		
	L5	22 10	1/2 inch	3	none
10 meters (30 mc)	L1, L3	22 5	close-wound		
	L2, L4	22 5 1/2	1/2 inch		
	L5	22 5 1/4	1/2 inch	2	none
6 meters (50 mc)	L1, L3	14 3	close-wound		
	L2, L4	14 3	5/16 inch		
	L5	14 3	5/16 inch	1 1/2	none

Spacing between L1 and L2 and between L3 and L4 is about 1/16 inch to 1/8 inch; vary for best results. All coils wound on 3/8-inch-diameter forms. All wire enameled. Tap column shows number of turns up from ground end.

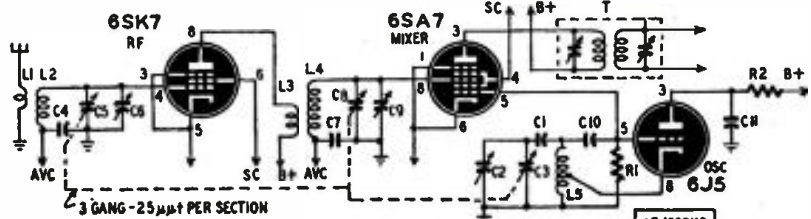

- R1—47,000 ohms, 1/2 watt
- R2—5,000 to 10,000 ohms, 1/2 watt
- C1—see coil table
- C2, C4, C7—3-30- μ f mica trimmer
- C3, C5, C8—25- μ f, 3-gang tuning capacitor

- C4, C7—.05- μ f, 600-volt paper
- C10—100- μ f mica
- C11—.01- μ f, 600-volt paper
- T—1500-kc i.f. transformer
- L1, L2, L3, L4, L5—see table

Dr. Willard H. Bennett has been designated head of the Physical Electronics Section of the Atomic and Molecular Physics Division, National Bureau of Standards, where he will be actively engaged in basic research on cathode emission processes and the physical properties of negative atomic ions. Dr. Bennett is responsible for the recently



developed radio-frequency mass spectrometer tube and assisted in the early development of a gas-filled, cold-cathode rectifier. He has also done considerable research on high-voltage generators and tubes and numerous other electronic devices.

Ricardo Muniz of Rutherford, N. J., well known to readers of Gernsback publications as the author of articles on technical subjects, has been appointed to the post of General Manager of the Television Receiver Division of Allen B. Dumont Laboratories, Inc., of Passaic and Clifton, N. J., according to Leonard F. Cramer, Vice President of the company.



George D. O'Neill, assistant to the manager of research, Sylvania Electric Products, Inc., Flushing, N. Y., has been elected Fellow by the Board of Directors of the Institute of Radio Engineers. He will receive a Fellowship Award for his work in electron-tube theory and design during the Institute's National Convention in March, 1949.

Among his engineering contributions widely used in radio and electronic developments are:



twin-element tubes; indirectly heated power output tubes; indirectly heated, low-voltage-drop rectifiers; and microwave developments restricted for security reasons. During his career as a radio engineer, he has been granted twenty patents and now has six applications pending.

Milton L. Kuder, prominent in Navy radar and guided-missile development projects, has been appointed to the staff of the National Bureau of Standards, Mr. Kuder will be concerned with research and engineering in the Bureau's Ordnance Research Section.

Dr. Allen V. Austin has been named Chief of the Electronics Division, National Bureau of Standards, Washington, D. C., to succeed the late Harry Diamond.

JANUARY, 1949

The Capacitors that Lick

MOISTURE

VIBRATION

HEAT

... yet cost you not one cent extra!

SPRAGUE PHENOLIC MOLDED TUBULAR CAPACITORS

Types **TM** and **MB**

(600 Volts)

(1600 Volts)

Take a look at Sprague Type TM and MB Phenolic Molded Tubular Capacitors! See how their sturdy phenolic jackets offer complete protection against moisture, vibration and heat—the three factors that cause 9 out of 10 failures in ordinary wax tubulars. Then try Sprague TM's and MB's on your toughest jobs—and you'll quickly understand why these little units represent the greatest capacitor development in modern radio servicing history! Sprague TM's and MB's are a "must" for auto radio, aircraft radio and television applications. And because they cost exactly the same as ordinary wax cardboard tubulars, wise servicemen use them exclusively for all service replacements. There are no service complaints, no dissatisfied customers when you use Sprague TM's and MB's.

Get the genuine article! Be sure and ask for Sprague TM's and MB's by name!



SPRAGUE PRODUCTS COMPANY

North Adams • Massachusetts

JOBBING DISTRIBUTING ORGANIZATION FOR PRODUCTS OF THE SPRAGUE ELECTRIC COMPANY

ALL IN 1



**TUBE TESTER
SET TESTER
BATTERY TESTER
CONDENSER TESTER
AUDIO R.F. - F.M.
SIGNAL GENERATOR**

RCP Model 8573
at the record smashing price only **\$99.95**

Every square inch solid-packed with value! Look what you get in this phenomenally low-priced tester: (1) A complete tube tester with over 800 listings in its famous Rollindex roll chart, (2) A battery tester indicating actual voltage under rated load, (3) A capacitor tester, (4) A fixed point calibrated AM-FM signal generator, (5) An audio oscillator; and a dozen additional features.

Readable scale divisions on the ohm meter start at 0.05 ohm to 25 megohms.

DC Volts: 0, 2.5, 10, 50, 250, 1000, 5000
AC Volts: 0, 10, 50, 250, 1000, 5000
DC Milliamps: 0, .5, 2.5, 10, 50, 250, 1000
DC Amps: 0, 10
Ohms: 0, 250, 2500, 25000
Megohms: 0, 2.5, 25
Decibels: -8 to +15, 15 to 29, 29 to 49, 32 to 55
Output Voltmeter: 0, 10, 50, 250, 1000, 5000

Complete with tubes, batteries and test leads, output leads, etc., housed in natural finish oak case; hammertone gray panel. See this outstanding buy at your jobber today—or write for new catalogue I C.

RCP INSTRUMENTS—BEST FOR EVERY TEST

RADIO CITY PRODUCTS CO., INC.
152 West 25th St. New York 1, N. Y.

FREE ILLUSTRATED 1949 CATALOG

Of Radio and Electronic Tubes and Parts

Send For It Today

All brand new merchandise selling retail at wholesale prices—catering to Hams, Experimenters, Servicemen, and Students.

A new radio company dealing only in mail orders to give you quicker service on all orders large or small.

RADIO MAIL ORDERS
75 BARCLAY ST., DEPT. RE, NY 7, NY



WE ARE LOOKING FOR TUBES!

WHAT HAVE YOU GOT?

Interested in small or large quantities of all types of Transmitting, Industrial, and Receiving Tubes. Send offerings to:

T. L. BLACK, WHOLESALE TUBE DIV.
NIAGARA RADIO SUPPLY CORP.
160 Greenwich St., New York 6, N. Y.

Headphone BARGAINS

Type MS23—8000 ohm impedance, highly sensitive, lightweight only 9 oz. Leather covered spring steel adjustable headband. 12" cord with PL54 plug attached at side out of way. Jack and rubber cord supplied to extend length to 5 1/2 feet. Removable rubber ear cushions. Brand New—\$13.50 Value

Stk. No. 17A37
SPECIAL PER PAIR. \$2.45



Type MS30—8000 ohm impedance. Small yet highly sensitive. Built on hearing aid principle with ear fitting soft rubber cushions attached to receivers... shut out outside noise. Comfortable, light metal band easily shapes to contour of head. Supplied complete as illustrated with 6 foot cord and PL55 plug, shirt clip and matching transformer for 8000 ohm impedance. Very popular for conversion to mikes, telephone sets, miniature crystal sets and all around headphone use. Brand New. A Terrific Value! No. 17A420X. Per Pair... **\$1.29**



5BP4 CATHODE RAY TUBE \$2.95

Hos 5" white screen. Quality make individually boxed in cushioned carton. Brand New, Perfect, Guaranteed. No. 367206. **\$2.95**

SPECIAL EACH

ORDER NOW from this ad—include postage.

FREE—the big NEW B-A Catalog No. 491. 132 pages of Outstanding Values. Write if you have not received it.

BURSTEIN-APPLEBEE
1012-14 M'GEE STREET.
KANSAS CITY 6, MISSOURI

TS-10 SOUND POWERED HANDSETS

These are what you have been waiting for! ALL BRAND NEW. Made by WE, RCA and Automatic Elect. Requires no batteries or transformers of course! Useful for TV antenna installations, intercoms, line communication, etc. No battery feature makes it possible to provide communications in plants where explosive chemicals are used. Clip a TS-10 on each end of a line and have your communication in a jiffy. Air-mail or wire your orders now as quantity is limited. **PRICE, per pair \$16.95**

COMPLETE TELEPHONE SYSTEM!
Consists of 2—TS-13 Handsets, 2—RM32 Telephone Boxes and 250' duplex copper telephone wire. All equipment N.W. **\$10.95 per set**

RM-53 REMOTE CONTROL BOX
Two way telephone conversation can be routed over a transmitter and receiver output transferred to a telephone line with this handy remote control box. Talk over transmitter via telephone. **ONLY \$2.50 ea.** (Send 25¢ Deposit On All Orders. Balance COD)

OFFENBACH & REIMUS CO.
372 Ellis Street San Francisco 2, Calif.

Come to the Great SHOPS OF COYNE

Learn **RADIO-TELEVISION SERVICE**

PRACTICAL SHOP TRAINING—NOT HOME STUDY

Trained Radio men needed now. Get Radio-Television training and be ready for a real future. Learn on actual equipment at Coyne. 50th Anniversary Year. Not "Home Study". Free employment service to graduates. Many earn while learning. If you are short of money, ask about Student Finance Plan. G.I. Approved. Coupon brings special plan for men of draft age.

SEND COUPON FOR FREE BOOK

B. W. COOKE, President
COYNE ELECTRICAL & RADIO SCHOOL
500 S. Paulina St., Dept. 19-8H, Chicago 12, Ill.

Send Big Free Radio-Television Book, also your special plan for men of draft age.

NAME.....
ADDRESS.....
CITY.....STATE.....

Charles Freshman, Chicago-born pioneer radio manufacturer, died October 2 at his Pasadena, Calif., home. The founder of the Charles Freshman Company, a radio manufacturing company in New York in the early 1920's, he introduced the Freshman Masterpiece, the first low-cost, mass-produced radio for home use. Later he set up plants in Chicago and other cities. In 1928 he sold out his interest in the firm and was Eastern sales director for the Belmont Radio Corporation of Chicago before his retirement.



Dr. Robert D. Huntoon has been appointed Chief of the Atomic and Molecular Physics Division, National Bureau of Standards, Washington, D. C. He will also serve as consultant to several specialized laboratories of the Bureau's Electronics Division.

Arnold Everett Bowen, research engineer of the Bell Telephone Laboratories, died at the age of 47 in Stroudsburg, Pa., after a brief illness. Mr. Bowen helped to develop the system for transmitting microwaves through hollow guides, which made possible new forms of radar used in World War II. During the war, he served in Washington as officer-in-charge of the Air Forces' Airborne Radar Equipment Board with the rank of lieutenant colonel.



Dr. Newbern Smith has been appointed Chief of the Central Radio Propagation Laboratory of the National Bureau of Standards, Washington, D. C., where he will plan and direct basic theoretical and experimental radio wave propagation research, head the operation of the world-wide network of radio propagation observatories, and direct development of radio measurement standards at frequencies from 10 kilocycles per second to 300,000 megacycles per second.



G. Lester Jones has been appointed Chief Engineer of Lear, Incorporated, of Grand Rapids, Mich., according to an announcement made by Mr. Richard M. Mock, President of Lear, Inc. During the past year, Mr. Jones served as assistant to the President of Indian Motorcycle, Springfield, Mass., where he supervised subcontracting and tooling of two new motorcycles. Mr. Jones was instrumental in setting up their new plant in East Springfield.

CIRCUIT-DESIGN AID

Patent No. 2,446,993
Joseph Alter, Long Branch, N. J.

This device is intended to save time in designing r.f. and a.f. amplifiers. It aids the designer in selecting optimum values for the components. All the components that might be used in a standard voltage- or power-amplifier circuit (the drawing shows an audio voltage amplifier) are mounted on a panel, with several different types

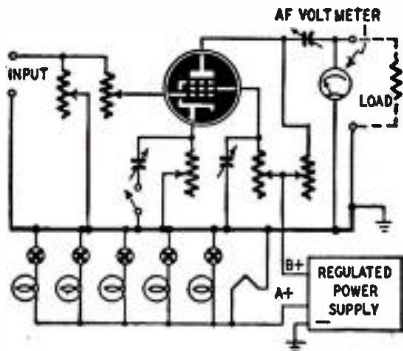

of tube sockets wired in parallel. All components are made variable to eliminate the necessity for soldering in a number of different capacitors or resistors.

Indicating lights are placed above the controls to indicate which ones are in use.

SUPERSONIC INSPECTION

Patent No. 2,448,398
Vincent G. Shaw, Pittsburgh, Pa.
(Assigned to Sperry Products, Inc.)

The thickness of an object, or the distance from its surface to a flaw beneath it, is measured by the time needed for supersonic waves to travel through it. As in radar, the time between a transmitted pulse and its reflection (from the flaw or the other surface of the body) is observed on a cathode-ray tube.

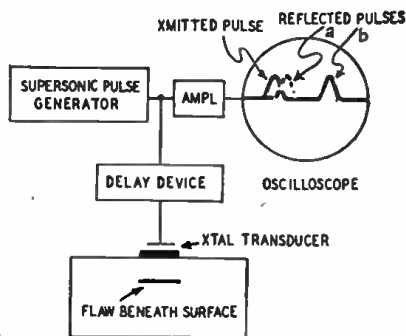

If a fissure or break exists very close to the surface of the material, the reflected pulse occurs within a very short time and may interfere with the original pulse. The transmitted pulse may overload the oscilloscope amplifier. If the reflection occurs almost immediately there is not enough time to restore the amplifier to normal sensitivity.

An artificial transmission line or other delay circuit is added in series with the crystal transducer to delay the reflection so that it cannot interfere with the transmitted pulse. In the diagram, the reflected pulse is shown occurring at *a* without the delay network, and at *b* with the delay circuit added.

H.F. ELECTRONIC SWITCH

Patent No. 2,439,651
Robert B. Dome, Bridgeport, Conn.
(Assigned to General Electric Co.)

In radar, for example, it is necessary to switch rapidly from one antenna to another. This switching may be done effectively as described here.

The output of each antenna is passed through separate and similar channels. Each contains two parallel networks and a rectifier. The tube cathodes are connected across a square-wave generator so they conduct alternately. The par-

★ BRAND NEW! ★ SUPER-SENSITIVE ★ TELEVISION SET! ★ DESIGNED FOR REMOTE ★ "FRINGE AREA" OPERATION



★ A 34 tube TV set with remarkable gain and hold characteristics. Set contains 10" picture tube. A natural for "fringe area" dealers who must supply their customers with good television reception. AVAILABLE FOR IMMEDIATE DELIVERY.

★ **\$469 complete** Write for technical data and further information.

- ★ SEND FOR FREE PROJECTION TELEVISION CATALOG
- 5TP4 Projection Kinescope Tube
 - 30 KV RF Power Supply
 - Projection Television Chassis
 - Hi-Voltage Coils
 - Hi-Voltage Television Capacitors
- ★ Include 25% Deposit With Order, Balance C.O.D.

★ JUST RECEIVED! ★ THE NEW SPELLMAN ★ F1.9 PROJECTION TV LENS

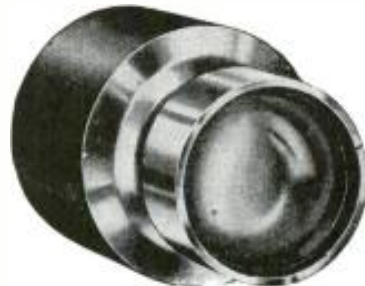

★ Dimensions: Length 7", Diameter 4 1/4" F1.9 EF.5 in. (127.0 mm.) This lens incorporates in barrel a corrective lens for use with a 5TP4 projection tube. It is easily removable for use with flat type tubes. Lens can be utilized to project picture sizes from several inches to 7x9 feet.

★ Only **\$90** complete with mounting ring. Machined slotted Mounting Ring available for hand focusing adjustment. Has 4 holes for easy mounting on plate. \$8.00 extra.

- Stand for Projection Television Sets
- Front and Rear Projection Television Screens
- Hi-Voltage RF Coils—15KV, 25KV, 30KV
- Hi-Voltage Meter—0 to 30KV

PIONEERS IN PROJECTION TELEVISION
SPELLMAN TELEVISION CO., INC.
DEPT. B, 130 WEST 24th STREET, NEW YORK 11, N. Y. • AL 5-3680

AC POWER SUPPLY AND SPEAKER

Completely wired power supply and speaker, with volume control 15 W and on & off switch, housed in a metal cabinet, size 4 1/2" x 5 1/2" x 4 1/2". For receiver shown below or any other type command receiver; ready to plug into receiver or rack, and 110 Volt 60 cycle line.



Price — Completely Wired
Kit of Parts only

BC 454 COMMAND RECEIVER

3 to 6 Megacycles. Covers 75 and 80 meter amateur band. Price, complete with Schematics—

NEW **\$6.95**

TUNING CRANK for Comm. Receivers..... 65c ea.

SELSYN TRANSMITTER & INDICATOR

Ideal as Radio Beam Position Indicator for Ham, Television, or Commercial use. Complete with 1-32 five inch Indicator. Autosyn Trans., 12 Volt 60 cycle transformer, and wiring instructions. Price: NEW



1-82 Indicator, only **\$4.95**

TRANSFORMERS

Primary 110 Volt 60 cycle; 24 Volt Sec. 1 amp... **\$1.95**
Primary 110 Volt 60 cycle; 24 Volt Sec. .5 amp... **\$1.50**
Primary 110 Volt 60 cycle; 14-14 Volt Sec. 7 1/2 or 15 amp. **\$4.95**
Primary 110 Volt 60 cycle; 12 Volt Sec. 1 amp... **\$1.50**

ADDRESS DEPT. RE

Prices are F.O.B., Lima, Ohio
25% DEPOSIT ON C.O.D. ORDERS

DYNAMOTORS

INPUT	OUTPUT	STOCK NO.	PRICE
9 V. DC	405 V. 95 MA	DM 635 X	\$3.95
12 V. DC	220 V. 100 MA	D 402	3.95
12 V. DC	440 V. 200 MA	D 401	7.95
12 V. DC	F/ SCR 522	PE 98	12.95
28 V. DC	F/ SCR 522	PE 94	7.95
12/24 V. DC	F/ No. 19 MARK II	P/S #3	9.50
13/26 V. DC	F/ BC 645	PE 101	2.95
28 V. DC	400 Cycle Inverter	MG-149F	12.95
12/24 V. DC	500 V. 50 MA	USA/ 0151	1.95
28 V. DC	F/ Comm. Receivers	DM 32	1.95

MOTOR—6 or 12 Volt AC-DC. Heavy Duty reversible motor with 5/16" x 7/16" shaft. Price: NEW... **\$2.95**

TUNING UNITS

TU-17 or TU-25 for BC 223—NEW	\$4.50 each
TU-5 for BC 191—BC 375—NEW	\$3.95
TU-7-8-9-10 or 26 for BC 191—BC 375—NEW	\$2.95
RF Unit for BC 312—1st, 2nd, or 3rd	\$1.50
Detector Assy. BC 348-Q	\$1.25

THREE FOR \$1.50 SPECIALS

- RF Unit 6 to 9.1 MC F/ BC 454
- 465 KC IF Iron Core 1st, 2nd, or 3rd.
- 455 KC IF Standard Replacement
- 456 KC IF Pec Wee
- 30 MC IF FM or T.V. Broad Band
- 2.65 MC IF FM Narrow Band Assy.

SELSYNS

110 Volt 60 cycle, 78411 Size V	\$5.95 Pair
2J1G1—110 Volt 60 cycle. Instructions	\$3.00 Pair

CHOKES

CHOKE—5-20 H 500 MA (Swinging), 5000V Test.	\$7.95
CHOKE—8 H 500 MA Filter, 5000 V Test.	\$8.50

FAIR RADIO SALES 132 SOUTH MAIN ST. LIMA, OHIO

RADIO TUBES

All Brand New

MONEY BACK GUARANTEE!

THIS LIST COMPRISES OVER

100,000 TUBES

RUSH YOUR ORDERS IN

1A7.	Sylvania	.59
1H5.	Kenrad	.59
1LC6.	Sylvania	.69
1LD6.	Sylvania	.49
1LE3.	Sylvania	.79
1LN5.	Sylvania	.39
1N5.	Sylvania	.59
1R5.	Unbranded	.49
1S5.	Tungsol	.49
1T4.	Unbranded	.29
3Q 5.	R.C.A.	.59
3S 4.	Unbranded	.29
5Y3.	R.C.A.	.39
6B66.	Philco	1.59
6C4.	Nat. Union	.22
6C8.	Stand. Brand	.69
6H6.	Western Elec.	.37
6SA7.	Stand. Brand	.46
6SK7.	Stand. Brand	.46
6SL7.	Philco	.49
6SQ7.	General Elec.	.39
6X5.	Stand. Brand	.49
12K8.	R.C.A.	.57
12S J7.	Tungsol	.49
12 SR7.	Kenrad	.29
14A7.	Sylvania	.49
14B6.	Sylvania	.49
14Q 7.	Sylvania	.49
14R7.	Sylvania	.49
25A6.	Stand Brand	.79
25L6.	Sylvania	.54
35L6.	Sylvania	.55
35W4.	Tungsol	.37
35Y4.	Sylvania	.59
35Z5.	R.C.A.	.39
50A5.	Sylvania	.69
50L6.	R.C.A.	.55
117L7.	Philco	.88
117Z3.	Tungsol	.69
117Z6.	Sylvania	.74
OZ4.	Stand. Brand	.59
8016.	Philco	1.59
9001.	Hytron	.39
9002.	Hytron	.39
9003.	Hytron	.39
9004.	Stand. Brand	.59
K55B.	Hytron	.29
27.	Philco	.36
37.	R.C.A.	.34
77.	Nat. Union	.39
78.	Philco	.49

Substitutes of other standard brands will be made if listed brands are out of stock

BROOKS RADIO DIST. CORP.
80 Vesey St., Dept. A, New York 7, N. Y.

allel circuits are made to resonate at the radar frequency.

The variable resistor R is adjusted so that the total resistance between the L center-tap and ground is $R_0/4$ during periods of conduction. (R_0 is the impedance of the parallel network LC at the radar frequency.) With this adjustment currents are attenuated to zero (theoretically).

During non-conducting periods the added resistance of L2C2 upsets this condition. There is practically no current flow through this network, therefore attenuation is almost zero.

Currents from both channels are mixed in a transformer circuit. The output transformers are spaced a quarter wavelength from the common line to prevent interaction.

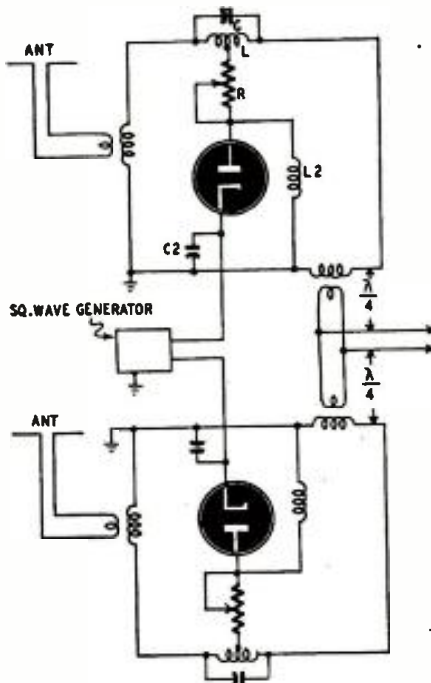

H. F. GENERATOR

Patent No. 2,448,501

Howard J. Tyzzer, Caldwell, N. J.
(Assigned to Ferris Laboratories)

Most technicians and designers have had experience with the mysterious behavior of high-frequency circuits. Dead spots may appear over portions of the dial due to transit time difficulties and h.f. losses. When these dead spots are eliminated by circuit changes, they frequently reappear at other points of the dial, making it difficult to design an oscillator or amplifier to cover a wide band.

A switching arrangement is used in the h.f. oscillator shown here. A three-way switch is thrown automatically as the tuning condenser is rotated. The switch changes the feedback circuit to produce more efficient operation over each portion of the dial.

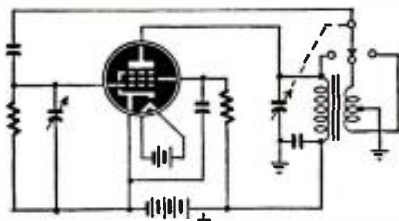

FREQUENCY MEASUREMENT

Patent No. 2,445,800

Alfred Mortlock, London, England
(assigned to Standard Tel. and Cables Limited, London)

This circuit is effective over the audio range. During each cycle a condenser becomes charged and then discharges through a voltmeter, which rises in proportion to the frequency.

The input tube is biased to block during half of each cycle. During these periods condenser C charges from the B-supply through one of the

Here's BIG NEWS!

INTERCOM AND RADIO COMBINATION



at a PRICE That Can't Be Beat

6 tube superhet—3 tube intercom permits communication between radio-master and up to 4 sub-stations.
Original cost \$64.50

WHILE THEY LAST \$29.95
With 1 sub-station and 50 feet of cable
Extra Sub-stations \$3.95 each



MIDGET I. F. TRANSFORMERS

Original List \$2.10

At discounts up to 86%

NOW 36c EACH

400-500 Kc range
1 1/4" square, 3" high
hi-gain iron core.

INPUT—A826
OUTPUT—A827

Specify Type
Matched Pair 69c
Dozen \$3.95
Egg Crate of 100 \$29.00

1 meg. VOLUME CONTROLS



85% DISCOUNT

Universal with switch

Better Hurry
THESE WON'T LAST AT THIS PRICE 29c Each



Demand This Seal of Quality

ORDER INSTRUCTIONS

Minimum order—\$2.00. 25% deposit with order required for all C.O.D. shipments. Be sure to include sufficient postage—excess will be refunded. Orders received without postage will be shipped express collect. All prices F.O.B. Detroit.

RADIO SUPPLY & ENGINEERING CO., Inc.
85 SELDEN AVE. DETROIT 1, MICH.

rectifiers. When the tube begins to conduct, C discharges through it and through the other rectifier. Charging and discharging pulses are filtered by R-C circuits. The meter is connected across A and B.

It is often more convenient to have the meter read in proportion to the logarithm of the frequency, rather than directly with frequency. The values shown provide a logarithmic relationship over a range of 800-10,000 cycles.

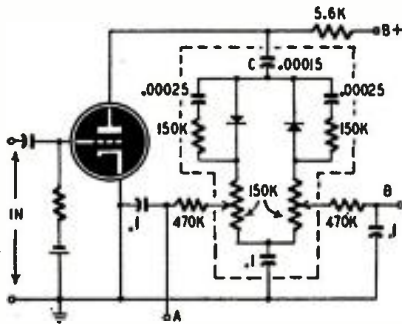

FREQUENCY SUBDIVIDER

Patent No. 2,445,161

Vernon H. Vogel, Cedar Rapids, Iowa
(assigned to Collins Radio Co.)

This frequency subdivider is designed for efficiency and simplicity. While the following de-

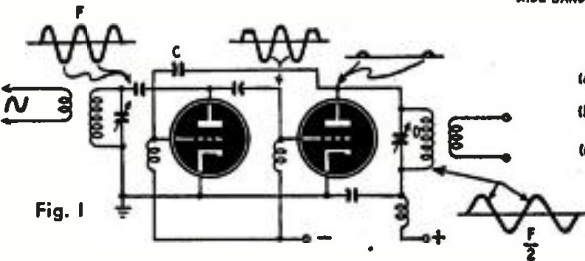

Fig. 1

scribes only the second subharmonic, others may be generated if desired.

The input circuit (Fig. 1) is tuned to an incoming signal of frequency f . The output is a high-Q circuit tuned to $f/2$. The second triode is a class-C amplifier biased to twice cutoff. When a signal is applied, subharmonic energy is available at circuit O. Due to flywheel action the voltage will be nearly sinusoidal (Fig. 2-a) although the plate current is composed of pulses (Fig. 2-b). Part of the output is fed back through condenser C to the first tube to control its grid bias.

STATIC ELIMINATOR

Patent No. 2,444,455

Emile Labin, New York City and
Ross B. Hoffman, E. Orange, N. J.

(assigned to Federal Tel. and Radio Corp.)

Designed especially for pulse communication, this receiver can greatly reduce and even completely eliminate static and noise. It includes a resonant circuit tuned to a low-frequency component of the desired pulses. The circuit is shock-excited by every incoming pulse, whether

During positive output peaks (such as P in Fig. 2-a) the bias is reduced. Therefore, the grid goes positive and clips the positive peak of the signal (Fig. 2-c). During negative peaks (such as N), the negative bias is increased and there is no clipping. Therefore, only alternate positive peaks of incoming signal are lost. This is shown in Fig. 2-c.

As a result of clipping action, only alternate cycles are effective in driving the class-C amplifier. This increases output at the desired subharmonic.

noise or signal, but the desired pulses produce greatest output. Pulses of other timing such as static are greatly reduced.

Incoming signals and noise are first amplified in a wide-band amplifier. This is followed by the shock-excited circuit which has a Q of about

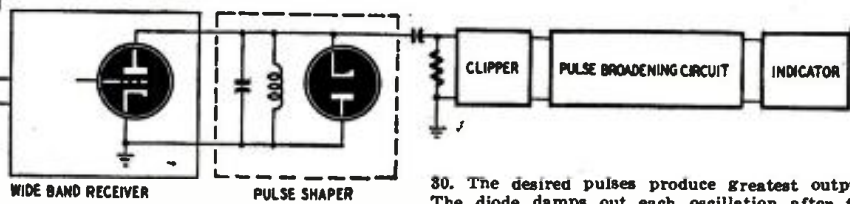

WIDE BAND RECEIVER

PULSE SHAPER

30. The desired pulses produce greatest output. The diode damps out each oscillation after the first half-cycle. The noise which still remains is lost in the clipper circuit which transmits only signals which have greater than predetermined amplitude.

To produce a greater effect in the pulse indicator (which may be an oscilloscope) the pulses may be widened in a pulse-broadening circuit. This is similar to the previous resonant circuit except that it is tuned to a lower frequency. When it is shock-excited, the output pulses from this circuit are relatively wide.

This receiver can improve the signal-to-noise ratio by about 14 db.

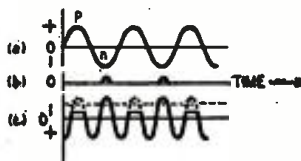

Fig. 2

For GREATER Earnings... LEARN RADIO-ELECTRONICS

This fast-growing science of RADIO, TELEVISION, RADAR and ELECTRONICS, offers tremendous opportunities, and in no industry is RADIO-ELECTRONICS more important than in aviation. A skilled technician who knows the modern application of electronic devices, as used in the aircraft industry, is always in demand . . . not only in aviation, but in many other industries. Many large organizations call on Spartan regularly for graduates. Often, students are hired months before graduation.

Don't confuse the RADIO-ELECTRONICS course offered by SPARTAN with other courses, offered anywhere! As a graduate from this famous school you will know the application to industrial control devices; to the search for petroleum; and the important uses of radar, television and other electronic equipment.

SPARTAN offers two complete and thorough courses. You will work on the most modern and complete equipment. You will build equipment. You may join the SPARTAN "Ham" Club. Either course prepares you for Federal Communication Commission license tests — first class radio telephone, second class radio telegraph, or class "B" radio amateur.



SPARTAN'S 21 years of teaching civilian and army personnel is your assurance of receiving the best possible training in the least possible time. You'll not need MORE than Spartan training — you cannot afford to take LESS.

BIG CATALOG — Free

NAME _____ AGE _____

ADDRESS _____

CITY _____ STATE _____

Dept. RE-19

G. I. APPROVED — Write TODAY for Complete Information

SPARTAN
SCHOOL OF RADIO AND ELECTRONICS

SCHOOL of AERONAUTICS COLLEGE of ENGINEERING
MAXWELL W. BALFOUR, DIRECTOR ADDRESS DEPT. RE-19
TULSA, OKLAHOMA

U. H. F. NOISE DIODE

Noise generators using standard temperature-limited diodes have been used in laboratories for measuring the sensitivity and noise factor in receivers. Such generators were often limited in their high-frequency range and were suitable only for narrow-band tuned circuits.

The Type TT-1 co-axial noise diode was developed to overcome these limitations. This tube, developed by RCA and now being manufactured by Eclipse-Pioneer Division of Bendix Aviation Corp., goes up to 3,000 mc and is suitable for untuned wide-band circuits.



Noise-factor measurements are made by connecting a properly loaded temperature-limited diode across the input of the receiver and measuring the receiver noise output with an output meter. After noting the reading, the diode is turned on and its filament current increased until receiver output is twice its original value. The diode anode current is used as the receiver noise factor after it has been corrected for transit time and spurious receiver response.

The 100-ma maximum anode current makes noise factor measurements possible up to 20 db. The transit-time reduction is 3 db at 3,000 mc.

The co-axial diode consists of an outer conductor (the anode) and a concentric inner conductor. The ratios of the diameters of the conductors produces a 50-ohm characteristic impedance, making the diode suitable for direct connection to the antenna terminals of many high-frequency receivers. The 3.2-volt, 2.5-amp. filament current enters the diode through a lead inside the inner conductor and returns through the inner conductor itself. Further information on this tube is to be found in the March 1947 issue of *RCA Review*.

One billionth of an ampere can be measured by a new microammeter developed by RCA. The instrument is expected to be important in various branches of research. It may be used with multiplier phototubes to measure light intensities and the density of gases and in atomic research for checking ionization-chamber currents.

JANUARY, 1949



- ★Wide-Range
- ★Scratch
- ★Suppressor
- ★Volume
- ★Expander

Supreme performance with any variable reluctance pickup.

EXCLUSIVE G.E. PICKUP CIRCUIT

New circuits enable you to attain full benefit from the new G-E Variable Reluctance Magnetic pickup. Employs an exclusive, humless pre-equalized pre-amplifier to produce the most satisfying musical amplifier the world has ever known. If you are a perfectionist, you are the one for whom the ACA-100GE was designed. Send for technical literature.

AMPLIFIER CORP. OF AMERICA

398-10 Broadway, New York 13, N. Y.

BRAND NEW SURPLUS! GUARANTEED!
3/4 RPM, HI-TORQUE ELECTRIC MOTOR
\$2.85 Plus 40c Postage and Handling

- Operates on 110V AC, 60-cycles (Requires only 12 MFD condenser.)
- Reversible, Self-Locking Clutch, Quiet.
- With Full Instructions.
- FOR ROTATING HAM, FM, TELEVISION ANTENNAS AND MANY OTHER USES.
- FB for that new QUAD

BARGAIN RADIO, Dept. BR-3
 249 N. Juanita Los Angeles 4, California

RADIO MADE EASY!

A JRI Trainer

A NEW APPROACH to radio receiver repairing. Here is a METHOD of radio repairing that can be LEARNED QUICKLY—Begin repairing immediately. The electronic field is wide open. Prepare Yourself for a GOOD INCOME NOW! Discover for yourself that radio repairing is EASY TO LEARN by this NEW METHOD. Send for the JRI Home Trainer TODAY. \$2.00 postpaid or plus c.o.d. charge. Satisfaction guaranteed.

THE JRI TRAINERS
 P. O. Box 2091, Dept. 100-A, Chicago 9, Ill.

We have increased our production so we are now able to again make immediate delivery on Wright Verified Speakers with the



Mounting Bracket

write for literature

WRIGHT, Inc.

2234 University Ave.
 St. Paul W4 Minn.

BUYING SURPLUS MEANS SURPLUS SAVINGS

Brand New! Kenyon Filament Transformers



For 304 TL's. Will operate two 304 TL's, etc. Sec. 5 Volts, C.T. at 60 amps. Pri. 115 Volts—60 cycles. Shpg. wt. 26 lbs.

\$8.95

WESTINGHOUSE TERMINAL STRIPS

12 connections, molded black Phenolic. Brass screws, terminal 1 1/2 x 1 1/2 x 9/16". Shpg. wt. 1 lb. 99c

Synchronous (Self-Rectifying) VIBRATOR

Hermetically Sealed. Good for 100 milliamperes. Does not require rectifier tube. Fits standard octal tube socket. Orig. Gov't price over \$5. Shpg. wt. 2 lbs.

6 Volt Model...\$1.29
 12 Volt Model...99c

8x8x8 MFD—600 V OIL FILTER CONDENSER

Perfect for a lifetime power supply—in the same price range as Electrolytics. Packed Unit Shpg. Wt. 4 1/2 lbs.

\$3.75 each
 3 for \$9.95

HEINMAN POWER CIRCUIT BREAKERS

Like new! Protect your rig from blown-out fuses. Shipping wt. 21 lbs.

5 amp, 115vNet 99c
 20 amp, 115vNet \$1.39

NEW! RL-42-B ANTENNA REEL Motor & Gear Box Perfect Beam Rotator



Lightweight (4 lbs.), easy mounted, magnetic clutch, will reverse with a.p.d.t. switch. Also for barbecue spit or door opener. Many other uses. Shpg. wt. 5 lbs.

\$4.25

Shipment made by either fast truck freight or express collect, or by parcel post if postage is included with order. No deposit required on C.O.D.'s. No orders less than \$2.50, please.

ELECTRONIC SALES COMPANY

5559 West Adams—Dept. RC-1
 Los Angeles 16, Calif.

GREYLOCK A Dependable Name in RADIO TUBES

GT, Glass & Miniature Types
 All Tubes in individual Cartons

5Y3GT	12AT6	1R5	} 39c each
6AT6	12BA6	1T4	
6BA6	12BE6	1U4	
6BE6	12K7GT	185	
6SA7GT	12Q7GT	384	
6BJ7GT	12SA7	394	
6BK7GT	12SK7	3V4	
6BQ7GT	12SQ7	12AU6	
6SQ7GT	25L6GT	12BF6	
6V8GT	25Z6GT	35B5	
6X4	35W4	35L6GT	
6X5GT	50B5	35Z5GT	
12A6GT	50L6	117Z5	

SPECIAL OFFER! All 39c Tubes may be purchased in lots of 100 assorted, at \$35.00 per 100.

6A7	6AU6	6GG6	} 49c each
6AC5	6BH6	6SN7GT	
6AK5	6BJ6	12AU7	
6AQ5	6C6	25Z5	
6AQ6	6D6	75	
6AJ5	6SL7GT	6AL5	

1H5GT	1R7B	117L7	} 59c each
1R5GT	70L7	6L6GA	
32L7	84	53	

SPECIAL!! 6BG6G\$.89
 Standard Replacement **VOLUME CONTROLS**.
 All sizes, 1 1/2" shaft, less switch, each\$.24
 With SPST switch, each\$.34
 With DPST Switch, each\$.44

PM SPEAKERS Less Trans.
 4" with Alnico V Magnet\$1.14
 5" with Alnico V Magnet\$ 1.14
 6" with Alnico V Magnet\$ 1.49
 8" PM with plastic cone, and 8-oz. Alnico V Magnet\$ 1.35
 6"x4" PM with Alnico V Magnet\$ 1.19
 WEBSTER AJJ Pickup, plastic arm\$ 1.49

SELENIUM RECTIFIERS
 100 Ma.\$.59
 75 Ma.\$.49

TERMS: Net C.O.D., F.O.B. N.Y.C. 35c Handling
 Charge on all orders under \$5.00
 Write for Bargain Catalog C-1

GREYLOCK ELECTRONIC SUPPLY CO.
 30 Church Street New York 7, N. Y.

RADIO AMATEUR NEWCOMER

the only comprehensive book for the beginner!

You need no other book to get your license and get on the air. Ideal for those just getting started, or getting interested in amateur radio.

ABSOLUTELY COMPLETE

- How-to-build simple equipment for a complete station on all newcomer bands.
- Operating instructions.
- Simple theory.
- Complete section of study questions, including those needed to pass the license exam.
- U. S. A. Amateur radio regulations.



Written by the editors of **RADIO HANDBOOK.**

1.00 AT YOUR DEALER. On direct orders from us please add 10c for mailing.

Editors and Engineers
1305 KENWOOD ROAD, SANTA BARBARA, CALIFORNIA

HEADSET H-16U SPECIAL



8000 ohm Dual. Headset H-16/U—most sensitive phones built—noiseproof—may be used as a sound powered intercom—Also used with simple Xtal to make a complete radio receiver—light, durable, efficient, molded, soft neoprene earcups, shaped to snugly and comfortably envelope the entire ear. Everyone BRANDED the entire ear. Everyone BRANDED.

NEW. Complete with illustrated manual. Send money order or check today. **\$1.89**
Special per pair.

Plus 25c each for postage

ATTENTION Amateurs-Experimenters-Inventors

Cut your cost on radio supplies and equipment in half. Clip coupon today.

Hundreds of "hard to get" war surplus items along with the best in standard brand equipment—all at great savings to you. Let us know your particular requirements. IMMEDIATE DELIVERY.

PLEASE PUT MY NAME ON YOUR MAILING LIST FOR SPECIAL BULLETINS.

NAME _____
ADDRESS _____ ZONE _____
CITY _____ STATE _____

NIAGARA RADIO SUPPLY CORP.
160 Greenwich St., New York City 6, N. Y.

RADIOMEN! ELECTRICIANS!

Get this Valuable Book

FREE

for Merely Examining Coyne's NEW Pay-Raising

5 VOLUME APPLIED PRACTICAL RADIO SET

Here's a PRACTICAL set of radio books just off the press! Gives you "know how" on everything in Radio today. Basic principles to newest in Television and F.M.—how construct, install, service. Latest trouble-shooting methods. 1000 illustrations, over 1500 pages. Ideal for reference or home training. To prove how valuable these great books can be to you, Coyne will give you a FREE copy of our new, helpful "150 New Radio Diagrams Explained" for looking over the 5 Vol. Set. OFFER LIMITED—ACT NOW! We will send you 5 vol. set APPLIED PRACTICAL RADIO for 7 days FREE examination together with Radio Diagrams. Look set over for 7 days. If you like it send \$15 cash, or \$3 after 7 days—and \$3 monthly until \$16.75 is paid. If you don't want the set, return it and you owe NOTHING. Either way you keep Diagrams Book Free. SEND NO MONEY! Coupon asks for 200 books free and get your gift book for doing it! Send coupon NOW!

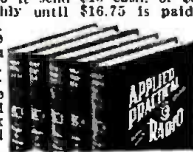

500 South Paulina St., Chicago 12, Illinois
OK. Send me, postpaid, Coyne's new 5 volume set, "APPLIED PRACTICAL RADIO" for 7 Days FREE TRIAL per your offer. Also send, absolutely FREE, "150 New Radio Diagrams Explained" as a gift.

NAME _____ AGE _____
ADDRESS _____
TOWN _____ ZONE _____ STATE _____

MULTIMETER SHOWS ONLY DESIRED SCALE

Ever since the invention of the multimeter, radiomen have complained that a single meter face with enough scales to cover all the ranges is confusing and time-wasting.

The Simpson Electric Company has put on the market a multimeter designed to solve this problem. Known as the Roto-Ranger Model 221, it has 18 different ranges, measuring voltage, current, and resistance. Instead of having all the scales printed on its face, there is a mask over the entire meter face. As the photograph shows, a slit in the mask is just large enough to reveal a single calibrated scale.

The cutaway view of the rear of the panel indicates how the scales are changed. A drum behind the meter has 18 slotted recesses, each containing a single volt, ohm, or current scale. A molded wheel on the end of the drum is scalloped, with each scallop recessed to fit a 3/16-inch ball bearing. The ball bearings comprise the indexing mechanism, which holds the drum securely in any of its 18 positions.

Movement of the drum is controlled entirely by the range-selector knob. A pair of beveled gears transmits motion of the selector-switch shaft to a shaft which moves the drum.

In addition to the single-scale meter feature, the Roto-Ranger incorporates an unusual range switch. Unlike most rotary switches, it is entirely enclosed.



A front view of the Roto-Ranger Model 221.

The contacts are molded into plastic discs and are silver-plated. Separate bakelite pockets are provided for each of the shunt and multiplier resistors, as well as for each of the batteries. Though the cutaway photograph does not show it, switch and rotating scale are completely enclosed. No wiring is visible except that connecting equipment inside the housings with the four pin jacks, which are mounted on a small panel of high-dielectric material.

The 18 ranges of the Roto-Ranger measure up to 5,000 volts a.c. or d.c. at 20,000 ohms per volt; 10 amperes d.c.; and 20 megohms. An output scale is included.

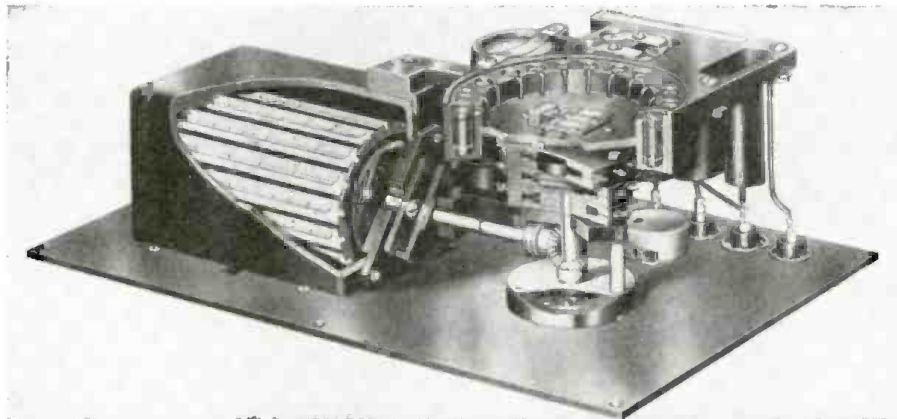

Mechanism which keeps rotating dial and switch in step. Note encased multiplier resistors.

PROBLEMS OF ELECTRONIC BAKING

Recent experiments in England have drawn attention to the problems of baking bread electronically. The tests were conducted by the British General Electric Company, Ltd., using standard high-frequency dielectric heaters.

One of the most interesting factors in electronic baking is illustrated by the photograph of two loaves of bread. The loaf on the right, baked by ordinary radiant heat common in today's bakeries, looks normal in every way. The loaf on the left, however, has no crust. It was baked by high-frequency dielectric heating, one characteristic of which is that the heat penetrates into the very center of the heated object even before it acts on the outer surfaces. Be-

cause all parts of the bread are heated at about the same time and to about the same degree, no crust can develop. But most people seem to prefer bread with

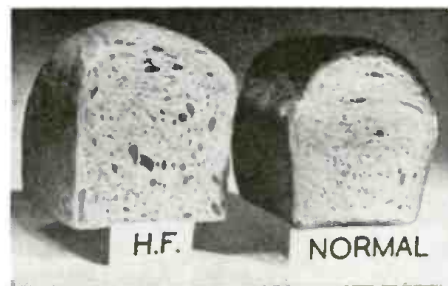

How electronic and ordinary baking compare.

RADIO-ELECTRONICS for

a crust except when it is used for sandwich making or other special purpose.

Another difficulty is placing the bread and electrodes in their correct relative positions. For uniform heating, the air gap between the electrodes and the heated material must be uniform at all points, and it should be very small. Since bread batter is not rigid, it must be held in a container. Baking tins cannot, of course, be used, since they shield the bread electrically. Wood and cardboard containers were used in the recent experiments with some success, but

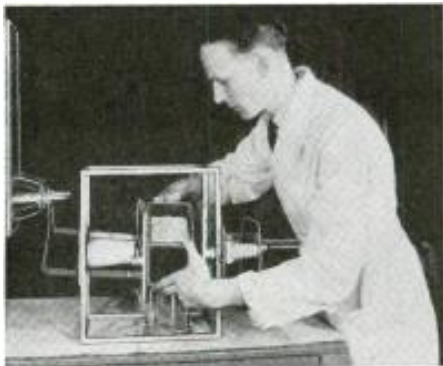

"Oven" is designed to keep load constant.

a fully satisfactory solution has not yet been found.

Bread creates additional difficulties because it rises during baking. Any uneven bulges cause some parts of the loaf to come closer to the electrodes than others, with the resultant danger of local burning. The photograph of a loaf of bread being placed between the electrodes shows how this problem was at least partially solved. The sides of the container are made rigid so that the loaf rises only in a vertical direction. Then the electrodes are placed at the sides of the container.

Heating time is extremely important, much more so than with ordinary radiant heating. Heat continues to be generated in the bread all the time it is between the electrodes and undesirably high temperatures may develop if it is left in too long. Since the heat initially centers within the loaf, the outside of the loaf does not necessarily indicate how well the bread is baked. If the process is used commercially, automatic timing devices will be necessary to prevent drying, toasting, or even total burning of the loaf. It is interesting to consider that if the bread were allowed to toast, it would actually develop a crust on the inside!

The practical results of high-frequency baking are fairly encouraging. Baking time for an individual loaf is less than 5 minutes. However, because the heating kills the yeast almost instantly, very little rising takes place during baking and a longer "rising" time must be allowed the raw dough before baking so the yeast can work.

Although the results are interesting, General Electric states, baking does not appear to be an immediate commercial application for dielectric heaters, especially when its high cost is considered.

RUGGED! DURABLE!

A POWER SUPPLY THAT CAN REALLY "TAKE IT"



Model "A"

6V 15 Amp. or 12V 7 1/2 Amp. DC filtered from 105V to 125V 60 cycle power line.



This model has proper rectifier, choke coil, condenser and transformer to provide heavy instantaneous output and still maintain rated output under unusual load and heat conditions.

Ideal long life power supply for testing auto radios with solenoid tuning and tone controls; 12 volt marine and aircraft radios; telephone circuits, laboratory apparatus, etc.

Write for complete information

ELECTRO PRODUCTS LABORATORIES

Pioneer Manufacturers of Battery Eliminators

549 W. Randolph St.

Chicago 6, Ill.

NOW! BUILD 15 RADIOS \$14.75
COMPLETE KIT ONLY...



ABSOLUTELY NO KNOWLEDGE OF RADIO NECESSARY YOU NEED NO ADDITIONAL PARTS!

Operates on 110-120 volts AC/DC. Contains everything you need: instruction book, metal chassis, tubes, condensers, resistors and all other necessary radio parts. The 36-page instruction book written by expert radio instructors and engineers teaches you to build radios in a professional manner. The first circuit built is a simple one-tube detector receiver. Each succeeding circuit incorporates new arrangements of detectors, RF and AF amplifiers. This kit is excellent for learning the principles of receiver, transmitter and amplifier design. It is used in many radio schools and colleges. All of the commonly-used detectors are used, including diode, grid leak, plate and infinite-impedance. The transmitters are designed with Hartley and Armstrong oscillators, using screen-grid and control-grid modulation. Both vacuum tube and selenium rectification.

THE PROGRESSIVE RADIO KIT is the ONLY COMPLETE KIT are employed in these circuits. The circuits are designed to provide excellent performance. Altogether, fifteen circuits are constructed, including 11 receivers, 1 audio amplifier, and 3 transmitters. The sets start with simple circuits of 1 tube plus rectifier, gradually grow more complex, and finish with several examples of radio sets using three tubes plus rectifier.

PROGRESSIVE RADIO KIT . . . ONLY \$14.75

SPECIAL FREE OFFER

Electrical and Radio Tester sent absolutely FREE with each Progressive Radio Kit. PLUS FREE membership in Progressive Radio Club. Entitles you to free expert advice and consultation service with licensed radio technician. Write for further information or ORDER YOUR KIT NOW!

WE PAY POSTAGE ON PREPAID ORDERS

C.O.D. ORDERS SHIPPED COLLECT

ATTENTION RADIOMEN!! Send for Your FREE DEALERS catalog and Price List Today!

- RADIO KITS • AMPLIFIER KITS • FM COIL & CONDENSER KITS • RESISTOR KITS • CONDENSER KITS • RADIO TOOL KITS • FM-AM CHASSIS • SPEAKERS • RADIO PARTS • PORTABLE RADIOS • CAMERA-RADIOS • TUBES • AUTO RADIOS • HOME RADIOS • TELEVISION SETS • TELEVISION CABINETS • TEST EQUIPMENT • FM TUNERS

PROGRESSIVE ELECTRONICS CO.

DEPT. RE-20 497 UNION AVE. BROOKLYN 11, N. Y.

"POCKET TALKIE"! As low as \$9.95
REALLY WORKS—talk and hear 2-10 miles or more—FITS IN YOUR POCKET! Uses flashlight batteries. ABOUT SIZE OF 2 PACKETS CIGARETTES! Wt. 1 LB. SEND \$1.00 (cash, check or MO) (\$1.52 C.O.D.) for EZ to read plans, assembly ins., pictures and parts price lists with Dr. TAILORED CATALOGUE ON 135 OTHER PRODUCTS SUCH AS: (\$1.00 refunded on parts order) 3-Tube Pocket Radio, Clear Box Transmitter, Dash Car Transmitter, Radio Garage Door Opener.
MOTOR INDUSTRIES, Dept. CW-1, Kearney, Nebr.

TALK-SING-PLAY OVER ANY RADIO
With the NEWEST REAL RADIO MIKE! Attaches in a JIFFY—FULL INSTRUCTIONS GIVEN! SWELL FOR "PARTIES"—"CUT-IN" ON OR "KID" REGULAR NETWORK PROGRAMS OR PUT ON YOUR OWN BROADCASTS! AMAZE YOUR FRIENDS—REAL FUN! LEARN RADIO BROADCASTING! BEAUTIFUL SILVER PLASTIC Detachable base—6 ft. wire!
SEND NO MONEY Just pay postman once or send \$2.99 and we pay postage!
ORDER your own REAL RADIO MIKE TODAY—NOW!
MIDWAY SALES CO. Dept. MRC-1, Kearney, Nebr.

BRITISH "RADIO NURSE"

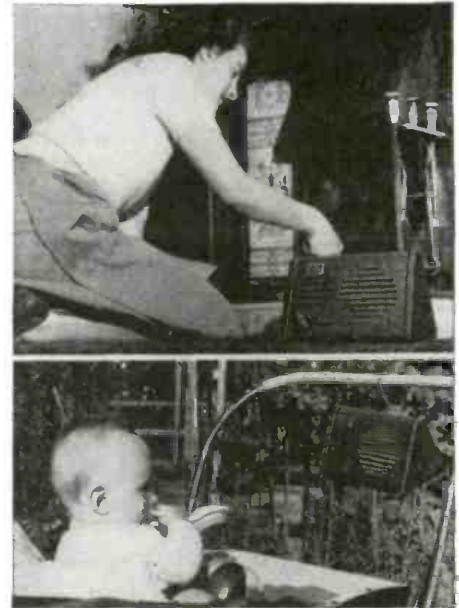

Courtesy British Information Service

This English version of the Radio Nurse is an ordinary intercom. The master unit is set up at some spot near the mother and the remote hung on the handlebar of the baby's carriage.

TELESETS FIXED RIGHT!

A new racket involving phony television repairmen is being foisted upon television set owners in a number of cities, *Radio & Television Weekly* reported last month.

Usually operating in pairs, thieves spot prospects by looking for TV antennas. Then, usually during the week when the head of the family is at work, they ring the bell. The conversation with the housewife goes like this:

"We understand from your husband that you've been having trouble with your television receiver. We come from the service department."

"Yes, we have been having some trouble."

The two phony repairmen then make a pretense of examining the set and announce that it will have to be taken back to the repair shop. They walk out of the house with the television receiver, and that is the last seen of them or the set.

Television set owners should be warned of this racket. They should be advised to check the credentials of any repairmen who come around. Otherwise, the trouble may be cured permanently by the theft of the set.

Most-needed inventions of 1949, according to the National Inventors Council, include a number of improvements and ideas in the radio-electronic field.

First among these is simplified frequency control of radio equipment, either with synthetic quartz crystals or magnetostriction units or some other means, and new construction methods for ultra-lightweight radio equipment. Other needed inventions are satisfactory miniature batteries and a high-speed electronic telegraph printer. A more efficient collapsible field antenna was also listed.

HARD-TO-GET PARTS

POWERFUL ALL-PURPOSE INDUCTION MOTOR

IDEAL FOR EXPERIMENTERS—101 USES



Sturdily constructed to precision standards, this self-starting shaded pole A.C. induction motor is powerful enough for a number of uses. Some of these are: Automatic Timing Devices, Current Interrupters, Electric Fans, Electric Chimes, Window Displays, Photocell Control Devices, Electric Vibrators, Small Grinders, Buffers and Polishers, Miniature Pumps, Mechanical Models, Sirens, and other applications.

Consumes about 15 watts of power and has a speed of 3,000 r.p.m. When geared down, this sturdy unit will constantly operate an 18-inch turntable loaded with 200 lbs. dead weight—THAT'S POWER!
Dimensions 3" high by 1 3/4" deep; has 4 convenient mounting studs; shaft is 3/16" long by 3/16" diameter, and runs in self-aligning oil-retaining bearings. Designed for 110-20 volts, 50-60 cycles, A.C. only. Shp. Wt. 2 lbs.

ITEM NO. 147 YOUR PRICE..... \$2.45

ULTRA MAGNET

LIFTS MORE THAN 20 TIMES ITS OWN WEIGHT

LITTLE GIANT MAGNET

Lifts 5 lbs. easily. Weighs 4 oz. Made of ALNICO new high-magneto steel. Complete with keeper. World's most powerful magnet ever made. The experimenter and hobbyist will find hundreds of excellent uses for this high quality permanent magnet. Measures 1 3/4 x 1 1/4". Shp. Wt. 3/4 lbs.

ITEM NO. 159 YOUR PRICE..... \$1.25



GENUINE MICROPHONE TRANSMITTERS

Regular telephone transmitters taken from a large telephone supply company's overstock. Work perfectly on 2 dry cells. Can be used on P.E. systems, call systems, inter-communications sets, short-line telephone circuits, house-to-house or farm-to-farm 'phone lines, also to talk through your own radio or W. T. Carlsberg's microphone pick-up. Useful replacements on battery-operated telephone sets.

THESE ARE GENUINE TRANSMITTERS, MADE BY KELOGG, WESTERN ELECTRIC AND ST. BERG-CARLSON, excellent in appearance and operation. A remarkable value and one seldom offered in these times. Shp. Wt. 1 lb.

ITEM NO. 160 YOUR PRICE..... \$1.95



WATTHOUR METER

Completely overhauled and ready for immediate service. Designed for recording 110-volt, 60 cycle 2-wire A.C. circuit. Simple to install: Disconnect power, remove 2 wires to the load. Sturdily constructed in heavy metal housing, 8 1/2" high, 6 1/2" wide, 5" deep. Westinghouse, G. E. Fort Wayne, Sangamo or other available make. Shp. Wt. 1 1/4 lbs.

ITEM NO. 33 YOUR PRICE..... \$5.95

AMAZING BLACK LIGHT!!

Powerful 250-Watt Ultra-Violet Source



The best and most practical source of ultra-violet light for general experimental and entertainment use. Makes all fluorescent substances brilliantly luminous. No transformers of any kind needed. Fits any standard lamp socket. Brings out beautiful statement hues in various types of materials. Swell for amateur parties, plays, etc.; to obtain unique lighting effects. Built only. Shp. Wt. 2 lbs.

ITEM NO. 87 YOUR PRICE..... \$1.95

WESTERN ELECTRIC BREAST MIKE

This is a fine light-weight aircraft carbon microphone. It weighs only 1 lb. Mike comes with breastplate mounting and has 2-way swiveling adjustment so that it can be adjusted to any desired position. There are 2 woven straps that go around neck, the other around chest. Straps can be snapped on and off quickly by an ingenious arrangement.

This excellent mike can be adapted for home broadcasting or private communication systems. By dismounting breastplate, it can be used as desk mike.

Comes complete with 6-foot cord and hard rubber plug. Finished in shearhardized plate, non-rustable. Shipping weight, 2 lbs.

ITEM NO. 152 YOUR PRICE..... \$1.45



FACTORY SPEAKER REPAIRS SINCE 1927

RM-4 RECORDING MOTOR. Back again by popular demand! This terrific little motor at a truly amazing price. Heavy duty 110V. 60 cycles. Silent operating for WIRE, TAPE or DISC RECORDING. 3 3/4" sq. x 2 3/4". Less turntable, mtg. plate & reduction drive wheel. Shpg. wt. 6 lbs. \$4.95

HIGH FIDELITY CRYSTAL MICROPHONES The microphone buy of the year! Made for a world famous hearing aid manufacturer. Now at a sensationally low price. Sensitive diaphragm type. Small size (1 3/4" O.D. x 1/2" deep). Ideal for REGULAR, LAPEL or CONTACT MIKE or as PILLOW SPEAKER. Rubber shock-mtd. metal frame. Less housing..... 98c

SHOCK MOUNTS—Moulded live rubber in sturdy metal frames at money-saving prices.
1" mtg. holes, 3/32" hole..... ea. 10; 12 for \$1.00
1 1/2" mtg. holes, 1/4" hole..... ea. 15; 8 for \$1.00
2 1/2" mtg. holes, 1/2" hole..... ea. 49 (Shpg. wt. 2 lbs.)
INSULATED STAPLES. Handy size #7 (1/2" x 3/8"). Sale price, per 100..... \$2.99
CO-AXIAL FITTING M-359 (83-1AP). Low loss poly. Priced for quick turnover..... \$2.99
4 for 1.00
ARC 5/BC 457-8-9 P.A. COILS. Nos. 7991, 7247-48-49-50; ranges from 1.5 to 9Mc. They're going fast! Order yours now!..... \$3.99
Kit of all five..... 1.49

FREE SUPPLEMENT CHECK FREE SUPPLEMENT DESIRED
 "RECORDING PARTS & ACCESSORIES"
 "ALNICO MAGNETS"
 "HEARING AID & MINIATURE PARTS"
 "RADIO & ELECTRONIC PARTS"
 "GEARS, SHAFTS & PULLEYS"

PE-157 POWER SUPPLY. A "gold mine" of relays, switches, selenium rect., jacks, etc., incomplete army unit. Surplus stock at a terrific saving to you. Portable hinged lid metal case (6"x6"x12") OD crackle finish. PLUS descriptive 173p. TECH MANUAL. Shpg. wt. 20 lbs. \$2.49

JUMBO RADIO PARTS ASSORTMENT A grab-bag of radio values that will delight you. 17 lbs. of useful items at one bargain price! New & dismantled Radio & Electronic components. 17 FULL POUNDS OF COILS, SOCKETS, WIRE, SPEAKER ACCESSORIES, HARDWARE, RESISTORS, CONDENSERS, TRANSFORMERS, etc., etc. All these and MUCH MORE (Shpg. wt. 21 lbs.) ONLY \$2.95

POWER RHEOSTATS. The rheostat of a thousand uses. Indispensable around the shop or home for controlling small motors, electric trains, toys, etc. Famous make, wire-wound 1/2" shafts.
25 watt; 20, 100, 175, 370 or 400 ohms. ea. .89
50 watt; 2, 25, 50, 300, 500, 1250, 2K, 3K
or 7500 ohms..... ea. 1.29
SPECIALS!! 25 watt; 250 ohms..... ONLY .39
6 for 2.98
50 watts, 15 ohms..... ONLY .98

TUBES AT NEW LOW PRICES!! STOCK UP NOW at up to 80% off list. Bargains without equal. Perfect condition. GUARANTEED FOR 90 DAYS: Unsealed cartons.
#27, 35, 39, 77, 85, 5W4, 6A7, 6H6, 6K7 or 6X5..... .39
#41, 78, 1A7, 5U4, 5Y4, 6A4, 6B7, 6C5, 6F5, 6F6, 6G5, 6J5, 6SA7, 6SD7, 6SH7, 6SK7, 6U7, 7A7, 7B8, 7Y4, 12SK7, 12X7 or 50B5..... .49
TUBE CARTONS:
Miniature (1" sq. x 2 1/4") per 100..... .98
GT size (1 1/2" sq. x 3 1/2") per 100..... 1.25
Medium (1 1/2" sq. x 4 1/2") per 100..... 1.49
Large (2" sq. x 5") per 100..... 1.79

RADIO PARTS KIT
#1. R. F. Antenna & OSC COILS. 10 asstd. \$.98
#2. SPEAKER CONES 4" to 12" moulded & free-edge (magnetic incl.). Less voice coils. Kit of 12 asstd. 2.00
#3. KNOBS; wood & bakelite; set screw & push-on types. Kit of 25 asstd. .98
#9. WAFER SOCKETS; 4 to 8 prong. Kit of 12 asstd. .25
#10. VOLTAGE DIVIDERS; Multi-tapped; high wattages, kit of 10 asstd. 1.98
#11. SHIELD CANS; for coils, tubes, transformers, etc. Kit of 15 asstd. .98
#20. SPEAKER REPAIR KIT. Save time & money with this professional kit. Contains: 25 mtg. rings, 25 voice coil forms, 10 spindlers, 3 yds. felt strip, 20 channels leather segments, kit of 16 shims & tube of cement. All for..... 2.49
#27. PRECISION RESISTORS. Famous makes, wire-wound 4 or 1% Ohmages to 400K. Kit of 10 asstd. 1.98
MINIMUM ORDER \$2.00
20% deposit required on COD's
Please add sufficient postage.
Components no radio amateur or professional can be without, at prices you can't afford to miss. Order your kits now!

LEOTONE RADIO CO.
65-67 Day St., New York 7, N. Y.
WOrth 2-0284

HUDSON SPECIALTIES CO.
40 West Broadway, Dept. RE-1-49, New York 7, N. Y.
I have circled below the numbers of the items I'm ordering. My full remittance of \$..... (include shipping charges) is enclosed (NO C.O.D. ORDERS UNLESS ACCOMPANIED WITH A DEPOSIT.)
OR my deposit of \$..... is enclosed (20% required). Ship order C.O.D. for balance. NO C.O.D. ORDERS FOR LESS THAN \$5.00. BE SURE TO INCLUDE SHIPPING CHARGES.
Circle Item No. wanted:
147 159 160 87 152 33
Name.....
Address.....
City..... State.....
Please Print Clearly

ELECTRONIC LITERATURE

Any or all of these catalogs, bulletins, and periodicals are available to you if you write to us on your letterhead (do not use postcards) and request them by number. It is necessary to send only the number of the item you want. We will forward the request to the manufacturers, who in turn will send the literature directly to you. This offer void after six months.

J-1—1949 ALLIED CATALOG

The latest Allied Radio Corporation catalog, No. 117, needs no introduction to most servicemen, amateurs, and experimenters. It has 176 pages and contains complete listings of radio and electronic parts and equipment, tools, supplies, and books.—*Gratis*

J-2—INSTRUMENT CATALOG

Bradshaw Instruments Co. issues a four-page illustrated leaflet describing the Range Master Models 10 and 10-P multimeters, the Model 30 multitester, and the Model 300 signal generator.—*Gratis*

J-3—ELECTRIC PLANT GUIDE

A 20-page guide points out differences between the a.c., d.c., and battery-charging electric plants made by D. W. Onan & Sons, Inc., and gives instructions for choosing the proper type and size for any application. A.c. models supply from 300 to 35,000 watts at all standard voltages and frequencies. D.c. models deliver 750 to 15,000 watts at 115 volts, and 2 to 15 kw at 230 volts. Battery-charging plants deliver 30 to 3,500 watts at 6, 12, 32, and 110 volts d.c.—*Gratis*

J-4—CONVERTER CATALOG

This 12-page catalog lists specifications of vibrator-type converters and power supplies made by Electronic Laboratories, Inc. Converters deliver 115-volt, 60-cycle a.c. from 6-, 12-, 32-, and 110-volt d.c. and from 115-volt, 25- and 50-cycle sources. Power supplies deliver high-voltage d.c. from 6-volt d.c., and 6 or 12 volts d.c. from 115-volt a.c. Replacement vibrators for converters, amplifiers, and transmitters are listed.—*Gratis*

J-5—POWER SUPPLY BULLETIN

A 2-page bulletin, issued by Electro Products Laboratories, Inc., lists several types of A- and B-eliminators for use with 1.4- and 2-volt battery radios. They are available for operating from 6-volt d.c. or 117-volt 60-cycle sources. A 6- or 12-volt d.c. supply is also listed.—*Gratis*

J-6—PRIMER ON C-R TUBES

The Cathode-ray Tube and Typical Applications, by Instrument Division, Allen B. Du Mont Labs., Inc., is a 63-page non-technical discussion of the cathode-ray tube and its functions. Supplied with a wall-chart, the book is intended for schools and colleges.—*Gratis to teachers and instructors requesting on school stationery, 50c per copy at all others*

OPPORTUNITY AD-LETS

Advertisements in this section cost 25c a word for each insertion. Name, address and initials must be included at the above rate. Cash should accompany all classified advertisements unless placed by an accredited advertising agency. No advertisement for less than ten words accepted. Ten percent discount allowed on orders for twelve issues. Objectionable or misleading advertisements not accepted. Advertisements for February, 1949, issue, must reach us not later than December 24, 1948. Radio-Electronics, 25 W. Broadway, New York 7, N. Y.

SELECTED GROUP OF MEN, GRADUATES OF WELL-KNOWN trade school, desire employment in Radio Field. Will travel anywhere. Qualified in radio servicing, installation, test instruments, circuit operation, etc. Contact Placement Dept., Eastern Technical School, 888 Purchase Street, New Bedford, Mass.

AMATEUR RADIO LICENSES. COMPLETE THEORY preparation for passing amateur radio examinations. Home study and resident courses. American Radio Institute, 101 West 63rd St., New York City. See our ad on Page 95.

WE REPAIR ALL TYPES OF ELECTRICAL INSTRUMENTS, tube checkers and analyzers. Hazelton Instrument Co. (Electric Meter Laboratory), 140 Liberty Street, New York, N. Y. Telephone—Barclay 7-4239.

WANTED—5000 LBS. ALUMINUM FOIL .00017" TO 18"—Any width. Good-All Condenser Co., Ogallala, Nebraska.

YOU CAN ACCURATELY ALIGN SUPERHETERODYNE receivers without signal generator. Complete instructions \$1. Money-back guarantee. Chas. Gates, Pecos 2, Texas.

LANCASTER, ALLWINE & ROMMEL, 436 BOWEN Building, Washington 5, D.C. Registered Patent Attorneys. Practice before United States Patent Office. Validity and Infringement Investigations and Opinions. Booklet and form "Evidence of Conception" forwarded upon request.

MAGAZINES (BACK DATED)—FOREIGN, DOMESTIC, arts. Books, booklets, subscriptions, pin-ups, etc. Catalog, 10c (refunded). Ciccone's, 863 First Ave., New York 17, N. Y.

TRANSFORMERS—85,000 VOLTS AT 30 MA. 2—350 Amp., 5 Volt Jobs. Make offer. Bradshaw Instruments, 348 Livingston St., Brooklyn 23, N. Y.

WANTED: USED SPRAYBERRY RADIO N.D. COURSE. Box 192, Ouzay, Colo.

NEW CANTONED TUBES 39c. 1A5gt. 1R5. IS5. IT4. 384. 8V4. 5X3gt. 6AJ5. 6AK5. 6AQ6. 6BA6. 6BE6. 6BH6. 6BL6. 6C5gt. 6J5gt. 6SA7gt. 6SQ7gt. 6V6gt. 6X4. 12AT6. 12BA6. 12BE6. 12A8gt. 25L6gt. 32L7gt. 35B5. 35W4. 47. 50B5. 70L7gt. 80. 117L7gt. 117Z3. Write for catalog. Henshaw Radio, 3619 Troost, Kansas City, Missouri.

YOU CAN HAVE 26 YEARS RADIO EXPERIENCE AT your fingertips. 1're repaired over 45,000 radios. Have perfected simple, easy system anyone can follow step by step. No calculations, no formulas. Total price, \$2.00 postpaid or C.O.D. Money-back guarantee. Ross Radio, 14615-B Grand-river, Detroit 27, Michigan.

LONO PLAYING RECORD TURNTABLES, 33 1/4 AND 78 R.P.M., take 12" record, volume control, pickup input. Modify these high quality precision made, units for use with your record player. Regularly \$49.50. Our price \$4.99. Ask for bargain list. Amphier and Radio Parts, Mogul's, 68 West 48th Street, New York 19, New York.

NEWSFLASH from Radio Britain. PRACTICAL WIRELESS, Britain's leading radio monthly, covers entire British-European radio-television field. Latest advances "over there" detailed and explained by experts in every issue. Packed with new ideas and information essential to DX "hams" listening to Europe, servicing experts and all radio enthusiasts. For annual subscription (12 issues mailed direct to your address from London), send only \$2.00 to George Newnes Ltd. (PW/33), 342, Madison Avenue, New York 17.

12B8 & 25B8 TUBES. ADAPTER UNIT USING 2 miniature tubes (6AT6 & 6BA6 for 12B8, and 12AT6 & 12BA6 for 25B8). Takes less space than original tube—nothing else to buy—just plug in & it works. Money-back guarantee. 12B8 or 25B8 unit complete: \$2.49 each. 10 units for \$22.50. Send 25% deposit, balance C.O.D. Write for free parts catalog. COMMERCIAL RADIO, 36 Brattle St., Boston, Mass.

WANTED: APR-5A, APR-4 RECEIVERS AND TUNING Units. Antennas, Radar Scanners, VHF-SHF Gear. Laboratory and Test Equipment of all types. Also quantity stocks of all types of surplus materials for marketing. Engineering Associates, Farhills Branch Box 29C, Dayton 9, Ohio.

PORTABLE SUITCASE SIZE RADIO SHOP. BUILD it and be ready for ready cash. Carry it in your car and double your income. Write, Grand Federal, Argentine Branch Box 57C, Kansas City 3, Kansas.

CRYSTAL SET—TELEPHONE COMBINATION DIAGRAM and instructions 25c. Includes attractive offer, literature, year's membership in "CRYSTAL-X CRYSTAL SET CLUB", Box 608, Torrance, Calif.

RADIOMEN, SERVICEMEN, BEGINNERS—MAKE more money, easily, quickly, \$250 weekly possible. We show you how. Information free. Merit Products, 216-32L 132nd Avenue, Springfield Gardens 13, New York.

"RADIO BUILDER" FOR CRYSTAL 1-TUBE EXPERIMENTERS. 3 issues 25c. Laboratories, Eye-b, San Carlos, California.

PHONOGRAPH RECORDS 20c. CATALOGUE. Paramount, J-313 East Market, Wilkes-Barre, Penna.

TELEPHONE DIALS. USED. NATIONALLY KNOWN make. Standard speed, 10 pulses per second. Re-built \$2.25. Re-adjusted \$125. postpaid. Kiesel Electric Products, 431-C Sherman, Galton, Ohio.

THE HOUSE OF TUBES
GEORGE W. KLEIN

8748 Linwood Ave., Detroit 6, Mich.
Phone: Tyler 8-7129

World wide finest and fastest service. List your needs with us on all ham gear. All tubes are standard brands and guaranteed. Merchandise in original package. Minimum order \$5.00. 25% deposit required on all C O D orders. F O B Detroit. Request our prices on receiving tubes.

15E	\$1.50	954	\$5.50
15R	1.50	955	.50
1H20	.50	958	.50
100R	1.00	957	.50
VR75	1.35	958	.50
VR90	1.35	958	.50
VR105	1.35	1819	.50
VR150	1.30	1824	.60
HY114B	2.25	1825	.60
2C26	.35	1826	.60
2D21	1.80	1829	.60
2X2	1.35	1830	.60
23D4	.80	2050	.80
3B25	4.50	2051	.80
3C24	.80	7193	.30
RK34	1.10	8085	2.95
6AK5	1.58	9001	.60
6AK6	1.15	9002	.60
120A	1.25	9003	.60
1H20	.55	9004	.60
127A	3.00	9005	.60
211	.85	9006	.60
3D21A	7.50	CK1006	.65
10Y	1.95	10T1	.35
304B	.95	A5588	.85
304TL	.85	SCOPE	TUBES
316A	1.50	2AP1	2.95
323A	.80	9003/VR90	1.35
350A	.80	OC3/VR105	1.35
446A	.80	OD3/VR150	1.30
615B	1.10	2C26A	7.75
800	1.95	2E25	5.50
801A	3.75	2E30	2.45
802	1.95	3B4	3.90
803	3.95	10Y	1.95
805	3.75	884	1.75
807	2.50	1616	8.65
808	1.85	5514	4.95
809	1.85	5516	5.95
810	4.95	E1148	2.25
811	2.45	HY24	1.50
812	3.50	HY31Z	5.50
813	5.95	HY69	5.50
814	4.95	HY75A	4.70
816	2.95	HY815	2.25
826	.95	HY1231Z	5.50
829B	3.75	HY1269	5.50
832A	3.75		
836	1.75		
837	1.75		
838	1.75		
860	2.50		
866A	1.95		
874	1.20		
884	1.35		
876	1.25		
931A	2.95		

THE HOUSE OF TUBES
8748 Linwood Ave., Detroit 6, Mich.
Phone: Tyler 8-7129

E-Z TO ASSEMBLE! Save Money With This WAR SURPLUS PHOTO FLASH Aircraft KIT!



Offered at fraction of original cost. Simple to assemble. Save many dollars. Comes brand new in its original box complete with: Gray metal finished case, all connectors, relay control, 2 condensers each 2000 volts—light output 100 watt seconds, 4 HIGH SPEED FLASH TUBES—plastic sealed, unbreakable. ALSO 4 reflectors, transformer, connectors, connecting cords, spare parts. After conversion unit operates on battery or on 110 volt A.C. by flick of switch. Complete instructions and diagrams.

Immediate Delivery on all mail orders Complete **\$68**

CINEX, INC., 145 W. 44th St., N. Y. 19, N. Y. Dept. 10-1

HOW TO GET THE MOST

from only
BASIC TEST EQUIPMENT

Servicing by Signal Substitution

The Simple, Modern, Dynamic Speed approach to receiver alignment and adjustment problems, FM-AM-TV.

- Nothing complex to learn
- No extra equipment to purchase
- Universal — non-obsolete
- Employs only Basic Test Equipment



S-S-S tells HOW — in simple, direct language.

New 9th edition now off the press. 100 pages of valuable information.

Available from all leading radio parts and equipment distributors or directly from factory at only 40¢ per copy.

PRECISION APPARATUS COMPANY, Inc. • 92-27 Horace Harding Blvd., Elmhurst 4, N. Y.

MORT'S NEW YEAR SPECIALS

NEW HF 10 TRUSOUND AMPLIFIER



A general purpose unit of small size (6" x 9" x 7") for high quality reproduction of sound, music and speech from records, radio, microphone. Engineered and built to meet the high quality standards required of an amplifier when used in conjunction with the new high fidelity pickups. FM-AM tuners and wide range speaker systems. NOTE THESE FEATURES:

- ★ 10 Watts undistorted power output 18 watts peak.
- ★ Inputs: High gain for variable reluctance pickups; for high impedance mikes. Low gain for FM-AM tuners and high output pickups.
- ★ Selector switch for rapid changeover.
- ★ Hum level 70 db below 12 watts.
- ★ Tone compensation. Separate continuously variable base and treble controls.
- ★ Treble—from 10 db to minus 15 db at 10,000 cps.
- ★ Bass—from plus 10 db to minus 15 db at 50 cps.
- ★ Note—flat characteristics obtained with controls centered.
- ★ Output impedance 2, 4, 8, 16 and 500 ohms.
- ★ Straight AC for 110-120V 50-60 cycles fused.
- ★ Tubes—6SL7, 6SC7, 2—6V6, 5Y3.
- ★ Chassis and shield silver grey hammeroid finish. Complete with Tubes and Cover. \$29.95

SPECIAL LOW PRICE ON SPEAKERS

5" 1275 Ohm Field. \$1.79 ea.
6" 1275 Ohm Field. 1.98 ea.
3" PM with transformer. 1.45 ea.

MICRO GROOVE PHONO PLAYER

A NEW Trusound Micro Groove Record Player. Proven in hundreds of broadcasting stations in the U. S. The Trusound Microgroove Record Player uses the new SHURE Featherweight arm and cartridge. Overall wt. 8 grams. Prolongs life of the fine micro-groove recordings. The 33 1/3 RPM constant speed motor is smooth and quiet with no WOWS or rumbles to interfere with your listening pleasure.

List Price. \$24.95
Your Cost in lots of 1-3. \$7.50 ea.
4 or More. \$13.95 ea.

10 LB. SURPRISE PACKAGE

Containing miscellaneous Radio Pkts. Condensers, Hardware, etc. Easily worth much more.
10 lbs. \$1.98

CONDENSERS

1 MFD Generator Condenser in Metal Can. 22c ea. 10 for \$2.00
Television Condenser
.001, 6,000V. 49c ea. 100 for \$45.00
.0005, 6,000V. 49c ea. 100 for \$45.00

Write for Our Free 1949 Catalog.
TERMS: Minimum order \$3.00. 25% deposit.
Bal. C.O.D.. F.O.B. Chicago

Mort's Radio Shack

Dept. RC-1A
630 W. Randolph St., Chicago 6, Illinois

NEW PRINTED LEARN FUN CIRCUITS PROFIT

DESIGN-REPAIR-RESEARCH

Now Faster and Easier

Be first to learn the new printed-circuit methods. Most new radios have partly printed circuits. Paint WORKING circuits over your sketches. Kits of conductor and resistance paints: Standard \$3. Super \$5 (has silver ink). Instructions. Valuable for colleges. Free descriptive literature. Just send cash or M. O. and note with name, address and desired kit to:

MICROCIRCUITS CO.
Dept. 2D New Buffalo, Michigan

Radio courses are the most popular of all studies among veterans taking correspondence training under the GI Bill, the Veterans' Administration reported recently. Twenty-six percent of the veteran students are enrolled in radio and other communication courses.



R & M's GOT IT!

NO MORE SEARCHING FOR HARD-TO-GET

SURPLUS RADIO EQUIPMENT

Three large warehouses stocked with thousands of govt. surplus equipment and parts, priced at a fraction of original cost.

Write for complete price list. Individual data supplied on specific equipment.

R and M

RADIO COMPANY



1426 N. Quincy St., Dept. F, Arlington, Va.

LITZ WIRE

Magnet Wire

★ LARGE STOCK ★

MAGNET WIRE, Incorporated
25 WEST BROADWAY
Worth 4-5447, Beekman 3-8465
Cable Address: "Magnetwire, New York"

ANSWERS TO QUIZ ON PAGE 37

1. If the control were open, there would be no d.c. path from grid of the tube to ground: the grid would block, and the set would squeal and motor-boat. If shorted, however, the grid would be at ground potential for audio. To check, touch the center lug with a screwdriver held in your bare hand. If nothing is heard, the grid is shorted to ground, probably through a shorted control or a lug touching the control's case.

2. Anywhere between 1 and 3 watts, depending on the resistances. If the 2-watt resistor were twice as large as the 1-watt unit, twice the voltage of the 1-watt unit, and therefore twice the wattage ($P=E^2/R$), would appear across it. Then if this wattage were 2, the wattage across the smaller resistor would be 1, and total circuit dissipation would be 3 watts. If both resistors were equal, the same voltage would appear across each, and each would have to dissipate the same power. Obviously, the maximum for each resistor would be 1 watt, with total circuit dissipation of 2 watts. To convince yourself, assign values to a pair of resistors and work out the current, voltages, and wattages.

3. In the parallel circuit the voltage across both resistors is the same, but the current through each varies with the resistance values. Again maximum dissipation is from 1 to 3 watts, depending on the resistances.

4. A practical temporary repair is shown in the diagram. R1 is 0.8 times

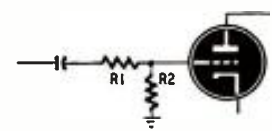

the original volume control's resistance, and R2 is 0.2 times the original.

5. If the receiver is an a.c. model, remove tubes one by one, beginning with the antenna end of the circuit. After each tube is removed, rotate the volume control and note the change in background noise it causes. When, after removing a particular tube, rotating the control has no effect on the noise, you can assume that the control was in the circuit of the tube just removed.

In an a.c.-d.c. set, removing a tube opens the filament string. However, if you rotate the volume control before the filaments have a chance to cool down, you will still hear the change in noise. Of course, you must replace each tube and give the heaters time to warm up again before pulling out the next.

Radar for locating icebergs was used last summer by ships of the U. S. Coast Guard. Since the international service for detection of icebergs, derelicts, and other obstructions was set up in 1914, operations from both ships and aircraft have often been hampered by fog. The radar penetrates fog. A standard radar scope shows the icebergs as pips on the screen and their exact locations are worked out with the aid of loran.

Radio Thirty-Five Years Ago
In Gernsback Publications

HUGO GERNSBACK
Founder

Modern Electrics.....	1908
Electrical Experimenter.....	1913
Radio News.....	1919
Science & Invention.....	1920
Radio-Craft.....	1929*
Short-Wave Craft.....	1930
Wireless Association of America.....	1908

Some of the larger libraries in the country still have copies of **ELECTRICAL EXPERIMENTER** on file for interested readers.

In ELECTRICAL EXPERIMENTER
January, 1915

- Wireless Telegraphy from Airplanes
- Short-Wave Receiving Loose Coupler
- Aerial Insulators
- Mounting Detector Crystals, by Ralph E. Brooks
- Hy-Tone Radio Test Buzzer
- High Tension Aerial Switch by John Chambers
- A Synchronous Rotary Spark Gap for Small Coils, by Earl Emendorfer
- An Acoustic Radio Amplifier
- The E. I. Co. Laboratory at New York
- Long Distance Radio Receiving
- 110 Volt Transmitting Set on Batteries

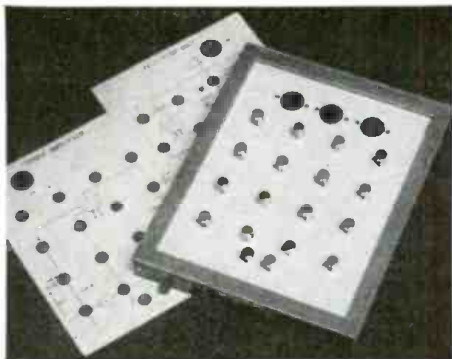

NEW SUPER-CLIP-BOARD

King of all clip-boards is this "Electronic Circuit Panel" developed recently by Kepco Laboratories. It substitutes push-down binding posts for the clips, and circuits are printed on sheets with holes which fit over the posts. Thus it is necessary only to wire directly over the line below to follow the circuit. The 23 circuit charts cover a wide range of circuits, from diode detectors to scale-of-two counters. Blank sheets are also provided for the students' own circuits. Rear wiring shown below.



JANUARY, 1949

LET THIS "AUTOMATIC TEACHER"
show you exactly how to repair over
4800 RADIO MODELS
without expensive test equipment!

GHIRARDI SAVES YOU TIME
—HELPS YOU MAKE MONEY

Ghirardi's **RADIO TROUBLESHOOTER'S HANDBOOK** is the ideal manual to show you exactly how to repair radios at home in spare time—quickly and without a lot of previous experience or costly test equipment. It contains **MORE THAN 4 POUNDS OF FACTUAL**, time-saving, money-making repair data for repairing all models and makes of radios better, faster and more profitably than you may have thought possible!

NOT A "STUDY" BOOK

RADIO TROUBLESHOOTER'S HANDBOOK can easily pay for itself the first time you use it. You don't have to study it. Simply look up the make, model, and trouble symptom of the Radio you want to repair and go to work. No lost time! Clear instructions tell exactly what the trouble is likely to be—**EXACTLY** how to fix it. Actually, this big 714-page manual-size **HANDBOOK** brings you factual, specific repair data for the common troubles that occur in practically every radio in use today—for over 4800 popular models of Home and Auto radio receivers and Automatic record changers of 202 manufacturers! In addition, there are hundreds of pages of helpful repair charts, tube charts, data on tuning alignment, transformer troubles, tubes and parts substitution, etc., etc.—all for only \$5 (\$5.50 foreign). Read it for 10 days . . . at our risk! Use coupon.

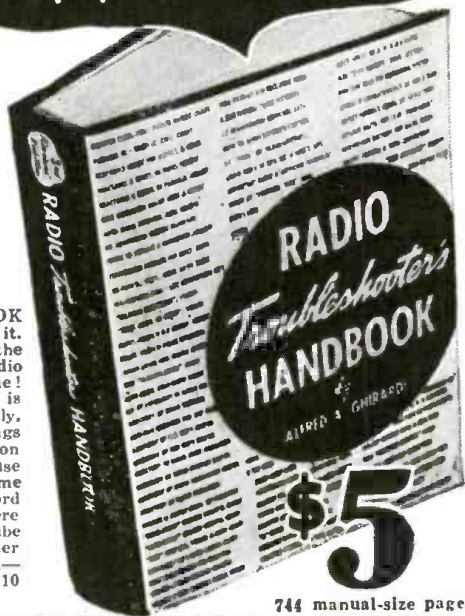

744 manual-size pages

Get a Complete **RADIO-ELECTRONIC**
SERVICE EDUCATION
AT HOME—WITHOUT AN INSTRUCTOR

COMPLETE DATA ON TEST INSTRUMENTS
—TROUBLESHOOTING—REPAIR

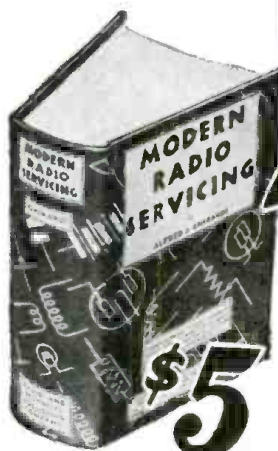

1300 pages. 706 illus.
723 review questions

A. A. Ghirardi's big 1300-page **MODERN RADIO SERVICING** is the finest, most complete instruction book on Radio-Electronic service work for either the novice or the professional Radio-Electronic serviceman—bar none! Read from the beginning, it is a **COMPLETE COURSE IN SERVICING** by the most modern methods. Used for reference, it is an invaluable means of brushing up on any servicing problem.

Gives complete information on all essential service instru-

ment types; how they work (with wiring diagrams), when and why to use them; how to build your own; preliminary trouble checks; circuit and parts analysis; parts repair, replacement, substitution; obscure radio troubles; aligning and neutralizing; interference reduction — and hundreds of other subjects including How to Start and Operate a Successful Radio Electronic Service Business. 723 self-testing review questions help you check your progress **EVERY STEP OF THE WAY**. Only \$5 complete \$5.50 foreign).

10 DAYS' FREE EXAMINATION

Technical Division, **MURRAY HILL BOOKS, INC.**
Dept. RC-19, 232 Madison Ave., New York 16, N. Y.

Send me the books checked below for 10 days examination on approval. In 10 days I will pay for the books plus a few cents postage, or return them postpaid. (Postage paid on cash orders; same return privilege. Books sent on approval in U. S. only.)

- MODERN RADIO SERVICING** \$5 (\$5.50 foreign)
- RADIO TROUBLESHOOTER'S HANDBOOK** \$5 (\$5.50 foreign)
- Special MONEY-SAVING COMBINATION**
Both big books for only \$9.50 (\$10.50 foreign)

Name.....
Address.....
City & Dist. No..... State.....
(Please print or write plainly)

You Can't Go Wrong on a Ghirardi Radio Book

MONEY-SAVING OFFER! Get BOTH big books — Radio's most famous Service Library — over 2030 pages — at a bargain combination price. See coupon.

ONLY \$99.50 IS THE COST!

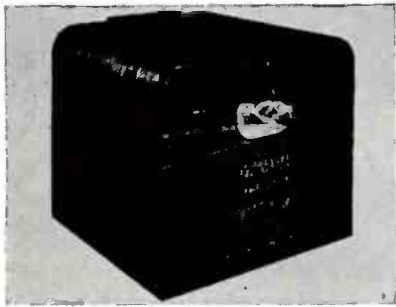

for the SENSATIONAL-NEW-IMPROVED
10 INCH

TELEVISION KIT

Complete with new built-in pretuned and aligned 13 Channel tuner, all parts and easy step-by-step instructions and schematics.

\$99.50 less tubes

Kit, complete with all tubes..... \$149.50
Specially designed cabinet for kit..... 25.00

An amazing value! Even a beginner can assemble one of these fine, new improved television kits. Uses the new 13 channel tuner, prewired and factory aligned for the entire television spectrum. High quality parts and excellent circuit assure perfect performance. Circuit designed by outstanding T.V. engineers. Contains RF stage, oscillator and mixer. Uses new I.F. coils providing maximum gain and picture definition. Sound reception is high quality FM for years of listening pleasure.

Same quality and features for 7" KIT complete, less tubes..... \$59.50
Complete, with tubes..... 99.50
Specially designed cabinet for 7" kit..... 22.50
This kit can be used with Sylvania 10 HP4 10" picture tube without modifications.
7" and 10" KITS AVAILABLE FOR IMMEDIATE DELIVERY FROM STOCK!

The New Model B-45 Battery Operated SIGNAL GENERATOR

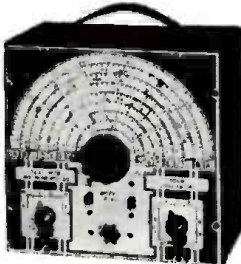

for servicing AM, FM and Television Receivers. R.F. frequencies from 150 Kilocycles to 50 Megacycles (150 Kc. to 12.5 Mc. on Fundamentals and from 11 Mc. to 50 Mc. on Harmonics). Complete with shielded test lead, self-contained batteries and instructions. NET..... **\$27.75**

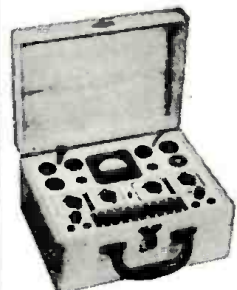

The New Model TC-50

TUBE AND SET TESTER

A complete laboratory, all purpose test-instrument, this versatile combination tube and set tester will accurately test all up-to-date designed tubes. The multi-meter section affords many necessary measurements for everyday's service work.

The New Model TC-50 Tube and Set Tester combines seven instruments, D.C.V., A.C.V., D.C.M.A., Ohms, Output Meter, Decibel Meter and Tube Tester. Full scale accuracy to 2%. English Reading GOOD and RAD scale for testing tubes. Onscreen reduced to absolute minimum. Simple and quick reading charts for tube testing. Multimeter section affords most popular everyday's measurements.

Model TC-50 Tube and Set Tester operates on 90-120 Volts 60 cycles A.C. Housed in a sturdy beautiful portable, hand-rubbed cabinet. Complete with test leads, tube charts and all detailed, operating instructions. Size 8" x 10 1/2" x 5"..... NET **\$39.50**
IMMEDIATE DELIVERY FROM STOCK

All orders filled same day received

Metropolitan ELECTRONIC & INSTRUMENT CO.
Dept. RC-1 12 WARREN ST. N. Y. 7, N. Y.

GET YOUR TEST INSTRUMENT KITS from GREEN

HIGH PRECISION VACUUM TUBE VOLTMETER

Model 221K **\$23.95**
Complete Kit

THE MOST USEFUL TOOL ON YOUR RADIO BENCH! D.C. and A.C. ranges 0-5, 10, 100, 500, and 1000 volts. Ohmmeter ranges from .2 ohm to 1,000 megohms in steps of Rx1, Rx10, Rx1000, Rx10,000 and Rx1 megohm. Db scale from -20 to 55 Db in 5 ranges. D.C. input resistance is 25 megohms. A.C. input impedance is over 1 1/2 megohms. Diode A.C. rectifier for greater accuracy and wider frequency range to 30 Kc. Large, rugged, 4 1/2" meter with all A.C. and D.C. readings on one simple scale. All multiplier resistors matched to 1% accuracy. Complete with 6H6, 6X5, 6SN7 tubes and test prods. All numbers etched into panel; can never rub off. Heavy gauge steel cabinet. Size: 9-7/16" x 6" x 5". Shipping Wt. 10 lbs. **NOTHING ELSE TO BUY!**
Model P-75 germanium crystal probe for visual RF signal tracing, and measurements to over 200 megacycles..... **\$7.50**



ASSEMBLED VTVM

Model 221—Includes all advantages of above. Completely assembled, hand calibrated and tested and ready to use, at the amazingly low **\$49.95** price of.....



POCKET VOLT-OHM-MILLIAMETER COMPLETE KIT

Model 511-K A "MUST" FOR EVERY SERVICEMAN! The small, handy instrument that every repairman uses a thousand times a day! Large 3" meter, beautiful etched panel. Simple to assemble. A PERFECT KIT FOR BEGINNERS. Ranges, DC -0/5/50/250/500/2500 volts. AC -0/10/100/500/1000 volts. Output -0/10/100/500/1000 volts. DC Ma. -0/1/10. DC Amps. -0/1/10. Ohmmeter -0/500/100,000 ohms/0/1 mek. Db meter -8 to 55 Db..... **\$14.95**

ASSEMBLED—READY TO USE
Model 511—Completely wired, tested and assembled at the factory. Rugged, built for heavy duty..... **\$17.95**

OSCILLOSCOPE KIT

Model 400-K Indispensable for AM, FM, and TELEVISION. Horizontal sweep circuit 15 to 30,000 cycles. All controls on front panel. Linea sweep with 884 gas triode. Graph screen for measuring peak to peak voltage. Frequency response of horizontal and vertical amplifiers from 50 cycles to 50 Kc. Input impedance 1 megohm and 50 mmfd. Etched panel for long life. Full complement: 2-687, 2-5Y3, 1-884, 1-58P1. Provision for external synchronization, test voltage and intensity modulation. Deflection sensitivity: .65 volts per inch full gain. Detailed instructions and pictorial diagrams included. **NOTHING ELSE TO BUY!** Size: 8 1/2" W x 13" H x 17" D. Ships wt 40 lbs..... **\$39.45**

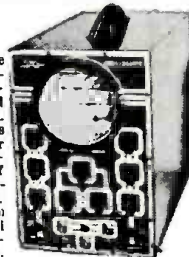

COMPLETELY FACTORY WIRE OSCILLOSCOPE

Model 400—Same as above but wired, tested and assembled. A sturdy well-designed instrument, ready to use on your work bench. Don't wait, order NOW!..... **\$69.95**

SENSATIONAL PRICE REDUCTION!

Model 113-A MULTI-ANALYST
NOW FOR THE FIRST TIME **\$69.95**

A Complete VTVM that follows signal from antenna to speaker! Extremely sensitive wide range AUDIBLE signal tracer. 6 tubes—Gain over 90 in probe alone! Limited quantity—order NOW!

20% Deposit required with O. O. D. Orders. All orders P. O. B. New York. All orders must include shipping charges.

THE HOUSE OF BARGAINS GREEN RADIO DISTRIBUTORS

Electronic Supplies and Equipment
482 Sutter Avenue, D1 2-4444, Brooklyn 7, N. Y.

RADAR TELESCOPE

Radio astronomy will be studied at Cornell University with a new radio telescope, the university announced last month. The telescope, completion of which is expected in a few months, will consist of a 17-foot parabolic reflector with a small antenna at the focal point. Sensitive receivers will record extraterrestrial r.f. noise. This is the first instrument of its capabilities built especially to study cosmic noise. The telescope described last March was a converted Wurzburg radar antenna.



New radar telescope at Cornell University.

The analogy between the radio telescope and a standard optical telescope is very close. Both are used to detect electro-magnetic radiations. The optical telescope receives radiations in the visible range, which includes a band of frequencies about one decade wide, that is, with a 10 to 1 ratio between the highest and lowest frequencies. The radio telescope receives frequencies between 20 and 30,000 mc.

Cosmic noise or static in the r.f. range originates at certain places in the universe and has certain frequencies at each place. The parabolic antenna is very sharply beamed and polarized. It will scan areas of the sky with diameters of 2 to 30 degrees, depending on frequency. It will be rotatable in several directions, as well as turning on its own axis to vary polarization.

Receivers for 50, 200, 1400, and 3000 mc are being assembled. Through the comparatively new medium of radio astronomy Cornell hopes to discover much new and enlightening information about the structure of the universe.

Television may be used for teaching deaf children as the result of experiments conducted by RCA and Dictograph. Group hearing aids will be tied into the sound channel of the receiver. A demonstration of the new technique was given last month in Detroit at the convention of Teachers of Deaf Children, a national organization.

LIKES NEW R-E FORMAT

Dear Editor:

As a faithful reader of your magazine for the past 10 years, I think you have set the pace for magazines. I've always longed for one which had all the items on successive pages. Thanks to you, a feature may be read without thumbing through the whole magazine.

Your new name surely expresses the contents of the magazine and in my opinion could not have been better.

WALDEN MCKIM,
Bessemer, Ala.

LANGHAM HAS A FAN

Dear Editor:

How about a few more articles like those by James R. Langham? I think an article written in story form with a bit of humor is very informative as well as being amusing. Of course I don't mean that all articles should be written that way!

I regard the Technote Section very highly, as well as articles such as W. G. Eslick's "Time-Saving Repair Tips" (July, 1948). The magazine has provided me with much of my radio education and I hope it will continue to do so in the future.

BERT DE KAT,
Minburn, Canada

R-E INTERPRETS SCIENCE

Dear Editor:

Your article describing the transistor in the September issue was of great interest to me.

A private experimenter of limited formal education, I sometimes find such periodicals as the *Journal of Applied Physics*, *Physical Review*, and so on, hard to understand. RADIO-ELECTRONICS has become a sort of interpreter for translating scientific literature into the little fellow's language.

Keep up the good work!

HERMON E. COTTER,
Detroit, Mich.

DOWN WITH NOISE!

Dear Editor:

I agree with Mr. Ward (Communications, November) that ignition noise must go, and the sooner the better. But let's not stop with ignition noise—let's go further and eliminate *all* man-made static! We should have little trouble dealing with radio interference now that there are plenty of spark-plug suppressors and power-line filters on the market.

As Mr. Boehnke said (same issue), an interfering amateur gets into plenty of trouble; at the same time we have to put up with noise caused by some defective household appliance.

Interference makes things even harder for us in Alaska than for you in the States. We rely on short-wave reception for the programs you hear from your local station.

FLOYD P. BROWN, JR.,
Sitka, Alaska

**SENSATIONAL RADIONIC OFFER
TUBES 32c**

in bulk, lots of 100 per type

Individually White Boxed, asst'd 36c each

Made by leading manufacturer—unbranded. RMA guarantee. Money back, less postage, if not completely satisfied. THOUSANDS OF SATISFIED BUYERS!

1R5	6B8G	6SK7GT	12S7GT
155	6C8G	6S8GT	12SK7GT
1T4	6K5GT	6V6GT	32L7GT
1U5	6K6GT	6X5GT	35W4
3Q4	6SA7GT	12AT6	50B5
354	6SD7GT	12BA6	117L7GT
6AT6	6SF5GT	12BE6	117Z3
6BA6	6SG7GT	12SA7GT	
6BE6			

RCA • GE • SYLVANIA • NATIONAL
UNION • KEN-RAD • HYTRON
TUNGSOL • RAYTHEON

Type	Packed in bulk 100 per type	Individually white boxed - assorted
5Y3GT	40¢	49¢
6F6GT	55¢	69¢
6SN7GT	75¢	85¢
12S97GT	55¢	65¢
25L6GT	65¢	75¢
25Z5	55¢	65¢
25Z6GT	55¢	65¢
35L6GT	65¢	75¢
35Z5GT	45¢	55¢
50L6GT	65¢	75¢

Above 10 types show manufacturer's brands. Shipment will be made of makes available when order is received. STANDARD RMA GUARANTEE APPLIES

Specify price when ordering . . .
What other types can you use—bulk packed—100 to a carton. LET US QUOTE!

Minimum order \$3.00. 20% deposit, balance C.O.D.

Send for Free Bargain Bulletins

RADIONIC EQUIPMENT COMPANY

Tribune Theater Entrance
170A Nassau Street, N. Y. C. 7
Worth 2-0421
Open daily 9-6 :: Saturday 9-5

JANUARY VALUES

3 TUBE PHONO
AMPLIFIER

\$1.95

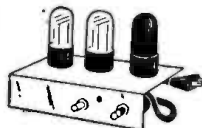

COMPLETELY WIRED,
VOLUME and TONE CONTROLS

Set of 3 tubes: 50L6, 35Z5, 12SQ7	\$1.25
Output trans. 50L6	.35
1/2 Meg. vol. control	.15
1/2 Meg. vol. control with sw	.35
AB dual control 200M ohm	.69
4" pm speaker	.95
5" pm speaker	1.15
6" pm speaker	1.55
6x4" pm speaker	1.39
8" pm speaker	2.49
Webster pickups	1.79
Astatic Cartridges L-70A, L-26A	1.49
Alliance motor & Turntable	2.50
G.E. Reluctance Cartridge	4.54
Phono Pre-Amplifier complete with tubes	4.95
Phono Oscillator complete with tubes	4.52
Oscillator Coil, 12SA7	.15

VM #400 INTERMIX CHANGER \$19.95

SEABURG 3 POST INTERMIX CHANGER \$27.50

Automatic Stop	\$3.89
Slow speed motor and TT	3.89
Slow speed pickup with QT cartridge	3.89
F.P. cond., 4 section, 10 MFD-400V	.39
I F transformers 456KC	
Input or output, ea.	.39

All prices F.O.B. N.Y.C.—on C.O.D. 25% Deposit.
Write for latest circular

THE ROSE COMPANY

98 Park Place, Dept. C, New York 7, N. Y.



TINY RADIO!

Red plastic case. No tubes, batteries or electric "plugs" needed! Guaranteed to receive local stations. Only \$3.99 (ck. Mo. cash) postpaid or send only \$1.00 and pay \$2.99 C.O.D. Complete ready to play on easy connection. With Personal phone. Get Your tiny radio now!

MIDWAY SALES CO., DEPT. TRC-1, KEARNEY, NEBR.

it's Free!



NEW
1949
EDITION

our
29th year

**THE MOST FAMOUS
TIME AND MONEY SAVER
IN RADIO-ELECTRONICS!**

**BIG 180-PAGE
LAFAYETTE-CONCORD
CATALOG**

This great 180-page buying guide pays you dividends on every order you send to Lafayette-Concord. Look:

- 1. GREATEST VALUES**
You get the *lowest* prices in the industry, because you deal with the *biggest* radio supply organization in the world! Lafayette buys in huge quantities, and the savings are passed along to you. You lop off a quarter, a buck or two on most every buy. That kind of money adds up, mister. Lafayette reliability is an old story to 500,000 satisfied customers . . . So why take chances on unknowns? Trade with Lafayette where you'll be *sure* of a square deal.
- 2. MOST COMPLETE STOCKS**
You name it; we have it if *anybody* does . . . in the house, all ready to ship! Headquarters for hi-fi, TV, P.A., testing equipment, parts, tools, kits. You can one-stop-shop for *all* the famous brands in radio. Also, thousands and thousands of hard-to-find parts . . . the kind that can drive you crazy if you don't know just where to lay your hands on them!
- 3. FASTEST DELIVERY**
You order from the nearest of our three great mail order centers: Chicago, New York, Atlanta. Each center keeps large catalog stocks on hand, to give you same-day service on your orders! Or you can shop in person at any of our outlets in 5 cities. Figure out how much this set-up saves you in time and shipping costs!
Now you can see why veteran radio men feel positively naked without a copy of the Lafayette-Concord catalog around the shop or shack! If you don't have it, shoot the coupon to us on a penny postcard. We'll see to it that you get one fast!

IN NEW YORK — 100 Sixth Avenue • 542 East Fordham Road
IN CHICAGO — 901 W. Jackson Blvd. • 229 West Madison Street
IN BOSTON — 110 Federal Street • IN NEWARK — 24 Central Avenue
IN ATLANTA — 265 Peachtree Street

LAFAYETTE-CONCORD
THE WORLD'S LARGEST RADIO SUPPLY COMPANY

LAFAYETTE-CONCORD, Dept. JA-9
100 Sixth Ave., New York 13
901 W. Jackson Blvd., Chicago 7
265 Peachtree St., Atlanta 3

Please send FREE catalog No. 89

NAME.....
ADDRESS.....
CITY.....ZONE.....STATE.....

**RUSH!!
FOR
FREE
180-PAGE
CATALOG
PASTE ON
PENNY
POSTCARD**

RADIO SCHOOL DIRECTORY

• SPECIALIZE • • SPECIALIZE •



You can become a Radio and Television Technician now!

A million new jobs — almost 4,000 a week — will be created in the television industry during the next five years according to estimates of industry leaders. Actually, during 1948, television grew faster than any other industry in the history of America.

Here is a real opportunity for you. Trained television technicians are in demand. By starting now, you can get in on the ground floor — grow as television grows.

To help supply this needed manpower, the Milwaukee School of Engineering has expanded its radio and television courses. Now you can get complete practical, technical training in the MSOE laboratories. *This is not just a serviceman's course.* It prepares you for a career in all of the technical phases of television and radio.

This special course Prepares you for any of the following careers:

- | | | |
|-----------------------|-----------------------------|----------------------------|
| Television Serviceman | Supervisor in Radio and | Police, Taxi-Cab and Rail- |
| Radio Serviceman | Television Assembly | road Transmitter Operator |
| Radio and Television | Radio and Television Tester | Police, Taxi-Cab and Rail- |
| Retailer | Broadcast Radio-Operator | road Receiver Serviceman |

OTHER COURSES AVAILABLE		
SERVICE 6 to 12 Months	TECHNICIAN 1 to 2 Years	PROFESSIONAL 3 Years
• Electricity	• Electrotechnics	• Electrical Engineering
• Welding	• Radio and Television	• Bachelor of Science
• Refrigeration	• Electronics	• Degree
• Heating	• Refrigeration, Heating and Air Conditioning	• Major in Electronics or Power

MILWAUKEE SCHOOL OF ENGINEERING

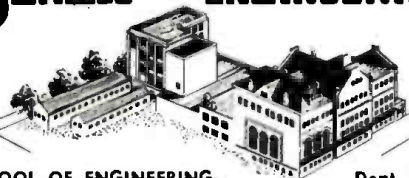

A Technical Institute
Founded 1920

by Oscar Werwith

MILWAUKEE SCHOOL OF ENGINEERING,
N. Broadway and E. State

Dept. RE-149
Milwaukee, Wis.

Without obligation send me free booklet "Career Building" and more details on course in Radio and Television or.....course.

Name.....Age.....

Address.....

City.....State.....

LEARN RADIO!

IN ONLY 10 MONTHS
PREPARE FOR A GOOD JOB!
COMMERCIAL OPERATOR (CODE)
BROADCAST ENGINEER
RADIO SERVICEMAN

Television Servicing—15 Months

Veterans get \$130.00 Equipment
SEND FOR FREE LITERATURE
BALTIMORE TECHNICAL INSTITUTE
1425 Eutaw Place, Dept. C, Baltimore 17, Md.

RADIO ENGINEERING!

Complete Radio Engineering Course. Bachelor of Science Degree. Courses also in Civil, Electrical, Mechanical, Chemical, Aeronautical Engineering; Business Administration, Accounting, Secretarial Science. Graduates successful. 65th year. Enter Jan., March, June, Sept. Write for catalog.

DEGREE IN 27 MONTHS

TRI-STATE COLLEGE 2419 College Ave. ANGOLA INDIANA

WANTED:

Men and Women to Fill
TOP RADIO JOBS
in AM—FM—Television

If you are looking for a career with a future, why not join the hundreds of graduates from the Don Martin School of Radio Arts now successfully employed in the radio industry. The demand is great for qualified radio personnel in AM-FM-Television. Train now to be an announcer, script writer, disk jockey, news-caster, or radio technician. Complete day and night classes... the latest equipment. Free placement service. Approved for veterans. Write for free booklet.

Don Martin School of Radio Arts
1655 North Cherokee St. Hollywood 28, Calif.

TELEVISION NEW, INTERESTING TECHNICAL CAREER

As Television gains momentum, rapidly, constantly, it offers to properly-trained technicians careers with a future in Industry, Broadcasting or own Business.

Train at an institute that pioneered in TELEVISION TRAINING since 1938. Morning, Afternoon or Evening Sessions in laboratory and theoretical instruction, under guidance of experts, covering all Phases of Radio, Frequency Modulation, Television. Licensed by N. Y. State. Free Placement Service. Approved for Veterans.

ENROLL NOW FOR NEW CLASSES
Visit, Write or Phone

RADIO-TELEVISION INSTITUTE

480 Lexington Ave., N. Y. 17 (46th St.)
Plaza 3-4585 2 blocks from Grand Central



RADIO COURSES

Preparatory, Service, Broadcast, Television, Marine Operating, Aeronautical, Frequency Modulation, Radar.

Classes now forming for mid-year term Feb. 1st Entrance exam. Jan. 17
Veterans. Literature.

COMMERCIAL RADIO INSTITUTE
(Founded 1920)
38 West Biddle Street, Baltimore 1, Md.

SOUND RECORDING SCHOOL

A practical engineering course in Sound Fundamentals, Recording, and Sound Transmission measurements; in a laboratory containing transmission sets, oscillators, square wave generator and intermodulation analyzer, and other equipment.

Complete recording studio assimilating broadcast, motion picture and commercial sound recording, under the direction of H. M. Tremaine.

HOLLYWOOD SOUND INSTITUTE, Inc.
1040-C No. Kenmore Hollywood 27, Calif.

RADIO COURSES

- RADIO OPERATING
- RADIO SERVICING
- CODE
- ELECTRONICS
- F. M. TELEVISION
- REFRIGERATION SERVICING

Write for Catalog and Picture Brochure
Y.M.C.A. TRADE & TECHNICAL SCHOOLS
15 W. 63rd St. (N'r B'way) New York City



RADIO and TELEVISION

Thorough Training in All Technical Phases

APPROVED FOR VETERANS
DAYS—EVENINGS WEEKLY RATES

RCA GRADUATES ARE IN DEMAND
For Free Catalog Write Dept. RC-49

RCA INSTITUTES, Inc.
A Service of Radio Corporation of America
350 WEST 4TH STREET NEW YORK 14, N. Y.

ELECTRIC SHAVERS INTERFERE WITH FM?

Dear Editor:

The letters on FM interference you have published during past months have left me puzzled as to why the powerful buzz-saw interference of electric razors eludes not only the execration it deserves, but even mention. Razor interference is an even greater evil than ignition noise. Why is the lesser evil dwelt on to the exclusion of the greater?

I could name a Scandinavian country where everything likely to create interference must by law be quieted. Laws like this will have to be passed here some day . . . meantime, what primitive chaos!

I wonder if the silence of the press

on razor interference is evidence of how subservient it is to commercial interests? (Aren't motor cars also objects of commerce?—Editor.)

I'd like to see what the neighbor's beard does to television—but not in my living room. The ruination of music is bad enough, thank you!

C. P. BROCKETT,
Ajax, Ontario

(In our experience, a genuine FM set—not a wide-band, high-frequency AM set—gives practically no evidence of an electric shaver, even brought close to the antenna lead. Have other readers had shaver trouble?—Editor)

WANTS MORE COMMERCIAL AUDIO CIRCUITS

Dear Editor:

May I take this opportunity to say I like your new title, style, and layout very much? I am an audio fan, and I wish to thank you for the very fair way you allocate space to the different departments. My friends and I all think it is the most interesting of the many publications we get. You cater to every-

body, and I think everybody should be well satisfied.

Your latest Audio-Sound issue was, of course, especially interesting to me. Could we have a few more circuits like the Langevin 122 amplifier? They keep us up on modern practice.

H. G. WARREN,
Luton, England

RADIO-ELECTRONICS GREET'S RADIO-ELECTRONICS

Dear Editor:

Congratulations! We, too, feel that the name RADIO-ELECTRONICS more adequately describes the material in your excellent magazine. Every month we look forward to our copy.

Veterans who started our own radio and appliance business, we have many reasons for praising your magazine. The help we have received from your many diversified articles has been a

boon to our technicians.

You and we both arrived at the same name, but by different routes; we through imagination and nerve—and a little money; you through years of hard work and of literally growing up with the industry.

Keep up the good work!

J. M. BURDETT,
RADIO-ELECTRONICS,
Kapuskasung, Ontario

LONG BEACH, CALIF., WILL HAVE PORT RADAR

Dear Editor:

We appreciate your inquiry regarding the installation by us of a port radar. Our Board of Harbor Commissioners is giving final consideration to . . . the installation on our pier of a pilot station for such radar equipment.

Incidentally, you committed a grave error in stating, "that you plan the construction of a port radar for Los Angeles." There is a keen rivalry be-

tween the ports of Long Beach and Los Angeles even though they are located in the same geographical area; this radar is being considered for Long Beach. At the present time we are the fourth largest producer of oil in the state of California with an annual income from oil of approximately \$30 million per year. Therefore we prefer that a distinction be made between the two ports.

A. K. MADDY,
Executive Secretary,
Board of Harbor Commissioners,
Long Beach, Calif.

(RADIO-ELECTRONICS desires to apologize for its error, and wishes the port of Long Beach every success in its struggle for its proper place in the sun. Latest report, incidentally, says contract has been let and work is about to start.—Editor)

SHORT CUT **CODE SPEED**
Be an Expert

Learn to be a Telegraph or Radio Operator. Thousands of men needed. Intensely interesting work—good pay. Learn at home or wherever you are, quickly, easily, with the famous Candler Code System. Qualify for amateur of commercial license. Book of particulars Free.

CANDLER SYSTEM CO.
Dept. 3-A, Box 928 Denver 1, Colo.

CORRESPONDENCE COURSES IN RADIO and ELECTRICAL ENGINEERING

ELECTRICAL ENGINEERING Get good grasp of wide electrical field. Prepare yourself at Low Cost, for secure future. Modern course. So simplified anyone can understand quickly.

RADIO ENGINEERING Extra fine course in radio. public address, photo-electric work. Trains you to be super-service man, real vacuum-tube technician. Servicemen needed badly. Diploma on completion. Many Graduates earning big pay.

Send postcard for Free Copies of school catalog, full details, all about deferred payment plan, experimental kits, etc.

WRITE \$25 Either about deferred payment plan, experimental kits, etc.

Lincoln Engineering School, Box 931-C-139, Lincoln 2, Neb.

RADIO

TECHNICIAN and RADIO SERVICE COURSES
FM and TELEVISION

AMERICAN RADIO INSTITUTE
101 West 63rd St., New York 23, New York
Approved Under GI Bill of Rights
Licensed by New York State

AUTO RADIO RECEPTION Intensified
with the **SIGNAL**

A featherweight unit that gives greatly increased signal pickup when attached to any type whip car aerial. Attached instantly—adjustable for any angle—will not wind-whip—highly decorative—not-rusting, allows use of rod in telescoped position or extended—greater volume—greater distance.

The Signal Sac is the most unusual auto radio item to appear on the market in the past ten years.

Available in Red, Blue, Green, or natural anodized aluminum finish.
List price \$2.00
Your Cost \$1.20

Specify colors wanted. Check with order. Postpaid in U.S.A. (Jobber inquiries invited.)

WORLD IN COLOR PRODUCTIONS
108 W. Church St. Elms, N. Y.

The HOUSE OF A MILLION RADIO PARTS

Specials in Condensers

5 Mfd. 35V Tubular	10 for \$1.25
10 Mfd. 150V "	10 for \$1.95
20 Mfd. 150V "	10 for \$2.25
8 Mfd. 400V "	10 for \$2.95
8-8 Mfd. 450V "	10 for \$4.95
2" Round G.E. 0-1 R.F. Meter	\$1.95

Write for Bulletin No. C.914

Lifetime Sound Equipment Co.
311-313 Jefferson Ave., TOLEDO 2, OHIO

Get Started in Radio

10 "HOW-TO-DO-IT" BOOKS

Get a solid foundation in radio by means of these 10 timely text books. Each clearly written, profusely illustrated, contains over 15,000 words. You'll be amazed at the wealth of information packed into these handy books. Excellent for reference—ideal for technical library. Your money back if not satisfied.

5 BOOKS for 50c
10 BOOKS for \$1.00
Sent to You Postpaid

No. 1—How To Make Four Diode Short Wave Sets
No. 2—How To Make The Most Popular All-Wave 1 and 2 Tube Receiver
No. 3—Alternating Current for Beginners
No. 4—All About Aerials
No. 5—Beginners' Radio Dictionary (Leading Terms)
No. 6—How To Have Fun With Radio
No. 7—How To Read Radio Diagrams
No. 8—Radio for beginners
No. 9—Simple Electrical Experiments
No. 10—Television

Remit by check or money order—register letter if you send cash or stamps.

RADIO PUBLICATIONS
25A West B'way. New York (7)

\$3.00 FOR CARTOON IDEAS

RADIO-CRAFT prints several radio cartoons every month. Readers are invited to contribute humorous radio ideas which can be used in cartoon form. It is not necessary that you draw a sketch, unless you wish.

IDEAS NOT WANTED
No electrical or radio definitions wanted. Some of these were published in the past, but the subject is about exhausted. All checks are payable on publication.

Address:
RADIO CARTOONS, RADIO-CRAFT
25 West Broadway, New York 7, N. Y.

Send for FREE Catalog
of Sensational NEW 1949
MIDWEST RADIOS

EASY TERMS
Powerful
5 WAVE BAND SERIES
16 AM-FM CHASSIS
SEPARATE CHASSIS OR COMPLETE CONSOLES AVAILABLE

SYMPHONY GRAND
AM-FM RADIO-PHONOGRAPH CONSOLE

A magnificent musical instrument. Uses the powerful Series 16 AM-FM Radio Chassis. Offers Flash-O-Matic Volume and Band Indication; TELEVISION Audio Switch-Over; Giant 14 1/2" Panasonic Speaker; Color-Ray Tuning; No-Drift FM. Other console and table models with Series 16, 12, or 8 chassis.

SEND THIS COUPON TODAY
BUY DIRECT FROM FACTORY AND SAVE!
SEND THIS COUPON TODAY. Write in Name and Address (Please Print) on Coupon or to Postcard.

MIDWEST RADIO & TELEVISION CORP.
Dept. 385, 909 Broadway, Cincinnati 2, Ohio
Please send me your new FREE 1949 Catalog.

NAME.....
ADDRESS.....
CITY..... ZONE..... STATE.....

MINIATURE STORAGE BATTERIES

A real power supply for that pocket transceiver (each battery 3/4x1 1/4x3/8 in.)
Real, rechargeable Storage Batteries, built for Radio Soudé transmitters. Drycharged—just add standard electrolyte (1.280 Sulphuric Acid). Directions included. Plugs into standard Octal socket.

Each set includes one 2-volt and three 36-volt (total 108v.) units, the latter good for 100 MA intermittent drain. Recharge at 20 MA.

Set of 4 batteries **\$3.00** postpaid in U.S.

ENGINEERING ASSOCIATES
Far Hills Branch Box 28, Dayton 9, Ohio

500 FORMULAS TO SUCCESS

MANY million dollar firms started with a single formula, for which they paid a big price. Here you have 500—no less—tried and tested formulas, recipes and processes for making things... all at the ridiculously low price of 25c.
Here is your opportunity to start a business with but a few dollars' capital and with undreamed of profits in prospect. You can also use these formulas in your own home to cut household expenses to the bone. Or you can put them to use in your workshop to cut costs as much as 100%.
Quit paying out many dollars in profits to manufacturers, wholesalers, and dealers, when you can make the same thing yourself for a few cents. It's so easy when you follow our simple instructions.



66 PAGES, 3200 WORDS IN TEXT
Send for "500 FORMULAS AND RECIPES" today. Enclose 25c, that's all! You won't be asked for another cent now or later. Sold on a money-back guarantee.

NATIONAL PLANS COMPANY
P. O. BOX 26 R. STATION N. New York 23, N. Y.

TALK ANYWHERE

Instantly To Anyone with Inter-Talkie! Just push buttons and talk to or from 7 different places! Not a phone—loud volume—no electric "plugs-in" or tubes needed! Sit or hang it! Simple and quick to hook up. For homes, offices, stores, farms, etc. ONLY Guaranteed! Write for free details today! Agents wanted. **\$9.97** Each

MIDWAY SALES CO., Dept. RC-1, Kearney, Neb.

You Can't Match these MID-AMERICA Values!



Electronic Lab Model 2606 PORTA-POWER

Ready for immediate installation to operate mobile transmitters, receivers, public address systems, etc. Requires only 6 VDC input; supplies 300 VDC at 100 MA under load. Hum-free output. Trim metal case with bumper feet; measures only 5"x5 1/4"x4 1/4". Complete with 6X5 tube. Nothing else to buy. Regular \$29.95. You save 60%!

ONLY **\$11.95**
807 SCOOP! Famous-make 807's at a wonderful bargain price. Only 400 on hand, so order quick. First come, first served. Each only **\$1**

BK-22-K Relay Assembly
Part of the 269-F Direction Finder. Contains many useful parts; 12-volt DPST relay, 28-volt stepping relay with 5-deck, 6 position switch, fuse clips, terminal boards, other parts. Brand new... **\$2.49**

FM-AM and HAM ANTENNA
AN-104-B. 1/2 wave at 100-156 MC; formerly used with SCR-522, 274-N, ARC-5. A pair make an excellent broad-band dipole for FM reception. Coaxial connector in base. Very sturdy. Use anywhere. MA-2153. **39c**

Money-Saving KITS!

MA-2481—communication knob kit for amateurs and set-builders. 18 set-screw knobs for 1/4" shafts. Many ore expensive brass-insert construction. Plenty of knobs to give professional appearance to any transmitter, receiver, etc. A really terrific value.....**\$1.49**
MA-50870—31 miniature base pilot light sockets in a great assortment to meet every set-builder's needs. Never before at this low price.....**89¢**
MA-2480—40 push-on knobs in a wide variety of types PLUS a generous assortment of felt washers. Meets more replacement needs. All knobs for 1/4" shafts; no less than 3 of any type.....**98¢**
MA-3050—Stearite and glazed porcelain stand-off insulators. Total of 32 in 8 different types. Keep high voltage and rf away from chassis or panel. Ideal for all amateurs.....**79¢**

T-17 Microphone
Famous T-17 carbon mike with built-in hiss filter. 5-foot rubber covered cable with PL-68 plug. These are used units but in perfect operating condition. Don't miss out on this great value..... **79c**

PARI-DYNAMIC J-61 Speaker Wall BAFFLE

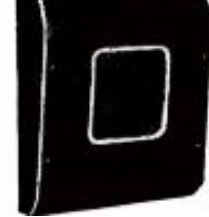

Handsome cabinet completely enclosed and finished with simulated brown leather and chrome trim. Internal sound-absorbing material corrects for high-fidelity reproduction. Takes any 6" speaker. Wonderful for homes, stores, offices, etc. Regular \$14.50. Shpg. wt. 8 1/2 Lbs. Not many of these at this price. **\$4.95** MA-2287

Order from this Ad

Quantities on above-listed items are strictly limited! You must act fast to make sure you get what you want. send 25¢ deposit. Pay balance plus postage on delivery. Get your name and address on Mid-America's select mailing list to receive monthly bargain bulletins that give you first crack at the latest, greatest, money-saving buys in radio parts, electronic equipment, tubes, etc. Send orders and mailing list data to Desk RC-19.

MID-AMERICA CO. Inc.

STORE: 2412 S. Michigan Ave. Chicago 16, Ill.
WAREHOUSE: 2307 S. Archer Ave. Chicago 16, Ill.

Index to Advertisers

Adson Radio Company	74
Allied Radio Corporation	55
Almo Radio Company	69
American Phenolic	61
Amplifier Corp. of America	71, 85
Arrow Electronics	70
Associated Radio Distributors	68
Bargain Radio	85
Bell Telephone Laboratories, Inc.	Back Cover
Brooks Radio Distributing Co.	82
Buffalo Radio Supply	58, 59
Burstein-Applebee Company	80
Capitol Radio Engineering Institute	6, 8
Cinex, Inc.	89
Cleveland Institute of Radio	20
Communications Equipment Company	77
Coyne Electrical School	80, 86
DeForest's Training, Inc.	11
Editors & Engineers	86
Electronic Sales Company	85
Electro Products Laboratories	87
Engineering Associates	96
Espey Manufacturing Co.	71
Esse Radio Company	72, 73
Fair Radio Sales	81
General Electronic Distributing Co.	76
General Test Equipment	74
Green Radio Distributor	92
Greylock Electronic Supply Co.	85
Heath Company	14, 15, 16, 17
The House of Tubes	89
Hudson Specialties	88
Instructograph Company	71
International Resistance Company	4
Island Radio Distributors	68
The JRI Trainers	85
Lafayette-Concord	93
Lake Radio Sales Company	74
Larry Lynde Radio Supply Company	69
Leotone Radio Corporation	98
Lifetime Sound Equipment Company	95
McMurdo Silver Company	Inside Front Cover
Magnet Wire, Inc.	90
Malfz Electric Company	70
Metropolitan Electronic & Instrument Co.	92
Microcircuits Company	90
Mid-America Company	96
Midway Sales Company	87, 93, 96
Midwest Radio Corporation	96
Mori's Radio Shack	90
Moss Electronic Distributing Co.	75
Motor Industries Company	87
Murray Hill Books, Inc.	74, 91
National Plans Company	96
National Radio Institute	3
National Schools	5
Newark Electric Company	97
Niagara Radio Supply Company	80, 86
Offenbach & Reimus Company	80
Ohmite Manufacturing Company	12
Opad-Graen Company	77
Opportunity Adlets	89
Pilot Radio	9
Precision Apparatus Company	90
Progressive Electronics Company	87
R & M Radio Company	90
Radio City Products Co., Inc.	80
Radio Corporation of America	13
Radio Dealers Supply Company	64
Radio Electric Products Inc.	68
Radio-Electronics Library Series	64
Radio Mail Orders	80
Radianic Equipment Company	93
Radio Parts Sales Company	69
Radio Publications	95

RADIO SCHOOL DIRECTORY
(Pages 94-95)

American Radio Institute	
Baltimore Technical Institute	
Candler System Company	
Commercial Radio Institute	
Don Martin School of Radio Arts	
Hollywood Sound Institute, Inc.	
Lincoln Engineering School	
Milwaukee School of Engineering	
RCA Institutes	
Radio Television Institute	
Tri-State College	
YMCA Trade & Technical Schools	

Radio Supply & Engineering Company	82
The Rose Company	93
Howard W. Sams & Co., Inc.	19
Senco Radio, Inc.	18
N. Silverstine Company	62, 63
Spartan School of Aeronautics	83
Spellman Television Company	81
Sprague Products Company	79
Spayberry Academy of Radio	7
Supreme Publications	57
Sylvania Electric Products	10
Technical Radio Parts	97
Television Assembly Company	66, 67
Transvision	65
Triplett Manufacturing Company	Inside Back Cover
Wells Sales, Inc.	98
E. C. Wenger Company	69
World in Color Productions	95
Wright, Inc.	85
Zack Radio Supply Company	69

POST WAR COMMUNICATIONS RECEIVER MANUAL including Aircraft and Marine Radio, compiled and published by Howard W. Sams & Co., Inc., Indianapolis, Ind. 8½ x 11 inches, pages not numbered. Price \$3.00.

Amateur and commercial radio operators, servicemen, and shortwave listeners will appreciate the wealth of technical data on communications receivers and allied equipment made between the end of the war and mid-summer 1948. The average amateur—always wondering about the other fellow's receiver—will find delight in circuits and data on 26 communications receivers, the Gon-Set converter and RME's preselector and converters.

Flyers, amateur and professional sailors, and aircraft- and marine-radio technicians will be interested in data on 22 pieces of marine and aircraft radio equipment.

The material, prepared in the same manner as the Photofact folders, contains diagrams, keyed photographs and pertinent servicing information, on all the equipment described.—*R.F.S.*

HANDBOOK OF INDUSTRIAL ELECTRONIC CIRCUITS, compiled by John Markus and Vin Zeluff. Published by McGraw-Hill Book Co., Inc., New York, N. Y. 272 pages, 11¼ x 9 inches. Price \$6.50.

This is a compilation of 433 practical electronic circuits that have appeared in *Electronics*, *Electronic Industries*, *QST*, *Radio*, *Review of Scientific Instruments*, *Sylvania News*, *RCA Review* and others. The authors were careful to select only practical circuits that illustrate novel approaches to particular problems. The circuits have parts values so the reader can use them without spending time experimenting or computing the value of each component.

The circuits are divided into 20 classifications according to function. Among the chapter headings are: Capacitance Control, Cathode-Ray, Metal Locating, Temperature Control, Timing, Photoelectric, Ultrasonic, and Motor-Control Circuits. Stroboscopes, voltage regulators, multivibrators, oscillators, limiters and power supplies are also described.

The material is listed in a cross-index so the reader can find a circuit although it may be known by a variety of names. The original source of material is given at the end of each article.

Engineers and students may find material in this book that will save countless hours spent in searching through technical literature. Instructors can use many of the circuits to illustrate theoretical text-book material.

RADIO RECEIVER DESIGN, PART II, by K. R. Sturley. Published by John Wiley and Sons, Inc. 5¼ x 8¾ inches, 480 pages. Price \$5.50.

This, plus Part I of the same work, published in 1943, is, in the true sense of the word, a textbook. The author, head of the Engineering Training Department of the BBC, has compiled all the available information on receivers.

Each portion of a receiver has been given a comprehensive treatment. The chapter on a.f. amplifiers, for example, is 55 pages long and all information except that directly applicable to receivers has been excluded. A separate 75-page chapter takes care of power amplifiers.

There are eight chapters in the volume, six of them rounding out the AM receiver information with material on power supplies, automatic gain control, push-button, remote, and automatic tuning, and performance measurements, and the last two dealing with FM and TV receivers.

The material is compressed to give the maximum information in a given space, though the old engineering practice of stating a proposition in very vague (and uninformative) terms and then restating it mathematically appears to delay the reader to some extent. However, this is a minor complaint. More important is the fact that almost every useful formula for receiver design is given.

In short, the book is uninteresting from a literary standpoint, but an unusually complete reference text for receiver design engineers, for which purpose it was obviously written.—*R.H.D.*

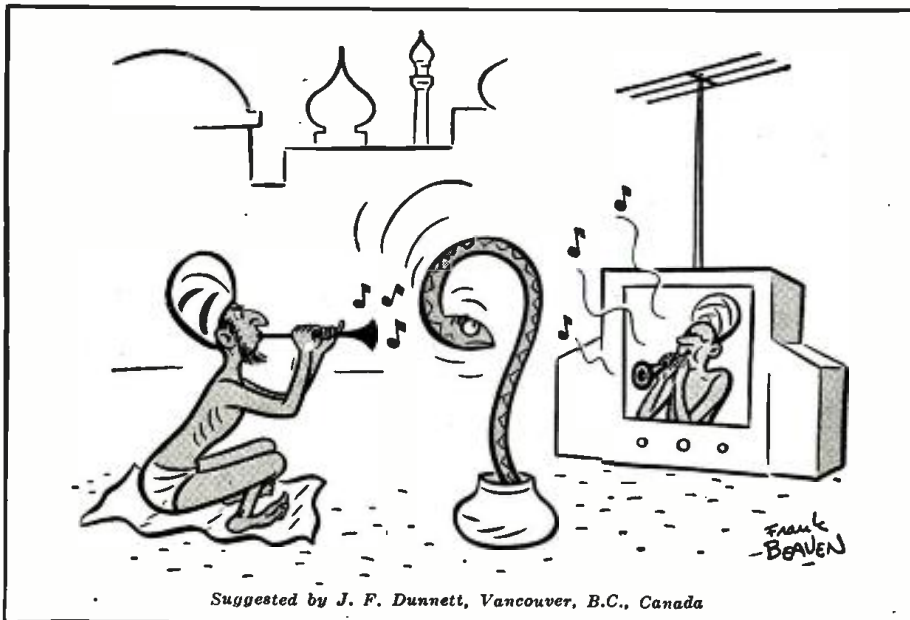

For EVERYONE interested in
TELEVISION • RADIO • ELECTRONICS
SOUND SYSTEMS • INDUSTRIAL EQUIPMENT
EVERYTHING in standard brand equipment!

Professionals! Radio Homs! Television Enthusiasts! Beginner! Oldtimers! Amateurs! Hobbyists! Here's one book that's a MUST for you! Our FREE 148 page catalog lammed with over 20,000 different items. The smallest part to the most complete industrial system from one dependable source!

24-HR. MAIL ORDER SERVICE • ONE YEAR TO PAY

3 GREAT STORES: Uptown at 115 West 45th St. and Downtown at 212 Fulton St. in **NEW YORK** 323 W. Madison St. in the heart of **CHICAGO**

MAIL ORDER DIVISIONS: 242 W. 55th St., N. Y. 19 and 323 West Madison St., Chicago 6, Illinois



Please send me FREE the Newark 1949 Catalog
NAME _____
ADDRESS _____ CITY _____ STATE _____

TECHNICAL KO's

Special: 10% discount on orders of \$5.00 or more.

OIL-FILLED CONDENSERS		TRANSMITTING MICAS	
.05 MFD 1000V	\$0.35	.00005 2500V	\$0.15
.05 500V	.14	.00005 3000V	.35
.1 2500V	.75	.00005 5000V	.85
.1 7500V	1.65	.000087 2500V	.20
2x.1 7000V	4.10	.00007 2500V	.20
.12 15000V	7.95	.00025 2500V	.25
.25 1000V	.35	.00025 5000V	.85
.25 4000V	2.15	.005 2500V	.25
.25 6000V	3.75	.00072 5000V	.85
10x.25 600V	1.05	.0008 5000V	.85
.5 600V	.28	.0001 2500V	.25
.5 1000V	.40	.0011 5000V	.85
.5 2000V	.75	.002 1000V	.20
.75 400V	.30	.002 2000V	.65
.85 600V	.35	.003 2500V	.30
1.0 1000V	.45	.003 3000V	.65
2.0 200V	.20	.004 2500V	.35
2.0 600V	.40	.005 1000V	.15
2.0 1000V	.60	.005 3000V	.65
4.0 600V	.80	.006 2000V	.35
4.0 1000V	1.00	.008 1200V	.15
5.0 220VAC	.55	.01 1200V	.15
6.0 1000V	1.45		
8.0 600V	.85		
8.0 1000V	1.75		
10.0 600V	1.00		
30.0 90VAC	1.40		
30.0 330VAC	3.75		

TUBES-CHOKE-POTS	
Tubes—12K8 Metal	.29
Choke—100MA-10H. 250 Ohm	1.59
Pots: 20K-50K-100K	.19
Dual ½ Meg	
'250K-50K'	.30

SHIELDED WIRE #22..... 50 Ft. for .65
RESISTOR KIT Assorted ½&1W 100 for 1.49
BATHTUB KIT 3x.1, .5, .05, ETC. 10 for .58
CONDENSER KIT .01-.00001.....100 for 2.99
MICAS .01, .002, .005, ETC. All Values .08
.01 150V PAPER (MIDGET).....60 for 1.00
0.1 600V PAPER.....8 for 1.00

\$2.00 min. order F.O.B., N.Y.C. Add postage 50% deposit, balance C.O.D. with all orders. Manufacturers inquiries invited. Send for Flyer. Prices are subject to change without notice.

TECHNICAL RADIO PARTS CO.
MOVED TO LARGER QUARTERS
557 McDonald Ave., Brooklyn 18, N. Y.
DEPT. RE-8

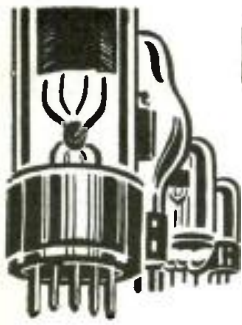

TUBES

Guaranteed by **WELLS**

• TRANSMITTING
• RECEIVING
• INDUSTRIAL
• SPECIAL PURPOSE

Brand new, standard make tubes by the thousands are ready for immediate delivery at the lowest prices in our history. Check this list for exceptional values in magnetrons, cathode ray tubes, voltage regulators, transmitting tubes and also neon, pilot and flashlight bulbs. Be sure to order enough for future needs directly from this ad or through your local parts jobber.

Type	Price	Type	Price	Type	Price	Type	Price			
01A	.50	VR78	.68	838	3.25	2051	.95			
1822	5.55	VR90	.70	841	.55	7193	.35			
1R4/1294	.85	VR92	.65	843	.55	8011	2.55			
2J22	14.85	VR105	.70	860	2.55	8012	4.35			
2J31	14.85	VR150	.70	861	34.50	8020	3.25			
2J32	14.85	VT127 ENGLISH	.35	864	.55	9001	.70			
2J38	18.95	VT127A TRIODE	2.55	865	2.55	9002	.65			
2J48	16.55	211	.65	869	24.95	9003	.55			
2J158	9.85	217C	5.95	869B	28.95	9004	.55			
5J23	14.85	218	4.45	872A	2.45	9006	.55			
5J29	14.95	282B	4.35	874	2.15	CFQ72	1.55			
2C26	.55	250R	7.85	878	2.15	FG105	10.95			
2C26A	.70	304TH	6.55	884	1.50	KU610	7.45			
2C34	.44	304TL	.90	885	.85	RK20A	4.95			
2C44	1.25	305A	12.45	930	1.10	12X825 2 Amp Tungar	2.95			
2E22	1.35	305B	6.75	954	.55	RK34	.45			
2X2/879	.75	316A	.55	955	.55	GL471A	.95			
3C24/24G	.49	350A	2.75	956	.55	EF50	.70			
3AP1/906P1	2.75	350B	2.55	957	.55	HY415	1.25			
3BP1	2.75	371A	2.55	1005	.45	704A	1.55			
3CP1	2.75	371B	2.55	2050	.75	705A	2.15			
3E29/829B	3.95	388A	6.45	1148	.40	707A	19.95			
3FP7	2.95	417A	19.85	1201/7ES	.95					
3HP7	2.95	GL434	2.95	1616	1.25					
5AP1	3.75	446A	1.55	1619	.55	NEON BULBS FOR RADIO USE				
5BP1	2.85	446B	1.55	1624	1.25	NE-15	.06			
5BP4	3.95	GL471A	2.95	1625	.45	NE-48	.24			
5GP1	6.55	481	4.50	1626	.45	NE-16	.24			
5HP4	5.95	WL530	24.95	1629	.45	NE-51	.06			
12HP7	10.95	WL531	19.95	1641/RK60	.65					
6A6	.90	532A	3.55							
6B7	.99	GL559	3.75							
6C21	19.95	WL681	19.95							
6H6	.52	700B	9.95							
6J5	.52	700C	9.95							
6SL7	.65	700D	9.95							
6U5/6G5	.70	702A	2.95							
7A7	.70	707B	23.25							
7C4/1203	.45	708A	6.55	Stock No.	Mazda No.	Volts	Watts	Bulb	Base	Ea. Price
7H7	.75	710A	2.15	350-40	64	6-8	E3 CP	G-6	DC Bay	.07
7Q7	.70	714AY	9.95	350-50	1820	28	.1 Amp	T-3 1/2	Min Bay	.12
10	.52	715B	7.95	350-31	57	12-16	1.5CP	G-4 1/2	Min Bay	.08
10Y	.55	717A	.90	350-42	Spec.	12	6 Watts	S-6	Canal Scr	.13
12A6	.35	721A	3.95	350-20	1446	12	.2 Amp	G-3 1/2	Min Scr	.07
12C8	.35	721B	3.95	350-14	49	2	.06	T-3 1/4	Min Bay	.06
12SH7	.45	724B	4.25	350-15	356	120	3 Watts	S-6	Can Bay	.11
REL21	3.65	725A	19.95	348-22	PR-10	6	.5 Amp	B-3 1/2	Min Flang	.05
FG17	2.95	726A	19.95	350-18	1477	24	.17 Amp	T-3	Min Bay	.16
30/VT67 (For	.95	726C	19.95	LB-101	323	3 (Aircraft)		T-1 1/2	953	.22
33/VT33 (Walkie Talkies...	.95	801A	.80	350-19	Proj. Bulb	120	500 Watts	T-20	Med Pt	1.45
34	.35	803	7.75	LB-103	44 (Ruby)	6-8	.25 Amp	T-3 1/2	Min Bay	.04
RK34	.45	805	5.75	LB-102	1195	12-16	.50CP	RP-11	DC Bay	.14
39/44	.34	807	1.20	LB-104	313	28	.17 Amp	T-3 1/2	Min Bay	.11
41/VT51	.55	810	7.95	LB-105	1816	13	.33 Amp	T-3 1/2	Min Bay	.12
VT52/45SPEC	.55	813	7.85	LB-106	12A	12	.09-Amp 11	T-2	Tel Base	.18
46	.85	814	3.75	LB-107	24-A2 W E	24	.75-Amp 105	T-2	Tel Base	.18
76	.55	826	.49	LB-108	S 14 ARGON	105	2 1/2 Watts	Med	Screw	.22
77	.55	828	4.55							
78	.55	829B	3.95							
83	.85	830B	3.75							
83V	.95	832	2.75							
100R	3.45	832A	3.50							
EF50/VT250	.65	837	1.25							

Cut Out This Page
For Ready Reference

Distributors: Our standard jobber arrangement
applies. Order directly from this ad.

Manufacturers: Write for quantity prices.



320 N. LA SALLE ST. DEPT. Y, CHICAGO 10, ILL.

Printed in the U.S.A.

RADIO-ELECTRONICS for JANUARY, 1949

GREATEST ADVANCE IN V.O.M. HISTORY

Beautiful Streamlined Instrument.

Large 5 1/2 Inch Meter in special molded case under panel.

Resistance Scale Markings From .2 Ohm To 100 Megohms ... Zero Ohms Control Flush With Panel.

Only one switch ... Has Extra Large Knob 2 1/2" Long ... Easy To Turn ... Flush With Panel Surface.

New Molded Selector Switch ... Contacts Are Fully Enclosed ... will retain lubrication without dust contamination.

Batteries Easily Replaced ... New Double Suspended Contacts.

All Resistors Are Precision Film Or Wire Wound Types ... Sealed For Permanent Accuracy.

Unit Construction ... Resistors, Shunts, Rectifier, Batteries All Are Housed In A Molded Base Built Right Over The Switch ... Provides Direct Connections Without Cabling ... No Chance For Shorts.



Inside view cover removed...inverted

TECH DATA

D.C. VOLTS: 0-3-12-60-300-1200-6000, at 20,000 Ohms/Volt
 A.C. VOLTS: 0-3-12-60-300-1200-6000, at 5,000 Ohms/Volts
 D.C. MICROAMPERES: 0-60, at 250 Millivolts
 D.C. MILLIAMPERES: 0-1.2-12-120, at 250 Millivolts
 D.C. AMPERES: 0-12, at 250 Millivolts
 OHMS: 0-1000-10,000; 4.4 Ohms at center scale on 1000 scale;
 44 Ohms center scale on 10,000 range.
 MEGOHMS: 0-1-100
 DECIBELS: -30 to +4, +16, +30, +44, +56, +70
 OUTPUT: Condenser in series with A.C. Volt ranges

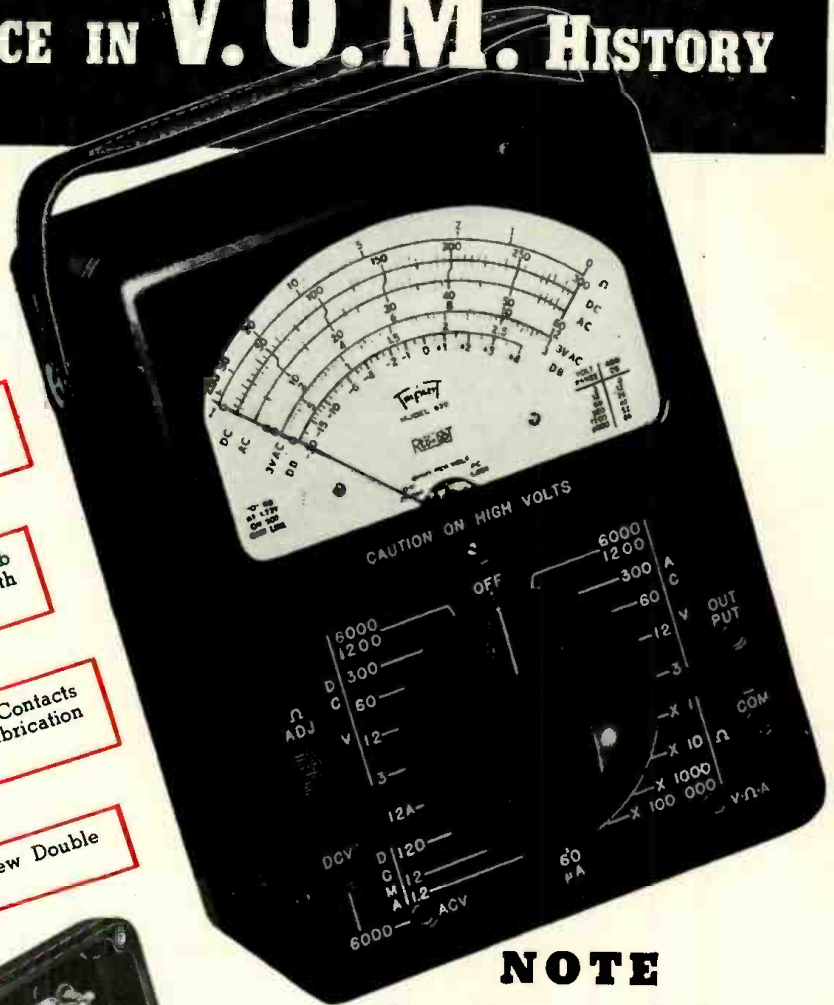

NOTE the Sensational Improvements Model 630

\$3750 U.S.A.
Dealer Net

Leather Carrying Case \$5.75
 ADAPTER PROBE FOR TV
 HIGH VOLTAGE TESTS EXTRA

A completely new Volt-Ohm-Mil-Ammeter that does more.... has proved components.... and will give a lifetime of satisfaction.

Precision first...to Last

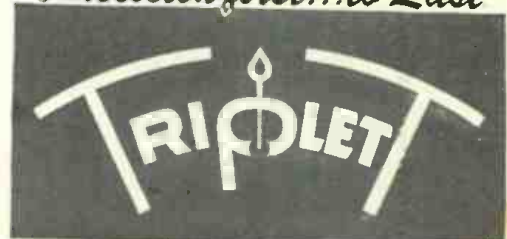

TRIPLETT ELECTRICAL INSTRUMENT CO. • BLUFFTON, OHIO

In Canada: Triplett Instruments of Canada, Georgetown, Ontario

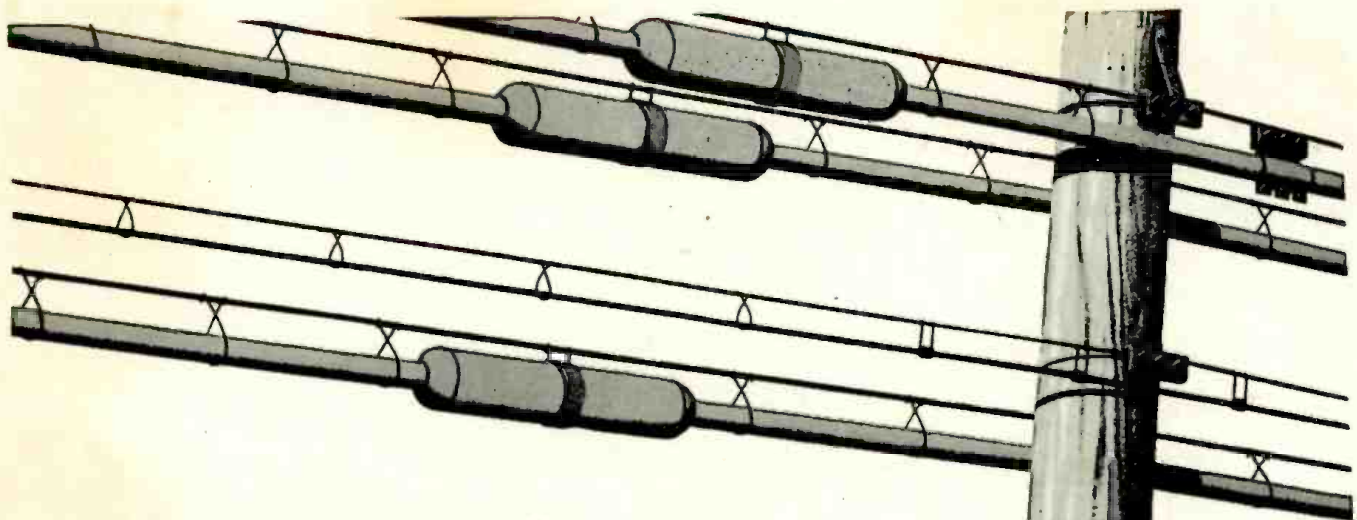

The **case** of the Creeping Sleeve

Lead sheathing on telephone cable meets many stresses — the tug of its own weight, wind pressure, contraction and expansion from cold and heat. Then, too, there's the pressure of nitrogen gas put in Long Distance cable to warn of sheath breaks and keep out moisture.

And, sometimes, lead is subject to "creep"—a permanent stretching — even when the stress is but a fraction of the normal tensile strength. Creep is especially likely at the lead sleeves used where two lengths of cable are joined. The sleeve may stretch and break open exposing telephone circuits to the elements.

So Bell Laboratories scientists have developed methods to test and control creep. In a special testing room, weights are applied to scores of samples of lead, under controlled conditions. Exact records of the amount of creep are obtained with a precision instrument.

Years of careful study have produced a lead composition which resists creep and yet has all the other properties required of sleeves. This means better telephone service for you and helps give that service at lowest possible cost. It is an example of the way Bell Telephone Laboratories scientists study and improve every part of the great telephone plant.

BELL TELEPHONE LABORATORIES

EXPLORING AND INVENTING, DEVISING AND PERFECTING, FOR CONTINUED IMPROVEMENTS AND ECONOMIES IN TELEPHONE SERVICE.

1441
 12

 2882
 1441

 40.18292
 172.92

 213.71
 203.93

 10.786

