

RADIO — ELECTRONICS

JULY 1953

LATEST IN TELEVISION • SERVICING • AUDIO

RADIO-CONTROLLED
MODEL SPEEDBOAT

See page 48

HUGO GERMSBACK—Editor

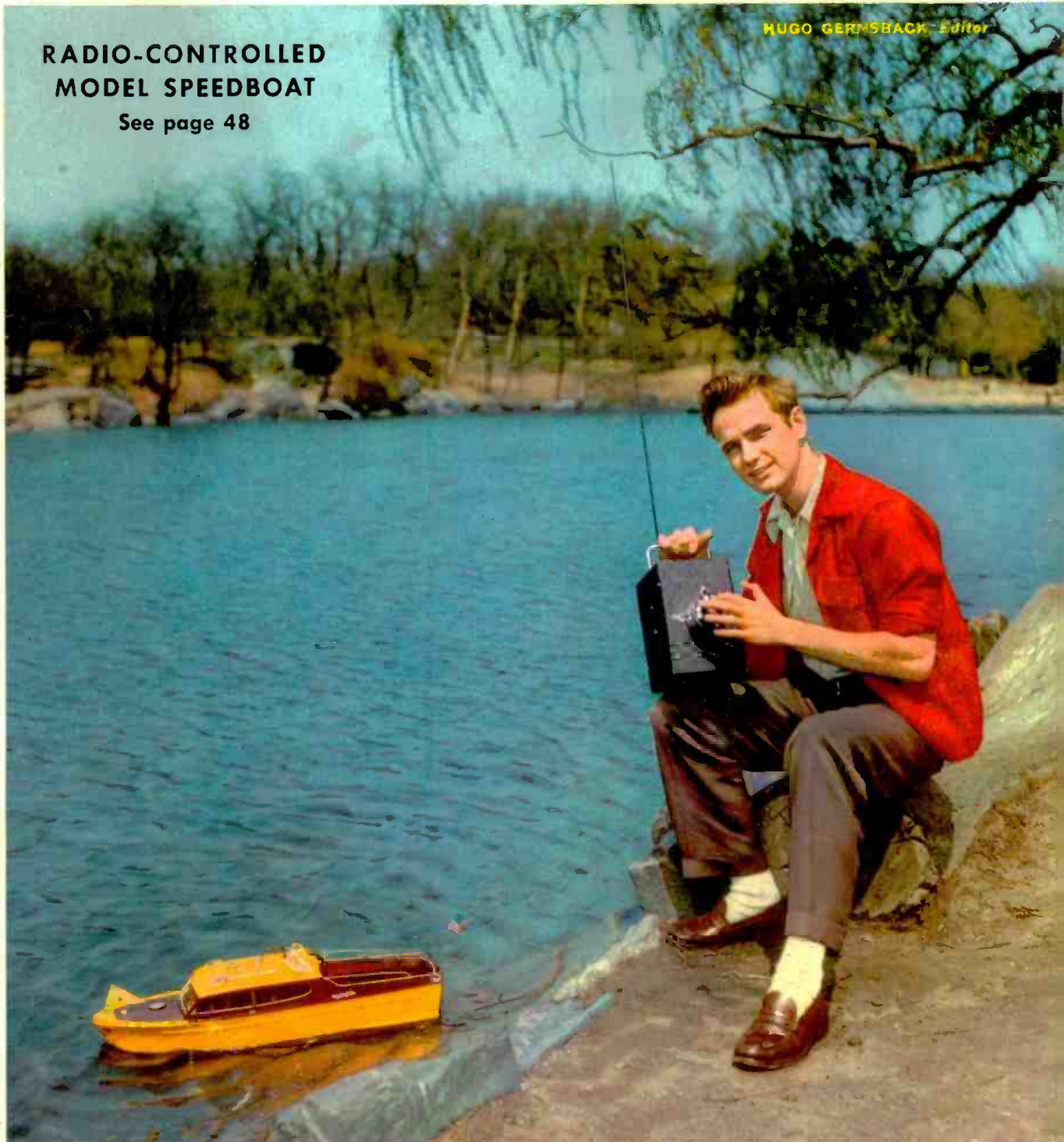

30¢

U. S. and
CANADA

**In this issue: Community TV Systems •
Novice 2-Tube Superhet • Advanced Scope Techniques**

"MY WORD! SUCH REALISM WITH THAT
NEW DU MONT PICTURE TUBE"

Mr. Serviceman:
Put this cartoon to
work in your own local
advertising. Attract
more attention—attract
more business! Ask
your Du Mont distributor
for the complete
details. It's
absolutely free!

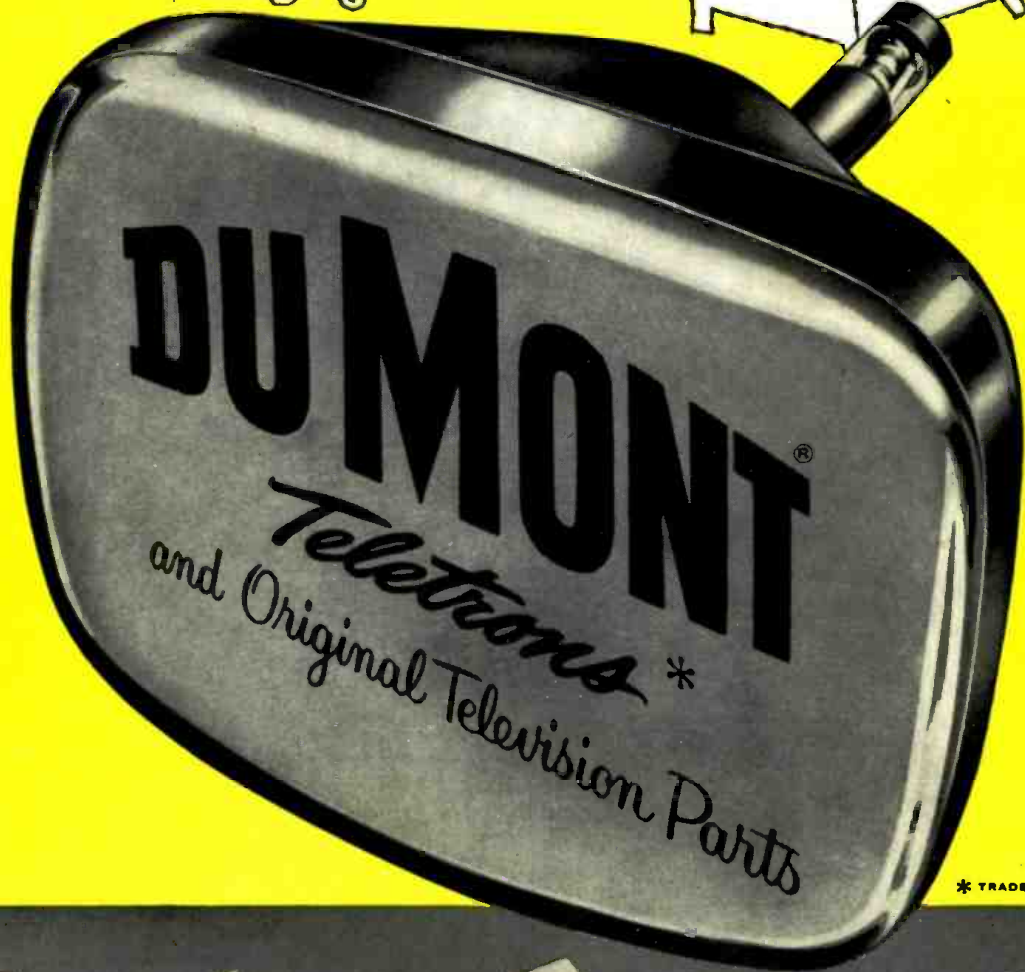

ALLEN B. DU MONT LABORATORIES, INC., CLIFTON, N. J. Replacement Sales, Cathode-Ray Tube Division

YOU PRACTICE COMMUNICATIONS with Kits I Send You

Build This Transmitter

As part of my Communications Course I send you parts to build the low power Broadcasting Transmitter shown at the right. Use it to get practical experience putting a station "on the air," perform procedures required of Broadcast Station operators. You build many other pieces of equipment with kits I send. I train you for your FCC Commercial Operator's License.

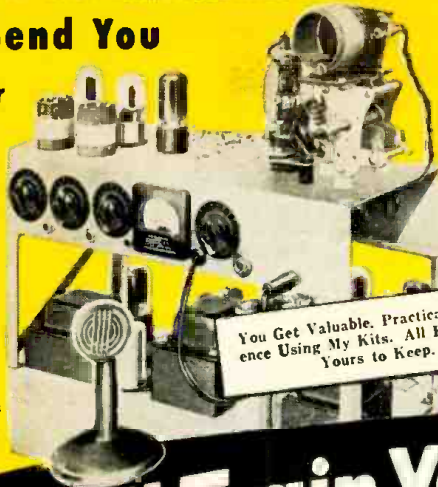

You Get Valuable, Practical Experience Using My Kits. All Equipment Yours to Keep.

YOU PRACTICE SERVICING with Kits I Send You

Build This Tester

You build this Multimeter from parts I send. use it to earn extra money in your spare time fixing neighbors' Radios. I also send you speaker, tubes, chassis, transformer, loop antenna, everything you need to build a modern Radio and other equipment. You get practical experience working with circuits common to both Radio and Television. All equipment is yours to keep. See and read about it in my FREE 64-page book. Just cut out and mail coupon below!



J. E. Smith has trained more men for Radio-TV than any other man.

I Will Train You at Home to be a RADIO-TELEVISION Technician

TELEVISION

Today's Good Job Maker



TV now reaches from coast-to-coast. Over 15 million TV sets are now in use; 108 TV stations are operating and 1800 new TV stations have been authorized. This means more jobs, good pay jobs with bright futures. Now is the time to get ready for success in TV. Find out what Radio-Television offers you. Mail coupon now for my 2 Books FREE!

America's Fast Growing Industry Offers You Good Pay, Success

Do you want a good pay job, a bright future, security? Then get into the fast growing RADIO-TELEVISION industry. Hundreds I've trained are successful RADIO-TELEVISION TECHNICIANS. Most had no previous experience, many no more than grammar school education. Keep your job while training at home. Learn RADIO-TELEVISION principles from easy-to-understand lessons. Get practical experience on actual equipment you build with parts I send you.

Make Extra Money in Spare Time While Training

The day you enroll I start sending you SPECIAL BOOKLETS that show you how to service neighbors' Radios in spare time while training. Use MULTITESTER you build to help service sets, get practical experience working on circuits common to both Radio and Television. Find out how you can realize your ambition to be successful in the prosperous RADIO-TELEVISION industry. Even without Television, the industry is bigger than ever before. 105 million home and auto Radios, over 2900 Radio Stations, expanding Aviation and Police Radio. Micro-Wave Relay, FM and Television are making opportunities for Servicing and Communications Technicians.

Mail Coupon — Find Out What Radio-TV Offers You

Send for my FREE DOUBLE OFFER. Cut out and mail coupon below. Send in envelope or paste on postal. You will get actual Servicing Lesson to prove it's practical to learn at home. You'll also receive my 64-page Book, "How to Be a Success in Radio-Television." Read what my graduates are doing, earning, see photos of equipment you practice with at home. J. E. Smith, President, Dept. 3GF, National Radio Institute, Washington 9, D. C.

I TRAINED THESE MEN



Has Growing Business

"I am becoming an expert Teletician as well as Radiotician. Without your practical course I feel this would have been impossible. My business continues to grow." —Philip G. Brogan, Louisville, Ky.

Good Job with Station

"I am Broadcast Engineer at WLPM. Another technician and I have opened a Radio-TV service shop in our spare time. Big TV sales here. As a result we have more work than we can handle." —J. H. Bangley, Jr., Suffolk, Va.

Praises NRI as Best Course

"I was a high school student when I enrolled. My friends began to bring their Radios to me. I realized a profit of \$300 by the time I completed the course." —John Hopper, Nitro, West Va.

NRI Training Leads to Good Jobs Like These



Broadcasting: Chief Technician, Chief Operator, Power Monitor, Recording Operator, Remote Control Operator, Servicing: Home and Auto Radios, P.A. Systems, Television Receivers, Electronic Controls, FM Radios. In Radio Plants: Design Assistant, Transmitter Design Technician, Tester, Serviceman, Service Manager. Ship and Harbor Radio: Chief Operator, Assistant Operator, Radiotelephone Operator. Government Radio: Operator in Army, Navy, Marine Corps, Coast Guard; Forestry Service Dispatcher, Airways Radio Operator. Aviation Radio: Transmitter Technician, Receiver Technician, Airport Transmitter Operator, Television: Pick-up Operator, Voice Transmitter Operator, Television Technician, Remote Control Operator, Service and Maintenance Technician.

Operator in Army, Navy, Marine Corps, Coast Guard; Forestry Service Dispatcher, Airways Radio Operator. Aviation Radio: Transmitter Technician, Receiver Technician, Airport Transmitter Operator, Television: Pick-up Operator, Voice Transmitter Operator, Television Technician, Remote Control Operator, Service and Maintenance Technician.



AVAILABLE
to all qualified
VETERANS
UNDER G.I. BILLS

Tested Way to Better Pay

Good for Both - FREE

MR. J. E. SMITH, President, Dept. 3GF
National Radio Institute, Washington 9, D. C.
Mail me Sample Lesson and 64-page Book, FREE. (No salesmen will call. Please write plainly.)

Name..... Age.....
Address.....
City..... Zone..... State.....

VETS write in date of discharge.....

The ABC's of
SERVICING

How to Be a
Success
in RADIO-
TELEVISION

RADIO - ELECTRONICS

Formerly RADIO-CRAFT • Incorporating SHORT WAVE CRAFT • TELEVISION NEWS • RADIO & TELEVISION*

Hugo Gernsback
Editor and Publisher

M. Harvey Gernsback
Editorial Director

Fred Shunaman
Managing Editor

Robert F. Scott
W2PWW, Technical Editor

Mortimer Bernstein
Associate Editor

I. Queen
Editorial Associate

Matthew Mandl
Television Consultant

Angie Pascale
Production Manager

Wm. Lyon McLaughlin
Tech. Illustration Director

Sol Ehrlich
Art Director

Lee Robinson
General Manager

John J. Lamson
Sales Manager

G. Aliquo
Circulation Manager

Adam J. Smith
Director, Newsstand Sales

Robert Fallath
Promotion Manager



Member
Magazine Publishers
Association

ON THE COVER (See page 48)
Radio-controlled model speed-boat starts out on a trial run on a lake in New York's Central Park.
Color original by Avery Slack

CONTENTS

JULY, 1953

Editorial (Page 23)

Guided Missiles by Hugo Gernsback 23

Audio (Pages 24-30)

Audio Reactance Charts by Hector E. French 24
Bookshelf Enclosure for Good Bass 27
The Importance of Balance in Push-Pull Amplifiers by Joseph Marshall 28

Television (Pages 31-44)

Television?—It's a Cinch! by E. Aisberg 31
Circuit Shorts by Robert F. Scott 35
Community TV Systems by E. D. Lucas, Jr. 37
Television Service Clinic Conducted by Matthew Mandl 41
UHF Growing Pains Mark First Year of Unfreeze by Eric Leslie 43
TV DX in July 105

Servicing—Test Instruments (Pages 45-47)

Advanced Scope Techniques by Louis E. Garner, Jr. 45
Test Crystals with Your Signal Generator by Ronald L. Ives 47

Construction (Pages 48-63)

Radio Controlled Speedboat (Cover Feature) by M. Gordon Moses 48
Novice Two-Tube Superhet by Richard Graham 51
Transistor Control Relay by Edwin Bohr 53
A High-Performance Portable by Charles Erwin Cohn 56

Broadcasting & Communications (Page 66)

Broadcasters to Meet Defense Emergencies 66

New Design (Page 68)

New Tubes 68

Electronics (Pages 76-80)

Stimulation of Plant Growth by George Obolensky 76

Departments

The Radio Month	10	Try This One ...	90	People	106
Radio Business...	14	Radio-Electronic		Communications	108
With the		Circuits	93	Electronic	
Technician	70	Question Box	98	Literature	110
New Patents	82	Technotes	102	Book Reviews	111
New Devices	87	Miscellany	104		



MEMBER Audit Bureau of Circulations

Vol. XXIV, No. 7

RADIO-ELECTRONICS, July 1953, Vol. XXIV, No. 7. Published monthly at Erie Ave., F to G Sts., Philadelphia 32, Pa., by Gernsback Publications, Inc. Entered as Second Class matter September 27, 1948, at the Post Office at Philadelphia, Pa., under the Act of March 3, 1879.
SUBSCRIPTION RATES: In U. S. and Canada, in U. S. possessions, Mexico, South and Central American countries, \$3.50 for one year; \$6.00 for two years; \$8.00 for three years; single copies 50¢. All other foreign countries \$4.50 a year, \$8.00 for two years; \$11.00 for three years.
EXECUTIVE, EDITORIAL and ADVERTISING OFFICES: 25 West Broadway, New York 7, N. Y. Telephone REctor 2-8630. Gernsback Publications, Inc. Hugo Gernsback, President; M. Harvey Gernsback, Vice-President; G. Aliquo, Secretary.
SUBSCRIPTIONS: Address correspondence to Radio-Electronics, Subscription Dept., Erie Avenue, F to G Sts., Philadelphia 32, Pa., or 25 West Broadway, New York 7, N. Y. When ordering a change please furnish an address stencil impression from a recent wrapper. Allow one month for change of address.
BRANCH ADVERTISING OFFICES: Chicago: 100 E. Ohio St., Tel. Superior 7-1796. Los Angeles: Ralph W. Harker, 1127 Wilshire Blvd., Tel. Madison 6-1271. San Francisco: Ralph W. Harker, 582 Market St., Tel. Garfield 1-2481. **FOREIGN AGENTS:** Great Britain: Atlas Publishing and Distributing Co., Ltd., London E.C.4. Australia: McGill's Agency, Melbourne. France: Brentano's, Paris 2e. Belgium: Agence et Messageries de la Presse, Brussels. Holland: Trilectron, Heemstede. Greece: International Book & News Agency, Athens. So Africa: Central News Agency, Ltd., Johannesburg; Capetown; Durban. Natal, Universal Book Agency, Johannesburg. Middle East: Steinsitzky Middle East Agency, Jerusalem. India: Broadway News Centre, Dadar, Bombay 214. Pakistan: Paradise Book Stall, Karachi 3. Copyright 1953 by Gernsback Publications, Inc. Text and illustrations must not be reproduced without permission of copyright owners. **POSTMASTER:** If undeliverable send form 3578 to: RADIO-ELECTRONICS, 25 West Broadway, New York 7, N. Y. *Trademark registered U.S. Patent Office.

RADIO-ELECTRONICS

ADVANCE! Raise your earning power—learn RADIO-TELEVISION-ELECTRONICS by SHOP-METHOD HOME TRAINING

GOOD JOBS AWAIT THE TRAINED RADIO-TV TECHNICIAN

There is a place for *you* in the great Radio-Television-Electronics industry when you are trained as National Schools will train you at home!

Trained technicians are in growing demand at good pay—in manufacturing, broadcasting, television, communications, radar, research laboratories, home Radio-TV service, and other branches of the field. National Schools Master Shop-Method Home Training, with newly added lessons and equipment, trains you in your spare time, right in your own home, for these fascinating opportunities. **OUR METHOD IS PROVED BY THE SUCCESS OF NATIONAL SCHOOLS TRAINED MEN, ALL OVER THE WORLD, SINCE 1905.**

EARN WHILE YOU LEARN

Many National students pay for all or part of their training with spare time earnings. We'll show you how you can do the same! Early in your training, you receive "Spare-time Work" Lessons which will enable you to earn extra money servicing neighbors' and friends' Radio and Television receivers, appliances, etc.



Signal Generator

Audio Oscillator

T. R. F. Receiver

National Schools Training is All-Embracing

National Schools prepares you for your choice of many job opportunities. Thousands of home, portable, and auto radios are being sold daily—more than ever before. Television is sweeping the country, too. Co-axial cables are now bringing Television to more cities, towns, and farms every day! National Schools' *complete* training program qualifies you in all fields. Read this partial list of opportunities for trained technicians:

- Business of Your Own • Broadcasting
- Radio Manufacturing, Sales, Service • Telecasting
- Television Manufacturing, Sales, Service
- Laboratories: Installation, Maintenance of Electronic Equipment
- Electrolysis, Call Systems
- Garages: Auto Radio Sales, Service
- Sound Systems and Telephone Companies, Engineering Firms
- Theatre Sound Systems, Police Radio
- And scores of other good jobs in many related fields.

TELEVISION TRAINING

You get a complete series of up-to-the-minute lessons covering all phases of repairing, servicing and construction. The same lesson texts used by resident students in our modern and complete Television broadcast studios, laboratories and classrooms!



MASTER ALL PHASES!
Get Master Shop-Method Home Training from an Established Practical Resident School with its own Training Shops, Laboratories, Studios — almost 50 Years of Successful Experience in Training Ambitious Men.
We Bring National Schools To You!



You also receive this Multitester

Superheterodyne Receiver

LEARN BY DOING

You receive and keep all the modern equipment shown above, including tubes and valuable, professional quality Multitester. *No extra charges.*

FREE! RADIO-TV BOOK AND SAMPLE LESSON!

Send today for National Schools' new, illustrated Book of Opportunity in Radio-Television-Electronics, and an actual Sample Lesson. No cost—no obligation. Use the coupon now—we'll answer by return airmail.

APPROVED FOR VETERANS AND NON-VETERANS
Check coupon below

Both Resident and Home Study Courses Offered!

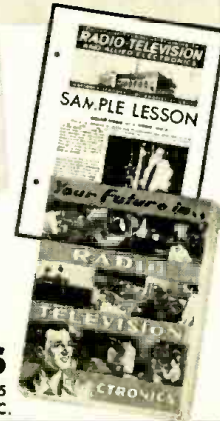

NATIONAL SCHOOLS

LOS ANGELES 37, CALIFORNIA • ESTABLISHED 1905
IN CANADA: 193 E. HASTINGS STREET, VANCOUVER, B.C.

FIND OUT NOW—MAIL COUPON TODAY!

NATIONAL SCHOOLS, Dept. RG-73
4000 South Figueroa Street
Los Angeles 37, California

Mail in envelope or paste on postal card.

Send FREE Radio-TV Electronics book and FREE sample lesson. I understand no salesman will call on me.

NAME _____ AGE _____

ADDRESS _____

CITY _____ ZONE _____ STATE _____

Check here if released from service less than 4 years ago.
 Check here if interested in Resident Training at Los Angeles.

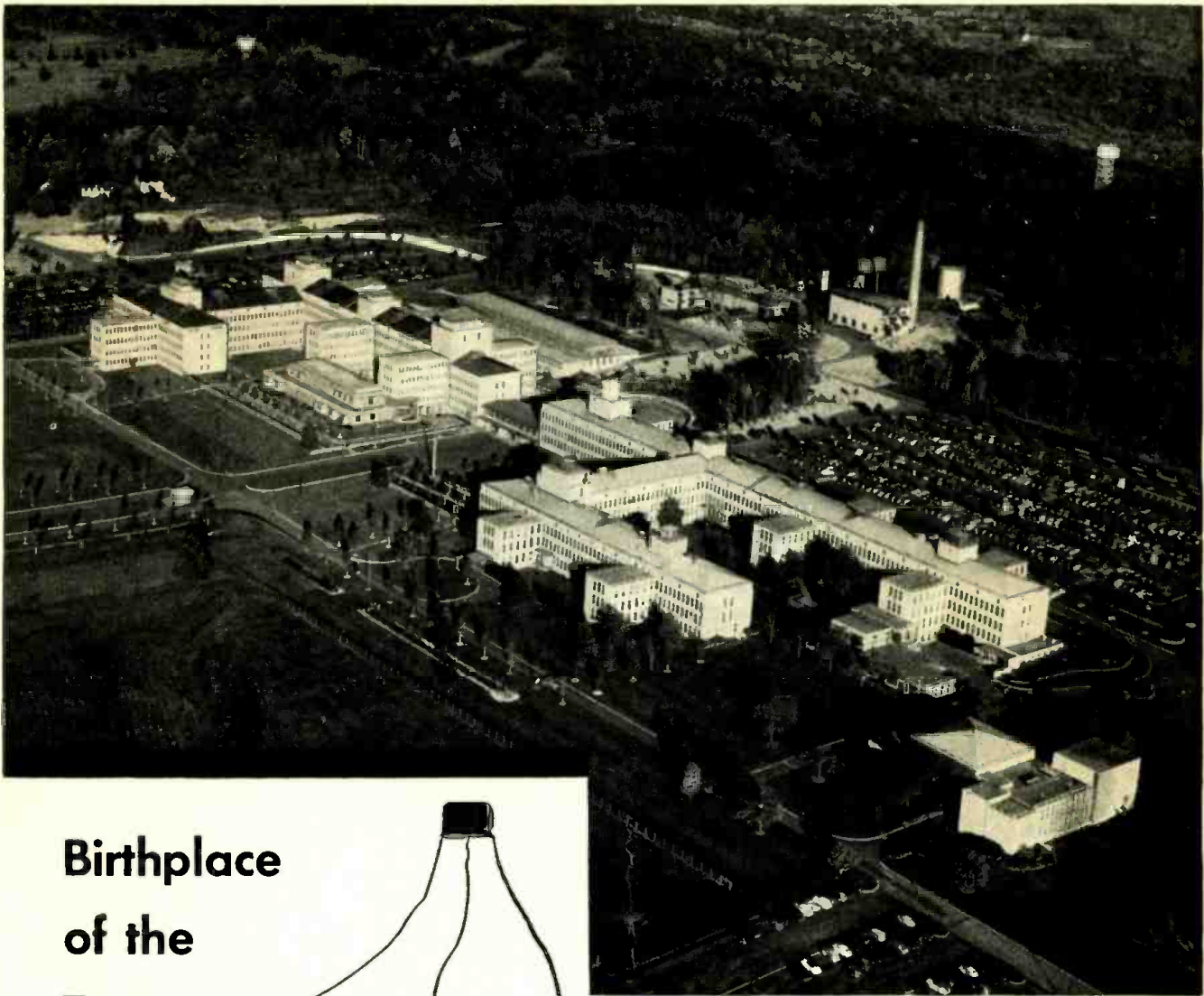

Birthplace of the Transistor

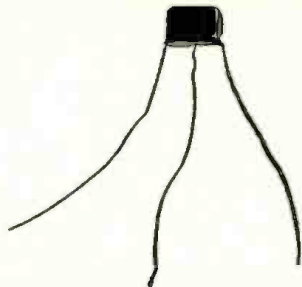

Bell Telephone Laboratories at Murray Hill, N. J. Other laboratories are in New York City and at Whippany and Holmdel, N. J.

The *Transistor*, that revolutionary new electronics device, is a product of *telephone* research. It was conceived, invented and developed at Bell Telephone Laboratories by men in search of ways to improve telephone service. It was announced just five years ago.

The *Transistor* can do most of the things that vacuum tubes can do—and others, too—but it is not a vacuum tube. It works on entirely new physical principles. Rugged, simple and tiny, the Transistor uses incredibly small amounts of power—and then only when actually operating.

Transistors promise smaller and cheaper electronic equipment and the spread of electronics where other equipment has not been able to do the job as economically. They are already at work in the Bell System, generating the signals that carry dialed numbers between cities, and selecting the best route for calls through complex switching systems. Engineers see many other possibilities: for example, as voice amplifiers in telephone sets to aid the hard of hearing, and as switches.

Recognizing the tremendous possibilities of the *Transistor* in every phase of the electronics industry, the Bell System has made the invention available to 40 other companies. Thus, again, basic research to improve telephony contributes importantly to many other fields of technology as well.

TRANSISTOR SUMMARY

Basically, a *Transistor* is a tiny wafer of germanium with three electrodes, over-all about the size of a coffee bean.

It can amplify signals 100,000 times on much less power than a pocket flashlight requires. This opens the door to its use in smaller telephone exchanges where vacuum tube equipment would be too costly to operate.

Unlike a vacuum tube, the *Transistor* has no vacuum and no filament to keep hot. It operates instantly, without "warm-up" delay. The Transistor can also be used as an electric eye and to count electrical pulses.



BELL TELEPHONE LABORATORIES

Improving telephone service for America
provides careers for creative men in scientific and technical fields.

RADIO-ELECTRONICS

What you can do now
to speed your

SUCCESS IN RADIO- TELEVISION- ELECTRONICS

Send for this **FREE CREI Booklet** and see



THERE IS A vacancy coming up. It means a boost in pay, prestige and security. Can you fill it? The answer is "No," if you postpone your preparation for success.

The answer is "Yes," if opportunity finds you ready. "Ready" means "TRAINED." And your training must start now, if you expect to be big enough for a bigger job. You ask "What can I do now?" You will find many valuable suggestions in a free booklet, "Your Future in the New World of Electronics." Not only does it picture fabulous opportunities . . . it tells you what to do to grow with an industry desperately seeking trained men. Expansion is phenomenal: In the defense build-up alone, many billions in electronics contracts have been awarded. It is estimated that by 1961 the radio-electronics industry will do no less than \$10 billion per year, excluding defense orders.

Growing civilian markets include radio-equipped police cars, fire-equipment, taxis, planes, ships—in increasing numbers. There are industrial radio network installations, medical applications, and countless others. There are nearly 200 TV stations now on the air, and 2000 more on the way. Already it is estimated there are over 21,000,000 TV sets and over 100,000,000 radios in operation. How these figures will increase in the next few years, the most daring experts are reluctant to predict. This much is certain: Limitless numbers of positions must be filled—in development, research, design, production, testing, inspection, manufacture, broadcasting, telecasting, and servicing. To fill these posts, trained men are needed—men who somewhere along the line are alert enough to improve their knowledge and skills. "Your Future in the New World of Electronics" shows how CREI Home Study leads to greater earnings, by helping get you ready for the openings described above.

CREI promises no short cuts. In an accredited technical school such as this, *you must study* to transform your ambition and energy into knowledge that pays off. Since its founding in 1927, CREI has provided thousands of professional radio men with technical educations. During

World War II CREI trained thousands more for the Armed Services. Leading firms choose CREI courses for group training in electronics at company expense; among them are United Air Lines, Canadian Broadcasting Corporation, Trans Canada Airlines, Bendix Products Division, All American Cables and Radio, Inc., RCA Victor Division, Mochlett Laboratories, Canadian Marconi and Heppner Mfg. CREI's practical courses are prepared by recognized experts. You get up-to-date material; your work is under the personal supervision of a CREI staff instructor, who knows and teaches you what industry needs. Training is accomplished on your own time, during hours chosen by you. As a graduate, you'll find your CREI diploma the key to success in Radio, TV and Electronics. At your service is the CREI Placement Bureau, which finds positions for advanced students and graduates. Although CREI does not guarantee jobs, requests for personnel far exceed current supply. CREI alumni hold top positions in America's leading firms.

Now is the time to decide—to act. When opportunity knocks, knowledge must be "at home." You supply the willingness to learn. We supply the technical training. This combination of ambition and knowledge is unbeatable in the new Age of Electronics. Fill out the coupon and mail it now. We'll promptly send you your free copy of "Your Future in the New World of Electronics."

CREI resident instruction (day or night) is offered in Washington, D. C. New classes start once a month. VETERANS: If you were discharged after June 27, 1950—let the new G.I. Bill of Rights help you obtain CREI resident instruction. Check the coupon for full information.

MAIL COUPON FOR FREE BOOKLET

CAPITOL RADIO ENGINEERING INSTITUTE

Dept. 147, 3224 16th St., N.W., Washington 10, D. C.

Send booklet "Your Future in the New World of Electronics" and course outline.

CHECK FIELD OF GREATEST INTEREST TV, FM & Advanced AM Servicing Aeronautical Radio Engineering Practical Radio Engineering Broadcast Radio Engineering (AM, FM, TV) Practical Television Engineering

Name

Street

City Zone State

Check— Residence School Veteran

acclaimed!

BY THOSE WHO KNOW AT THE CHICAGO SHOW

THE GREAT NEW VEE-D-X ROTATOR

They came — they saw — they bought. Their interest, their enthusiasm and their endorsement exceeded our fondest hopes. The VEE-D-X Rotator was truly the **BRIGHTEST STAR** at the Show.

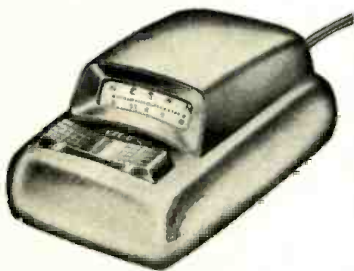

THE MAGNIFICENT Decorator Styled CONTROL CONSOLE

Beautiful and efficient, the VEE-D-X console has unique fingertip action control which operates with a convenient downward pressure. It is streamlined, compact and engineered for instantaneous clockwise and counter-clockwise action. Choice of colors — Heather Green and Cordovan Mahogany.

**DO YOUR CUSTOMERS
A GOOD TURN BY
INSTALLING THE**



"IT STOLE THE SHOW"

And it will steal the spotlight wherever a rotator is needed. The VEE-D-X rotator and control console are packaged with the highest "EYE-Q" of any on the market.

**VEE-D-X
ANTENNA ROTATOR**

A FEW NOTES A FEW QUOTES from the CHICAGO SHOW

NOTE: Finest in design, construction and performance.

QUOTE: "Congratulations! This is the rotator that we want."

NOTE: It's streamlined.

QUOTE: "Your in-line mounting finally gives us a good looking rotator."

NOTE: Finest gearing of any rotator.

QUOTE: "Your gear train is really something, and it's built with watch precision."

NOTE: Three world-famous manufacturers collaborated in producing the VEE-D-X Rotator.

QUOTE: "At last we've got a rotator that is absolutely complete and ready to install with no bag of loose bolts and nuts or other accessories to fumble around with."

NOTE: Beautiful Decorator Styled Control Console.

QUOTE: "Your control console is the smoothest, most compact unit I've seen yet - and it's really got eye appeal."

A PRODUCT OF LaPOINTE ELECTRONICS INC. • ROCKVILLE, CONNECTICUT

RADIO-ELECTRONICS



ANOTHER D.T.I.

EXCLUSIVE!

Easy-to-learn-from home MOVIES help speed you toward a

PROFITABLE, BRIGHT FUTURE IN

TELEVISION
RADIO • ELECTRONICS

REAL OPPORTUNITY FOR YOU!

You use this 16 mm. Movie Projector and Films at HOME

Thanks to this exclusive D.T.I. home training aid, many important Television-Radio fundamentals quickly become "movie clear." Now you can actually see electrons on the march and other "hidden actions"—a wonderful advantage that's almost like having a teacher in your home.

RIGHT: At Home You Build and Keep this 5-INCH Oscilloscope

... one of the most useful test units in the TV Electronic field, and almost a "must" for servicing TV sets. No need to buy a costly "scope" when you graduate. This quality, commercial-type unit will serve you for years to come.



LEFT: At Home You Build and Keep A Jewel-Bearing Multi-Meter

... an extremely handy meter. Together with the Oscilloscope, it can also help you "earn while you learn"—servicing in your spare time.

Act now!

MAIL THIS COUPON TODAY. GET THIS EXCITING PUBLICATION.

89 WAYS TO EARN MONEY IN TELEVISION RADIO ELECTRONICS

DEPT. RE-7-J
DeFOREST'S TRAINING, INC.,
2533 N. ASHLAND AVENUE,
CHICAGO 14, ILLINOIS

I would like your Opportunity Bulletin showing "89 Ways To Earn Money In Television-Radio-Electronics"; also, complete facts about the training opportunities made possible by your organization.

Name _____ Age _____
Address _____ Apt. _____
City _____ Zone _____ State _____

This great, billion dollar opportunity field now offers you a chance of a lifetime to get started toward a real job or your own profitable business. With the TV station limit now raised from over 100 to 2053, Television in the next several years will be headed for almost every community. Mail coupon today. See how you may prepare to cash in on one of the most active fields of our time.

GET STARTED this Wonderfully Practical Way

You don't have to know the first thing about Television-Radio-Electronics at present. D.T.I. supplies you at home with (a) the knowledge, (b) practical experience and (c) employment service—EVERYTHING YOU NEED to help you get started in Television-Radio-Electronics.

FIRST: You receive well-illustrated lessons.

SECOND: You use visual training movies—a great aid to helping you understand important basic points FASTER . . . EASIER . . . BETTER. D.T.I., alone, brings you this wonderful visual training method at home—the same type the armed forces, colleges and industrial organizations are using with such remarkable results.

THIRD: You get many shipments of parts for setting up your own Home Laboratory—working over 300 construction and test procedures for the practical experience you need. This includes building and keeping a 5-inch commercial-type Oscilloscope, a jewel-bearing Multi-Meter, and a big 21-INCH TV Set. D.T.I. also offers another home training, but without the TV Set.

FOURTH: Upon completing your training, you can then get the fine help of D.T.I.'s effective Employment Service—which has nationwide contacts with many employers of trained Television-Radio-Electronic men.

If preferred, you can get all your training in D.T.I.'s thoroughly equipped electronic training laboratories in Chicago. Get the complete story. We believe what we have for you will really surprise you. MAIL THE COUPON TODAY.



21 INCH

Build and keep this BIG DTI engineered TV set—easily converted to U.H.F.

"ONE OF AMERICA'S FOREMOST TELEVISION TRAINING CENTERS"

— Established 1931 —



MILITARY SERVICE

If subject to military service, the training information we have for you should prove very helpful.

DeFOREST'S TRAINING, INC.

AFFILIATED WITH

DeVRY Technical INSTITUTE

CHICAGO 14, ILLINOIS

take the
kick
out of
TV



Burton Browne advertising



CORONA FREE HVO-X7 FLYBACK TRANSFORMER

Merit's famous HV07 is now treated to a miracle-tough, new non-hygroscopic insulation. Liquid-molded, this latest development in insulating materials encloses the high voltage winding, is impervious to moisture and high humidity and forms a watertight seal for the high voltage lead. Unaffected physically or electrically by cycles of heat and cold, it will withstand operating temperatures 50% above normal without change. Its high dielectric constant affords maximum protection with minimum distributive capacity.

MERIT COIL AND TRANSFORMER CORP.
4425 NORTH CLARK ST., CHICAGO 40

MERIT



Hugo Gernsback, with S. L. Baraf of U.T.C., president of the Parts Show Corporation and toastmaster of the banquet at which the globe was presented.

A SCULPTURED SILVER GLOBE was presented to Hugo Gernsback, publisher and editor of RADIO-ELECTRONICS, as a trophy representing "Fifty years of devoted effort and contributions to the radio-electronic art and to scientific prognostication—1903-1953." The presentation was made at the Radio Industry Banquet of the 1953 Electronic Parts Show in Chicago May 18. Mr. Gernsback is at the left side of the photograph above.

The globe, which shows the land masses of the world in relief, rests on a tapered cylindrical base on which are inscribed the names of the large number of individual and corporate sponsors who contributed to the award, and the names of prominent scientists living and dead whose pioneering labors have contributed to the progress of the radio-electronic art.

NEW FINDINGS IN V.H.F. DX transmission over mountainous areas are under intensive study by Government scientists. Tests on frequencies between 38 and 160 mc show the existence of signal "paths" relatively free from transmission loss or fading over distances as great as 200 miles. Calculations indicate the equivalent increase in transmitter power—as great as 70 db (10 million times)—may hold at even greater distances, and at frequencies up to 1,000 mc and more.

These discoveries—in addition to their military value—may eventually make it possible to get consistent television reception at great distances over mountain terrain, provided the right locations are found for the transmitting antennas. A receiver just behind a mountain, however, might get nothing at all, due to the natural deflecting effect of any large obstacle on very short electromagnetic waves.

THE LATE DR. FRANK CONRAD, pioneer engineer, who established the world's first regularly scheduled broadcast station (KDKA) in 1920, was unanimously chosen for the fourth annual Radio Hall of Fame Award of the Radio Pioneers. Five living leaders received citations from the Pioneers—Dr. V. K. Zworykin; Dr. E. F. W. Alexanderson; John V. L. Hogan; Dr. O. H. Caldwell; and Donald Manson, retired general manager of the Canadian Broadcasting Corporation.

Dr. Conrad spent his entire career with Westinghouse, rose from bench hand to assistant chief engineer which position he held at his death in 1941. He held over 200 patents.

MULTIPLE SKY-WAVE ECHOES that interfere with high-speed code and facsimile transmission over long-distance radio circuits can be eliminated by a new method developed by Dr. Millett G. Morgan. Reflections from the two principal layers of the ionosphere and from "waves" in their surfaces can transform a single transmitted dot into a whole series of dots at the receiving end.

Dr. Morgan, who is director of research at Dartmouth University's Thayer School of Engineering, found the solution is to transmit an elliptically polarized signal from two antennas, adjusting the axis ratio of the ellipse continually to counteract changes in the heights and surface irregularities of the ionosphere layers. It may be possible to make these adjustments automatically with the aid of a small pilot transmitter that continuously "sounds" the confirmation of the ionosphere.

MANY HAPPY RETURNS of the day to the transistor, whose birth was announced June 30, 1948.

RADIO-ELECTRONICS

HERE'S A WINNING CARD...



The **RAYTHEON** Bonded Electronic Technician's Identification Card

is mighty important to customers. It instantly identifies the bearer as an expert technician representing a reputable company — lends reassurance to the apprehensive set owner.

But this is only one of the ways the *Raytheon Bonded Electronic Technician Program* helps you. The cash-protection of the Raytheon Bond (backed by

Continental Casualty Company), the Raytheon "Code of Ethics" and the sound, sensible business methods the code suggests all help to create customer confidence and good will. That means more business now, and more business in the future from a steadily increasing backlog of satisfied customers.

This potent weapon in the war against consumer mistrust is yours *without cost* if you can qualify for it. It is Raytheon's investment in *your* future. Call your Raytheon Tube Distributor today, and ask him if you can become a *Raytheon Bonded Electronic Technician*.



RIGHT...FOR SOUND AND SIGHT



RAYTHEON MANUFACTURING COMPANY

Receiving Tube Division
 Newton, Mass., Chicago, Ill., Atlanta, Ga., Los Angeles, Calif.

Excellence in Electronics

RAYTHEON MAKES ALL THESE:
 RECEIVING AND PICTURE TUBES • RELIABLE SUBMINIATURE AND MINIATURE TUBES • GERMANIUM DIODES AND TRANSISTORS • NUCLEONIC TUBES • MICROWAVE TUBES

A.R.R.L.'S 1953 NATIONAL CONVENTION will be held at the Shamrock Hotel, Houston, Texas, July 9, 10, 11, and 12. More than 2,500 licensed amateurs and representatives of the electronics industry are expected to attend. The Houston Amateur Radio Club, Inc., is sponsoring the 4-day meeting, which is the seventh national convention in the A.R.R.L.'s history.

"PAY-AS-YOU-SEE" TELEVISION

—at least on a nationwide basis—was viewed as a dead duck by Brig. Gen. David Sarnoff in an address at the convention of the NARTB in Los Angeles. Emphasizing that this was his personal opinion and not RCA policy, General Sarnoff cited the failure of "wired wireless" subscriber radio service in the early days of radio (1924-1925), and said that any attempt to transform our present TV system to a regulated public-utility type of service—except on a strictly local basis—would destroy our "freedom to look and freedom to listen," and would jeopardize "the preservation of our present competitive system of broadcasting."

AN ATOMIC DRY CELL with a gas electrolyte activated by nuclear radiation has been invented by Philip E. Ohmart, president and director of research of the Ohmart Corporation, Cincinnati, Ohio. The inventor found that a measurable unidirectional current flowed between two air-insulated electrodes of lead and gold when the air surrounding them was exposed to radiation from a microscopic quantity of radium. Reversing the connections reversed the direction of current flow, proving that ionization of the gas electrolyte by *beta* radiation was responsible for the current. As a double check, Mr. Ohmart built an airtight cell and connected it to a vacuum pump. As the air was exhausted the current dropped steadily, reached zero, and then *reversed itself* when the cell was almost completely evacuated.

Further research led to the adoption of colloidal graphite (*Aquadag*) instead of gold as the positive element. An experimental model develops enough power to run a tiny electric motor for demonstration purposes, but the principal uses for the Ohmart "atomic" battery at present are in radioactivity-detection instruments.

EYE FATIGUE AND HEADACHES

from watching radar screens in almost total darkness pose new problems for military medics. Their recommendations—as reported in the *U. S. Armed Forces Medical Journal*—are almost identical to those made for TV-viewing: Increase the ambient lighting; reduce uninterrupted watching time (in this case to shifts of one-half hour or less); and arrange more comfortable seating for radar operators. They also suggest operators put on dark-red goggles before leaving the radar room to lessen the discomfort of sudden exposure to bright sunlight and to speed accommodation to comparative darkness on return.

A 3-D TV DEMONSTRATION was presented recently by the American Broadcasting Company over KECA-TV in Hollywood. The test system uses a synchronized mirror rotating 30 times per second in front of the TV camera to produce two images with an apparent lateral displacement equivalent to the average pair of human eyes. These are reproduced on separate picture tubes at the receiver, and projected onto a special screen. Viewers must wear polarized glasses.

A little initial confusion was created by the fact that the pictures came in upside down and either the receivers or the viewers had to be turned bottom-up. An invited audience found the results strikingly effective.

CANADA'S TV POLICY will be to establish at least one TV station in each province before permitting additional stations in areas already served, according to a recent statement by National Revenue Minister J. J. McCann. When an adequate national TV system has been developed, private stations may be permitted in areas covered by government-owned CBC stations, and the CBC may establish stations in areas receiving service from private TV stations. Licenses granted for private stations in areas not covered by CBC will contain a provision permitting the government-controlled network to take over if the area cannot support more than one TV outlet.

Meanwhile applications have been filed for private TV stations in Calgary (channel 2); Edmonton (3); Kitchener (6); Rimouski (3); Saskatoon (8); and Regina (2).

A TEST OF BINAURAL broadcasting on AM was made recently by Rensselaer Polytechnic Institute, Troy, N. Y., in co-operation with WGY, WTRY, WHAZ, WPTR, and WXXW. Two microphones spaced about 10 feet apart were linked by wire lines to separate transmitters. A third mike, midway between the first two, fed both lines simultaneously. Listeners were advised to use two receivers tuned to equal volume, with the same 10-foot spacing between them.

Most binaural broadcasting done in recent months has been by simultaneous transmission over AM and FM stations. The Rensselaer experiment is the first one reported in several years using AM transmission only.

Reports from the public agreed with a special panel of six experts that this form of binaural transmission was highly effective on small vocal groups and solo instruments but not so good for band music because of confusing reverberations.

AN ULTRAVIOLET PHOTOMETER for detecting extremely minute concentrations of dangerous gases in air has been developed by scientists of the Du Pont Company. The new instrument is 100 times as sensitive as the human eye, and can detect changes as small as 1 part in 10,000 in the light absorbed by gaseous mixtures. END

TUNG-SOL statistical quality control methods produce the industry's most reliable tubes for all uses.

Tung-Sol makes: All-Glass Sealed Beam Lamps, Miniature Lamps, Signal Flashers, Picture Tubes, Radio, TV and Special Purpose Electron Tubes.

TUNG-SOL ELECTRIC INC.
Newark 4, N. J.

Sales Offices: Atlanta, Chicago,
Culver City (Los Angeles),
Dallas, Denver, Detroit, Newark

TUNG-SOL
RADIO, TV TUBES, DIAL LAMPS

**big values
new releases**

in ALLIED'S latest Catalog & Supplement!

FREE: SEND FOR BOTH



KNIGHT PORTABLE RADIO KIT

Build this powerful 3-way superhet portable for AC, DC or battery operation. Tunes 535-1650 kc broadcast band; has built-in antenna, PM speaker, printed audio circuit, handsome carrying case. Easy to assemble from illustrated manual. High-quality kit includes all parts, tubes and case (less batteries). Shpg. wt., 6 lbs.
83-730. Only.....\$18.75
Battery Kit.....\$3.64

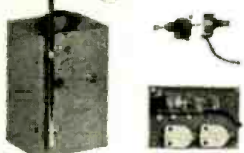

PHILMORE RADIO CONTROL KIT

Build your own remote-control transmitter and receiver. Operates model airplanes, boats, autos, etc. Crystal-controlled transmitter for 27.255 mc (requires easily obtained FCC operating permit). High-gain super-regenerative receiver. Easy to build. Complete with all parts, telescoping antenna, crystal and cabinet (less batteries). 4 1/2 lbs.
83-034. Only.....\$41.47
Complete Set of Batteries.....\$7.15



WELLER SOLDERING GUNS

Squeeze the trigger—you're ready to solder in 5 seconds. Latest heavy-duty, instant-heat gun; with 2 spotlights that light up working area. Air-cooled transformer. 3 lbs.
46-642. Single-heat, only...\$9.75
46-641. Dual-heat, only...\$11.71



PET 1/4" DRILL VALUE

Precision gear-type chuck drill with pistol grip. Instant-release lock-type trigger switch built into grip. Forced ventilation; runs cool. Speed: no-load, 1600 rpm; full-load, 900 rpm. Capacity: 1/4" in steel, 1/2" in hardwood. 6-ft. cord. For 110-120 v. AC or DC. 4 lbs.
46-280. Only.....\$17.21



TV BOOSTER BARGAIN

Famous Standard Coil printed circuit TV booster at less than half original price. Provides uniform gain on all 12 VHF channels. Easy to tune; use with indoor antenna in primary areas, with outdoor antenna in near-fringe areas. Improves reception markedly. For 110-120 v., 60 cy. AC. Shpg. wt., 4 lbs.
97-233. While they last, Only.....\$9.95



ELECTRO-VOICE UHF CONVERTER

New! Micrometer tuning for smooth, continuous reception of all UHF channels. Just connect to antenna input of any VHF TV set and plug in. Operates with all-channel antenna or separate VHF and UHF types. Single-knob, easy control. Uses VHF channels 5 or 6 as IF. 300 ohms input and output imp. Complete with tubes. For 110-120 v., 60 cy. AC. 5 lbs.
98-097. Only.....\$33.96



JFD UHF-VHF ANTENNA

Wonderfully efficient; uses conical element and reflector for VHF and "bow-tie" for UHF. Equipped with printed circuit antenna coupler for excellent signal transfer into single transmission line. Easy to install. (Less mast and 300-ohm twin line.) Shpg. wt., 6 lbs.
98-368. Only.....\$11.20



EQUIPTO "LITTLE GEM" CABINET

New! Drawer cabinet for small parts. Contains 4 drawers, with dividers for 48 compartments (dividers adjustable on 1 1/2" centers). Each drawer 1 1/2" h, 11" w, 11" d. Cabinet overall, 3 1/2 x 11 x 11". Olive green baked enamel finish. Shpg. wt., 20 lbs.
86-066. Only.....\$17.80



TRAV-ELECTRIC SENIOR CONVERTER

Ultra-compact 60 cycle converter for changing 6 volts DC to 110 volts AC. Capacity: 30 watts continuous, 40-45 watts intermittent. Simply plugs into auto cigarette lighter. Permits mobile use of broadcast and SW radios, recorders, dictating machines, fluorescent lamps, etc. Fully filtered. Only 2 1/2 x 2 1/2 x 3 1/2". 3 1/2 lbs.
80-272. Only.....\$10.63



TV CASTER BASE

Easy to install under any TV console—permits quick and easy rolling to any desired location. Rolls smoothly in any direction. Steel frame is adjustable to 30" wide, 27" deep to fit practically any console. No tools required for installation. Shpg. wt., 11 1/2 lbs.
98-989. Only.....\$5.95

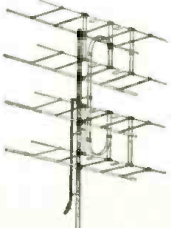

FINNEY 400A UHF-VHF ANTENNA

New! Double lateral UHF-VHF antenna featuring 32 driven elements for high gain and directivity, with superior signal-to-noise ratio. Superb for fringe-area reception—good for VHF up to 150 miles or more. Rugged; corrosion-proof; pre-assembled, lightweight. Requires 10-ft. mast and 300-ohm twinline. 14 lbs.
97-104. Only.....\$32.34



TAP-A-LINE

New type electrical line outlet, powering as many as 3 separate appliances from any wall outlet. Plastic cased; 12" long, 1" square. With 6-ft. cord and plug. Rated 1000 watts. 1 1/2 lbs.
52-636. Only.....\$1.47



KNIGHT VT VOLT-OHM-MILLIAMMETER KIT

Terrific Value! Response to 2.5 mc. Bridge-type circuit; 1% resistors. Input res.: DC, 20 megs; AC, 1.5 megs. 4 1/2" meter. Ranges: AC p-to-p volts, 0-8-28-84-280-840-2800; AC rms & DC volts, 0-3-10-30-100-300-1000; DC ma. 0-3-10-30-100-300-1000; res. 0-1000-10K-100K ohms & 0-1-10-1000 megs; cap., .005-.5, .05-5, 5-50, 5-500, 50-5000 mfd. With tubes, leads, case, instructions. For 110-120 v. DC or 60 cy. AC.
83-120. Only.....\$24.95
83-121. Hi-V Probe; extends DC range to 30 KV \$6.95
83-122. Hi-Frequency Probe for AC range to 200mc \$5.95

**FREE
Catalog and
Supplement**

ALLIED RADIO CORP., Dept. 2-G-3
833 W. Jackson Blvd., Chicago 7, Ill.

- Send FREE ALLIED Catalog and Supplement
- Enter order for _____

_____ \$ _____ enclosed.

Name _____
Address _____
City _____ Zone _____ State _____

ALLIED RADIO

**ELIMINATE
CORROSION OF
ANTENNAS**

**HELP PREVENT
CORONA WITH**

KRYLON®

100% ACRYLIC



**JUST PRESS
THE
BUTTON**

Krylon is a tough, quick-drying Acrylic coating that has become a "must" in TV service. Because of its high dielectric strength it helps prevent corona. Spray it on high voltage coil and insulation, the socket of the high voltage rectifier and component parts of the rectifier circuit.

Krylon is nationally advertised.

USE THE KRYLON FAMILY



CLEAR rustproofs, waterproofs, insulates. Goes on clear and stays clear.



ALUMINUM is non-conductive. Protects and insulates.



WHITE is popular for touching up chipped white goods. Will not discolor.



BLACK is newest Krylon product. Use for touch-up, stenciling and marking.

TECHNICAL CHARACTERISTICS

Dielectric constant—2.8 to 3.4 (1,000 cycles)
Dielectric strength—400 to 800 (number of volts necessary to cause electric arc through Krylon coat one mil thick)
Electrical resistance—10¹⁰ ohms/cm²

In U.S.A. and CANADA
SEE YOUR JOBBER
Or Write Direct
Department 3107



KRYLON, Inc.

2038 Washington Ave., Phila. 46, Pa.



BAROMETER of the PARTS INDUSTRY

During May, 70 of the leading 400 manufacturers of Radio-Television-Electronic parts and equipment made changes in their lines. There was an increase in "change activity" as compared to April.

In price revisions by the number of manufacturers and products affected, the following summary illustrates the comparative trend for the months of April and May.

	No. of Manufacturers	
	April	May
Increased prices	22	24
Decreased prices	8	16

	No. of Products	
	April	May
Increased prices	967	368
Decreased prices	466	125

For a summary of the most active product categories, see the following tables:

Product Group	Increased Prices		Decreased Prices		New Products		Discontinued Products	
	No. of Mfrs.	No. of Products	No. of Mfrs.	No. of Products	No. of Mfrs.	No. of Products	No. of Mfrs.	No. of Products
Antennas & Access.	5	14**	6	83*	15	461*	9	107**
Capacitors	1	9**	0	0**	3	28**	1	127*
Controls & Resistors	0	0	0	0	0	0**	1	93*
Sound & Audio Prod.	8	119*	2	4*	16	150*	12	92*
Test Equipment	3	13**	0	0	2	26*	2	2**
Transformers	2	54*	0	0	3	53*	3	27*
Tubes	4	156*	7	37*	7	27**	4	17**
Wire & Cable	1	3**	1	1**	2	28*	2	7

* Increase over April
** Decrease from April

Comment: The product picture has been altered slightly since the last reported period with more manufacturers reporting changes in their line. The sudden activity among wire and capacitor manufacturers has decreased considerably, while sound and antenna manufacturers again dominate this "change activity" scene.

This data is prepared by the staff of United Catalog Publishers, Inc., 110 Lafayette Street, New York, publishers of Radio's Master, the Official Buying Guide of the Parts Industry.

Merchandising and Promotion

Ward Products Corp., division of The Gabriel Co., Cleveland, launched a new promotion aimed at building auto antenna sales. The program, "How You Can Sell More Auto Antennas," is de-



scribed in an 8-page booklet which points out new sales prospects and describes the completely prepared promotional material, including mats, radio announcements, post cards, point-of-purchase displays, etc.

Raytheon Manufacturing Co., Waltham, Mass., presented the latest in its lectures on "How to Interpret What You See in UHF," in Los Angeles recently. William Ashby of Raytheon gave the main speech, which was illustrated with slides. Over 1,750 TV service technicians from Southern California attended the lecture which was co-sponsored by local Raytheon distributors.

The General Electric Tube Department, Schenectady, N. Y., is sponsoring

a contest for service technicians in which \$7,125 will be distributed to the 140 contestants who best explain in 50 words or less how they would use \$2,500 to better their businesses. The "Write Your Own Ticket" contest runs from June 15 to August 31.

Jensen Industries, Chicago, introduced a new phonograph needle display and storage case which serves as a com-



bination sales and inventory unit. It is available to dealers with the purchase of a special "turnover balanced" assortment of 27 conventional Jensen needles.

Minnesota Mining & Manufacturing Co., St. Paul, has compiled a kit of national consumer magazine articles on tape recording in business, the church, and the home. It is being offered in limited quantities to tape distributors.

Technical Appliance Corp., Sherburne, N. Y., is offering a new package dispenser for the Taco Selectronic antenna selecting switch. The dispenser holds 10 individually boxed units.

This name
 spells Quality
 and Profits



UNBEATABLE quality is built into every Sylvania product. Even beyond that, Sylvania quality goes back to its essential metals, chemicals, and materials.

Sylvania quality is fundamental

Sylvania grinds and formulates its own phosphors, and applies them by improved methods which assure maximum uniformity and fine picture-tube performance. Sylvania draws its own high-quality tungsten filaments and winds and tests its own coils.

Naturally, this far-reaching quality control results in an enviable nation-wide reputation. Today 7 of the top 10 television set makers use Sylvania Picture Tubes and Receiving Tubes. Naturally, too, Sylvania quality pays off in fewer call-backs, more satisfied customers . . . and *more profits for you.*

You'll find your friendly Sylvania Distributor a mighty high quality man to do business with, too. Call him today!



Be sure to install Sylvania Picture Tubes and Receiving Tubes in all the sets you service. Your customers know about Sylvania's fine quality and they'll appreciate your selection of Sylvania products for their sets.

SYLVANIA

Sylvania Electric Products Inc., 1740 Broadway, New York 19, N. Y.



**LIGHTING • RADIO
 ELECTRONICS • TELEVISION**

In Canada, Sylvania Electric (Canada) Ltd., University Tower Bldg.
 St. Catherine St., Montreal, P. Q.

TURNER'S NEW UHF CONVERTER

Gives clearer sharper TV pictures

Easy-to-read illuminated slide rule dial

Attractive Mahogany plastic cabinet

Smooth, single knob continuous tuning

Use with UHF or VHF-UHF combination antenna

It's smaller! 8 by 6 by 6

Get the best UHF-TV reception . . . get the UHF Converter shown to give sharper, clearer pictures than other leading converters in actual comparison tests . . . get the new Turner UHF Converter.

Turner's Converter is smaller than most . . . takes less room on the receiver. Its handsome mahogany plastic cabinet is an attractive addition to any room. The unit is self powered and complete with all tubes and instructions. Silver-plated coaxial tuning elements for longer wear. Lowest noise figure possible. The finest Converter you can buy for the sharpest, clearest UHF-TV reception.

TURNER UHF CONVERTER, List price-----\$57.50



THE TURNER COMPANY

933 17th Street N.E., Cedar Rapids, Iowa

EXPORT: Ad. Auriema, Inc.
89 Broad St., New York 4, N. Y.

IN CANADA: Canadian Marconi Co.
Toronto, Ont., and Branches.

**OVER 50,000
TECHNICIANS
HAVE LEARNED**

**HOW TO GET
THE MOST OUT
OF BASIC TEST
EQUIPMENT**

for A.M. - F.M. - TV



ONLY 40¢
103 pages. Invaluable information that will help you *re-double* the value of your basic test equipment.

**'SERVICING BY
SIGNAL SUBSTITUTION'**
A BEST SELLER FOR OVER 12 YEARS!
(NEW, UP-TO-DATE, 12th EDITION)

The Modern, Simplified, Dynamic Approach to Receiver Adjustment & Alignment Problems.

- ★ Nothing complicated to learn
- ★ No extra equipment to purchase
- ★ Universal... non-obsolete
- ★ Employs only Basic Test Instruments

Ask for "S.S.S." at your local Radio Parts Jobber or remit 40¢ in small stamps or coin directly to factory.

PRECISION APPARATUS COMPANY, INC.
92-27 HORACE HARDING BLVD., ELMHURST 4, N. Y.

Ram Electronics Sales Corp., Irvington-on-Hudson, N. Y., conducted a technical review and discussion for the Television Technicians Association of Perth Amboy, N. J., sponsored by Monmouth Radio Supply Co., local distributor. Al Friedman and Victor Markosian, Ram's national field sales engineer and chief engineer, respectively, presided. Ram will conduct similar forums in other localities at a later date.

McIntosh Laboratory, Binghamton, N. Y., and Weathers Industries, Barrington, N. J., recently conducted an audio demonstration in Chicago. The demonstration was unique in that it featured the kind of good music that most likely would be played in the home, rather than "show" pieces. The program was presented in a living-room setting.

Burgess Battery Co., Freeport, Ill., is distributing two point-of-purchase sales aids—a counter card showing the



latest makes and models of portable radios and the Burgess batteries they use, and a three-dimensional, electric flasher sign for window or counter.

Lloyd Austin, assistant chief engineer of Simpson Electric Co., Chicago, addressed a special clinic for radio service technicians now handling TV, sponsored by the Engineering Department of the University of Missouri. He also spoke on u.h.f. test equipment at the Annual Spring Convention of NATESA in Kansas City, Mo.

Production and Sales

RTMA reported the production of 2,259,943 TV receivers during the first quarter of 1953. This is an annual rate in excess of 9,000,000—almost double the 1,300,000 sets produced in the 1952 period. During the same period, 3,834,784 radios were produced.

RTMA reported that a total of 122,058,756 receiving tubes valued at \$82,955,367 were produced during the first three months of 1953. During the same period, 2,798,921 TV picture tubes valued at \$67,696,464 were manufactured. Of this total, more than 65% were in the 19- to 21-inch category.

Show Notes

The Fourth Annual Convention-Conference of NEDA, to be held in St. Louis, September 14 to 16, promises to be a sellout, judging by the present rate of applications for booths, according to L. B. Calamaras, executive vice-president of NEDA.

The Western Electronic Show and



Leonard C. Lane,
B.S., M.A.
President of Radio-Television
Training Association,
Exec. Dir. of Pierce School
of Radio and Television

AMAZING NEW TRAINING PLAN

NOW . . . YOU CAN BECOME A

LICENSED* TV TECHNICIAN

LICENSED TV MEN MAKE MORE MONEY

**AT NO EXTRA COST!
YOU GET A ROUND TRIP TO
NEW YORK CITY**

FROM ANYWHERE IN THE U.S. OR CANADA—I pay your way to New York and return, PLUS 2 FREE weeks, 50 hours of advanced instruction and shop training at the PIERCE SCHOOL OF RADIO & TELEVISION. You use modern electronics equipment, including student-operated TV and Radio stations. You go behind the scenes of New York's big Radio-TV centers, to study first hand. And I give you all this AT NO EXTRA COST! (Applies to complete Radio-TV course only.)

Only RTTA makes this amazing offer.

EXTRA FEATURES THAT MEAN MORE MONEY FOR YOU!

Thousands of new job opportunities will be available for you right in your own state, now that the government has lifted restrictions on new TV stations. My simple, successful methods can PREPARE YOU NOW to take your place in America's booming TELEVISION and Electronics industries . . . help you get the success and happiness that you always wanted out of life. You learn the practical, easy way by using actual parts and equipment in the 15 big Radio-TV kits I send you, including a COMPLETE TV RECEIVER yours to build and keep.

My Advanced Training Prepares You For Better Jobs Then, after you finish your training for a position as a full-fledged TV Technician—where you can write your own ticket and choose from dozens of fascinating careers—I don't stop there! I continue to train you—AT NO EXTRA COST—to qualify for even better pay in the BETTER JOBS that demand FCC licenses, with my . . .

FREE FCC COACHING COURSE
PREPARES YOU AT HOME FOR YOUR
FCC LICENSE
THE BEST JOBS IN TV AND RADIO
REQUIRE AN FCC LICENSE
Given to every student at NO EXTRA COST after
TV Theory and Practice is completed.

**SET-UP YOUR OWN HOME LABORATORY
WITH THE 15 BIG TELEVISION-RADIO
KITS WE SEND YOU (At No Extra Cost)**

**YOU BUILD
AND KEEP
ALL THESE
UNITS**

—INCLUDING BIG SCREEN TV RECEIVER,

- plus Super-Hot Radio Receiver,
- R.F., Signal Generator,
- Combination Voltmeter-Ammeter
- Ohmmeter,
- C-W Telephone Receiver, AC-DC Power Supply.
- Everything Furnished Including All Tubes, and Big TV Tube



TAKES UP TO
21 in.
PICTURE TUBE

**NOW! Advanced FM-TV Training
For Men Who Know Radio**
Prepares You For Higher Pay Jobs
In A Few Months
COMPLETE theory and practical training course . . . complete with kits including large screen TV receiver.
FCC License Coaching Course Included FREE.

ATTENTION! VETERANS!

MY SCHOOLS FULLY APPROVED TO TRAIN VETERANS UNDER NEW G. I. BILL!
If discharged after June 27, 1950—CHECK COUPON BELOW! Also approved for RESIDENT TRAINING in New York City . . . qualifies you for full subsistence allowance up to \$160 per month.



I GET MY GRADUATES GOOD PAYING JOBS

"As Merchant Ship Radio Officer, I receive \$867 for 40-day trip. Your training helped me get this fine position."
—Stanley Nawrocki

I now hold a fine airlines position at La Guardia Field, New York City, thanks to your excellent training."
—Joseph Rosenberg

"Your excellent instruction helped me get my present job as an airport radio mechanic for American Airlines."
—Eugene E. Basko

"Thanks to your training, I qualified for a good job as a Receiver Tester at Federal Television and Radio."
—Paul Frank Seler

Many others working at NBC, RCA, CBS, Dumont, Philco, Emerson, Admiral and other leading firms.



**BOTH
FREE**
New Illustrated Book plus Sample Lesson

NO SALESMAN WILL CALL!

Mr. Leonard C. Lane, President
RADIO-TELEVISION TRAINING ASSN.
1629 Broadway, Radio City Station
New York 19, N. Y.

Dept. R-7

Dear Mr. Lane:
Mail me your NEW FREE BOOK and SAMPLE LESSON that will show me how I can make BIG MONEY in TELEVISION. I understand I am under no obligation and no salesman will call.

Name _____ Age _____
Address _____
City _____ Zone _____ State _____

I am interested in: Radio-TV Advanced FM-TV
VETERANS: If qualified under new G.I. Bill, check here

RADIO-TELEVISION TRAINING ASSOCIATION

1629 Broadway, Radio City Station, New York City 19, N. Y.

Approved as a Correspondence School under the laws of the State of New York

NEWEST FASTEST SELLER in the field!



CDP
COMPOUND DIFFRACTION PROJECTOR

Public Address Loudspeaker System
setting new standards for VOICE PENETRATION AND MUSICASTING

- Greatly outperforms comparably sized reentrant horns
- Tremendous penetrating power and coverage at very low unit energy cost
- Exclusive E-V coaxial design and diffraction principle
- Peak-free response ± 5 db to 10,000 cps
- Delivers 2½ octaves more musical range
- Weather-proof, blast-proof, splash-proof Virtually indestructible

Model 848 CDP. 25 watts. 16 ohms.
List Price, \$59.00 Net, \$35.40

COMPARE POLAR PATTERN
Sound distribution of CDP exceeds 120° at all frequencies up to 10,000 cps.

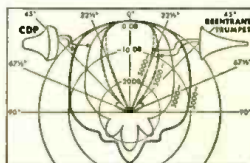

COMPARE RESPONSE AND EFFICIENCY
Note extended high frequency range of CDP. Response is smooth, peak-free ± 5 db to 10,000 cps.

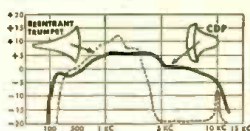

Write for Free Bulletin No. 197

*Pat. Pend.

Electro-Voice

421 CARROL ST. • BUCHANAN, MICHIGAN
Export: 13 E. 40th St., New York 16, U. S. A. Cables: Arlob

Convention will open with a record 316 booths, according to Heckert Parker, business manager of the show. Last year's booth total was 224. The 1953 show will be held in the San Francisco Civic Auditorium, August 19 to 21.

New Plants and Expansions

Raytheon Manufacturing Co., Waltham, Mass., is constructing a new TV picture tube plant in Quincy, Mass. Governor Christian A. Herter of Massachusetts spoke at the cornerstone-laying ceremonies.

Erie Resistor Corp., Erie, Pa., manufacturer of electronic components, will build a new plant in Holly Springs, Miss.

Oxford Electric Co., Chicago speaker manufacturer, acquired Radionic Controls, Inc., and the Wilder Manufacturing Co., both near Carbondale, Ill. Hugo Sundberg, vice-president of Oxford was elected executive vice-president of the two new subsidiaries. All products will be manufactured under the supervision of Oxford personnel and sold under the Oxford name.

Rohn Manufacturing Co., Peoria, Ill., manufacturer of towers and accessories, has located its executive offices next to its factory in enlarged and renovated quarters. The new mailing address is 116 Limestone, Bellevue, Peoria, Ill.

National Electric Products Corp., Pittsburgh, wire and antenna manufacturer, moved its executive offices to new and larger quarters at 140 Stanwix Street.

Davis Electronics, TV antenna manufacturer, moved its offices and assembly manufacturing to its new plant in Burbank, Calif. The new quarters provide approximately five times as much floor space as the company had at its previous location.

Electric Regulator Corp., manufacturer of Regohm voltage regulators for the electrical and electronics industries, is building a new 2,100-square-foot addition to its plant in Norwalk, Conn.

Hepner Manufacturing Co., Round Lake, Ill., opened a second plant in Mendota, Ill., for the exclusive manufacture of ferrite rod antennas and fly-back transformers.

Continental Electronics Corp., Philadelphia, is expanding its present factory facilities in order to double its output of Piktron, an exchange line of television picture tubes.

Allen B. Du Mont Laboratories officially opened its new Instrument Division plant in Clifton, N. J.

Aerovox Corp., New Bedford, Mass., acquired Cinema Engineering Company, Burbank, Calif., designer and manufacturer of electronic components and equipment. A. C. Davis, who founded the company in 1936, will remain as its director, and James Fouch will be retained as general manager. Cinema is currently building an additional new plant in Burbank. Cinema will become an Aerovox division. The acquisition of Cinema is the second addition to Aerovox's West Coast facilities. The company is constructing a new plant in Monrovia, Calif.



OWN THIS GREAT LIBRARY for complete authoritative analyses of all important AUDIO AMPLIFIERS

Only data of its kind available on hundreds of important audio amplifiers. Complete, uniform, detailed analysis of each unit, based on actual laboratory study of the equipment. Includes circuit diagrams, chassis photo views, parts data, full technical coverage. Available in four profusely illustrated volumes—absolutely indispensable to audiophiles, engineers and students.

- VOL. 4. Covers 75 audio amplifiers and important tuners produced during 1951 and 1952. Never before available in a single compilation. 352 pages, 8½ x 11".
ORDER AA-4. Only \$3.95
- VOL. 3. Covers 50 audio amplifiers and 22 FM and AM tuners made during 1950. Detailed data on design and servicing. 352 pages, 8½ x 11".
ORDER AA-3. Only \$3.95
- VOL. 2. Covers 104 amplifiers and 12 tuners produced in 1949. 368 pages, 8½ x 11".
ORDER AA-2. Only \$3.95
- VOL. 1. Covers 102 post-war amplifiers and tuners produced through 1948. 352p, 8½ x 11".
ORDER AA-1. Only \$3.95

BEST-SELLER ON AUDIO!



"The Recording and Reproduction of Sound"
Only complete reference on AUDIO! New second edition—over 800 pages. Chapters on sound wave behavior; recording methods; the decibel; phono reproducers; cutting styli; microphones; loudspeakers; dividing networks; attenuators; mixers; amplifiers; tuners; home music systems—hundreds of other subjects. The great Audio book by Oliver Read—largest-selling in its field.
ORDER RR-2. Only \$7.95

HOWARD W. SAMS & CO., INC.

Order from your Parts Jobber today, or write direct to Howard W. Sams & Co., Inc. 2205 East 46th St., Indianapolis 5, Ind.

\$..... enclosed. Send following books:
 AA-1 (\$3.95) AA-3 (\$3.95) RR-2 (\$7.95)
 AA-2 (\$3.95) AA-4 (\$3.95)

Name.....
Address.....
City.....Zone...State.....

START ON THE ROAD TO SUCCESS

Study the RCA TV Servicing Course in your spare time

ARE YOU SATISFIED with the position you now hold? Do you feel you're worth more money? Are you pleased with yourself, your work, your associates . . . and your future? What does the next year hold for you . . . and the year after that?

Are you content merely to plod along through the best years of your life . . . or do you want to get into more pleasant work . . . hold a well-paid job . . . perhaps establish your own business?

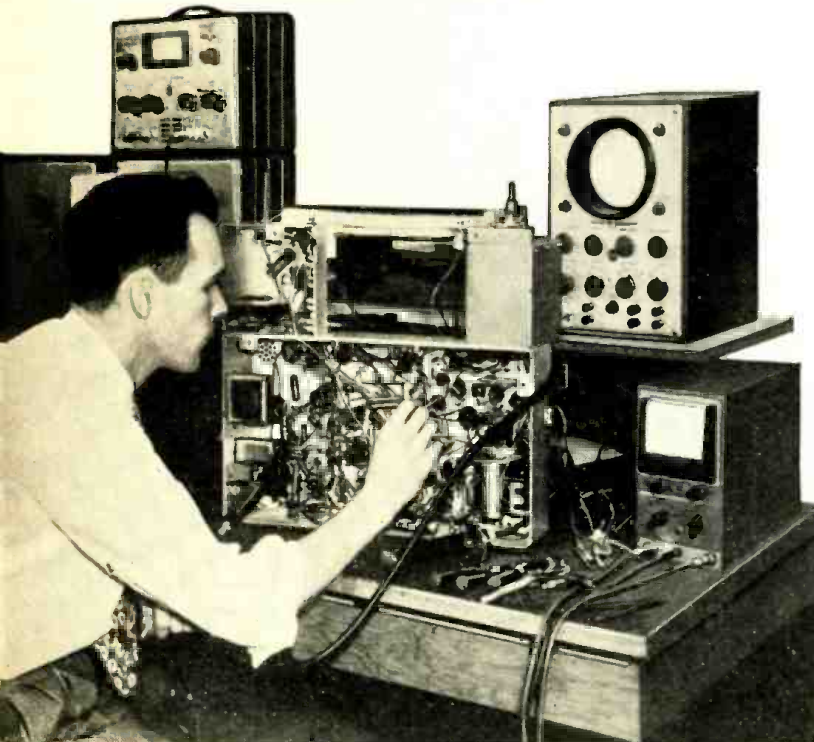

If you are looking for a REAL opportunity . . . If you want to GROW with a GROWING INDUSTRY . . . If you want to grasp the success that should be yours, *then we say to you, study TV Servicing.*

Everyone knows that Television is the fastest growing industry today. Opportunities are going begging for men who have the training and ability to grasp them. Now is the time to start on the road to success in TV Servicing.

Study at Home in your spare time

The RCA Institutes Home Study Course in TV Servicing is easy to learn. You progress rapidly, step by step, as you learn the procedure of servicing and trouble-shooting TV receivers and installing TV antennas. Hundreds of pictures and diagrams help you understand the how-it-works information and the how-to-do-it techniques.

A Service of Radio Corporation of America

The RCA Institutes TV Servicing course was written and planned by instructors with years of specialized experience in training men. You get up-to-the-minute information, too, because you study right at the source of the latest developments in Television. Your lessons are carefully examined and accurately graded by competent teachers who are interested in helping YOU to succeed.

RCA Institutes is licensed by the University of the State of New York . . . an affiliate member of the American Society for Engineering Education . . . approved by leading Radio-Television Service Organizations.

It costs so little to gain so much

RCA Institutes makes it easy for you to take advantage of the big opportunities in TV Servicing. The cost of the TV Servicing Home Study Course has been cut to a minimum. You pay for the course on a pay-as-you-learn unit lesson basis. *No other home study course in TV Servicing offers so much for so little cost to you.*

RCA Institutes conducts a resident school in New York City offering day and evening courses in Radio and TV Servicing, Radio Code and Radio Operating, Radio Broadcasting, Advanced Technology. Write for free catalog on resident courses.



RCA INSTITUTES, INC.
A SERVICE OF RADIO CORPORATION of AMERICA
350 WEST FOURTH STREET, NEW YORK 14, N. Y.

SEND FOR FREE BOOKLET—Mail the coupon—today. Get complete information on the RCA INSTITUTES Home Study Course in Television Servicing. Booklet gives you a general outline of the course by units. See how this practical home study course trains you quickly, easily. Mail coupon in envelope or paste on postal card.



MAIL COUPON NOW!

RCA INSTITUTES, INC., Home Study Dept. RE-753
350 West Fourth Street, New York 14, N. Y.

Without obligation on my part, please send me copy of booklet "RCA INSTITUTES Home Study Course in TELEVISION SERVICING." (No salesman will call.)

Name _____ (please print)

Address _____

City _____ Zone _____ State _____

R_x for UHF's fringe areas!

CHANNEL MASTER'S all-UHF TWIN CORNER REFLECTOR

the most sensitive fringe area antenna ever developed for UHF!

- Two dipoles—actually two antennas in one.
- Provides twice the gain of any standard-type UHF Corner Reflector.
- Instantly installed in just three steps.
- Furnishes far better picture quality — at far greater distances.
- Eliminates UHF's TWIN TERRORS. Features vibration-proof construction; and "free-space" terminals.



model no. 406

up to
16 DB gain!

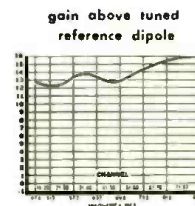

horizontal polar pattern (relative voltage)

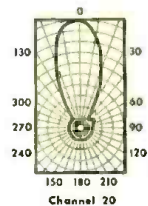

practically
no
assembly
necessary

CHANNEL MASTER'S 10-ELEMENT DELTA-WELD YAGI

custom-designed for your specific area!



model no. 408

gain above
reference dipole
16 DB
10 elements

**CHANNEL MASTER
engineering
pays off on UHF!**

- Elements permanently WELDED IN POSITION on crossarm.
- Custom construction — designed for almost any UHF area.
- Delta-matched dipole for excellent impedance match.
- Brilliant performance. Average gain: over 11 DB, single bay; over 14 DB, stacked. Even higher on some models.
- Eliminates UHF's TWIN TERRORS.



CHANNEL MASTER CORP.
BELLVILLE, O. S.

Write for complete technical literature.

At Last! a YAGI for the ENTIRE LOW BAND!

CHANNEL MASTER'S Newest futuramic

Completely covers every low band channel-2 through 6

Now the extraordinary high gain of a Yagi . . . the razor-sharp directivity of a Yagi . . . Not on just one channel — but clear across the entire Low Band!

Designed for service TODAY and TOMORROW in these 3 booming VHF markets:

Areas in which present VHF stations are changing channels (on the Low Band).

The Futuramic Yagi provides better reception than conventional Yagis on the present channels — and when the shift occurs this superior reception will continue on the new channel WITHOUT INTERRUPTION. And you can make your change-over installations NOW.

Areas in which a new VHF station is being added to the present one (on the Low Band).

The great number of single channel Yagis now in use will not bring in the new channel. If an additional Yagi is installed it will have to be tied into the present installation with separate leads and a switching system. However, one Futuramic will do the job of BOTH antennas — at lower cost — with better results on BOTH channels.

Areas served at present by two or more VHF stations on the Low Band.

You no longer have to compromise between conventional broad band antennas, and separate Yagis for each channel. The Futuramic gives you the full advantages of both. It combines highest gain and sharpest directivity with simple, economical installation.

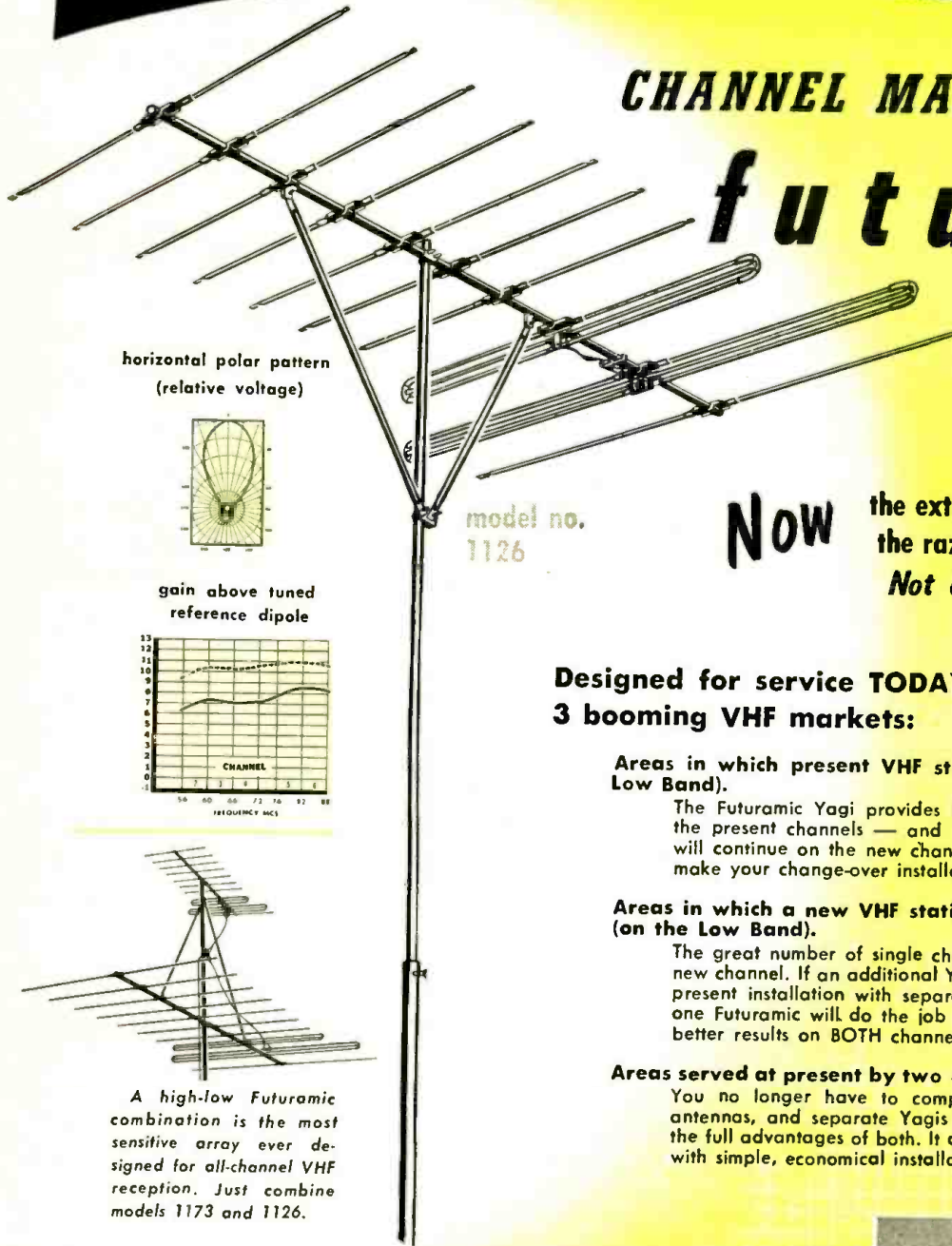

horizontal polar pattern (relative voltage)

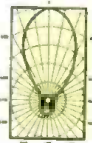

gain above tuned reference dipole

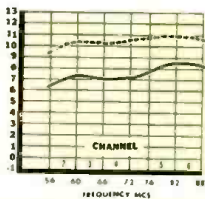

A high-low Futuramic combination is the most sensitive array ever designed for all-channel VHF reception. Just combine models 1173 and 1126.

Now — 6 great Futuramic models, designed for every reception area:

model no.	channels covered	list price
1173	7 — 13	\$20 ⁸³
1124	2, 3, and 4	\$40 ⁹⁷
1125	2, 3, 4, and 5	
1136	3, 4, 5, and 6	
1146	4, 5, and 6	
1126	2, 3, 4, 5, and 6	

CHANNEL MASTER
engineering
pays off on VHF!



CHANNEL MASTER CORP. GREENVILLE, N. C.





320K SIG. GEN.
KIT \$19.95 WIRED \$29.95



145K SIG. TRACER
KIT \$19.95 WIRED \$28.95



950K R-C BRIDGE &
R.C.L. COMP. KIT \$19.95
WIRED \$29.95



360K SWEEP GEN.
KIT \$34.95 WIRED \$49.95



New 214K VTVM KIT
\$34.95 WIRED \$54.95



New 377K SINE & SQUARE
WAVE AUDIO GEN. KIT \$31.95
WIRED \$49.95



1040K BATTERY ELIM.
KIT \$25.95 WIRED \$34.95



1171K RES. DECADE BOX
KIT \$19.95 WIRED \$24.95



625K TUBE TESTER
KIT \$34.95 WIRED \$49.95



CRA PIX TUBE ADAPTOR
for Tube Tester \$4.50



New 565K MULTIMETER
KIT \$24.95 WIRED \$29.95
20,000 Ω/v ; 31 ranges



315K DELUXE SIG. GEN.
KIT \$39.95 WIRED \$59.95



HIGH VOLTAGE
PROBE \$6.95



221K VTVM KIT \$25.95
WIRED \$49.95

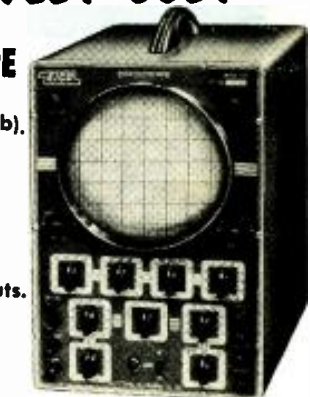

470K KIT \$79.95 WIRED \$129.50



425K 5" PUSH-PULL SCOPE
KIT \$44.95 WIRED \$79.95



NEW!

MODEL 495-K SCOPE VOLTAGE
CALIBRATOR
KIT \$12.95 WIRED \$17.95

OVER 1/4 MILLION

EICO INSTRUMENTS

in use the world over!



EICO new modern facilities for research, development and production—your greater assurance of . . .

LABORATORY PRECISION AT LOWEST COST

NEW 7" Push-Pull OSCILLOSCOPE

- Boosted vert. sensitivity: 10 mv rms/in.
- Extended flat freq. response: 10 cps—1 MC (± 2 db).
- 3-step freq.-compensated attenuator; cathode follower input.
- Internal voltage calibrator; dir.-cal. screen.
 - Extended sweep range: 15 cps—100 kc.
- Int. pos. or neg., ext. & line sync.
 - On front panel: sawtooth, 60 cps outputs; intensity mod. & ext. sync inputs.
 - Var. phasing of int. 60 cps sweep.
 - Direct connection to CRT plates.

You Build EICO Kits in One Evening, but . . . They last a Lifetime! and You SAVE OVER 50%

YOU be the judge. See the famous EICO line TODAY — in stock at your local jobber — and SAVE!

Write NOW for FREE newest Catalog 7-C.

America's greatest instrument values bear the name—



ELECTRONIC INSTRUMENT CO., Inc., 84 Withers Street, Brooklyn 11, N. Y.

GUIDED MISSILES

... Electronically-steered missiles are becoming more complex ...

By HUGO GERNSBACK

THE PROBLEM of electronically-guided missiles, which at one time seemed not too difficult to solve, is becoming extremely complex as time goes on. The Germans particularly were far ahead of anyone about ten years ago, and although the U. S. has spent over three billion dollars in eight years of research, we still have not advanced much beyond the Germans' accomplishments of a decade ago, according to those best informed on the subject.

One reason, possibly the main one, for our present lack of progress, is that as the art of guided missiles advances, more and more complications are encountered. When the Germans did most of their epoch-making research, which they immediately translated into actual weapons, the problems were far more simple. Airplanes at that time had not reached supersonic speeds, while today planes actually have flown over 1238 miles an hour. (The Federal Skyrocket.) These speeds are increasing continually and the time is not far off when weapons will fly at the rate of 10 miles a second, which is 36,000 miles per hour. It is one thing to build missiles of the V-1 and V-2 types, which move at rates of 600 and 3,000 miles per hour respectively, but quite another problem to shoot them down. While it is true that electronically-guided guns did shoot down a goodly percentage of V-1's over England during World War II, it is also true that far too many got through, destroying a vast portion of London.

A great deal of progress has been made in the meanwhile. Our modern radar interceptor guns will bring down a fair percentage of enemy long-distance bombing planes. Still no one in authority will admit that the problem is anywhere near being solved, because even huge slow-moving bombing planes, if launched in sufficient quantity by an enemy, cannot all be shot down. Many will get through even today.

This situation will become worse if instead of piston propelled bombers an enemy used rocket planes. A much larger percentage of such faster flying planes will get through any modern radar gun barrage. It is probably fair to say that the problem of ground-to-air defense cannot be solved completely, that is, no radar-electronically-operated and guided gun can ever bring down all the attacking planes or missiles over a given point.

The chief reason for this is the very complexity of the problem. We shall give here only a few of the reasons. All of the following interfere with surface-to-air missiles—even if the missile is one that seeks its target electronically or otherwise:

Changing air currents, humidity, clouds, barometric pressures, whether the missile approaches the target from the North or East (the rotation of the Earth must be taken into consideration!), heat, cold—all of these have their effect on the accuracy of the missile.

When missiles begin moving between 5 and 10 miles a second, in the not too distant future, the probability of hits by guided missiles becomes far more difficult. Even the matter of detonating the missile becomes a problem of some magnitude. If the contact is made a tenth of a second too fast or too slow, the missile will not reach its target. As the present speed of planes and rockets increases, this condition steadily worsens, as a little reflection will make clear.

For these reasons, military scientists and electronic researchers and physicists in general are mostly agreed today that surface-to-air guided missiles are inefficient now, and perhaps will be used only for specific purposes, i.e., to guard vital installations, warships, flat-tops, etc., to shoot down the *occasional* missile that gets through in spite of all other defenses.

The best defense would seem to be not surface-to-air means, but air-to-air defense. One of the great difficulties with a surface or ground-to-air defense is that the target is usually sighted too late. There simply isn't time enough for preparation, even if there is no gun crew and the shooting is all controlled electronically. On the other hand, when we have a *mobile* air defense which by radar and other means is constantly on the lookout for enemy missiles while they still are far distant from our vital centers, then there is a much better chance to cope with the problem. Hundreds of miles away from our shores or borders, the defending, highly mobile force will be in a much better position to cope with enemy missiles, whether they are bombing planes, rockets, or other fast flying weapons.

The time element here is much more advantageous for the defender, even if the oncoming missiles should move at 10 miles a second. Here we can have a mobile aerial defense *in depth*, meaning that there can be successive lines of aerial defenses which are able to deal much more effectively with the enemy. The outermost "front" line will probably be guided television-controlled flying weapons which are now a reality.* A line of unmanned observation planes will follow the television-radar planes, while behind these will be another force of special electronically-equipped fighter planes. While the latter are manned, the men are really only "battle-technicians" because in the future no man will be able to shoot down a fast-flying missile. All the shooting will be done by radar and electronic means. The crews will only steer their planes in the general direction of the enemy; the planes do the rest.

Now comes the most complex part of the entire problem: that is, *the enemy also has the same radar-electronic means that we have*. His attacking flotilla will have electronic gear by which he will try, by counter measures, to upset and jam the defender's radio waves so that the latter's attacking missiles will malfunction and become harmless.

To be sure, the defender has the same means. Specially-built and engineered guided missiles which must be jam-proof, have even now been evolved.

As anyone familiar with warfare knows, there has never been invented a weapon to which a counter was not found. This law remains as true today as it was in the day of the bow and arrow. War simply has become more complex. Thus the battles of the future will be fought not so much by human brains, which are now far too slow, but by electronic brains—electronic super-computers and similar means.

In the end, the side with the best electronic gear and the fastest electronic computers will probably win the future aerial battles.

END

*The writer was the first to technically describe the manless "Radio-Controlled Television Plane." See November 1924 issue of THE EXPERIMENTER.

Audio Reactance Charts

*Simplified nomograms
for quick solutions
to some very common
audio design problems*

By HECTOR E. FRENCH

ALMOST every radio amateur or audio enthusiast tries at one time or another to calculate the frequency response of an audio amplifier while the design is still on paper. Or, even worse, he tries to design a particular frequency-response characteristic into an amplifier. But the harder he tries, the more mixed up he is apt to become when he tries to use the ordinary garden-variety reactance chart.

What's the reason for all this? Aren't reactance charts supposed to simplify these problems?

Well, they are supposed to, but for any one of a number of reasons they don't always work out. To begin with, the usual reactance chart gives too much information for too many values of too many variables over too wide a frequency range. And to add a finishing blow, it does not always give the decimal point, which means that the point usually lands in the wrong spot and spoils the whole calculation.

In an attempt to make reactance charts easier to use in audio circuit design, I studied all the reactance charts I could find, and then developed the two charts shown here specifically for audio applications.

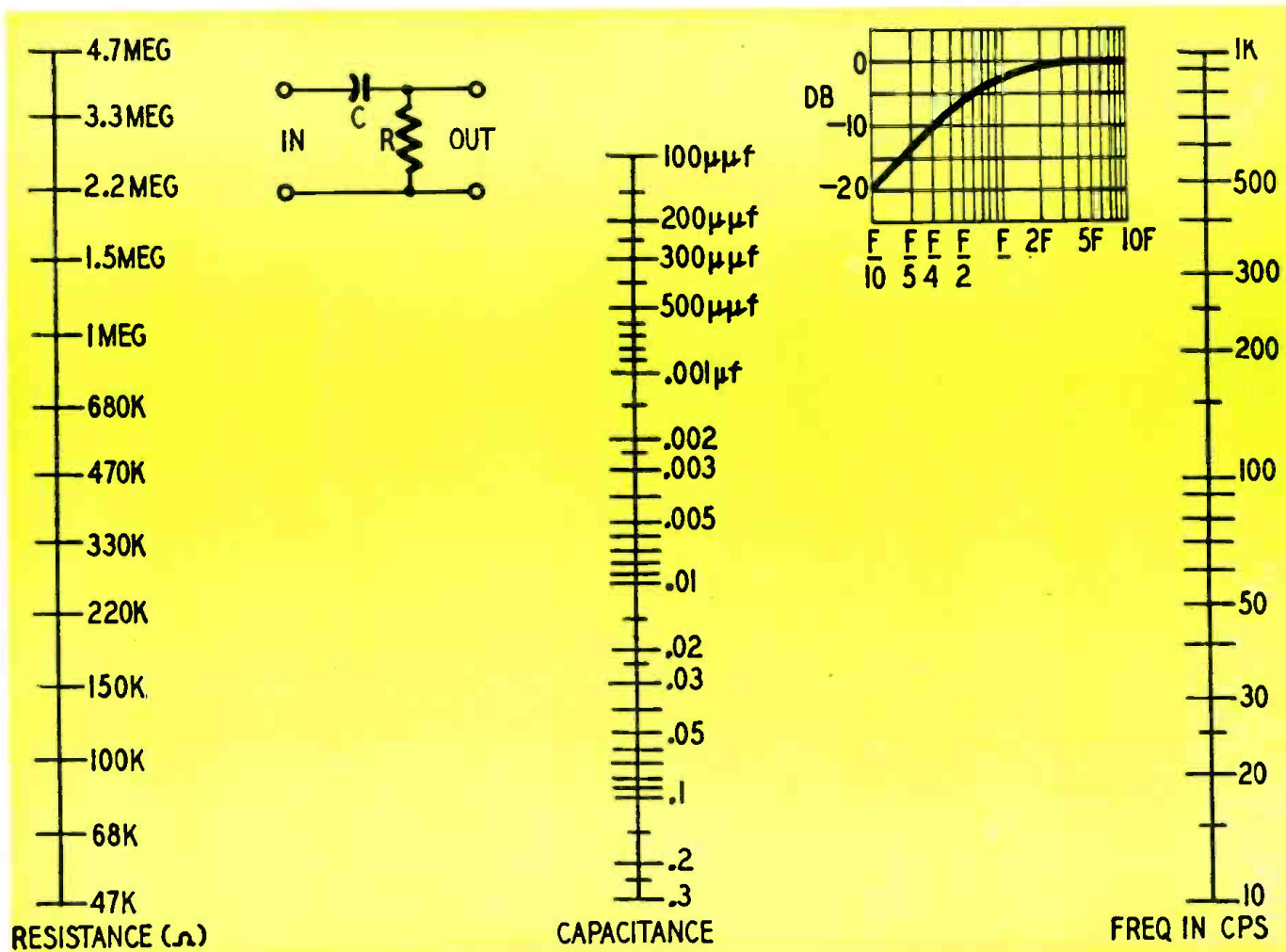

Simplified reactance nomogram for solving low-frequency-cutoff problems in audio design work. Note that the resistance scale shows only standard 20%-tolerance values, and that the response is down 3 db at the cutoff frequency F.

The first feature of these charts is that they separate the audio spectrum into two parts. The low-frequency chart, covering 10 cycles to 1 kc, is intended for design problems where the frequency response must drop off *below* a certain frequency. And the high-frequency chart, which covers 1 kc to 100 kc, is intended for design problems where the frequency response drops off *above* a certain frequency. With two charts there is no unnecessary information to confuse things and in addition, the frequency scale is stretched out for easier reading.

To make these charts even simpler to use, the only reactance considered is *capacitive* reactance, since the usual audio circuit contains so many more capacitors than inductors. The output transformer is generally the only inductance which carries audio frequencies, and there is very little to be lost and much to be gained in simplicity of operation by omitting inductive reactance entirely.

Probably the most novel feature is the use of commercial resistor values instead of the customary logarithmic scales of ten. Each value of resistance is given in one of the standard $\pm 20\%$ RTMA values, which works out much

better than the usual chart, where the user has to fit the commercial resistor values into the decimal type of division. Also note that each scale is identified specifically as ohms, microfarads, or cycles per second. This eliminates all possibility of error in selecting a position for the decimal point.

As a final aid to easier operation, each chart includes a basic circuit diagram and a frequency-response curve for a specific single-section resistance-capacitance filter. For example, the low-frequency chart shows a series capacitor and a shunt resistance (the same as the coupling circuit between a plate and the following grid in a resistance-coupled amplifier). The frequency-response curve on this reactance chart makes it possible to draw the response curve for any combination of resistance and capacitance given on the chart. A similar basic circuit and response curve are given on the high-frequency chart.

Applications

In using these charts to design an amplifier, sound system, or modulator, the first question to be settled is usually something like this: "What frequencies do we want to pass, and what

frequencies do we want to discard?"

Take a low-frequency problem as an illustration. In amateur phone transmission, some operators like to cut their speech response below 300 cycles to improve their intelligibility and help punch through QRM. Voice frequencies below 300 cycles require considerable power to transmit, but actually contribute very little to maintaining communication under difficulties. Therefore these frequencies can be discarded in order to use the remaining speech frequencies more effectively.

The first thing to do, then, in this sample use of the low-frequency reactance chart, is to decide that the frequencies below 300 cycles are to be reduced, and the next thing is to refer to the chart itself. The basic circuit diagram in the upper left corner of the chart is identical to the coupling circuit between the plate of one stage and the grid of the next, so it will be necessary only to pick the correct values for a coupling capacitor and grid resistor in the modulator to get the desired response in this part of the circuit.

To find these values, just lay a straightedge across the low-frequency reactance chart, with one end of the

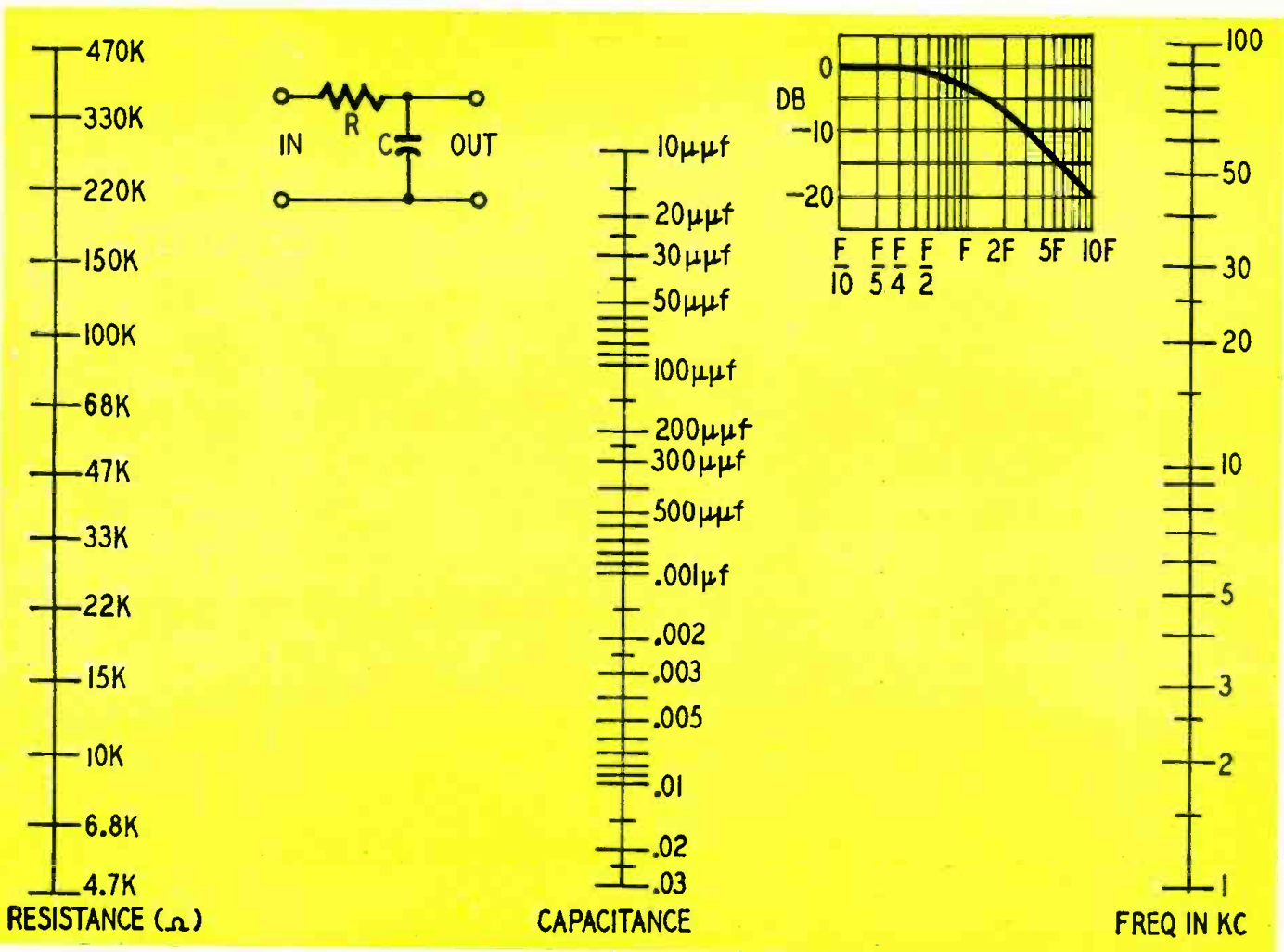

The high-frequency section of the simplified reactance nomogram. To use either chart, merely lay a straightedge across the values desired on any two scales. The straightedge will intersect the third scale at the corresponding value of R, C, or F for the circuit shown. Examples and further instructions for using these reactance nomograms are given in the text.

straightedge at 300 cycles and the other end at one of the commercial values of resistance. For example, if a 1-megohm grid resistor is to be used, reference to the capacitance graduations shows that a 500- μf coupling capacitor is required. If no 500- μf capacitor is available, a .001- μf capacitor and a 470,000-ohm grid resistor will do exactly the same job.

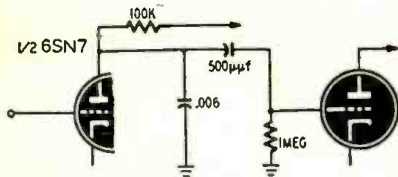

Fig. 1—Part of a communications-type modulator with values derived from the reactance charts for reducing non-essential speech frequency components below 300 cycles and above 3 kilocycles.

To see how this affects the frequency response, refer to the response curve in the upper right corner of the chart. A little mental calculation shows that if the value indicated as F is 300 cycles, the response is down 6 db at $F/2$, or 150 cycles, and is down 12 db at $F/4$, or 75 cycles. A complete low-frequency response curve for this part of the modulator can be drawn up by simply substituting the specific frequencies in this curve, as will be shown in a few moments.

The high-frequency problems of an amateur phone transmitter are somewhat similar to the low-frequency problems. In amateur communication, cutting off the frequencies above 3,000 cycles can eliminate a great deal of sideband interference. The signal will sound the same when tuned in on a communications receiver, but the operator who is trying to pull in a weak signal a few kilocycles away will have less trouble from interference. By discarding frequencies above 3,000 cycles, the weaker station has a chance to be heard without interference from modulation sidebands spreading 4 or 5 kilocycles on either side of the stronger carrier. So for this illustration, let's decide to reduce the response at frequencies above 3,000 cycles, and to do this, refer to the high-frequency reactance chart.

The circuit diagram on the high-frequency reactance chart may not look as familiar as the one shown for the low frequencies. However, if the resistance R is the plate resistance of one stage, and a shunting capacitance C is added to the circuit (if it is not already present as stray wiring capacitance and as the input capacitance of the next stage), the combination of plate resistance and shunting capacitance becomes exactly like the combination shown in the circuit.

Let's assume that the first stage is a low- μ triode, such as one section of a 6SN7, with a load resistance of 100,000 ohms. The tube manuals show that the plate resistance of one section of a 6SN7 is 7,700 ohms, which is so much

lower than the load resistance that the 7,700-ohm plate resistance becomes the controlling value. Therefore, if we lay a straightedge across the high-frequency reactance chart between 3,000 cycles and 7,700 ohms, the resulting value of capacitance is .006 μf . A .006- μf capacitor between plate and ground will reduce the response at frequencies above 3,000 cycles. The frequency-response curve on the chart shows that if the frequency F is 3,000 cycles, the response will be down 6 db at $2F$, or 6,000 cycles.

These samples of low-frequency and high-frequency calculations are summed up in the schematic diagram of Fig. 1, which shows the essential elements of the circuit that results. The frequency response of this part of the modulator is shown in Fig. 2, and includes both the high-frequency and the low-frequency characteristics.

This is the simplest possible circuit for this particular job, because it requires only one additional component—the .006- μf capacitor. The rest of the circuit requires only specific values for

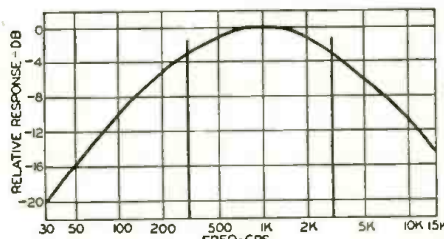

Fig. 2—Over-all frequency response of the a.f. circuit section shown in Fig. 1.

components that are in all resistance-coupled amplifier circuits no matter what the desired response may be.

Music systems

It's in the reproduction of music that the right frequency response can pay big dividends. And, surprisingly enough, the best amplifier for a given installation is not always the one with the widest frequency response. Instead, it is usually the amplifier designed to match the characteristics of the input signal, and the characteristics of the speaker and its enclosure. Here's where reactance charts can simplify the design problems.

For example, consider the low-frequency problems. Any loudspeaker, in almost any enclosure, has a tendency to generate large amounts of distortion and cross modulation near its low-frequency limit of response. If the speaker is ineffective below 90 cycles in its enclosure, cutting the response of the amplifier below 90 cycles often gives much cleaner bass response.

This strange result is actually very logical. Below 90 cycles the speaker cone just swooshes back and forth without radiating anything that can be heard. But if the speaker cone is called on by the program to do some fancy swooshing near 50 or 60 cycles, the resulting high-amplitude movements generate enough cross modulation and distortion to make crisp, clean, bass reproduction

impossible—and all because of frequencies that wouldn't be heard anyway. It's obviously much better to reduce the response below 90 cycles. It doesn't cost anything, and the results are often well worth the effort.

Even if the music to be reproduced has no components below the low-frequency limit of the speaker, there are always low-frequency noises like turntable rumble, power-supply hum, and even voltage surges on the power line. These noises may not be audible by themselves but they can still be a very potent cause of fuzzy, indistinct, bass response by contributing harmonics and cross-modulation products in the audible range.

To reduce the low-frequency response in this case, use the low-frequency reactance chart in exactly the same manner as in the modulator design. A few moments with the straight-edge show that a .0025- μf coupling capacitor, and a grid resistor of 680,000 ohms will drop the response below 90 cycles as planned.

Reducing the high-frequency response may also improve the quality in certain cases. For example, in AM broadcasting, there is often nothing but noise and distortion above 5,000 cycles. The same thing is true with 78-r.p.m. records above (roughly) 7,000 cycles. And an inexpensive crystal pickup often has a sharp resonance peak anywhere from 4,000 cycles up, which artificially boosts the needle scratch near that frequency and gives the music a harsh quality.

The response of the speaker itself at high frequencies is also important. If you study a speaker response curve closely, you will find that the response becomes more and more irregular as the frequency increases. The curve becomes especially jagged near the upper limit of the speaker response, and then drops off irregularly. These jagged peaks often add unnatural harshness to reproduced music. The harshness may not be apparent at first, but if the music is fatiguing after a half hour or so of listening, these irregular peaks may be partly at fault. Here's another case where proper high-frequency response can improve the reproduction.

There's another very important point in this connection, and that has to do with harmonic distortion. It is these upper audio frequencies which contain the harmonic-distortion components, and a well-chosen high-frequency response can actually improve the distortion figure of the amplifier.

As an example, let's assume that the

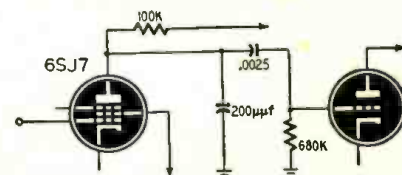

Fig. 3—Music-system amplifier designed to reduce speaker and record distortion by attenuating audio frequencies below 90 cycles and above 7,000 cycles.

music to be reproduced has nothing of interest beyond about 7,000 cycles. This would apply to the type of PA system usually rented for dances with 78-r.p.m. records, for example. To have definite figures, we'll further assume that the input tube is a pentode, such as a 6SJ7, operating with a load resistance of 100,000 ohms. The tube manuals show the plate resistance of a 6SJ7 to be over 1 megohm, which is so much higher than the 100,000-ohm load resistance that the load resistance becomes the

controlling value. By laying a straight-edge between 7,000 cycles and 100,000 ohms on the high-frequency reactance chart, the capacitance can be read directly as 200 μmf . This capacitance would be used as shown in the circuit of Fig. 3, with the over-all frequency response (including the low-frequency characteristics) shown in Fig. 4.

This, too, is the simplest possible circuit for the job, because it requires only one additional component, the 200 μmf capacitor.

There's one situation that still hasn't been considered, and which might be troublesome. If the input tube in this last example is a high- μ triode, such as one section of a 6SL7, with the same load resistance of 100,000 ohms, an added problem is introduced. In this case, the tube manuals show the plate resistance to be 44,000 ohms, which means that the plate resistance and the load resistance are so close together in value that neither one can be ignored. Therefore, it is necessary to

calculate the resistance of the two in parallel, which turns out to be close to 30,000 ohms. Now if the straight-edge is laid across the chart to intersect the values of 7,000 cycles and 30,000 ohms, the appropriate capacitance is 700 μmf , instead of the 200 μmf used with the pentode.

These reactance charts are not limited to these two applications, but can apply to any situation where the effects of resistance combined with capacitance are to be found in terms of frequency. This includes such problems as designing equalizers for phonograph pickups, designing correction networks for the frequency characteristics of a room, building up simple low-pass or high-pass filters, and the like. The only practical restriction is in the design of feedback amplifiers. The information built into these charts is not sufficient to predict the response with feedback when the resistance and capacitance elements involved are in the feedback loop.

END

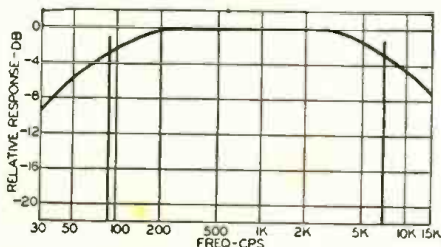

Fig. 4—Over-all frequency response of the amplifier stage shown in Fig. 3.

BOOKSHELF ENCLOSURE FOR GOOD BASS

Some hi-fi fans are not getting the best from their audio equipment because they lack space for the large enclosure which they believe necessary for good bass. In many instances, the need for a really good enclosure can be met by the R-J-type 8-inch bookshelf speaker cabinet in Fig. 1 and 2. The frame is made from $\frac{1}{2}$ -inch 5-ply wood. Pieces G, H, and J are cut to length from $\frac{3}{4}$ -inch square stock. Fiberglass acoustic material about $\frac{1}{2}$ inch thick is placed on the bottom, back, and the end of the enclosure away from the speaker. The acoustic lining should be cut so that it covers one-half to three-quarters of the total surface of the piece on which it is mounted.

The speaker mounts over a $6\frac{3}{4}$ -inch

circular cutout in the center of K. The speaker opening in the front panel (F) is centered over the cutout in K and is laid out by transferring the outline

Materials for enclosure		
NUMBER OF PIECES	DIMENSIONS IN INCHES	USE
2	10 x 23 $\frac{1}{2}$ x $\frac{1}{2}$	A and B
2	10 x 10 x $\frac{1}{2}$	C and D
2	10 x 22 $\frac{1}{2}$ x $\frac{1}{2}$	E and F
4	9 x $\frac{3}{4}$ x $\frac{3}{4}$	G
4	21 x $\frac{3}{4}$ x $\frac{3}{4}$	H
2	8 $\frac{1}{2}$ x $\frac{3}{4}$ x $\frac{3}{4}$	J
1	10 x 10 x $\frac{1}{2}$	K

Note: A, B, C, D, E, F, and K are 5-ply, $\frac{1}{2}$ -inch plywood. G, H, and J are cut from $\frac{3}{4}$ -inch stock.

shown in Fig. 2 to a sheet of $\frac{1}{4}$ -inch cross-section paper fastened to one end of the front panel.

The dimensions and drawings for the top, bottom, and sides are for standard box-type joints which should be held firmly together with glue and screws or dowels. If you have woodworking equipment to handle the job, you can make the top and bottom joints as shown in the circled drawings. The front panel should be cut for a tight fit into the recess formed by the sides, top, and bottom and then glued and screwed in place. The back (E) is fastened on with screws which may be removed for mounting the speaker. Note that the $\frac{3}{4}$ -inch square pieces are used in all corners except the two between the front and sides C and D. END

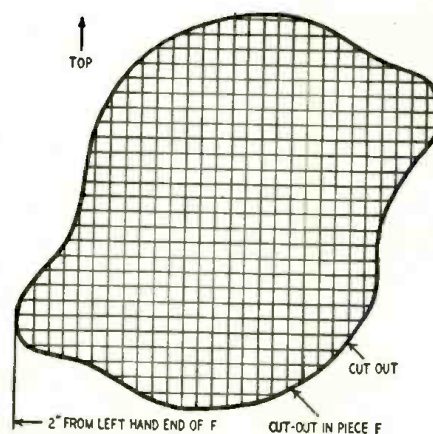
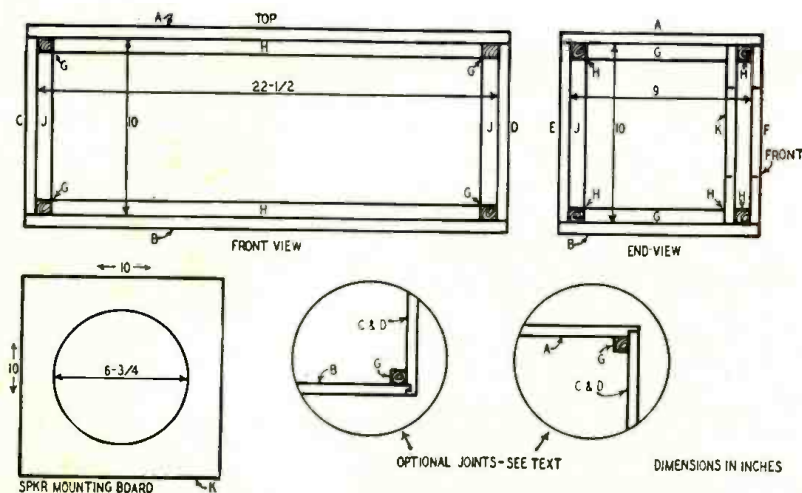



Fig. 2—Opening in front panel. Transfer each point on drawing to a grid of $\frac{1}{4}$ -inch squares on F. Connect all points by smooth lines. Cut out and sand edges.

Fig. 1—The construction of a bookshelf-type cabinet for an 8-inch speaker. The $\frac{3}{4}$ -inch blocks are used in all corners except where sides C and D meet front F.

JULY, 1953

The importance of BALANCE



in push-pull amplifiers

Suggestions for getting

maximum output quality

from high-fidelity units - **By JOSEPH MARSHALL**

INVERSE feedback is unquestionably the most valuable high-fidelity tool developed in our generation. The improvements it has made possible are almost magical when viewed in the perspective of the days before feedback. Unfortunately, the tendency has been to consider it a cure-all for any and all high-fidelity problems. If it is not included in a design to begin with, it is thrown in quickly as soon as something goes wrong.

I do not mean to disparage feedback in the slightest, but its versatility and effectiveness have tended to obscure a number of other basic principles in amplifier design. Observing these principles will greatly reduce the probability of a high-fidelity design going wrong in the first place, and makes the application of feedback much simpler and considerably more effective. One of these basic principles is the need for balance in push-pull amplifiers.

The great virtue of the push-pull amplifier in audio design is its ability to cancel even-order harmonic distortion. This feature allows us to drive the tubes harder and get more than twice the output of a single tube if we wish. It also improves the low-frequency response by reducing unbalanced d.c. in the output transformer primary which might saturate the core and reduce the inductance of the windings. In addition, push-pull operation almost entirely eliminates hum and noise from the power supply, but still the principal reason for using it is the distortion-canceling feature. It sounds simple: merely hook up two tubes in push-pull and you cancel second-harmonic and all other even-order distortion, thus disposing of the largest portion of distortion at one crack.

Unfortunately, this does not always follow as inescapably as day follows night. In fact, it is a very rare push-pull amplifier which fully exploits these distortion-canceling characteristics. Very few of them realize even 75% of the possible benefits; and many push-pull amplifiers produce even more distortion than a properly designed single-ended amplifier.

The fact that a push-pull amplifier utilizes only 75% of the distortion-canceling abilities of the circuit may not be serious in speech-range public-address equipment. But in high-fidelity amplifiers enjoyment of the wide frequency response is entirely dependent on reducing distortion to an absolute minimum. The amplitude of most music and voice sounds around and above 10,000 cycles is normally 30 or 40 db below the average sound level. Even 1% distortion of mid-range sounds would be louder than the normal h.f. components, and would not only mask them but also make them annoying to hear. To insure acceptable reproduction of the high frequencies, distortion must be reduced to the smallest possible fraction of 1%. This improvement is easily attainable by making the most efficient use of push-pull design.

The distortion-canceling property of a push-pull amplifier depends entirely on balance. Complete cancellation is achieved only when equal signals are fed to both sides, when both sides amplify equally, and when both produce the same amount of distortion. On the other hand, if the output and distortion of one side are 10% greater than the other, at best only 90% of the distortion is canceled.

The situation actually becomes even worse at some points in the dynamic

range, especially at the points of maximum drive. For instance, suppose we deliver equal signals to both sides, but that one side is overbiased, either because the tube draws more current, or because its cathode resistor is higher than that of the other tube. Thus the overbiased tube reaches the bend of its curve before the other, and may generate 5% or more second-harmonic distortion while the correctly biased tube generates only 1%. After cancellation we have one side passing on a signal with 4% distortion, while the other side has none. From a distortion point of view, the amplifier would be much better if the overbiased section were not functioning at all—in other words, if it were an unbalanced single-ended stage.

Theoretically, it's simple to achieve complete cancellation; in practice, however, it may call for rather heroic measures.

Static balance

It is easier to get balance with transformer coupling than with resistance coupling. In high-quality transformers the turns ratios and d.c. resistances of the two sides are balanced to 1% or better; even the cheaper ones are not more than 3 or 4% out of balance. However, an input or output transformer does not automatically insure balance. In the first place, it is difficult to obtain identical tubes, and if one tube draws more current than the other, the two sections will be unbalanced. It is easy to get *static* balance by adjusting the bias voltages of the individual tubes so that both draw equal no-signal currents. This, of course, is fairly standard procedure. Almost all good power amplifiers have some means of adjusting

the bias to, the output tubes. But for minimum distortion, the driver stage should also be balanced.

Two ways of doing this easily and inexpensively are shown in Fig. 1. At *a* we use a small potentiometer ahead of a common bias resistor. By adjusting in one direction or the other from center, both tubes can be made to draw equal currents under static conditions. In *b* the two tubes have separate bias resistors, but one of these is adjustable.

Note that the circuit at *a* includes a bypass capacitor across the common bias resistor. No doubt you have read that such a bypass capacitor is not really necessary in push-pull stages. As a matter of fact, if the stage operates at a low level—one which never approaches the bend of the tube curves and therefore generates little or no distortion—a common *unbypassed* cathode resistor serves as a balancing device. However, if the stage is operated at signal levels high enough to produce distortion, the bypass capacitor is absolutely essential.

Harmonics cancel only where they appear out of phase. This is true in the output circuit. But the cathode resistor

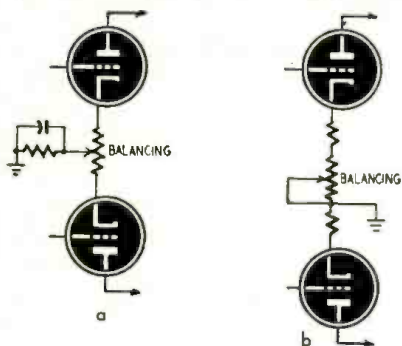

Fig. 1—Static balancing arrangements for push-pull amplifiers. (a) Mutual bias potentiometer with bypass for common cathode resistor. (b) Balance adjustment in one cathode without bypassing. See text for complete analysis.

is common to both the input and output circuits. In the cathode circuit the even-order output harmonics from one side of the stage appear *in phase* with the input signal of the other side. This is a form of positive feedback. The in-phase harmonics add themselves to the input signal and are amplified by the stage, producing a very serious form of distortion. This may not be important in cheap amplifiers, but it is most objectionable in high-fidelity designs.

We have seen a number of 6B4 amplifiers with large amounts of inverse feedback, which sounded terrible for this reason. These tubes need nearly 150 volts drive grid-to-grid. To produce this much, even with an interstage transformer, the drivers themselves have to be driven well into the nonlinear portions of their curves, generating a great deal of distortion. Fed back through the common cathode resistor, this distortion was not affected by the feedback network and was amplified to such an extent that there was much more distortion than the 6B4's would normally

produce by themselves. For this reason, it should be routine to include a large bypass capacitor across common bias resistors in all high-level stages of high-fidelity amplifiers.

On the other hand, in amplifiers where the driver has to deliver only moderate voltage to the following stage, the circuit of *b* with separate unbypassed cathode resistors is preferable. Since the positive feedback referred to previously is present only with a common cathode resistor, an unbypassed resistor for a single section will not produce it. In addition, omitting the capacitors gives a small amount of negative feedback which helps preserve the balance and improves the frequency response as well.

Dynamic balance

Unfortunately, *static* balance is not necessarily *dynamic* balance. A stage which is balanced perfectly at zero input or at some fixed value of signal input will probably be out of balance somewhere in its dynamic or frequency range. Even a change in line voltage may throw the sides out of balance; and a stage balanced at zero input will almost invariably be out of balance at maximum input. An amplifier with plate-current meters in all plate circuits and means for controlling bias and plate voltages is very instructive in this respect.

The simplest way to check balance is to connect a high-resistance voltmeter from plate to plate of the stage to be balanced. Balance is indicated by zero voltage: adjust the balancing potentiometer until the meter indicates no voltage difference between the two sections. (This assumes that the d.c. resistances of the two halves of the push-pull plate load are equal.) This is most dramatically visible with power stages but is also true of voltage amplifiers.

Aside from negative feedback, there is another expedient which may be used to get approximate dynamic balance. This is shown in Fig. 2 and is an unbypassed choke of about 25 henries in series with the center-tap of the output transformer or the junction of the plate-load resistors. (A resistor may also be used this way, though it is not as effective as the choke.) Its operation is quite simple. The choke (or resistor) is an impedance common to both

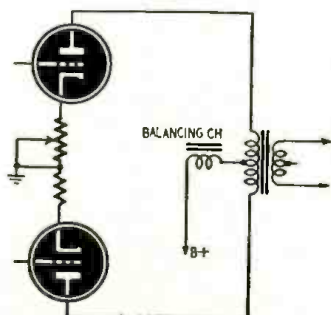

Fig. 2—Inserting a high impedance in the common B plus return improves balance by equalizing plate-current variations in the two sides of the circuit.

sides of the push-pull stage. As long as the currents flowing through both tubes are identical, there will be identical voltage drops for both tubes in the common choke. The moment one tube begins to draw more or less current, the voltage drop across the choke will increase or decrease as the case may be. This in turn will change the current of the other tube in the *opposite* direction, thus bringing the total voltage drop closer to the original. The same thing will apply of course to the a.c. currents generated in the plate circuit, so that both the d.c. parameters and the a.c. signal are kept much more closely in balance than if the common impedance were not there.

This method will not guarantee absolutely perfect balance, but even an arbitrary inductance value of 15 to 25 henries will improve the dynamic balance by a very large factor. This method works well in class A output stages. Whether it should be used in AB operation is another matter. It would improve the dynamic balance over the class A portion of the range; but the reduced regulation in the high-output class AB region might be deleterious. We have found it satisfactory and even valuable in several amplifiers. Many of the tubes used in power stages, especially the transmitting types, may have a variation as great as 5 ma between the two sides. Although they can be brought to static balance by adjusting

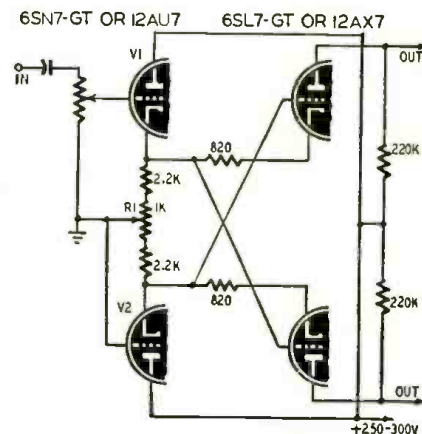

Fig. 3—Cross-coupled phase inverter with cathode balancing potentiometer.

the bias, they are very likely to produce severe unbalance and distortion at maximum output. The common choke reduces this materially without too much sacrifice of output power.

Balancing R-C Stages

The problem of balancing resistance-coupled push-pull stages is a little more troublesome. All the methods described above can and should be applied to R-C amplifiers as well as to transformer-coupled types, provided the much more serious unbalance due to unequal component parameters is also taken care of. One way to solve this is to use precision (1% or better) resistors in the grid and plate circuits, and to balance the cathode circuits by the methods shown in

Fig. 1. It goes without saying that the use of anything but matched pairs is out of the question in a high-fidelity amplifier—but it is not necessary to go to the expense of precision resistors. Ordinary 10% or even 20% resistors can be checked carefully on a bridge or an ohmmeter, to find pairs which match within 1 or 2%. Balance is much more important than actual value. Whether a plate-load resistor is 250,000 ohms or only 200,000 ohms is generally immaterial, as long as the two on opposite sides of the same push-pull stage are as nearly identical as possible. The improvement obtainable in an amplifier by replacing random-value resistors with matched pairs is quite astonishing, especially at maximum output. To a lesser degree, the same thing is true of coupling capacitors, although here the improvement is in frequency balance.

Phase inverters

We come now to a matter of quite serious importance: balance in the phase inverter. It is obvious that no matter how well balanced the succeeding stages are, if the stage which originates the push-pull signal is not balanced, and therefore delivers unequal signals to the two sides, all the balancing work is undone, as far as canceling distortion is concerned. This problem has been discussed many times in this and other periodicals.

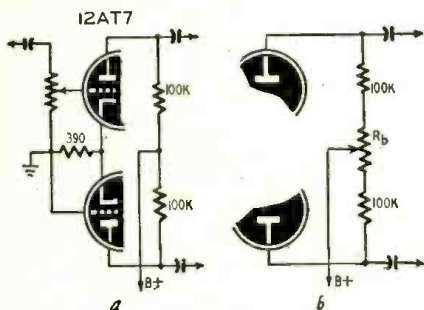

Fig. 4—(a) Basic cathode-coupled phase inverter. (b) Balancing potentiometer inserted in phase-inverter output circuit.

The most foolproof phase inverter is a good center-tapped transformer. True, a transformer with wide-range frequency response is expensive and bulky; but it will supply signals balanced to 1% or better. Only one vacuum-tube phase inverter we know of can approach a transformer in this respect. This is the cross-coupled inverter diagrammed in Fig. 3. By adjusting R1, the output can be balanced to 1% or even better, and the balance holds over its entire dynamic range. A simple way to balance it is to unground the grid of V2 and connect it to the grid of V1. Now feed in any signal and adjust R1 until the signal is inaudible or has minimum value at the output.

The second-best tube-type phase inverter is the cathode-coupled circuit given in Fig. 4-a. Theoretically, the output will be balanced if the plate resistors on both sides are identical. In practice a balance within 5% is achievable. A simple way to balance this in-

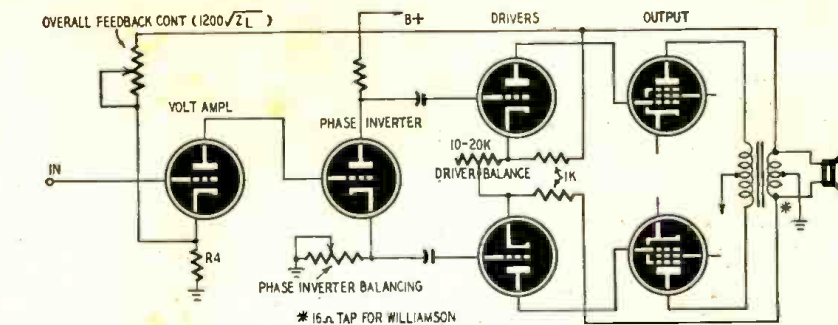

Fig. 5—A combination of balancing arrangements for a Williamson-type amplifier. The adjustable cathode resistor in the phase inverter equalizes the outputs to the driver grids. Feedback from the output-transformer secondary to the driver cathodes helps equalize the push-pull stages. See discussion in the text. Only components essential to the discussion are shown in this schematic.

verter is to insert a potentiometer (R_b) between the two load resistors as shown at *b*, and adjust for equal outputs.

The split-load inverter used in the Williamson and other amplifiers can be balanced by making the cathode resistor variable and adjusting it for equal outputs from cathode and plate. This inverter is not balanced perfectly at high frequencies but this is said not to be serious. In any case, whichever circuit is used, the resistors in the two sides should match as closely as possible.

Feedback balancing

There is one more tool for balancing which remains for discussion and that is inverse feedback. It is the most important single corrective and, moreover, it produces dynamic rather than static balance. (More important, perhaps, it produces frequency balance as well.) To be effective in balancing, inverse feedback itself must be balanced. The single-ended type of feedback used in the Williamson circuit is not effective for balancing, although it is effective in reducing distortion by other means.

The ideal amplifier should have two feedback networks: one for balancing push-pull stages, and another to the

input of the amplifier, for over-all frequency correction and distortion cancellation. For example, in the Williamson circuit balanced feedback could be applied to the driver cathodes by using an output transformer with a center-tapped secondary or split output windings. See Fig. 5. This is in addition to the feedback to the cathode of the input stage. About 10 db of feedback could be applied to the drivers and another 10 db to the input stage. In this way, and in conjunction with the other balancing measures described, we could combine the distortion-canceling properties of push-pull operation with those of inverse feedback, and presumably produce an amplifier with the absolute minimum of distortion.

In any case, the first and most important goal in high-fidelity design is to reduce distortion to the point where it cannot mar the enjoyment of a wide frequency range, which in itself is relatively simple to achieve. In approaching this goal, the use to the fullest extent of the distortion-canceling feature of push-pull amplifiers is an important and relatively inexpensive step that should be taken by all designers who want highest possible fidelity. END

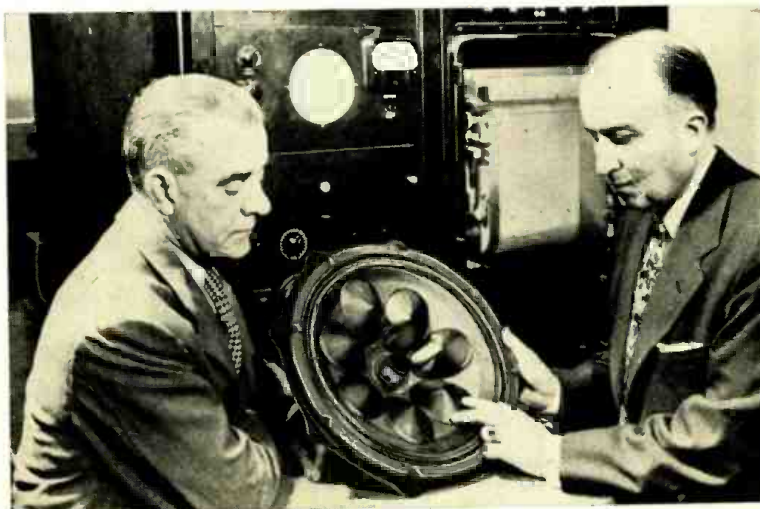

New RCA LC-1A high-fidelity speaker shown here by Dr. H. F. Olson (right) and John Preston, co-developer, has irregularly spaced deflector domes mounted on its 15-inch main diaphragm to break up symmetrical standing-wave interference patterns and flatten the frequency response.

TELEVISION?

...it's a cinch!

From the original "La Télévision? . . . Mais c'est très simple!" Translated from the French by Fred Shunaman. All North American rights reserved. No extract may be printed without the permission of RADIO-ELECTRONICS and the author.

By E. AISBERG

Fifth Conversation:

Sawing into the heart of a deflection system—electromechanical or all-electronic sweep? Some problems of time and supersonic speeds

KEN—Just what's going on now? Why the important, secretive air?

WILL—Nothing in particular! I'm just getting ready to take out a patent, that's all . . .

KEN—A patent! I'd like to see the invention you'd turn out! May I ask just what scientific field you've selected to turn your genius loose in?

WILL—Television, of course. Ever since the last time we talked, it's been getting me more and more excited! You've been moving pretty slow with your explanations of how it works, so I've been digging into it myself. That's how I happened to invent my "rotating deflector."

KEN—Rotating deflector? That sure sounds like something new. I don't think I ever heard of anything like it.

WILL—I can trust you, Ken, so I'll tell you my idea. Strictly confidential, of course. Ever since we talked about electrostatic and magnetic deflection, I've been thinking hard about the way the spot is swept to make the lines of a frame . . .

KEN—Yes, we did cover that question in our third conversation, when we were studying the electrostatic deflection tube.

WILL—I remember it very well. You have to apply a voltage that starts negative and gets steadily more positive, to move the spot from left to right at a uniform speed. Then we have to get the spot back almost instantly, so we have to drop quickly back to the original negative value, and start all over again.

KEN—Do you think you can draw a figure showing that kind of voltage?

WILL—Sure! The passage from the negative voltage, $-V$, to the positive voltage, $+V$, is made at a constant rate, so the spot will move steadily across the screen, without changing its speed. So, on this graph, we make a straight line rising progressively from $-V$ to $+V$, in time t , which is the duration of one line on the screen. The straight vertical line represents the almost instant change back to the starting value that brings the spot back again. And then the whole thing repeats.

The electronic saw

KEN—Does the shape of that line you've just drawn remind you of anything?

WILL—Yes, it's called a "sawtooth voltage," though I suppose on magnetic deflection tubes you'd have to use a sawtooth current?

KEN—Quite right.

WILL—And the same type of voltage (or current) deflects the spot in the vertical direction. However, the frequency is much lower, for it determines the number of pictures (or in the interlaced system, the number of half-pictures) a second.

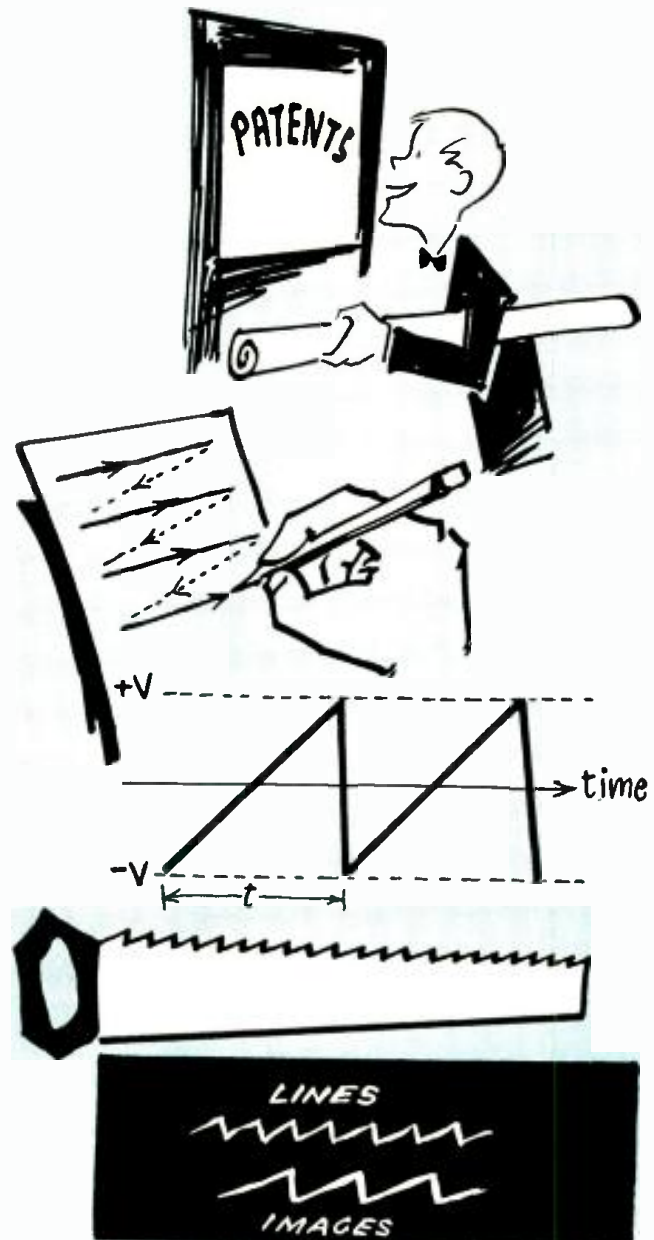

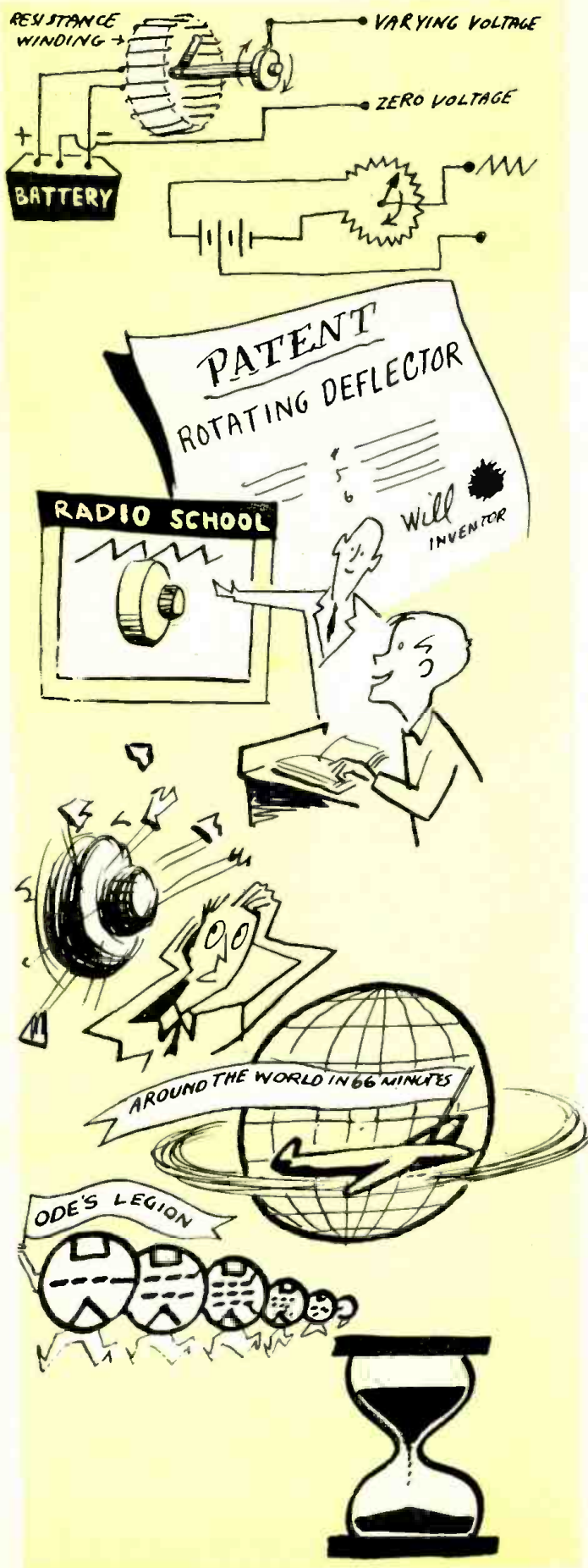

KEN—I can see you really *have* been thinking about this problem. But none of this explains your “rotating deflector.”

WILL—We’re getting to it. The device which I have the honor of presenting to you is a sawtooth generator for both horizontal and vertical spot deflection. It’s composed essentially of a cylinder of insulating material on which is wound a toroid of resistance wire. A shaft is placed along the axis of the cylinder. As this shaft rotates, a contact attached to it makes contact with the resistance wire on the interior face (or one edge) of the cylinder.

KEN—Once you’ve stripped the Patent Office language off this device of yours, I can’t see that we have anything more than an ordinary potentiometer, of the type used for volume controls in some old radios.

WILL—Exactly! The only difference between my potentiometer and any other is that it has no stops, so the contact can keep turning continuously in the same direction.

KEN—But just what is this remarkable invention going to do?

WILL—Haven’t you already gathered, Ken, that I intend to put a battery or other voltage source across the ends of my potentiometer? Then, as the contact moves, it passes progressively from a high negative to a high positive voltage; and, as it passes the last wire, it snaps back instantly to the negative voltage, as required in a TV deflection system.

Weakness of a mechanical system

KEN—Congratulations, Will. The idea (in itself) is good, and I’ve actually seen a demonstration apparatus in a radio school that worked exactly that way.

WILL—That’s not all there is to the idea. I’m going to turn this potentiometer with a motor which will make exactly 60 turns per second, to give the correct vertical deflection voltage. Then, with a system of gears, another potentiometer will be turned to give the horizontal deflection.

KEN—Just what would your gear ratio have to be, and how fast would that make your second potentiometer turn?

WILL—That’s not hard to figure out. With two fields a frame, the ratio would have to be 2 to 525, or $262\frac{1}{2}$ to 1. And the speed of the second pot would be 525 times 60, or 31,500 turns. . .

KEN—. . . per second! Or a little less than two million r.p.m.! Just what kind of a gear are you going to get that will hold together at that speed? And wouldn’t your resistance wire wear out a trifle fast?

WILL—Now, why didn’t I think of that? Well, just another good idea gone wrong. So I guess we’ll just have to toss mechanical methods on the junk pile and use some 100% electronic method. . .

KEN—When you bet on electronics, you win! Only an electron can move fast enough to do what’s needed at TV sweep frequencies. Suppose you have a 16-inch tube—the line is just a little more than a foot long. The spot goes across the screen—and back—525 times a frame, or 1,050 times. And there are 30 frames a second. Figure it out, and you’ll find that the spot is moving a little faster than 6 miles a second. At that rate, it would travel around the earth at the equator in very little more than an hour!

The electronic hourglass

WILL—Boy, when this army of ‘odes—the pentodes, triodes, diodes, and all the rest—get under way, supersonic planes just don’t move compared to them!

KEN—Actually, tubes play only a subordinate part in these time-bases, sweep circuits, or sawtooth generators, as they are called.

WILL—What a flock of queer names! But why time-bases? Is that because the voltages increase proportionately with time?

KEN—Probably. But whatever you call them, we need voltages that increase linearly with time, like those you’ve just drawn.

WILL—This time-base, then is a sort of hourglass where the grains of sand are replaced by electrons?

KEN—It’s a good picture! Just as the amount of sand in

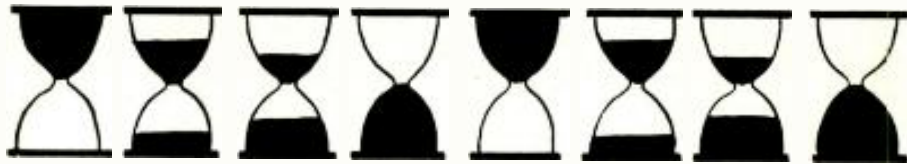

the bottom half of the glass increases steadily till—just as all the sand has run out—you turn the glass over and the bottom half is suddenly empty again, so in the time-base generator, the current charges a capacitor steadily till the moment of discharge. Then it also becomes suddenly “empty” and the cycle starts again.

WILL—So, a time-base is mostly a capacitor, if I get you right. But why does it discharge faster than it charges?

KEN—Because you charge it through a resistor. Just picture a source of direct voltage E connected through a resistor R to a capacitor C . Here, I’ll draw it. When you close the circuit, a current flows that starts to charge the capacitor to the same voltage as that of the source. But you don’t get the full charge instantly, because the resistor limits the amount of current that can flow.

WILL—I guess you could compare that to a tank of water E connected through a thin pipe R to a smaller tank C at a lower level. When the valve is turned, C doesn’t fill up immediately to the level of E because the pipe R prevents the water from rushing into it instantaneously.

KEN—Your comparisons are getting good today! And the bigger the tank E is in comparison with C , the better the comparison. In electrical terms, the job of charging the capacitor C shouldn’t have any noticeable effect on the source voltage E .

WILL—It seems to me that the charging time depends on the capacitance at C as well as the size of the resistor R . The bigger C is, the more electrons you have to put in to charge it. Just the same as if you make the water tank C bigger, it will take more time for the water to reach the same level as E .

KEN—That’s exactly why the product of resistance and capacitance (RC) is called the *time-constant* of the circuit. If you express R in ohms and C in farads (or R in megohms and C in microfarads, as we usually do in electronic calculations), this time-constant will give you, in seconds, the time it will take for the capacitor C to reach roughly $\frac{1}{2}$ the voltage of the source.

WILL—So, with a resistance of 10,000 ohms and a capacitor of 2 microfarads, we’d have a time-constant of 20,000 seconds?

KEN—Not bad for a first approximation; you’re only about a million times off! Didn’t we say *ohms* and *farads*, or *megohms* and *microfarads*? Ten thousand ohms is .01 megohm, so your time-constant is $2 \times .01$ or two-hundredths of a second!

WILL—Excuse the slight mistake! I see now that if we want our capacitor to discharge instantly, we have to have a very small resistance in circuit with it.

KEN—In actual practice, you close the key K , and put a dead short across the capacitor. (TO BE CONTINUED)

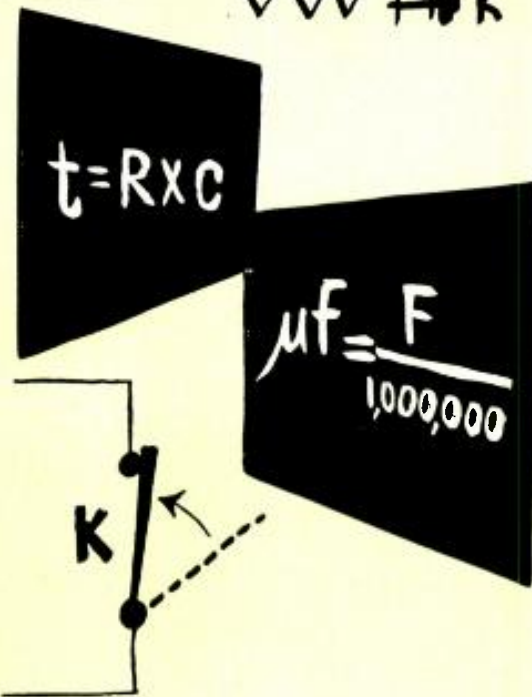
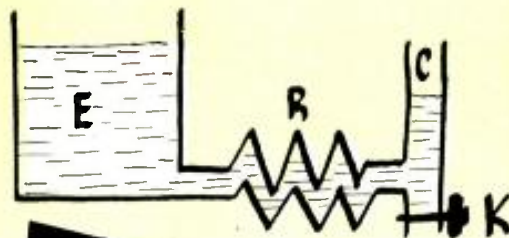
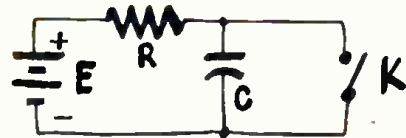

NO GOOD COLOR TV TUBE YET, SAYS SIRAGUSA

Production of color TV receivers before a satisfactory 3-color picture tube is available in mass quantities would be “a serious mistake,” according to Ross D. Siragusa, president of Admiral Corporation. Speaking at a recent dinner in New York City, the Chicago executive said that his company’s laboratories already have color-receiver circuits which produce excellent results—but the color tube is the chief problem. “Scientific progress cannot be produced or hastened by either congress-

sional mandate or wishful thinking,” said Mr. Siragusa. “The industry has to have the right color picture tube and the right tube simply doesn’t exist at present. . . . In our laboratories we have color receivers with circuits which produce excellent results, but the color tube is the chief problem.”

“Both of the two types available are handmade, bulky, and very costly. One does not give a color picture we consider satisfactory. The other is extremely complex, and has 12 critical

interdependent adjustments for bringing the three colors into registration. That makes thousands of combinations of adjustments possible, only one of which is correct.”

Mr. Siragusa added that one of Admiral’s engineers had spent a year merely learning the technique of making the registration adjustments, and said that “when the color-tube problem is solved we will be able to manufacture sets at a price well within the reach of the great mass of American families.”

UNUSUAL TV SERVICE CASES

*A pretty pair of tricky ones—
Could you have cracked them?*

THE PERSISTENT INTERMITTENT

The trouble was that lines or groups of lines were missing in the picture. Sometimes it appeared as though part of a frame were superimposed on the whole frame. Seldom did the picture lose either horizontal or vertical sync. Sometimes the video would be missing in one or several irregularly spaced bands, an inch or so wide. Occasionally the set would work perfectly for a week. Trouble was usually in the afternoon, seldom at night.

I worked (intermittently) on the problem for over a year. The set was bench tested several times. It was baked till the plastic installation was ready to drip. Capacitors were replaced. All to no effect. The set had a perfect bench record, but never failed to act up in the home. The afternoon cycle of interference was especially mystifying.

The trouble must be outside the set, I thought. I discovered that I could duplicate the video display by flicking the antenna terminals with a screwdriver. I decided the interference, whatever it was, must be coming in via the antenna. An ohmmeter was placed across the terminals of the 300-ohm lead. Violent gyration of the antenna and lead revealed nothing. Inch-by-inch inspection also produced no results.

An inside antenna was substituted for the outside one. Signals were weaker, but the trouble was still there. (The above tests were carried out at various times because of the intermittent nature of the trouble.)

After prolonged self-consultation I asked: "Could the trouble actually be in the old antenna and be radiating to the indoor one?" I shorted and grounded the outside lead. The set operated without a peep of interference.

Then we took down the line and placed each side across a storage battery. After a few seconds one side opened up! Only then was it revealed that the strands at one point were alternately broken so that they lapped each other by about a quarter of an inch. (See the drawing.) The lead went

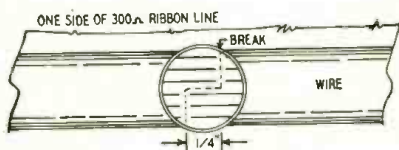

up along the west wall of the house, and evidently in the afternoons the temperatures were high enough to expand the plastic and allow the wires to

make and break contact in the wind. At night the plastic tightened and the wires made good contact.

The moral of this story is to short and ground out any suspected antenna when another is substituted!—*Edward P. Eardley*

THE UNEXPLAINABLE JITTER

My most unusual service job was on a Transvision model A chassis with a 12-inch tube. The complaint was a horizontal jitter in the picture. Close observation showed that the video information on random lines was displaced horizontally $\frac{1}{4}$ to $\frac{1}{2}$ inch. The vertical edges of the raster were straight and did not tear but the picture information within the line moved back and forth. The jitter did not follow modulation on the sound channel.

After substituting tubes and checking resistors and capacitors, I hooked up the scope. With it, I detected a slight fuzziness on the peaks of the waveform anywhere in the horizontal sweep circuit from the sync amplifiers to the deflection yoke. The fuzziness on the waveform represented a voltage which was only about 2 to 5% of the total. I replaced the horizontal oscillator and flyback transformers and the yoke, one by one, without eliminating the trouble.

I left the TV set running on the bench while I stopped to do a quick job

on a 5-tube a.c.-d.c. midget. As soon as the little set started working it picked up the usual warbling note from the horizontal sweep circuit of the TV set. Suddenly, I noticed a hissing and spitting noise in the background of the horizontal sweep radiation. *This unusual background noise was exactly in step with the interference in the picture.*

Now the path was clear! I made a probe consisting of a piece of shielded mike cable with the insulated center lead extending about 1 inch beyond the shield. The other end of the center conductor was connected to the antenna post of the AM set through a .001- μ f capacitor and the shield was grounded to the radio chassis.

By placing the end of the probe close to the various components in the horizontal sweep circuit, I was able to detect the nature of the voltage in each. When the probe was placed close to the 47,000-ohm, 1-watt feedback resistor (between the damper-tube plate and the horizontal oscillator) the hissing was much louder. I changed this resistor and the trouble cleared up. I had previously checked this resistor and found that its resistance was right on the button.

After completing the repair job, I continued to experiment with the probe and found that this method of signal tracing can be extremely useful. I can probe anywhere in a TV set and get the characteristic sounds of each circuit. For example, there is the low-frequency buzz from the vertical circuits and the swishing from the video amplifiers.

I have found that the ear can detect foreign sounds that are 20 to 40 db below the level of the principal signal coming through. Such extraneous signals are often difficult to detect on a scope because it is a linear device and signals 20 db or so down are likely to be lost on the trace.—*William H. Greenbaum*

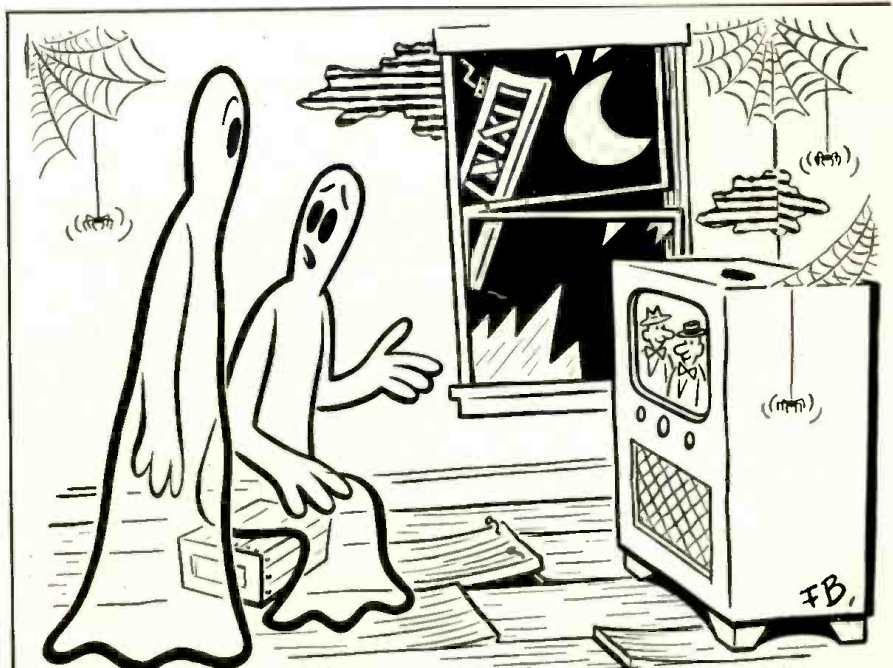

Suggested by Richard Frato, Detroit, Mich.
"Dear, you'd better call the servicemen—we're getting an awful lot of people on the screen lately."



Circuit Shorts

By ROBERT F. SCOTT

*Improved a.g.c. systems
for better TV reception
in weak-signal locations*

NOW that more and more people are buying TV sets in extreme fringe areas 100 miles or more from the nearest station, most set manufacturers have switched to cascode tuners for their higher gain and exceptionally high signal-to-noise ratio. Cascode r.f. amplifiers provide the highest signal-to-noise ratio when they are operated at maximum gain. Therefore, a.g.c. voltage should not be applied to the tuner until the r.f. signal level is high enough to overload the first i.f. amplifier. In the average set using a cascode tuner, the *tuner a.g.c.* bias should be delayed until the input signal rises to 300 to 500 microvolts. Applying tuner-a.g.c. voltage too soon reduces the r.f.-signal voltage to the point where converter noise predominates and decreases the signal-to-noise ratio.

If the a.g.c. voltage is delayed too long, the first i.f. amplifier will overload and there may be cross-modulation in the tuner. So, to provide optimum receiver performance under all operating conditions, various TV set manufacturers have developed various methods of delaying the application of a.g.c. voltage to the tuner.

The grid-voltage plate-current characteristics of the triode r.f. amplifiers and the i.f. amplifier pentodes are vastly different. This makes it desirable to use different values of a.g.c. voltage on the tuner and i.f. strip in addition to the delayed a.g.c. on the tuner.

The basic system of delaying and grading the a.g.c. voltages for the r.f. and i.f. circuits consists of developing the a.g.c. voltage across a voltage divider which is common to a portion of the B plus circuit. The a.g.c. and B plus voltages are polarized so that their currents flow in opposite directions through the voltage divider. If the currents through any section of the divider are equal, the net result will be zero current and the voltage across this section is also zero. The voltage at any point on the divider can be varied by varying the magnitude of one of the currents. Since the B voltage is fixed and the available a.g.c. voltage depends on the strength of the incoming signal,

the voltage at any point can be made to vary between any two desirable levels by careful selection of the divider resistances and the B plus voltage. Clamping diodes or a fixed negative bias source are used to prevent the r.f. amplifier grid voltage from dropping below the minimum level required for proper operation for the optimum signal-to-noise ratio.

The Du Mont system

The a.g.c. circuit in the Du Mont RA-166, RA-167, and similar chassis is essentially a standard 6AU6 keyed-a.g.c. system with provision for delaying the application of the tuner a.g.c. voltage. The circuit is shown in Fig. 1.

The 6AU6 a.g.c.-keyer tube develops a negative voltage across the a.g.c. load resistor which consists of R5, R3, and R4 in series. With a strong signal applied to the antenna terminals of the set, a plate current of approximately 225 μ a flows to ground through the a.g.c. load resistors. By itself, this current would make point A about 55 volts negative with respect to ground, but note that point A is also connected to the 270-volt B plus line through R1 and R2. Resistors R1, R2, R3, and R4 now form a B plus voltage divider. A current of 100 μ a flows from ground to the 270-volt line. This 100- μ a current opposes the normal 225- μ a current produced by the 6AU6, so the net current through R3 and R4 is reduced to only 125 μ a. This current, flowing from the

6AU6 plate to ground, makes point A 31 volts negative and the junction of R3 and R4 approximately 5.9 volts negative. The i.f. amplifiers receive their a.g.c. voltage from this point.

Since R1 and R2 are in series between points 31 volts negative and 270 volts positive, there is a total voltage drop of 301 volts across them. This voltage divides with a drop of about 274 volts across R1 and 27 volts across R2. This makes point B 27 volts positive with respect to point A, or 4 volts negative with respect to ground. The a.g.c. voltage for the tuner is tapped off at point B.

A reduction in the strength of the incoming signal decreases the negative voltage developed at A. As A becomes more positive there is a corresponding change in the voltage at B. For example, if A rises 4 volts from minus 31 to minus 27, B rises from minus 4 volts to zero.

If the signal is too weak to develop minus 27 volts at A, point B would go positive if it were not for the action of diode D2. The instant point B starts to go positive, D2 conducts and presents a low-impedance path to ground, so B remains at ground potential.

Diode D1 is connected in parallel with D2 through the 220,000-ohm a.g.c.-filter resistor. When the plate of D2 is at zero volts, contact potential develops about minus 0.5 volt at the plate of D1. This contact potential supplies the minimum bias of 0.5 volt that must be

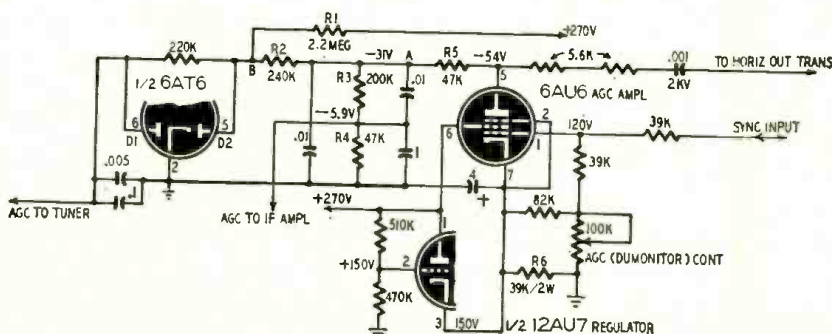
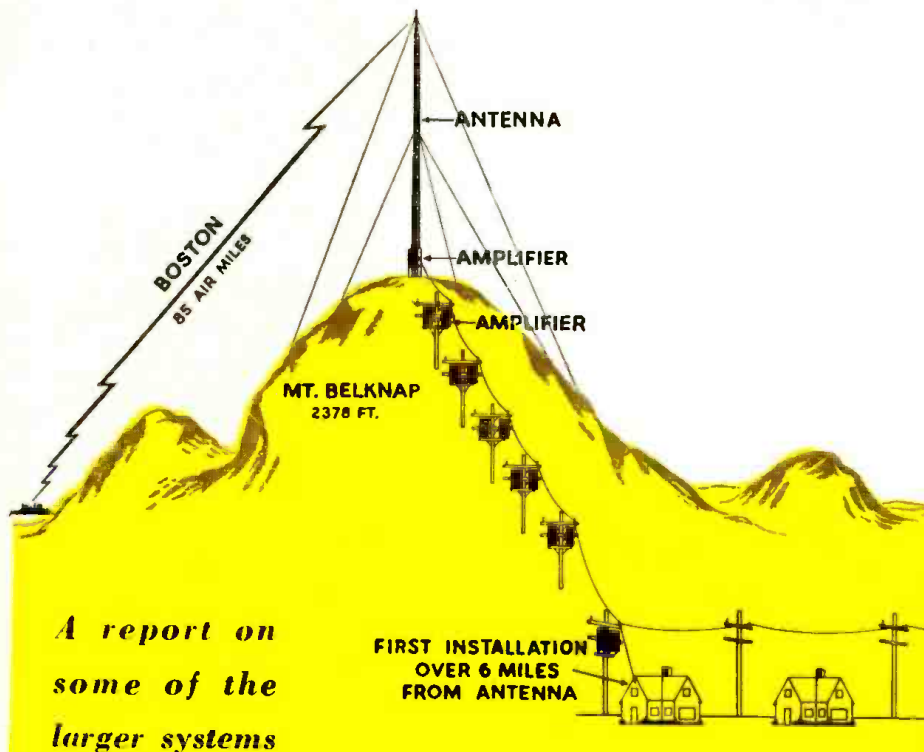

Fig. 1—Delayed keyed-a.g.c. circuits of the late-model Du Mont RA-166, 167, 170, and 171 Telesets. The 12AU7 voltage-regulator tube stabilizes the gain of the 6AU6 a.g.c. amplifier against variations in B plus and power-line voltages.

COMMUNITY TV SYSTEMS



*A report on
some of the
larger systems*

By E. D. LUCAS, JR.

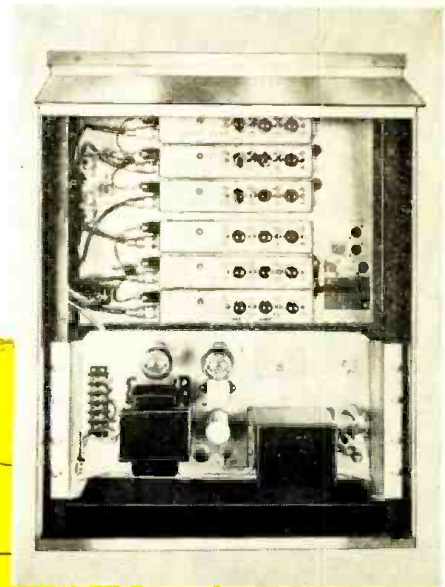

Amplifier unit of the RCA SX-8C tower amplifier distribution system.

THE community-television system for bringing good TV reception to entire towns or cities has become big business in the short span of three years. More than 160 companies are now operating community systems in 26 states. Some of these systems serve as many as 2,000 homes, and the plant investment in the larger installations amounts to a quarter of a million dollars or more.

While a community-TV system is basically an expanded version of the master-antenna devices installed in apartment houses, hotels, or dealers' stores (see "TV Distribution Systems" by Eric Leslie, in the January, 1953 *RADIO-ELECTRONICS*) it must actually be treated like a public utility. In plant investment, in construction, in operating and maintenance techniques, the larger community installations resemble local independent telephone companies in rendering a communications service to several hundred, or even thousands, of subscribers.

The elements of a community-TV system include: one or more receiving antennas mounted on a tower or towers; r.f. amplifiers, often with associated channel converters and automatic-gain-control equipment; and distribution circuits for feeding the amplified TV signals to individual subscribers. Associated with the principal elements are the miscellany of other

essential items, including coaxial cables of various kinds, steel supporting or "messenger" cable, lashing wire, poles and crossarms, power transformers, and test equipment.

Preliminary tests

Every installation of a community-TV system should start with a *field survey* to determine the best site for the master antennas, since picture quality is the only product the system has for sale. There are several technical and economic factors to be considered. On the technical side, signal levels should be measured accurately under varying weather conditions and at various times of the day and night to determine maxima and minima. (Most manufacturers of community-TV equipment recommend a minimum of 100 microvolts at the antenna on each channel, although some systems are operating with daytime signals as low as 70 microvolts.) Electrical noise from power lines, automotive ignition, and FM or AM radio and television interference at the antenna site should be studied. Other important factors include airline distances to the TV transmitters; reports from neighboring set owners, if any, as to consistency of signals; distance of the proposed site from the nearest power source, and to the nearest homes; and accessibility of the site—especially in bad weather.

Antennas

Most community installations use an individual Yagi antenna for each channel to be received. Where signals are extremely weak, vertically and horizontally stacked Yagi arrays may be necessary, especially on high-band v.h.f. channels or on u.h.f. (These complex arrays are very bulky for low-band v.h.f. channels.) Corner reflectors and arrays with large numbers of driven elements backed up by "bedspring" reflectors have also proved useful for pulling in distant high-band-v.h.f. and u.h.f. stations.

Where there is room enough at the antenna site, some community-TV operators have installed rhombic antennas, but the general experience with rhombics has been disappointing. They are so highly directional that orientation is a very tricky job, and most community-antenna sites are on exposed hilltops where gales are apt to change the orientation of a rhombic without notice.

Where the signal level is reasonably good—200 microvolts or more on each channel—well-designed all-channel antennas are suitable. But individual Yagi antennas of good electrical design and sturdy mechanical construction, properly cut for each channel to be received, are probably the best and certainly the most popular types for community systems. For one thing,

most preamplifiers are designed to boost individual channels; and this makes it easier to line up each antenna for maximum signal, and it eliminates low-level mixing networks, and simplifies the problem of equalizing the output on all channels. Separate antennas also make it possible to trap out noise or interference on an individual-channel basis.

A sensible safeguard, especially where the antenna site is on a relatively inaccessible mountaintop, is to provide duplicate antennas, lead-ins, and preamplifiers, with changeover-switching facilities at the bottom of the mountain or some easily reached spot.

When installing the antennas, it is important to check reception at various heights because of the "layer" effect. Layering occurs because ground waves and reflected waves will be either additive or subtractive depending on their phase relations at various heights above the ground. For example, good signals may be received at a height of 60 feet, while 10 feet higher or lower the level may be down 10 db.

Where necessary, traps can be inserted in the lead-in cable from the antenna to eliminate interference from FM stations, amateur transmitters, or adjacent-channel TV stations. These high-Q traps, usually of the bridged-T type, pass the desired channel with minimum attenuation (1 db or less) and attenuate unwanted frequencies by 40 db or more. The lead-in-cable is generally RG-58/U coaxial; but RG-11/U cable is more suitable for runs of more than 75 feet with weak signals, especially on higher frequencies. This cable should be anchored firmly to the antenna and tower, of course, to prevent whipping in the wind. An antenna-matching network is installed when feeding a single broad-band preamplifier from several individual channel antennas, and matching transformers are used, of course, for hooking up 300-ohm antennas to 72-ohm lead-in cable.

Head-end equipment

Electronic equipment for amplifying the signals picked up at the community-antenna site includes one or more of the following three major units: preamplifier; channel converter; and output amplifier (with or without a.g.c.).

Four principal techniques have been employed with these head-end units:

1. Broad-band preamplifiers and output amplifiers. One example is the Spencer-Kennedy Laboratories' "distributed" amplifier, used without either channel converters or a.g.c. The number of broad-band preamplifiers connected in cascade at the antenna site depends, naturally, on the incoming-signal level, amplifier gain, and the output level required to overcome cable losses and deliver adequate signal to the next amplifier. As many as three SKL broad-band amplifiers have been cascaded at the antenna site. See Fig. 1.

2. Broad-band preamplifiers; "re-amplifier" with separate strips for

Fig. 1—Block diagram of SKL (Spencer-Kennedy Laboratories) community-TV antenna system. Individual-channel antennas feed up to three cascaded broadband amplifiers through a matching network.

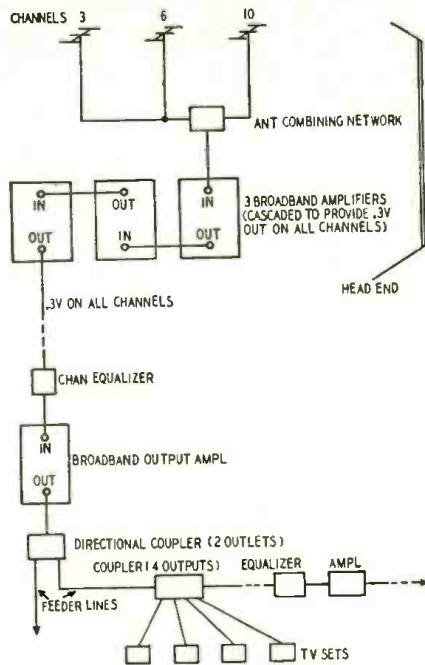

each channel and a.g.c. See Fig. 2. This combination is used in many SKL and Jerrold installations.

3. Individual-channel preamplifiers; similar strip-type re-amplifiers with output-mixing network and a.g.c. See Fig. 3. This system is used in Philco and some International Telemeter installations.

4. Individual-channel preamplifiers; high-to-low and low-to-low channel converters (either or both); similar strip-type re-amplifiers with output-mixing networks and a.g.c. See Fig. 4. RCA, Jerrold, and International Telemeter use this system.

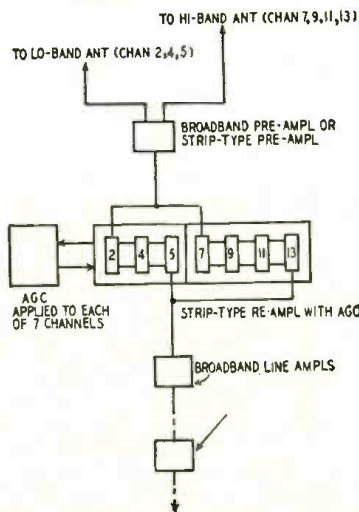

Fig. 2—A composite dual-antenna community TV system. Preamplifier feeds "re-amplifiers" with individual a.g.c. The input lines are shown at top of channel units; outputs at the bottom feed broadband amplifiers which supply signals to the distribution system.

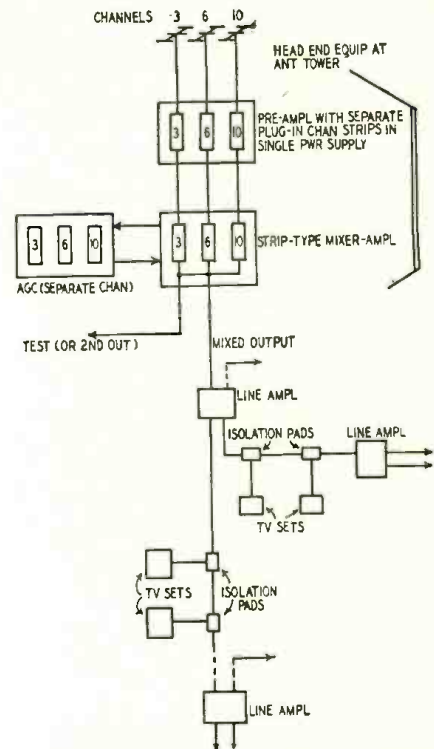

Fig. 3—Block diagram of Philco community-TV antenna distribution system.

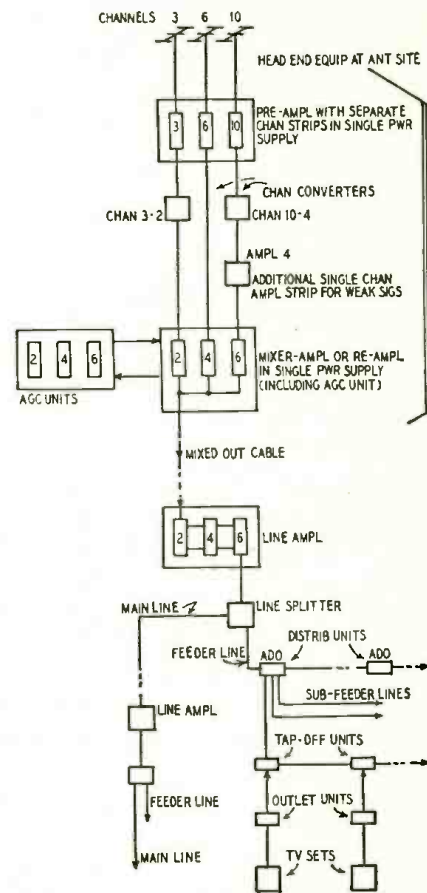

Fig. 4—Jerrold community-TV system. Channel converters eliminate high-band losses in transmission lines, and reduce adjacent-channel interference.

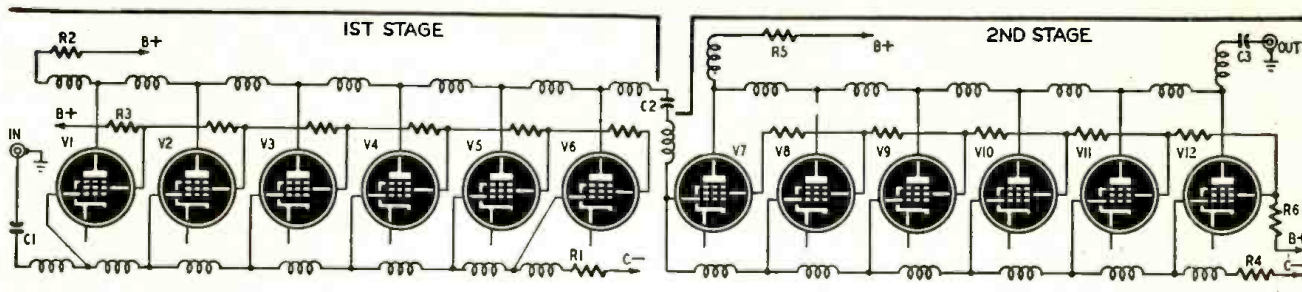

Fig. 5—The SKL "distributed" amplifier. Grid and plate networks delay signals so that all outputs are in phase.

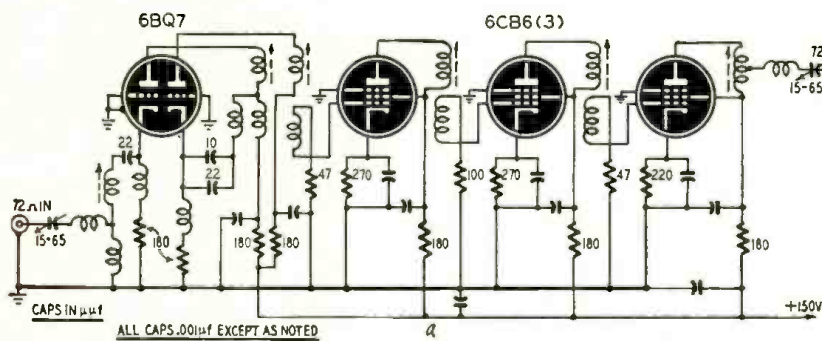

FIG. 6-a

Fig. 6—(a) Jerrold broadband amplifier for low-band TV channels (2-6). (b) High-band (7-13) version of the Jerrold broadband television amplifier.

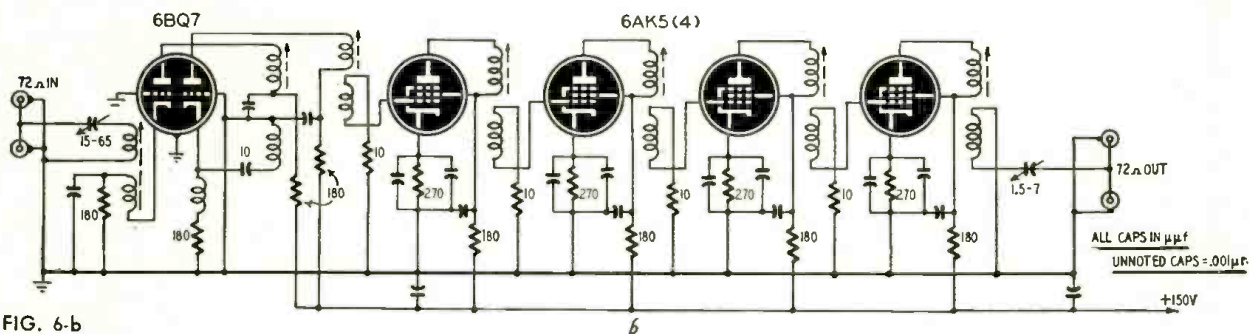

FIG. 6-b

Preamplifiers for community-TV systems generally have low-noise input circuits and voltage gains ranging from about 20 to 55 db. The object is the highest possible signal-to-noise ratio, since the first amplifier stage establishes the minimum system-noise level.

In a few cases a stage of amplification has been used in the form of a single-tube booster directly at the antenna terminals atop the tower. A unit like the Taco *Supercharger* provides a gain of up to 18 db with a single 6AK5 stage carefully tuned for maximum gain, narrow bandwidth, and high signal-to-noise ratio. Power is supplied from a small 24-volt transformer at the tower base.

Broadband preamplifiers have the advantage of covering several channels with a single unit, and provide moderate gain with a minimum number of tubes. Their disadvantages are: no gain control for individual channels; usually no method of adjusting level except by means of line pads with insertion loss; and no a.g.c.

The SKL amplifier

The SKL model 212TV chain amplifier (Fig. 5) is a two-stage "distributed" amplifier. Each stage consists of six 6AK5 tubes, with their plates and grids connected at intervals along ar-

tificial delay lines. Signals entering the input travel down the grid delay line, which is formed by inductances and the input capacitances of the tubes. Each wave of signals excites successive grids until it is finally absorbed by the grid terminating resistor. Meanwhile, an amplified wave is initiated in the plate line and travels toward the output. This forward wave increases in amplitude at each successive plate until it reaches the output.

Gain of this broad-band amplifier averages about 20 db over the entire band from 40 to 225 mc. One major advantage of this type of amplifier, in addition to its broad response, is its reliability. There is no appreciable frequency drift and failure of a tube does not mean the failure of the entire amplifier but merely a loss of about 1.6 db in gain. Drawbacks are: lower gain for a given number of tubes; no gain control for various channels, and thus the need for an equalizer; possible cumulative build-up in frequency-response errors as amplifiers are cascaded.

The Jerrold equipment

The Jerrold broad-band amplifier, model ABC-213, has separate amplifier strips for the low and high v.h.f.

bands. Both have a low-noise grounded-grid 6BQ7 input stage (Fig. 6.), followed by three 6CB6 double-tuned stages for the low band (a), and four 6AK5 double-tuned stages in the high-band strip (b). Both strips are peaked to give maximum gain at the upper end of each band. The gain of the low-band strip ranges from 28 to 37 db; high-band gain from 30 to 35 db. The output level of each strip is nominally about 0.5 volt r.m.s., but when used to amplify signals from several channels the output of each strip is kept down to about 0.2 volt to avoid cross-modulation.

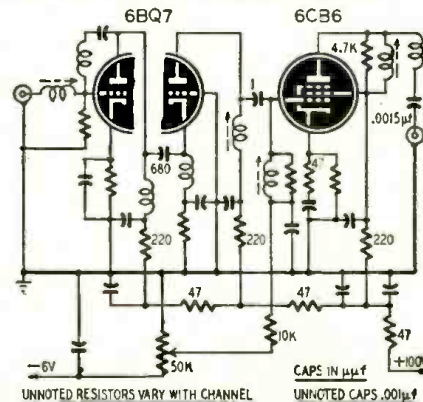

Fig. 7—Philco low-band preamplifier.

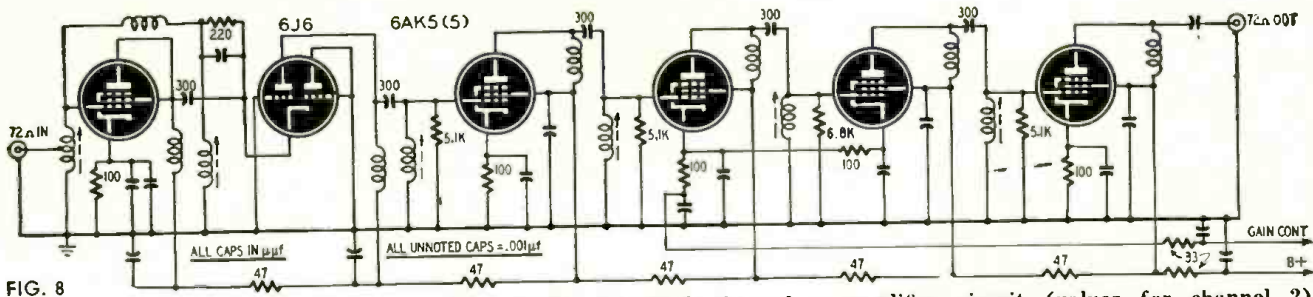

FIG. 8

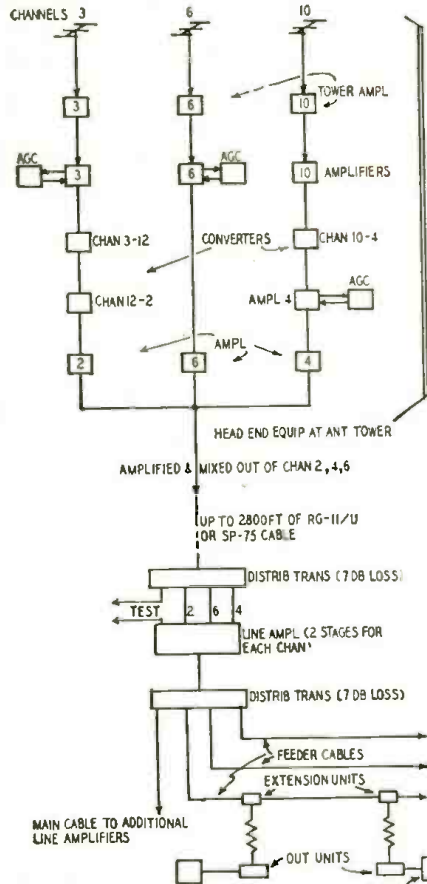

FIG. 9

Fig. 8—Jerrold single-channel preamplifier circuit (values for channel 2). Fig. 9—Block diagram of RCA community-TV antenna system. All head-end units are designed for single-channel operation. Note double-conversion arrangement for changing channel 3 to channel 12, and then back down to channel 2. Fig. 10—(a) RCA single-channel preamplifier strip for low band channels. (b) The RCA high-band single-channel preamplifier has extra r.f. stage to overcome generally lower signal levels and increased coaxial-line losses at high frequencies.

Advantages of this amplifier include fairly high gain with few tubes, compact design, and reasonably low noise figure. Disadvantages are: it is susceptible to cross-modulation in the presence of strong input signals from several channels; there is no gain control for individual channels; and failure of a single tube in either the high- or low-band strip results in loss of signals from all stations in the corresponding band.

Individual-channel preamplifiers

These are available from several manufacturers, including Philco, RCA, Jerrold, International Telemeter, and Lyn Mar Engineers.

Like the other manufacturers, Philco provides different amplifier-strip designs for the low and high v.h.f. bands. The low-band version (Fig. 7) has two tubes—a 6BQ7 cascode-type low-noise input amplifier feeding into a conventional 6CB6 r.f. stage. The high-band strip has the same input and 6CB6 stages, plus an additional 6AK5 output stage. Gain on both types of strip is controlled by varying the bias on the 6CB6 grid. Stagger tuning gives a 6-mc bandwidth, with an

average gain of about 25 db. Strips are equipped with Jones plugs for easy replacement in the power-supply chassis, a desirable feature from the standpoint of maintenance.

The Jerrold strip-type preamplifier (Fig. 8) includes a low-noise cascode input stage with a 6AK5 feeding a grounded-grid 6J6, and four stagger-tuned 6AK5 amplifier stages. Nominal gain is about 54 db on low-band channels and 48 db on the high band. Major advantage of this preamplifier is its high gain and relatively low noise. Disadvantages include a tendency toward frequency drift and thus need for realignment; cross-modulation unless input and output levels are held within close limits; loss of reception from one channel in case of failure of one tube.

The RCA tower preamplifier is designed to operate with a channel converter, if required, and is planned for one-, two-, or three-channel operation. In a typical installation (Fig. 9), the preamplifier strips or input amplifiers (Figs. 10-a and 10-b) are stagger-tuned for a 6-mc bandwidth, and consist of three cascaded 6AK5 stages for the low band, with an extra 6AN5 output stage for added gain on the high band. Total gain of the RCA tower-amplifier system, including input-amplifier strip, converter, and output-amplifier strip (similar to Fig. 10-a), is about 60 db, with an output level of about 1.25 volts. Merits and demerits of these amplifiers are similar to those made by Jerrold, except that the stability of the RCA design is somewhat greater and there is gain in the converter stage instead of loss.

(TO BE CONTINUED)

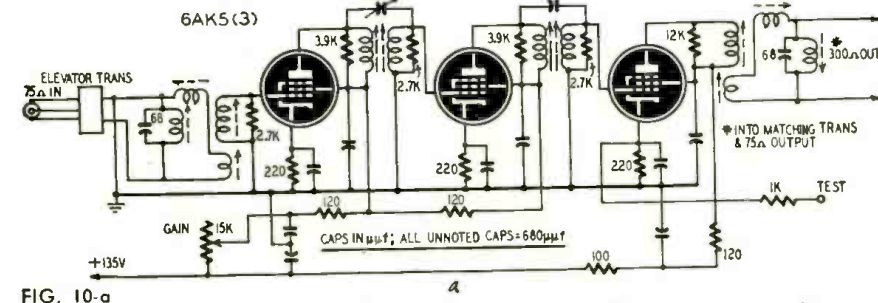

FIG. 10-a

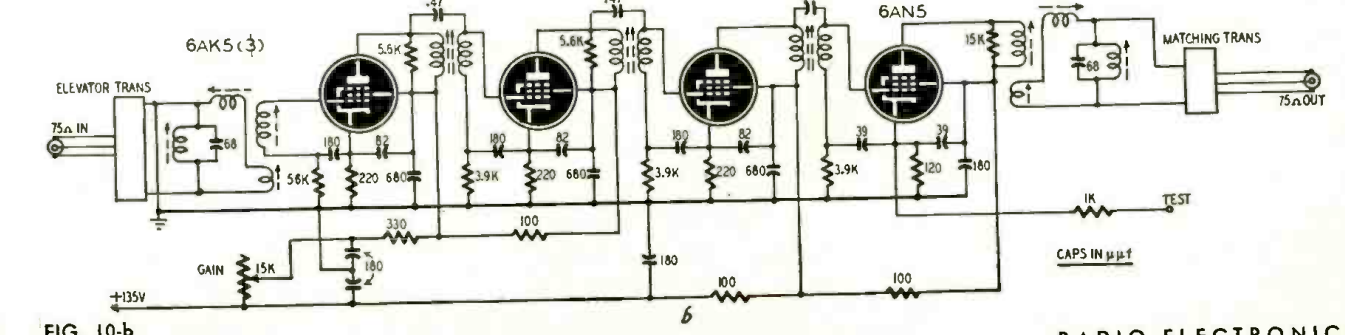

FIG. 10-b



Left-hand foldover caused by excessive plate voltage on the horizontal oscillator in a Synchroguide sweep system.

A NUMBER of readers have asked about the advantages of tilting antennas in ultra-fringe areas. This may reduce fading and improve the signal strength for stations beyond the line of sight. The same holds true for nearer stations in mountainous terrain where the signal arrives at an angle above the horizontal. In some instances, tilting the antenna upward 15 to 20 degrees has improved reception to a considerable extent.

Several factors must be considered. A dipole antenna with a reflector has the vertical-directivity pattern shown in Fig. 1 (looking at the antenna from the side). Single-bay antennas have a fairly broad pickup so that the reduction in strength for a signal arriving at an angle *B* or *C* is not too severe. When directors are added to such an antenna to form a Yagi the pattern elongates and becomes narrower as shown in Fig. 2. Here an upward tilt would be very helpful if signals arrive at an angle above the horizontal.

When Yagi antennas are stacked, as shown in Fig. 3, the vertical-directivity pattern becomes extremely narrow, and virtually no signal would be received if it arrived at the angle *C*. This is why stacked antennas sometimes give poor reception in ultra-fringe areas

*Author: Mandl's Television Servicing

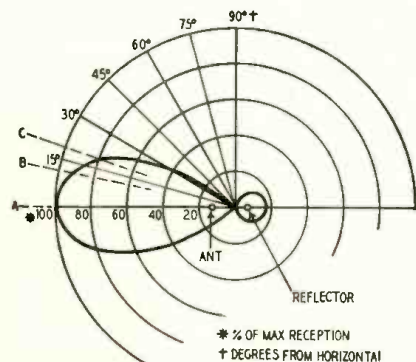

Fig. 1—Vertical-directivity pattern of a horizontal dipole with reflector. The principal lobe offers little discrimination against signals from *B* and *C*.

even though stacking gives a 3-db increase in forward sensitivity. For the same reason, increasing the antenna height may improve reception little unless it is possible to raise the antenna high enough to intercept the line-of-sight transmission.

The advantages of stacking of course can be realized by tilting the stacked array in the same way as the single-bay antenna. The vertical-tilt orientation will be more critical with a stacked array, though a 15-degree tilt is a good average for flat terrain beyond the line of sight. When the signal comes over a mountain top, the angle will have to be set experimentally for best average results. If the mountain is some distance from the receiver the tilt angle can be determined before the antenna is attached to the mast. One technician can hold the antenna and tilt it at several angles between 10 and 30 degrees, while another checks performance at the receiver.

A simpler method would be to use a field-strength meter on the roof-top. After the proper tilt angle has been established the antenna can be mounted 20 to 30 feet above the site without too great a change in the angle of the arriving signal.

W. S. Huffmire reports some interesting results in an area entirely sur-

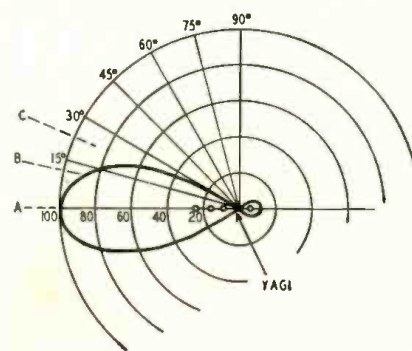

Fig. 2—Narrower vertical-directivity pattern obtained by adding director elements. The response to signals arriving from *C* has been reduced about 50%.

rounded by 500-foot hills. Vertical-tilt effects were obtained by installing horizontal antennas $\frac{1}{2}$ or $1\frac{1}{2}$ wavelengths above ground. This creates two main lobes at equal angles to the horizontal. (See Fig. 4.)

Trailing bars

In an RCA 17T201 receiver the picture is smeared horizontally by dark shadow bars running from edge to edge of the raster. These bars show when a white or very light object appears against a neutral background in a scene. Shadows appear as a faint gray in pictures of little contrast, but in pictures of great contrast the bars show up almost black. These bars are the exact height of the white object in the scene and follow any motion made by the object. This trouble does not appear until the set is in operation long enough to warm up. I would appreciate any advice you can give me regarding possible causes of this trouble. E. H., Corona, Calif.

Trailing smears and bars which follow the motion of objects on the screen are usually caused by troubles in the video-detector and video-amplifier circuits. The tubes should be checked and a new video-detector crystal should be installed. Also check the coupling capacitors in the video-amplifier circuits

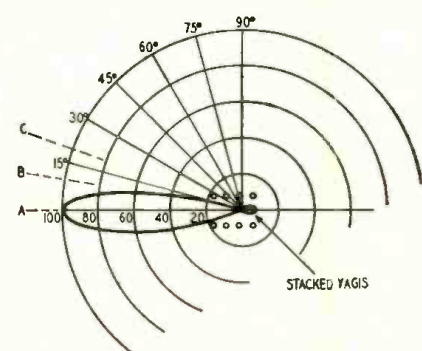

Fig. 3—Stacked Yagis boost forward gain, but the extremely narrow principal lobe reduces the response to signals arriving from other directions.

and values of the load resistors, particularly the one in the video-detector circuit. An abnormal increase in the value of load resistors or leaky coupling capacitors can affect the phase

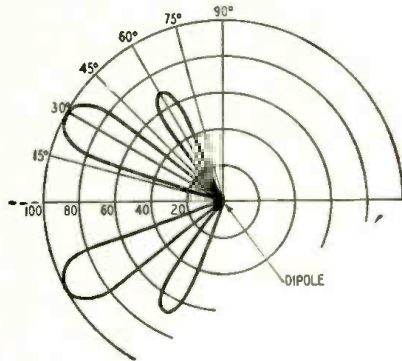

Fig. 4—Mounting a half-wave horizontal dipole at a multiple of one-half wavelength above the ground splits the main forward lobe into two or more tilted lobes. These improve pickup of signals arriving at vertical angles.

shift and frequency response enough to cause the condition you described. If these procedures do not help, check the peaking coils.

Operation on 50-cycle lines

We have encountered a difficult problem in television receivers in this area. Our alternating current is 50-cycle, and television receivers designed for 60 cycles have a 10-cycle flicker which is very annoying. Increasing the filter capacitance does very little to eliminate the defect. Many service technicians have been removing the power transformer, rectifier tube, and filter capacitors and placing them on a separate chassis. This, however, is expensive and an unsightly solution. We also have trouble with small radios as well as record players. What can be done with the latter to bring the speed up to normal and keep the heating down to a safe limit? F. B., Mexico.

The better-grade radios which are marked "50-60 cycle" operation will work on either frequency because the power transformer and filter components have been designed for such operation. In many cheaper sets the power transformer just barely meets the requirements for 60 cycles and overheats on 50-cycle operation. Proper operation at 50 as well as 60 cycles requires a transformer with a greater core area or a larger number of turns per volt. Windings designed for 60 cycles have less inductive reactance at the lower frequency and draw excessive current.

The problem is not too serious in a radio, provided the low-voltage power supply has adequate filtering. A record player with a 60-cycle synchronous motor trouble will not run at the right speed at a different line frequency.

The increase in the voltage-boost potential resulting from the conversion has upset the horizontal oscillator circuit. Check the voltages in the hori-

zontal oscillator control and horizontal oscillator stages against those given in the service notes for this receiver. If the voltages are correct, align the synchroguide system with an oscilloscope according to the step-by-step procedure given in the service notes. The hold control will then give good stability at its center range. Do not adjust the hold control to position the picture, because this will cause the foldover again. Picture positioning must be done with the focus-coil assembly.

The only solution is to install a 50-cycle phonograph motor (or a non-synchronous, adjustable-speed type) and power transformer.

In television receivers the flicker results from the frequency and phase difference between the 60-cycle vertical sweep and the 50-cycle line voltage. Additional B plus filtering may help, but often sufficient hum is introduced by the fields of the filter choke and power transformer to produce the flicker. As you pointed out, service technicians have found a partial solution in rewiring the unit so that the power supply is separate from the main chassis. This puts sufficient distance between sensitive circuits and the fields generated in the power supply to minimize flicker.

Channel-49 Yagi

Please give me dimensions for constructing a channel-49 Yagi. Is it possible to modify an existing 8-element channel-13 Yagi for channel 49? J. P., Winchester, Ind.

There is a considerable difference in dimensions between the two types and the change-over entails entire rebuilding. Fig. 5 gives the dimensions for a channel-49 Yagi. The two inner directors should be 7.7 inches in length and the last director is cut slightly shorter for increased sound reception for this

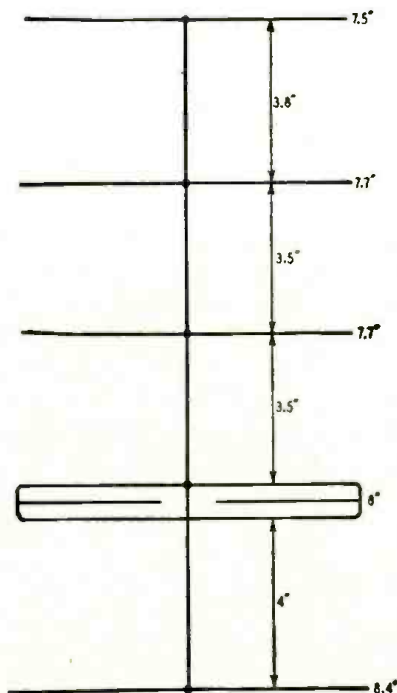

Fig. 5—Dimensions of channel-49 Yagi.

channel. When more directors are added, gain increases, bandwidth decreases, and orientation is more critical.

The double-folded dipole compensates for the drop in impedance which results from adding directors to a dipole.

No horizontal hold

The horizontal hold does not work properly in a Philco 49-1040 TV receiver. The picture slips and a black bar appears in the center of the screen. —J. D., Minneapolis, Minn.

From your description the trouble may be in the 270- μ f capacitor between a section of the horizontal oscillator transformer and the 7N7 blocking oscillator. Replace it with a 270- μ f mica or ceramic type. Replacing the 7N7 horizontal oscillator tube may also cure the defect. All the resistors in this circuit section are critical and should be of 10% tolerance or less. Adjusting both sides of the transformer is necessary after changes are made.

H.v. in Philmore

In a Philmore there is no high voltage. The 1B3-GT fails to light, when in the set, although it lights when tested externally. I have checked all the tubes from the horizontal oscillator through the horizontal output and high-voltage systems. All check good and the d.c. voltages on them are within normal tolerance. I have replaced the flyback transformer. What else could cause this? J. C., Pensacola, Florida.

As you have checked all tubes and voltages in the horizontal section the trouble must be caused by a defective component part. The horizontal oscillator is probably not generating the necessary sweep signals. If this stage is not oscillating there will be no horizontal sweep and no high voltage. There may also be a defective component in the discharge circuit which is preventing the formation of a sawtooth. The best way to isolate the defective stage is to use your oscilloscope to find out whether the loss of signal occurs after the oscillator or after the discharge tube. Then check resistors and capacitors until the defective one is found.

Attic antenna

We would like your opinion regarding the effect of a slate roof on an antenna installation in an attic. In an area where signal strength is high and indoor antennas work well, would the slate roof diminish signals to a considerable extent? In one installation we got considerable snow where a slate roof was overlaid with a layer of asphalt shingles. J. D., Agawam, Mass.

Slate diminishes signals to a much greater extent than asphalt shingles. The slate and asphalt combination you mentioned would give poor results. You would find a considerable difference in reception with an outdoor antenna even though it is no higher than the antenna under the slate roof. The slate acts as a partial reflecting surface for high frequencies. END

Luhf growing pains mark first year of unfreeze

By ERIC LESLIE

JULY 1, 1952, was the historic date on which the FCC lifted the ban on new TV-station construction and brought in our present "third period" of TV expansion. On that date there were 109 TV stations on the air.

Only 11 days later, the first construction permits (coincidentally 11 in number) were granted. One of these was for Denver's KFEL-TV (channel 2) and one for Portland's KPTV (channel 27). These were the first post-freeze v.h.f. and u.h.f. stations to get on the air.

And it didn't take them long to get going. KFEL-TV hit the air with test programs on July 18, less than three weeks after the freeze was lifted. The first u.h.f. station, KPTV, started broadcasting September 18, and the third post-freeze station (Denver again, KBTU on channel 9) went on the air October 2. From then on, new stations started transmitting in such numbers that their openings attracted little attention outside their own service areas.

In spite of tests carried on for more than two years at Bridgeport and elsewhere, no one was willing to stick his neck out and predict what would happen on the new u.h.f. TV band. There was more than a little quiet skepticism about u.h.f. in the industry. The best indication of the broadcasters' attitude was a frantic rush for v.h.f. assignments and a relative coolness toward allocations in the u.h.f. spectrum.

But when KPTV started broadcasting, it became apparent that the situation was not going to be so bad after all. Coverage was actually somewhat greater than had been expected, though shadow effect was exactly as bad as had been predicted. It rapidly became clear that TV owners with a tall hill between them and the transmitter would have to keep on going to the movies for visual entertainment.

The antenna problem—another of the great unknowns—was not as hard to crack as expected. A simple u.h.f. antenna would—if the lead-in was not too long—bring in a satisfactory signal in good locations. Some TV owners near the station found it quite possible to get good pictures with indoor antennas—the old familiar rabbit ears.

Portland's success was somewhat marred because it immediately became a testing ground for all the new u.h.f. equipment developed up to that time, much of which was unsatisfactory. But

it was a great triumph for u.h.f., and swung the spirits of the promotional experts from pessimism to extreme optimism. Customers in newer areas were assured that u.h.f. was a cinch—no outdoor antenna needed, no interference as on v.h.f.—in fact no problems at all! To which the outraged purchaser often had to add—no picture! Previous pessimism had harmed Portland by making dealers over-careful about stocking up on u.h.f. equipment, with the result that there was a near-famine when the station opened. Optimism did far more damage in later u.h.f. areas by letting down set owners who had been talked into inadequate setups by salesmen who knew no more about the facts of life on the u.h.f. band than the customer did. Once he got the idea—from the results he got in his own home and at his own expense—that u.h.f. TV was *not* good, he became a very effective barrier to new sales to his neighbors, and it was only when his own installation had been straightened out that the overdue u.h.f. antennas blossomed out on other houses in the vicinity.

Transmitters contributed their share to the snarl. All started out with less power than had been considered sufficient for adequate coverage. And more than one had difficulty in maintaining even that power. Variations from day to day—or even hour to hour—as tubes or other components moved toward breakdown caused the customer to blame alternately his receiver, the conditions, the transmitter, and himself for letting himself be talked into u.h.f. TV.

A little experience straightened out most of the earlier problems. After the first few days of broadcasting the capabilities and limitations of various antennas, tuners, and converters were pretty well pinpointed. Within a month or so the transmitters were working with reasonable regularity. And the public had learned to be very skeptical of *anyone's* claims. Servicing u.h.f. receivers is still full of unsolved problems, but the technician has lost his fear of them. He knows that the bulk of the troubles occur in the body of the receiver and not in the front end—exactly as with v.h.f. sets. And when troubles do occur in the front end, they

can be remedied merely by replacing a tube as often as in sets built for the lower frequencies.

The question of coverage has been at least partly settled—though possibly increases in transmitter power may reopen it in some locations, and the effect of foliage in heavily wooded areas may make the summer and winter patterns somewhat different. Experience with the first few stations indicates that a good signal may be expected up to about 30 miles over relatively flat, clear terrain. Good signals may be laid down even at 40 miles, in some places, but somewhere between those two distances we are likely to run into the limit of practical reception unless transmitter or receiver antenna sites are exceptional.

And above all things, u.h.f. *does not* render the outdoor antenna unnecessary. This fallacy was probably responsible for more unhappiness than any combination of other misconceptions. Not only is a good outdoor antenna needed in the majority of installations, but the boys who have been putting them up say that each u.h.f.-antenna installation is likely to be a highly individual job, with small variations adding up to big differences in results obtained. Even more than in the case of v.h.f., the antenna is the most important part of the receiver.

In the earliest installations, some of the best-publicized types of antennas and lead-ins gave very poor results, in spite of all the skill and care of the technician. But by now, the types that do not work well on u.h.f. have been pretty well weeded out, and are no longer likely to be an important factor. The same goes for converters. Some of those used at Portland worked—others did not. But because Portland by that very fact became the laboratory of u.h.f., manufacturers have been able to correct equipment weaknesses, and the technician is not likely to run into the same troubles with components in the future. Would that as much could be said for the claims of the "sales engineers" whose statements never seem to have been de-bugged, no matter how often contradicted by the evidence of actual reception.

All TV stations in operation as of May 26 are listed on page 44.

Alabama

WAFM-TV	Birmingham	13
WBRC-TV	Birmingham	6
WALA-TV	Mobile	10
WKAB-TV	Mobile	48
WCOV-TV	Montgomery	20

Arizona

KTYL-TV	Mesa (Phoenix)	12
KPHO-TV	Phoenix	5
KOPO-TV	Tucson	13

Arkansas

KRTV	Little Rock	17
------	-------------	----

California

KMJ-TV	Fresno	24
KECA-TV	Los Angeles	7
KHJ-TV	Los Angeles	9
KLAC-TV	Los Angeles	13
KNBH	Los Angeles	4
KNXT	Los Angeles	2
KTLA	Los Angeles	5
KTTV	Los Angeles	11
KFMB-TV	San Diego	8
KGO-TV	San Francisco	7
KPIX	San Francisco	5
KRON-TV	San Francisco	4
KVEC-TV	San Luis Obispo	6

Colorado

KKTV	Colorado Springs	11
KBTV	Denver	9
KFEL-TV	Denver	2
KDZA-TV	Pueblo	3

Connecticut

WICC-TV	Bridgeport	43
WKNB-TV	New Britain	30
WNHC-TV	New Haven	6

Delaware

WDEL-TV	Wilmington	12
---------	------------	----

District of Columbia

WMAL-TV	Washington	7
WNBW	Washington	4
WTOP-TV	Washington	9
WTTG	Washington	5

Florida

WFTL-TV	Fort Lauderdale	23
WMBR-TV	Jacksonville	4
WTVJ	Miami	4
WSUN-TV	St. Petersburg	38

Georgia

WAGA-TV	Atlanta	5
WLWA	Atlanta	8
WSB-TV	Atlanta	2

Hawaii

KGMB-TV	Honolulu	9
KONA	Honolulu	11

Illinois

WBMM-TV	Chicago	4
WBKB	Chicago	7

WGN-TV	Chicago	9
WNBQ	Chicago	5
WEEK-TV	Peoria	43
WTVO	Rackford	39
WHBF-TV	Rack Island	4

Indiana

WTTV	Bloomington	10
WFBM-TV	Indianapolis	6
WFAM-TV	Lafayette	59
WLBC-TV	Muncie	49
WSBT-TV	South Bend	34

Iowa

WOI-TV	Ames	4
WOC-TV	Davenport	6
KVTV	Sioux City	9

Kentucky

WAVE-TV	Louisville	3
WHAS-TV	Louisville	11

Louisiana

WAFB-TV	Baton Rouge	28
WDSU-TV	New Orleans	6

Maine

WABI-TV	Bangor	5
---------	--------	---

Maryland

WAAM	Baltimore	13
WBAL-TV	Baltimore	11
WMAR-TV	Baltimore	2

Massachusetts

WBZ-TV	Boston	4
WNAC-TV	Boston	7
WHYN-TV	Holyoke	55
WWLP	Springfield	61

Michigan

WPAG-TV	Ann Arbor	20
WBKZ-TV	Battle Creek	64
WWJ-TV	Detroit	4
WJBK-TV	Detroit	2
WXYZ-TV	Detroit	7
WOOD-TV	Grand Rapids	7
WKZO-TV	Kalamazoo	3
WJIM-TV	Lansing	6
WKNX-TV	Saginaw	57

Minnesota

WFTV	Duluth	38
KSTP-TV	Minneapolis-St. Paul	5
WCCO-TV	Minneapolis	4

Mississippi

WJTV	Jackson	25
------	---------	----

Missouri

WDAF-TV	Kansas City	4
KSD-TV	St. Louis	5
KTTS-TV	Springfield	10

Nebraska

KFOR-TV	Lincoln	10
KOLN-TV	Lincoln	12
KMTV	Omaha	3
WOW-TV	Omaha	6

New Jersey

WFGP-TV	Atlantic City	46
WATV	Newark	13

New Mexico

KOB-TV	Albuquerque	4
--------	-------------	---

New York

WNBF-TV	Binghamton	12
WBEN-TV	Buffalo	4
WTVE	Elmira	24
WABC-TV	New York	7
WABD	New York	5
WCBS-TV	New York	2
WNBT	New York	4
WOR-TV	New York	9
WPIX	New York	11
WHAM-TV	Rochester	6
WRGB	Schenectady	4
WSYR-TV	Syracuse	5
WHEN	Syracuse	8
WKTV	Utica	13

North Carolina

WBTV	Charlotte	3
WFMY-TV	Greensboro	2

North Dakota

WDAY-TV	Fargo	6
KCJB-TV	Minot	13

Ohio

WAKR-TV	Akron	49
WCPO-TV	Cincinnati	9
WKRC-TV	Cincinnati	12
WLWT	Cincinnati	5
WEWS	Cleveland	5
WNBK	Cleveland	4
WXEL	Cleveland	9
WBNS-TV	Columbus	10
WLWC	Columbus	3
WTVN	Columbus	6
WHIO-TV	Dayton	7
WLWD	Dayton	2
WLOK-TV	Lima	73
WSPD-TV	Toledo	13
WFMJ-TV	Youngstown	73
WKBN-TV	Youngstown	27
WH-12-TV	Zanesville	50

Oklahoma

KSWO-TV	Lowton	7
WKY-TV	Oklahoma City	4
KOTV	Tulsa	6

Oregon

KPTV	Portland	27
------	----------	----

Pennsylvania

WFBG-TV	Altoona	10
WLEV-TV	Bethlehem	51
WICU	Erie	12
WHP-TV	Harrisburg	55
WJAC-TV	Johnstown	6

WGAL-TV	Lancaster	8
WKST-TV	New Castle	45
WCAU-TV	Philadelphia	10
WFIL-TV	Philadelphia	6
WPTZ	Philadelphia	3
WDTV	Pittsburgh	2
WEEU-TV	Reading	33
WHUM-TV	Reading	61
WBRE-TV	Wilkes-Barre	28
WSBA-TV	York	43

Rhode Island

WJAR-TV	Providence	11
---------	------------	----

South Carolina

WCOS-TV	Columbia	25
---------	----------	----

South Dakota

KELO-TV	Sioux Falls	11
---------	-------------	----

Tennessee

WMCT	Memphis	5
WSM-TV	Nashville	4

Texas

KFDA-TV	Amarillo	10
KGNC-TV	Amarillo	4
KTBC-TV	Austin	7
KRLD-TV	Dallas	4
WFAA-TV	Dallas	8
KROD-TV	El Paso	4
KTSM-TV	El Paso	9
WBAP-TV	Fort Worth	5
KGUL-TV	Galveston	11
KPRC-TV	Houston	2
KUHT	Houston	8
KCBD-TV	Lubbock	11
KDUB-TV	Lubbock	13
KEYL	San Antonio	5
WOAI-TV	San Antonio	4
KFDX-TV	Wichita Falls	3
KWFT-TV	Wichita Falls	6

Utah

KDYL-TV	Salt Lake City	4
KSL-TV	Salt Lake City	5

Virginia

WLVA-TV	Lynchburg	13
WTAR-TV	Norfolk	4
WTVR	Richmond	6
WROV-TV	Roanoke	27
WSLS-TV	Roanoke	10

Washington

KVOS-TV	Bellingham	12
KING-TV	Seattle	5
KHQ-TV	Spokane	6
KXLY-TV	Spokane	4
KTNT-TV	Tacoma	11

West Virginia

WSAZ-TV	Huntington	3
---------	------------	---

Wisconsin

WBAY-TV	Green Bay	2
WTMJ-TV	Milwaukee	3

Stations in boldface type are post-freeze; earlier stations are in lightface.

Advanced SCOPE TECHNIQUES

By LOUIS E. GARNER, JR.

help you
interpret what you
see—and broaden
the range of jobs
you can handle

WITHOUT question, the cathode-ray oscilloscope is the most versatile piece of test equipment available to the radio-television technician, the experimenter, and the laboratory engineer. In laboratory work, the scope is generally used to the limit of its capabilities. Too often, however, the average experimenter and the service technician use the scope only for observing waveforms or measuring frequencies by means of Lissajou figures. This failure to take advantage of the scope's potentialities is due in part to the rather sketchy instructions generally supplied with the instrument, and in part to the operator's lack of familiarity with his instrument.

A review of scope techniques used in engineering laboratories may prove helpful. The use of Lissajou figures, which is adequately covered in standard texts and instruction manuals, will be omitted.

Deflection polarity

It is often important to know whether the upper half-cycle of a signal seen on a scope is the positive or negative half-cycle in the original. Referring to Fig. 1, if the upper half-cycle of

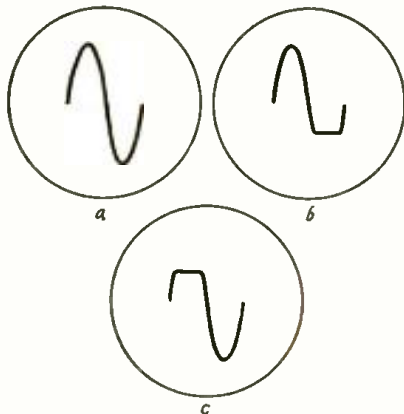

Fig. 1—(a) Sine-wave scope trace discussed in the text. (b) Clipped negative half-cycle due to excessive bias. (c) Clipped positive half-cycle caused by insufficient bias or low plate voltage. Traces b and c may be confused if scope's deflection polarity is not known.

the sine wave (a) is the positive half of the original signal, then the wave shapes shown in Figs. 1-b and 1-c indi-

cate different causes of distortion. 1-b may be caused by excessive bias on an amplifier stage, so that the tube is driven beyond cutoff on negative half-cycles. 1-c may be caused by inadequate bias or too low plate voltage.

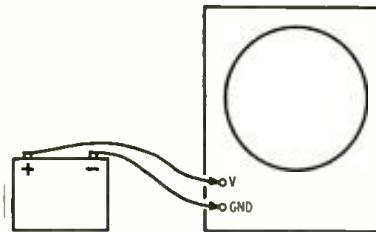

Fig. 2—Setup for checking deflection polarity of an oscilloscope. See text.

On the other hand, if the upper half-cycle seen on the scope is the negative half-cycle of the original wave, the causes for conditions 1-b and 1-c are reversed.

Thus, when using a scope, it is important to know whether a positive signal deflects the spot upward or downward. Either situation may exist, depending on the number of amplifier stages in the scope and exactly how the vertical-deflection plates are connected to the amplifier.

The simple technique illustrated in Fig. 2 may be used to determine the deflection polarity of any scope. Any ordinary dry cell or B battery can be used. Connect the negative terminal of the battery to the GND terminal of the scope, turn on the scope sweep, turn up the vertical-gain control, and center the trace. Next, touch the positive battery terminal to the VERTICAL-INPUT terminal, watching the scope face closely. The line will be deflected momentarily either up or down, then will return to center.

If the deflection is upward, then the positive half-cycle of any observed signal will appear on the upper part of the scope screen, and vice versa.

Keep your eyes on the screen when making this test, since the deflection occurs only at the instant the battery terminal is touched to the input.



A commercial oscilloscope with built-in 10-range voltage source and meter for peak-to-peak screen-scale calibration.

Calibrating the sweep in microseconds: In studying complex waveforms, it is often desirable to know the duration of a pulse, or even of a complete complex cycle, as shown in Fig. 3-a. In some types of analysis, the rise time of a sharp pulse (Fig. 3-b) must be known accurately.

Some expensive scopes have provision for making such measurements in the form of a sweep calibrated directly in microseconds per inch-deflection. However, even ordinary scopes can easily be calibrated for specific applications by using the technique shown in Fig. 4.

Connect an ordinary signal generator to the VERTICAL-INPUT terminals of the scope, set the frequency to the desired value, and adjust the scope sweep until one cycle occupies a fixed number of squares on the scope scale. When

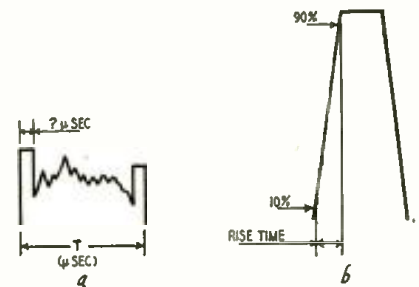

Fig. 3—Representative waveforms whose duration may have to be measured. (a) Complex wave. (b) Pulse-waveform display levels for measuring rise time.

adjusting the scope sweep, use the smallest possible amount of sync, and obtain the single cycle by careful adjustment of the FINE-FREQUENCY control. This insures that the scope sweep is accurately on frequency. If too much sync gain is used, the signal to be checked may give a false indication by saturating the sync circuit. This will cause a change in the scope sweep frequency.

As an example, if the scope sweep is

adjusted until one cycle of a 100-kc signal occupies ten horizontal spaces on the screen, then each space represents 1 microsecond. If a sharp pulse is then observed (signal generator disconnected), and it rises from 10% to 90% of its peak value in the space of one-half a square, its rise time is 0.5 microsecond.

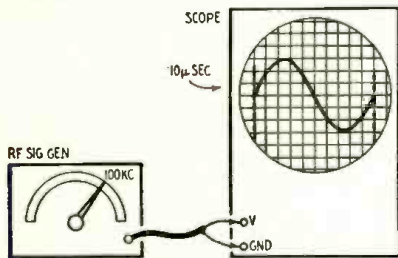

Fig. 4—Equipment setup for calibrating scope screen in time units. One complete cycle of a 100-kc signal is expanded horizontally to occupy 10 scale divisions. Each scale division then represents one microsecond. Higher or lower frequencies may be used for measuring other time units where required.

The relationship between the frequency of the calibrating signal and the time duration of one cycle in microseconds is:

$$T = \frac{1,000,000}{f \text{ (c.p.s.)}}$$

If the scope is to be calibrated so that ten spaces represent one microsecond, a single cycle of 1-mc signal is made to occupy that much space by adjusting the internal sweep. Other values are given below:

Time for One Cycle	Sweep Frequency
10,000 microseconds	100 cps
1,000 microseconds	1,000 cps
100 microseconds	10,000 cps
10 microseconds	100,000 cps
1 microsecond	1 megacycle
0.1 microsecond	10 megacycles

Most older scopes, and many of the less expensive scopes of today, use thyatron sweep circuits. These have an upper sweep limit of about 30 kc, so that a single cycle at 100 kc or 1 mc cannot be observed. However, a satisfactory calibration may still be obtained by adjusting the sweep till several cycles are observed, then expanding the trace with the HORIZONTAL-GAIN control until one cycle occupies the desired number of squares on the scope graph screen.

This brings up another important technique:

Obtaining linear sweep

In many scopes the internal sweep is not linear at its high- and low-frequency extremes. This condition distorts signals, and causes crowding at one or both ends of the trace, as illustrated in Fig. 5-a.

Generally, a portion of the sweep will be reasonably linear. The technique, then, is to expand the trace horizontally until it oversweeps the screen, as shown in Fig. 5-b, and to use only the desired linear portion. The sweep frequency can be increased until the smallest possible number of undistorted

complete cycles occupy the full width of the cathode-ray tube screen.

Measuring peak voltages

The technique shown in Fig. 6 may be used for calibrating the vertical amplifier of an oscilloscope for direct measurement of a.c. voltages, and is particularly valuable for checking peak-to-peak voltages of complex signals such as are found in a TV receiver.

A known a.c. voltage (from a filament transformer in this case) is applied to the VERTICAL-INPUT terminals of the scope, and the VERTICAL-GAIN control is adjusted until the signal occupies the desired number of vertical divisions on the graph screen. With the gain control left in this position, the deflection obtained with any other signal indicates the peak (or peak-to-peak) voltage exactly.

As an example, the peak-to-peak value of a 6.3-volt (r.m.s.) signal is 18 volts. If a 6.3-volt signal is applied to the scope input, and the VERTICAL-GAIN control is adjusted until the trace occupies 18 vertical divisions, each square represents 1 volt. Thus, if an-

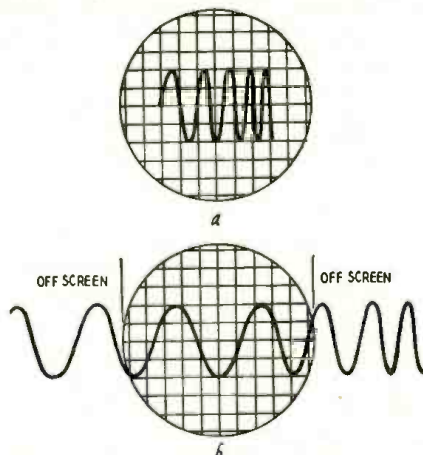

Fig. 5—(a) Nonlinear scope sweep compresses part of horizontal display. (b) Expanding the horizontal trace to show only undistorted cycles on the screen.

other signal is observed without changing the position of the gain control, and a deflection of two squares is obtained, the new signal has a peak-to-peak value of 2X1, or 2 volts.

To determine the peak-to-peak value of any calibrating voltage (and hence the value in volts represented by each square of the scope screen for a particular gain setting), simply measure the voltage with an accurate a.c. voltmeter and multiply the indicated voltage by 2.82 (3 may be used for most practical work). This assumes, of course, that a sine-wave signal is used for calibration.

Plotting curves

The scope may be used to plot any curve showing the relationship between two varying electrical quantities, or between any two related quantities that can be converted into proportional voltages. As an example, the setup shown in Fig. 7 may be used for obtaining a B-H or hysteresis-characteristic curve

of a transformer core made of iron or other magnetic materials.

The voltage across R1 is proportional to the current in L1 and thus is proportional to the magnetomotive force. The voltage induced in L2 is proportional to the derivative of the magnetic flux . . . that is, to the number of flux lines produced. An integrating network consisting of R2 and C1 is used to obtain a voltage proportional to the

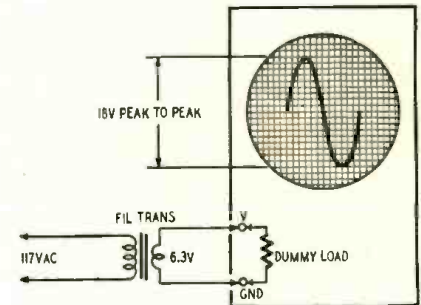

Fig. 6—Calibrating the oscilloscope screen for peak-to-peak voltage measurements. Dummy load should be adjusted so that an accurate r.m.s. voltmeter across the input terminals reads exactly 6.3 volts.

lines of flux, and this is applied to the vertical input of the scope.

Thus, since the horizontal deflection of the spot on the C-R tube is proportional to magnetomotive force (input current), and the vertical deflection is proportional to the number of flux lines produced, a conventional B-H curve is traced on the scope screen.

In an actual setup, the input voltage to the transformer is controlled by a Variac or a large wirewound potentiometer (about 600 ohms at 50 watts). R1 should be kept as small as practicable—about 50 to 200 ohms generally being used. If preferred, a 75-watt lamp may be used in place of R1. R2 may have a value of 10,000 ohms, and C1 should be a 4-μf paper unit.

Satisfactory curves can still be obtained if the integrating network R2-C1 is replaced simply by a load resistor R3. This load is necessary to prevent core saturation with low exciting current in the primary. Without a load (or integrating network), the flux density

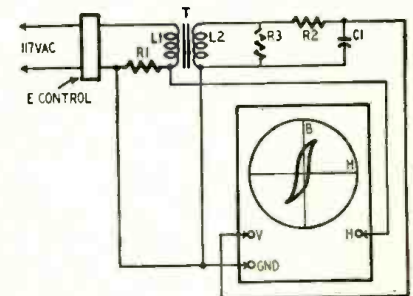

Fig. 7—Equipment setup for checking hysteresis characteristics of iron and transformer core. See text for details.

will be driven beyond saturation on peaks, and a distorted hysteresis loop will result. The exact load value can be determined experimentally for the transformer but 10,000 ohms is usually satisfactory for a start. END

Test Crystals with your Signal Generator

By RONALD L. IVES

An easy modification that can also supply TV-marker frequencies

NEARLY every amateur operator and serious experimenter has a simple AM signal generator—usually a variable-frequency r.f. oscillator with a fixed-frequency audio oscillator for modulation. Amateurs especially generally need some type of crystal tester or harmonic generator as well. This is usually a “Rube Goldberg” assembly of junk-box parts, capable only of emitting the fundamental and harmonics of the crystal under test.

Typical circuits of a signal generator (a) and a crystal oscillator (b) are shown in Fig. 1. Since many of the components—including the power supply—are the same for both circuits, the signal generator can be made to perform all the functions of the crystal oscilla-

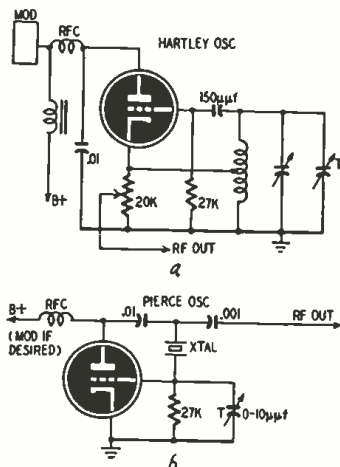
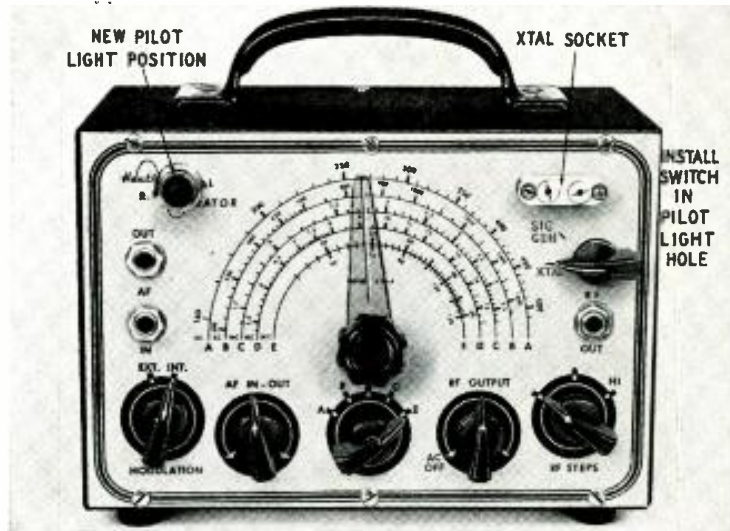

Fig. 1—Typical oscillator circuits. (a) Hartley oscillator used in many signal generators. (b) Pierce crystal oscillator preferred for high harmonic output.

tor—and even modulate the crystal output—by simply adding a 4-pole, 2-position switch, a crystal socket, a small trimmer, and a fixed capacitor. The circuit of the combination signal generator-crystal oscillator is given in Fig. 2.

Arrange the components so that all leads carrying r.f. are as short as possible, to minimize changes in the calibration of the signal generator. The trimmer C1 is not always necessary with triodes, except with 6C4 tubes. About 5 µf is adequate, but the adjustment is usually not critical. If this crystal circuit is applied to an electron-coupled oscillator, the grid-to-ground trimmer may be necessary for adequate feedback.

When the switch is in the SIG. GEN. position, the instrument functions as



A Heathkit signal generator converted for normal or crystal operation. Most commercial generators can be adapted easily without seriously affecting accuracy of frequency-dial calibrations if additional r.f. wiring is done carefully.

before modification, except for a possible slight shift in the calibration. This can usually be compensated for by adjusting the trimmer on the main tuning capacitor (C2) or the band trimmers.

When the switch is set for XTAL, the output contains the crystal fundamental, many of its harmonics, and some strong spurious frequencies.

To determine the fundamental frequency of a crystal, plug it in the oscillator socket, set the selector to XTAL position, and log all frequencies at which its output can be picked up on the receiver. If in doubt as to whether you are picking up the crystal output or the carrier from some other local oscillator, turn on the signal-generator modulation. This will permit definite identification. After logging, determine the common difference between the logged frequencies. This will be the fundamental of the crystal.

When, as is common, the successive differences are not quite the same, their average will give a good indication of the fundamental frequency of the crystal. With many receivers, differences up to 5 percent result from circuit and calibration vagaries.

The XTAL position is also highly useful for aligning communications receivers equipped with crystal filters. In some models the filter crystal can be removed from the receiver and inserted in the oscillator to provide the i.f.-aligning signal. After alignment, the crystal is replaced in the filter circuit, then phased, and the receiver is ready for operation.

The Pierce crystal-oscillator circuit used is a particularly good one for test purposes, as almost any crystal that will oscillate at all will operate quite well, and at its fundamental frequency.

Numerous tests with a signal generator modified in this manner (see photo) indicate that the modification is well worth the \$2 and 2 hours it cost.

One additional kink in crystal testing: If the frequency of the crystal and its condition are completely unknown, quite a bit of time may be used up in looking for an oscillation, only to find,

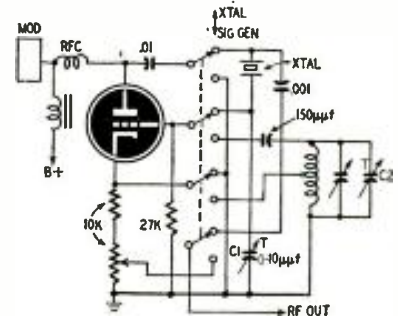
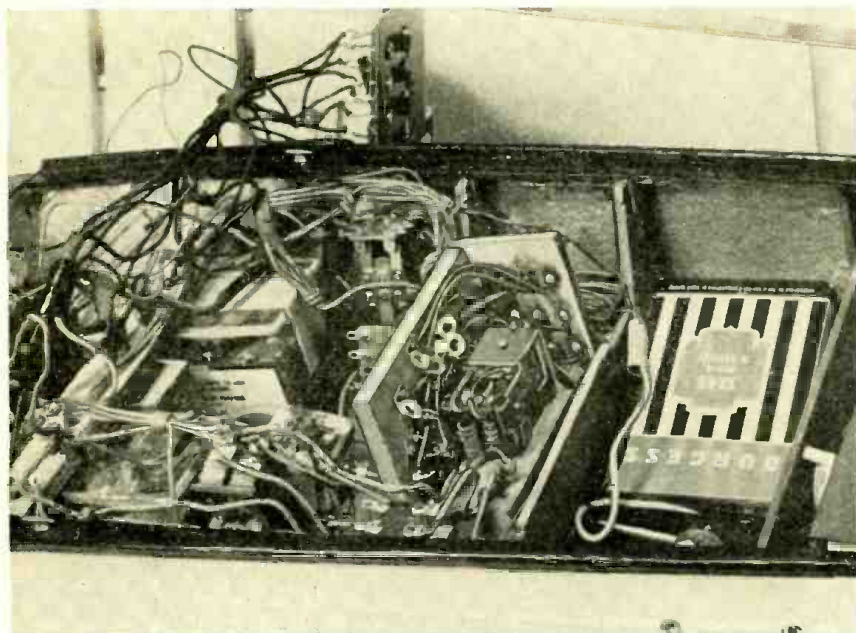

Fig. 2—Switching arrangement for adapting signal generator for crystal testing. Trimmer capacitor T1 is generally needed only with some small triodes.

later, that the crystal is dead. If you connect a vacuum-tube voltmeter across the output of the signal generator, it will read if the crystal is oscillating, and will not read if the crystal is dead. (Set the meter on its lowest a.c. range, and connect a capacitor in series with the input.)

END

RADIO CONTROLLED SPEEDBOAT



A closeup of the heart of the radio-control mechanism. The selector relay (SR in the schematic) is the partially walled-in unit at the left of the 45-volt B battery.

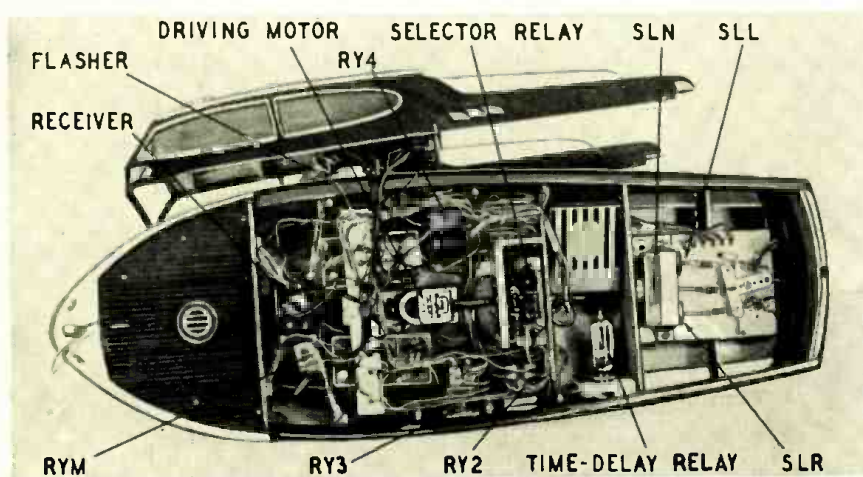

This bird's-eye view into the hold of the model cabin cruiser with the deck and superstructure removed shows the layout of the complete radio-control installation.

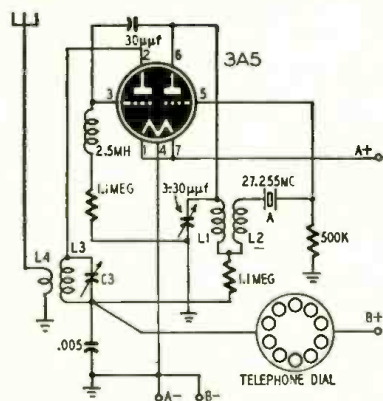

L1-8T N°22 ENAM } ON SAME FORM 1/2" DIA
L2-4T }
C3-L3=27MC TANK; L4-4T N°18 HOOKUP WIRE

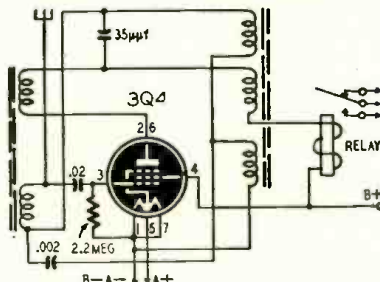

Fig. 1 (left)—Circuit of the *Telasco* 27.255-mc control transmitter. Power input to the final is less than 5 watts.

Fig. 2 (above)—Schematic of the regenerative receiver installed in the model speedboat. An extra feedback winding energizes the plate-load relay.

Telephone-dial

control on the FCC's

new license-free

27.255-mc channel

By M. GORDON MOSES

IN THE HEAT of summer, there is no better electronic project than one which can be pursued outdoors. Sailing a model power speedboat under radio control offers as much excitement and pleasure as actually being at the helm of a full-size water craft. Operation on a license-free band makes construction even more attractive.

The basic model

The boat chosen was a Sterling Model Company type B6M, a scale reproduction of a 32-foot Chris-Craft cabin cruiser. Dimensions are approximately 28 inches long and 9 inches wide at the beam. The cabin and rear decks are removable to facilitate a neat, compact radio control layout. Over-all height at the cabin roof is 10 inches, providing ample room in the cabin for additional control components. Actual "bathtub" tests on the finished model showed a displacement of over 14 pounds, more than adequate for the most advanced radio control work. The installation weighed 8½ pounds and the water line falls flush with the underside of the bangrails. A specially constructed rudder mechanism permits left-right-neutral rudder action with automatic limit switches to cut out power and conserve battery drain. The motor as shown is a No. 108, manufactured by K & O Company, Los Angeles. Since tests proved it to be short-lived, it will be replaced with a "Hi-Drive" unit made by Specialty Battery Division of the Rayovac Company. Several views of the boat showing placement of components are shown in the photos.

The transmitter

Fig. 1 is a schematic of the transmitter, a conventional 2-stage unit em-

ploying a Raytheon 3A5 h.f. twin triode. The first stage is a crystal-controlled oscillator and the second stage is an r.f. amplifier. These units have a final input of 4.8 watts, meeting FCC requirements for power on the new 27.255-mc band for radio control, and they are manufactured by American Telasco, Ltd., Huntington, Long Island. Routine form 555 (FCC) should be filled out and sent to the FCC before operation.

A modified telephone dial pulses the B plus. The unit is tuned with a 0-50-ma meter in the plate lead; a dip in current indicates optimum operation. For control under 100 feet, 67½ volts B plus is sufficient, but 135 volts assures reliable control over a radius of a half mile.

The receiver

A schematic of the receiver is shown in Fig. 2. A commercial regenerative unit built around a 3Q4 pentode, it employs an added loop of positive feedback to reinforce plate current change to a subminiature sensitive relay. The antenna is approximately 20 inches long. The unit should be tuned with the cabin top off while the boat is in the water due to the "loading" effect of the water. The receiver is also a Telasco, Ltd., unit.

The constructor of course can construct his own receiver, though FCC regulations make it advisable to use a commercial transmitter. A suitable circuit for such a receiver was published in the article "Model Plane Control" in the June, 1952, issue of this magazine.

The control circuit

Since operation is on one spot frequency only (27.255 mc ± 0.04%) single-channel control must be employed. A time-delay control circuit, utilizing a make-before-break relay and a lock-release relay as major elements, is shown in Fig. 3. Operation of the circuit is as follows:

All spring relays (selector SR and automatic motor RYM excepted) are shown normally unenergized. When a signal is received from the transmitter, sensitive relay RY1 closes its contacts 1 and 2, energizing a d.p.d.t. relay RY2 (Potter & Brumfield KR-11, 6-volt d.c. coil). Contacts 2 and 3 on RY2 complete a 6-volt circuit to the release coil RYR4 on RY4 (Potter & Brumfield LK-11, 6-volt d.c. coils), and contacts 5 and 6 on RY2 operate selector relay SR (specially built—see P. 50) through batteries B1 and B2.

When the signal ceases, RY2 de-energizes, activating heater of time-delay relay TDR (Amperite No. 6NO5 or 6NO5T) through contacts on 5 and 6 on RY3 (make-before-break 2-stack, Guardian Electric Co.), 2 and 3 on RY4, 4 and 6 on RY2, by furnishing 6 volts from B1 via the B1 plus contact RY2-3 and B1 minus contact RY2-6.

After 5 seconds, contacts 1 and 2 on TDR close, activating RY3 coil and

completing circuit to RYL4 (the locking coil) through RY3-1, RY3-3, and B1. Note that RY3-1 and RY3-3 complete the circuit to RYL4 coil and hold it closed until TDR heater cuts out when RY3-5 and RY3-6 open up.

When TDR heater cools, heater secondary contacts TDR-1 and TDR-2 open and release RY3. Now RYL4 is locked in and the heater is out through open contacts of RYL4-2 and RYL4-3. RYL4-4 and RYL4-6 are locked in,

completing the circuit from the common inner ring of selector to B1 minus. The shorting bar SB will now complete the return circuit through the ship's function on which SB is resting, back through a 6-volt or 12-volt positive bus bar. All relays are now ready for the next cycle.

If the transmitter is pulsed consecutively within intervals that are reasonably less than 5 seconds, the circuit to the heater of TDR does not have

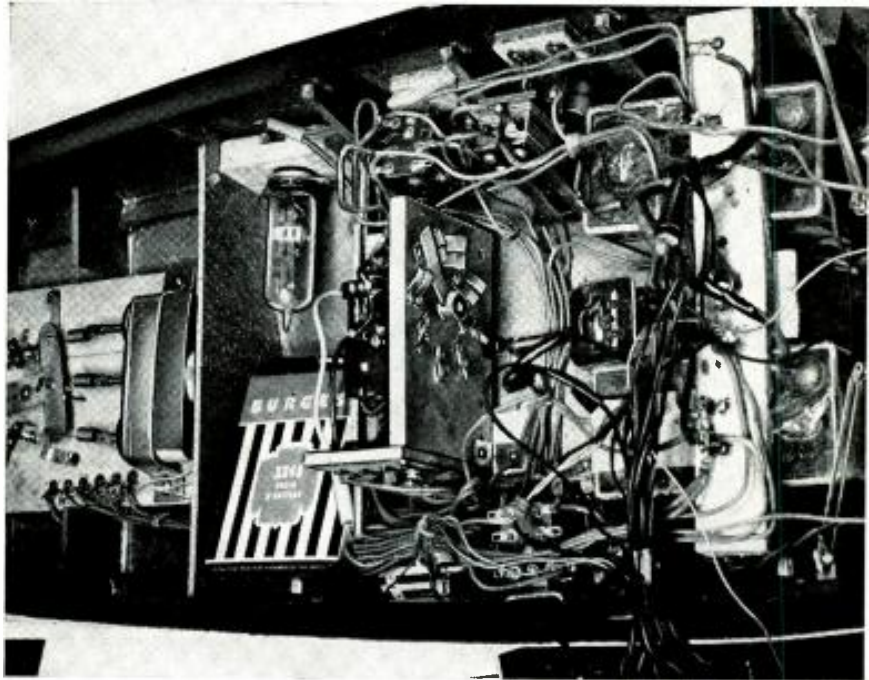

Locations of the principal control components in the model speedboat's hull. The rotary selector switch in the center controls all operations of the model.

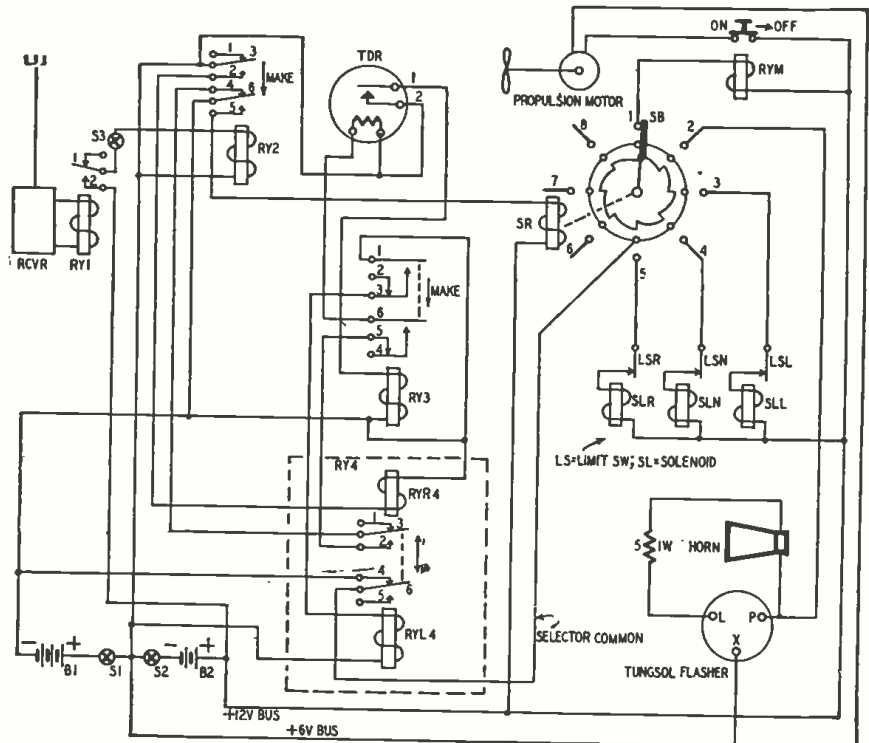
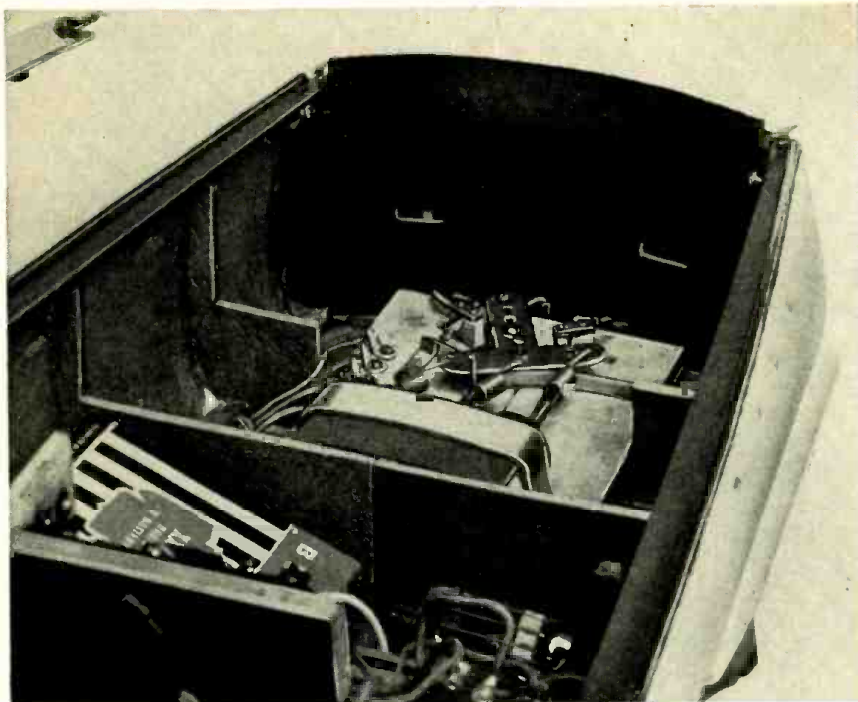
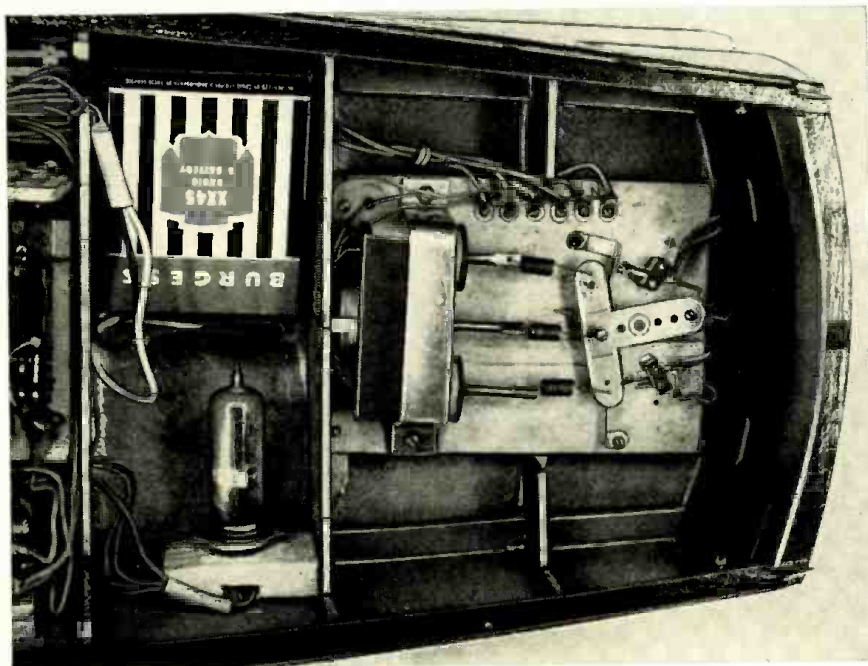

Fig. 3—Wiring diagram of the control circuits. The selector relay SR is a modified Lionel train-control unit. See the text for details of relay operation. There is an error in the relay wiring. Contacts 4 and 6 are transposed on RY3. Revise the wiring and numbering of RY3 so contacts 5 and 6 are normally closed.



The stern of the model speedboat showing the solenoid-operated tiller mechanism. The limit switches at port and starboard positions reduce battery drain.



This overhead view of the speedboat's stern shows the simple construction and mounting arrangements of the tiller, control solenoids, and plunger linkages.

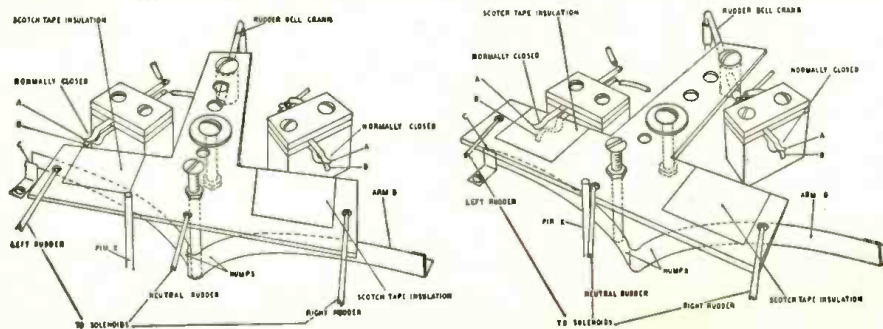

Fig. 4—Two views of the rudder action. When either full right or full left rudder is applied the A,B, switches are opened; at neutral rudder, switch C,D.

opportunity to energize, and hence the selector relay can be made to bypass undesired circuits. Leaving the shorting bar in any given position over 5 seconds will lock RYL4 in and complete the ship's function circuit corresponding to that position. By changing the heater characteristic of TDR (10-, 15-, or even 30-second units are available) more freedom of operation is gained at the expense of speed of response to the transmitter signal.

The ship's function circuits include a motor relay, RYM; three rudder solenoids, SLR (right rudder), SLN (neutral rudder), and SLL (left rudder); and a "beeping" horn. This accounts for five of the eight selector circuits. Plans are being made to install a set of running lights in the future. Time and ingenuity are the only limits to further ship's functions.

Rudder details

The rudder mechanism is shown in detail in Fig. 4. Very little power is required to turn the rudder, and the natural forward motion of the boat helps further to foster easy rudder action.

Materials for control unit

Relays: RY1—sensitive relay, Telasco 5-A or equivalent; RY2—Potter & Brumfield KR-11, d.p.d.t., 6-volt d.c. coil; RY3—Guardian, d.p.d.t., make-before-break, 2-stack, 6-volt d.c. coil; RY4—Potter & Brumfield LK-11 with 6-volt d.c. coils; SR and RYM—selector and motor relays, see text; TDR—Amperite 6N05 or 6N08T, time-delay relay, 6-volt heater, normally open type.

Miscellaneous: B1, B2—Willard NT-6 batteries, 6-volts, 2 ampere-hours; S1, S2, S3—s.p.s.t. slide switches; resistor (in horn circuit), 5 ohms, 1 watt.

Power is economized by the limit cutout switches A,B and C,D. A flat brass arm which acts as the tiller is forced between the A,B contacts at either full right or full left rudder, opening the active solenoid. A small pin X under the tiller presses against a spring-brass arm D to close C,D, except when the tiller is in the neutral position. The tiller arm was cut from stiff brass, the switch arms from thin spring brass. The solenoids are 1 inch in diameter and 1¼ inches long, fully wound with No. 22 double cotton covered wire.

Special components

Special attention is called to the selector relay (SR) and the motor relay (RYM). The selector relay is built around an automatic reversing relay sold by Lionel Electric Corp. These have 12-volt coils and a ratchet mechanism. By drifting the rotor pin out and inserting a longer shaft into the ratchet wheel, a unit can be made up as shown in Fig. 3 and the photos.

The same basic unit is used as a motor relay (RYM) by tying off the leads properly; the net result of the revamping is a s.p.s.t. switch which provides "on-off" alternate switch action with successive pulses. In this way, the motor can be kept on while other ship's functions are being actuated.

END

NOVICE TWO-TUBE SUPERHET



has full-band
coverage on 40
and 80 meters

By RICHARD GRAHAM

THE mere thought of constructing a superhet receiver is enough to arouse a feeling of fear and frustration in the hearts of most budding hams and novices. Who can blame them, considering the tricky alignment and tracking problems which one finds in the average home-made superhet? It's no wonder that the novice who must build his equipment settles for an inferior t.r.f. or regenerative receiver. This need not be the case if you construct this simplified superhet which was designed with the novice and radio beginner specifically in mind.

The set has only two tubes, both of which perform dual functions. Tracking problems have been eliminated by using separately tuned oscillator and r.f. sections. Ready-made coils eliminate another bothersome headache for the beginner. The oscillator and i.f. adjustments are exceedingly simple, thus making this receiver ideal for the novice who wants something better than just a simple regenerative or t.r.f. type of receiver.

This super covers not only the 80-meter novice frequencies but also all the general class amateur frequencies on both 80 and 40 meters, thus preventing obsolescence. After all, today's novice will be of legal necessity, next year's general class licensee. As such, he'll probably be interested in both 80- and 40-meter c.w. operation. This extra band feature adds very little to the cost (one coil and one switch) and is certainly worth having, even as a novice, for it enables you to listen to what's going on on another band, dx, conditions, etc.

The circuit is simple

Circuitwise, the receiver consists of a 6BA7 mixer and oscillator, 12AT7 regenerative detector and audio amplifier, and a simple selenium-rectifier power supply. See Fig. 1.

The mixer-oscillator circuit performs in the usual way. A signal appearing on the control grid of the 6BA7 (pin 7) beats with an oscillator voltage to produce another totally different frequency in the plate circuit. This latter frequency is called the i.f. (intermediate frequency). However in this partic-

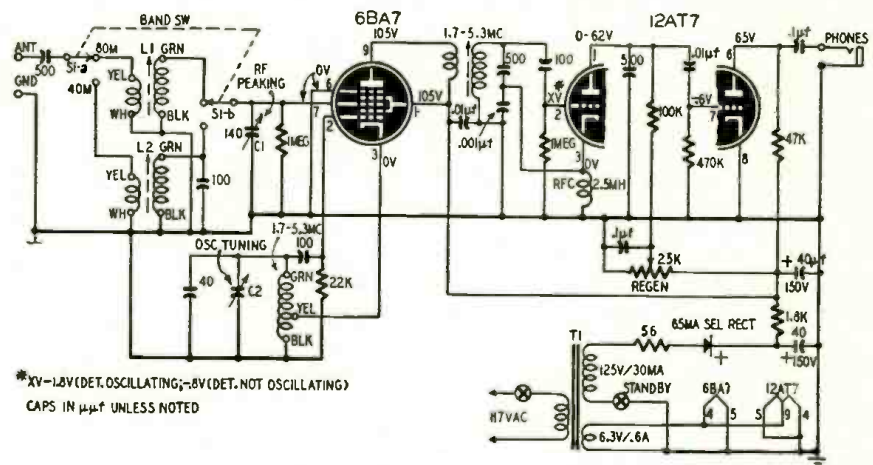

*XV—125V (DET. OSCILLATING); -8V (DET. NOT OSCILLATING)
CAPS IN μF UNLESS NOTED

Fig. 1—Schematic of the superhet for the novice and budding ham. A regenerative second detector provides high sensitivity and serves as a b.f.o. for c.w.

ular circuit, we use what normally is an inherent disadvantage of superheterodyne reception—the image frequency—to provide two-band reception. When the local oscillator section of the receiver is working on 5.25 mc and the i.f. is peaked to 1.75 mc, either a 3.5-mc or a 7.0-mc signal can be heard. Thus the incoming signal can be either the sum or of difference between the i.f. and oscillator frequencies. Whether the sum or difference frequency predominates is determined by the r.f. tuned circuits L1-C1 (80 meters) and L2-C1 (40 meters). These circuits are switched in or out of the circuit according to which band is desired.

One-half of a 12AT7 double-triode is used as a regenerative detector to convert the i.f. signal to an audio signal. A regenerative detector is used because its sensitivity is higher than other types of detectors. This adds another panel control (the regeneration control); however the inconvenience is more than made up by the increased sensitivity. This particular circuit arrangement is slightly different from the usual regenerative detector. In this case it was dictated by the choice of the i.f. coil. In most cases, regenerative detectors use a tickler feedback system which involves another winding on the coil. This

type of coil isn't easily obtainable, so I used a standard 1.7-5.3-mc r.f. coil in a Colpitts circuit. The Colpitts circuit is usually used as an oscillator. However a regenerative detector is only a modified oscillator which is made to just barely oscillate. The REGENERATION control is used to adjust the plate voltage on the detector to bring the circuit up to the fringe of oscillation. At this point a part of the amplified r.f. signal appearing in the plate circuit is fed back into the grid in the same phase as the original signal to increase the amplitude of the input signal. Thus the sensitivity of the detector has been increased tremendously.

This i.f. signal which has been detected or rectified is amplified by the second half of the 12AT7. The output of this audio amplifier is then fed into a pair of headphones. Use high-impedance phones or the audio output will appear weak.

To obtain the utmost in economy as well as safety, a simple transformer-fed half-wave selenium-rectifier type of power supply is used. Safety-wise this type of supply is a cut above the usual a.c.-d.c. type of supply, yet it retains the simplicity and most of the economy of this type supply without any sacrifice of safety. The transformer delivers

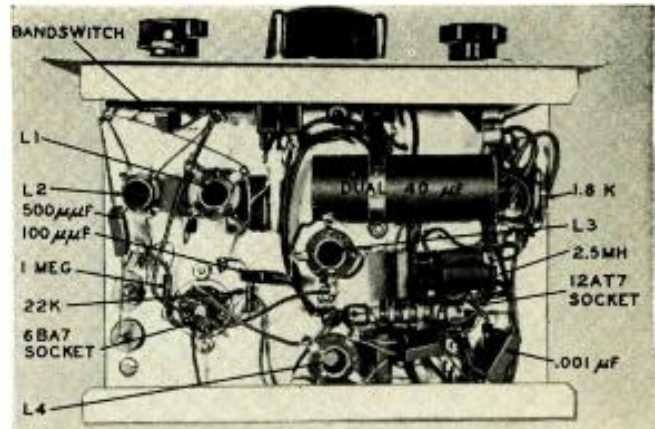
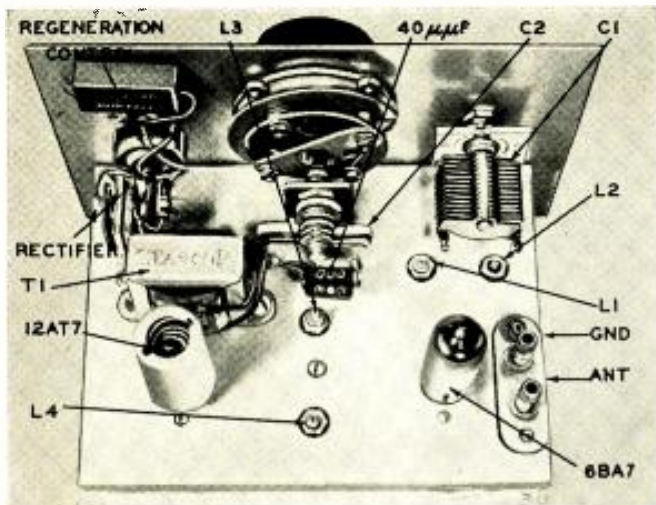

Top and bottom views of two-tube communications superhet. Note the simplicity of the parts layout and wiring.

30 ma d.c., which is adequate for this set. It also has a 6.3-volt winding which takes care of the heater requirements of the 6BA7 and 12AT7.

Constructing the set

The receiver is constructed on a standard 5 x 7 x 2-inch chassis, similar to the Bud type AC-402 chassis which has closed ends. The depth of the chassis is its most important consideration because coils L1, L2, L3, and L4 all extend approximately 1½ inches below the top of the chassis.

Keep all r.f. coil and capacitor leads short and direct. Other wiring such as the filament and d.c. wiring can be arranged to suit your convenience. The photographs of the unit showing the placement of the major components can be used by the constructor as a guide.

A 5-plate, 35- μ f variable capacitor was purchased for use as C2. However, I removed one plate to obtain more bandsread. This plate was easily removed by grasping it with a pair of long-nose pliers and bending. To make tuning even easier, it is suggested that the constructor purchase one of the vernier type of dials. The particular one used in this model was adapted from a surplus unit.

After the set is finished recheck the wiring against the schematic diagram before the set is plugged into the a.c. line. While plugging the set in immediately after it is finished without a recheck is an easy way to trouble-shoot (just follow the smoke!), don't do it—it's usually expensive. If after you've finished rechecking the wiring, the set doesn't work, there is the possibility that some component is defective. Most beginning novices don't own a v.t.v.m., but more often than not, one can borrow or use a friend's meter. Often the local radio technician will prove a friend when you explain your predicament. At any rate the voltage of various points around the circuit is shown on the schematic as an aid to trouble-shooting if anything of this sort does develop.

Alignment of this receiver is quite simple and can be carried out with the aid of another communications receiver,

or in the more conventional way with a signal generator. The method used will depend mainly on which instrument can be procured more easily.

To align the receiver with another receiver, first set the communications receiver to 1750 kc (1.75 mc) and place its antenna lead near coil L4 on the novice receiver. Advance the REGENERATION control on the novice receiver until a high-pitched squeal is heard in the headphones. Tune the adjusting screw on L4 until a carrier is heard in the communications receiver. Place the antenna lead farther away to prevent overloading of the communications receiver, and adjust L4 to the exact frequency of 1.75 mc. Lock the adjusting screw in this position with the lock-nut provided with the coil.

Next tune the communications receiver to 5,250 kc. (5.25 mc). Back off on the REGENERATION control so that the detector is not oscillating. Rotate C2 until the plates are almost all the way in. This will give us a little overlap on the band edges. Place the antenna lead from the communications receiver near L3 and tune the adjusting screw on coil L3 until a carrier is heard. Move the antenna lead farther away and tune L3 for exactly 5.25 mc.

The only remaining adjustments are those of L1 for 80 meters and L2 for 40 meters. Actually there is quite a bit of leeway in these particular adjustments, since any change in the inductance of L1 or L2 caused by these adjustments can be easily made up by adjusting the capacitor C1 to tune to resonance. Set the slugs in L1 and L2 so approximately six screw-threads are still exposed. Connect an antenna to the receiver. Advance the REGENERATION control until a rushing sound is heard in the headphones. Turn the big dial (C2) until a signal is heard. Rotate C1 for maximum volume. If the plates on C2 are all the way in for maximum volume, turn the adjustment screw of L1 (for 80 meters) or L2 (for 40 meters) in. This increases the inductance of these coils so less capacitance is needed to tune to resonance. Reverse the procedure if the plates are all the way out on C1 at maximum volume.

To align the receiver with a signal generator, place the signal generator output leads between pin 7 of the 12BA7 and ground. Tune the generator to 1.75 mc. Adjust L4 for maximum output in the phones. Next, transfer the generator output leads to the antenna and ground terminals. Tune the generator to 3.5 mc and switch the receiver to 80 meters. Tune the receiver so that the plates of C2 are almost all the way in. Adjust L3 for maximum output. Adjust C1 and L1 as necessary for maximum output. For 40-meter alignment, switch

Materials for Two-tube Novice Receiver

Capacitors: (Mica) 1—40, 3—100, 3—500 μ f; 1—.001 μ f. (Paper) 2—.01, 2—.01 μ f, 400 volts. (Electrolytic) 1—40 x 40 μ f, 150 volts, dual. (Variable air-spaced) 1—35, 1—140 μ f.
Resistors: 1—56, 1—1,800, 1—22,000, 1—47,000, 1—100,000, 1—470,000 ohms, ½ watt; 2—1 megohm, ½ watt; 1—25,000 ohms, potentiometer.
Coils: 1—1.7-5.3-mc antenna coil (L1, Meissner 14-1061), 1—5.3-16.5-mc antenna coil (L2, Meissner 14-1064), 1—1.7-5.3-mc oscillator coil (L3, Meissner 14-1063), 1—1.7-5.3-mc r.f. coil (L4, Meissner 14-1062), 1—2.5-mh r.f. choke.
Switches: 1—2-position, 2-pole, single-deck rotary; 2—s.p.s.t. toggle.
Miscellaneous: 1—6BA7, 1—12AT7 tube; 1—65-ma selenium rectifier; 1—power transformer, 125 volts at 30 ma and 6.3 volts at 600 ma (Stancor PS-8415 or equivalent); 1—open-circuit phone jack, 2—9-pin miniature sockets (one with shield); 5 x 7 x 2-inch chassis (Bud AC-402 or equivalent); vernier dial, knobs, hookup wire.

the set to 40 meters, set the signal generator to 7 mc, and tune in the signal with C2. (The plates of C2 should be almost fully meshed.) Peak the signal with C1 and the slug in L2. Vary the setting of the slug so the signal is maximum with C1 almost fully closed.

For convenience, a paper scale can be made and the band limits marked for the settings of C1. In this case, these scales were made on a file card in india ink, then coated with colorless nail polish and cemented to the panel.

Tuning the receiver

As indicated before in the discussion of alignment, when tuning the receiver, keep the regeneration control adjusted so that a rushing sound is heard in the earphones (not a squeal). This indicates that the circuit is just barely oscillating and is the most sensitive condition. Peak up the signal by tuning C1 for maximum volume. END

TRANSISTOR CONTROL RELAY

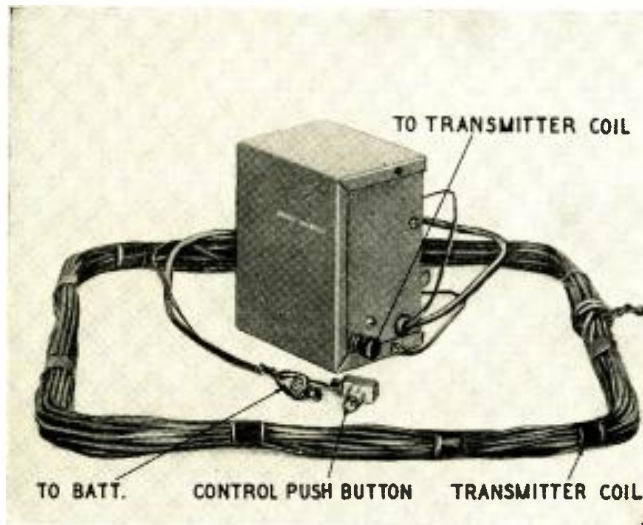

(Above)—The car-transmitter case and loop winding.
(Right)—Inside layout of the control-relay housing.

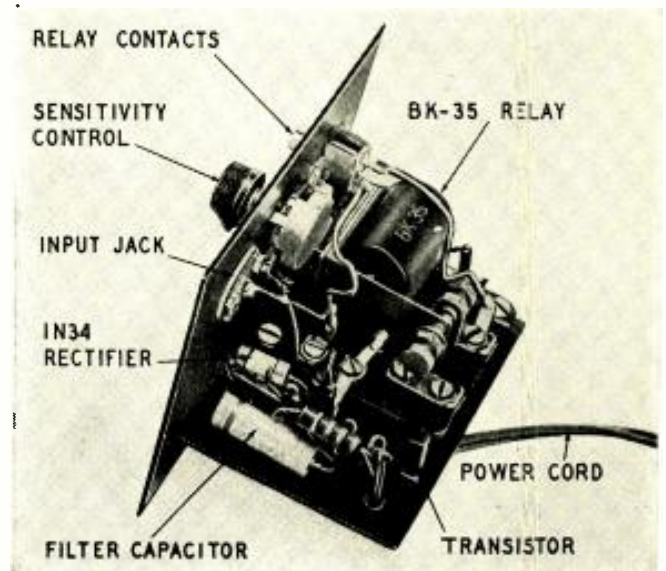

A tubeless gadget for remote switching with radio, light-beam, or magnetic-field control

By EDWIN BOHR

THE HEART of this tubeless remote-control relay is the new Raytheon CK-722 junction transistor. It will operate garage-door openers, lighting circuits, or alarms, or will perform almost any type of switching operation. The relay can be operated by a photocell, radio signal, thermocouple, or any device that will furnish .00025 watt of power.

Many transistor-operated circuits have been more novel than practical. We assure you this one is entirely practical—for two reasons. First, this transistor relay fills some honest-to-goodness everyday applications. Second, it costs only a little more than most vacuum-tube operated circuits.

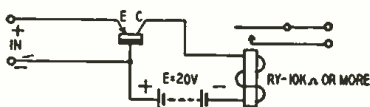

Fig. 1—Basic P-N-P junction-transistor relay circuit. Relay operates only when a positive signal or pulse is applied to the emitter electrode of the transistor.

The total cost of the unit—including the transistor—was only \$13.15.

When you consider that the transistor will probably give years of service without attention, with negligible power consumption, also its ruggedness and small size, the transistor-operated circuit in this instance is a real buy.

Basic circuit

The basic circuit is shown in Fig. 1. Note that no bias is applied to the emitter circuit. Under these conditions only a few microamperes of collector hole current will flow through the relay. This type of operation is similar to biasing a vacuum tube to cutoff. With this P-N-P transistor, however, zero bias cuts off the emitter current and any further negative bias produces no effect.

The transistor will pass only the positive half-cycle of an a.c. input signal or a positive-polarity d.c. signal. These are desirable features in a relay circuit.

Since the current amplification of a

junction transistor is a little less than 1 (see "Transistors," by John R. Pierce, in the June RADIO-ELECTRONICS), the power gain of the unit depends on the resistance of the relay in the collector circuit. For a given current change through the transistor, the voltage change across the relay coil depends on the coil resistance.

A relay with a high-resistance winding will operate on a much lower current than a low-resistance relay. But a 10,000-ohm relay, for example, that will operate on one milliamperes of current, requires 10 volts across the winding, or a power input of 10 milliwatts. It is difficult to get this much voltage and power from a radio control signal, but it is entirely practical with low-frequency magnetic fields.

The transistor will amplify a signal current with a small voltage change to a much larger voltage change across the relay coil. A 10,000-ohm relay in the collector circuit will give a power gain of about 10. As the relay resistance is increased, the supply voltage

also may be increased with a resulting greater power gain. If a 50,000-ohm or 100,000-ohm relay were available, the sensitivity could be increased 5 to 10 times.

(At this point it is well to remember that few components have been designed to match the characteristics of the transistor. We must still use vacuum-tube-engineered components. This situation will change in the months to come.)

The relay circuit

We found that a surplus relay—the BK-35—was the ideal unit for use with the CK-722 transistor. This relay has been advertised by several dealers for about \$3, or it can be removed from a surplus 75-mc marker-beacon receiver. The relay will close on less than 0.5 milliamperes without any readjustment and has a coil resistance of about 11,000 ohms.

A small power supply with a 1N34 rectifier was built for the relay circuit.

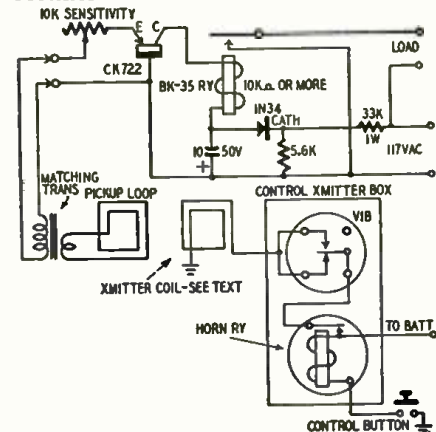

Fig. 2—Circuit of the transistor control relay and tubeless car transmitter. The units are linked by inductive coupling between the low-frequency magnetic field in the transmitter coil and the pickup loop imbedded in the ground.

The voltage divider across the power line assures that the 75-volts peak back-voltage rating of the 1N34 will not be exceeded.

A desirable feature of the power supply (in this case) is its *poor* voltage regulation. Its equivalent internal resistance is about 5,000 ohms. This resistance, together with the resistance of the relay, prevents the collector rating of the transistor from ever being exceeded.

The power-supply output voltage is negative to ground, since the collector must be supplied with a negative potential. Note that the a.c. input is applied to the *cathode* end (K or *cath*) of the 1N34, and that the *positive* side of the electrolytic is grounded. Check the output with a voltmeter for correct polarity before connecting it to the transistor circuit. A high positive voltage applied to the collector can ruin the transistor.

A series-resistance sensitivity control is inserted in the emitter circuit. It is needed where large control voltages—two or three volts—are likely to be

encountered. This control corresponds to an adjustable cathode-bias resistor on a triode vacuum tube: increasing the series resistance increases the bias and limits the current through the tube.

The emitter input impedance of the circuit (grounded-base, zero-bias operation) was measured and found to be about 3,000 ohms for *very small* signals, and around 1,000 ohms for signals large enough to actuate the relay. A signal of 0.5 volt will actuate the relay, so this represents a power of .00025 watt. The BK-35 relay can very probably be adjusted to close on even less input power.

Operation

We have been using the relay to turn on the yard and garage lights at the touch of a button in an automobile. It could just as easily operate a garage-door opener.

The automobile transmitter uses no tubes and is very simple, inexpensive, and rugged. About two hours are needed to assemble and install the transmitter and the cost is roughly \$6.

Magnetic coupling is used between the automobile and relay. A 6-volt vibrator interrupts the battery current flowing through a transmitter coil mounted under the car. Another coil—the pickup loop—buried in the driveway has a current induced in it by the coil mounted under the car. The current in the pickup loop operates the relay.

A horn relay mounted in series with the vibrator permits the push-button control to be wired with ordinary low-current hookup wire. This relay costs about 75 cents at most auto-supply stores. It is not necessary to ground the vibrator or relay, but connections should be as short as possible and made with heavy primary wire.

A convenient place to mount the transmitter coil is between the front-bumper braces under the radiator grill of the car. The coil itself is 100 feet of No. 14 wire, wound in a rectangle approximately one foot square. Ordinary weatherproof light wire is inexpensive and ideal for this purpose. More turns can be used in the coil to increase the field strength, but if too much resistance is added to the coil the advantage of additional turns will be neutralized by the reduced current.

The pickup coil is also 100 feet of wire, but is wound in a square 1.5 or 2 feet on a side. Smaller wire may be used for this coil—hookup wire will do. We used the wire from an old 6-volt speaker field for the pickup coil.

A matching transformer must be used between the pickup coil and the transistor input. An ordinary output transformer will do the job very well. The voice-coil winding goes to the pickup coil and the primary leads go to the transistor. If the transformer has several taps, try changing them to find the combination that gives the greatest sensitivity. An old vibrator or filament transformer also will work

—sometimes even better than an output transformer—because of the lower winding resistance.

The operating radius of the unit is about two feet. The transistor relay is actuated as the automobile passes over the pickup coil. You may find it convenient to use a ratchet-type relay in conjunction with the transistor relay. This will allow *up-down* or *on-off* operation of the controlled device.

Pulses from the transmitter coil are unidirectional or polarized. If the relay fails to operate, or lacks sensitivity,

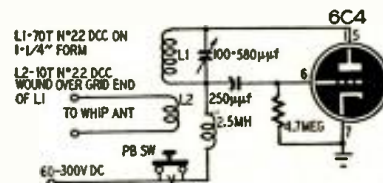

Fig. 3—Low-power 420-kc transmitter for r.f. operation of the control relay.

simply reverse the leads between the pickup loop and the matching transformer, or the input leads to the transistor—not both. It is also possible to operate two separate transistor relays selectively by reversing the direction of current flow and pulse polarity through the transmitter coil.

Construction

A standard five-prong in-line subminiature socket is used for the transistor. You can push out the second and fourth contacts, leaving three contacts with spaces between them. The raised dot on the socket should line up with the red dot on the transistor. Do not solder to the socket with the transistor in place, since the transistor's characteristics can be changed by excessive heat.

Materials for relay

Resistors: 1—33,000 ohms, 1 watt; 1—5,600 ohms, 1/2 watt; 1—10,000-ohm potentiometer.
Capacitor: (Electrolytic) 1—10 uf, 50 volts.
Miscellaneous: 1—CK-722 junction transistor; 1—5-pin, in-line subminiature socket; 1—BK-35 relay or equivalent (see text); 1—1N34 germanium diode; 1 plate-to-voice coil output transformer; 1—4-prong 6.3-volt vibrator; 1 horn relay; push-button switch; vibrator socket; chassis; wire; solder; hardware.

The wires from the pickup coil do not have to be shielded, as there is not much likelihood of picking up hum or other disturbances at these low impedances.

But, if the relay unit is more than about 20 feet from the pickup loop, mount the transformer at the loop end of the circuit to reduce line losses.

If a greater operating radius for the unit is desired, it can be obtained in two ways. Either add an extra transistor amplifier ahead of the relay stage or install a low-frequency r.f. oscillator in the car. An effective and simple transmitter operating at about 420 kc is shown in Fig. 3. At the relay end simply connect the transistor input to a parallel resonant circuit instead of to the pickup loop and matching transformer. The coil and trimmer can be the same as in the transmitter. END

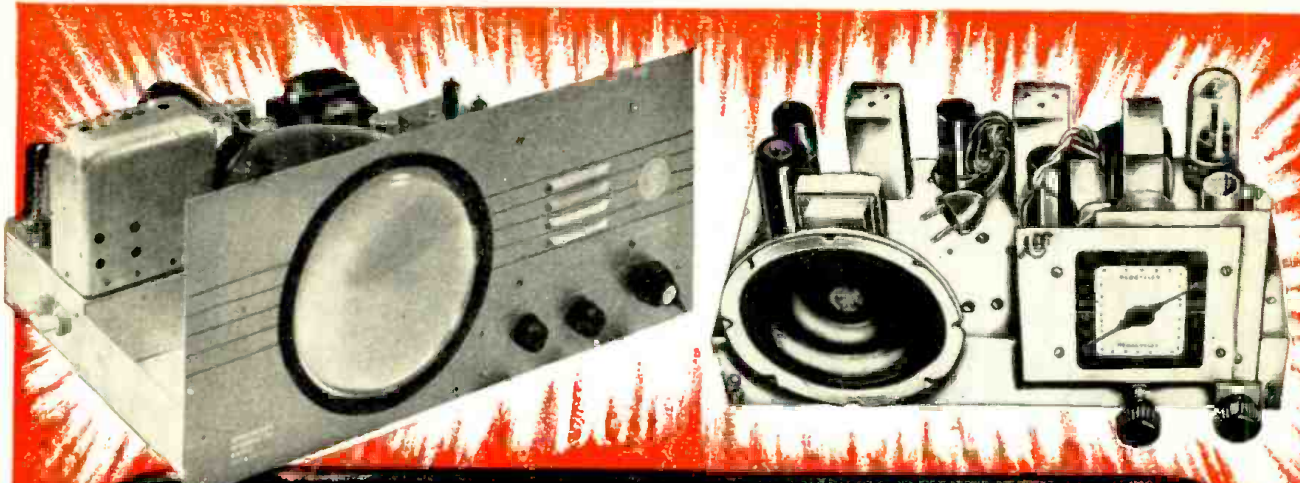

TRAIN *FASTER*—TRAIN *BETTER*—TRAIN *EASIER* IN 10 MONTHS—OR LESS—FOR **RADIO-TELEVISION**

Our 21st Year Training Men for Greater Incomes and Security in Radio-Television

I SEND YOU 18 BIG KITS

of Radio Television parts and equipment. Much of your training will be actual construction and experimentation . . . the kind of truly PRACTICAL instruction that prepares you for your Radio-Television career.



Frank L. Sprayberry
President
Sprayberry Academy
of Radio

NEW! NO OBLIGATION PLAN

You Have No Monthly Payment Contract to Sign
Pay For Your Training as You Earn and Learn

You can get into Radio-Television, today's fastest growing big money opportunity field, in *months* instead of years! My completely new "package unit" training plan prepares you in as little as 10 months or even less! *No monthly payment contract to sign—thus NO RISK to you!* This is America's finest, most complete, practical training—gets you ready to handle any practical job in the booming Radio-Television industry. Start your own profitable Radio-Television shop . . . or accept a good paying job. I have trained hundreds of successful Radio-Television technicians during the past 21 years—and stand ready to train you, even if you have no previous experience! Mail coupon and get all the facts—FREE!



Valuable Equipment Included With Training

The new Sprayberry "package" plan includes many big kits of genuine, professional Radio-Television equipment. You perform over 300 demonstrations, experiments and construction projects. You build a powerful 6-tube 2-band radio set, multi-range test meter, signal generator, signal tracer, many other projects. All equipment and lessons are *yours to keep* . . . you have practically everything you need to set up your own profitable Radio-Television service shop.

Earn Extra Money While You Learn!

All your 10 months of training is IN YOUR HOME in spare hours. Keep on with your present job and income while learning. With each training "package" unit, you receive extra plans and "Business Builder" ideas for spare time Radio-Television jobs. New television stations everywhere, open vast new opportunities for trained Radio-Television Technicians—and those in training. If you expect to be in the armed forces later, there is no better preparation than practical Sprayberry Radio-Television training.

YOU BUILD the Television set and the powerful superhet radio receiver shown above. IN ADDITION to the other test units shown here (many are not shown because of lack of space). All equipment I send you is **YOURS TO KEEP.**

Approved for Veterans under the G. I. Bill

SPRAYBERRY ACADEMY OF RADIO 111 NORTH CANAL ST. Dept. 20-Y, Chicago 6, Ill.

**MAIL COUPON
TODAY!
NO OBLIGATION**

**SPRAYBERRY ACADEMY OF RADIO, Dept. 20-Y
111 North Canal St., Chicago 6, Ill.**

Please rush to me all information on your 10-MONTH Radio-Television Training Plan. I understand this does not obligate me and that no salesman will call upon me. Be sure to include 3 books FREE.

Name..... Age.....

Address.....

City..... Zone..... State.....

I invite you to get all the facts—
**FREE TO YOU 3 BIG
RADIO-TELEVISION BOOKS**

I want you to have ALL the facts about my new 10-MONTH Radio-Television Training—without cost! Rush coupon for my three big Radio-Television books: "How to Make Money in Radio-Television," PLUS my new illustrated Television Bulletin PLUS an actual sample Sprayberry Lesson—ALL FREE. No obligation and no salesman will call. Mail coupon NOW!



A HIGH- PERFORMANCE PORTABLE

By CHARLES ERWIN COHN

FOR maximum utility a portable should have very high sensitivity, not only to give good performance in remote locations, but to take advantage of the low electrical noise levels in most outdoor areas.

The superheterodyne circuit used in practically every AM radio can be considered the ultimate in performance, simplicity, and low cost, so that any attempt to boost the sensitivity by improving the circuit cannot expect to proceed very far. There is much more room for improvement in the antenna and the sound reproducer. The usual loop antenna and loudspeaker, though convenient, are woefully inefficient compared to a whip antenna and a pair of headphones. In addition, headphones can give better tone quality than the tiny speakers found in average portables, and make it possible to eliminate the power-output tube with its heavy B-battery drain. While a speaker requires about a tenth of a watt to give fairly decent output, headphones can deliver the same volume at the ear with as little as 1/100,000 watt. This is a gain in sensitivity of 40 db, which is equivalent to 100 times as much voltage gain. The effective gain would probably be even greater, as a loudspeaker must compete against ambient noise, which can be almost completely eliminated with headphones, especially if provided with suitable rubber pads.

By putting these ideas to work, even at the slight cost in convenience which they entail, I was able to build a simple receiver with extremely high sensitivity. The schematic is shown in Fig. 1, and is a conventional superhet with a few variations.

Circuit details

A *Vari-Loopstick* was used instead of (CONTINUED ON PAGE 61)



Photo A (left); Photo B (below)—Front and back views of the high-gain portable. The *Vari-loopstick* is mounted on the strap across the back of the tuning capacitor. The socket at the side can be used to check battery voltages, or for plugging in an external power supply.

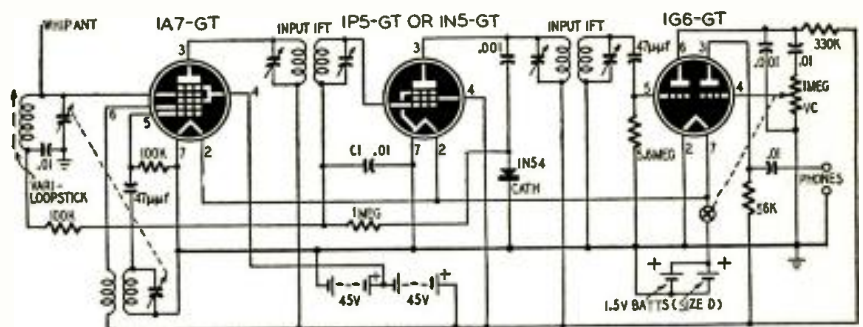
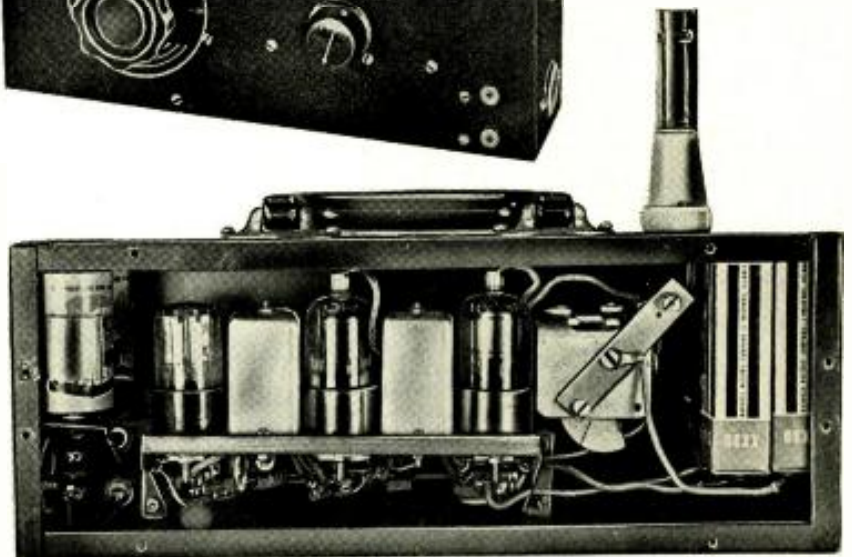

Fig. 1—Schematic of the high-performance portable. The ferrite-core antenna coil, whip antenna, and grid-leak detector give exceptional sensitivity and ample headphone volume without the extra drain of an audio power-amplifier stage.

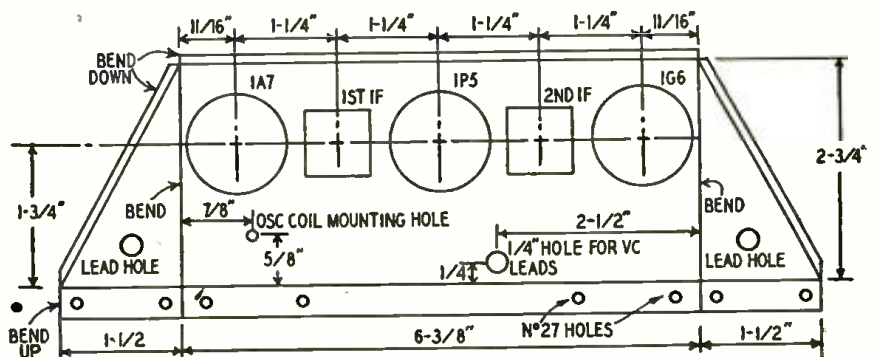
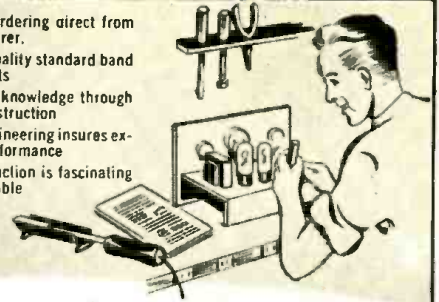

Fig. 2—Suggested layout for the chassis of the portable receiver. Mounting holes for the i.f. transformers and tube sockets will depend on the types used. The chassis can be formed from 22-gauge aluminum or cold-rolled steel.

BUILD YOUR OWN Heathkits

- TEST INSTRUMENTS
- AMPLIFIERS
- RECEIVERS, etc.

- 1 Save by ordering direct from manufacturer.
- 2 All high quality standard band components
- 3 Increased knowledge through actual construction
- 4 Sound engineering insures excellent performance
- 5 Kit construction is fascinating and enjoyable



\$43.50
Shipping
Wt. 26 lbs.

Heathkit MODEL O-8 OSCILLOSCOPE KIT

The outstanding new 1953 model O-8 Heathkit Oscilloscope features the finest performance ever offered in this extremely popular kit instrument. Primarily intended as a general purpose oscilloscope for the faithful reproduction of actual wave forms and other electrical phenomena, it's vastly improved band width, good 100 KC square wave reproduction, three step vertical input attenuator, .025 volts per inch vertical sensitivity, etc., admirably qualify this instrument for TV and radio servicing, Laboratory use, ham application and all general electronic development work. Improved vertical band width is obtained through the use of shunt peaking chokes with proper cathode compensation in the push-pull output stage. For additional flexibility of operation, provisions have been made for direct connections to the deflection plates, a Z axis input and a spot shape control for really fine focusing.

This beautiful kit is complete with all 10 tubes, including a 5" cathode ray tube, calibrated graph screen and flexible test leads. All necessary construction components, such as hardware, chassis, transformer, etc., and a detailed step by step construction manual, greatly simplify the assembly of this instrument.

Heathkit

VOLTAGE CALIBRATOR KIT

The use of a Voltage Calibrator will greatly increase oscilloscope usefulness. Provides a convenient method of making peak to peak voltage measurements by establishing a relationship between the unknown wave shape and the Voltage Calibrator. Voltage ranges .01-100 volts peak to peak. The Voltage Calibrator features direct reading scales and a regulated power supply system.



MODEL VC-2
\$11.50
Shipping Wt. 4 lbs.

Heathkit

ELECTRONIC SWITCH KIT

The Heathkit Electronic Switch Kit will further extend scope usefulness by permitting simultaneous observation of two individually controlled traces. Continuously variable switching rates 10 cps to 2,000 cps in three ranges. Will also serve as a square wave generator over the range of switching frequencies.



MODEL S-2
\$19.50
Shipping Wt. 11 lbs.

Heathkit VACUUM TUBE VOLTMETER KIT

The beautiful new 1953 Heathkit Model V-6 VTVM, the world's most popular kit instrument, now offers many outstanding new features in addition to retaining all of the refinements developed and proven through the production of over 70,000 VTVM kits. The Heathkit VTVM now features extended voltage ranges with 50% greater coverage on the DC range. New 1 1/2 volt low scale provides well over 2 1/2 inches of scale length per volt permitting faster measurements with greater accuracy. AC and DC ranges are 0-1.5-5-15-50-150-500-1500 volts (1,000 volts maximum on AC). Ohmmeter ranges are X1, X10, X100, X1,000, X10K, X100K X1 meg. Measures .1 ohm to 1,000 megohms. Other features are db scale, center scale zero adjust and polarity reversal switch. High 11 megohm input resistance virtually eliminates circuit loading.

The low anti-inflation price of this tremendously popular kit includes all tubes, necessary constructional material, test leads and the construction manual.

MODEL V-6
\$24.50
Shipping Wt. 6 lbs.



Heathkit AC VACUUM TUBE VOLTMETER KIT

A new amplifier type AC VTVM that makes possible those sensitive measurements so essential in laboratory or audio work. Ten voltage ranges covering from .01 RMS full scale to 300 volts RMS full scale. Input impedance 1 megohm with frequency response 20-50,000 cycles. Ten DB ranges from -52 to +52 DB. Four diodes in meter bridge circuit for maximum linearity.

MODEL AV-2
\$29.50
Shipping Wt. 5 lbs.



Heathkit

HANDITESTER KIT

The ever popular Handitester is now supplied with a Simpson 400 microampere meter movement. Provides AC and DC voltage ranges 0-10-30-300-1,000-5,000 volts. Ohmmeter ranges 0-3,000 and 0-300,000 ohms. DC current measurements 0-10 and 0-100 milliamperes. A completely self contained portable instrument.

MODEL M-1
\$13.50
Shipping Wt. 3 lbs.



EXPORT AGENT
ROCKE INTERNATIONAL CORP.
13 E. 40th ST.
NEW YORK CITY (16)
CABLE ARIR-N.Y.

The HEATH COMPANY

... BENTON HARBOR 20, MICHIGAN

HEATHKITS for the ENGINEER

Heathkit VISUAL AURAL SIGNAL TRACER KIT



MODEL T-3
\$22.50
Shipping
Wt. 10 lbs.

Designed especially for service applications in AM-SW, FM-TV repair work. RF and audio two channel input. More than adequate sensitivity—new noise locator circuit—calibrated wattmeter—substitution speaker—visual signal indication. Can be used with scope and VTVM, checks phono cartridges, phono mechanisms, microphones, tuners, etc. Let the Heathkit Visual Aural Signal Tracer help you.

Heathkit RESISTANCE SUBSTITUTION BOX KIT



Choice of 36 switch selected resistance values 15 ohms to 10 megohms. All standard RTMA 1 watt 10% resistors. Buy several for those lab and service applications.

MODEL RS-1
Ship. Wt. **\$5.50**
2 lbs.

Heathkit AMATEUR TRANSMITTER KIT



MODEL AT-1
\$29.50

Shipping Wt. 15 lbs.

Here is the long awaited Heathkit entry into the amateur radio field. The Heathkit AT-1 Transmitter kit is a well designed basic transmitter incorporating many desirable features and providing maximum overall performance.

Convenient band switching eliminates the bother and annoyance of plug in coils. It is merely necessary to switch to the desired frequency and plug in your favorite crystal or VFO. This transmitter features a self-contained power supply mounted on the same chassis and cabinet enclosed to minimize TVI. AC line by-passed to reduce radiation.

The coils supplied with the Heathkit AT-1 are pre-wound and adjusted for the necessary frequency coverage of 80-40-20-10 meters. The entire kit is supplied complete with all tubes, coils, punched and formed chassis and cabinet, as well as all constructional material required. A detailed assembly and operation manual is also furnished.

Heathkit CONDENSER CHECKER KIT



An instrument designed solely for its particular job. Not a "sideline" of a multiple function instrument. Measures value and quality of unknown condensers and resistors. Capacity range .00001 mfd to 1,000 mfd. Resistance range 100 ohms to 5 megohms. Sensitive electron beam indicator—five polarizing test voltages—safety spring return leakage test switch. An amazingly accurate instrument at this low price.

MODEL C-3
\$19.50 Shipping
Wt. 8 lbs.

Heathkit SIGNAL GENERATOR KIT



MODEL SG-7
\$19.50
Ship. Wt. 8 Lbs.

A service "must" is a reliable source of modulated (400 cycles) or unmodulated RF output. Frequency range 150 KC to 150 MC. Step attenuated and variable output—internal or external modulation. High output level and performance with low cost.

Heathkit GRID DIP METER KIT



World's largest selling Grid Dip Meter. Five pre-wound coils—frequency coverage 2-250 mc. Simplified construction and operation

MODEL GD-1A
\$19.50
Ship. Wt. 4 Lbs.

Heathkit TUBE CHECKER KIT

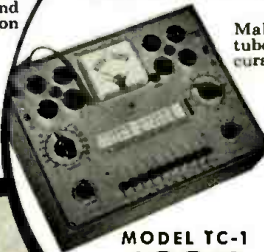

MODEL TC-1
\$29.50
Shipping Wt. 12 lbs.

Make those all important tube tests quickly and accurately. Checks all tube types encountered in radio and TV work. Simplified setup and switching system provides fast checks for shorts, opens, individual elements and over-all quality. Portable cabinet available at slight additional cost. TV picture tube adapter also available. See order blank.

Revised Roll Chart .50

Heathkit SQUARE WAVE GENERATOR KIT



MODEL SQ-1
\$29.50 Ship. Wt. 12 lbs.

True square wave output with frequency range 10 cycles to 100 KC. High variable output voltage level 0-20 volts at 600 ohms output impedance. Provisions for external synchronization. The ideal instrument for TV service work and wide band amplifier circuit development.

Heathkit LABORATORY REGULATED POWER SUPPLY KIT



MODEL PS-2
\$29.50
Ship. Wt. 17 lbs.

A regulated variable 160-450 volt DC output power supply for the lab or service shop. Accurate voltage and current measurements with large Simpson meter. AC supply 6.3 volts at 4 amperes—standby switch eliminates warmup time. Low hum content—5 tube circuit. AC and DC output voltages isolated from panel for maximum operational flexibility.

Heathkit VIBRATOR TESTER KIT



MODEL VT-1
\$14.50
Shipping Wt. 6 lbs.

Checks for starting and quality of interrupter and self rectifier type vibrators. Five sockets—checks hundreds of types. Operates from continuously variable type battery eliminator.

ROCKE INTERNATIONAL CORP.
131 E. 40th ST.
NEW YORK CITY (16)
CABLE 49148 N Y

The HEATH COMPANY

... BENTON HARBOR 20, MICHIGAN

RADIO-ELECTRONICS

SERVICEMAN · AMATEUR · STUDENT

Heathkit IMPEDANCE BRIDGE KIT

Provides choice of Wheatstone, Capacitance Comparison, Maxwell or Hay bridge circuits. Measurement of resistance-capacitance-inductance-dissipation factor-storage factor. 1% precision silver mica capacitance standard 1/2% precision resistors.



MODEL IB-18
\$69.50
Shipping Wt. 15 lbs.

Heathkit DECADE RESISTANCE KIT



MODEL DR-1
\$19.50

Ship. Wt. 4 lbs.

Individual switch selection of twenty 1% precision resistors in 1 ohm steps from 1 to 99,999 ohms. Sturdy ceramic wafer switches featuring silver plated contacts and smooth positive detent action.

Heathkit INTERMODULATION ANALYZER KIT



MODEL IM-1
Shipping Wt. 17 lbs.
\$39.50

Intermodulation distortion analysis is one of the most satisfactory methods of checking audio equipment. The IM-1 features two self contained high frequency generators (3,000 and 7,000 cycles) a 60 cycle low frequency source, intermodulation section, AC VTVM, and power supply all in one complete unit. Direct reading IM percentages on 3 calibrated scales 30%—10%—3%.

Heathkit AUDIO OSCILLATOR KIT

MODEL AO-1
\$24.50

Ship. Wt. 11 lbs.



Features sine or square wave coverage from 20-20,000 cycles in 3 ranges. Variable 10 volt output level at 600 ohms impedance. Thermistor controlled linearity—precision multiplier resistors—distortion less than .6%. An outstanding instrument value at this amazing low price.

Heathkit Q METER KIT

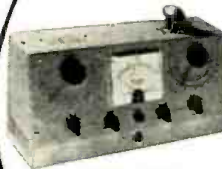

MODEL QM-1
\$39.50 Ship. Wt. 14 lbs.

A typical Heathkit invasion of the laboratory instrument field. Here is the first successful low priced Q meter ever offered in kit form. Oscillator supplies RF in the range of 150 KC to 18 mc. Reads Q directly on calibrated meter scales. Measures Q of condensers, RF resistance and distributed capacity of coils. Calibrate capacitor with range of 40 mmf to 450 mmf with vernier ±3 mmf. All measurements made at the operating frequency.

Heathkit AUDIO FREQUENCY METER KIT



MODEL AF-1
\$34.50

Ship. Wt. 12 lbs.

Indicates audio frequency on large 4 1/2" Simpson meter. Ranges 10 cycles to 100 kc at input voltage level of 3-300 volts RMS. The input wave shape is not at all critical. Useful in production line testing—indicating square wave frequency—determining generator output. Operation entirely electronic, no vibrating reeds.

Heathkit BAR GENERATOR KIT



MODEL BG-1
\$14.50

Ship. Wt. 6 lbs.

The Heathkit BG-1 Bar Generator represents another welcome addition to the fast growing line of popular Heathkits. The station transmitted test pattern is rapidly disappearing and the Bar Generator is the logical answer to the TV serviceman's problem in obtaining quick accurate adjustment information.

The Bar Generator produces a series of horizontal or vertical bars on the TV screen. These bars are equally spaced and will quickly indicate picture linearity of the receiver under test. Since picture linearity is independent of transmitting frequency, it is unnecessary to provide coverage throughout the VHF range, thereby holding down instrument cost.

The Heathkit Bar generator is simple to use and is extremely portable, providing a quick means of checking the television receiver either in your workshop or in the customer's home.

Heathkit DECADE CONDENSER KIT

Switch selected 1% silver mica precision condensers providing capacity range of 100 mmf. to 0.111 mfd. in steps of 100 mmf.

MODEL DC-
\$16.50

Shipping Wt. 4 lbs.



Heathkit AUDIO GENERATOR KIT

A new extended range 18 cycles—1 megacycle audio instrument at a remarkably low price. Five continuously variable output ranges—600 ohm output impedance—low distortion figure, less than .4% from 100 cps through audible range.



MODEL AG-8
\$29.50

Ship. Wt. 11 lbs.

Heathkit TELEVISION SWEEP GENERATOR KIT

Frequency coverage 10-90 mc and 150-230 mc. Variable sweep width 0-12 mc. built in absorption type marker, step and continuously variable output and blanking circuit.



MODEL TS-2
Ship. Wt. 20 lbs. **\$39.50**

Heathkit BATTERY ELIMINATOR KIT

A variable 0-8 volt DC supply source rated at 10 amperes continuously and up to 15 amperes intermittently. Voltmeter, ammeter, automatic overload relay, fuse protection—heavy duty Mallory 17 disc rectifier.

MODEL BE-3
Ship. Wt. 17 lbs. **\$24.50**



WRITE FOR *Free* CATALOG

New 32 page 1953 Catalog lists all kits, specifications, schematics and latest price information.

EXPORT AGENT
ROCKE INTERNATIONAL CORP.
13 E. 40th ST.
NEW YORK CITY (16)
CABLE 48148 N.Y.

The HEATH COMPANY

... BENTON HARBOR 20, MICHIGAN

**Heathkit
SUPERHETERODYNE
RECEIVER KITS**



Broadcast Model BR-1 5 Tube-Broadcast Band 550 to 1600 KC coverage. Shipping Weight 11 lbs.
\$19.50



Three Band Model AR-1 6 Tube all wave circuit 3 Ranges, continuous coverage 550 KC to over 20 MC. Shipping Weight 11 lbs.
\$23.50

**NEW HEATHKIT WILLIAMSON TYPE
AMPLIFIER KIT**

The ideal amplifier for custom high fidelity audio installations. Tops in performance, value, and flexibility of operation. Either Altec Lansing Peerless or Acrosound output transformers available. First Williamson type amplifier supplied with a matching preamplifier.

PRICES OF VARIOUS COMBINATIONS

- W-2 Amplifier Kit (Incl. Main Amplifier with Peerless Output Transformer, Power Supply and WA-P1 Preamplifier Kit) Shipping Weight 37 lbs. Shipped express only **\$69.50**
- W-2M Amplifier Kit (Incl. Main Amplifier with Peerless Output Transformer and Power Supply) Shipping Weight 29 lbs. Shipped express only **\$49.75**
- W-3 Amplifier Kit (Incl. Main Amplifier with Acrosound Output Transformer, Power supply and WA-P1 Preamplifier Kit) Shipping Weight 37 lbs. Shipped express only **\$69.50**
- W-3M Amplifier Kit (Incl. Main Amplifier with Acrosound Output Transformer and Power Supply) Shipping Weight 29 lbs. Shipped express only **\$49.75**
- WA-P1 Preamplifier Kit only, Shipping Weight 6 lbs. Shipped express or parcel post..... **\$19.75**



**Heathkit
ECONOMY 6 WATT
AMPLIFIER KIT**

MODEL A-7
\$14.50



Dual inputs—separate bass and treble tone controls—output impedances 4-8-15 ohms.

Ship. Wt. 10 LBS. A-7A Amplifier with pre-amplifier stage for low level inputs... **\$16.50**

**Heathkit
HIGH FIDELITY 20 WATT
AMPLIFIER KIT**

MODEL A-8
\$33.50



Shipping Wt. 16 lbs.

A high fidelity full 20 watt general purpose amplifier. Dual inputs and separate tone controls for maximum flexibility. Peerless output transformer 4, 8 and 16 ohms.

A-8A with additional preamplifier stage for low level cartridge, microphone, etc. **\$35.50**

**Heathkit FM
TUNER KIT**

MODEL FM-2

\$22.50

Shipping Wt. 9 lbs.

Sensitive transformer operated 8 tube circuit. Frequency coverage 88-108 mc. Pre-assembled and tuned "front end." Vernier tuning with slide rule type dial.

HEATH COMPANY • Benton Harbor 20, Mich.

ORDER BLANK

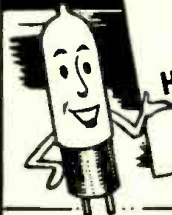

MAIL YOUR ORDER TODAY TO THE
HEATH COMPANY
BENTON HARBOR 20,
MICHIGAN

From _____

SHIP VIA

- Parcel Post
- Express
- Freight
- Best Way

(PLEASE PRINT)

QUANTITY	ITEM	PRICE	QUANTITY	ITEM	PRICE
	Heathkit Oscilloscope Kit—Model O-8 (26 lbs.)	\$43.50		Heathkit Square Wave Generator—Model SQ-1 (12 lbs.)	29.50
	Heathkit Amateur Transmitter Kit—Model AT-1 (15 lbs.)	29.50		Heathkit AC VTVM Kit—Model AV-2 (5 lbs.)	29.50
	Heathkit Bar Generator Kit—Model BG-1 (6 lbs.)	14.50		Heathkit Intermodulation Analyzer Kit—Model IM-1 (17 lbs.)	39.50
	Heathkit Voltage Calibrator Kit Model VC-2 (4 lbs.)	11.50		Heathkit Regulated Power Supply Kit—Model PS-2 (17 lbs.)	29.50
	Heathkit Electronic Switch Kit—Model S-2 (11 lbs.)	19.50		Heathkit Handitester Kit—Model M-1 (3 lbs.)	13.50
	Heathkit TV Alignment Generator Kit—Model TS-2 (20 lbs.)	39.50		Heathkit Decade Resistance Kit—Model DR-1 (4 lbs.)	19.50
	Heathkit Q Meter Kit—Model QM-1 (14 lbs.)	39.50		Heathkit Decade Condenser Kit—Model DC-1 (4 lbs.)	16.50
	Heathkit Grid Dip Meter Kit—Model GD-1A (4 lbs.)	19.50		Heathkit Impedance Bridge Kit—Model IB-1B (15 lbs.)	69.50
	Heathkit VTVM Kit—Model V-6 (6 lbs.)	24.50		Heathkit Resistance Substitution Box Kit—Model RS-1 (2 lbs.)	5.50
	Heathkit Visual-Aural Signal Tracer Kit—Model T-3 (10 lbs.)	22.50		Heathkit F. M. Tuner Kit—Model FM-2 (9 lbs.)	22.50
	Heathkit Condenser Checker Kit—Model C-3 (8 lbs.)	19.50		Heathkit Broadcast Receiver Kit—Model BR-1 (11 lbs.)	19.50
	Heathkit RF Signal Generator Kit—Model SG-7 (8 lbs.)	19.50		Heathkit Three Band Receiver Kit—Model AR-1 (11 lbs.)	23.50
	Heathkit Tube Checker Kit—Model TC-1 (12 lbs.)	29.50		Heathkit Amplifier Kit—Model A-7 (10 lbs.)	14.50
	Heathkit Portable Tube Checker Kit—Model TC-1P (15 lbs.)	34.50		Heathkit Amplifier Kit—Model A-7A (10 lbs.)	16.50
	Heathkit Portable Tube Checker Cab. only No. 365 (8 lbs.)	7.50		Heathkit Amplifier Kit—Model A-8 (16 lbs.)	33.50
	Heathkit TV Tube Adapter No. 355 (1 lb.)	4.50		Heathkit Amplifier Kit—Model A-8A (16 lbs.)	35.50
	Heathkit Battery Eliminator Kit—Model BE-3 (17 lbs.)	24.50		Williamson Type Amplifier Kit (Type: Shipped express only)	
	Heathkit Vibrator Tester Kit—Model VT-1 (6 lbs.)	14.50		WA-P1 Preamplifier Kit (6 lbs.) (Shipped exp. or p.p.)	
	Heathkit Audio Generator Kit—Model AG-8 (11 lbs.)	29.50			
	Heathkit Audio Oscillator Kit—Model AO-1 (11 lbs.)	24.50			
	Heathkit Audio Frequency Meter Kit—Model AF-1 (12 lbs.)	34.50			

Enclosed find () check () money order for
Please ship C.O.D. () postage enclosed for

pounds.

On Express orders do not include transportation charges—they will be collected by the express agency at time of delivery.

ON PARCEL POST ORDERS include postage for weight shown..... ORDERS FROM CANADA must include full remittance for merchandise.

a conventional antenna coil, with its input lead connected to a whip antenna. The *Vari-Loopstick* was chosen rather than the cheaper *Ferri-Loopstick* because its screw adjustment makes for greater convenience and accuracy in alignment.

A 1A7-GT converter works into a 1P5-GT or 1N5-GT i.f. stage, which in turn feeds a 1G6-GT grid-leak detector and audio amplifier. This gives much more gain in one tube envelope than the usual diode-triode or diode-pentode.

A 1N54 high-back-resistance crystal diode serves as an a.v.c. rectifier, its back resistance serving as the usual load resistor.

Octal tubes were used instead of miniatures, both for their greater ease of wiring, and because there is no satisfactory miniature equivalent of the 1G6-GT. Overcompactness can only lead to trouble, as anyone who has worked with some of the commercial "personal portables" will agree.

Construction

The physical construction of the set is shown in Photos A and B, which show the front and back views of the equipment respectively.

Photo B shows the internal arrangement of the set. At the left are the A batteries, which are two size-D flashlight cells in parallel. They are mounted in a sheet-metal holder attached to the end of the cabinet. In the center is the chassis shelf which holds the tubes and i.f. transformers, as well as most of the wiring. This is made of sheet metal according to the pattern in Fig. 2, and is attached to the front panel with screws. All mounting and wiring on this shelf must be completed before it is mounted in the case. The volume control and switch are behind the 1P5 tube in the center. The i.f. transformers should not be bigger than 1 1/3 inches square and must both be the input type. Punch a small hole in the side of the first i.f.-transformer can, and bring the lead for the grid cap of the 1P5-GT out through the hole as shown. The oscillator coil is a standard battery-type (air core) and is mounted behind the 1A7 socket at the right side of the chassis shelf.

Next to the chassis shelf is the two-gang tuning capacitor. This is the superhet type with cut-plate oscillator section. The capacitor frame should have tapped holes in front so that it may be mounted through holes in the front panel and dial plate. The diagonal crosspiece on the back of the tuning capacitor is the bracket for the *Vari-Loopstick*. Install the capacitor with the trimmers on top, and drill holes in the top of the case so that these trimmers and the i.f. trimmers can be reached for alignment. These holes can be closed with snap buttons between alignments. To the right of the capacitor are the B batteries, two Burgess XX30, which are held against the end of the case with a bracket.

The whip antenna was purchased for \$2.49 from the Burstein-Applebee Co., under their catalog number 19B764. It

JULY, 1953

Brand New- Just Off The Press!

FREE

TO ANY RADIOMAN WHO WANTS A BIGGER INCOME...



SERVICING 2-WAY MOBILE RADIO SYSTEMS PAYS BIG MONEY

Get Your FCC COMMERCIAL RADIO OPERATOR LICENSE IN A MINIMUM OF TIME!

Get This Amazing Booklet FREE



TV ENGINEERING included in our training and coaching

HERE IS YOUR GUARANTEE
If you fail to pass your Commercial License exam after completing our course, we guarantee to continue your training without additional cost of any kind, until you successfully obtain your Commercial License, provided you first sit for this examination within 90 days after completing your course.

TELLS HOW

We Guarantee TO TRAIN AND COACH YOU AT HOME IN SPARE TIME UNTIL YOU GET YOUR FCC LICENSE

TELLS HOW

Employers Make Job Offers To Our Graduates Every Month In Practically Every Field Of Radio!

TELLS HOW

Our Amazingly Effective JOB FINDING SERVICE Helps CIRE Students Get Better Jobs

Gets Five Job-Offers
"Your JOB FINDING SERVICE is a grand way of obtaining employment for your graduates who have obtained their 1st class license. Since my name has been on the list, I have received calls or letters from five stations in the southern states, and am now employed as Transmitter Engineer at WMMT."
Elmer Powell, Box 274, Sparta, Tenn.

Get Both Booklets Free MAIL COUPON NOW



E Cleveland Institute of Radio Electronics
4900 Euclid Avenue, Desk RE-54
Cleveland 3, Ohio
(Address to Desk No. to Avoid Delay)

Without obligation, I want to know how I can get my FCC commercial ticket in a minimum of time, and all about the profit opportunities in all types of radio jobs, including 2-WAY MOBILE RADIO SERVICING. Rush me your FREE BOOKLETS: "MONEY MAKING FCC LICENSE INFORMATION" and "THERE'S MONEY FOR YOU IN 2-WAY MOBILE RADIO SERVICING", and give me the details about all radio fields that offer employment opportunities at good pay. Also send me your free sample FCC-type license examination.

NAME.....
ADDRESS.....
CITY..... ZONE..... STATE.....
(Paste on a 2-cent postcard.)
 If you are owner or manager of a radio-TV service shop check here for Employers Plan and enclose this coupon with your business card or letterhead.

The NEW Gernsback Library

TV • RADIO • AUDIO



RADIO & TV HINTS—No. 47

You can profit from the time saving tricks of the trade gathered from the experience of the experts and passed on to you in this book. Over 300 hints, gimmicks and short cuts on radio, TV and audio grouped under seven sections for easy reference.—Test Instruments, Tools, TV, Radio Servicing, Audio, Amateur and Miscellaneous. 112 Pages. 132 Illustrations. \$1.00

TELEVISION TECHNOTES—No. 46

Shows you how to cut routine trouble shooting to the bone in servicing TV sets. Gives the symptoms, causes, and cures of over 600 actual troubles which crop up in scores of sets made by 27 manufacturers. Compiled from manufacturers' service notes and the reports of practicing service technicians. If you're in TV servicing, you'll find this book as helpful as any tool or instrument on your work bench. 128 Pages. 58 Illustrations. \$1.50



BASIC RADIO COURSE—No. 44

John T. Frye, RADIO-ELECTRONICS' popular technician-writer teaches you more about theory in his easy going style than you can get out of many books costing dollars more. From the point of view of the practical radio man, he leads you from Ohm's Law to Service Techniques in enjoyable and understandable steps. 176 Pages. 120 Illustrations. Hard Cover \$2.25

Practical, easy-to-read technical books

Radio Tube Fundamentals—No. 45

A clear-cut explanation of how and why tubes behave as they do in modern radio circuits! Written from the standpoint of the practicing service technician. 96 Pages. 74 Illustrations. \$1.00

High-Fidelity Techniques—No. 42

James R. Langham, RADIO-ELECTRONICS' famous audio writer tells you how to get top performance from your hi-fi equipment. He mixes solid facts with rare humor. 112 Pages. Illustrated. \$1.00

Practical Disc Recording—No. 39

Last word in making good disc recordings. Covers theory and practical techniques. A full chapter is devoted to each important recording component. 96 Pages. Illustrated. 75¢

Model Control By Radio—No. 43

What radio control is and how to use it for remote control of model boats, planes, etc. Theory plus practical construction details on components and complete systems. 112 Pages. 114 Illustrations. \$1.00

Public-Address Guide—No. 41

Tells how to make extra money in P. A. work, covers every phase of installation and maintenance plus construction details on all-purpose P. A. system. 80 Pages. Illustrated. 75¢

See your distributor—or mail this coupon

GERNSBACK PUBLICATIONS, INC. Dept. 73
25 West Broadway
New York 7, N. Y.

Enclosed is my remittance of \$ _____
Please send me, postpaid, the books checked below:

39 41 42 43 44 45 46 47

Name _____

(Please print clearly)

Street _____

City _____ Zone _____ State _____

COMING!
NEW—GERNSBACK LIBRARY
BOOK No. 48
High-Fidelity—Design, Construction,
Measurements.
Watch for it!

collapses to a length of 9 inches and extends to 5 feet, and is prepared for mounting by drilling out the eyelet on the bottom, removing the soldering lug, and tapping the hole with an 8-32 thread. The antenna can then be screwed on top of a hollow porcelain insulator, as shown in the photos. A soldering lug under the head of the mounting screw inside the insulator serves as a connection point, with the lead brought down through a hole in the top of the cabinet under the insulator. For ease in wiring, it is advisable to clip off the antenna lead supplied with the *Vari-Loopstick* and use a separate lead.

The wiring of this set is simple and noncritical, and follows standard practice. All fixed capacitors should be ceramic types. They are so much smaller than corresponding paper or mica units that they are essential in such a compact layout. If possible, use a pencil or gun-type iron for soldering, especially for making connections after the chassis shelf is in place. The case is a standard 5 x 13 x 3-inch steel chassis turned on its side. Its top surface is the front panel, and the bottom plate serves as a back cover. The tuning and volume knobs and the phone-tip jacks can be seen on the front panel in Photo A. On the right-hand end of the cabinet are a Fahnestock clip for a ground wire and an octal socket. This socket is not connected up at present, but can be used for operating the set from an external power supply, or as a group of test points for checking the internal batteries without removing them from the case.

Alignment procedure

Alignment of this set follows standard superhet practice. Either audible or output-meter indication can be used. A 0-1 d.c. milliammeter connected across the 330,000-ohm detector plate resistor can serve as an output meter, stronger signals being indicated by lower meter readings. Before alignment disable the a.v.c. by shorting out the .01- μ f a.v.c. capacitor C1. The set can be aligned on stations, although a

Materials for portable

Resistors: 1—5.6 megohms, 1—1 megohm, 1—330,000, 2—100,000, 1—56,000 ohms, 1/2 watt; 1—1-megohm potentiometer (audio taper) with s.p.s.t. switch. Capacitors: (Ceramic) 4—.01, 2—.001 μ f, 2—47 μ f. (Air variable) 1—2-gang broadcast tuning capacitor, with cut-plate oscillator section. Miscellaneous: 1 *Vari-loopstick*; 1—battery-type broadcast-band oscillator coil; 2 input-type 455-kc i.f. transformers (see text); 1—IN54 germanium-crystal diode; 1—1A7-GT, 1—1P5-GT or 1N5-GT, 1—1G6-GT; 4 octal sockets; 1—5 x 13 x 3-inch metal chassis with bottom plate; 1—collapsible whip antenna (see text); 1 pair—high-impedance headphones; 2—45-volt B batteries (Burgess type XX30 or equivalent); 2—D-type 1.5-volt flashlight cells; 1—carrying handle; knobs, terminals, wire, solder, hardware.

signal generator is preferable if available.

The first step is to align the i.f.'s by connecting the signal generator to the top cap of the 1A7 and peaking the i.f. trimmers.

For the r.f. alignment the signal generator must radiate its signal into the set through a short antenna wire connected to its probe. The whip an-

tenna must be fully extended. During the adjustments, the hand must not come too close to the antenna, or it may introduce hand capacitance and throw off the alignment. Due to the lack of an oscillator-padder adjustment, the i.f. determines the lowest signal frequency to which the receiver will tune. This frequency must be determined by trial and error. To lower this minimum frequency, the i.f. must be raised, and vice versa. After these adjustments are complete, peak the oscillator at the maximum signal frequency by turning the gang all the way out and adjusting the oscillator trimmer.

The low-frequency r.f. adjustment is the slug of the *Vari-Loopstick*, which is peaked up on a signal near the low end of the dial. Then adjust the r.f. trimmer on a signal near the high end of the dial. Due to the large capacitance of the antenna, you may have some difficulty getting this trimmer to peak. In that case, either reduce the maximum frequency or accept a compromise adjustment.

The sensitivity of this set has come up to the highest expectations. With the antenna fully extended in an outdoor location in Chicago it will receive over 25 stations with listenable volume, some as far away as 150 miles. Selectivity also is good, although the strong a.v.c. action may make it seem broad on very strong signals. A ground connection is not needed outdoors, but is helpful in some indoor locations. Since parts for this set, even all new, should not cost more than \$20, it represents a real bargain in performance. END

INSULATING R.F. CHOKES

To protect the metal ends of a r.f. choke from accidental contacts in a crowded radio chassis, I cut the rubber tips off old medicine droppers and slip them over the ends of the choke.

This kink can be especially helpful in preventing many of the intermittent troubles which develop in crowded electronic chassis because of accidental shorting of the choke to ground or because of a fault of some other component in the circuit.—*John A. Comstock*



"So that's the way your television set acts up?—I'll go see if I can fix it."

JULY, 1953

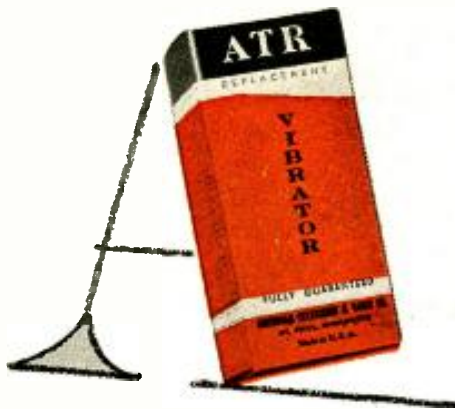

**auto-
radio**

VIBRATORS



have

ceramic

stack spacers

A COMPLETE LINE OF VIBRATORS

Designed for Use in Standard Vibrator-Operated Auto Radio Receivers. Built with Precision Construction, featuring Ceramic Stack Spacers for Longer Lasting Life. Backed by more than 22 years of experience in Vibrator Design, Development, and Manufacturing.



Free

- ✓ NEW MODELS
- ✓ NEW DESIGNS
- ✓ NEW LITERATURE

"A" Battery Eliminators, DC-AC Inverters, Auto Radio Vibrators

See your jobber or write factory



AMERICAN TELEVISION & RADIO Co.

Quality Products Since 1931

SAINT PAUL 1, MINNESOTA—U. S. A.

*Quality
conscious dealers
want the
Nepco Line*

Experience is a great teacher.
And experience has taught more
and more TV installers and service
men they can't afford to risk their
reputations on inferior materials.

That's why so many demand the
NEPCO LINE—television's "Master
of the Elements." They've found
that National Electric's complete
line of TV Antennas, Mounting
Accessories, and Wire provides
built-in ruggedness . . . meets the
test of time and weather—and
assures their reputation in both
the new and replacement markets.



EXAMINE THE NEPCO LINE—

**Quality materials
with the strength to
stay on the job . . .**

- * Extra heavy zinc galvanizing on all parts.
- * Baked on "Shera-solution" for *extra* corrosion protection.
- * Rigid heavy gauge steel used in all mounts (1 $\frac{3}{4}$ "x1 $\frac{1}{8}$ ").
- * Two 15' *stainless steel* chimney bands, $\frac{5}{16}$ " eye bolts, and 4 heavy gauge banding clips with patented imbedding screws available with each chimney mount.
- * All hardware corrosion-protected in the same complete manner as the mounts.

- * Every item in the NEPCO Line is engineered, tested and field proved to assure long service on the job.

**Plus features
for fast, easy installation
and handling**

- * Unique adjustable mast clamp with one bolt mounting.
- * Exclusive antenna mast clamp with positive alignment in all planes.
- * Patented imbedding type screw for positive electrical and mechanical locking.
- * Versatile mounts that accommodate all types of installations.

National

RADIO-ELECTRONICS

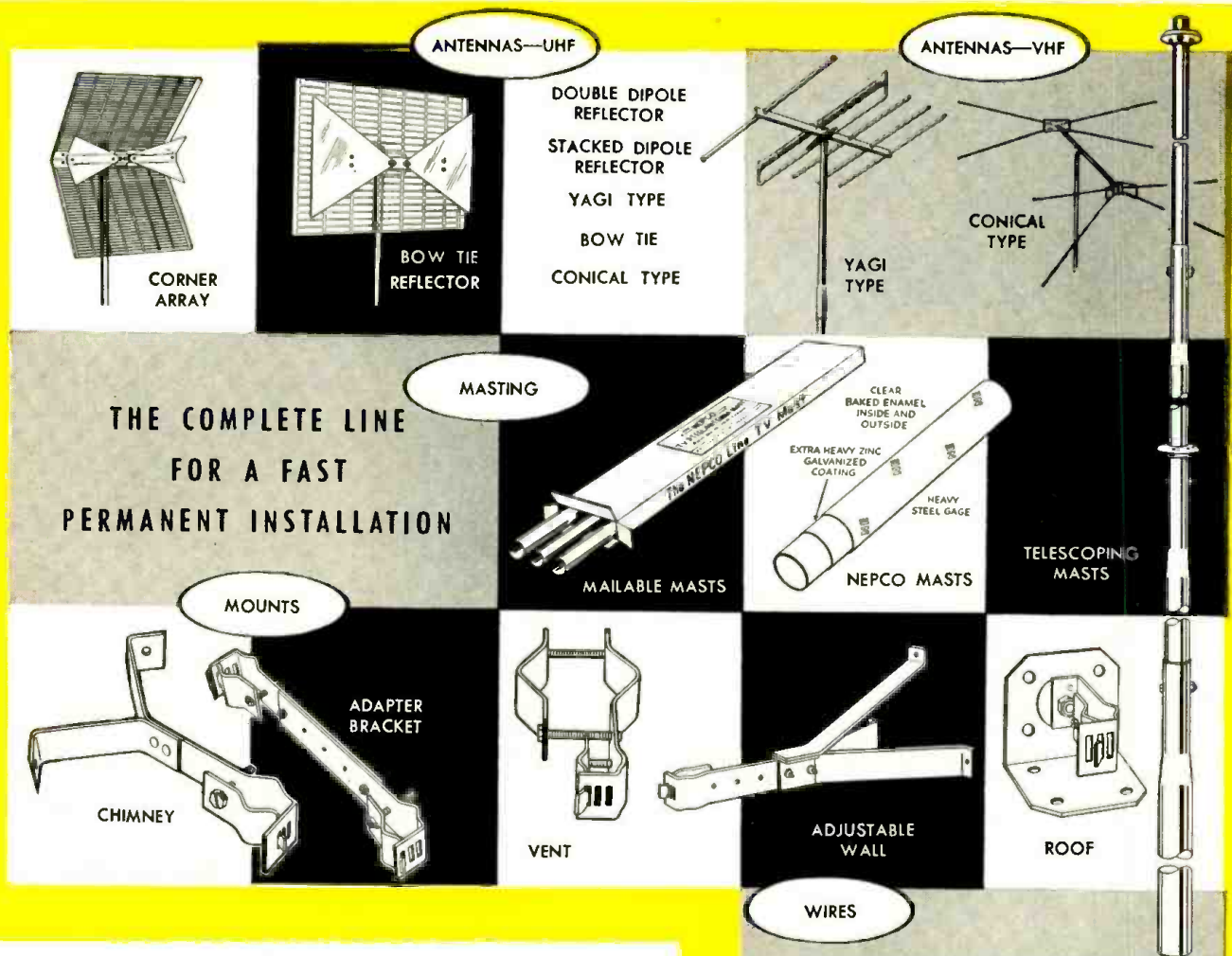

ANTENNAS—UHF

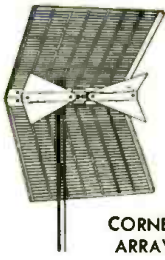

CORNER ARRAY

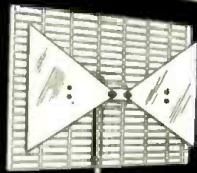

BOW TIE REFLECTOR

- DOUBLE DIPOLE REFLECTOR
- STACKED DIPOLE REFLECTOR
- YAGI TYPE
- BOW TIE
- CONICAL TYPE

ANTENNAS—VHF

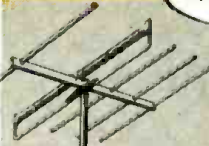

YAGI TYPE

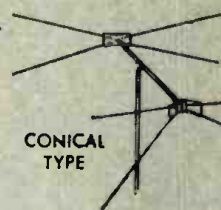

CONICAL TYPE

THE COMPLETE LINE
FOR A FAST
PERMANENT INSTALLATION

MASTING

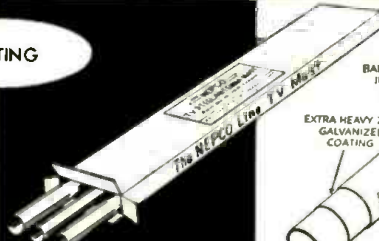

MAILEABLE MASTS

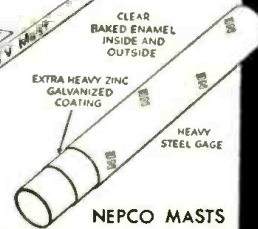

NEPCO MASTS

TELESCOPING MASTS

MOUNTS

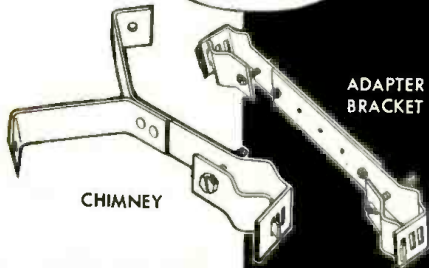

CHIMNEY

ADAPTER BRACKET

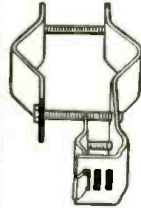

VENT

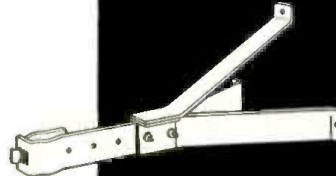

ADJUSTABLE WALL

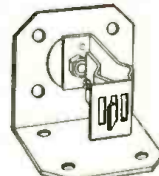

ROOF

WIRES



ZEE LINE

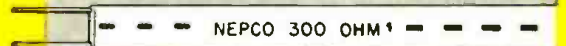

NEPCO 300 OHM

POLYON 300 OHM TWIN LEAD WIRE

YOU'LL FIND...

- * A line designed with your handling problems in mind . . . strong compact boxes easy to move and stack.
- * Large easy-to-read illustrated package labels.

In addition . . .

Brand recognition has been gained for the NEPCO Line through superior service on the job, and a national advertising and promotional program has created acceptance for this quality line.

The NEPCO Line is priced right for your customers.

Write, wire or phone for the name of your nearest representative today

Plus

- Wall Brackets
- Guy Rings
- Chimney Banding
- Banding and Mast Clamps

THE
NEPCO
LINE

Electric Products

Radio & Television Department, Pittsburgh, Pa.

**BETTER PICTURES... BETTER SOUND
PEAK PERFORMANCE ALL AROUND!**

the **NEW**
SKYLINE UHF-VHF

- ▶ ONE LEAD-IN
- ▶ ALL CHANNELS
- ▶ ALL FREQUENCIES

▶ PARTS AND PERFORMANCE
WARRANTY!

▶ PRE-ASSEMBLED

▶ QUICK RIG

▶ NOW 32 ELEMENTS

▶ SEPARATE UHF-VHF
CIRCUITS

▶ AMAZING RECEPTION TO
150 MILES AND MORE!

IT'S TOMORROW'S ANTENNA
TODAY!

SKYLINE MFG. CO., 1458 E. 17th Street, Cleveland 14, Ohio

Broadcasters To Meet Defense Emergencies

Conelrad (Control of Electronic Radiation) is a plan to protect the country in case of enemy air raids. It permits some broadcasting stations to remain on the air during attacks to broadcast important civil defense information, yet prevents enemy planes from "homing" on the signals and using them as guides.

According to the FCC Conelrad regulations, certain stations will prepare themselves to transmit on one of two frequencies, 640 or 1240 kc. These stations will be grouped in *clusters*, all of which are interconnected by wire lines and all of which will operate on the same frequency. A number of clusters will operate in a *division*. These will correspond to the USAF Air Divisions.

All stations which participate in the plan will be required to install equipment which will permit them to operate at reduced power on one or both Conelrad frequencies, and to turn the station on or off on receipt of signals received over wire *control lines*, which may also carry the programs transmitted during air alerts.

If an air raid alert is sounded, all AM broadcast stations not in the plan, and all FM and TV stations, will notify listeners that they are discontinuing normal broadcasting for an indefinite period, and that listeners can receive civil defense information at 640 or 1240 on their regular radio sets. Non-Conelrad stations will then close down.

The Conelrad stations remaining on reduce their power—probably to not more than 5 kw—and transmit in a peculiar random fashion calculated to confuse planes attempting to use their signals as direction indicators. The stations of a cluster will transmit one at a time for periods of from 5 to 40 seconds. As one station ceases transmission, another picks up without a break in the program. In a normal cluster any one station would be on the air from 5 to 40 seconds and off from 2 to 6 minutes. Most listeners would receive information without interruption, but planes trying to home on the evasive signal would be hopelessly confused.

With reduced station power there may be situations where a receiver near the edge of a cluster might fail to receive one or more of the stations in the cluster, and other situations where only one broadcast station might be available to cover a wide area. The first trouble is not likely to be common. With only two possible frequencies to tune to, the sensitivity control of the receiver can be turned up all the way. Automatic volume control will take care of the loud stations, and in most cases the weak ones will come in with sufficient volume.

Where only one station is available, it will operate in short bursts of 10 seconds or so, going off the air for a minimum of 30 minutes between bursts. Thus urgent messages can be sent without aiding enemy planes. **END**

RADIO-ELECTRONICS

ALL-CHANNEL **UHF** CONVERTER



**B-T
LABS**

Model BTU-2

Ultraverter

Ultra POWERFUL
Ultra DEPENDABLE

Employing the newly developed B-T Ultratuner, the B-T Ultraverter, Model BTU-2, provides for reception of all UHF channels on any TV set with quality unmatched by any converter, regardless of price. 'On/off' operation is automatically controlled by the power switch on the TV receiver. Terminals are provided for both VHF and UHF antennas.

MORE
POWER



Advanced circuit design assures high gain, high stability, and lowest noise performance. A high ratio vernier knob permits easy, accurate tuning on UHF channels from 14 through 83. Tube complement includes 6T4/6AF4, 6AB4, and Germanium Diode, 1N72.

GREATER
STABILITY
EASIER
TUNING



BLONDER-TONGUE LABORATORIES

WESTFIELD, N. J.

Manufacturers of TELEVISION AMPLIFIERS, UHF CONVERTERS, MIXERS, DISTRIBUTION UNITS and TV ACCESSORIES

Here's the new SHURE SLIM-X All-Purpose Crystal MICROPHONE



MODEL 777
List Price \$18.95
MODEL 777s
(with switch)
List Price \$20.95

(Price includes cradle for mounting on stand)

Its Versatility and "Hand-a-Bility" make it an ideal low-cost all-purpose microphone

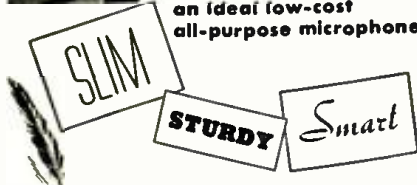

LIGHT! The new "777" Slim-X Microphones are rugged little microphones weighing only 6 ounces! They are designed for good-quality voice and music reproduction. Their versatility and "hand-a-bility" make them ideal for use by lecturers, announcers, instructors, and Hams; for audience participation shows; carnivals; panel and quiz shows; and use with home-recorders. When mounted on either cradle or swivel, the "777" can be removed in a flash (no tools necessary)—simply by lifting it out of the holder. This makes it an ideal "walk-around" hand-held microphone.

TECHNICAL INFORMATION: Smooth frequency response—60 to 10,000 c.p.s.; special-sealed crystal element—for long operating life; high impedance; 7' single-conductor cable, disconnect type. Dimensions: (Microphone only) Length, 4 1/2"; Diameter 1". Finish: Rich satin chrome overall.

NOTE: Lavalier cord for suspension of Microphone around neck is available. (optional).

ACCESSORIES FOR "777"

MODEL 538 STAND is a heavy die-cast base. Includes metal screw machine stud for connecting microphone adaptor to stand base.

List Price: \$3.00

MODEL A25 SWIVEL ADAPTOR features a long-life, high-quality swivel connector. Is lined with a long-life nylon sleeve—for noise-free and scratch-free insertion and removal of microphone.

List Price: \$5.00



SHURE BROTHERS, Inc.
MICROPHONES and ACOUSTIC DEVICES
225 W. Huron St., Chicago 10, Ill., Cable: SHUREMICRO



IN THE home-receiver field, the only new tube announced this month is the Sylvania 6BQ6-G. This is a large-bulb version of the familiar 6BQ6-GT, with better heat dissipation and higher plate-voltage ratings of 600 volts d.c. and 6,000 volts positive peak. Basing and other ratings are the same as those for the 6BQ6-GT.

Transistors are the real headliners this month. RCA announced four new commercial types—two contact transistors and two junction transistors. The 2N32 point-contact transistor is intended for pulse or switching applications, and can handle switching frequencies as high as 2.7 mc when used as a current amplifier, or as high as 900 kc as a voltage amplifier. (In this case the frequency limits or cutoff points are the frequencies at which the output is down 3 db from the response at 100 kc.) The 2N32 has a current gain of 2.2 and a power gain of 21 db when operated at a collector voltage of -25, and an emitter current of 0.5 ma, with a 10,000-ohm collector load, a signal-source impedance of 500 ohms,

and a signal frequency of 5,000 cycles. The 2N33 point-contact transistor is designed especially for oscillator service in the 50-mc region. A test circuit suggested by RCA for this transistor is given in Fig. 1-a. The 2N33 can deliver approximately 1 mw of r.f. in this circuit.

The RCA 2N34 and 2N35 are P-N-P and N-P-N junction transistors respectively, designed for low-level a.f.-amplifier service. Their characteristics are identical except for their opposite input and output polarities and operating voltages. This makes it possible to obtain push-pull output from a matched pair by feeding them from a common single-ended source (see "I.R.E. Convention 1953" by Fred Shunaman, in the June RADIO-ELECTRONICS). Both types have an α (current gain) of 0.98, and a power gain of 40 db at 5,000 cycles, with a collector load resistance of 30,000 ohms, and a signal-source impedance of 500 ohms. These ratings are with 6 volts d.c. on the collector, a collector current of approximately 10 microamperes, and an emitter current of about 1 ma.

The ratings given for all four RCA transistors are based on an ambient temperature of 25° C. All have the same 3-pin Linotetrar base shown in Fig. 1-b. Four of the new units just fill an ordinary thimble.

Mixer crystal

CBS-Hytron is producing a new germanium mixer diode—type 1N133—for u.h.f.-TV tuners. The 1N133 has a glass-filled phenolic case less than 1/2-inch long with notches at the cathode end for quick identification, and copper-clad steel connecting leads. In the representative mixer circuit shown in Fig. 2, the 1N133 has an average conversion gain of 0.5 and a noise figure of 16 db at 850 mc.

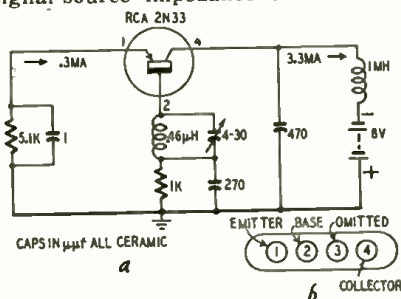
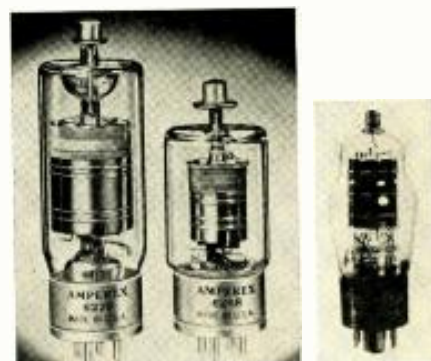

Fig. 1—(a) 50-mc oscillator using 2N33 transistor. (b) Basing of the four new RCA transistors described in the text.



(Left) New Amperex hydrogen thyratrons. (Right) Sylvania's new heavy-duty 6BQ6-G hybrid-output tube.

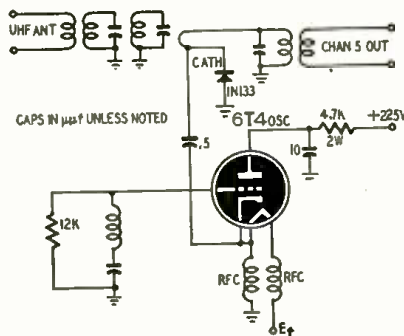

Fig. 2—Typical u.h.f. mixer circuit.

Industrial types

Two improved hydrogen thyratrons have been introduced by Amperex. These are the 6268 and 6279, which are completely interchangeable with the older 4C35 and 5C22 respectively. The new tubes have self-regulating sources of hydrogen, and have a minimum life expectancy of over 1,000 hours—almost double the life expectancy of the earlier types.

END

How to make PICTURE-TUBE SUBSTITUTIONS EASILY



New CBS-Hytron Substitution Chart for Television Picture Tubes helps you pick logical substitutions easily, quickly. It's a cinch to use this complete, up-to-date Chart. An Index of types leads you to proper Substitution Group listing all readily interchangeable types. You pick an available type . . . with the least number of necessary service adjustments. That's it. No other references required. You save time . . . money. You need this indispensable CBS-Hytron TV Substitution Chart. Get it from your CBS-Hytron distributor. Or write direct today.

WHAT'S IN IT

1. General Introduction outlines scope and purpose.
2. Introductory Notes give details on tabulation.
3. Typical Substitution shows how to use Chart.
4. Index indicates Substitution Group for each type.
5. Substitution Groups narrow choice to logical substitutions.
6. Basing and Outline Drawings give basing and dimensional data.

FEATURES

- All necessary data given for all electromagnetically deflected types, regardless of make.
- Directly interchangeable types indicated.
- Other popular substitutes and required service changes high-lighted and explained.
- Substitution, not conversion, emphasized.

GOT THESE HELPFUL GUIDES?



Miniature Guide includes 250 types, 111 basing diagrams. Indicates similar larger part types.



Crystal Diode Guide describes 92 types. Includes 7 dimensional diagrams. Indicates typical application for each type.



All are complete. Include all types, regardless of make. Give all pertinent data. Are free. Get yours today.

TV Picture-Tube Guide lists 164 types, 19 basing diagrams for all magnetically deflected picture tubes.

New . . . Free DECAL

Not just an identification. But a colorful decal that sells for you! *Sells* your magic ability to recapture new-set sparkle. Let this decal pull customers to you. Get it today from your CBS-Hytron distributor.



Manufacturers of
Receiving Tubes Since 1921



CBS-HYTRON Main Office: Danvers, Massachusetts

A Division of Columbia Broadcasting System, Inc.

NOW 3

CBS-HYTRON TEST ADAPTERS

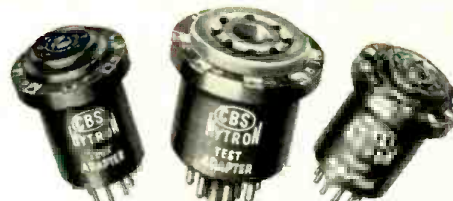

7-Pin Min.,
\$1.45 Net

8-Pin Octal,
\$2.25 Net

9-Pin Min.,
\$1.75 Net

BY POPULAR DEMAND. You can now buy CBS-Hytron Test Adapters in all three popular sizes: 7-pin miniature, 8-pin octal, 9-pin miniature.

You can now test *all* sockets dynamically . . . "topside." Without wrestling with heavy chassis. Without disturbing wiring or parts. Just plug tubes into Test Adapters and Adapters into sockets. Presto, socket connections are topside . . . ready for your test prod. You check voltage, resistance, gain, intermittents, oscillation. Trace signals, etc. All the e-a-s-y topside way. Order *all three* Test Adapters from your CBS-Hytron distributor today.

NEW precise OSCILLOSCOPE

(IN KIT AND WIRED FORM)

THE FASTEST-GROWING KIT MANUFACTURER IN THE WORLD

The Oscilloscope you've been seeking . . . No other oscilloscope at any price — high or low — with these desirable features — in both Kit and Wired Form:

SPECIFICATIONS. PRECISE MODEL 300 OSCILLOSCOPE —
VERTICAL — Vertical-Rail (3db) DC through 5 megacycles with sensitivity of greater than 10 millivolts push-pull (3.94 Millivolts/cm). Constant Resistance. Push-pull input immediately converted to single-ended normal or reverse phase by shorting bar at inputs 1 and 2. Frequency compensated vertical stepping attenuator selects AC or DC inputs. Push-pull DC amplifiers from input through output. Internal electronic mixing through inputs 1 and 2; five-way binding posts.
POSITIONING — Bridge type positioning on vertical and horizontal does not vary tube characteristics.
HORIZONTAL — Frequency compensated stepping attenuator in horizontal amplifier; Push-pull Horizontal out.
BLANKING — Internal (return trace blanked), external (return trace not blanked), 60 cycle or 120 cycle Blanking through Blanking amplifier circuit.
SYNCHRONIZATION — External, Internal Positive, Internal Negative, Internal 60 cycle or Internal 120 cycle Synchronization.
SWEEP RATE — Driven or non-driven linear sweeps from 1 cycle to 80KC in five ranges (1-10 cycles uses external C circuit); Trigger potentiometer.
MAGNIFIER — Electronic magnifier and magnifier positioner allows any part of a signal to be magnified up to ten times (equivalent to 70 inches of horizontal deflection).
CALIBRATION — Internal square wave calibrator and potentiometer for using oscilloscope at a VTVM on Peak to Peak measurements.
CALIBRATION SCREEN — Edge-illuminated scale and Graticule may be turned on or off; filtered screen.
OUTPUTS ON FRONT PANEL — Plus Gate output, Sawtooth output, 60 cycle phasing output, 60 cycle unphased output, Calibration output.
FOCUSING — Astigmatism, focus and intensity control.
CRT — NEW 7" Tube, normally supplied in medium persistence type 71P1 (oscilloscope green trace) — high persistence types available at additional cost.
DIRECT — Deflection Plates available from rear of cabinet.
INTENSITY MODULATION — Z modulation through modulation amplifier.
GENERAL — Low loss components; Over-designed fused power supply for additional circuitry. Deeply etched aluminum panel. New parts from original manufacturers — (NO SURPLUS); Steel cabinet: 11" x 14" x 17" complete with instruction book and all components; Accessories: Model 9121MM Oemodulator Probe and Model 960 Capacity Attenuator Probe available at extra cost.
 There are many additional features and circuits in kit form, which may be added to the Model 300. Please write us for descriptive literature.

300K—kit form **\$94.95**
 300W—factory wired **\$199.50**



MODEL 630 RF-AF-TV AND MARKER GENERATOR. For the first time in the history of the industry . . . SO MUCH FOR SO LITTLE. 110 MC on fundamentals; 330 MC on harmonics; Pre-tuned RF (within 1% head); AF from 20 to 20,000 cycles; variable % and Ext. Mod.; Cathode-Follower and Constant Z output; Stepping attenuator; Speech Amp.; Xtal Marker with Amp. control; RF and AF Standby; Wien Bridge AF; Colpitts RF; Illuminated Drum Dials; Coax output; Separately tuned coils; Filtered AC; Vernier tuning; Separate RF; Shielded; 8" x 11" x 5"; Etched panel.
 Model 630K . . . \$38.95 (pre-assembled head) **Model 630K \$33.95**
 Model 630W . . . \$53.95 (Factory wired)



MODEL 610 RF SIGNAL GENERATOR. The lowest priced signal generator in the field offering—Same RF head as Model 630; 110 MC on fundamentals; 330 MC on harmonics; 60 and 400 cycle AF; Cathode-follower output; Ext. Mod.; Speech Amp.; Individually tuned coils.
 Model 610K . . . \$28.95 (pre-assembled head) **Model 610K \$23.95**
 Model 610W . . . \$39.95 (wired)



MODEL 909 VACUUM TUBE VOLTMETER. 1% Ceramic Precision Resistor; Coax DC connector; FM zero alignment scale; Burn-out proof circuit. Rugged oversize 4 1/2" meter.
\$25.98
 Factory wired . . . \$44.98



MODEL 999 HIGH VOLTAGE PROBE. Designed for high voltage measurements with special emphasis on safety. Operational Simplicity and Rugged Construction. Exclusive Features: MULTIPLE INSULATION, MECHANICALLY SHOCKPROOF, CHANGEABLE TIPS; SWIVEL connection. Does are billions of billions to 1 that no breakdown will occur. INTERCHANGEABLE RESISTORS . . . Wired Only **\$4.98**



MODEL 912 RF PROBE. LOWEST PRICED—factory wired Probe in the industry. Individually calibrated at 75 MC for accuracy. Impedance and shunt capacity.
 Wired Only . . . **\$4.25**



MODEL 960 CAPACITY ATTENUATOR PROBE. Reduces input C and loading effects of an oscilloscope by 10 to 1. Adjustable for any scope. Lowest priced in the field, but still using highest quality components.
 Wired Only . . . **\$5.95**



MODEL 907 DELUXE VACUUM TUBE VOLTMETER. Another PRECISE first! Vertical or Horizontal construction. GIGANTIC 7 1/2" meter movement; all the unusual values and features of Model 909 in a really DELUXE version.
\$38.98
 Factory wired . . . \$57.98

PRECISE NEW MODEL 2768 — RESISTANCE DECADE BOX. PRECISE AGAIN LEADS THE FIELD with its New Low-Priced Resistance Decade Box. Ideal for specialized service work. Compact in size for Bench Drawers and Tool Boxes. Engineered with the customary Precision Accuracy and Dependability. 5 Separate Switches, 11 Positions on Each; plus or minus better than 1% for Extreme Accuracy. Readings from 10 OHM to 1,111,110 OHM in 5 Decades. Deeply etched Aluminum Panel; Rugged Construction; Complete with famous Precision Simplified Construction Manual. 3 1/2" x 6 1/4" x 2".
 Kit form **\$18.95**
 factory wired **\$24.95**
 478K—CAPACITY DECADE BOX (Not illus.) . . . \$18.95
 478W—CAPACITY DECADE BOX (Not illus.) factory wired **\$24.95**



MODEL 635 UNIVERSAL AF SINE, SQUARE AND PULSE GENERATOR. For accurate testing audio and video circuits. 1% Ceramic precision resistors; Wien Bridge; variable Z and cathode-follower output; minimum overshoot and roundoff through 100,000 cycles; sine waves through 200 KC.
 Factory wired . . . **\$52.50**

Prices slightly higher in the West. Prices and specifications subject to change without notice.

PRECISE DEVELOPMENT CORP. DEPT. RE-19
 999 LONG BEACH ROAD • OCEANSIDE, E. I., NEW YORK
 GENTLEMEN: Without any obligation on my part, kindly send me the following:
 PRECISE CATALOG
 NAME OF DISTRIBUTOR NEAREST ME

NAME _____
 ADDRESS _____
 CITY _____ ZONE _____ STATE _____

precise DEVELOPMENT CORP.
 OCEANSIDE, NEW YORK

G-E HOLDS SERVICE LUNCH

Problems of the service technician were discussed with the technical press at a luncheon given April 9 in New York City by the General Electric Co. Present were editors of all the magazines interested in radio and TV service.

G. A. Bradford, advertising manager of G-E's tube department, summarized what General Electric had done in the effort to sell the service technician to the set-owning public. He cited the well-known ads in national magazines, mailers made available to service organizations, the booklet distributed to set owners, and surveys made under the direction of the G-E tube department.

The meeting became a round table, at which problems of the service technician and the possibilities of reducing them through the joint efforts of the service technician and his associations, the manufacturers, and the service, trade, and technical magazines, were discussed.

N.H. TO BAN QRM?

An act introduced in the New Hampshire Legislature would give town and city councils the right to fine persons or corporations who unreasonably or unnecessarily disturb or interfere with radio or TV reception.

The bill provides that on receipt of a complaint, the town or city authorities shall investigate, and where the complaint is justified, shall give notice to the person, firm, or corporation to eliminate the cause of such unreasonable or unnecessary disturbance. If the disturbance is not eliminated within the time fixed in the notice (provided it can be corrected at a cost of not more than \$15) the willful violator would be subject to a \$50 fine, to be administered by the municipality.

The bill refers to persons or firms "having authority to transact business in this state" and presumably would not apply to a private citizen ruining neighbors' radio or TV reception with a radiating TV receiver. However, it might be applied to radiating community-antenna systems, which would be operated by concerns "having authority to transact business in the state."

SERIAL NUMBER BILL KILLED

The New York State bill which would have made it a misdemeanor for a dealer to sell electrical appliances from which identification numbers had been removed was vetoed by Governor Dewey.

The Governor pointed out that New York already has a law which makes the willful defacing of serial numbers a criminal act. This law, he pointed out, is intended to punish those who tamper with serial numbers to prevent the detection of a crime or to defraud the manufacturer or purchaser of the device.

The proposed law, he said, was weaker than the present one, since it specifically excepts second-hand sales.

RADIO-ELECTRONICS

WALSCO
HAS THE ONLY UHF
ANTENNAS WITH
AMAZING
X-77
INSULATOR

*Hollow, unbreakable X-77
 Insulator used exclusively on
 Walsco Corner Reflector and
 Reflecto-Fan.*

X-77 insulator makes Walsco the most efficient, all-band UHF antennas in America. Nothing compares with it!

X-77 is hollow, allowing lead-in wire to pass through the center. Wire is kept completely out of field pattern. It eliminates broken wires caused by strain of wire on antenna terminals. X-77 can't break . . . ever! It's 5 times stronger than polystyrene. Silicone treated to shed dust and moisture . . . not affected by extreme heat, cold or wind.

X-77 is non-hygroscopic. Outstanding insulating qualities will last indefinitely.

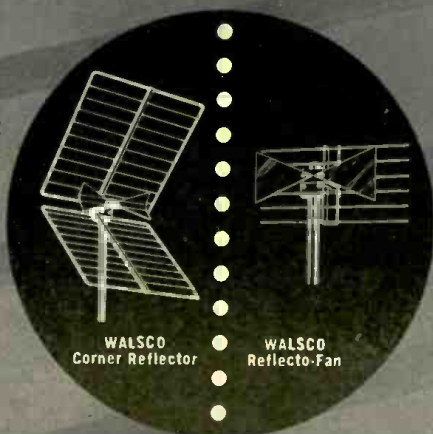

WALSCO
Corner Reflector

WALSCO
Reflecto-Fan

Largest in demand everywhere

	Catalog No.	Description	Avg. Gain (db)	List Price
Reflecto-Fan	4400	Single Bay	7.0	\$ 6.75
	*4402	Dual Stack	11.0	14.25
	*4404	4 Bay Stack	14.5	35.00
Corner Reflector	4450	Single Bay	11.2	14.50
	*4452	Dual Stack	16.4	32.00

WALSCO

Walter L. Schott Co.

Los Angeles 18, Calif.
 Chicago 6, Ill.

*Supplied with complete stacking kit.
 †Most not included in prices.

Overseas Representative: Ad Auriema, Inc., 89 Broad St., New York 4, N.Y.

EDLIE
says

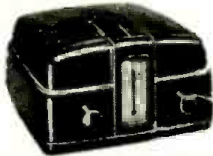

LOWEST PRICED SIGNAL GENERATOR, BROADCAST BAND

New simplified circuit provides the following switch tuned, tone modulated frequencies:

1. 455 K.C.—Intermediate I.F. frequency
2. 1500 K.C.—High frequency of Broadcast Band
3. 600 K.C.—Low frequency of Broadcast Band
4. Audio tone—for audio amplifier trouble shooting
5. An attenuator control is included for adjustment of the output signal strength housed in small black bakelite cabinet size 6"x6"x3 1/2". Can be useful for alignment of all Broadcast Band radio receivers.

\$7.95

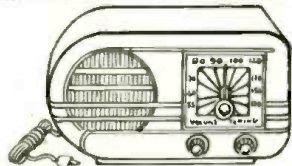

5 TUBE AC-DC SUPERHET KIT
Kit #1—Five Tube superheterodyne kit, A.C.-D.C. contains all components required to construct this latest design, highly sensitive superheterodyne broadcast receiver, complete with black bakelite cabinet (excludes wire and solder) Only **\$7.95**

Kit of 5 tubes (12AT6, 12BA6, 12BE6, 95WA, 50C51). Only \$3.25.

"Save with confidence"

The Lowest Priced Kits on the Market

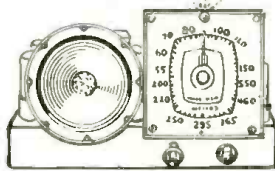

6-TUBE RADIO KIT

Kit #2—A low-priced 6 TUBE KIT designed for high sensitivity, excellent selectivity and good tone quality. Uses 25L6, 25Z6, 6SQ7, 6SA7, 6SK7, 6SK7 in an easily constructed circuit. The 6 Tube Kit is shipped with all parts, including punched chassis, resistors, condensers, coils, sockets, PM Speaker, hardware, etc.

And of a closeout price of **\$6.95**
Matched set of six tubes **\$3.25**
for kit

PHONO OSCILLATOR

Not a Kit!

Wireless phono oscillator transmits recording for crystal pickups or voice from carbon mike through radio without wires. Can also be used as an intercomm by using P.M. speaker as mike. Price (excluding **\$2.95** tubes)

With Complete Set of Tubes.....\$3.95

3-TUBE PHONO AMPLIFIER

Not a Kit!

An assembled unit ready for installation using tone and volume control and six feet of rubber **\$2.95** cord (Not including Tubes)

With Complete Set of Tubes.....\$3.95

Electronic Code Practice Oscillator & Blinker Kit

AC/DC or Battery Operated!

Kit #3—One of the most practical Code Practice Oscillators ever designed, yet one of the simplest to build and operate. Can be used with any number of headphones. Adjustable Pitch Control—Any type of headphone can be used.

No warmup time—ready to operate instantly.

Simple and safe to operate.

Operates anywhere—with AC or DC power, or from a 90 volt Miniature Battery.

Learn Blinker Code with flashing light.

Blinker can be used as signaling device.

International Morse Code included.

Kit **\$1.95** Assem-**\$2.95** each Med

Terms: All merchandise shipped F.O.B. New York City, prices are subject to change without notice. Include 20% deposit for C.O.D.'s.

WRITE FOR NEW CATALOG—Free!

OPPORTUNITY ADLETS

Rates—45¢ per word (including name, address and initials). Minimum ad 10 words. Cash must accompany all ads except those placed by accredited agencies. Discount 10% for 12 issues. Misleading or objectionable ads not accepted. Copy for September issue must reach us before August 21, 1953.
Radio-Electronics, 25 W. Broadway, New York 7, N. Y.

SPEAKERS REPAIRED at wholesale prices. Guaranteed workmanship. Fast service. Amprite Speakers Service, 70 Vesey St., New York 7, N. Y.

REPRESENTATIVES WANTED TO CONTACT Electrical, Electronic, Communications & Instrument trades for manufacturer of precision-made **UNIVERSAL NUT & SCREW STARTER**. Write Aviation Service Supply Co., Dept. RE, Stapleton Field, Denver, Colorado.

ISOLATION TRANSFORMER 35w 117v sec 117 or 135 plus 6.3v 45a 2 1/2 x 2 1/2 x 3. \$2.45 include postage 3 lbs. Bulletin available. Sell us your surplus material. Empire Electronics Co., 409b Ave. L, Brooklyn 30, N. Y.

TUBES AND EQUIPMENT BOUGHT, SOLD AND EXCHANGED. For a fair deal send details to B. N. Gensler W2L.N1, 136 Liberty, N. Y. 6, N. Y.

"RADIOBUILDER" MAGAZINE FOR EXPERIMENTERS—Beginners, 12 issues \$1.50; copy 15¢. Unusual Catalog free. Laboratories, 1131-B Valota, Redwood City, California.

WANTED: AN/APR-4, other "APR-", "TS-", "IE-", ARC-1, ARC-3, ART-13, BC-348, etc. Microwave Equipment, everything surplus. Special tubes, Tee Manuals, Lab Quality Equipment, Meters, Fast Action, Fair Treatment, Top Dollar! Littleil, Fairhills Box 26, Dayton 9, Ohio.

ALL TYPES OF ANTENNAS FOR AMATEUR AND TV. Aluminum Tubing, Willard Radcliff, Fostoria, Ohio.

RECONDITIONED TELEVISIONS. \$30 UP. W4AP1, 1420 South Randolph, Arlington, Virginia.

TV-FM ANTENNAS, ALL TYPES INCLUDING UHF. Mounts, accessories. Lowest prices. Wholesale Supply Co. Lunenburg 2, Mass.

WANTED

WE NEED YOUR SURPLUS ELECTRONIC EQUIPMENT

WE PAY TOP \$\$\$ FOR:

- ★ RADIO RECEIVERS
- ★ TRANSMITTERS
- ★ ARC-1
- ★ ARC-3
- ★ ART-13
- ★ CONTROL BOXES
- ★ INDICATORS
- ★ CLAMPS
- ★ PLUGS
- ★ CORDS
- ★ RELAYS
- ★ TELEPHONE MATERIALS
- ★ AN CONNECTORS
- ★ WE BUY ANYTHING!

Write, Wire today! Tell us what you have.

TALLEN CO., Inc., Dept. RE
159 Carlton Ave., Brooklyn 5, N. Y.

EDLIE Electronics

154 Greenwich St.
DI 9-3143
New York 6, N. Y.

Regency

UHF

the quarter million dollar converter

CONVERTER MODEL RC-600

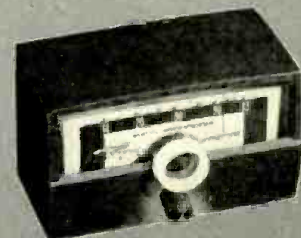

\$49.95 list

this TV set IMPROVES WITH AGE

Five years old next week—and now better than ever. When the original tube wore out it was replaced with a Rauland. Now pictures are brighter, sharper, clearer. Another Rauland success story—your cue to sell *improvement* through *replacement* with Rauland—and chalk up plus business.

THE RAULAND CORPORATION 4245 NORTH KNOX AVENUE
CHICAGO 41, ILLINOIS • MULBERRY 5-5000
ZENITH SUBSIDIARY

Burton Brown's advertisement

JULY, 1953



Facts listed are published through the courtesy of Mr. Anthony Todaro, part owner of a thriving radio and TV shop in Monessen, Pa. . . . Monessen Radio and Television. Mr. Todaro's growing business is based upon a policy of "the best" in material and service.

When reputations rely upon quality... **PERMA-TUBE** stands the test!

HERE'S THE PERMA-TUBE RECORD AT *MONESSEN RADIO AND TELEVISION

- 1 1800 installations without a single antenna mast failure.
- 2 Not a single claim for rusted, bent, twisted, or broken masts since PERMA-TUBE was adopted in 1949.
- 3 PERMA-TUBE installations show no wear after 41 months (average antenna life 27 months).
- 4 Storm that flattened 100 antennas failed to buckle PERMA-TUBE masts.
- 5 PERMA-TUBE supports shop's fine reputation for high-quality work.

Here's why PERMA-TUBE backs up quality service

- 1 PERMA-TUBE IS STURDY . . . it's made of special, high-strength, J&L steel.
- 2 PERMA-TUBE IS CORROSION-PROOF . . . it's treated with vinsynite—then coated inside and outside with a metallic vinyl resin base.
- 3 PERMA-TUBE IS EASILY INSTALLED . . . it's the only mast with both ends of the joint machine fitted.

Here's proof of how Perma-tube resists corrosion

Section of ordinary conduit tubing used for TV masts after 96 hours in a salt spray test (A.S.T.M. Designation B-117-49T) to accelerate corrosion. Extensive rust inside the mast has reduced strength—caused rusty water to drain onto the owner's home.

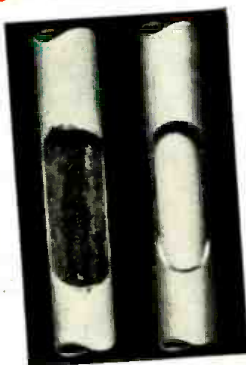

Section of PERMA-TUBE after 500 hours salt spray test shows no evidence of corrosion. Strength has been retained and the chance of rust streaks on owner's home is eliminated. Note sturdier wall thickness of PERMA-TUBE sample.

PERMA-TUBE IS AVAILABLE IN STANDARD LENGTHS . . . DIAMETERS . . . WALL THICKNESSES. FOR COMPLETE INFORMATION MAIL THIS COUPON

**J&L
STEEL**

Jones & Laughlin Steel Corporation
496 Gateway Center, Pittsburgh 30, Pa.

Without charge, please send me: Name of nearest distributor
 Complete information on PERMA-TUBE

Name _____

Company _____

Address _____

Stolen articles are usually found in the second-hand market. Thus the bill would have slight relation to detecting thefts or frauds, and might easily become a device to help enforce manufacturers' restrictive sales policies, or fair trade laws. It is not the function of a penal statute, Governor Dewey believed, to do this, since "injunctive relief or civil remedies are available to aggrieved manufacturers, and the criminal courts should not be a forum for the settlement of essentially economic disputes."

LOS ANGELES ARREST

The Los Angeles authorities are continuing an energetic—though possibly sometimes spotty—campaign against dishonest TV practices in that city. Lewis S. Scott was reported arrested recently on suspicion of grand theft. According to detectives, a set which had been checked in the police laboratory and found perfect was put out of order by installing two defective tubes and was taken to Scott's store. The bill was \$69.16. No details as to what repairs were claimed to have been made were given.

A little later, however, it was reported that Maurice Rappaport, the operator who had been sentenced to 150 days in jail for selling an old set for \$200 as "new" (RADIO-ELECTRONICS, May, 1953, page 116) was released after six days because he "was in financial difficulty and had a wife and children to support." In spite of his financial difficulty, however, a \$75 fine was levied.

CALIFORNIA LICENSE BILL

A bill which would create a board of radio and television examiners, and license all radio and TV technicians and apprentices has been referred to an interim committee of the Legislature for study.

Harry Ward, well known among South California technicians as active in radio and TV associations, was one of those who pleaded the cause of the licensing bill at the hearings.

The bill proposes:

1. To create a board of radio and television examiners in California and require the licensing of all radio and television technicians and apprentices. The board would consist of five members appointed by the Governor.

2. To give an examination to all persons applying for a technician's license.

3. Every license would have to be renewed prior to January 15 of each year.

4. The fees would be as follows: Application for registration for an apprentice, \$2; application for registration for technician, \$5.

5. The annual registration fee as a qualified technician under one or more classifications would be \$5. The annual license fee for service dealers and service organizations would be \$25 for the first year and \$15 thereafter. **END**

RADIO-ELECTRONICS

Centralab Controls —

always within reach . . . always right!

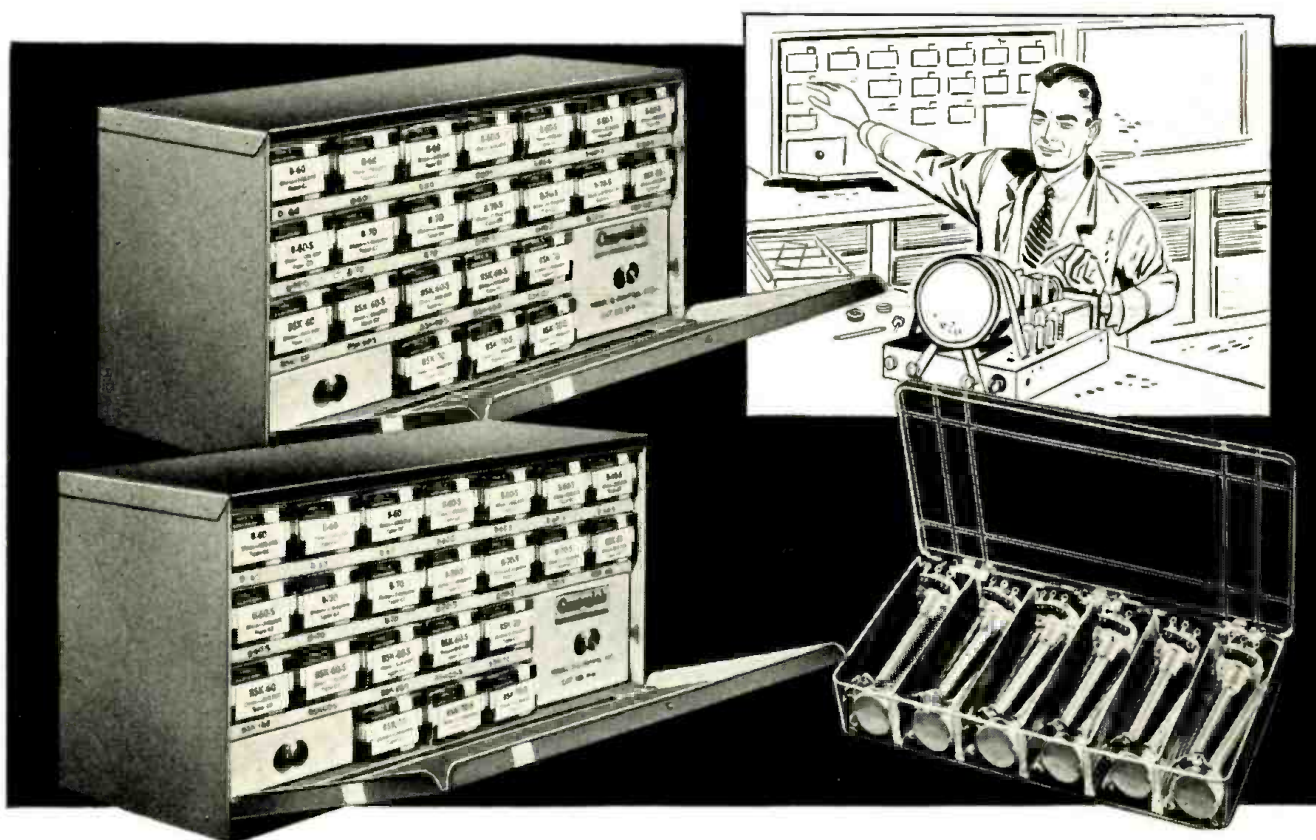

These handy Blue Shaft Kits^{*} help take "parts hunting" out of repair service

If you're like thousands of other busy Service Engineers, you can't afford to sacrifice profit time — hunting for repair parts. The smart, sure way to faster service is to have your Centralab controls on hand when you need 'em — in these handy Blue Shaft Control Kits. Assortments contain values you use every day, in plain or switch types. Switches are factory attached and tested for immediate installation. Included are *exact* service replacements for popular radio and TV sets.

Three kit deals are available: B-A Kit contains 22 controls (8 types) in 1/2 and 1 megohm. All units C2 (audio) taper. Newest, revised Kit B-B has 22 controls (15 different types), plus 4 "Fastatch"^{*} type KB line switches. Ten handy Plasti-Pak Kits of 12 controls each also save time. You pay for parts only — no charge for containers.

You can count on your Centralab Distributor for exact Blue Shaft replacements to keep kits well stocked. So see him soon — he'll be glad to supply the kits you need.

^{*}Trade Mark

Centralab

A Division of Globe-Union Inc.

Milwaukee 1, Wisconsin

In Canada, 635 Queen Street East, Toronto, Ontario

JULY, 1953

FAST MOVERS . . . NO "SLEEPERS"

Kit Deal B-A — 22 controls. 1/2 meg and 1 meg. 8 types have standard 3" shafts, full-length fluted mill. BSK types have 2 1/8" split-knurl shafts. In handy metal cabinet.

PLAIN TYPE				SWITCH TYPE			
3	B-60	1/2 meg.	C2	5	B-60-S	1/2 meg.	C2
2	B-70	1 meg.	C2	3	B-70-S	1 meg.	C2
2	BSK-60	1/2 meg.	C2	3	BSK-60-S	1/2 meg.	C2
2	BSK-70	1 meg.	C2	2	BSK-70-S	1 meg.	C2

Plus one metal cabinet

Kit Deal B-B (Revised) — 22 controls and 4 "Fastatch" switches. All have standard 3" shafts, full-length fluted mill. In handy metal cabinet.

PLAIN TYPE				SWITCH TYPE				"FASTATCH" SWITCHES		
1	B-5	1,000	C1	2	B-83	2.5 megs.	C1	2	KB-1	SPST
1	B-10	5,000	C1	1	B-84	3 megs.	C1	1	KB-2	DPST
1	B-26	25,000	C1	1	B-87	5 megs.	C1	1	KB-3	SPDT
2	B-31	50,000	C1	3	B-60-S	1/2 meg.	C1			
2	B-40	100,000	C1	1	BSK-60-S	1/2 meg.	C2			
1	B-59	500,000	C1	2	B-70-S	1 meg.	C2			
2	B-69	1 meg.	C1	1	BT-80-S	2 megs.	C1			
1	B-75	2 megs.	C1		T-600K		C13			

Plus one metal cabinet

Handy Plasti-Paks — 12 controls. 10 individual kits, also 8 type. Plain and switch type. C2 (audio) taper. Split-knurl shafts. In useful plastic containers.

CENTRALAB, A Division of Globe-Union Inc.
922G E. Keefe Ave., Milwaukee 1, Wisconsin

Please send me complete details on Centralab Radio-TV Kits as found in the new 32-page Catalog No. 28.

Name.....

Firm.....

Address.....

City..... Zone..... State.....

Stimulation of Plant Growth

by

ULTRASONIC WAVES

By **GEORGE OBOLENSKY**

*Seeds treated with
800-kc vibrations
show record yield*



The author with Dr. L. P. V. Johnson of the University of Alberta checking development of cereal grains grown from seeds treated with ultrasonic vibrations.

ULTRASONICS, the science of generating and using mechanical vibrations at frequencies of several hundred thousand or even millions of vibrations a second, has already opened new fields of research in chemistry, physics, and medicine. Chemists have used it for de-sooting smoke in smokestacks of big industries. U.S. Navy research physicists have found that ultrasonic waves can de-gas liquids, and even disperse and suspend in water, despite the force of gravity, everything from cooking fats to aluminum!

Ultrasonics can do things as diverse as breaking the molecule of water into its constituent elements, hydrogen and oxygen, and also sterilizing milk. In the field of physiology, it has been found that bacteria killed by ultrasonic waves release enzymes that would not be released if the bacteria were killed by any other method. In medicine, deep massage with ultrasonic waves is used successfully for relieving such ailments as rheumatism and arthritis.

In addition to these applications in medicine and industry, physicists have found that ultrasonic waves can also stimulate the growth of plants. Although this field of scientific research has received relatively little publicity, its importance can be seen from the fact that the French Government has set up a special research station for acoustical physiology which will do work in agricultural ultrasonics, and in

Germany the University of Hanover is conducting important experiments in this field.

In the more specialized field of plant cytology (cell structure), Doctors Wallace and Newcomer of the University of Connecticut succeeded in changing the chromosomes of sunflower plants with ultrasonic treatments. Other research workers treated potato tubers and found a significant increase in plant development and yield. According to their analysis, the ultrasonic waves seemed to have a physiological effect—the starch changes to sugar at a faster rate than usual—therefore the increased growth and yield.

At the Department of Plant Science of the University of Alberta, in western Canada, which is one of the great grain-producing areas of the world, the author conducted a series of experiments to determine the effect of ultra-

sonic treatment on the seeds of important cereal grains.

The purpose was not so much to observe the different growth developments, as to see the effect of different time exposures to ultrasonic waves.

The first experiments were made on "Olli" barley, an early-ripening variety, with a German machine—the Lehfeldt *ultra-vibrator*—which had a single crystal-controlled output frequency of 800 kc, and a maximum power output of 5 watts per square centimeter.

The seeds were first divided into three equal groups. These were then soaked in distilled water for two reasons:

1. To start the seeds germinating, as dormant plant cells do not respond to shock waves as well as germinated cells.

2. The water absorbed by the seeds is a much better conductor of ultra-

TABLE I

Time of Treatment in minutes	Average Height of Plants (in centimeters)			
	24-hour soaking		48-hour soaking	
	1st Rep.	2nd Rep.	1st Rep.	2nd Rep.
10	68.2	34.8	75.6	56.1
15	65.5	44.0	75.7	56.1
20	65.9	52.4	65.1	45.8
No treatment			52.9	
Rep.—Replicate				

To help you sell
EVEN MORE
of the easiest-to-sell Rotors

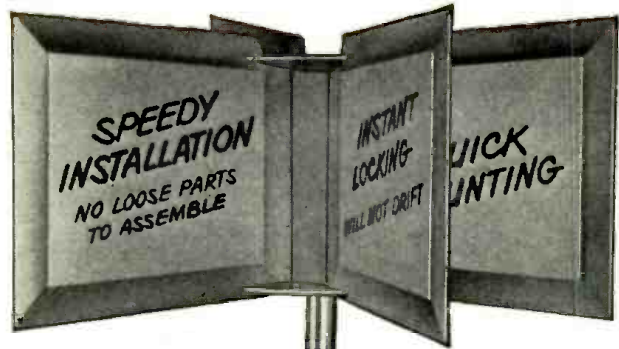

The C·D·R Rotor Moving Display

NOW... customers in YOUR STORE... will SEE and USE this ANIMATED and ILLUMINATED display to see for themselves the fast selling CDR ROTOR! Colorful... it's a silent salesman that does the job on its own! Be the first in your area with this new device... and SELL EVEN MORE CDR ROTORS... faster! After all... it's easy when the display demonstrates the greatest rotor value on the market today!



TR-12 Rotor... complete rotor unit including thrust bearing, handsome modern design plastic cabinet with meter control dial, uses 4 wire cable
\$47.95



THE **RADIART** CORPORATION
CLEVELAND 13, OHIO



CORNELL-DUBILIER
SOUTH PLAINFIELD, NEW JERSEY

NEW!!

Universal

NUT & SCREW STARTER

A specially engineered precision tool for mechanics, technicians, and repairmen in radio, electronics, and instruments fields. Eliminates fumbling and wasted time in starting or removing screws and nuts in hard-to-reach places.

FULLY GUARANTEED

Holds
Nuts
AND Screws!

Representatives inquiries invited...



Made of finest quality materials. Has lightweight aluminum handle and sleeve, and specially tempered dual blades of finest drill rod steel. Not magnetized. 6 sizes available separately or in boxed sets. See your dealer or jobber, or write to:

MFGD. BY
asSCO

Aviation Service Supply Co., Dept. RE
Stapleton Field Denver, Colorado

ADDITIONAL TV-RADIO SERVICE LIBRARY

HERE IS LATE INFORMATION IN A HANDY FORM FOR RADIO & TELEVISION REPAIRMEN, SERVICEMEN & STUDENTS

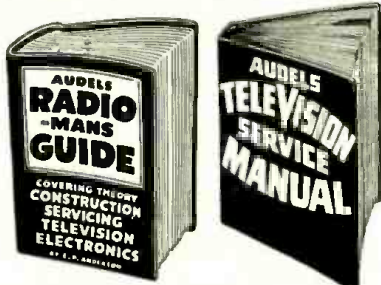

2 VOLS. \$6 COMPLETE \$1 MO.
IT PAYS TO KNOW!

AUDELS T.V.-RADIO SERVICE LIBRARY presents the important subjects of Modern Radio, Television, Industrial Electronics, F.M. Public Address Systems, Auto, Marine & Aircraft Radio, Phonograph Pick-Ups, etc. Covers Basic Principles—Construction—Installation—Operation—Repairs—Trouble Shooting. Shows How to get Sharp, Clear T.V. Pictures. Install Aerials—How to Test. Explains Color Systems & Methods of Conversion. 1001 Facts—Over 1260 Pages—625 Illustrations—Parts & Diagrams—Valuable for Quick Ready Reference & Home Study. Tells How to Solve T.V. & Radio Troubles—Answers T.V. & Radio Questions.

Get this information for Yourself.
7 DAY TEST—ASK TO SEE IT!

MAIL ORDER

AUDELS Publishers, 49 W. 23 St., N.Y. 10
Mail AUDELS T.V. RADIO SERVICE LIBRARY 2 vols. \$6
on 7 days free trial. If O.K. I will remit \$1 in 7 days and
\$1 monthly until \$6 is paid. Otherwise I will return them.

Name _____
Address _____
Occupation _____
Employed by _____ RE

(Advertisement)



"Quick, Watson, the JENSEN!"

WATCH FOR THE AUGUST ISSUE OF
RADIO-ELECTRONICS
ON THE NEWSSTANDS
JULY 24

sonic waves than air and gives a better impedance match to the crystal.

One group was soaked for 24 hours, and the other two groups for 48 hours.

In accordance with standard experimental practice, one of the groups was set aside as a *control* and was not subjected to ultrasonic treatment. Each of the two remaining groups was then divided into three equal subgroups. These were given ultrasonic treatment for periods of 10, 15, and 20 minutes respectively. The treated seeds were then divided again into two *replicates* (a term used in agricultural science to indicate seeds planted in different types of soil, or raised under different conditions for comparison purposes). All the seeds were then planted and allowed to mature. The results of the experiment are given statistically in Table I. The growth figures for both replicates are highly significant, and show unmistakably the added growth of the treated seeds.

In another test some sunflower seeds of the variety Mennonite were dehulled. The seeds were then given 1-minute, 3-minute, 6-minute, and 10-minute treatments by the methods previously described. At complete maturity the diameter of the sunflower heads were measured. The results are given in Table II.

TABLE II

Time of Treatment (in minutes)	Average Diam. of sunflower head (in centimeters)
1	13
3	15.2
6	13.3
10	18.0

It would seem that within certain ranges longer treatments produce greater effects. The exact position of the borderline of increase has yet to be determined. The growth can be expressed in terms of the number of watt-seconds used. The machine used was capable of producing 5 watts per square centimeter maximum. Thus 10 minutes treatment at 5 watts would be 50 watt-minutes per square centimeter. Using more energy does not always induce more growth. In the opinion of the author there is an ideal frequency for each type of plant which will give the best results. Different plants seem to require different frequencies and far different amounts of energy.

Some sunflower seed was obtained from Dr. Wallace of the University of Connecticut. These were progenies of treated seed of the Giant Russian variety. In this region (Edmonton, Canada) this variety ordinarily grows to a height of 10 feet or slightly less. The first and second generation from the original seeds are at present averaging about 14 feet and are still growing. The stalks of these plants produce a tremendous amount of fiber which has many industrial possibilities. Several research groups are interested in ana-

Valuable 3-way aid for Auto Radio Repair Men!



Once you're on the Delco Radio team you're in line for this three-way help: a reliable source for Delco Radio original equipment and replacement parts and universal replacement parts; a complete and comprehensive Delco Radio Service Manual; monthly issues of "Testing Tips," a bulletin giving the very latest factory information on testing and repairing Delco car radios—even the sensational new "Favorite Station" Signal-Seeking model! To get going with Delco Radio contact your nearest United Motors Electronics Parts Distributor. Don't delay—act today!



DELCO RADIO

DIVISION, GENERAL MOTORS CORPORATION, KOKOMO, INDIANA

A GENERAL MOTORS PRODUCT  A UNITED MOTORS LINE

DISTRIBUTED BY ELECTRONICS WHOLESALERS EVERYWHERE



**Don't
spoil
the
reflection**

Your reputation as a skilled Service Man depends a great deal on your choice of replacement parts. The performance of replacement speakers reflects upon your ability and knowledge. Be sure the reflection is favorable. Specify Utah* speakers—and your customers will say "That Service Man Knows His Business!"

*All Utah speakers have exclusive Utah Universal Angle Mounting.

FREE . . . WRITE TODAY FOR THE NEW UTAH
REPLACEMENT SPEAKER CATALOG S201
Export Dept. Rocke International Corporation, N. Y. C.

utah

RADIO PRODUCTS CO., INC.
HUNTINGTON, INDIANA

A WHOLLY OWNED SUBSIDIARY OF NEWPORT STEEL CORPORATION

J. S. C. Presents A NEW Tubular Twin Lead*

The best low loss, low cost 300 ohm lead-in for UHF and VHF television. Rain, snow, dirt or salt deposits do not materially affect impedance and electrical efficiency!

Look for
the Orange
and Blue
Disc of
Quality.



*Manufactured under license of Amphe-nol Pat. 2543696.

TELEVISION

Big demand for graduates

B.S. DEGREE IN 27 MONTHS in radio including TV engineering—VHF, UHF, AM and FM. Students use over \$100,000 worth of equipment including 2 large commercial type transmitters in new TV lab. Intense specialized course includes strong basis in mathematics, science and advanced design in radio and TV.

Hundreds of young men each year are earning engineering degrees in this recognized institution. Start any quarter. Many earn a major part of expenses in this industrial center. Low tuition. Competent instruction. Thorough, intense, practical program. Also B.S. DEGREE IN 27 MO. in Aeronautical, Chemical, Civil, Electrical and Mechanical Engineering. G.I. Gov't approved. Enter Sept., Dec., March, June. Free catalog. ENROLL NOW.

INDIANA TECHNICAL COLLEGE
1773 E. Washington Blvd., Fort Wayne 2, Indiana

When Answering Advertisements
Please Mention RADIO-ELECTRONICS

lyzing its potentialities. According to German sources the dry matter in the stalks usually contains 40% to 48% alpha-cellulose. This can be converted to a good-quality paper and also can be used in the textile industry.

It is interesting to note that some of the seeds treated are producing albino plants. These plants die early because they have no chlorophyll to produce food by photosynthesis. This indicates that, in some cases, ultrasonic waves are inducing mutations.

There is a great field for work on vegetable seeds like tomatoes and onions, because only small amounts of such seed are required for large acreages. Future study should be directed toward discovering whether ultrasonic treatment would make the crops mature earlier. At the present time, an experiment is being conducted to see if ultrasonic treatment can be used for killing loose smut, which is a common disease in cereal grains.

The author has treated potato tubers and found the same increases in the rate of growth and development as the other researchers mentioned above. Other preliminary work conducted with various breeds of oats and wheat has also shown promising results.

At present, the author is handicapped by lack of a precision ultrasonic generator that will give him an unrestricted choice of frequency and high output power. He cannot change the frequency of the Lehfeldt generator without changing a costly quartz crystal for another one equally expensive. He would like a machine capable of producing 20 watts or more ultrasonic power per square centimeter, but he is not an electrical engineer. He hopes that his problem will be solved in the very near future by electrical engineers. END

BROADCASTERS' "CAN-CAN"

New boons to broadcasters with more than a hint of forthcoming "technological unemployment" for large numbers of station personnel are foreshadowed by two recent announcements from widely different sources. The FCC upheld its recent rule relaxing license requirements for radio operators in many 1-kw and less broadcast AM and FM stations, and permitting remote-control operation of certain broadcast AM and FM stations with powers up to 10 kw.

The other announcement is the development by Ampex Electric Corporation of a continuous tape player which permits a station to broadcast an 8-hour all-tape program automatically, even including recorded station breaks and local announcements cut in by synchronized clock mechanisms. The new machine runs at 3 3/4 inches per second, and has flat response to 7,500 cycles. Special tape-duplicating equipment developed by Ampex for the new system enables a single operator to duplicate 1,200 hours of canned program in an 8-hour day. END

RADIO-ELECTRONICS

BUY TEST EQUIPMENT ON THIS RADICALLY NEW TIME PAYMENT PLAN

NO INTEREST!! - NO CARRYING CHARGES!!

USE CONVENIENT TIME PAYMENT ORDER BLANK BELOW

Superior's New Model 770

VOLT-OHM MILLIAMMETER

Sensitivity—1000 ohms per volt

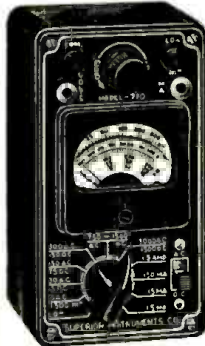

Uses latest design 2% accurate 1 Mil. D'Arsonval type meter. • Same zero adjustment holds for both resistance ranges. It is not necessary to readjust when switching from one resistance range to another. This is an important time-saving feature never before included in a V.O.M. in this price range. • Housed in round-cornered, molded case. • Beautiful black etched panel. Depressed letters filled with permanent white. Insures long-life even with constant use.

SPECIFICATIONS:

- 6 A.C. VOLTAGE RANGES: 0-15/30/150/300/1500/3000 Volts.
- 6 D.C. VOLTAGE RANGES: 0-7.5/15/75/150/750/1500 Volts.
- 4 D.C. CURRENT RANGES: 0-1.5/15/150 MA. 0-1.5 Amps.
- 2 RESISTANCE RANGES: 0-500 Ohms 0-1 Megohm.

Model 770 is an accurate pocket-size V.O.M. Measures only 3/8" x 5/8" x 2 1/4"

\$14.90 NET

The Model 770 comes complete with self-contained batteries, test leads and all operating instructions.

Superior's New Model TV-11

TUBE TESTER



• Uses the new self-cleaning Lever Action Switches for individual element testing. Because all elements are numbered according to pin number in the RMA base numbering system, the user can instantly identify which element is under test. Tubes having tapped filaments and tubes with filaments terminating in more than one pin are truly tested with the Model TV-11 as any of the pins may be placed in the neutral position when necessary. • Uses no combination type sockets. Instead individual sockets are used for each type of tube. Thus it is impossible to damage a tube by inserting it in the wrong socket. • Free-moving built-in roll chart provides complete data for all tubes. • Phono jack on front panel for plugging in either phones or external amplifier detects micaphonic tubes or noise due to faulty elements and loose external connections.

Operates on 105-130 Volt 60 Cycles A.C. Hand-rubbed oak cabinet complete with portable cover

\$47.50 NET

Superior's New Model 670-A

SUPER-METER

A combination volt-ohm milliammeter plus capacity reactance inductance and decibel measurements



SPECIFICATIONS:

- D.C. VOLTS: 0 to 7.5/15/75/150/750/1,500/7,000 Volts
- A.C. VOLTS: 0 to 15/30/150/300/1,500/3,000 Volts
- OUTPUT VOLTS: 0 to 15/30/150/300/1,500/3,000 Volts
- D.C. CURRENT: 0 to 1.5/15/150 Ma. 0 to 1.5/15 Amperes
- RESISTANCE: 0 to 1,000/100,000 Ohms 0 to 10 Megohms
- CAPACITY: .001 to 1 Mfd. 1 to 50 Mfd. (Quality test for electrolytics)
- REACTANCE: 50 to 2,500 Ohms 2,500 Ohms to 2.5 Megohms
- INDUCTANCE: .15 to 7 Henries 7 to 7,000 Henries
- DECIBELS: -6 to +18 +14 to +38 +34 to +58

Comes housed in rugged, crackle-finished steel cabinet complete with test leads and operating instructions. Size 6 1/4" x 9 1/2" x 4 1/2".

\$28.40 NET

ADDED FEATURE

The Model 670-A includes a special GOOD-BAD scale for checking the quality of electrolytic condensers at a test potential of 150 Volts.

Superior's New

TV BAR GENERATOR

THROWS AN ACTUAL BAR PATTERN ON ANY TV RECEIVER SCREEN!



CONNECTS DIRECT TO ANTENNA POST

NO CONNECTION INSIDE RECEIVER

Features—

Can be used when no stations are on the air. • Provides linear patterns to adjust vertical and horizontal linearity • Provides vertical and horizontal sweep signals • Provides signal for testing video amplifiers.

TV Bar Generator comes complete with shielded leads and detailed operating instructions. Only

\$39.95 NET

Superior's Model 660-A—A NEW A.C. OPERATED SIGNAL GENERATOR

Provides Complete Coverage for A.M.—F.M. and TV Alignment



• Tubes used: 1—6BE6 as R. F. Oscillator, mixer and amplifier. 1—6BE6 as Audio Oscillator. 1—6HG as Power Rectifier.

The Model 660-A comes complete with coaxial cable, test lead and instructions

\$42.95 NET

Generates Radio Frequencies from 100 Kilocycles to 60 Megacycles on fundamentals and from 60 Megacycles to 220 Megacycles on powerful harmonics. • Accuracy and stability are assured by the use of permeability trimmed Hi-Q coils. • R. F. available separately or modulated by the internal audio oscillator. Built in 400 cycle sine wave audio oscillator used to modulate the R. F. signal also available separately for audio testing of receivers, amplifiers, hard of hearing aids, etc. • R. F. Oscillator Circuit: A high transconductance heptode is used as an R. F. oscillator, mixer and amplifier. Modulation is effected by electron coupling in the mixer section thus isolating the oscillator from load changes and affording high stability. • A. F. Oscillator Circuit: A high transconductance heptode connected as a high-mu triode is used as an audio oscillator in a high-C Colpitts Circuit. The output (over 1 Volt) is nearly pure sine wave. • Attenuator: A 5 step ladder type of attenuator is used.

NEW TIME PAYMENT PLAN ORDER BLANK

MOSS ELECTRONIC DISTRIBUTING CO., INC. Dept. B-64, 38 Murray Street, New York 7, N. Y.

Please send me the units checked below. I am enclosing the down payment with order and agree to pay the monthly balance as shown. It is understood there will be no carrying, interest or any other charges, provided I send my monthly payments when due. It is further understood that should I fail to make payment when due, the full unpaid balance shall become immediately due and payable.

- MODEL 770 Total Price \$14.90 \$2.90 down payment. Balance \$2.00 monthly for 6 months.
- MODEL TV-11 Total Price \$47.50 \$11.50 down payment. Balance \$6.00 monthly for 6 months.
- MODEL 670-A Total Price \$28.40 \$7.40 down payment. Balance \$3.50 monthly for 6 months.
- TELEVISION BAR GENERATOR Total Price \$39.95 \$9.95 down payment. Balance \$5.00 monthly for 6 months.
- MODEL 660-A Total Price \$42.95 \$12.95 down payment. Balance \$5.00 monthly for 6 months.

- I enclose \$_____ as down payment.
- Ship C.O.D. for the down payment.

Signature _____

Name _____

Address _____

City _____

Zone _____

State _____



YOUR HIGH-PAYING
interesting career in
TELEVISION

starts here!

HOME STUDY COURSE

with one of America's
LARGEST schools



COMPLETE PARTS KIT INCLUDED. BUILD YOUR OWN TV SET!

There's a place for YOU in the tremendous, billion-dollar Television, Radio & Electronics industry! It's so easy to get started with the famous CRESCENT SCHOOL course. Learn at home, in your spare time. Illustrated, simplified lessons and kits to practice on. No previous training needed. Send for FREE sample lesson... make this day the day you started on your way to a brilliant profitable career!

APPROVED FOR KOREAN VETS

Also Day & Eve. Classes
Trained at Our School



CRESCENT SCHOOL

"One of the Largest of its kind"

SEND COUPON TODAY!

CRESCENT SCHOOL Dept. E7
500 Pacific Street, Bklyn. 17, N.Y.

Sirs: Rush your FREE sample lesson and full details about the CRESCENT SCHOOL Course—at no obligation to me!

Home Study Course Residential Course

NAME _____

ADDRESS _____

CITY _____ ZONE _____ STATE _____

EASY TO LEARN CODE

It is easy to learn or increase speed with an Instructograph Code Teacher. Affords the quickest and most practical method yet developed. For beginners or advanced students. Available tapes for beginner's alphabet to typical messages on all subjects. Speed range 5 to 40 WPM. Always ready—no QRM.



ENDORSED BY THOUSANDS!

The Instructograph Code Teacher literally takes the place of an operator-instructor and enables anyone to learn and master code without further assistance. Thousands of successful operators have "acquired the code" with the Instructograph System. Write today for convenient rental and purchase plans.

INSTRUCTOGRAPH COMPANY

4701 Sheridan Rd., Dept. RC, Chicago 40, Ill.

COMMERCIAL SILENCER

Patent No. 2,630,525

William M. Tonberlin, North Hollywood, Calif.;
Louis G. MacKenzie, Inglewood, Calif.; Paul
K. Bennett, Pasadena, Calif.
(Assigned to Musicast, Inc., Los Angeles, Calif.)

This patent covers an invention permitting a receiver to be silenced through commercials or—if desired—certain periods of recorded music as well, by an ultrasonic signal transmitted by the broadcast station. The invention applies to "store-casting" and similar schemes, in which a factory, for example, may be supplied with music without commercial announcements, and the vacant spaces in the program utilized for silent periods or announcements originating in the plant (or school, waiting room, or other establishment). If longer silent periods or more extensive local announcements are desired, the transmitted signal may be cut out automatically during selected musical periods—every fourth record for example, or during a lunch hour.

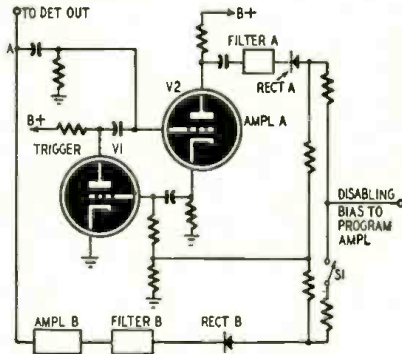

The r.f. circuits of the receiver are conventional. The detector output is fed simultaneously to the receiver's a.f. amplifier and to muting circuits which silence the set. These muting circuits (see diagram) consist of selective amplifiers and rectifiers for control frequencies A and B. The rectifiers produce negative voltages across series-connected load resistors. These voltages are used to bias the receiver's a.f. amplifier to cutoff during the commercial or (in one application) where a certain undesired musical selection is being transmitted.

V2 is the amplifier for control signal A. It operates with high bias so that its gain is low. V1 operates as a high-gain zero-bias amplifier. Since it is shunted across the input of V2, it serves as a low-impedance path which lowers the signal on V2 to the point where it will not develop enough negative bias to disable the main program amplifier.

When a B-frequency pulse is received, it is amplified through the B amplifier. The output is rectified and applied to the mid-point of the V1 grid resistor in the form of a negative pulse strong enough to block the tube. If an A-frequency signal is being transmitted, the output of V2 then rises, and is rectified and applied as a disabling signal to the main program amplifier, which is silenced. The increased signal at the cathode of V2, applied through a capacitor to the grid of V1, is sufficient to keep that tube cut off till the A-frequency signal ceases. Then V1 starts to conduct, and no signal can get through V2 till another B-frequency pulse is received from the transmitter.

During certain periods (say every fourth record) the B-frequency is sent continuously. If switch S1 is closed, the resulting rectified output is applied direct to the main amplifier, causing it to be cut off during these periods as well as when the A-frequency is transmitted. (Since no A-frequency signal is coming in, sets with S1 open will receive normally.)

These additional silent periods may be utilized for local announcements or other special purposes, or may simply provide interruptions in those industrial applications where discontinuous music is considered better than a continuous program for maintaining employee morale or production rates.

The inventor claims that unauthorized use of the equipment can be prevented by changing the ultrasonic frequencies occasionally. Components are made in plug-in form to make this easier. Further, due to its waveform and short duration, the B-frequency signal is hard to tune in and identify as to frequency. This makes piracy even more difficult.

RADELCO

LIGHTNING ARRESTOR

MODEL R-116

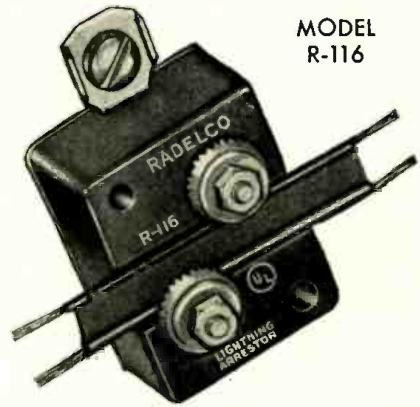

IT'S THE LOWEST PRICE UNDERWRITERS' LISTED ARRESTOR ON THE MARKET

ORDER FROM YOUR NEAREST PARTS JOBBER

LIST PRICE **90¢**

NOW! YOU'LL REALLY KNOW HOW TO USE OSCILLOSCOPES!



Here, at last, is a practical book that makes it easy for you to learn to use the oscilloscope FULLY on all types of AM, FM and TV service work—and dozens of other applications besides!

MODERN OSCILLOSCOPES AND THEIR USES, by Jacob H. Ruiter, Jr. of Allen B. DuMont Labs contains 326 fact-jammed pages of just the help you need—written so you can easily understand it. The book shows exactly how the 'scope works; how to use it on all service jobs from troubleshooting to realigning; how to make connections; how to adjust circuit components; how to set controls and how to analyze patterns. 370 illustrations including pattern photos make things doubly clear.

When, where why and exactly how to use your 'scope.

How to interpret patterns

How to handle tough jobs in less time

PRACTICE FROM IT 10 DAYS AT OUR RISK!

Dept. RE-73, RINEHART BOOKS, Inc., Technical Division, 232 Madison Ave., New York 16, N. Y.

Send MODERN OSCILLOSCOPES AND THEIR USES for 10-day FREE EXAMINATION. If I decide to keep the book, I will then remit \$6.00 plus a few cents postage in full payment. If not, I will return book postpaid and owe you nothing.

NAME _____
ADDRESS _____
CITY, ZONE, STATE _____
OUTSIDE U.S.A.—Price \$6.50 cash with order. Money back if book is returned in 10 days.

RADIO-ELECTRONICS

Depend on Mallory
for
Approved Precision Quality

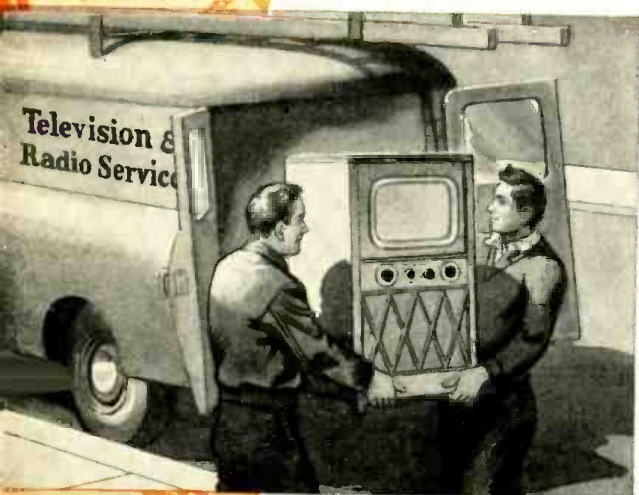

This Service Job Will Stay "Sold"!

For good reason, too. Mallory FP capacitors were used. They are engineered to duplicate the electrical characteristics of the original part in any TV or radio set that comes into your shop. They will give performance that's equal to . . . and often better than . . . the original equipment. You can count on Mallory FP's for precision quality . . . no call-backs.



Mallory FP's are the only fabricated plate capacitors available to the replacement market. They'll give you long lasting performance at high temperatures and greater ripple currents . . . even at 185° F. (85° C.).



When you use Mallory FP capacitors for all your service work, you can be sure that every job is right the first time. It just doesn't pay to take chances on capacitor performance. Always specify *brand* as well as rating when you order . . . ask for Mallory and watch your call-backs fall away to nothing. It costs no more to be sure with Mallory.

For plastic tubular replacements, ask your distributor for Mallory Plascaps®. They will put an end to premature shorts . . . leakage . . . off center cartridges . . . and unsoldered leads.

P. R. MALLORY & CO. Inc.
MALLORY

CAPACITORS • CONTROLS • VIBRATORS • SWITCHES • RESISTORS
• RECTIFIERS • VIBRAPACK® POWER SUPPLIES • FILTERS

APPROVED PRECISION PRODUCTS

P. R. MALLORY & CO. Inc., INDIANAPOLIS 6, INDIANA

to
**ELECTRO-MECHANICAL
ENGINEERS
and
DESIGNERS**

with experience in

**SMALL
PRECISION
DEVICES**

**HUGHES
RESEARCH
AND DEVELOPMENT
LABORATORIES.**

one of the nation's leading electronics organizations, are now creating a number of new openings for qualified electro-mechanical engineers and designers in important phases of its operations.

THE COMPANY

The Hughes Laboratories, located in Southern California, are presently engaged in the development and production of advanced radar devices, electronic computers and guided missiles.

THE OPPORTUNITIES

Opportunities are offered for men who will perform interesting work on development of intricate new devices in close association with outstanding scientists. Activities em-

brace a variety of challenging problems which require originality and afford unusual possibilities of progress in learning.

FIELDS OF WORK

The work includes such fields as those involving Servo Mechanisms, Computers, Microwave Tubes, Pulse Circuitry, Solid-State Physics, Miniaturization, Antennas—Waveguides, Heat Transfer, Hydraulics—Gyros, Test Equipment, Subminiatur-

ization, Stress Analysis, Instrumentation, Structures, and Precision Production Mechanisms.

YOUR FUTURE

Working experience in advanced techniques employing the above fields will increase your value to the Company as it further expands in development of electro-mechanical devices. Large-scale use of electronically controlled systems in business and industry is a certainty within the next few years.

HUGHES

Research and Development Laboratories
Scientific and Engineering Staff

How to apply

CULVER CITY
LOS ANGELES COUNTY
CALIFORNIA

Write today to address at left, giving details of qualifications and experience. Assurance is required that any relocation of an applicant will not cause disruption of an urgent military project.

MOSLEY 3-WAY TV ANTENNA SWITCH



Cat. No. F-20 MOSLEY 3-Way TV Antenna Switch
List Price\$3.75

UHF and VHF ANTENNA INSTALLATIONS

- Install anywhere. Extension rod supplied for back of set mounting.
- Constant impedance—Low loss—Solderless.
- Sturdy rotary switch making silver-to-silver contact.
- In brown or ivory polystyrene case.
- Also available in Flush Wall Plate style.

At Radio Parts Jobbers

MOSLEY Electronics, Inc.

8622 St. Charles Rock Road

St. Louis 14, Missouri



NEW PATENTS

HUMIDITY MEASUREMENT

Patent No. 2,629,054

Leo S. Craig, Shrewsbury, N. J.

(This invention may be used by the U.S. Government without payment of royalties)

This device is a humidity-controlled audio oscillator for modulating radiosonde transmitters. The tones produced by the oscillator indicate the relative humidity. The circuit is designed around a hygroscopic (humidity-sensitive) resistor. The resistance of the hygroscopic unit varies inversely as the humidity and varies the frequency of the oscillator.

Fig. 1 shows the hygroscopic unit, R1, in a blocking oscillator circuit used in a conventional radiosonde. When the tube conducts, grid current flows through R1 in the direction shown by

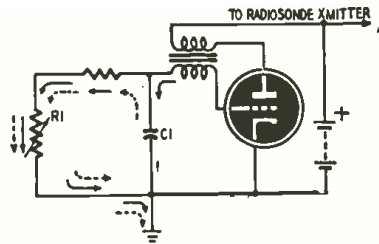

Fig. 1—Standard circuit for transmitting indications of relative humidity.

the solid arrows. When the tube blocks, capacitor C1 discharges through R1 in the same direction as the grid current. The discharge path is shown by dashed arrows.

When unidirectional currents are passed through electrolytic resistors (the hygroscopic units) they become polarized and cause erroneous indications. Polarization does not occur in a.c. circuits.

The improved circuit in Fig. 2 is designed to produce bidirectional currents through R1. When the tube is conducting, C1 and C2 charge until the charge on C2 drives the tube to cutoff. (The solid arrows show the direction of currents

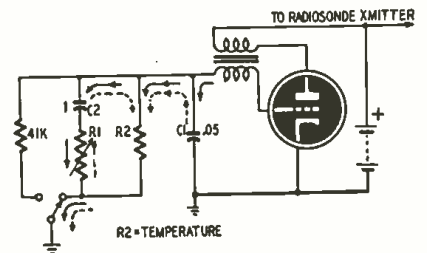

Fig. 2—Improved circuit cancels the effect of direct current through R1.

through R1 when the tube is conducting.) C1 and C2 discharge in the directions shown by the dashed arrows. The charge and discharge currents flow through R1 in opposite directions, producing the same effects as would be obtained with an a.c. supply.

When the humidity is low, R1 is practically an open circuit and the oscillator frequency is controlled by C2 and R2. When the humidity is high, the resistance of R1 is low and C1 is effectively shunted across C2 to produce a lower operating frequency.

The improved circuit can be compensated for temperature variations. Electrolytic resistors have a positive temperature coefficient. The circuit can be compensated by using suitable negative-temperature-coefficient resistors for R2. The performance of the circuit is checked by throwing the switch to substitute the 41,000-ohm resistor for the humidity-sensitive unit.

GUIDED MISSILE

Patent No. 2,629,289

Paul B. Hunter, Metuchen, N. J.

(Assigned to Sperry Corp., Great Neck, N. Y.)

When firing a gun or releasing a bomb, correct aim alone does not assure a direct hit. Target motion, wind resistance, and other factors must be reckoned with. The probability of a hit may be improved by guiding the missile while it

NEW PATENTS

is in flight. This invention permits a certain amount of "steering" by remote control.

A microwave transmitter sends a pencil-like beam in a line toward the target. The missile is equipped with a microwave receiver and several antennas on the fins. So long as each antenna receives the same power from the transmitter, the course of the projectile is unchanged. If the missile goes off the beam, one antenna receives a stronger signal than the others do. This causes the release of compressed gas from one side of the shell or bomb and its course is adjusted toward the center of the transmitted beam.

The microwave transmitter is situated near the gun position. Its antenna is highly directional and is coupled through a servomechanism to a telescope. Thus the telescope and antenna always point in the same direction.

When the missile is fired, an observer keeps it in view and, by pointing the telescope, directs the missile to the target.

TRANSISTOR TRIGGER

Patent No. 2,622,211

Robert L. Trent, For Hills, N. J.

(assigned to Bell Telephone Labs., Inc.)

High efficiency and small size make transistors desirable as trigger elements. But nonuniformity of base current often makes them impractical because the base current (in any transistor) is apt to vary considerably with temperature. Trigger circuits require a large base resistor; so small changes in base current cause a large change in bias voltage. This may change the mode of operation of the trigger circuit and amplitude of the pulse required for triggering may vary widely. Operation of this new transistor trigger circuit is almost independent of base current.

A crystal rectifier and a battery B are used in the base circuit of the trigger. The rectifier is biased by B for conduction. The current I_b must be larger than the static base current that flows. Thus I_b overcomes the normal base current and maintains the rectifier in a conducting state. R1 may be about 500 to 1,000 ohms. This value is too low to affect transistor bias, even if base current varies in some undesired manner.

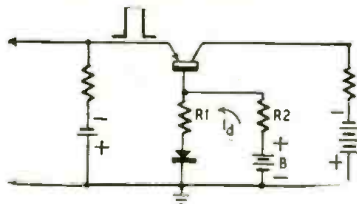

If a sufficiently large positive pulse is impressed on the emitter, the bias current will be greatly increased. It biases the rectifier to cutoff. When this happens, R2 becomes the base resistor. It may be 10,000 ohms or more. Due to the high base resistor, the input resistance of the transistor goes negative as needed for trigger operation.

In effect, this circuit switches R1 in and out. Normally the base resistor is low because current flows through R1. When the circuit is triggered, R1 is switched out, raising the base resistance as needed for triggering. END

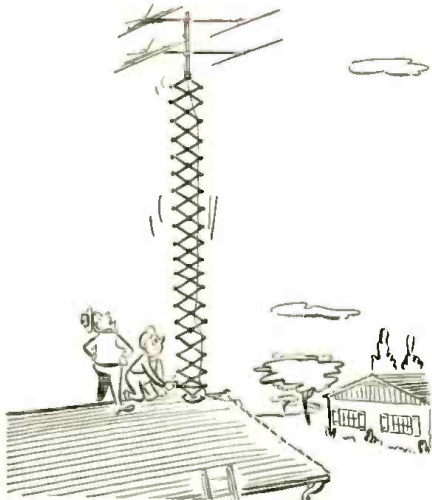

"Kinda wobbly—but it sure raises and lowers easy."

JULY, 1953

MODEL 480 GENESCOPE

Simpson

RECOMMENDED

by service managers of leading manufacturers:

don anderson
frank smolek
floyd makstein
norm cooper
max schinke
tim alexander

hoffman
zenith
emerson
hallcrafters
admiral
motorola

\$395 dealer's net

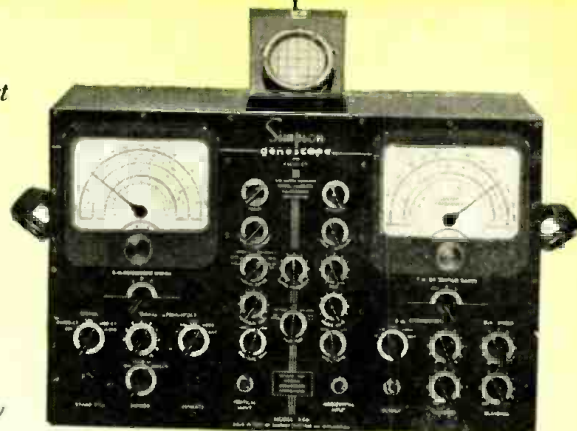

Simpson

SIMPSON ELECTRIC COMPANY, 5200 W. KINZIE ST., CHICAGO 44, ESTEBROOK 9-1121

BURTON BROWNE ADVERTISING

TRAIN AT HOME FOR UHF-TV AND

TELEVISION SERVICING

Learn practical, professional type TV Servicing without leaving your present job. Included are money-making extras such as set conversion, master antenna installation, UHF-TV, field servicing short cuts. You can start earning Television money after just few lessons. You learn to test, trouble shoot and repair all types of TV sets.

HERE'S HOW YOU GET EXPERIENCE!

You train on a large screen, modern TV receiver, furnished with the course and yours to keep! As an optional feature you can get two weeks actual experience with Chicago's largest independent servicing organization. You learn by doing! Age is no barrier. Many students are over 40! ACT NOW! Send for FREE Catalog and SAMPLE LESSON today!

TV COMMUNICATIONS INST.
205 W. Wacker Dr., Dept. RE-19
Chicago 6, Ill.

VETERANS!
T.C.I. is approved for G.I. training. Under Public Law 550. Check coupon.



MAIL NOW FOR FREE BOOKLET

MILTON S. KIVER, President
TELEVISION COMMUNICATIONS INST.
205 W. Wacker Dr., Dept. RE-19, Chicago 6, Ill.
Rush FREE Catalog and Sample Lesson. I am not obligated. Salesman will not call.

Name..... Veterans: Check here

Address.....

City..... Zone..... State.....

BEGINNERS check here for Pre-TV Radio Course.

UHF or VHF

there is an

AMPHENOL

antenna for every area

Whatever the location, whatever the problems presented by different areas, the expanded line of AMPHENOL antennas will provide top reception.

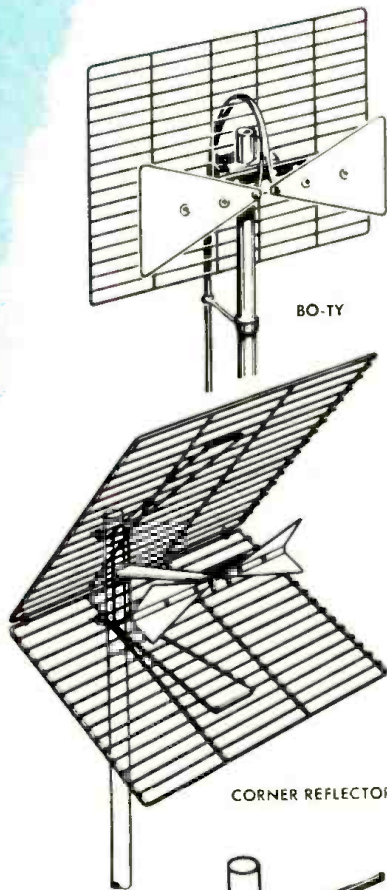

BO-TY

CORNER REFLECTOR

for VHF. For over four years the dependable INLINE has provided top viewing satisfaction to its users. With excellent gain and directional response, the INLINE is also available in a Stacked Array for additional gain in fringe areas and in a Piggy Back for multi-directional reception.

for UHF. Keeping pace with this expanding new market are a full line of AMPHENOL UHF antennas.

BO-TY and Reflector. With its rejection of unwanted signals off the back and sides, the BO-TY is excellent for major signal areas. Where additional gain is desired in fringe areas, two BO-TYs can be easily stacked.

CORNER REFLECTOR. The high ascending and strong forward radiation pattern of the new CORNER REFLECTOR make this AMPHENOL antenna ideal for fringe areas. Of exceptionally sturdy construction, the CORNER REFLECTOR also has the advantage of being mounted in front of the mast to insure no signal interference from the mast or accessories.

RHOMBIC. Another AMPHENOL antenna built to give the high gain needed for UHF in outlying districts. It also features rejection of ground reflections, an important consideration in UHF.

YAGI. There are 11 custom models of the YAGI for top reception across the entire UHF band. Each features extremely high gain on its assigned channels as well as a strong forward radiation pattern.

The above listing should make the choosing of the right antenna an easy task. For UHF or VHF, AMPHENOL antennas assure top reception.

AMERICAN PHENOLIC CORPORATION
Chicago 50, Illinois

AMPHENOL

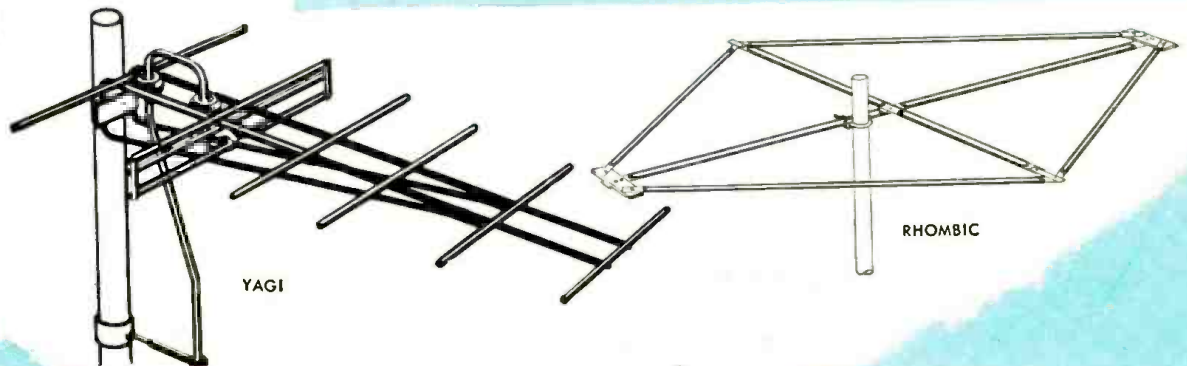

YAGI

RHOMBIC

TV SET COUPLER

RCA Victor Tube Department, Harrison, N. J., has announced a small coupling device which permits the simultaneous operation of two receivers from the same antenna.

Designed for use with antennas having 300-ohm ribbon-type transmission line, the coupler, RCA-240AL, is a quick-service item. It requires only a screwdriver and a few minutes of time for installation and features a self-contained wood-screw which facilitates mounting on wall or baseboard.



It is designed to eliminate wire-cutting and splicing operations. Transmission line connections are made by placing the lines in prepared grooves in the body of the coupler. Attachment of screw-type caps to the top and bottom of the coupler forces the lines against built-in contact points which pierce the insulation and make contact with the wires.

4-BAND RECEIVER

The National Company, Inc., of Malden and Melrose, Mass., has announced production of a new broadcast and short-wave receiver—the World Master, model NC-88.



Designed especially for short-wave listeners and radio amateurs, the receiver covers all frequencies from 540 kc. to 40 mc. in four bands. Features include calibrated bandspread, advanced a.c.-powered superhet circuit using 8 miniature tubes, a tuned r.f. stage, two i.f. stages, and a high-fidelity audio output stage.

WORK TABLES

Cooper Industries, 4953 W. Fullerton Ave., Chicago, Ill., has a new line of heavy-duty steel work-tables. The tops are all-steel with 1/2-inch masonite hard-surface cement-bonded to steel panels for a smooth, lasting work surface. Drawers, ledges, risers, and shelves are also furnished by Cooper for the tables.



Twenty stock sizes are available. The tables are easily dismantled and the legs may be removed for storage.

U.H.F. TUNER

Radio Receptor Co., Inc., 251 W. 19 St., New York 11, N. Y., has announced the new u.h.f. Cavi-Tuner, as well as a u.h.f. converter which incorporates the Cavi-Tuner and a power unit. The tuner permits reception of v.h.f. and u.h.f. stations.

The resonant-cavity principle with

variable dielectric tuning is used in the tuner. The Cavi-Tuner consists of three cavities, two functioning as a bandpass preselector, while the third controls the local oscillator frequency. The preselector is essentially an over-coupled double-tuned transformer. Two antenna inputs are available for use either with the common 300-ohm flat lead-in (balanced) or the shielded 75-ohm coaxial lead-in (unbalanced). The local oscillator, a Colpitts type, tunes below the signal frequency for double superheterodyne or converter applications. Mixing takes place in a low-noise diode, with an i.f. appearing at v.h.f. channels 5-6. Tuning is controlled by a single knob which functions as both a channel selector and fine-tuning control.

The i.f. output of this unit has a frequency of 76 to 88 mc (channels 5-6) but equipment is being developed to operate at 41 mc.



TEST INSTRUMENT

Century Electronics Co., 8509 21st Ave., Brooklyn, N. Y., has introduced its Dynatrace, a portable self-powered instrument designed to trace or inject signals through video, sound, sync, a.f.c., or vertical or horizontal sweep circuits. The Dynatrace uses an ingenious system of picking up its signal from one section of the receiver and feeding it through a network to other portions of the set. It will also trace voltages and locate open, shorted, or intermittent components.

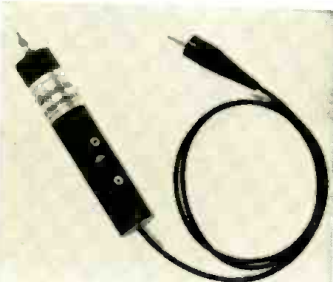

"Q" TESTER

Lako Manufacturing Co., 506-520 E. Townsend St., Milwaukee, Wis., has announced the model 400-A Q-tester. This instrument tests deflection yokes, width coils, and horizontal transformers without removing them from the set.

The unit drives the test part at proper waveform and frequency and measures the output voltage. Since the output is a function of the Q, a single shorted turn will result in almost negligible output compared to a good part.

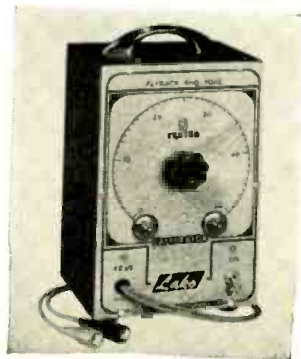

BUILD 15 RADIOS

ONLY

AT HOME \$19.95

With the New Improved 1953

Progressive Radio "EDU-KIT"

**NOW INCLUDES
SIGNAL TRACER
and
CODE OSCILLATOR**



- FREE TOOLS WITH KIT
- ABSOLUTELY NO KNOWLEDGE OF RADIO NECESSARY
- NO ADDITIONAL PARTS NEEDED
- EXCELLENT BACKGROUND FOR TV
- 10 DAY MONEY-BACK GUARANTEE

WHAT THE PROGRESSIVE RADIO "EDU-KIT" OFFERS YOU

The Progressive Radio "Edu-Kit" offers you a home study course at a rock bottom price. Our Kit is designed to train Radio Technicians, with the basic facts of Radio Theory and Construction Practice expressed simply and clearly. You will gain a knowledge of basic Radio Principles involved in Radio Reception, Radio

Transmission and Audio Amplification. You will learn how to identify Radio Symbols and Diagrams; how to build radios, using regular radio circuit schematics; how to mount various radio parts; Receivers, Transmitters, and Audio Amplifiers. You will learn how to operate trouble-shoot radios. You will learn code. You will receive training for F.C.C. license.

In brief, you will receive a basic education in Radio exactly like the kind you would expect to receive in a Radio Course costing several hundreds of dollars.

THE KIT FOR EVERYONE

The Progressive Radio "Edu-Kit" was specifically prepared for any person who has a desire to learn Radio. The Kit has been used successfully by young and old in all parts of the world. It is not necessary that you have even the slightest background in science or radio.

The Progressive Radio "Edu-Kit" is used by many Radio Schools and Clubs in this country and abroad. It is used by the Veterans Administration for Vocational Guidance and Training.

The Progressive Radio "Edu-Kit" requires no instructor. All instructions are included. All parts are individually boxed, and identified by name, photograph and diagram. Every step involved in building these sets is carefully explained. You cannot make a mistake.

PROGRESSIVE TEACHING METHOD

The Progressive Radio "Edu-Kit" comes complete with instructions. These instructions are arranged in a clear, simple and progressive manner. The theory of Radio Transmission, Radio Reception, Audio Amplification and servicing by diagram is clearly explained. Every part is identified by photograph and diagram. You will learn the function and theory of every part used.

The Progressive Radio "Edu-Kit" uses the principle of "Learn by Doing". Therefore you will build radios to illustrate the principle of "Learn by Doing". These radios are designed in a modern manner, according to the best principles of present-day educational practice. You begin by building a simple radio. The next set that you build is slightly more advanced. Gradually, in a progressive manner, you will find yourself constructing still more advanced radio sets, and radios, including Receivers, Transmitters, Amplifiers, Code Oscillator and Signal Tracer.

THE PROGRESSIVE RADIO "EDU-KIT" IS COMPLETE

You will receive every part necessary to build 15 different radio sets. Our kits contain tubes, tube sockets, chassis, variable condensers, resistors, selenium rectifiers, mica condensers, paper condensers, resistors, line cords, selenium rectifiers, the strips, coils, hardware, tubing, hook-up wire, solder, etc.

Every part that you need is included. These parts are individually packaged, so that you can easily identify every item. Tools are included, as well as an Electrical and Radio Tester. Complete, easy-to-follow instructions are provided. In addition, the "Edu-Kit" now contains lessons for servicing with the Progressive Signal Tracer, F.C.C. instructions, quizzes. The "Edu-Kit" is a complete radio course, down to the smallest detail.

TROUBLE-SHOOTING LESSONS

Trouble-shooting and servicing are included. You will be taught to recognize and repair troubles. You will build and learn to operate a Professional Signal Tracer. You receive an Electrical and Radio Tester, and learn to use it for radio repairs. While you are learning in this practical way, you will be able to do many a repair job for your neighbors and friends, and charge fees which will far exceed the cost of the "Edu-Kit". Here is your opportunity to learn radio quickly and easily, and have others pay for it. Our Consultation Service will help you with any technical problems which you may have.

FREE EXTRAS IN 1953

- ELECTRICAL AND RADIO TESTER • ELECTRIC SOLDERING IRON • BOOK ON TELEVISION • RADIO TROUBLE-SHOOTING GUIDE • MEMBERSHIP IN RADIO-TELEVISION CLUB • CONSULTATION SERVICE • QUIZZES • TRAINING FOR F.C.C. LICENSE

Send me the "Edu-Kit" with 10 Day Money-Back Guarantee—include All FREE extras.

Check or M.O. enclosed—postage prepaid
 C.O.D. (U. S. Only)—I will pay postage

Send further information.

NAME _____

ADDRESS _____

Outside U.S.A.—cash orders only; send international M.O. or check on U.S. bank. Postage Prepaid. "Edu-Kit" for 210-250 V. AC/DC \$22.45

PROGRESSIVE ELECTRONICS CO.

497 UNION AVE., Dept. RE-73, Brooklyn 11, N. Y.

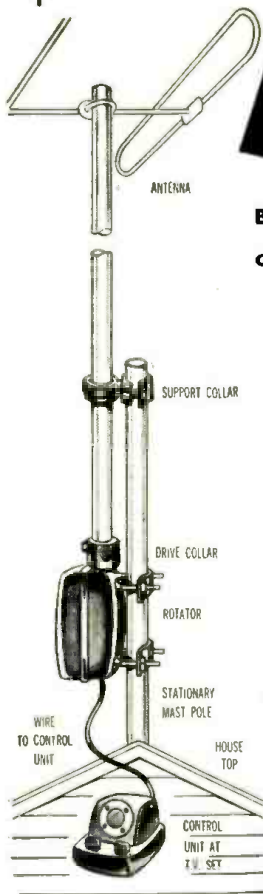

LOOK

BIGGEST BARGAIN IN T.V. TODAY

CHECK THESE OUTSTANDING FEATURES

1. High starting torque—no slipping.
2. 370-degree rotation—get all T.V. signals.
3. Surplus power—large or small antennas.
4. Outboard bearings—relieves wind load.
5. Sturdy compact construction—7 pounds.
6. Water-proof aluminum cover.
7. Finger-tip control unit—handsome finish.
8. Thirty feet 3 circuit weather proof lead wire.
9. Signal light indicates end of 370° rotation.
10. Easily installed—complete instructions—trouble free operation. Nationally advertised.

COMPLETE OUTFIT—Rotator, Bearings, Control unit and wiring at GIVE-AWAY price.

Limited Supply—Order Today!

First come—first served! This is the CHANCE of a LIFE. TIME close out. You must HURRY! Get your order in the mail today. Send no money. 10 days FREE TRIAL.

WAS \$39.95—NOW **\$16⁹⁵**
 GUARANTEED
 10 DAY FREE TRIAL
 SEND NO MONEY—WE SHIP C.O.D.

K. W. SALES CO.
 BOX 1212, TIPTON, INDIANA

Yes . . . of course Radio Receptor Co. is producing . . .

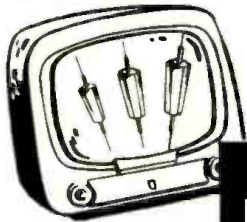

MIXER DIODES
 For U.H.F. — TV Tuners

The taper of the diode case allows polarity identification at a glance or at a touch thus speeding up assembly and reducing the possibility of error in connecting the diode into the circuit.

Featuring **polarity at a glance!**



- | | |
|---------------------------|--|
| 1N72
Germanium | Noise figure as a mixer better than 15DB @ 750 MC with 43.5 MC-IF circuit having a noise bandwidth of 3 MC and a noise figure of 4 DB. |
| 1N82
Silicon | Noise figure as a mixer better than 12DB @ 750 MC with 43.5 MC-IF circuit having a noise bandwidth of 3 MC and a noise figure of 4 DB. |
| 1N110
Germanium | Noise figure as a mixer better than 12DB @ 750 MC with 43.5 MC-IF circuit having a noise bandwidth of 3 MC and a noise figure of 4 DB. |

Supplied with or without pigtail leads.

Let Radio Receptor Co. Standard U.H.F. Diodes figure in your N.F. problems . . . Send us your specifications!

SELETRON & GERMANIUM DIVISION
RADIO RECEPTOR COMPANY, Inc.
 Since 1922 in Radio and Electronics
 SALES DEPARTMENT: 251 WEST 19TH STREET • NEW YORK 11, N. Y.
 FACTORY: 84 NORTH 9TH STREET • BROOKLYN 11, N. Y.

NEW DEVICES

KLIPSCH ENCLOSURE

G & H Wood Products Co., 75 N. 11th St., Brooklyn 11, N. Y., has released a Klipsch corner-horn enclosure design for 12- and 15-inch speakers, known as the Klipsch Rebel IV by Cabinart.

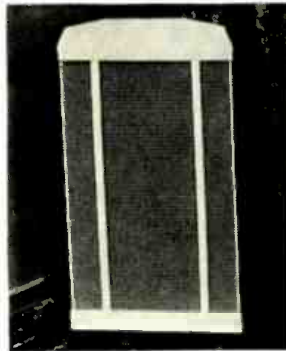

Available as a complete unit or in kit form, the Klipsch features large-enclosure performance within a minimum area. Cabinet design makes for easy accessibility to speaker and simplifies external installation. The built-in removable panel allows a variety of speaker combinations. The unit is available in limed oak, honey walnut, French mahogany, and black lacquer.

CABLE HANGER

Atlas Sound Corp., 1451-39th St., Brooklyn 18, N. Y., has released its model CH-1 cable hanger. Designed to be used with all types of microphone floor stands, the CH-1 enables the mike cable to be coiled and looped over the hook when moving, storing, or transporting the microphone and stand. All parts are finished in chrome.

screen reflectors, to minimize vibration, and Bronzidite, a military-specified plating, to prevent rust and corrosion in nonaluminum parts.



PHONOMOTORS

General Industries, Elyria, Ohio, has announced the addition of two new manually operated 3-speed phonomotors to its line.

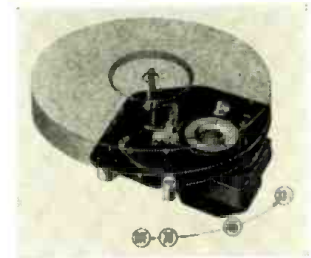

Model SS, with 2-pole motor, is a compact phonomotor incorporating vertical idler shifting principle. Model DSS, with 4-pole motor, is designed for high-fidelity applications in which compactness is secondary to need for absolute minimum stray field radiation. It is suited for all types of pickups, including magnetic.

TRANSMISSION LINE

Plastoid Corp., 42-61 24th St., Long Island City 1, N. Y., has announced a tubular twin-lead for u.h.f., designed for negligible attenuation under all weather conditions.

Known as Synkote Ultratube, the line has the leads spaced several millimeters within the tube, equidistant from the outer insulation. The ends may be sealed on the job by heating with a match and then clamping them shut with a pair of pliers.

The line is recommended for v.h.f. in stormy weather & fringe areas, and sea-coast areas where moisture and salt spray are factors.



ELECTRIC GUNS

Weller Electric Corp., Easton, Pa., has announced a new line of electric guns. The four new guns feature increased power up to 275 watts. Pistol grips are centered under the housings for better balance. Dual heat is provided on both heavy- and light-duty models, and all are equipped with two pre-focused spotlights.

Two accessory tips are provided with each model, a hat knife-blade cutting tip and a trowel-shaped smoothing tip.

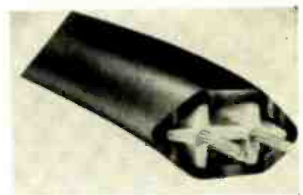

UHF CONVERTER

David Bogen Co., 29 Ninth Ave., New York 14, N. Y., has introduced a u.h.f. converter, the Bogen UCT. The unit features single-knob continuous tuning for channels 14-83. Its broad-band output operates through either channel 5 or 6 on the TV set. The input and output impedances are 300 ohms.



UHF ANTENNA

JFD Manufacturing Co., 6101 Sixteenth Ave., Brooklyn 4, N. Y., has introduced the model UHF611 Bowtie-Flector antenna, which receives channels 14-83. It is provided in stocked models with free Balune matching transformers for fringe and remote areas.

The antenna features rigid wire-frame

The converter is connected to the antenna input terminals of the u.h.f. receiver and measures 8 x 4 1/2 x 4 3/4 inches. **END**

All specifications given on these pages are from manufacturers' data.

RADIO-ELECTRONICS

Concord Radio presents the world's most powerful TV antenna!



22 Db gain
over tuned dipole!

motorless all-direction
ALL-CHANNEL
UHF-VHF-FM
reception

- Guaranteed 10 times more powerful than stacked 10 element Yagis.
- Receives channel 2-83 from all directions without a rotor.
- Broadband UHF-VHF and FM, motorless all direction reception.
- All aluminum flip-out assembly.

The only TV antenna that instantly beams the television set directly to the signal without a rotor. This antenna brings strong UHF and VHF signals from all directions to weak signal areas instantly . . . with a flick of the nine position switch located near the television set.

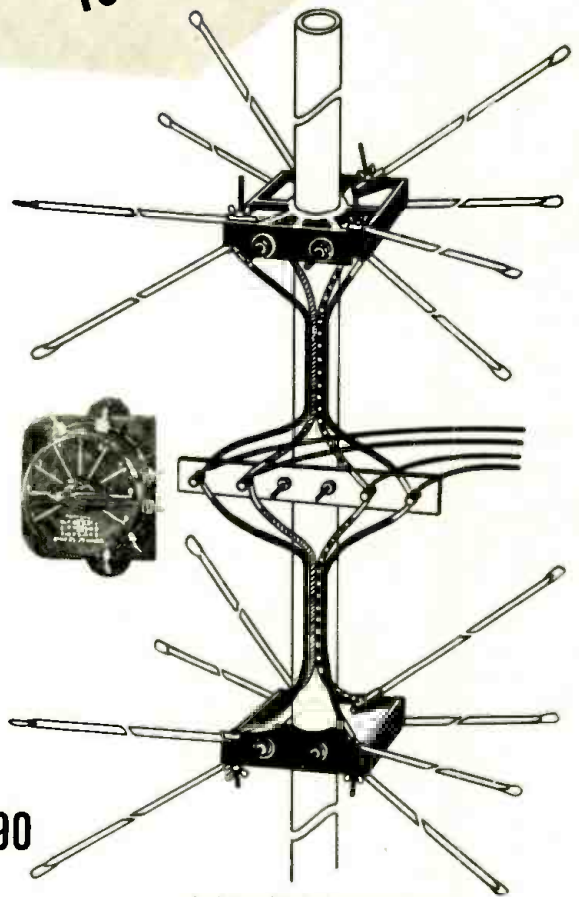

\$21⁹⁰

Dealer Price

LIST PRICE **\$36⁵⁰**

Includes Stacked Antenna Array. 9 Position Switch. Completely Wired Stacking Harness. A.I.M.—Automatic. Impedance Matching Coupler.

NEW!

FOUR CONDUCTOR AIR DIELECTRIC Tubular Matched Impedance TRANSMISSION LINE

Improves Both UHF and VHF Performance of any ALL-CHANNEL Antenna

100 Ft.	\$8.90
150 Ft.	\$13.90
200 Ft.	\$17.50

Minimum quantity 100 ft.



Mfg. solely by

ALL CHANNEL ANTENNA CORP.

under license Pat. No's 2,585,670.

2,609,503. 2,625,655. others pending.

MONEY BACK GUARANTEE To out-perform all other antennas (using rotor motors) on both UHF and VHF, including stacked ten element Yagis, stacked corner and bow-tie reflectors, four bay conicals, etc.

Concord Radio

54 Vesey Street, New York 7, N. Y. • DIgby 9-1132

JULY, 1953

CONCORD RADIO 54 Vesey Street, New York 7, N. Y.

Please send me.....amount at \$36.50 list price.

Please send me.....amount at \$21.90 dealer net.

Dealers order on letterhead.

Please send me.....feet of 4 conductor tubular at

Name.....

Address.....

City.....State.....

Check Enclosed Money Order Enclosed

C.O.D. enclosed please find 25% of total purchase price . . . check . . . Money Order.

Please put my name on your "Special Bargain" mailing list.

() Enclosed find \$.....in full. Send prepaid.

You can do MORE
with an RCP "DO-ALL"

for **UHF**
and
VHF

SIGNAL
GENERATOR

MARKER
GENERATOR

PATTERN
GENERATOR

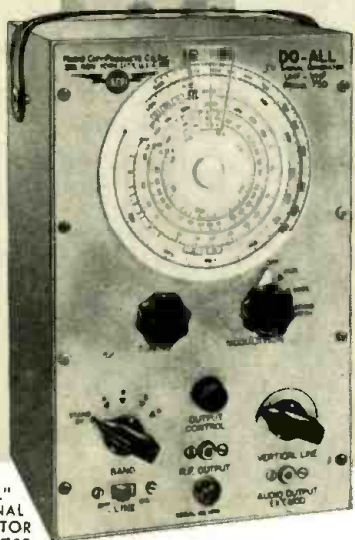

"DO-ALL"
TV SIGNAL
GENERATOR
MODEL 750

ONE

RCP "DO-ALL"
SIGNAL GENERATOR

for all

THREE

- SIGNAL GENERATOR
- MARKER GENERATOR
- PATTERN GENERATOR

Designed for portable or bench use, the 750 reflects the finest in construction and appearance. It is handsomely finished in an attractive brushed aluminum panel with a steel carrying case.

- Inductuner insures accuracy of within 1/2 of 1% over the entire range of 9 Mc to 900 Mc.
- All VHF frequencies are on fundamentals.
- RF's and IF's are clearly calibrated on a large etched aluminum dial.
- Steady horizontal bars, vertical bars and crosshatch pattern individually produced on all channels.

PRICE \$79.50

See Model 750 At Your Local Parts Distributor. Write For Complete Catalog RE-7.

RADIO CITY PRODUCTS CO., INC.

152 West 25th Street **RCP** New York 1, N. Y.

TRY THIS ONE

HANDY CHASSIS HOLDER

A pair of these chassis holders will help you to avoid scratching or cutting your hands while carrying heavy radio and TV chassis. The handles are bent

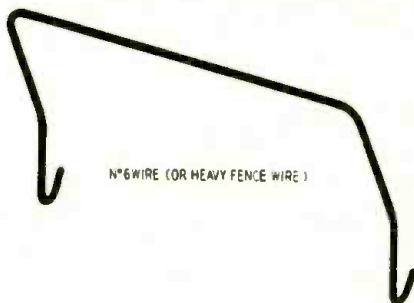

to the approximate shape shown from No. 6 or heavier wire. Use a stiff wire which will not deform under the weight of the chassis.—J. Alibanowicz

CRACKLE TOUCH-UP

Small chipped areas on black crackle metal chassis and cabinets can be easily hidden by carefully marking those areas with a black *Listo* or a similar type of marking pencil. The touched-up areas are very difficult to detect.

This suggestion will be particularly useful to those who are likely to chip the paint while punching or drilling black crackle metal stock.—R. J. Sandretto

TRANSPARENT TUNING TOOLS

Clear-plastic aligning tools are easily mislaid because their transparency makes them hard to see even when they are directly under one's nose. To make them more visible on the workbench stripe the outsides of these tools with red nail polish.—Charles Erwin Cohn

FM DIPOLE FOR TV

Recently I had occasion to use an FM dipole on a TV set in an area where stations were operating on channels 4, 5, and 7. The dipole worked fine without any alteration on channels 4 and 5, but on channel 7 there was a fuzzy picture. I experimented somewhat to sharpen 7, and found that I got the best picture with the hookup shown in the diagram. I got the clearest picture by putting a 3-foot length of wire between two poles on the roof, with the wire oriented so that it was broadside to the channel-7 signal.

Almost any heavy antenna wire will do. I attached this antenna by a short length of wire to one of the end leads of the dipole.—B. W. Welz

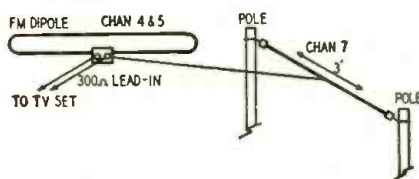

(This was a cut-and-try solution in a particular spot, and the same arrangement might not work as well in other locations.—Editor) **END**

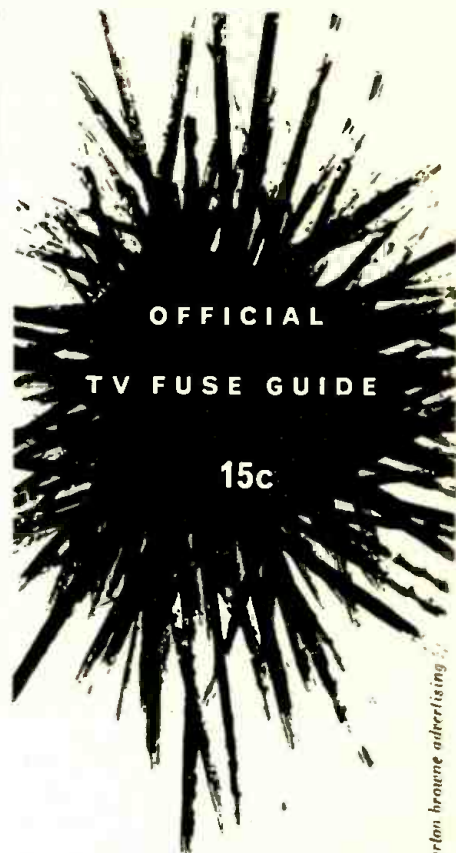

LITTELFUSE

Des Plaines, Ill.

FREE!

THE HOTTEST VALUE-
PACKED BULLETIN
IN THE MAILS!

Over 153,000 subscribers
buy and save through

WHOLESALE RADIO'S

**F.Y.I.
BULLETIN**

EVERYTHING
IN RADIO • TV
HI-FI SOUND

Write for
New FYI
#104
Just Off
The Press

WHOLESALE
RADIO PARTS
COMPANY, Inc.
311 W. Baltimore St.
Baltimore-T, Md.

NOVEL REGENERATIVE RECEIVER

The correct amount of coupling between the antenna and a regenerative detector is often a critical factor which determines the performance of regenerative receivers. If the coupling is too loose, signal transfer is poor and sensitivity is low. If the coupling is too tight, the detector is loaded heavily and the antenna may cause dead spots in the tuning range. This trouble can be minimized by using electronic coupling between the antenna and detector. This provides good signal transfer and good antenna isolation.

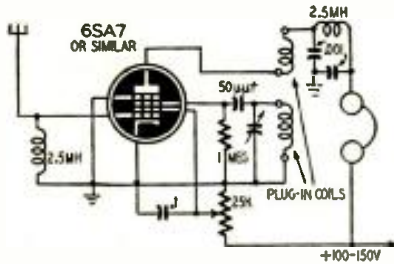

The diagram shows how a 6SA7 or similar converter-type tube can be used as a regenerative detector with one of the control grids used for electronic coupling to the antenna.

The antenna is connected to grid 1 and returned to ground through a 2.5-mh r.f. choke. The signal is amplified in the plate circuit and fed through the tickler into grid 3 through the tuned winding. This circuit is more sensitive than the usual regenerative job. If strong signals overload the set, replace the r.f. choke in the antenna circuit with a tuned antenna coil. Standard plug-in coils may be used.—John Sareda

MUSIC-CENTER CONTROL BOX

My radio equipment consists of the Radio Craftmen AM-FM and TV tuners and a separate power amplifier. With this equipment connected in the normal manner the tubes in the radio tuner are turned on while the TV set is in use.

Since the TV set is usually on for long periods of time, I decided to do something about the needless waste of power in the radio tuner which was not being used. After trying several schemes, I developed the switching circuit shown in the diagram. The wiring is installed in a 4 x 5 x 6-inch metal box with the receptacles on one side and the switch and pilot lamps on the other.

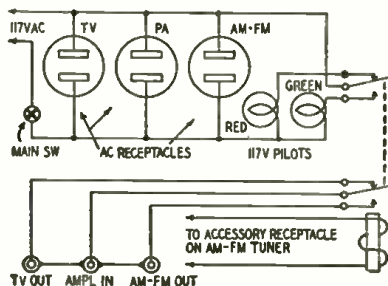

JULY, 1953



"Boy... Have I Got the Lines!"

You, too, can have the lines—that meet your exact leadline conditions — whether you are a TV Set Dealer or Service Organization making the finest television reception installations, or a TV fan that demands sharp, "SNOW-FREE" pictures.

We specialize in the manufacture of television transmission lines — built with only one idea in mind: "THE FINEST TELEVISION RECEPTION!"

For UHF and VHF

"SHEATH-LEED" — the all-weather leadline for the toughest conditions: Salt spray in coastal areas; hot, humid weather, or for frosty, icy, wintry wind-whipping conditions which impose a severe tax... Pure Polyethylene Tubing encasing Standard GOODLINE AIRLEAD.



"GOODLINE" AIRLEAD—standard of leadline excellence —with 80% of the loss producing web removed. Correct impedance for sharp, "snow-free" pictures. Of pure polyethylene with flexible stranded copper-clad conductors. MANY IMPORTANT FEATURES.

NEW FULL-WEB "SHEATH-LEED" — the pure polyethylene of "SHEATH-LEED" and full characteristics of GOODLINE AIRLEAD — but NO PERFORATED WEB. No 20 (7 strand 28) copperweld wire in pure electronic golden clear polyethylene — with a pure silver-gray polyethylene sheath overall — for Maximum Weather Protection.

Don Good, INC.

SOLD BY LEADING JOBBERS & DEALERS

Send coupon NOW!
Get samples "in your hands"
—you'll realize why
Don Good Products make
the finest television
reception possible.

DON GOOD, INC. I-6
1014 Fair Oaks Ave., So. Pasadena, Calif.
Please rush Samples and Complete Information covering Don Good Products.

Name _____
Street _____
City _____ State _____

PAY LESS FOR TUBES ★ INDIVIDUALLY BOXED • FULLY TESTED • EACH TUBE GUARANTEED FOR SIX MONTHS

Type	Price	Type	Price	Type	Price	Type	Price
1B3GT	\$.69	6A55	.50	634	.46	12B8	.45
1N5GT	.68	6A76	.38	6A7GT	.32	12B8	.47
1N5GT	.57	6A96	.43	6S17GT	.47	12B9T	.63
1R5	.56	6AV6	.38	65K7GT	.50	125A7GT	.52
155	.47	6BA6	.45	65L7GT	.62	125K7GT	.50
174	.56	6BC3	.53	65N7GT	.54	125L7GT	.61
1X2	.67	6BE6	.47	65O7GT	.42	125N7GT	.54
305GT	.65	6BQ6	1.34	6T8	.78	125Q7GT	.44
354	.55	6BH6	.57	6U8	.65	258Q6	.89
3V4	.56	6BJ6	.48	6V6GT	.46	25L6GT	.48
5U4Q	.43	6BL7	.83	6W4GT	.45	25Z6GT	.42
5V4Q	.73	6BQ6	.89	6W6GT	.57	35B5	.47
5Y3Q	.34	6BQ7	1.10	6X4	.34	35L6GT	.47
5Y3GT	.30	6BZ7	1.10	6X5GT	.33	35W4	.31
6AB4	.48	6C4	.34	6Z6	.38	35Z5GT	.30
6AF4	1.40	6C8	.53	12A7	.68	50B5	.47
6AQ5	.54	6CD6	1.85	12AU7	.55	50C5	.47
6AK5	.55	6J5GT	.40	12AV6	.38	50L6	.47
6AL5	.40	6J6	.62	12AV7	.80	117Z3	.39
6AQ5	.46	6K6GT	.41	12AX7	.61	117Z6	.68

Each tube is performance-proven. 25% deposit must accompany all orders. Balance C.O.D. All prices F.O.B., N.Y.C. If remittance is made with order, you can deduct 2%. \$1.00 handling charge for orders under \$10.00. Subject to Prior Sale. Importer inquiries invited.

PHILLIPS TUBE COMPANY

2281 1/2 Nostrand Ave.
Brooklyn 16, N. Y.
CLoverdale 3-8018-1-2

RIDER TEK- FILE*

packaged
tv
service
information—
factory—
authorized
factory—
approved
for easy
tv servicing...
tailor-made
for about
3000
models...
only
\$2 per pack
(at your jobbers)

*dependable replacement parts listing beginning with Pack 57

JOHN F. RIDER
Publisher, Inc.

480 Canal Street
New York 13, N. Y.

The radio and TV tuners and the amplifier line cords are plugged into the receptacles. The tuner output and amplifier input leads are fitted with RCA-type phono plugs which go into mating sockets in the control box. The d.p.d.t. 115-volt a.c. relay is wired so the TV sound feeds into the amplifier through its normally closed contacts. The relay coil is fed from the accessory receptacle on the rear of the radio tuner chassis. Pilot lamps show that the amplifier is on and indicate which tuner is operating at any time.—
Anthony Pusateri

Materials for control box

Miscellaneous: 3—a.c. receptacles (Amphenol 61F, 61-F1, or equivalent); 1—s.p.s.t. toggle switch; 1—control box approximately 4 x 5 x 6 inches; 1—115-volt, 60-cycle, d.p.d.t. relay; 1—115-volt pilot-lamp assembly with lamp and green jewel; 1—115-volt pilot-lamp assembly with lamp and red jewel; 3—RCA-type phono pin-plug and jack assemblies; 2—117-volt appliance cards.

CODE PRACTICE SET

This dual-purpose code practice set is useful for the would-be ham and the new licensee because it can be used for normal sending and receiving practice as well as serving as a b.f.o. for receiving c.w. signals on home-type all-wave sets. The unit consists of two multivibrators with 455-ke tank circuits connected across their outputs. The output coils feed 455-ke signals into the i.f. circuit of a superhet receiver. T2 is tuned exactly to the center of the receiver's i.f. pass-band and T1 is tuned to a frequency a few hundred cycles away. When the key is closed the receiver detects the signals from V1 and V2 and produces a beat note which is the difference between the two frequencies. T1 is fitted with a small panel-mounted trimmer, C1, which is used to adjust the pitch of the audio note.

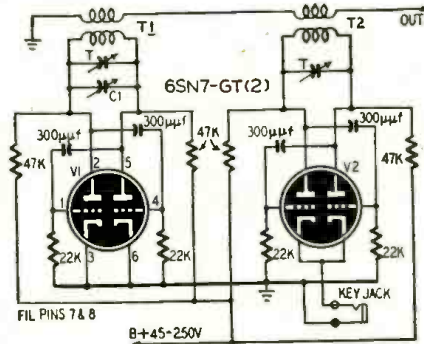

When the unit is used as a b.f.o., the key is opened so V1 operates alone. Its signal beats with the incoming c.w. signal to produce an audible note. The pitch of the note can be adjusted with the variable trimmer.

T1 and T2 were constructed from 455-ke capacitance-tuned i.f. transformers in the original model described in *Radio-Gen* (New Zealand). The trimmers were removed from the secondary windings which are connected in series and used as the output windings. C1 is a small air trimmer (about 35 µmf) connected across the primary of T1.

Scala
Super-Marker Injector
cuts bench time up to
75% on alignment jobs!



MODEL SMI 53
\$67.50

No longer do you have to connect and reconnect a maze of cables, look at erroneous response curves, worry about overloads, traps, and weak or invisible markers. The Scala Super-Marker Injector ends this completely! For example, a complete video IF alignment job can be accomplished with only two cables and no reconnections! (Marker bypasses receiver circuits entirely.)

Used with any standard marker generator, sweep generator and oscilloscope.

The Scala SMI53 can be used as high-gain amplifier or detector to extend the usefulness of Scala Probes for extremely low-level signal analysis: SIGNAL TRACING PROBE BZ-1, \$9.75; LOW CAPACITY PROBE BZ-2, \$9.75; 100:1 VOLTAGE DIVIDER PROBE BZ-3, \$9.75; VOLTAGE DOUBLER PROBE BZ-4, \$10.75; SCALA BZ-123 KIT OF BZ 1, 2 AND 3, \$27.45.

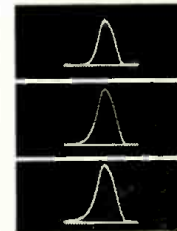

OLD METHOD OF ALIGNMENT

Progressive attenuation to which beat marker is subjected as it is run from top of curve to the point near the base of the curve, and finally into trap where it disappears into dip of the trap.

Alignment with the SCALA Super-Marker Injector

Now, with the Scala bypass marker system, marker appears at same level at all points on curve, including bottom of trap. Trap and response curve are not distorted by overload.

The Scala Super-Marker Injector Electronically mixes small sample of sweep voltage with small sample of marker voltage. Mixed frequencies are demodulated, filtered, reamplified... following which the large stable pip is electronically mixed with sweep-wave from picture detector. So the marker pip is always the same size, whether run into a trap on top the curve or along base line. Completely ends struggling with the problem of obtaining visible markers on ratio-detector curves under these conditions.

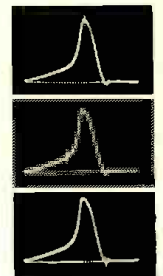

Scala

2814-19th STREET
SAN FRANCISCO 10, CALIFORNIA
RADIO-ELECTRONICS



The Picture Tells the Story

TV Antennas exist for one reason — to provide a clear, strong, sharp picture!

TRIO ZIG-ZAG* TV Antennas perform so well in this all important respect that they are America's most wanted.

Yes, a picture — the TV picture — tells the TRIO story more eloquently than anything else! Where all other antenna designs fail, high gain TRIO ZIG-ZAG TV Antennas consistently lock in sharp, clear pictures — from Maine to Texas, in city or country!

TRIO TV antennas look different, work different — provide a magnificent DIFFERENCE in picture quality!

*Patent Pending

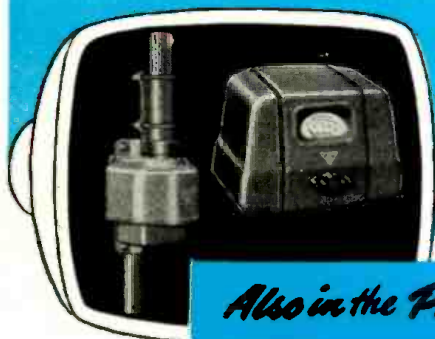

*New insulating sleeve, with flange or leakage path and elimination of slit, does away with assembly errors — elements cannot short out. For maximum strength, new steel, electro-plated element clamps have been introduced.

Also in the Picture

The TRIO Rotator and Direction Indicator are the most dependable ever built. Developed after \$50,000 research. Fully guaranteed for a FULL two years!



TRIO MANUFACTURING CO.

GRIGGSVILLE, ILLINOIS

Best Buy in UHF Antennas LOW IN COST — HIGH IN PERFORMANCE

NEW TRIO UHF BOW-TIE with reflector

Sturdy, broadband antennas of uniformly high gain that have been thoroughly field tested. Phasing strips installed, pre-assembled — a jiffy to attach reflector screen. Available in one, two and four bay models. Usual high-quality TRIO construction.

Model UBT-4
Supplied With
4 Foot Mast

Model UBT-1
Supplied With
2 Foot Mast

Model UBT-2
Supplied With
3 Foot Mast

NEW TRIO UHF MULTI-CHANNEL YAGI ANTENNAS

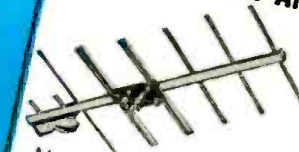

Broadband yagis developed by TRIO now successfully cover all UHF channels, rarely more than two needed for any one area.

These high gain six element yagis have sharper directivity, thereby eliminating ghosts, thoroughly field tested. Tire antenna mounted in front of mast remover metal in field of reflectors or antenna elements. Mast clamp supplied. Completely assembled.

- Model 6-UBY 14-26 for Channels 14-26
- Model 6-UBY 27-42 for Channels 27-42
- Model 6-UBY 43-60 for Channels 43-60
- Model 6-UBY 61-83 for Channels 61-83

WORLD'S LARGEST MANUFACTURER
OF CUSTOM BUILT TELEVISION

MATTISON

SILVER ROCKET 630 CHASSIS
• with TUNEABLE •

BUILT-IN BOOSTER
for Better DX Reception

Featuring NEW CASCODE TUNER
made for UHF interchangeable
tuning strips and 70° COSINE YOKE

Tube
Complement:
28 tubes
3 rectifiers
1 CRT

32



All Channel Booster

- Broad band single knob control pre-amplifier built in to eliminate long leads which may cause regeneration and attenuation of signal.
- ONLY THE MATTISON 630 CHASSIS HAS AN ALL CHANNEL TUNEABLE BUILT-IN BOOSTER THAT INCREASES SIGNAL STRENGTH UP TO 10 TIMES. THE SILVER ROCKET WILL OUT-PERFORM ANY CHASSIS MADE AND IS PRICED RIGHT TO SELL FAST WITH AN EXTRAORDINARY MARGIN OF PROFIT FOR YOU. WRITE FOR CONFIDENTIAL PRICE SCHEDULE.

ALL CABINETS MADE IN MATTISON'S OWN CABINET FACTORY!

ANNOUNCING
the New
AMBASSADOR
for 1953

The only open
face console
made in every
expensive
decorator
finish . . . on
guaranteed
genuine ma-
hogany, walnut,
oak and other
rare woods!



The AMBASSADOR 17" and 21"

Best Looking . . . Best Value, Too!
Full size console for eye level television. Available
in every extensive decorator finish. Feat-
uring removable safety glass. Dimensions height
42 inches, width 26 inches, depth 23 inches.

DEALERS! SERVICE DEALERS! Here is your
opportunity to become the "important" TV
Dealer in your area for THE FINEST CUS-
TOM-BUILT LINE OF TV RECEIVERS. FREE!!
Write for Mattison's merchandising portfolio
explaining the "UNASSEMBLED PLAN" and
"\$1,000,000 FLOOR PLAN."



Manufactured with integrity

When you buy from
Mattison you need
only one source of
supply! You can buy
a Mattison Chassis,
a Mattison Cabinet or
a complete Mattison
TV Set!

Mattison Television & Radio Corp.
10 West 181st St., Dept. RE, N.Y. 53, N.Y.

The unit operates with an insulated output lead placed close to the i.f. amplifier tube in the receiver. If this does not provide enough coupling, wrap two or three turns of the output lead around the grid lead of the i.f. amplifier tube.

To adjust the unit, tune in a station, set C1 to the center of its range, then adjust the semi-fixed trimmer on T1 until you get a zero beat. Now, disconnect the antenna from the receiver or tune the receiver to a dead spot on the dial. Key V2 while varying the trimmer on T2 to produce a note of about 400 cycles.

When the adjustments have been completed the unit can be used as described earlier. C1 operates as the pitch control.

Materials for code practice set

Miscellaneous: 4—47,000-, 4—22,000-ohms, 1/2-watt resistors; 4—300-μmf mica capacitors; 2—6SN7-GT tubes; 2—455-kc capacitance-tuned i.f. transformers; 1—midset variable air trimmer, about 35 μmf. Sockets, key jack, hookup wire.

SIMPLE BATTERY CHARGER

The battery charger shown in the diagram has been in service for the past two years and has given excellent service during this period. We use it for charging storage batteries which power some of our portable equipment. Up to six 6-volt or three 12-volt batteries can be connected in series for charging.

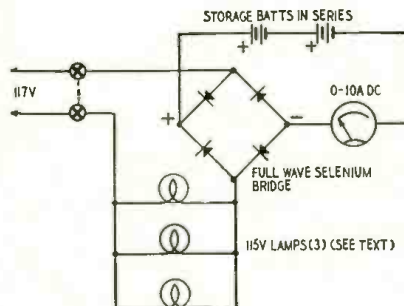

The batteries are charged by the output of the 120-volt, 5-amp full-wave bridge-type selenium rectifier. Charging current is regulated by inserting lamps in the sockets provided for them.

To use the charger, connect the batteries, then insert a 25-watt, 115-volt lamp into one of the sockets. Leave the other two sockets empty. Close the line switch and read the charging current on the meter. If the current is too low, change to a higher-wattage lamp or insert lamps in the other two sockets. The lamps act as line-dropping resistors. The charging current increases as the sum of the lamp wattages is increased.—Geo. R. Anglado

(Mr. Anglado does not state the size of the portable batteries he was charging, nor for what type of equipment they were used. However, with the lamps specified, the charging rate would range roughly between 1/4 and 3/4 ampere. A more flexible unit could be built with a 10-ampere rectifier and one or two more sockets. Then by using different lamps, large and small batteries could be charged.—Editor) END



be an expert on AUTO RADIO SERVICING!

Get the only authoritative compilation of its kind—complete Auto Radio Service Data coverage of all important models since 1946—in 3 great PHOTOFACT Manuals! All data complete, accurate, uniform—based on lab analysis of the actual auto radios covered. Helps you service any model quicker, easier—for greater profits. Get the complete Library!



VOL. 1. AUTO RADIO SERVICE MANUAL

Covers over 100 models made from 1946 to 1949 by 24 manufacturers. Each receiver is completely covered in uniform format; includes schematics, chassis photo views, replacement parts data, service hints, etc. All data based on actual lab analysis. 396 pages, 8 1/2 x 11".

ORDER AR-1. Only \$4.95



VOL. 2. AUTO RADIO SERVICE MANUAL

Covers 60 different chassis (40 models) used in 1948, 1949 and 1950 auto radio receivers. Authoritative, complete service data that makes your work quicker, easier and more profitable. 288 pages. 8 1/2 x 11".

ORDER AR-2. Only \$3.00



VOL. 3. AUTO RADIO SERVICE MANUAL

Covers 47 different chassis (80 models) used in 1950, 1951 and 1952 auto radio receivers. Absolutely the most complete, accurate and easy-to-use data available—uniform and practically presented to make you an expert on the repair of any auto radio. 288 pages. 8 1/2 x 11".

ORDER AR-3. Only \$3.00



SPECIAL OFFER!

All 3 Volumes, Yours for Only \$9.95
Save on the Complete Library—
see your PHOTOFACT Distributor

HOWARD W. SAMS & CO., INC.

Order from your Parts Jobber today, or write direct to HOWARD W. SAMS & CO., Inc. 2205 E. 46th Street, Indianapolis 5, Ind.

My (check) (money order) for \$ encl. Send:

AR-1 \$4.95 AR-2 \$3.00 AR-3 \$3.00

Complete 3-Volume Library \$9.95

Name

Address

City State

Now... One Name... One Source... for Top Quality TV Hardware!

ONLY **TELCO** STAND-OFFS
HAVE 6 DISTINCT ADVANTAGES

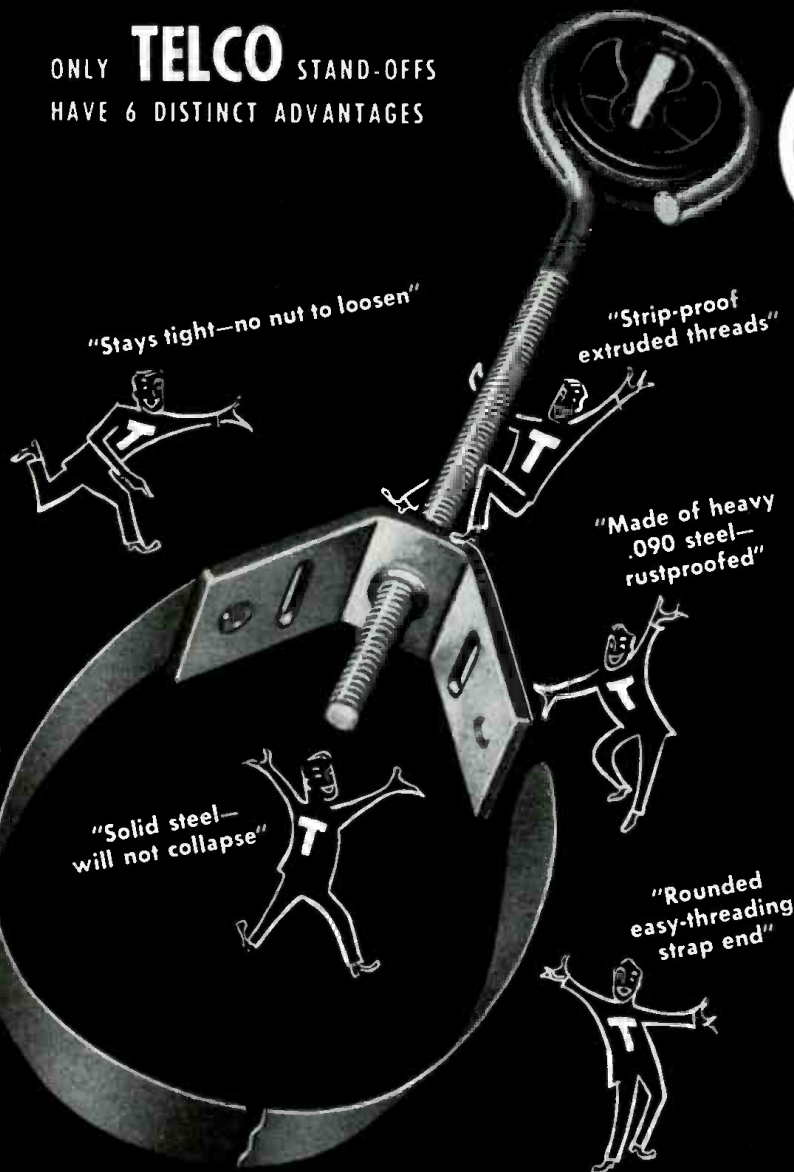

"Stays tight—no nut to loosen"

"Strip-proof
extruded threads"

"Made of heavy
.090 steel—
rustproofed"

"Solid steel—
will not collapse"

"Rounded
easy-threading
strap end"

TELCO



TELCO means Television Hardware . . . hundreds of finest quality items needed for TV installation. Here's everything you need in antenna mounts; also every type of antenna, both UHF and VHF and more real value for your money than ever before. Ask your parts distributor about **TELCO** . . . he's got these money-saving products.

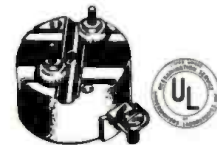

TELCO No. 8642

UNIVERSAL UHF LIGHTNING ARRESTOR

This one arrester fits all twin leads, mounts anywhere. UL approved. Hi-dielectric bakelite. All hardware included. List \$1.25

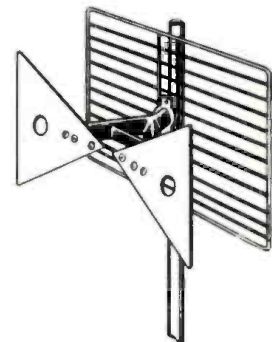

TELCO UHF WISHBONE BUTTERFLY ANTENNA
Newest design for all-channel reception. Tested and proved best in actual UHF areas. Highly directional. Rugged aluminum construction. low wind resistance. No. 8965 Telco Wishbone Butterfly Antenna. Single Bay with Tie Bar. List \$7.75

OVER 135 MILLION TELCO STAND-OFFS NOW IN USE

- Finest Polyethylene Insert
- Smooth, Rounded Bracket Slots . . . Never Cut Strap
- 29 Telco Stand-Off Styles Available
- The Strongest Stand-Offs Ever Made



WRITE TODAY for your free copy, new **TELCO** Catalog
TELEVISION HARDWARE MFG. CO.
910 TAYLOR AVENUE ROCKFORD, ILLINOIS
DIVISION OF GENERAL CEMENT MANUFACTURING CO.

Columbia

The Improved Deluxe Service Television Light!



HANDIER THAN A FLASHLIGHT!

Now . . . with complete swivel for better lighting and easier servicing!

EVERY SERVICEMAN, experimenter, model-maker, needs this handy item. No need to work in the dark . . . ample light is provided by a 7½ watt, 110 volt bulb that remains cool at all times.

Scientifically-designed, unbreakable aluminum reflector directs maximum light to point of work . . . A REAL TIME AND LABOR SAVER.

Carried by leading jobbers!

Have you seen our other TV service aids . . . "TV Service Cord" and "TV Picture Tube Extension Cable"?

We manufacture cord sets and cables to government and civilian specifications.

Columbia

WIRE & SUPPLY CO.

2850 Irving Park Road • Chicago 18, Ill.

"National distributors and warehouse for ANACONDA deansheath television and radio wires and cables"

AUTO-RADIO CONVERSION

? I have converted a Mopar 802 (Philco C-4608) auto radio for use in an a.c. operated home-type console. I replaced the vibrator pack with an a.c. power pack which delivers the same B voltages as the original unit. My difficulty is that I cannot get the speaker to work because I don't have a supply for its field coil. Is there a simple supply that I can use with the speaker field?—*E. E. S., Florence, S. C.*

A. Most electrodynamic auto radio speakers have 4-ohm fields which require approximately 1.5 amp at 6 to 6.5 volts d.c. Suitable supplies are shown in Figs. 1 and 2. However, the cost of the supply components is likely to be greater than a medium-priced extended-range 8- or 12-inch PM speaker which we would recommend for a console radio.

A full-wave center-tapped rectifier is shown in Fig. 1. This circuit can be

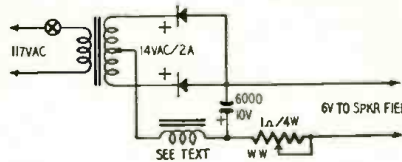

Fig. 1—A simple full-wave rectifier.

used as a trickle charger for light-duty storage batteries. In this case, the filter choke and capacitor may be eliminated. The rectifier may be a FTR (Federal Telephone & Radio 104D2943S or equivalent).

Although the full-wave bridge rectifier (Fig. 2) is more expensive than the center-tap type having the same current and voltage ratings, it is usually more readily available from dealers'

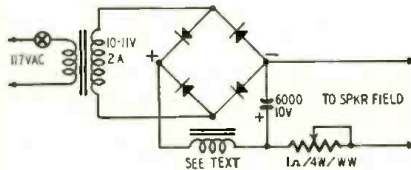

Fig. 2—Circuit with bridge rectifier.

stocks. The rectifier may be a Mallory 1B12C1J, *Seletron* U1B1S1B, or equivalent. Filter chokes in Figs. 1 and 2 should have an inductance of about .05 henry and a current capacity of at least 2 amp. These are not generally available on the open market. You can construct a suitable choke by removing the winding from a 100-ma receiving-type choke and replacing the winding with No. 14 cotton-covered enameled wire. Adjust the air gap for best filtering action.

These two supplies can be used to power heavy-duty 6-volt relays, for light electroplating, and as heater supplies for high-gain voltage amplifiers.

ANTENNA CALCULATIONS

? I want to experiment with antennas for the u.h.f. TV band but I can't be sure of the correct formula for determining the length of a dipole (one-half wavelength) radiator. I have seen a

BLAK-RAY SELF-FILTERING ULTRA-VIOLET LAMP

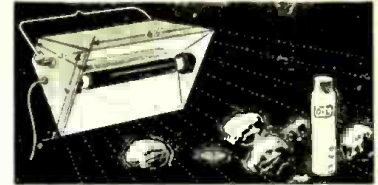

BLAK-RAY 4-watt lamp, model X-4, complete with U-V tube. This lamp gives long-wave ultra-violet radiation having a wave-length of 3654 to 4000 angstrom units. Some of the substances made to fluoresce visibly when illuminated by U-V light are certain woods, oils, minerals, milkstone, cloth, paints, plastics, yarn, drugs, crayons, etc. This lamp is self-filtering and the invisible U-V rays are harmless to the eyes and skin. Equipped with spectral-finish aluminum reflector. Consumes only 4 watts and can be plugged into any 110 volt 50-60 cycle A.C. outlet. Will give 2000 to 3000 hours of service. It weighs but 1¼ lbs. Approved by the Underwriters Laboratories and has a built-in transformer so that it may be safely used for long periods when necessary. Extra U-V tubes are available.

Ship wt. 4 lbs.
ITEM NO. 125
UNUSUAL BUY **\$14.75**

POWERFUL ALL PURPOSE MOTOR

Sturdy shaded pole A.C. induction motor. 15 watts, 3000 rpm. 3"x2"x1¼"; 4 mounting studs; 7/8" shaft, 3/16" diameter; 110-120 volts, 50-60 cycles. A.C. only. When geared down, this unit can operate an 18" turntable with a 200 lb. dead weight. Use it for fans, displays, timers and other purposes. Ship wt. 2 lbs.
ITEM NO. 147
UNUSUAL BUY **\$2.45**

WATTHOUR METER

Leading makes—reconditioned. Ideal for trailer parks. 100-110 volts, 60 cycles, 2-wire A.C. 5 amp. Heavy metal case 8½" x 6¼" x 5". Easy to install. Ship. wt. 14 lbs.
ITEM NO. 33
NOW ONLY **\$4.50**

WESTERN ELECTRIC BREAST MIKE

Lightweight 1 lb. carbon microphone. Aircraft type. Breastplate mounting, adjustable 2-way swivel. Easily fastened straps. For home broadcasts, communications etc. Complete with 6 foot cord, hard rubber plug. Sheradized plate, non-rusting finish. Ship. wt. 2 lbs.
ITEM NO. 152
NEW LOW PRICE **\$1.75**

AMAZING BLACK LIGHT

250-watt ultra-violet light source. Makes fluorescent articles glow in the dark. Fits any lamp socket. For experimenting, entertaining, unusual lighting effects. Ship. wt. 2 lbs.
ITEM NO. 87
A SAVING AT **\$2.45**

250 POWER TELESCOPE LENS KIT

Make your own high powered 6 ft. telescope! Kit contains 2" diam., 75" focal length, ground and polished objective lens and necessary eye pieces. Magnifies 50x to 250x. Full instructions. Ship. wt. 1 lb.
ITEM NO. 123
YOU SAVE AT **\$2.95**

HUDSON SPECIALTIES CO.
25 West Broadway, Dept. RE-7-53
New York 7, N. Y.

I am enclosing full remittance for items circled below. (Be sure to include shipping charges.)
OR, my deposit of \$. . . Ship balance C.O.D.
MINIMUM C.O.D. ORDER \$5.00
C.O.D. ORDERS ACCEPTED ONLY WITH 20% DEPOSIT
INCLUDE SHIPPING CHARGES.

Circle Items Wanted
87 147 33 152 125 123

Name _____
Please Print Clearly
Address _____
City _____ Zone _____ State _____

number of different formulas for finding the length of one-half wavelength. For example, in one formula, one-half wavelength in inches is found by dividing 5,540 by the frequency in megacycles. In another, the constant is 5,900. Are both formulas correct? If so, why the difference?—E. S. T., New Haven, Conn.

A. Dividing 5,900 by the frequency in megacycles gives the free-space length of the element. The free-space length is the length required to resonate the element if it were situated a great many wavelengths away from the earth and all other objects. When the antenna is relatively close to the earth and other objects, its physical length (as measured with a ruler) is somewhat shorter. Formulas which use a constant smaller than 5,900 have been corrected to compensate for physical factors which cause the physical length of the dipole to be shorter than its free-space length.

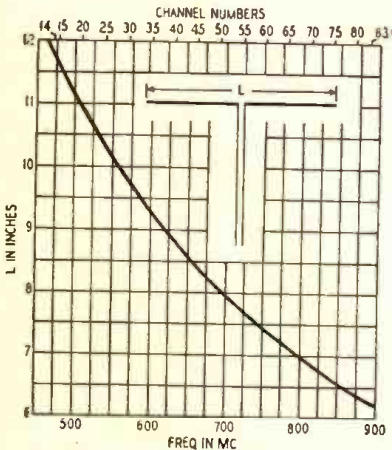

Antennas with thin-wire conductors supported by insulators at the ends are shorter than the free-space dimension because the insulators act as capacitors connected to the dipole ends. The added capacitance causes the dipole to resonate below the design frequency. The added capacitance is called end-effect and must be compensated for by multiplying the free-space constant (5,900) by a decimal constant K. Below about 35 mc, K is approximately 0.95 for most applications.

When dipole dimensions make it practical to do so, we often use rods and tubes as dipole elements. This minimizes the end-effect and introduces another factor which also causes shortening of the physical length of the dipole. Free-space length is reduced by a factor which is determined by the ratio of the diameter of the dipole element to the wavelength. This constant varies from about 0.98, when one wavelength is 10,000 times the conductor diameter, to about 0.92, when the diameter is one-tenth of wavelength.

When a dipole is installed in an array, or when parasitic elements are added, the configuration of the antenna also affects the length of the dipole. Thus, no formula for dipole length is exact unless it specifies the type of antenna, the ratio of conductor diameter to wavelength, and the number, length,

XCELITE Hand Tools
PREFERRED BY THE EXPERTS

THANKS, R-E!

We know it was a coincidence that our No. 99 PR Multi-Purpose Set appeared on the May '53 cover of your fine publication. Xcelite realizes the vast following R-E has in the industry, and appreciates the prominent representation even, as we say, it was pure "happencestance". Thanks again.

F. Birney Farrington, President
Xcelite, Incorporated

Xcelite No. 99 PR
Multi-Purpose Set

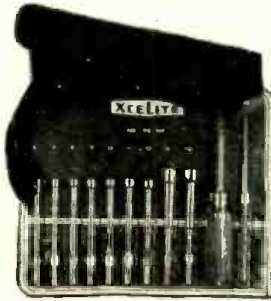

Includes handle; 9 precision-fit nut-drivers, from 3/16" to 1/2"; 2 popular Phillips and 2 regular screw-drivers, 13 ruggedly-made tools in handy plastic roll case. \$11.95 list



BUT—IT WAS NO COINCIDENCE THAT... the R-E photographer found this No. 99 Xcelite Set in the modern shop shown in the upper righthand picture. Leading Radio and TV men everywhere insist on XCELITE TOOLS because they take pride in owning the finest.

Ask your dealer to show you the complete XCELITE line.

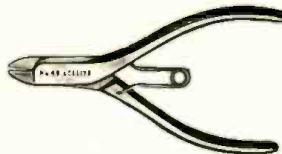

No. 49 XCELITE Electronic Midget Snips (shear action type). List \$3.70



Famous XCELITE "Stubby" Nut Driver only 3 3/4 inches overall. Shaft lengths up to 6".



CK-3 Roll Kit Combination: Includes 3 most popular Phillips drivers, plus 3 most-used regular screw-driver sizes. Husky detachable handle. \$4.35 list

XCELITE, INCORPORATED
(Formerly Park Metalware Co., Inc.)
Dept. J, Orchard Park, New York
Originators—Not Imitators

For Originality
LOOK TO XCELITE

ARKAY
world's finest radio kits
Write for free Brochure
RADIO KITS, INC., 120 Cedar St., N. Y. 6

ELECTRONIC HOBBYISTS
Build and play my latest polyphonic organ without a knowledge of music. Or get blueprints for a miniature electronic brain, and other projects. Send 3¢ stamp for air mail reply.
JIM KIRK, W6JKX
1552 Church St., San Francisco 14, Calif.

RECORDING TAPE (PLASTIC BASE) 40% OFF

WASHINGTON, D. C.: WHERE ELSE WOULD THERE BE MORE RECORD TAPE?
Each reel individually boxed. Choice of nationally famous top quality brands such as: Reeves (SPN-12) 3.20; Webcor (2908) 3.20; Audio (1251) 3.23; Scotch (111-A) 3.25; Irish Professional grade. (211 RPA) 3.30.
(LIST PRICE ON ABOVE TAPES ARE 5.50 EA.)
• 10% additional discount to Club Members of:
A. Tape-Response International 3488-22 St., San Francisco, Calif. (Fred Goetz, Secretary)
B. Voicepenance Club 1614 N. Mango Ave., Chicago, Illinois (John Schirmer, Secretary)
New empty plastic reels in boxes for easy labeling 3"-10¢; 4"-22¢; 5"-24¢; 7"-30¢ each. EMPTY BOXES: 3"-3¢; 4"-5¢; 5"-5¢; 7"-10¢.
• We carry new recorders, recording blanks, tape, tape recorders, etc., at large savings. PLEASE INCLUDE SUFFICIENT POSTAGE.
COMMISSIONED ELECTRONICS CO.
2503 Champlain Street, N.W., Washington 9, D.C.



Special Offer On This Complete RADIO ENGINEERING LIBRARY

New, Up-To-Date Edition of Famous Library Covers Whole Field of Radio Engineering. Places Latest Facts, Standards, Data Practice, and Theory At Your Fingertips

The five big volumes of the new edition of the Radio Engineering Library now include the very latest facts, standards, data, and practice. This Library will help solve hundreds of problems for designers, researchers, engineers, and students in any field based on radio.

Written by leading radio engineers, these books cover circuit phenomena, networks, tube theory, vacuum tubes, amplification, measurements, etc.—give specialized treatment of all fields of practical design and application. They provide you with a complete and dependable encyclopedia of facts.

- 5 Volumes, 3872 Pages, 2770 Illustrations
- Eastman's FUNDAMENTALS OF VACUUM TUBES, 3rd Edition.
- Terman's RADIO ENGINEERING, 3rd Edition.
- Everitt's COMMUNICATION ENGINEERING, 2nd Edition.
- Hund's HIGH FREQUENCY MEASUREMENTS, 2nd Edition.
- Henney's RADIO ENGINEERING HANDBOOK, 4th Edition.

SEND NO MONEY

Special Low Price—Easy Terms

On this special offer you get this Library for \$37.50, instead of \$43.50. You save \$6 and may pay on easy terms. Mail coupon below to examine the Library FREE for 10 days. No obligation. These books are recognized as standard works; you are bound to need them. So take advantage of this special money-saving offer. Mail coupon at once!

McGraw-Hill Book Co., Dept. RE-7
327 West 41st St., New York 36, N. Y.

Send for 10 days' FREE trial, the RADIO ENGINEERING LIBRARY. If not satisfied I will return books. Otherwise I will send \$7.50, plus delivery charges, then; and \$6 a month for 5 months. (Reg. price \$43.50, you save \$6).

Name

Home Address

City & State

Employed by.....

We'll Pay Delivery Charges if you enclose \$7.50 first payment WITH coupon. Same return privilege for full refund.

(Offer applies to U.S. only.)

and spacing of adjacent elements—if any—which may be part of the antenna.

In the u.h.f. TV band the average dipole has sufficient bandwidth to cover two or more channels on each side of the center frequency, so you should have good results by cutting the dipole to the free-space formula for one-half wavelength in inches: $5,900/f$, where f is the frequency in megacycles; or $5,900/6N + 389$, where N is the u.h.f. channel number.

The formulas above apply only when the dipole is used alone. If you add parasitic or driven elements to the dipole, or use dipole elements of unusually large diameter or shape, then you should not rely on the accuracy of the formulas. Instead, you may use them as a starting point for experiments leading to the results that you want. You can use the graph to determine the approximate electrical length of a dipole for the u.h.f. TV channels. This chart is taken from installation instructions for the Westinghouse model H-803 all-channel u.h.f. tuner.

RECEIVER QUERY

? Please prepare a diagram showing how I can connect a T-30 surplus throat mike through a small a.c.-d.c. receiver which has a phono input jack for an RCA 45-12 record player. I would also appreciate details on connecting two sets of headphones to an Admiral 20T1 TV receiver so the speaker cuts out when the phones are plugged in.—R. T. G., Cheektowaga, N. Y.

A. The diagram (Fig. 1) shows how a microphone transformer can be used to connect your throat mike to the input

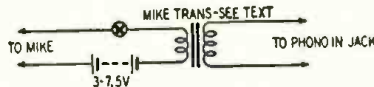

Fig. 1—Hookup for throat microphone.

of your receiver. The transformer should have a primary of about 50 ohms and a secondary of 10,000 ohms or higher.

Fig. 2 shows how the voice-coil circuit of your TV set can be modified for use with headphones. A Mallory 704A or equivalent jack and a 5-ohm,

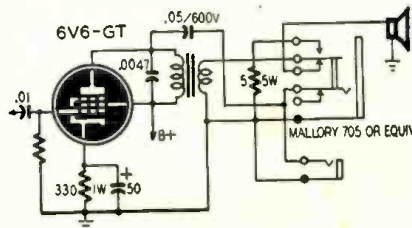

Fig. 2—Safe way to hook up headphones to the output of a TV receiver.

5-watt resistor are wired in as shown for the first headset. The second pair of phones is connected in parallel with the first through a simple open-circuit type jack. These phone jacks can be mounted in a small box connected to the receiver circuit through a convenient length of cable. END

TV Receiver Sensitivity Measurements made Simple with

The New "SensiMeter"*

Portable ... a "must" in fringe areas



Net \$129.50
*Pat. Applied For

Approved by leading television manufacturers!

- * Takes the guesswork out of TV service
- * Checks receiver from antenna terminals to picture tube
- * Microvolt scale is divided into 3 sections as a guide for the servicemen
- * Sensitivity testing is accepted by servicemen as the best method of determining the cause of bad pictures

Consult your jobber or write for further information

SERVICE INSTRUMENTS COMPANY
422 South Dearborn Street, Chicago 5, Illinois

RADELCO

INDOOR ANTENNA

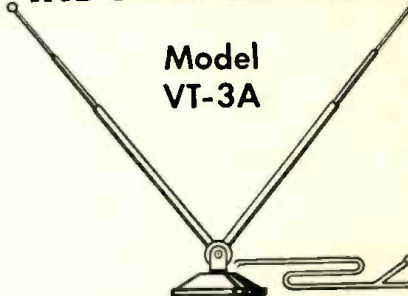

Model VT-3A

A high quality antenna, attractively designed and finished in mahogany lacquer to harmonize with all room furnishings. Three section, brass tubing masts with satin chrome finish extend to 45" for fine reception. Heavily weighted base. Lead and terminals included. A real value!

ORDER FROM YOUR NEAREST PARTS JOBBER LIST PRICE \$375

For accurate
flexible and
quick tube
testing at
low cost...
model 3413-A

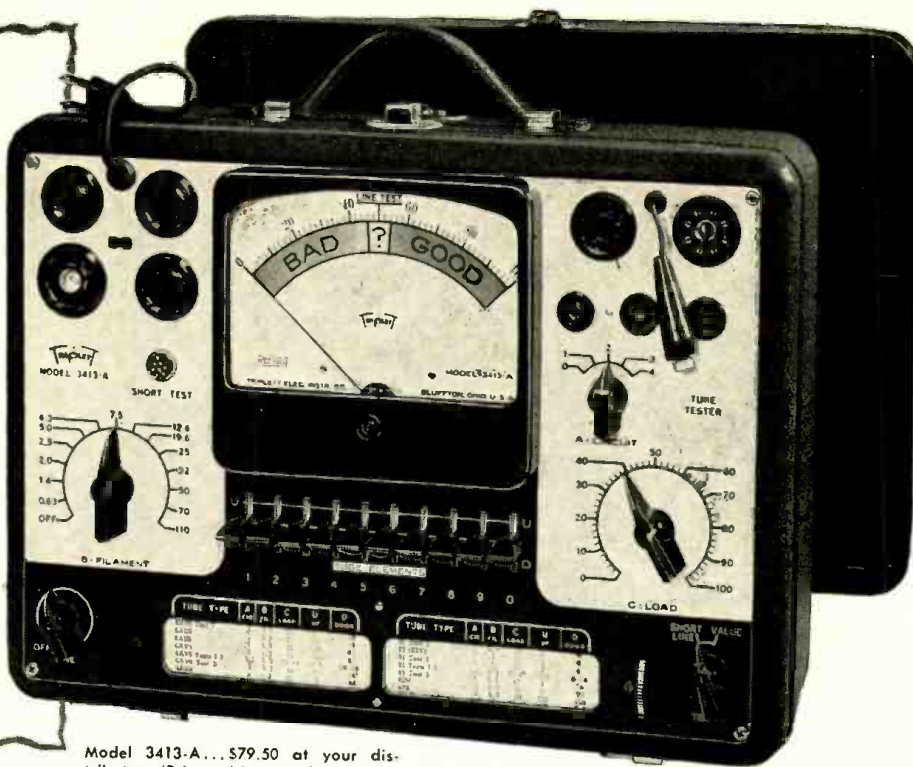

Model 3413-A...\$79.50 at your distributor. (Price subject to change.) BV Adapter, \$7.90 Add'l.

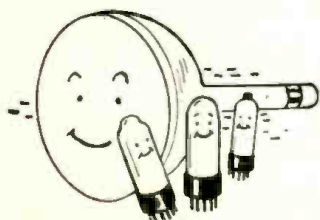

1. YOU CAN TEST MORE TYPES of tubes, also appliances for shorts and open circuits.

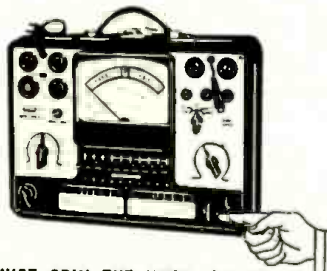

2. JUST SPIN THE KNOB—for correct, last-minute data, on the speed roll chart. Lists 700 tubes.

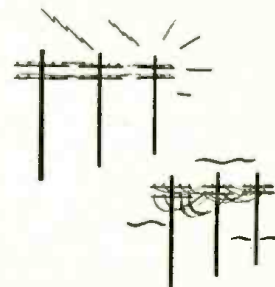

3. YOU CAN COMPENSATE for line voltage—just throw snap-action switch.

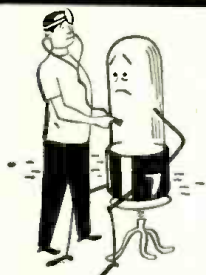

4. YOU CAN TEST EACH ELEMENT in each tube—by a simple flip of the switch.



5. YOU CAN TEST THE NEW TUBES—including those with low cathode current.



6. YOU GET NEW TUBE DATA—immediately, while it is still news. No waiting.

Nearly Half a Century of Service to the Service Man

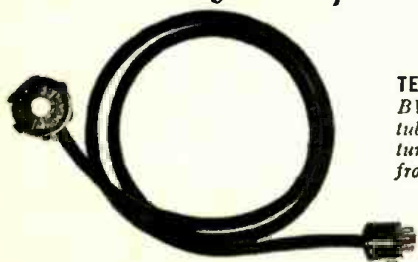

TESTS PICTURE TUBES, TOO! With this BV Adapter, Model 3413-A tests every tube in a TV receiver, including the Picture Tube—without even removing tube from receiver or carton! Saves time!

FOR THE MAN WHO TAKES PRIDE IN HIS WORK

Triplet

TRIPLETT ELECTRICAL INSTRUMENT CO., BLUFFTON, OHIO, U. S. A.

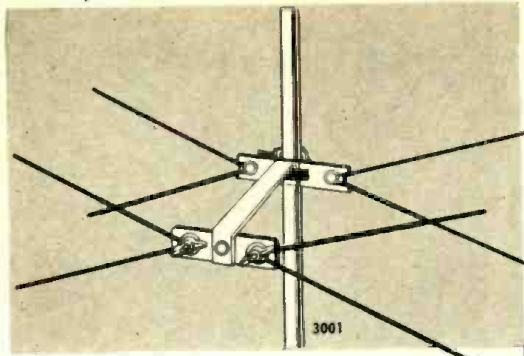

THE BASIC UHF ANTENNA

Best for any UHF installation

No matter what the specific requirement of an installation is—a Taco Bow Tie will fill it...

Taco's Bow Tie is the proved top performer. Now you can carry a single antenna with assurance that it will fill all your UHF needs with the easy adaptation of screen-type reflectors.

Fill all your needs with the best UHF antenna—The Taco Bow Tie.

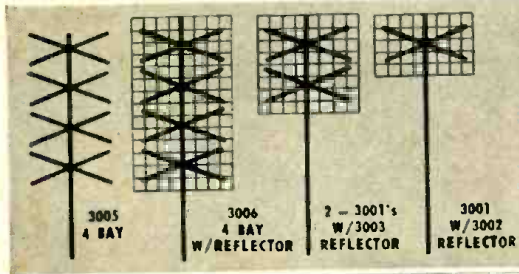

TACO

Technical Appliance Corporation,
Sherburne, N. Y.
In Canada: Hackbusch Electronics, Ltd.,
Toronto 4, Ont.

Get the complete story on the Taco UHF Team from your Taco distributor.



the
Engineered
Product

**Perma-Power
TV TUBE
BRITENER**

**extends useful life
of older TV tubes!**

manufactured by

Perma-Power COMPANY

Chicago 25, Illinois

Manufacturers of Electronic Equipment Since 1928

Windsor TUBES

TESTED and
GUARANTEED
for PEAK
PERFORMANCE!

TO MERIT your confidence—to insure your satisfaction—Every tube we ship has been tested in a radio or TV set for PEAK PERFORMANCE. Each tube is attractively packaged in individual carton—and carries full RTMA GUARANTEE!

Type	Price	Type	Price
1B3GT	\$.63	6B86G	.57
1R5	.56	6BQ6GT	.89
1S5	.47	6BQ7	.84
1T4	.56	6C4	.37
1U4	.55	6CB6	.53
1U5	.46	6CD6G	1.85
1X2A	.67	6J5GT	.40
3V4	.56	6J6	.62
5R4GY	.91	6K6GT	.41
5U4G	.40	6K7GT	.47
6AB4	.46	6S7GT	.50
6AG5	.54	6SK7GT	.50
6AK5	.95	6SL7GT	.62
6AL5	.40	6SN7GT	.54
6AQ5	.46	6SQ7GT	.42
6AU6	.43	6T8	.71
6BA6	.45	6V6GT	.46
6BC5	.53	6W4GT	.45
6BE6	.46	6W6GT	.51
		6X5GT	.33
		12A7G	.48
		12A7T	.68
		12A07	.53
		12AV7	.79
		12AX7	.61
		12BA6	.45
		12BE6	.47
		12BH7	.63
		12SA7GT	.52
		12SK7GT	.50
		12SQ7GT	.42
		25BQ6GT	.89
		25L6GT	.48
		35B5	.48
		35C5	.48
		35Z5GT	.30
		50B5	.47
		50C5	.47
		50L6GT	.47
		117Z3GT	.39

WRITE FOR ADDITIONAL TUBE TYPES AND PRICES. We also stock Special Purpose and Transmitting Tubes at similar savings!
25% Deposit with Order. All merchandise F.O.B. N.Y.C. For orders less than \$10, add \$1 handling cost. Deduct 2% if full remittance accompanies order. All merchandise subject to prior sale and price change without notice. Dept. C-7

Windsor ELECTRONIC TUBE CO.
1515-C SHEEPSHEAD BAY ROAD, BROOKLYN 35, N. Y.

TECHNOTES

G-E TV RECEIVERS

Vertical instability accompanied by excessive contrast, horizontal pulling, and little or no effect with variation of the contrast control may be the complaint in the G-E 16T1, 16T2, 16C103, 16C110, and similar sets. These troubles

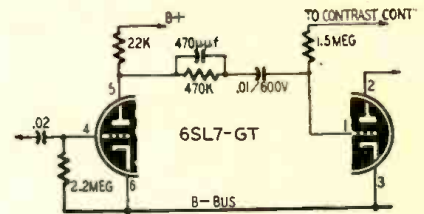

can be caused by excessive leakage in the .01-µf coupling capacitor connected to pin 1 of the 6SL7 sync separator and amplifier tube. This capacitor is shown in the diagram. Replace this capacitor with a high-quality, .01-µf, 600-volt unit.—William George

ADMIRAL SERIES 19 CHASSIS

In some sets, it may be difficult to adjust the horizontal lock-in range and frequency properly.

This difficulty is caused by critical components in the horizontal oscillator circuit. The coded components in the diagram should be checked for correct values.

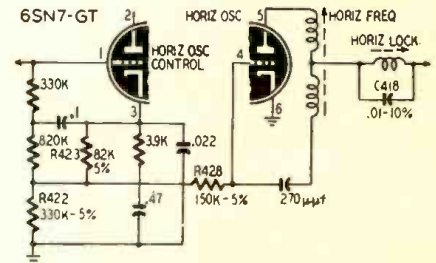

Replace components which are not within the specified tolerances. These tolerances are now being specified in production, and the following new parts numbers have been added: 64A2-16, 60B7-334, 60B7-823, and 60B7-154, for C418, R422, R423, and R428, respectively.—Admiral Radio & Television Service Bulletin

STROMBERG-CARLSON 116

In strong-signal areas, this set may produce milky, low-contrast pictures with sound bars and buzz in the audio.

This trouble is caused by overloading and can be eliminated by using an attenuator pad in series with the antenna lead-in. Resistor values for the pads will be found on the installation instruction sheets fastened to the rear panel of each set.—George R. Anglado

MEISSNER 8C FM TUNER

Complaints of excessive warmup drift in the Meissner 8C tuner are fairly common. This trouble is caused by overcompensation in the tuning of the ratio detector transformer.

The trouble can be cleared up by replacing the 70-µf, type N750 ceramic capacitor in the top of the ratio detector coil with a 68-µf, 5% silver mica capacitor.—Arthur R. Backstrom

WESTINGHOUSE H-600T16

Sound circuits dead. No video signal visible on the picture tube. Bright vertical line on the left side of the raster.

This trouble is likely to be caused by a defective 6Y6-G audio output tube. The plate-to-cathode resistance of this tube is in series with the B plus line supplying the screens of the first sound i.f., first and second video i.f., and r.f. amplifier stages, along with other points in the receiver circuit.

Replace the 6Y6-G and check the operation of the circuit by measuring the voltage between cathode and ground.—*Michael L. Tortariello*

WESTINGHOUSE H-196 AND H-207

The manufacturer's service notes state that a fixed bias should be applied to the a.g.c. line when using a v.t.v.m. and signal generator to align the video i.f. coils and traps. I find that more uniform results can be obtained by removing the fixed bias and using a sweep generator and scope.

Adjust the sensitivity control for 0.5 volt on the video i.f. a.g.c. line with no signal input to the receiver. Couple the sweep generator to the converter grid and adjust the sweep output for 1 volt on the a.g.c. line. At this setting, the sweep amplitude is optimum for best visual alignment.—*Wayne Miller*

HUM IN G-E 16K1, 16K2

Complaints of tunable hum (hum modulation) on the broadcast band of the 16K1 and 16K2 may be cleared up by connecting a .002- μ f, 600-volt capacitor from ground to the black lead on the primary of the power transformer.

If the complaint is residual hum on broadcast, phono, and TV, connect a 20- μ f, 450-volt capacitor across the 30- μ f input filter capacitor in the radio chassis. Rewire the cabling between the radio and TV chassis as follows:

1. Remove the BLUE and GREEN audio wires which connect through pins 3 and 2 of plug P4 and socket J4.

2. Connect these leads together through a new 2-pin connector (parts RJC-012 and RJC-013) and dress the leads as shown in the illustration.

3. Connect a 22- μ f capacitor from the high side of the volume control to ground at the tone control switch.

All late production models incorporate these changes.

—*G-E Radio Service Bulletin*

9T246 CONVERSION PROBLEM

After conversion to a larger tube, the left side of the picture was darker than the right. Backing off the brightness control made the left side totally black while the right half was still bright enough to watch.

During the conversion process, the picture-tube screen grid had been removed from the B plus line and connected to the boosted B plus circuit as recommended.

The trouble cleared up when a 01 μ f capacitor was connected from the screen grid to B minus.—*J. V. Cavaseno* END

FREE TV HIGH VOLTAGE DETECTO PROBE

With Every Order Of \$5 or Over

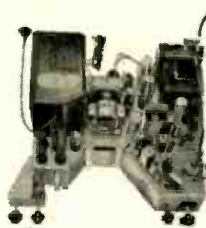

Build your own

**SUPER DELUXE
31-TUBE
#630 TV CHASSIS
With - U. H. F.**

With a #030 SUPER DELUXE 31-TUBE TV KIT including your favorite U.H.F. Station. Engineered in strict adherence to the genuine RCA #030 plus added features... OPERATES ALL 16" to 24" PICTURE TUBES... CASCODE TUNER... COSINE YOKE... LARGER POWER TRANSFORMER... KEYED AGC... 12" SPEAKER... CONDENSERS and RESISTORS at rated capacities and tolerances. You receive a COMPLETE SET OF PARTS AND TUBES, everything needed is included. You will enjoy building it with the "LIFE-SIZE easy to follow" step-by-step ASSEMBLING INSTRUCTIONS included with each kit.

only... **\$119.44** (LESS CRT & WIRE)



H-41", W-25", D-23"

MANHATTAN \$59.37

CUSTOM-BUILT TV CABINETS

2 LEADING STYLES in genuine Mahogany or Walnut (blend 10% extra). Drilled for a #030 or blank kit (panel for any make TV SET. Complete as pictured for 16", 17", 20" or 21" C.R.T.



H-25", W-26", D-22"

VOGUE \$39.89

STANDARD PICTURE TUBES—Brand New in Factory Sealed Cartons, 1 Year Guarantee

17"—17BP4A	\$29.63	20"—20CP4	\$39.74	21"—21EP4A	\$44.68
------------	---------	-----------	---------	------------	---------

PARTS For #630 TV SETS

PUNCHED CHASSIS PAN, cadmium plated	\$4.87
STANDARD CASCODE TUNER, incl. tubes	22.49
ESCUTCHEON PLATE, for tuner	.69
COMPLETE SET OF KNOBS, incl. decals	1.34
POWER TRANSFORMER, 295ma. 201T6	9.97
VERTICAL OUTPUT TRANS.	204T2... 2.69
VERTICAL BLOCKING TRANS.	208T2... 1.32
HORIZONTAL OUTPUT TRANS.	211T5... 3.98
FOCUS COIL, 470 ohms.	202D2... 3.42
DEFLECTION YOKE, Cosine 70°	202D2... 3.98
SOUND DISCRIMINATOR TRANS.	203K1... 1.12
1st I.F. TRANSFORMER	202K2... 1.08
2nd PIX I.F. TRANSFORMER	202K3... 1.08
1st or 2nd SOUND I.F. TRANS.	201K1... 1.02
HORIZONTAL DISCRIM. TRANS.	208T8... 1.49
FILTER CHOKE, 62 ohms.	202K4... 1.47
CATHODE TRAP COIL	202K4... 1.80
WIDTH CONTROL COIL, keyed AGC IR4AG	.79
ION TRAP BEAM BENDER, single 203D1	.79
HI VOLTAGE CAGE ASSEMBLY, complete	3.73
VOLTAGE DIVIDER SHIELD & COVER	1.79
HV RECTIFIER, SOCKET ASSEMBLY, single	.79
20kv FILTER CONDENSER (cartwheel)	.79
30kv FILTER CONDENSER (cartwheel)	1.83

#630 Parts & COMPLETE SETS

TV WIRE & SOLDER KIT, for any Set	\$1.49
630-KIT, screws, nuts, rivets, washers, etc.	1.69
VIDEO AND I.F. KIT, 19 items	7.84
AGC KIT, complete with instructions	4.59
VARIABLE CONTROL KIT, 9 controls	5.83
CARBON RESISTOR KIT, 107 resistors	6.98
WIREWOUND RESISTOR KIT, 4 resistors	2.31
BRACKET AND SHIELD KIT, 18 items	8.63
ELECTROLYTIC CONDENSER KIT, 6 cond	7.37
TUBULAR CONDENSER KIT, 38 condensers	4.28
CERAMIC CONDENSER KIT, 28 condensers	3.37
MICA CONDENSER KIT, 11 condensers	1.38

Brooks LIFE-SIZE TV Instructions \$2.49 Postpaid for building any #630 TV RECEIVER only

HINTS FOR BETTER PERFORMANCE \$1.00 ON YOUR #630 TV RECEIVER Postpaid

Brooks CASCODE MANUAL. How to install Cascode Tuner in any make TV set Postpaid 50¢

BROOKS RADIO & TV CORP., 84 Vesey St., New York 7, N.Y.

See the AUGUST issue of
SCIENCE-FICTION +
—a new adventure in reading

THE END OF THE MOON

Gustav Albrecht, eminent physicist, tells what will happen when our moon breaks up. Dramatically illustrated with color covers and interiors by Frank R. Paul.

SPACEBRED GENERATIONS

An absorbing novelette by Clifford D. Simak, one of the best of today's science fiction writers.



PLUS—many other stories and articles
This new Gernsback Magazine **NOW ON SALE**
Get a copy at your favorite newsstand now.
Don't say science fiction—say **SCIENCE-FICTION PLUS**

Value Scoop! Special Sale! HEAVY DUTY WORK TABLES



only
\$17.75
24" x 48"

**WITH ALL-STEEL
TOPS AND LEGS**

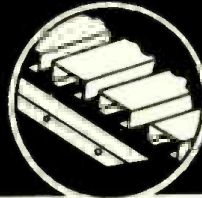

Ideal for Assembling, Packing, Inspection,
or Supporting Extra Heavy Loads!

All-steel top with 1/4" Masonite covering. Strong enough to support vises, small punch presses, etc. Warp-proof, no maintenance. Top construction engineered with 6" pressed steel channels. Drawers, ledges, risers and shelves furnished if desired.

20 STOCK SIZES AVAILABLE—
RANGING 4', 5', 6', and 8'
long—widths in multiples of 6".
Height 30" or 35" with 2 3/4"
leg adjustments.

24" x 4'	\$17.75
30" x 4'	20.75
24" x 5'	20.75
30" x 5'	25.90
24" x 6'	24.90
30" x 6'	31.10
24" x 8'	33.20
30" x 8'	41.45

Drawers and foot rests optional. Drawers \$4.70 Each.

FREE! CATALOG ILLUSTRATING TABLE MODELS
AND ACCESSORIES. WRITE TODAY!

COOPER Industries

INDUSTRIAL EQUIPMENT DIVISION
4953 West Fullerton Ave., Chicago 39, Ill.

**IMPOSSIBLE
BUT TRUE!**

SINGLE CHANNEL 5 ELEMENT DELTA-MATCH YAGIS

ONLY
\$200

each
LOTS OF 5

We know it's hard to believe, and we hardly believe it ourselves — but here it is, so make the most of it! These beautifully fabricated Yagis usually sell for 3 to 5 times our price!

Delta-Match principle insures flat response over entire channel bandwidth, providing maximum fidelity in both picture and audio portion of TV signal. These Yagis available for channels 2, 3, 4, 5 and 6, together with detailed instructions for cutting to channels 7, 8, 9, 10, 11, 12 or 13. Sorry, no less than 5 antennas of one channel. SPECIFY CHANNEL WHEN ORDERING.

Free with each order of 5 antennas 1 all-purpose hack-saw with blade and complete instructions for simple conversion of lower frequency Yagis to high frequency Yagis.

Stock No. YDMS—Packages of 5 Yagis. Net \$10.00
Wt. 40 lbs.

Concord Radio
55 Vesey Street, New York 7, N. Y.
Phone DLgby 9-1132

Spectacular KIT VALUES! 1000 RESISTORS



1/2 watt, 1 watt, 2 watt, 5 watt. All new. 5 and 10% tolerance. Well assorted, popular values. Sensationally low priced!
\$7.95
1000 resistors

15 "FP" CONDENSERS

Single, double, triple section, 10 to 80 Mfd. 25 to 450 Volts. Sturdy plastic utility box. Wt. 3 1/2 lbs. No. FPK15
\$3.98
Kit of 15 condensers



CONDENSER TREASURE CHEST



Surprise value! 75 paper, bypass, mica, electrolytic, "FP", oil-filled ceramic, TV and bathtub condensers. Plastic Utility box. Wt. 10 lbs. No. CTG75 KIT of 75 condensers
\$7.95

15 MICA CONDENSERS

Popular sizes, receiving type mica. 600 to 1000 volt test. Silver mica included. In plastic utility box. Wt. 1 1/2 lbs. No. MCK15 15 Micas Same as above. 75 Micas \$3.50
98c



25 CERAMIGONS



Fresh, new, popular assortment, worth twice the price! In sturdy plastic utility box, wt. 1 lb. No. CCK25 25 Ceramicons
\$1.49

Minimum order \$5. 25% Deposit with C.O.D. orders, F.O.B. N.Y.

CONCORD RADIO
55 Vesey St., New York 7, N. Y. Dept. C-7
Please include my name on your special bargain mailing list, free of charge.
NAME _____ CITY _____
ADDRESS _____

THE FUND REACHES
\$10,702.59



HELP - FREDDIE-WALK FUND

Little Freddie Thomason, armless and legless son of Herschel Thomason, radio technician of Magnolia, Arkansas, received the following letter from G. Carroll Utermahlen, of Baltimore, Maryland, who also enclosed a donation of \$1.00:

"Dear Little Freddie: I'm late with the enclosure but trust you will forgive me. Have been having the usual run of trouble here and have been very short of this green stuff. Yet . . . I slipped up before and am making up for it now . . . so . . . in spite of the delay, here she be.

"Once again I am in a position where I can run off a mimeographed memo to my pals, regarding my little chum Freddie. If the boys don't respond to the thing, I'm afraid I'm going to have to resort to BUCKSHOT . . . anyway . . . God bless you, little fellow, and I'll do my best to gather in some green stuff for you. 73 to you and the folks!"

So far we've had no reports of buckshot being used, but the enthusiasm expressed above is echoed by hundreds of loyal Freddie fans who, whenever they have a dollar to spare, send it along to the Help-Freddie-Walk fund with a message of encouragement.

We all realize that treatments, adjustments, etc., in connection with the mechanical appliances upon which Freddie will always be dependent, will cost thousands of dollars, and we are all just as aware of the fact that money is rather hard to come by these days; but we urge each and every reader to send in his contribution, no matter how small, whenever possible. No donation is too small to receive our sincere thanks and acknowledgment, as well as the appreciation of Freddie and his parents. *Make all checks, money orders, etc., payable to Herschel Thomason.* Address all letters to:

HELP-FREDDIE-WALK FUND
RADIO-ELECTRONICS
25 West Broadway
New York 7, N. Y.

FAMILY CIRCLE CONTRIBUTIONS

Balance as of April 16, 1953. . . . \$590.50
Laurie A. Bishop, Norwood, R.I. . . . 2.00
Ferne Steele, Los Angeles, California. . . 10.00

FAMILY CIRCLE Contributions as of
May 19, 1953. . . . \$602.50

RADIO-ELECTRONICS CONTRIBUTIONS

Balance as of April 16, 1953. . . . \$10,073.59
Lomer Biron, Quebec, Canada.50
Walter L. Schott Co., Los Angeles, Calif. 25.00
G. Carroll Utermahlen, Baltimore, Md. 1.00

RADIO-ELECTRONICS Contributions as of May 19, 1953. . . . \$10,100.09
FAMILY CIRCLE Contributions. . . . 602.50

TOTAL Contributions as of May 19, 1953 \$10,702.59

RADIO-ELECTRONICS

TV DX IN JULY

If you are reading this around the normal publication date, you still have some of the best TV of the year ahead of you. The last ten days of June, with some of the best TV dx of the year, have come to be well known among TV dx enthusiasts and hams who work on the v.h.f. bands as a period during which sporadic-E dx is almost continuous. This fortunate state of affairs can be expected to carry over into July as well.

The experienced dx observer will watch the closing days of June carefully, as he knows that there will be July recurrences 27 to 28 days later. Sporadic-E skip being associated in a general way with solar phenomena, marked disturbances follow the 27-day rotation cycle of the sun. This rhythm is usually discernible through at least three cycles, beginning in May (or, in some localities, April). Thus the observer who keeps records will have ample evidence of the dates in July when he can expect the most interesting conditions.

Aurora borealis, often considered a wintertime proposition, puts in at least one appearance normally in July.

Tropospheric propagation will be generally good during July, though the peak season for this sort of thing will come in the early fall. High-band signals should be strong during the early morning and late evening hours, and reception should be good in the period around sundown, particularly in fair, calm weather.

As this is our first summer of commercial u.h.f. TV operation we have much to learn about this new field. Reports of any unusual u.h.f. reception are solicited. We're still waiting for that first u.h.f. report! END

Radio Thirty-Five Years Ago
In Gernsback Publications

HUGO GERNSBACK Founder	
Modern Electrics	1908
Wireless Association of America	1908
Electrical Experimenter	1913
Radio News	1919
Science & Invention	1920
Television	1927
Radio-Craft	1929
Short-Wave Craft	1930
Television News	1931

Some of the larger libraries still have copies of ELECTRICAL EXPERIMENTER on file for interested readers.

JULY 1919
ELECTRICAL EXPERIMENTER

- Talking from 'Plane to Earth "Hello Europe"—Via Radio, by Charles M. Ripley
- Electrical Oscillators, by Nikola Tesla
- New 1 K.W. Panel Radio Transmitter, by Lester F. Ryan
- How European Radio "Sigs" are Photographed Here
- Musical Radio-Telegraph Sets, by Jacques Boyer
- Operate Your Audions on A.C., by Elliott A. White

JULY, 1953

Great, New 1953 Model 630-DX CHASSIS
terrific savings-immediate delivery



Includes newest developments—Cascode Tuner—30 Tubes—For 16" to 24" Picture Tube—Wonderful Saving! Adaptable for color & UHF!

The Great 630 with all the up-to-date improvements! Wonderful reception is yours today at this low-low price. Gives 3-times normal reception. Special super high-gain cascode coil tuner gives greater sensitivity, top performance on any channel. Aligned and tested for 5 hours. Molded condensers. 4 microvolts sensitivity. FM sound system. horizontal & linear lock and is directly adaptable for color & UHF.

Model 630-DX-1: RMA Guaranteed—Factory Wired, ready to play. Complete with 12" speaker, hardware and knobs.

\$145.50 (less CRT)

FREE: New Trouble Shooting Book with any chassis!

TV PICTURE TUBES
Full Year's Guarantee—Black Face—Brand New—Std. Brands.

17"	\$26.47
20"	\$38.87
21"	\$39.47

Universal Mounting Brackets **\$5.95**

New DeLUXE 630 DX-2
If you'll settle only for the finest—and you demand the best, you'll definitely want this super 630 DX-2 Chassis. You'll be amazed of fine quality pictures even in fringe areas up to 200 miles, and you won't even need a booster. Get the reception you want—don't settle for less!

Complete (less CRT) **\$159.50**

Write for New Catalog. 25% dep. with order. bal. C.O.D. All mds. subject to prior sale. F.O.B. NYC. Prices subject to change without notice.

The ROSE Co. 76 Vesey St., Dept. E-7
New York 7, N. Y., COrtlandt 7-6195

IT'S HERE!
The NEW IMPROVED DAVIS SUPER-VISION
ALL-CHANNEL TELEVISION ANTENNA
For FRINGE AREA and DX

Brings in the Signals STRONG and CLEAR up to 125 Miles and More Away from the Station

The NEW DAVIS SUPER-VISION has been WIND-TESTED and WEATHERIZED

...STURDY BUILT and STRENGTH-INCREASED so it will stand the gaff in any part of the country

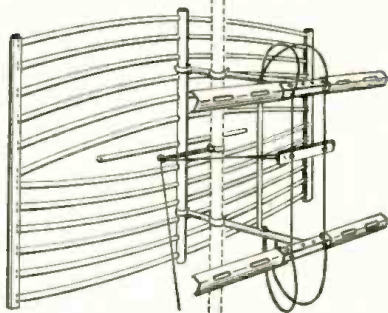

"The Original Antenna Sold With A Money-Back Guarantee"
Built By America's Fastest Growing Antenna Manufacturer

AT YOUR JOBBERS, or MAIL COUPON TO:

DAVIS ELECTRONICS 1-36
4313 West Magnolia Blvd., Burbank, California
SIRS: RUSH INFORMATION TO ME AS CHECKED BELOW:

Send Free Technical Data on new SUPER-VISION ANTENNA.

Send Name and Address of NEAREST JOBBER.

Name _____
Street _____
City _____ State _____

PEN-OSCIL-LITE
Extremely convenient test oscillator for all radio servicing; alignment. • Small as a pen • Self powered. • Range from 700 cycles audio to over 600 megacycles u.h.f. • Output from zero to 125 v. • Low in cost • Used by Signal Corps • Write for information.

GENERAL TEST EQUIPMENT
38 Argyle Ave. Buffalo 9, N. Y.

LEARN WITH "AMECO" COURSES
Simple, Low Cost, Home-Study Courses prepare you to pass F.C.C. Code and Theory license examinations.
Write for details and receive free sample F.C.C.-type questions and answers for all amateur examinations.

BECOME A RADIO AMATEUR

FREE →
AMERICAN ELECTRONICS CO.
1203 Bryant Ave. (Dept. RE-7), New York 59, N. Y.

SERVICE TECHNICIANS

What was your most unusual service case? Not necessarily the most difficult one, but the one you will remember longest, either because of the problem itself or because of other conditions surrounding the job. If the experience was interesting to you, it probably will be to other readers of RADIO-ELECTRONICS. We will pay \$10 for each "My Most Unusual Service Job" item we consider outstanding enough to publish in this magazine. If the item is striking enough or carries sufficient technical information to be worth more than \$10 in our opinion, it will be paid for at our regular space rates. Address your stories to

Unusual Service Job
RADIO-ELECTRONICS 25 West Broadway, New York 7, N. Y.

Let me show you how EASY it is to
LEARN TV
the practical way--



ASSEMBLE A
**TRANSVISION
TV KIT**

Pay as You Wire **\$39**
Down Payment

I WILL HELP YOU to start learning TV the practical way — by assembling a TRANSVISION TV KIT in EASY STAGES. For only \$39 you get PACKAGE #1 (standard first pkg. for all of our kits). This package gives you the BASIC CHASSIS and over 450 TV COMPONENTS with complete Instructions, Drawings, Photos, Service Booklet, and a year's subscription to my "TV and Electronics Notes". When ready, you order the next stage (pkg. #2), etc. Low prices make your complete kit a terrific buy!



FREE CATALOG Shows 6 Great TV Kits:
EXCLUSIVE: Only Transvision TV Kits are adaptable to UHF. Ideal for FRINGE AREAS. No Previous Technical Knowledge required. Write now!

TRANSVISION, INC., Dept. RE7
NEW ROCHELLE, N. Y.

--- MAIL THIS COUPON TODAY ---

Mr. D. Gnessin, Educational Director
TRANSVISION, INC., NEW ROCHELLE, N. Y. Dept. RE7

I'm enclosing \$_____ deposit. Send standard kit PACKAGE #1, with all Instruction Material. Balance C.O.D.

Send FREE copy of your new TV Kit Catalog.

Name _____
Address _____
City _____ State _____

Tremendous Opportunities in
COIN TV
and **COMMERCIAL TV**

TRANSVISION offers the only specially designed line of Coin-Operated and Commercial TV with the **PREVIEWER* ATTACHMENT** (Pat. Pend.)

This field offers rich rewards to enterprising servicemen or dealers — on part time or full time basis.

*The Electronic Previewer is a patented device which makes coin operation really pay off in a big way. Boosts revenue by "sampling" — by giving a short preview of TV programs to prospective customers. Works like magic in enticing sales.

Get details now.
TRANSVISION, INC.
NEW ROCHELLE, N. Y.



--- MAIL THIS COUPON TODAY ---
TRANSVISION, INC., NEW ROCHELLE, N. Y. Dept. RE7

Rush full details on COIN OPERATED TV.

Name _____
Address _____
City _____ State _____

Don G. Mitchell, who has been president of SYLVANIA ELECTRIC PRODUCTS since 1946, was elected chairman of the Board of Directors. H. Ward Zimmer, former executive vice-president, succeeds him as president. Max F. Balcom retired as chairman of the Board, but remains as a director in an advisory and consultant capacity. Other top-level Sylvania personnel appointments in-



D. G. Mitchell



H. W. Zimmer

clude W. Benton Harrison, former treasurer, to vice-president in charge of finance; Walter R. Seibert, formerly controller, and Leon C. Guest, Jr., formerly assistant controller, who were named treasurer and controller, respectively.

Dr. John Ruze, specialist in electronic research, joined GABRIEL Co. as director of the Gabriel Laboratories in Needham Heights, Mass. Dr. Ruze has done extensive research in the design and development of antenna systems. Gabriel is the parent company of Ward Products and Workshop Associates. Both subsidiaries are manufacturers of antennas and antenna accessories.



Dr. J. Ruze

Walter J. Brock was appointed Midwest sales manager for CBS-HYTRON, Danvers, Mass. He was formerly sales representative at CBS-Hytron's Chicago sales office.



W. J. Brock

Charles E. Balz was promoted to sales manager of BURGESS BATTERY Co., United States Battery Division, Freeport, Ill. He was assistant sales manager for the past two years, and before that was advertising and promotion manager.

Grady L. Roark was appointed manager of marketing for the GENERAL ELECTRIC TUBE DEPARTMENT, with headquarters in Schenectady, N. Y. He had been manager of equipment tube sales for the department. In his new position he succeeds Eugene F. Peterson, who was named manager of marketing for the entire General Electric Radio and Television Department.



G. L. Roark

**STAN-BURN
E-D-A-R-K-E**

*** CATHODE RAY TUBE SPECIALS ***

ONE YEAR GUARANTEE		STAN-BURN	
G.E.		STAN-BURN	
* 5TP4 \$44.95	10BP4A \$11.00
* 7JP4 17.10	12LP4A 14.20
* 10BP4A 19.25	14CP4 17.00
* 10FP4A 24.00	18DP4 17.50
* 12KP4A 27.10	16AP4 21.60
* 12LP4A 21.70	16FP4 19.60
* 12UP4B 28.25	16CP4 21.60
* 14CP4 24.50	16EP4A 22.60
* 16AP4A 30.95	16DP/MP4 19.80
* 16DP4A 28.20	16DP/MP4A 20.60
* 16GP4 31.25	16KP4 18.50
* 16KP4/16RP4 28.20	16LP4 20.60
* 17BP4A 23.90	16LP4A 21.60
* 17CP4 23.90	17BP4 18.50
* 19AP4A 39.45	17CP4 21.60
* 20CP4 24.75	19AP4 23.90
* 20LP4 37.50	19AP4A 23.90
* 21EP4A 37.35	20CP4 29.50
* 24AP4 A 78.50	21EP4 32.50

*** ANTENNA SPECIALS ***

	1-12	12 or more
* RED DOUBLE "V" Antenna \$2.29 \$2.09
* RMS EVA 100 Double 2.49 2.39
* 10 Element Conical 3.55 3.75
* Folded H Straight Low Quick Rig 4.25 3.25
* 1/2" elements 4.95 3.75
* WINDOW CONICALS7969
* MASTS 10 FOOT SWAGED 1.39 1.29
* NEPCO MASTS 1.69 1.49

* TV WIRE 42 Mil. 300 OHM \$9.95 M Ft.
55 Mil. 300 OHM 11.95 M Ft.
12" Heavy Sulf. Speaker with Cascade Tuner \$149.50
12" Heavy Sulf. Speaker \$42.00

*** WIRE RECORDERS IN STOCK ***

PENTRON—Model 9T3C—2-speed Tape Recorder Write for Price.
* RADIO CRAFTSMAN Model C400—Hi Fi Amplifier Net \$42.90
* Model C10—AM-FM Tuner Net \$31.50
* Model C500—Williamson Amplifier Net \$99.50
* We also carry MASC—BOGEN—PILOT, etc. Amplifiers—Pre-Amps, FM Tuners and WEBSTER Tape Recorders.

* 6"x9" PM SPEAKER \$3.98
* 7" FM SPEAKER 3.98
* 77JL G.E. Flyback 1.98
* 70" Yoke 1.98
* 630 Vert. Output Upright 1.98
* 630 Vert. Output Potted 1.29
* 630 Vert. Blocking Xform.89
* CASCODE TUNERS 19.95
* STANDARD TUNERS 17.95
* DUMONT 21.25mc 14.95

* AUTHORIZED DISTRIBUTORS for: General Electric, Kenrad, Tung-Sol, National Union, De Wald, Regal, Automatic and General Motors.

* AUTOMATIC CUSTOM-BUILT RADIOS for Plymouth, Ford, Chevrolet and many others, always in stock. We carry a complete stock of HI-FIDELITY and SOUND EQUIPMENT. Send us your requests. We also carry a complete line of popular makes of Radio tubes at 50/10% discount. Also many other special purpose and transmitting tubes, and all electronic parts and equipment at lowest prices. Send us a list of your requirements for prompt quotations.
* Terms: 20% with order. Balance COD. All prices FOB. NEW YORK Warehouse. Minimum order \$5.00.
* Write for our latest price list and Hi-Fi Catalog to Dept. RE-7

STAN-BURN RADIO and ELECTRONICS CO.
(C.B.S. THEATRE BLDG.)
1697 BROADWAY • NEW YORK 19, N.Y.

SPEAKER RECONING

Complete line Cones, Spiders, Rings and Voice Coils. Custom Built Voice Coils. Low prices. Write for Parts List and Reconing information.
WESTERN ELECTRONICS CO.
Dept. A
3164 West Colfax Denver 4, Colo.

SUBSCRIBERS

If you're moving, please don't forget to send us your address as it appears on the copy of the magazine, including the numbers shown beside your name, as well as your new address.

If we receive this information before the 20th of the month, you will continue getting the magazine without interruption.

Your cooperation will be most helpful and greatly appreciated.

The New TELE-MATIC TWO-SET COUPLER

TOP PERFORMANCE . . . LOWEST COST

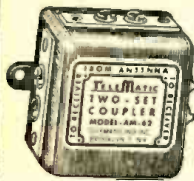

The Mini-Coupler outperforms couplers selling at many times its price!

Only \$3.50 List
(full trade discount)

- 2-stage transformer (inductive coupling)
- Compact, 2" x 2" x 1 1/2", fits anywhere
- Screw Terminals
- Minimum inter-set coupling
- No dummy load required for single-set operation

Available at Leading Jobbers
Send for FREE booklet on TV INTERFERENCE



IT'S TERRIFIC! GREYLOCK'S BIG NEW BARGAIN FLYER



JUST OUT! for every RADIO & TV SERVICEMAN, AMATEUR, EXPERIMENTER, TECHNICIAN

Shop the NEW GREYLOCK Bargain Flyer #200-1 and save a bundle of DOLLARS!

Typical Greylock Values: Picture Tube Specials

10BP4.....\$12.00	14CP4.....\$16.80
12LP4.....\$14.40	18RP4.....\$19.20
14BP4.....\$16.80	16KP4.....\$19.20

F.O.B. NYC.

Full 1-year Guarantee from date of Purchase.

FREE — Big 68-page GREYLOCK 1953 CATALOG "The essential Buying Guide" of the Radio & TV Industries — free to all purchasers from our new Bargain Flyer

GET YOUR FREE COPY TODAY!

GREYLOCK
ELECTRONICS SUPPLY CO.
115 Liberty St., N. Y. 6
Phone BE. 3-0224

GREYLOCK ELECTRONICS Dept. C-7
115 Liberty St., N. Y. 6

Send FREE Bargain Flyer #200-1 at once to:

Name _____
Address _____
City _____ State _____

Obituaries

John J. Mucher, chairman of the Board and one of the founders of CLAROSTAT MANUFACTURING Co., Dover, N. H., passed away at his home in Dover.

Edwin I. Guthman, president and founder of EDWIN I. GUTHMAN & Co., Chicago, radio and TV components manufacturer, died in Chicago. He had been chairman of the Coil Section of RTMA.

Personnel Notes

... Jerry Kirshbaum, vice-president of Precision Apparatus Corp., was elected president of the SALES MANAGERS CLUB — Eastern Group. Robert D. Ferree, distributor sales manager of International Resistance Corp., is the new vice-president, and Walter Jablon, vice-president of David Bogen Co., was re-elected secretary-treasurer. B. L. Cahn, vice-president of Insuline Corp. of America, serves as director to the Executive Board of the Show Corporation for a two-year term, and Vinton K. Ulrich, manager of the National Union Renewal Sales Division, continues another year as director.

... Jerome E. Respass, J. Ronald Regnier, Henry Sears, Charles E. Saltzman, and Henry L. Shepherd, executives and directors of LAPOINTE ELECTRONICS, Rockville, Conn., were named to the newly formed Executive Committee of the company.

... Sarkes Tarzian, president of the Bloomington, Ind., company bearing his name, was elected president of the Bloomington Chamber of Commerce.

... Bruce Holmstrom was appointed advertising manager of TELEX, INC., St. Paul, Minn., headset manufacturer.

... David B. Tolins, Jr., joined JFD MANUFACTURING Co., Brooklyn, N. Y., in the new position of publicity director. He was formerly with Rocke International Corp.

... Robin S. Kersh, C. Swan Weber, Franklin L. Snyder, Bruce D. Henderson, and William C. Rowland, WESTINGHOUSE ELECTRIC CORP. executives, were elected vice-presidents of the corporation.

... V. E. (Vic) Wollang was appointed manager of distributor and export sales of OXFORD ELECTRIC CORP., Chicago. He had been doing sales co-ordination work with the company.

... Peter L. Jensen, president of JENSEN INDUSTRIES, Chicago, was honored with the presentation of a television set by officials of the Electronic Parts and Equipment Manufacturers. Mr. Jensen is celebrating his 50th anniversary in the sound industry.

... D. W. Gunn was appointed to the new post of assistant general sales manager of Radio Tube and TV Picture Tube Sales of SYLVANIA ELECTRIC PRODUCTS. He was formerly equipment sales manager and will continue his duties as manager of sales to Sylvania equipment accounts.

... Clyde Matthews joined the LINCOLN SCHOOL OF RADIO AND TELEVISION, New York City, as director of the Public Relations Department. He headed his own public relations firm formerly. END



L. Veltri, busy service-dealer of Westchester, N. Y., reports:

I SAVED \$940*
by making a \$59 INVESTMENT
in a Transvision
FIELD STRENGTH METER

* Says Mr. Veltri: "... The way I figure, in the last 6 months I saved that much money in installation time alone ..."



FIELD STRENGTH METER
Saves 50% of Installation Cost
Pays for itself on 3 or 4 jobs

NO TV SET NEEDED

Works from antenna . . .

Measures actual picture signal strength directly from antenna. Shows antenna orientation maxima. Compares gain of antenna systems. Measures TVI on all channels. Checks receiver re-radiation (local oscillator). Permits one man antenna installation.

PREVENT WASTE OF SERVICING TIME!

By checking antenna performance with the Field Strength Meter, the serviceman can determine whether the TV set or antenna, or both, are the source of trouble. Call backs are eliminated.

Wide range: Measures field strength from 10-50,000 microvolts. Has Fringe Area Switch for weak signal areas. 13 channel selector. Individually calibrated on every channel.

ADAPTABLE for UHF

Model FSM-2, for 110V AC only. Complete with tubes. Wt. 13 lbs. net \$59.

Model FSM-3B, for 110V AC and Battery Operation (all batteries and cables included). Wt. 22 lbs. net \$79.

Order direct from factory:

TRANSVISION INC., NEW ROCHELLE, N. Y.

FREE: Sample copy of "TV and Electronics Notes". Or send 50¢ for year's subscription.



10 DAY TRIAL

Buy and try this fine instrument for 10 DAYS. Then, if you wish, you may return it. Your purchase price less 10% (our cost of handling and re-packaging) will be promptly refunded.

TRANSVISION, INC.
DEPT. RE-7F NEW ROCHELLE, N. Y.

() Send me _____ Model FSM-2; _____ FSM-3B

() Enclosed find \$ _____ deposit. Balance C.O.D.

() Enclosed find \$ _____ in full.

I accept your 10 Day Trial terms.

Name _____

Address _____

City _____ State _____

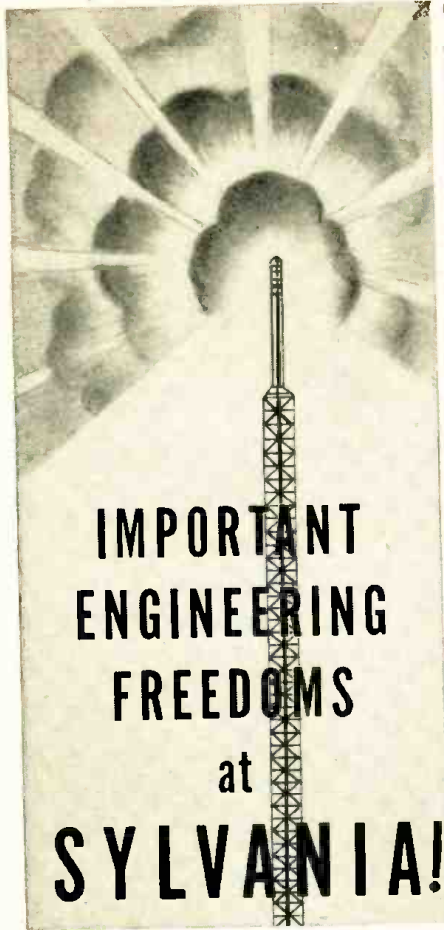

**IMPORTANT
ENGINEERING
FREEDOMS
at
SYLVANIA!**

All too often, farsighted engineering ideas and aims are held in check by everyday job requirements. Engineers made of the right "stuff" hold a secret yearning to break the shackles of today — to think in terms of the possibilities of tomorrow.

Sylvania thinks that way, too — has thought so for years. As a result, Sylvania encourages its engineers to pioneer, develop, follow through on their ideas, write and speak on their chosen subject to gain professional recognition.

If you are looking for a stimulating challenge that will last a lifetime — investigate the splendid career opportunities with fast-growing Sylvania.

Send your resume to:

JOHN C. WELD
Supervisor of Employment
254 Rano Street, Buffalo 7, New York

DONALD BRADLEY
Personnel Supervisor
70 Forsyth Street
Boston, Mass.



SYLVANIA
ELECTRIC PRODUCTS INC.
RADIO AND TELEVISION DIVISION
254 RANO STREET
BUFFALO 7, NEW YORK

JERROLD COMMUNITY-TV

Dear Editor:

I read with a great deal of interest the letter on pages 154 and 155 of your May issue regarding community-TV troubles.

The problem of system radiation—as your reader from West Virginia states—is one of the most serious problems affecting community-antenna systems from several standpoints.

1. If a community-antenna system radiates, it interferes with the television reception enjoyed by people in the community who have put up their own antennas. Therefore, if only for the sake of good public relations, it is essential that such interference be eliminated.

2. Such interference violates FCC regulations. Although up to now the FCC has been very co-operative in this regard in working with community antenna systems, there is no doubt that in the future—if many of these community-antenna systems do not correct their radiation problems—it will be necessary for the FCC to step in and take stringent action.

3. Radiation can be costly to the community-system operators. Many people deliberately place their receiving antennas within a few feet of the cable, and effectively "steal" signals from the system without paying either for connection or for monthly service.

It is necessary, therefore, in installing a community-antenna system to take all precautions to make certain that the system does not radiate.

There are three main sources of such radiation, namely, the amplifying and distribution equipment, the coaxial cables, and the television receivers. To do a thorough job and eliminate all radiation it is necessary to tackle the problem in respect to all three.

As for the equipment, there are several very important factors. First, with regard to my own company's apparatus, considerable engineering effort has been spent to develop the Jerrold amplifiers to a point where our equipment itself is "cold." In many of our earlier amplifiers we had a severe radiation problem, but the amplifiers being produced today do not radiate. A dipole placed within three feet of one of our community-antenna system amplifiers, turned up to rated output, will pick up less than 5 microvolts of signal.

However, when this equipment is installed in a weatherproof box on a pole it can still cause radiation problems unless great care is taken to prevent the r.f. signals from getting on the outer braid of the coaxial cable and also on the a.c. power line. To prevent the former, Jerrold has developed a feed-through coaxial fitting which grounds the outer sheath of the coax at the weatherproof box. To prevent radiation into the power line we have developed a power-line filter that is installed in every weatherproof box. This prevents r.f. signals from getting from the box to the outside through the power circuits.

100% Complete Bulk Tape Erasure on the Reel WITHOUT REWINDING!



The Magneraser®

The Perfect Magnetic Tape Eraser

Erase a recorded reel of tape — faster and more completely! No matter what tape recorder you are using, regardless of what brand of tape you are using, or how severely the tape is overloaded, the Magneraser will eliminate the recorded signal completely, and bring the background noise level 3 to 6 db. below that of brand new unused tape! No contact with erase heads — means less tape wear.



To operate, simply place the Magneraser on top of the reel of tape, and move it around as per instructions supplied. In a matter of seconds, the tape is wiped absolutely clean of all signal.

Size 4" Diameter, 2 1/2" High; Weight 2 1/2 lbs.; Operating Current 100/130 volts, 25/60 cycles; Power consumption 60 watts. Furnished with 8 ft. cord, molded rubber plug, and operating instructions. See your local dealer or write direct to factory.

List Price \$24.00
Professional Net Price **\$18.00**

ACCESSORIES DIVISION



**AMPLIFIER CORP.
of AMERICA**
398 Broadway, N. Y. 13, N. Y.



17" Table
\$122.68
Pl. \$12.27 Fed.
Excise Tax

Check these luxury features: Ultra sensitivity, dynamic range control. UHF adaptability, Duo power supply. Acoustic-clear Sound System... All in a beautiful Mahogany Finish Cabinet.

21" Console
\$164.95
Pl. \$16.50 Fed.
Excise Tax

20" Table
\$134.50
Pl. \$13.45 Fed.
Excise Tax

20" Console
\$149.95
Pl. \$15.00 Fed.
Excise Tax

ALSO AVAILABLE T.V. CHASSIS

All sets have full 1 yr. factory picture tube warranty, and standard 90 day RTMA parts warranty.
MAIL and Phone orders filled. \$25 deposit, Balance C.O.D., Shipping Charges Add'l.

STEPHEN SALES CORP.

45 Crosby St., N. Y. 12, Phone WO 4-1233

Dealer Inquiries Invited

\$3.00 FOR CARTOON IDEAS

RADIO-ELECTRONICS prints several radio cartoons every month. Readers are invited to contribute humorous radio ideas which can be used in cartoon form. It is not necessary that you draw a sketch, unless you wish.

Address
RADIO-CARTOONS, RADIO-ELECTRONICS
25 West Broadway, New York 7, N. Y.

EXPERIMENTERS SPECIALS



1 RPM MOTOR
115 volts, 60 cycles. Syn-
chron model 600. Use for
timing devices, models,
displays, gadgets, etc.
Stock No. RE-5
Price **\$2.95** each



AMPERE DEMAND METER
Stewart Warner-748A. In-
dicates, up to 20 Amperes
long time average current
draw. High time lag—
follows heating effect of
supply transformers. Use
to check motor and line
overload as well as peak
average demand. Indicating
average and average
peak recorder pointers.
Stock No. RE-119
Special @ **\$3.95** each



Redmond 6 Volt DC Motor
—An ideal small dc motor
for the experimenter. Oper-
ates from 6 volts dc at
3000 rpm. Requires 1.75
amperes for 1/100 horse-
power.
Stock No. RE-137
Special **\$2.95** each



RESISTOR KIT
A miracle of value. 99 car-
bon-on-ceramic deposited
resistors. German made.
10% tolerance. 11 popu-
lar values 100 ohms to
100 K. Assorted 1/2, 1/4,
and 1 watt. 9 compartment
hinged covered clear plastic
box.
Stock No. RE-1002
Special at only **\$1.98**

Drafting Machine—Manufactured by Star Watch
Case Co. as Vector Plotting Machine Type AN-
5748. Converted by us with two 18" arms, adjustable
angle between arms. Arms do not have ineb scales.
Ideal for electrical drafting. Stock #RE-249.
Price **\$27.50**

Write for free catalogue of Electronic, Aircraft, Hy-
draulic, and other equipment.
ELECTRO DEVICES, INC.
4-6 Godwin Ave. Paterson, N. J.

ENGINEERS!!!

OPEN THIS DOOR TO A
bright future!

- Test & Inspection Engineers
- Radar Field Eng.
- Electronics Engineers
- Components Engineers



TV Receiver Design Eng.

You're needed to work on: Radar, G.C.A., Mobile Radio, Auto Radio, Airborne Communication & Navigation Equipment, Television, Antennas, Microwave Equipment, Servo Mechanisms and Guided Missiles.

You benefit from high wages, modern, air-conditioned plant, paid vacations and holidays, group insurance and good chance for advancement. Housing immediately available in beautiful suburban and country areas that surround our plant. Write, wire or phone MR. L. H. NOGGLE, Dept. R.

Bendix Radio

DIVISION OF BENDIX AVIATION CORPORATION
BALTIMORE-4, MD. Phone: TOWSON 2200

When properly installed with feed-through fittings and power-line filters there is negligible (less than 2 microvolts at a distance of 3 feet) radiation from one of our weatherproof boxes, and, thus, from our equipment.

Radiation from the coaxial cables has been eliminated now by the use of the new double-shielded cable developed especially for us. This cable is Jerrold radiation-proof cable and is known as JRP-59 and JRP-11. The cable is made double-shielded and double-jacketed. To prevent radiation, though, even with this cable, a number of precautions must be taken. First, it is essential that all cables be properly terminated. Any improper termination can cause severe standing waves and radiation. Also, it is essential in making any connections to either the main or feeder cables to take great care that all fittings are tight, and that exposed fittings are thoroughly weatherproofed in order to prevent oxidation. Our field engineers have demonstrated on numerous occasions that a system completely double-shielded with no radiation can have excessive radiation that can be picked up as much as two or three hundred yards away from cables simply by loosening a cable fitting or two.

To reduce radiation still further, and also to comply with specifications of the telephone and power companies for grounding the system, it is essential that the messenger cable and the coaxial cable be grounded at regular intervals. Specifications call for grounding at least one out of every ten poles, but we have found that grounding more often—usually about one in every five poles—helps considerably.

The third source of radiation, the receivers themselves, is a very difficult one to handle. Most receivers have an open strip of 300-ohm lead between the antenna terminals on the back of the set and the tuner in the receiver. In installing a community-antenna system Jerrold specifications call for the use of coaxial cable right up to the antenna terminals of the receiver, in order to minimize any radiation from the system. However, on strong signals the short open lead between the terminals and tuner can radiate and possibly affect sets from 50 to 100 feet away in neighbors' homes. To minimize this, Jerrold has brought out a new matching transformer for 300 to 72 ohms.

To eliminate set radiation one of two methods is recommended. Either run the coaxial lead from the community-antenna system *directly to the tuner* and insert the matching transformer there, or install the matching transformer on the back of the receiver and put shielded loom over the 300-ohm lead in the receiver.

We will be happy to work with any community-antenna operators to solve their problems, in the over-all interest of making sure that community antennas serve a useful and not a nuisance function in their communities.

JERROLD ELECTRONICS CORPORATION
Milton J. Shapp, President
Philadelphia, Pa.

COMPARISON PROVES

EICO OFFERS

GREATEST V-O-M values!



GET the MOST for your money — *Before you buy.* see chart below!

World-renowned **EICO**
VOLT-OHM-MILLIAMMETERS

*#536 KIT \$12.90. Wired \$14.90
#526 KIT (with 1% multipliers)
only \$13.90. Wired \$16.90

VERIFY AT YOUR DEALER'S	EICO	Co. A	Co. B	Co. C	Co. D
	\$12.90 up (KIT)	All Over \$24.00			EICO price range
31 ranges?	YES	No	No	No	No
Full-size 3-inch meter?	YES	Yes	Yes	Yes	No
400 ua sensitivity?	YES	Yes	Yes	Yes	No
Zero to 1 v. range on both AC and DC?	YES	No	No	No	No
5000 v. range on both AC and DC?	YES	Yes	No	Yes	No
AC/DC sens. 1000 a /v.?	YES	Yes	Yes	Yes	No
DC and AC Current Ranges?	YES	No	No	No	No
In KIT and Wired Form?	YES	Wired Only	Wired Only	Wired Only	Wired Only
Lowest cost in the industry?	YES *See Above	No	No	No	No
		All over \$24.00			EICO Price range

Write for FREE Catalog MC-7 & name of local dealer. Prices 5% higher on West Coast.

ELECTRONIC INSTRUMENT CO., Inc.
84 WITHERS STREET, BROOKLYN 11, N. Y.



THE Case WITH A 1,000 APPLICATIONS

This all-purpose case is ideal for housing meters, controls and switches of all types.

Made of heavy molded block plastic with matching phenolic panel.

Easy to drill and saw.

Available in two sizes;
5-1/4" x 6-7/8" x 2-5/16"
3-3/4" x 6-1/4" x 2"

Ask your Distributor for Waldom's Plastic Case.

WALDOM ELECTRONICS INC.

911 N. Larrabee St., Chicago 10, Ill.

BARGAINS • BARGAINS • BARGAINS

BARGAINS • BARGAINS • BARGAINS

Famous
STEVE-EL
BRANDED

TUBES

All Brand New
Individually Boxed
FAR BELOW WHOLESALE COST!

1A7 .59	6AV6 .37	6F6 .49	6V8 .83	12BA7 .59	35Z5 .33
1B3 .53	6AS5 .49	6J5 .37	6W4 .45	12BE6 .46	50B5 .48
1P5 .56	6AO5 .37	6J6 .41	6W6 .52	25A7 .52	50C5 .47
1S5 .48	6AX4 .52	6L6G .89	6X5 .37	12SK7 .49	50L6 .48
1U4 .48	6BB .52	6SA .44	7C6 .42	25W .47	117Z3 .36
1U5 .48	6BA6 .45	6SA7 .52	7N7 .62	12SQ7 .42	
1X2 .63	6BC5 .58	6SG7 .49	7X7 .62	14AF7 .59	
3V4 .48	6BC7 .46	6SK7 .49	12A6 .48	12A7 .64	
5U4 .47	6BE6 .48	6SL7 .52	12AT7 .68	19T8 .78	
5W4 .46	6BG6 .1.21	6SN7 .54	12AT7 .68	25RQ6 .77	
6A8 .62	6BM6 .62	6SQ7 .42	12AU6 .48	25WA .48	
6B7 .51	6BJ6 .53	6S4 .44	12AV7 .67	25W4 .48	
6AG5 .62	6BN6 .74	6T8 .74	12AV6 .52	25Z6 .42	
6AK5 1.17	6C4 .34	6U6 .57	12AX7 .57	35C5 .47	
6AL5 .41	6CB6 .48	6U8 .78	12AZ7 .84	35L6 .47	
6AV6 .43	6CD6 1.21	6V6GT .46	12BA6 .46	35W4 .38	

SPECIAL
DISCOUNTS
50 Asst 15%
100 10%

WEN ELECTRONIC SOLDERING GUN

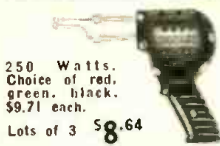

250 Watts.
Choice of red,
green, black.
\$9.71 each.
Lots of 3 \$8.64

AUTO SPEAKER

Special Sale!
Famous Brand.
All New!
5" 4 ohm
5 1/2" 4 ohm
6" 4 ohm
Any assortment of 10. 99c ea.

Minimum order \$3.00

3 SPEED Portable RECORD PLAYER



Complete with
amplifier,
speaker, bet-
manent needle.
Smart leather-
ette case

\$14.99

lots of 3

\$15.99 each

SUPREME TESTERS



Model 600
Tube & Set Tester \$89.95
Model 616
Tube & Battery Tester \$69.95

Another NEW STEVE-EL STORE!

166 Washington Street, New York City

Come in and get acquainted.

STEVE-EL ELECTRONICS CORP.

Dept. E-7 61 Reade St., New York 7, N. Y. Cortland 7-0086

LEARN

Television-Radio Electricity

REFRIGERATION-ELECTRONICS
IN THE GREAT
SHOPS OF **COYNE**

**TRAIN QUICKLY! OLDEST, BEST
EQUIPPED SCHOOL of ITS KIND in U.S.
Young and Older Men . . .**

Come to the Great Shops of Coyne in Chicago. Get practical training in TELEVISION-RADIO or ELECTRICITY—vital in Defense Program. Prepare now for a better job or better service rating.

START NOW—PAY LATER

You can finance most of your tuition, pay for it later in easy monthly payments. Special plan for men of Draft Age. Part time employment service available.

FREE BOOK Clip coupon for Big Free Illustrated Book. Indicate below, course that interests you. No salesman will call. Act NOW.

COYNE
ELECTRICITY ★ TELEVISION
RADIO ★ REFRIGERATION ★ ELECTRONICS

B. W. COOKE, Pres.
COYNE School
500 S. Paulina St., Chicago 12, Ill. Dept. B3-81H

Send FREE BOOK and full details on:

TELEVISION-RADIO ELECTRICITY

NAME _____

ADDRESS _____

CITY _____ STATE _____

TV ROTARY SWIVEL . . . Excellent for live, Chassis Servicing. Display. Sturdy built-bearing hardware. mid. between two 13" masonite turntables. . . . \$5.95

MS-32 HEADSET . . . leather head; less plush. . . . 2.49

MATCHING XEPR for HS-30 . . . original carton.59

T-44A MAGNETIC MIKE . . . original carton.59

ALNICO MAGNET KIT . . . Powerful Bar, Block. "U" Rod types. Kit of 10 asstd. . . . 1.98

CRYSTAL MIKE cartridges (British). Sensitive hi-imped. high output. 1" x 1 1/2". . . . \$1.98 (Other cartridges in stock. Write your needs)

HEARING AID AMPLIFIER chassis (2 tube). Make a real vest pocket radio or amplifier adding only simple tuner & phone. Ready-wired. with schematics for 2 or 3 tube set. (1/2" x 2" x 5"). Lens tubes & case. . . . \$2.49

SET OF 2 Sub-Min. Tubes for Above. 2.98

HEAR AID BONE CONDUCTION RECV (4K80A1 1/2) impd. magnetic type . . . reduced to \$1.98

! TUBE CLEARANCE SALE! . . . 90 DAY GUARANTEE! Standard brands, unsealed cartons. . . . \$2.34, 26, 27, 31, 41, 42, 55, 56, 89 or 9K7. ca. 29c 6K7 2.14, 110, 116, 5Y3, 5Y4, 6BT, 6C5, 6C5, 6W5, 6P3, 6Q6, 6SD7, 6SQ7, 6T7, 78 or 80 ea. 39c 11A, 5U4, 6A8, 6AG5, 6AU6, 6BE8, 6C10, 6F6, 6H6, 6J6, 6SA7, 6SK7, 6SN7, 6W4, 7A4, 12SN7, 45 or 77 . . . ea. 49c 1A7, 11C6, 11J14, 2A3, 2A6, 6A3, 6A6, 6BB, 6BQ6, 6SC7, 6SF5, 6SH7, 6T8, 6U7, 7AG7, 7B8, 7A7, 7C3, 7C7, 7F7, 7Y4, 12A6, 12AU7, 12AV7, 47, 50, 58 or 81 . . . ea. 69c

TUBE CARTONS . . . plain white; prices per 100 MIN (1 1/2" sq. x 2 1/2") . . . \$1.20; GT (1 1/2" sq. x 3 1/2") . . . \$1.45 MED (1 1/2" sq. x 4 1/2") . . . \$1.65; LARGE (2" sq. x 3") . . . \$3.98



! SUPER \$\$\$ SAVINGS! . . . with the New "Jumbo Radio-Electronics Parts Kit" Gold-Mine" of inventory odds & ends: coils, switches, resistors, condensers, wire, controls, etc. (valuing wt. 20 lbs.) . . . \$3.95

RADIO HARDWARE TREASURE . . . Full lb. Can of: Nuts, Screws, Washers, Lugs, etc. 89c
MOULDED BAKELITE CONDENSERS (Micaoid) . . . 20mmf.-2mf. 200-600V 50 asstd. . . . \$1.98 100 asstd. 2.98

! EVERYONE CAN DO IT! . . . SAVE \$\$\$ REPAIRING YOUR OWN SPEAKERS! . . . VOICE The LEOTONE precision-made CONE & VOICE COIL ASSEMBLIES, complete with Spider, Leads & Instructions. (Send all specs. or sample). Any 4" or 5" size . . . \$1.10; Any 6" size . . . \$1.80; Any 8" size . . . \$2.50; Any 10" size . . . \$3.00; ONLY CONE CENTERING SHIMS . . . 10 asstd. coded plastic in leather case39 SPEAKER CEMENT & SOLVENT . . . 3 oz. each with applicator brush89 (FREE "SPEAKER PARTS MANUAL" NOW READY)

"DIRECT FACTORY SPEAKER REPAIRS SINCE 1927" Min. Order \$3.00. 20% deposit req. on all C.O.D.'s. Please add sufficient postage—excess refunded.

LEOTONE RADIO CORP.
87 Day Street
New York 7, N. Y.

RADIO-TV SERVICING

RCA Test Equipment Division has prepared a 34-page booklet, *This Business of Radio and TV Servicing*, to help the service technician promote good management by suggesting certain business practices which apply particularly to the servicing field.

Among the subjects discussed are planning and using a Budget (with a section on control over salaries and wages); daily time report; supervision; training; customer relations; test equipment; materials; stock control; reducing other operating costs and expenses; and business forms. The book is profusely illustrated with pictures and charts, and interspersed with pages describing RCA test equipment.

Free on request to Commercial Engineering Section, RCA Tube Department, Harrison, N. J.

FILTER CATALOG

Cornell-Dubilier has completed a 12-page catalog describing more than 135 Quietone filters. Bulletin NB-148 lists filters for attenuating r.f. in industrial, marine, aircraft, automotive, military, and household equipment.

Descriptions include electric and physical characteristics, outline drawings, circuit diagrams, photographs, and charts.

Free on request from Cornell-Dubilier Electric Corp., South Plainfield, N. J.

STAINLESS WIRE

Allegheny Ludlum Steel Corp. has published a 20-page booklet of technical data on the application of stainless-steel wire. Tables of physical properties, corrosion resistance, and analysis are included. A discussion of the principle uses of stainless wire covers cold heading, weaving, heat-resisting belts, rope, spring wire, slide forming, welding, and winding.

Copies available from Advertising Department, Allegheny Ludlum Steel Corp., 2020 Oliver Bldg., Pittsburgh 22, Pa.

PARTS CATALOG

An 8-page, 2-color catalog of special TV and radio parts is available from Heppner. Ion traps, centering devices, electrodynamic speakers, ferrite-rod antennas, flyback transformers, and focus magnets are illustrated and described.

Request No. 20 from Heppner Mfg. Co., Round Lake, Ill.

MOBILE PRODUCTS

All mobile radiotelephone equipment and accessories made by Kaar are described in a new 8-page brochure. The equipment is for use in the 152-174-mc band, the 25-50-mc band, and the 1600-6000-ke band.

Free on request to Kaar Engineering Corp., Middlefield Road, Palo Alto, Cal.

RECORDER USES

G-E's Photoelectric Recorder Applications is a 12-page illustrated bulletin which describes applications of the recorder with seismology, psychology, textile, metals, fatigue, and research testing equipment.

Request Bulletin GEA-5536 from General Electric, Schenectady, N. Y.

END

SYNCHROS, SELF-SYNCHRONOUS DEVICES AND ELECTRICAL SERVO-MECHANISMS, by Leonard R. Crow. Published by The Scientific Book Publishing Co., Vincennes, Ind. 5 1/4 x 8 1/2 inches, 222 pages. Price \$4.20.

The purpose of this book is to present to the reader a comprehensive understanding of the theory and functional applications of synchros and other self-synchronous electrical devices. The book is illustrated with a large number of basic schematic diagrams and a few photographs of servomechanisms.

One chapter is devoted entirely to experimental set-ups and procedures with step-by-step listings of the observations which may be obtained and a review which explains the hows and whys of each observation.

The language is straight-forward and free from mathematical formulas, equations, and analyses. This work would make a good text for Armed Forces training courses, trade schools, and for the home student of electricity or electronics. Engineers and technicians will find it an introduction into the field which will make advanced texts easier to read and understand.—*RFS*

THE LIVING BRAIN, by W. Grey Walter. W. W. Norton & Co., Inc., 101 Fifth Avenue, New York, N. Y. 6 x 8 1/2 inches, 311 pages. Price \$3.95.

DESIGN FOR A BRAIN, by W. Ross Ashby. John Wiley & Sons, Inc., 440 Fourth Avenue, New York, N. Y. 6 x 9 inches, 260 pages. Price \$6.00.

A noted American psychologist-physiologist once remarked to a group

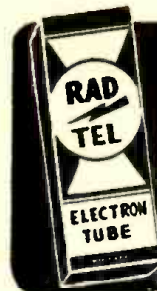
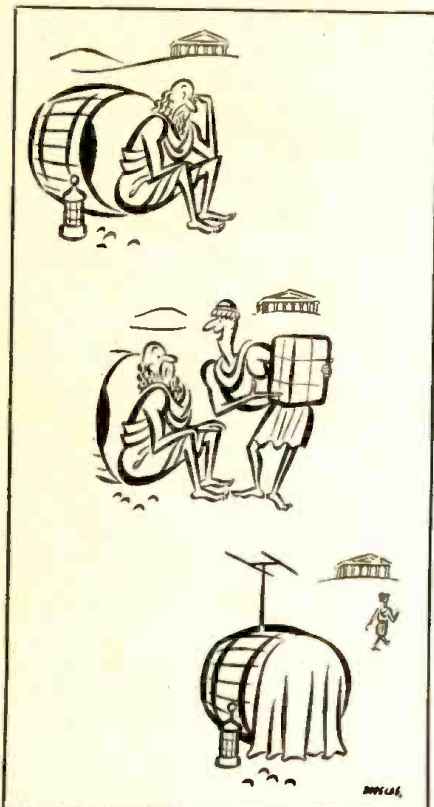

70% to 90% off list!
TOP TUBE BUYS

All Tubes Individually Boxed! Check this list for Rigidly-Tested, Full 1-Year Guaranteed Tubes.

Type	Price	Type	Price	Type	Price	Type	Price	Type	Price
1A5GT	.30	3V4	.47	6B6GG	1.25	6U6	.63	198GG6	.95
1A6G	.30	5U4G	.45	6B6	.46	6U4	.61	19C6	.70
1A7GT	.47	5V4	.73	6B6J	.39	6V6GT	.39	19C8	.70
1A85	.30	5W4	.50	6B7	.59	6W4GT	.44	19V8	.89
1B3	.65	5X4	.40	6BL7	.59	6W6GT	.44	24A	.63
1B5	.30	5Y3G	.32	6BQ6GT	.59	6X4	.37	25AV5	.77
1B7GT	.30	5Y3GT	.32	6BQ7	.95	6X5GT	.37	25BQ6GT	.62
1CSGT	.43	5Y4G	.35	6BZ7	.95	6X8	.61	25L6GT	.78
1E7	.29	5Z3	.46	6C4	.37	6Y6G	.48	25W4	.56
1G4GT	.24	6A7	.59	6C5GT	.39	7A4	.47	25Z5	.40
1G6	.30	6A8	.62	6C6	.58	7B7	.53	25Z6GT	.37
1M4G	.30	6AB4	.44	6C8G	.24	7C6	.44	25Z7	.45
1MSGT	.40	6AG5	.43	6CB6	.44	7C6	.40	27	.39
1M6	.24	6AJ5	.90	6CD6G	1.11	7E6	.30	32L7	.89
1J6	.24	6AK5	.75	6D6	.45	7X7	.70	35B5	.40
1L4	.46	6AL5	.38	6E5	.48	12A8	.61	35C5	.39
1L5	.51	6AQ5	.39	6F5GT	.39	12AL5	.37	35L6GT	.39
1N5	.46	6AR5	.37	6F6	.37	12AT6	.37	35W4	.37
1P5	.57	6ARS	.37	6F8G	.24	12AT7	.56	35Z4	.39
1Q5	.58	6A55	.50	6G6G	.52	12AU7	.38	35Z5GT	.37
1R5	.45	6AT6	.37	6H6GT	.41	12AV6	.39	36	.60
1S5	.39	6AU6	.38	6J5GT	.37	12AV7	.59	41	.42
1T4	.45	6AV5	.83	6J6	.52	12AX4	.48	42	.42
1T5	.53	6AV6	.37	6J7G	.43	12AX7	.48	43	.55
1U4	.45	6AX4	.53	6J8	.30	12AZ7	.69	45	.55
1U5	.39	6AX6G	.24	6K5	.47	12BA6	.38	45Z5	.49
1V	.60	6B4G	.64	6K6GT	.37	12BA7	.60	50B5	.39
1X2	.63	6BA5	.39	6K7	.44	12BD6	.45	50C5	.59
2A3	.70	6BA7	.57	6L5	.24	12BE6	.39	50L6GT	.41
2A4G	.24	6BC5	.44	6L6	.64	12BF6	.39	50V7	.50
2X2	1.50	6BC7	.34	6Q7	.45	12BH7	.63	53	.24
3A4	.45	6BD5GT	.59	6S4	.38	12BH7	.65	56	.24
3E5	.46	6BD6	.45	6S8	.53	12CB	.34	57	.58
3Q4	.48	6BE5	.39	6S4GT	.43	12CF6	.34	58	.60
3Q5GT	.49	6BF5	.41	6SD7GT	.41	12F5GT	.34	70L7GT	1.09
3S4	.46	6BF6	.37	6S5GT	.46	12J7GT	.34	75	.41
				6SG7GT	.41	12K7GT	.34	76	.44
				6SH7	.73	12S8	.70	77	.57
				6SJ7G	.41	12S4GT	.44	78	.47
				6SK7GT	.41	12S5	.50	80	.35
				6SL7GT	.41	12S6GT	.52	83	.68
				6SN7GT	.48	12S7	.44	85	.59
				6SN7GT	.52	12SK7GT	.48	89	.99
				6SQ7GT	.37	12SL7GT	.47	117L7	.37
				6SR7GT	.45	12SW7GT	.52	117Z3	.37
				6SS7	.42	12S07	.47	807	.99
				6T8	.56	12SR7	.49	1274	.99
				6U4	.60	14W7	.30	2050	1.85
				6U5	.44	14W7	.30	6113	1.00

Rad Tel TUBE CO.

"Integrity Is Our Chief Asset"
Phone: Essex 5-2947

TERMS: A 25% deposit must accompany all orders—balance C.O.D. All shipments F.O.B. Irvington warehouse. Orders under \$10—\$1.00 handling charge. Subject to prior sale. Don't Delay... Order Today!

115 COIT ST.
Dept. RE-7
IRVINGTON II, N. J.

WANTED
To Manufacture and Sell—
Electronic Accessory Items

For FACSIMILE—RADIO—TELEPHONE—TELEVISION

Note—We have a special immediate need of Facsimile Equipment for Intra-Office and Plant use.

We NEED: Selective Radio Signal Transmitter and Selective Radio Signal Receiver to locate doctors in hospitals.

Receiver weight should be 5-10 ounces.

Will furnish capital if necessary to complete desirable developments.

Can we represent you with Sales & Service?
What have you to offer?

RADIO ENGINEERING COMPANY
Inquirer Building
Philadelphia 30, Pennsylvania

ENJOY 3 COLOR TELEVISION FILTER SCREEN NOW

Changes dull eye-straining black-white pictures into beautiful color tones. Seconds to attach. Send \$1.50 for 16" or under, \$2 size 17", \$2.50 size 20", \$3 size 21", \$4.00 size 24". Money back Guarantee if not delighted.

Zingo Products, Johnstown 13, New York

THE NEW DYNATRACER*

Designed To
DOUBLE YOUR PROFITS
CHECK SETS IN THE HOME
Makes TV servicing easier, faster and more accurate at LOW COST.

Trace signals and voltages—Locate defective components instantly.

Requires No Additional Equipment

"DYNATRACER" is a portable self-powered quality instrument that is used under actual operating conditions. "DYNATRACER" is designed to trace signals through any video, sound, sync, F.C. vertical or horizontal sweep circuit and instantly isolate trouble to a stage or component.

ADDED FEATURE:—
With a flick of the switch, the "DYNATRACER" will also trace voltages and instantly locate open, shorted or intermittent condensers, resistors, coils, speakers, transformers, etc. Complete Instructions and Trouble-Shooting Methods Enclosed. Satisfaction guaranteed. Century instruments are quality engineered for accurate and efficient servicing.

CENTURY ELECTRONICS CO.
8509-21st Ave., Dept. 104, Brooklyn 14, N. Y.

\$4.95
PPD. OR COD PLUS POSTAGE WITH CHARGES

Please mention RADIO-ELECTRONICS when answering advertisements

ADVERTISING INDEX

NEED TUBES?

Barry for FAST-DELIVERY on all types. Tubes Individually cartoned and carry Standard RMA GUARANTEE.

Tube Orders Over \$8.00 with full remittance Prepaid To You in USA.

All tubes INDIVIDUALLY retested (not just spot-checked) on our Hickok Mutual-Conductance Tube-Tester to insure you 100% perfect merchandise. For your maximum money's worth, buy in full confidence from TUBE-SPECIALISTS. Here is a partial listing of our large stocks. You may order types not listed at approx. same savings. Phone Rector 2-2552 for fast delivery. Only famous brands shipped. Try us and be convinced.

0A2	.90	6BN6	1.30	12SA7	.75
0B2	1.00	6BZ7	1.20	12SF5	.70
0C3/VR105	1.00	6BZ9	1.49	12SG7	.80
0D3/V150	1.05	6C4	.47	12SJ7	.69
024	.85	6C6	.58	12SK7	.70
1A7GT	.85	6CD6-G	1.50	12SL7GT	.65
1A4	.90	6H6	.60	12SN7GT	.70
1AX2	1.10	6H6-M	.60	12SQ7GT	.83
1B3GT	.85	6F8-G	.85	12SR7	.60
1L4	.60	6CG6-G	.85	14A7/12B7	.90
1NSGT	.87	6J5GT	.45	14F7	.90
1N23A	2.60	719	.60	14Q7	.90
1N34	.60	6J7	.70	14Q7-A	44.00
1N34A	.73	6K6GT	.59	19B6-G	1.95
1N48	.75	6K7-M	.70	19B7	1.30
1N54	.75	6K7-M	.49	25A	1.25
1R5	.85	6L5-G	1.19	25BQ6GT	1.00
1S5	.85	6L6-G	1.19	25L6GT	.89
1T4	.60	6L6-GA	.80	25Z5	.67
1U4	.88	6L6-M	.80	25Z5	.67
1U5	.70	6M7-M	.80	25Z6	.67
1V2	.67	6N7-M	.80	25Z6	.67
1X2-A	.90	6Q7GT	.98	35B5	.40
2C43	1.30	7F7-M	1.20	35C5	.40
2E24	2.50	55RGT	.76	35L5	.69
2X2	.45	55A7GT	.88	35W4	.53
3A4	.59	55C7	.72	35Y4	.73
3AP1	9.00	55C7	.72	35Y4	.73
3BP11	9.50	55H7	.69	42	.65
3C23	9.70	55H7	.69	42	.65
3C24/24-G	1.35	65K7GT	.62	50A5	.90
3D6/1299	.50	65L7GT	.70	50C5	.85
3E29/829B	8.90	65N7GT	.68	50L6GT	.55
3Q4	.90	65Q7GT	1.30	617Z3	1.00
3R GT/G	.99	6T8	.87	117Z6	1.00
3S4	.60	6T8	.85	250-TH	17.00
3V4	.85	6V6GT	.55	274-A & B	2.95
5AW4GT	1.35	6W6GT	.85	304-TH	7.75
5D21	9.70	7A7	.65	304-TL	8.75
5R4QY	1.25	8X4	.85	311A	6.50
5U4Q	.55	6X5GT	.88	371-B	.85
5V4-G	.42	6Y6-G	.82	725-A	5.50
5Y3GT	.42	6Y6-G	.82	725-A	5.50
6A8	.88	7A7 (XXL)	.79	805	3.25
6A8B	.75	7A7	.69	814	3.50
6A87	.98	7A8	.80	866-A	1.55
6AC7	.70	7B5	.69	1613	.75
6AF4	1.40	7C7	.80	1616	.75
6AG5	.85	788	.80	1622(6L6M)	1.95
6A07	1.20	788	.80	1625	.35
6AH8	1.00	7C6	.69	1626	.35
6A15	1.30	7C7	.80	1626	.35
6AK5	.70	7F7-M	.90	1632	.70
6AL5	.50	7H7	.72	2050	1.35
6AM5	2.25	7H7	.90	2050	1.35
6AQ5	.78	7Y4	.87	5514	4.50
6A08	.60	7Y4	.76	5514	4.50
6AT8	.60	7Y4	.76	5514	4.50
6AXGT	.95	12A8	.55	5646	1.25
6A08	.59	12AT8	.55	5646	1.25
6AY4	.59	12AT8	.55	5646	1.25
6AX4GT	1.00	12A8	.55	CK-5744	2.25
6AX5GT	.70	12A8	.55	CK-5888	.08
6B8E	.70	12A7	.49	5910	.95
6B8C	.75	12AX7	.85	8020	.78
6B8G-G	1.15	12A8	.55	8020	.78
6R8G-O	1.85	12B6	.57	9003	.98
6B8H	.60	12B7	1.15	9004	.98
6B8B	.85	12B7	1.20	9008	.25
6B8T	1.45				

CBS-HYTRON CATHODE-RAY PICTURE TUBES
First Quality in factory-sealed cartons. Full Year Warranty Card on each tube. Remember! No seconds; no re-bulbs! Prices include Fed. Tax.
C.R. Tubes via Express Collect.
73P4 .18.75 16P4 .26.75 17NP4 .25.50
10P4A .21.00 16P4A .30.00 20CP4A .38.50
12LP4A .21.50 16P4 .30.00 21EP4A .38.95
14CP4 .24.00 17BP4A .24.75 21FP4A .36.00
16AP4 .31.00 17CP4 .25.25 21FP4A .36.00

- Buy your SELENIUM RECTIFIERS and associated XFMRs, Chokes & Capacitors Direct and Save!
- See last month's ad for list and prices. Write for quotes on special reorders. Very fast delivery.
- New 2 piece tube cartons—Holds 100 GT Type Tubes. Box up your Bulk Tubes . . . 35¢ ea.

- Ceramic 3" Pedestal Insulator W/Steel MTG. Base 20¢ ea.

- Well known 12 volt Vihrajack—NEW—350 Volts @ 125 MA W/top brand vibrator. Only \$8.95 each

Western Electric Filter Chokes. Brand New. Hermetically sealed. 8 hy @ 300 ma-.75 ohms D.C. resistance 13 KV Test Ins. Only \$5.00

- Western Electric Steel deluxe Comm'l Grey Panels—10 1/2" x 19". Brand new. . . \$1.00 each

W.E. Push-to-Talk F3 Hand sets—Brand new with 4 Cond. Coiled cords. Model F-3-EW-3 W-built-in Switch . . . \$9.75 ea.

WANTED: For cash (or swap) your excess lots of new XMTG. Special-Purpose. Radio and TV Tubes. Send list with details for our offer.

CARTER DYNAMOTORS
100 Volts out. @ 170 MA. from your 8 Volt battery. Compact. In original CARTER CARTONS. . . \$28.00

Trim. Model 100 "Featherweight" Headsets \$49.50 & Band. New. in orig. mfr.'s carton. . . \$49.50



1368 Liberty Street, N. Y. 6, N. Y. Rector 2-2562
Terms: 25% with order, balance C.O.D.—Send a few cents for postage—All merchandise guaranteed. F.O.B. N.Y.C. *Please, minimum order \$2*.

Allied Radio Corp.	13
American Electrical Heater Co.	30
American Electronics Co.	105
American Phenolic Corp.	86
American Television and Radio Co.	63
Amplifier Corporation of America	108
Arkay Radio Klls. Inc.	99
Audel Publishers	78
Aviation Service Supply Co.	78
Barry Electronics	112
Bell Telephone Labs.	6
Bendix Radio	109
Blonder-Tongue Labs.	67
Brooks Radio and TV Corp.	103
CBS-Hytron (Div. of Columbia Broadcasting System)	69
Capitol Radio Engineering Institute	7
Centralab—Div. of Globe Union	75
Century Electronics Co.	111
Channel Master Corp.	20, 21
Cleveland Institute of Radio Electronics	61
Columbia Wire and Supply Co.	98
Commissioners of Electronics	99
Concord Radio	89, 104
Cooper Industries	101
Coyne Electrical and TV Radio School	110
Crescent School	82
Davis Electronics	105
DeForest's Training, Inc.	9
Deco Radio (Div. of General Motors Corp.)	79
DuMont Labs., Inc. Allen B.	Inside Front Cover
Edlie Electronics	72
Electro Devices	109
Electro-Voice, Inc.	18
Electronic Instrument Co., Inc.	22, 109
General Cement Mfg. Co.	97
General Test Equipment	105
Good, Inc. Don	93
Graylock Electronic Supply Co.	107
Heath Co.	57, 58, 59, 60
Hudson Specialties Co.	98
Hughes Research and Development	84
Indiana Technical School	80
Instructograph Co.	82
Jensen Industries	80
Jerry Specialty Co.	78
Jones and Laughlin Steel Corp.	74
K. W. Sales Co.	88
Kirk, Jim	99
Krylon, Inc.	14
LaPointe Electronics, Inc.	8
Leotone Radio Corp.	110
Littlefuse, Inc.	92
Mallory and Co., Inc. P. R.	83
Mattison Television and Radio Corp.	96
McGraw-Hill Book Co.	100
Merit Coil and Transformer Co.	10
Mosley Electronics	84
Moss Electronic Distributing Co.	81
National Electric Products Corp.	64, 65
National Radio Institute	3
National Schools	5
Opportunity Adlets	72
Perma-Power Co.	102
Phillips Tube Co.	93
Precise Development Corp.	70
Precision Apparatus Co., Inc.	16
Pre-Probe Co.	91
Progressive Electronics	87
Pyramid Electric Co.	Inside Back Cover
RCA Institutes, Inc.	19
RCA Victor Division (Radio Corporation of America)	Back Cover
Rad-Tel Tube Co.	111
Radelco Manufacturing Co.	82, 100
Radiart Corp.	77
Radio City Products	92
Radio Engineering Co.	111
Radio Receptor Co., Inc.	88

RADIO SCHOOL DIRECTORY PAGE 113

Candler System Co.	
Indiana Technical College	
Indianapolis Electronic School	
Milwaukee School of Engineering	
RCA Institutes, Inc.	
Tri-State College	
Valparaiso Technical Institute	
Western Television Institute	

Radio-Television Training, Inc., Assn.	17
Rauland Corp., The	73
Raytheon Manufacturing Co.	11
Regency Div. (I.D.E.A., Inc.)	72
Rider, Inc., John F.	94
Rinehart Books, Inc.	82
Rose Co.	105
Sams and Co., Inc., Howard W.	18, 96
Scala Radio Co.	94
Schott Co., Walter L.	71
Science Fiction	103
Service Instruments Co.	109
Seymour Electronics	91
Shure Brothers	109
Simpson Electric Co.	85, 91
Skyline Manufacturing Co.	66
Sprayberry Academy of Radio	55
Stan-Burn Radio and Electronics Co.	108
Stephen Sales Co.	108
Steve-El Electronics Corp.	110
Sylvania Electric Products	15, 108
Tab	114
Tallen Co., Inc.	72
Technical Appliances Co.	102
Telematic Industries, Inc.	106
Television Communications Institute	85
Television Hardware Mfg. Co.	97
Transvision, Inc.	106, 107
Trlo Manufacturing Co.	95
Triplett Electrical Instrument Co.	101
Tung-Sol Electric Co.	12
Turner Co., The	16
Utah Radio Products Co.	80
Waldom Electronics, Inc.	109
Wells Sales	112
Western Electronics Co.	106
Wholesale Radio Parts Co., Inc.	92
Windsor Electric Tube Co.	102
Xcelite Inc.	99
Zingo Products	111

Radio-Electronics does not assume responsibility for any errors appearing in above Index.

WHEN YOU ORDER

WELLS COMPONENTS...

HERE'S WHAT YOU GET

- IMMEDIATE DELIVERY FROM STOCK (in any quantity)
- FINEST QUALITY OF FAMOUS BRANDS
- GENERALLY LOWER PRICES
- RETURN PRIVILEGE FOR FULL CREDIT IF NOT SUITED TO YOUR REQUIREMENTS

The valuable service Wells provides to the industry is being used by many of our greatest manufacturers as a matter of course.

Our vast stock (the world's largest) may contain just the components you need to fill urgent orders — at a substantial savings in time and cost.

- ADEL CLAMPS • ANTENNAS, Insulators, Mast Sections • BINDING POSTS • BLOWERS • CABLE ASSEMBLIES • CHOKES • COILS • CONDENSERS Oil Filled, Bathub, Hearing Aid, Transmitting Micas, Silver Micas, Ceramic, Variable, Trimmer • CRYSTALS • FILTERS • FUSES & MOUNTINGS • GENERATORS • GROUND RODS • HEADSETS • I.F. COILS • JACKS • JACK BOXES • KEYS, Telegraph KNOBS • LAMPS • LORD MOUNTS • LUGS MOTORS & BRUSHES • PLUGS • RECTIFIERS Selenium, Copper Oxide, Meter, Diode • RESISTORS—All Types • SELSYNS • SOCKETS • SWITCHES Aircraft, Micro, Switchettes, Toggle • TIMERS • TUBING—Flexible • TUNING SHAFTS • TRANSFORMERS All Types • VIBRATORS • WALKIE TALKIES

DYNAMOTORS

OVER 100,000 NEW DYNAMOTORS IN STOCK!

DM 32A — DM 53A — PE 86 — PE 101C
DM 33A — D 101 — PE 94, etc.

Large quantities of brushes for all types of dynamotors and motors.

Write us for quotations. Advise us your requirements.

A complete Signal Corps stock number listing of items in our stock. Write for listing No. 5G-200. (For government agencies and contractors only.)

Manufacturers and distributors—write for new Condenser Catalog C-10 now available.

Write, Wire, Phone Your Requirements all phones: SEEley 8-4143



833 W. CHICAGO AVE., DEPT. Y, CHICAGO 22, ILL. RADIO-ELECTRONICS

of radiomen that it was easier to discuss brain and nerve functions with electronic engineers than with medical men "because the electronics men understand what you're talking about."

The authors of these two books have the distinction of being psychologist-physiologists who have developed electronic devices to further their study of the human brain. Walter is the inventor of *Machina speculatrix* (embodied in the electronic turtles Elmer and Elsie which were described in many popular magazines), and *Machina docilis*, an electronic device which can learn from experience. Ashby is the inventor of the *homeostat* ("The Electronic Brain," RADIO-ELECTRONICS, March, 1949).

The two books are devoted entirely to the human brain, and demonstrate forcibly that the radio-electronic worker is indeed in an excellent position to understand modern works on the brain. Ashby's book in particular uses terms and approaches much more familiar to the vocabulary and methods of electronics than of traditional physiology. Chapter headings include: Dynamic Systems, Stability, Parameters, Step-functions, Ultrastability, Fully Connected Systems, and others only slightly less reminiscent of the field of electronics. Walter's book is less mechanistic, but its heavy reliance on electroencephalography, its schematic diagrams of model nerves and of *M. speculatrix* and *M. docilis*, make an understanding of electronics almost absolutely essential for its full appreciation.

Either or both of these books will be interesting reading for the electronic technician who is interested in the workings of his own communications system.—FS

BLUE BOOK OF ELECTRICAL ESTIMATING, by George L. Sherlock. Published by Estimating Handbooks Associates, DeKalb, Ill. 5 x 8½ inches, 120 pages (plus 120 pages for notes). Price \$7.75.

This reference manual is needed by electricians, architects and executives who must estimate electrical costs accurately. It contains information gathered over many years by an expert in this line. It shows how to estimate time and cost of 2,000 different wiring jobs, including installation of conduit, motors, outlets, panels, etc. Carpentry, excavating, drilling and concrete work are covered.

The book outlines each type of job and describes the factors and conditions relating to each. Examples are given. These are followed by charts which show the time required for installing various sizes of conduit, motor, duct, and other equipment. Different columns show the cost per unit if the labor rate is known.

The book is printed in blue ink. Text and charts appear only on right-hand pages. The left-hand pages are ruled and reserved for special notes. A handy and comprehensive index pinpoints the type of job desired.—IQ

END

Unlimited Opportunities in
RADIO ENGINEERING

DEGREE IN 27 MONTHS

Complete Radio Engineering course including Telev., U. H. F. and F. M. Bachelor of Science Degree also in Mech., Civil, Elect., Chem., and Aero. Eng.; Bus. Adm., Acct. Extensive campus, modern buildings, well equipped labs. Low cost. Prep courses. Personalized, practical instruction. Founded 1884. Placement service. Growing shortage of engineers. Prepare now. Approved for Korean vets. Enter September, January, March, June. Write for catalog.



TRI-STATE COLLEGE

2473 College Ave. ANGOLA, IND.



RCA INSTITUTES, INC.

A service of Radio Corporation of America
350 West 4th St., New York 14, N. Y.

OFFERS COURSES IN ALL TECHNICAL PHASES OF RADIO, TELEVISION, ELECTRONICS

Approved for Veterans
Write Dept. RC-53 for Catalog



TV REPAIRMEN MAKE TOP MONEY!

In just 39 weeks, you can get complete TV service training! Streamlined course gives you all essentials for a good job as service technician. Graduates in great demand; jobs are plentiful in this growing field. Other courses in electronics, radio operation and maintenance. Day or evening classes; modern equipment. Opportunity for employment in local industry.

Write for Catalog 111 Today

INDIANAPOLIS ELECTRONIC SCHOOL
312 E. Washington, Indianapolis 4, Ind.

GET INTO TV SERVICING

Send for free 24-page illustrated booklet which tells you how to become a successful TV technician. America's leading TV servicing school offers you a specialized training program that omits non-essential math & design theory. You concentrate on radio & TV servicing only. You get professional training & experience right in our fully-equipped shops & laboratories. Send for this booklet today. Write Dept. E-73. No obligation—no salesman will call. Approved for Veterans

WESTERN TELEVISION INSTITUTE
341 W. 18th St. Los Angeles 15, Calif.

RADIO ENGINEERING DEGREE IN 27 MONTHS

Intensive, specialized course including strong basis in mathematics and electrical engineering, advanced radio theory and design, television. Modern lab. Low tuition. Self-help opportunities. Also B.S. degree in 27 months in Aeronautical, Chemical, Civil, Electrical, and Mechanical Engineering. G.I. Gov't approved. Enter September, December, March, June. Catalog.

INDIANA TECHNICAL COLLEGE
157 E. Washington Blvd., Fort Wayne 2, Indiana

GET INTO ELECTRONICS

You can enter this uncrowded, interesting field. Defense expansion, new developments demand trained specialists. Study all phases radio & electronics theory and practice: TV; FM; broadcasting; servicing; aviation, marine, police radio. 18-month course. Graduates in demand by major companies. H.S. or equivalent required. Begin Jan., March, June, Sept. Campus life. Write for catalog.

VALPARAISO TECHNICAL INSTITUTE
Dept. C Valparaiso, Ind.

CODE SENDING RECEIVING SPEED

Be a "key" man. Learn how to send and receive messages in code by telegraph and radio. Commerce needs thousands of men for jobs. Good pay adventure, interesting work. Learn at home quickly through famous Candler System. Qualify for Amateur or Commercial License. Write for FREE BOOK. **CANDLER SYSTEM CO.** Dept. 3-11, Box 928, Denver 1, Colo., U.S.A.

BECOME AN

ELECTRICAL ENGINEER



Bachelor of Science Degree in 36 months.

Major in Electronics or Power. Now, prepare for a career in these rapidly expanding fields.

This school will prepare you to become an engineer, technician or service man. Previous military, academic or practical training may be evaluated for advanced credit.

Enter Both Radio and Television

In 12 months you can attain the Radio-Technician's certificate. An added 6 months course qualifies you for the Radio-TV Technician's certificate and the Degree of "Associate in Applied Science." The Technician's course is the first third of the program leading to a Bachelor of Science Degree in Electrical Engineering with a major in Electronics.

Also offered: 12-month Radio-TV service course; 12-month Electronics or Electro Technician Courses; 6-month Electrical Service Course and 3-month refresher and general preparatory classes.

Terms Open April, July, Oct., Jan.

Famous for its Concentric Curriculum. Faculty of specialists. 50,000 former students. Annual enrolment from 48 states and 23 overseas countries. Non-profit. 50th year. Courses approved for Veterans.



MILWAUKEE SCHOOL OF ENGINEERING

MILWAUKEE SCHOOL OF ENGINEERING
Dept. RE-753, 1025 N. Milwaukee
Milwaukee 1, Wisconsin

Send: Free 160-page Catalog describing Electrical Engineering Courses; Booklet on Careers in Radio-TV.

I am interested in _____ name of course _____
Name _____ Age _____
Address _____
City _____ Zone _____ State _____
If veteran, indicate date of discharge _____

RM29
For Field Phone Use by Remote Control of Transceiver. Simple 2 wire 15 mile Operation. Includes talk listen & ringing Circuits good for TV antenna installation. NEW \$10.95

RM53
Remote Control Xmitter or Intercom. Least Hertz Plus Cable, Includes Condensers, Switches, Jacks & Matching Xfmr. Mike to Grid. Line to Grid & Line to Line. In 7 1/2 x 4 1/2 Metal Box. NEW \$14.25

RELAY SALE
SPST mini size 115VAC 2A etc. .98¢; 3 for \$7.75
SPDT mini size 115VAC 2A etc. .98¢; 3 for \$7.75
SPDT 24V DC. 5A CTS 98¢
SPNO 115 V AC. 18A CTS \$2.99
SPDum. 115V AC. 18A CTS \$2.99
DPDT . SPNO. 12 DC. 10 A CTS \$2.25; 2 for \$3.75
DPDT Clear S/S 5010. Detail House 18-28V 2AMP Cts. Nitrogen Std. New Stock SPECIAL. \$2.98

AUDIO COMPONENTS
GE RPK041 Phono Cart. \$4.49
GE RPK050 Triple Play Cart. 7.98
GE RPK051 Triple Play Cart. 7.98
Pickup Arm & Xtal HI-Output 2.98
PM 12" GE 51201 Hi-Fidelity Speaker. 18.98
PM 8" Blue BT18-1 PermLux.13.00
PM 5" Speaker God Tone.1.98
PM 10" Hi-Fi Speaker & Amp.1.98
Tweeter 10 Watt 40-20000 cy.19.98
Crystal Mike & Cable.2.98
Crystal Mike Cartridge (Lapel Type).3.98
Crystal Mike Cart. Ceramic Wetproof.3.98

HI-FI AUDIO AMPLIFIER
Model 1150 HI-FI 10 watt. less than 2% distortion-response -1DB to 20000 CPS. HUM-70DB. separate bass & treble controls. 6 impedance selector switch, built in equalizer pre-amps for GE Cartridge. Tubes: 2-6X4, 2-6V6, 5Y3GT \$29.95
Hi-Fi SPECIAL \$47.00
Model 1150 & GE 51201. Hi-Fi amplifier & Speaker SPECIAL. \$47.00

AUDIO AMPLIFIERS READY TO GO
Model 305PM 5 Watt Amp. as pictured above. Features Mike & Phono Inpts. W/Sepr. Gain Controls. Latest Computerized Tone Control. Complete 100% 50 mhz 350VDC FT. \$14.98
Model 100PO Phono CS Phonograph Broadcasts Through Your Radio. No Direct Hookups. W/Tubes. \$14.98
Model 302PA 3 Tube Phono Amp. Ideal for Custom Building Your Phonograph. W/Tubes. \$4.98

CTD FRESH STOCK 59¢ WHILE THEY LAST
Your selection of 10 at 59¢ each or smaller quantity at indicated prices.
ELECTROLYTIC CONDENSERS
2X 20MFD 450VDC. 69¢; 3 for \$1.95
3X 15MFD 450VDC. 79¢; 3 for \$1.95
3X 20MFD 400VDC. 79¢; 2 for \$1.29
80MFD 450VDC. 79¢; 2 for \$1.29
25MFD 450VDC. 79¢; 2 for \$1.29
45MFD 450VDC. 79¢; 2 for \$1.29
2X 20MFD 450VDC. 69¢; 3 for \$1.95
50 mfd 350VDC FT. 5 for \$1.00
30-15-10 mfd 250VDC. 5 for \$1.00
10-20mfd 250-250VDC. 5 for \$1.00
20-20mfd 250-250VDC. 5 for \$1.00
WRITE FOR ADDITIONAL LISTINGS

SELENIUM RECTIFIERS
We specialize in Rectifiers, Power supplies to specifications. Immediate delivery.
Current 18/14 30/28 54/40 130/100
(cont.) Volts Volts Volts Volts
1AMP 2.15 3.50 7.50 15.00
2AMP 2.20 3.60 5.40 10.50
4AMP 4.25 7.95 12.95 25.25
6AMP 4.75 8.95 13.95 27.75
10AMP 6.75 12.75 20.00 40.00
12AMP 8.50 16.25 25.50 45.00
20AMP 12.25 23.50 35.00 70.00
30AMP 20.00 38.50
Full-Wave Beam Rectifier Trans. in Kit Form. All 115V/60 cy Inputs up to 14VDC at 12 amps. \$23.98
up to 28VDC at 12 amps. \$27.95
up to 28VDC at 48 amps. \$129.00

RECTIFIER XFORMS
18-12-0 CT-0 12-18V 4amp. \$8.75
18-12-0 CT-0 12-18V 12amp. 16.75
18-12-0 CT-0 12-18V 25.75
18 Volt 3AMP. \$1.98; 3 for \$5.49

BATTERY CHARGER RECTIFIER
10-0-10V (CT) 100 Amp. fan cooled. Replace your old inefficient sulfated rectifier w/new selenium type. SPECIAL. \$11.98

DC POWER SUPPLY
0 to 12 Vdc/2 Amp. variable DC supply. un-cased and completely built-inpt. 115V/60 cy. Stable LAI supply. Remote adjustment. D.C. plating, battery charging, model railroads, includes voltage or speed control and center off reversing sw. Ideal for "HO" locomotives.
RECTIFIER CHOKES
4 Amp 1/2 Hy 1 Ohm \$7.95
12 Amp .01 Hy 1 Ohm \$14.95
24 Amp .004 Hy .025 Ohm \$29.95

FEDERAL RECTIFIER KIT
"FEDERALS"-All Purpose Selenium Rectifier Kit. You can make 4 different Rectifiers 1/2 Wave/FW CT or Bridge. 8 Plates Rated 18V 12Amp each. All Hardware & Lugs & Instructions. SPECIAL \$19.99

CHROME VANADIUM SPEED DRILLS
1 1/2" Dia. 6 Flute. Chrome Vanadium SPEED STEEL. Top Quality for Machinists for all purpose use. Standard Full Length 1 1/2" to 2 1/2" Drill Index. With Mount \$9.69
12 PCS SET 1/16" to 3/4" \$34.49
60 PCS DRILLS #1 to #60 with Index. \$29.98
1/4" SPEED ELECTRIC DRILL W/Jacobs Wormgear Chuck & 20 Pcs Drills & Index. "TAB" SPECIAL \$22.00
1/2" SPEED ELECTRIC DRILL W/Jacobs Wormgear Chuck & 20 Pcs Drills & Index. "TAB" SPECIAL \$39.00

"TAB" THAT'S A BUY

RHEOSTATS
Check these newly reduced prices
6 ohm 25W Model H. 1.49; 2 for 2.49
15 ohm 25W w/knob. 1.49; 2 for 2.49
20 ohm 50W Model J. 1.98; 2 for 3.50
60 ohm 50W w/knob. 2.25; 2 for 3.98
100 ohm 50W Model K. 1.98; 2 for 3.50
200 ohm 25W Model D. 1.49; 2 for 2.49
250 ohm 25W Model E. 1.19; 3 for 2.98
300 ohm 25W Model F. 2.98; 2 for 5.00
350 ohm 5000 ohm Slotted w/hat. 25 watt. 79¢; 3 for 2.00

SOCKET ASSEMBLIES
PILOT LIGHT SOCKET, Bayonet with 1/2 Jewel. As shown. 25¢; 5 for \$1.25
PILOT LIGHT SOCKET 1/2 Jewel. Hi-Polish Finish. "TAB" Special. 59¢; 10 for \$4.50
1" PILOT, 1" LIGHT SOCKET, w/115V 3 Watt Bulb. 79¢

CU-24/ART 13 LOADING CONDENSERS
Three 25MFD 10,000V condenser Pwr. AIT 13 NEW \$2.49
Hi-VOLTAGE Ceramic Condensers. Excellent minimum plate rated as follows
185-200-280-100 MMF P/O shown
AIT 13 51.79 2000-47A \$1.98
11 BRAND NEW \$1.98

INFRARED SNOOPSCOPE
SEE-IN-DARK TUBE
Image-Converter Tube. High sensitivity simplifies design 2 dia. 185 mhz. 1700 data & tube. \$4.98; 2 for \$9.49
SNOOPSCOPE PWR SUPPLY
280VDC 35MA Using Double-Crkt. Transformer. Rectifier, Sockets, Resistors, Capacitors and Diagram. \$6.98

FL-5 FILTER
Range or voice. Filters 1020 cycle. Shunt. Excellent CW Work. 59¢; 2 for \$1.00
BANDPASS FILTER
Sharp Cutoff HIQ. Cased & Shunted. Excellent CW Work. 59¢; 2 for \$1.00
UTCR31. 1024 1500 Cts. \$1.50; 2 for \$2.50

TOOL KIT
My Buddy. 8 pcs. tool kit. 5 interchangeable screw driver blades. 1 steel tube Hule & Cutters. As shown. \$1.49
Screw Drivers. Assorted High Quality Magnetized. Tool Steel Hammer. Unbreakable Plastic Handles. 12" & smaller. Incl Phillips 1/2" & 3/8" bits. \$1.25
6 Pcs Set. as above. \$1.10
Write for Tool Sheet

REDUCED METER SPECIALS
0-5 MA DC Tuning Meter \$12.50
0-100 VAC 1/2" 1.49; 2 for 2.49
0-30 VDC "AN" Type \$2.95; 2 for 5.00
0-15 VAC GE 2 1/2" RND 800V \$1.29
0-150 VAC WSTGHS/2 1/2" RND 60 eye. \$4.49
0-150 VAC 25-125V/3 1/2" RND \$3.98
0-1 MADC GE 3 1/2" RND BRL CSD. \$3.99
0-1 MADC WSTGHS/3 1/2" RND \$4.49
0-50 Microamps Weston 30 1/2" \$13.98
0-500 MADC 3 1/2" RND Triple/221 4.98
0-2-20 VAC 2 1/2" RND \$1.98
0-120 MA RF 3 1/2" RND Weston 301. 9.95

TELEVISION COMPONENT BUYS
Horiz Def Output & Hivoltz xmr 51M RCA 211T4, for 15"-18" picture tubes. \$1.98
Hivoltage Condenser 300MFD 50KV. \$1.98
Hivoltage Condenser 500MFD 50KV. \$6.99

TUBES

0A2	.95	6B7	1.69	12M7	1.29	CK539DX	2.19
0A3 VR75	1.04	6B8GT	1.20	12BY7	1.35	CK541DX	1.99
0A4	1.37	6B9	1.67	12CA6	1.25	CK542DX	1.99
0B3 VR90	1.09	6C8B	.63	12DA7GT	.69	CK544DX	.99
0C3 VR105	1.15	6C8B	.63	12EQ7	.80	CK546DX	.80
0D3 VR150	1.15	6C8B	.63	12F6GT	1.29	CK547DX	1.98
1R1 9016	.81	6C8B	.63	12F7GT	.49	CK571AX	2.49
1X2A	1.29	6M6	.60	12G7	.83	CK573AX	3.49
1X2B	1.29	6M6	.60	12H7	1.49	CK574AX	3.49
1X2C	1.53	6J4	6.66	12J7GT	.59	CK1027	2.98
5R4QV	1.55	6J6	.63	12K7	.72	CK1089	2.98
5R4GV	1.75	6J6GT	.63	12L7GT	.72	CK5672	1.25
5R4G	.43	6K4A	6.45	12M7GT	.75	CK5676	1.29
5Y3GT	.43	6L6	2.09	12N7GT	.63	CK5678	1.29
6AG5	1.39	6L6C	1.35	19T8	1.58	5B7	5.49
6AR5	1.39	6L6CA	1.35	19Y8	1.82	CK5702	3.49
6AU6	1.49	6L6CAY	2.29	25B06GT	1.19	CK5703	1.29
6AM6	1.22	6SA7GT	.63	25L6GT	.89		
6AR5	1.22	6S7GT	.90	25S6GT	.99		
6AK5	.74	6SD7GT	.60	25Z6GT	.99	1N21A	1.55
6AK6	1.05	6SF5	.77	28D7	.95	1N21C	21.50
6AL7	1.29	6S7GT	.72	35T6GT	.69	1N23	1.25
6AL7GT	1.29	6S7	.72	50L6GT	.69	1N22	1.25
6AN5	2.90	6SH7	.61	80	.80	1N23A	2.20
6AQ6	.81	6SK7GT	.70	82	1.19	1N23B	2.25
6AQ6GT	2.98	6SL7GT	.69	82V	1.39	1N23C	2.25
6AR5	2.98	6SNT	.69	81	1.45	1N26	8.75
6AS5	.79	6SQ7GT	.63	83V	1.79	1N27	1.55
6AS5GT	4.65	6SR7	.65	84-624	1.59	1N34A	9.00
6AT6	.63	6S7	.65	117N7GT	2.49	1N35	1.69
6AU6GT	1.10	6V6	1.39	117F7GT	1.33	1N38A	1.15
6AV5GT	.59	6V6GT	1.39	117G7	1.49	1N41	8.99
6AW6	1.89	6X4	1.98	CK5011	2.20	1N45	1.45
6B4C	1.23	12A1K5	.59	CK5024K	1.49	1N46	.69
6B6A	1.27	12A1L5	.75	CK5034K	1.49	1N48	4.00
6B6C	1.27	12A1L5	.75	CK5036K	1.49	1N48	.55
6B6C	.63	12A7	.72	CK5038K	1.49	1N51	1.55
6B6C	1.65	12A8U	.72	CK5099K	1.71	1N52	1.39
6B6D	.83	12A7V	.49	CK5144K	1.69	1N54	.89
6B6E	.98	12A7V	.49	CK5224K	1.29	1N54A	1.15
6B6E	.98	12A7V	.49	CK5254K	1.29	1N54B	1.15
6B6E	.98	12A7V	.49	CK5264K	1.29	1N58	1.19
6B6E	.65	12A7V	.49	CK5284K	1.49	1N58A	1.15
6B6E	.65	12A7V	.49	CK5294K	1.71	1N61	2.07
6B6E	.65	12A7V	.49	CK5324K	1.89	1N63 K63	2.49
6B6E	.65	12A7V	.49	CK5334K	1.29	1N63	1.15
6B6E	.65	12A7V	.49	CK5344K	1.29	1N69	.99
6B6E	.65	12A7V	.49	CK5364K	.99	1N86	1.15
6B6E	.65	12A7V	.49	CK5374K	3.04	1N87	1.15
6B6E	.65	12A7V	.49	CK5384K	.98	1N88	1.15

THAT'S "TAB" THAT'S A BUY
DEPT. 7RE 111 LIBERTY STREET NEW YORK 6, N. Y. U.S.A.

OIL CONDENSERS WAREHOUSE CLEARANCE SALE
5MFD 150VDC. 95¢; 2 for \$1.50
5MFD 330VAC 1000VDC. 55¢; 4 for 1.95
5MFD 400VDC. 1.50; 3 for 4.00
10MFD 400VDC. 95¢; 2 for 1.50
3MFD 330VAC 1000VDC. 49¢; 3 for 1.29
2x2MFD 600VDC. 1.50; 3 for 4.50

BATHTUB SIDE TERMINALS
1MFD 600VDC. 39¢; 3 for 1.00
1MFD 200VDC. 1.05; 5 for 4.50
2x1MFD 400VDC. 49¢; 5 for 2.00
WHITE FOR ADDITIONAL LISTING

MICA CONDENSERS

Fig.	MFD	WVDC	PRICE
A	.033	600	69¢; 5 for 2.29
A	.02	600	69¢; 5 for 2.29
A	.015	600	56¢; 3 for 1.20
B	.01	1000	49¢; 3 for 1.25
B	.01	1200	49¢; 3 for 1.25
H	.008	600	39¢; 3 for 1.00
A	.005	2500	1.19; 3 for 2.95
B	.003	1200	58¢; 3 for 1.25
A	.002	2500	98¢; 3 for 2.25
A	.001	1200	58¢; 3 for 1.25
C	.00075	5000	2.98; 2 for 5.00
C	.0007	3000	89¢; 3 for 2.39
A	.0004	2500	58¢; 3 for 1.00
C	.0001	3000	89¢; 3 for 2.00
C	.0001	3000	89¢; 3 for 2.00
C	.00005	3000	39¢; 4 for 1.00

866A KIT and XFORMER
2 Tubes. Sects. xmr. 1 1/2" 60V Inpt. Output 10V/100mA. \$4.98
DIODE PROBE TUBE
Unexcelled for No-Loss VHF testing. Ultra-sensitive subminiature envelope. New. \$2.50; 5 for \$11.95
w/data VPO2

TOGGLE SWITCHES
SPST GE 2 1/2" 29¢; 4 for 5.98
SPDT BRLT CSD Momentary. 49¢; 5 for \$2.00
DPST BRLT CSD 15A/125V. 89¢; 3 for \$2.50
DPST 20A/250V. 89¢; 3 for \$2.50
DPDT Center Off. 75¢
SPDT Momentary Both Sides. 85¢
DPDT Center Off. 85¢; 6 for \$5.00

STORAGE BATTERIES
36 Volt Willamette Stand NEW. 5.02
Designed Portable Equip. Models. 98¢; 4 for \$3.92
(4) 36V Batteries w/Lead. 2.98
2V 20AH w/Lead & accl. 3.59
6V 40AH Willamette. 3.25
6V 40AH Battery. 3.25
6V 40AH Battery. 6.98
6V 40AH Battery. 9.25
We ship nationwide.

CIRCUIT BREAKERS
Heinmann Magn. Bkrs. Amps. 7, 7.7, 8, 12, 15, 20, 30, 35, 40, 80, 180 & 250. \$1.69; 10 for \$15.98
Sq. 1/2, 3/4, 1, 1 1/2, 2, 3, 4, 5, 6, 8, 10, 15, 20, 25, 30, 35, 40, 50, 60, 75, 100, 150, 200, 250, 300, 350, 400, 500, 600, 750, 1000, 1500, 2000, 2500, 3000, 3500, 4000, 5000, 6000, 7500, 10000, 15000, 20000, 25000, 30000, 35000, 40000, 50000, 60000, 75000, 100000, 150000, 200000, 250000, 300000, 350000, 400000, 500000, 600000, 750000, 1000000, 1500000, 2000000, 2500000, 3000000, 3500000, 4000000, 5000000, 6000000, 7500000, 10000000, 15000000, 20000000, 25000000, 30000000, 35000000, 40000000, 50000000, 60000000, 75000000, 100000000, 150000000, 200000000, 250000000, 300000000, 350000000, 400000000, 500000000, 600000000, 750000000, 1000000000, 1500000000, 2000000000, 2500000000, 3000000000, 3500000000, 4000000000, 5000000000, 6000000000, 7500000000, 10000000000, 15000000000, 20000000000, 25000000000, 30000000000, 35000000000, 40000000000, 50000000000, 60000000000, 75000000000, 100000000000, 150000000000, 200000000000, 250000000000, 300000000000, 350000000000, 400000000000, 500000000000, 600000000000, 750000000000, 1000000000000, 1500000000000, 2000000000000, 2500000000000, 3000000000000, 3500000000000, 4000000000000, 5000000000000, 6000000000000, 7500000000000, 10000000000000, 15000000000000, 20000000000000, 25000000000000, 30000000000000, 35000000000000, 40000000000000, 50000000000000, 60000000000000, 75000000000000, 100000000000000, 150000000000000, 200000000000000, 250000000000000, 300000000000000, 350000000000000, 400000000000000, 500000000000000, 600000000000000, 750000000000000, 1000000000000000, 1500000000000000, 2000000000000000, 2500000000000000, 3000000000000000, 3500000000000000, 4000000000000000, 5000000000000000, 6000000000000000, 7500000000000000, 10000000000000000, 15000000000000000, 20000000000000000, 25000000000000000, 30000000000000000, 35000000000000000, 40000000000000000, 50000000000000000, 60000000000000000, 75000000000000000, 100000000000000000, 150000000000000000, 200000000000000000, 250000000000000000, 300000000000000000, 350000000000000000, 400000000000000000, 500000000000000000, 600000000000000000, 750000000000000000, 1000000000000000000, 1500000000000000000, 2000000000000000000, 2500000000000000000, 3000000000000000000, 3500000000000000000, 4000000000000000000, 5000000000000000000, 6

PORTRAIT OF PROGRESS



1945
9,000 square feet



TODAY
137,000 square feet

Pyramid's unparalleled growth reflects the truth of the statement: In capacitors, your best bet, your best buy, is



PYRAMID

PYRAMID ELECTRIC COMPANY
NORTH BERGEN, NEW JERSEY

Free literature on request



Partners

... for extra profit

EVERY successful service call automatically results in *extra profit . . . in dollars and cents . . . and in increased "customer confidence."* You can insure *both* kinds of profit by coupling your good name in partnership with another . . . *RCA.*

Wherever you go, the familiar RCA emblem serves as your silent partner, helping you to sell your service and build repeat business. And the superior quality of RCA Receiving Tubes and Kinescopes protects your profit by cutting those costly call-backs caused by premature tube failures.

Helping you to safeguard your reputation is a vital, everyday service of RCA Tubes. And that protection is yours at no extra cost.



"Sign up" for Success

Identify yourself with RCA! Ask your *RCA Tube Distributor* today how you can qualify for a Dealer Identification Plaque displaying your name. He'll give you full details on the big RCA Sales Promotion Program.



RADIO CORPORATION of AMERICA
ELECTRON TUBES

HARRISON, N. J.